

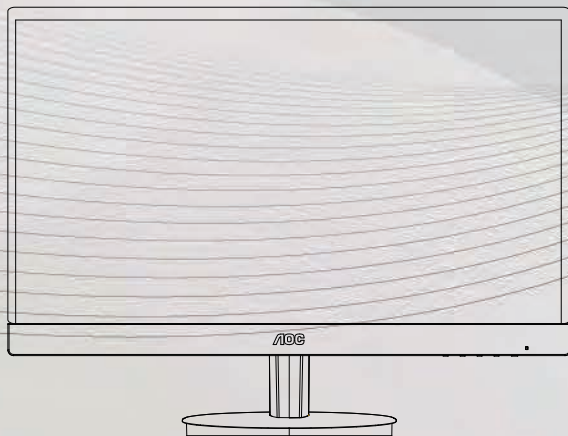

LCD Monitor User Manual LED Backlight
I2269V_{WM}/I2269V_W/I2369V
I2369V_M/I2769V/I2769V_M



Safety.....	3
National Conventions.....	3
Power	4
Installation.....	5
Cleaning.....	6
Other.....	7
Setup	8
Contents in Box	8
Setup Stand & Base	9
Adjusting Viewing Angle.....	10
Connecting the Monitor.....	11
Adjusting	12
Setting Optimal Resolution	12
Windows Vista	12
Windows XP	14
Windows ME/2000.....	15
Hotkeys.....	16
Using"Mobile High-Defintion Link"	17
OSD Setting.....	20
Luminance	21
Image Setup	23
Color Setup.....	25
Picture Boost	27
OSD Setup	29
Extra	31
Exit.....	33
LED Indicator	34
Driver	35
Monitor Driver	35
Windows 7	35
Windows Vista	39
Windows XP	41
Windows 2000	44
Windows ME.....	44
i-Menu.....	45
e-Saver	46
Screen+	47
Troubleshoot.....	48
Specification.....	49
General Specification.....	49
Preset Display Modes.....	50
Pin Assignments	51
Plug and Play.....	53
Regulation.....	54
FCC Notice	54
CE Declaration of Conformity	54
WEEE Declaration	55
Service.....	57
Warranty Statement for Europe	57
Warranty Statement for North & South America (excluding Brazil).....	59
Congratulations	62

Safety

National Conventions

The following subsections describe notational conventions used in this document

Notes, Cautions, and Warnings

Throughout this guide, blocks of text may be accompanied by an icon and printed in bold type or in italic type. These blocks are notes, cautions, and warnings, and they are used as follows:



NOTE: A NOTE indicates important information that helps you make better use of your computer system.





CAUTION: A CAUTION indicates either potential damage to hardware or loss of data and tells you how to avoid the problem.





WARNING: A WARNING indicates the potential for bodily harm and tells you how to avoid the problem. Some warnings may appear in alternate formats and may be unaccompanied by an icon. In such cases, the specific presentation of the warning is mandated by regulatory authority.

Power

 The monitor should be operated only from the type of power source indicated on the label. If you are not sure of the type of power supplied to your home, consult your dealer or local power company.

 The monitor is equipped with a three-pronged grounded plug, a plug with a third (grounding) pin. This plug will fit only into a grounded power outlet as a safety feature. If your outlet does not accommodate the three-wire plug, have an electrician install the correct outlet, or use an adapter to ground the appliance safely. Do not defeat the safety purpose of the grounded plug.

 Unplug the unit during a lightning storm or when it will not be used for long periods of time. This will protect the monitor from damage due to power surges.

 Do not overload power strips and extension cords. Overloading can result in fire or electric shock.

 To ensure satisfactory operation, use the monitor only with certified computers which have appropriate configured receptacles marked between 100 - 240V ~, Min. 5A

 The wall socket shall be installed near the equipment and shall be easily accessible.

Installation

! Do not place the monitor on an unstable cart, stand, tripod, bracket, or table. If the monitor falls, it can injure a person and cause serious damage to this product. Use only a cart, stand, tripod, bracket, or table recommended by the manufacturer or sold with this product. Follow the manufacturer's instructions when installing the product and use mounting accessories recommended by the manufacturer. A product and cart combination should be moved with care.

! Never push any object into the slot on the monitor cabinet. It could damage circuit parts causing a fire or electric shock. Never spill liquids on the monitor.

! Do not place the front of the product on the floor.

! If you mount the monitor on a wall or shelf, use a mounting kit approved by the manufacturer and follow the kit instructions.

! Leave some space around the monitor as shown below. Otherwise, air-circulation may be inadequate hence overheating may cause a fire or damage to the monitor.

See below the recommended ventilation areas around the monitor when the monitor is installed on the stand:

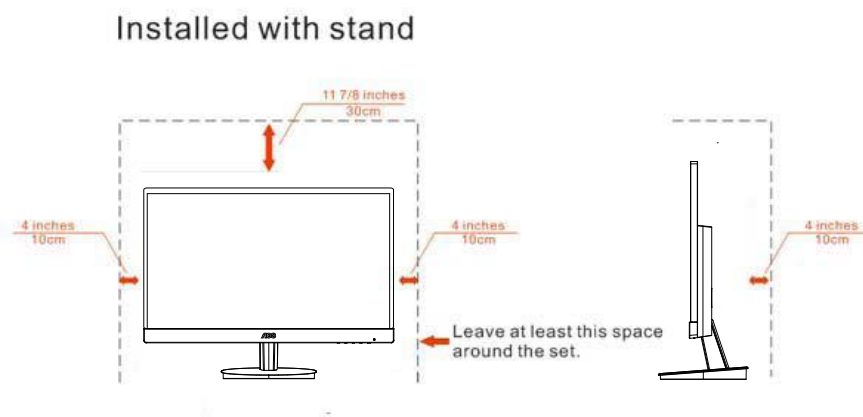

Cleaning

 Clean the cabinet regularly with cloth. You can use soft-detergent to wipe out the stain, instead of strong-detergent which will cauterize the product cabinet.

 When cleaning, make sure no detergent is leaked into the product. The cleaning cloth should not be too rough as it will scratch the screen surface.

 Please disconnect the power cord before cleaning the product.

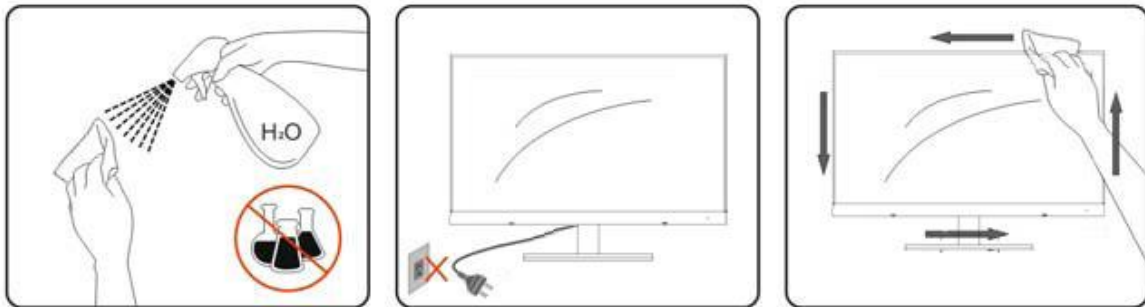

Other

 If the product is emitting a strange smell, sound or smoke, disconnect the power plug IMMEDIATELY and contact a Service Center.

 Make sure that the ventilating openings are not blocked by a table or curtain.

 Do not engage the LCD monitor in severe vibration or high impact conditions during operation.

 Do not knock or drop the monitor during operation or transportation.

Setup

Contents in Box

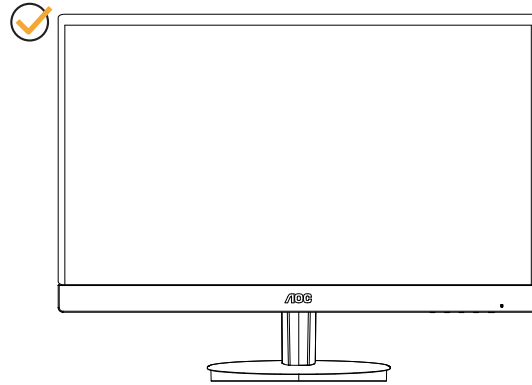

Monitor



CD Manual



Base

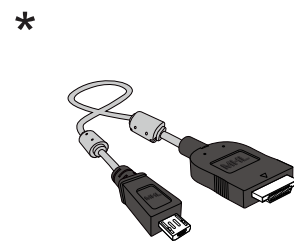

MHL Cable



Power Cable



Analog Cable



DVI Cable



DP Cable



Audio Cable

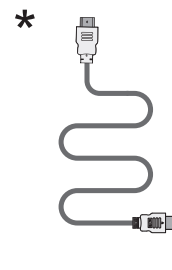

HDMI Cable

* Not all signal cables (VGA, DVI, MHL and HDMI cables) will be provided for all countries and regions. Please check with the local dealer or AOC branch office for confirmation.

Setup Stand & Base

Please setup or remove the base following the steps as below.

Setup:

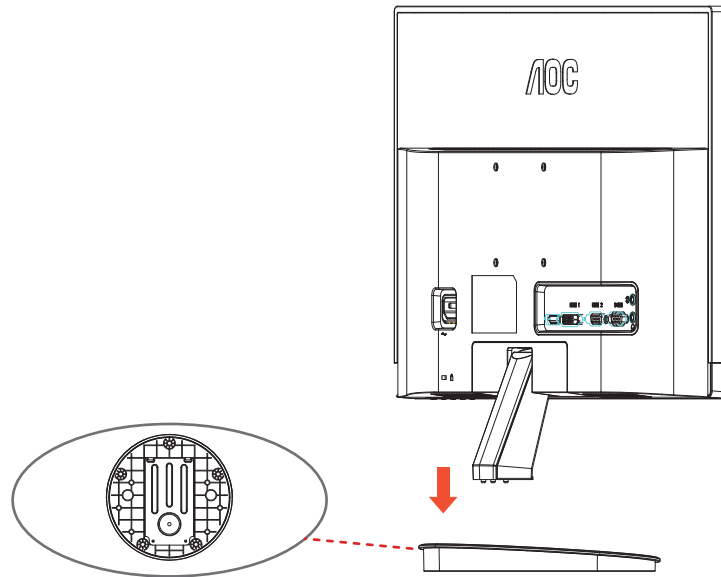

Remove:

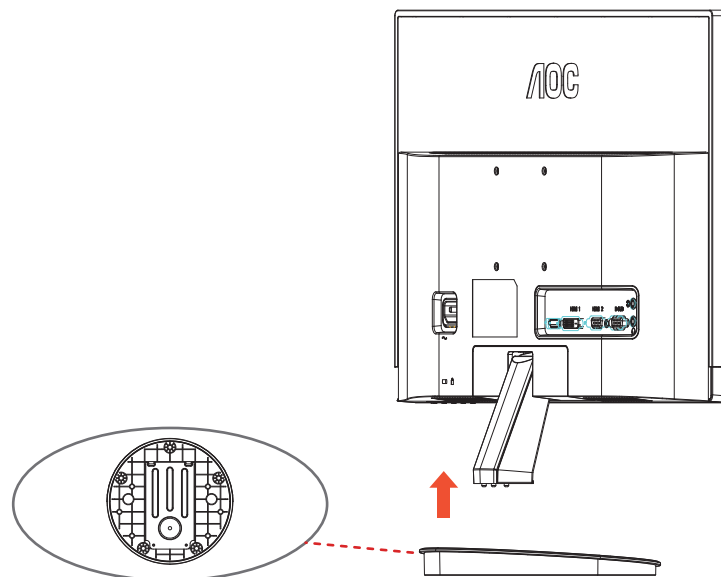

Adjusting Viewing Angle

For optimal viewing it is recommended to look at the full face of the monitor, then adjust the monitor's angle to your own preference.

Hold the stand so you will not topple the monitor when you change the monitor's angle.

You are able to adjust the monitor's angle from -5° to 23° .

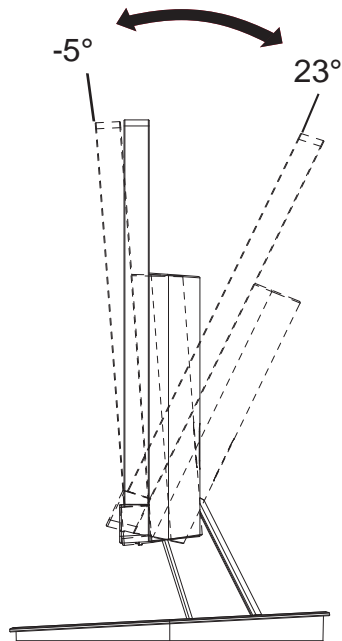

NOTE:

Do not touch the LCD screen when you change the angle. It may cause damage or break the LCD screen.

Connecting the Monitor

Cable Connections In Back of Monitor and Computer

I2269V_{WM}/I2369V_M/I2769V_M

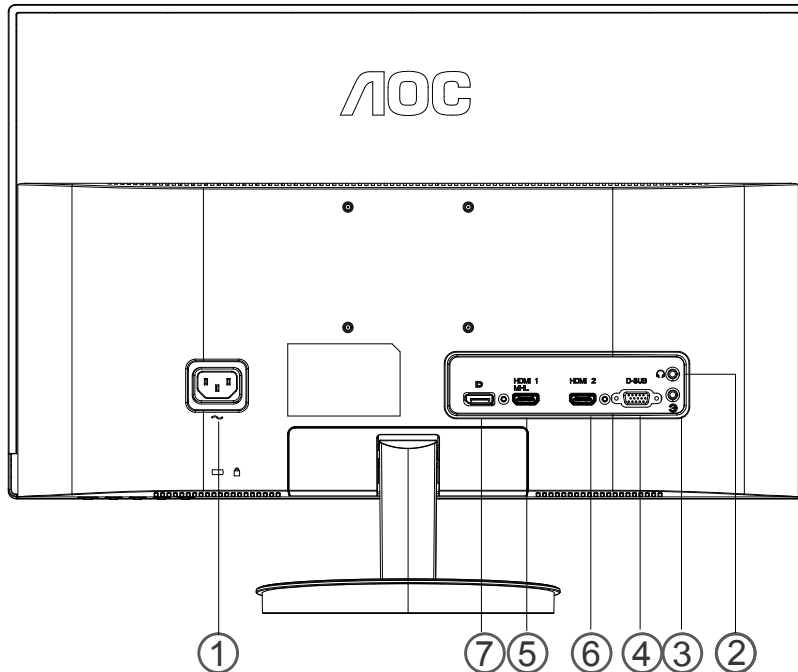

1. Power
2. Earphone
3. Audio port
4. D-Sub port
5. HDMI1/MHL port
6. HDMI2 port
7. DP port

To protect equipment, always turn off the PC and LCD monitor before connecting.

- 1 Connect the power cable to the AC port on the back of the monitor.
- 2 Connect one end of the 15-pin D-Sub/HDMI/MHL/DP port to the back of the monitor and connect the other end to the computer's D-Sub/HDMI/mobile MHL/DP port.
- 3 Turn on your monitor and computer.

If your monitor displays an image, installation is complete. If it does not display an image, please refer to Troubleshooting.

Connecting the Monitor

Cable Connections In Back of Monitor and Computer

I2269Vw/I2369V /I2769V

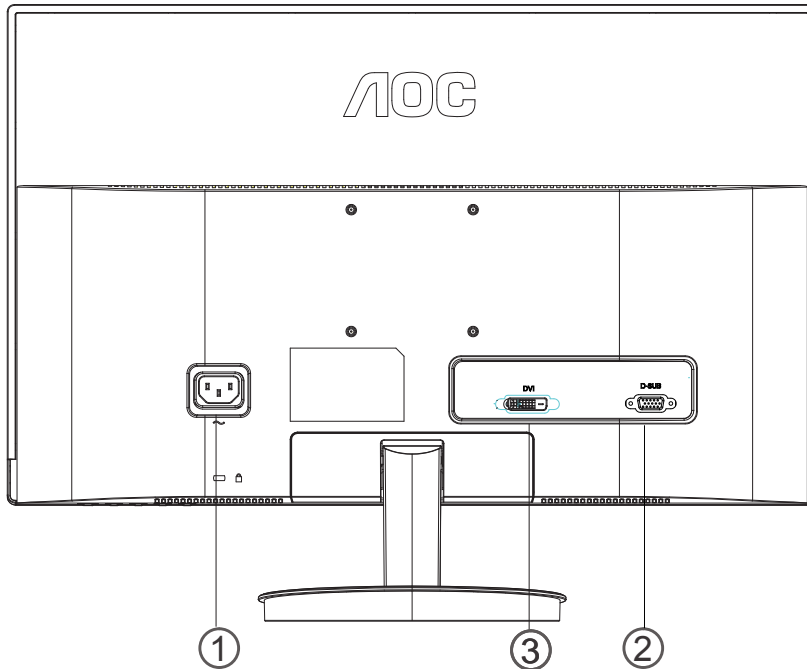

1. Power
2. D-Sub port
3. DVI port

To protect equipment, always turn off the PC and LCD monitor before connecting.

- 1 Connect the power cable to the AC port on the back of the monitor.
- 2 Connect one end of the 15-pin D-Sub/DVI port to the back of the monitor and connect the other end to the computer's D-Sub/DVI.
- 3 Turn on your monitor and computer.

If your monitor displays an image, installation is complete. If it does not display an image, please refer Troubleshooting.

Adjusting

Setting Optimal Resolution

Windows Vista

For Windows Vista:

1 Click **START**.

2 Click **CONTROL PANEL**.



3 Click **Appearance and Personalization**.



4 Click **Personalization**



5 Click **Display Settings**.



6 Set the resolution **SLIDE-BAR** to Optimal preset resolution .



Windows 8

For Windows 8:

1. Right click and click **All apps** at the bottom-right of the screen.

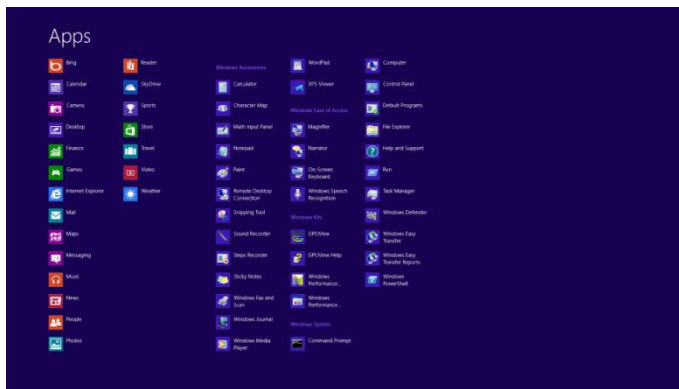
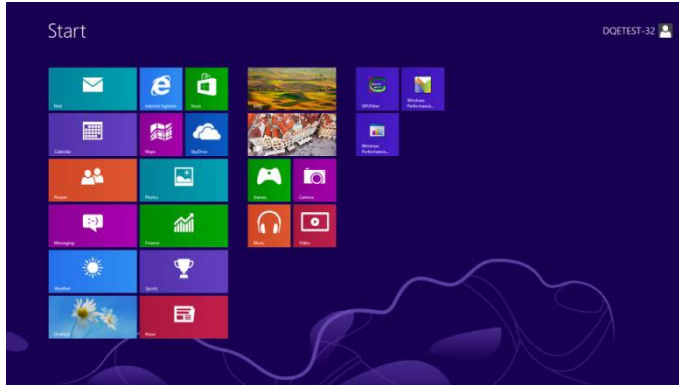

2. Set the "view by" to "Category".
3. Click **Appearance and Personalization**.



4. Click **DISPLAY**.

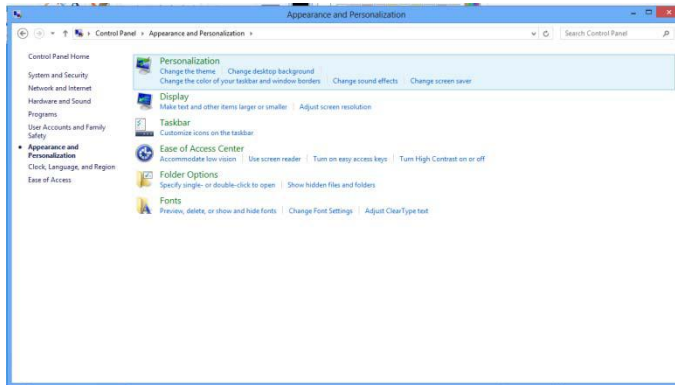

5. Set the resolution **SLIDE-BAR** to 1920x1080 or 2560x1080.

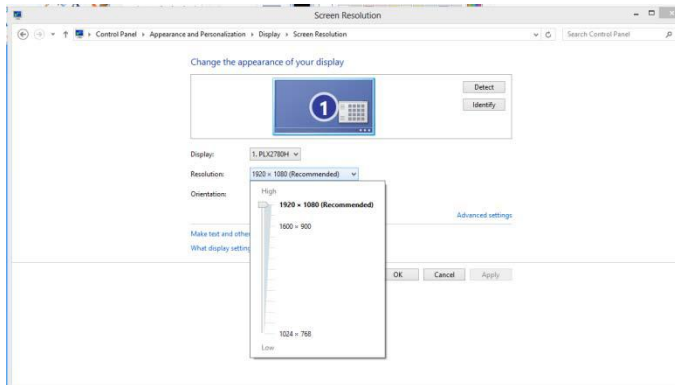

Windows XP

For Windows XP:

1 Click **START**.



2 Click **SETTINGS**.

3 Click **CONTROL PANEL**.

4 Click **Appearance and Themes**.

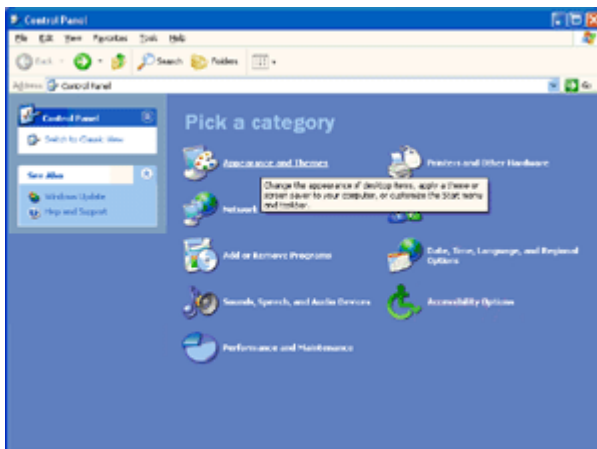

5 Double click **DISPLAY**.

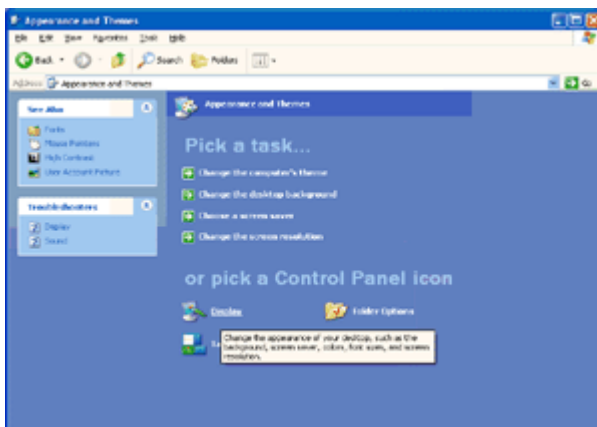

6 Click **SETTINGS**.

7 Set the resolution **SLIDE-BAR** to Optimal preset resolution

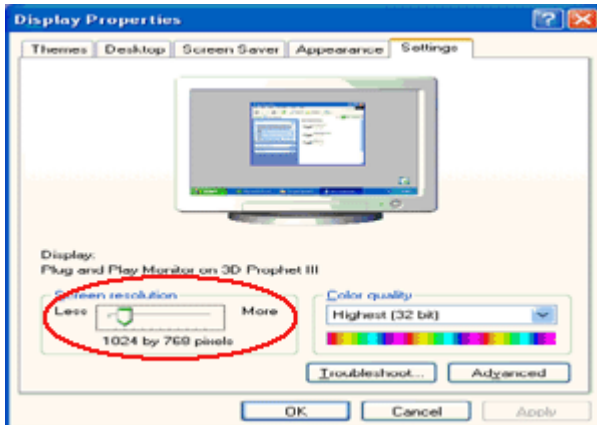

Windows ME/2000

For Windows ME/2000:

1 Click **START**.

2 Click **SETTINGS**.

3 Click **CONTROL PANEL**.

4 Double click **DISPLAY**.

5 Click **SETTINGS**.

6 Set the resolution **SLIDE-BAR** to Optimal preset resolution

Hotkeys

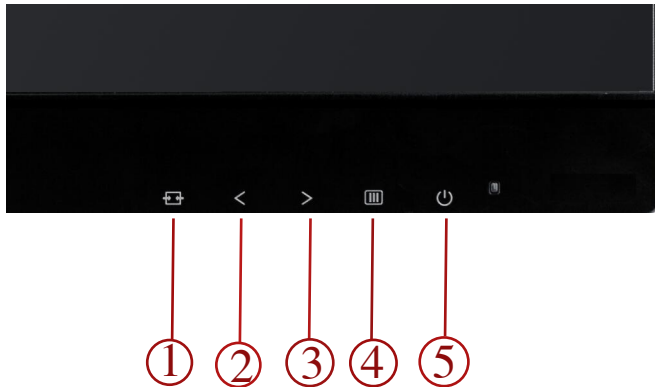

I2269V_{WM}/I2369V_M/I2769V_M

1	Source/Auto/Exit
2	Clear Vision/ <
3	Volume/ >
4	Menu/Enter
5	Power

I2269V_w/I2369V/I2769V

1	Source/Auto/Exit
2	Clear Vision/ <
3	4:3 or wide / >
4	Menu/Enter
5	Power

Menu/Enter

Press to display the OSD or confirm the selection.

Power

Press the Power button to turn on/off the monitor.

Volume/ >

When there is no OSD, press Volume adjust volume.

4:3 or wide image ratio / >

When there is no OSD, press > hotkey continuously to change 4:3 or wide image ratio. (If the product screen size is 4:3 or input signal resolution is wide format, the hot key is disable to adjust.)

Auto / Exit / Source hot key

When there is no OSD, press Auto/Source button continuously about 2 second to do auto configure.

When the OSD is closed, press Source button will be Source hot key function. Press Source button continuously to select the input source showed in the message bar, press Menu/Enter button to change to the source selected.

Clear Vision/<

1. When there is no OSD, Press the "<" button to activate Clear Vision
2. Use the ">" or "<" buttons to select between weak, medium, strong, or off settings. Default setting is always "off"
3. Press and hold "<" button for 5 seconds ,the vertical line will display while no vertical line in screen; Press and hold "<" button for 5 seconds ,the vertical line will disappear while the vertical line is moving in screen; Press the "<" Button to turn the monitor clear vision Off / Strong / Medium / Weak, the left of vertical line will be the effect demo and right of vertical line will be clear vision off ;When display picture in screen will be more obviously.

Clear Vision function will provides the best image viewing experience by converting low resolution and blurry images into clear and vivid images.



Using "MHL(Mobile High-Definition Link)"

1. "MHL" (Mobile High-Definition Link)

This feature allows you to enjoy videos and photos (imported from a connected mobile device that supports MHL) on the screen of the product.

- To use the MHL function, you need an MHL-certified mobile device. You can check if your mobile device is MHL certified on the device manufacturer's website. To find a list of MHL-certified devices, visit the official MHL website (<http://www.mhlconsortium.org>).
- To use the MHL function, the latest version of software must be installed on the mobile device.
- On some mobile devices, the MHL function may not be available depending on the device's performance or functionality.
- Since the display size of the product is larger than those of mobile devices, the picture quality may degrade.
- This product is officially MHL-certified. If you encounter any problem when using the MHL function, please contact the manufacturer of the mobile device.
- The picture quality may degrade when content (imported from the mobile device) with a low Resolution is played on the product.

Using "MHL"

1. Connect the micro USB port on the mobile device to the [HDMI 1 / MHL] port on the product using the MHL cable.

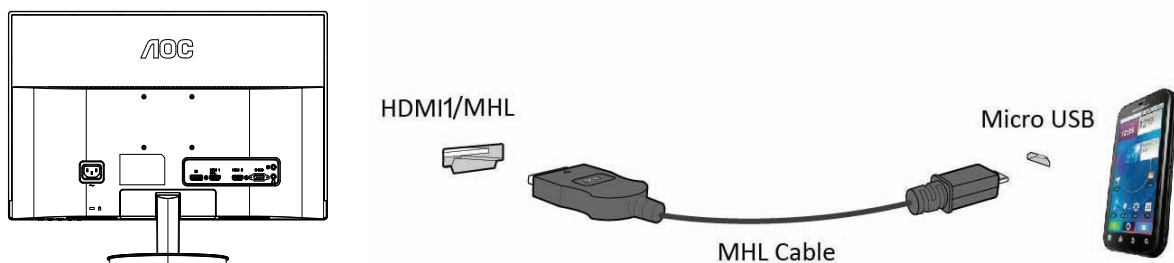

- When the MHL cable is used, [HDMI 1 / MHL] is the only port on this monitor that supports the MHL function.
 - Mobile device must be purchased separately.
2. Press the source button  and switch to HDMI 1/MHL to activate MHL mode.
 3. After about 3 seconds, the MHL screen will be displayed if MHL mode is active.
Remark: The indicated time "3 sec later" may vary depending on the mobile device.

When the mobile device is not connected or does not support MHL

- If MHL mode is not activated, check the connection of the mobile device.

-
- If MHL mode is not activated, check if the mobile device supports MHL.
 - If MHL mode is not activated even though the mobile device supports MHL, update the firmware of the mobile device to the latest version.

OSD Setting

Basic and simple instruction on the control keys.



- 1) Press the **MENU-button** to activate the OSD window.
- 2) Press **<or >** to navigate through the functions. Once the desired function is highlighted, press the **MENU-button** to activate it . press **<or >** to navigate through the sub-menu functions. Once the desired function is highlighted, press **MENU-button** to activate it.
- 3) Press **<or >** to change the settings of the selected function. Press **AUTO** to exit. If you want to adjust any other function, repeat steps 2-3.
- 4) OSD Lock Function: To lock the OSD, press and hold the **MENU button** while the monitor is off and then press **power button** to turn the monitor on. To un-lock the OSD - press and hold the **MENU button** while the monitor is off and then press **power button** to turn the monitor on.

Notes:

- 1) If the product has only one signal input, the item of "Input Select" is disable to adjust.
- 2) If the product screen size is 4:3 or input signal resolution is wide format, the item of "Image Ratio" is disable to adjust.
- 3) One of non-standard ECO, DCR , DCB, Picture Boost is activated, the other three of functions are turned off accordingly.

Luminance



1. Press **MENU** (Menu) to display menu.



2. Press < or > to select  (Luminance), and press **MENU** to enter.



3. Press < or > to select submenu, and press **MENU** to enter.









4. Press < or > to adjust.



5. Press **AUTO** to exit.

I2269V_{WM}/I2369V_M/I2769V_M

	Brightness	0-100		Backlight Adjustment
	Contrast	0-100		Contrast from Digital-register.
	Eco mode	Standard	<input checked="" type="checkbox"/>	Standard Mode
		Text		Text Mode
		Internet		Internet Mode
		Game		Game Mode
		Movie		Movie Mode
		Sports		Sports Mode
	Gamma	Gamma1		Adjust to Gamma1
		Gamma2		Adjust to Gamma 2
		Gamma3		Adjust to Gamma 3
	DCR	Off		Disable dynamic contrast ratio
		On		Enable dynamic contrast ratio
	Overdrive	Weak		Adjust the response time
		Medium		
Strong				
Off				
DPS	Off		Dynamic Power saving	
	On			

I2269V_w/I2369V /I2769V









	Brightness	0-100		Backlight Adjustment
	Contrast	0-100		Contrast from Digital-register.
	Eco mode	Standard		Standard Mode
		Text		Text Mode
		Internet		Internet Mode
		Game		Game Mode
		Movie		Movie Mode
		Sports		Sports Mode
	Gamma	Gamma1		Adjust to Gamma1
		Gamma2		Adjust to Gamma 2
		Gamma3		Adjust to Gamma 3
	DCR	Off		Disable dynamic contrast ratio
		On		Enable dynamic contrast ratio

Image Setup



1. Press **MENU** (Menu) to display menu.



2. Press < or > to select  (Image Setup), and press **MENU** to enter.



3. Press < or > to select submenu, and press **MENU** to enter.



4. Press < or > to adjust.



5. Press **AUTO** to exit.

	Clock	0-100	Adjust picture Clock to reduce Vertical-Line noise.
	Phase	0-100	Adjust Picture Phase to reduce Horizontal-Line noise
	Sharpness	0-100	Adjust picture sharpness
	H.Position	0-100	Adjust the horizontal position of the picture.
	V.Position	0-100	Adjust the vertical position of the picture.

Color Setup



1. Press **MENU** (Menu) to display menu.



2. Press < or > to select  (Color Setup), and press **MENU** to enter.



3. Press < or > to select submenu, and press **MENU** to enter.



4. Press < or > to adjust.



5. Press **AUTO** to exit.

	Color setup.	Warm		Recall Warm Color Temperature from EEPROM.
		Normal		Recall Normal Color Temperature from EEPROM.
		Cool		Recall Cool Color Temperature from EEPROM.
		sRGB		Recall sRGB Color Temperature from EEPROM.
		User	Red	
	Green			Green Gain Digital-register.
	Blue			Blue Gain from Digital-register
	DCB Mode	Full Enhance	on or off	Disable or Enable Full Enhance Mode
		Nature Skin	on or off	Disable or Enable Nature Skin Mode
		Green Field	on or off	Disable or Enable Green Field Mode
Sky-blue		on or off	Disable or Enable Sky-blue Mode	
AutoDetect		on or off	Disable or Enable AutoDetect Mode	
DCB Demo		On or off	Disable or Enable Demo	

Picture Boost



1. Press **MENU** (Menu) to display menu.



2. Press < or > to select  (Picture Boost), and press **MENU** to enter.



3. Press < or > to select submenu, and press **MENU** to enter.



4. Press < or > to adjust.



5. Press **AUTO** to exit.

	Frame Size	14-100	Adjust Frame Size
	Brightness	0-100	Adjust Frame Brightness
	Contrast	0-100	Adjust Frame Contrast
	H. position	0-100	Adjust Frame horizontal Position
	V. position	0-100	Adjust Frame vertical Position
	Bright Frame	on or off	Disable or Enable Bright Frame

OSD Setup



1. Press **MENU** (Menu) to display menu.



2. Press < or > to select  (OSD Setup), and press **MENU** to enter.



3. Press < or > to select submenu, and press **MENU** to enter.



4. Press < or > to adjust.



5. Press **AUTO** to exit.

	H.Position	0-100	Adjust the horizontal position of OSD
	V.Position	0-100	Adjust the vertical position of OSD
	Timeout	5-120	Adjust the OSD Timeout
	Transparence	0-100	Adjust the transparence of OSD
	Language		Select the OSD language
	Break Reminder	Off On	Break reminder if the user continuously work for more than 1hrs

Extra



1. Press **MENU** (Menu) to display menu.



2. Press < or > to select  (Extra), and press **MENU** to enter.



3. Press < or > to select submenu, and press **MENU** to enter.



4. Press < or > to adjust.



5. Press **AUTO** to exit.

I2269V_{WM} / I2369V_M / I2769V_M

	Input Select	Auto	Select to Auto Detect input signal
		D-SUB	Select D-SUB Signal Source as Input
		HDMI1/MHL	Select HDMI1/MHL Source as Input
		HDMI2	Select HDMI2 Source as Input
	Auto Config	yes or no	Auto adjust the picture to default
	Image Ratio	wide or 4:3	Select wide or 4:3 format for display
	DDC-CI	yes or no	Turn ON/OFF DDC-CI Support
	Off Timer	0~24hours	Select timing to turn off the monitor.
Information		Show the information of the main image and sub-image source	

I2269V_w / I2369V / I2769V

	Input Select	Auto	Select to Auto Detect input signal
		D-SUB	Select D-SUB Signal Source as Input
		DVI	Select DVI Source as Input
	Auto Config	yes or no	Auto adjust the picture to default
	Image Ratio	wide or 4:3	Select wide or 4:3 format for display
	DDC-CI	yes or no	Turn ON/OFF DDC-CI Support
	Reset	yes or no	Reset the menu to default
	Off Timer	0~24hours	Select timing to turn off the monitor.
Information		Show the information of the main image and sub-image source	

Exit





1. Press **MENU** (Menu) to display menu.



2. Press < or > to select  (Exit), and press **MENU** or **AUTO** to exit.

	Exit		Exit the main OSD
---	------	--	-------------------

LED Indicator

Status	LED Color	
Full Power Mode	Green	
Active-off Mode	orange	

Driver

Monitor Driver

Windows 8

1. Start Windows® 8
2. Right click and click **All apps** at the bottom-right of the screen.
3. Set the **“View by”** to **“Large icons”** or **“Small icons”**.
4. Click on the **“Display”** icon.
5. Click on the **“Change display settings”** button.
6. Click the **“Advanced Settings”** button.
7. Click the **“Monitor”** tab and then click the **“Properties”** button.
8. Click the **“Driver”** tab.
9. Open the **“Update Driver Software-Generic PnP Monitor”** window by clicking on **“Update Driver...”** and then click the **“Browse my computer for driver software”** button.
10. Select **“Let me pick from a list of device drivers on my computer”**.
11. Click the **“Have Disk”** button. Click on the **“Browse”** button and navigate to the following directory:
X:\Driver\module name (where X is the drive letter designator for the CD-ROM drive).
12. Select the **“xxx.inf”** file and click the **“Open”** button. Click the **“OK”** button.
13. Select your monitor model and click the **“Next”** button. The files will be copied from the CD to your hard disk drive.
14. Close all open windows and remove the CD.
15. Restart the system. The system will automatically select the maximum refresh rate and corresponding Color Matching Profiles.

Windows 7

1. Start Windows® 7
2. Click on the **'Start'** button and then click on **'Control Panel'**.

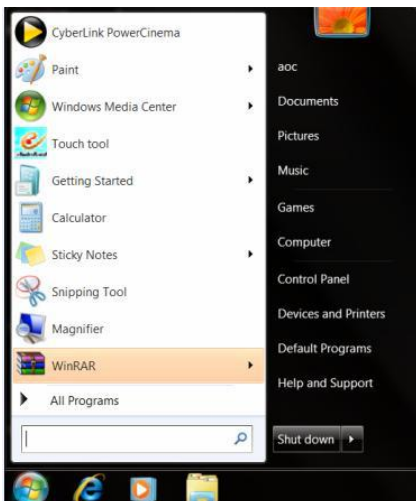

3. Click on the “**Display**” icon.

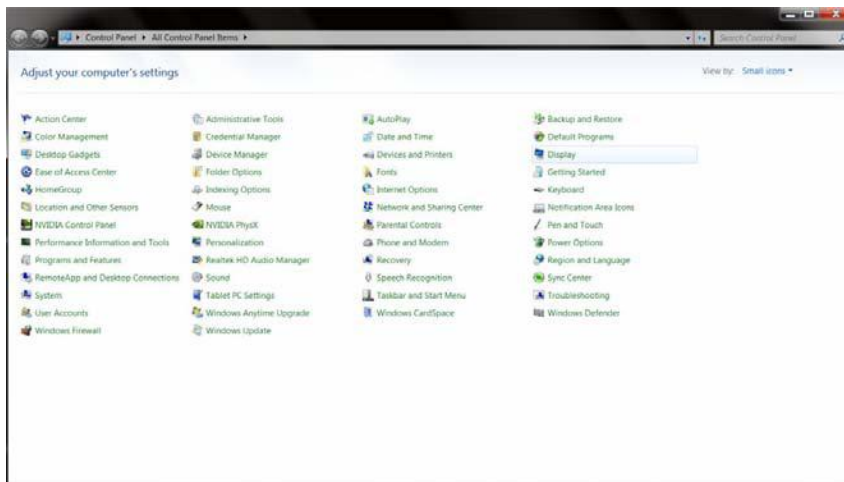

4. Click on the “**Change display settings**” button.

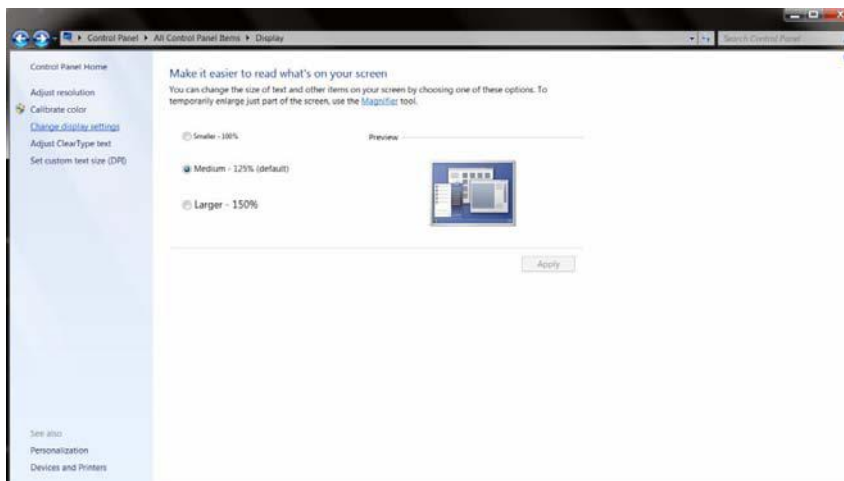

5. Click the “**Advanced Settings**” button.

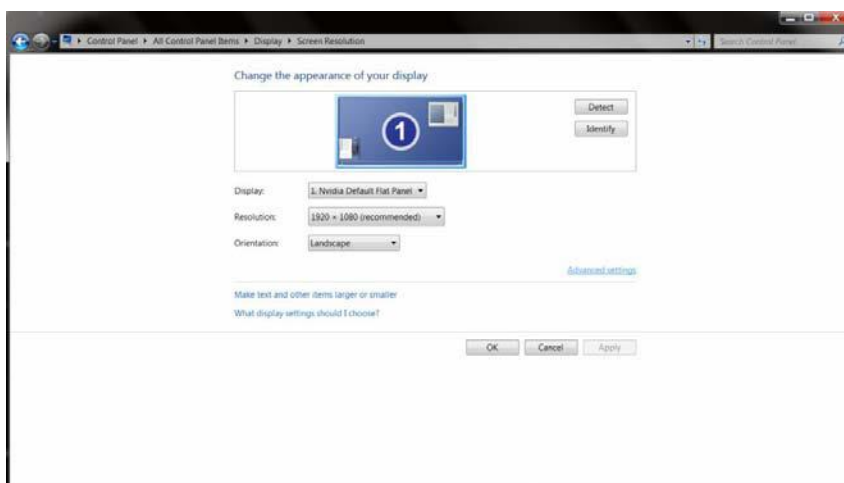

6. Click the **“Monitor”** tab and then click the **“Properties”** button.

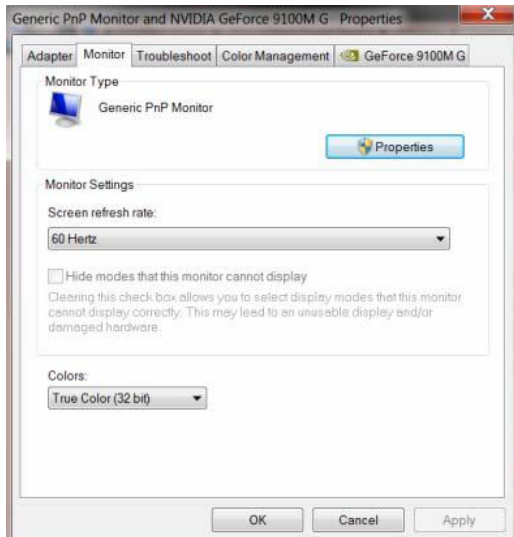

7. Click the **“Driver”** tab.

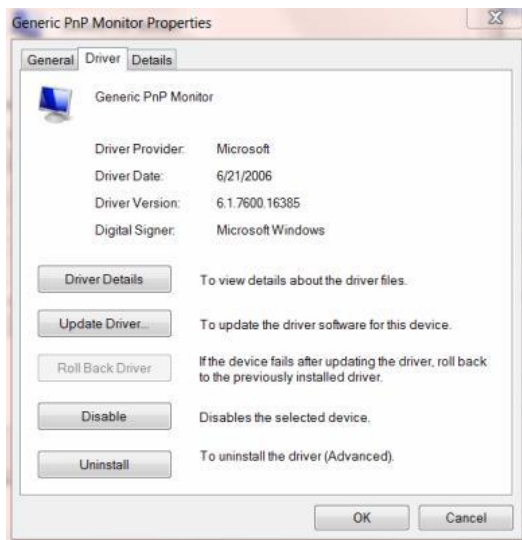

8. Open the **“Update Driver Software-Generic PnP Monitor”** window by clicking on **“Update Driver...”** and then click the **“Browse my computer for driver software”** button.

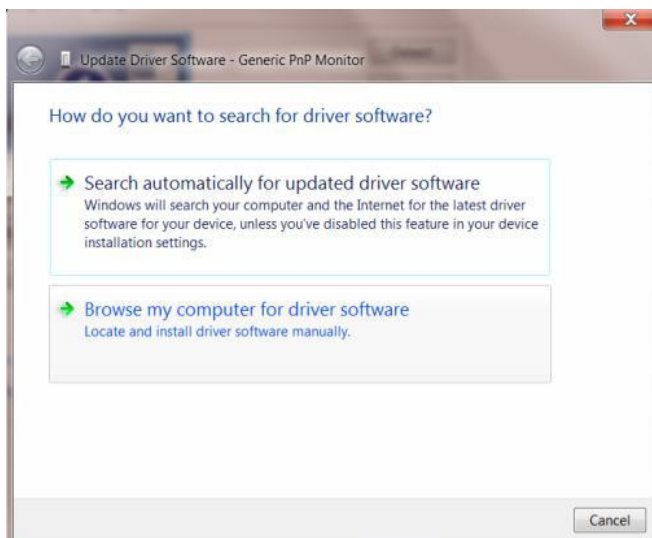

9. Select "**Let me pick from a list of device drivers on my computer**".

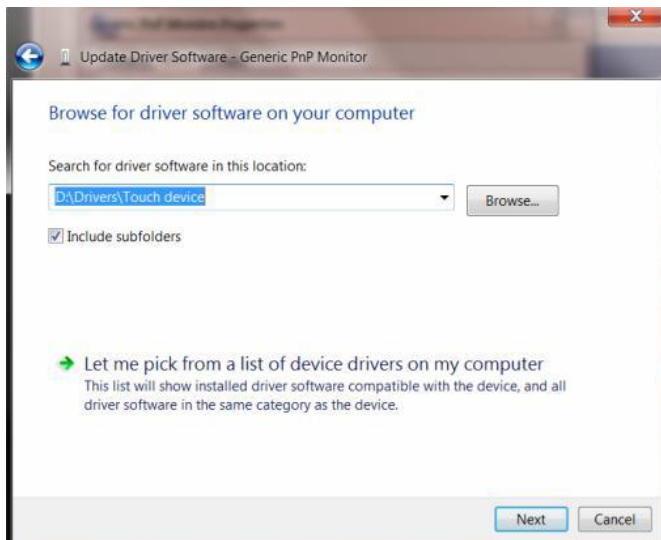

10. Click the "**Have Disk**" button. Click on the "**Browse**" button and navigate to the following directory:
X:\Driver\module name (where X is the drive letter designator for the CD-ROM drive).

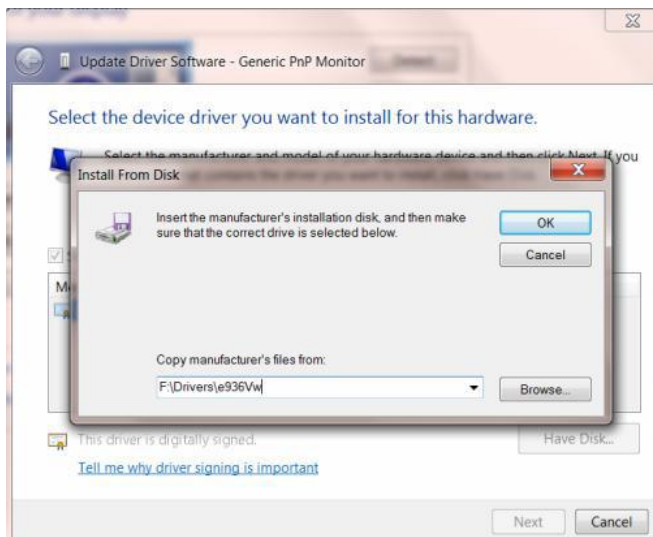

11. Select the "**xxx.inf**" file and click the "**Open**" button. Click the "**OK**" button.
12. Select your monitor model and click the "**Next**" button. The files will be copied from the CD to your hard disk drive.
13. Close all open windows and remove the CD.
14. Restart the system. The system will automatically select the maximum refresh rate and corresponding Color Matching Profiles.

Windows Vista

1. Click "Start " and "Control Panel". Then, double-click on "Appearance and Personalization".



2. Click "Personalization" and then "Display Settings".

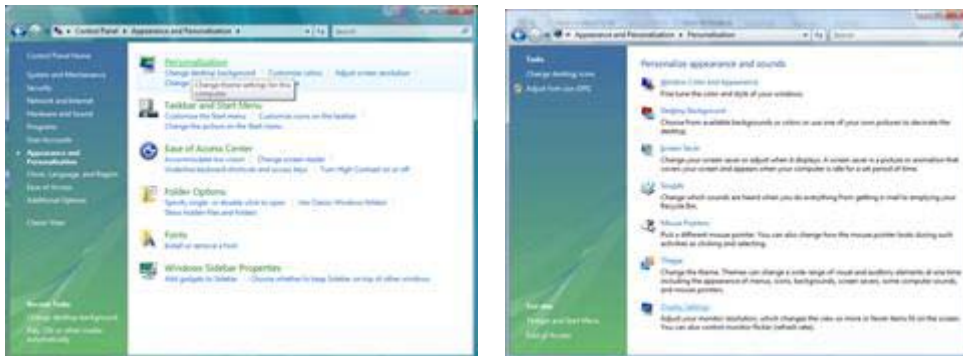

3. Click "Advanced Settings...".



4. Click "Properties" in the "Monitor" tab. If the "Properties" button is deactivated, it means the configuration for your monitor is completed. The monitor can be used as is.

If the message "Windows needs..." is displayed, as shown in the figure below, click "Continue".

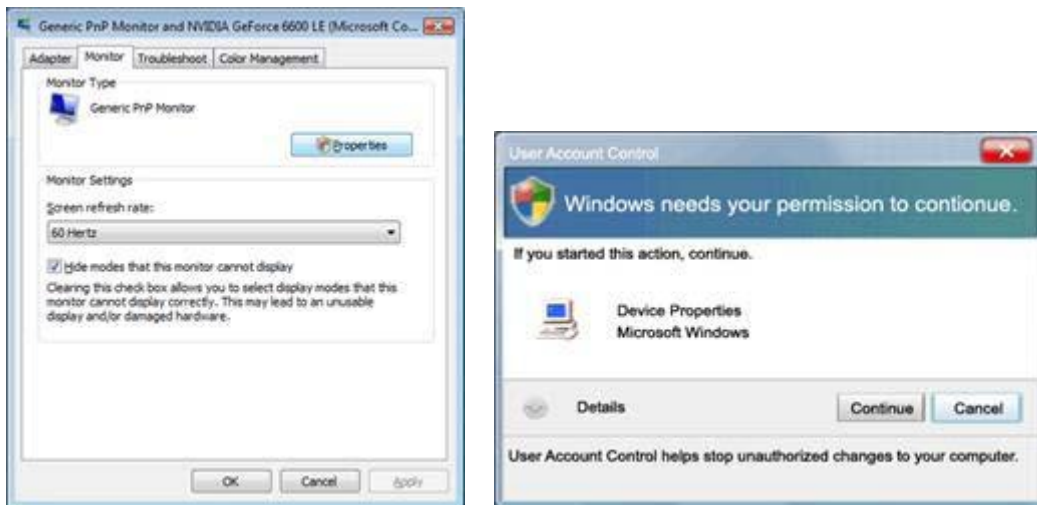

5. Click "Update Driver..." in the "Driver" tab.

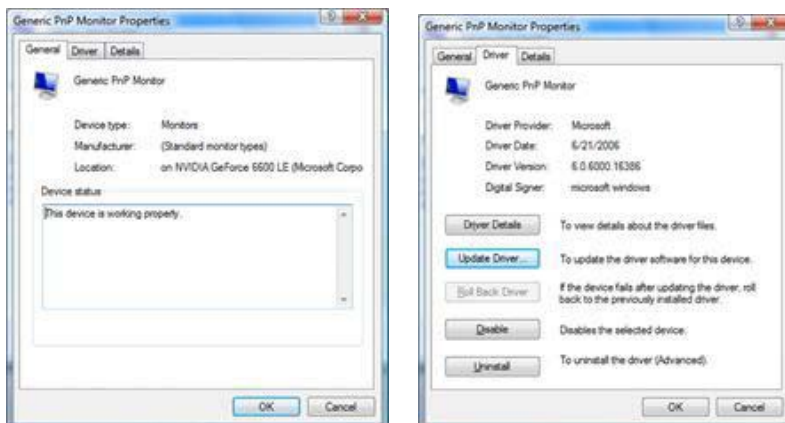

6. Check the "Browse my computer for driver software" checkbox and click "Let me pick from a list of device drivers on my computer".

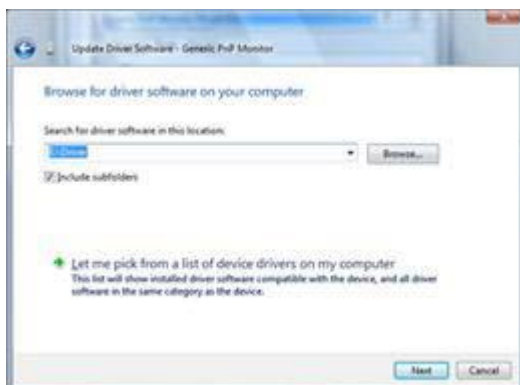

7. Click on the 'Have disk...' button, then click on the 'Browse...' button and then select the appropriate drive F:\Driver (CD-ROM Drive).

8. Select your monitor model and click on the 'Next' button.

9. Click "Close" → "Close" → "OK" → "OK" on the following screens displayed in sequence.

Windows XP

1. Start Windows® XP
2. Click on the 'Start' button and then click on 'Control Panel'.



3. Select and click on the category 'Appearance and Themes'

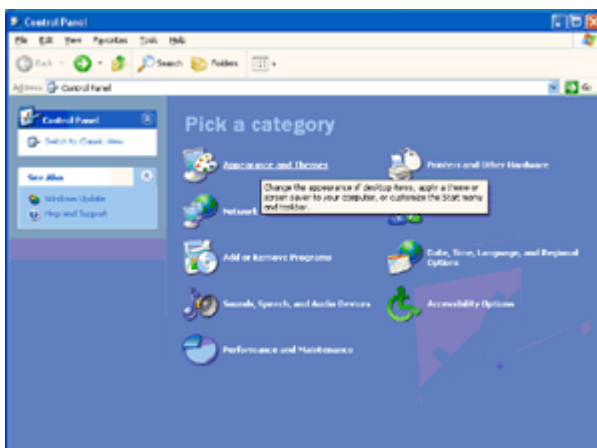

4. Click on the 'Display' Item.

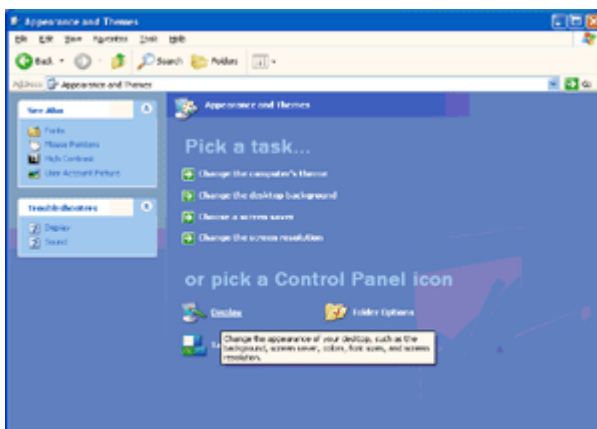

5. Select the 'Settings' tab then click on the 'Advanced' button.

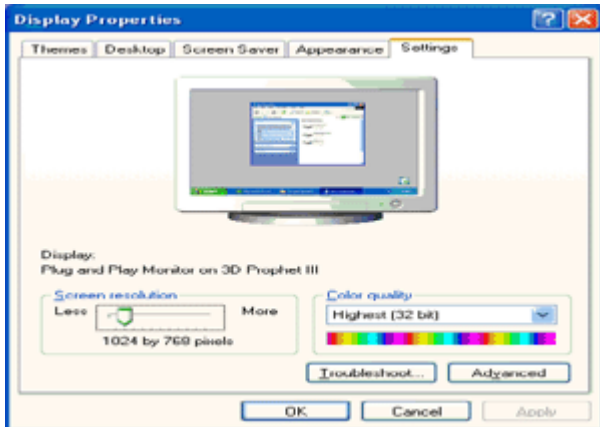

6. Select 'Monitor' tab

- If the 'Properties' button is inactive, it means your monitor is properly configured. Please stop installation.

- If the 'Properties' button is active, click on 'Properties' button.

Please follow the steps below.

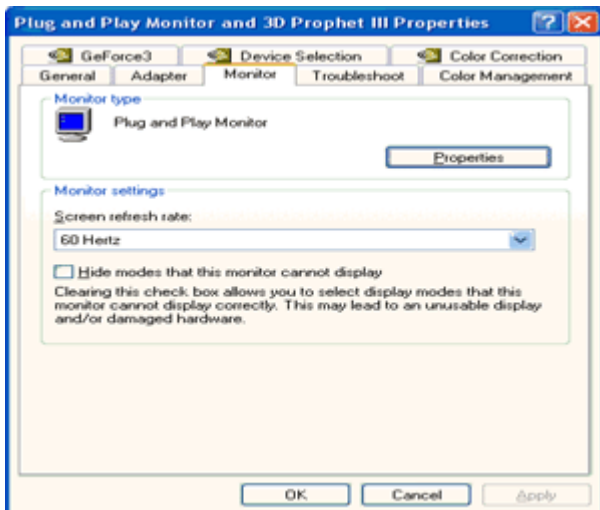

7. Click on the 'Driver' tab and then click on 'Update Driver...' button.

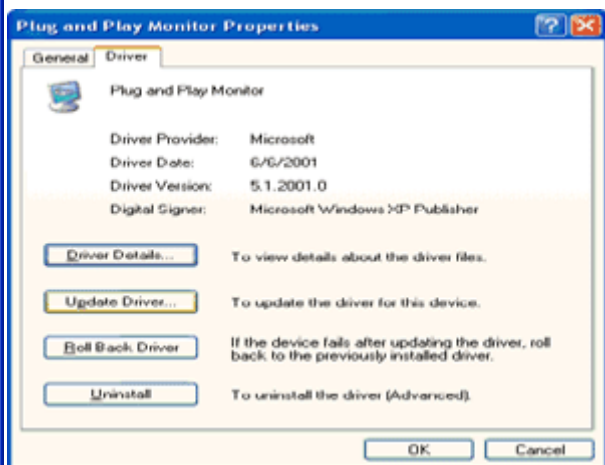
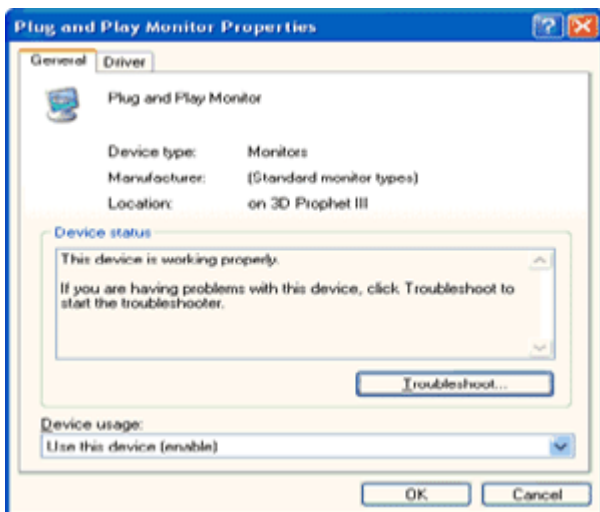

8. Select the 'Install from a list or specific location [advanced]' radio button and then click on the 'Next' button.

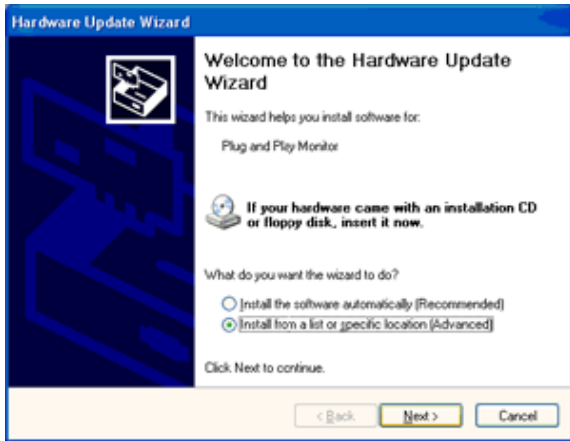

9. Select the 'Don't Search. I will choose the driver to install' radio button. Then click on the 'Next' button.

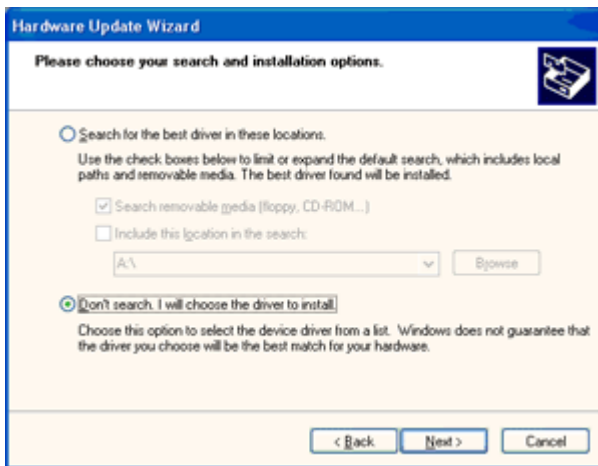

10. Click on the 'Have disk...' button, then click on the 'Browse...' button and then select the appropriate drive F: (CD-ROM Drive).

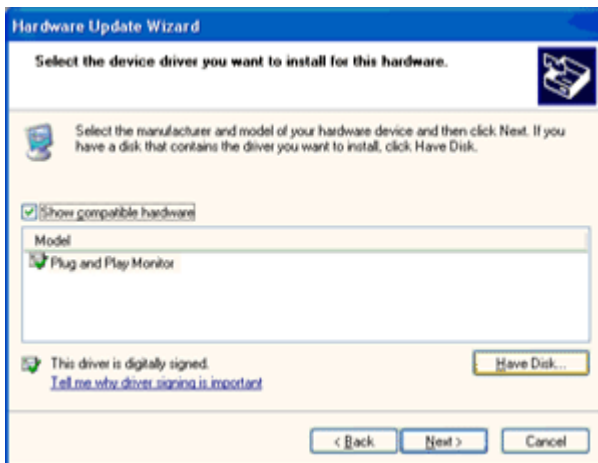

11. Click on the 'Open' button, then click the 'OK' button.

12. Select your monitor model and click on the 'Next' button.

- If you can see the 'has not passed Windows® Logo testing to verify its compatibility with Windows® XP' message, please click on the 'Continue Anyway' button.

13. Click on the 'Finish' button then the 'Close' button.

14. Click on the 'OK' button and then the 'OK' button again to close the Display Properties dialog box.

Windows 2000

1. Start Windows® 2000
 2. Click on the 'Start' button, point to 'Settings', and then click on 'Control Panel'.
 3. Double click on the 'Display' Icon.
 4. Select the 'Settings' tab then click on 'Advanced...'
 5. Select 'Monitor'
 - If the 'Properties' button is inactive, it means your monitor is properly configured. Please stop installation.
 - If the 'Properties' button is active. Click on 'Properties' button. Please follow the steps given below.
 6. Click on 'Driver' and then click on 'Update Driver...' then click on the 'Next' button.
 7. Select 'Display a list of the known drivers for this device so that I can choose a specific driver', then click on 'Next' and then click on 'Have disk...'
 8. Click on the 'Browse...' button then select the appropriate drive F: (CD-ROM Drive).
 9. Click on the 'Open' button, then click on the 'OK' button.
 10. Select your monitor model and click on the 'Next' button.
 11. Click on the 'Finish' button then the 'Close' button.
- If you can see the 'Digital Signature Not Found' window, click on the 'Yes' button.

Windows ME

1. Start Windows® Me
2. Click on the 'Start' button, point to 'Settings', and then click on 'Control Panel'.
3. Double click on the 'Display' Icon.
4. Select the 'Settings' tab then click on 'Advanced...'
5. Select the 'Monitor' button, then click on 'Change...' button.
6. Select 'Specify the location of the driver(Advanced)' and click on the 'Next' button.
7. Select 'Display a list of all the drivers in a specific location, so you can choose the driver you want', then click on 'Next' and then click on 'Have Disk...'
8. Click on the 'Browse...' button, select the appropriate drive F: (CD-ROM Drive) then click on the 'OK' button.
9. Click on the 'OK' button, select your monitor model and click on the 'Next' button.
10. Click on 'Finish' button then the 'Close' button.

i-Menu



Welcome to "i-Menu" software by AOC. i-Menu makes it easy to adjust your monitor display setting by using on screen menus instead of the OSD button on the monitor. To complete installation, please follow the installation guide.



e-Saver



Welcome to use AOC e-Saver monitor power management software! The AOC e-Saver features Smart Shutdown functions for your monitors, allows your monitor to timely shutdown when PC unit is at any status (On, Off, Sleep or Screen Saver); the actual shutdown time depends on your preferences (see example below).

Please click on "driver/e-Saver/setup.exe" to start installing the e-Saver software, follow the install wizard to complete software installation.

Under each of the four PC status, you may choose from the pull-down menu the desired time (in minutes) for your monitor to automatically shutdown. The example above illustrated:

- 1) The monitor will never shutdown when the PC is powered on.
- 2) The monitor will automatically shutdown 5 minutes after the PC is powered off.
- 3) The monitor will automatically shutdown 10 minutes after the PC is in sleep/stand-by mode.
- 4) The monitor will automatically shutdown 20 minutes after the screen saver appears.

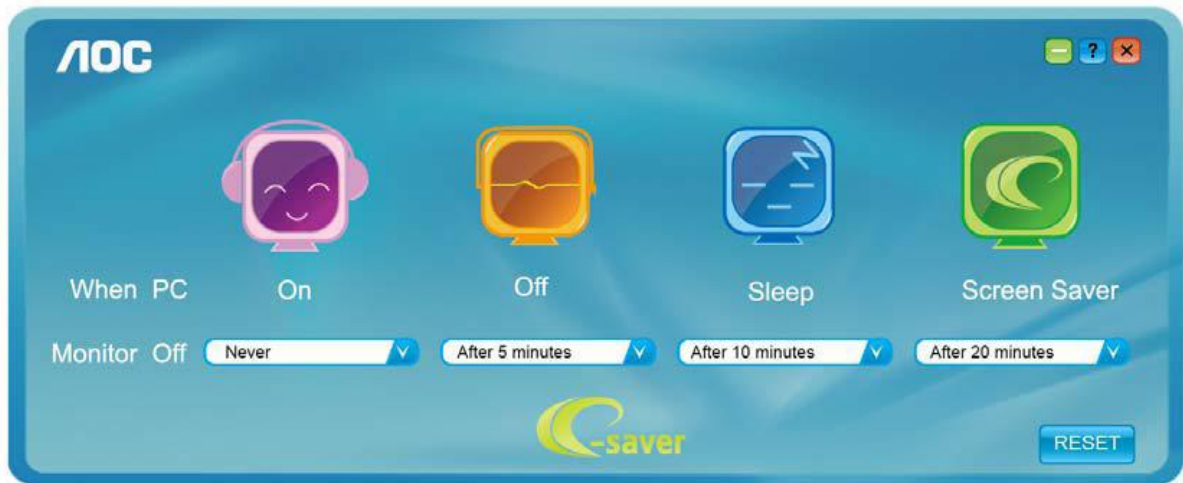

You can click "RESET" to set the e-Saver to its default settings like below.

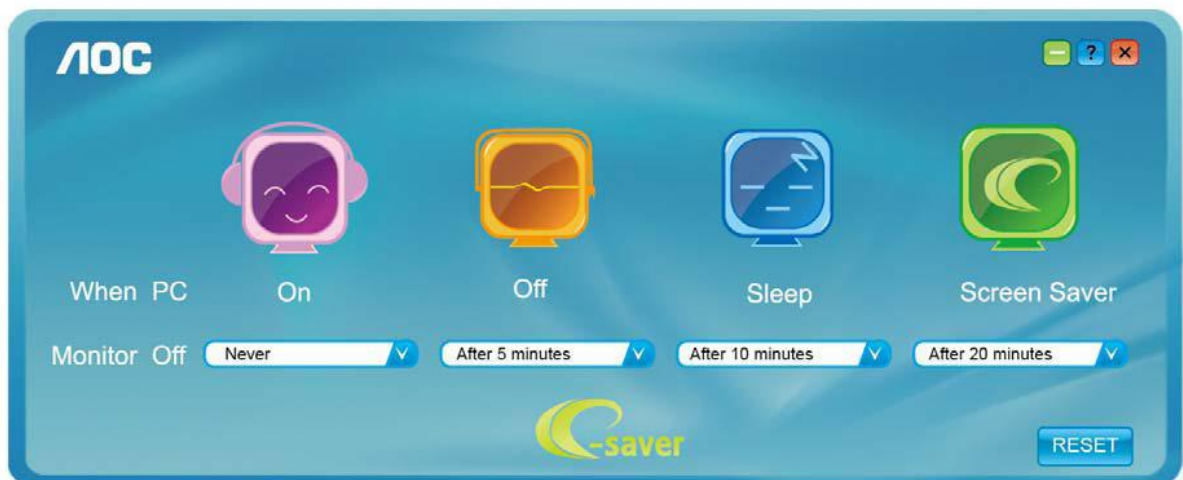

Screen+



Welcome to "Screen+" software by AOC, Screen+ software is a desktop screen splitting tool, it splits the desktop into different panes, each pane displays a different window. You only need to drag the window to a corresponding pane, when you want to access it. It supports multiple monitor display to make your task easier. Please follow the installation software to install it.



Troubleshoot

Problem & Question	Possible Solutions
Power LED Is Not ON	Make sure the power button is ON and the Power Cord is properly connected to a grounded power outlet and to the monitor.
No images on the screen	<ul style="list-style-type: none"> • Is the power cord connected properly? Check the power cord connection and power supply. • Is the cable connected correctly? (Connected using the D-sub cable) Check the DB-15 cable connection. (Connected using the DVI cable) Check the DVI cable connection. * DVI input is not available on every model. • If the power is on, reboot the computer to see the initial screen (the login screen), which can be seen. If the initial screen (the login screen) appears, boot the computer in the applicable mode (the safe mode for Windows ME/XP/2000) and then change the frequency of the video card. (Refer to the Setting the Optimal Resolution) If the initial screen (the login screen) does not appear, contact the Service Center or your dealer. • Can you see "Input Not Supported" on the screen? You can see this message when the signal from the video card exceeds the maximum resolution and frequency that the monitor can handle properly. Adjust the maximum resolution and frequency that the monitor can handle properly. • Make sure the AOC Monitor Drivers are installed.
Picture Is Fuzzy & Has Ghosting Shadowing Problem	Adjust the Contrast and Brightness Controls. Press to auto adjust. Make sure you are not using an extension cable or switch box. We recommend plugging the monitor directly to the video card output connector on the back .
Picture Bounces, Flickers Or Wave Pattern Appears In The Picture	Move electrical devices that may cause electrical interference as far away from the monitor as possible. Use the maximum refresh rate your monitor is capable of at the resolution your are using.
Monitor Is Stuck In Active Off-Mode"	The Computer Power Switch should be in the ON position. The Computer Video Card should be snugly fitted in its slot. Make sure the monitor's video cable is properly connected to the computer. Inspect the monitor's video cable and make sure no pin is bent. Make sure your computer is operational by hitting the CAPS LOCK key on the keyboard while observing the CAPS LOCK LED. The LED should either turn ON or OFF after hitting the CAPS LOCK key.
Missing one of the primary colors (RED, GREEN, or BLUE)	Inspect the monitor's video cable and make sure that no pin is damaged. Make sure the monitor's video cable is properly connected to the computer.
Screen image is not centered or sized properly	Adjust H-Position and V-Position or press hot-key (AUTO).
Picture has color defects (white does not look white)	Adjust RGB color or select desired color temperature.
Horizontal or vertical disturbances on the screen	Use Windows 95/98/2000/ME/XP shut-down mode Adjust CLOCK and FOCUS. Press to auto-adjust.

Specification

General Specification

I2269V_{WM}

Panel	Model name	I2269V _{WM}
	Driving system	TFT Color LCD
	Viewable Image Size	546.20mm Diagonal
	Pixel pitch	0.08265*RGB(H)mm x 0.24795 (V)mm
	Video	R, G, B Analog Interface ,HDMI ,MHL,DP
	Separate Sync.	H/V TTL
	Display Color	16.7M Colors
	Dot Clock	170MHz
Resolution	Horizontal scan range	30kHz to 83kHz
	Horizontal scan Size(Maximum)	476.06mm
	Vertical scan range	50Hz to 76Hz
	Vertical scan Size(Maximum)	267.79mm
	Optimal preset resolution	1920×1080@60Hz
	Plug & Play	VESA DDC2B/C1
	Input Connector	VGA,HDMI, DP
	Input Video Signal	Analog: 0.7Vp-p(standard),75 OHM,Positive,HDMI,MHL,DP
	Power Source	100-240V~, 50/60Hz
	Power Consumption	Active<30W(Typical) Standby < 0.5 W
Off timer	0-24 hrs	
Physical Characteristics	Connector Type	VGA, HDMI, DP
	Signal Cable Type	Detachable
	Dimensions & Weight:	
	Height (with base)	379.4mm
	Width	498.3mm
	Depth	189.2mm
	Weight (monitor only)	3.55kg
Environmental	Temperature:	

	Operating	0° to 40°
	Non-Operating	-25°to 55°
	Humidity:	
	Operating	10% to 85% (non-condensing)
	Non-Operating	5% to 93% (non-condensing)
	Altitude:	
	Operating	0~ 5000m (0~ 16404 ft)
	Non-Operating	0~ 12192m (0~ 40000 ft)

Panel	Model name	I2269Vw
	Driving system	TFT Color LCD
	Viewable Image Size	546.20mm Diagonal
	Pixel pitch	0.08265*RGB(H)mm x 0.24795 (V)mm
	Video	R, G, B Analog Interface ,DVI
	Separate Sync.	H/V TTL
	Display Color	16.7M Colors
	Dot Clock	170MHz
Resolution	Horizontal scan range	30kHz to 83kHz
	Horizontal scan Size(Maximum)	476.06mm
	Vertical scan range	50Hz to 76Hz
	Vertical scan Size(Maximum)	267.79mm
	Optimal preset resolution	1920×1080@60Hz
	Plug & Play	VESA DDC2B/C1
	Input Connector	VGA, DVI
	Input Video Signal	Analog: 0.7Vp-p(standard),75 OHM,Positive,DVI
	Power Source	100-240V~, 50/60Hz
	Power Consumption	Active<25W(Typical)
		Standby < 0.5 W
Off timer	0-24 hrs	
Physical Characteristics	Connector Type	VGA, DVI
	Signal Cable Type	Detachable
	Dimensions & Weight:	
	Height (with base)	379.4mm
	Width	498.3mm
	Depth	189.2mm
	Weight (monitor only)	3.45kg
Environmental	Temperature:	
	Operating	0° to 40°
	Non-Operating	-25°to 55°
	Humidity:	
	Operating	10% to 85% (non-condensing)
	Non-Operating	5% to 93% (non-condensing)
	Altitude:	
	Operating	0~ 5000m (0~ 16404 ft)
	Non-Operating	0~ 12192m (0~ 40000 ft)

Panel	Model name	I2369V
	Driving system	TFT Color LCD
	Viewable Image Size	584.2mm Diagonal
	Pixel pitch	0.0884*RGB(H)mm x 0.2652 (V)mm
	Video	R, G, B Analog Interface ,DVI
	Separate Sync.	H/V TTL
	Display Color	16.7M Colors
	Dot Clock	170MHz
Resolution	Horizontal scan range	30kHz to 83kHz
	Horizontal scan Size(Maximum)	509.18mm
	Vertical scan range	50Hz to 76Hz
	Vertical scan Size(Maximum)	286.42mm
	Optimal preset resolution	1920x1080@60Hz
	Plug & Play	VESA DDC2B/C1
	Input Connector	VGA,DVI
	Input Video Signal	Analog: 0.7Vp-p(standard),75 OHM,Positive,DVI
	Power Source	100-240V~, 50/60Hz
	Power Consumption	Active<30W(Typical)
		Standby < 0.5 W
Off timer	0-24 hrs	
Physical Characteristics	Connector Type	VGA, DVI
	Signal Cable Type	Detachable
	Dimensions & Weight:	
	Height (with base)	398mm
	Width	531.4mm
	Depth	204mm
	Weight (monitor only)	3.75kg
Environmental	Temperature:	
	Operating	0° to 40°
	Non-Operating	-25°to 55°
	Humidity:	
	Operating	10% to 85% (non-condensing)
	Non-Operating	5% to 93% (non-condensing)
	Altitude:	
	Operating	0~ 5000m (0~ 16404 ft)
	Non-Operating	0~ 12192m (0~ 40000 ft)

Panel	Model name	I2369VM
	Driving system	TFT Color LCD
	Viewable Image Size	584.20mm Diagonal
	Pixel pitch	0.0884*RGB(H)mm x 0.2652 (V)mm
	Video	R, G, B Analog Interface ,HDMI ,MHL,DP
	Separate Sync.	H/V TTL
	Display Color	16.7M Colors
	Dot Clock	170MHz
Resolution	Horizontal scan range	30kHz to 83kHz
	Horizontal scan Size(Maximum)	509.18mm
	Vertical scan range	50Hz to 76Hz
	Vertical scan Size(Maximum)	286.42mm
	Optimal preset resolution	1920x1080@60Hz
	Plug & Play	VESA DDC2B/C1
	Input Connector	VGA,HDMI, DP
	Input Video Signal	Analog: 0.7Vp-p(standard),75 OHM,Positive,HDMI,MHL,DP
	Power Source	100-240V~, 50/60Hz
	Power Consumption	Active<35W(Typical)
		Standby < 0.5 W
Off timer	0-24 hrs	
Physical Characteristics	Connector Type	VGA, HDMI, DP
	Signal Cable Type	Detachable
	Dimensions & Weight:	
	Height (with base)	398mm
	Width	531.4mm
	Depth	204mm
	Weight (monitor only)	3.80kg
Environmental	Temperature:	
	Operating	0° to 40°
	Non-Operating	-25°to 55°
	Humidity:	
	Operating	10% to 85% (non-condensing)
	Non-Operating	5% to 93% (non-condensing)
	Altitude:	
	Operating	0~ 5000m (0~ 16404 ft)
	Non-Operating	0~ 12192m (0~ 40000 ft)

Panel	Model name	I2769V	
	Driving system	TFT Color LCD	
	Viewable Image Size	686mm Diagonal	
	Pixel pitch	0.1038*RGB(H)mm x 0.3114 (V)mm	
	Video	R, G, B Analog Interface ,DVI	
	Separate Sync.	H/V TTL	
	Display Color	16.7M Colors	
	Dot Clock	170MHz	
Resolution	Horizontal scan range	30kHz to 83kHz	
	Horizontal scan Size(Maximum)	597.888mm	
	Vertical scan range	50Hz to 76Hz	
	Vertical scan Size(Maximum)	336.312mm	
	Optimal preset resolution	1920x1080@60Hz	
	Plug & Play	VESA DDC2B/C1	
	Input Connector	VGA,DVI	
	Input Video Signal	Analog: 0.7Vp-p(standard),75 OHM,Positive,DVI	
	Power Source	100-240V~, 50/60Hz	
	Power Consumption	Active	<30W(Typical)
		Standby	< 0.5 W
Off timer	0-24 hrs		
Physical Characteristics	Connector Type	VGA, DVI	
	Signal Cable Type	Detachable	
	Dimensions & Weight:		
	Height (with base)	448.8mm	
	Width	621.9mm	
	Depth	213.2mm	
	Weight (monitor only)	4.90kg	
Environmental	Temperature:		
	Operating	0° to 40°	
	Non-Operating	-25°to 55°	
	Humidity:		
	Operating	10% to 85% (non-condensing)	
	Non-Operating	5% to 93% (non-condensing)	
	Altitude:		
	Operating	0~ 5000m (0~ 16404 ft)	
	Non-Operating	0~ 12192m (0~ 40000 ft)	

Panel	Model name	I2769VM
	Driving system	TFT Color LCD
	Viewable Image Size	686mm Diagonal
	Pixel pitch	0.1038*RGB(H)mm x 0.3114 (V)mm
	Video	R, G, B Analog Interface ,HDMI,MHL,DP
	Separate Sync.	H/V TTL
	Display Color	16.7M Colors
	Dot Clock	170MHz
Resolution	Horizontal scan range	30kHz to 83kHz
	Horizontal scan Size(Maximum)	597.888mm
	Vertical scan range	50Hz to 76Hz
	Vertical scan Size(Maximum)	336.312mm
	Optimal preset resolution	1920x1080@60Hz
	Plug & Play	VESA DDC2B/C1
	Input Connector	VGA,HDMI, DP
	Input Video Signal	Analog: 0.7Vp-p(standard),75 OHM,Positive,HDMI,MHL,DP
	Power Source	100-240V~, 50/60Hz
	Power Consumption	Active<35W(Typical)
		Standby < 0.5 W
Off timer	0-24 hrs	
Physical Characteristics	Connector Type	VGA, HDMI, DP
	Signal Cable Type	Detachable
	Dimensions & Weight:	
	Height (with base)	448.8mm
	Width	621.9mm
	Depth	213.2mm
	Weight (monitor only)	5.0kg
Environmental	Temperature:	
	Operating	0° to 40°
	Non-Operating	-25°to 55°
	Humidity:	
	Operating	10% to 85% (non-condensing)
	Non-Operating	5% to 93% (non-condensing)
	Altitude:	
	Operating	0~ 5000m (0~ 16404 ft)
	Non-Operating	0~ 12192m (0~ 40000 ft)

Preset Display Modes

STAND	Resolution	HORIZONTAL FREQUENCY(kHZ)	VERTICAL FREQUENCY(Hz)
VGA	640x480@60Hz	31.469	59.940
	640x480@72Hz	37.861	72.809
	640x480@75Hz	37.500	75.00
SVGA	800x600@56Hz	35.156	56.250
	800x600@60Hz	37.879	60.317
	800x600@72Hz	48.077	72.188
	800x600@75Hz	46.875	75.000
XGA	1024x768@60Hz	48.363	60.004
	1024x768@70Hz	56.476	70.069
	1024x768@75Hz	60.023	75.029
SXGA	1280x1024@60Hz	63.981	60.020
	1280x1024@75Hz	79.976	75.025
WXGA+	1440x900@60Hz	55.935	59.887
WSXGA	1680x1050@60Hz	65.290	59.954
HD	1920x1080@60Hz	67.500	60.000
***	1280x960@60HZ	60.000	60.000
IBM MODE DOS	640x350@70Hz	31.469	70.087
	720x400@70Hz	31.469	70.087
MAC MODE VGA	640x480@67Hz	35.000	66.667
MAC MODE SVGA	832x624@75Hz	49.725	74.551
MAC MODE XGA	1024x768@75Hz	60.241	74.927

HDMI timing

Format	Resolution	Vertical frequency
480p	640 x 480	60Hz
480p	720 x 480	60Hz
576p	720 x 576	50Hz
720p	1280 x 720	50Hz , 60Hz
1080i	1920 x 1080	50Hz , 60Hz
1080p	1920 x 1080	50Hz, 60Hz

MHL timing

Format	Resolution	Type	Vertical frequency
480p	640 x 480	SD	60Hz
480p	720 x 480	SD	60Hz
576p	720 x 576	SD	50Hz
720p	1280 x 720	HD	50Hz , 60Hz
1080i	1920 x 1080	HD	50Hz , 60Hz
1080p	1920 x 1080	HD	30Hz, 50Hz, 60Hz

Pin Assignments

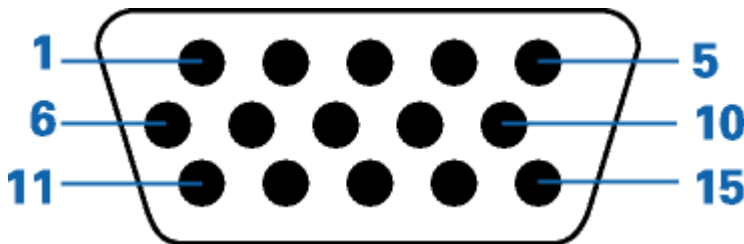

Pin Number	15-Pin Side of the Signal Cable
1	Video-Red
2	Video-Green
3	Video-Blue
4	N.C.
5	Detect Cable
6	GND-R
7	GND-G
8	GND-B
9	+5V
10	Ground
11	N.C.
12	DDC-Serial data
13	H-sync
14	V-sync
15	DDC-Serial clock

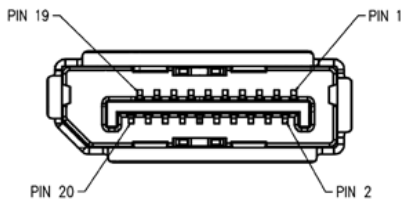

PIN	MNEMONIC	SIGNAL
1	ML Lane 3 (n)	Lane 3 -
2	GND	Ground
3	ML Lane 3 (p)	Lane 3 +
4	ML Lane 2 (n)	Lane 2 -
5	GND	Ground
6	ML Lane 2 (p)	Lane 2 +
7	ML Lane 1 (n)	Lane 1 -
8	GND	Ground
9	ML Lane 1 (p)	Lane 1 p
10	ML Lane 0 (n)	Lane 0 -
11	GND	Ground
12	ML Lane 0 (p)	Lane 0 +
13	GND	Ground
14	GND	Ground
15	AUX CH (p)	Aux Channel +
16	GND	Ground
17	AUX CH (n)	Aux Channel -
18	HPD	Hot Plug Detect
19	Return	Return
20	DP PWR	Source Power In

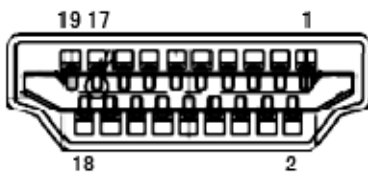

Pin No.	Signal Name	Pin No.	Signal Name	Pin No.	Signal Name
1	TMDS Data 2+	9	TMDS Data 0	17	DDC/CEC Ground
2	TMDS Data 2 Shield	10	TMDS Clock +	18	+5V Power
3	TMDS Data 2	11	TMDS Clock Shield	19	Hot Plug Detect
4	TMDS Data 1+	12	TMDS Clock		
5	TMDS Data 1Shield	13	CEC		
6	TMDS Data 1	14	Reserved (N.C. on device)		
7	TMDS Data 0+	15	SCL		
8	TMDS Data 0 Shield	16	SDA		

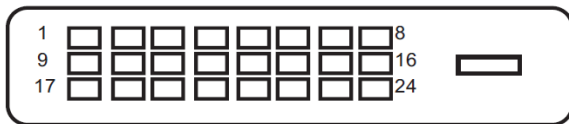

Pin Number	24-Pin Color Display Signal Cable	Pin Number	24-Pin Color Display Signal Cable
1	TMDS data 2-	13	TMDS data 3+
2	TMDS data 2+	14	+5V Power
3	TMDS data 2/4 Shield	15	Ground (for+5V)
4	TMDS data 4-	16	Hot Plug Detect
5	TMDS data 4+	17	TMDS data 0-
6	DDC Clock	18	TMDS data 0+
7	DDC Data	19	TMDS data 0/5 Shield
8	N.C.	20	TMDS data 5-
9	TMDS data 1-	21	TMDS data 5+
10	TMDS data 1+	22	TMDS Clock Shield
11	TMDS data 1/3 Shield	23	TMDS Clock +
12	TMDS data 3-	24	TMDS Clock -

Plug and Play

Plug & Play DDC2B Feature

This monitor is equipped with VESA DDC2B capabilities according to the VESA DDC STANDARD. It allows the monitor to inform the host system of its identity and, depending on the level of DDC used, communicate additional information about its display capabilities.

The DDC2B is a bi-directional data channel based on the I2C protocol. The host can request EDID information over the DDC2B channel.

Regulation

FCC Notice

FCC Class B Radio Frequency Interference Statement WARNING: (FOR FCC CERTIFIED MODELS)

NOTE: This equipment has been tested and found to comply with the limits for a Class B digital device, pursuant to Part 15 of the FCC Rules. These limits are designed to provide reasonable protection against harmful interference in a residential installation. This equipment generates, uses and can radiate radio frequency energy, and if not installed and used in accordance with the instructions, may cause harmful interference to radio communications. However, there is no guarantee that interference will not occur in a particular installation. If this equipment does cause harmful interference to radio or television reception, which can be determined by turning the equipment off and on, the user is encouraged to try to correct the interference by one or more of the following measures:

Reorient or relocate the receiving antenna.

Increase the separation between the equipment and receiver.

Connect the equipment into an outlet on a circuit different from that to which the receiver is connected.

Consult the dealer or an experienced radio/TV technician for help.

NOTICE :

The changes or modifications not expressly approved by the party responsible for compliance could void the user's authority to operate the equipment.

Shielded interface cables and AC power cord, if any, must be used in order to comply with the emission limits.

The manufacturer is not responsible for any radio or TV interference caused by unauthorized modification to this equipment. It is the responsibilities of the user to correct such interference. It is the responsibility of the user to correct such interference.

CE Declaration of Conformity

T h i s p r o d u c t i s i n c o n f o r m i t y w i t h t h e f o l l o w i n g s t a n d a r d s

- EN60950-1:2006 and A11+A1 (Safety requirement of Information Technology Equipment).
- EN 55022:2006+A1: 2007 (Radio Disturbance requirement of Information Technology Equipment).
- EN55024:1998+A1:2001+A2:2003 (Immunity requirement of Information Technology Equipment).
- EN 61000-3-2:2006+A1: 2009+A2: 2009 (Harmonic current emissions).
- EN 61000-3-3:2008 (Voltage fluctuations & flicker) following provisions of directives applicable.
- 2006/95/EC (Low Voltage Directive).
- 2004/108/EC (EMC Directive).
- 2005/32/EC (EuP Directive, EC No. 1275/2008 implementing Directive for Standby and Off mode power consumption) and is produced by a manufacturing organization on ISO9000 level.

WEEE Declaration

Disposal of Waste Equipment by Users in Private Household in the European Union.



This symbol on the product or on its packaging indicates that this product must not be disposed of with your other household waste. Instead, it is your responsibility to dispose of your waste equipment by handing it over to a designated collection point for the recycling of waste electrical and electronic equipment. The separate collection and recycling of your waste equipment at the time of disposal will help to conserve natural resources and ensure that it is recycled in a manner that protects human health and the environment. For more information about where you can drop off your waste equipment for recycling, please contact your local city office, your household waste disposal service or the shop where you purchased the product .



WEEE/E-Waste declaration for India



This symbol on the product or on its packaging indicates that this product must not be disposed of with your other household waste. Instead, it is your responsibility to dispose of your waste equipment by handing it over to a designated collection point for the recycling of waste electrical and electronic equipment. The separate collection and recycling of your waste equipment at the time of disposal will help to conserve natural resources and ensure that it is recycled in a manner that protects human health and the environment. For more information about where you can drop off your waste equipment for recycling in India, please visit the below web link.

www.aocindia.com/ewaste.php

Service

EU WARRANTY FOR AOC MONITORS

LIMITED THREE-YEAR WARRANTY*

For AOC LCD Monitors sold within Europe, AOC International (Europe) B.V. warrants this product to be free from defects in material and workmanship for a period of Three (3) years after the original date of consumer purchase. During this period, AOC International (Europe) B.V. will, at its option, either repair the defective product with new or rebuilt parts, or replace it with a new or rebuilt product at no charge except as *stated below. In the absent of the proof of purchase, the warranty will start 3 months after the date of manufacturing indicated on the product.

If the product appears to be defective, please contact your local dealer or refer to the service and support section on www.aoc-europe.com for warranty instructions. Deliver the product freight pre-paid, along with the dated proof of purchase, to the AOC Certified or Authorized Service Center under the following condition:

- Make sure the LCD Monitor is packed in a proper carton box (AOC prefers the original carton box to protect your monitor well enough during transport).
- Put the RMA number on the address label
- Put the RMA number on the shipping carton

AOC International (Europe) B.V. is not responsible for any damaged during transport due to improper packing. AOC International (Europe) B.V. will pay the return shipping charges within one of the countries specified within this warranty statement. AOC International (Europe) B.V. is not responsible for any costs associated with the transportation of product across international borders. This includes the international border within the European Union. If the LCD Monitor is not available for collection when the carrier attends, you will be charged a collection fee.

*** This limited warranty does not cover any losses or damages that occur as a result of:**

- Improper installation or maintenance
- Misuse
- Neglect
- Any cause other than ordinary commercial or industrial application
- Adjustment by non-authorized source
- Repair, modification, or installation of options or parts by anyone other than an AOC Certified or Authorized Service Center
- Improper environments like humidity and dusts
- Damaged by violence
- Excessive or inadequate heating or air conditioning or electrical powers failures, surges, or other irregularities

All AOC LCD Monitors are produced according to the ISO 9241-307 Class 1 pixel policy standards.

ALL EXPRESS AND IMPLIED WARRANTIES FOR THIS PRODUCT (INCLUDING THE WARRANTIES OF MERCHANTABILITY AND FITNESS FOR A PARTICULAR PURPOSE) ARE LIMITED IN DURATION TO A PERIOD OF THREE (3) YEARS FOR PARTS AND LABOR FROM THE ORIGINAL DATE OF CONSUMER PURCHASE. NO WARRANTIES (EITHER EXPRESSED OR IMPLIED) APPLY AFTER THIS PERIOD. AOC INTERNATIONAL (EUROPE) B.V. OBLIGATIONS AND YOUR REMEDIES HEREUNDER ARE SOLELY AND EXCLUSIVELY AS STATED HERE. AOC INTERNATIONAL (EUROPE) B.V. LIABILITY, WHETHER BASED ON CONTRACT, TORT, WARRANTY, STRICT LIABILITY, OR OTHER THEORY, SHALL NOT EXCEED THE PRICE OF THE INDIVIDUAL UNIT WHOSE DEFECT OR DAMAGE IS THE BASIS OF THE CLAIM. IN NO EVENT SHALL AOC INTERNATIONAL (EUROPE) B.V. BE LIABLE FOR ANY LOSS OF PROFITS, LOSS OF USE OR FACILITIES OR EQUIPMENT, OR OTHER INDIRECT, INCIDENTAL, OR CONSEQUENTIAL DAMAGE. SOME STATES DO NOT ALLOW THE EXCLUSION OR LIMITATION OF INCIDENTAL OR CONSEQUENTIAL DAMAGES, SO THE ABOVE LIMITATION MAY NOT APPLY TO YOU. ALTHOUGH THIS LIMITED WARRANTY GIVES YOU SPECIFIC LEGAL RIGHTS, YOU MAY HAVE OTHER RIGHTS, WHICH MAY VARY FROM COUNTRY TO COUNTRY. THIS LIMITED WARRANTY IS ONLY VALID FOR PRODUCTS PURCHASED IN THE MEMBER COUNTRIES OF THE EUROPEAN UNION.

Warranty Statement for North & South America (excluding Brazil)

WARRANTY STATEMENT
for AOC Color Monitors
Including those Sold within North America as Specified

Envision Peripherals, Inc. warrants this product to be free from defects in material and workmanship for a period of three (3) years for parts & labor and one (1) year for CRT Tube or LCD Panel after the original date of consumer purchase. During this period, EPI (EPI is the abbreviation of Envision Peripherals, Inc.) will, at its option, either repair the defective product with new or rebuilt parts, or replace it with a new or rebuilt product at no charge except as *stated below. The parts or product that are replaced become the property of EPI.

In the USA to obtain service under this limited warranty, call EPI for the name of the Authorized Service Center closest to your area. Deliver the dated proof of purchase to the EPI Authorized Service Center.

If you cannot deliver the product in person:

- Pack it in its original shipping container (or equivalent)
- Put the RMA number on the address label
- Put the RMA number on the shipping carton
- Insure it (or assume the risk of loss/damage during shipment)
- Pay all shipping charges

EPI is not responsible for damage to inbound product that was not properly packaged.

EPI will pay the return shipment charges within one of the countries specified within this warranty statement. EPI is not responsible for any costs associated with the transportation of product across international borders. This includes the international borders of the countries within this warranty statements.

In the United States and Canada contact your Dealer or EPI Customer Service, RMA Department at the toll free number (888) 662-9888. Or you can request an RMA Number online at www.aoc.com/na-warranty.

* This limited warranty does not cover any losses or damages that occur as a result of:

- Shipping or improper installation or maintenance
- Misuse
- Neglect
- Any cause other than ordinary commercial or industrial application
- Adjustment by non-authorized source
- Repair, modification, or installation of options or parts by anyone other than an EPI Authorized Service Center
- Improper environment
- Excessive or inadequate heating or air conditioning or electrical power failures, surges, or other irregularities

This three-year limited warranty does not cover any of the product's firmware or hardware that you or any third party have modified or altered; you bear the sole responsibility and liability for any such modification or alteration.

ALL EXPRESS AND IMPLIED WARRANTIES FOR THIS PRODUCT (INCLUDING THE WARRANTIES OF MERCHANTABILITY AND FITNESS FOR A PARTICULAR PURPOSE) ARE LIMITED IN DURATION TO A PERIOD OF THREE (3) YEARS FOR PARTS AND LABOR AND ONE (1) YEAR FOR CRT TUBE OR LCD PANEL FROM THE ORIGINAL DATE OF CONSUMER PURCHASE. NO WARRANTIES (EITHER EXPRESSED OR IMPLIED) APPLY AFTER THIS PERIOD. IN THE UNITED STATES OF AMERICA, SOME STATES DO NOT ALLOW LIMITATIONS ON HOW LONG AN IMPLIED WARRANTY LASTS, SO THE ABOVE LIMITATIONS MAY NOT APPLY TO YOU.

EPI OBLIGATIONS AND YOUR REMEDIES HEREUNDER ARE SOLELY AND EXCLUSIVELY AS STATED HERE. EPI' LIABILITY, WHETHER BASED ON CONTRACT, TORT, WARRANTY, STRICT LIABILITY, OR OTHER THEORY, SHALL NOT EXCEED THE PRICE OF THE INDIVIDUAL UNIT WHOSE DEFECT OR DAMAGE IS THE BASIS OF THE CLAIM. IN NO EVENT SHALL ENVISION PERIPHERALS, INC. BE LIABLE FOR ANY LOSS OF PROFITS, LOSS OF USE OR FACILITIES OR EQUIPMENT OR OTHER INDIRECT, INCIDENTAL, OR CONSEQUENTIAL DAMAGE. IN THE UNITED STATES OF AMERICA, SOME STATES DO NOT ALLOW THE EXCLUSION OR LIMITATION OF INCIDENTAL OR CONSEQUENTIAL DAMAGES. SO THE ABOVE LIMITATION MAY NOT APPLY TO YOU. ALTHOUGH THIS LIMITED WARRANTY GIVES YOU SPECIFIC LEGAL RIGHTS. YOU MAY HAVE OTHER RIGHTS WHICH MAY VARY FROM STATE TO STATE.

In the United States of America, this limited warranty is only valid for Products purchased in the Continental United States, Alaska, and Hawaii.

Outside the United States of America, this limited warranty is only valid for Products purchased in Canada.

Information in this document is subject to change without notice.

For more details, please visit:

USA: <http://us.aoc.com/support/warranty>

ARGENTINA: <http://ar.aoc.com/support/warranty>

BOLIVIA: <http://bo.aoc.com/support/warranty>

CHILE: <http://cl.aoc.com/support/warranty>

COLOMBIA: <http://co.aoc.com/warranty>

COSTA RICA: <http://cr.aoc.com/support/warranty>

DOMINICAN REPUBLIC: <http://do.aoc.com/support/warranty>

ECUADOR: <http://ec.aoc.com/support/warranty>

EL SALVADOR: <http://sv.aoc.com/support/warranty>

GUATEMALA: <http://gt.aoc.com/support/warranty>

HONDURAS: <http://hn.aoc.com/support/warranty>

NICARAGUA: <http://ni.aoc.com/support/warranty>

PANAMA: <http://pa.aoc.com/support/warranty>

PARAGUAY: <http://py.aoc.com/support/warranty>

PERU: <http://pe.aoc.com/support/warranty>

URUGUAY: <http://pe.aoc.com/warranty>

VENEZUELA: <http://ve.aoc.com/support/warranty>

IF COUNTRY NOT LISTED: <http://latin.aoc.com/warranty>



Only for AOC branded monitors sold within the continental United States.

All AOC branded monitors are now covered by the EASE Program. If your monitor malfunctions at any time during the first three months, AOC will provide a replacement monitor within 72 hours after you are approved for our program. If your monitor qualifies for the EASE program, AOC will pay for freight both ways.

Step 1: Phone our TECH Department at 888.662.9888

Step 2: Fill out and return EASE registration forms by mail or fax.

Step 3: We will issue a Return Authorization Number upon verification into the program.

Step 4: A monitor will be advance shipped to your location.

Step 5: We will issue a UPS Call Tag to pick up the defective unit.

Step 6: Please review the following chart to see your EASE program qualifications.

WARRANTY PERIOD	COVERAGE AT NO CHARGE	CUSTOMER CHARGES
Within the first three months of purchase: Covered by EASE	- New AOC monitor - Call tag dispatched and return freight charges via UPS	- None*
Between 4 months – 1 Year	- All Parts & Labor Including CRT Tube & LCD Panel	- UPS Return Freight to AOC
Between 1 Year - 3 Years: Covered by standard limited warranty	- Parts & Labor (excluding CRT Tube & LCD Panel)	- UPS Return Freight to AOC

*AOC will need to obtain a credit card number if you would like to get a new AOC monitor advanced shipped to your location, prior to the defective unit arriving at AOC's service center. If you do not wish to supply a credit card, AOC will only ship the new monitor, once the defective unit arrives at the AOC service center.



Congratulations!

This product is designed for both you and the planet!



TCO Development works for sustainable IT - manufacture, use and recycling of IT products reflecting environmental, social and economic responsibility.

TCO Certified is a third party verified program, where every product model is tested by an accredited impartial test laboratory. TCO

Certified represents one of the toughest certifications for ICT products worldwide.

Some of the Usability features of TCO Certified Displays:

- Visual Ergonomics for image quality is tested to ensure top performance and reduce sight and strain problems. Important parameters are Resolution, Luminance, Contrast, Reflection and Colour characteristics
- Products are tested according to rigorous safety standards at impartial laboratories
- Electric and magnetic fields emissions as low as normal household background levels
- Workload ergonomics to ensure a good physical environment

Some of the Environmental features of TCO Certified Displays:

- Production facilities have an Environmental Management System (EMAS or ISO 14001)
- Low energy consumption to minimize climate impact
- Restrictions on Chlorinated and Brominated flame retardants, plasticizers, plastics and heavy metals such as cadmium, mercury and lead (RoHS compliance)
- Both product and product packaging is prepared for recycling
- The brand owner offers take-back options

Corporate Social Responsibility

- The brand owner demonstrates the product is manufactured under working practices that promote good labour relations and working conditions.

The Criteria Document can be downloaded from our web site. The criteria included in this label have been developed by TCO Development in co-operation with scientists, experts, users as well as manufacturers all over the world. Since the end of the 1980s TCO has been involved in influencing the development of IT equipment in a more user and environmentally friendly direction. Our ICT product labeling system began in 1992 and is now requested by users and ICT-manufacturers all over the world.

For more information, please visit
www.tcodevelopment.com

