

**M4A87TD  
EVO**

**Motherboard**

**ASUS®**

**Copyright © 2010 ASUSTeK COMPUTER INC. All Rights Reserved.**

No part of this manual, including the products and software described in it, may be reproduced, transmitted, transcribed, stored in a retrieval system, or translated into any language in any form or by any means, except documentation kept by the purchaser for backup purposes, without the express written permission of ASUSTeK COMPUTER INC. ("ASUS").

Product warranty or service will not be extended if: (1) the product is repaired, modified or altered, unless such repair, modification or alteration is authorized in writing by ASUS; or (2) the serial number of the product is defaced or missing.

ASUS PROVIDES THIS MANUAL "AS IS" WITHOUT WARRANTY OF ANY KIND, EITHER EXPRESS OR IMPLIED, INCLUDING BUT NOT LIMITED TO THE IMPLIED WARRANTIES OR CONDITIONS OF MERCHANTABILITY OR FITNESS FOR A PARTICULAR PURPOSE. IN NO EVENT SHALL ASUS, ITS DIRECTORS, OFFICERS, EMPLOYEES OR AGENTS BE LIABLE FOR ANY INDIRECT, SPECIAL, INCIDENTAL, OR CONSEQUENTIAL DAMAGES (INCLUDING DAMAGES FOR LOSS OF PROFITS, LOSS OF BUSINESS, LOSS OF USE OR DATA, INTERRUPTION OF BUSINESS AND THE LIKE), EVEN IF ASUS HAS BEEN ADVISED OF THE POSSIBILITY OF SUCH DAMAGES ARISING FROM ANY DEFECT OR ERROR IN THIS MANUAL OR PRODUCT.

SPECIFICATIONS AND INFORMATION CONTAINED IN THIS MANUAL ARE FURNISHED FOR INFORMATIONAL USE ONLY, AND ARE SUBJECT TO CHANGE AT ANY TIME WITHOUT NOTICE, AND SHOULD NOT BE CONSTRUED AS A COMMITMENT BY ASUS. ASUS ASSUMES NO RESPONSIBILITY OR LIABILITY FOR ANY ERRORS OR INACCURACIES THAT MAY APPEAR IN THIS MANUAL, INCLUDING THE PRODUCTS AND SOFTWARE DESCRIBED IN IT.

Products and corporate names appearing in this manual may or may not be registered trademarks or copyrights of their respective companies, and are used only for identification or explanation and to the owners' benefit, without intent to infringe.

**Offer to Provide Source Code of Certain Software**

This product may contain copyrighted software that is licensed under the General Public License ("GPL") and under the Lesser General Public License Version ("LGPL"). The GPL and LGPL licensed code in this product is distributed without any warranty. Copies of these licenses are included in this product.

You may obtain the complete corresponding source code (as defined in the GPL) for the GPL Software, and/or the complete corresponding source code of the LGPL Software (with the complete machine-readable "work that uses the Library") for a period of three years after our last shipment of the product including the GPL Software and/or LGPL Software, which will be no earlier than December 1, 2011, either (1) for free by downloading it from <http://support.asus.com/download>;

or

(2) for the cost of reproduction and shipment, which is dependent on the preferred carrier and the location where you want to have it shipped to, by sending a request to:

ASUSTeK Computer Inc.  
Legal Compliance Dept.  
15 Li Te Rd.,  
Beitou, Taipei 112  
Taiwan

In your request please provide the name, model number and version, as stated in the About Box of the product for which you wish to obtain the corresponding source code and your contact details so that we can coordinate the terms and cost of shipment with you.

The source code will be distributed WITHOUT ANY WARRANTY and licensed under the same license as the corresponding binary/object code.

This offer is valid to anyone in receipt of this information.

ASUSTeK is eager to duly provide complete source code as required under various Free Open Source Software licenses. If however you encounter any problems in obtaining the full corresponding source code we would be much obliged if you give us a notification to the email address [gpl@asus.com](mailto:gpl@asus.com), stating the product and describing the problem (please do NOT send large attachments such as source code archives etc to this email address).

# Contents

Notices.....	vi
Safety information .....	vii
About this guide .....	vii
M4A87TD EVO specifications summary.....	ix

## Chapter 1

<b>1.1</b>	<b>Welcome!</b> .....	<b>1-1</b>
<b>1.2</b>	<b>Package contents</b> .....	<b>1-1</b>
<b>1.3</b>	<b>Special features</b> .....	<b>1-1</b>
1.3.1	Product highlights .....	1-1
1.3.2	ASUS Unique Features.....	1-2
<b>1.4</b>	<b>Before you proceed</b> .....	<b>1-4</b>
<b>1.5</b>	<b>Motherboard overview</b> .....	<b>1-4</b>
1.5.1	Placement direction .....	1-4
1.5.2	Screw holes .....	1-4
1.5.3	Motherboard layout .....	1-5
1.5.4	Layout contents.....	1-5
<b>1.6</b>	<b>Central Processing Unit (CPU)</b> .....	<b>1-6</b>
1.6.1	Installing the CPU .....	1-6
1.6.2	Installing the heatsink and fan .....	1-7
<b>1.7</b>	<b>System memory</b> .....	<b>1-9</b>
1.7.1	Overview .....	1-9
1.7.2	Memory configurations.....	1-9
1.7.3	Installing a DIMM .....	1-16
1.7.4	Removing a DIMM .....	1-16
<b>1.8</b>	<b>Expansion slots</b> .....	<b>1-17</b>
1.8.1	Installing an expansion card .....	1-17
1.8.2	Configuring an expansion card .....	1-17
1.8.3	PCI slots.....	1-17
1.8.4	PCI Express 2.0 x1 slots.....	1-17
1.8.5	PCI Express 2.0 x16 slots.....	1-17
<b>1.9</b>	<b>Jumper</b> .....	<b>1-18</b>
<b>1.10</b>	<b>Onboard switches</b> .....	<b>1-19</b>
<b>1.11</b>	<b>Onboard LEDs</b> .....	<b>1-21</b>
<b>1.12</b>	<b>Connectors</b> .....	<b>1-23</b>
1.12.1	Rear panel connectors.....	1-23

# Contents

1.12.2	Internal connectors .....	1-25
<b>1.13</b>	<b>Software support.....</b>	<b>1-33</b>
1.13.1	Installing an operating system .....	1-33
1.13.2	Support DVD information .....	1-33

## Chapter 2

<b>2.1</b>	<b>Knowing BIOS .....</b>	<b>2-1</b>
<b>2.2</b>	<b>Updating BIOS.....</b>	<b>2-1</b>
2.2.1	ASUS Update utility .....	2-2
2.2.2	ASUS EZ Flash 2 utility.....	2-3
2.2.3	ASUS CrashFree BIOS 3 utility .....	2-4
<b>2.3</b>	<b>BIOS setup program .....</b>	<b>2-5</b>
2.3.1	BIOS menu screen.....	2-6
2.3.2	Menu bar.....	2-6
2.3.3	Navigation keys.....	2-7
2.3.4	Menu items .....	2-7
2.3.5	Submenu items .....	2-7
2.3.6	Configuration fields .....	2-7
2.3.7	General help .....	2-7
2.3.8	Pop-up window .....	2-7
2.3.9	Scroll bar.....	2-7
<b>2.4</b>	<b>Main menu .....</b>	<b>2-8</b>
2.4.1	SATA 1–6 .....	2-8
2.4.2	Storage Configuration .....	2-9
2.4.3	System Information .....	2-10
<b>2.5</b>	<b>Ai Tweaker menu.....</b>	<b>2-11</b>
2.5.1	CPU Level UP .....	2-11
2.5.2	OC Tuner Utility.....	2-11
2.5.3	Ai Overclock Tuner .....	2-11
2.5.4	CPU Ratio .....	2-12
2.5.5	DRAM Frequency .....	2-12
2.5.6	CPU/NB Frequency .....	2-13
2.5.7	HT Link Speed .....	2-13
2.5.8	DRAM Timing Configuration .....	2-13
2.5.9	DRAM Driving Configuration.....	2-14
2.5.10	CPU & NB Voltage Mode .....	2-14

# Contents

2.5.11	CPU VDDA Voltage .....	2-15
2.5.12	DRAM Voltage .....	2-15
2.5.13	HT Voltage .....	2-15
2.5.14	NB Voltage .....	2-15
2.5.15	CPU Load-Line Calibration .....	2-15
2.5.16	CPU/NB Load-Line Calibration .....	2-15
2.5.17	CPU Spread Spectrum .....	2-15
2.5.18	PCIe Spread Spectrum .....	2-15
<b>2.6</b>	<b>Advanced menu .....</b>	<b>2-16</b>
2.6.1	CPU Configuration .....	2-16
2.6.2	Chipset .....	2-17
2.6.3	Onboard Devices Configuration .....	2-17
2.6.4	USB Configuration .....	2-18
2.6.5	PCIe PnP .....	2-19
<b>2.7</b>	<b>Power menu .....</b>	<b>2-20</b>
2.7.1	Suspend Mode .....	2-20
2.7.2	Repost Video on S3 Resume .....	2-20
2.7.3	ACPI 2.0 Support .....	2-20
2.7.4	ACPI APIC support .....	2-20
2.7.5	APM Configuration .....	2-21
2.7.6	Hardware Monitor .....	2-21
<b>2.8</b>	<b>Boot menu .....</b>	<b>2-23</b>
2.8.1	Boot Device Priority .....	2-23
2.8.2	Boot Settings Configuration .....	2-23
2.8.3	Security .....	2-24
<b>2.9</b>	<b>Tools menu .....</b>	<b>2-25</b>
2.9.1	ASUS EZ Flash 2 .....	2-25
2.9.2	Express Gate .....	2-25
2.9.3	ASUS O.C. Profile .....	2-26
2.9.4	AI NET 2 .....	2-26
<b>2.10</b>	<b>Exit menu .....</b>	<b>2-27</b>

## Notices

### Federal Communications Commission Statement

This device complies with Part 15 of the FCC Rules. Operation is subject to the following two conditions:

- This device may not cause harmful interference, and
- This device must accept any interference received including interference that may cause undesired operation.

This equipment has been tested and found to comply with the limits for a Class B digital device, pursuant to Part 15 of the FCC Rules. These limits are designed to provide reasonable protection against harmful interference in a residential installation. This equipment generates, uses and can radiate radio frequency energy and, if not installed and used in accordance with manufacturer's instructions, may cause harmful interference to radio communications. However, there is no guarantee that interference will not occur in a particular installation. If this equipment does cause harmful interference to radio or television reception, which can be determined by turning the equipment off and on, the user is encouraged to try to correct the interference by one or more of the following measures:

- Reorient or relocate the receiving antenna.
- Increase the separation between the equipment and receiver.
- Connect the equipment to an outlet on a circuit different from that to which the receiver is connected.
- Consult the dealer or an experienced radio/TV technician for help.



---

The use of shielded cables for connection of the monitor to the graphics card is required to assure compliance with FCC regulations. Changes or modifications to this unit not expressly approved by the party responsible for compliance could void the user's authority to operate this equipment.

---

### Canadian Department of Communications Statement

This digital apparatus does not exceed the Class B limits for radio noise emissions from digital apparatus set out in the Radio Interference Regulations of the Canadian Department of Communications.

This class B digital apparatus complies with Canadian ICES-003.

### REACH

Complying with the REACH (Registration, Evaluation, Authorisation, and Restriction of Chemicals) regulatory framework, we published the chemical substances in our products at ASUS REACH website at <http://green.asus.com/english/REACH.htm>.



---

**DO NOT** throw the motherboard in municipal waste. This product has been designed to enable proper reuse of parts and recycling. This symbol of the crossed out wheeled bin indicates that the product (electrical and electronic equipment) should not be placed in municipal waste. Check local regulations for disposal of electronic products.

---



---

**DO NOT** throw the mercury-containing button cell battery in municipal waste. This symbol of the crossed out wheeled bin indicates that the battery should not be placed in municipal waste.

---

# Safety information

## Electrical safety

- To prevent electrical shock hazard, disconnect the power cable from the electrical outlet before relocating the system.
- When adding or removing devices to or from the system, ensure that the power cables for the devices are unplugged before the signal cables are connected. If possible, disconnect all power cables from the existing system before you add a device.
- Before connecting or removing signal cables from the motherboard, ensure that all power cables are unplugged.
- Seek professional assistance before using an adapter or extension cord. These devices could interrupt the grounding circuit.
- Ensure that your power supply is set to the correct voltage in your area. If you are not sure about the voltage of the electrical outlet you are using, contact your local power company.
- If the power supply is broken, do not try to fix it by yourself. Contact a qualified service technician or your retailer.

## Operation safety

- Before installing the motherboard and adding devices on it, carefully read all the manuals that came with the package.
- Before using the product, ensure all cables are correctly connected and the power cables are not damaged. If you detect any damage, contact your dealer immediately.
- To avoid short circuits, keep paper clips, screws, and staples away from connectors, slots, sockets and circuitry.
- Avoid dust, humidity, and temperature extremes. Do not place the product in any area where it may become wet.
- Place the product on a stable surface.
- If you encounter technical problems with the product, contact a qualified service technician or your retailer.

## About this guide

This user guide contains the information you need when installing and configuring the motherboard.

### How this guide is organized

This guide contains the following parts:

- **Chapter 1: Product introduction**  
This chapter describes the features of the motherboard and the new technology it supports.
- **Chapter 2: BIOS setup**  
This chapter tells how to change system settings through the BIOS Setup menus. Detailed descriptions of the BIOS parameters are also provided.

## Conventions used in this guide

To ensure that you perform certain tasks properly, take note of the following symbols used throughout this manual.



**DANGER/WARNING:** Information to prevent injury to yourself when trying to complete a task.



**CAUTION:** Information to prevent damage to the components when trying to complete a task.



**IMPORTANT:** Instructions that you **MUST** follow to complete a task.



**NOTE:** Tips and additional information to help you complete a task.

## Where to find more information

Refer to the following sources for additional information and for product and software updates.

### 1. ASUS websites

The ASUS website provides updated information on ASUS hardware and software products. Refer to the ASUS contact information.

### 2. Optional documentation

Your product package may include optional documentation, such as warranty flyers, that may have been added by your dealer. These documents are not part of the standard package.

## Typography

### **Bold text**

Indicates a menu or an item to select.

### *Italics*

Used to emphasize a word or a phrase.

### <Key>

Keys enclosed in the less-than and greater-than sign means that you must press the enclosed key.  
Example: <Enter> means that you must press the Enter or Return key.

### <Key1>+<Key2>+<Key3>

If you must press two or more keys simultaneously, the key names are linked with a plus sign (+).  
Example: <Ctrl>+<Alt>+<D>



## M4A87TD EVO specifications summary

<b>CPU</b>	<p>AMD® Socket AM3 for AMD® Phenom™ II / Athlon™ II / Sempron™ 100 Series Processors</p> <p>AMD® 140W CPU Support</p> <p>AMD® Cool 'n' Quiet™ 2.0 Technology (by CPU type)</p> <p>Supports 45nm CPU</p>
<b>Chipset</b>	AMD® 870 / SB850
<b>System bus</b>	Up to 5200 MT/s; HyperTransport™ 3.0 interface
<b>Memory</b>	<p>4 x DIMM, max. 16 GB, DDR3 2000 (O.C.) / 1600 / 1333 / 1066 MHz ECC / non-ECC, un-buffered memory</p> <p>Dual-channel memory architecture</p> <p>DDR3 Memory Ultra Low Voltage support</p> <p>* Due to OS limitation, when installing total memory of 4GB capacity or more, Windows® 32-bit operating system may only recognize less than 3GB. Install a 64-bit Windows® OS when you want to install 4GB or more memory on the motherboard.</p> <p>** Due to CPU spec., AMD 100 and 200 series CPUs support up to DDR3 1066MHz. With ASUS design, this motherboard can support up to DDR3 1333MHz.</p> <p>*** Refer to <a href="http://www.asus.com">www.asus.com</a> or this user manual for the Memory QVL (Qualified Vendors Lists)</p>
<b>Multi-GPU support</b>	Supports ATI® Quad-GPU CrossFireX™ Technology
<b>Expansion slots</b>	<p>2 x PCIe 2.0 x16 slots (blue at x16 mode, black at x4 mode)</p> <p>1 x PCIe 2.0 x1 slot</p> <p>3 x PCI 2.2 slots</p>
<b>Storage</b>	<p><b>SB850 chipset:</b></p> <ul style="list-style-type: none"> <li>- 6 x SATA 6Gb/s supporting RAID 0, 1, 5, and 10</li> </ul> <p><b>JMicron® JMB361 SATA &amp; PATA controllers:</b></p> <ul style="list-style-type: none"> <li>- 1 x UltraDMA 133/100 for up to 2 PATA devices</li> <li>- 1 x External SATA 3Gb/s port (SATA On-the-Go)</li> </ul>
<b>LAN</b>	RTL8111E PCIe Gigabit LAN controller featuring AI NET 2
<b>Audio</b>	<p>VIA® VT1818 8-channel High Definition Audio CODEC</p> <ul style="list-style-type: none"> <li>- Supports Jack-Detection, Multi-Streaming and Front Panel Jack-Retasking</li> <li>- Optical S/PDIF Out port at back I/O</li> <li>- Supports 192kHz/24bit BD Lossless Sound</li> <li>- ASUS Noise Filter</li> </ul>
<b>IEEE 1394</b>	VIA® VT6308P controller supports 2 x IEEE 1394a ports
<b>USB</b>	<p><b>NEC USB 3.0 controller:</b></p> <ul style="list-style-type: none"> <li>- 2 x USB 3.0/2.0 ports (blue at back panel)</li> </ul> <p><b>SB850 chipset:</b></p> <ul style="list-style-type: none"> <li>- 12 x USB 2.0 ports (6 ports at midboard; 6 ports at back panel)</li> </ul>

(continued on the next page)

## M4A87TD EVO specifications summary

<b>ASUS Unique Features</b>	<b>ASUS Xtreme Design</b> <b>ASUS Hybrid Processor—TurboV EVO</b> <ul style="list-style-type: none"><li>- TurboV, CPU Level UP, Turbo Key</li></ul> <b>ASUS Hybrid Switch</b> <ul style="list-style-type: none"><li>- Core Unlocker</li></ul> <b>ASUS Hybrid OS—Express Gate</b> <b>ASUS Power Solutions</b> <ul style="list-style-type: none"><li>- ASUS EPU</li></ul> <b>ASUS Exclusive Feature</b> <ul style="list-style-type: none"><li>- MemOK!</li></ul> <b>ASUS Quiet Thermal Solution</b> <ul style="list-style-type: none"><li>- ASUS Fanless Design: heatsink solution</li><li>- ASUS Fan Xpert</li></ul> <b>ASUS EZ DIY</b> <ul style="list-style-type: none"><li>- ASUS CrashFree BIOS 3</li><li>- ASUS O.C. Profile</li><li>- ASUS EZ Flash 2</li><li>- ASUS MyLogo 2™</li><li>- Multi-language BIOS</li></ul>
<b>ASUS Exclusive Overclocking Features</b>	<b>Precision Tweaker 2</b> <ul style="list-style-type: none"><li>- vCore: Adjustable CPU voltage at 0.003125V increment</li><li>- vDDNB: CPU NB voltage at 0.003125V increment</li><li>- vNB: Adjustable North Bridge voltage at 0.00625V increment</li><li>- vHT bus: Adjustable HT voltage at 0.00625V increment</li><li>- vDRAM Bus: Adjustable DRAM voltage at 0.00625V increment</li></ul> <b>SFS (Stepless Frequency Selection):</b> <ul style="list-style-type: none"><li>- CPU CLK tuning from 100MHz up to 600MHz at 1MHz increment</li><li>- Memory tuning from 1066MHz up to 2000MHz</li><li>- PCI Express frequency tuning from 100MHz up to 150MHz at 1MHz increment</li></ul> <b>Overclocking protection:</b> <ul style="list-style-type: none"><li>- ASUS C.P.R. (CPU Parameter Recall)</li></ul>
<b>Rear panel I/O ports</b>	1 x PS/2 keyboard port (purple) 1 x PS/2 mouse port (green) 2 X USB 3.0/2.0 ports (blue) 1 x Optical S/PDIF Out port 1 x IEEE 1394a port 1 X ESATA port 1 x LAN (RJ-45) port 6 x USB 2.0/1.1 ports 8-channel audio I/O ports

(continued on the next page)

## M4A87TD EVO specifications summary

<b>Internal I/O connectors</b>	3 x USB 2.0 connectors support additional 6 USB 2.0 ports 1 x IDE connector 1 x S/PDIF out header 1 x CPU fan connector 1 x chassis fan connector (4-pin) 1 x power fan connector (3-pin) 1 x COM port connector 6 x SATA 6Gb/s connectors 1 x system panel connector 1 x high definition front panel audio connector 1 x 24-pin EATX power connector 1 x 4-pin ATX 12V power connector 1 x Core Unlocker switch 1 x IEEE1394a connector 1 x MemOK! button
<b>BIOS features</b>	8 Mb Flash ROM, SPI, AMI BIOS, PnP, DMI 2.0, WfM2.0, SM BIOS 2.5, ACPI 2.0a, Multi-language BIOS, ASUS EZ Flash 2, ASUS CrashFree BIOS 3
<b>Manageability</b>	WfM 2.0, DMI 2.0, WOL by PME, WOR by PME, PXE
<b>Support DVD contents</b>	Drivers ASUS PC Probe II ASUS Express Gate ASUS Update Anti-virus software (OEM version)
<b>Form factor</b>	ATX form factor: 12 in x 8.8 in (30.5 cm x 22.4 cm)

\* Specifications are subject to change without notice.



# Chapter 1

## Product introduction

### 1.1 Welcome!

Thank you for buying an ASUS® M4A87TD EVO motherboard!

The motherboard delivers a host of new features and latest technologies, making it another standout in the long line of ASUS quality motherboards!

Before you start installing the motherboard, and hardware devices on it, check the items in your package with the list below.

### 1.2 Package contents

Check your motherboard package for the following items.

Motherboard	ASUS M4A87TD EVO motherboard
Cables	1 x Ultra DMA 133/100 cable 2 x Serial ATA 3.0Gb/s cable 2 x Serial ATA 6.0Gb/s cable 1 x 2 in 1 Q-connector
Accessories	1 x I/O shield
Application DVD	ASUS motherboard support DVD
Documentations	User manual



If any of the above items is damaged or missing, contact your retailer.

### 1.3 Special features

#### 1.3.1 Product highlights



#### AMD® Socket AM3; Phenom™ II / Athlon™ II / Sempron™ 100 Series Processors

This motherboard supports AMD® AM3 multi-core processors with unique L3 cache and delivers better overclocking capabilities with less power consumption. It features dual-channel DDR3 1333 memory support and accelerates data transfer rate up to 5200MT/s via HyperTransport™ 3.0 based system bus. This motherboard also supports AMD® CPUs in the new 45nm manufacturing process.



### AMD® 870 chipset

AMD® 870 Chipset is designed to support up to 5200MT/s HyperTransport™ 3.0 (HT 3.0) interface speed and PCI Express™ 2.0 x16 graphics. It is optimized with AMD®'s latest AM3 and multi-core CPUs to provide excellent system performance and overclocking capabilities.



### DDR3 2000(O.C.) support

This motherboard supports DDR3 2000(O.C.), which provides faster data transfer rate and more bandwidth to increase memory data transfer rate and computing efficiency. This enhances system performance in 3D graphics and other memory demanding applications.



### True SATA 6Gb/s Support

Supporting next-generation Serial ATA (SATA) storage interface, this motherboard delivers up to 6.0Gb/s data transfer rates. Additionally, get enhanced scalability, faster data retrieval, double the bandwidth of current bus systems.



### True USB 3.0 Support

Experience ultra-fast data transfers at 4.8Gbps with USB 3.0—the latest connectivity standard. Built to connect easily with next generation components and peripherals, USB 3.0 transfers data 10X faster and is also backward compatible with USB 2.0 components.

## 1.3.2 ASUS Unique Features

### ASUS Exclusive Features



#### Core Unlocker

ASUS Core Unlocker simplifies the activation of a latent AMD® CPU—with just a simple switch. Enjoy an instant performance boost by simply unlocking the extra cores, without performing complicated BIOS changes.



#### MemOK!

MemOK! Quickly ensures memory boot compatibility. This remarkable memory rescue tool requires a mere push of a button to patch memory issues. MemOK! Determines failsafe settings and dramatically improves your system boot success. Get your system up and running in no time!

### ASUS Power Solutions



#### 8+1 Phase Power Design

To fully unleash the next-generation AM3 CPU's potential, ASUS M4A87TD EVO motherboard has adopted the brand-new 8-phase VRM power design, which delivers high power efficiency and supreme overclocking ability. This series' high quality power components effectively lowers system temperature to ensure longer component lifespan. ASUS M4A87TD EVO also features an extra 1-phase power for integrated memory/HT controller to provide independent power to vital components.



### ASUS EPU

The ASUS EPU (Energy Processing Unit) provides total system power management by detecting current PC loadings and intelligently moderating power usage for critical PC components in real-time—helping save power and money!

## ASUS Hybrid OS



### ASUS Express Gate

Express Gate is an ASUS exclusive OS that provides you with quick access to the Internet and key applications before entering the Windows® OS.

## ASUS Quiet Thermal Solutions



### Fanless Design: stylish heatsink solution

The streamline-shaped heatsink features 0-dB thermal solution that offers users a noiseless PC environment. Not only the beautifully curved fins upgrade the visual enjoyment for motherboard users, but also the special thickened bottom design effectively cools down hot airflows generated by the north bridge chipset. Combined with usability and aesthetics, the ASUS streamline-shaped heatsink will give users an extremely silent and cooling experience with the elegant appearance!

## ASUS Intelligent Overclocking Tools



### TurboV EVO

Whether novice or enthusiast, TurboV EVO satisfies overclockers of any level. Intelligently push systems to the fastest, stable clock speeds with Auto-Tuning. Turbo Key boosts performance with a simple touch, while TurboV offers additional advanced options for breaking those records!



### CPU Level UP

Ever wish that you could have a more expansive CPU? Upgrade your CPU at no additional cost with CPU Level UP! Simply pick the processor you want to OC to, and the motherboard will do the rest! See the new CPU speed and enjoy that performance instantly. Overclocking is never as easy as this.



### Auto Tuning

Auto Tuning is an intelligent tool that automates overclocking to achieve a total system level up. This tool also provides stability testing. Even O.C. beginners can achieve extreme yet stable overclocking results with Auto Tuning!

## 1.4 Before you proceed

Take note of the following precautions before you install motherboard components or change any motherboard settings.



- Unplug the power cord from the wall socket before touching any component.
- Before handling components, use a grounded wrist strap or touch a safely grounded object or a metal object, such as the power supply case, to avoid damaging them due to static electricity.
- Hold components by the edges to avoid touching the ICs on them.
- Whenever you uninstall any component, place it on a grounded antistatic pad or in the bag that came with the component.
- Before you install or remove any component, switch off the ATX power supply and detach its power cord. Failure to do so may cause severe damage to the motherboard, peripherals, or components.

## 1.5 Motherboard overview

### 1.5.1 Placement direction

When installing the motherboard, ensure that you place it into the chassis in the correct orientation. The edge with external ports goes to the rear part of the chassis as indicated in the image below.

### 1.5.2 Screw holes

Place six (6) screws into the holes indicated by circles to secure the motherboard to the chassis.



Do not overtighten the screws! Doing so can damage the motherboard.

Place this side towards the rear of the chassis.

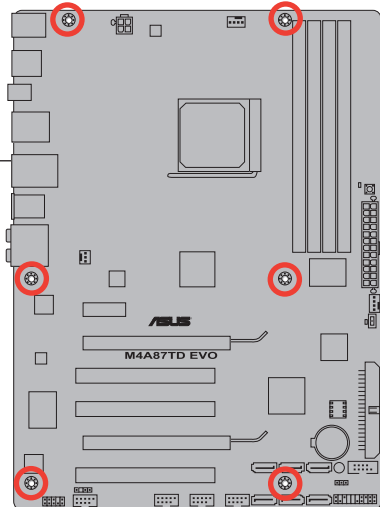



## 1.5.3 Motherboard layout

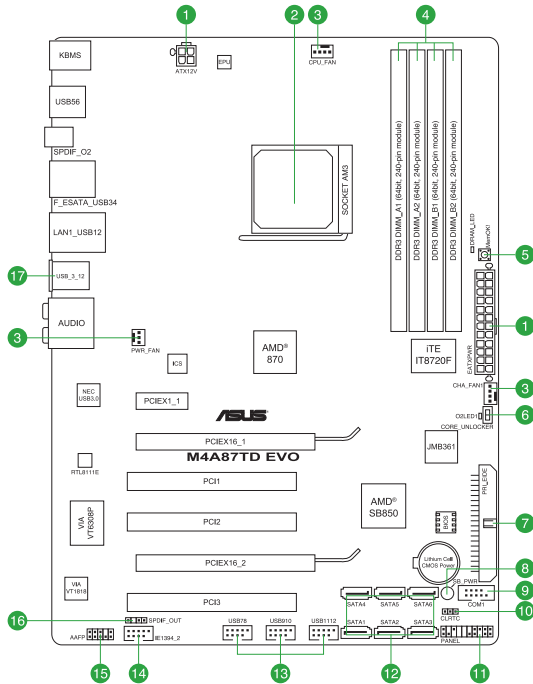

## 1.5.4 Layout contents

Connectors/Jumpers/Slots	Page
1. ATX power connectors (24-pin EATXPWR, 4-pin ATX12V)	1-26
2. CPU socket AM3	1-6
3. CPU, Chassis and Power Fan connectors (4-pin CPU_FAN, 4-pin CHA_FAN1, 3-pin PWR_FAN)	1-28
4. DDR3 DIMM slots	1-9
5. MemOK! switch	1-19
6. Core Unlocker switch (CORE_UNLOCKER)	1-20
7. IDE connector (40-1 pin PRI_IDE)	1-25
8. Standby power LED (SB_PWR)	1-21
9. Serial port connector (10-1 pin COM1)	1-31
10. Clear RTC RAM (CLRRTC)	1-18
11. System panel connector (20-8 pin PANEL)	1-29
12. Serial ATA 6Gb/s connectors (7-pin SATA1-6)	1-27
13. USB connectors (10-1 pin USB78, USB910, USB1112)	1-30
14. IEEE 1394a connector (10-1 pin IE1394_2)	1-32
15. Front panel audio connector (10-1 pin AAFP)	1-31
16. Digital audio connector (4-1 pin SPDIF_OUT)	1-30
17. USB 3.0 connectors	1-24

## 1.6 Central Processing Unit (CPU)

The motherboard comes with an AM3 socket designed for AMD® Phenom™ II / Athlon™ II / Sempron™ 100 Series Processors.



The CPU socket is not compatible with AMD® Opteron™ processors. Do not install an Opteron™ processor on this motherboard.

### 1.6.1 Installing the CPU

To install a CPU:

1. Locate the CPU socket on the motherboard.

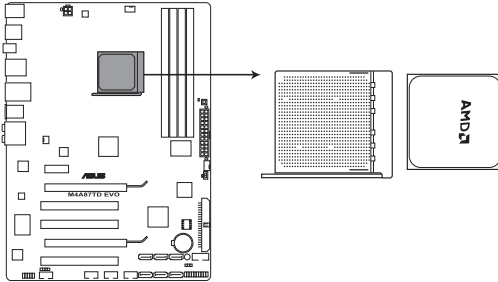

M4A87TD EVO CPU socket AM3

2. Press the lever sideways to unlock the socket, then lift it up to a 90°–100° angle.

Socket lever

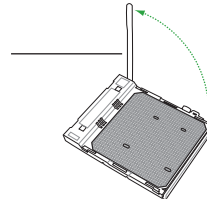

Ensure that the socket lever is lifted up to 90°–100° angle, otherwise the CPU will not fit in completely.

3. Position the CPU above the socket such that the CPU corner with the gold triangle matches the socket corner with a small triangle.
4. Carefully insert the CPU into the socket until it fits in place.



The CPU fits only in one correct orientation. DO NOT force the CPU into the socket to prevent bending the pins and damaging the CPU!

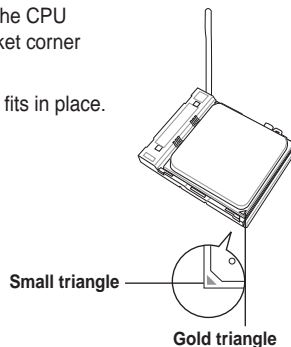

- When the CPU is in place, push down the socket lever to secure the CPU. The lever clicks on the side tab to indicate that it is locked.
- Install a CPU heatsink and fan following the instructions that came with the heatsink package. You can also refer to section **1.6.2 Installing the heatsink and fan** for instructions.
- Connect the CPU fan cable to the CPU\_FAN connector on the motherboard.

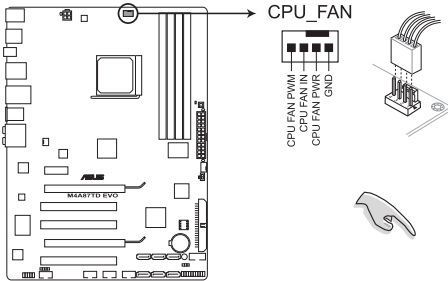
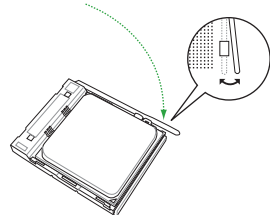

M4A87TD EVO CPU fan connector

Do not forget to connect the CPU fan connector! Hardware monitoring errors can occur if you fail to plug this connector.

## 1.6.2 Installing the heatsink and fan



Ensure that you use only AMD-certified heatsink and fan assembly.

To install the CPU heatsink and fan:

- Place the heatsink on top of the installed CPU, making sure that the heatsink fits properly on the retention module base.



- The retention module base is already installed on the motherboard upon purchase.
- You do not have to remove the retention module base when installing the CPU or installing other motherboard components.
- If you purchased a separate CPU heatsink and fan assembly, ensure that a Thermal Interface Material is properly applied to the CPU heatsink or CPU before you install the heatsink and fan assembly.

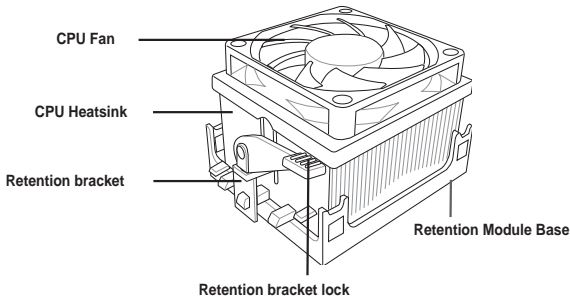



---

Your boxed CPU heatsink and fan assembly should come with installation instructions for the CPU, heatsink, and the retention mechanism. If the instructions in this section do not match the CPU documentation, follow the latter.

---

2. Attach one end of the retention bracket to the retention module base.

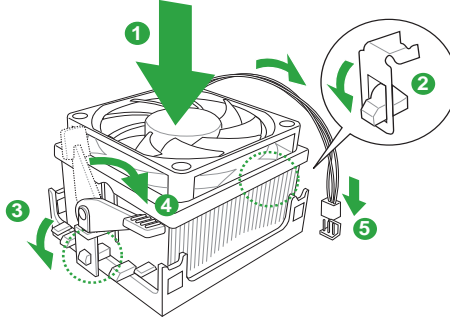

3. Align the other end of the retention bracket to the retention module base. A clicking sound denotes that the retention bracket is in place.



---

Ensure that the fan and heatsink assembly perfectly fits the retention mechanism module base, otherwise you cannot snap the retention bracket in place.

---

4. Push down the retention bracket lock on the retention mechanism to secure the heatsink and fan to the module base.
5. When the fan and heatsink assembly is in place, connect the CPU fan cable to the connector on the motherboard labeled CPU\_FAN.



---

Do not forget to connect the CPU fan connector! Hardware monitoring errors can occur if you fail to plug this connector.

---

## 1.7 System memory

### 1.7.1 Overview

The motherboard comes with four Double Data Rate 3 (DDR3) Dual Inline Memory Modules (DIMM) sockets. A DDR3 module has the same physical dimensions as a DDR2 DIMM but is notched differently to prevent installation on a DDR2 DIMM socket. DDR3 modules are developed for better performance with less power consumption. The figure illustrates the location of the DDR3 DIMM sockets:

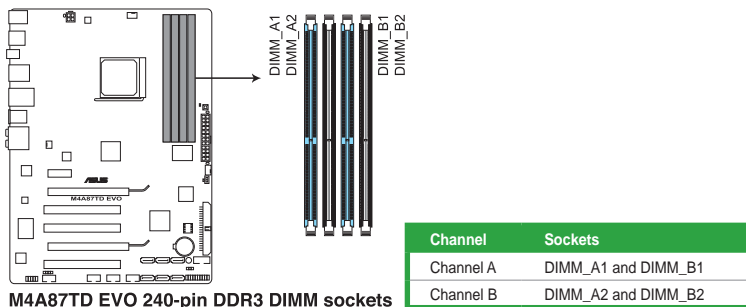

M4A87TD EVO 240-pin DDR3 DIMM sockets

### 1.7.2 Memory configurations

You may install 1GB, 2GB and 4GB unbuffered ECC/non-ECC DDR3 DIMMs into the DIMM sockets.



- You may install varying memory sizes in Channel A and Channel B. The system maps the total size of the lower-sized channel for the dual-channel configuration. Any excess memory from the higher-sized channel is then mapped for single-channel operation.
- Always install DIMMs with the same CAS latency. For optimum compatibility, we recommend that you obtain memory modules from the same vendor.
- Due to the memory address limitation on 32-bit Windows OS, when you install 4GB or more memory on the motherboard, the actual usable memory for the OS can be about 3GB or less. For effective use of memory, we recommend that you install a 64-bit Windows OS when having 4GB or more memory installed on the motherboard.
- Due to CPU spec., AMD 100 and 200 series CPUs support up to DDR3 1066MHz. With ASUS Design, this motherboard can support up to DDR3 1333MHz.
- When overclocking, some AMD CPU models may not support DDR3 1600 or higher frequency DIMMs.
- This motherboard does not support DIMMs made up of 512Mb (64MB) chips or less (Memory chip capacity counts in Megabit, 8 Megabit/Mb = 1 Megabyte/MB).



- The default memory operation frequency is dependent on its Serial Presence Detect (SPD), which is the standard way of accessing information from a memory module. Under the default state, some memory modules for overclocking may operate at a lower frequency than the vendor-marked value. To operate at the vendor-marked or at a higher frequency, refer to section **2.5 Ai Tweaker menu** for manual memory frequency adjustment.
- For system stability, use a more efficient memory cooling system to support a full memory load (4 DIMMs) or overclocking condition.

## M4A87TD EVO Motherboard Qualified Vendors Lists (QVL)

### DDR3-2000MHz capability

Vendor	Part No.	Size	SS/DS	Chip Brand	Chip NO.	Timing	Voltage	DIMM socket support (Optional)		
								1 DIMM	2 DIMM	4 DIMM
CORSAIR	TW3X4G2000C7GT ES ver2.1	4GB(2 x 2GB)	DS	-	-	7-8-7-20	2.1V	•		

### DDR3-1866MHz capability

Vendor	Part No.	Size	SS/DS	Chip Brand	Chip NO.	Timing	Voltage	DIMM socket support (Optional)		
								1 DIMM	2 DIMM	4 DIMM
G.SKILL	F3-15000CL9D-4GBRH (XMP)	4GB(2 x 2GB)	DS	-	-	9-9-9-24	1.65	•		
G.SKILL	F3-15000CL9D-4GBTD(XMP)	4GB(2 x 2GB)	DS	-	-	9-9-9-24	1.65	•		
KINGSTON	KHX1866C9D3T1K3/6GX(XMP)	6GB(3 x 2GB)	DS	-	-	9	1.65	•		
Crucial	BL12864BE2009.8SFB3(EPP)	1GB	SS	-	-	9-9-9-28	2	•		
G.SKILL	F3-16000CL9T-6GBPS(XMP)	6GB(3 x 2GB)	DS	-	-	9-9-9-24	1.65	•		
GEIL	GU34GB2000C9DC(XMP)	4GB(2 x 2GB)	DS	-	-	9-9-9-28	2	•		
KINGSTON	KHX2000C9D3T1FK3/6GX(XMP)	6GB(3 x 2GB)	DS	-	-	9	1.65	•		
KINGSTON	KHX2000C9D3T1K3/6GX(XMP)	6GB(3 x 2GB)	DS	-	-	9	1.65	•		
OCZ	OCZ3B2000LV6GK	6GB(3 x 2GB)	DS	-	-	7-8-7	1.65	•		
G.SKILL	F3-17066CL8D-4GBPS(XMP)	4GB(2 x 2GB)	DS	-	-	8-8-8-24	1.65	•		
G.SKILL	F3-17066CL9T-6GB-T	6GB(3 x 2GB)	DS	-	-	9-9-9-24	1.65	•		
GEIL	GE34GB2133C9DC(XMP)	4GB(2 x 2GB)	DS	-	-	9-9-9-28	1.65	•		
GEIL	GU34GB2133C9DC(XMP)	4GB(2 x 2GB)	DS	-	-	9-9-9-28	1.65	•		
KINGSTON	KHX2133C8D3T1K2/4GX(XMP)	4GB(2 x 2GB)	DS	-	-	8	1.65	•		
KINGSTON	KHX2133C9D3T1K2/4GX(XMP)	4GB(2 x 2GB)	DS	-	-	9	1.65	•		

### DDR3-1800MHz capability

Vendor	Part No.	Size	SS/DS	Chip Brand	Chip NO.	Timing	Voltage	DIMM socket support (Optional)		
								1 DIMM	2 DIMM	4 DIMM
KINGSTON	KHX1800C9D3T1K3/6GX(XMP)	6GB(3 x 2GB)	DS	-	-	-	1.65	•	•	•
Patriot	PVS32G1800LLKN(EPP)	2GB(2 x 1GB)	SS	-	-	8-8-8-20	1.9	•		

### DDR3-1600MHz capability

Vendor	Part No.	Size	SS/DS	Chip Brand	Chip NO.	Timing	Voltage	DIMM socket support (Optional)		
								1 DIMM	2 DIMM	4 DIMM
A-DATA	AX3U1600PB1G8-2P	2GB(2 x 1GB)	SS	-	-	8-8-8-24	1.65-1.85	•	•	•
A-DATA	AD31600E001GMU	3GB(3 x 1GB)	SS	-	-	8-8-8-24	1.65-1.85	•	•	•
A-DATA	AX3U1600PB1G8-3P	3GB(3 x 1GB)	SS	-	-	8-8-8-24	1.65-1.85	•	•	•
A-DATA	AX3U1600XB2G7-EF(XMP)	4GB(2 x 2GB)	DS	-	-	7-7-7-20	1.75-1.85	•	•	•
A-DATA	AD31600F002GMU(XMP)	6GB(3 x 2GB)	DS	-	-	7-7-7-20	1.75-1.85	•	•	•
A-DATA	AX3U1600BG2G9-3G	6GB(3 x 2GB)	DS	-	-	9-9-9-24	1.65-1.85	•	•	•
A-DATA	AX3U1600XB2G7-FF(XMP)	6GB(3 x 2GB)	DS	-	-	7-7-7-20	1.75-1.85	•	•	•
CORSAIR	TRX3X3G1600C8DVer2.1(XMP)	3GB(3 x 1GB)	SS	-	-	8-8-8-24	1.65	•		

## DDR3-1600MHz capability (continued)

Vendor	Part No.	Size	SS/DS	Chip Brand	Chip NO.	Timing	Voltage	DIMM socket support (Optional)		
								1 DIMM	2 DIMM	4 DIMM
CORSAIR	TR3X3G1600C9Ver1.1(XMP)	3GB(3 x 1GB)	SS	-	-	9-9-9-24	1.65	•	•	
CORSAIR	CMG4GX3M2A1600C6	4GB( 2x 2GB)	DS	-	-	6-6-6-18	1.65	•		
CORSAIR	CMD4GX3M2A1600C8(XMP)	4GB(2 x 2GB)	DS	-	-	8-8-8-24	1.65	•		
CORSAIR	CMG4GX3M2A1600C7(XMP)	4GB(2 x 2GB)	DS	-	-	7-7-7-20	1.65	•	•	
CORSAIR	CMX4GX3M2A1600C9(XMP)	4GB(2 x 2GB)	DS	-	-	9-9-9-24	1.65	•	•	•
CORSAIR	TR3X6G1600C8D	6GB(3 x 2GB)	DS	-	-	8-8-8-24	1.65	•	•	•
CORSAIR	TR3X6G1600C8DVer2.1(XMP)	6GB(3 x 2GB)	DS	-	-	8-8-8-24	1.65	•	•	•
CORSAIR	TR3X6G1600C9Ver2.1(XMP)	6GB(3 x 2GB)	DS	-	-	9-9-9-24	1.65	•	•	•
CORSAIR	CMD8GX3M4A1600C8(XMP)	8GB(4 x 2GB)	DS	-	-	8-8-8-24	1.65	•	•	•
CORSAIR	CMX8GX3M4A1600C9(XMP)	8GB(4 x 2GB)	DS	-	-	9-9-9-24	1.65	•	•	•
Crucial	BL12864BA1608.8SFB(XMP)	1GB	SS	-	-	-	1.8	•	•	•
Crucial	BL25664BN1608.16FF(XMP)	2GB	DS	-	-	8-8-8-24	1.65	•	•	•
G.SKILL	F3-12800CL9D-2GBNQ	2GB(2 x 1GB)	SS	-	-	-	1.6	•	•	•
G.SKILL	F3-12800CL9D-4GBRL	4GB(4 x 1GB)	SS	-	-	-	1.6	•	•	•
G.SKILL	F3-12800CL7D-4GBECO(XMP)	4GB(2 x 2GB)	DS	-	-	7-8-7-24	-	•	•	•
G.SKILL	F3-12800CL7D-4GBRH(XMP)	4GB(2 x 2GB)	DS	-	-	7-7-7-24	1.65	•	•	•
G.SKILL	F3-12800CL8D-4GBRH(XMP)	4GB(2 x 2GB)	DS	-	-	8-8-8-24	1.6	•	•	•
G.SKILL	F3-12800CL9D-4GBECO(XMP)	4GB(2 x 2GB)	DS	-	-	9-9-9-24	1.35	•	•	•
G.SKILL	F3-12800CL8T-6GBP(XMP)	6GB(3 x 2GB)	DS	-	-	8-8-8-21	1.6-1.65	•	•	•
G.SKILL	F3-12800CL9T-6GBNQ	6GB(3 x 2GB)	DS	-	-	9-9-9-24	1.5-1.6	•	•	•
KINGMAX	FLGD45F-B8MF7(XMP)	1GB	SS	-	-	-	-	•	•	•
KINGMAX	FLGE85F-B8MF7(XMP)	2GB	DS	-	-	-	-	•	•	•
KINGSTON	KHX1600C9D3K3/12GX(XMP)	12GB(3 x 4GB)	DS	-	-	-	1.65	•	•	•
KINGSTON	KHX1600C9D3K3/12GX(XMP)	12GB(3 x 4GB)	DS	-	-	9	1.65	•	•	•
KINGSTON	KHX1600C8D3K2/4GX(XMP)	4GB(2 x 2GB)	DS	-	-	8	1.65	•	•	•
KINGSTON	KHX1600C8D3K2/4GX(XMP)	4GB(2 x 2GB)	DS	-	-	8	1.65	•	•	•
KINGSTON	KHX1600C8D3T1K2/4GX(XMP)	4GB(2 x 2GB)	DS	-	-	8	1.65	•	•	•
KINGSTON	KHX1600C9D3K2/4G	4GB(2 x 2GB)	DS	-	-	-	1.7-1.9	•		
KINGSTON	KHX1600C9D3K3/6GX(XMP)	6GB(3 x 2GB)	DS	-	-	9	1.65	•	•	•
OCZ	OCZ3P1600EB1G	1GB	SS	-	-	7-6-6-24	-			
OCZ	OCZ3BE1600C8LV4GK	4GB( 2x 2GB )	DS	-	-	8-8-8	1.65	•	•	
OCZ	OCZ3P16004GK(XMP)	4GB( 2x 2GB )	DS	-	-	7-7-7	1.9	•		
OCZ	OCZ3OB1600LV4GK	4GB(2 x 2GB)	DS	-	-	9-9-9	1.65	•		
OCZ	OCZ3P1600EB4GK	4GB(2 x 2GB)	DS	-	-	7-7-6	1.8			•
OCZ	OCZ3P1600LV4GK	4GB(2 x 2GB)	DS	-	-	7-7-7	1.65	•		
OCZ	OCZ3X16004GK(XMP)	4GB(2 x 2GB)	DS	-	-	7-7-7	1.9	•	•	•
OCZ	OCZ3X1600LV4GK(XMP)	4GB(2 x 2GB)	DS	-	-	8-8-8	1.65	•	•	•
OCZ	OCZ3FXE1600C7LV6GK	6GB(3 x 2GB)	DS	-	-	7-7-7	1.65	•	•	
OCZ	OCZ3G1600LV6GK	6GB(3 x 2GB)	DS	-	-	8-8-8	1.65	•		
OCZ	OCZ3G1600LV6GK	6GB(3 x 2GB)	DS	-	-	8-8-8	1.65	•	•	
OCZ	OCZ3X1600LV6GK(XMP)	6GB(3 x 2GB)	DS	-	-	8-8-8	1.65	•	•	•
OCZ	OCZ3X1600LV6GK(XMP)	6GB(3 x 2GB)	DS	-	-	8-8-8	1.65	•	•	•
Super Talent	WP160UX4G8(XMP)	4GB(2 x 2GB)	DS	-	-	8	-	•	•	•
Super Talent	WP160UX4G9(XMP)	4GB(2 x 2GB)	DS	-	-	9	-	•	•	•
Super Talent	WB160UX6G8(XMP)	6GB(3 x 2GB)	DS	-	-	-	-	•	•	•

## DDR3-1600MHz capability (continued)

Vendor	Part No.	Size	SS/ DS	Chip Brand	Chip NO.	Timing	Voltage	DIMM socket support (Optional)		
								1 DIMM	2 DIMM	4 DIMM
Super Talent	WB160UX6G8(XMP)	6GB(3 x 2GB)	DS	-	-	8	-	*	*	*
Cell Shock	CS322271	2GB(2 x 1GB)	DS	-	-	7-7-7-14	1.7-1.9	*	*	*
EK Memory	EKM324L28BP8-116(XMP)	4GB(2 x 2GB)	DS	-	-	9	-	*	*	*
Elixir	M2Y2G64CB8HA9N-DG(XMP)	2GB	DS	-	-	-	-	*	*	*
Mushkin	996657	4GB(2 x 2GB)	DS	-	-	7-7-7-20	-	*	*	*
Mushkin	998659(XMP)	6GB(3 x 2GB)	DS	-	-	9-9-9-24	1.5-1.6	*	*	*
Patriot	PVT33G1600ELK	3GB(3 x 1GB)	SS	-	-	9-9-9-24	1.65	*	*	*
PATRIOT	PGS34G1600LLKA	4GB(2 x 2GB)	DS	-	-	7-7-7-20	1.7	*	*	*
Patriot	PVS34G1600ELK	4GB(2 x 2GB)	DS	-	-	9-9-9-24	1.8	*	*	*
Patriot	PVS34G1600LLK(XMP)	4GB(2 x 2GB)	DS	-	-	7-7-7-20	1.9	*	*	*
Patriot	PVS34G1600LLKN	4GB(2 x 2GB)	DS	-	-	7-7-7-20	2.0	*	*	*
Patriot	PVT36G1600ELK	6GB(3 x 2GB)	DS	-	-	9-9-9-24	1.65	*	*	*
Patriot	PVT36G1600ELK	6GB(3 x 2GB)	DS	-	-	9-9-9-24	1.65	*	*	*
Patriot	PVT36G1600LLK(XMP)	6GB(3 x 2GB)	DS	-	-	8-8-8-24	1.65	*	*	*
Team	BoxP/N: TXD34096M1600HC6DC-L (TXD32048M1600HC6-L)(XMP)	4GB(2 x 2GB)	DS	-	-	6-7-6-18	1.65	*	*	*

## DDR3-1333MHz capability

Vendor	Part No.	Size	SS/ DS	Chip Brand	Chip NO.	Timing	Voltage	DIMM socket support (Optional)		
								1 DIMM	2 DIMM	4 DIMM
A-DATA	AD3133301GOU	1GB	SS	A-DATA	AD30908C8D-15IG	-	-	*	*	*
A-DATA	AD31333002GOU	2GB	DS	A-DATA	AD30908C8D-15IG	-	-	*	*	*
A-DATA	AD3U1333B2G9-2	2GB	DS	A-DATA	AD30908C8D-15IG	-	-	*	*	*
A-DATA	AX3U1333PB2G7-2P	4GB (2 x 2GB)	DS	-	-	7-7-7-20	1.65- 1.85	*	*	*
A-DATA	AD3U1333C4G9-B	4GB	DS	Hynix	H5TQ2G83AFRH9C	1333-9-9- 9-24	-	*	*	*
A-DATA	AD31333E002G0U	6GB (3 x 2GB)	DS	-	-	7-7-7-20	1.65- 1.85	*	*	*
A-DATA	AX3U1333PB2G7-3P	6GB (3 x 2GB)	DS	-	-	7-7-7-20	1.65- 1.85	*	*	*
Apacer	78.A1GC6.9L1	2GB	DS	Apacer	AM5D5808DEWSBG	9	-	*	*	*
CORSAIR	TR3X3G1333C9 (Ver2.1)	3GB (3 x 1GB)	SS	-	-	9-9-9-24	1.5	*	*	*
CORSAIR	CM3X1024-1333C9DHX	1GB	DS	-	-	-	1.1	*	*	*
CORSAIR	BoxP/N:TWIN3X2048- 1333C9 (CM3X1024-1333C9)Ver1.1	2GB (2 x 1GB)	DS	-	-	9-9-9-24	1.70	*	*	*
CORSAIR	CM3X2G1333C9	2GB	DS	-	-	9-9-9-24	1.5	*	*	*
CORSAIR	BoxP/N:TW3X4G1333C9DHX (CM3X2048- 1333C9DHX)Ver3.2	4GB (2 x 2GB)	DS	-	-	9-9-9-24	1.70	*	*	*
CORSAIR	TR3X6G1333C9 (Ver2.1)	6GB (3 x 2GB)	DS	-	-	9-9-9-24	1.5	*	*	*
CORSAIR	CMX8GX3M4A1333C9	8GB (4 x 2GB)	DS	-	-	9-9-9-24	1.5	*	*	*
Crucial	CT12864BA1339.8FF	1GB	SS	MICRON	D9KPT	9	-	*	*	*
Crucial	CT12864BA1339.8SFD	1GB	SS	MICRON	MT8JF12864AY- 1G4D1	-	-	*	*	*
Crucial	CT12872BA1339.9FF	1GB	SS	MICRON	D9KPT(ECC)	9	-	*	*	*



## DDR3-1333MHz capability (continued)

Vendor	Part No.	Size	SS/ DS	Chip Brand	Chip NO.	Timing	Voltage	DIMM socket support (Optional)		
								1 DIMM	2 DIMM	4 DIMM
Crucial	BL25664BN1337.16FF(XMP)	2GB	DS	-	-	7-7-7-24	1.65	*	*	*
Crucial	CT25664BA1339.16FF	2GB	DS	MICRON	D9KPT	9	-	*	*	*
Crucial	CT25664BA1339.16SFD	2GB	DS	MICRON	D9JNM	-	-	*	*	*
Crucial	CT25672BA1339.18FF	2GB	DS	MICRON	D9KPT(ECC)	9	-	*	*	*
Crucial	BL25664BA1336.16SFB1	4GB (2 x 2GB)	DS	NA	-	6-6-6-20	1.8	*	*	*
ELPIDA	EBJ10UE8BAW0-DJ-E	1GB	SS	ELPIDA	J1108BAG-DJ-E	9	-	*	*	*
ELPIDA	EBJ10UE8BDF0-DJ-F	1GB	SS	ELPIDA	J1108BDSE-DJ-F	-	-	*	*	*
ELPIDA	EBJ10UE8EDF0-DJ-F	1GB	SS	ELPIDA	J1108EDSE-DJ-F	-	-	*	*	*
ELPIDA	EBJ21UE8BAW0-DJ-E	2GB	DS	ELPIDA	J1108BAG-DJ-E	9	-	*	*	*
ELPIDA	EBJ21UE8BDF0-DJ-F	2GB	DS	ELPIDA	J1108BDSE-DJ-F	-	-	*	*	*
ELPIDA	EBJ21UE8EDF0-DJ-F	2GB	DS	ELPIDA	J1108EDSE-DJ-F	-	-	*	*	*
G.SKILL	F3-10600CL8D-2GBHK	2GB (2 x 1GB)	SS	-	-	-	1.65	*	*	*
G.SKILL	F3-10666CL7T-6GBPK(XMP)	2GB	DS	-	-	7-7-7-18	1.5-1.6	*	*	*
G.SKILL	F3-10666CL7D-4GBPI(XMP)	4GB (2 x 2GB)	DS	-	-	7-7-7-21	1.5	*	*	*
G.SKILL	F3-10666CL7D-4GBRH(XMP)	4GB (2 x 2GB)	DS	-	-	7-7-7-21	1.5	*	*	*
G.SKILL	F3-10666CL8D-4GBECO(XMP)	4GB (2 x 2GB)	DS	-	-	8-8-8-24	1.35	*	*	*
G.SKILL	F3-10666CL8D-4GBHK(XMP)	4GB (2 x 2GB)	DS	-	-	8-8-8-21	1.5-1.6	*	*	*
G.SKILL	F3-10666CL8D-4GBRM(XMP)	4GB (2 x 2GB)	DS	-	-	8-8-8-21	1.5-1.6	*	*	*
G.SKILL	F3-10666CL9T-6GBNQ	6GB (3 x 2GB)	DS	-	-	9-9-9-24	1.5	*	*	*
GEIL	GG34GB1333C9DC	4GB (2 x 2GB)	DS	GEIL	GL1L128M88BA12N	9-9-9-24	1.3	*	*	*
GEIL	GV34GB1333C7DC	4GB (2 x 2GB)	DS	-	-	7-7-7-24	1.5	*	*	*
Hynix	HMT112U6BFR8C-H9	1GB	SS	Hynix	H5TQ1G83BFR	9	-	*	*	*
Hynix	HMT125U6BFR8C-H9	2GB	DS	Hynix	H5TQ1G83BFR	9	-	*	*	*
Hynix	HMT125U6BFR8C-H9	2GB	DS	Hynix	H5TQ1G83BFRH9C	9	-	*	*	*
KINGMAX	FLFD45F-B8KG9	1GB	SS	KingMax	KFB8FNGBF-ANX-15A	-	-	*	*	*
KINGMAX	FLFE85F-B8KG9	2GB	DS	KingMax	KFB8FNGBF-ANX-15A	-	-	*	*	*
KINGSTON	KVR1333D3N9/1G	1G	SS	Kingston	D1288JELDPGD9U	-	1.5	*	*	*
KINGSTON	KVR1333D3N9/2G	2GB	DS	Qimonda	IDSH1G-03A1F1C-13H	9	1.5	*	*	*
KINGSTON	KVR1333D3E9S/4G	4GB	DS	SAMSUNG	K4B2G0846B-HCH9	-	1.5	*	*	*
KINGSTON	KVR1333D3N9/4G	4GB	DS	SAMSUNG	K4B2G0846B-HCH9	9	1.5	*	*	*
MICRON	MT8JTF12864AZ-1G4F1	1GB	SS	MICRON	9FF22 D9KPT	9	-	*	*	*
MICRON	MT8JTF12864AZ-1G4F1	1GB	SS	MICRON	D9KPT	9	-	*	*	*
MICRON	MT9JSF12872AZ-1G4F1	1GB	SS	MICRON	D9KPT(ECC)	9	-	*	*	*
MICRON	MT16JF25664AZ-1G4F1	2GB	DS	MICRON	D9KPT	9	-	*	*	*
MICRON	MT16JF25664AZ-1G4F1	2GB	DS	MICRON	9FF22 D9KPT	9	-	*	*	*
MICRON	MT18JSF25672AZ-1G4F1	2GB	DS	MICRON	D9KPT(ECC)	9	-	*	*	*
OCZ	OCZ3P1333LV3GK	3GB (3 x 1GB)	SS	-	-	7-7-7	1.65	*	*	*
OCZ	OCZ3G1333ULV4GK	4GB (2 x 2GB)	DS	-	-	8-8-8	1.65	*	*	*

## DDR3-1333MHz capability (continued)

Vendor	Part No.	Size	SS/ DS	Chip Brand	Chip NO.	Timing	Voltage	DIMM socket support (Optional)		
								1 DIMM	2 DIMM	4 DIMM
OCZ	OCZ3P1333LV4GK	4GB (2 x 2GB)	DS	-	-	7-7-7	1.65	•	•	•
OCZ	OCZ3G1333LV6GK	6GB (3 x 2GB)	DS	-	-	9-9-9	1.65			•
OCZ	OCZ3P1333LV6GK	6GB (3 x 2GB)	DS	-	-	7-7-7	1.65	•		
OCZ	OCZX1333LV6GK(XMP)	6GB (3 x 2GB)	DS	NA	-	8-8-8	1.6	•	•	•
PSC	AL7F8G73D-DG1	1GB	SS	PSC	A3P1GF3DGF	-	-	•	•	•
PSC	AL8F8G73D-DG1	2GB	DS	PSC	A3P1GF3DGF	-	-	•	•	•
SAMSUNG	M378B2873DZ1-CH9	1GB	SS	SAMSUNG	K4B1G0846D	9	-	•	•	•
SAMSUNG	M378B2873EH1-CH9	1GB	SS	SAMSUNG	K4B1G0846E	-	-	•	•	•
SAMSUNG	M391B2873DZ1-CH9	1GB	SS	SAMSUNG	K4B1G0846D(ECC)	9	-	•	•	•
SAMSUNG	M378B5673DZ1-CH9	2GB	DS	SAMSUNG	K4B1G0846D	9	-	•	•	•
SAMSUNG	M378B5673EH1-CH9	2GB	DS	SAMSUNG	K4B1G0846E	-	-	•	•	•
SAMSUNG	M391B5673DZ1-CH9	2GB	DS	SAMSUNG	K4B1G0846D(ECC)	9	-	•	•	•
SAMSUNG	M378B5273BH1-CH9	4GB	DS	SAMSUNG	K4B2G0846B-HCH9	9	-	•	•	•
Super Talent	W1333X2G8(XMP)	2GB (2 x 1GB)	SS	-	-	8	1.8	•	•	•
Asint	SLY3128M8-EDJ	1GB	SS	Asint	DDRIII1208-DJ	-	-	•	•	•
Asint	SLY3128M8-EDJE	1GB	SS	ELPIDA	J1108BASE-DJ-E	-	-	•	•	•
Asint	SLZ3128M8-EDJ	2GB	DS	Asint	DDRIII1208-DJ	-	-	•	•	•
Asint	SLZ3128M8-EDJE	2GB	DS	ELPIDA	J1108BASE-DJ-E	-	-	•	•	•
ASUS	N/A	1GB	DS	-	-	-	-	•	•	•
ATP	AQ28M64A8BJH9S	1GB	SS	SAMSUNG	K4B1G0846E	-	-	•	•	•
ATP	AQ28M72D8BJH9S	1GB	SS	SAMSUNG	K4B1G0846D(ECC)	-	-	•	•	•
ATP	AQ56M64B8BJH9S	2GB	DS	SAMSUNG	K4B1G0846D	-	-	•	•	•
ATP	AQ56M72E8BJH9S	2GB	DS	SAMSUNG	K4B1G0846D(ECC)	-	-	•	•	•
BUFFALO	FSH1333D3G-T3G(XMP)	3GB (3 x 1GB)	SS	-	-	7-7-7-20	-	•	•	•
EK Memory	EKM324L28BP8-113	4GB (2 x 2GB)	DS	-	-	9	-	•	•	•
Elixir	M2Y2G64CB8HA9N-CG	2GB	DS	-	-	-	-	•	•	•
Elixir	M2Y2G64CB8HC9N-CG	2GB	DS	-	-	-	-	•	•	•
Patriot	PVT33G1333ELK	3GB (3 x 1GB)	SS	-	-	9-9-9-24	1.65	•	•	•
Patriot	PVS34G1333LLK	4GB (2 x 2GB)	DS	-	-	7-7-7-20	1.7	•	•	•
Patriot	PVT36G1333ELK	6GB (3 x 2GB)	DS	-	-	9-9-9-24	1.65	•	•	•
Silicon Power	SP001GBLTU1333S01	1GB	SS	NANYA	NT5CB128M8AN-CG	-	-	•		•
Silicon Power	SP001GBLTU1333S02	1GB	SS	S-POWER	I0YT3E0	9	-	•		
Silicon Power	SP002GBLTU1333S02	2GB	DS	S-POWER	I0YT3E0	9	-	•	•	•
UMAX	E41302GP0-73BDB	2GB	DS	UMAX	U2S24D30TP-13	-	-	•	•	•

## DDR3-1066MHz capability

Vendor	Part No.	Size	SS/ DS	Chip Brand	Chip NO.	Timing	Voltage	DIMM socket support (Optional)		
								1 DIMM	2 DIMM	4 DIMM
Crucial	CT12864BA1067.8FF	1GB	SS	MICRON	D9KPT	7	-	•	•	•
Crucial	CT12864BA1067.8SFD	1GB	SS	MICRON	D9JNL	7	-	•	•	•
Crucial	CT12872BA1067.9FF	1GB	SS	MICRON	D9KPT(ECC)	7	-	•	•	•
Crucial	CT25664BA1067.16FF	2GB	DS	MICRON	D9KPT	7	-	•	•	•
Crucial	CT25664BA1067.16SFD	2GB	DS	MICRON	D9JNL	7	-	•	•	•
Crucial	CT25672BA1067.18FF	2GB	DS	MICRON	D9KPT(ECC)	7	-	•	•	•
ELPIDA	EBJ10UE8EDF0-AE-F	1GB	SS	ELPIDA	J1108EDSE-DJ-F	-	-	•	•	•
ELPIDA	EBJ11UD8BAFA-AG-E	1GB	DS	ELPIDA	J5308BASE-AC-E	8	-	•	•	•
ELPIDA	EBJ21UE8BAV0-AE-E	2GB	DS	ELPIDA	J1108BABG-DJ-E	7	-	•	•	•
ELPIDA	EBJ21UE8EDF0-AE-F	2GB	DS	ELPIDA	J1108EDSE-DJ-F	-	-	•	•	•
Hynix	HMT112U6AFP8C-G7N0	1GB	SS	HYNIX	H5TQ1G83AFP7C	7	-	•	•	•
Hynix	HYMT112U64ZNF8-G7	1GB	SS	HYNIX	HY5TQ1G831ZNF7-G7	7	-	•	•	•
Hynix	HMT125U6AFP8C-G7N0	2GB	DS	HYNIX	H5TQ1G83AFP7C	7	-	•	•	•
Hynix	HYMT125U64ZNF8-G7	2GB	DS	HYNIX	HY5TQ1G831ZNF7-G7	7	-	•	•	•
KINGSTON	KVR1066D3N7/1G	1GB	SS	KINGSTON	D1288JEKAPA7U	7	1.5	•	•	•
KINGSTON	KVR1066D3N7/2G	2GB	DS	KINGSTON	D1288JEKAPGA7U	7	1.5	•	•	•
KINGSTON	KVR1066D3N7/2G	2GB	DS	ELPIDA	J1108BABG-DJ-E	-	1.5	•	•	•
KINGSTON	KVR1066D3N7/4G	4GB	DS	SAMSUNG	K4B2G0846B-HCF8	-	1.5	•	•	•
MICRON	MT8JTF12864AY-1G1D1	1GB	SS	MICRON	7VD22	7	-	•	•	•
MICRON	MT8JTF12864AZ-1G1F1	1GB	SS	MICRON	8ZF22 D9KPV	7	-	•	•	•
MICRON	MT8JTF12864AZ-1G1F1	1GB	SS	MICRON	D9KPT	7	-	•	•	•
MICRON	MT9JSF12872AZ-1G1F1	1GB	SS	MICRON	D9KPT(ECC)	7	-	•	•	•
MICRON	MT16JTF25664AY-1G1D1	2GB	DS	MICRON	7VD22	7	-	•	•	•
MICRON	MT16JTF25664AZ-1G1F1	2GB	DS	MICRON	8ZF22 D9KPV	7	-	•	•	•
MICRON	MT16JTF25664AZ-1G1F1	2GB	DS	MICRON	D9KPT	7	-	•	•	•
MICRON	MT18JSF25672AZ-1G1F1	2GB	DS	MICRON	D9KPT(ECC)	7	-	•	•	•
SAMSUNG	M378B5273BH1-CF8	4GB	DS	SAMSUNG	K4B2G0846B-HCF8	8	1.5	•	•	•
Asint	SLY3128M8-EAE	1GB	SS	Asint	DDRIII1208-AE	-	-	•	•	•
Asint	SLZ3128M8-EAE	2GB	DS	Asint	DDRIII1208-AE	-	-	•	•	•
Elixir	M2Y2G64CB8HA9N-BE	2GB	DS	-	-	-	-	•	•	•
Elixir	M2Y2G64CB8HC5N-BE	2GB	DS	Elixir	N2CB1G80CN-BE	-	-	•	•	•
Elixir	M2Y2G64CB8HC9N-BE	2GB	DS	-	-	-	-	•	•	•
WINTEC	3DU3191A-10	1GB	DS	Qimonda	IDSH51-03A1F1C-10F	7	-	•	•	•



When overclocking, some AMD CPU models may not support DDR3 1600 or higher frequency DIMMs.



### Side(s): SS - Single-sided DS - Double-sided DIMM support:

- **A\***: Supports one module inserted into slot A1 as Single-channel memory configuration.
- **B\***: Supports two modules inserted into either the blue slots or the black slots as one pair of Dual-channel memory configuration.
- **C\***: Supports four modules inserted into both the blue slots and the black slots as two pairs of Dual-channel memory configuration.



Visit the ASUS website for the latest QVL.

### 1.7.3 Installing a DIMM



Ensure to unplug the power supply before adding or removing DIMMs or other system components. Failure to do so may cause severe damage to both the motherboard and the components.

1. Unlock a DIMM socket by pressing the retaining clips outward.
2. Align a DIMM on the socket such that the notch on the DIMM matches the DIMM slot key on the socket.

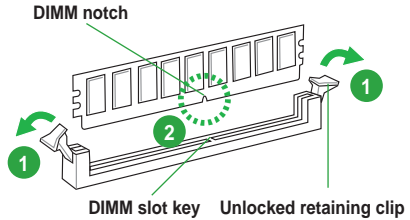

A DIMM is keyed with a notch so that it fits in only one direction. DO NOT force a DIMM into a socket in the wrong direction to avoid damaging the DIMM.

3. Hold the DIMM by both of its ends, then insert the DIMM vertically into the socket. Apply force to both ends of the DIMM simultaneously until the retaining clips snap back into place, and the DIMM cannot be pushed in any further to ensure proper sitting of the DIMM.

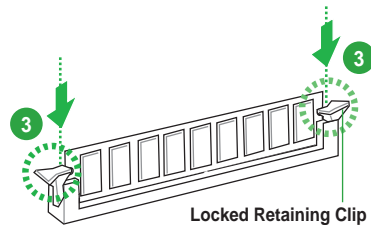

Always insert the DIMM into the socket VERTICALLY to prevent DIMM notch damage.

### 1.7.4 Removing a DIMM

1. Simultaneously press the retaining clips outward to unlock the DIMM.
2. Remove the DIMM from the socket.

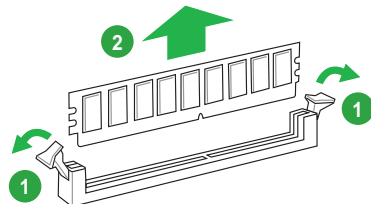

Support the DIMM lightly with your fingers when pressing the retaining clips. The DIMM might get damaged when it flips out with extra force.

## 1.8 Expansion slots

In the future, you may need to install expansion cards. The following sub-sections describe the slots and the expansion cards that they support.



---

Unplug the power cord before adding or removing expansion cards. Failure to do so may cause you physical injury and damage motherboard components.

---

### 1.8.1 Installing an expansion card

To install an expansion card:

1. Before installing the expansion card, read the documentation that came with it and make the necessary hardware settings for the card.
2. Remove the system unit cover (if your motherboard is already installed in a chassis).
3. Remove the bracket opposite the slot that you intend to use. Keep the screw for later use.
4. Align the card connector with the slot and press firmly until the card is completely seated on the slot.
5. Secure the card to the chassis with the screw you removed earlier.
6. Replace the system cover.

### 1.8.2 Configuring an expansion card

After installing the expansion card, configure it by adjusting the software settings.

1. Turn on the system and change the necessary BIOS settings, if any. See Chapter 2 for information on BIOS setup.
2. Assign an IRQ to the card.
3. Install the software drivers for the expansion card.



---

When using PCI cards on shared slots, ensure that the drivers support "Share IRQ" or that the cards do not need IRQ assignments. Otherwise, conflicts will arise between the two PCI groups, making the system unstable and the card inoperable.

---

### 1.8.3 PCI slots

The PCI slots support cards such as a LAN card, SCSI card, USB card, and other cards that comply with PCI specifications.

### 1.8.4 PCI Express 2.0 x1 slots

This motherboard supports PCI Express x1 network cards, SCSI cards, and other cards that comply with the PCI Express specifications.

### 1.8.5 PCI Express 2.0 x16 slots

This motherboard supports two PCI Express 2.0 x16 graphics cards that comply with the PCI Express specifications.

## 1.9 Jumper

### Clear RTC RAM (CLRRTC)

This jumper allows you to clear the Real Time Clock (RTC) RAM in CMOS. You can clear the CMOS memory of date, time, and system setup parameters by erasing the CMOS RTC RAM data. The onboard button cell battery powers the RAM data in CMOS, which include system setup information such as system passwords.

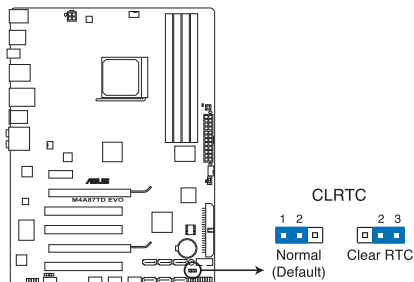

**M4A87TD EVO Clear RTC RAM**

To erase the RTC RAM

1. Turn OFF the computer and unplug the power cord.
2. Move the jumper cap from pins 1-2 (default) to pins 2-3. Keep the cap on pins 2-3 for about 5–10 seconds, then move the cap back to pins 1-2.
3. Plug the power cord and turn ON the computer.
4. Hold down the <Del> key during the boot process and enter BIOS setup to re-enter data.



---

Except when clearing the RTC RAM, never remove the cap on CLRRTC jumper default position. Removing the cap will cause system boot failure!

---



- If the steps above do not help, remove the onboard battery and move the jumper again to clear the CMOS RTC RAM data. After the CMOS clearance, reinstall the battery.
  - You do not need to clear the RTC when the system hangs due to overclocking. For system failure due to overclocking, use the C.P.R. (CPU Parameter Recall) feature. Shut down and reboot the system so the BIOS can automatically reset parameter settings to default values.
  - Due to the chipset behavior, AC power off is required to enable C.P.R. function. You must turn off and on the power supply or unplug and plug the power cord before rebooting the system.
-

## 1.10 Onboard switches

Onboard switches allow you to fine-tune performance when working on a bare or open-case system. This is ideal for overclockers and gamers who continually change settings to enhance system performance.

### 1. MemOK! switch

Installing DIMMs that are incompatible with the motherboard may cause system boot failure, and the DRAM\_LED near the MemOK! switch lights continuously. Press and hold the MemOK! switch until the DRAM\_LED starts blinking to begin automatic memory compatibility tuning for successful boot.

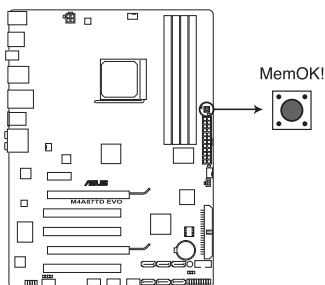

M4A87TD EVO MemOK! switch



- Refer to section 1.11 **Onboard LEDs** for the exact location of the DRAM\_LED.
- The DRAM\_LED also lights when the DIMM is not properly installed. Turn off the system and reinstall the DIMM before using the MemOK! function.
- The MemOK! switch does not function under Windows® OS environment.
- During the tuning process, the system loads and tests failsafe memory settings. It takes about 30 seconds for the system to test one set of failsafe settings. If the test fails, the system reboots and test the next set of failsafe settings. The blinking speed of the DRAM\_LED increases, indicating different test processes.
- Due to memory tuning requirement, the system automatically reboots when each timing set is tested. If the installed DIMMs still fail to boot after the whole tuning process, the DRAM\_LED lights continuously. Replace the DIMMs with ones recommended in the Memory QVL (Qualified Vendors Lists) in this user manual or on the ASUS website at [www.asus.com](http://www.asus.com).
- If you turn off the computer and replace DIMMs during the tuning process, the system continues memory tuning after turning on the computer. To stop memory tuning, turn off the computer and unplug the power cord for about 5–10 seconds.
- If your system fail to boot due to BIOS overclocking, press the MemOK! switch to boot and load BIOS default settings. A message will appear during POST reminding you that the BIOS has been restored to its default settings.
- We recommend that you download and update to the latest BIOS version from the ASUS website at [www.asus.com](http://www.asus.com) after using the MemOK! function.

## 2. Core Unlocker switch

This switch allows you to unlock the extra cores of your CPU.



For ensuring the system performance, turn the switch setting to **Enable** when the system is powered off.

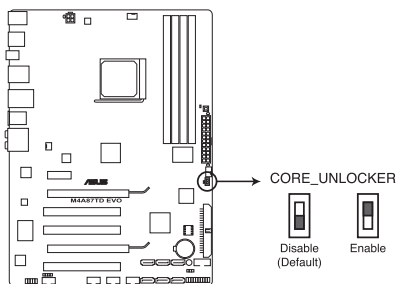

**M4A87TD EVO CORE\_UNLOCKER**



- The **Core Unlocker LED** near the Core Unlocker switch lights when the switch setting is turned to **Enable**. Refer to section 1.11 **Onboard LEDs** for the exact location of the **Core Unlocker LED**.
- You may also press <4> during the Power-On-Self-Test (POST) or enable the **ASUS Core Unlocker** item in the BIOS menu to activate the Core Unlocker function.
- The system will use the last setting you have made.
- If you clear the CMOS or load the BIOS setup defaults, the **ASUS Core Unlocker** item in the BIOS menu follows the current setting of the Core Unlocker switch.



## 1.11 Onboard LEDs

### 1. Standby Power LED

The motherboard comes with a standby power LED. The green LED lights up to indicate that the system is ON, in sleep mode, or in soft-off mode. This is a reminder that you should shut down the system and unplug the power cable before removing or plugging in any motherboard component. The illustration below shows the location of the onboard LED.

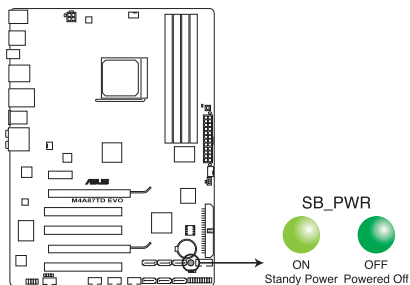

**M4A87TD EVO Onboard LED**

### 2. Core Unlocker LED

The Core Unlocker LED lights when the Core Unlocker switch is turned to **Enable**.

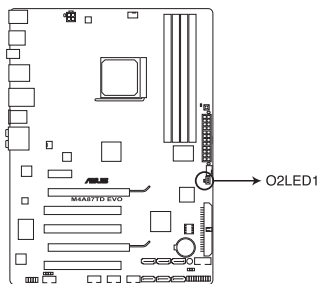

**M4A87TD EVO CORE\_UNLOCKER LED**



---

The Core Unlocker LED keeps on lighting even though the **ASUS Core Unlocker** item in the BIOS menu is set to [Disabled].

---

### 3. DRAM LED

DRAM LED checks DRAM status during motherboard booting process. If an error is found , the LED will continue lighting until the problem is solved. This user-friendly design provides an intuitional way to locate the root problem within a second.

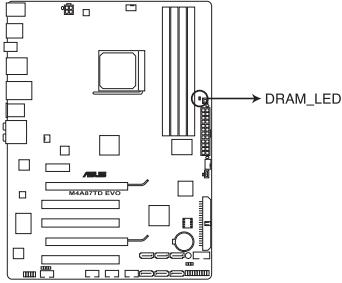

**M4A87TD EVO DRAM LED**

## 1.12 Connectors

### 1.12.1 Rear panel connectors

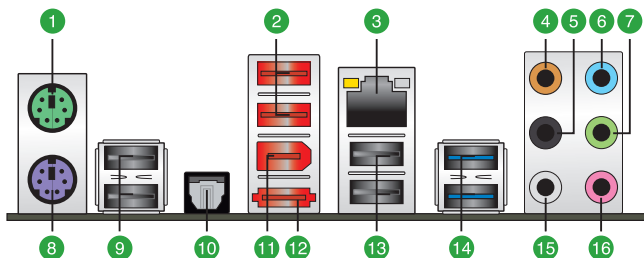

1. **PS/2 mouse port (green).** This port is for a PS/2 mouse.
2. **USB 2.0 ports 3 and 4.** These 4-pin Universal Serial Bus (USB) ports are available for connecting USB 2.0 devices.
3. **LAN (RJ-45) port.** This port allows Gigabit connection to a Local Area Network (LAN) through a network hub.

Activity Link LED		Speed LED	
Status	Description	Status	Description
OFF	No link	OFF	10 Mbps connection
ORANGE	Linked	ORANGE	100 Mbps connection
BLINKING	Data activity	GREEN	1 Gbps connection

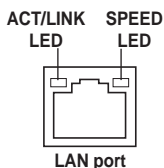

4. **Center/Subwoofer port (orange).** This port connects the center/subwoofer speakers.
5. **Rear Speaker Out port (black).** This port connects the rear speakers in a 4-channel, 6-channel, or 8-channel audio configuration.
6. **Line In port (light blue).** This port connects the tape, CD, DVD player, or other audio sources.
7. **Line Out port (lime).** This port connects a headphone or a speaker. In 4-channel, 6-channel, and 8-channel configuration, the function of this port becomes Front Speaker Out.
8. **PS/2 keyboard port (purple).** This port is for a PS/2 keyboard.
9. **USB 2.0 ports 5 and 6.** These 4-pin Universal Serial Bus (USB) ports are available for connecting USB 2.0 devices.
10. **Optical S/PDIF Out port.** This port connects an external audio output device via an optical S/PDIF cable.
11. **IEEE 1394a port.** This 6-pin IEEE 1394a port provides high-speed connectivity for audio/video devices, storage peripherals, PCs, or portable devices.
12. **External SATA port.** This port connects to an external Serial ATA hard disk drive.



DO NOT insert different connectors to the external SATA ports.

- 13. **USB 2.0 ports 1 and 2.** These 4-pin Universal Serial Bus (USB) ports are available for connecting USB 2.0 devices.
- 14. **USB 3.0 ports 1 and 2 (blue).** These 4-pin Universal Serial Bus (USB) ports are available for connecting USB 3.0 devices.
- 15. **Side Speaker Out port (gray).** This port connects the side speakers in an 8-channel audio configuration.
- 16. **Microphone port (pink).** This port connects a microphone.



Refer to the audio configuration table below for the function of the audio ports in 2, 4, 6, or 8-channel configuration.

### Audio 2, 4, 6, 8-channel configuration

Port	Headset 2-channel	4-channel	6-channel	8-channel
Light Blue	Line In	Line In	Line In	Line In
Lime	Line Out	Front Speaker Out	Front Speaker Out	Front Speaker Out
Pink	Mic In	Mic In	Mic In	Mic In
Orange	–	–	Center/Subwoofer	Center/Subwoofer
Black	–	Rear Speaker Out	Rear Speaker Ou	Rear Speaker Out
Gray	–	–	–	Side Speaker Out

## 1.12.2 Internal connectors

### 1. IDE connector (40-1 pin PRI\_IDE)

The onboard IDE connector is for Ultra DMA 133/100/66 signal cable. There are three connectors on each Ultra DMA 133 / 100 / 66 signal cable: blue, black, and gray. Connect the blue connector to the motherboard's IDE connector, then select one of the following modes to configure your devices:

	Drive jumper setting	Mode of device(s)	Cable connector
Single device	Cable-Select or Master	-	Black
Two devices	Cable-Select	Master	Black
		Slave	Gray
	Master	Master	Black or gray
	Slave	Slave	

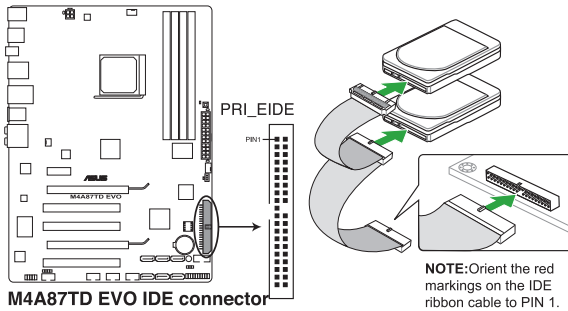

- Pin 20 on the IDE connector is removed to match the covered hole on the Ultra DMA cable connector. This prevents incorrect insertion when you connect the IDE cable.
- Use the 80-conductor IDE cable for Ultra DMA 133/100/66 IDE devices.



If any device jumper is set as "Cable-Select", ensure that all other device jumpers have the same setting.

## 2. ATX power connectors (24-pin EATXPWR, 4-pin ATX12V)

These connectors are for an ATX power supply. The plugs from the power supply are designed to fit these connectors in only one orientation. Find the proper orientation and push down firmly until the connectors completely fit.

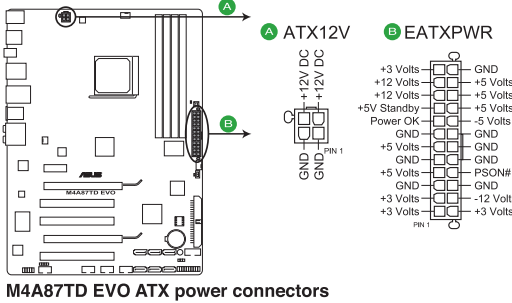

- For a fully configured system, we recommend that you use a power supply unit (PSU) that complies with ATX 12 V Specification 2.0 (or later version) and provides a minimum power of 600 W.
- Use of a PSU with a higher power output is recommended when configuring a system with more power-consuming devices. The system may become unstable or may not boot up if the power is inadequate.
- If you are uncertain about the minimum power supply requirement for your system, refer to the **Recommended Power Supply Wattage Calculator** at <http://support.asus.com/PowerSupplyCalculator/PSCalculator.aspx?SLanguage=en-us> for details.

### 3. AMD® SB850 Serial ATA Serial ATA 6.0 Gb/s connectors (7-pin SATA 1-6)

These connectors are for the Serial ATA 6.0 Gb/s signal cables for Serial ATA hard disk drives and optical disc drives.

If you installed Serial ATA hard disk drives, you can create a RAID 0, RAID 1, RAID 5, or RAID 10 configuration through the onboard AMD® SB850 controller.

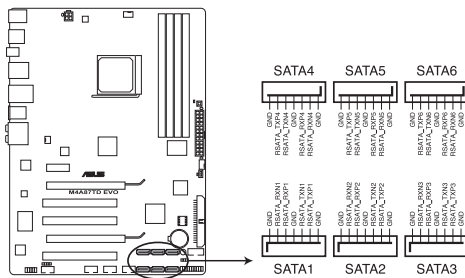

M4A87TD EVO SATA connectors

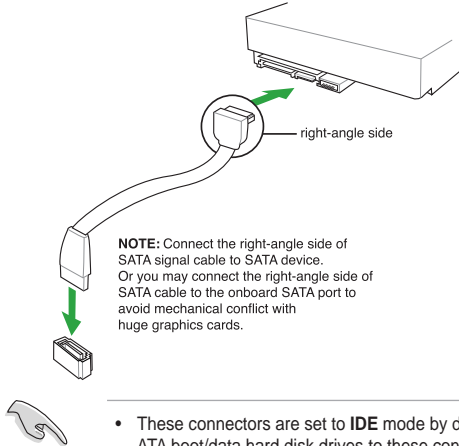

**NOTE:** Connect the right-angle side of SATA signal cable to SATA device. Or you may connect the right-angle side of SATA cable to the onboard SATA port to avoid mechanical conflict with huge graphics cards.

- These connectors are set to **IDE** mode by default. In **IDE** mode, you can connect Serial ATA boot/data hard disk drives to these connectors. If you intend to create a Serial ATA RAID set using these connectors, set the **SATA Port** item in the BIOS to [RAID]. See section 2.4.2 Storage Configuration for details.
- You must install Windows® XP Service Pack 2 or later version before using Serial ATA hard disk drives. The Serial ATA RAID feature is available only if you are using Windows® XP SP2 or later version.
- When using hot-plug and NCQ, set the **SATA Port** item in the BIOS to [AHCI]. See section 2.4.2 Storage Configuration for details.

#### 4. CPU, Chassis and Power Fan connectors (4-pin CPU\_FAN, 4-pin CHA\_FAN1, 3-pin PWR\_FAN)

Connect the fan cables to the fan connectors on the motherboard, ensuring that the black wire of each cable matches the ground pin of the connector.



Do not forget to connect the fan cables to the fan connectors. Insufficient air flow inside the system may damage the motherboard components. These are not jumpers! DO NOT place jumper caps on the fan connectors.

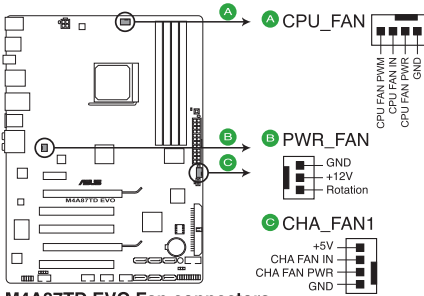

- The CPU\_FAN connector supports the CPU fan of maximum 2A (24 W) fan power.
- Only the CPU\_FAN and CHA\_FAN1 connectors support the ASUS Fan Xpert feature.
- If you install two VGA cards, we recommend that you plug the rear chassis fan cable to the motherboard connector labeled CHA\_FAN1 for better thermal environment.



## 5. System panel connector (20-8 pin PANEL)

This connector supports several chassis-mounted functions.

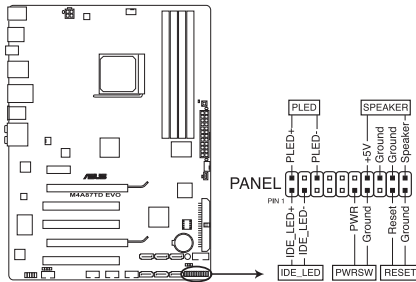

- **System power LED (2-pin PLED)**

This 2-pin connector is for the system power LED. Connect the chassis power LED cable to this connector. The system power LED lights up when you turn on the system power, and blinks when the system is in sleep mode.

- **Hard disk drive activity LED (2-pin IDE\_LED)**

This 2-pin connector is for the HDD Activity LED. Connect the HDD Activity LED cable to this connector. The IDE LED lights up or flashes when data is read from or written to the HDD.

- **System warning speaker (4-pin SPEAKER)**

This 4-pin connector is for the chassis-mounted system warning speaker. The speaker allows you to hear system beeps and warnings.

- **ATX power button/soft-off button (2-pin PWRSR)**

This connector is for the system power button. Pressing the power button turns the system on or puts the system in sleep or soft-off mode depending on the BIOS settings. Pressing the power switch for more than four seconds while the system is ON turns the system OFF.

- **Reset button (2-pin RESET)**

This 2-pin connector is for the chassis-mounted reset button for system reboot without turning off the system power.

## 6. USB connectors (10-1 pin USB78, USB910, USB1112)

These connectors are for USB 2.0 ports. Connect the USB module cable to any of these connectors, then install the module to a slot opening at the back of the system chassis. These USB connectors comply with USB 2.0 specification that supports up to 480 Mbps connection speed.

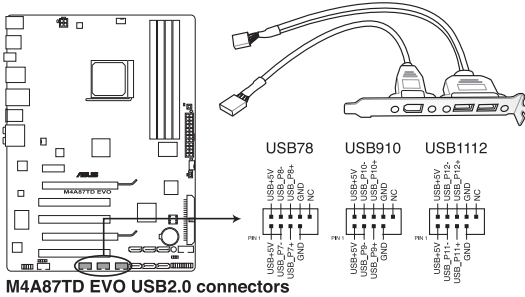

Never connect a 1394 cable to the USB connectors. Doing so will damage the motherboard!



The USB 2.0 module is purchased separately.

## 7. Digital audio connector (4-1 pin SPDIF\_OUT)

This connector is for an additional Sony/Philips Digital Interface (S/PDIF) ports.

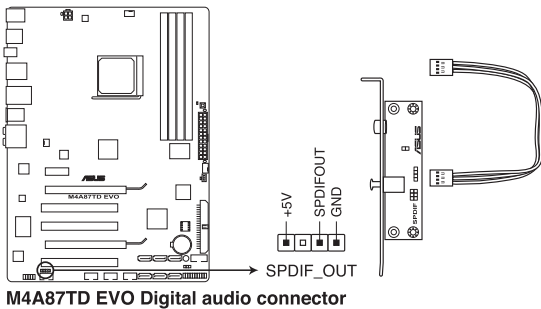

The S/PDIF module is purchased separately.

## 8. Front panel audio connector (10-1 pin AAFP)

This connector is for a chassis-mounted front panel audio I/O module that supports either High Definition Audio or AC'97 audio standard. Connect one end of the front panel audio I/O module cable to this connector.

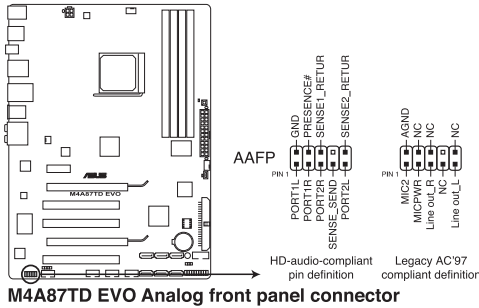

- We recommend that you connect a high-definition front panel audio module to this connector to avail of the motherboard high-definition audio capability.
- If you want to connect a high-definition front panel audio module to this connector, ensure that the **Azalia Front Panel** item in the BIOS is set to [HD]. If you want to connect an AC'97 front panel audio module to this connector, set the item to [AC'97]. See page 2-18 for details.

## 9. Serial port connector (10-1 pin COM1)

The connector is for a serial (COM) port. Connect the serial port module cable to the connector, then install the module to a slot opening at the back of the system chassis.

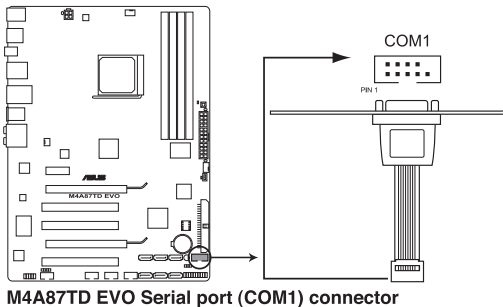

The serial port bracket (COM1) is purchased separately.

**10. IEEE 1394a port connector (10-1 pin IE1394\_2)**

This connector is for an IEEE 1394a port. Connect the IEEE 1394a module cable to this connector, then install the module to a slot opening at the back of the system chassis.

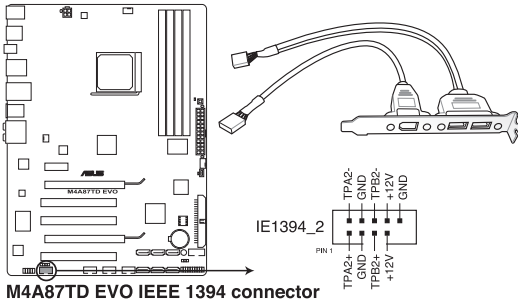

Never connect a USB cable to the IEEE 1394a connector. Doing so will damage the motherboard!



The IEEE 1394a module is purchased separately.

## 1.13 Software support

### 1.13.1 Installing an operating system

This motherboard supports Windows® 7/Vista/XP Operating Systems (OS). Always install the latest OS version and corresponding updates to maximize the features of your hardware.



- Motherboard settings and hardware options vary. Use the setup procedures presented in this chapter for reference only. Refer to your OS documentation for detailed information.
- Ensure that you install Windows® XP Service Pack 2 or later versions before installing the drivers for better compatibility and system stability.

### 1.13.2 Support DVD information

The Support DVD that comes with the motherboard package contains the drivers, software applications, and utilities that you can install to avail all motherboard features.



- The contents of the Support DVD are subject to change at any time without notice. Visit the ASUS website at [www.asus.com](http://www.asus.com) for updates.
- For detailed software instructions, see the **Manual** folder in the Support DVD or download the latest software manual from the ASUS website at [www.asus.com](http://www.asus.com).

#### To run the Support DVD

Place the Support DVD to the optical drive. The DVD automatically displays the Drivers menu if Autorun is enabled in your computer.



The screen on this page is used for reference only.

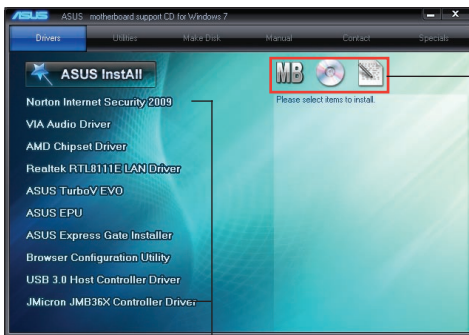

Click an icon to display Support DVD/motherboard information

Click an item to install



If Autorun is NOT enabled in your computer, browse the contents of the Support DVD to locate the file ASSETUP.EXE from the BIN folder. Double-click the ASSETUP.EXE to run the DVD.



# Chapter 2

## BIOS setup

### 2.1 Knowing BIOS

BIOS (Basic Input and Output System) stores system hardware settings such as storage device configuration, overclocking settings, advanced power management, and boot device configuration that are needed for system startup in the motherboard CMOS. In normal circumstances, the default BIOS settings apply to most conditions to ensure optimum performance. **We recommend that you not change the default BIOS settings** except in the following circumstances:

- An error message appears on the screen during the system bootup and requests you to run the BIOS Setup.
- You have installed a new system component that requires further BIOS settings or update.



---

Inappropriate settings of the BIOS may result to instability or failure to boot. **We strongly recommend that you change the BIOS settings only with the help of a trained service personnel.**

---

### 2.2 Updating BIOS

The ASUS website publishes the latest BIOS versions to provide enhancements on system stability, compatibility, or performance. However, BIOS updating is potentially risky. If there is no problem using the current version of BIOS, **DO NOT manually update the BIOS.** Inappropriate BIOS updating may result in the system's failure to boot. Carefully follow the instructions of this chapter to update your BIOS if necessary.



---

Visit the ASUS website at [www.asus.com](http://www.asus.com) to download the latest BIOS file for this motherboard.

---

The following utilities allow you to manage and update the motherboard BIOS setup program.

1. **ASUS Update:** Updates the BIOS in Windows® environment.
2. **ASUS EZ Flash 2:** Updates the BIOS using a USB flash disk.
3. **ASUS CrashFree BIOS 3 utility:** Restores the BIOS using the motherboard support DVD or a USB flash drive when the BIOS file fails or gets corrupted.

Refer to the corresponding sections for details on these utilities.



---

Save a copy of the original motherboard BIOS file to a USB flash drive in case you need to restore the BIOS in the future. Copy the original motherboard BIOS using the **ASUS Update** utility.

---

## 2.2.1 ASUS Update utility

The ASUS Update is a utility that allows you to manage, save, and update the motherboard BIOS in Windows® environment.



- 
- ASUS Update requires an Internet connection either through a network or an Internet Service Provider (ISP).
  - This utility is available in the support DVD that comes with the motherboard package.
- 

### Installing ASUS Update

To install ASUS Update:

1. Place the support DVD in the optical drive. The **Drivers** menu appears.
2. Click the **Utilities** tab, and then click **Install ASUS Update**.
3. Follow the onscreen instructions to complete the installation.



---

Quit all Windows® applications before you update the BIOS using this utility.

---

### Updating the BIOS

To update the BIOS:

1. From the Windows® desktop, click **Start > Programs > ASUS > ASUSUpdate > ASUSUpdate** to launch the ASUS Update utility.
2. From the dropdown list, select any of the updating process:

#### Updating from the Internet

- a. Select **Update BIOS from the Internet**, and then click **Next**.
- b. Select the ASUS FTP site nearest you to avoid network traffic, or click **Auto Select**, and then click **Next**.
- c. From the FTP site, select the BIOS version that you wish to download, and then click **Next**.



---

The ASUS Update utility is capable of updating itself through the Internet. Always update the utility to avail all its features.

---

#### Updating from a BIOS file

- a. Select **Update BIOS from a file**, and then click **Next**.
  - b. Locate the BIOS file from the **Open** window, and then click **Open**.
3. Follow the onscreen instructions to complete the updating process.



## 2.2.2 ASUS EZ Flash 2 utility

The ASUS EZ Flash 2 feature allows you to update the BIOS without using an OS-based utility.



Before you start using this utility, download the latest BIOS from the ASUS website at [www.asus.com](http://www.asus.com).

To update the BIOS using EZ Flash 2

1. Insert the USB flash disk that contains the latest BIOS file to the USB port, and then launch EZ Flash 2 in any of these two ways:
  - Press <Alt> + <F2> during POST.
  - Enter the BIOS setup program. Go to the **Tools** menu to select **EZ Flash 2** and press <Enter> to enable it.

Press <Tab> to switch between drives until the correct BIOS file is found.

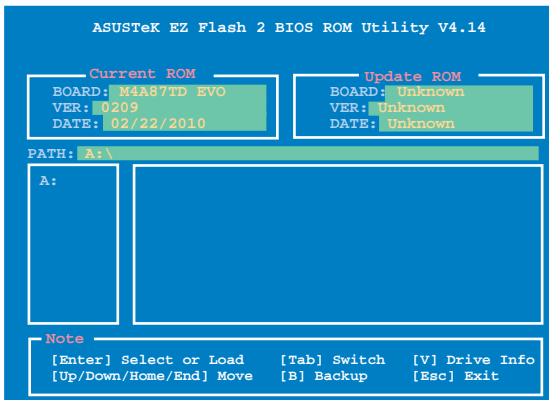

2. When the correct BIOS file is found, EZ Flash 2 performs the BIOS update process and automatically reboots the system when done.



- Only a USB flash disk with FAT 32/16 format and single partition can support the ASUS EZ Flash 2 utility.
- DO NOT shut down or reset the system while updating the BIOS to prevent system boot failure!



Ensure to load the BIOS default settings to ensure system compatibility and stability. Select the **Load Setup Defaults** item under the **Exit** menu. Refer to section **2.10 Exit Menu** for details.

### 2.2.3 ASUS CrashFree BIOS 3 utility

The ASUS CrashFree BIOS 3 utility is an auto recovery tool that allows you to restore the BIOS file when it fails or gets corrupted during the updating process. You can restore a corrupted BIOS file using the motherboard support DVD or a USB flash drive that contains the BIOS file.



---

The BIOS file in the motherboard support DVD may be older than the BIOS file published on the ASUS official website. If you want to use the newer BIOS file, download the file at [support.asus.com](http://support.asus.com) and save it to a USB flash drive.

---

### Recovering the BIOS

To recover the BIOS:

1. Turn on the system.
2. Insert the motherboard support DVD to the optical drive, or the USB flash drive containing the BIOS file to the USB port.
3. The utility automatically checks the devices for the BIOS file. When found, the utility reads the BIOS file and starts flashing the corrupted BIOS file.
4. Turn off the system after the utility completes the updating process and power on again.
5. The system requires you to enter BIOS Setup to recover BIOS setting. To ensure system compatibility and stability, we recommend that you press <F2> to load default BIOS values.



---

**DO NOT** shut down or reset the system while updating the BIOS! Doing so can cause system boot failure!

---

## 2.3 BIOS setup program

This motherboard supports a programmable firmware chip that you can update using the provided utility described in section **2.2 Updating BIOS**.

Use the BIOS Setup program when you are installing a motherboard, reconfiguring your system, or prompted to "Run Setup". This section explains how to configure your system using this utility.

Even if you are not prompted to use the Setup program, you can change the configuration of your computer in the future. For example, you can enable the security password feature or change the power management settings. This requires you to reconfigure your system using the BIOS Setup program so that the computer can recognize these changes and record them in the CMOS RAM of the firmware chip.

The firmware chip on the motherboard stores the Setup utility. When you start up the computer, the system provides you with the opportunity to run this program. Press **<Del>** during the Power-On Self-Test (POST) to enter the Setup utility. Otherwise, POST continues with its test routines.

If you wish to enter Setup after POST, reboot the system by doing any of the following procedures:

- Restart using the OS standard shut-down procedure.
- Press **<Ctrl>+<Alt>+<Del>** simultaneously.
- Press the reset button on the system chassis.
- Press the power button to turn the system off then back on.



---

Using the power button, reset button, or the **<Ctrl>+<Alt>+<Del>** keys to force reset from a running operating system can cause damage to your data or system. We recommend to always shut-down the system properly from the operating system.

---

The Setup program is designed to make it as easy to use as possible. Being a menu-driven program, it lets you scroll through the various submenus and make your selections from the available options using the navigation keys.



- 
- The default BIOS settings for this motherboard apply for most conditions to ensure optimum performance. If the system becomes unstable after changing any BIOS settings, load the default settings to ensure system compatibility and stability. Select the **Load Setups Default** item under the Exit Menu. See section **2.10 Exit Menu**.
  - The BIOS setup screens shown in this section are for reference purposes only, and may not exactly match what you see on your screen.
  - Visit the ASUS website at [www.asus.com](http://www.asus.com) to download the latest BIOS file for this motherboard.
-

### 2.3.1 BIOS menu screen

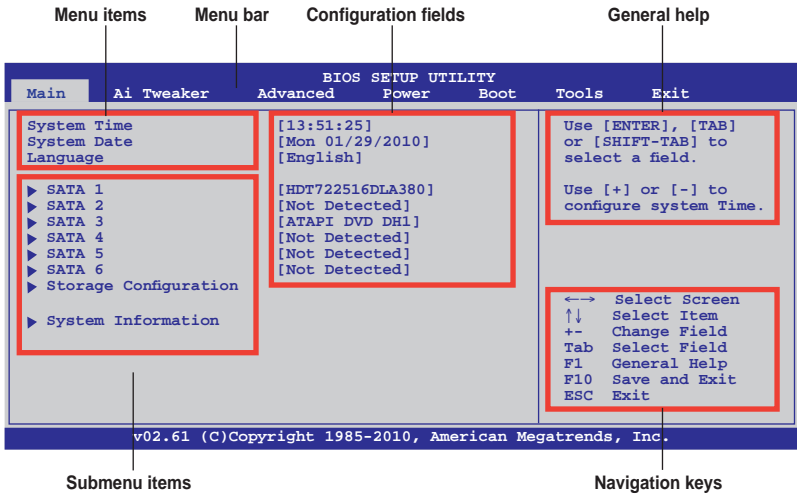

### 2.3.2 Menu bar

The menu bar on top of the screen has the following main items:

- Main** For changing the basic system configuration
- Ai Tweaker** For changing the overclocking settings
- Advanced** For changing the advanced system settings
- Power** For changing the advanced power management (APM) configuration
- Boot** For changing the system boot configuration
- Tools** For changing the system tools configuration
- Exit** For selecting the exit options and loading default settings

To select an item on the menu bar, press the right or left arrow key on the keyboard until the desired item is highlighted.



- The BIOS setup screens shown in this chapter are for reference purposes only, and may not exactly match what you see on your screen.
- Visit the ASUS website at [www.asus.com](http://www.asus.com) to download the latest BIOS information.

### 2.3.3 Navigation keys

At the bottom right corner of a menu screen are the navigation keys for that particular menu. Use the navigation keys to select items in the menu and change the settings.



---

Some of the navigation keys differ from one screen to another.

---

### 2.3.4 Menu items

The highlighted item on the menu bar displays the specific items for that menu. For example, selecting Main shows the Main menu items.

The other items (Advanced, Power, Boot, Tools, and Exit) on the menu bar have their respective menu items.

### 2.3.5 Submenu items

A solid triangle before each item on any menu screen means that the item has a submenu. To display the submenu, select the item and press <Enter>.

### 2.3.6 Configuration fields

These fields show the values for the menu items. If an item is user-configurable, you can change the value of the field opposite the item. You cannot select an item that is not user-configurable.

A configurable field is enclosed in brackets, and is highlighted when selected. To change the value of a field, select it then press <Enter> to display a list of options. Refer to **2.3.8 Pop-up window**.

### 2.3.7 General help

At the top right corner of the menu screen is a brief description of the selected item.

### 2.3.8 Pop-up window

Select a menu item then press <Enter> to display a pop-up window with the configuration options for that item.

### 2.3.9 Scroll bar

A scroll bar appears on the right side of a menu screen when there are items that do not fit on the screen. Press the <Up> / <Down> arrow keys or <Page Up> / <Page Down> keys to display the other items on the screen.

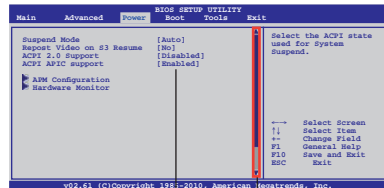

Pop-up window  
Scroll bar

## 2.4 Main menu

When you enter the BIOS Setup program, the **Main** menu screen appears, giving you an overview of the basic system information.



Refer to section **2.3.1 BIOS menu screen** for information on the menu screen items and how to navigate through them.

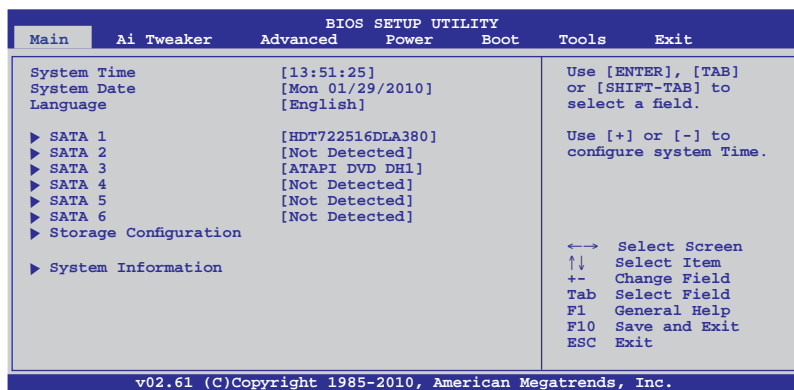

### 2.4.1 SATA 1–6

While entering Setup, the BIOS automatically detects the presence of SATA devices. There is a separate submenu for each SATA device. Select a device item and press <Enter> to display the SATA device information.

The BIOS automatically detects the values opposite the dimmed items (Device, Vendor, Size, LBA Mode, Block Mode, PIO Mode, Async DMA, Ultra DMA, and SMART Monitoring). These values are not user-configurable. These items show **N/A** if no SATA device is installed in the system.

#### Type [Auto]

Allows you to select the type of device installed.

[Not Installed] Select this option if no device is installed.

[Auto] Allows automatic selection of the appropriate device type.

[CDROM] Select this option if you are specifically configuring a CD-ROM drive.

[ARMD] Select [ARMD] (ATAPI Removable Media Device) if your device is either a ZIP, LS-120, or MO drive.



This item appears in **SATA 5/SATA 6** only.

#### LBA/Large Mode [Auto]

[Auto] Select [Auto] to enable the LBA mode (Logical Block Addressing mode) if the device supports this mode, and if the device was not previously formatted with LBA mode disabled.

[Disabled] Disables this function.

### **Block (Multi-Sector Transfer) M [Auto]**

- [Auto] When set to [Auto], the data transfer from and to the device occurs in multiple sectors at a time if the device supports multi-sector transfer feature.
- [Disabled] When set to [Disabled], the data transfer from and to the device occurs one sector at a time.

### **PIO Mode [Auto]**

- [Auto] Allows automatic selection of the PIO (Programmed input/output) modes, which correspond to different data transfer rates.
- [0] [1] [2] [3] [4] Sets the PIO mode to Mode 0, 1, 2, 3, or 4.

### **DMA Mode [Auto]**

DMA (Direct Memory Access) allows your computer to transfer data to and from the hardware devices installed with much less CPU overhead.

The DMA mode consists of SDMA (single-word DMA), MDMA (multi-word DMA), and UDMA (Ultra DMA). Setting to [Auto] allows automatic selection of the DMA mode.

### **SMART Monitoring [Auto]**

- [Auto] Allows automatic selection of the S.M.A.R.T (Smart Monitoring, Analysis, and Reporting Technology).
- [Enabled] Enables the S.M.A.R.T feature.
- [Disabled] Disables the S.M.A.R.T feature.

### **32Bit Data Transfer [Enabled]**

- [Enabled] Sets the controller to combine two 16-bit reads from the hard disk into a single 32-bit double word transfer to the processor. This makes more efficient use of the PCI bus as fewer transactions are needed for the transfer of a particular amount of data.
- [Disabled] Disables this function.

## **2.4.2 Storage Configuration**

The Storage Configuration menu allows you to configure your storage devices. Select an item then press <Enter> to display the submenu.

### **OnChip SATA Channel [Enabled]**

- [Enabled] Enables the onboard channel SATA port.
- [Disabled] Disables the onboard channel SATA port.



The following two items appear only when you set the **OnChip SATA Channel** item to [Enabled].

---

## SATA Port1–Port4 [IDE]

Allows you to set the SATA configuration.

- [IDE] Set to [IDE] when you want to use the Serial ATA hard disk drives as Parallel ATA physical storage devices.
- [RAID] Set to [RAID] when you want to create a RAID configuration from the SATA hard disk drives.
- [AHCI] Set to [AHCI] when you want the SATA hard disk drives to use the AHCI (Advanced Host Controller Interface). The AHCI allows the onboard storage driver to enable advanced Serial ATA features that increases storage performance on random workloads by allowing the drive to internally optimize the order of commands.

### SATA Port5–Port6 [IDE]

Setting this item to [IDE] instead of [RAID] or [AHCI] allows the system to recognize the optical drives connected to the SATA connectors 5 or 6 when installing OS.



- When the **SATA Port1–Port 4** and the **SATA Port5–Port 6** items are set to [AHCI], the information of the SATA connectors 1–6 can be seen only under the OS environment or during POST.
- For Windows® XP OS, you have to install the AHCI driver, so that you could use the SATA connectors 1–6 in AHCI mode under the OS environment.



If you use a SATA optical drive to run the OS installation disk, we strongly recommend that you install the optical drive to the SATA connectors 5/6 and set them to [IDE] mode.

## 2.4.3 System Information

This menu gives you an overview of the general system specifications. The BIOS automatically detects the BIOS information, CPU specification, and system memory in this menu.



## 2.5 Ai Tweaker menu

The Ai Tweaker menu items allow you to configure overclocking-related items.



Take caution when changing the settings of the Ai Tweaker menu items. Incorrect field values can cause the system to malfunction.



The default values of the following items vary depending on the CPU and memory modules you install on the motherboard.

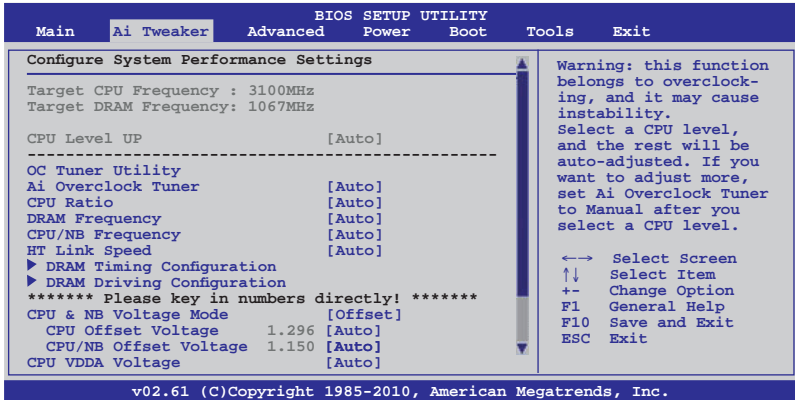

Scroll down to display the following items:

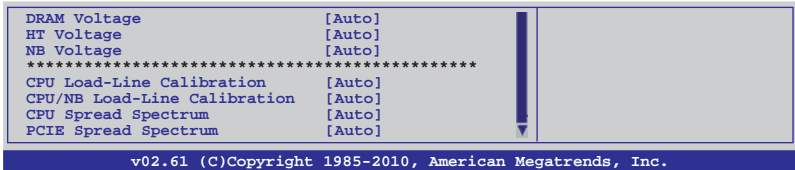

### 2.5.1 CPU Level UP [Auto]

Allows you to select a CPU level, and the related parameters will be automatically adjusted according to the selected CPU level. If you want to manually configure the settings in detail, set **Ai Overclock Tuner** to [Manual] after selecting a CPU level.

Configuration options: [Auto] [Phenom II-955] [Phenom II-3.4G] [Phenom II-3.6G]



- The configuration options vary depending on the CPU model you install on the motherboard.
- The CPU Level UP function support depends on CPU types.

### 2.5.2 OC Tuner Utility

OC Tuner utility automatically overclocks the frequency and voltage of the CPU and DRAM. Press <Enter> to start auto tuning. It takes around five minutes, and the system will reboot for several times until auto tuning is completed.

### 2.5.3 Ai Overclock Tuner [Auto]

Allows you to select the CPU overclocking options to achieve the desired CPU internal frequency. Select any of these preset overclocking configuration options:

<b>Manual</b>	Allows you to individually set overclocking parameters.
<b>Auto</b>	Loads the optimal settings for the system.
<b>D.O.C.P</b>	Allows you to select a DRAM O.C. profile, and the related parameters will be adjusted automatically.
<b>CPU Level UP</b>	Allows you to select a CPU level, and the related parameters will be adjusted automatically.



The configuration options for the following sub-items vary depending on the CPU/DIMMs you install on the motherboard.

## OC From CPU Level UP [Auto]

This item appears only when you set the **Ai Overclock Tuner** item to [Manual] and allows you to select a CPU level. The related parameters will be automatically adjusted according to the selected CPU level.

### DRAM O.C. Profile [DDR3-1600MHz]

This item appears only when you set the **Ai Overclock Tuner** item to [D.O.C.P.] and allows you to select a DRAM O.C. profile, which applies different settings to DRAM frequency, DRAM timing and DRAM voltage. Configuration options: [DDR3-1600MHz] [DDR3-1800MHz] [DDR3-1866MHz] [DDR3-2000MHz]

### Profile Info : xxxMHz-x-x-x-xx

This item appears only when you set the **Ai Overclock Tuner** item to [D.O.C.P.] and displays the current DRAM profile information. The profile information varies according to the **DRAM O.C. Profile** you've selected.

## 2.5.4 CPU Ratio [Auto]

Allows you to set the ratio between the CPU Core Clock and the FSB Frequency. Use the <+> and <-> keys to adjust the ratio. The valid value ranges vary according to your CPU model.

## CPU Bus Frequency [XXX]

This item appears only when you set the **Ai Overclock Tuner** item to [Manual] and displays the frequency sent by the clock generator to the system bus and PCI bus. Use the <+> and <-> keys to adjust the CPU Bus frequency. You can also key in the desired frequency using the numeric keypad. The values range from 100 to 600.

## PCIe Frequency [XXX]

This item appears only when you set the **Ai Overclock Tuner** item to [Manual] and allows you to set the PCI Express frequency. Use the <+> and <-> keys to adjust the PCIe frequency. You can also key in the desired value using the numeric keypad. The values range from 100 to 150.

## 2.5.5 DRAM Frequency [Auto]

Allows you to set the DDR3 operating frequency. The configuration options vary with the **CPU Bus Frequency** item settings.



Selecting a very high DRAM frequency may cause the system to become unstable! If this happens, revert to the default setting.

## 2.5.6 CPU/NB Frequency [Auto]

Allows you to select the CPU/NB frequency.

Configuration options: [Auto] [1200MHz] [1400MHz] [1600MHz] [1800MHz] [2000MHz]

## 2.5.7 HT Link Speed [Auto]

Allows you to select the HyperTransport link speed.

Configuration options: [Auto] [200MHz] [400MHz] [600MHz] [800MHz] [1000MHz] [1200MHz] [1400MHz] [1600MHz] [1800MHz] [2000MHz]

## 2.5.8 DRAM Timing Configuration



The configuration options for some of the following items vary depending on the DIMMs you install on the motherboard.

### DRAM CAS# Latency [Auto]

Configuration options: [Auto] [4 CLK] – [12 CLK]

### DRAM RAS# to CAS# Delay [Auto]

Configuration options: [Auto] [5 CLK] – [12 CLK]

### DRAM RAS# PRE Time [Auto]

Configuration options: [Auto] [5 CLK] – [12 CLK]

### DRAM RAS# ACT Time [Auto]

Configuration options: [Auto] [15 CLK] – [30 CLK]

### DRAM READ to PRE Time [Auto]

Configuration options: [Auto] [4 CLK] [5 CLK] [6 CLK] [7 CLK]

### DRAM Row Cycle Time [Auto]

Configuration options: [Auto] [11 CLK] – [41 CLK]

### DRAM WRITE Recovery Time [Auto]

Configuration options: [Auto] [5 CLK] [6 CLK] [7 CLK] [8 CLK] [10 CLK] [12 CLK]

### DRAM RAS# to RAS# Delay [Auto]

Configuration options: [Auto] [4 CLK] [5 CLK] [6 CLK] [7 CLK]

### DRAM READ to WRITE Delay [Auto]

Configuration options: [Auto] [3 CLK] – [17 CLK]

### DRAM WRITE to READ Delay(DD) [Auto]

Configuration options: [Auto] [2 CLK] – [10 CLK]

### DRAM WRITE to READ Delay(SD) [Auto]

Configuration options: [Auto] [4 CLK] [5 CLK] [6 CLK] [7 CLK]

### DRAM WRITE to WRITE Timing [Auto]

Configuration options: [Auto] [3 CLK] – [10 CLK]

### **DRAM READ to READ Timing [Auto]**

Configuration options: [Auto] [3 CLK] – [10 CLK]

### **DRAM REF Cycle Time [Auto]**

Configuration options: [Auto] [90ns] [110ns] [160ns] [300ns] [350ns]

### **DRAM Refresh Rate [Auto]**

Configuration options: [Auto] [Every 7.8ms] [Every 3.9ms]

### **DRAM Command Rate [Auto]**

Configuration options: [Auto] [1T] [2T]

## **2.5.9 DRAM Driving Configuration**



---

The configuration options for some of the following items vary depending on the DIMMs you install on the motherboard.

---

### **CKE drive strength [Auto]**

Configuration options: [Auto] [1x] [1.25x] [1.5x] [2x]

### **CS/ODT drive strength [Auto]**

Configuration options: [Auto] [1x] [1.25x] [1.5x] [2x]

### **ADDR/CMD drive strength [Auto]**

Configuration options: [Auto] [1x] [1.25x] [1.5x] [2x]

### **MEMCLK drive strength [Auto]**

Configuration options: [Auto] [0.75x] [1x] [1.25x] [1.5x]

### **Data drive strength [Auto]**

Configuration options: [Auto] [0.75x] [1x] [1.25x] [1.5x]

### **DQS drive strength [Auto]**

Configuration options: [Auto] [0.75x] [1x] [1.25x] [1.5x]

### **Processor ODT [Auto]**

Configuration options: [Auto] [240 ohms +/- 20%] [120 ohms +/- 20%] [60 ohms +/- 20%]



---

Some of the following items are adjusted by typing the desired values using the numeric keypad and press the <Enter> key. You can also use the <+> and <-> keys to adjust the value. To restore the default setting, type [auto] using the keyboard and press the <Enter> key.

---

## **2.5.10 CPU & NB Voltage Mode [Offset]**

Allows you to set the CPU & CPU/NB Voltage Mode. Different sub-items appear according to the **CPU & NB Voltage Mode** item setting. Configuration options: [Offset] [Manual]

### CPU Offset Voltage [Auto]

This item appears only when you set the **CPU & NB Voltage Mode** item to [Offset] and allows you to set the CPU Offset voltage. The values range from 0.003125V to 0.700000V with a 0.003125V interval.

#### CPU/NB Offset Voltage [Auto]

This item appears only when you set the **CPU & NB Voltage Mode** item to [Offset] and allows you to set the CPU/NB Offset voltage. The values range from 0.003125V to 0.700000V with a 0.003125V interval.

#### CPU Voltage [Auto]

This item appears only when you set the **CPU & NB Voltage Mode** item to [Manual] and allows you to set a fixed CPU voltage.

#### CPU/NB Voltage [Auto]

This item appears only when you set the **CPU & NB Voltage Mode** item to [Manual] and allows you to set a fixed CPU/NB voltage.

### **2.5.11 CPU VDDA Voltage [Auto]**

Allows you to set the CPU VDDA voltage. The values range from 2.20000V to 2.90000V with a 0.00625V interval.

### **2.5.12 DRAM Voltage [Auto]**

Allows you to set the DRAM voltage. The values range from 1.20000V to 2.20000V with a 0.00625V interval.

### **2.5.13 HT Voltage [Auto]**

Allows you to set the HyperTransport voltage. The values range from 1.20000V to 1.40000V with a 0.00625V interval.

### **2.5.14 NB Voltage [Auto]**

Allows you to set the Northbridge voltage. The values range from 1.10000V to 1.25000V with a 0.00625V interval.

### **2.5.15 CPU Load-Line Calibration [Auto]**

Allows you to select the CPU Load-Line mode.  
Configuration options: [Auto] [Disabled] [Enabled]

### **2.5.16 CPU/NB Load-Line Calibration [Auto]**

Allows you to select the CPU/NB Load-Line mode.  
Configuration options: [Auto] [Disabled] [Enabled]

### **2.5.17 CPU Spread Spectrum [Auto]**

[Auto] Automatic configuration.  
[Disabled] Enhances the CPU overclocking ability.  
[Enabled] Sets to [Enabled] for EMI control.

### **2.5.18 PCIE Spread Spectrum [Auto]**

[Auto] Automatic configuration.  
[Disabled] Enhances the PCIE overclocking ability.  
[Enabled] Sets to [Enabled] for EMI control.

## 2.6 Advanced menu

The **Advanced** menu items allow you to change the settings for the CPU and other system devices.



Be cautious when changing the settings of the Advanced menu items. Incorrect field values can cause the system to malfunction.

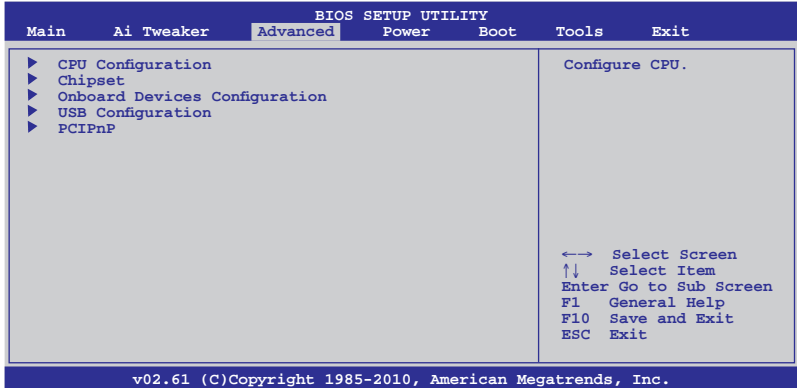

### 2.6.1 CPU Configuration

The items in this menu show the CPU-related information that the BIOS automatically detects.

#### Microcode Updation [Enabled]

[Enabled] Allows the system to update the Microcode automatically, enhancing system performance.

[Disabled] Disables this function.

#### Secure Virtual Machine Mode [Enabled]

[Enabled] Enables the AMD Secure Virtual Machine mode.

[Disabled] Disables this function.

#### Cool'n'Quiet [Enabled]

[Enabled] Enables the AMD Cool'n'Quiet function.

[Disabled] Disables this function.

#### ASUS Core Unlocker [Disabled]

[Enabled] Enables the ASUS Core Unlocker to get the full computing power of the processor.

[Disabled] Disables this function.

#### C1E Support [Enabled]

[Enabled] Enables the C1E support function. This item should be enabled in order to enable the Enhanced Halt State.

[Disabled] Disables this function.

## 2.6.2 Chipset

The Chipset menu allows you to change the advanced chipset settings. Select an item then press <Enter> to display the submenu.

### DRAM Controller configuration

#### Channel Interleaving [XOR of Address bit]

Configuration options: [Disabled] [Address bits 6] [Address bits 12]  
[XOR of Address bits [20:16, 6]] [XOR of Address bits [20:16, 9]]

#### MemClk Tristate C3/ATLVID [Disabled]

Configuration options: [Disabled] [Enabled]

#### Memory Hole Remapping [Enabled]

Configuration options: [Disabled] [Enabled]

#### DCT Unganged Mode [Always]

Configuration options: [Auto] [Always]

#### Power Down Enable [Disabled]

Enables or disables the DDR power down mode.

Configuration options: [Disabled] [Enabled]

#### **Power Down Mode [Channel]**

This item appears only when you enable the previous item and allows you to set the DDR power down mode. Configuration options: [Channel] [Chip Select]

### ECC Configuration

#### ECC Mode [Disabled]

Disables or sets the DRAM ECC mode that allows the hardware to report and correct memory errors.

[Disabled] Disables the DRAM ECC mode.

[Basic] Set to [Basic] to adjust ECC mode automatically.

[Good] Set to [Good] to adjust ECC mode automatically.

[Super] Set to [Super] to adjust the DRAM BG Scrub sub-item manually.

[Max] Set to [Max] to adjust ECC mode automatically.

[User] Set to [User] to adjust all the subitems manually.

### Primary Display Adapter [PCI-E]

Allows you to select the graphics controller to use as the primary boot device.

Configuration options: [PCI-E] [PCI]

## 2.6.3 Onboard Devices Configuration

### HD Audio Azalia Device [Enabled]

Allows you to enable or disable the HD Audio controller.

Configuration options: [Disabled] [Enabled]



---

The following item appear only when you set the HD Audio Azalia Device item to [Enabled].

---

### Azalia Front Panel [HD]

Allows you to set the front panel audio connector (AAFP) mode to legacy AC'97 or high-definition audio depending on the audio standard that the front panel audio module supports.

- [AC 97] Sets the front panel audio connector (AAFP) mode to legacy AC'97  
[HD] Sets the front panel audio connector (AAFP) mode to high definition audio.

### **Serial Port1 Address [3F8/IRQ4]**

Allows you to select the Serial Port1 base address.

Configuration options: [3F8/IRQ4] [2F8/IRQ3] [3E8/IRQ4] [2E8/IRQ3]

### Serial Port1 Mode [Normal]

Allows you to select the Serial Port1 mode.

Configuration options: [Normal] [IrDA] [ASK IR]

### **Onboard LAN [Enabled]**

[Enabled] Enables the onboard LAN controller.

[Disabled] Disables the controller.

### Onboard LAN Boot ROM [Disabled]

This item appears only when you set the previous item to [Enabled].

[Enabled] Enables the onboard Gigabit LAN Boot ROM.

[Disabled] Disables the LAN Boot ROM.

### **Onboard 1394 Controller [Enabled]**

[Enabled] Enables the onboard IEEE 1394a controller.

[Disabled] Disables the controller.

### **Onboard ATA Controller [Enabled]**

[Enabled] Enables the onboard ATA controller.

[Disabled] Disables the controller.

### Onboard ATA Controller ROM [Enabled]

This item appears only when you set the previous item to [Enabled].

[Enabled] Enables the onboard ATA controller ROM.

[Disabled] Disables the onboard ATA controller ROM.

### **Onboard USB 3.0 Controller [Enabled]**

[Enabled] Enables the USB 3.0 controller.

[Disabled] Disables the controller.

## **2.6.4 USB Configuration**

The items in this menu allow you to change the USB-related features. Select an item and press <Enter> to display the configuration options.



---

The USB Devices Enabled item shows the auto-detected values. If no USB device is detected, the item shows None.

---



## USB Support [Enabled]

- [Enabled] Enables the USB Host Controllers.
- [Disabled] Disables the controllers.



---

The following items appear only when you set USB Support to [Enabled].

---

## Legacy USB Support [Auto]

- [Auto] Allows the system to detect the presence of USB devices at startup. If detected, the USB controller legacy mode is enabled. If no USB device is detected, the legacy USB support is disabled.
- [Enabled] Enables the support for USB devices on legacy operating systems (OS).
- [Disabled] Disables the function.

## USB 2.0 Controller Mode [HiSpeed]

- [FullSpeed] Sets the USB 2.0 controller mode to FullSpeed (12 Mbps).
- [HiSpeed] Sets the USB 2.0 controller mode to HiSpeed (480 Mbps).

## BIOS EHCI Hand-off [Enabled]

- [Enabled] Enables the support for operating systems without an EHCI hand-off feature.
- [Disabled] Disables the function.

## 2.6.5 PCIPnP

The PCI PnP menu items allow you to change the advanced settings for PCI/PnP devices.

### Plug And Play O/S [No]

- [Yes] When set to [Yes] and if you install a Plug and Play operating system, the operating system configures the Plug and Play devices not required for boot.
- [No] When set to [No], BIOS configures all the devices in the system.

## 2.7 Power menu

The **Power** menu items allow you to change the settings for the Advanced Configuration and Power Interface (ACPI) and the Advanced Power Management (APM). Select an item then press **<Enter>** to display the configuration options.

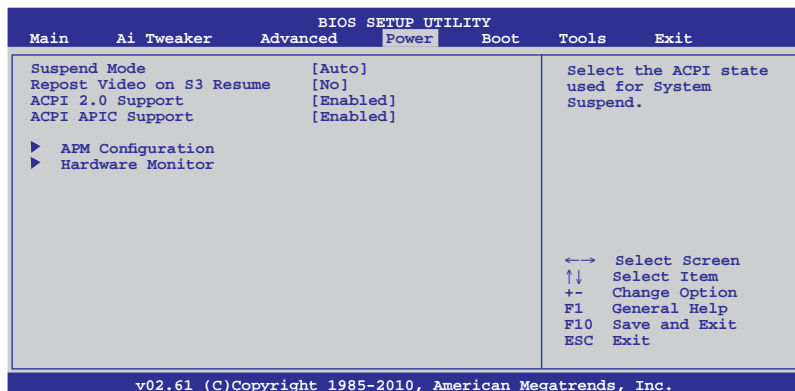

### 2.7.1 Suspend Mode [Auto]

Allows you to select the Advanced Configuration and Power Interface (ACPI) state to be used for system suspend. Configuration options: [S1 (POS) Only] [S3 Only] [Auto]

[S1(POS) Only] - Enables the system to enter the ACPI S1 (Power on Suspend) sleep state.

In S1 sleep state, the system appears suspended and stays in a low power mode. The system can be resumed at any time.

[S3 Only] - Enables the system to enter the ACPI S3 (Suspend to RAM) sleep state (default).

In S3 sleep state, the system appears to be off and consumes less power than in the S1 state. When signaled by a wake-up device or event, the system resumes to its working state exactly where it was left off.

[Auto] - Detected by OS.

### 2.7.2 Repost Video on S3 Resume [No]

Determines whether to invoke VGA BIOS POST on S3/STR resume.

[No] The system will not invoke VGA BIOS POST on S3/STR resume.

[Yes] The system invokes VGA BIOS POST on S3/STR resume.

### 2.7.3 ACPI 2.0 Support [Enabled]

Allows you to add more tables for Advanced Configuration and Power Interface (ACPI) 2.0 specifications. Configuration options: [Disabled] [Enabled]

### 2.7.4 ACPI APIC support [Enabled]

Allows you to enable or disable the Advanced Configuration and Power Interface (ACPI) support in the Application-Specific Integrated Circuit (ASIC). When set to [Enabled], the ACPI APIC table pointer is included in the RSDT pointer list.

Configuration options: [Disabled] [Enabled]

## 2.7.5 APM Configuration

### EuP Ready [Disabled]

- [Disabled] Disables the Energy Using Products (EuP) Ready function.
- [Enabled] Allows BIOS to switch off some power at S5 state to get system ready for the EuP requirement. When set to [Enabled], power for WOL, WO\_USB, audio and onboard LEDs will be switched off at S5 state.

### Restore On AC Power Loss [Power Off]

- [Power On] The system goes into on state after an AC power loss.
- [Power Off] The system goes into off state after an AC power loss.
- [Last State] The system goes into either off or on state, whatever the system state was before the AC power loss.

### Power On By PCI/PCIE Device [Disabled]

- [Disabled] Disables the PME to wake up from S5 by PCI/PCIE devices.
- [Enabled] Allows you to turn on the system through a PCI/PCIE LAN or modem card. This feature requires an ATX power supply that provides at least 1A on the +5VSB lead.

### Power On By PS/2 Devoces [Disabled]

- [Disabled] Disables the Power On by a PS/2 devices.
- [Enabled] Enables the Power On by a PS/2 devices. This feature requires an ATX power supply that provides at least 1A on the +5VSB lead.

### Power On By Ring [Disabled]

- [Disabled] Disables to power up the computer when the external modem receives a call while the computer is in Soft-off mode.
- [Enabled] The computer could be powered up when the external modem receives a call while the computer is in Soft-off mode.



---

The computer cannot receive or transmit data until the computer and applications are fully running. Thus, connection cannot be made on the first try. Turning an external modem off and then back on while the computer is off causes an initialization string that turns the system power on.

---

### Power On By RTC Alarm [Disabled]

- [Disabled] Disables RTC to generate a wake event.
- [Enabled] When set to [Enabled], the items **RTC Alarm Date (Days)** and **RTC Alarm Time (HH:MM:SS)** will become user-configurable with set values.

## 2.7.6 Hardware Monitor

### CPU/MB Temperature [xxx°C/xxx°F]

The onboard hardware monitor automatically detects and displays the motherboard and CPU temperatures. Select [Ignored] if you do not wish to display the detected temperatures.

### **CPU Fan / Power Fan / Chassis Fan Speed [xxxxRPM] or [Ignored]**

The onboard hardware monitor automatically detects and displays the CPU fan, power fan and chassis fan speeds in rotations per minute (RPM). If the fan is not connected to the motherboard, the field shows N/A. Select [Ignored] if you do not wish to display the detected speed.

### **VCORE / 3.3V / 5V / 12V Voltage**

The onboard hardware monitor automatically detects the voltage output through the onboard voltage regulators. Select Ignored if you do not wish to display the detected voltage output.

### **CPU Q-Fan Function [Enabled]**

Allows you to enable or disable the CPU Q-Fan feature that smartly adjusts the fan speeds for more efficient system operation. Configuration options: [Disabled] [Enabled]

#### *CPU Fan Speed Low Limit [200 RPM]*

A warning message will appear to remind you that the CPU fan speed is lower than the selected value.

Configuration options: [500RPM] [400RPM] [300RPM] [200RPM] [100RPM] [Ignored]

#### *CPU Q-Fan Mode [Optimal]*

Allows you to set the appropriate performance level of the CPU Q-Fan. When set to [Optimal], the CPU fan automatically adjusts depending on the CPU temperature. Set this item to [Silent] to minimize fan speed for quiet CPU fan operation, or [Performance] to achieve the maximum CPU fan speed.

Configuration options: [Performance] [Optimal] [Silent]

### **Chassis Q-Fan Function [Disabled]**

Allows you to enable or disable the chassis Q-Fan feature that smartly adjusts the fan speeds for more efficient system operation. Configuration options: [Disabled] [Enabled]

## 2.8 Boot menu

The **Boot** menu items allow you to change the system boot options. Select an item then press **<Enter>** to display the submenu.

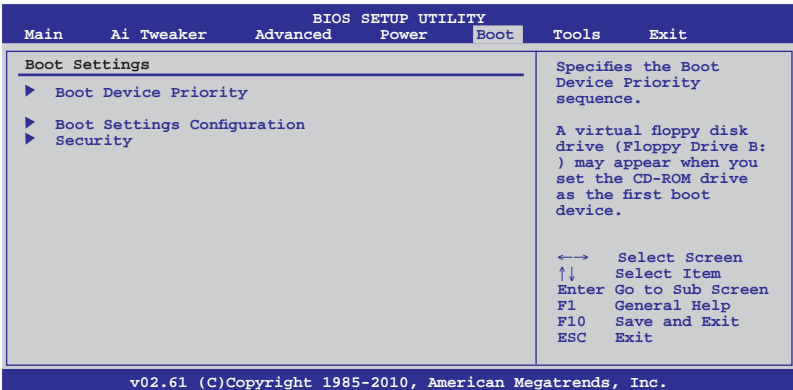

### 2.8.1 Boot Device Priority

#### 1st–xth Boot Device

These items specify the boot device priority sequence from the available devices. The number of device items that appears on the screen depends on the number of devices installed in the system.

Configuration options: [1st FLOPPY DRIVE] [Hard Drive] [ATAPI CD-ROM] [Disabled]

### 2.8.2 Boot Settings Configuration

#### Quick Boot [Enabled]

Enabling this item allows the BIOS to skip some power on self tests (POST) while booting to decrease the time needed to boot the system. When set to **[Disabled]**, BIOS performs all the POST items. Configuration options: [Disabled] [Enabled]

#### Full Screen Logo [Enabled]

This allows you to enable or disable the full screen logo display feature.

Configuration options: [Disabled] [Enabled]



Set this item to **[Enabled]** to use the ASUS MyLogo 2™ feature.

#### AddOn ROM Display Mode [Force BIOS]

Sets the display mode for option ROM. Configuration options: [Force BIOS] [Keep Current]

#### Bootup Num-Lock [On]

Allows you to select the power-on state for the NumLock. Configuration options: [Off] [On]

#### Wait for 'F1' If Error [Enabled]

When set to [Enabled], the system waits for the F1 key to be pressed when error occurs.

Configuration options: [Disabled] [Enabled]

#### Hit 'DEL' Message Display [Enabled]

When set to [Enabled], the system displays the message **Press DEL to run Setup** during POST. Configuration options: [Disabled] [Enabled]

## 2.8.3 Security

The Security menu items allow you to change the system security settings. Select an item then press **<Enter>** to display the configuration options.

### Change Supervisor Password

Select this item to set or change the supervisor password. The Supervisor Password item on top of the screen shows the default Not Installed. After you set a password, this item shows Installed.

To set a Supervisor Password

1. Select the Change Supervisor Password item and press **<Enter>**.
2. From the password box, type a password composed of at least six letters and/or numbers, then press **<Enter>**.
3. Confirm the password when prompted.

The message "Password Installed" appears after you successfully set your password.

To change the supervisor password, follow the same steps as in setting a supervisor password.

To clear the supervisor password, select the Change Supervisor Password then press **<Enter>**. The message "Password Uninstalled" appears.



---

If you forget your BIOS password, you can clear it by erasing the CMOS Real Time Clock (RTC) RAM. See section 1.9 **Jumper** for information on how to erase the RTC RAM.

---

After you have set a supervisor password, the other items appear to allow you to change other security settings.

### User Access Level [Full Access]

This item allows you to select the access restriction to the Setup items.

Configuration options: [No Access] [View Only] [Limited] [Full Access]

**No Access** prevents user access to the Setup utility.

**View Only** allows access but does not allow change to any field.

**Limited** allows changes only to selected fields, such as Date and Time.

**Full Access** allows viewing and changing all the fields in the Setup utility.

### Change User Password

Select this item to set or change the user password. The User Password item on top of the screen shows the default Not Installed. After you set a password, this item shows Installed.

To set a User Password:

1. Select the Change User Password item and press **<Enter>**.
2. On the password box that appears, type a password composed of at least six letters and/or numbers, then press **<Enter>**.
3. Confirm the password when prompted.

The message "Password Installed" appears after you set your password successfully.

To change the user password, follow the same steps as in setting a user password.

### Clear User Password

Select this item to clear the user password.

## Password Check [Setup]

When set to **[Setup]**, BIOS checks for user password when accessing the Setup utility. When set to **[Always]**, BIOS checks for user password both when accessing Setup and booting the system. Configuration options: [Setup] [Always]

## 2.9 Tools menu

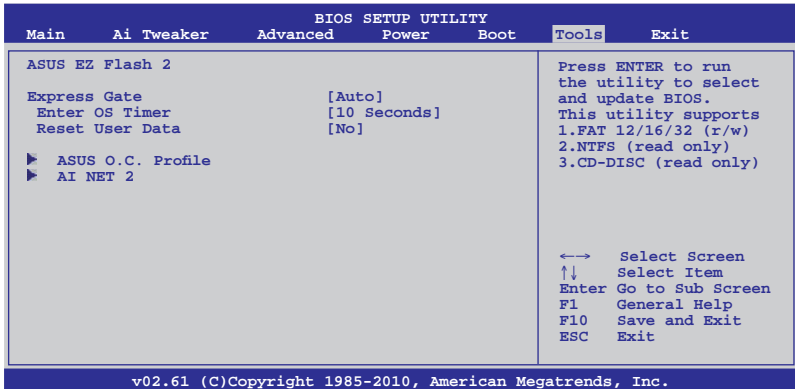

### 2.9.1 ASUS EZ Flash 2

Allows you to run ASUS EZ Flash 2. When you press **<OK>**, a confirmation message appears. Use the left/right arrow key to select between **[Yes]** or **[No]**, then press **<OK>** to confirm your choice.

### 2.9.2 Express Gate [Auto]

Allows you to enable or disable the ASUS Express Gate feature. The ASUS Express Gate feature is a unique instant-on environment that provides quick access to the Internet browser and Skype. Configuration options: [Enabled] [Disabled] [Auto]

### Enter OS Timer [10 Seconds]

Sets countdown duration that the system waits at the Express Gate's first screen before starting Windows or other installed OS. Choose [Prompt User] to stay at the first screen of Express Gate for user action. Configuration options: [Prompt User] [1 second] [3 seconds] [5 seconds] [10 seconds] [15 seconds] [20 seconds] [30 seconds]

### Reset User Data [No]

Allows you to clear Express Gate's user data.

Configuration options: [No] [Reset]

When setting this item to [Reset], make sure to save the setting to the BIOS so that the user data will be cleared the next time you enter the Express Gate. User data includes the Express Gate's settings as well as any personal information stored by the web browser (bookmarks, cookies, browsing history, etc.). This is useful in the rare case where corrupt settings prevent the Express Gate environment from launching properly.



The first time wizard will run again when you enter the Express Gate environment after clearing its settings.

### 2.9.3 ASUS O.C. Profile

This item allows you to store or load multiple BIOS settings.

#### Add Your CMOS Profile.

Allows you to save the current BIOS file to the BIOS Flash. In the **Name** sub-item, type your profile name and press <Enter>, and then choose a profile number to save your CMOS settings in the **Save To** sub-item. You can save eight (8) CMOS profiles.

#### Load CMOS Profile.

Allows you to load the previous BIOS settings saved in the BIOS Flash. Press <Enter>, and choose a profile to load.

#### Start O.C. Profile

Allows you to run the utility to save and load CMOS. Press <Enter> to run the utility.



- This function can support devices such as a USB flash disk or a floppy disk with FAT 32/16 format and single partition only.
- DO NOT shut down or reset the system while updating the BIOS to prevent the system boot failure!
- We recommend that you update the BIOS file only coming from the same memory/CPU configuration and BIOS version.
- Only the "xxx.CMO" file can be loaded.

### 2.9.4 AI NET 2

#### Check Realtek LAN cable [Disabled]

Enables or disables checking of the Realtek LAN cable during the Power-On Self-Test (POST). Configuration options: [Disabled] [Enabled]



## 2.10 Exit menu

The Exit menu items allow you to load the optimal or failsafe default values for the BIOS items, and save or discard your changes to the BIOS items.

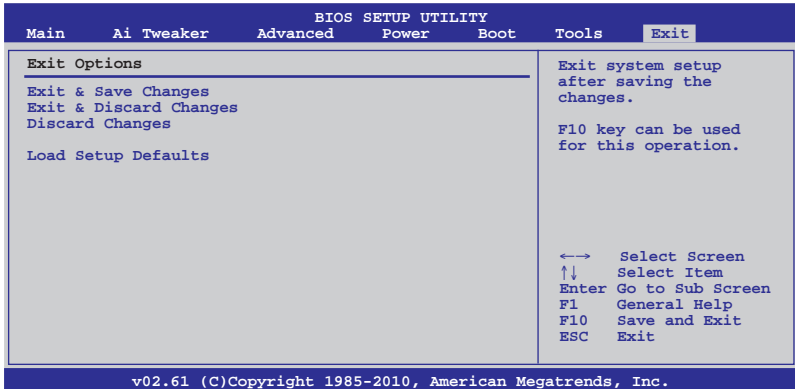

Pressing <Esc> does not immediately exit this menu. Select one of the options from this menu or <F10> from the legend bar to exit.

### Exit & Save Changes

Once you are finished making your selections, choose this option from the Exit menu to ensure the values you selected are saved to the CMOS RAM. An onboard backup battery sustains the CMOS RAM so it stays on even when the PC is turned off. When you select this option, a confirmation window appears. Select **OK** to save changes and exit.



If you attempt to exit the Setup program without saving your changes, the program prompts you with a message asking if you want to save your changes before exiting. Press <Enter> to save the changes while exiting.

### Exit & Discard Changes

Select this option only if you do not want to save the changes that you made to the Setup program. If you made changes to fields other than System Date, System Time, and Password, the BIOS asks for a confirmation before exiting.

### Discard Changes

This option allows you to discard the selections you made and restore the previously saved values. After selecting this option, a confirmation appears. Select OK to discard any changes and load the previously saved values.

### Load Setup Defaults

This option allows you to load the default values for each of the parameters on the Setup menus. When you select this option or if you press <F5>, a confirmation window appears. Select OK to load default values. Select **Exit & Save Changes** or make other changes before saving the values to the non-volatile RAM.



## **ASUS contact information**

### **ASUSTeK COMPUTER INC.**

Address	15 Li-Te Road, Peitou, Taipei, Taiwan 11259
Telephone	+886-2-2894-3447
Fax	+886-2-2890-7798
E-mail	info@asus.com.tw
Web site	www.asus.com.tw

#### ***Technical Support***

Telephone	+86-21-38429911
Online support	support.asus.com

### **ASUS COMPUTER INTERNATIONAL (America)**

Address	800 Corporate Way, Fremont, CA 94539, USA
Telephone	+1-812-282-3777
Fax	+1-510-608-4555
Web site	usa.asus.com

#### ***Technical Support***

Telephone	+1-812-282-2787
Support fax	+1-812-284-0883
Online support	support.asus.com

### **ASUS COMPUTER GmbH (Germany and Austria)**

Address	Harkort Str. 21-23, D-40880 Ratingen, Germany
Fax	+49-2102-959911
Web site	www.asus.de
Online contact	www.asus.de/sales

#### ***Technical Support***

Telephone (Component)	+49-1805-010923*
Telephone (System/Note/Eee/LCD)	+49-1805-010920*
Support Fax	+49-2102-9599-11
Online support	support.asus.com

\* EUR 0.14/minute from a German fixed landline; EUR 0.42/minute from a mobile phone.

# DECLARATION OF CONFORMITY

Per FCC Part 2, Section 2.1077 (a)



Responsible Party Name: **Asus Computer International**

Address: **800 Corporate Way, Fremont, CA 94539.**

Phone/Fax No: **(510)739-3777/(510)608-4555**

hereby declares that the product

**Product Name : Motherboard**

**Model Number : M4A87TD EVO**

Conforms to the following specifications:

- FCC Part 15, Subpart B, Unintentional Radiators
- FCC Part 15, Subpart C, Intentional Radiators
- FCC Part 15, Subpart E, Intentional Radiators

### Supplementary Information:

This device complies with part 15 of the FCC Rules. Operation is subject to the following two conditions: (1) This device may not cause harmful interference, and (2) this device must accept any interference received, including interference that may cause undesired operation.

Representative Person's Name : Steve Chang / President

Signature :   
Date: Mar. 22, 2010

# EC Declaration of Conformity



We, the undersigned,

Manufacturer: **ASUSTEK COMPUTER INC.**  
Address: **No. 150, LITE RD., PEITOU, TAIPEI 112, TAIWAN R.O.C.**  
Country: **TAIWAN**  
Authorized representative in Europe: **ASUS COMPUTER GmbH**  
Address: **HARKORT STR. 21-23, 40880 RATINGEN**  
Country: **GERMANY**

declare the following apparatus:

Product name : **Motherboard**  
Model name : **M4A87TD EVO**

conform with the essential requirements of the following directives:

- 2004/108/EC-EMC Directive**
- EN 55022:2006+A1:2007
- EN 61000-3-2:2006
- EN 55013:2001+A1:2003+A2:2006
- 1999/5/EC-R & TTE Directive**
- EN 300 328 V1.7 (12006-05)
- EN 300 440-2 V1.2 (12008-03)
- EN 301 511 V8.0.2 (2003-03)
- EN 301 908-1 V3.2.1 (2007-05)
- EN 301 908-2 V3.2.1 (2007-05)
- EN 301 888 V1.4.1 (2005-05)
- EN 301 888 V1.4.1 (2005-05)
- EN 50360:2001
- EN 50371:2002
- EN 62311:2008
- EN 62311:2008

- EN 55024:1998+A1:2001+A2:2003
- EN 61000-3-3:1995+A1:2001+A2:2005
- EN 55020:2007
- EN 301 488-1 V1.8.1 (2008-04)
- EN 301 488-2 V1.8.1 (2008-08)
- EN 301 488-4 V1.3.1 (2006-08)
- EN 301 488-7 V1.3.1 (2005-11)
- EN 301 488-9 V1.4.1 (2007-11)
- EN 301 488-10 V1.4.1 (2007-11)
- EN 301 488-11 V1.4.1 (2007-09)
- EN 301 488-12 V1.4.1 (2007-09)
- EN 302 328-2 V1.2 (2007-06)
- EN 302 328-3 V1.3.1 (2007-09)
- EN 301 357-2 V1.3.1 (2006-05)

### CE marking

- 2006/95/EC-LVD Directive**
- EN 60950-1:2001+A11:2004
- EN 60950-1:2006
- 2009/4/25/EC-EP Directive**

Regulation (EC) No. 1275/2008  
 EN 62301:2005  
Regulation (EC) No. 642/2009  
 EN 62301:2005



(EC conformity marking)

Position : **CEO**  
Name : **Jerry Shon**



Signature : \_\_\_\_\_

Declaration Date: **Mar. 22, 2010**  
Year to begin affixing CE marking: **2010**