

P8Z77-M

ASUS[®]

Motherboard

E7075

First Edition
February 2012

Copyright © 2012 ASUSTeK Computer Inc. All Rights Reserved.

No part of this manual, including the products and software described in it, may be reproduced, transmitted, transcribed, stored in a retrieval system, or translated into any language in any form or by any means, except documentation kept by the purchaser for backup purposes, without the express written permission of ASUSTeK Computer Inc. ("ASUS").

Product warranty or service will not be extended if: (1) the product is repaired, modified or altered, unless such repair, modification or alteration is authorized in writing by ASUS; or (2) the serial number of the product is defaced or missing.

ASUS PROVIDES THIS MANUAL "AS IS" WITHOUT WARRANTY OF ANY KIND, EITHER EXPRESS OR IMPLIED, INCLUDING BUT NOT LIMITED TO THE IMPLIED WARRANTIES OR CONDITIONS OF MERCHANTABILITY OR FITNESS FOR A PARTICULAR PURPOSE. IN NO EVENT SHALL ASUS, ITS DIRECTORS, OFFICERS, EMPLOYEES OR AGENTS BE LIABLE FOR ANY INDIRECT, SPECIAL, INCIDENTAL, OR CONSEQUENTIAL DAMAGES (INCLUDING DAMAGES FOR LOSS OF PROFITS, LOSS OF BUSINESS, LOSS OF USE OR DATA, INTERRUPTION OF BUSINESS AND THE LIKE), EVEN IF ASUS HAS BEEN ADVISED OF THE POSSIBILITY OF SUCH DAMAGES ARISING FROM ANY DEFECT OR ERROR IN THIS MANUAL OR PRODUCT.

SPECIFICATIONS AND INFORMATION CONTAINED IN THIS MANUAL ARE FURNISHED FOR INFORMATIONAL USE ONLY, AND ARE SUBJECT TO CHANGE AT ANY TIME WITHOUT NOTICE, AND SHOULD NOT BE CONSTRUED AS A COMMITMENT BY ASUS. ASUS ASSUMES NO RESPONSIBILITY OR LIABILITY FOR ANY ERRORS OR INACCURACIES THAT MAY APPEAR IN THIS MANUAL, INCLUDING THE PRODUCTS AND SOFTWARE DESCRIBED IN IT.

Products and corporate names appearing in this manual may or may not be registered trademarks or copyrights of their respective companies, and are used only for identification or explanation and to the owners' benefit, without intent to infringe.

Offer to Provide Source Code of Certain Software

This product may contain copyrighted software that is licensed under the General Public License ("GPL") and under the Lesser General Public License Version ("LGPL"). The GPL and LGPL licensed code in this product is distributed without any warranty. Copies of these licenses are included in this product.

You may obtain the complete corresponding source code (as defined in the GPL) for the GPL Software, and/or the complete corresponding source code of the LGPL Software (with the complete machine-readable "work that uses the Library") for a period of three years after our last shipment of the product including the GPL Software and/or LGPL Software, which will be no earlier than December 1, 2011, either

(1) for free by downloading it from <http://support.asus.com/download>;

or

(2) for the cost of reproduction and shipment, which is dependent on the preferred carrier and the location where you want to have it shipped to, by sending a request to:

ASUSTeK Computer Inc.
Legal Compliance Dept.
15 Li Te Rd.,
Beitou, Taipei 112
Taiwan

In your request please provide the name, model number and version, as stated in the About Box of the product for which you wish to obtain the corresponding source code and your contact details so that we can coordinate the terms and cost of shipment with you.

The source code will be distributed WITHOUT ANY WARRANTY and licensed under the same license as the corresponding binary/object code.

This offer is valid to anyone in receipt of this information.

ASUSTeK is eager to duly provide complete source code as required under various Free Open Source Software licenses. If however you encounter any problems in obtaining the full corresponding source code we would be much obliged if you give us a notification to the email address gpl@asus.com, stating the product and describing the problem (please do NOT send large attachments such as source code archives etc to this email address).

Contents

Safety information	v
About this guide	vi
P8Z77-M specifications summary	vii

Chapter 1

Product introduction

1.1	Before you proceed	1-1
1.2	Motherboard overview	1-2
1.2.1	Placement direction	1-2
1.2.2	Screw holes	1-2
1.2.3	Motherboard layout	1-3
1.2.4	Layout contents.....	1-3
1.3	Central Processing Unit (CPU)	1-4
1.3.1	Installing the CPU	1-4
1.3.2	CPU heatsink and fan assembly installation.....	1-6
1.4	System memory	1-7
1.4.1	Overview	1-7
1.4.2	Memory configurations.....	1-8
2.3.4	DIMM installation	1-14
1.5	Expansion slots.....	1-15
1.5.1	Installing an expansion card	1-15
1.5.3	PCI Express x1 slot.....	1-16
1.5.4	PCI Express x16 slot.....	1-16
1.5.2	Configuring an expansion card	1-16
1.6	Onboard switches	1-17
1.7	USB BIOS Flashback	1-18
1.8	Onboard LEDs	1-19
1.9	Jumpers	1-20
1.10	Connectors	1-21
1.10.1	Rear panel connectors.....	1-21
1.10.2	Internal connectors	1-22
1.11	Software support.....	1-29
1.11.1	Installing an operating system	1-29
1.11.2	Support DVD information	1-29

Contents

Chapter 2

BIOS information

2.1	Managing and updating your BIOS	2-1
2.1.1	ASUS Update utility	2-1
2.1.2	ASUS EZ Flash 2	2-2
2.1.3	ASUS CrashFree BIOS 3 utility	2-3
2.1.4	ASUS BIOS Updater	2-4
2.2	BIOS setup program	2-6
2.2.1	EZ Mode	2-7
2.2.2	Advanced Mode	2-8
2.3	Main menu	2-10
2.3.1	System Language [English]	2-10
2.3.2	System Date	2-10
2.3.3	System Time	2-10
2.3.4	Security	2-10
2.4	Ai Tweaker menu	2-12
2.4.1	Ai Overclock Tuner [Auto]	2-13
2.4.2	OC Tuner	2-14
2.4.3	DRAM Timing Control	2-15
2.4.4	CPU Power Management	2-15
2.4.5	DIGI+ VRM	2-15
2.4.6	CPU Voltage [Offset Mode]	2-16
2.5	Advanced menu	2-18
2.5.1	CPU Configuration	2-18
2.5.2	PCH Configuration	2-20
2.5.3	SATA Configuration	2-20
2.5.4	System Agent Configuration	2-20
2.5.5	USB Configuration	2-21
2.5.6	Onboard Devices Configuration	2-22
2.5.7	APM	2-22
2.5.8	Network stack [Disabled Link]	2-23
2.6	Monitor menu	2-24
2.7	Boot menu	2-27
2.8	Tools menu	2-29
2.8.1	ASUS EZ Flash 2 Utility	2-29
2.8.2	ASUS O.C. Profile	2-29
2.8.3	ASUS SPD Information	2-29
2.9	Exit menu	2-30

Safety information

Electrical safety

- To prevent electric shock hazard, disconnect the power cable from the electric outlet before relocating the system.
- When adding or removing devices to or from the system, ensure that the power cables for the devices are unplugged before the signal cables are connected. If possible, disconnect all power cables from the existing system before you add a device.
- Before connecting or removing signal cables from the motherboard, ensure that all power cables are unplugged.
- Seek professional assistance before using an adapter or extension cord. These devices could interrupt the grounding circuit.
- Ensure that your power supply is set to the correct voltage in your area. If you are not sure about the voltage of the electrical outlet you are using, contact your local power company.
- If the power supply is broken, do not try to fix it by yourself. Contact a qualified service technician or your retailer.

Operation safety

- Before installing the motherboard and adding devices on it, carefully read all the manuals that came with the package.
- Before using the product, ensure that all cables are correctly connected and the power cables are not damaged. If you detect any damage, contact your dealer immediately.
- To avoid short circuits, keep paper clips, screws, and staples away from connectors, slots, sockets and circuitry.
- Avoid dust, humidity, and temperature extremes. Do not place the product in any area where it may become wet.
- Place the product on a stable surface.
- If you encounter technical problems with the product, contact a qualified service technician or your retailer.

About this guide

This user guide contains the information you need when installing and configuring the motherboard.

How this guide is organized

This guide contains the following parts:

- **Chapter 1: Product introduction**
This chapter describes the features of the motherboard and the new technology it supports.
- **Chapter 2: BIOS information**
This chapter tells how to change system settings through the BIOS Setup menus. Detailed descriptions of the BIOS parameters are also provided.

Conventions used in this guide

To ensure that you perform certain tasks properly, take note of the following symbols used throughout this manual.



DANGER/WARNING: Information to prevent injury to yourself when trying to complete a task.



CAUTION: Information to prevent damage to the components when trying to complete a task.



IMPORTANT: Instructions that you **MUST** follow to complete a task.



NOTE: Tips and additional information to help you complete a task.

Where to find more information

Refer to the following sources for additional information and for product and software updates.

1. ASUS websites

The ASUS website provides updated information on ASUS hardware and software products. Refer to the ASUS contact information.

2. Optional documentation

Your product package may include optional documentation, such as warranty flyers, that may have been added by your dealer. These documents are not part of the standard package.

Typography

Bold text

Indicates a menu or an item to select.

Italics

Used to emphasize a word or a phrase.

<Key>

Keys enclosed in the less-than and greater-than sign means that you must press the enclosed key.

Example: <Enter> means that you must press the Enter or Return key.

<Key1>+<Key2>+<Key3>

If you must press two or more keys simultaneously, the key names are linked with a plus sign (+).

Example: <Ctrl>+<Alt>+<D>

P8Z77-M specifications summary

CPU	<p>LGA1155 socket for Intel® 3rd/2nd Generation Core™ i7/ i5/ i3/ Pentium® / Celeron® Processors</p> <ul style="list-style-type: none"> - Supports 22/32nm CPU - Supports Intel® Turbo Boost Technology 2.0 <p>* The Intel® Turbo Boost Technology 2.0 support depends on the CPU types.</p> <p>** Refer to www.asus.com for Intel CPU support list</p>
Chipset	Intel® Z77 Express Chipset
Memory	<p>4 x DIMM, max. 32GB, DDR3 2400(O.C.)*/2200(O.C.)*/2133(O.C.)/2000(O.C)/1866(O.C.)/1600/1333 MHz, non-ECC, un-buffered memory</p> <ul style="list-style-type: none"> - Dual channel memory architecture - Supports Intel® Extreme Memory Profile (XMP) <p>* Hyper DIMM support is subject to the physical characteristics of individual CPUs. Please refer to Memory QVL(Qualified Vendors List) for details.</p>
Expansion slots	<p>1 x PCI Express 3.0*/2.0 x16 slots (at x16)</p> <p>1 x PCI Express 2.0 x16 slot [black] (runs at x4 mode, compatible with PCIe x1 and x4 devices)</p> <p>1 x PCI Express 2.0 x1 slots</p> <p>1 x PCI</p> <p>* PCIe 3.0 speed is supported by Intel® 3rd generation Core™ processors.</p>
VGA	<p>Integrated Graphics Processor- Intel® HD Graphics support</p> <p>Multi-VGA output support: HDMI/ DVI-D/ D-sub port</p> <p>Supports HDMI 1.4a with max. resolution 1920 x 1200@60Hz</p> <p>Supports DVI-D with max. resolution 1920 x 1200@60Hz</p> <p>Supports D-sub with max. resolution 2048 x 1536@75Hz</p> <p>Supports Intel® InTru™ 3D/Quick Sync Video/Clear Video HD Technology/Insider™</p>
Multi-GPU support	<p>Supports LucidLogix Virtu MVP Technology*</p> <p>Supports AMD® CrossFireX™ Technology</p> <p>* LucidLogix Virtu MVP supports Windows 7 operating systems.</p>
Storage	<p>Intel® Z77 Express Chipset</p> <ul style="list-style-type: none"> - 2 x SATA 6.0 Gb/s ports (gray) with RAID 0, 1, 5, 10 support - 4 x SATA 3.0 Gb/s ports (blue) with RAID 0, 1, 5, 10 support - Supports Intel® Smart Response Technology, Intel® Rapid Start Technology, Intel® Smart Connect Technology* <p>* Supports on Intel® Core™ processor family with Windows 7 operating systems.</p>

(continues on the next page)

P8Z77-M specifications summary

LAN	Realtek® 8111F Gigabit LAN controller
Audio	Realtek® ALC887 8-channel audio CODEC* - Supports jack-detection, multi-streaming, front panel jack-retasking - Optical S/PDIF out port at back I/O * Use a chassis with HD audio module in the front panel to support an 8-channel audio output
USB	Intel® Z77 Express Chipset- supports ASUS USB 3.0 Boost UASP Mode*. - 2 x USB 3.0/2.0 ports at mid-board for front panel support - 2 x USB 3.0/2.0 ports at back panel(blue) Intel® Z77 Express Chipset - 10 x USB 2.0/1.1 ports (6 ports at mid-board, 4 ports at back panel) *The USB3.0 ports only support Windows 7 or later versions. UASP standard only supports Windows 8.
ASUS Exclusive Overclocking Features	Precision Tweaker 2: - vCore: Adjustable CPU voltage at 0.005V increment - vDRAM Bus: 127-step Memory voltage control - vPCH: 177-step Chipset voltage control - iGPU: 238-step iGPU voltage control SFS (Stepless Frequency Selection) - BCLK/PCIE frequency tuning from 80MHz up to 300MHz at 0.1MHz increment Overclocking Protection: - ASUS C.P.R.(CPU Parameter Recall)
ASUS unique features	ASUS Digital Power Design - ASUS DIGI+ VRM Utility ASUS Exclusive Features - ASUS EPU - TurboV EVO - Network iControl featuring instant network bandwidth domination for top network program in use - USB 3.0 Boost - Disk Unlocker - AI Charger - AI Suite II - Anti Surge - MemOK!

(continues on the next page)

P8Z77-M specifications summary

ASUS unique features (continued)	<p>ASUS Quiet Thermal Solution</p> <ul style="list-style-type: none"> - ASUS Fan Xpert+ - ASUS Fanless Design: Heat-sink solution <p>ASUS EZ DIY</p> <ul style="list-style-type: none"> - ASUS USB BIOS Flashback with USB BIOS Flashback Wizard for EZ BIOS download scheduling - ASUS UEFI BIOS EZ Mode featuring user-friendly graphics interface - ASUS O.C. Tuner - ASUS CrashFree BIOS 3 - ASUS EZ Flash 2 <p>ASUS Q-Design</p> <ul style="list-style-type: none"> - ASUS Q-Slot - ASUS Q-DIMM - ASUS Q-Connector
Back Panel I/O Ports	<p>1 x DVI-D port 1 x HDMI port 1 x D-sub port 1 x Optical S/PDIF out 1 x LAN (RJ45) ports 2 x USB 3.0/2.0 ports 4 x USB 2.0/1.1 ports (1 supports USB BIOS Flashback) 1 x PS/2 keyboard/mouse combo port 3 Audio jacks support 8-channel*</p> <p>*Use a chassis with HD audio module in the front panel to support an 8-channel audio output.</p>
Internal connectors/ switches/ buttons	<p>1 x USB 3.0/2.0 connector supports additional 2 USB ports (19-pin) 3 x USB 2.0/1.1 connectors support additional 6 USB ports (blue) 2 x SATA 6.0Gb/s connectors (2 x gray) 4 x SATA 3.0Gb/s connectors (blue) 1 x CPU Fan connector (4-pin) 3 x Chassis Fan connectors (4-pin) Front panel audio connector (AAFP) 1 x S/PDIF out header 24-pin EATX Power connector 8-pin EATX 12V Power connector System Panel(Q-Connector) 1 x MemOK! button 1 x BIOS Flashback button 1 x Clear CMOS jumper 1 x COM port header 1 x TPM header</p>

(continues on the next page)

P8Z77-M specifications summary

BIOS features	64 Mb Flash ROM, UEFI AMI BIOS, PnP, DMI2.0, WfM2.0, SM BIOS 2.5, ACPI 2.0a, Multi-language BIOS, ASUS EZ Flash 2, ASUS CrashFree BIOS 3, F12 PrintScreen, F3 Shortcut Function and ASUS DRAM SPD (Serial Presence Detect) memory information
Manageability	WfM 2.0, DMI 2.0, WOL by PME, PXE, WOR by PME
Accessories	1 x Serial ATA 6.0Gb/s cables 1 x Serial ATA 3.0Gb/s cables ASUS I/O shield 2 in 1 Q-connector User's manual
Support DVD	Drivers ASUS Utilities ASUS Update Anti-virus software (OEM version)
Form factor	uATX Form Factor, 9.6"x 9.6" (24.4cm x 24.4cm)

** Specifications are subject to change without notice.*

Chapter 1

Product introduction

Thank you for buying an ASUS® P8Z77-M motherboard!

Before you start installing the motherboard, and hardware devices on it, check the items in your motherboard package. Refer to the specification list on page x for the list of accessories.



If any of the items is damaged or missing, contact your retailer.

1.1 Before you proceed

Take note of the following precautions before you install motherboard components or change any motherboard settings.



-
- Unplug the power cord from the wall socket before touching any component.
 - Before handling components, use a grounded wrist strap or touch a safely grounded object or a metal object, such as the power supply case, to avoid damaging them due to static electricity.
 - Hold components by the edges to avoid touching the ICs on them.
 - Whenever you uninstall any component, place it on a grounded antistatic pad or in the bag that came with the component.
 - Before you install or remove any component, ensure that the ATX power supply is switched off or the power cord is detached from the power supply. Failure to do so may cause severe damage to the motherboard, peripherals, or components.
-

1.2 Motherboard overview

Before you install the motherboard, study the configuration of your chassis to ensure that the motherboard fits into it.



Ensure that you unplug the power cord before installing or removing the motherboard. Failure to do so can cause you physical injury and damage motherboard components.

1.2.1 Placement direction

When installing the motherboard, ensure that you place it into the chassis in the correct orientation. The edge with external ports goes to the rear part of the chassis as indicated in the image below.

1.2.2 Screw holes

Place eight screws into the holes indicated by circles to secure the motherboard to the chassis.



Do not overtighten the screws! Doing so can damage the motherboard.

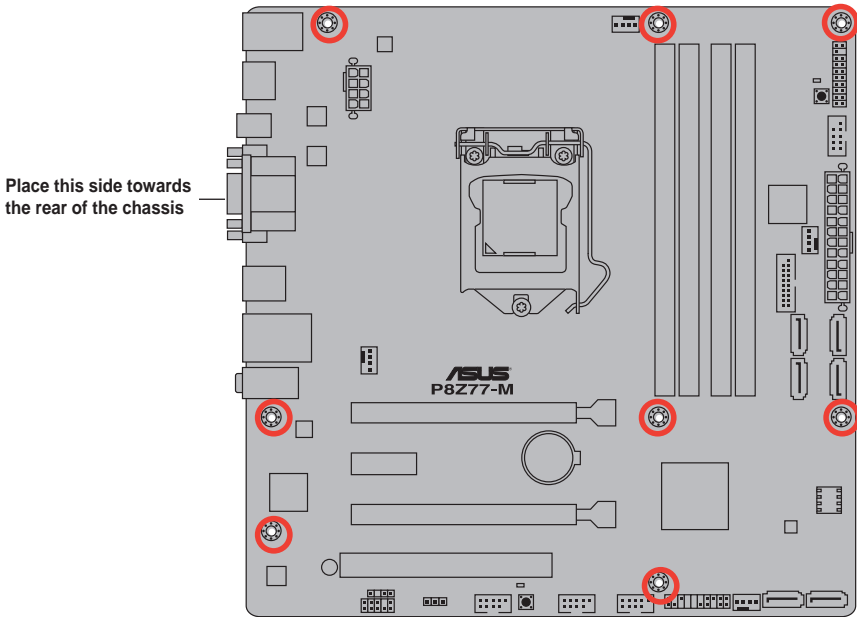

1.2.3 Motherboard layout

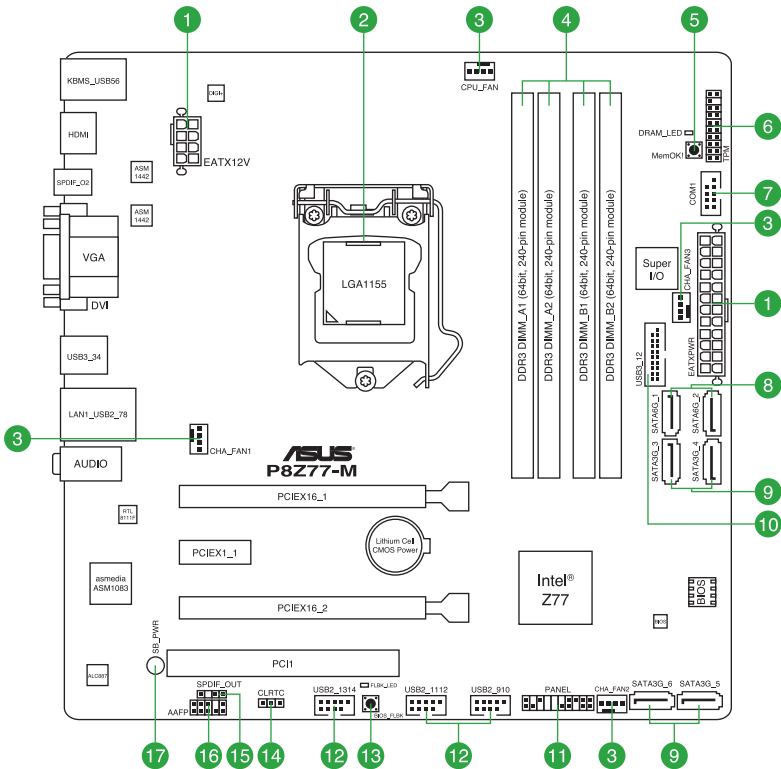

1.2.4 Layout contents

Connectors/Jumpers/Slots/Switches/LED	Page	Connectors/Jumpers/Slots/Switches/LED	Page
1. ATX power connectors (24-pin EATXPWR, 8-pin ATX12V)	1-23	10. Intel® Z77 USB 3.0 connector (USB3_12)	1-27
2. Intel® LGA1155 CPU socket	1-4	11. System panel connector (20-8 pin PANEL)	1-28
3. CPU and chassis fan connectors (4-pin CPU_FAN, 4-pin CHA_FAN 1-3)	1-25	12. USB 2.0 connectors (10-1 pin USB910; USB1112; USB1314)	1-26
4. DDR3 DIMM slots	1-7	13. USB BIOS flashback button	1-18
5. MemOK! switch	1-17	14. Clear CMOS	1-20
6. TPM connector (20-1 pin TPM)	1-25	15. Digital audio connector (4-1 pin SPDIF_OUT)	1-27
7. Serial port connector (10-1 pin COM1)	1-26	16. Front panel audio connector (10-1 pin AAFP)	1-22
8. Intel® Z77 Serial ATA 6.0 Gb/s connectors (7-pin SATA6G_1/2 [gray])	1-24	17. Standby Power LED	1-19
9. Intel® Z77 Serial ATA 3.0 Gb/s connectors (7-pin SATA3G_3-6 [blue])	1-24		

1.3 Central Processing Unit (CPU)

The motherboard comes with a surface mount LGA1155 socket designed for the Intel® 3rd/2nd Generation Core™ i7 / Core™ i5 / Core™ i3 / Pentium / Celeron Processors.

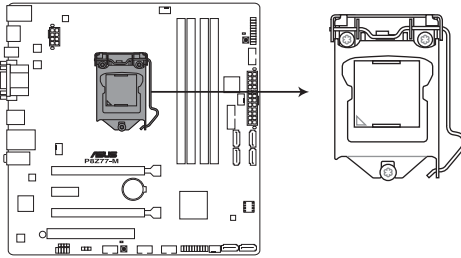

P8Z77-M CPU LGA1155



Ensure that all power cables are unplugged before installing the CPU.



- The LGA1156 CPU is incompatible with the LGA1155 socket. DO NOT install a LGA1156 CPU on the LGA1155 socket.
- Upon purchase of the motherboard, ensure that the PnP cap is on the socket and the socket contacts are not bent. Contact your retailer immediately if the PnP cap is missing, or if you see any damage to the PnP cap/socket contacts/motherboard components. ASUS will shoulder the cost of repair only if the damage is shipment/transit-related.
- Keep the cap after installing the motherboard. ASUS will process Return Merchandise Authorization (RMA) requests only if the motherboard comes with the cap on the LGA1155 socket.
- The product warranty does not cover damage to the socket contacts resulting from incorrect CPU installation/removal, or misplacement/loss/incorrect removal of the PnP cap.

1.3.1 Installing the CPU



The LGA1156 CPU is incompatible with the LGA1155 socket. DO NOT install a LGA1156 CPU on the LGA1155 socket.

1

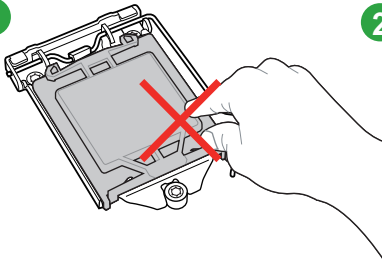

2

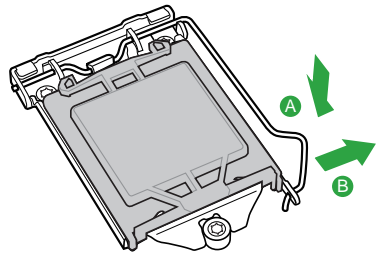

3

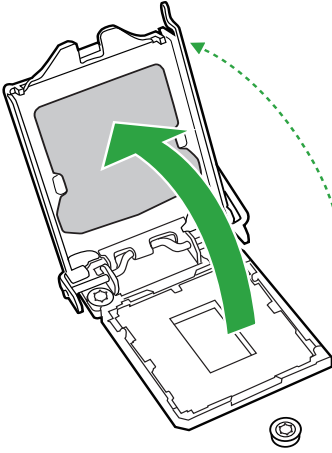

4

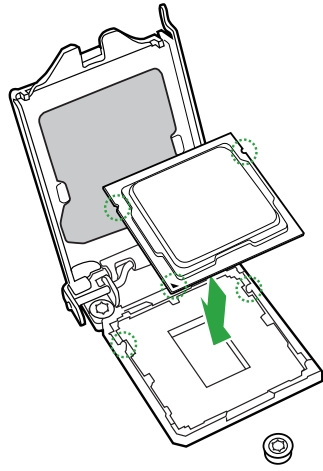

5

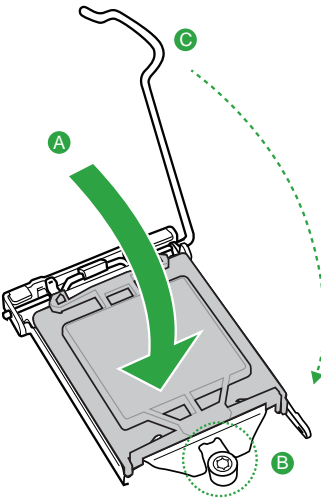

6

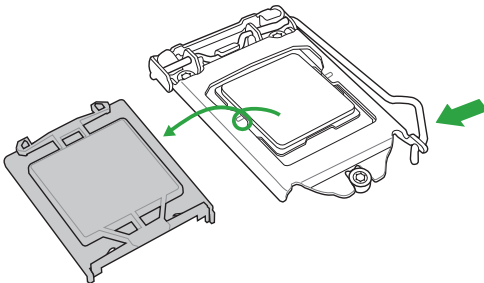

1.3.2 CPU heatsink and fan assembly installation

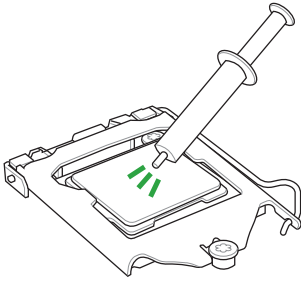

Apply the Thermal Interface Material to the CPU heatsink and CPU before you install the heatsink and fan if necessary.

To install the CPU heatsink and fan assembly

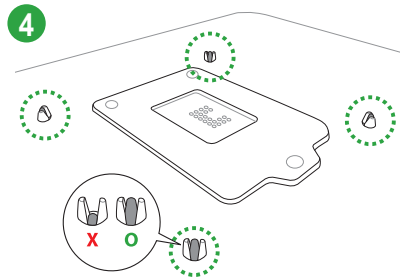
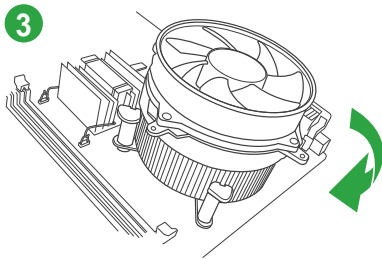
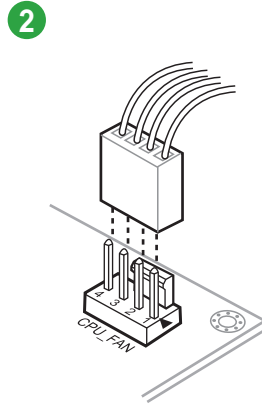
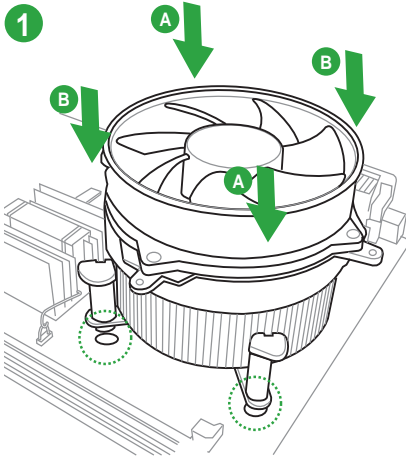

To uninstall the CPU heatsink and fan assembly

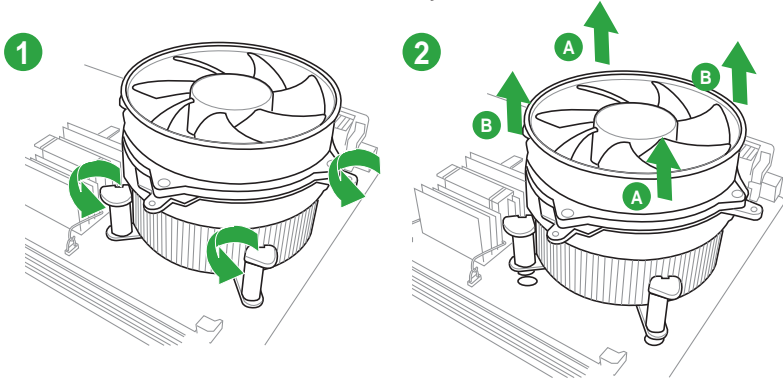

1.4 System memory

1.4.1 Overview

The motherboard comes with four Double Data Rate 3 (DDR3) Dual In-line Memory Modules (DIMM) slots.



A DDR3 module is notched differently from a DDR or DDR2 module. DO NOT install a DDR or DDR2 memory module to the DDR3 slot.

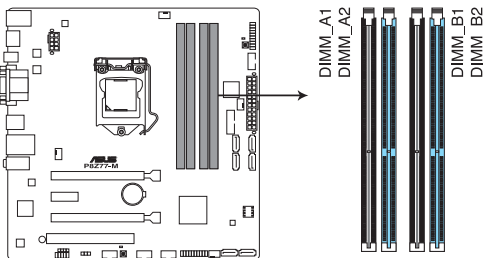

P8Z77-M 240-pin DDR3 DIMM sockets

Recommended memory configurations

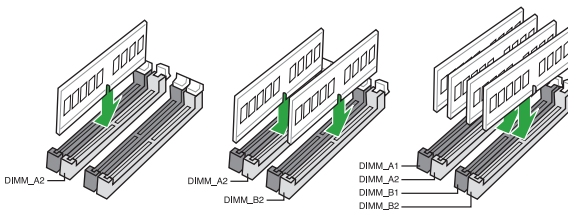

Install one memory module in slot A2 first as a single-channel operation.

1.4.2 Memory configurations

You may install 1GB, 2GB, 4GB and 8GB unbuffered non-ECC DDR3 DIMMs into the DIMM sockets.



- You may install varying memory sizes in Channel A and Channel B. The system maps the total size of the lower-sized channel for the dual-channel configuration. Any excess memory from the higher-sized channel is then mapped for single-channel operation.
- Due to Intel 2nd Generation processors' behavior, DDR3 2200/2000/1800 MHz memory module will run at DDR3 2133/1866/1600 MHz frequency as default.
- According to Intel CPU spec, DIMM voltage below 1.65V is recommended to protect the CPU.
- Always install DIMMs with the same CAS latency. For optimum compatibility, we recommend that you obtain memory modules from the same vendor.
- Due to the memory address limitation on 32-bit Windows OS, when you install 4GB or more memory on the motherboard, the actual usable memory for the OS can be about 3GB or less. For effective use of memory, we recommend that you do any of the following:
 - Use a maximum of 3GB system memory if you are using a 32-bit Windows OS.
 - Install a 64-bit Windows OS when you want to install 4GB or more on the motherboard.
 For more details, refer to the Microsoft® support site at <http://support.microsoft.com/kb/929605/en-us>.
- This motherboard does not support DIMMs made up of 512Mb (64MB) chips or less (Memory chip capacity counts in Megabit, 8 Megabit/Mb = 1 Megabyte/MB).



- The default memory operation frequency is dependent on its Serial Presence Detect (SPD), which is the standard way of accessing information from a memory module. Under the default state, some memory modules for overlocking may operate at a lower frequency than the vendor-marked value. To operate at the vendor-marked or at a higher frequency, refer to section **2.4 Ai Tweaker menu** for manual memory frequency adjustment.
- For system stability, use a more efficient memory cooling system to support a full memory load (4 DIMMs) or overlocking condition.

P8Z77-M Motherboard Qualified Vendors Lists (QVL)

DDR3-2400(O.C.) MHz capability

Vendors	Part No.	Size	SS/DS	Chip Brand	Chip NO.	Timing	Voltage	DIMM socket support (Optional)		
								1 DIMM	2 DIMM	4 DIMM
A-DATA	AX3U2400GC4G10(XMP)	4GB	DS	-	-	10-11-11-30	1.65	*	*	*
CORSAIR	CMGTX8(XMP)	8GB (4x 2GB)	SS	-	-	10-12-10-30	1.65	*	*	*
CORSAIR	CMGTX3(XMP)	2GB	DS	-	-	9-11-9-27	1.65	*	*	*
G.SKILL	F3-19200CL11Q-16GBZHD(XMP)	16GB (4x 4GB)	DS	-	-	11-11-11-31	1.65	*	*	*
G.SKILL	F3-19200CL11Q-16GBZHD(XMP)	16GB (4x 4GB)	DS	-	-	11-11-11-31	1.65	*	*	*
G.SKILL	F3-19200CL9Q-16GBZMD(XMP)	16GB (4x 4GB)	DS	-	-	9-11-11-31	1.65	*	*	*
G.SKILL	F3-19200CL9D-4GBPIS(XMP)	4G (2x 2G)	DS	-	-	9-11-9-28	1.65	*	*	*
GEIL	GOC316GB2400C10QC(XMP)	16GB (4x 4GB)	DS	-	-	10-11-11-30	1.65	*	*	*
GEIL	GOC316GB2400C11QC(XMP)	16GB (4x 4GB)	DS	-	-	11-11-11-30	1.65	*	*	*
Kingston	KHX2400C11D3K4/8GX(XMP)	8GB (4x 2GB)	SS	-	-	11-13-11-30	1.65	*	*	*
Transcend	TX2400KLU-4GK (381850)(XMP)	2GB	DS	-	-	-	1.65	*	*	*
Transcend	TX2400KLU-4GK(374243)(XMP)	2GB	DS	-	-	-	1.65	*	*	*
Patriot	PVV34G2400C9K(XMP)	4GB (2x 2GB)	DS	-	-	9-11-9-27	1.66	*	*	*

* The memory modules in 2400MHz and above are supported by Intel 3rd Generation Core Processors.

**Due to the behavior of the Intel 2nd Generation Processor, DDR3 2200 and above/2000/1800 MHz memory module will run at DDR3 2133/1866/1600 MHz frequency as default.

DDR3-2200(O.C.) MHz capability

Vendors	Part No.	Size	SS/DS	Chip Brand	Chip NO.	Timing	Voltage	DIMM socket support (Optional)		
								1 DIMM	2 DIMM	4 DIMM
G.SKILL	F3-17600CL7D-4GBFLS(XMP)	4G (2x 2G)	DS	-	-	7-10-10-28	1.65	*	*	*
GEIL	GET34GB2200C9DC(XMP)	4GB (2x 2GB)	DS	-	-	9-10-9-28	1.65	*	*	*
GEIL	GET38GB2200C9ADC(XMP)	8GB (2x 4GB)	DS	-	-	9-11-9-28	1.65	*	*	*

* The memory modules in 2200MHz and above are supported by Intel 3rd Generation Core Processors.

**Due to the behavior of the Intel 2nd Generation Processor, DDR3 2200 and above/2000/1800 MHz memory module will run at DDR3 2133/1866/1600 MHz frequency as default.

DDR3-2133(O.C.) MHz capability

Vendors	Part No.	Size	SS/DS	Chip Brand	Chip NO.	Timing	Voltage	DIMM socket support (Optional)		
								1 DIMM	2 DIMM	4 DIMM
A-DATA	8154A 1044(XMP)	2GB	SS	-	-	9-9-9-24	1.55-1.75	*	*	*
A-DATA	AX3U2133C2G9B(XMP)	2GB	SS	-	-	9-11-9-27	1.55-1.75	*	*	*
A-DATA	AX3U2133GC2G9B(XMP)	2GB	SS	-	-	9-9-9-24	1.55-1.75	*	*	*
A-DATA	AX3U2133GC4G9B(XMP)	16GB (4x 4GB)	DS	-	-	9-11-9-27	1.65	*	*	*
Apacer	78.BAGE4.AFD0C(XMP)	8GB (2x 4GB)	DS	-	-	9-9-9-24	-	*	*	*
CORSAIR	CMT4GX3M2A2133C9(XMP)	4GB (2x 2GB)	DS	-	-	9-10-9-24	1.65	*	*	*
CORSAIR	CMT4GX3M2B2133C9(Ver7.1)(XMP)	4GB (2x 2GB)	DS	-	-	9-9-9-24	1.5	*	*	*
CORSAIR	CMT4GX3M2B2133C9(XMP)	4GB (2x 2GB)	DS	-	-	9-10-9-27	1.5	*	*	*
G.SKILL	F3-17000CL9Q-16GBXLD(XMP)	16GB (4x 4GB)	DS	-	-	9-11-9-28	1.65	*	*	*
G.SKILL	F3-17000CL9Q-16GBZH(XMP)	16GB (4x 4GB)	DS	-	-	9-11-10-28	1.65	*	*	*
G.SKILL	F3-17066CL9Q-16BTDD(XMP)	16GB (4x 4GB)	DS	-	-	9-9-9-24	1.65	*	*	*
G.SKILL	F3-17000CL11Q2-64GBZLD(XMP)	64GB (8x 8GB)	DS	-	-	11-11-11-30	1.5	*	*	*
G.SKILL	F3-17066CL9D-8GBPID(XMP)	8GB (2x 4GB)	DS	-	-	9-9-9-24	1.65	*	*	*
KINGSTON	KHX2133C11D3K4/16GX(XMP)	16GB (4x 4GB)	DS	-	-	11-12-11-30	1.65	*	*	*
KINGSTON	KHX2133C9AD3T1K2/4GX(XMP)	4GB (2x 2GB)	DS	-	-	-	1.65	*	*	*
KINGSTON	KHX2133C9AD3T1K2/4GX(XMP)	4GB (2x 2GB)	DS	-	-	9	1.65	*	*	*
KINGSTON	KHX2133C9AD3W1K2/4GX(XMP)	4GB (2x 2GB)	DS	-	-	9	1.65	*	*	*
KINGSTON	KHX2133C9AD3X2K2/4GX(XMP)	4GB (2x 2GB)	DS	-	-	9	1.65	*	*	*
KINGSTON	KHX2133C9AD3X2K2/4GX(XMP)	4GB (2x 2GB)	DS	-	-	9-9-9-24	1.65	*	*	*
KINGSTON	KHX2133C9AD3T1FK4/8GX(XMP)	8GB (4x 2GB)	DS	-	-	9	1.65	*	*	*
OCZ	OCZ3XTEP2133C9LV4GK	2GB	DS	-	-	7-7-7-20	1.65	*	*	*
Patriot	PVV34G2133C9K(XMP)	4GB (2x 2GB)	DS	-	-	9-11-9-27	1.66	*	*	*

DDR3-2000(O.C.) MHz capability

Vendors	Part No.	Size	SS/ DS	Chip Brand	Chip NO.	Timing	Voltage	DIMM socket support (Optional)		
								1 DIMM	2 DIMM	4 DIMM
A-DATA	AX3U2000GB2G9B(XMP)	2GB	DS	-	-	9-11-9-27	1.55-1.75	*	*	*
A-DATA	AX3U2000GC4G9B(XMP)	4GB	DS	-	-	9-11-9-27	1.55-1.75	*	*	*
Apacer	78.AAGD5.9KD(XMP)	6GB(3 x 2GB)	DS	-	-	9-9-9-27	-	*	*	*
CORSAIR	CMT6GX3M3A2000C8(XMP)	6GB (3x 2GB)	DS	-	-	8-9-8-24	1.65	*	*	*
G.SKILL	F3-16000CL9D-4GBRH(XMP)	4GB(2 x 2GB)	DS	-	-	9-9-9-24	1.65	*	*	*
G.SKILL	F3-16000CL9D-4GBTD(XMP)	4GB(2 x 2GB)	DS	-	-	9-9-9-24	1.65	*	*	*
GEIL	GUP34GB2000C9DC(XMP)	4GB (2x 2GB)	DS	-	-	9-9-9-28	1.65	*	*	*
KINGSTON	KHX2000C9AD3T1K3/6GX (XMP)	6GB (3x 2GB)	DS	-	-	9	1.65	*	*	*
Transcend	TX2000KLN-8GK (388375) (XMP)	4GB	DS	-	-	-	1.6	*	*	*
AEXEA	AXA3ES2G2000LG28V(XMP)	2GB	DS	-	-	-	1.65	*	*	*
AEXEA	AXA3ES4GK2000LG28V (XMP)	4GB (2x 2GB)	DS	-	-	-	1.65	*	*	*
Asint	SLA302G08-ML2HB(XMP)	4GB	DS	Hynix	H5TQ2G83BFRH9C	9-9-9-27	-	*	*	*
Gingle	FA3JRS673A801A	2GB	DS	-	-	9-9-9-24	-	*	*	*
Patriot	PX7312G2000ELK(XMP)	12GB (3x 4GB)	DS	-	-	9-11-9-27	1.65	*	*	*
Patriot	PV736G2000ELK(XMP)	6GB (3x 2GB)	DS	-	-	7-7-7-20	1.65	*	*	*
Silicon Power	SP002GBLYU200S02(XMP)	2GB	DS	-	-	-	-	*	*	*
Team	TXD32048M2000C9(XMP)	2GB	DS	Team	T3D1288RT-20	9-9-9-24	1.5	*	*	*
Team	TXD32048M2000C9-L(XMP)	2GB	DS	Team	T3D1288LT-20	9-9-9-24	1.5	*	*	*

DDR3-1866(O.C.) MHz capability

Vendors	Part No.	Size	SS/ DS	Chip Brand	Chip NO.	Timing	Voltage	DIMM socket support (Optional)		
								1 DIMM	2 DIMM	4 DIMM
A-DATA	AX3U1866GC2G9B(XMP)	2GB	SS	-	-	9-11-9-27	1.55-1.75	*	*	*
A-DATA	AX3U1866GC4G9B(XMP)	4GB	DS	-	-	9-11-9-27	1.55-1.75	*	*	*
CORSAIR	CMT32GX3M4X1866C9(Ver1.50)(XMP)	32GB (4x 8GB)	DS	-	-	9-10-9-27	1.5	*	*	*
CORSAIR	CMT32GX3M4X1866C9(Ver3.23)(XMP)	32GB (4x 8GB)	DS	-	-	10-10-10-27	1.5	*	*	*
CORSAIR	CMT32GX3M4X1866C9(Ver3.23)(XMP)	32GB (4x 8GB)	DS	-	-	10-10-10-27	1.5	*	*	*
CORSAIR	CMZ8GX3M2A1866C9(XMP)	8GB (2x 4GB)	DS	-	-	9-10-9-27	1.5	*	*	*
Crucial	BLE4G3D1869DE1XT0.16FMD(XMP)	4GB	DS	-	-	9-9-9-27	1.5	*	*	*
G.SKILL	F3-14900CL9Q-16GBXL(XMP)	16GB (4x 4GB)	DS	-	-	9-10-9-28	1.5	*	*	*
G.SKILL	F3-14900CL9Q-16GBZL(XMP)	16GB (4x 4GB)	DS	-	-	9-10-9-28	1.5	*	*	*
G.SKILL	F3-14900CL10Q2-64GBZLD(XMP)	64GB (8x 8GB)	DS	-	-	10-11-10-30	1.5	*	*	*
G.SKILL	F3-14900CL9D-8GBSR(XMP)	8GB (2x 4GB)	DS	-	-	9-10-9-28	1.5	*	*	*
G.SKILL	F3-14900CL9Q-8GBFLD(XMP)	8GB (2x 4GB)	DS	-	-	9-9-9-24	1.6	*	*	*
Patriot	PXD34G1866ELK(XMP)	4GB (2x 2GB)	SS	-	-	9-9-9-24	1.65	*	*	*
Patriot	PXD38G1866ELK(XMP)	8GB (2x 4GB)	DS	-	-	9-11-9-27	1.65	*	*	*

DDR3-1600 MHz capability

Vendors	Part No.	Size	SS/DS	Chip Brand	Chip NO.	Timing	Voltage	DIMM socket support (Optional)		
								1 DIMM	2 DIMM	4 DIMM
A-DATA	AM2U16BC2P1	2GB	SS	A-DATA	3CCD-1509A	-	-	*	*	*
A-DATA	AM2U16BC4P2	4GB	DS	A-DATA	3CCD-1509A	-	-	*	*	*
A-DATA	AX3U1600G4G9(XMP)	4GB	DS	-	-	-	1.55-1.75	*	*	*
A-DATA	AX3U1600PC4G8(XMP)	4GB	DS	-	-	8-8-8-24	1.55-1.75	*	*	*
CORSAIR	HX3X12G1600C9(XMP)	12GB(6x 2GB)	DS	-	-	9-9-9-24	1.6	*	*	*
CORSAIR	CMZ16GX3M4A1600C9(XMP)	16GB(4x 4GB)	DS	-	-	9-9-9-24	1.5	*	*	*
CORSAIR	CMG4GX3M2A1600C6	4GB(2x 2GB)	DS	-	-	6-6-6-18	1.65	*	*	*
CORSAIR	CMP6GX3M3A1600C8(XMP)	6GB(3x 2GB)	DS	-	-	8-8-8-24	1.65	*	*	*
CORSAIR	CMP6GX3M3A1600C8(XMP)	6GB(3x 2GB)	DS	-	-	8-8-8-24	1.65	*	*	*
CORSAIR	CMX6GX3M3C1600C7(XMP)	6GB(3x 2GB)	DS	-	-	7-8-7-20	1.65	*	*	*
CORSAIR	CMZ8GX3M2A1600C8(XMP)	8GB(2x 4GB)	DS	-	-	8-8-8-24	1.5	*	*	*
CORSAIR	CMZ8GX3M2A1600C9(XMP)	8GB(2x 4GB)	DS	-	-	9-9-9-24	1.5	*	*	*
Crucial	BL12864BN1608.8FF(XMP)	2GB(1x 1GB)	SS	-	-	8-8-8-24	1.65	*	*	*
Crucial	BLT4G3D1608DT1TX0.16FM(XMP)	4GB	DS	-	-	8-8-8-24	1.5	*	*	*
G.SKILL	F3-12800CL7Q-16GBXH(XMP)	16GB(4x 4GB)	DS	-	-	7-8-7-24	1.6	*	*	*
G.SKILL	F3-12800CL9Q-16GBXL(XMP)	16GB(4x 4GB)	DS	-	-	9-9-9-24	1.5	*	*	*
G.Skill	F3-12800CL9Q-16GBZL(XMP)	16GB(4x 4GB)	DS	-	-	9-9-9-24	1.5	*	*	*
G.SKILL	F3-12800CL7D-8GBRH(XMP)	8GB(2x 4GB)	DS	-	-	7-8-7-24	1.6	*	*	*
G.SKILL	F3-12800CL9D-8GBRL(XMP)	8GB(2x 4GB)	DS	-	-	9-9-9-24	1.5	*	*	*
G.SKILL	F3-12800CL9D-8GBSR2(XMP)	8GB(2x 4GB)	DS	-	-	9-9-9-24	1.25	*	*	*
G.SKILL	F3-12800CL8D-8GBECO(XMP)	8GB(2x4GB)	DS	-	-	8-8-8-24	1.35	*	*	*
GEIL	GET316GB1600C9QC(XMP)	16GB(4x 4GB)	DS	-	-	9-9-9-28	1.6	*	*	*
GEIL	GUP34GB1600C7DC(XMP)	4GB(2x 2GB)	DS	-	-	7-7-7-24	1.6	*	*	*
KINGMAX	FLGE85F-C8KL9A(XMP)	2GB	SS	KINGMAX	N/A	9-9-9-28	-	*	*	*
KINGMAX	FLGF65F-C8KL9A(XMP)	4GB	DS	KINGMAX	N/A	9-9-9-28	-	*	*	*
KINGSTON	KHX1600C9D3K3/12GX(XMP)	12GB(3x 4GB)	DS	-	-	9	1.65	*	*	*
KINGSTON	KHX1600C9D3T1BK3/12GX(XMP)	12GB(3x 4GB)	DS	-	-	9	1.65	*	*	*
KINGSTON	KHX1600C9D3K3/12GX(XMP)	12GB(3x 4GB)	DS	-	-	-	1.65	*	*	*
KINGSTON	KHX1600C9D3K6/24GX(XMP)	24GB(6x 4GB)	DS	-	-	9	1.65	*	*	*
Kingston	KHX1600C9D3K8/32GX(XMP)	32GB(4x 8GB)	DS	-	-	9-9-9-27	1.65	*	*	*
KINGSTON	KHX1600C8D3K2/4GX(XMP)	4GB(2x 2GB)	DS	-	-	8	1.65	*	*	*
KINGSTON	KHX1600C9D3K2/4GX(XMP)	4GB(2x 2GB)	DS	-	-	-	1.65	*	*	*
KINGSTON	KHX1600C9D3LK2/4GX(XMP)	4GB(2x 2GB)	DS	-	-	-	1.65	*	*	*
KINGSTON	KHX1600C9D3X2K2/4GX(XMP)	4GB(2x 2GB)	DS	-	-	9	1.65	*	*	*
KINGSTON	KHX1600C9D3K3/6GX(XMP)	6GB(3x 2GB)	DS	-	-	9	1.65	*	*	*
KINGSTON	KHX1600C9D3K3/6GX(XMP)	6GB(3x 2GB)	DS	-	-	9	1.65	*	*	*
KINGSTON	KHX1600C9D3T1K3/6GX(XMP)	6GB(3x 2GB)	DS	-	-	-	1.65	*	*	*
KINGSTON	KHX1600C9D3T1K3/6GX(XMP)	6GB(3x 2GB)	DS	-	-	9	1.65	*	*	*
KINGSTON	KHX1600C9D3P1K2/8G	8GB(2x 4GB)	DS	-	-	9	1.5	*	*	*

(continues on next page)

DDR3-1600 MHz capability (continued)

Vendors	Part No.	Size	SS/ DS	Chip Brand	Chip NO.	Timing	Voltage	DIMM socket support (Optional)		
								1 DIMM	2 DIMM	4 DIMM
MICRON	MT16KTF51264Z-1G6M1	4GB	DS	MICRON	D9PFJ	11-11-11-28	-	*	*	*
OCZ	OCZ3BE1600C8LV4GK	4GB(2x 2GB)	DS	-	-	8-8-8	1.65	*	*	*
Transcend	TS256MLK64V6N	2GB	SS	Transcend	K4B2G0846C	-	-	*	*	*
Transcend	TS512MLK64V6N	4GB	DS	Transcend	K4B2G0846C	-	-	*	*	*
Transcend	JM1600KLN-8GK	8GB(2x 4GB)	DS	Transcend	TK483PCW3	-	-	*	*	*
Asint	SLZ3128M8-EGJ1D(XMP)	2GB	DS	Asint	3128M8-GJ1D	-	-	*	*	*
Asint	SLA302G08-EGG1C(XMP)	4GB	DS	Asint	302G08-GG1C	9-9-9-27	-	*	*	*
Asint	SLA302G08-EGJ1C(XMP)	4GB	DS	Asint	302G08-GJ1C	9-9-9-27	-	*	*	*
ATP	AQ12M64B8BK0S	4GB	DS	SAMSUNG	K4B2G08460	-	NO	*	*	*
EK Memory	EKM324L28BP8-16(XMP)	4GB(2x 2GB)	DS	-	-	9	-	*	*	*
EK Memory	EKM324L28BP8-16(XMP)	4GB(2x 2GB)	DS	-	-	9	-	*	*	*
Elixir	M2X2F64CB88G7N-DG(XMP)	2GB	SS	Elixir	N2CB2G80GN-DG	9-9-9-28	-	*	*	*
Elixir	M2X4G64CB8HG5N-DG(XMP)	4GB	DS	Elixir	N2CB2G80GN-DG	9-9-9-28	-	*	*	*
GoodRam	GR1600D364L9/2G	2GB	DS	GoodRam	GF1008KC-JN	-	-	*	*	*
KINGTIGER	KTG2G1600PG3(XMP)	2GB	DS	-	-	-	-	*	*	*
Mushkin	996805(XMP)	4GB(2x 2GB)	DS	-	-	6-8-6-24	1.65	*	*	*
Mushkin	998805(XMP)	6GB(3x 2GB)	DS	-	-	6-8-6-24	1.65	*	*	*
Patriot	PX7312G1600LLK(XMP)	12GB(3x 4GB)	DS	-	-	8-8-8-24	1.65	*	*	*
Patriot	PGS34G1600LLKA2	4GB(2x 2GB)	DS	-	-	8-8-8-24	1.7	*	*	*
Patriot	PGS34G1600LLKA	4GB(2x 2GB)	DS	-	-	7-7-7-20	1.7	*	*	*
Patriot	PVV38G1600LLK(XMP)	8GB(2x 4GB)	DS	-	-	8-9-8-24	1.65	*	*	*
Patriot	PX538G1600LLK(XMP)	8GB(2x 4GB)	DS	-	-	8-9-8-24	1.65	*	*	*
SanMax	SMD-4G68HP-16KZ	4GB	DS	Hynix	H5TQ2G83BFRPBC	-	1.5	*	*	*
Team	TXD31024M1600C8-D(XMP)	1GB	SS	Team	T3D1288RT-16	8-8-8-24	1.65	*	*	*
Team	TXD32048M1600HC8-D(XMP)	2GB	DS	Team	T3D1288RT-16	8-8-8-24	1.65	*	*	*

DDR3-1333 MHz capability

Vendors	Part No.	Size	SS/ DS	Chip Brand	Chip NO.	Timing	Voltage	DIMM socket support (Optional)		
								1 DIMM	2 DIMM	4 DIMM
A-DATA	AD6311B0823EV	2GB	SS	A-DATA	3CCA-1509A	-	-	*	*	*
A-DATA	AXDU1333GC2G9(XMP)	2GB	SS	-	-	9-9-9-24	1.25-1.35	*	*	*
A-DATA	AD6311C1624EV	4GB	DS	A-DATA	3CCA-1509A	-	-	*	*	*
A-DATA	SU3U1333W8G9(XMP)	8GB	DS	ELPIDA	J4208BASE-DJ-F	-	-	*	*	*
Apacer	78.A1GC6.9L1	2GB	DS	Apacer	AM5D5808FEQSBG	9	-	*	*	*
Apacer	78.B1GDE.9L10C	4GB	DS	Apacer	AM5D5908CEHSBG	9	-	*	*	*
CORSAIR	TW3X4G1333C9A	4GB(2x 2GB)	DS	-	-	9-9-9-24	1.5	*	*	*
CORSAIR	CMX8GX3M2A1333C9(XMP)	8GB(2x 4GB)	DS	-	-	9-9-9-24	1.5	*	*	*
ELPIDA	EBJ41UF8BCF0-DJ-F	4GB	DS	ELPIDA	J2108BCSE-DJ-F	-	-	*	*	*
G.SKILL	F3-10600CL9D-4GBNT	4GB(2x 2GB)	DS	G.SKILL	D3 128M8CE9 2GB	9-9-9-24	1.5	*	*	*
G.SKILL	F3-10666CL9D-8GBRL	8GB(2x 4GB)	DS	-	-	9-9-9-24	1.5	*	*	*
G.SKILL	F3-10666CL9D-8GBRL	8GB(2x 4GB)	DS	-	-	9-9-9-24	1.5	*	*	*
G.SKILL	F3-10666CL9D-8GBXL	8GB(2x 4GB)	DS	-	-	9-9-9-24	1.5	*	*	*
GEIL	GET316GB1333C9QC	16GB(4x 4GB)	DS	-	-	9-9-9-24	1.5	*	*	*
GEIL	GG34GB1333C9DC	4GB(2x 2GB)	DS	GEIL	GL1L128M88BA115FW	9-9-9-24	1.3	*	*	*

(continues on next page)

DDR3-1333 MHz capability (continued)

Vendors	Part No.	Size	SS/ DS	Chip Brand	Chip NO.	Timing	Voltage	DIMM socket support (Optional)		
								1 DIMM	2 DIMM	4 DIMM
GEIL	GG34GB1333C9DC	4GB(2x 2GB)	DS	GEIL	GL1L128M88BA15B	9-9-9-24	1.3	*	*	*
GEIL	GB34GB1333C7CD	4GB(2x 2GB)	DS	GEIL	GL1L128M88BA15FW	7-7-7-24	1.5	*	*	*
GEIL	GVP38GB1333C9DC	8GB(2x 4GB)	DS	-	-	9-9-9-24	1.5	*	*	*
GEIL	GVP38GB1333C7QC	8GB(4x 2GB)	DS	-	-	7-7-7-24	1.5	*	*	*
Hynix	HMT325U6BFR8A-H9	2GB	SS	Hynix	H5TQ2G83BFR	-	-	*	*	*
Hynix	HMT125U6TFR8A-H9	2GB	DS	Hynix	H5TC1G83TFR	-	-	*	*	*
KINGMAX	FLFE85F-C8KL9	2GB	SS	KINGMAX	KFC8FNLMX-F-DXX-15A	-	-	*	*	*
KINGMAX	FLFE85F-C8KM9	2GB	SS	Kingmax	KFC8FNLMX-F-BXX-15A	-	-	*	*	*
KINGMAX	FLFE85F-B8KL9	2GB	DS	KINGMAX	KFB8FNLMX-BNF-15A	-	-	*	*	*
KINGMAX	FLFF65F-C8KL9	4GB	DS	KINGMAX	KFC8FNLMX-F-DXX-15A	-	-	*	*	*
KINGMAX	FLFF65F-C8KM9	4GB	DS	Kingmax	KFC8FNLMX-F-BXX-15A	-	-	*	*	*
KINGSTON	KVR1333D3S8N9/2G	2GB	SS	Micron	IFD77 D9LGK	-	1.5	*	*	*
KINGSTON	KVR1333D3N9/2G	2GB	DS	Kingston	D1288JPNDDPLD9U	9	1.5	*	*	*
KINGSTON	KHX1333C9D3UK2/4GX (XMP)	4GB(2x 2GB)	DS	-	-	9	1.25	*	*	*
KINGSTON	KVR1333D3N9K2/4G	4GB(2x 2GB)	DS	KINGSTON	D1288JEMFPGD9U	-	1.5	*	*	*
KINGSTON	KVR1333D3E9S/4G	4GB	DS	Elpida	J2108ECSE-DJ-F	9	1.5	*	*	*
MICRON	MT8JTF25664AZ-1G4D1	2GB	SS	Micron	D9LGK	-	-	*	*	*
MICRON	MT8JTF25664AZ-1G4D1	2GB	SS	Micron	D9LGK	-	-	*	*	*
MICRON	MT8JTF25664AZ-1G4M1	2GB	SS	MICRON	D9PFJ	-	-	*	*	*
MICRON	MT16JTF51264AZ-1G4D1	4GB	DS	Micron	D9LGK	-	-	*	*	*
OCZ	OCZ3G1333LV4GK	4GB(2x 2GB)	DS	-	-	9-9-9	1.65	*	*	*
OCZ	OCZ3RPR1333C9LV8GK	8GB(2x 4GB)	DS	-	-	9-9-9	1.65	*	*	*
PSC	PC310600U-9-10-A0	1GB	SS	PSC	A3P1GF3FGF	-	-	*	*	*
PSC	PC310600U-9-10-B0	2GB	DS	PSC	A3P1GF3FGF	-	-	*	*	*
SAMSUNG	M378B5773DH0-CH9	2GB	SS	SAMSUNG	K4B2G08460	-	-	*	*	*
SAMSUNG	M378B5673FH0-CH9	2GB	DS	SAMSUNG	K4B1G0846F	-	-	*	*	*
SAMSUNG	M378B5273CH0-CH9	4GB	DS	SAMSUNG	K4B2G0846C	-	-	*	*	*
SAMSUNG	M378B5273DH0-CH9	4GB	DS	SAMSUNG	K4B2G08460	-	-	*	*	*
SAMSUNG	M378B1G73AH0-CH9	8GB	DS	SAMSUNG	K4B4G0846A-HCH9	-	-	*	*	*
Transcend	JM1333KLN-2G (582670)	2GB	SS	Micron	ICD77 C9LGK	-	-	*	*	*
Transcend	JM1333KLN-2G	2GB	SS	Transcend	TK483PCW3	-	-	*	*	*
Transcend	TS256MLK64V3N(585541)	2GB	SS	Micron	ICD77 D9LGK	9	-	*	*	*
Transcend	TS256MLK64V3N(566577)	2GB	SS	Hynix	H5TQ2G83BFR	9	-	*	*	*
Transcend	TS256MLK64V3N(574206)	2GB	SS	Micron	D9LGK	9	-	*	*	*
Transcend	JM1333KLN-4G(583782)	4GB	DS	Transcend	TK483PCW3	9	-	*	*	*
Transcend	JM1333KLN-4G	4GB	DS	Transcend	TK483PCW3	9	-	*	*	*
Transcend	TS512MLK64V3N(585538)	4GB	DS	Micron	IED27 D9LGK	-	-	*	*	*
Transcend	TS512MLK64V3N(574831)	4GB	DS	Micron	D9LGK	9	-	*	*	*
ACTICA	ACT1GHU64B8F1333S	1GB	SS	SAMSUNG	K4B1G0846F	-	-	*	*	*
ACTICA	ACT1GHU72C8G1333S	1GB	SS	SAMSUNG	K4B1G0846F(ECC)	-	-	*	*	*
ACTICA	ACT2GHU64B8G1333M	2GB	DS	Micron	D9KPT	-	-	*	*	*
ACTICA	ACT2GHU64B8G1333S	2GB	DS	SAMSUNG	K4B1G0846F	-	-	*	*	*
ACTICA	ACT2GHU72D8G1333M	2GB	DS	Micron	D9KPT(ECC)	-	-	*	*	*
ACTICA	ACT2GHU72D8G1333S	2GB	DS	SAMSUNG	K4B1G0846F(ECC)	-	-	*	*	*
ACTICA	ACT4GHU64B8H1333H	4GB	DS	Hynix	H5TQ2G83AFR	-	-	*	*	*
ACTICA	ACT4GHU72D8H1333H	4GB	DS	Hynix	H5TQ2G83AFR(ECC)	-	-	*	*	*
ATP	AQ56M72E8BJH9S	2GB	DS	SAMSUNG	K4B1G0846F(ECC)	-	-	*	*	*
ATP	AQ12M72E8BKH9S	4GB	DS	SAMSUNG	K4B2G0846C(ECC)	-	-	*	*	*

(continues on next page)

DDR3-1333 MHz capability (continued)

Vendors	Part No.	Size	SS/ DS	Chip Brand	Chip NO.	Timing	Voltage	DIMM socket support (Optional)		
								1 DIMM	2 DIMM	4 DIMM
BUFFALO	D3U1333-1G	1GB	SS	Elpida	J1108BFBFG-DJ-F	-	-	*	*	*
BUFFALO	D3U1333-2G	2GB	DS	Elpida	J1108BFBFG-DJ-F	-	-	*	*	*
BUFFALO	D3U1333-4G	4GB	DS	NANYA	NT5CB256M8BN-CG	-	-	*	*	*
EK Memory	EKM324L28BP8-113	4GB(2x 2GB)	DS	-	-	9	-	*	*	*
Elixir	M2F2G64CB88B7N-CG	2GB	SS	Elixir	N2CB2G808N-CG	-	-	*	*	*
Elixir	M2F2G64CB88D7N-CG	2GB	SS	Elixir	M2CB2G8BDN-CG	-	-	*	*	*
Elixir	M2F4G64CB8HB5N-CG	4GB	DS	Elixir	N2CB2G808N-CG	-	-	*	*	*
Elixir	M2F4G64CB8HD5N-CG	4GB	DS	Elixir	M2CB2G8BDN-CG	-	-	*	*	*
GoodRam	GR1333D364L9/2G	2GB	DS	Qimonda	IDSH1G-03A1F1C-13H	-	-	*	*	*
KINGTIGER	F10DA2T1680	2GB	DS	KINGTIGER	KTG1333PS1208NST-C9	-	-	*	*	*
KINGTIGER	KTG2G1333PG3	2GB	DS	-	-	-	-	*	*	*
Patriot	PSD32G13332	2GB	DS	Patriot	PM128M8D3BU-15	9	-	*	*	*
Patriot	PGS34G1333LKA	4GB(2x 2GB)	DS	-	-	7-7-7-20	1.7	*	*	*
Patriot	PG38G1333EL(XMP)	8GB	DS	-	-	-	1.5	*	*	*
RiDATA	C304627CB1AG22Fe	2GB	DS	RiDATA	C304627CB1AG22Fe	9	-	*	*	*
RiDATA	E304459CB1AG32Cf	4GB	DS	RiDATA	E304459CB1AG32Cf	9	-	*	*	*
SanMax	SMD4G68H1P-13HZ	4GB	DS	Hynix	H5TQ2G83BFRH9C	-	1.5	*	*	*
Silicon Power	SP001GBLTE133S01	1GB	SS	NANYA	NT5CB128M8AN-CG	-	-	*	*	*
Silicon Power	SP001GBLTU133S02	1GB	SS	S-POWER	10YT3E5	9	-	*	*	*
Silicon Power	SP002GBLTE133S01	2GB	DS	NANYA	NT5CB128M8AN-CG	-	-	*	*	*
Team	TXD31024M1333C7(XMP)	1GB	SS	Team	T3D1288LT-13	7-7-7-21	1.75	*	*	*
Team	TXD31048M1333C7-D(XMP)	1GB	SS	Team	T3D1288LT-13	7-7-7-21	1.75	*	*	*
Team	TXD32048M1333C7-D(XMP)	2GB	DS	Team	T3D1288LT-13	7-7-7-21	1.5-1.6	*	*	*



Side(s): SS - Single-sided DS - Double-sided DIMM support:

- **1 DIMM:** Supports one (1) module inserted into any slot as Single-channel memory configuration. **We suggest that you install the module into A2 slot.**
- **2 DIMMs:** Supports two (2) modules inserted into either the blue slots or the black slots as one pair of Dual-channel memory configuration. **We suggest that you install the modules into slots A2 and B2 for better compatibility.**
- **4 DIMMs:** Supports four (4) modules inserted into both the blue and black slots as two pairs of Dual-channel memory configuration.



- ASUS exclusively provides hyper DIMM support function.
- Hyper DIMM support is subject to the physical characteristics of individual CPUs. Load the X.M.P. settings in the BIOS for the hyper DIMM support.
- Visit the ASUS website for the latest QVL.

2.3.4 DIMM installation

1

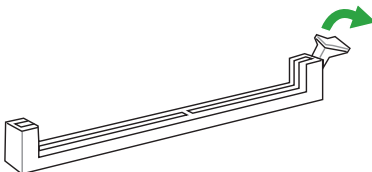

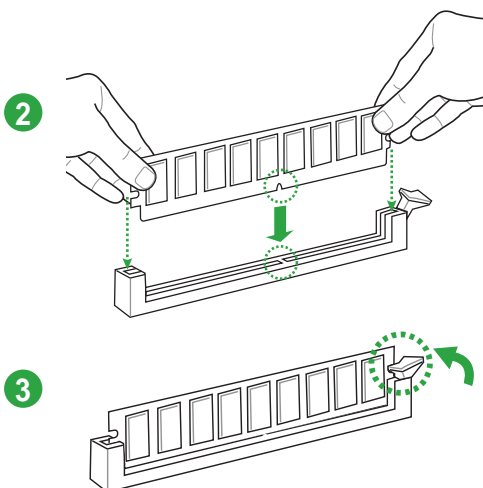

To remove a DIMM

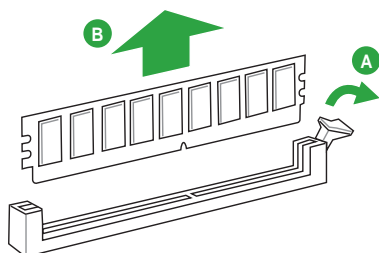

1.5 Expansion slots

In the future, you may need to install expansion cards. The following sub-sections describe the slots and the expansion cards that they support.



Unplug the power cord before adding or removing expansion cards. Failure to do so may cause you physical injury and damage motherboard components.

1.5.1 Installing an expansion card

To install an expansion card:

1. Before installing the expansion card, read the documentation that came with it and make the necessary hardware settings for the card.
2. Remove the system unit cover (if your motherboard is already installed in a chassis).
3. Remove the bracket opposite the slot that you intend to use. Keep the screw for later use.
4. Align the card connector with the slot and press firmly until the card is completely seated on the slot.
5. Secure the card to the chassis with the screw you removed earlier.
6. Replace the system cover.

1.5.2 Configuring an expansion card

After installing the expansion card, configure it by adjusting the software settings.

1. Turn on the system and change the necessary BIOS settings, if any. See Chapter 2 for information on BIOS setup.
2. Assign an IRQ to the card.
3. Install the software drivers for the expansion card.



When using PCI cards on shared slots, ensure that the drivers support "Share IRQ" or that the cards do not need IRQ assignments. Otherwise, conflicts will arise between the two PCI groups, making the system unstable and the card inoperable.

1.5.3 PCI Express x1 slot

This motherboard supports PCI Express x1 network cards, SCSI cards, and other cards that comply with the PCI Express specifications.

1.5.4 PCI Express x16 slot

This motherboard has a PCI Express 3.0/2.0 x16 slot that supports PCI Express 3.0/2.0 x16 graphic cards complying with the PCI Express specifications.



In single VGA card mode, use the PCIe 3.0/2.0 x 16_1 slot (navy blue) for a PCIe x16 graphics card to get better performance.

Expansion Slots	
①	PCIe x16_1
②	PCIe x1_1
③	PCIe x16_2
④	PCI1

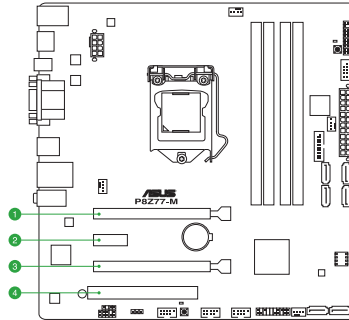

IRQ assignments for this motherboard

	A	B	C	D	E	F	G	H
Intel PCH SATA controller #0	-	-	-	shared	-	-	-	-
Intel PCH SATA controller #1	-	-	-	shared	-	-	-	-
SMBUS Controller	-	-	shared	-	-	-	-	-
Thermal Controller	-	-	shared	-	-	-	-	-
EHCI #0	-	-	-	-	-	-	-	shared
EHCI #1	shared	-	-	-	-	-	-	-
PCIe x16_1	shared	-	-	-	-	-	-	-
PCIe x16_2	shared	-	-	-	-	-	-	-
PCIe x1_1	shared	-	-	-	-	-	-	-
PCI	shared	-	-	-	-	-	-	-
Realtek 8111F LAN	-	-	shared	-	-	-	-	-

1.6 Onboard switches

Onboard switches allow you to fine-tune performance when working on a bare or open-case system. This is ideal for overclockers and gamers who continually change settings to enhance system performance.

1. MemOK! switch

Installing DIMMs that are incompatible with the motherboard may cause system boot failure, and the DRAM_LED near the MemOK! switch lights continuously. Press and hold the MemOK! switch until the DRAM_LED starts blinking to begin automatic memory compatibility tuning for successful boot.

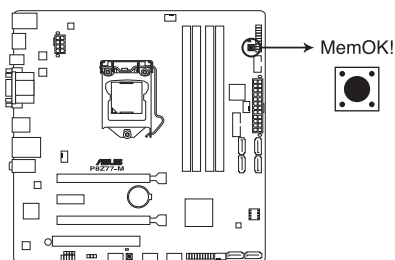

P8Z77-M MemOK! switch



- Refer to section **1.8 Onboard LEDs** for the exact location of the DRAM_LED.
- The DRAM_LED also lights when the DIMM is not properly installed. Turn off the system and reinstall the DIMM before using the MemOK! function.
- The MemOK! switch does not function under Windows™ OS environment.
- During the tuning process, the system loads and tests failsafe memory settings. It takes about 30 seconds for the system to test one set of failsafe settings. If the test fails, the system reboots and test the next set of failsafe settings. The blinking speed of the DRAM_LED increases, indicating different test processes.
- Due to memory tuning requirement, the system automatically reboots when each timing set is tested. If the installed DIMMs still fail to boot after the whole tuning process, the DRAM_LED lights continuously. Replace the DIMMs with ones recommended in the Memory QVL (Qualified Vendors Lists) in this user manual or on the ASUS website at www.asus.com.
- If you turn off the computer and replace DIMMs during the tuning process, the system continues memory tuning after turning on the computer. To stop memory tuning, turn off the computer and unplug the power cord for about 5–10 seconds.
- If your system fail to boot due to BIOS overclocking, press the MemOK! switch to boot and load BIOS default settings. A message will appear during POST reminding you that the BIOS has been restored to its default settings.
- We recommend that you download and update to the latest BIOS version from the ASUS website at www.asus.com after using the MemOK! function.

1.7 USB BIOS Flashback

USB BIOS Flashback allows you to easily update the BIOS without entering the BIOS or operating system. Just connect the USB storage device containing the BIOS file to the USB port, press the BIOS Flashback switch, and the BIOS is updated automatically.

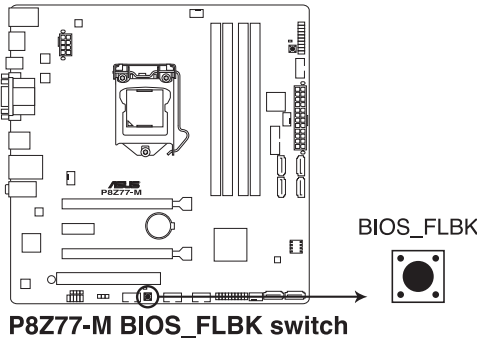

- 1 Install USB BIOS Flashback wizard from the support DVD and download the latest BIOS file to a USB flash drive.
- 2 Connect the USB flash drive to the bottom of USB2.0 port (LAN1_USB2_78 connector) at the rear panel.
- 3 Press the USB Flashback switch for three seconds until the FLBK_LED flashes. The FLBK_LED goes out when the BIOS update is completed.

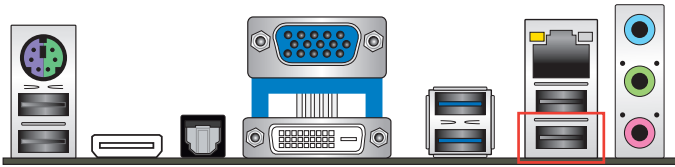

1. Do not disconnect the USB flash drive or power system, or move the CLRTC jumper during the BIOS updating process. Doing so will interrupt the BIOS updating process. In case of interruption, follow the steps again to update the BIOS.
2. If FLBK_LED flashes for five seconds and turns into a stable light, this indicates that USB BIOS Flashback is not working properly due to improper USB flash drive connection, BIOS file name error, or incompatible BIOS file format. If this happens, restart the system.
3. BIOS updating poses some risks. If the BIOS program is damaged during the updating process and the system fails to reboot, please contact your local ASUS Service Center for assistance

1.8 Onboard LEDs

1. Standby power LED (SB_PWR)

The motherboard comes with a standby power LED that lights up to indicate that the system is ON, in sleep mode, or in soft-off mode. This is a reminder that you should shut down the system and unplug the power cable before removing or plugging in any motherboard component. The illustration below shows the location of the onboard LED.

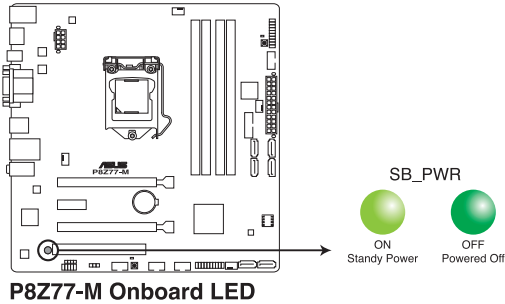

2. DRAM LED (DRAM_LED)

The DRAM_LED lights up when the DIMM is not properly installed. Turn off the system and reinstall the DIMM before using the MemOK! function.

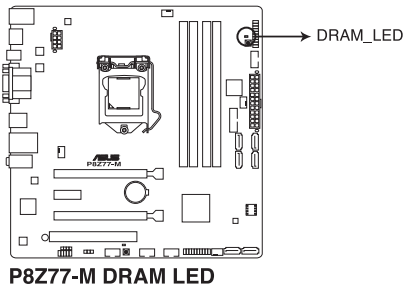

1.9 Jumpers

Clear RTC RAM (3-pin CLRTC)

This jumper allows you to clear the Real Time Clock (RTC) RAM in CMOS. You can clear the CMOS memory of date, time, and system setup parameters by erasing the CMOS RTC RAM data. The onboard button cell battery powers the RAM data in CMOS, which include system setup information such as system passwords.

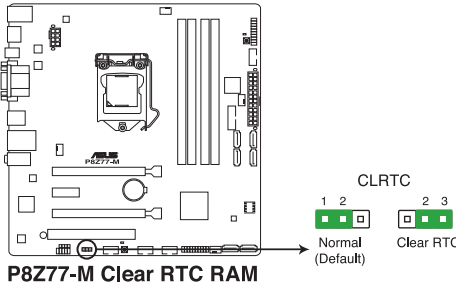

To erase the RTC RAM:

1. Turn OFF the computer and unplug the power cord.
2. Move the jumper cap from pins 1-2 (default) to pins 2-3. Keep the cap on pins 2-3 for about 5-10 seconds, then move the cap back to pins 1-2.
3. Plug the power cord and turn ON the computer.
4. Hold down the key during the boot process and enter BIOS setup to re-enter data.



Except when clearing the RTC RAM, never remove the cap on CLRTC jumper default position. Removing the cap will cause system boot failure!



- If the steps above do not help, remove the onboard battery and move the jumper again to clear the CMOS RTC RAM data. After the CMOS clearance, reinstall the battery.
- You do not need to clear the RTC when the system hangs due to overclocking. For system failure due to overclocking, use the C.P.R. (CPU Parameter Recall) feature. Shut down and reboot the system so the BIOS can automatically reset parameter settings to default values.
- Due to the chipset behavior, AC power off is required to enable C.P.R. function. You must turn off and on the power supply or unplug and plug the power cord before rebooting the system.

1.10 Connectors

1.10.1 Rear panel connectors

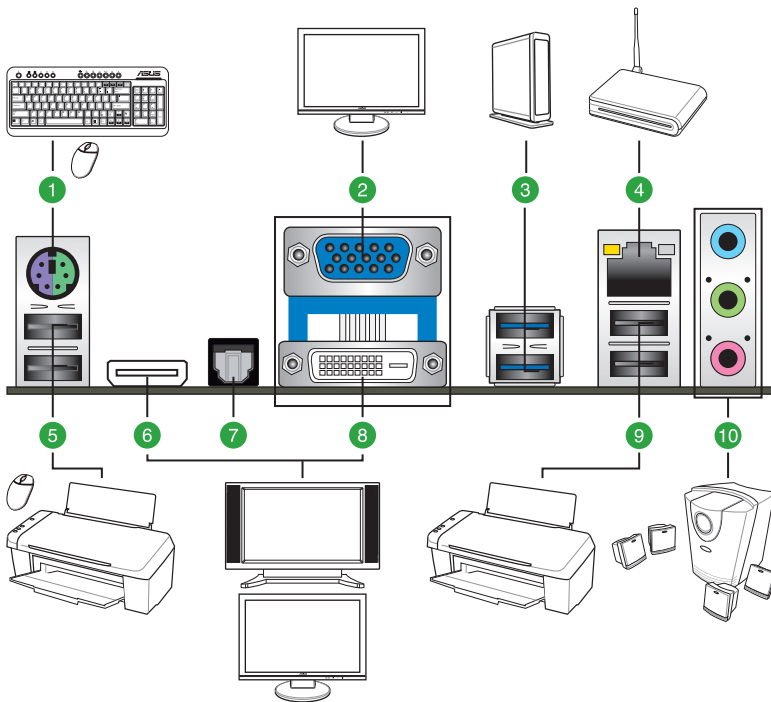

Rear panel connectors			
1.	PS/2 keyboard/mouse combo port	6.	HDMI port
2.	VGA port	7.	Optical S/PDIF Out port
3.	USB 3.0 ports 3 and 4**	8.	DVI-D
4.	Intel® LAN (RJ-45) port	9.	USB 2.0 ports 7 and 8*
5.	USB 2.0 ports 5 and 6	10.	Audio I/O ports

* The bottom USB port supports USB BIOS Flashback.

** USB 3_34 runs at USB3.0 speed under Windows 7 or later operating system only.

LAN port LED indications

Activity/Link LED		Speed LED	
Status	Description	Status	Description
OFF	No link	OFF	10Mbps connection
ORANGE	Linked	ORANGE	100Mbps connection
BLINKING	Data activity	GREEN	1Gbps connection

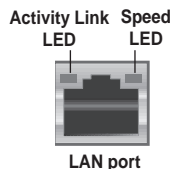

Audio 2, 4, 6, or 8-channel configuration

Port	Headset 2-channel	4-channel	6-channel	8-channel
Light Blue (Rear panel)	Line In	Rear Speaker Out	Rear Speaker Out	Rear Speaker Out
Lime (Rear panel)	Line Out	Front Speaker Out	Front Speaker Out	Front Speaker Out
Pink (Rear panel)	Mic In	Mic In	Bass/ Center	Bass/ Center
Lime (Front panel)	–	–	–	Front Speaker Out

- Line In port (light blue).** This port connects to the tape, CD, DVD player, or other audio sources.
- Line Out port (lime).** This port connects to a headphone or a speaker. In the 4, 6, and 8-channel configurations, the function of this port becomes Front Speaker Out.
- Microphone port (pink).** This port connects to a microphone.



To configure an 8-channel audio output:

Use a chassis with HD audio module in the front panel to support 8-channel audio output.

1.10.2 Internal connectors

1. Front panel audio connector (10-1 pin AAFP)

This connector is for a chassis-mounted front panel audio I/O module that supports either HD Audio or legacy AC '97 audio standard. Connect one end of the front panel audio I/O module cable to this connector.

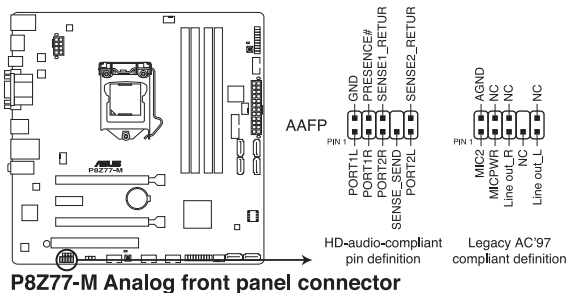

- We recommend that you connect a high-definition front panel audio module to this connector to avail of the motherboard's high-definition audio capability.
- If you want to connect a high-definition front panel audio module to this connector, set the **Front Panel Type** item in the BIOS setup to **[HD]**. If you want to connect an AC'97 front panel audio module to this connector, set the item to **[AC97]**. By default, this connector is set to **[HD]**. See section 2.5.6 **Onboard Devices Configuration** for details.

2. ATX power connectors (24-pin EATXPWR, 8-pin ATX12V)

These connectors are for ATX power supply plugs. The power supply plugs are designed to fit these connectors in only one orientation. Find the proper orientation and push down firmly until the connectors completely fit.

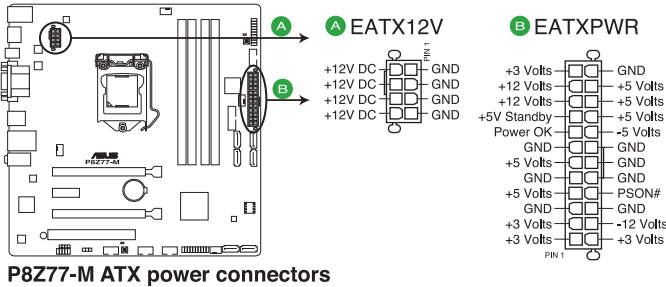

- For a fully configured system, we recommend that you use a power supply unit (PSU) that complies with ATX 12 V Specification 2.2 (or later version) and provides a minimum power of 350 W.
- DO NOT forget to connect the 8-pin ATX +12V power plug. Otherwise, the system will not boot up.
- Use of a PSU with a higher power output is recommended when configuring a system with more power-consuming devices. The system may become unstable or may not boot up if the power is inadequate.
- If you want to use two or more high-end PCI Express x16 cards, use a PSU with 1000W power or above to ensure the system stability.



- If you are uncertain about the minimum power supply requirement for your system, refer to the Recommended Power Supply Wattage Calculator at <http://support.asus.com/PowerSupplyCalculator/PSCalculator.aspx?SLanguage=en-us> for details.

PSU Suggested List

Model		
AcBel IP-500 HB9024	Delta GPS-550AB	SAMA YUHUI-350P
Antec EA-430D	DELUX-DLP-650PG	Seasonic SS-850EM
Antec EA-750	ENERMAX ERV1050EWT	Segotep SG-400PYJ
ASUS P-50GA	EnerMAX MAXREVO	Seventeam ST550EAJ-05F
ASUS U-75HA	EnerMAX EP600AWT	Seventeam ST-522HLP
AMA-AA1200U-C	EnerMAX EPM850EWT	SHARKOON SHA-R600M
Be quiet BQT L6-UA	Geil TTB800G	Silverstone SST-ST40F-ES
Bubalus PE600WJD	Gigabyte P610A-C2	Silverstone SST-ST1500
Centurystar ST-330	GoldenField ATX-S395	Snake PMW-350WL
CoolerMaster RS-850EMBA	GoldenField JHTS-S398	THERMALTAKE TP-1200AH3CSG
CoolerMaster RS-A00-ESBA	GreatWall-ATX-350P4	THERMALTAKE TR2 RX-650AL3CH
CoolerMaster-RS-C50-EMBA-D2	GreatWall-BTX-400SD	THERMALTAKE TR2 RX-750AH3CH
CoolerMaster RS-C00-80GA-D3	GreatWall BTX-500GT	THERMALTAKE TR2 RX-850AH3CH
Corsair CMPSU-450VX	HAMER MIT750	THERMALTAKE TR2-RX-1200AH3CH
Corsair CMPSU-750TX	Huntkey HK400-55AP	Thermaltake W0132RE
Corsair CMPSU-850AX	In Win COMMANDER IRP-COM1500	Thermaltake W0171
CORSAIR CMPSU-1000HX	OCZ OCZ550FTY	

3. Intel® Z77 Serial ATA 6.0 Gb/s connectors (7-pin SATA6G_1/2 [gray])

These connectors connect to Serial ATA 6.0 Gb/s hard disk drives via Serial ATA 6.0 Gb/s signal cables.

If you installed Serial ATA hard disk drives, you can create a RAID 0, 1, 5, and 10 configuration with the Intel® Rapid Storage Technology through the onboard Intel® Z77 chipset.

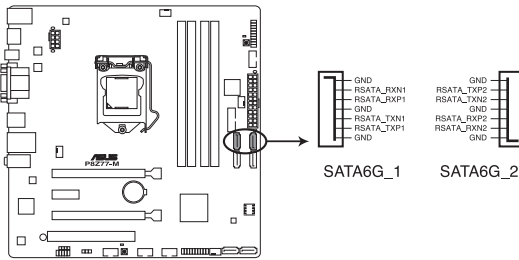

P8Z77-M Intel® SATA 6.0 Gb/s connectors

4. Intel® Z77 Serial ATA 3.0 Gb/s connectors (7-pin SATA3G_3-6 [blue])

These connectors connect to Serial ATA 3.0 Gb/s hard disk drives and optical disc drives via Serial ATA 3.0 Gb/s signal cables.

If you installed Serial ATA hard disk drives, you can create a RAID 0, 1, 5, and 10 configuration with the Intel® Rapid Storage Technology through the onboard Intel® Z77 chipset.

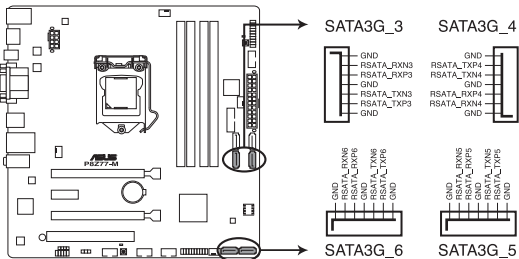

P8Z77-M Intel® SATA 3.0 Gb/s connectors



- These Serial ATA 6.0Gb/s and 3.0Gb/s connectors are set to [AHCI Mode] by default. If you intend to create a Serial ATA RAID set using these connectors, set the **SATA Mode** item in the BIOS to [RAID Mode]. Refer to section **2.5.3 SATA Configuration** for details.
- You must install Windows® XP Service Pack 3 or later versions before using Serial ATA hard disk drives. The Serial ATA RAID feature is available only if you are using Windows® XP SP3 or later versions.

5. CPU and chassis fan connectors (4-pin CPU_FAN, 4-pin CHA_FAN1-3)

Connect the fan cables to the fan connectors on the motherboard, ensuring that the black wire of each cable matches the ground pin of the connector.

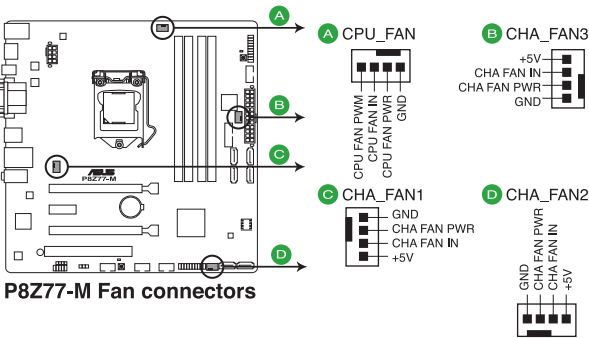

Do not forget to connect the fan cables to the fan connectors. Insufficient air flow inside the system may damage the motherboard components. These are not jumpers! Do not place jumper caps on the fan connectors!



- The CPU_FAN connector supports the CPU fan of maximum 1A (12 W) fan power.
- CPU fan (4-pin) and CHA fans (3-pin/ 4-pin) support ASUS Fan Xpert+ feature.
- If you install two VGA cards, we recommend that you plug the rear chassis fan cable to the motherboard connector labeled CHA_FAN1-3 for better thermal environment.

6. TPM connector (20-pin TPM)

This connector supports a Trusted Platform Module (TPM) system, which can securely store keys, digital certificates, passwords, and data. A TPM system also helps enhance network security, protects digital identities, and ensures platform integrity.

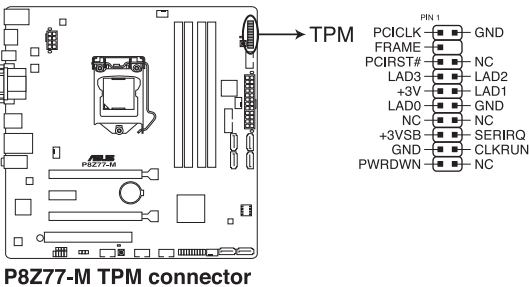

TPM module is purchased separately.

7. Serial port connectors (10-1 pin COM1)

The connector is for a serial (COM) port. Connect the serial port module cable to the connector, then install the module to a slot opening at the back of the system chassis.

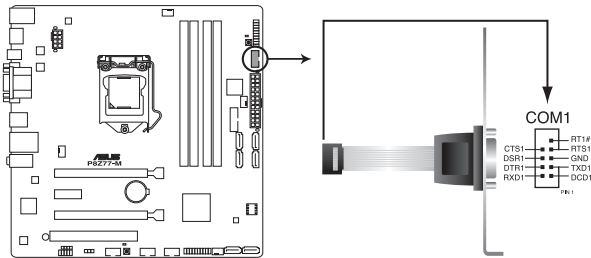

P8277-M Serial port (COM1) connector



The serial port bracket (COM1) is purchased separately.

8. USB 2.0 connectors (10-1 pin USB910; USB1112; USB1314)

These connectors are for USB 2.0 ports. Connect the USB module cable to any of these connectors, then install the module to a slot opening at the back of the system chassis. These USB connectors comply with USB 2.0 specification that supports up to 480 Mbps connection speed.

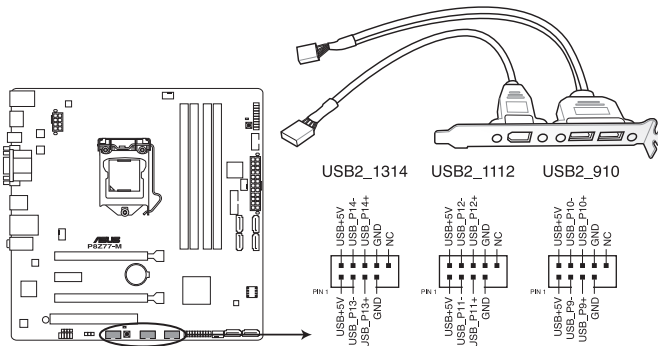

P8277-M USB2.0 connectors



Never connect a 1394 cable to the USB connectors. Doing so will damage the motherboard!



You can connect the front panel USB cable to the ASUS Q-Connector (USB, blue) first, and then install the Q-Connector (USB) to the USB connector onboard if your chassis supports front panel USB ports.



The USB 2.0 module is purchased separately.

9. Intel® Z77 USB 3.0 connectors (20-1 pin USB3_12)

This connector is for the additional USB 3.0 ports, and complies with the USB 3.0 specification that supports up to 480 Mbps connection speed. If the USB 3.0 front panel cable is available from your system chassis, with this USB 3.0 connector, you can have a front panel USB 3.0 solution.

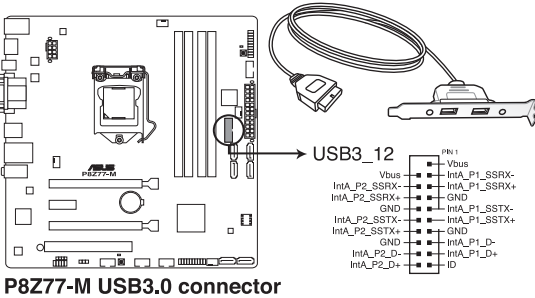

- The USB 3.0 module is purchased separately.
- The USB 3.0 ports run at USB3.0 speed on Windows 7 or later versions.

10. Digital audio connector (4-1 pin SPDIF_OUT)

This connector is for an additional Sony/Philips Digital Interface (S/PDIF) port(s). Connect the S/PDIF Out module cable to this connector, then install the module to a slot opening at the back of the system chassis.

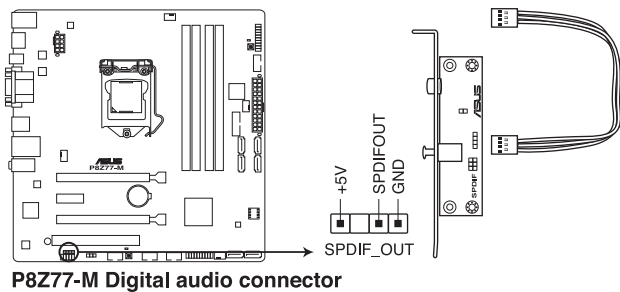

- The S/PDIF module is purchased separately.

11. System panel connector (20-8 pin PANEL)

This connector supports several chassis-mounted functions.

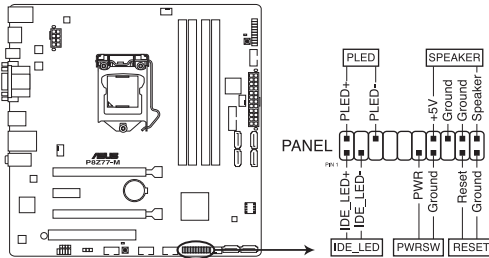

P8Z77-M System panel connector

- **System power LED (2-pin PLED)**

This 2-pin connector is for the system power LED. Connect the chassis power LED cable to this connector. The system power LED lights up when you turn on the system power, and blinks when the system is in sleep mode.

- **Hard disk drive activity LED (2-pin IDE_LED)**

This 2-pin connector is for the HDD Activity LED. Connect the HDD Activity LED cable to this connector. The IDE LED lights up or flashes when data is read from or written to the HDD.

- **System warning speaker (4-pin SPEAKER)**

This 4-pin connector is for the chassis-mounted system warning speaker. The speaker allows you to hear system beeps and warnings.

- **ATX power button/soft-off button (2-pin PWRSW)**

This connector is for the system power button. Pressing the power button turns the system on or puts the system in sleep or soft-off mode depending on the BIOS settings. Pressing the power switch for more than four seconds while the system is ON turns the system OFF.

- **Reset button (2-pin RESET)**

This 2-pin connector is for the chassis-mounted reset button for system reboot without turning off the system power.

1.11 Software support

1.11.1 Installing an operating system

This motherboard supports Windows® XP/ 64-bit XP/ 7 / 64-bit 7 operating systems (OS). Always install the latest OS version and corresponding updates to maximize the features of your hardware.



- Motherboard settings and hardware options vary. Use the setup procedures presented in this chapter for reference only. Refer to your OS documentation for detailed information.
- Ensure that you install the Windows® XP Service Pack 3 or later versions before installing the drivers for better compatibility and system stability.

1.11.2 Support DVD information

The support DVD that comes with the motherboard package contains the drivers, software applications, and utilities that you can install to avail all motherboard features.



The contents of the support DVD are subject to change at any time without notice. Visit the ASUS website at www.asus.com for updates.

To run the Support DVD

Place the support DVD into the optical drive. The DVD automatically displays the Drivers menu if Autorun is enabled in your computer. Click each menu tab and select the items you want to install.



The following screen is for reference only.

The Drivers menu shows the available device drivers if the system detects installed devices. Install the necessary drivers to use the devices.

The Make Disk menu contains items to create the RAID/AHCI driver disk.

The Manual menu contains the list of supplementary user manuals. Click an item to open the folder of the user manual.

The Utilities menu shows the applications and other software that the motherboard supports.

Click the Contact tab to display the ASUS contact information.

Click an icon to display DVD/ motherboard information.

Click an item to install



If Autorun is NOT enabled in your computer, browse the contents of the support DVD to locate the file ASSETUP.EXE from the BIN folder. Double-click the ASSETUP.EXE to run the DVD.

Chapter 2

BIOS information

2.1 Managing and updating your BIOS

The ASUS website publishes the latest BIOS versions to provide enhancements on system stability, compatibility, or performance. However, BIOS updating is potentially risky. If there is no problem using the current version of BIOS, **DO NOT manually update the BIOS**. Inappropriate BIOS updating may result in the system's failure to boot. Carefully follow the instructions of this chapter to update your BIOS if necessary.



Visit the ASUS website (www.asus.com) to download the latest BIOS file for this motherboard.

The following utilities allow you to manage and update the motherboard BIOS setup program.

1. **ASUS Update:** Updates the BIOS in Windows® environment.
2. **ASUS EZ Flash 2:** Updates the BIOS using a USB flash drive.
3. **ASUS CrashFree BIOS 3:** Restores the BIOS using the motherboard support DVD or a USB flash drive when the BIOS file fails or gets corrupted.
4. **ASUS BIOS Updater:** Updates the BIOS in DOS environment using the motherboard support DVD and a USB flash disk drive.

Refer to the corresponding sections for details on these utilities.

2.1.1 ASUS Update utility

The ASUS Update is a utility that allows you to manage, save, and update the motherboard BIOS in Windows® environment. The ASUS Update utility allows you to:

- Update the BIOS directly from the Internet
- Download the latest BIOS file from the Internet
- Update the BIOS from an updated BIOS file
- View the BIOS version information

This utility is available in the support DVD that comes with the motherboard package.



ASUS Update requires an Internet connection either through a network or an Internet Service Provider (ISP).

Launching ASUS Update

After installing AI Suite II from the motherboard support DVD, launch ASUS Update by clicking **Update > ASUS Update** on the AI Suite II main menu bar.



Quit all Windows® applications before you update the BIOS using this utility.

Updating the BIOS

To update the BIOS:

1. From the Windows® desktop, click **Start > Programs > ASUS > AI Suite II > AI Suite II** to launch the AI Suite II utility. The AI Suite II Quick Bar appears.
2. Click **Update** button from the Quick Bar, and then click **ASUS Update** from the popup menu. The **ASUS Update** main screen appears. From the list, select either of the following methods:

Updating from the Internet

- a. Select **Update BIOS from the Internet**, then click **Next**.
- b. Select the ASUS FTP site nearest you to avoid network traffic, then click **Next**.
- c. From the FTP site, select the BIOS version that you wish to download then click **Next**.



The ASUS Update utility is capable of updating itself through the Internet. Always update the utility to avail all its features.

Updating from a BIOS file

- a. Select **Update BIOS from file**, then click **Next**.
 - b. Locate the BIOS file from the **Open** window, then click **Open**.
3. Follow the onscreen instructions to complete the updating process.

2.1.2 ASUS EZ Flash 2

The ASUS EZ Flash 2 feature allows you to update the BIOS without using an OS-based utility or a bootable floppy disk.



Before you start using this utility, download the latest BIOS file from the ASUS website at www.asus.com.

To update the BIOS using EZ Flash 2:

1. Insert the USB flash disk that contains the latest BIOS file to the USB port.
2. Enter the **Advanced Mode** of the BIOS setup program. Go to the **Tool** menu to select **ASUS EZ Flash 2 Utility** and press <Enter> to enable it.
3. Press <Tab> to switch to the **Drive** field.
4. Press the Up/Down arrow keys to find the USB flash disk that contains the latest BIOS, and then press <Enter>.
5. Press <Tab> to switch to the **Folder Info** field.
6. Press the Up/Down arrow keys to find the BIOS file, and then press <Enter> to perform the BIOS update process. Reboot the system when the update process is done.



-
- This function supports USB flash disks with **FAT 32/16** format and single partition only.
 - **DO NOT** shut down or reset the system while updating the BIOS to prevent system boot failure!
-

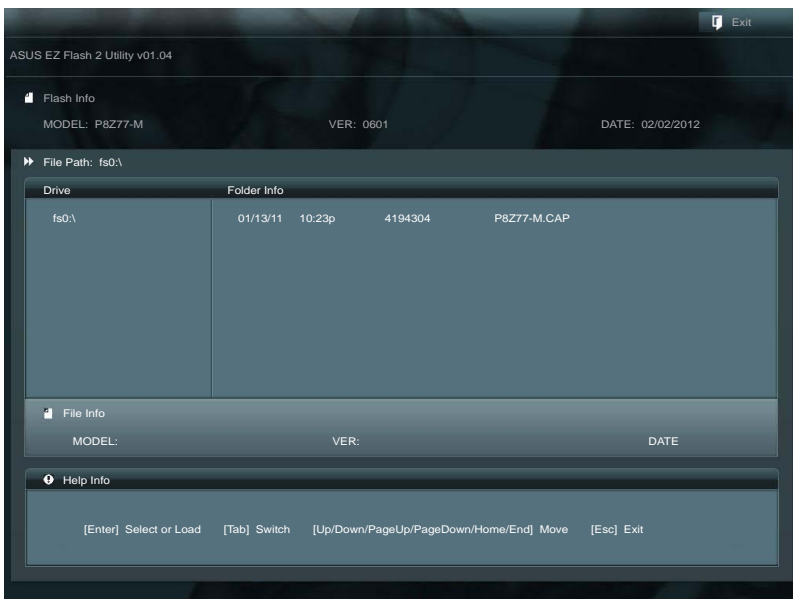

2.1.3 ASUS CrashFree BIOS 3 utility

The ASUS CrashFree BIOS 3 is an auto recovery tool that allows you to restore the BIOS file when it fails or gets corrupted during the updating process. You can restore a corrupted BIOS file using the motherboard support DVD or a USB flash drive that contains the updated BIOS file.



- Before using this utility, rename the BIOS file in the removable device into **P8Z77-M.CAP**.
- The BIOS file in the motherboard support DVD may be older than the BIOS file published on the ASUS official website. If you want to use the newer BIOS file, download the file at support.asus.com and save it to an USB flash drive.

Recovering the BIOS

To recover the BIOS:

1. Turn on the system.
2. Insert the support DVD to the optical drive or the USB flash drive that contains the BIOS file to the USB port.
3. The utility automatically checks the devices for the BIOS file. When found, the utility reads the BIOS file and enters ASUS EZ Flash 2 utility automatically.
4. The system requires you to enter BIOS Setup to recover BIOS setting. To ensure system compatibility and stability, we recommend that you press <F5> to load default BIOS values.



DO NOT shut down or reset the system while updating the BIOS! Doing so can cause system boot failure!

2.1.4 ASUS BIOS Updater

The ASUS BIOS Updater allows you to update BIOS in DOS environment. This utility also allows you to copy the current BIOS file that you can use as a backup when the BIOS fails or gets corrupted during the updating process.



The succeeding utility screens are for reference only. The actual utility screen displays may not be same as shown.

Before updating BIOS

1. Prepare the motherboard support DVD and a USB flash drive in FAT32/16 format and single partition.
2. Download the latest BIOS file and BIOS Updater from the ASUS website at <http://support.asus.com> and save them on the USB flash drive.



- NTFS is not supported under DOS environment. Do not save the BIOS file and BIOS Updater to a hard disk drive or USB flash drive in NTFS format.
- Do not save the BIOS file to a floppy disk due to low disk capacity.

3. Turn off the computer and disconnect all SATA hard disk drives (optional).

Booting the system in DOS environment

1. Insert the USB flash drive with the latest BIOS file and BIOS Updater to the USB port.
2. Boot your computer. When the ASUS Logo appears, press <F8> to show the **BIOS Boot Device Select Menu**. Insert the support DVD into the optical drive and select the optical drive as the boot device.

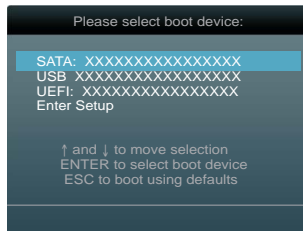

3. When the **Make Disk** menu appears, select the **FreeDOS command prompt** item by pressing the item number.
4. At the FreeDOS prompt, type **d:** and press <Enter> to switch the disk from Drive C (optical drive) to Drive D (USB flash drive).

```
Welcome to FreeDOS (http://www.freedos.org)!  
C:\>d:  
D:\>
```

Updating the BIOS file

To update the BIOS file using BIOS Updater

1. At the FreeDOS prompt, type `bupdater /pc /g` and press <Enter>.

```
D:\>bupdater /pc /g
```

2. The BIOS Updater screen appears as below.

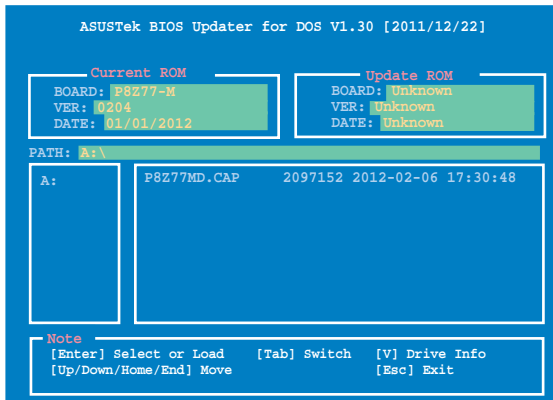

3. Press <Tab> to switch between screen fields and use the <Up/Down/Home/End> keys to select the BIOS file and press <Enter>. BIOS Updater checks the selected BIOS file and prompts you to confirm BIOS update.



4. Select **Yes** and press <Enter>. When BIOS update is done, press <ESC> to exit BIOS Updater. Restart your computer.



DO NOT shut down or reset the system while updating the BIOS to prevent system boot failure!



- For BIOS Updater version 1.30 or later, the utility automatically exits to the DOS prompt after updating BIOS.
- Ensure to load the BIOS default settings to ensure system compatibility and stability. Select the **Load Optimized Defaults** item under the **Exit BIOS** menu.
- Ensure to connect all SATA hard disk drives after updating the BIOS file if you have disconnected them.

2.2 BIOS setup program

A BIOS setup program is provided for BIOS item modification. When you start up the computer, the system provides you with the opportunity to run this program. Press during the Power-On Self-Test (POST) to enter the Setup utility. Otherwise, POST continues with its test routines.

If you wish to enter Setup after POST, press <Ctrl> + <Alt> + <Delete>, or press the reset button on the system chassis to restart the system. You can also turn the system off and then turn it back on to restart the system. Do this last option only if the first two failed.



-
- The BIOS setup screens shown in this section are for reference purposes only, and may not exactly match what you see on your screen.
 - If the system becomes unstable after changing any BIOS setting, load the default settings to ensure system compatibility and stability. Select the **Load Optimized Defaults** item under the **Exit** menu. See section **2.9 Exit Menu** for details.
 - If the system fails to boot after changing any BIOS setting, try to clear the CMOS and reset the motherboard to the default value. See section **1.9 Jumpers** for information on how to erase the RTC RAM.
-

The BIOS setup program is designed to make it as easy to use as possible. Being a menu-driven program, it lets you scroll through the various submenus and select from the available options using a keyboard or a USB mouse.

The BIOS setup program can be used under two modes: **EZ Mode** and **Advanced Mode**. You can change modes from the **Exit** menu or from the **Exit/Advanced Mode** button in the **EZ Mode/Advanced Mode** screen.

2.2.1 EZ Mode

By default, the EZ Mode screen appears when you enter the BIOS setup program. The EZ Mode provides you an overview of the basic system information, and allows you to select the display language, system performance mode and boot device priority. To access the Advanced Mode, click **Exit/Advanced Mode**, then select **Advanced Mode** or press F7 hot key for the advanced BIOS settings.



The default screen for entering the BIOS setup program can be changed. Refer to the **Setup Mode** item in section 2.7 **Boot menu** for details.

Exits the BIOS setup program without saving the changes, saves the changes and resets the system, or enters the Advanced Mode

Displays the CPU/motherboard temperature, CPU/5V/3.3V/12V voltage output, CPU/chassis/power fan speed

Selects the display language of the BIOS setup program

ASUS UEFI BIOS Utility - EZ Mode

14:13

Friday 02/10/2012

P8Z77-M
BIOS Version : 0601
CPU Type : Intel (R) Core(TM) i7-2700K CPU @ 3.50GHz
Speed : 3506 MHz
Total Memory : 2048 MB (DDR3 1333MHz)

English

Exit/Advanced Mode

Temperature

CPU	+105.8°F/+41.0°C
MB	+93.2°F/+34.0°C

Voltage

CPU	1.104V	5V	5.040V
3.3V	3.360V	12V	11.994V

Fan Speed

CPU_FAN	4873RPM	CHA_FAN1	N/A
CHA_FAN2	N/A	CHA_FAN3	N/A

System Performance

Quiet | Performance | Energy Saving | Normal | ASUS Optimal mode

Boot Priority

Use the mouse to drag or keyboard to navigate to decide the boot priority.

Boot Menu(F8) | Default(F5)

Selects the boot device priority

Displays the system properties of the selected mode on the right hand side

Power Saving mode

Normal mode

ASUS Optimal mode

Selects the boot device priority



- The boot device options vary depending on the devices you installed to the system.
- The **Boot Menu(F8)** button is available only when the boot device is installed to the system.

2.2.2 Advanced Mode

The **Advanced Mode** provides advanced options for experienced end-users to configure the BIOS settings. The figure below shows an example of the **Advanced Mode**. Refer to the following sections for the detailed configurations.



To access the EZ Mode, click **Exit**, then select **ASUS EZ Mode**.

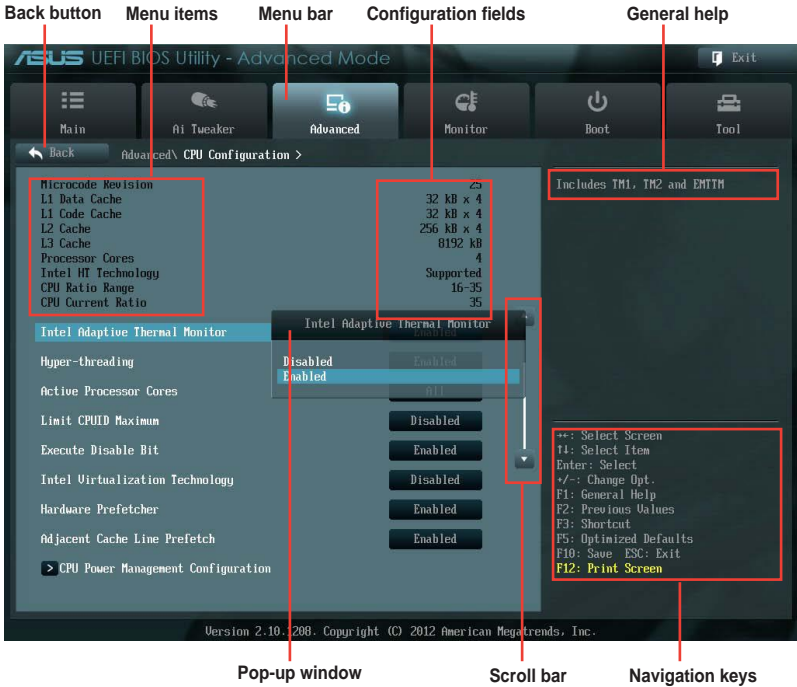

Menu bar

The menu bar on top of the screen has the following main items:

Main	For changing the basic system configuration
Ai Tweaker	For changing the overclocking settings
Advanced	For changing the advanced system settings
Monitor	For displaying the system temperature, power status, and changing the fan settings
Boot	For changing the system boot configuration
Tool	For configuring options for special functions
Exit	For selecting the exit options and loading default settings

Menu items

The highlighted item on the menu bar displays the specific items for that menu. For example, selecting **Main** shows the Main menu items.

The other items (Ai Tweaker, Advanced, Monitor, Boot, Tool, and Exit) on the menu bar have their respective menu items.

Back button

This button appears when entering a submenu. Press <Esc> or use the USB mouse to click this button to return to the previous menu screen.

Submenu items

A greater than sign (>) before each item on any menu screen means that the item has a submenu. To display the submenu, select the item and press <Enter>.

Pop-up window

Select a menu item and press <Enter> to display a pop-up window with the configuration options for that item.

Scroll bar

A scroll bar appears on the right side of a menu screen when there are items that do not fit on the screen. Press the Up/Down arrow keys or <Page Up> / <Page Down> keys to display the other items on the screen.

Navigation keys

At the bottom right corner of the menu screen are the navigation keys for the BIOS setup program. Use the navigation keys to select items in the menu and change the settings.

General help

At the top right corner of the menu screen is a brief description of the selected item.

Configuration fields

These fields show the values for the menu items. If an item is user-configurable, you can change the value of the field opposite the item. You cannot select an item that is not user-configurable.

A configurable field is highlighted when selected. To change the value of a field, select it and press <Enter> to display a list of options.

2.3 Main menu

The Main menu screen appears when you enter the Advanced Mode of the BIOS Setup program. The Main menu provides you an overview of the basic system information, and allows you to set the system date, time, language, and security settings.

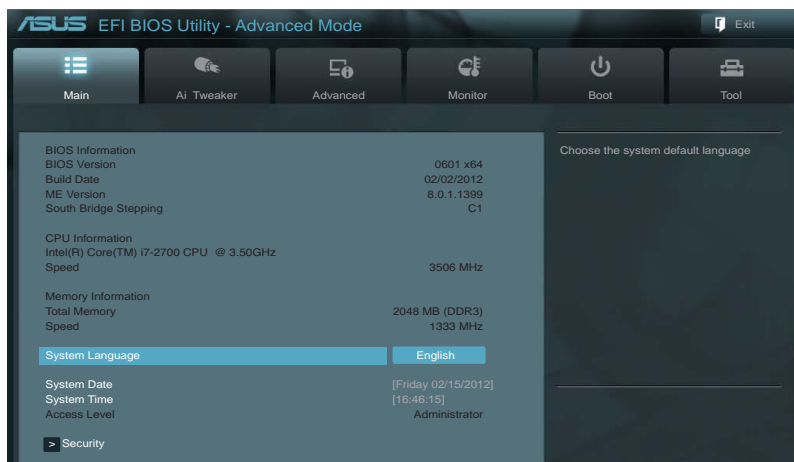

2.3.1 System Language [English]

Allows you to choose the BIOS language version from the options. Configuration options:

[English] [Français] [Español] [Deutsch] [Русский] [日本語] [繁體中文][简体中文]

2.3.2 System Date

Allows you to set the system date.

2.3.3 System Time

Allows you to set the system time.

2.3.4 Security

The Security menu items allow you to change the system security settings.



- If you have forgotten your BIOS password, erase the CMOS Real Time Clock (RTC) RAM to clear the BIOS password. See section 1.9 Jumpers for information on how to erase the RTC RAM.
- The **Administrator** or **User Password** items on top of the screen show the default **Not Installed**. After you set a password, these items show **Installed**.

Administrator Password

If you have set an administrator password, we recommend that you enter the administrator password for accessing the system. Otherwise, you might be able to see or change only selected fields in the BIOS setup program.

To set an administrator password:

1. Select the **Administrator Password** item and press <Enter>.
2. From the **Create New Password** box, key in a password, then press <Enter>.
3. Confirm the password when prompted.

To change an administrator password:

1. Select the **Administrator Password** item and press <Enter>.
2. From the **Enter Current Password** box, key in the current password, then press <Enter>.
3. From the **Create New Password** box, key in a new password, then press <Enter>.
4. Confirm the password when prompted.

To clear the administrator password, follow the same steps as in changing an administrator password, but press <Enter> when prompted to create/confirm the password. After you clear the password, the **Administrator Password** item on top of the screen shows **Not Installed**.

User Password

If you have set a user password, you must enter the user password for accessing the system. The **User Password** item on top of the screen shows the default **Not Installed**. After you set a password, this item shows **Installed**.

To set a user password:

1. Select the **User Password** item and press <Enter>.
2. From the **Create New Password** box, key in a password, then press <Enter>.
3. Confirm the password when prompted.

To change a user password:

1. Select the **User Password** item and press <Enter>.
2. From the **Enter Current Password** box, key in the current password, then press <Enter>.
3. From the **Create New Password** box, key in a new password, then press <Enter>.
4. Confirm the password when prompted.

To clear the user password, follow the same steps as in changing a user password, but press <Enter> when prompted to create/confirm the password. After you clear the password, the **User Password** item on top of the screen shows **Not Installed**.

2.4 Ai Tweaker menu

The Ai Tweaker menu items allow you to configure overclocking-related items.



Be cautious when changing the settings of the Ai Tweaker menu items. Incorrect field values can cause the system to malfunction.



The configuration options for this section vary depending on the CPU and DIMM model you installed on the motherboard.

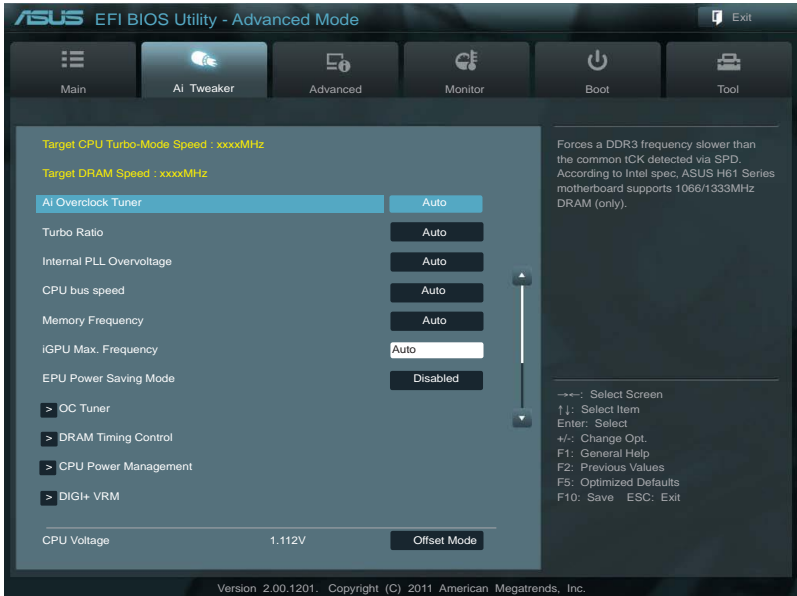

Scroll down to display the following items:

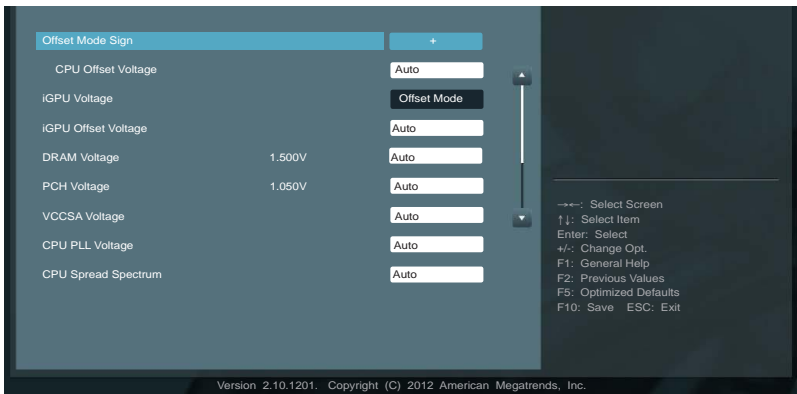

Target CPU Turbo-Mode Speed : xxxxMHz

Displays the current CPU turbo-mode speed.

Target DRAM Speed : xxxxMHz

Displays the current DRAM speed.

2.4.1 Ai Overclock Tuner [Auto]

Allows you to select the CPU overclocking options to achieve the desired CPU internal frequency. Select any of these preset overclocking configuration options:

- [Auto] Loads the optimal settings for the system.
- [Manual] Allows you to individually set overclocking parameters.
- [X.M.P.] If you install memory modules supporting the eXtreme Memory Profile (X.M.P.) Technology, choose this item to set the profiles supported by your memory modules for optimizing the system performance.

BCLK/PEG Frequency [100.0]

Allows you to adjust the CPU and VGA frequency to enhance the system performance. Use the <+> and <-> keys to adjust the value. You can also key in the desired value using the numeric keypad. The values range from 80.0MHz to 300.0MHz.

eXtreme Memory Profile [High Performance]

This item appears only when you set the **Ai Overclock Tuner** item to [X.M.P.] and allows you to select the X.M.P. mode supported by your memory module.

Configuration options: [Disabled] [Profile #1] [Profile #2]

Turbo Ratio [By All Cores]

Allows you to manually adjust the Turbo CPU ratio.

- [Auto] All Turbo ratio are set by Intel CPU default settings.
- [By ALL Cores (Can Adjust in OS)] All numbers of active cores will be set to one single Turbo ratio in OS.
- [By Per Core (Cannot Adjust in OS)] All numbers of active cores can be set to an individual Turbo ratio in BIOS.

By ALL Cores (Can Adjust in OS) [Auto]

This item appears only when you set the **Turbo Ratio** item to [By ALL Cores (Can Adjust in OS)]. Use the <+> and <-> keys to adjust the value.

1-/2-/3-/4-Core Ratio Limit [Auto]

This item appears only when you set the **Turbo Ratio** item to [By Per Core (Cannot Adjust in OS)]. Use the <+> and <-> keys to adjust the value.



Options may vary with CPU type. When using Intel 3rd Generation Core Processor, options may appear as below.

Turbo Ratio [Auto]

Allows you to manually adjust the Turbo CPU ratio.

- [Auto] All Turbo ratio are set by Intel CPU default settings.
- [Manual] Allows you to manually set a Turbo Ratio for every core activation of a fully unlocked CPU.



The following items appear when you set **Turbo Ratio** to [Manual].

Ratio Synchronizing Control [Disabled]

Allows you to set Turbo Ratio for each or all core-activating conditions.

[Disabled] Sets one single Turbo Ratio for all core activations.

[Enabled] Sets an individual Turbo Ratio for every core activation.

1-Core Ratio Limit [Auto]

Allows you to assign core ratio values. Use the <+> and <-> keys to adjust the value from 35 to 59.

2-Core Ratio Limit [Auto]

Allows you to assign core ratio values. Use the <+> and <-> keys to adjust the value from 35 to 59.

3-Core Ratio Limit [Auto]

Allows you to assign core ratio values. Use the <+> and <-> keys to adjust the value from 35 to 59.

4-Core Ratio Limit [Auto]

Allows you to assign core ratio values. Use the <+> and <-> keys to adjust the value from 35 to 59.

Internal PLL Overvoltage [Auto]

Allows you to set the Internal PLL Overvoltage.

Configuration options: [Auto] [Enabled] [Disabled]

CPU bus speed: DRAM speed ratio mode [Auto]

Allows you to set the CPU bus speed to DRAM speed ratio mode.

Configuration options: [Auto] [100:100] [100:133]

Memory Frequency [Auto]

Allows you to set the memory operating frequency. The configuration options vary with the **BCLK/PCIE Frequency** item settings.



Selecting a very high memory frequency may cause the system to become unstable! If this happens, revert to the default setting.

iGPU Max. Frequency [Auto]

Allows you to configure the iGPU frequency. Use the <+> and <-> keys to adjust the value.

The values range from 1350MHz to 3000MHz with a 50MHz interval.

EPU Power Saving Mode [Disabled]

Allows you to enable or disable the EPU power saving function.

Configuration options: [Disabled] [Enabled]

EPU Setting [Auto]

This item appears only when you set the **EPU Power Saving Mode** item to [Enabled.] and allows you to select the EPU power saving mode.

Configuration options: [Auto] [Light Power Saving Mode] [Medium Power Saving Mode] [Max Power Saving Mode]

2.4.2 OC Tuner

OC Tuner automatically overclocks the frequency and voltage of CPU and DRAM for enhancing the system performance. Configuration options: [OK] [Cancel]

2.4.3 DRAM Timing Control

The sub-items in this menu allow you to set the DRAM timing control features. Use the <+> and <-> keys to adjust the value. To restore the default setting, type [auto] using the keyboard and press the <Enter> key.



Changing the values in this menu may cause the system to become unstable! If this happens, revert to the default settings.

2.4.4 CPU Power Management

The sub-items in this menu allow you to set the CPU ratio and features.

CPU Ratio [Auto]

Allows you to manually adjust the maximum non-turbo CPU ratio. Use <+> and <-> keys or the numeric keypad to adjust the ratio. The valid value ranges vary according to your CPU model.

Enhanced Intel SpeedStep Technology [Enabled]

Allows you to enable or disable the Enhanced Intel® SpeedStep Technology (EIST).

[Disabled] Disables this function.

[Enabled] The operating system dynamically adjusts the processor voltage and core frequency which may result in decreased average consumption and decrease average heat production.

Turbo Mode [Enabled]

[Enabled] Allows processor cores to run faster than marked frequency in specific conditions.

[Disabled] Disables this function.



The following three items appear only when you set both the **Enhanced Intel® SpeedStep Technology** and **Turbo Mode** items to [Enabled].

Long Duration Power Limit [Auto]

Use the <+> and <-> keys to adjust the value.

Long Duration Maintained [Auto]

Use the <+> and <-> keys to adjust the value.

Short Duration Power Limit [Auto]

Use the <+> and <-> keys to adjust the value.

Primary Plane Current Limit [Auto]

Maximum instantaneous current allowed at any given time for CPU cores

Use <+> and <-> key to adjust the value at 0.125A increment.

Secondary Plane Current Limit [Auto]

Maximum instantaneous current allowed at any given time for Internal Graphics cores.

Use <+> and <-> key to adjust the value at 0.125A increment.

2.4.5 DIGI+ VRM

CPU Load-Line Calibration [Auto]

Load-line is defined by Intel VRM spec and affects CPU voltage. The CPU working voltage will decrease proportionally to CPU loading. Higher value gets a higher voltage and better overclocking performance, but increases the CPU and VRM thermal. This item allows you to adjust the voltage range from the following percentages to boost the system performance: 0% (Regular), 25% (Medium), 50% (High), 75% (Ultra High) and 100% (Extreme).

Configuration options: [Auto] [Regular] [Medium] [High] [Ultra High] [Extreme]



The actual performance boost may vary depending on your CPU specification.

CPU Voltage Frequency [Auto]

Frequency switching affects the VRM transient response, and the thermal component. Higher frequency gets quicker transient response.

Configuration options: [Auto] [Manual]



DO NOT remove the thermal module when switching to Manual Mode. The thermal conditions should be monitored.

CPU Power Phase Control [Standard]

Allows you to control the power phase based on the CPU's demands.

Configuration options: [Standard] [Optimized] [Extreme] [Manual Adjustment]



DO NOT remove the thermal module when switching to Extreme and Manual Mode. The thermal conditions should be monitored.

CPU Power Duty Control [T.Probe]

DIGI + VRM Duty control adjusts the current and thermal conditions of every component's phase.

Configuration options: [T. Probe] - Select to maintain the VRM thermal balance.
[Extreme] - Select to maintain the current VRM balance.

CPU Current Capability [100%]

Allows you to configure the total power range, and extends the overclocking frequency range simultaneously.

Configuration options: [100%] [110%] [120%]



Choose a higher value when overclocking, or under a high CPU loading for extra power support.

CPU Power Thermal Control [125]

Allows you to adjust CPU power thermal range and extend the overclocking tolerance to enlarge O.C. potential.

[+] To offset the voltage by a positive value.

[-] To offset the voltage by a negative value.

iGPU Load-line Calibration [Auto]

Allows you to set the iGPU Load-line Calibration.

Configuration options: [Auto] [Regular] [High] [Extreme]

iGPU Current Capability [100%]

Allows you to set the iGPU Current Capability.

Configuration options: [100%] [110%] [120%]



Do not remove the thermal module while changing the DIGI+ VRM related parameters . The thermal conditions should be monitored.

2.4.6 CPU Voltage [Offset Mode]

[Manual Mode] Allows you to set a fixed CPU voltage.

[Offset Mode] Allows you to set the Offset voltage.

Offset Mode Sign [+]

This item appears only when you set the **CPU Voltage** item to [Offset Mode].

- [+] To offset the voltage by a positive value.
- [-] To offset the voltage by a negative value.

CPU Offset Voltage [Auto]

This item appears only when you set the **CPU Voltage** item to [Offset Mode] and allows you to set the Offset voltage. The values range from 0.005V to 0.635V with a 0.005V interval.

iGPU Voltage [Offset Mode]

- [Manual Mode] Allows you to set a fixed iGPU voltage.
- [Offset Mode] Allows you to set the offset voltage.

iGPU Offset Voltage [Auto]

Allows you to set the iGPU Offset voltage. The values range from 0.005V to 0.635V with a 0.005V interval.

DRAM Voltage [Auto]

Allows you to set the DRAM voltage. The values range from 1.200V to 2.135V with a 0.005V interval.



According to Intel CPU spec, DIMMs with voltage requirement over 1.65V may damage the CPU permanently. We recommend you install the DIMMs with the voltage requirement below 1.65V.

PCH Voltage [Auto]

Allows you to set the Platform Controller Hub voltage. The values range from 0.80V to 1.685V with a 0.005V interval.



- The values of the CPU Manual Voltage, CPU Offset Voltage, DRAM Voltage, VCCSA Voltage, VCCIO Voltage, and PCH Voltage items are labeled in different color, indicating the risk levels of high voltage settings.
 - The system may need better cooling system to work stably under high voltage settings.
-

VCCSA Voltage [Auto]

Allows you to set the VCCIO voltage. The values range from 0.925V to 1.025V with a 0.1V interval.

CPU PLL Voltage [Auto]

Allows you to set the CPU and PCH PLL voltage. The values range from 1.80V to 1.90V with a 0.1V interval.

CPU Spread Spectrum [Auto]

- [Auto] Automatic configuration.
- [Disabled] Enhances the BCLK overlocking ability.
- [Enabled] Sets to [Enabled] for EMI control.

2.5 Advanced menu

The Advanced menu items allow you to change the settings for the CPU and other system devices.



Be cautious when changing the settings of the Advanced menu items. Incorrect field values can cause the system to malfunction.

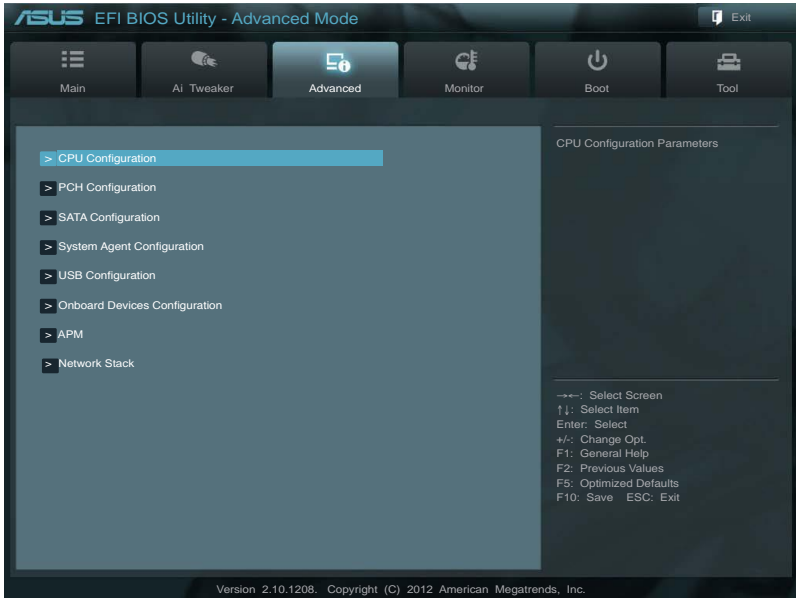

2.5.1 CPU Configuration

The items in this menu show the CPU-related information that the BIOS automatically detects.



The items shown in submenu may be different due to the CPU you installed.

Intel Adaptive Thermal Monitor [Enabled]

[Enabled] Enables the overheated CPU to throttle its clock speed to cool down.

[Disabled] Disables the CPU thermal monitor function.

Hyper-threading [Enabled]

The Intel Hyper-Threading Technology allows a hyper-threading processor to appear as two logical processors to the operating system, allowing the operating system to schedule two threads or processes simultaneously.

[Enabled] Two threads per activated core are enabled.

[Disabled] Only one thread per activated core is enabled.

Active Processor Cores [All]

Allows you to choose the number of CPU cores to activate in each processor package.
Configuration options: [All] [1] [2] [3]

Limit CPUID Maximum [Disabled]

[Enabled] Allows legacy operating systems to boot even without support for CPUs with extended CPUID functions.

[Disabled] Disables this function.

Execute Disable Bit [Enabled]

[Enabled] Enables the No-Execution Page Protection Technology.

[Disabled] Forces the XD feature flag to always return to zero (0).

Intel Virtualization Technology [Disabled]

[Enabled] Allows a hardware platform to run multiple operating systems separately and simultaneously, enabling one system to virtually function as several systems.

[Disabled] Disables this function.

Hardware Prefetcher [Enabled]

[Enabled] Allows a hardware platform to run multiple operating systems separately and simultaneously, enabling one system to virtually function as several systems.

[Disabled] Disables this function.

Adjacent Cache Line Prefetch [Enabled]

[Enabled] Allows a hardware platform to perform adjacent cache line prefetching.

[Disabled] Disables this function.

CPU Power Management Configuration

CPU Ratio [Auto]

Allows you to set the ratio between the CPU Core Clock and the BCLK Frequency. Use <+> and <-> keys to adjust the ratio. The valid value ranges vary according to your CPU model.

Enhanced Intel SpeedStep Technology [Enabled]

Allows you to enable or disable the Enhanced Intel® SpeedStep Technology (EIST).

[Disabled] The CPU runs at its default speed.

[Enabled] The operating system controls the CPU speed.

Turbo Mode [Enabled]

Allows you to set the processor cores to run faster than the marked frequency in a specific condition.

Configuration options: [Enabled] [Disabled]



This item appears only when you set the EIST to [Enabled], and allows you to enable or disable the Intel® Turbo Mode Technology.

CPU C1E [Auto]

[Enabled] Enables the C1E support function. This function must be enabled to enable or disable the Intel® Turbo Mode Technology.

[Disabled] Disables the function.

CPU C3 Report [Auto]

Allows you to disable or enable the CPU C3 report to OS.

CPU C6 Report [Auto]

Allows you to disable or enable the CPU C6 report to OS.

2.5.2 PCH Configuration

High Precision Timer [Enabled]

Allows you to enable or disable the High Precision Event Timer.

Configuration options: [Enabled] [Disabled]

Intel(R) Rapid Start Technology [Disabled]

Allows you to enable or disable Intel(R) Rapid Start Technology.

Configuration options: [Enabled] [Disabled]

Intel(R) Smart Connect Technology [Disabled]

ISCT Configuration [Disabled]

Allows you to enable or disable ISCT Configuration.

Configuration options: [Enabled] [Disabled]

2.5.3 SATA Configuration

While entering Setup, the BIOS automatically detects the presence of SATA devices. The SATA Port items show **Not Present** if no SATA device is installed to the corresponding SATA port.

SATA Mode Selection [AHCI Mode]

Allows you to set the SATA configuration.

- [IDE] Set to [IDE] when you want to use the Serial ATA hard disk drives as Parallel ATA physical storage devices.
- [AHCI] Set to [AHCI] when you want the SATA hard disk drives to use the AHCI (Advanced Host Controller Interface). The AHCI allows the onboard storage driver to enable advanced Serial ATA features that increases storage performance on random workloads by allowing the drive to internally optimize the order of commands.
- [RAID] Set to [RAID] when you want to create a RAID configuration from the SATA hard disk drives.

S.M.A.R.T. Status Check [Enabled]

S.M.A.R.T. (Self-Monitoring, Analysis and Reporting Technology) is a monitor system. When read/write of your hard disk errors occur, this feature allows the hard disk to report warning messages during the POST.

Configuration options: [Enabled] [Disabled]

Hot Plug [Disabled]

These items appear only when you set the **SATA mode** item to [AHCI Mode] or [RAID Mode], and allow you to enable/disable SATA Hot Plug Support.

Configuration options: [Disabled] [Enabled]

2.5.4 System Agent Configuration

Memory Remap Feature [Enabled]

[Enabled] Allow you to enable remapping the memory above 4GB.

[Disabled] Disables this function.

Graphics Configuration

Primary Display [Auto]

Allows you to select a primary display from iGPU, PCIe, or PCI graphic devices.
Configuration options: [Auto] [iGPU] [PCIe][PCI]

iGPU Memory [64M]

This item selects DVMT 5.0 pre-allocated graphic memory size, used by the internal graphic device.
Configuration options: [32M] [64M] [96M]~[1024M]

Render Standby [Enabled]

Allows you to enable or disabled render standby support.
Configuration options: [Disabled] [Enabled]

iGPU Multi-Monitor [Disabled]

Allows you to enable the iGPU Multi-Monitor. For Lucid Virtu MVP function supports, set this item to [Enabled] to empower both integrated and discrete graphics. iGPU shared system memory size is fixed in 64MB
Configuration options: [Disabled] [Enabled]

NB PCIe Configuration

Allows you to configure the NB PCI Express settings.

PCIEX16_1 Link Speed [Auto]

Allows you to configure the PCIEX16_1 speed.
Configuration options: [Auto] [Gen1] [Gen2]

2.5.5 USB Configuration

The items in this menu allow you to change the USB-related features.



The **USB Devices** item shows the auto-detected values. If no USB device is detected, the item shows **None**.

Legacy USB Support [Enabled]

- [Enabled] Enables the support for USB devices on legacy operating systems (OS).
- [Disabled] The USB devices can be used only for the BIOS setup program.
- [Auto] Allows the system to detect the presence of USB devices at startup. If detected, the USB controller legacy mode is enabled. If no USB device is detected, the legacy USB support is disabled.

Legacy USB3.0 Support [Enabled]

- [Enabled] Enables the support for USB 3.0 devices on legacy operating systems (OS).
- [Disabled] Disables the function.

Intel xHCI Mode [Smart Auto]

- [Smart Auto] Enables optimized xHCI.
- [Auto] Allows the system to set the xHCI.
- [Enabled] Enables the operation of xHCI controller.
- [Disabled] Disables the function.

EHCI Hand-off [Disabled]

- [Enabled] Enables the support for operating systems without an EHCI hand-off feature.
- [Disabled] Disables the function.

2.5.6 Onboard Devices Configuration

HD Audio Controller [Enabled]

- [Enabled] Enables the High Definition Audio Controller.
[Disabled] Disables the controller.



The following item appears only when you set the **HD Audio Controller** item to [Enabled].

Front Panel Type [HD]

Allows you to set the front panel audio connector (AAFP) mode to legacy AC'97 or high-definition audio depending on the audio standard that the front panel audio module supports.

- [HD] Sets the front panel audio connector (AAFP) mode to high definition audio.
[AC97] Sets the front panel audio connector (AAFP) mode to legacy AC'97.

SPDIF Out Type [SPDIF]

- [SPDIF] Sets to [SPDIF] for SPDIF audio output.
[HDMI] Sets to [HDMI] for HDMI audio output.

Realtek LAN Controller [Enabled]

- [Enabled] Enables the Realtek LAN controller.
[Disabled] Disables the controller.

Realtek PXE OPROM [Disabled]

This item appears only when you set the previous item to [Enabled] and allows you to enable or disable the PXE OptionRom of the Realtek LAN controller.

Configuration options: [Enabled] [Disabled]

Serial Port Configuration

The sub-item in this menu allow you to set the serial port configuration.



This item functions only if there is a serial port (COM1) connector on the motherboard.

Serial Port [Enabled]

Allows you to enable or disable the serial port (COM).

Configuration options: [Enabled][Disabled]

Change Settings [IO=3F8h; IRQ=4]

Allows you to select the Serial Port base address.

Configuration options: [IO=3F8h; IRQ=4][IO=2F8h; IRQ=3][IO=3E8h; IRQ=4][IO=2E8h; IRQ=3]

2.5.7 APM

ErP Ready [Disabled]

This item allows user to switch off some power at S5 to get the system ready for ErP requirement. When set enabled to Enabled, all other PME options will be switched off.

Configuration options: [Disabled] [Enabled]

Restore AC Power Loss [Power Off]

- [Power On] The system goes into on state after an AC power loss.
- [Power Off] The system goes into off state after an AC power loss.
- [Last State] The system goes into either off or on state, whatever the system state was before the AC power loss.

Power On By PS/2 Keyboard [Disabled]

This item allows you to set the specific button of the keyboard to power on the system.
Configuration options: [Disabled] [Space Bar] [Ctrl-Esc] [Power Key]

Power On By PCIE/PCI [Disabled]

- [Disabled] Disables the PCIE/PCI devices to generate a wake-on-LAN feature of the Intel/Realtek LAN device.
- [Enabled] Enables the PCIE/PCI devices to generate a wake-on-LAN feature of the Intel/Realtek LAN device.

Power On By Ring [Disabled]

- [Disabled] Disables the Ring devices to generate a wake-on-LAN feature of the Intel/Realtek LAN device.
- [Enabled] Enables the Ring devices to generate a wake-on-LAN feature of the Intel/Realtek LAN device.

Power On By RTC [Disabled]

- [Disabled] Disables RTC to generate a wake event.
- [Enabled] When set to [Enabled], the items **RTC Alarm Date (Days)** and **Hour/Minute/Second** will become user-configurable with set values.

2.5.8 Network stack [Disabled Link]

This item allows you to enable/ disable UEFI network stack funtion.
Configuration options: [Disabled Link] [Enabled]

2.6 Monitor menu

The Monitor menu displays the system temperature/power status, and allows you to change the fan settings.

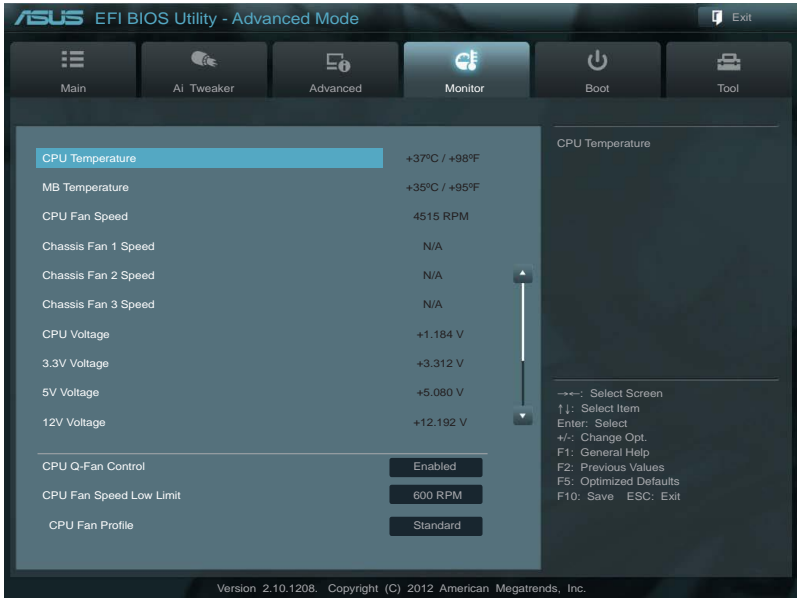

Scroll down to display the following items:



CPU Temperature / MB Temperature [xxx°C/xxx°F]

The onboard hardware monitor automatically detects and displays the CPU and motherboard temperatures. Select **Ignore** if you do not wish to display the detected temperatures.

CPU / Chassis1/3 Fan Speed [xxxx RPM] or [Ignore] / [N/A]

The onboard hardware monitor automatically detects and displays the CPU and chassis fan 1/2/3 speeds in rotations per minute (RPM). If the fan is not connected to the motherboard, the field shows **N/A**. Select **Ignore** if you do not wish to display the detected speed.

CPU Voltage, 3.3V Voltage, 5V Voltage, 12V Voltage

The onboard hardware monitor automatically detects the voltage output through the onboard voltage regulators. Select **Ignore** if you do not want to detect this item.

CPU Q-Fan Control [Enabled]

[Disabled] Disables the CPU Q-Fan control feature.

[Enabled] Enables the CPU Q-Fan control feature.

CPU Fan Speed Low Limit [600 RPM]

This item appears only when you enable the **CPU Q-Fan Control** feature and allows you to disable or set the CPU fan warning speed. Configuration options: [Ignore] [200 RPM] [300 RPM] [400 RPM] [500 RPM] [600 RPM]

CPU Fan Profile [Standard]

This item appears only when you enable the **CPU Q-Fan Control** feature and allows you to set the appropriate performance level of the CPU fan.

[Standard] Sets to [Standard] to make the CPU fan automatically adjust depending on the CPU temperature.

[Silent] Sets to [Silent] to minimize the fan speed for quiet CPU fan operation.

[Turbo] Sets to [Turbo] to achieve maximum CPU fan speed.

[Manual] Sets to [Manual] to assign detailed fan speed control parameters.



The following four items appear only when you set **CPU Fan Profile** to [Manual].

CPU Upper Temperature [70]

Use the <+> and <-> keys to adjust the upper limit of the CPU temperature. The values range from 20°C to 75°C.

CPU Fan Max. Duty Cycle(%) [100]

Use the <+> and <-> keys to adjust the maximum CPU fan duty cycle. The values range from 20% to 100%. When the CPU temperature reaches the upper limit, the CPU fan will operate at the maximum duty cycle.

CPU Lower Temperature [20]

Use the <+> and <-> keys to adjust the lower limit of the CPU temperature. The values range from 20°C to 75°C.

CPU Fan Min. Duty Cycle(%) [20]

Use the <+> and <-> keys to adjust the minimum CPU fan duty cycle. The values range from 0% to 100%. When the CPU temperature is under the lower limit, the CPU fan will operate at the minimum duty cycle.

Chassis1/3 Q-Fan Control [Enabled]

[Disabled] Disables the Chassis Q-Fan control feature.

[Enabled] Enables the Chassis Q-Fan control feature.

Chassis Fan Speed Low Limit [600 RPM]

This item appears only when you enable the **Chassis Q-Fan Control** feature and allows you to disable or set the chassis fan warning speed. Configuration options: [Ignore] [200RPM] [300 RPM] [400 RPM] [500 RPM] [600 RPM]

Chassis Fan Profile [Standard]

This item appears only when you enable the **Chassis Q-Fan Control** feature and allows you to set the appropriate performance level of the chassis fan.

[Standard] Sets to [Standard] to make the chassis fan automatically adjust depending on the chassis temperature.

[Silent] Sets to [Silent] to minimize the fan speed for quiet chassis fan operation.

[Turbo] Sets to [Turbo] to achieve maximum chassis fan speed.

[Manual] Sets to [Manual] to assign detailed fan speed control parameters.



The following four items appear only when you set **Chassis Fan Profile** to [Manual].

Chassis Upper Temperature [70]

Use the <+> and <-> keys to adjust the upper limit of the CPU temperature. The values range from 40°C to 75°C.

Chassis Fan Max. Duty Cycle(%) [100]

Use the <+> and <-> keys to adjust the maximum chassis fan duty cycle. The values range from 60% to 100%. When the chassis temperature reaches the upper limit, the chassis fan will operate at the maximum duty cycle.

Chassis Lower Temperature [40]

Displays the lower limit of the chassis temperature.

CPU Fan Min. Duty Cycle(%) [60]

Use the <+> and <-> keys to adjust the minimum chassis fan duty cycle. The values range from 60% to 100%. When the chassis temperature is under 40°C, the chassis fan will operate at the minimum duty cycle.

Anti Surge Support [Enabled]

This item allows you to enable or disable the Anti Surge function.

Configuration options: [Disabled] [Enabled]

2.7 Boot menu

The Boot menu items allow you to change the system boot options.

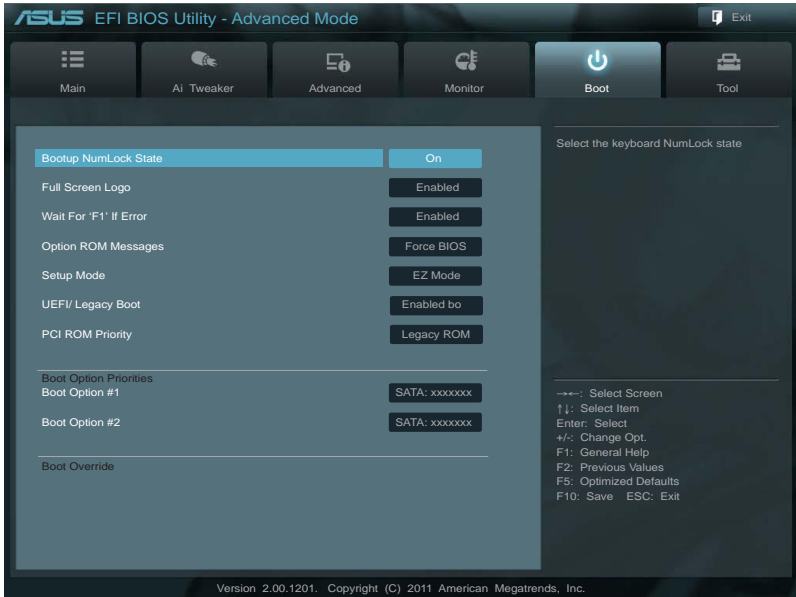

Bootup NumLock State [On]

[On] Sets the power-on state of the NumLock to [On].

[Off] Sets the power-on state of the NumLock to [Off].

Full Screen Logo [Enabled]

[Enabled] Enables the full screen logo display feature.

[Disabled] Disables the full screen logo display feature.



Set this item to [Enabled] to use the ASUS MyLogo 2™ feature.

Post Report [5 sec]

This item appears only when the Full Screen Logo item is set to [Disabled] and allows you to set the waiting time for the system to display the post report. Configuration options: [1 sec] [2 sec] [3 sec] [4 sec] [5 sec] [6 sec] [7 sec] [8 sec] [9 sec] [10 sec] [Until Press ESC]

Wait for 'F1' If Error [Enabled]

When this item is set to [Enabled], the system waits for the F1 key to be pressed when error occurs. Configuration options: [Disabled] [Enabled]

Option ROM Messages [Force BIOS]

- [Force BIOS] The third-party ROM messages will be forced to display during the boot sequence.
- [Keep Current] The third-party ROM messages will be displayed only if the third-party manufacturer had set the add-on device to do so.

Setup Mode [EZ Mode]

- [Advanced Mode] Sets Advanced Mode as the default screen for entering the BIOS setup program.
- [EZ Mode] Sets EZ Mode as the default screen for entering the BIOS setup program.

UEFI/Legacy Boot [Enable both UEFI and Legacy]

- [Enable both UEFI and Legacy] Enables both UEFI and Legacy boot.
- [Disable UEFI] Enables the Legacy boot, and disables the UEFI boot.
- [Disable Legacy] Enables the UEFI boot, and disables the Legacy boot.

PCI ROM Priority [Legacy ROM]

In case of multiple option ROMs (Legacy and EFI Compatible), specifies what PCI option ROM to launch.

Configuration options: [Legacy ROM] [EFI Compatible ROM]

2.7.1 Boot Option Priorities

These items specify the boot device priority sequence from the available devices. The number of device items that appears on the screen depends on the number of devices installed in the system.



- To select the boot device during system startup, press <F8> when ASUS Logo appears.
- To access Windows OS in Safe Mode, do any of the following:
 - Press <F5> when ASUS Logo appears.
 - Press <F8> after POST.

2.7.2 Boot Override

These items displays the available devices. The number of device items that appears on the screen depends on the number of devices installed in the system. Click an item to start booting from the selected device.

2.8 Tools menu

The Tools menu items allow you to configure options for special functions. Select an item then press <Enter> to display the submenu.

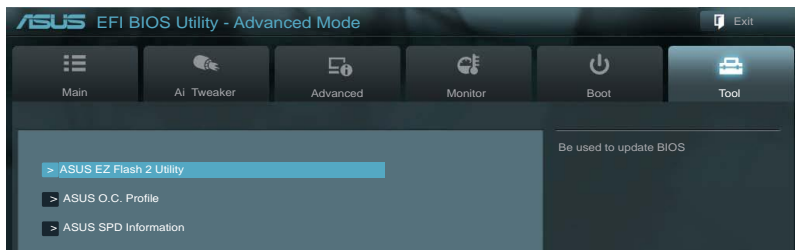

2.8.1 ASUS EZ Flash 2 Utility

Allows you to run ASUS EZ Flash 2. Press [Enter] to launch the ASUS EZ Flash 2 screen.



For more details, see section [2.1.2 ASUS EZ Flash 2](#).

2.8.2 ASUS O.C. Profile

This item allows you to store or load multiple BIOS settings.



The **Setup Profile Status** items show **Not Installed** if no profile is created.

Label

Allows you to input the label of the setup profile.

Save to Profile

Allows you to save the current BIOS settings to the BIOS Flash, and create a profile. Key in a profile number from one to eight, press <Enter>, and then select **Yes**.

Load from Profile

Allows you to load the previous BIOS settings saved in the BIOS Flash. Key in the profile number that saved your CMOS settings, press <Enter>, and then select **Yes**.



- DO NOT shut down or reset the system while updating the BIOS to prevent the system boot failure!
 - We recommend that you update the BIOS file only coming from the same memory/CPU configuration and BIOS version.
-

2.8.3 ASUS SPD Information

DIMM Slot # [DIMM_A2]

Displays the Serial Presence Detect (SPD) information of the DIMM module installed on the selected slot. Configuration options: [DIMM_A1] [DIMM_A2] [DIMM_B1] [DIMM_B2]

2.9 Exit menu

The Exit menu items allow you to load the optimal default values for the BIOS items, and save or discard your changes to the BIOS items. You can access the **EZ Mode** from the Exit menu.

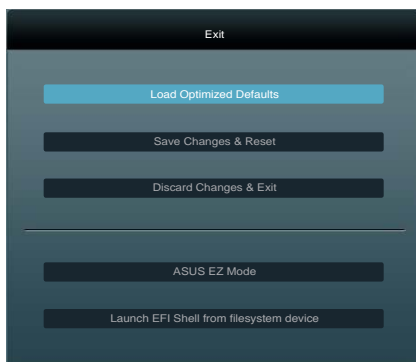

Load Optimized Defaults

This option allows you to load the default values for each of the parameters on the Setup menus. When you select this option or if you press <F5>, a confirmation window appears. Select **Yes** to load the default values.

Save Changes & Reset

Once you are finished making your selections, choose this option from the Exit menu to ensure the values you selected are saved. When you select this option or if you press <F10>, a confirmation window appears. Select **Yes** to save changes and exit.

Discard Changes & Exit

This option allows you to exit the Setup program without saving your changes. When you select this option or if you press <Esc>, a confirmation window appears. Select **Yes** to discard changes and exit.

ASUS EZ Mode

This option allows you to enter the EZ Mode screen.

Launch EFI Shell from filesystem device

This option allows you to attempt to launch the EFI Shell application (shellx64.efi) from one of the available devices that have a filesystem.

Appendices

Notices

Federal Communications Commission Statement

This device complies with Part 15 of the FCC Rules. Operation is subject to the following two conditions:

- This device may not cause harmful interference.
- This device must accept any interference received including interference that may cause undesired operation.

This equipment has been tested and found to comply with the limits for a Class B digital device, pursuant to Part 15 of the FCC Rules. These limits are designed to provide reasonable protection against harmful interference in a residential installation. This equipment generates, uses and can radiate radio frequency energy and, if not installed and used in accordance with manufacturer's instructions, may cause harmful interference to radio communications. However, there is no guarantee that interference will not occur in a particular installation. If this equipment does cause harmful interference to radio or television reception, which can be determined by turning the equipment off and on, the user is encouraged to try to correct the interference by one or more of the following measures:

- Reorient or relocate the receiving antenna.
- Increase the separation between the equipment and receiver.
- Connect the equipment to an outlet on a circuit different from that to which the receiver is connected.
- Consult the dealer or an experienced radio/TV technician for help.



The use of shielded cables for connection of the monitor to the graphics card is required to assure compliance with FCC regulations. Changes or modifications to this unit not expressly approved by the party responsible for compliance could void the user's authority to operate this equipment.

IC: Canadian Compliance Statement

Complies with the Canadian ICES-003 Class B specifications. This device complies with RSS 210 of Industry Canada. This Class B device meets all the requirements of the Canadian interference-causing equipment regulations.

This device complies with Industry Canada license exempt RSS standard(s). Operation is subject to the following two conditions: (1) this device may not cause interference, and (2) this device must accept any interference, including interference that may cause undesired operation of the device.

Cet appareil numérique de la Classe B est conforme à la norme NMB-003 du Canada. Cet appareil numérique de la Classe B respecte toutes les exigences du Règlement sur le matériel brouilleur du Canada.

Cet appareil est conforme aux normes CNR exemptes de licence d'Industrie Canada. Le fonctionnement est soumis aux deux conditions suivantes :

- (1) cet appareil ne doit pas provoquer d'interférences et
- (2) cet appareil doit accepter toute interférence, y compris celles susceptibles de provoquer un fonctionnement non souhaité de l'appareil.

Canadian Department of Communications Statement

This digital apparatus does not exceed the Class B limits for radio noise emissions from digital apparatus set out in the Radio Interference Regulations of the Canadian Department of Communications.

This class B digital apparatus complies with Canadian ICES-003.

VCCI: Japan Compliance Statement

VCCI Class B Statement

情報処理装置等電波障害自主規制について

この装置は、情報処理装置等電波障害自主規制協議会（VCCI）の基準に基づくクラスB情報技術装置です。この装置は家庭環境で使用されることを目的としていますが、この装置がラジオやテレビジョン受信機に近接して使用されると、受信障害を引き起こすことがあります。

取扱説明書に従って正しい取り扱いをして下さい。

KC: Korea Warning Statement

B급 기기 (가정용 방송통신기자재)

이 기기는 가정용(B급) 전자파적합기기로서 주로 가정에서 사용하는 것을 목적으로 하며, 모든 지역에서 사용할 수 있습니다.

*당해 무선설비는 전파혼신 가능성이 있으므로 인명안전과 관련된 서비스는 할 수 없습니다.

REACH

Complying with the REACH (Registration, Evaluation, Authorisation, and Restriction of Chemicals) regulatory framework, we published the chemical substances in our products at ASUS REACH website at <http://csr.asus.com/english/REACH.htm>.



DO NOT throw the motherboard in municipal waste. This product has been designed to enable proper reuse of parts and recycling. This symbol of the crossed out wheeled bin indicates that the product (electrical and electronic equipment) should not be placed in municipal waste. Check local regulations for disposal of electronic products.



DO NOT throw the mercury-containing button cell battery in municipal waste. This symbol of the crossed out wheeled bin indicates that the battery should not be placed in municipal waste.

ASUS Recycling/Takeback Services

ASUS recycling and takeback programs come from our commitment to the highest standards for protecting our environment. We believe in providing solutions for you to be able to responsibly recycle our products, batteries, other components as well as the packaging materials. Please go to <http://csr.asus.com/english/Takeback.htm> for detailed recycling information in different regions.

DECLARATION OF CONFORMITY

Per FCC Part 2, Section 2.1077(a)



Responsible Party Name: **Asus Computer International**

Address: **800 Corporate Way, Fremont, CA 94539.**

Phone/Fax No: **(510)739-3777/(510)608-4555**

hereby declares that the product

Product Name : Mother board

Model Number : P8Z77-M

Conforms to the following specifications:

- FCC Part 15, Subpart B, Unintentional Radiators
- FCC Part 15, Subpart C, Intentional Radiators
- FCC Part 15, Subpart E, Intentional Radiators

Supplementary Information:

This device complies with part 15 of the FCC Rules. Operation is subject to the following two conditions: (1) This device may not cause harmful interference, and (2) this device must accept any interference received, including interference that may cause undesired operation.

Representative Person's Name : Steve Chang / President

Signature : Steve Chang
Date : Feb.7, 2012

Ver. 11010

EC Declaration of Conformity



We, the undersigned,

Manufacturer: **ASUSTeK COMPUTER INC.**
Address, City: **No. 150, LITE RD., PEITOU, TAIPEI 112, TAIWAN R.O.C.**
Country: **TAIWAN**
Authorized representative in Europe: **ASUS COMPUTER GmbH**
Address, City: **HARKORT STR. 21-23, 40880 RATINGEN**
Country: **GERMANY**

declare the following apparatus:

Product name : **Mother board**
Model name : **P8Z77-M**

conform with the essential requirements of the following directives:

2004/108/EC-EMC Directive
 EN 55022:2006+A1:2007
 EN 61000-3-2:2006
 EN 55013:2007+A1:2003+A2:2006

1999/5/EC-R & TTE Directive

EN 300 328 V1.7.1(2006-10)
 EN 300 440-2 V1.2.1(2008-03)
 EN 301 511 V9.0.2(2009-09)
 EN 301 888-3 V2.1(2007-09)
 EN 301 888-3 V3.1(2007-09)
 EN 301 833 V1.4.1(2005-03)
 EN 302 544-2 V1.1.1(2009-01)
 EN 300 328 V1.7.1(2006-10)
 EN 300 329 V1.3.1(2007-09)
 EN 300 329 V1.1.1(2006-09)
 EN 302 623 V1.1.1(2009-01)

2006/95/EC-LVD Directive

EN 60951-1 A11:2009
 EN 60951-1 A12:2011
 EN 60965:2002 /A12:2011

2007/29/EC-EMC Directive

Regulation (EC) No. 1275/2008
 EN 62301:2005
Regulation (EC) No. 642/2009
 EN 62301:2005
Ver. 11121



(EC conformity marking)

Position : **CEO**
Name : **Jerry Shan**

Signature : Jerry Shan

Declaration Date: **Feb. 7, 2012**
Year to begin affixing CE marking: **2012**

ASUS contact information

ASUSTeK COMPUTER INC.

Address	15 Li-Te Road, Peitou, Taipei, Taiwan 11259
Telephone	+886-2-2894-3447
Fax	+886-2-2890-7798
E-mail	info@asus.com.tw
Web site	www.asus.com.tw

Technical Support

Telephone	+86-21-38429911
Online support	support.asus.com

ASUS COMPUTER INTERNATIONAL (America)

Address	800 Corporate Way, Fremont, CA 94539, USA
Telephone	+1-812-282-3777
Fax	+1-510-608-4555
Web site	usa.asus.com

Technical Support

Telephone	+1-812-282-2787
Support fax	+1-812-284-0883
Online support	support.asus.com

ASUS COMPUTER GmbH (Germany and Austria)

Address	Harkort Str. 21-23, D-40880 Ratingen, Germany
Fax	+49-2102-959911
Web site	www.asus.de
Online contact	www.asus.de/sales

Technical Support

Telephone	+49-1805-010923*
Support Fax	+49-2102-9599-11
Online support	support.asus.com

* EUR 0.14/minute from a German fixed landline; EUR 0.42/minute from a mobile phone.