

**PRIME X370-PRO**

**ASUS®**

**Motherboard**

E12577

Revised Edition v2

February 2017

**Copyright© 2017 ASUSTeK COMPUTER INC. All Rights Reserved.**

No part of this manual, including the products and software described in it, may be reproduced, transmitted, transcribed, stored in a retrieval system, or translated into any language in any form or by any means, except documentation kept by the purchaser for backup purposes, without the express written permission of ASUSTeK COMPUTER INC. ("ASUS").

Product warranty or service will not be extended if: (1) the product is repaired, modified or altered, unless such repair, modification of alteration is authorized in writing by ASUS; or (2) the serial number of the product is defaced or missing.

ASUS PROVIDES THIS MANUAL "AS IS" WITHOUT WARRANTY OF ANY KIND, EITHER EXPRESS OR IMPLIED, INCLUDING BUT NOT LIMITED TO THE IMPLIED WARRANTIES OR CONDITIONS OF MERCHANTABILITY OR FITNESS FOR A PARTICULAR PURPOSE. IN NO EVENT SHALL ASUS, ITS DIRECTORS, OFFICERS, EMPLOYEES OR AGENTS BE LIABLE FOR ANY INDIRECT, SPECIAL, INCIDENTAL, OR CONSEQUENTIAL DAMAGES (INCLUDING DAMAGES FOR LOSS OF PROFITS, LOSS OF BUSINESS, LOSS OF USE OR DATA, INTERRUPTION OF BUSINESS AND THE LIKE), EVEN IF ASUS HAS BEEN ADVISED OF THE POSSIBILITY OF SUCH DAMAGES ARISING FROM ANY DEFECT OR ERROR IN THIS MANUAL OR PRODUCT.

SPECIFICATIONS AND INFORMATION CONTAINED IN THIS MANUAL ARE FURNISHED FOR INFORMATIONAL USE ONLY, AND ARE SUBJECT TO CHANGE AT ANY TIME WITHOUT NOTICE, AND SHOULD NOT BE CONSTRUED AS A COMMITMENT BY ASUS. ASUS ASSUMES NO RESPONSIBILITY OR LIABILITY FOR ANY ERRORS OR INACCURACIES THAT MAY APPEAR IN THIS MANUAL, INCLUDING THE PRODUCTS AND SOFTWARE DESCRIBED IN IT.

Products and corporate names appearing in this manual may or may not be registered trademarks or copyrights of their respective companies, and are used only for identification or explanation and to the owners' benefit, without intent to infringe.

**Offer to Provide Source Code of Certain Software**

This product contains copyrighted software that is licensed under the General Public License ("GPL"), under the Lesser General Public License Version ("LGPL") and/or other Free Open Source Software Licenses. Such software in this product is distributed without any warranty to the extent permitted by the applicable law. Copies of these licenses are included in this product.

Where the applicable license entitles you to the source code of such software and/or other additional data, you may obtain it for a period of three years after our last shipment of the product, either

(1) for free by downloading it from <https://www.asus.com/support/>

or

(2) for the cost of reproduction and shipment, which is dependent on the preferred carrier and the location where you want to have it shipped to, by sending a request to:

ASUSTeK Computer Inc.

Legal Compliance Dept.

15 Li Te Rd.,

Beitou, Taipei 112

Taiwan

In your request please provide the name, model number and version, as stated in the About Box of the product for which you wish to obtain the corresponding source code and your contact details so that we can coordinate the terms and cost of shipment with you.

The source code will be distributed WITHOUT ANY WARRANTY and licensed under the same license as the corresponding binary/object code.

This offer is valid to anyone in receipt of this information.

ASUSTeK is eager to duly provide complete source code as required under various Free Open Source Software licenses. If however you encounter any problems in obtaining the full corresponding source code we would be much obliged if you give us a notification to the email address [gpl@asus.com](mailto:gpl@asus.com), stating the product and describing the problem (please DO NOT send large attachments such as source code archives, etc. to this email address).

# Contents

Safety information.....	v
About this guide.....	vi
PRIME X370-PRO specifications summary.....	viii
Package contents.....	xii
Installation tools and components.....	xiii

## Chapter 1: Product Introduction

1.1	Motherboard overview.....	1-1
1.1.1	Before you proceed.....	1-1
1.1.2	Motherboard layout.....	1-2
1.1.3	Central Processing Unit (CPU).....	1-4
1.1.4	System memory.....	1-4
1.1.5	Expansion slots.....	1-6
1.1.6	Jumpers and Headers.....	1-8
1.1.7	Internal connectors.....	1-10

## Chapter 2: Basic Installation

2.1	Building your PC system.....	2-1
2.1.1	Motherboard installation.....	2-1
2.1.2	CPU installation.....	2-3
2.1.3	CPU heatsink and fan assembly installation.....	2-4
2.1.4	DIMM installation.....	2-6
2.1.5	ATX power connection.....	2-7
2.1.6	SATA device connection.....	2-7
2.1.7	Front I/O connector.....	2-8
2.1.8	Expansion card installation.....	2-9
2.1.9	M.2 installation.....	2-10
2.2	Motherboard rear and audio connections.....	2-11
2.2.1	Rear I/O connection.....	2-11
2.2.2	Audio I/O connections.....	2-12
2.3	Starting up for the first time.....	2-15
2.4	Turning off the computer.....	2-15

## Chapter 3: BIOS Setup

3.1	Knowing BIOS.....	3-1
3.2	BIOS setup program.....	3-2
3.2.1	EZ Mode.....	3-3
3.2.2	Advanced Mode.....	3-4
3.2.3	QFan Control.....	3-7
3.3	My Favorites.....	3-9

<b>3.4</b>	<b>Main menu .....</b>	<b>3-11</b>
<b>3.5</b>	<b>Ai Tweaker menu.....</b>	<b>3-11</b>
<b>3.6</b>	<b>Advanced menu .....</b>	<b>3-17</b>
	3.6.1 CPU Configuration .....	3-17
	3.6.2 NB Configuration.....	3-18
	3.6.3 SATA Configuration .....	3-18
	3.6.4 Onboard Devices Configuration.....	3-19
	3.6.5 APM Configuration.....	3-20
	3.6.6 Network Stack.....	3-20
	3.6.7 HDD/SSD SMART Information .....	3-21
	3.6.8 USB Configuration .....	3-21
	3.6.9 AMD CBS.....	3-21
<b>3.7</b>	<b>Monitor menu .....</b>	<b>3-22</b>
<b>3.8</b>	<b>Boot menu .....</b>	<b>3-25</b>
<b>3.9</b>	<b>Tool menu .....</b>	<b>3-29</b>
	3.9.1 ASUS EZ Flash 3 Utility .....	3-29
	3.9.2 ASUS Overclocking Profile .....	3-29
	3.9.3 ASUS SPD Information .....	3-29
<b>3.10</b>	<b>Exit menu .....</b>	<b>3-30</b>
<b>3.11</b>	<b>Updating BIOS.....</b>	<b>3-31</b>
	3.11.1 EZ Update.....	3-31
	3.11.2 ASUS EZ Flash 3.....	3-32
	3.11.3 ASUS CrashFree BIOS 3.....	3-34

**Chapter 4: RAID Support**

<b>4.1</b>	<b>AMD RAID Array configurations.....</b>	<b>4-1</b>
	4.1.1 RAID definitions .....	4-1
	4.1.2 Installing Serial ATA hard disks .....	4-2
	4.1.3 Setting up RAID from RAIDXpert2 Configuration Utility in UEFI BIOS.....	4-2
	4.1.4 AMD RAID Array configuration in Option ROM utility .....	4-5
<b>4.2</b>	<b>Creating a RAID driver disk .....</b>	<b>4-10</b>
	4.2.1 Creating a RAID driver disk in Windows® .....	4-10

**Appendix**

<b>Notices .....</b>	<b>A-1</b>
<b>ASUS contact information.....</b>	<b>A-5</b>

# Safety information

## Electrical safety

- To prevent electrical shock hazard, disconnect the power cable from the electrical outlet before relocating the system.
- When adding or removing devices to or from the system, ensure that the power cables for the devices are unplugged before the signal cables are connected. If possible, disconnect all power cables from the existing system before you add a device.
- Before connecting or removing signal cables from the motherboard, ensure that all power cables are unplugged.
- Seek professional assistance before using an adapter or extension cord. These devices could interrupt the grounding circuit.
- Ensure that your power supply is set to the correct voltage in your area. If you are not sure about the voltage of the electrical outlet you are using, contact your local power company.
- If the power supply is broken, do not try to fix it by yourself. Contact a qualified service technician or your retailer.

## Operation safety

- Before installing the motherboard and adding devices on it, carefully read all the manuals that came with the package.
- Before using the product, ensure all cables are correctly connected and the power cables are not damaged. If you detect any damage, contact your dealer immediately.
- To avoid short circuits, keep paper clips, screws, and staples away from connectors, slots, sockets and circuitry.
- Avoid dust, humidity, and temperature extremes. Do not place the product in any area where it may become wet.
- Place the product on a stable surface.
- If you encounter technical problems with the product, contact a qualified service technician or your retailer.

## About this guide

This user guide contains the information you need when installing and configuring the motherboard.

## How this guide is organized

This guide contains the following parts:

### 1. Chapter 1: Product Introduction

This chapter describes the features of the motherboard and the new technology it supports. It includes description of the switches, jumpers, and connectors on the motherboard.

### 2. Chapter 2: Basic Installation

This chapter lists the hardware setup procedures that you have to perform when installing system components.

### 3. Chapter 3: BIOS Setup

This chapter tells how to change system settings through the BIOS Setup menus. Detailed descriptions of the BIOS parameters are also provided.

### 4. Chapter 4: RAID Support

This chapter describes the RAID configurations.

## Where to find more information

Refer to the following sources for additional information and for product and software updates.

### 1. ASUS website

The ASUS website ([www.asus.com](http://www.asus.com)) provides updated information on ASUS hardware and software products.

### 2. Optional documentation

Your product package may include optional documentation, such as warranty flyers, that may have been added by your dealer. These documents are not part of the standard package.

## Conventions used in this guide

To ensure that you perform certain tasks properly, take note of the following symbols used throughout this manual.



**DANGER/WARNING:** Information to prevent injury to yourself when trying to complete a task.



**CAUTION:** Information to prevent damage to the components when trying to complete a task.



**IMPORTANT:** Instructions that you **MUST** follow to complete a task.



**NOTE:** Tips and additional information to help you complete a task.

## Typography

**Bold text**

Indicates a menu or an item to select.

*Italics*

Used to emphasize a word or a phrase.

<Key>

Keys enclosed in the less-than and greater-than sign means that you must press the enclosed key.

Example: <Enter> means that you must press the Enter or Return key.

<Key1> + <Key2> + <Key3>

If you must press two or more keys simultaneously, the key names are linked with a plus sign (+).

## PRIME X370-PRO specifications summary

<b>CPU</b>	<p>AM4 socket for AMD Ryzen™/7th Generation A-series/Athlon™ Processors</p> <p>Supports CPU up to 8 cores*</p> <p>* Due to CPU limitation, CPU cores supported varies by processor.</p> <p>** Refer to <a href="http://www.asus.com">www.asus.com</a> for the AMD CPU support list.</p>
<b>Chipset</b>	AMD X370 Chipset
<b>Memory</b>	<p><b>AMD Ryzen™ Processors</b></p> <p>4 x DIMM, max. 64GB DDR4 3200(O.C.)/2933(O.C.)/2666/2400/2133 MHz, ECC and non-ECC, un-buffered memory</p> <p><b>AMD 7th Generation A-series/Athlon™ Processors</b></p> <p>4 x DIMM, max. 64GB DDR4 2400/2133 MHz, non-ECC, un-buffered memory</p> <p>Dual channel memory architecture</p> <p>* Refer to <a href="http://www.asus.com">www.asus.com</a> for the Memory QVL (Qualified Vendors List) Please refer to Memory QVL (Qualified Vendors List) for details.</p> <p>** Hyper DIMM support is subject to the physical characteristics of individual CPUs.</p>
<b>Expansion slots</b>	<p><b>AMD Ryzen™ Processors</b></p> <p>2 x PCI Express 3.0/2.0 x16 slots (single at x16 or dual at x8/x8 mode)</p> <p><b>AMD 7th Generation A-series/Athlon™ Processors</b></p> <p>1 x PCI Express 3.0/2.0 x16 slot (single at x8)</p> <p><b>AMD X370 chipset</b></p> <p>1 x PCI Express 2.0 x16 slot (max. at x4 mode)*</p> <p>3 x PCI Express 2.0 x1 slots</p> <p>* PCIe16_3 slot shares bandwidth with PCIeX1_1 and PCIeX1_3.</p>
<b>VGA</b>	<p>Integrated AMD Radeon™ R Series Graphics in the 7th Generation A-Series APU</p> <p>Multi-VGA output support: DisplayPort/HDMI ports</p> <p>Supports DisplayPort 1.2 with max. resolution 4096 x 2160@60Hz</p> <p>Supports HDMI 1.4b with max. resolution 4096 x 2160 @24Hz / 2560 x 1600 @60Hz</p> <p>Maximum shared memory of 2048MB</p>
<b>Multi-GPU support</b>	<p><b>AMD Ryzen™ Processors</b></p> <p>Supports NVIDIA® 2-Way SLI™ Technology</p> <p>Supports AMD CrossFireX™ Technology</p> <p><b>AMD 7th Generation A-series/Athlon™ Processors</b></p> <p>Supports AMD CrossFireX™ Technology</p>
<b>Storage</b>	<p><b>AMD Ryzen™ Processors</b></p> <p>- 1 x M.2 Socket 3 with M Key, type 2242/2260/2280/22110 (PCIe 3.0 x4 and SATA modes) storage devices support</p> <p><b>AMD 7th Generation A-series/Athlon™ Processors</b></p> <p>- 1 x M.2 Socket 3 with M Key, type 2242/2260/2280/22110(PCIe 3.0 x2 and SATA modes) storage devices support</p> <p><b>AMD X370 chipset with RAID 0, 1, 10 support</b></p> <p>- 8 x SATA 6.0 Gb/s ports (gray)</p>

(continued on the next page)



## PRIME X370-PRO specifications summary

LAN	Intel® I211AT Gigabit LAN
Audio	<p><b>Realtek® S1220A 8-channel high definition audio CODEC</b></p> <ul style="list-style-type: none"> <li>- Audio Shielding: Ensures precision analog/digital separation and greatly reduces multi-lateral interference</li> <li>- Dedicated audio PCB layers: Separate layers for left and right channels to guard the quality of the sensitive audio signals</li> <li>- Premium Japanese audio capacitors: Provide warm, natural and immersive sound with exceptional clarity and fidelity</li> <li>- Supports jack-detection, multi-streaming, front panel jack-retasking</li> <li>- High quality 120dB SNR stereo playback output (Line-out@back) &amp; 113dB SNR input (Line-in) support</li> <li>- Optical S/PDIF out port at back I/O</li> </ul>
USB	<p><b>AMD Ryzen™/7th Generation A-series/Athlon™ Processors</b></p> <ul style="list-style-type: none"> <li>- 4 x USB 3.0/2.0 ports (4 ports at back panel[blue])</li> </ul> <p><b>AMD X370 Chipset</b></p> <ul style="list-style-type: none"> <li>- 1 x USB 3.1/3.0/2.0 front panel connector</li> <li>- 4 x USB 3.0/2.0 ports (2 ports at mid-board; 2 ports at back panel, Type-A[blue] and Type-C)</li> <li>- 4 x USB 2.0/1.1 ports at mid-board</li> </ul> <p><b>ASMedia USB 3.1 controllers</b></p> <ul style="list-style-type: none"> <li>- 2 x USB 3.1/3.0/2.0 ports (2 ports at back panel[teal blue])</li> </ul>
ASUS Exclusive Features	<p><b>&lt;Performance Optimization&gt;</b></p> <p><b>5-Way Optimization</b></p> <ul style="list-style-type: none"> <li>- Whole system optimization with a single click! Perfectly consolidates TPU, EPU, DIGI+ VRM, Fan Xpert 4, and Turbo App.</li> </ul> <p><b>DIGI+ VRM</b></p> <ul style="list-style-type: none"> <li>- 6+4 Phase digital power design</li> </ul> <p><b>TPU</b></p> <ul style="list-style-type: none"> <li>- Auto Tuning</li> </ul> <p><b>EPU</b></p> <ul style="list-style-type: none"> <li>- EPU</li> </ul> <p><b>Fan Xpert 4</b> featuring system performance tuning, network priority, and audio scene configuration for selected applications</p> <p><b>Turbo App</b> featuring system performance tuning, network priority, and audio scene configuration for selected applications.</p> <p><b>Gaming Scenario</b></p> <p><b>AURA</b></p> <ul style="list-style-type: none"> <li>- Bright up your Build</li> </ul> <p><b>Audio Features</b></p> <ul style="list-style-type: none"> <li>- Audio that roars on the battlefield</li> </ul>

(continued on the next page)

## PRIME X370-PRO specifications summary

<p><b>ASUS Exclusive Features</b></p>	<p><b>EZ DIY</b></p> <p><b>UEFI BIOS EZ Mode</b></p> <ul style="list-style-type: none"> <li>- featuring friendly graphics user interface</li> <li>- ASUS CrashFree BIOS 3</li> <li>- ASUS EZ Flash 3</li> </ul> <p><b>Q-Design</b></p> <ul style="list-style-type: none"> <li>- ASUS Q-Shield</li> <li>- ASUS Q-Slot</li> <li>- ASUS Q-DIMM</li> <li>- ASUS Q-Connector</li> </ul>
<p><b>ASUS Special Features</b></p>	<p><b>Special Features:</b></p> <p><b>ASUS SafeSlot</b></p> <ul style="list-style-type: none"> <li>- Protect your graphics card Investment</li> </ul> <p><b>ASUS 5X Protection III</b></p> <ul style="list-style-type: none"> <li>- ASUS SafeSlot Core - Fortified PCIe with solid soldering</li> <li>- ASUS LANGuard - Protects against LAN surges, lightning strikes and static-electricity discharges!</li> <li>- ASUS Overvoltage Protection - World-class circuit-protecting power design</li> <li>- ASUS DIGI+ VRM - 6+4 Phase digital power design</li> <li>- ASUS DRAM Overcurrent Protection: Enhanced DRAM overcurrent protection</li> <li>- ASUS Stainless - Steel Back I/O: 3X corrosion-resistance for greater durability!</li> <li>- ASUS ESD Guards - Enhanced ESD protection</li> <li>- AI Suite 3</li> <li>- Ai Charger</li> </ul>
<p><b>ASUS Quiet Thermal Solution</b></p>	<p>Quiet Thermal Design:</p> <ul style="list-style-type: none"> <li>- ASUS Fan Xpert 4</li> <li>- Stylish Fanless Design: Chipset Heat-sink &amp; MOS Heat-sink solution</li> </ul>
<p><b>ASUS Exclusive Overclocking Features</b></p>	<p><b>Precision Tweaker 2:</b></p> <ul style="list-style-type: none"> <li>- vVDDCR CPU: Adjustable CPU voltage at 0.00625V increment</li> <li>- vVDDCR SOC: Adjustable CPU/NB voltage at 0.00625V increment</li> <li>- vDRAM Bus: Adjustable DRAM voltage at 0.005V increment</li> </ul> <p><b>Overclocking Protection:</b></p> <ul style="list-style-type: none"> <li>- ASUS C.P.R.(CPU Parameter Recall)</li> </ul>

*(continued on the next page)*

## PRIME X370-PRO specifications summary

<b>Back Panel I/O Ports</b>	<p>1 x PS/2 Keyboard/Mouse Combo port</p> <p>1 x DisplayPort</p> <p>1 x HDMI port</p> <p>1 x Intel LAN (RJ45) port</p> <p>2 x USB 3.1/3.0/2.0 port (teal blue, Type A)</p> <p>1 x USB 3.0/2.0 port (Type C)</p> <p>5x USB 3.0/2.0 ports (blue, Type A)</p> <p>1 x Optical S/PDIF out</p> <p>5 x Audio Jacks (Line in, Front Speaker Out, Mic in, Center/Subwoofer, Rear Speaker Out)</p>
<b>Internal I/O connectors</b>	<p>1 x USB 3.1/3.0/2.0 front panel connector</p> <p>1 x USB 3.0/2.0 connectors support additional 2 USB ports (19-pin)</p> <p>2 x USB 2.0/1/1 connectors support additional 4 USB ports</p> <p>1 x M.2 Socket 3 for M Key, type 2242/2260/2280/22110 devices support, (both SATA &amp; PCIE mode)</p> <p>8 x SATA 6.0Gb/s connectors (gray)</p> <p>1 x CPU Fan header (4-pin) for both 3-pin(DC mode) and 4-pin(PWM mode) CPU coolers control with auto detection support</p> <p>1 x CPU OPT Fan header (4-pin)</p> <p>1 x AIO Pump header (4-pin)</p> <p>1 x W_PUMP+ header (4-pin)</p> <p>2 x Chassis Fan connectors (4-pin) for both 3-pin(DC mode) and 4-pin(PWM mode) coolers control with auto detection support</p> <p>1 x Aura RGB header</p> <p>1 x Front panel audio connector (AAFP)</p> <p>1 x TPM connector</p> <p>1 x COM connector</p> <p>1 x 24-pin EATX Power connector</p> <p>1 x 8-pin EATX 12V Power connector</p> <p>1 x System Panel</p> <p>1 x Clear CMOS header</p>
<b>BIOS Features</b>	<p>128 Mb Flash ROM, UEFI AMI BIOS, PnP, DMI3.0, WfM2.0, SM BIOS 3.0, ACPI 6.1, Multi-language BIOS, ASUS EZ Flash 3, CrashFree BIOS 3, F11 EZ Tuning Wizard, F6 Qfan Control, F3 My Favorites, Last Modified log, F12 PrintScreen, and ASUS DRAM SPD (Serial Presence Detect) memory information</p>
<b>Manageability</b>	<p>WfM 2.0, DMI 3.0, WOL by PME, PXE</p>
<b>Support DVD contents</b>	<p>Drivers</p> <p>ASUS Utilities</p> <p>EZ Update</p> <p>Anti-virus software (OEM version)</p>
<b>OS support</b>	<p>Windows® 10 64-bit</p>
<b>Form factor</b>	<p>ATX Form Factor, 12"x 9.6" (30.5cm x 24.4cm)</p>



- Specifications are subject to change without notice.
- Visit the ASUS website for the software manual.

## Package contents

Check your motherboard package for the following items:

### Motherboard

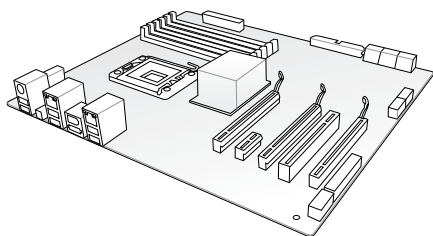

**ASUS PRIME X370-PRO motherboard**

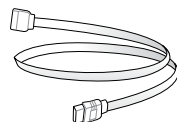

**4 x Serial ATA 6.0 Gb/s cables**



**1 x M.2 screw package**

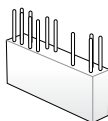

**1 x Q-Connector**

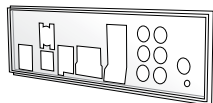

**1 x ASUS Q-Shield**

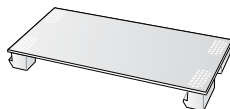

**1 x ASUS SLI HB BRIDGE(2-WAY-M)**



**1 x User Manual**

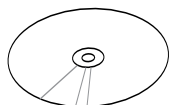

**1 x Support DVD**



- 
- If any of the above items is damaged or missing, contact your retailer.
  - The illustrated items above are for reference only. Actual product specifications may vary with different models.
-

# Installation tools and components

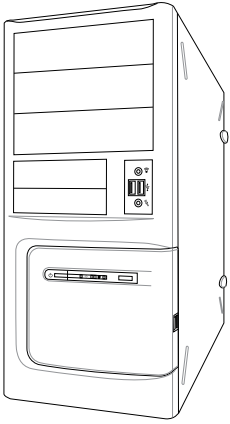

PC chassis

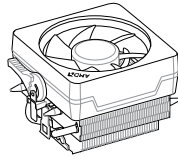

AMD AM4 compatible CPU Fan



AMD AM4 CPU

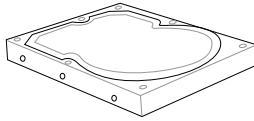

SATA hard disk drive



Phillips (cross) screwdriver

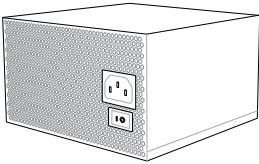

Power supply unit

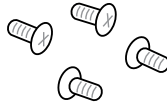

1 bag of screws

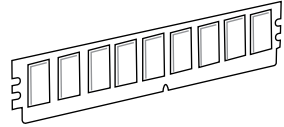

DIMM

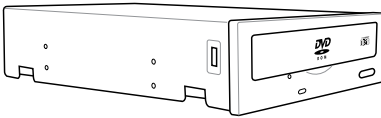

SATA optical disc drive (optional)

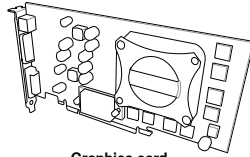

Graphics card



The tools and components in the table above are not included in the motherboard package.



# Product Introduction

# 1

## 1.1 Motherboard overview

### 1.1.1 Before you proceed

Take note of the following precautions before you install motherboard components or change any motherboard settings.



- 
- Unplug the power cord from the wall socket before touching any component.
  - Before handling components, use a grounded wrist strap or touch a safely grounded object or a metal object, such as the power supply case, to avoid damaging them due to static electricity.
  - Hold components by the edges to avoid touching the ICs on them.
  - Whenever you uninstall any component, place it on a grounded antistatic pad or in the bag that came with the component.
  - Before you install or remove any component, ensure that the ATX power supply is switched off or the power cord is detached from the power supply. Failure to do so may cause severe damage to the motherboard, peripherals, or components.
-

## 1.1.2 Motherboard layout

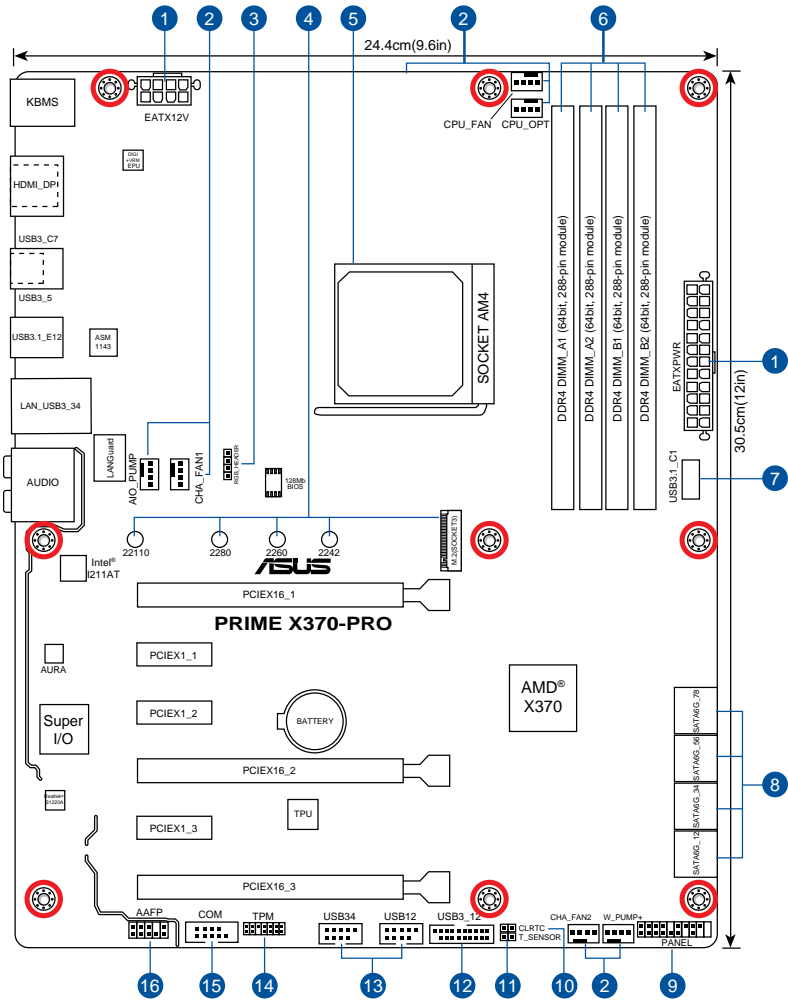

Refer to 1.1.9 Internal connectors and 2.2.1 Rear I/O connection for more information about rear panel connectors and internal connectors.



## Layout contents

Connectors/Jumpers/Buttons and switches/Slots	Page
1. ATX power connectors (24-pin EATXPWR; 8-pin EATX12V)	1-14
2. CPU, CPU optional, AIO pump, W_pump+, and chassis fan connectors (4-pin CPU_FAN; 4-pin CPU_OPT; 4-pin AIO_PUMP; 4-pin W_PUMP+; 4-pin CHA_FAN1-2)	1-4
3. RGB header (4-pin RGB_HEADER)	1-9
4. M.2 socket 3	1-17
5. AM4 socket	1-4
6. DDR4 DIMM slots	1-4
7. USB 3.1 connector (20 pin USB3.1_C1)	1-12
8. Serial ATA 6 Gb/s connectors (7-pin SATA6G_12; SATA 6G_34; SATA 6G_56; SATA 6G_78)	1-10
9. System panel connector (20-5 pin PANEL)	1-15
10. Clear RTC RAM jumper (2-pin CLRTC)	1-8
11. Thermal sensor connector (2-pin T_SENSOR)	1-16
12. USB 3.0 connector (20-1 pin USB3_12)	1-12
13. USB 2.0 connectors (10-1 pin USB12; USB34)	1-11
14. TPM connector (14-1 pin TPM)	1-16
15. Serial port connector (10-1 pin COM)	1-17
16. Front panel audio connector (10-1 pin AAFP)	1-11

### 1.1.3 Central Processing Unit (CPU)

The motherboard comes with a AM4 socket for AMD Ryzen™ /7th Generation A-series / Athlon™ Processors.

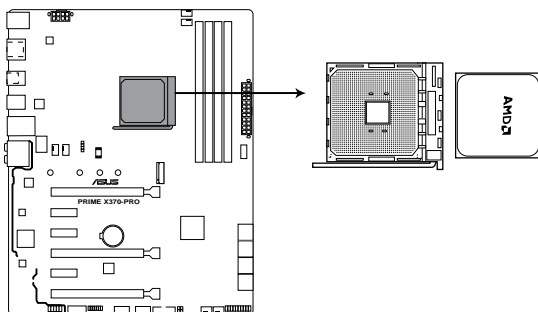

**PRIME X370-PRO CPU socket AM4**



The AM4 socket has a different pinout from the AM3+/FM2+/FM2 socket. Ensure that you use a CPU designed for the AM4 socket. The CPU fits in only one correct orientation. **DO NOT** force the CPU into the socket to prevent bending the pins and damaging the CPU!

### 1.1.4 System memory

The motherboard comes with four DDR4 (Double Data Rate 4) Quad Inline Memory Modules (DIMM) slots.



A DDR4 module is notched differently from a DDR, DDR2, or DDR3 module. **DO NOT** install a DDR, DDR2, or DDR3 memory module to the DDR4 slot.

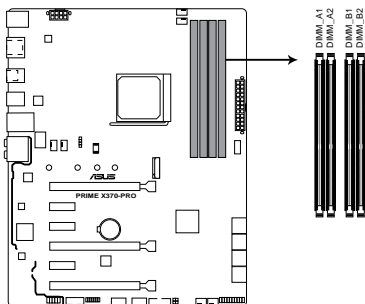

**PRIME X370-PRO 288-pin DDR4 DIMM sockets**

## Recommended memory configurations

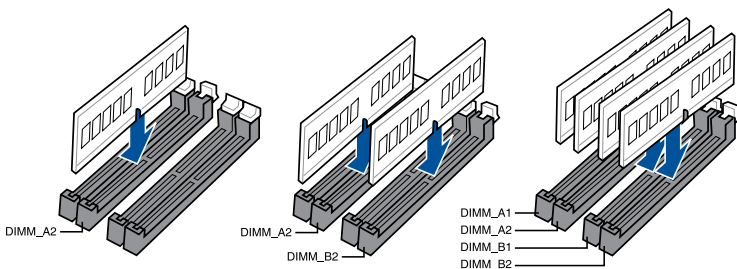

## Memory configurations

You may install 1 GB, 2 GB, 4 GB, 8 GB and 16 GB unbuffered ECC and non-ECC DDR4 DIMMs into the DIMM sockets.



- You may install varying memory sizes in Channel A and Channel B. The system maps the total size of the lower-sized channel for the dual-channel configuration. Any excess memory from the higher-sized channel is then mapped for single-channel operation.
- This motherboard does not support DIMMs made up of 512 Mb (64 MB) chips or less (Memory chip capacity counts in Megabit, 8 Megabit/Mb = 1 Megabyte/MB).



- The default memory operation frequency is dependent on its Serial Presence Detect (SPD), which is the standard way of accessing information from a memory module. Under the default state, some memory modules for overclocking may operate at a lower frequency than the vendor-marked value.
- For system stability, use a more efficient memory cooling system to support a full memory load (4 DIMMs) or overclocking condition.
- Always install the DIMMS with the same CAS Latency. For an optimum compatibility, we recommend that you install memory modules of the same version or data code (D/C) from the same vendor. Check with the vendor to get the correct memory modules.

## 1.1.5 Expansion slots



Unplug the power cord before adding or removing expansion cards. Failure to do so may cause you physical injury and damage motherboard components.

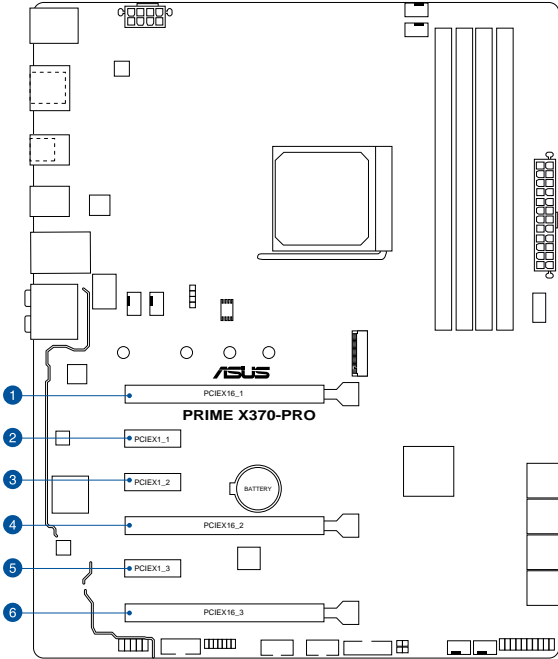

Slot No.	Slot Description
1	PCIe 3.0/2.0 x16_1 slot
2	PCIe 2.0 x1_1 slot
3	PCIe 2.0 x1_2 slot
4	PCIe 3.0/2.0 x16_2 slot
5	PCIe 2.0 x1_3 slot
6	PCIe 2.0 x16_3 slot

VGA configuration	PCI Express 3.0 operating mode	
	PCIe 3.0/2.0 x16_1	PCIe 3.0/2.0 x16_2
Single VGA/PCIe card	x16 (single VGA recommended)	N/A
Dual VGA/PCIe card	x8	x8



- Due to CPU limitation, PCIe 3.0/2.0 x16\_1 working at @x16 or x8 varies by processor when using one graphics card.
- We recommend that you provide sufficient power when running CrossFireX™ or SLI® mode.
- Connect chassis fans to the motherboard chassis fan connectors when using multiple graphics cards for better thermal environment.

## IRQ assignments for this motherboard

### For AMD 7th Generation A-series/Athlon™ Processors

	A	B	C	D	E	F	G	H
PCIe x16_1	-	-	-	shared	-	-	-	-
PCIe x16_2	shared	-	-	-	-	-	-	-
PCIe x16_3	-	shared	-	-	-	-	-	-
PCIe x1_1	-	-	shared	-	-	-	-	-
PCIe x1_2	-	-	-	shared	-	-	-	-
PCIe x1_3	-	-	-	shared	-	-	-	-
M.2	-	-	-	shared	-	-	-	-
CPU USB3.0 XHCI Controller	-	-	shared	-	-	-	-	-
AMD Chipset XHCI Controller	shared	-	-	-	-	-	-	-
SATA Controller	-	-	-	shared	-	-	-	-
HD Audio Controller	-	-	-	-	-	-	shared	-
Intel LAN	-	-	shared	-	-	-	-	-
ASMedia Connector	shared	-	-	-	-	-	-	-

### For AMD Ryzen™ Processors

	A	B	C	D	E	F	G	H
PCIe x16_1	-	-	-	-	-	-	shared	-
PCIe x16_2	shared	-	-	-	-	-	-	-
PCIe x16_3	-	shared	-	-	-	-	-	-
PCIe x1_1	-	-	shared	-	-	-	-	-
PCIe x1_2	-	-	-	shared	-	-	-	-
PCIe x1_3	-	-	-	shared	-	-	-	-
M.2	shared	-	-	-	-	-	-	-
CPU USB3.0 XHCI Controller	-	-	-	-	-	-	-	shared
AMD Chipset XHCI Controller	shared	-	-	-	-	-	-	-
SATA Controller	-	shared	-	-	-	-	-	-
HD Audio Controller	-	-	-	shared	-	-	-	-
Intel LAN	-	-	shared	-	-	-	-	-
ASMedia Connector	shared	-	-	-	-	-	-	-

## 1.1.6 Jumpers and Headers

### 1. Clear RTC RAM jumper (2-pin CLRRTC)

This jumper allows you to clear the Real Time Clock (RTC) RAM in CMOS. You can clear the CMOS memory of date, time, and system setup parameters by erasing the CMOS RTC RAM data. The onboard button cell battery powers the RAM data in CMOS, which include system setup information such as system passwords.

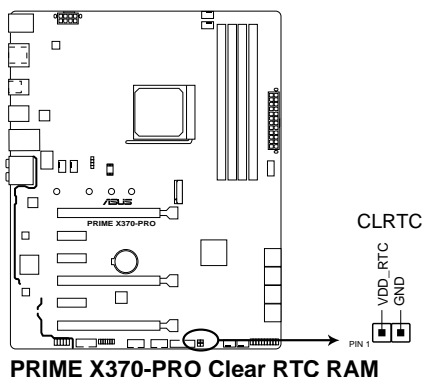

To erase the RTC RAM:

1. Turn OFF the computer and unplug the power cord.
2. Short-circuit pin 1-2 with a metal object or jumper cap for about 5-10 seconds.
3. Plug the power cord and turn ON the computer.
4. Hold down the <Delete> key during the boot process and enter BIOS setup to re-enter data.



Except when clearing the RTC RAM, never place a metal object or jumper cap on the CLRRTC jumper. Placing a metal object or jumper cap will cause system boot failure!



- If the steps above do not help, remove the onboard battery and place a metal object or jumper cap again to clear the CMOS RTC RAM data. After the CMOS clearance, reinstall the battery.
- You do not need to clear the RTC when the system hangs due to overclocking. For system failure due to overclocking, use the C.P.R. (CPU Parameter Recall) feature. Shut down and reboot the system so the BIOS can automatically reset parameter settings to default values.
- Due to the chipset behavior, AC power off is required to enable C.P.R. function. You must turn off and turn on the power supply or unplug and plug the power cord before rebooting the system.

## 2. RGB Header (4-pin RGB\_HEADER)

This connector is for RGB LED strips.

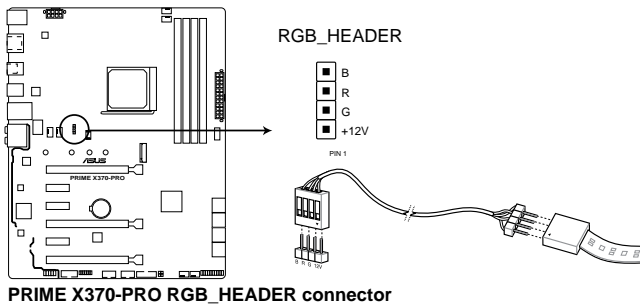

The RGB header supports 5050 RGB multi-color LED strips (12V/G/R/B), with a maximum power rating of 2A (12V), and no longer than 2 m.



Before you install or remove any component, ensure that the ATX power supply is switched off or the power cord is detached from the power supply. Failure to do so may cause severe damage to the motherboard, peripherals, or components.



- Actual lighting and color will vary with LED strip.
- If your LED strip does not light up, check if the RGB LED extension cable and the RGB LED strip is connected in the correct orientation, and the 12V connector is aligned with the 12V header on the motherboard.
- The LED strip will only light up under the operating system.
- The LED strip is purchased separately.

## 1.1.7 Internal connectors

### 1. Serial ATA 6 Gb/s connectors (7-pin SATA6G\_12; SATA 6G\_34; SATA 6G\_56; SATA 6G\_78)

These connectors connect to Serial ATA 6 Gb/s hard disk drives via Serial ATA 6 Gb/s signal cables.

If you installed Serial ATA hard disk drives, you can create a RAID 0, 1, and 10 configuration through the onboard AMD X370 chipset.

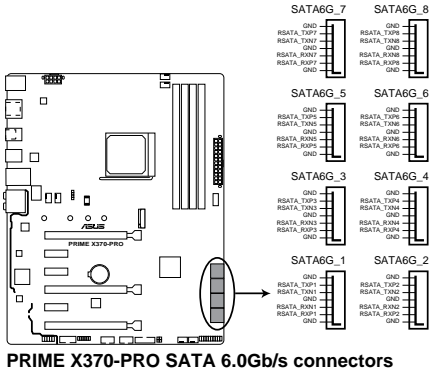

PRIME X370-PRO SATA 6.0Gb/s connectors

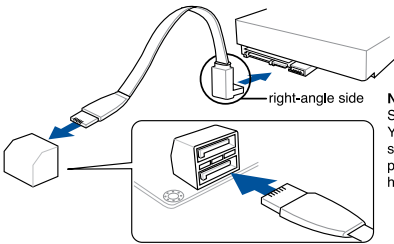

**NOTE:** Connect the right-angle side of SATA signal cable to SATA device. You may also connect the right-angle side of SATA cable to the onboard SATA port to avoid mechanical conflict with huge graphics cards.



These connectors are set to **[AHCI Mode]** by default. If you intend to create a Serial ATA RAID set using these connectors, set the SATA Mode item in the BIOS to **(RAID)**.



## 2. Front panel audio connector (10-1 pin AAFP)

This connector is for a chassis-mounted front panel audio I/O module that supports HD Audio. Connect one end of the front panel audio I/O module cable to this connector.

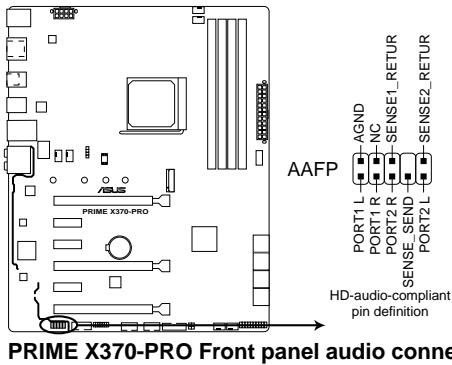

We recommend that you connect a high-definition front panel audio module to this connector to avail of the motherboard's high-definition audio capability.

## 3. USB 2.0 connectors (10-1 pin USB12; USB34)

These connectors are for USB 2.0 ports. Connect the USB module cable to these connectors, then install the module to a slot opening at the back of the system chassis. This USB connector complies with USB 2.0 specification that supports up to 480 Mb/s connection speed.

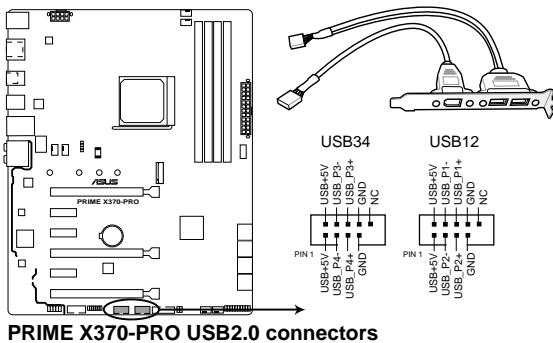

**DO NOT** connect a 1394 cable to the USB connectors. Doing so will damage the motherboard!



The USB 2.0 module is purchased separately.

#### 4. USB 3.0 connector (20-1 pin USB3\_12)

This connector allows you to connect a USB 3.0 module for additional USB 3.0 front or rear panel ports. With an installed USB 3.0 module, you can enjoy all the benefits of USB 3.0 including faster data transfer speeds of up to 5 Gb/s, faster charging time for USB-chargable devices, optimized power efficiency, and backward compatibility with USB 2.0.

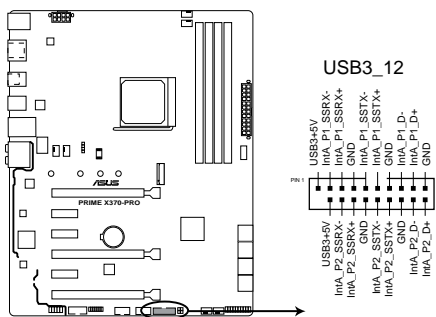

**PRIME X370-PRO USB3.0 Front panel connector**



The USB 3.0 module is purchased separately.



The plugged USB 3.0 device may run on xHCI mode depending on the operating system's setting.

#### 5. USB 3.1 connector (20-pin USB3.1\_C1)

This connector allows you to connect a USB 3.1 module for additional USB 3.1 front or rear panel ports. The latest USB 3.1 connectivity provides data transfer speeds of up to 10 Gbps. The next-generation standard is completely backward-compatible with your existing USB devices.

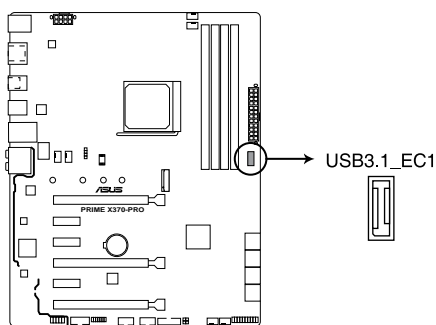

**PRIME X370-PRO USB3.1\_EC1**

6. CPU, CPU optional, AIO pump, W\_Pump, and chassis fan connectors (4-pin CPU\_FAN; 4-pin CPU\_OPT; 4-pin AIO\_PUMP; 4-pin W\_PUMP+; 4-pin CHA\_FAN1-2)

Connect the fan cables to the fan connectors on the motherboard, ensuring that the black wire of each cable matches the ground pin of the connector.

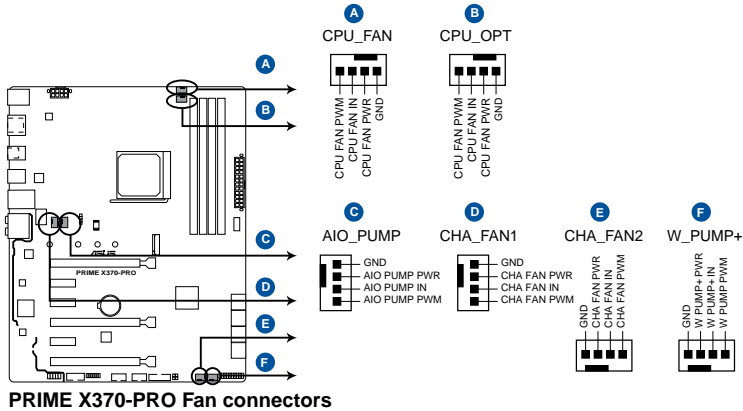

- DO NOT forget to connect the fan cables to the fan connectors. Insufficient air flow inside the system may damage the motherboard components. These are not jumpers! Do not place jumper caps on the fan connectors!
- Ensure that the CPU fan cable is securely installed to the CPU fan connector.



- The CPU\_FAN connector supports the CPU fan of maximum 1A (12 W) fan power.
- Connect the fan of your water cooling kit to the AIO\_PUMP / W\_PUMP+ connector.

## 7. ATX power connectors (24-pin EATXPWR; 8-pin EATX12V)

These connectors are for ATX power supply plugs. The power supply plugs are designed to fit these connectors in only one orientation. Find the proper orientation and push down firmly until the connectors completely fit.

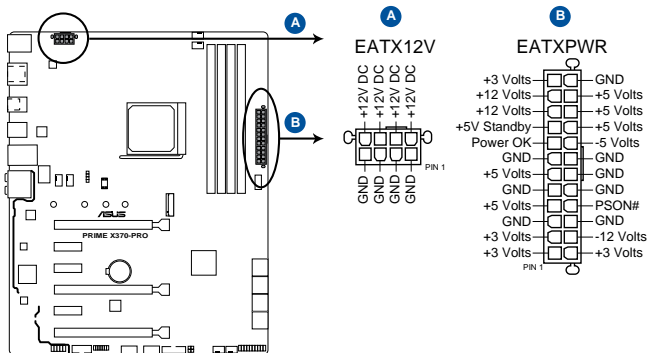

**PRIME X370-PRO ATX power connectors**



- For a fully configured system, we recommend that you use a power supply unit (PSU) that complies with ATX 12 V Specification 2.0 (or later version) and provides a minimum power of 350 W.
- DO NOT forget to connect the 8-pin EATX12V power plug. Otherwise, the system will not boot.
- We recommend that you use a PSU with a higher power output when configuring a system with more power-consuming devices. The system may become unstable or may not boot up if the power is inadequate.
- If you want to use two or more high-end PCI Express x16 cards, use a PSU with 1000W power or above to ensure the system stability.

## 8. System panel connector (20-5 pin PANEL)

This connector supports several chassis-mounted functions.

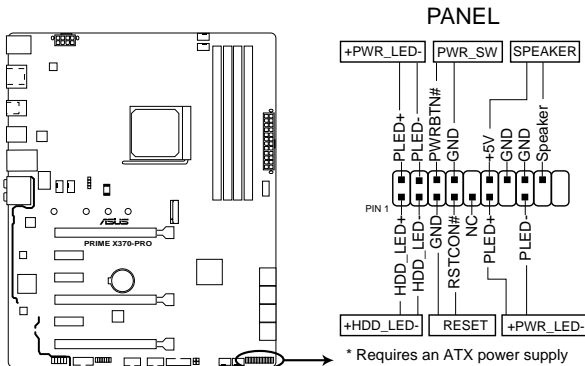

**PRIME X370-PRO System panel connector**

- **System power LED (4-pin +PWR\_LED-)**

This 2-pin connector is for the system power LED. Connect the chassis power LED cable to this connector. The system power LED lights up when you turn on the system power, and blinks when the system is in sleep mode.

- **Hard disk drive activity LED (2-pin +HDD\_LED-)**

This 2-pin connector is for the HDD Activity LED. Connect the HDD Activity LED cable to this connector. The HDD LED lights up or flashes when data is read from or written to the HDD.

- **System warning speaker (4-pin SPEAKER)**

This 4-pin connector is for the chassis-mounted system warning speaker. The speaker allows you to hear system beeps and warnings.

- **ATX power button/soft-off button (2-pin PWR\_SW)**

This connector is for the system power button. Pressing the power button turns the system on or puts the system in sleep or soft-off mode depending on the operating system settings. Pressing the power switch for more than four seconds while the system is ON turns the system OFF.

- **Reset button (2-pin RESET)**

This 2-pin connector is for the chassis-mounted reset button for system reboot without turning off the system power.

## 9. TPM connector (14-1 pin TPM)

This connector supports a Trusted Platform Module (TPM) system, which securely stores keys, digital certificates, passwords and data. A TPM system also helps enhance network security, protect digital identities, and ensures platform integrity.

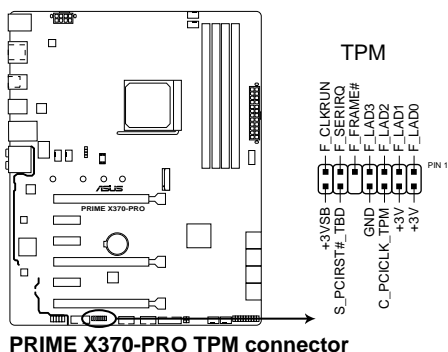

The TPM module is purchased separately.

## 10. Thermal sensor connector (2-pin T\_SENSOR)

This connector is for the thermistor cable that monitors the temperature of the devices and the critical components inside the motherboard. Connect the thermistor cable and place the sensor on the device or the motherboard's component to detect its temperature.

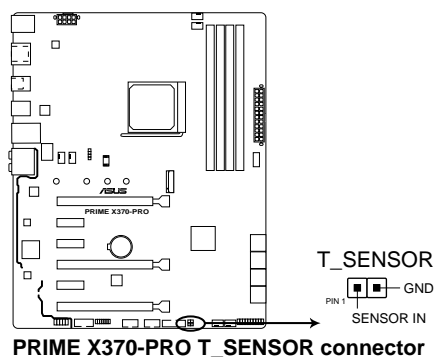

## 11. M.2 socket (M.2(Socket 3))

These sockets allow you to install a M.2 SSD module.

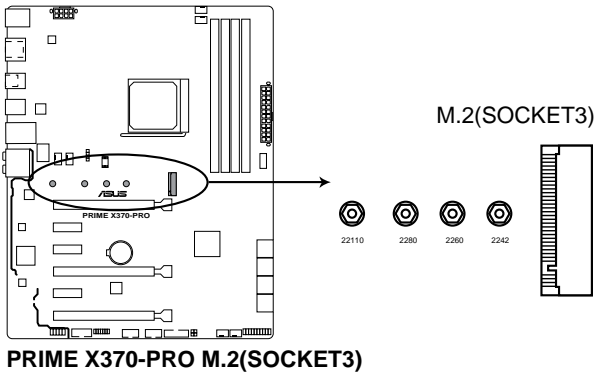

- M.2 socket supports PCIe 3.0 x4 and SATA mode M Key design and type 2242 / 2260 / 2280 / 22110 PCIe and SATA storage devices.
- Due to CPU limitation, M.2 working at @PCIe 3.0 x4 or x2 varies by processors.



The M.2 SSD module is purchased separately.

## 12. Serial port connector (10-1 pin COM)

This connector is for a serial (COM) port. Connect the serial port module cable to this connector, then install the module to a slot opening at the back of the system chassis.

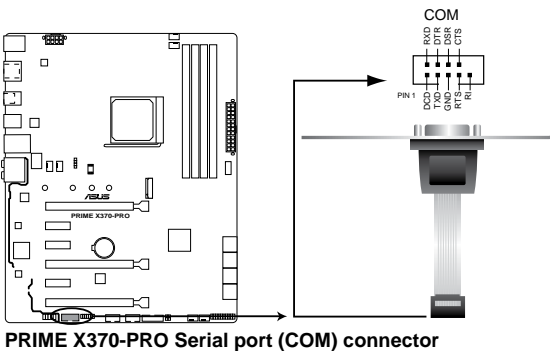

The COM module is purchased separately.





# Basic Installation

# 2

## 2.1 Building your PC system



The diagrams in this section are for reference only. The motherboard layout may vary with models, but the installation steps are the same for all models.

### 2.1.1 Motherboard installation

1. Install the ASUS Q-Shield to the chassis rear I/O panel.

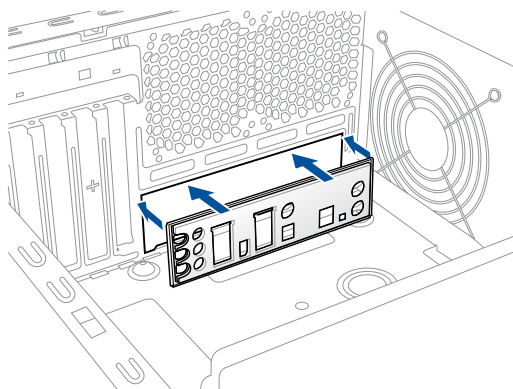

2. Place the motherboard into the chassis, ensuring that its rear I/O ports are aligned to the chassis' rear I/O panel.

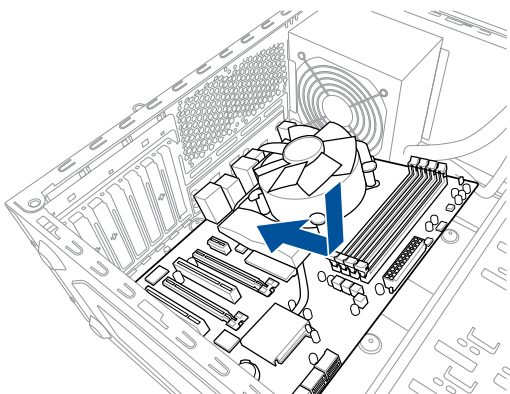

3. Place nine screws into the holes indicated by circles to secure the motherboard to the chassis.

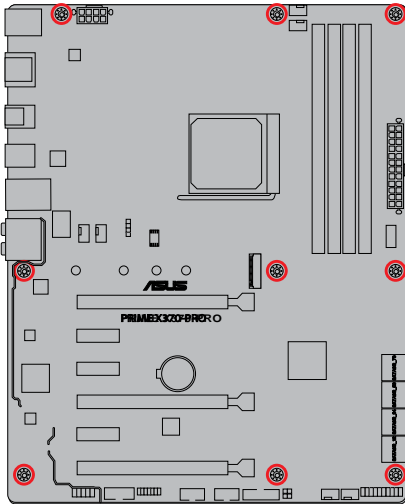
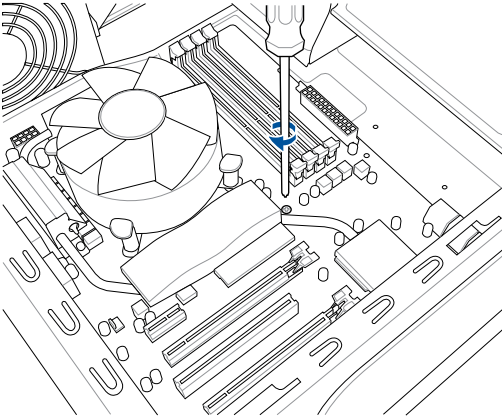

DO NOT overtighten the screws! Doing so can damage the motherboard.

## 2.1.2 CPU installation



- Unplug all the power cables before installing the CPU.
- Ensure that you use a CPU designed for the AM4 socket. The CPU fits in only one correct orientation. DO NOT force the CPU into the socket to prevent bending the pins and damaging the CPU

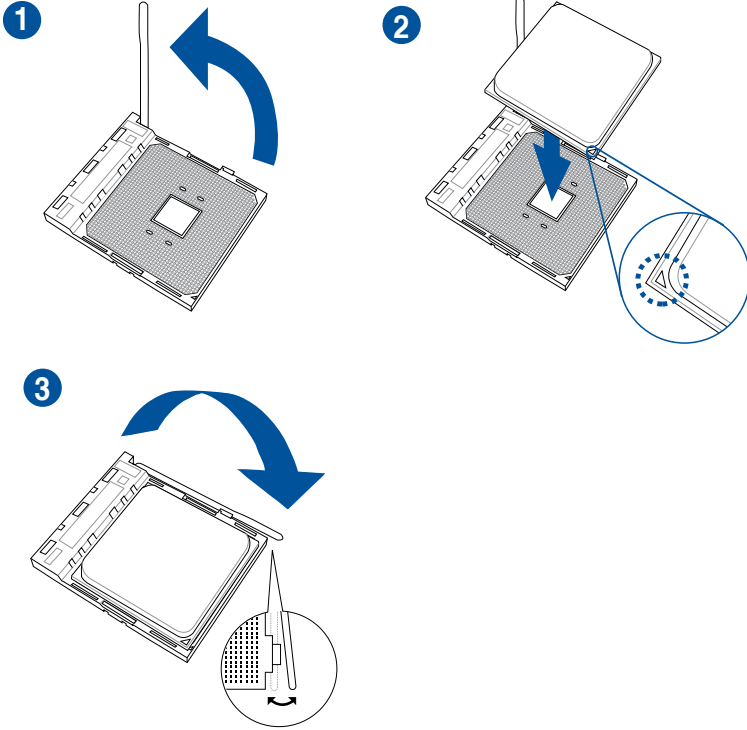

## 2.1.3 CPU heatsink and fan assembly installation



Apply the Thermal Interface Material to the CPU heatsink and CPU before you install the heatsink and fan if necessary.

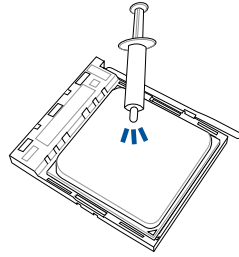

### Type 1

1

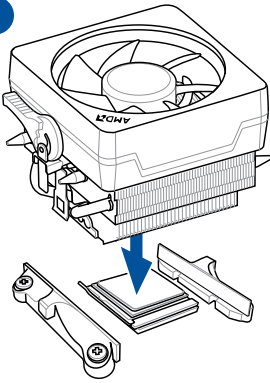

2

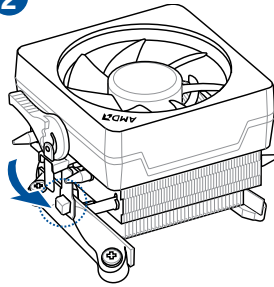

3

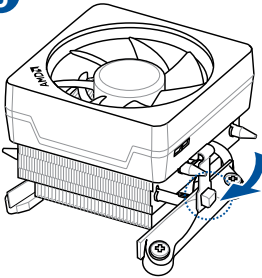

4

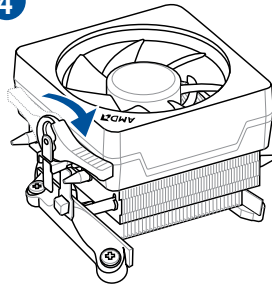

5

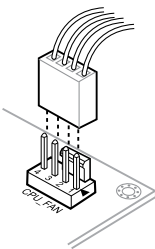

## Type 2

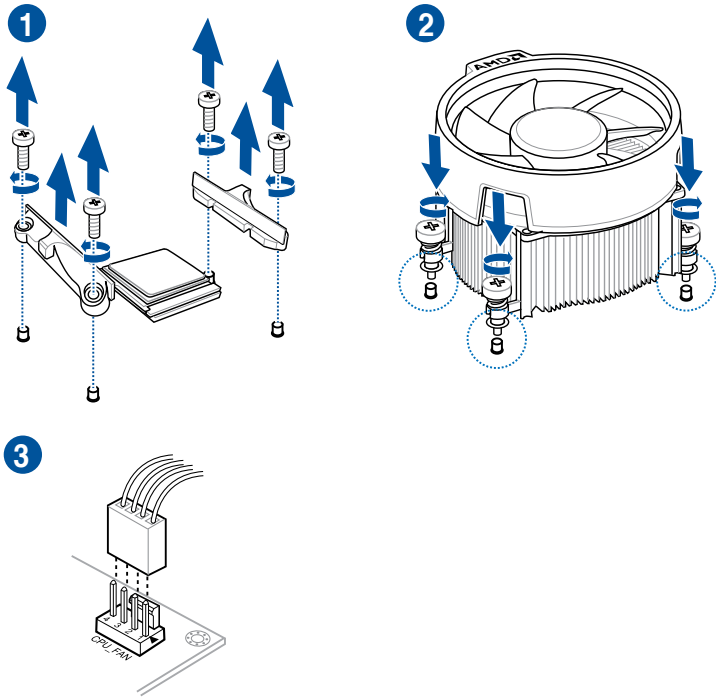

When using this type of CPU fan, remove the screws and the retention module only. Do not remove the plate on the bottom.

## 2.1.4 DIMM installation

1

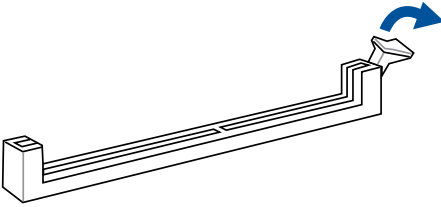

2

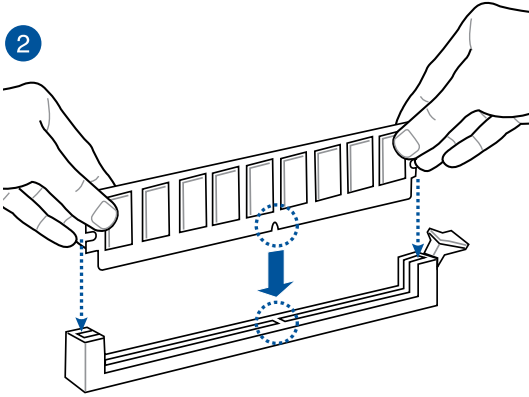

3

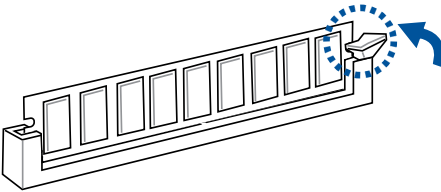

To remove a DIMM

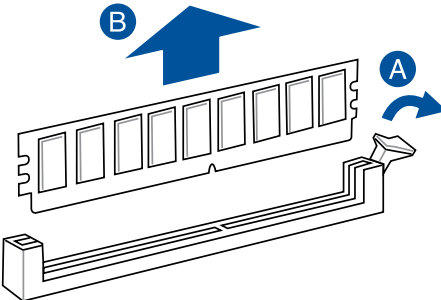

## 2.1.5 ATX power connection

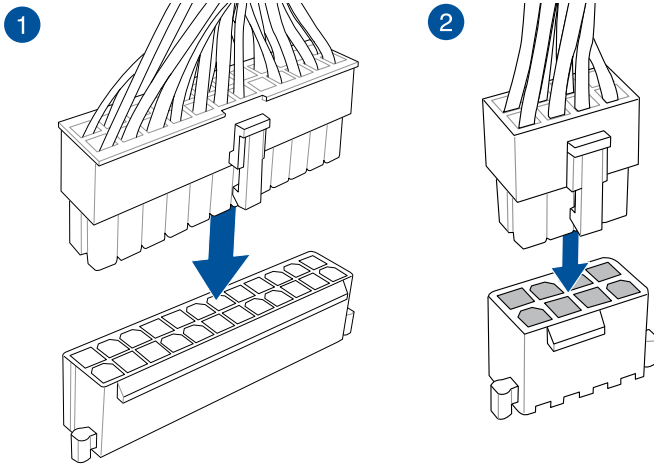

Ensure to connect the 8-pin power plug.

## 2.1.6 SATA device connection

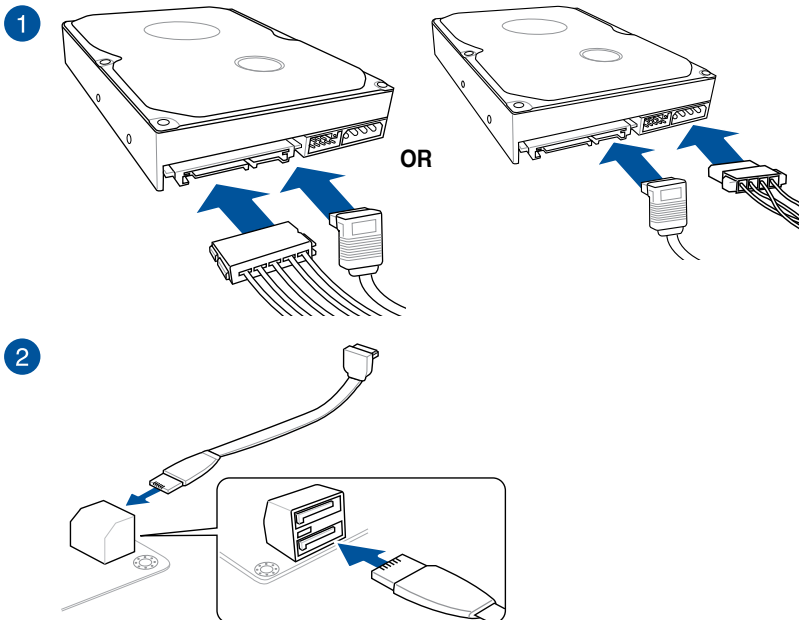

## 2.1.7 Front I/O connector

### To install ASUS Q-Connector

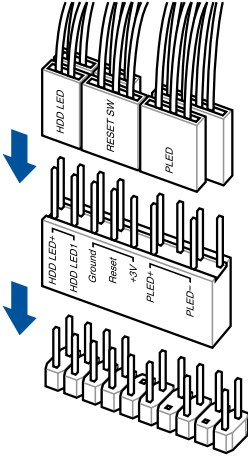

### To install USB 2.0 connector

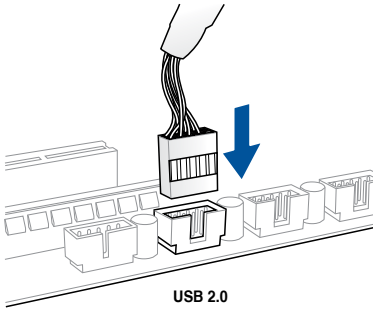

### To install front panel audio connector

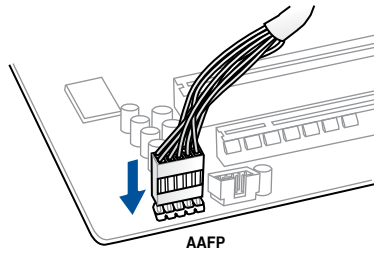

### To install USB 3.0 connector

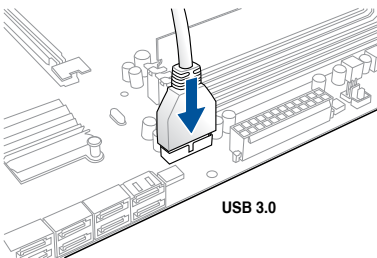



## 2.1.8 Expansion card installation

To install PCIe x16 cards

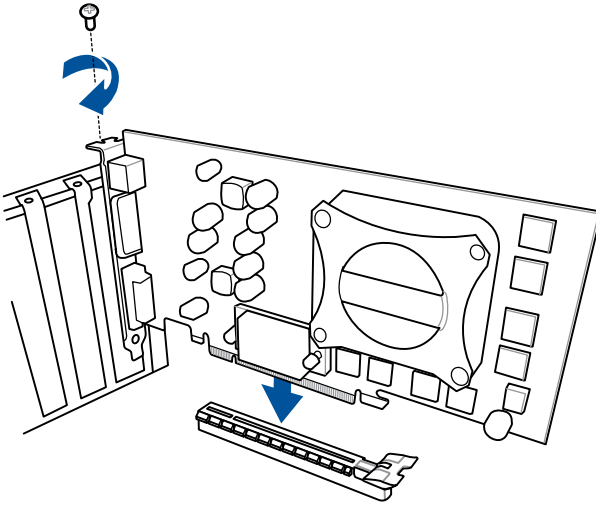

To install PCIe x1 cards

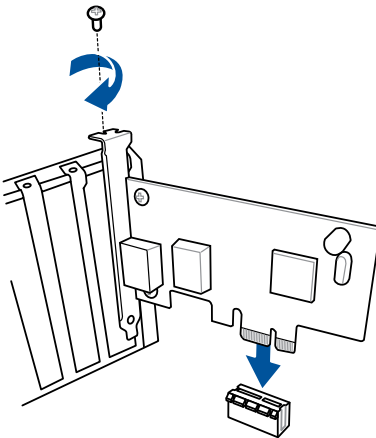

## 2.1.9 M.2 installation

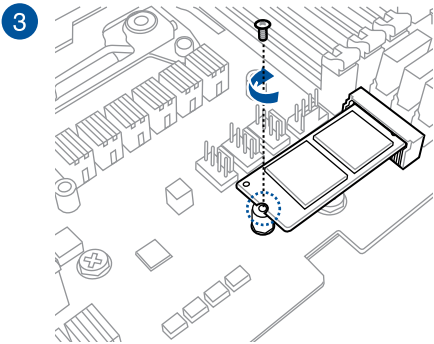
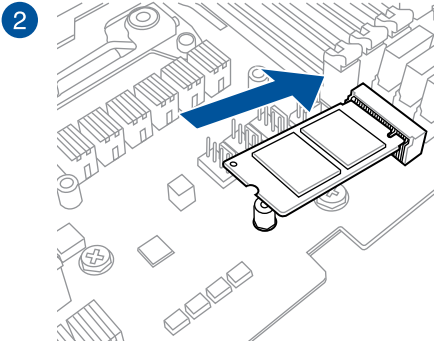
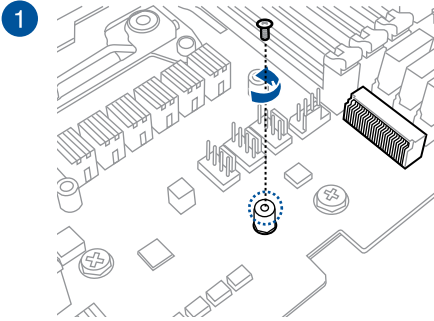

Supported M.2 type varies per motherboard.

## 2.2 Motherboard rear and audio connections

### 2.2.1 Rear I/O connection

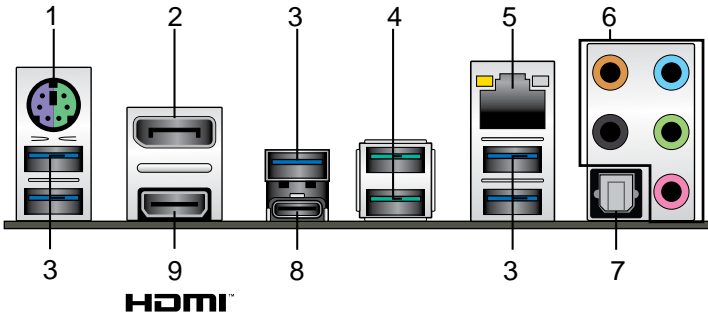

Rear panel connectors	
1. PS/2 keyboard/mouse combo port	6. Audio I/O ports**
2. DisplayPort	7. Optical S/PDIF Out port
3. USB 3.0 port 5	8. USB 3.0 Type-C port C7
4. USB 3.1 Type-A ports E12	9. HDMI 1.4b port
5. Intel® LAN port*	

\* and \*\*: Refer to the tables on the next page for LAN port LEDs and audio port definitions.



- USB 3.1/3.0 devices can only be used as data storage only.
- We strongly recommend that you connect your devices to ports with matching data transfer rate. Please connect your USB 3.0 devices to USB 3.0 ports and your USB 3.1 devices to USB 3.1 ports for faster and better performance for your devices.

#### \* LAN ports LED indications

Activity Link LED		Speed LED	
Status	Description	Status	Description
Off	No link	Off	10 Mbps connection
Orange	Linked	Orange	100 Mbps connection
Orange (Blinking)	Data activity	Green	1 Gbps connection
Orange (Blinking then steady)	Ready to wake up from S5 mode		

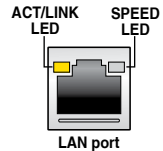

You can disable the LAN controllers in BIOS. Due to hardware design, the LAN1 port's LEDs may continue to blink even when disabled.

**\*\* Audio 2, 4, 6 or 8-channel configuration**

Port	Headset 2-channel	4-channel	6-channel	8-channel
Light Blue	Line In	Line In	Line In	Side Speaker Out
Lime	Line Out	Front Speaker Out	Front Speaker Out	Front Speaker Out
Pink	Mic In	Mic In	Mic In	Mic In
Orange	–	–	Center/Sub woofer	Center/Sub woofer
Black	–	Rear Speaker Out	Rear Speaker Out	Rear Speaker Out

## 2.2.2 Audio I/O connections

### Audio I/O ports

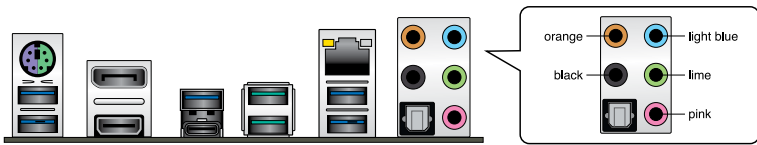

### Connect to Headphone and Mic



### Connect to Stereo Speakers

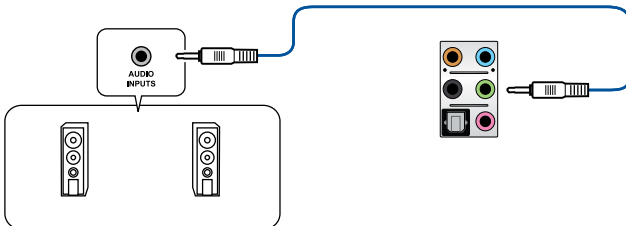

## Connect to 2 Speakers

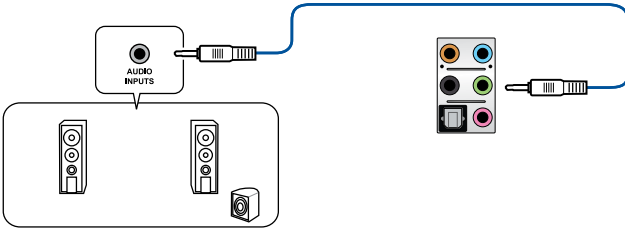

## Connect to 4 Speakers

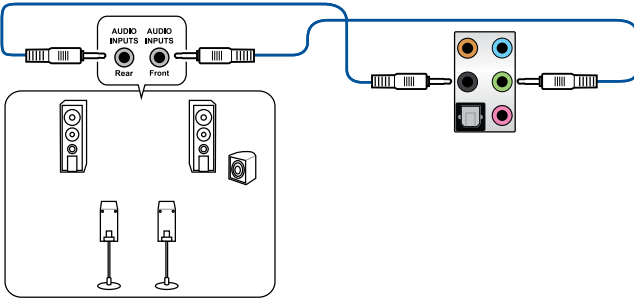

## Connect to 6 Speakers

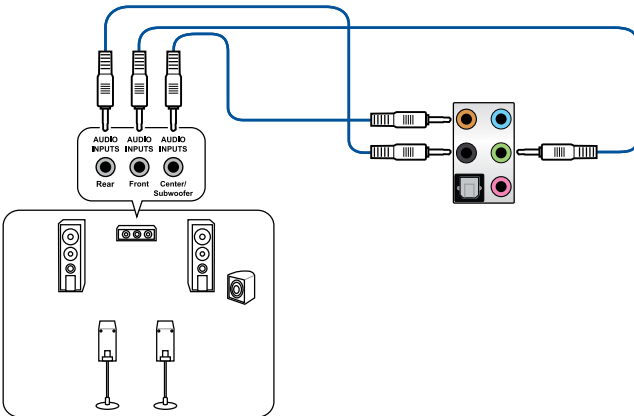

# Connect to 8 Speakers

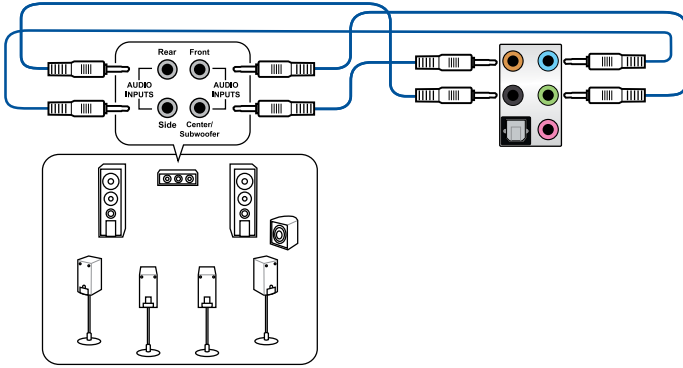

## 2.3 Starting up for the first time

1. After making all the connections, replace the system case cover.
2. Ensure that all switches are off.
3. Connect the power cord to the power connector at the back of the system chassis.
4. Connect the power cord to a power outlet that is equipped with a surge protector.
5. Turn on the devices in the following order:
  - a. Monitor
  - b. External SCSI devices (starting with the last device on the chain)
  - c. System power
6. After applying power, the system power LED on the system front panel case lights up. For systems with ATX power supplies, the system LED lights up when you press the ATX power button. If your monitor complies with the “green” standards or if it has a “power standby” feature, the monitor LED may light up or change from orange to green after the system LED turns on.

The system then runs the power-on self tests (POST). While the tests are running, the BIOS beeps (refer to the BIOS beep codes table) or additional messages appear on the screen. If you do not see anything within 30 seconds from the time you turned on the power, the system may have failed a power-on test. Check the jumper settings and connections or call your retailer for assistance.

BIOS Beep	Description
One short beep	VGA detected Quick boot set to disabled No keyboard detected
One continuous beep followed by two short beeps then a pause (repeated)	No memory detected
One continuous beep followed by three short beeps	No VGA detected
One continuous beep followed by four short beeps	Hardware component failure

7. At power on, hold down the <Delete> key to enter the BIOS Setup. Follow the instructions in Chapter 3.

## 2.4 Turning off the computer

While the system is ON, press the power button for less than four seconds to put the system on sleep mode or soft-off mode, depending on the BIOS setting. Press the power switch for more than four seconds to let the system enter the soft-off mode regardless of the BIOS setting.





# BIOS Setup

# 3

## 3.1 Knowing BIOS



---

The new ASUS UEFI BIOS is a Unified Extensible Interface that complies with UEFI architecture, offering a user-friendly interface that goes beyond the traditional keyboard-only BIOS controls to enable a more flexible and convenient mouse input. You can easily navigate the new UEFI BIOS with the same smoothness as your operating system. The term "BIOS" in this user manual refers to "UEFI BIOS" unless otherwise specified.

---

BIOS (Basic Input and Output System) stores system hardware settings such as storage device configuration, overclocking settings, advanced power management, and boot device configuration that are needed for system startup in the motherboard CMOS. In normal circumstances, the default BIOS settings apply to most conditions to ensure optimal performance. **DO NOT change the default BIOS settings** except in the following circumstances:

- An error message appears on the screen during the system bootup and requests you to run the BIOS Setup.
- You have installed a new system component that requires further BIOS settings or update.



---

Inappropriate BIOS settings may result to instability or boot failure. **We strongly recommend that you change the BIOS settings only with the help of a trained service personnel.**

---



- When downloading or updating the BIOS file, rename it as **X370PRO.CAP** for this motherboard.
  - BIOS settings and options may vary due to different BIOS release versions. Please refer to the latest BIOS version for settings and options.
-

## 3.2 BIOS setup program

Use the BIOS Setup to update the BIOS or configure its parameters. The BIOS screen include navigation keys and brief onscreen help to guide you in using the BIOS Setup program.

### Entering BIOS at startup

To enter BIOS Setup at startup, press <Delete> or <F2> during the Power-On Self Test (POST). If you do not press <Delete> or <F2>, POST continues with its routines.

### Entering BIOS Setup after POST

To enter BIOS Setup after POST:

- Press <Ctrl>+<Alt>+<Delete> simultaneously.
- Press the reset button on the system chassis.
- Press the power button to turn the system off then back on. Do this option only if you failed to enter BIOS Setup using the first two options.

After doing either of the three options, press <Delete> key to enter BIOS.



- 
- The BIOS setup screens shown in this section are for reference purposes only, and may not exactly match what you see on your screen.
  - Ensure that a USB mouse is connected to your motherboard if you want to use the mouse to control the BIOS setup program.
  - If the system becomes unstable after changing any BIOS setting, load the default settings to ensure system compatibility and stability. Select the **Load Optimized Defaults** item under the **Exit** menu or press hotkey <F5>. See section **3.10 Exit Menu** for details.
  - If the system fails to boot after changing any BIOS setting, try to clear the CMOS and reset the motherboard to the default value. See section **1.1.6 Jumpers and Headers** for information on how to erase the RTC RAM via the Clear CMOS button.
  - The BIOS setup program does not support the Bluetooth devices.
- 

### BIOS menu screen

The BIOS Setup program can be used under two modes: **EZ Mode** and **Advanced Mode**. You can change modes from **Setup Mode** in **Boot menu** or by pressing the <F7> hotkey.

## 3.2.1 EZ Mode

By default, the EZ Mode screen appears when you enter the BIOS setup program. The EZ Mode provides you an overview of the basic system information, and allows you to select the display language, system performance, mode and boot device priority. To access the Advanced Mode, select **Advanced Mode** or press the <F7> hotkey for the advanced BIOS settings.



The default screen for entering the BIOS setup program can be changed. Refer to the **Setup Mode** item in section **Boot menu** for details.

The screenshot shows the ASUS UEFI BIOS Utility in EZ Mode. The interface is dark-themed with various system information panels. Red boxes and lines connect specific parts of the interface to descriptive callouts:

- Information Panel:** Displays system properties of the selected mode. Callout: "Displays the system properties of the selected mode. Click < or > to switch EZ System Tuning modes".
- Temperature and Voltage Panels:** Displays CPU/motherboard temperature, CPU voltage output, CPU/chassis/power fan speed, and SATA information. Callout: "Displays the CPU/motherboard temperature, CPU voltage output, CPU/chassis/power fan speed, and SATA information".
- Language Selection:** Callout: "Selects the display language of the BIOS setup program".
- EZ System Tuning:** Callout: "Displays the CPU Fan's speed. Click the button to manually tune the fans".
- Boot Priority:** Callout: "Click to go to Advanced mode".
- Default(F5) / Save & Exit(F10):** Callout: "Saves the changes and resets the system".
- Advanced Mode(F7):** Callout: "Click to display boot devices".
- Search of FAQ:** Callout: "Search on the FAQ".
- Boot Menu(F8):** Callout: "Selects the boot device priority".
- Q-Fan Control:** Callout: "Loads optimized default settings".



The boot device options vary depending on the devices you installed to the system.

### 3.2.2 Advanced Mode

The Advanced Mode provides advanced options for experienced end-users to configure the BIOS settings. The figure below shows an example of the Advanced Mode. Refer to the following sections for the detailed configurations.



To switch from EZ Mode to Advanced Mode, click **Advanced Mode(F7)** or press the <F7> hotkey.

The screenshot shows the BIOS Advanced Mode interface. The top bar includes the time (01:34), language (English), MyFavorite(F3), Qfan Control(F6), and Hot Keys. A menu bar at the top lists: My Favorites, Main, AI Tweaker, **Advanced**, Monitor, Boot, Tool, and Exit. The main area is titled 'Advanced SATA Configuration' and lists various SATA ports (SATA0\_0 to SATA0\_6) with their status (e.g., Disabled, Enabled, Empty). A pop-up menu is open over the SATA0\_0 'Enabled' status, showing options for 'Disabled' and 'Enabled', with 'Enabled' selected. On the right, a 'Hardware Monitor' panel displays CPU frequency (3100 MHz), temperature (45°C), APU frequency (80.0 MHz), and core voltage (1.373 V). Below it, the 'Memory' section shows frequency (2133 MHz) and voltage (1.200 V). The 'Voltage' section shows +12V (12.095 V), +5V (5.688 V), +3.3V (3.287 V), and -1.2V (3.287 V). At the bottom, there is a footer with 'Version 2.17.1246, Copyright (C) 2016 American Megatrends, Inc.', 'Last Modified', 'EZ Mode(F7)', and 'Search on FAQ'.

Labels in the image point to the following features:

- Pop-up Menu
- Configuration fields
- Menu bar
- Language
- MyFavorite(F3)
- Qfan Control(F6)
- Hot Keys
- Scroll bar
- Menu items
- General help
- Last modified settings
- Go back to EZ Mode
- Search on the FAQ

Displays the CPU temperature, CPU, and memory voltage output

## Menu bar

The menu bar on top of the screen has the following main items:

<b>My Favorites</b>	For saving the frequently-used system settings and configuration.
<b>Main</b>	For changing the basic system configuration
<b>Ai Tweaker</b>	For changing the overclocking settings
<b>Advanced</b>	For changing the advanced system settings
<b>Monitor</b>	For displaying the system temperature, power status, and changing the fan settings.
<b>Boot</b>	For changing the system boot configuration
<b>Tool</b>	For configuring options for special functions
<b>Exit</b>	For selecting the exit options and loading default settings

## Menu items

The highlighted item on the menu bar displays the specific items for that menu. For example, selecting **Main** shows the Main menu items.

The other items (My Favorites, Ai Tweaker, Advanced, Monitor, Boot, Tool, and Exit) on the menu bar have their respective menu items.

## Submenu items

A greater than sign (>) before each item on any menu screen means that the item has a submenu. To display the submenu, select the item and press <Enter>.

## Language

This button above the menu bar contains the languages that you can select for your BIOS. Click this button to select the language that you want to display in your BIOS screen.

## My Favorites (F3)

This button above the menu bar shows all BIOS items in a Tree Map setup. Select frequently-used BIOS settings and save it to MyFavorites menu.



---

Refer to section **3.3 My Favorites** for more information.

---

## Q-Fan Control (F6)

This button above the menu bar displays the current settings of your fans. Use this button to manually tweak the fans to your desired settings.



---

Refer to section **3.2.3 QFan Control** for more information.

---

## Search on FAQ

Move your mouse over this button to show a QR code, scan this QR code on your mobile device to connect to the BIOS FAQ web page of the ASUS support website. You can also scan the following QR code:



## Hot keys

This button above the menu bar contains the navigation keys for the BIOS setup program. Use the navigation keys to select items in the menu and change the settings.

## Scroll bar

A scroll bar appears on the right side of a menu screen when there are items that do not fit on the screen. Press the Up/Down arrow keys or <Page Up> / <Page Down> keys to display the other items on the screen.

## General help

At the bottom of the menu screen is a brief description of the selected item. Use <F12> key to capture the BIOS screen and save it to the removable storage device.

## Configuration fields

These fields show the values for the menu items. If an item is user-configurable, you can change the value of the field opposite the item. You cannot select an item that is not user-configurable.

A configurable field is highlighted when selected. To change the value of a field, select it and press <Enter> to display a list of options.

## Last Modified button

This button shows the items that you last modified and saved in BIOS Setup.

### 3.2.3 QFan Control

The QFan Control allows you to set a fan profile or manually configure the operating speed of your CPU and chassis fans.

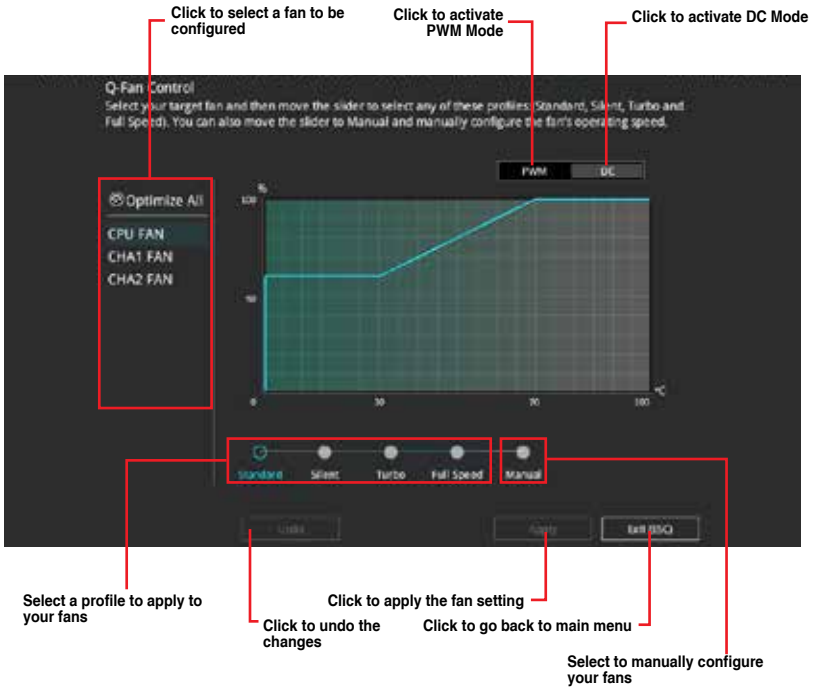

## Configuring fans manually

Select **Manual** from the list of profiles to manually configure your fans' operating speed.

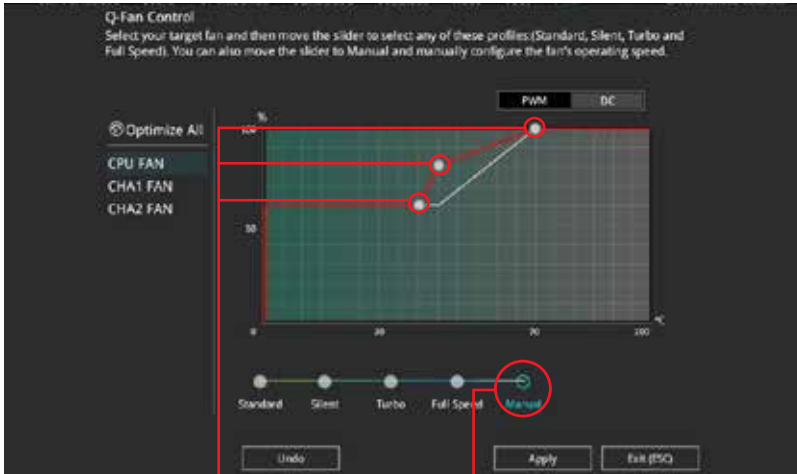

Speed points

Select to manually  
configure your fans

To configure your fans:

1. Select the fan that you want to configure and to view its current status.
2. Click and drag the speed points to adjust the fans' operating speed.
3. Click **Apply** to save the changes then click **Exit (ESC)**.



### 3.3 My Favorites

My Favorites is your personal space where you can easily save and access your favorite BIOS items. My Favorites comes with several performance, power saving, and fast boot related items by default. You can personalize this screen by adding or removing items.

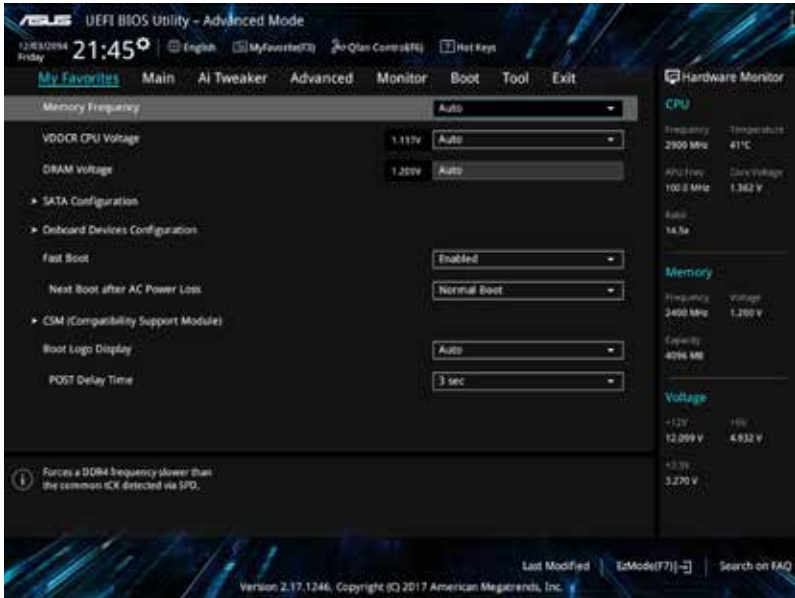

## Adding items to My Favorites

To add BIOS items:

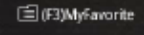
1. Press <F3> on your keyboard or click  from the BIOS screen to open Setup Tree Map screen.
2. On the Setup Tree Map screen, select the BIOS items that you want to save in My Favorites screen.

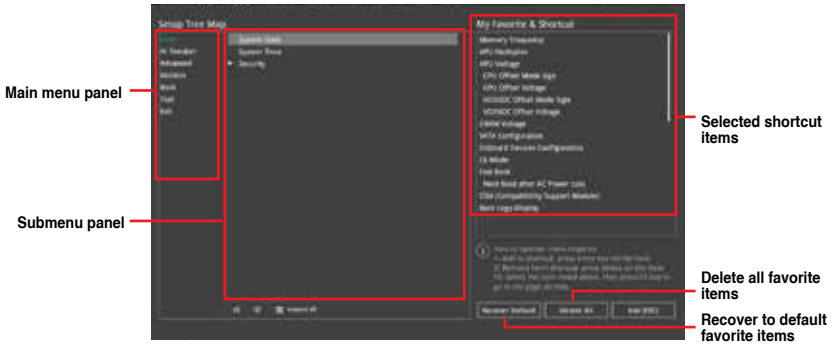

3. Select an item from main menu panel, then click the submenu that you want to save as favorite from the submenu panel and click  or press <Enter> on your keyboard.



You cannot add the following items to My Favorite items:

- Items with submenu options
- User-managed items such as language and boot order
- Configuration items such as Memory SPD Information, system time and date.

4. Click **Exit (ESC)** or press <Esc> key to close Setup Tree Map screen.
5. Go to My Favorites menu to view the saved BIOS items.

## 3.4 Main menu

The Main menu screen appears when you enter the Advanced Mode of the BIOS Setup program. The Main menu provides you an overview of the basic system information, and allows you to set the system date, time, language, and security settings.

### Security

The Security menu items allow you to change the system security settings.



- If you have forgotten your BIOS password, erase the CMOS Real Time Clock (RTC) RAM to clear the BIOS password. See section 1.1.6 **Jumpers and Headers** for information on how to erase the RTC RAM via the Clear CMOS button.
- The Administrator or User Password items on top of the screen show the default **[Not Installed]**. After you set a password, these items show **[Installed]**.

## 3.5 Ai Tweaker menu

The Extreme Tweaker menu items allow you to configure overclocking-related items.



Be cautious when changing the settings of the Extreme Tweaker menu items. Incorrect field values can cause the system to malfunction

### Ai Overclock Tuner



The configuration options for this section vary depending on the CPU and memory modules you installed on the motherboard.

Allows you to select the CPU overclocking options to achieve the desired CPU internal frequency. Configuration options:

[Auto]	Loads the optimal settings for the system.
[Manual]	Allows you to individually set overclocking parameters.
[D.O.C.P.]	If you install memory modules supporting the eXtreme Memory Profile (X.M.P.) Technology, choose this item to set the profiles supported by your memory modules for optimizing the system performance.



The [D.O.C.P.] configuration option appears only when you install memory modules supporting the eXtreme Memory Profile(X.M.P.) Technology.

### APU Frequency

This item allows you to set the APU frequency to enhance the system performance. Use the <+> or <-> to adjust the value. The values range from 90.0 MHz to 300.0 MHz.



We recommend you to set the value based on the CPU specification, as high APU frequencies may damage the CPU permanently.



This item appears only when you install an AMD 7<sup>th</sup> Generation A-series/Athlon™ processor.

## Memory Frequency



---

The configuration options displayed vary depending on the CPU installed.

---

This item allows you to set the memory operating frequency. The configurable options vary with the BCLK (base clock) frequency setting. Select the auto mode to apply the optimized setting. Configuration options: [Auto] [DDR4-1333MHz] - [DDR4-3200MHz]

## APU Multiplier [Auto]



---

This item appears only when you install an AMD 7<sup>th</sup> Generation A-series/Athlon™ processor.

---

Allows you to set the multiplier between the APU Core Clock and the APU Bus Frequency. Use the <+> and <-> keys to adjust the value. You can also key in the desired value using the numeric keypad.

## Custom CPU Core Ratio [Auto]



---

This item appears only when you install an AMD Ryzen™ processor.

---

Allows you to set the CPU core ratio automatically or manually. When you set this item to [Manual], the CPU frequency equals (FID/DID) x 200. Configuration options: [Auto] [Manual]

### CPU Core Ratio [Auto]

This item appears when you set **Custom CPU Core Ratio** to [Auto]. Use the <+> and <-> keys to adjust the value. You can also key in the desired value using the numeric keypad.

### FID [Auto]

This item appears when you set **Custom CPU Core Ratio** to [Manual]. Use the <+> and <-> keys to adjust the value. You can also key in the desired value using the numeric keypad. The values range from 16 to 255.

### DID [Auto]

This item appears when you set **Custom CPU Core Ratio** to [Manual]. Use the <+> and <-> keys to adjust the value. You can also key in the desired value using the numeric keypad. The values range from 8 to 48.

## EPU Power Saving Mode [Disabled]

Allows you to enable or disable the EPU power saving function.

Configuration options: [Disabled] [Enabled]

## TPU

This item allows you to automatically overclock the CPU and DRAM frequencies and voltage for an enhanced system performance.

[Keep Current Settings]      Keep the current settings without changing anything.

[TPU I ]                          Applies air cooling overclocking conditions.

[TPU II ]                         Applies water cooling overclocking conditions.



---

Ensure to use water cooling device before selecting [TPU II].

---

## DRAM Timing Control

The sub-items in this menu allow you to set the DRAM timing control features. Use the <+> and <-> keys to adjust the value. To restore the default setting, type [auto] using the keyboard and press <Enter>.



---

Changing the values in this menu may cause the system to become unstable! If this happens, revert to the default settings.

---

## TDP Configuration



---

This item appears only when you install an AMD 7<sup>th</sup> Generation A-series/Athlon™ processor.

---

This item allows you to configure TDP.

### Target TDP [Auto]

This item allows you to configure the target TDP. Use the <+> and <-> keys to adjust the value. The value ranges from 45 to 65. To restore the default setting, type [auto] using the keyboard and press <Enter>.

## DIGI+ VRM

### VDDCR Load-Line Calibration [Auto]

Load-line is defined by AMD VRM specification and affects the CPU power voltage. The CPU working voltage will decrease proportionally depending on the CPU loading. Higher levels of the load-line calibration can get a higher voltage and a better overclocking performance but increases the CPU and VRM thermal. Configuration options: [Auto][Level 1] [Level 2] ~ [Level 7] [Level 8]



- The boosted performance may vary depending on the CPU specification. Do not remove the thermal module.
  - The configuration levels vary depending on the CPUs installed.
- 

### VDDCR Current Capability [100%]

Allows you to configure the total power range, and extends the overclocking frequency range simultaneously. Configuration options: [100%] [110%] [120%] [130%] [140%]



---

Choose a higher value when overclocking, or under a high CPU loading for extra power support.

---

### VDDCR CPU Switching Frequency [Auto]

This item affects the VRM transient response speed and the component thermal production. Select [Manual] to configure a higher frequency for a quicker transient response speed. Configuration options: [Auto] [Manual]



---

DO NOT remove the thermal module. The thermal conditions should be monitored.

---



---

The following item appears only when you set the **VDDCR CPU Switching Frequency** to **[Manual]**.

---

### **Fixed VDDCR CPU Switching Frequency (KHz) [300]**

This item allows you to set a higher frequency for a quicker transient response speed. Use the <+> and <-> keys to adjust the value. The values range from 300KHz to 600KHz with a 50KHz interval.

### **VRM Spread Spectrum [Off]**

Enable this item to reduce the peak noise or disable it when overclocking.  
Configuration options: [On] [Off]

### **VDDCR CPU Power Duty Control [T.Probe]**

DIGI + VRM Duty control adjusts the current and thermal conditions of every component's phase.

[T. Probe] Select to maintain the VRM thermal balance.

[Extreme] Select to maintain the current VRM balance.

### **VDDCR CPU Power Phase Control [Standard]**

This item allows you to set the power phase control of the CPU. Configuration options: [Standard] [Optimized] [Extreme] [Manual]



---

The following item appears only when you set the **VDDCR CPU Power Phase Control** to **[Manual]**.

---

### **Manual Adjustment [Fast]**

This item allows you to set a faster phase response for the CPU to increase system performance or to slower phase response to decrease DRAM power efficiency.  
Configuration options: [Ultra Fast] [Fast] [Medium] [Regular]

### **VDDCR SOC Load Line Calibration [Auto]**

Load-line is defined by AMD VRM specification and affects the GT power voltage. The GT working voltage will decrease proportionally depending on the GT loading. Higher levels of the load-line calibration can get a higher voltage and a better overclocking performance but increases the GT and VRM thermal. Select from level 1 to 8 to adjust the GT power voltage from 0% to 100%. Configuration options: [Auto] [Level 1] [Level 2] ~ [Level 7] [Level 8]



- The boosted performance may vary depending on the GT specification. Do not remove the thermal module.
  - The configuration levels vary depending on the CPUs installed.
- 

### **VDDCR SOC Current Capability [100%]**

Allows you to configure the total power range, and extends the overclocking frequency range simultaneously. Configuration options: [100%] [110%] [120%] [130%] [140%]



Choose a higher value when overclocking, or under a high GT loading for extra power support.

---

### VDDCR SOC Switching Frequency [Auto]

The switching frequency will affect the GT transient response speed and the component thermal production. Select [Manual] to configure a higher frequency for a quicker transient response speed. Configuration options: [Auto] [Manual]



DO NOT remove the thermal module. The thermal conditions should be monitored.



The following item appears only when you set the **VDDCR SOC Switching Frequency** to [Manual].

### Fixed VDDCR SOC Switching Frequency (KHz) [300]

This item allows you to set a higher frequency for a quicker transient response speed. Use the <+> and <-> keys to adjust the value. The values range from 300KHz to 600KHz with a 50KHz interval.

### VCCDR SOC Power Phase Control [Standard]

This item allows you to set the power phase control of GT. Configuration options: [Standard] [Optimized] [Extreme] [Manual]



DO NOT remove the thermal module when setting this item to [Extreme] . The thermal conditions should be monitored.



The following item appears only when you set the **VDDCR SOC Power Phase Control** to [Manual].

### Manual Adjustment [Fast]

This item allows you to set a faster phase response for the CPU to increase system performance or to slower phase response to decrease DRAM power efficiency. Configuration options: [Ultra Fast] [Fast] [Medium] [Regular]

### VDDCR CPU Voltage [Auto]

This item allows you to configure the amount of voltage fed to the CPU cores. Increase the voltage when setting a high Core Frequency value. Configuration options: [Auto] [Manual] [Offset]



- The following item appears only when you set the VDDCR CPU Voltage to [Manual].
- [Offset] is available for some specific CPU types.

### VDDCR CPU Voltage Override [Auto]

Allows you to set the CPU Core Voltage override. Use the <+> or <-> keys to adjust the value. The values range from 0.75V to 2.0V with a 0.00625V interval.

### VDDCR CPU Offset Mode Sign [+]

- [+] To offset the voltage by a positive value.
- [-] To offset the voltage by a negative value.

### **VDDCR CPU Offset Voltage [Auto]**

Allows you to set the VDDCR CPU Offset Voltage. Use the <+> or <-> keys to adjust the value. The values range from 0.00625V to 0.50000V with a 0.00625V interval.

### **VDDCR SOC Voltage [Auto]**

Allows you to set the VDDCR SOC Voltage. Configuration options: [Auto] [Manual] [Offset].

### **VDDCR SOC Voltage Override [Auto]**

This item appears only when you set VDDCR SOC Voltage to [Manual] and allows you to set the CPU Core Voltage override. Use the <+> or <-> keys to adjust the value. The values range from 0.75V to 1.8V with a 0.00625V interval.

### **VDDCR SOC Offset Mode Sign [+]**

[+] To offset the voltage by a positive value.

[-] To offset the voltage by a negative value.

### **VDDCR SOC Offset Voltage [Auto]**

Allows you to set the VDDCR SOC Offset Voltage. Use the <+> or <-> keys to adjust the value. The values range from 0.00625V to 0.50000V with a 0.00625V interval.

### **DRAM Voltage [Auto]**

This item allows you to set the voltage for the DRAM. Use the <+> and <-> keys to adjust the value. The values range from 1.20V to 1.35V with a 0.005 interval when using an AMD 7<sup>th</sup> generation A-series/Athlon™ Processor; from 1.20V to 1.8V with a 0.005 interval when using an AMD Ryzen™ Processor.

### **1.05V SB Voltage [Auto]**

This item allows you to set the voltage for the 1.05V SB voltage. Use the <+> and <-> keys to adjust the value. The values range from 1.05V to 1.1V with a 0.05V interval.

### **2.5V SB Voltage [Auto]**

This item allows you to set the voltage for the 2.5V SB voltage. Use the <+> and <-> keys to adjust the value. The values range from 2.5V to 2.55V with a 0.05V interval.

### **VDDP Voltage [Auto]**

This item allows you to set the voltage for the VDDP voltage. Use the <+> and <-> keys to adjust the value. The values range from 1.05V to 1.2V with a 0.05V interval.

### **CPU 1.80V Voltage [Auto]**

This item allows you to set the voltage for the APU 1.80V voltage. Use the <+> and <-> keys to adjust the value. The values range from 1.80V to 2.2V with a 0.005 interval.

### **VTTDDR Voltage [Auto]**

This item allows you to set the voltage for the VTTDDR voltage. Use the <+> and <-> keys to adjust the value. The values range from 0.600V to 1/2VDDQ+0.2V with a 0.005V interval.



### **VPP\_MEM Voltage [Auto]**

This item allows you to set the voltage for the VPP\_MEM voltage. Use the <+> and <-> keys to adjust the value. The values range from 2.500V to 2.800V with a 0.005V interval.

### **VDDP Standby Voltage [Auto]**

This item allows you to set the voltage for the VDDP standby voltage. Use the <+> and <-> keys to adjust the value. The values range from 1.05V to 1.2V with a 0.005V interval when using an AMD 7<sup>th</sup> generation A-series/Athlon™ Processor; from 0.9V to 1.05V with a 0.005 interval when using an AMD Ryzen™ Processor..

## **3.6 Advanced menu**

The Advanced menu items allow you to change the settings for the CPU and other system devices.



Be cautious when changing the settings of the Advanced menu items. Incorrect field values can cause the system to malfunction.

### **TPM Device Selection**

Allows you to select the TPM device. You can select the Firmware TPM to enable the AMD CPU fTPM or select Discrete TPM to disable the AMD CPU fTPM. Configuration options: [Firmware TPM] [Discrete TPM]

#### **3.6.1 CPU Configuration**

The items in this menu show the CPU-related information that the BIOS automatically detects.



The items in this menu may vary based on the CPU installed.

### **PSS Support [Enabled]**

Enables or disables the generation of ACPI\_PPC, \_PSS, and \_PCT objects.

Configuration options: [Enabled] [Disabled]

### **NX Mode [Enabled]**

Enables or disables the No-execute page protection function.

Configuration options: [Enabled] [Disabled]

### **SVM [Enabled]**

Enables or disables CPU virtualization. Configuration options: [Disabled] [Enabled]

### **CPB Mode [Auto]**

Allows you to disable CPB mode function. Configuration options: [Enabled] [Disabled]

### **C6 Mode [Enabled]**

Enables or disables C6 mode function. Configuration options: [Disabled] [Enabled]

### **IOMMU [Enabled]**

Enables or disables IOMMU support. Configuration options: [Auto] [Disabled] [Enabled]

### **Bank Interleaving [Enabled]**

Enables or disables the bank memory interleaving. Configuration options: [Enabled] [Disabled]

### **Channel Interleaving [Enabled]**

Enables or disables the channel memory interleaving. Configuration options: [Enabled] [Disabled]

### **Core Leveling Mode [Automatic mode]**

Allows you to change the number of Compute Units on the system. Configuration options: [Automatic mode] [One core per processor] [One Compute Unit] [One core per Compute Unit]

## **3.6.2 NB Configuration**

### **IGFX Multi-Monitor [Disabled]**

Enables or disables the Internal Graphics Device Multi-Monitor support for add-on VGA devices. And the memory size of Internal Graphics Device will keep memory reserved. Configuration options: [Disabled] [Enabled]

### **Primary Video Device [PCIe / PCI Video]**

Selects the primary display device. Configuration options: [IGFX Video] [PCIe / PCI Video]

### **UMA Frame Buffer Size [Auto]**

This item appears only when you set the previous item to [Force] and allows you to set the UMA Frame Buffer Size. Configuration options: [Auto] [32M] [64M] [128M] ~ [2G]



---

**NB Configuration** function is not support when using an AMD Ryzen™ processor.

---

## **3.6.3 SATA Configuration**

### **Hyper kit Mode [Disabled]**

Enables or disables the hyper kit mode. Disables this option for M.2 devices or enables this option for ASUS Hyper kit card. Configuration options: [Disabled] [Enabled]

### **SATA Port Enable [Enabled]**

Enables or disables the serial ATA. . Configuration options: [Disabled] [Enabled]

### **SATA Mode Selection [AHCI]**

Allows you to set the SATA configuration.

- |        |  |
|--------|--|
| [AHCI] | Set to [AHCI] when you want the SATA hard disk drives to use the AHCI (Advanced Host Controller Interface). The AHCI allows the onboard storage driver to enable advanced Serial ATA features that increases storage performance on random workloads by allowing the drive to internally optimize the order of commands. |
| [RAID] | Set to [RAID Mode] when you want to create a RAID configuration from the SATA hard disk drives.  |

## SMART Self Test

SMART (Self-Monitoring, Analysis and Reporting Technology) is a monitoring system that shows a warning message during POST (Power-on Self Test) when an error occurs in the hard disks. Configuration options: [On] [Off]

## SATA6G\_1~8 Hot-Plug [Enabled]

Allows you to enable/disable the SATA6G\_1~8 hot-plug port(s). Configuration options: [Disabled] [Enabled]

## 3.6.4 Onboard Devices Configuration

The items in this menu allow you to switch between PCIe Lanes and configure onboard devices.

### HD Audio Controller [Enabled]

This item allows you to use the Azalia High Definition Audio Controller. Configuration options: [Disabled] [Enabled]

### PCIEX16\_3 4X-2X Switch [Auto]

This item allows you to select the bandwidth of the PCIEX16\_3 slot. Configuration options: [Auto] [2X] [4X]

### Asmedia USB 3.1 Controller [Enabled]

[Enabled] Enables the USB 3.1 controller.  
[Disabled] Disables the controller.

### RGB LED lighting [On]

This item allows you to turn the RGB LED lighting on or off.  
Configuration options: [On] [Off]

### In sleep, hibernate and soft off states [On]

This item appears when you set RGB LED light to [Enabled].  
[On] LEDs will light up in S3 (sleep), S4 (hibernate) and S5 (soft off) states.  
[Off] LEDs will not light up in S3 (sleep), S4 (hibernate) and S5 (soft off) states.

### Intel LAN Controller [On]

This item allows you to enable or disable the Intel LAN controllers.  
Configuration options: [On] [Off]

### Intel LAN OPROM [Off]

This item appears only when you set the previous item to [On] and allows you to enable or disable the PXE OptionRom of the Intel LAN controller. Configuration options: [On] [Off]

### Charging USB devices in Power State S5 [Disabled]

[Enabled] Charges USB devices even in when the system is in Power State S5.  
[Disabled] Disables this function.

### USB Type C Power Switch for USB3\_C7 [Auto]

[Enabled] For Type C power on.  
[Auto] Turn Off Type C power if the device is not supported.

## Serial Port Configuration

The sub-items in this menu allow you to set the serial port configuration.

### Serial Port [On]

Allows you to enable or disable the serial port (COM). Configuration options: [On] [Off]

### Change Settings [IO=3F8h; IRQ=4]

This item appears only when you set the **Serial Port** to [On] and allows you to select the Serial Port base address. Configuration options: [IO=3F8h; IRQ=4] [IO=2F8h; IRQ=3] [IO=3E8h; IRQ=4] [IO=2E8h; IRQ=3]

## 3.6.5 APM Configuration

The items in this menu allow you to set system wake and sleep settings.

### ErP Ready [Disabled]

This item allows you to switch off some power at S4+S5 or S5 to get the system ready for ErP requirement. When set to **[Enabled]**, all other PME options are switched off.

Configuration options: [Disabled] [Enable(S4+S5)] [Enable(S5)]

### Restore AC Power Loss [Power Off]

[Power On] The system goes into on state after an AC power loss.

[Power Off] The system goes into off state after an AC power loss.

[Last State] The system goes into either off or on state, whatever the system state was before the AC power loss.

### Power On By PCI-E/PCI [Disabled]

This item allows you to enable or disable the Wake-on-LAN function of the onboard LAN controller or other installed PCIe/PCI LAN cards. Configuration options: [Disabled] [Enabled]

### Power On By Ring [Disabled]

[Disabled] Disables Ring to generate a wake event.

[Enabled] Enables Ring to generate a wake event.

### Power On By RTC [Disabled]

[Disabled] Disables RTC to generate a wake event.

[Enabled] When set to [Enabled], the items **RTC Alarm Date (Days)** and **Hour/Minute/Second** will become user-configurable with set values.

## 3.6.6 Network Stack

### Network Stack [Disabled]

This item allows user to disable or enable the UEFI network stack. Configuration options: [Disabled] [Enabled]



---

The following two items appear only when you set the previous item to [Enabled].

---

### Ipv4 / Ipv6 PXE Support [Enabled]

This item allows you to enable or disable the Ipv4/Ipv6 PXE wake event. Configuration options: [Disabled] [Enabled]

### 3.6.7 HDD/SSD SMART Information

This menu displays the SMART information of the connected devices.



---

NVM Express devices do not support SMART information.

---

### 3.6.8 USB Configuration

The items in this menu allow you to change the USB-related features.

#### Legacy USB Support [Enabled]

[Enabled] Enables the support for USB devices on legacy operating systems (OS).

[Disabled] The USB devices can be used only for the BIOS setup program.

[Auto] Allows the system to detect the presence of USB devices at startup. If detected, the USB controller legacy mode is enabled. If no USB device is detected, the legacy USB support is disabled.

#### XHCI Hand-off [Disabled]

[Enabled] Enables the support for operating systems without an XHCI hand-off feature.

[Disabled] Disables the function.

#### USB Device Enable [Enabled]

Allows you to enable or disable all USB ports. Configuration options: [Disabled] [Enabled]



---

The **Mass Storage Devices** item shows the auto-detected values. If no USB device is detected, the item shows **None**.

---

#### USB Single Port Control

Allows you to enable/disable individual USB ports.

##### USB3\_1/2/3/4/5/9/10/C7 [Enabled]

Allows you to enable or disable an individual USB 3.0 port. Refer to the section **1.1.2 Motherboard layout** in this user manual for the locations of the USB ports. Configuration options: [Enabled] [Disabled].

##### USB3.1\_C1 [Enabled]

Allows you to enable or disable an individual USB 3.1 port. Refer to the section **1.1.2 Motherboard layout** in this user manual for the locations of the USB ports. Configuration options: [Enabled] [Disabled].

##### USB1~4[Enabled]

Allows you to enable or disable an individual USB port. Refer to the section **1.1.2 Motherboard layout** in this user manual for the locations of the USB ports.

### 3.6.9 AMD CBS

The items in this menu display the CPU-related information that the BIOS automatically detects.



---

This item appears only when you install an AMD Ryzen™ processor.

---

## 3.7 Monitor menu

The Monitor menu displays the system temperature/power status, and allows you to change the fan settings.

### Qfan Configuration

#### Q-Fan Tuning

Click [OK] button to detect the lowest speed and configure the minimum duty circle for each fan. Do not shut down or reset your system during the tuning progress.

Configuration options: [Ok] [Cancel]

#### CPU Q-Fan Control [Auto]

[Auto] Enables the CPU Q-Fan control for 4-pin CPU fan.

[Disabled] Disables the CPU Q-Fan control feature.

[DC Mode] Enable the CPU Q-Fan control in DC mode for 3-pin CPU fan.

[PWM Mode] Enable the CPU Q-Fan control in PWM mode for 4-pin CPU fan.

#### CPU Fan Speed Lower Limit [200 RPM]

This item appears only when you enable the CPU Q-Fan Control feature and allows you to disable or set the CPU fan warning speed. Configuration options: [Ignore]

[200RPM] [300 RPM] [400 RPM] [500 RPM] [600RPM]

#### CPU Fan Profile [Standard]

This item appears only when you enable the CPU Q-Fan Control feature and allows you to set the appropriate performance level of the CPU fan.

[Standard] Sets to [Standard] to make the CPU fan automatically adjust depending on the CPU temperature.

[Silent] Sets to [Silent] to minimize the fan speed for quiet CPU fan operation.

[Turbo] Sets to [Turbo] to achieve maximum CPU fan speed.

[Manual] Sets to [Manual] to assign detailed fan speed control parameters.



---

The following six items appear only when you set **CPU Fan Profile** to [Manual].

---

#### CPU Upper Temperature [70]

Use the <+> and <-> keys to adjust the upper limit of the CPU temperature. The values range from 25°C to 75°C.

#### CPU Fan Max. Duty Cycle(%) [100]

Use the <+> and <-> keys to adjust the maximum CPU fan duty cycle. The values range from 20% to 100%. When the CPU temperature reaches the upper limit, the CPU fan will operate at the maximum duty cycle.

#### CPU Middle Temperature [45]

Use the <+> or <-> keys to set the value for CPU Middle Temperature. The range of the values depends on the CPU installed.

#### CPU Fan Middle Duty Cycle(%) [60]

Use the <+> or <-> keys to adjust the CPU fan middle duty cycle. The values range from 20% to 100%. When the CPU temperature reaches the upper limit, the CPU fan operates at the maximum duty cycle.

**CPU Lower Temperature [40]**

Use the <+> or <-> keys to adjust the CPU fan's lower temperature. The values range from 0°C to 75°C.

**CPU Fan Min. Duty Cycle(%) [60]**

Use the <+> and <-> keys to adjust the minimum CPU fan duty cycle. The values range from 20% to 100%. When the CPU temperature is under the lower limit, the CPU fan will operate at the minimum duty cycle.

**Chassis Fan(s) Configuration****Chassis Fan1/2 Q-Fan Control [Auto]**

[Disabled] Disables the chassis Q-Fan control feature.

[Auto] Enables the Chassis Q-Fan control for 4-pin Chassis fan.

[PWM mode] Enables the chassis Q-Fan control in PWM mode for 4-pin chassis fan.

[DC mode] Enables the chassis Q-Fan control in DC mode for 3-pin chassis fan.



---

The following items appear only when you set the Chassis Fan 1/2 Q-Fan Control to **[Auto]**, **[PWM Mode]** or **[DC Mode]**.

---

**Chassis Fan 1/2 Q-Fan Source [CPU]**

This item controls the assigned fan according to the selected temperature source. Configuration options: [CPU] [Motherboard] [VRM] [PCH] [T\_Sensor] [Multiple Sources]

**Chassis Fan 1/2 Speed Low Limit [600 RPM]**

This item allows you to disable or set the chassis fan warning speed. Configuration options: [Ignore] [200RPM] [300 RPM] [400 RPM] [500 RPM] [600 RPM]

**Chassis Fan 1/2 Profile [Standard]**

This item allows you to set the appropriate performance level of the chassis fan.

[Standard] Sets to [Standard] to make the chassis fan automatically adjust depending on the chassis temperature.

[Silent] Sets to [Silent] to minimize the fan speed for quiet chassis fan operation.

[Turbo] Sets to [Turbo] to achieve maximum chassis fan speed.

[Manual] Sets to [Manual] to assign detailed fan speed control parameters.



---

The following six items appear only when you set **Chassis Fan 1/2 Profile** to [Manual].

---

**Chassis Fan 1/2 Upper Temperature [70]**

Use the <+> or <-> keys to adjust the upper limit of the chassis temperature. The values range from 40°C to 75°C.

**Chassis Fan 1/2 Max. Duty Cycle(%) [100]**

Use the <+> or <-> keys to adjust the maximum chassis fan duty cycle. The values range from 60% to 100%. When the chassis temperature reaches the upper limit, the chassis fan will operate at the maximum duty cycle.

**Chassis Fan 1/2 Middle Temperature [45]**

Use the <+> or <-> keys to set the value for Chassis Fan Middle Temperature.

**Chassis Fan 1/2 Middle Duty Cycle(%) [60]**

Use the <+> or <-> keys to adjust the chassis fan middle duty cycle. The values range from 60% to 100%.

**Chassis Fan 1/2 Lower Temperature [40]**

Use the <+> or <-> keys to adjust the chassis fans' lower temperature. The values range from 40°C to 75°C.

**Chassis Fan 1/2 Min. Duty Cycle(%) [60]**

Use the <+> or <-> keys to adjust the minimum chassis fan duty cycle. The values range from 60% to 100%. When the chassis temperature is under the lower limit, the chassis fan operates at the minimum duty cycle.

**AIO\_PUMP/W\_PUMP+ Control [Disabled]**

Use the <+> and <-> keys to adjust the AIO\_PUMP/W\_PUMP+ control. The values range from 20% to 100%. When the AIO\_PUMP/W\_PUMP+ temperature is under the lower limit, the AIO\_PUMP/W\_PUMP+ fan will operate at the minimum duty cycle.

- [Auto] Enables the AIO\_PUMP/W\_PUMP+ control for 4-pin CPU fan.
- [Disabled] Disables the AIO\_PUMP/W\_PUMP+ control feature.
- [DC Mode] Enable the AIO\_PUMP/W\_PUMP+ control in DC mode for 3-pin AIO\_PUMP/W\_PUMP+ fan.
- [PWM Mode] Enable the AIO\_PUMP/W\_PUMP+ control in PWM mode for 4-pin AIO\_PUMP/W\_PUMP+ fan.



---

The following items appear only when you set the AIO\_PUMP/W\_PUMP+ Control to **[Auto]**, **[PWM Mode]** or **[DC Mode]**.

---

**AIO\_PUMP/W\_PUMP+ Upper Temperature [70]**

Use the <+> or <-> keys to adjust the upper limit of the AIO\_PUMP/W\_PUMP+ temperature. The values range from 40°C to 75°C.

**AIO\_PUMP/W\_PUMP+ Max. Duty Cycle(%) [100]**

Use the <+> or <-> keys to adjust the maximum AIO\_PUMP/W\_PUMP+ duty cycle. The values range from 60% to 100%. When the AIO\_PUMP/W\_PUMP+ temperature reaches the upper limit, the AIO\_PUMP/W\_PUMP+ fan will operate at the maximum duty cycle.

**AIO\_PUMP/W\_PUMP+ Middle Temperature [45]**

Use the <+> or <-> keys to set the value for AIO\_PUMP/W\_PUMP+ Middle Temperature.

**AIO\_PUMP/W\_PUMP+ Middle Duty Cycle(%) [60]**

Use the <+> or <-> keys to adjust the AIO\_PUMP/W\_PUMP+ middle duty cycle. The values range from 60% to 100%.

**AIO\_PUMP/W\_PUMP+ Lower Temperature [40]**

Use the <+> or <-> keys to adjust the AIO\_PUMP/W\_PUMP+' lower temperature. The values range from 40°C to 75°C.

**AIO\_PUMP/W\_PUMP+ Min. Duty Cycle(%) [60]**

Use the <+> or <-> keys to adjust the minimum AIO\_PUMP/W\_PUMP+ duty cycle. The values range from 60% to 100%. When the AIO\_PUMP/W\_PUMP+ temperature is under the lower limit, the AIO\_PUMP/W\_PUMP+ fan operates at the minimum duty cycle.



## 3.8 Boot menu

The Boot menu items allow you to change the system boot options.

### Fast Boot [Enabled]

[Disabled] Allows your system to go back to its normal boot speed.

[Enabled] Allows your system to accelerate the boot speed.



---

The following items appear only when you set the Fast Boot to **[Enabled]**.

---

### Next Boot after AC Power Loss

[Normal Boot] Returns to normal boot on the next boot after an AC power loss.

[Fast Boot] Accelerates the boot speed on the next boot after an AC power loss.

## Boot Configuration

### Boot Logo Display [Auto]

[Auto] Adjusts logo automatically based on Windows® display requirements.

[Full Screen] Maximize the boot logo size.

[Disabled] Hide the logo during POST.

### POST Delay Time [3 sec]

This item appears only when you set Boot Logo Display to [Auto] and [Full Screen].

This item allows you to select the desired additional POST waiting time to easily enter the BIOS setup. You can only execute the POST delay time during Normal Boot. The values range from 0 to 10 seconds.



---

This feature will only work under normal boot.

---

### Post Report [5 sec]

This item appears only when you set Boot Logo Display to [Disabled]. This item allows you to select a desired post report waiting time. Configuration options: [1 sec] ~ [10 sec] [Until Press ESC].

### Bootup NumLock State [Enabled]

This item allows you to enable or disable power-on state of the NumLock.

Configuration options: [Disabled] [Enabled]

### Wait for 'F1' If Error [Enabled]

When this item is set to [Enabled], the system waits for the F1 key to be pressed when error occurs. Configuration options: [Disabled] [Enabled]

### Option ROM Messages [Force BIOS]

[Force BIOS] The third-party ROM messages will be forced to display during the boot sequence.

[Keep Current] The third-party ROM messages will be displayed only if the third-party manufacturer had set the add-on device to do so.

### Interrupt 19 Capture [Disabled]

This item allows you to trap Interrupt 19 by the option ROMs. Configuration options: [Disabled] [Enabled]

**Setup Mode [EZ Mode]**

[Advanced Mode] This item allows you to go to Advanced Mode of the BIOS after POST.

[EZ Mode] This item allows you to go to EZ Mode of the BIOS after POST.

**CSM (Compatibility Support Module)**

This item allows you to configure the CSM (Compatibility Support Module) items to fully support the various VGA, bootable devices and add-on devices for better compatibility.

**Launch CSM [Enabled]**

[Auto] The system automatically detects the bootable devices and the add-on devices.

[Enabled] For better compatibility, enable the CSM to fully support the non-UEFI driver add-on devices or the Windows® UEFI mode.

[Disabled] Disable the CSM to fully support the non-UEFI driver add-on devices or the Windows® UEFI mode.



---

The following items appear only when you set the Launch CSM to **[Enabled]**.

---

**Boot Devices Control [UEFI and Legacy OPROM]**

This item allows you to select the type of devices that you want to boot. Configuration options: [UEFI and Legacy OPROM] [Legacy OPROM only] [UEFI only]

**Boot from Network Devices [Legacy only]**

This item allows you to select the type of network devices that you want to launch. Configuration options: [Ignore] [Legacy only] [UEFI driver first]

**Boot from Storage Devices [Legacy only]**

This item allows you to select the type of storage devices that you want to launch. Configuration options: [Ignore] [Legacy only] [UEFI driver first]

**Boot from PCI-E Expansion Devices [Legacy only]**

This item allows you to select the type of PCI-E expansion devices that you want to launch. Configuration options: [Legacy only] [UEFI driver first]

**Secure Boot**

This item allows you to configure the Windows® Secure Boot settings and manage its keys to protect the system from unauthorized access and malwares during POST.

**OS Type [Windows UEFI mode]**

Allows you to select your installed operating system.

[Windows UEFI mode] This item allows you to select your installed operating system. Execute the Microsoft® Secure Boot check. Only select this option when booting on Windows® UEFI mode or other Microsoft® Secure Boot compliant OS.

[Other OS]

Get the optimized function when booting on Windows® non-UEFI mode. Microsoft® Secure Boot only supports Windows® UEFI mode.

### **Key Management**

This allows you to manage the Secure Boot keys.

#### **Install Default Secure Boot keys**

This item allows you to clear all default Secure Boot keys.

#### **Save Secure Boot Keys**

This item allows you to save the PK (Platform Keys) to a USB storage device.

#### **PK Management**

The Platform Key (PK) locks and secures the firmware from any non-permissible changes. The system verifies the PK before your system enters the OS.

#### **Set New Key**

This item allows you to load the downloaded PK from a USB storage device.



---

The PK file must be formatted as a UEFI variable structure with time-based authenticated variable.

---

#### **Delete Key**

This item allows you to delete the PK from your system. Once the PK is deleted, all the system's Secure Boot keys will not be active.

#### **KEK Management**



---

Key-exchange Key (KEK) refers to Microsoft® Secure Boot Key-Enrollment Key (KEK).

---

#### **Delete Key**

Allows you to delete the KEK from your system.

Configuration options: [Yes] [No]

#### **Set New Key**

Allows you to load the downloaded KEK from a USB storage device.

#### **Append Key**

Allows you to load the additional KEK from a storage device for an additional db and dbx loaded management.



---

The KEK file must be formatted as a UEFI variable structure with time-based authenticated variable.

---

#### **DB Management**

##### **Delete Key**

Allows you to delete the db file from your system.

Configuration options: [Yes] [No]

##### **Set New Key**

Allows you to load the downloaded db from a USB storage device.

#### **Append Key**

Allows you to load the additional db from a storage device so that more images can be loaded securely.



---

The db file must be formatted as a UEFI variable structure with time-based authenticated variable. DBX Management

---

#### **DBX Management**

##### **Delete Key**

Allows you to delete the dbx file from your system.

##### **Set New Key**

Allows you to load the downloaded dbx from a USB storage device.

Configuration options: [Yes] [No]

##### **Append Key**

Allows you to load the additional dbx from a storage device so that more db's images cannot be loaded.



---

The dbx file must be formatted as a UEFI variable structure with time-based authenticated variable.

---

#### **Boot Option Priorities**

These items specify the boot device priority sequence from the available devices. The number of device items that appears on the screen depends on the number of devices installed in the system.



---

To select the boot device during system startup, press <F8> when the ASUS Logo appears.

---

#### **Boot Override**

These items displays the available devices. The number of device items that appears on the screen depends on the number of devices installed in the system. Click an item to start booting from the selected device.

## 3.9 Tool menu

The Tool menu items allow you to configure options for special functions. Select an item then press <Enter> to display the submenu.

### Setup Animator

This item allows you to enable or disable the Setup animator.

Configuration options: [Disabled] [Enabled]

### 3.9.1 ASUS EZ Flash 3 Utility

This item allows you to run ASUS EZ Flash 3. When you press <Enter>, a confirmation message appears. Use the left/right arrow key to select between [Yes] or [No], then press <Enter> to confirm your choice.



---

For more details, refer to section 3.11.2 **ASUS EZ Flash 3**.

---

### 3.9.2 ASUS Overclocking Profile

This item allows you to store or load multiple BIOS settings.

#### Load from Profile

This item allows you to load the previous BIOS settings saved in the BIOS Flash. Key in the profile number that saved your BIOS settings, press <Enter>, and then select **Yes**.



- DO NOT shut down or reset the system while updating the BIOS to prevent the system boot failure!
  - We recommend that you update the BIOS file only coming from the same memory/CPU configuration and BIOS version.
- 

#### Profile Name

This item allows you to key in a profile name.

#### Save to Profile

This item allows you to save the current BIOS settings to the BIOS Flash, and create a profile. Key in a profile number from one to eight, press <Enter>, and then select **Yes**.

#### Load/Save Profile from/to USB Drive

This item allows you to load or save profile from your USB drive, load and save profile to your USB drive.

### 3.9.3 ASUS SPD Information

This item allows you to view the DRAM SPD information.

## 3.10 Exit menu

The Exit menu items allow you to load the optimal default values for the BIOS items, and save or discard your changes to the BIOS items. You can access the EZ Mode from the Exit menu.

### Load Optimized Defaults

This option allows you to load the default values for each of the parameters on the Setup menus. When you select this option or if you press <F5>, a confirmation window appears. Select **OK** to load the default values.

### Save Changes & Reset

Once you are finished making your selections, choose this option from the Exit menu to ensure the values you selected are saved. When you select this option or if you press <F10>, a confirmation window appears. Select **OK** to save changes and exit.

### Discard Changes & Exit

This option allows you to exit the Setup program without saving your changes. When you select this option or if you press <Esc>, a confirmation window appears. Select **Yes** to discard changes and exit.

### Launch EFI Shell from filesystem device

This item allows you to attempt to launch the EFI Shell application (shellx64.efi) from one of the available filesystem devices.

## 3.11 Updating BIOS

The ASUS website publishes the latest BIOS versions to provide enhancements on system stability, compatibility, and performance. However, BIOS updating is potentially risky. If there is no problem using the current version of BIOS, DO NOT manually update the BIOS. Inappropriate BIOS updating may result to system's failure to boot. Carefully follow the instructions in this chapter to update your BIOS when necessary.



---

Visit <http://www.asus.com> to download the latest BIOS file for this motherboard.

---

The following utilities allow you to manage and update the motherboard BIOS setup program.

1. EZ Update: Updates the BIOS in Windows® environment.
2. ASUS EZ Flash 3: Updates the BIOS using a USB flash drive.
3. ASUS CrashFree BIOS 3: Restores the BIOS using the motherboard support DVD or a USB flash drive when the BIOS file fails or gets corrupted.

### 3.11.1 EZ Update

The EZ Update is a utility that allows you to update the motherboard BIOS in Windows® environment.



- EZ Update requires an Internet connection either through a network or an ISP (Internet Service Provider).
  - This utility is available in the support DVD that comes with the motherboard package.
-

### 3.11.2 ASUS EZ Flash 3

ASUS EZ Flash 3 allows you to download and update to the latest BIOS through the Internet without having to use a bootable floppy disk or an OS-based utility.



Updating through the Internet varies per region and Internet conditions. Check your local Internet connection before updating through the Internet.

#### To update the BIOS by USB:

1. Enter the Advanced Mode of the BIOS setup program. Go to the Tool menu to select **ASUS EZ Flash Utility** and press <Enter>.
2. Insert the USB flash disk that contains the latest BIOS file to the USB port.
3. Select **by USB**.

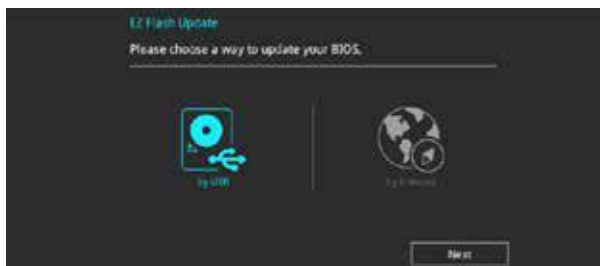

4. Press <Tab> to switch to the Drive field.
5. Press the Up/Down arrow keys to find the USB flash disk that contains the latest BIOS, and then press <Enter>.
6. Press <Tab> to switch to the Folder Info field.
7. Press the Up/Down arrow keys to find the BIOS file, and then press <Enter> to perform the BIOS update process. Reboot the system when the update process is done.







- This function can support devices such as a USB flash disk with FAT 32/16 format and single partition only.
- DO NOT shut down or reset the system while updating the BIOS to prevent system boot failure!



Ensure to load the BIOS default settings to ensure system compatibility and stability. Select the Load Optimized Defaults item under the Exit menu. See section **3.10 Exit Menu** for details.

### To update the BIOS by Internet:

1. Enter the Advanced Mode of the BIOS setup program. Go to the Tool menu to select **ASUS EZ Flash Utility** and press <Enter>.
2. Select **by Internet**.

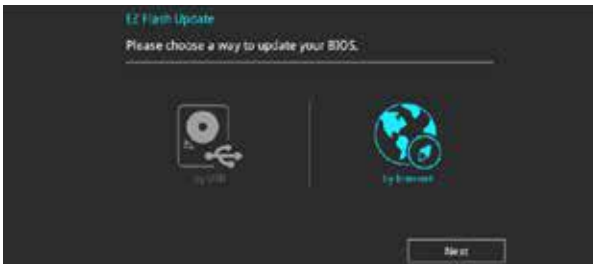

3. Press the Left/Right arrow keys to select an Internet connection method, and then press <Enter>.



4. Follow the onscreen instructions to complete the update.
5. Reboot the system when the update process is done.



Ensure to load the BIOS default settings to ensure system compatibility and stability. Select the Load Optimized Defaults item under the Exit menu. See section **3.10 Exit Menu** for details.

### 3.11.3 ASUS CrashFree BIOS 3

The ASUS CrashFree BIOS 3 utility is an auto recovery tool that allows you to restore the BIOS file when it fails or gets corrupted during the updating process. You can restore a corrupted BIOS file using the motherboard support DVD or a USB flash drive that contains the BIOS file.



---

The BIOS file in the motherboard support DVD may be older than the BIOS file published on the ASUS official website. If you want to use the newer BIOS file, download the file at <https://www.asus.com/support/> and save it to a USB flash drive.

---

#### Recovering the BIOS

##### To recover the BIOS:

1. Turn on the system.
2. Insert the motherboard support DVD to the optical drive, or the USB flash drive containing the BIOS file to the USB port.
3. The utility automatically checks the devices for the BIOS file. When found, the utility reads the BIOS file and enters ASUS EZ Flash 3 automatically.
4. The system requires you to enter BIOS Setup to recover the BIOS setting. To ensure system compatibility and stability, we recommend that you press <F5> to load default BIOS values.



---

**DO NOT** shut down or reset the system while updating the BIOS! Doing so can cause system boot failure!

---



# RAID Support

# 4

## 4.1 AMD RAID Array configurations

The motherboard supports RAID 0, RAID 1, and RAID 10 configurations.



If you want to install a Windows® operating system to a hard disk drive included in a RAID set, you have to create a RAID driver disk and load the RAID driver during OS installation. Refer to section 4.2 **Creating a RAID driver disk** for details.

### 4.1.1 RAID definitions

**RAID 0 (Data striping)** optimizes two identical hard disk drives to read and write data in parallel, interleaved stacks. Two hard disks perform the same work as a single drive but at a sustained data transfer rate, double that of a single disk alone, thus improving data access and storage. Use of two new identical hard disk drives is required for this setup.

**RAID 1 (Data mirroring)** copies and maintains an identical image of data from one drive to a second drive. If one drive fails, the disk array management software directs all applications to the surviving drive as it contains a complete copy of the data in the other drive. This RAID configuration provides data protection and increases fault tolerance to the entire system. Use two new drives or use an existing drive and a new drive for this setup. The new drive must be of the same size or larger than the existing drive.

**RAID 10** is data striping and data mirroring combined without parity (redundancy data) having to be calculated and written. With the RAID 10 configuration you get all the benefits of both RAID 0 and RAID 1 configurations. Use four new hard disk drives or use an existing drive and three new drives for this setup.

## 4.1.2 Installing Serial ATA hard disks

The motherboard supports Serial ATA hard disk drives. For optimal performance, install identical drives of the same model and capacity when creating a disk array.

To install the SATA hard disks for a RAID configuration:

1. Install the SATA hard disks into the drive bays.
2. Connect the SATA signal cables.
3. Connect a SATA power cable to the power connector on each drive.

## 4.1.3 Setting up RAID from RAIDXpert2 Configuration Utility in UEFI BIOS

You must enable the RAID function in the BIOS Setup before creating RAID set(s) using SATA hard disks :

1. Enter the BIOS Setup during POST.
2. Go to the **Advanced** menu > **SATA Configuration**, then press <Enter>.
3. Set the **SATA Configuration Mode Selection** item to **[RAID]**.
4. Go to the **Boot** menu > **CSM (Compatibility Support Module)** > **Launch CSM**, then set the item to **[Disabled]**.
5. Save your changes and exit the BIOS Setup, then enter the BIOS Setup again.
6. Go to the **Advanced** menu > **RAIDXpert2 Configuration Utility**, then press <Enter> to display the RAIDXpert2 configuration utility menu.



Refer to Chapter 3 for details on entering and navigating through the BIOS Setup.



Due to chipset limitation, when SATA ports are set to RAID mode, all SATA ports run at RAID mode together.

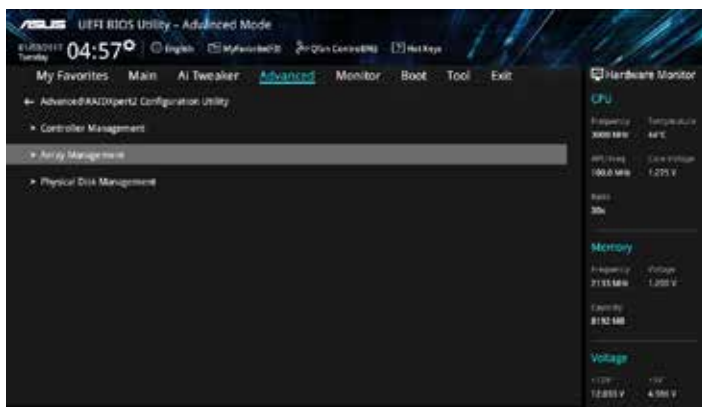

## Creating a RAID set

To create a RAID set:

1. From **RAIDXpert2 Configuration Utility > Array Management**, select **Create Array** and press <Enter>. The following screen appears:

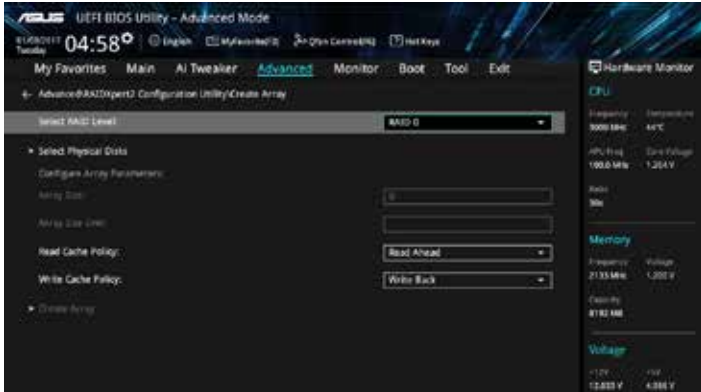

2. When the RAID Level item is selected, press <Enter> to select the RAID level to create, and then press <Enter>.
3. Under Select Physical Disks, press <Enter>. The following screen appears.

You can select SATA, SSD or both. Turn **ON** the disks you want to include in the RAID set and select **Apply Changes**, then press <Enter>.

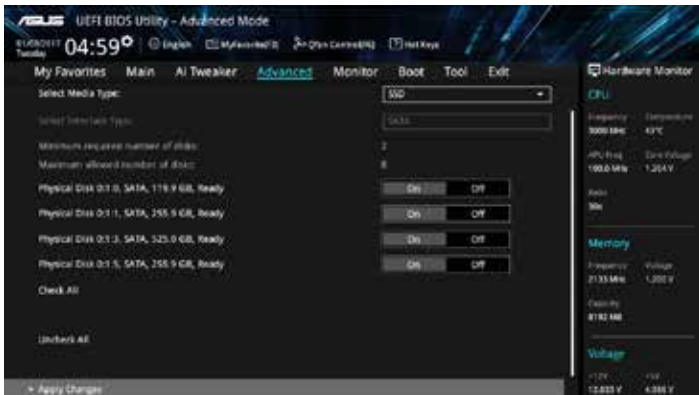

- When return to the RAIDXpert2 Configuration Utility menu, select the Array Size and other detailed policies, press <Enter>. Save changes when finish.



You can specify the array size to be created. Choosing the value 0 will set the maximum supported array size when a valid configuration is selected.

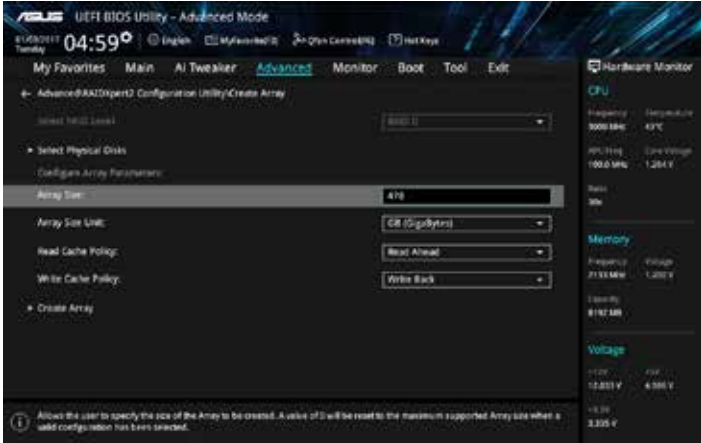

## Deleting a RAID set



Be cautious when deleting a RAID set. You will lose all data on the hard disk drives when you delete a RAID set.

To delete a RAID set:

- Select **RAIDXpert2 Configuration Utility > Delete Array** and press <Enter>. Select the Array you want to delete and select **Delete Array**, press <Enter>.

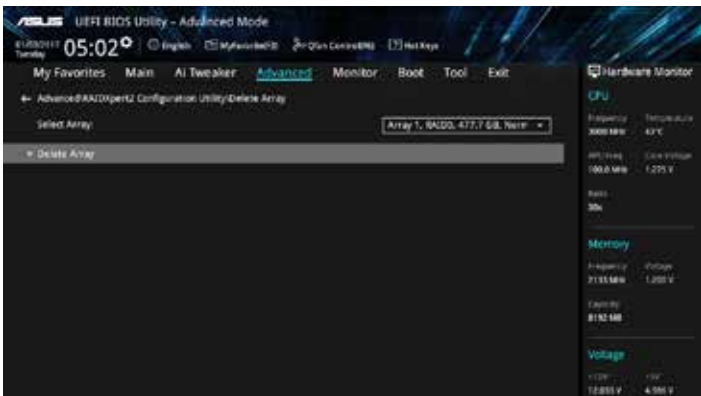

2. Select **On** to confirm your choice and then select **Yes** to delete the RAID Array and return to the **RAIDXpert2 Configuration Utility** menu, or select **No** to cancel.



#### 4.1.4 AMD RAID Array configuration in Option ROM utility

To enter the AMD RAID Array configuration Option ROM utility:

1. Turn on the system.
2. During POST, press **<Ctrl> + <R>** to display the utility main menu.

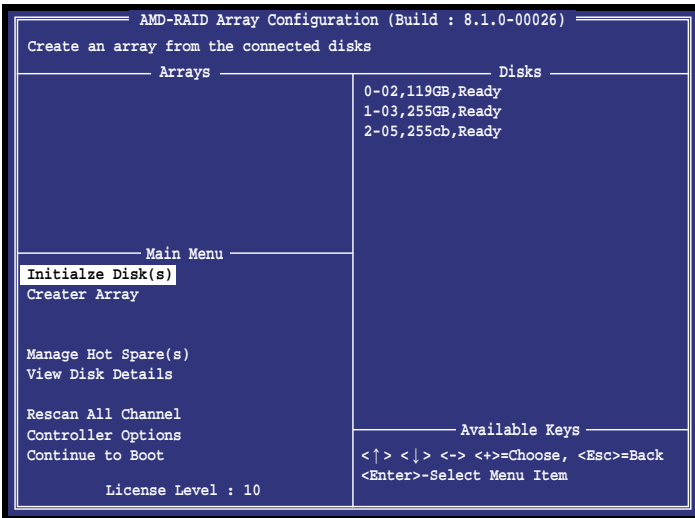



The navigation keys at the lower right corner of the screen allow you to move through the menus and select the menu options.



The RAID BIOS setup screens shown in this section are for reference only and may not exactly match the items on your screen.



The utility supports maximum four hard disk drives for RAID configuration.

## Creating a RAID set

To create a RAID set:

1. From the utility main menu, select **Create Array** and press <Enter>. The following screen appears. Press <Insert> to select Disks to use.

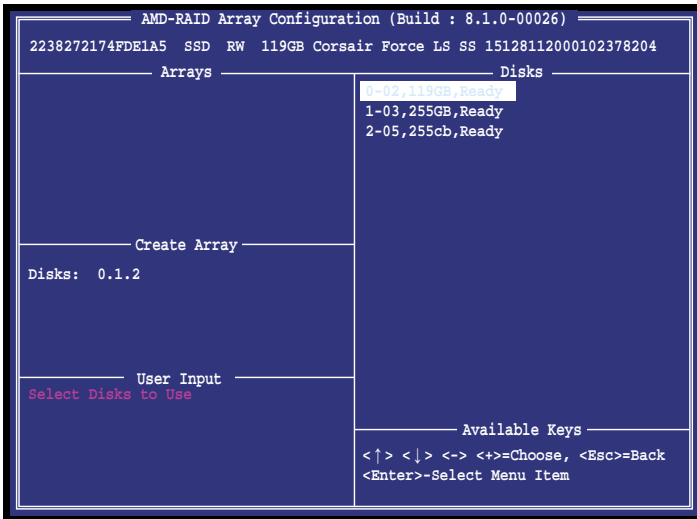

2. Press the arrow keys to select a RAID level to create, and then press <Enter>.

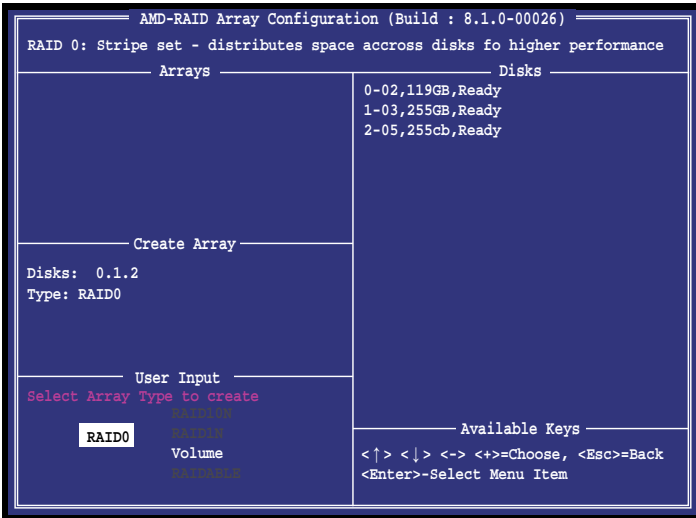

3. Use the arrow keys to select the strip size for the RAID array (for RAID 0, 1, 10), and then press <Enter>.

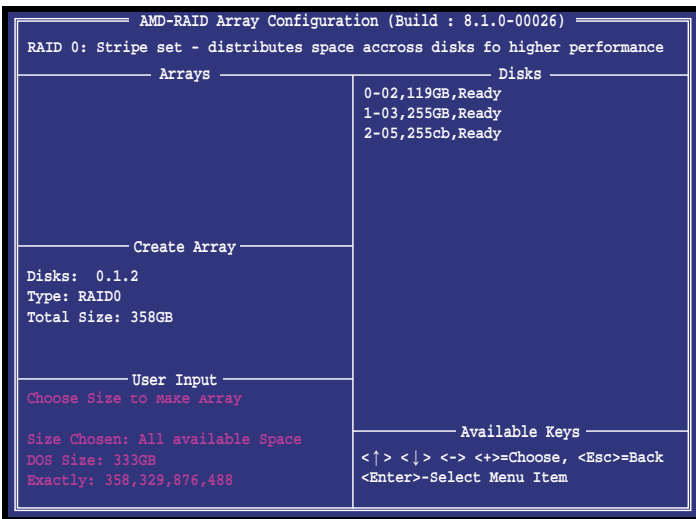

We recommend a lower strip size for server systems, and a higher strip size for multimedia computer systems used mainly for audio and video editing.

- Press the arrow keys to select a caching mode to create, and then press <Enter>.

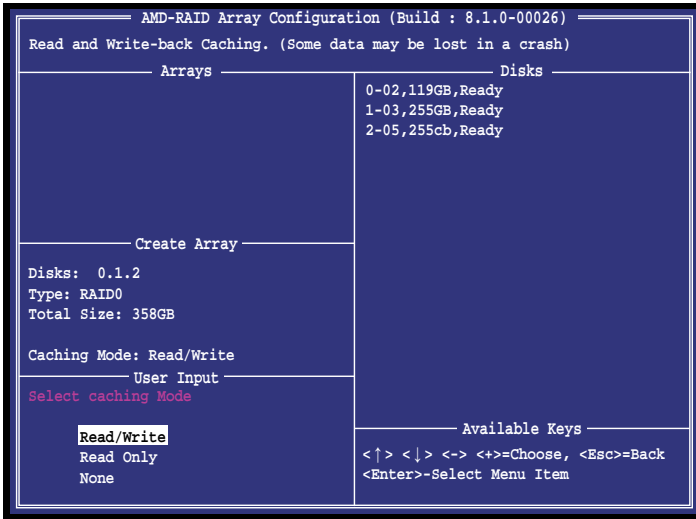

- Press <C> to confirm to create the RAID volume and return to the main menu, or <Esc> to go back, or <M> to go to Main Menu.

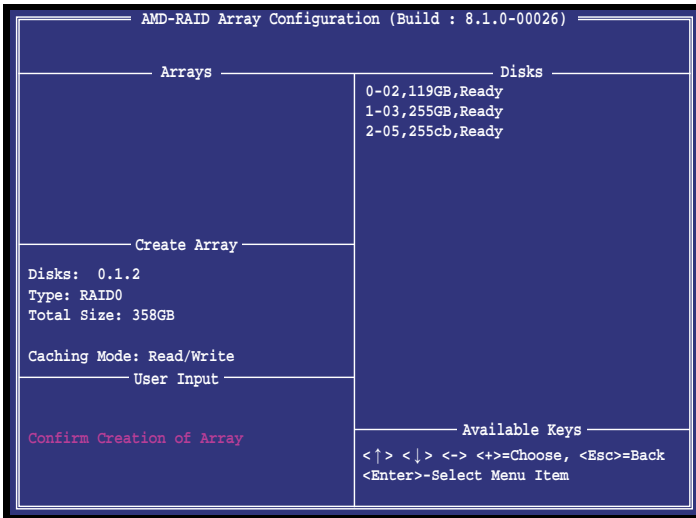

## Deleting a RAID set



Be cautious when deleting a RAID set. You will lose all data on the hard disk drives when you delete a RAID set.

To delete a RAID set:

1. From the utility main menu, select **Delete Array(s)** and press <Enter>. The following screen appears:

```
AMD-RAID Array Configuration (Build : 8.1.0-00026)
1----RAID0, 358GB, Normal(R/W)
----- Arrays -----
1----RAID0, 358GB, Normal(R/W)
----- Disks -----
0-02,119GB,Ready
1-03,255GB,Ready
2-05,255cb,Ready

----- Main Menu -----
Create Array
Delete Array(s)

View Disk Details
View Array Details
Rescan All Channels
Controller Options
Continue to Boot

----- Available Keys -----
<↑> <↓> <-> <+>=Choose, <Esc>=Back
<Enter>-Select Menu Item

License Level : 10
```

2. Use the up/down arrow key to select the RAID set you want to delete, and then press <Delete>. The following warning message appears:

```
All data on the selected array(s), along
with the array(s) themselves will be lost!
Are you sure you want to continue?

Press <C> to continue, <Esc> to cancel
```

3. Press <C> to delete the RAID set and return to the utility main menu, or press <Esc> to return to cancel.

To exit the utility, press <Ctrl> + <Alt> + <Delete>.

## 4.2 Creating a RAID driver disk

### 4.2.1 Creating a RAID driver disk in Windows®

To install the RAID driver for Windows® OS:

1. During the OS installation, click **Load Driver** to allow you to select the installation media containing the RAID driver.
2. Insert the supported USB flash drive with RAID driver into the USB port, and then click **Browse**.
3. Click the name of the device you've inserted, go to **Drivers > RAID**, and then select the RAID Bottom drivers first and click **OK**, then select the RAID driver for the corresponding OS version, click **OK**.
4. Follow the succeeding screen instructions to complete the installation.



---

To set up a Windows® UEFI operating system under RAID mode, ensure to load the UEFI driver for your optical drive.

---

# Appendix

## Notices

### Federal Communications Commission Statement

This device complies with Part 15 of the FCC Rules. Operation is subject to the following two conditions:

- This device may not cause harmful interference.
- This device must accept any interference received including interference that may cause undesired operation.

This equipment has been tested and found to comply with the limits for a Class B digital device, pursuant to Part 15 of the FCC Rules. These limits are designed to provide reasonable protection against harmful interference in a residential installation. This equipment generates, uses and can radiate radio frequency energy and, if not installed and used in accordance with manufacturer's instructions, may cause harmful interference to radio communications. However, there is no guarantee that interference will not occur in a particular installation. If this equipment does cause harmful interference to radio or television reception, which can be determined by turning the equipment off and on, the user is encouraged to try to correct the interference by one or more of the following measures:

- Reorient or relocate the receiving antenna.
- Increase the separation between the equipment and receiver.
- Connect the equipment to an outlet on a circuit different from that to which the receiver is connected.
- Consult the dealer or an experienced radio/TV technician for help.



---

The use of shielded cables for connection of the monitor to the graphics card is required to assure compliance with FCC regulations. Changes or modifications to this unit not expressly approved by the party responsible for compliance could void the user's authority to operate this equipment.

---

## IC: Canadian Compliance Statement

Complies with the Canadian ICES-003 Class B specifications. This device complies with RSS 210 of Industry Canada. This Class B device meets all the requirements of the Canadian interference-causing equipment regulations.

This device complies with Industry Canada license exempt RSS standard(s). Operation is subject to the following two conditions: (1) this device may not cause interference, and (2) this device must accept any interference, including interference that may cause undesired operation of the device.

Cet appareil numérique de la Classe B est conforme à la norme NMB-003 du Canada. Cet appareil numérique de la Classe B respecte toutes les exigences du Règlement sur le matériel brouilleur du Canada.

Cet appareil est conforme aux normes CNR exemptes de licence d'Industrie Canada. Le fonctionnement est soumis aux deux conditions suivantes :

- (1) cet appareil ne doit pas provoquer d'interférences et
- (2) cet appareil doit accepter toute interférence, y compris celles susceptibles de provoquer un fonctionnement non souhaité de l'appareil.

## Canadian Department of Communications Statement

This digital apparatus does not exceed the Class B limits for radio noise emissions from digital apparatus set out in the Radio Interference Regulations of the Canadian Department of Communications.

This class B digital apparatus complies with Canadian ICES-003.

## VCCI: Japan Compliance Statement

### Class B ITE

この装置は、クラスB情報技術装置です。この装置は、家庭環境で使用することを目的としています。この装置がラジオやテレビジョン受信機に近接して使用されると、受信障害を引き起こすことがあります。

取扱説明書に従って正しい取り扱いをして下さい。

VCCI-B

## KC: Korea Warning Statement

B급 기기 (가정용 방송통신기자재)

이 기기는 가정용(B급) 전자파적합기기로서 주로 가정에서 사용하는 것을 목적으로 하며, 모든 지역에서 사용할 수 있습니다.

## REACH

Complying with the REACH (Registration, Evaluation, Authorisation, and Restriction of Chemicals) regulatory framework, we published the chemical substances in our products at ASUS REACH website at <http://csr.asus.com/english/REACH.htm>.



DO NOT throw the motherboard in municipal waste. This product has been designed to enable proper reuse of parts and recycling. This symbol of the crossed out wheeled bin indicates that the product (electrical and electronic equipment) should not be placed in municipal waste. Check local regulations for disposal of electronic products.



DO NOT throw the mercury-containing button cell battery in municipal waste. This symbol of the crossed out wheeled bin indicates that the battery should not be placed in municipal waste.

## ASUS Recycling/Takeback Services

ASUS recycling and takeback programs come from our commitment to the highest standards for protecting our environment. We believe in providing solutions for you to be able to responsibly recycle our products, batteries, other components as well as the packaging materials. Please go to <http://csr.asus.com/english/Takeback.htm> for detailed recycling information in different regions.

## Regional notice for California

**WARNING!** This product may contain chemicals known to the State of California to cause cancer, birth defects or other reproductive harm. Wash hands after handling.

## Google™ License Terms

Copyright© 2016 Google Inc. All Rights Reserved.

Licensed under the Apache License, Version 2.0 (the "License"); you may not use this file except in compliance with the License. You may obtain a copy of the License at:

<http://www.apache.org/licenses/LICENSE-2.0>

Unless required by applicable law or agreed to in writing, software distributed under the License is distributed on an "AS IS" BASIS, WITHOUT WARRANTIES OR CONDITIONS OF ANY KIND, either express or implied.

See the License for the specific language governing permissions and limitations under the License.



**English** ASUSTeK Computer Inc. hereby declares that this device is in compliance with the essential requirements and other relevant provisions of related Directives. Full text of EU declaration of conformity is available at: [www.asus.com/support](http://www.asus.com/support)

**Français** AsusTek Computer Inc. déclare par la présente que cet appareil est conforme aux critères essentiels et autres clauses pertinentes des directives concernées. La déclaration de conformité de l'UE peut être téléchargée à partir du site Internet suivant: [www.asus.com/support](http://www.asus.com/support).

**Deutsch** ASUSTeK Computer Inc. erklärt hiermit, dass dieses Gerät mit den wesentlichen Anforderungen und anderen relevanten Bestimmungen der zugehörigen Richtlinien übereinstimmt. Der gesamte Text der EU-Konformitätserklärung ist verfügbar unter: [www.asus.com/support](http://www.asus.com/support)

**Italiano** ASUSTeK Computer Inc. con la presente dichiara che questo dispositivo è conforme ai requisiti essenziali e alle altre disposizioni pertinenti con le direttive correlate. Il testo completo della dichiarazione di conformità UE è disponibile all'indirizzo: [www.asus.com/support](http://www.asus.com/support)

**Русский** Компания ASUS заявляет, что это устройство соответствует основным требованиям и другим соответствующим условиям соответствующих директив. Подробную информацию, пожалуйста, смотрите на [www.asus.com/support](http://www.asus.com/support)

**Български** С настоящото ASUSTEK Computer Inc. декларира, че това устройство е в съответствие със съществените изисквания и другите приложими постановления на свързаните директиви. Пълният текст на декларацията за съответствие на ЕС е достъпен на адрес: [www.asus.com/support](http://www.asus.com/support)

**Hrvatski** ASUSTeK Computer Inc. ovim izjavljuje da je ovaj uređaj sukladan s bitnim zahtjevima i ostalim odgovarajućim odredbama vezanih direktiva. Cijeli tekst EU izjave o sukladnosti dostupan je na: [www.asus.com/support](http://www.asus.com/support)

**Čeština** Společnost ASUSTEK Computer Inc. tímto prohlašuje, že toto zařízení splňuje základní požadavky a další příslušná ustanovení souvisejících směrnic. Plné znění prohlášení o shodě EU je k dispozici na adrese: [www.asus.com/support](http://www.asus.com/support)

**Dansk** ASUSTeK Computer Inc. erklærer hermed, at denne enhed er i overensstemmelse med hovedkravene og andre relevante bestemmelser i de relaterede direktiver. Hele EU-overensstemmelseserklæringen kan findes på: [www.asus.com/support](http://www.asus.com/support)

**Nederlands** ASUSTEK Computer Inc. verklaart hierbij dat dit apparaat voldoet aan de essentiële vereisten en andere relevante bepalingen van de verwante richtlijnen. De volledige tekst van de EU-verklaring van conformiteit is beschikbaar op: [www.asus.com/support](http://www.asus.com/support)

**Eesti** Käesolevaga kinnitab ASUSTEK Computer Inc, et see seade vastab asjakohaste direktiivide olulistele nõuetele ja teistele asjassepuutuvatele sätetele. El vastavusdeklaratsiooni täielik tekst on saadaval järgmisel aadressil: [www.asus.com/support](http://www.asus.com/support)

**Suomi** ASUSTEK Computer Inc. ilmoittaa täten, että tämä laite on asiaankuuluvien direktiivien olennaisten vaatimusten ja muiden tätä koskevien säädösten mukainen. EU-yhdenmukaisuusilmoituksen koko teksti on luettavissa osoitteessa: [www.asus.com/support](http://www.asus.com/support)

**Ελληνικά** Με το παρόν, η AsusTek Computer Inc. δηλώνει ότι αυτή η συσκευή συμμορφώνεται με τις θεμελιώδεις απαιτήσεις και άλλες σχετικές διατάξεις των Οδηγιών της ΕΕ. Το πλήρες κείμενο της δήλωσης συμμόρφωσης είναι διαθέσιμο στη διεύθυνση: [www.asus.com/support](http://www.asus.com/support)

**Magyar** Az ASUSTEK Computer Inc. ezennel kijelenti, hogy ez az eszköz megfelel a kapcsolódó irányelvek lényeges követelményeinek és egyéb vonatkozó rendelkezéseinek. Az EU megfélelősegi nyilatkozat teljes szövege innen letölthető: [www.asus.com/support](http://www.asus.com/support)

**Latviski** ASUSTEK Computer Inc. ar šo paziņo, ka šī ierīce atbilst saistošo Direktīvu būtiskajām prasībām un citiem citiem saistošajiem nosacījumiem. Pilns ES atbilstības paziņojuma teksts pieejams šeit: [www.asus.com/support](http://www.asus.com/support)

**Lietuviai** „ASUSTEK Computer Inc.“ šiuo tvirtina, kad šis įrenginys atitinka pagrindinius reikalavimus ir kitas svarbias susijusių direktyvų nuostatas. Visą ES atitikties deklaracijos tekstą galima rasti: [www.asus.com/support](http://www.asus.com/support)

**Norsk** ASUSTEK Computer Inc. erklærer herved at denne enheten er i samsvar med hovedsaklige krav og andre relevante forskrifter i relaterede direktiver. Fullstendig tekst for EU-samsvarserklæringen finnes på: [www.asus.com/support](http://www.asus.com/support)

**Polski** Firma ASUSTEK Computer Inc. niniejszym oświadcza, że urządzenie to jest zgodne z zasadniczymi wymogami i innymi właściwymi postanowieniami powiązanych dyrektyw. Pełny tekst deklaracji zgodności UE jest dostępny pod adresem: [www.asus.com/support](http://www.asus.com/support)

**Português** A ASUSTEK Computer Inc. declara que este dispositivo está em conformidade com os requisitos essenciais e outras disposições relevantes das Diretivas relacionadas. Texto integral da declaração da UE disponível em: [www.asus.com/support](http://www.asus.com/support)

**Română** ASUSTEK Computer Inc. declară că acest dispozitiv se conformează cerințelor esențiale și altor prevederi relevante ale directivelor conexe. Textul complet al declarației de conformitate a Uniunii Europene se găsește la: [www.asus.com/support](http://www.asus.com/support)

**Srpski** ASUSTEK Computer Inc. ovim izjavljuje da je ovaj uređaj u saglasnosti sa osnovnim zahtevima i drugim relevantnijim odredbama povezanih Direktiva. Pun tekst EU deklaracije o usaglašenosti je dostupan da adres: [www.asus.com/support](http://www.asus.com/support)

**Slovensky** Spoločnosť ASUSTEK Computer Inc. týmto vyhlasuje, že toto zariadenie vyhovuje základným požiadavkám a ostatým príslušným ustanoveniam príslušných smerníc. Celý text vyhlásenia o zhode pre štáty EÚ je dostupný na adrese: [www.asus.com/support](http://www.asus.com/support)

**Slovenščina** ASUSTEK Computer Inc. izjavlja, da je ta naprava skladna z bistvenimi zahtevami in drugimi ustreznimi določbami povezanih direktiv. Celotno besedilo EU-izjave o skladnosti je na voljo na spletnem mestu: [www.asus.com/support](http://www.asus.com/support)

**Español** Por la presente, ASUSTEK Computer Inc. declara que este dispositivo cumple los requisitos básicos y otras disposiciones pertinentes de las directivas relacionadas. El texto completo de la declaración de la UE de conformidad está disponible en: [www.asus.com/support](http://www.asus.com/support)

**Svenska** ASUSTEK Computer Inc. förklarar härmed att denna enhet överensstämmer med de grundläggande kraven och andra relevanta föreskrifter i relaterade direktiv. Fulltext av EU-försäkran om överensstämmelse finns på: [www.asus.com/support](http://www.asus.com/support)

**Українська** ASUSTEK Computer Inc. заявляє, що цей пристрій відповідає основним вимогам та іншим відповідним положенням відповідних Директив. Повний текст декларації відповідності стандартам ЄС доступний на: [www.asus.com/support](http://www.asus.com/support)

**Türkçe** ASUSTEK Computer Inc., bu aygıtın temel gereksinimlerle ve ilişkili Yönergelerin diğer ilgili kullarıyla uyumlu olduğunu beyan eder. AB uyuşluk bildirimini tam metni şu adreste bulunabilir: [www.asus.com/support](http://www.asus.com/support)

**Bosanski** ASUSTEK Computer Inc. ovim izjavljuje da je ovaj uređaj uskladen sa bitnim zahtjevima i ostalim odgovarajućim odredbama vezanih direktiva. Cijeli tekst EU izjave o uskladenosti dostupan je na: [www.asus.com/support](http://www.asus.com/support)

## ASUS contact information

### ASUSTeK COMPUTER INC.

Address 4F, No. 150, Li-Te Road, Peitou, Taipei 112, Taiwan  
Telephone +886-2-2894-3447  
Fax +886-2-2890-7798  
Web site [www.asus.com](http://www.asus.com)

#### **Technical Support**

Telephone +86-21-38429911  
Fax +86-21-5866-8722, ext. 9101#  
Online support <http://qr.asus.com/techserv>

### ASUS COMPUTER INTERNATIONAL (America)

Address 800 Corporate Way, Fremont, CA 94539, USA  
Telephone +1-510-739-3777  
Fax +1-510-608-4555  
Web site <http://www.asus.com/us/>

#### **Technical Support**

Support fax +1-812-284-0883  
Telephone +1-812-282-2787  
Online support <http://qr.asus.com/techserv>

### ASUS COMPUTER GmbH (Germany and Austria)

Address Harkort Str. 21-23, 40880 Ratingen, Germany  
Fax +49-2102-959931  
Web site <http://www.asus.com/de>  
Online contact <http://eu-rma.asus.com/sales>

#### **Technical Support**

Telephone +49-2102-5789555  
Support Fax +49-2102-959911  
Online support <http://qr.asus.com/techserv>

**DECLARATION OF CONFORMITY**

Per FCC Part 2 Section 2. 1077(a)

**Responsible Party Name: Asus Computer International****Address: 800 Corporate Way, Fremont, CA 94539.****Phone/Fax No: (510)739-3777/(510)608-4555**

hereby declares that the product

**Product Name : Motherboard****Model Number : PRIME X370-PRO**

Conforms to the following specifications:

 FCC Part 15, Subpart B, Unintentional Radiators**Supplementary Information:**

This device complies with part 15 of the FCC Rules. Operation is subject to the following two conditions: (1) This device may not cause harmful interference, and (2) this device must accept any interference received, including interference that may cause undesired operation.

Representative Person's Name : Steve Chang / President

A handwritten signature in blue ink that reads "Steve Chang".

Signature :

Date : Jan. 16, 2017

Ver. 140331