

**RAMPAGE V
EXTREME**

ASUS®

Motherboard

Copyright © 2014 ASUSTeK COMPUTER INC. All Rights Reserved.

No part of this manual, including the products and software described in it, may be reproduced, transmitted, transcribed, stored in a retrieval system, or translated into any language in any form or by any means, except documentation kept by the purchaser for backup purposes, without the express written permission of ASUSTeK COMPUTER INC. ("ASUS").

Product warranty or service will not be extended if: (1) the product is repaired, modified or altered, unless such repair, modification or alteration is authorized in writing by ASUS; or (2) the serial number of the product is defaced or missing.

ASUS PROVIDES THIS MANUAL "AS IS" WITHOUT WARRANTY OF ANY KIND, EITHER EXPRESS OR IMPLIED, INCLUDING BUT NOT LIMITED TO THE IMPLIED WARRANTIES OR CONDITIONS OF MERCHANTABILITY OR FITNESS FOR A PARTICULAR PURPOSE. IN NO EVENT SHALL ASUS, ITS DIRECTORS, OFFICERS, EMPLOYEES OR AGENTS BE LIABLE FOR ANY INDIRECT, SPECIAL, INCIDENTAL, OR CONSEQUENTIAL DAMAGES (INCLUDING DAMAGES FOR LOSS OF PROFITS, LOSS OF BUSINESS, LOSS OF USE OR DATA, INTERRUPTION OF BUSINESS AND THE LIKE), EVEN IF ASUS HAS BEEN ADVISED OF THE POSSIBILITY OF SUCH DAMAGES ARISING FROM ANY DEFECT OR ERROR IN THIS MANUAL OR PRODUCT.

SPECIFICATIONS AND INFORMATION CONTAINED IN THIS MANUAL ARE FURNISHED FOR INFORMATIONAL USE ONLY, AND ARE SUBJECT TO CHANGE AT ANY TIME WITHOUT NOTICE, AND SHOULD NOT BE CONSTRUED AS A COMMITMENT BY ASUS. ASUS ASSUMES NO RESPONSIBILITY OR LIABILITY FOR ANY ERRORS OR INACCURACIES THAT MAY APPEAR IN THIS MANUAL, INCLUDING THE PRODUCTS AND SOFTWARE DESCRIBED IN IT.

Products and corporate names appearing in this manual may or may not be registered trademarks or copyrights of their respective companies, and are used only for identification or explanation and to the owners' benefit, without intent to infringe.

Offer to Provide Source Code of Certain Software

This product contains copyrighted software that is licensed under the General Public License ("GPL"), under the Lesser General Public License Version ("LGPL") and/or other Free Open Source Software Licenses. Such software in this product is distributed without any warranty to the extent permitted by the applicable law. Copies of these licenses are included in this product.

Where the applicable license entitles you to the source code of such software and/or other additional data, you may obtain it for a period of three years after our last shipment of the product, either

(1) for free by downloading it from <http://support.asus.com/download>

or

(2) for the cost of reproduction and shipment, which is dependent on the preferred carrier and the location where you want to have it shipped to, by sending a request to:

ASUSTeK Computer Inc.
Legal Compliance Dept.
15 Li Te Rd.,
Beitou, Taipei 112
Taiwan

In your request please provide the name, model number and version, as stated in the About Box of the product for which you wish to obtain the corresponding source code and your contact details so that we can coordinate the terms and cost of shipment with you.

The source code will be distributed WITHOUT ANY WARRANTY and licensed under the same license as the corresponding binary/object code.

This offer is valid to anyone in receipt of this information.

ASUSTeK is eager to duly provide complete source code as required under various Free Open Source Software licenses. If however you encounter any problems in obtaining the full corresponding source code we would be much obliged if you give us a notification to the email address gpl@asus.com, stating the product and describing the problem (please DO NOT send large attachments such as source code archives, etc. to this email address).

Contents

Safety information.....	vii
About this guide.....	viii
RAMPAGE V EXTREME specifications summary	x
OC Panel specifications summary	xv
Package contents.....	xvi
Installation tools and components.....	xvii

Chapter 1: Product Introduction

1.1 Special features.....	1-1
1.1.1 Product highlights.....	1-1
1.1.2 ROG Unique Gaming Features.....	1-2
1.1.3 ROG exclusive features	1-3
1.1.4 ASUS special features	1-5
1.1.5 ROG rich-bundled software.....	1-6
1.2 Motherboard overview.....	1-7
1.2.1 Before you proceed.....	1-7
1.2.2 Motherboard layout	1-8
1.2.3 Central Processing Unit (CPU)	1-10
1.2.4 System memory	1-11
1.2.5 Expansion slots.....	1-18
1.2.6 Onboard buttons and switches.....	1-21
1.2.7 Onboard LEDs	1-27
1.2.8 Jumper	1-34
1.2.9 Internal connectors.....	1-35
1.2.10 Probelt.....	1-45

Chapter 2: Basic Installation

2.1 Building your PC system.....	2-1
2.1.1 Motherboard installation.....	2-1
2.1.2 CPU installation.....	2-3
2.1.3 CPU heatsink and fan assembly installation	2-5
2.1.4 DIMM installation.....	2-8
2.1.5 ATX Power connection.....	2-9
2.1.6 SATA device connection	2-10
2.1.7 Front I/O Connector	2-11
2.1.8 Expansion Card installation.....	2-12
2.1.9 Wi-Fi antenna installation.....	2-13

Contents

2.2	BIOS update utility	2-14
2.3	Motherboard rear and audio connections	2-15
2.3.1	Rear I/O connection	2-15
2.3.2	Audio I/O connections	2-17
2.4	OC Panel	2-19
2.4.1	OC Panel Overview	2-19
2.4.2	Setting up your OC Panel in Normal Mode	2-21
2.4.3	Setting up your OC Panel in Extreme Mode	2-23
2.5	Starting up for the first time	2-24
2.6	Turning off the computer	2-24
 Chapter 3: BIOS setup		
3.1	Knowing BIOS	3-1
3.2	BIOS setup program	3-2
3.2.1	EZ Mode	3-3
3.2.2	Advanced Mode	3-4
3.3	My Favorites	3-6
3.4	Main menu	3-7
3.5	Extreme Tweaker menu	3-9
3.6	Advanced menu	3-28
3.6.1	CPU Configuration	3-29
3.6.2	PCH Configuration	3-32
3.6.3	PCH Storage Configuration	3-33
3.6.4	System Agent Configuration	3-35
3.6.5	USB Configuration	3-36
3.6.6	Platform Miscellaneous Configuration	3-38
3.6.7	Onboard Devices Configuration	3-39
3.6.8	APM	3-41
3.6.9	Network Stack Configuration	3-42
3.6.10	ROG Effects	3-42
3.7	Monitor menu	3-43
3.8	Boot menu	3-47
3.9	Tool menu	3-53
3.10	Exit menu	3-55
3.11	Updating BIOS	3-56
3.11.1	EZ Update	3-56
3.11.2	ASUS EZ Flash 2	3-57
3.11.3	ASUS CrashFree BIOS 3	3-58
3.11.4	ASUS BIOS Updater	3-59

Contents

Chapter 4: Software support

4.1	Installing an operating system	4-1
4.2	Support DVD information	4-1
4.2.1	Running the support DVD	4-1
4.2.2	Obtaining the software manuals	4-3
4.3	Software information	4-4
4.4	AI Suite 3	4-4
4.5	Dual Intelligent Processors 5	4-7
	5-Way Optimization	4-7
	Turbo Processing Unit (TPU)	4-8
	Fan Xpert 3	4-10
	DIGI+ Power Control	4-11
	Turbo App	4-13
	Energy Processing Unit (EPU)	4-14
	USB 3.0 Boost	4-17
	EZ Update	4-18
	System Information	4-19
	USB BIOS Flashback	4-21
	USB Charger+	4-22
	Push Notice	4-23
	Ai Charger+	4-26
	Wi-Fi Engine	4-27
	Wi-Fi GO! and Remote GO!	4-29
	ASUS Media Streamer	4-39
4.6	ROG Audio features	4-41
	Sonic Studio	4-41
	Sonic SenseAmp	4-43
	Sonic SoundStage	4-45
	DTS Connect	4-46
4.7	Sonic Radar II	4-47
4.8	GameFirst III	4-49
4.9	KeyBot	4-52
4.10	ASUS Disk Unlocker	4-54
4.11	RAMDisk	4-55
4.12	MemTweakIt	4-58
4.13	ROG CPU-Z	4-60
4.14	ROG Connect	4-61

Chapter 5: RAID support

5.1 RAID configurations 5-1

- 5.1.1 RAID definitions 5-1
- 5.1.2 Installing Serial ATA hard disks 5-2
- 5.1.3 Setting the RAID item in BIOS 5-2
- 5.1.4 Intel® Rapid Storage Technology Option ROM utility 5-3

5.2 Creating a RAID driver disk 5-8

- 5.2.1 Creating a RAID driver disk without entering the OS 5-8
- 5.2.2 Creating a RAID driver disk in Windows® 5-8
- 5.2.3 Installing the RAID driver during Windows® OS installation 5-9

Appendices

Notices A-1

ASUS contact information A-5

Safety information

Electrical safety

- To prevent electrical shock hazard, disconnect the power cable from the electrical outlet before relocating the system.
- When adding or removing devices to or from the system, ensure that the power cables for the devices are unplugged before the signal cables are connected. If possible, disconnect all power cables from the existing system before you add a device.
- Before connecting or removing signal cables from the motherboard, ensure that all power cables are unplugged.
- Seek professional assistance before using an adapter or extension cord. These devices could interrupt the grounding circuit.
- Ensure that your power supply is set to the correct voltage in your area. If you are not sure about the voltage of the electrical outlet you are using, contact your local power company.
- If the power supply is broken, do not try to fix it by yourself. Contact a qualified service technician or your retailer.

Operation safety

- Before installing the motherboard and adding devices on it, carefully read all the manuals that came with the package.
- Before using the product, ensure all cables are correctly connected and the power cables are not damaged. If you detect any damage, contact your dealer immediately.
- To avoid short circuits, keep paper clips, screws, and staples away from connectors, slots, sockets, and circuitry.
- Avoid dust, humidity, and temperature extremes. Do not place the product in any area where it may become wet.
- Place the product on a stable surface.
- If you encounter technical problems with the product, contact a qualified service technician or your retailer.

About this guide

This user guide contains the information you need when installing and configuring the motherboard.

How this guide is organized

This guide contains the following parts:

1. Chapter 1: Product introduction

This chapter describes the features of the motherboard and the new technology it supports. It includes description of the switches, jumpers, and connectors on the motherboard.

2. Chapter 2: Basic Installation

This chapter lists the hardware setup procedures that you have to perform when installing system components.

3. Chapter 3: BIOS setup

This chapter explains how to change system settings through the BIOS Setup menus. Detailed descriptions of the BIOS parameters are also provided.

4. Chapter 4: Software support

This chapter describes the contents of the support DVD that comes with the motherboard package and the software.

5. Chapter 5: RAID support

This chapter describes the RAID configurations.

Where to find more information

Refer to the following sources for additional information and for product and software updates.

1. ASUS website

The ASUS website (www.asus.com) provides updated information on ASUS hardware and software products.

2. Optional documentation

Your product package may include optional documentation, such as warranty flyers, that may have been added by your dealer. These documents are not part of the standard package.

Conventions used in this guide

To ensure that you perform certain tasks properly, take note of the following symbols used throughout this manual.



DANGER/WARNING: Information to prevent injury to yourself when trying to complete a task.



CAUTION: Information to prevent damage to the components when trying to complete a task



IMPORTANT: Instructions that you **MUST** follow to complete a task.



NOTE: Tips and additional information to help you complete a task.

Typography

Bold text

Indicates a menu or an item to select.

Italics

Used to emphasize a word or a phrase.

<Key>

Keys enclosed in the less-than and greater-than sign means that you must press the enclosed key.

Example: <Enter> means that you must press the Enter or Return key.

<Key1> + <Key2> + <Key3>

If you must press two or more keys simultaneously, the key names are linked with a plus sign (+).

RAMPAGE V EXTREME specifications summary

CPU	<p>New Intel® Core™ i7 Processors on LGA 2011-v3 socket Supports 22nm CPU Supports Intel® Turbo Boost Technology 2.0*</p> <p>*The support of these features depends on the CPU types.</p>
Chipset	<p>Intel® X99 Express Chipset</p>
Memory	<p>8 x DIMM, max. 64GB, DDR4 3300(O.C.)*/3000(O.C.)*/2800(O.C.)*/ 2666(O.C.)*/2400(O.C.)*/2133 MHz, non-ECC, un-buffered memory Quad channel memory architecture Supports Intel® Extreme Memory Profile (XMP)</p> <p>* Hyper DIMM support is subject to the physical characteristics of individual CPUs.</p> <p>** Please refer to Memory QVL (Qualified Vendors List) for details.</p>
Expansion Slots	<p>4 x PCIe 3.0/2.0 x16 slots (supports x16, x16/x16, x16/x8/x8, or x16/x8/x8/x8 mode with 40-Lane CPU; supports x16, x16/x8, or x8/ x8/x8 with 28-Lane CPU)*</p> <p>1 x PCIe 2.0 x16 slot (max. at x4 mode)**</p> <p>1 x PCIe 2.0 x1 slot**</p> <p>* The PCIe_X8_4 slot shares bandwidth with the M.2 x 4. When PCIe_X8_4 is occupied, the M.2 will be disabled. The PCIe_X8_4 slot will be disabled when using a 28-LANE CPU</p> <p>**The PCIe_X4_1 (gray) slot shares bandwidth with the PCIe_X1_1 slot, USB3_E910 and SATAExpress_E1 connector. When the PCIe_X4_1 slot is occupied by an X1 or X2 device, the SATAEXPRESS_E1 will be disabled. When the PCIe_X4_1 is occupied by an X4 device, the SATAEXPRESS_E1, USB3_E910, and the PCIe_X1_1slot will be disabled.</p>
Multi-GPU Technology	<p>Supports NVIDIA® 4-Way/3-Way/2-Way SLI™ Technology Supports AMD® 4-Way/3-Way/2-way CrossFireX™ Technology</p> <p>*28-LANE CPUs can only support up to 3-Way SLI™/CrossFireX™</p>
Storage	<p>Intel® X99 Express Chipset with RAID 0, 1, 5, 10, and Intel Rapid Storage Technology 13 support:</p> <ul style="list-style-type: none"> - 1 x SATA Express port (red@bottom, compatible with 2 x SATA 6.0 Gb/s ports) - 1 x M.2 Socket 3 with M Key, type 2260/2280/22110 storage devices support (Supports PCIe SSDs only) - 8 x SATA 6Gb/s ports* - Supports Intel® Smart Response Technology, Intel® Rapid Recovery Technology** <p>ASMedia® SATA Express controller***:</p> <ul style="list-style-type: none"> - 1 x SATA Express port (red@top, compatible with 2 x SATA 6.0 Gb/s ports) <p>* Due to chipset behavior, the SATA6G_78, SATA6G_910 ports do not support IRST including RAID configuration.</p> <p>** These functions will work depending on the CPU installed.</p> <p>***These SATA ports share bandwidth with the PCIe_X4_1 slot and when the PCIe_X4_1 slot is occupied, the SATA ports will be disabled. These SATA ports are for data hard drives only. ATAPI devices are not supported.</p>

(continued on the next page)

RAMPAGE V EXTREME specifications summary

<p>LAN</p>	<p>Intel® I218-V Gigabit LAN- Dual interconnect between the integrated Media Access Controller (MAC) and physical layer (PHY) Anti-surge LANGuard ROG GameFirst III</p>
<p>Wireless / Bluetooth</p>	<p>Wi-Fi 802.11 a/b/g/n/ac supports dual frequency band 2.4/5 GHz up to 1300 Mb/s transfer speed Bluetooth v4.0</p>
<p>SupremeFX High Definition Audio</p>	<p>ROG SupremeFX 2014 8-Channel High Definition Audio CODEC</p> <ul style="list-style-type: none"> - SupremeFX Shielding Technology - ELNA® Premium audio capacitors - Content Protection for Full Rate lossless DVD Audio, Blu-ray DVD, and HD-DVD audio content playback - Jack-detection, Multi-streaming, and Front Panel Jack-retasking - Optical S/PDIF out port at back panel <p>Audio Features</p> <ul style="list-style-type: none"> - Sonic SoundStage - Sonic SenseAmp - Sonic Studio - Sonic Radar II - DTS Connect
<p>USB</p>	<p>Intel® X99 Express Chipset - supports Asus USB 3.0 Boost:</p> <ul style="list-style-type: none"> - 4 x USB 3.0 ports (at mid-board [red])* - 6 x USB 2.0 ports (2 ports at back panel, 4 ports at mid-board)** <p>ASMedia® USB 3.0 controller:</p> <ul style="list-style-type: none"> - 10 x USB 3.0 ports (at back panel [blue])** <p>* 2 x USB2.0 ports at mid-board shares with ROG extension (ROG_EXT) port.</p> <p>** USB3_E910 ports at back panel will be disabled when the PCIE_X4_1 slot is occupied by an X4 bandwidth device</p>
<p>Back Panel I/O Ports</p>	<p>1 x Clear CMOS button 1 x ROG Connect On/Off switch 1 x PS/2 keyboard/mouse combo port 2 x USB 2.0 ports (top port for KeyBot, bottom port for ROG Connect) 10 x USB 3.0 ports [blue] 1 x Anti-surge LAN (RJ45) port 1 x ASUS Wi-Fi GO! module (Wi-Fi 802.11 a/b/g/n/ac and Bluetooth v4.0) 1 x Optical S/PDIF out 5 x Gold-plated audio jacks</p>

(continued on the next page)

RAMPAGE V EXTREME specifications summary

<p>Internal I/O Connectors</p>	<p>2 x USB 3.0 connectors support additional 4 USB 3.0 ports 2 x USB 2.0 connectors support additional 4 USB 2.0 ports [one connector via ROG_EXT header] 2 x SATA Express (compatible with 4 SATA 6Gb/s ports) 8 x SATA 6Gb/s connectors 1 x ROG extension (ROG_EXT) header 1 x 4-Pin CPU fan connector 1 x 4-Pin CPU optional fan connector 6 x 4-Pin Chassis fan connectors 3 x Thermal sensor connectors 1 x 24-pin EATX power connector 1 x 8-pin EATX 12V power connector 1 x 4-pin EATX 12V power connector 1 x EZ Plug connector 9 x Probelts Measurement Points 1 x Power-on button 1 x Reset button 1 x Safe boot button 1 x ReTry button 1 x LN2 mode jumper 1 x Slow mode switch 1 x MemOK! button 1 x M.2 Socket 3 for M Key, type 2260/2280/22110 storage devices (supports PCIe SSDs only) 1 x KeyBot button 1 x Sonic SoundStage button 1 x BIOS Switch button 1 x Thunderbolt header (5-pin) for ASUS ThunderboldEX II series support 1 x Front panel audio connector (AAFP) 1 x TPM connector 1 x System panel connector</p>
<p>Form Factor</p>	<p>Extended ATX Form Factor, 12-inch x 10.7-inch (30.5cm x 27.2 cm)</p>
<p>BIOS Features</p>	<p>2 x 128 Mb Flash ROM, UEFI AMI BIOS, PnP, DMI2.7, WfM2.0, SM BIOS 2.8, ACPI 5.0, Multi-language BIOS, ASUS EZ Flash 2, CrashFree BIOS 3, F11 EZ Tuning Wizard, F6 Qfan Control, F3 My Favorites, Quick Note, Last Modified log, F12 PrintScreen, F3 Shortcut functions, and ASUS DRAM SPD (Serial Presence Detect) memory information.</p>
<p>Manageability</p>	<p>WfM2.0, DMI2.7, WOL by PME, PXE</p>

(continued on the next page)

RAMPAGE V EXTREME specifications summary

<p>Software</p>	<p>Drivers ROG GameFirst III ROG RAMDisk ROG CPU-Z ROG Mem Tweaktl Kaspersky® Anti-Virus DAEMON Tools Pro Standard ASUS WebStorage HomeCloud ASUS Utilities</p>
<p>Operating Systems Support</p>	<p>Windows® 8.1 / Windows® 8 / Windows® 7</p>
<p>ROG Exclusive Features</p>	<p>Extreme Engine Digi+ IV OC Zone - ReTry button - Safe Boot button - LN2 Mode header - Slow Mode switch - Start button - Reset button - Probelt - PCIe x16 lane switch DirectCU thermal design ROG RAMDisk KeyBot - CPU Level Up - X.M.P. - DirectKey UEFI BIOS features : - Extreme Tweaker - Tweakers' Paradise - ROG SSD Secure Erase - GPU.DIMM Post - O.C. Profile - Graphics Card Information Preview ROG Connect* - RC Diagram - RC Remote - RC Poster Probelt</p> <p>* The dedicated ROG Connect cable is sold separately.</p>

(continued on the next page)

RAMPAGE V EXTREME specifications summary

Special Features

ASUS Dual Intelligent Processors 5

- 5-Way Optimization tuning key perfectly consolidates TPU, EPU, DIGI+ Power Control, Fan Xpert 3, and Turbo App

ASUS HomeCloud Server

Wi-Fi GO!

- Wi-Fi GO! Function: Cloud GO!, Remote Desktop, Remote Keyboard & Mouse, and File Transfer
- Wi-Fi GO! & NFC Remote app for portable smartphones/tablets, supports iOS 7 & Android 4.0 systems

Media Streamer

- Pipe music or movies from your PC to a smart TV, your entertainment goes wherever you go!
- Media Streamer app for portable smartphone/tablet, supporting iOS 7 & Android 4.0 systems

ASUS Exclusive Features:

- AI Suite 3
- USB 3.0 Boost
- USB Charger+
- AI Charger+
- Push Notice
- Disk Unlocker

ASUS EZ DIY

- USB BIOS Flashback
- ASUS CrashFree BIOS 3
- ASUS EZ Flash 2
- ASUS C.P.R.(CPU Parameter Recall)
- MemOK!

ASUS Q-Design

- ASUS Q-Code
- ASUS Q-Shield
- ASUS Q-Connector
- ASUS Q-LED (CPU, DRAM, VGA, and Boot Device LED)
- ASUS Q-Slot
- ASUS Q-DIMM

*Specifications are subject to change without notice.

OC Panel specifications summary

Display	2.6-inch LCM
Features	<p>Pure hardware-based overclocking support Boot debug POST code</p> <p>Intuitive tuning in two OC modes - EXTREME Mode for subzero OC benching* - NORMAL Mode for in-chassis usage**</p> <p>Seamless integration with CPU Level Up at one-click OC button Real-time control and display CPU fan speed, temperature, BCLK and RATIO Adjustable system voltages, frequencies on-the-fly Stylish design with 90 plus-degree-tilt movable faceplate (EXTREME Mode)</p> <p>FanSpeed Control button - Standard/Silent/Turbo mode</p> <p>Four (4) additional 4-pin fan headers LCM backlight on/off</p> <p>ROG exclusive features - VGA Hotwire - Subzero Sense - Slow Mode - Pause Switch - VGA SMB header - Probelit</p> <p>* EXTREME MODE capabilities, including V1, V2, DRAM and other voltage definitions, vary by chipset. Please refer to your motherboard manual for details.</p> <p>** One 5.25-inch drive bay is required for NORMAL Mode installation</p>
I/O Ports	POWER : 1 x SATA power connector ROG_EXT port : 1 x 18-1 pin data connection port FAN : 4 x 4-pin extra Fan connectors
Power	Voltage: +12V, +5V, +5VSB Power consumption: 5A
Installation Requirements	1 x 5.25-inch drive bay required for NORMAL Mode installation 1 x SATA power cable from system power supply
Compatibility	RAMPAGE V EXTREME and other motherboards with ROG_EXT port * Visit the ASUS website at www.asus.com for the latest motherboard support/compatibility lists. ** Install the latest utility/firmware (ROG Connect Plus) for better compatibility.

Package contents



Check your motherboard package for the following items.

Motherboard	ROG RAMPAGE V EXTREME
Cables	1 x 3-in-1 thermistor cables 5 x 2-in-1 SATA 6.0 Gb/s signal cables 1 x SLI® cable 1 x CrossFireX™ cable
Accessories	I/O Shield 1 x ASUS 3T3R dual band Wi-Fi moving antennas (Wi-Fi 802.11a/b/g/n/ac compliant) 1 x 3-Way SLI™ bridge 1 x 4-Way SLI™ bridge 1 x 2-in-1 Q-Connector Kit 1 x ROG Door Hanger 1 x 12-in-1 ROG Cable Label 1 x X-Socket 2 kit OC Panel Kit - 1 x OC Panel cable - 1 x OC Panel screw pad - 1 x OC Panel case housing
Application DVD	ROG motherboard support DVD
Documentation	User guide

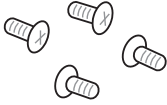

If any of the above items is damaged or missing, contact your retailer.

Installation tools and components

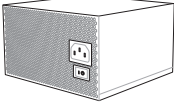
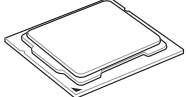
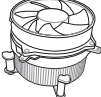
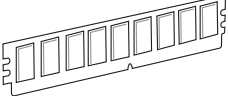
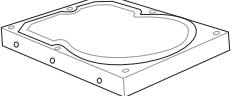
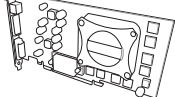
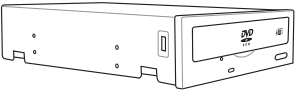
	
1 set of screws	Philips (cross) screwdriver
	
PC chassis	Power supply unit
	
Intel LGA 2011-3 CPU	Intel LGA 2011-3 compatible CPU Fan
	
DDR4 DIMM	SATA hard disk drive
	
Graphics card	SATA optical disc drive (optional)



The tools and components in the table above are not included in the motherboard package.

Product introduction

1

1.1 Special features

1.1.1 Product highlights

LGA2011-v3 socket for Intel® Core™ i7 processor family

This motherboard supports Intel® Core™ i7 processors in the LGA2011-v3 package. It provides great graphics and system performance with its GPU, dual-channel DDR4 memory slots and PCI Express 2.0/3.0 expansion slots.

Intel® X99 Express Chipset

Intel® X99 Express Chipset is a single chipset that supports the LGA2011-v3 socket for Intel® Core™ i7 processors. It utilizes serial point-to-point links, which increases bandwidth and enhances the system's performance. It natively supports up to eight (8) USB 3.0 ports, fourteen (14) SATA 6 Gb/s ports, and M.2 support for faster data retrieval. It also enables the iGPU function for Intel® integrated graphics performance.

PCIe 3.0 Ready

The PCI Express bus standard delivers improved encoding for twice the performance of current PCIe 2.0. Total bandwidth for a x16 link reaches a maximum of 32Gb/s, double the 16Gb/s of PCIe 2.0 in x16 mode. PCIe 3.0 provides you unprecedented data speeds with the convenience and seamless transition offered by complete backward compatibility with PCIe 1.0 and PCIe 2.0 devices, and improves and optimizes graphics performance.

* This motherboard is ready to support PCIe 3.0 specification. Functions are available when using PCIe 3.0-compliant devices. Refer to www.asus.com for updated details.

3-Way/4-way/Quad-GPU SLI™ and CrossFireX™ Support

This motherboard features Intel's powerful new X99 platform and optimizes PCIe allocation in multi-GPU SLI and CrossFireX solutions to give you the ultimate gaming experience.

Quad-Channel DDR4 Support

The motherboard supports the quad-channel DDR4 memory that supports memory frequencies of up to 3300 MHz to boost the system's performance and to meet the higher bandwidth requirements of 3D graphics, multimedia, and Internet applications.

SATA Express support

SATA Express provides faster data transfer speeds of up to 10 Gb/s allowing your system to catch up with the speed of the SSDs. It also features backward compatibility with up to two SATA drives of the same speed.

PCIe 3.0 X4 M.2 Support

With PCIe 3.0 x4 bandwidth, M.2 supports up to 32Gbit/s data-transfer speeds. It is the perfect choice for a system drive making your OS and apps launch as fast as possible.

1.1.2 ROG Unique Gaming Features

ROG SupremeFX 2014

The re-engineered ROG-exclusive SupremeFX audio technology features an onboard 8-channel high-definition sound of true audiophile-grade performance that is equal in power, clarity, and range to dedicated sound cards. Its unique Red Line Shielding and special metallic cover provides pristine sound and a highly attractive look for the motherboard that is in keeping with the ROG style. The Japan-made premium ELNA capacitor ensures warm natural sound with exceptional clarity for all your gaming and multimedia activities. SupremeFX revolutionizes the way you hear games, movies, music, and even other people via chat - letting you rule and discover a totally whole new dimension of superior audio.

ROG GameFirst III

ASUS GameFirst III is a network management software that features four preset packet prioritized profiles (Optimization, Game, Media Streaming and File Sharing) prioritizing the user's needs. Users can also manually allocate bandwidth and adjust priority settings of each application to run more quickly and smoothly.

Intel® Gigabit LAN

This LAN solution from Intel features high TCP and UDP throughput with lower CPU utilization for a smooth networking experience. It has advanced features including advanced interrupt-handling and low-power consumption.

Sonic Radar II

Sonic Radar II technology displays an unobtrusive overlay that lets you pinpoint the direction and origin of in-game sounds such as gunshots, footsteps, and call-outs so you can practice your enemy-locating skills. In the 2014 version, you can install your favorite FPS games and customize the settings of the overlay, shortcut keys, and audio enhancer.

Sonic Studio

Sonic Studio is an audio tuning software that simulates 7.1-channel audio even through a stereo (2.0-channel) headset with its virtual surround-sound function. It comes with six superb audio enhancements including Reverb, Bass Boost, Equalizer, Voice Clarity, Smart EQ (Smart Volume), and Virtual Surround.

Sonic SoundStage

Sonic SoundStage is an on-board solution that improves audio experience when you connect your front-panel headset. It works with any operating system and on any game. You can choose from any of the four presets or manually fine tune your own settings to fire up your game.

Sonic SenseAmp

Sonic SenseAmp is an exclusive ROG invention that automatically detects your headset's impedance and adjusts the built-in amp accordingly. Simply plugging in your headphones triggers Sonic SenseAmp's automatic tuning.

1.1.3 ROG exclusive features

Extreme Engine Digi+ IV

Nothing delivers purer power than Extreme Engine Digi+ IV — Rampage V Extreme's exclusive voltage-regulator module (VRM). Engineered with alloy chokes and upgraded with brand-new current-sensing technology, Extreme Engine Digi+ IV's high-frequency pulse-width modulation (PWM) implementation scales to 1 MHz allowing the VRM to achieve a 40% increase in stability!

iROG

The iROG is a special IC that fully maximizes ROG's unique functions, providing you with full control of your motherboard at any stage. It greatly improves your overclocking experience and offers advanced system control and management features purely at a hardware level.

RAMDisk

RAMDisk reserves part of the system memory and turns it into actual storage, so you can store your favorite app and game cache files in it to achieve a high-speed RAM performance boost. With the Dynamic Memory Allocation function, it can also release the unused memory of RAMDisk back to the system as needed. Plus, this can be used to extend SSD lifespan and keeps your main storage optimized for important tasks. To protect your junctioned data, RAMDisk features auto data backup and restore.



NOTE: RAMDisk only supports 64-bit operating systems.

CPU Level Up

With ROG's CPU Level Up, overclocking has never been so easy and hassle-free. With three predefined profiles for each processor, simply select the profile you like to attain and the motherboard will do the rest.

ROG Connect

ROG Connect allows you to monitor the status of your desktop PC and tweak its parameters in real-time via a notebook. ROG Connect links your main system to a notebook through a USB cable, allowing you to view real-time POST code and hardware status readouts on your notebook as well as make on-the-fly parameter adjustments at a hardware level.

KeyBot

KeyBot is a built-in microprocessor that provides an instant upgrade to your keyboard. You can configure and assign macros to specific keys on your keyboard to perform specific or several task at the same time. You can also configure your PC to wake up in CPU Level UP, XMP, or directly to BIOS.



This feature supports USB keyboards only.

GPU.DIMM Post

GPU.DIMM Post enables you to catch potential problems even before you enter the OS, saving you valuable time when detecting component failure under extreme conditions. With GPU.DIMM Post, you can quickly and easily check your graphic cards and memory modules' statuses in the BIOS as well as overclocking settings.

BIOS Print

ROG offers a whole new UEFI BIOS feature to handle the demands of an overclocking experience. The motherboard features ROG BIOS Print that allows you to easily share your BIOS settings to others with the press of a button.

Probel

This motherboard consists of nine (9) Probel measurement points that helps you detect your system's current voltage. With the use of a multimeter device, these points can help measure your system's important system voltages.

Extreme Tweaker

Extreme Tweaker is the one stop shop to fine-tune your system to optimal performance. With Extreme Tweaker, you can adjust the system settings such as frequency, over-voltage, memory timings, and more.

Loadline Calibration

Maintaining ample voltage support for the CPU is critical during overclocking. Loadline Calibration ensures stable and optimal CPU voltage under heavy loading. It helps overclockers utilize the motherboard's OC capabilities and benchmark scores.

OC Panel

Overclocking made easier than ever! No more messing with the BIOS, OS, or software utilities. OC Panel is the next step in dedicated direct tweaking. It can be mounted into a drive bay or kept as an external console. While operating in normal mode, the OC Panel displays information covering CPU temp, ratio, base clock, and CPU fan speed. With one press of the CPU Level Up button, you can instantly apply custom profiles calibrated by the world's leading overclockers. The FanSpeed Control feature allows you to control the case fan blower RPMs. In extreme mode, some of the most commonly used voltage tuning settings are offered along with Subzero Sense and VGA Hotwire. These features gives you field access to super-cool liquid thermal temp readings and streamlined hardware-level GPU overvolting.

1.1.4 ASUS special features

AI Suite 3

With its user-friendly interface, ASUS AI Suite 3 consolidates all the exclusive ASUS features into a single software package. It allows you to monitor fan speeds, voltages, and sensor readings.

USB BIOS FlashBack

USB BIOS Flashback offers a hassle-free updating solution for your ultimate convenience. Simply install a USB storage device containing the BIOS file, press the BIOS Flashback button for three seconds, and the UEFI BIOS is automatically updated even without entering the existing BIOS or operating system. It also allows you to regularly check for UEFI BIOS updates and download the latest BIOS automatically.

1.1.5 ROG rich-bundled software

Kaspersky® Anti-Virus

Kaspersky® Anti-Virus Personal offers premium antivirus protection for individual users and home offices. The product incorporates the Kaspersky® Anti-Virus engine which is renowned for malicious program detection and ranks among the industry's highest.

DAEMON Tools Pro Standard

DAEMON Tools Pro offers essential functionality to backup CD, DVD, and Blu-ray discs. It converts optical media to be accessed by mounting images of the discs onto a virtual drive. DAEMON Tools Pro organizes data, music, video, and photo collections on a PC, notebook, or netbook.

ROG CPU-Z

ROG CPU-Z, authorized by Intel's CPU Identification (CPUID), is a customized ROG utility that allows you to quickly view information about your system's main components. It gives current information and status of the CPU, motherboard, memory, and other main components. Styled consistently with the ROG style, show off your PC specifications with pride.

MemTweakIt

MemTweakIt is a DRAM efficiency tool that allows you to fine-tune your DRAM in real time and allows you to post and share your DRAM configuration scores to the ROG website.

DTS Connect

To get the most out of your audio entertainment across all formats and quality levels, DTS Connect combines two enabling technologies, DTS Neo:PC™ up-mixes stereo sources (CDs, MP3s, WMAs, internet radio) into as many as 7.1 channels of incredible surround sound. Consumers can connect their PC to a home theater system. DTS Interactive is capable of performing multi-channel encoding of DTS bitstreams on personal computers, and sending encoded bitstreams out of a digital audio connection (such as S/PDIF or HDMI) designed to deliver audio to an external decoder.

1.2 Motherboard overview

1.2.1 Before you proceed

Take note of the following precautions before you install motherboard components or change any motherboard settings.



-
- Unplug the power cord from the wall socket before touching any component.
 - Before handling components, use a grounded wrist strap or touch a safely grounded object or a metal object, such as the power supply case, to avoid damaging them due to static electricity.
 - Hold components by the edges to avoid touching the ICs on them.
 - Whenever you uninstall any component, place it on a grounded antistatic pad or in the bag that came with the component.
 - Before you install or remove any component, ensure that the ATX power supply is switched off or the power cord is detached from the power supply. Failure to do so may cause severe damage to the motherboard, peripherals, or components.
-

Layout contents

Connectors/Jumpers/Slots		Page
1	DDR4 DIMM slots channel	1-11
2	LGA2011-v3 CPU socket	1-10
3	ATX power connectors (24-pin EATXPWR; 4-pin EATX12V_1; 8-pin EATX12V_2; 4-pin EZ_PLUG)	1-42
4	Thermal sensor cable connectors (2-pin T_SENSOR1, T_SENSOR2, T_SENSOR3)	1-37
5	PCIe x16 Lane switch	1-25
6	CPU and chassis fan connectors (4-pin CPU_FAN; 4-pin CPU_OPT; 4-pin CHA_FAN1A-3A; 4-pin CHA_FAN1B-3B)	1-38
7	Q-Code LED	1-28
8	Power-on (START) button	1-21
9	LN2 Mode jumper (3-pin LN2)	1-34
10	Reset button	1-21
11	Slow Mode Switch (SLOW_MODE)	1-26
12	Safe Boot button (SAFE_BOOT)	1-24
13	ReTry button (RETRY)	1-23
14	MemOK! button (MemOK!)	1-22
15	Probelt	1-45
16	USB 3.0 connector (20-1 pin USB3_34)	1-37
17	M.2 connector	1-41
18	Intel® X99 Serial ATA 6 Gb/s connectors (7-pin SATA6G_1-10; SATAEXPRESS_1)	1-35
19	ASMedia® Serial ATA 6 Gb/s connectors (7-pin SATA6G_E3E4; SATAEXPRESS_E1)	1-36
20	KeyBot button (KEYBOT)	1-25
21	BIOS Switch button (BIOS_SWITCH)	1-23
22	System panel connector (20-8 pin PANEL)	1-43
23	Thunderbolt header (5-pin TB_HEADER)	1-41
24	USB 2.0 connector (10-1 pin USB91112, USB 1314)	1-38
25	ROG Extension connector (18-1 pin ROG_EXT)	1-36
26	SOUNDSTAGE button (SOUNDSTAGE)	1-24
27	TPM connector (20-1 pin TPM)	1-40
28	Front panel audio connector (10-1 pin AAFP)	1-40
29	ROG Logo LED connector (3-pin)	1-44

1.2.3 Central Processing Unit (CPU)

The motherboard comes with a surface mount LGA2011-v3 socket designed for Intel® Core™ i7 Processor Family for the LGA 2011-v3 socket.

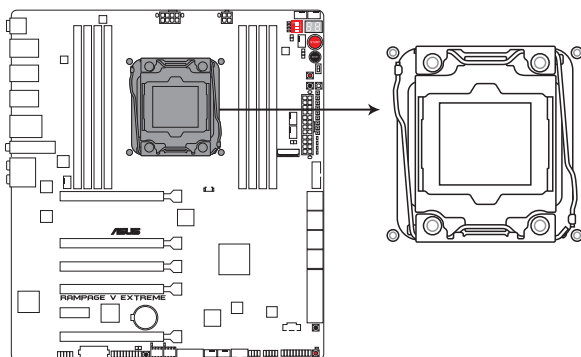

RAMPAGE V EXTREME CPU LGA2011-v3 Socket



Ensure that all power cables are unplugged before installing the CPU.



- Upon purchase of the motherboard, ensure that the PnP cap is on the socket and the socket contacts are not bent. Contact your retailer immediately if the PnP cap is missing, or if you see any damage to the PnP cap/socket contacts/motherboard components. ASUS will shoulder the cost of repair only if the damage is shipment/transit-related.
 - Keep the cap after installing the motherboard. ASUS will process Return Merchandise Authorization (RMA) requests only if the motherboard comes with the cap on the LGA2011-v3 socket.
 - The product warranty does not cover damage to the socket contacts resulting from incorrect CPU installation/removal, or misplacement/loss/incorrect removal of the PnP cap.
-

1.2.4 System memory

The motherboard comes with eight Double Data Rate 4 (DDR4) Dual Inline Memory Module (DIMM) slots.



A DDR4 module is notched differently from a DDR3 or DDR2 module. DO NOT install a DDR3 or DDR2 memory module to the DDR4 slot.

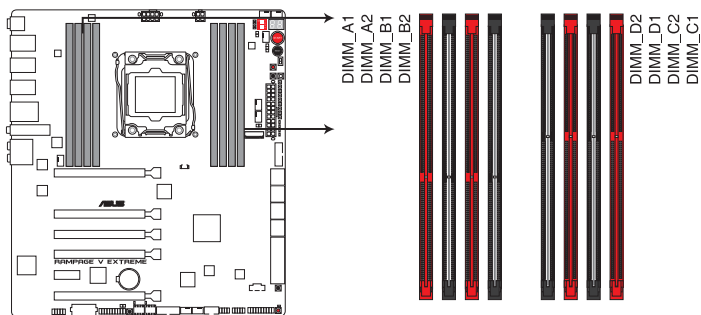

RAMPAGE V EXTREME 288-pin DDR4 DIMM socket

Recommended memory configurations

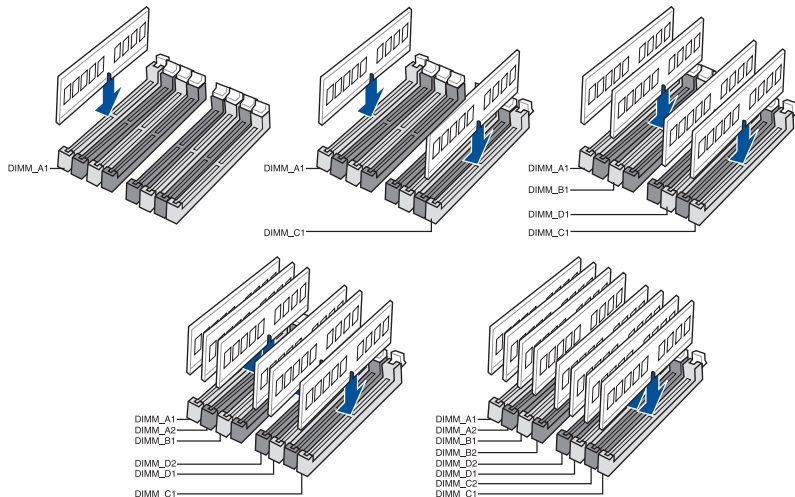

Memory configurations

You may install 2 GB, 4 GB, and 8 GB unbuffered and non-ECC DDR4 DIMMs into the DIMM sockets.



-
- You may install varying memory sizes in Channel A, Channel B, Channel C, and Channel D. The system maps the total size of the lower-sized channel for the dual-channel configuration. Any excess memory from the higher-sized channel is then mapped for single-channel operation.
 - According to Intel® CPU spec, DIMM voltage below 1.65V is recommended to protect the CPU.
 - Always install DIMMs with the same CAS latency. For optimum compatibility, we recommend that you obtain memory modules from the same vendor.
 - Due to the memory address limitation on 32-bit Windows® OS, when you install 4GB or more memory on the motherboard, the actual usable memory for the OS can be about 3GB or less. For effective use of memory, we recommend that you do any of the following:
 - a) Use a maximum of 3 GB system memory if you are using a 32-bit Windows® OS.
 - b) Install a 64-bit Windows® OS when you want to install 4GB or more on the motherboard.
 - c) For more details, refer to the Microsoft® support site at <http://support.microsoft.com/kb/929605/en-us>.
 - This motherboard does not support DIMMs made up of 512Mb (64MB) chips or less (Memory chip capacity counts in Megabit, 8 Megabit/Mb = 1 Megabyte/MB).
-



-
- The default memory operation frequency is dependent on its Serial Presence Detect (SPD) which is the standard way of accessing information from a memory module. Under the default state, some memory modules for overclocking may operate at a lower frequency than the vendor-marked value. To operate at the vendor-marked or at a higher frequency, refer to the **Extreme Tweaker menu** section for manual memory frequency adjustment.
 - For system stability, use a more efficient memory cooling system to support a full memory load (8 DIMMs) or overclocking condition.
 - Memory modules with memory frequency higher than 2133MHz and their corresponding timing or the loaded XMP profile is not the JEDEC memory standard. The stability and compatibility of the memory modules depend on the CPU's capabilities and other installed devices.
 - Always install the DIMMS with the same CAS Latency. For an optimum compatibility, we recommend that you install memory modules of the same version or data code (D/C) from the same vendor. Check with the vendor to get the correct memory modules.
-

RAMPAGE V EXTREME Motherboard Qualified Vendors List (QVL)

DDR4 3300 MHz capability

Vendors	Part No.	Size	SS/ DS	Chip Brand	Chip NO.	Timing	Voltage	DIMM socket support (Optional)		
								2	4	8
G.SKILL	F4-3300C17Q-16GRR	16GB(4x4GB)	SS	Gskill	NA	17-20-20-44	1.5V	•	•	

DDR4 3000 MHz capability

Vendors	Part No.	Size	SS/ DS	Chip Brand	Chip NO.	Timing	Voltage	DIMM socket support (Optional)		
								2	4	8
G.SKILL	F4-3000C16Q-16GRR	16GB (4x 4GB)	SS	Hynix	H5AN4GBNMFR-TFC	16-16-16-36	1.35V	•	•	
G.SKILL	F4-3000C16Q-32GRR	32GB (4x 8GB)	DS	Hynix	H5AN4GBNMFR-TFC	16-16-16-36	1.35V	•	•	

DDR4 2800 MHz capability

Vendors	Part No.	Size	SS/ DS	Chip Brand	Chip NO.	Timing	Voltage	DIMM socket support (Optional)		
								2	4	8
A_DATA	AX4U2800W8G17-DRZ	8GB	DS	Hynix	H5AN4G8 NMFR	17-18-18-36	1.2V	•	•	
CORSAIR	CMD16GX4M4A2800C16	16GB(4GB*4)	SS	-	-	16-18-18-36	1.2V	•	•	
CORSAIR	CMD32GX4M4A2800C16	32GB(8GB*4)	DS	-	-	16-18-18-36	1.2V	•	•	
CORSAIR	CMD64GX4M8A2800C16	64GB(8GB*8)	DS	-	-	16-18-18-36	1.2V	•	•	•
CORSAIR	CMD16GX4M4A2800C15	16GB(4GB*4)	SS	-	-	15-17-17-36	1.2V	•	•	
CORSAIR	CMD32GX4M4A2800C15	32GB(8GB*4)	DS	-	-	15-17-17-36	1.2V	•	•	
CORSAIR	CMK16GX4M4A2800C16	16GB(4GB*4)	SS	-	-	16-18-18-36	1.2V	•	•	
CORSAIR	CMK32GX4M4A2800C16	32GB(8GB*4)	DS	-	-	16-18-18-36	1.2V	•	•	
CORSAIR	CMK64GX4M8A2800C16	64GB(8GB*8)	DS	-	-	16-18-18-36	1.2V	•	•	•
CORSAIR	CMK16GX4M4A2800C15R	16GB(4GB*4)	SS	-	-	15-17-17-36	1.2V	•	•	
CORSAIR	CMK32GX4M4A2800C15R	32GB(8GB*4)	DS	-	-	15-17-17-36	1.2V	•	•	
G.SKILL	F4-2800C17Q-16GRR	16GB(4GB*4)	SS	-	-	17-18-18-35	1.2V	•	•	
G.SKILL	F4-2800C17Q-32GRR	32GB(8GB*4)	DS	-	-	17-18-18-35	1.2V	•	•	

DDR4 2666 MHz capability

Vendors	Part No.	Size	SS/ DS	Chip Brand	Chip NO.	Timing	Voltage	DIMM socket support (Optional)		
								2	4	8
CORSAIR	CMD16GX4M4A2666C14	16GB(4GB*4)	SS	-	-	14-16-16-35	1.2V	•	•	
CORSAIR	CMD32GX4M4A2666C14	32GB(8GB*4)	DS	-	-	14-16-16-35	1.2V	•	•	
CORSAIR	CMK16GX4M4A2666C15	16GB(4GB*4)	SS	-	-	15-17-17-35	1.2V	•	•	
CORSAIR	CMK32GX4M4A2666C15	32GB(8GB*4)	DS	-	-	15-17-17-35	1.2V	•	•	
CORSAIR	CMK16GX4M4A2666C14R	16GB(4GB*4)	SS	-	-	14-16-16-35	1.2V	•	•	
CORSAIR	CMK32GX4M4A2666C14R	32GB(8GB*4)	DS	-	-	14-16-16-35	1.2V	•	•	
G.SKILL	F4-2666C15Q-16GRR	16GB(4GB*4)	SS			15-17-17-36	1.2V	•	•	
G.SKILL	F4-2666C15Q-32GRR	32GB(8GB*4)	DS			15-17-17-36	1.2V	•	•	

DDR4 2400 MHz capability

Vendors	Part No.	Size	SS/ DS	Chip Brand	Chip NO.	Timing	Voltage	DIMM socket support (Optional)		
								2	4	8
A_DATA	AX4U2400W8G16-DRZ	8GB	SS	SK hynix	H5AN4G8NMFR	16-16- 16-39	1.2V	•	•	
CORSAIR	CMD16GX4M4A2400C14	16GB(4GB*4)	SS	-	-	14-16- 16-31	1.2V	•	•	
CORSAIR	CMD32GX4M4A2400C14	32GB(8GB*4)	DS	-	-	14-16- 16-31	1.2V	•	•	
CORSAIR	CMD64GX4M8A2400C14	64GB(8GB*8)	DS	-	-	14-16- 16-31	1.2V	•	•	•
CORSAIR	CMD16GX4M4A2400C13	16GB(4GB*4)	SS	-	-	13-15- 15-31	1.2V	•	•	
CORSAIR	CMD32GX4M4A2400C13	32GB(8GB*4)	DS	-	-	13-15- 15-31	1.2V	•	•	
CORSAIR	CMK16GX4M4A2400C14B	16GB(4GB*4)	SS	-	-	14-16- 16-31	1.2V	•	•	
CORSAIR	CMK16GX4M4A2400C14R	16GB(4GB*4)	SS	-	-	14-16- 16-31	1.2V	•	•	
CORSAIR	CMK16GX4M4A2400C14	16GB(4GB*4)	SS	-	-	14-16- 16-31	1.2V	•	•	
CORSAIR	CMK32GX4M4A2400C14	32GB(8GB*4)	DS	-	-	14-16- 16-31	1.2V	•	•	
CORSAIR	CMK64GX4M8A2400C14	64GB(8GB*8)	DS	-	-	14-16- 16-31	1.2V	•	•	•
CORSAIR	CMK16GX4M4A2400C13R	16GB(4GB*4)	SS	-	-	13-15- 15-31	1.2V	•	•	
CORSAIR	CMK32GX4M4A2400C13R	32GB(8GB*4)	DS	-	-	13-15- 15-31	1.2V	•	•	
G.SKILL	F4-2400C15Q-16GRR	16GB (4x 4GB)	SS	Hynix	H5AN4GBNMFR- TFC	15-15- 15-35	1.2V	•	•	
G.SKILL	F4-2400C15Q-32GRR	32GB (4x 8GB)	DS	Hynix	H5AN4GBNMFR- TFC	15-15- 15-35	1.2V	•	•	
G.SKILL	F4-2400C15Q2-64GRR	64GB (8x 8GB)	DS	Hynix	H5AN4GBNMFR- TFC	15-15- 15-35	1.2V	•	•	•
G.SKILL	F4-2400C17Q-16GRR	16GB(4GB*4)	SS	-	-	17-17- 17-40	1.2V	•	•	
G.SKILL	F4-2400C17Q-32GRR	32GB(8GB*4)	DS	-	-	17-17- 17-40	1.2V	•	•	
G.SKILL	F4-2400C17Q2-64GRR	64GB(8GB*8)	DS	-	-	17-17- 17-40	1.2V	•	•	•
panram	PUD42400C154GNJK	4GB	SS	-	-	15-15- 15-36	1.2V	•	•	
panram	PUD42400C158GNJK	8GB	DS	-	-	15-15- 15-36	1.2V	•	•	
panram	PUD42400C154G2NJK	8GB(4GB*2)	SS	-	-	15-15- 15-36	1.2V	•	•	
panram	PUD42400C158G2NJK	16GB(8GB*2)	DS	-	-	15-15- 15-36	1.2V	•	•	

DDR4 2133 MHz capability

Vendors	Part No.	Size	SS/ DS	Chip Brand	Chip NO.	Timing	Voltage	DIMM socket support (Optional)		
								2	4	8
Micron	MTA8ATF51264AZ-2G1A1	4GB	SS	Micron	D9RGQ	15-15-15-37	1.2V	•	•	•
Micron	MTA16ATF1G64AZ-2G1A1	8GB	DS	Micron	D9RGQ	15-15-15-37	1.2V	•	•	•
Crucial	CT4G4DFS8213.8FA1	4GB	SS	Micron	D9RGQ	15-15-15-37	1.2V	•	•	•
Crucial	CT8G4DFD8213.16FA1	8GB	DS	Micron	D9RGQ	15-15-15-37	1.2V	•	•	•
Samsung	M378A5143DB0-CPB	4GB	SS	Samsung	K4A4G085WD-BCPB	15-15-15-37	1.2V	•	•	•
SK hynix	HMA451U6MFR8N-TF	4GB	SS	SK hynix	H5AN4G8NMFRFC	15-15-15-37	1.2V	•	•	•
SK hynix	HMA41GU6MFR8N-TF	8GB	DS	SK hynix	H5AN4G8NMFRFC	15-15-15-37	1.2V	•	•	•
A_DATA	AX4U2133W4G13-DRZ	4GB	SS	SK hynix	H5AN4G8NMFR	13-13-13-36	1.2V	•	•	
A_DATA	AX4U2133W8G13-DRZ	8GB	DS	SK hynix	H5AN4G8NMFR	13-13-13-36	1.2V	•	•	
A_DATA	AX4U2133W4G15-DRZ	4GB	SS	SK hynix	H5AN4G8NMFR	15-15-15-37	1.2V	•	•	
A_DATA	AX4U2133W8G15-DRZ	8GB	DS	SK hynix	H5AN4G8NMFR	15-15-15-37	1.2V	•	•	
CORSAIR	CMK8GX4M2A2133C15	8GB(4GB*2)	SS	-	-	15-15-15-36	1.2V	•	•	
CORSAIR	CMK16GX4M2A2133C15	16GB(8GB*2)	DS	-	-	15-15-15-36	1.2V	•	•	
CORSAIR	CMK8GX4M2A2133C15R	8GB(4GB*2)	SS	-	-	15-15-15-36	1.2V	•	•	
CORSAIR	CMK16GX4M4A2133C13B	16GB(4GB*4)	SS	-	-	13-15-15-28	1.2V	•	•	
CORSAIR	CMK16GX4M4A2133C13R	16GB(4GB*4)	SS	-	-	13-15-15-28	1.2V	•	•	
CORSAIR	CMK16GX4M4A2133C13	16GB(4GB*4)	SS	-	-	13-15-15-28	1.2V	•	•	
CORSAIR	CMK32GX4M4A2133C13	32GB(8GB*4)	DS	-	-	13-15-15-28	1.2V	•	•	
CORSAIR	CMK64GX4M8A2133C13	64GB(8GB*8)	DS	-	-	13-15-15-28	1.2V	•	•	•
CORSAIR	CMK16GX4M4A2133C12R	16GB(4GB*4)	SS	-	-	12-14-14-27	1.2V	•	•	
CORSAIR	CMK32GX4M4A2133C12R	32GB(8GB*4)	DS	-	-	12-14-14-27	1.2V	•	•	
CORSAIR	CMD16GX4M4A2133C12	16GB(4GB*4)	SS	-	-	12-14-14-27	1.2V	•	•	
CORSAIR	CMD32GX4M4A2133C12	32GB(8GB*4)	DS	-	-	12-14-14-27	1.2V	•	•	

(Continued on the next page)

DDR4 2133 MHz capability

Vendors	Part No.	Size	SS/ DS	Chip Brand	Chip NO.	Timing	Voltage	DIMM socket support (Optional)		
								2	4	8
G.SKILL	F4-2133C12Q-16GRR	16GB(4GB*4)	SS	Hynix	H5AN4GBNMFR-TFC	12-12-12-32	1.2V	•	•	
G.SKILL	F4-2133C12Q-32GRR	32GB(8GB*4)	DS	Hynix	H5AN4GBNMFR-TFC	12-12-12-32	1.2V	•	•	
G.SKILL	F4-2133C12Q2-64GRR	64GB(8GB*8)	DS	Hynix	H5AN4GBNMFR-TFC	12-12-12-32	1.2V	•	•	•
G.SKILL	F4-2133C15Q-16GRR	16GB(4GB*4)	SS	Micron	Z9RGR	15-15-15-35	1.2V	•	•	
G.SKILL	F4-2133C15Q-32GRR	32GB(8GB*4)	DS	Micron	Z9RGR	15-15-15-35	1.2V	•	•	
G.SKILL	F4-2133C15Q2-64GRR	64GB(8GB*8)	DS	Micron	Z9RGR	15-15-15-35	1.2V	•	•	•
Kingston	KVR21N15/8	8GB	DS	SK hynix	H5AN4G8NMFRTFC	15-15-15-37	1.2V	•	•	
panram	PUD42133C154GNJK	4GB	DS	-	-	15-15-15-36	1.2V	•	•	
panram	PUD42133C158GNJK	8GB	DS	-	-	15-15-15-36	1.2V	•	•	
panram	PUD42133C154G2NJK	8GB(4GB*2)	SS	-	-	15-15-15-36	1.2V	•	•	
panram	PUD42133C158G2NJK	16GB(8GB*2)	DS	-	-	15-15-15-36	1.2V	•	•	
SUPER TALENT	FBU2B008GM	8GB	DS	-	-	15-15-15-36	1.2V	•	•	•



Side(s): SS - Single-sided DS - Double-sided DIMM support:

- 1** Supports one (1) module inserted into any slot as Single-channel memory configuration. We suggest that you install the module into A1 slot.
- 2** Supports two (2) modules inserted into any two (2) of the red slots as one pair of dual-channel memory configuration. We suggest that you install the modules into slots A1 and C1 for better compatibility.
- 4** Supports four (4) modules inserted into the four (4) red slots as two pairs of quad-channel memory configuration. We suggest that you install the modules into slots A1, B1, C1, and D1 for better compatibility.
- 6** Supports six (6) modules inserted into four red slots and two black slots as three pairs of quad-channel memory configuration. We suggest that you install the modules into slots A1, A2, B1, C1, D1, and D2 for better compatibility.
- 8** Supports eight (8) modules inserted into all slots as fully-loaded quad-channel memory configurations.



- ASUS exclusively provides hyper DIMM support function.
- Hyper DIMM support is subject to the physical characteristics of individual CPUs. Load the X.M.P. or D.O.C.P. settings in the BIOS for the hyper DIMM support.
- Visit the ASUS website for the latest QVL.

1.2.5 Expansion slots



Ensure to unplug the power cord before adding or removing expansion cards. Failure to do so may cause you physical injury and damage motherboard components.

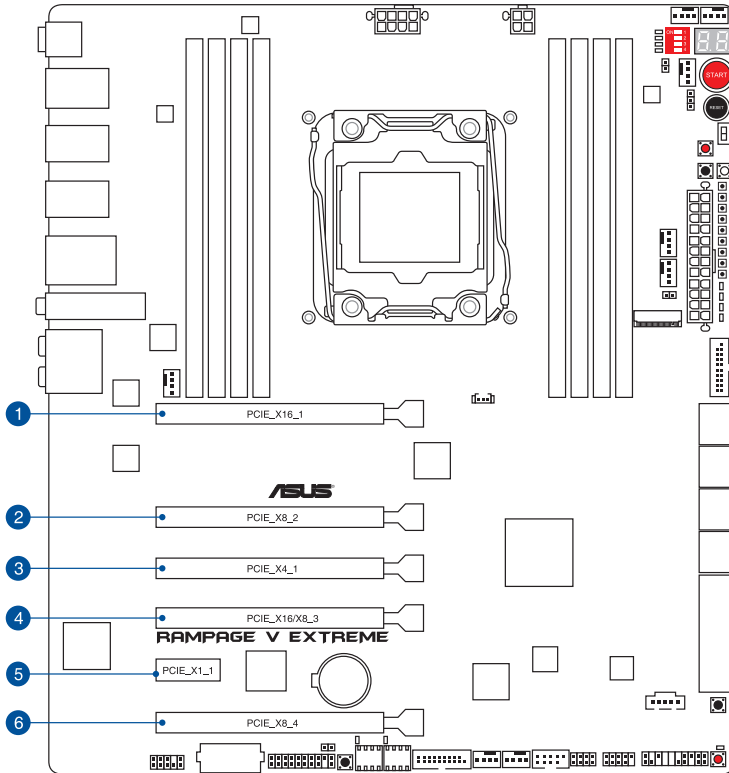

Slot No.	Slot Description
1	PCIe 3.0 x16_1 slot
2	PCIe 3.0 x8_2 slot
3	PCIe 2.0 x4_1 slot
4	PCIe 3.0 x16/8_3 slot
5	PCIe 2.0 x1_1 slot
6	PCIe 3.0 x8_4 slot



- We recommend that you provide sufficient power when running CrossFireX™ or SLI mode.
- While running at four heavy loaded VGA cards, ensure to plug in the 4-pin extra PCIe power supply for stability.

Refer to the following configuration table for installation.

PCIe 3.0 operating mode for 40 lanes CPU

Red PCIe slot	Single VGA	SLI/CFX	3-way SLI/CFX	4-way SLI/CFX
PCIE_X16_1	x16	x16	x16	x16
PCIE_X8_2	—	—	x8	x8
PCIE_X16/X8_3	—	x16	x8	x8
PCIE_X8_4	—	—	—	x8

PCIe 3.0 operating mode for 28 lanes CPU

Red PCIe slot	Single VGA	SLI/CFX	3-way SLI/CFX
PCIE_X16_1	x16	x16	x8
PCIE_X8_2	—	—	x8
PCIE_X16/X8_3	—	x8	x8



- The PCIE_X8_4 slot shares bandwidth with M.2 x 4. When PCIE_X8_4 is occupied, the M.2 will be disabled.
- The PCIE_X8_4 slot will be disabled when using a 28-LANE CPU.
- The PCIE_X4_1 (gray) slot shares bandwidth with the PCIE_X1_1 slot, USB3_E910, and SATAExpress_E1 connector. When the PCIE_X4_1 slot is occupied by an X1 or X2 device, the SATAEXPRESS_E1 will be disabled. When the PCIE_X4_1 slot is occupied by X4 device, both the SATAEXPRESS_E1, USB3_E910 ports, and the PCIE_X1_1 slot will be disabled.

IRQ assignments for this motherboard

	A	B	C	D	E	F	G	H
PCIE_X16_1	shared	-	-	-	-	-	-	-
PCIE_X8_2	shared	-	-	-	-	-	-	-
PCIE_x4_1	shared	-	-	-	-	-	-	-
PCIE_X16/X8_3	shared	-	-	-	-	-	-	-
PCIE_X8_4	shared	-	-	-	-	-	-	-
PCIE_X1_1	-	-	shared	-	-	-	-	-
Intel LAN controller	-	-	-	-	shared	-	-	-
SATA #0	-	shared	-	-	-	-	-	-
SATA #1	-	shared	-	-	-	-	-	-
HD Audio	-	-	-	-	-	-	shared	-
EHCI #0 (USB 2.0)	-	-	-	-	-	shared	-	-
EHCI #1 (USB 2.0)	-	shared	-	-	-	-	-	-
XHCI (USB 3.0)	-	-	-	-	-	-	-	shared

1.2.6 Onboard buttons and switches

Onboard buttons and switches allow you to fine-tune performance when working on a bare or open-case system. This is ideal for overclockers and gamers who continually change settings to enhance system performance.

1. Power-on (START) button

The motherboard comes with a power-on button that allows you to power up or wake up the system. The button also lights up when the system is plugged to a power source indicating that you should shut down the system and unplug the power cable before removing or installing any motherboard component.

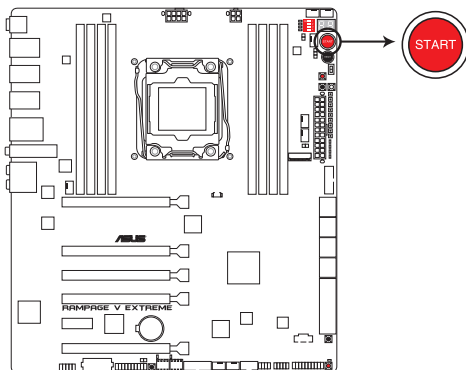

RAMPAGE V EXTREME Power on button

2. Reset button

Press the Reset button to reboot the system.

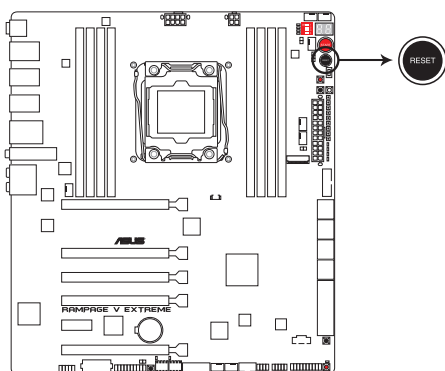

RAMPAGE V EXTREME Reset button

3. MemOK! button (MemOK!)

Installing DIMMs that are not compatible with the motherboard may cause system boot failure. One indicator is the DRAM_LED lighting continuously.

Press and hold the MemOK! button to initiate the memory compatibility tuning process that can help lead to a successful boot.

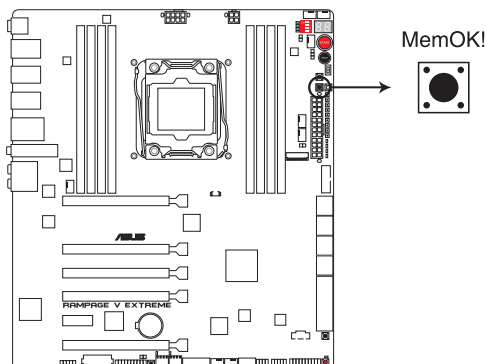

RAMPAGE V EXTREME MemOK! button



- Refer to the **Onboard LEDs** section for the exact location of the DRAM_LED.
- The DRAM_LED also lights up when the DIMM is not properly installed. Turn off the system and reinstall the DIMM before using the MemOK! function.
- The MemOK! button does not function under Windows® OS environment.
- During the tuning process, the system loads and tests failsafe memory settings. It takes about 30 seconds for the system to test one set of failsafe settings. If the test fails, the system reboots and test the next set of failsafe settings. The blinking speed of the DRAM_LED increases, indicating different test processes.
- Due to memory tuning requirement, the system automatically reboots when each timing set is tested. If the installed DIMMs still fail to boot after the tuning process is completed, the DRAM_LED lights continuously. Replace the DIMMs with ones recommended in the Memory QVL (Qualified Vendors Lists) in this user manual or at www.asus.com.
- If you turn off the computer and replace DIMMs during the tuning process, the system continues memory tuning after turning on the computer. To stop memory tuning, turn off the computer and unplug the power cord for about 5–10 seconds.
- If your system fails to boot up due to BIOS overlocking, press the MemOK! button to boot and load the BIOS default settings. A message will appear during POST to remind you that the BIOS has been restored to its default settings.
- We recommend that you download and update to the latest BIOS version from www.asus.com after using the MemOK! function.

4. ReTry button (RETRY)

The ReTry button is specially designed for overclockers and is most useful during the booting process where the Reset button is rendered useless. When pressed, it forces the system to reboot while retaining the same settings to be retried in quick succession to achieve a successful POST.

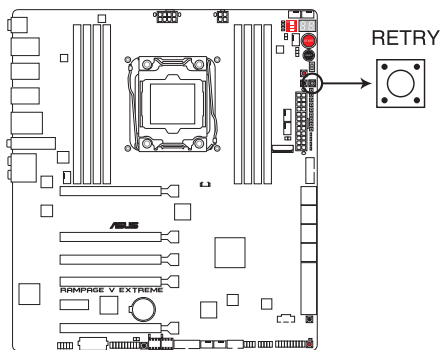

RAMPAGE V EXTREME RETRY button

5. BIOS Switch button (BIOS_SWITCH)

The motherboard comes with two BIOS. Press the BIOS button to switch BIOS and load different BIOS settings. The nearby BIOS LEDs indicate the currently selected BIOS.

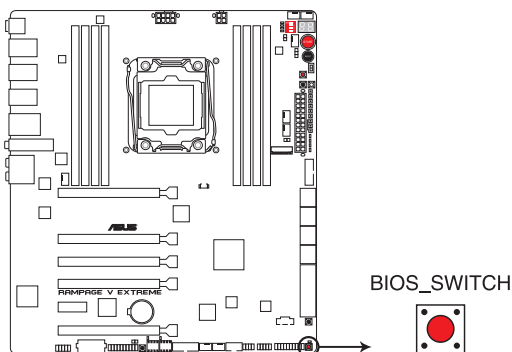

RAMPAGE V EXTREME BIOS_SWITCH button

6. Safe Boot button (SAFE_BOOT)

The Safe Boot button can be pressed anytime to force the system to reboot into the BIOS safe mode. This button temporarily applies safe settings to the BIOS while retaining any overclocked settings allowing you to modify the settings causing boot failure. Use this button when overclocking or tweaking the settings of your system.

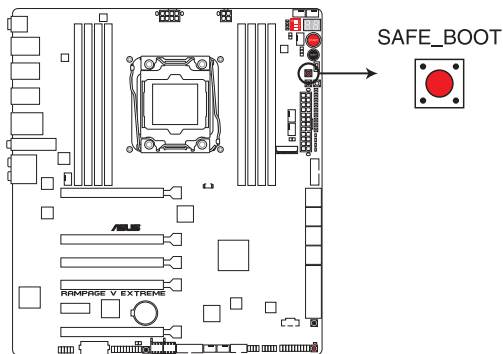

RAMPAGE V EXTREME SAFE_BOOT button

7. SOUNDSTAGE button (SOUNDSTAGE)

Press this button to activate the Sonic SoundStage feature.

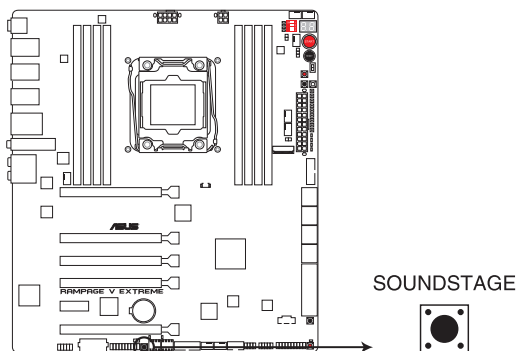

RAMPAGE V EXTREME SOUNDSTAGE button

8. KeyBot button (KEYBOT)

Press this button to activate the KeyBot feature and enable any custom macros and functions stored in the KeyBot microchip.

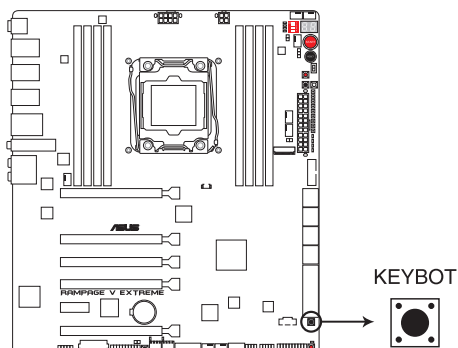

RAMPAGE V EXTREME KEYBOT button



- The KeyBot feature only supports USB keyboards connected on the designated USB port. For the location of the KeyBot USB port, refer to the Rear I/O connection section of this user guide.
- The KEYBOT_LED near the KEYBOT button lights up if the Keybot function is enabled.
- For more information about the KeyBot feature, refer to the **Software Support** chapter of this user guide.

9. PCIe x16 Lane switch

These slide switches allows you to enable and disable the corresponding PCIe x16 slots. When one of the installed PCIe x16 cards is out of order, you can use the slide switch to find out the faulty one without removing the cards.

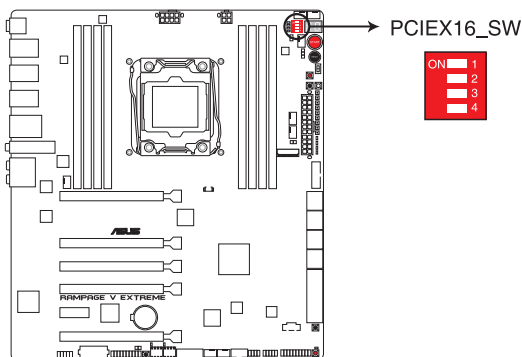

RAMPAGE V EXTREME PCIe x16 Lane switch

10. Slow Mode Switch (SLOW_MODE)

Slow Mode Switch is employed during LN2 benching. Some processors have a small optimum temperature range to run at their highest frequency. Temperatures that fall outside this band may yield instability. For example, a processor may need to operate at -80°C under load and only 75°C when idle to maintain stability at 5.8GHz.

At lower frequencies, the CPU's temperature tolerance increases. It will however remain stable at lower frequencies at much colder or warmer temperatures. Once it comes out of a heavy load while transitioning over to a light load, when the temperature does not warm fast enough, it may crash. To overcome this, simply flip the switch over to decrease the processor frequency. Switching over to Slow-Mode during critical moments when Temperature/Max Frequency alignment is off-sync can prevent a lot of crashes, even when trying to boot into the OS at cold temperatures.

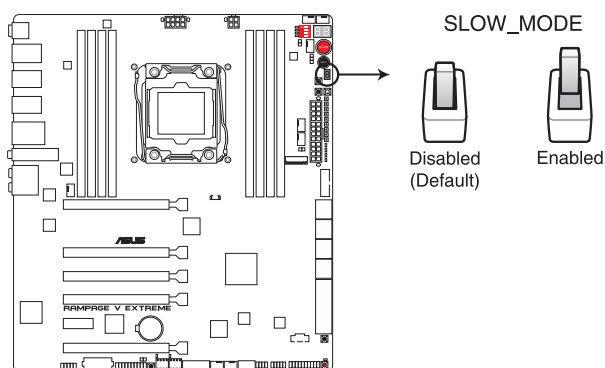

RAMPAGE V EXTREME Slow Mode switch

1.2.7 Onboard LEDs

1. BIOS LED

The BIOS LEDs help indicate the BIOS activity. Press the BIOS button to switch between BIOS1 and BIOS2 and the LED lights up when the corresponding BIOS is in use.

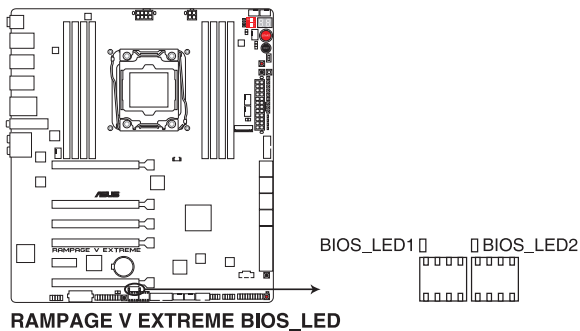

2. PCIe Lane LED indicator

Indicates the PCIe lane used.

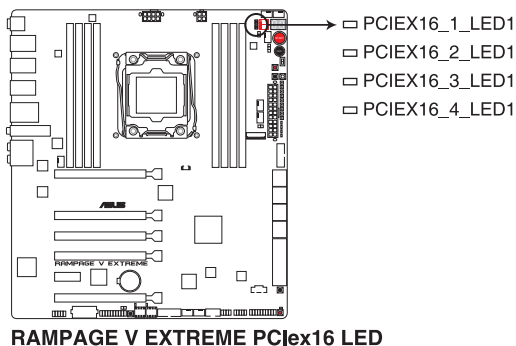

3. Q LED

Q LEDs check key components (CPU, DRAM, VGA card, and boot devices) in sequence during motherboard booting process. If an error is found, the corresponding LED will continue lighting until the problem is solved. This user-friendly design provides an intuitive way to locate the root-cause of the problem within seconds.

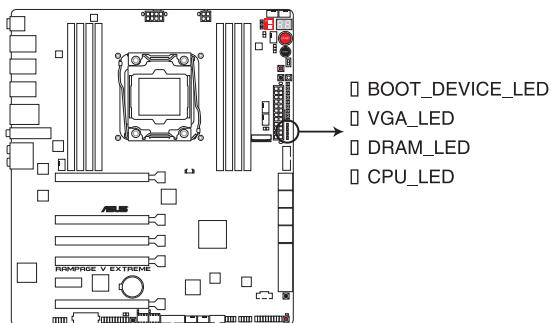

**RAMPAGE V EXTREME CPU/ DRAM/
BOOT_DEVICE/ VGA LED**

4. Q-Code LED

The Q-Code LED design provides you with a 2-digit error code that displays the system status. Refer to the Q-Code table on the next page for details.

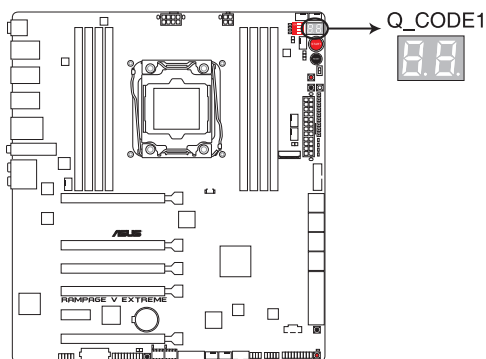

RAMPAGE V EXTREME Q-Code LED

Q-Code table

Code	Description
00	Not used
01	Power on. Reset type detection (soft/hard).
02	AP initialization before microcode loading
03	System Agent initialization before microcode loading
04	PCH initialization before microcode loading
06	Microcode loading
07	AP initialization after microcode loading
08	System Agent initialization after microcode loading
09	PCH initialization after microcode loading
0B	Cache initialization
0C – 0D	Reserved for future AMI SEC error codes
0E	Microcode not found
0F	Microcode not loaded
10	PEI Core is started
11 – 14	Pre-memory CPU initialization is started
15 – 18	Pre-memory System Agent initialization is started
19 – 1C	Pre-memory PCH initialization is started
2B – 2F	Memory initialization
30	Reserved for ASL (see ASL Status Codes section below)
31	Memory Installed
32 – 36	CPU post-memory initialization
37 – 3A	Post-Memory System Agent initialization is started
3B – 3E	Post-Memory PCH initialization is started
4F	DXE IPL is started
50 – 53	Memory initialization error. Invalid memory type or incompatible memory speed

(continued on the next page)

Q-Code table

Code	Description
54	Unspecified memory initialization error
55	Memory not installed
56	Invalid CPU type or Speed
57	CPU mismatch
58	CPU self test failed or possible CPU cache error
59	CPU micro-code is not found or micro-code update is failed
5A	Internal CPU error
5B	Reset PPI is not available
5C – 5F	Reserved for future AML error codes
E0	S3 Resume is started (S3 Resume PPI is called by the DXE IPL)
E1	S3 Boot Script execution
E2	Video repost
E3	OS S3 wake vector call
E4 – E7	Reserved for future AML progress codes
E8	S3 Resume Failed
E9	S3 Resume PPI not Found
EA	S3 Resume Boot Script Error
EB	S3 OS Wake Error
EC – EF	Reserved for future AML error codes
F0	Recovery condition triggered by firmware (Auto recovery)
F1	Recovery condition triggered by user (Forced recovery)
F2	Recovery process started
F3	Recovery firmware image is found
F4	Recovery firmware image is loaded
F5 – F7	Reserved for future AML progress codes
F8	Recovery PPI is not available

(continued on the next page)

Q-Code table

Code	Description
F9	Recovery capsule is not found
FA	Invalid recovery capsule
FB – FF	Reserved for future AMI error codes
60	DXE Core is started
61	NVRAM initialization
62	Installation of the PCH Runtime Services
63 – 67	CPU DXE initialization is started
68	PCI host bridge initialization
69	System Agent DXE initialization is started
6A	System Agent DXE SMM initialization is started
6B – 6F	System Agent DXE initialization (System Agent module specific)
70	PCH DXE initialization is started
71	PCH DXE SMM initialization is started
72	PCH devices initialization
73 – 77	PCH DXE Initialization (PCH module specific)
78	ACPI module initialization
79	CSM initialization
7A – 7F	Reserved for future AMI DXE codes
90	Boot Device Selection (BDS) phase is started
91	Driver connecting is started
92	PCI Bus initialization is started
93	PCI Bus Hot Plug Controller Initialization
94	PCI Bus Enumeration
95	PCI Bus Request Resources
96	PCI Bus Assign Resources
97	Console Output devices connect
98	Console input devices connect
99	Super IO Initialization
9A	USB initialization is started
9B	USB Reset

(continued on the next page)

Q-Code table

Code	Description
9C	USB Detect
9D	USB Enable
9E – 9F	Reserved for future AMI codes
A0	IDE initialization is started
A1	IDE Reset
A2	IDE Detect
A3	IDE Enable
A4	SCSI initialization is started
A5	SCSI Reset
A6	SCSI Detect
A7	SCSI Enable
A8	Setup Verifying Password
A9	Start of Setup
AA	Reserved for ASL (see ASL Status Codes section below)
AB	Setup Input Wait
AC	Reserved for ASL (see ASL Status Codes section below)
AD	Ready To Boot event
AE	Legacy Boot event
AF	Exit Boot Services event
B0	Runtime Set Virtual Address MAP Begin
B1	Runtime Set Virtual Address MAP End
B2	Legacy Option ROM Initialization
B3	System Reset
B4	USB hot plug
B5	PCI bus hot plug
B6	Clean-up of NVRAM
B7	Configuration Reset (reset of NVRAM settings)
B8– BF	Reserved for future AMI codes
D0	CPU initialization error
D1	System Agent initialization error

(continued on the next page)

Q-Code table

Code	Description
D2	PCH initialization error
D3	Some of the Architectural Protocols are not available
D4	PCI resource allocation error. Out of Resources
D5	No Space for Legacy Option ROM
D6	No Console Output Devices are found
D7	No Console Input Devices are found
D8	Invalid password
D9	Error loading Boot Option (LoadImage returned error)
DA	Boot Option is failed (StartImage returned error)
DB	Flash update is failed
DC	Reset protocol is not available

ACPI/ASL Checkpoints

Code	Description
0x01	System is entering S1 sleep state
0x02	System is entering S2 sleep state
0x03	System is entering S3 sleep state
0x04	System is entering S4 sleep state
0x05	System is entering S5 sleep state
0x10	System is waking up from the S1 sleep state
0x20	System is waking up from the S2 sleep state
0x30	System is waking up from the S3 sleep state
0x40	System is waking up from the S4 sleep state
0xAC	System has transitioned into ACPI mode. Interrupt controller is in PIC mode.
0xAA	System has transitioned into ACPI mode. Interrupt controller is in APIC mode.

1.2.8 Jumper

1. LN2 Mode jumper (3-pin LN2_MODE)

With LN2 mode activated, the ROG motherboard is optimized to remedy the cold-boot bug during POST and help the system boot successfully.

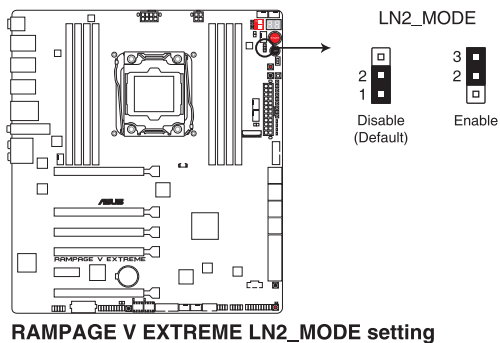

1.2.9 Internal connectors

1. Intel® X99 Serial ATA 6 Gb/s connectors (7-pin SATA6G_1-10; SATAEXPRESS_1)

These connectors connect to Serial ATA 6 Gb/s hard disk drives via Serial ATA 6 Gb/s signal cables.

If you installed Serial ATA hard disk drives, you can create a RAID 0, 1, 5, and 10 configuration with the Intel® Rapid Storage Technology through the onboard Intel® X99 chipset.

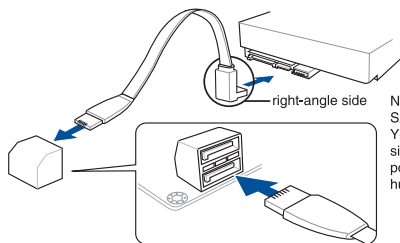
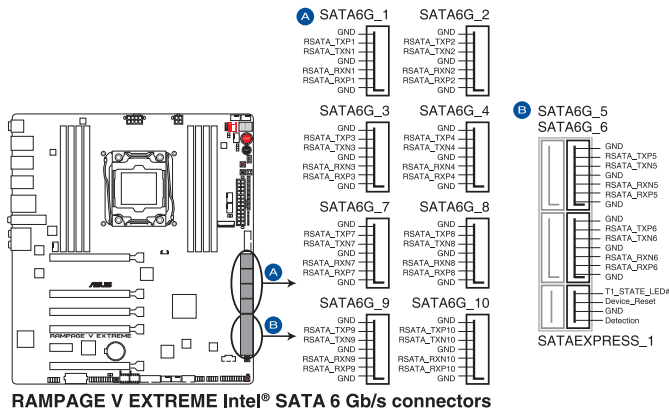

NOTE: Connect the right-angle side of SATA signal cable to SATA device. You may also connect the right-angle side of SATA cable to the onboard SATA port to avoid mechanical conflict with huge graphics cards.

- These connectors are set to **[AHCI Mode]** by default. If you intend to create a Serial ATA RAID array using these connectors, set the SATA Mode item in the BIOS to **[RAID Mode]**. Refer to the **PCH Storage Configuration** section for details.
- Before creating a RAID array, refer to the **RAID configurations** section or the manual bundled in the motherboard support DVD.

2. ASMedia® Serial ATA 6 Gb/s connectors (7-pin SATA6G_E3E4; SATAEXPRESS_E1)

These connectors connect to Serial ATA 6 Gb/s hard disk drives via Serial ATA 6 Gb/s signal cables.

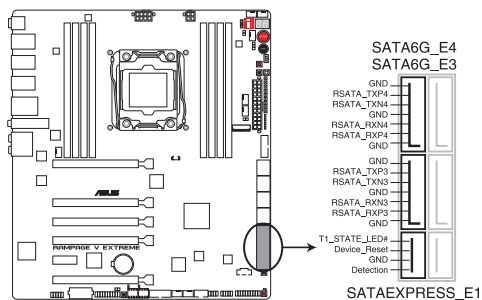

RAMPAGE V EXTREME ASMedia® SATA 6 Gb/s connectors



- The ASMedia storage controller can only support AHCI mode.
- These SATA ports are for data drives only.
- The PCIE_X4_1 (gray) slot shares bandwidth with the PCIE_X1_1 slot, USB3_E910 and SATAExpress_E1 connector. When the PCIE_X4_1 slot is occupied by an X1 or X2 device, the SATAEXPRESS_E1 will be disabled. When the PCIE_X4_1 slot is occupied by X4 device, both the SATAEXPRESS_E1, USB3_E910 ports, and the PCIE_X1_1 slot will be disabled.

3. ROG Extension connector (18-1 pin ROG_EXT)

This connector is for the OC Panel and other ROG accessories supporting the ROG_EXT connector.

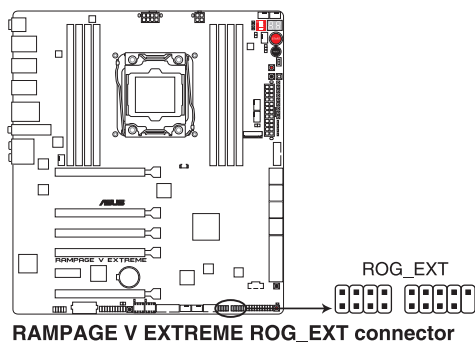

RAMPAGE V EXTREME ROG_EXT connector

4. Thermal sensor cable connectors (2-pin T_SENSOR1, T_SENSOR2, T_SENSOR3)

These connectors are for temperature monitoring. Connect the thermal sensor cables to these connectors and place the other end on the devices that you want to monitor. The optional fans 1, 2, and 3 can work with the temperature sensors for a more efficient cooling solution.

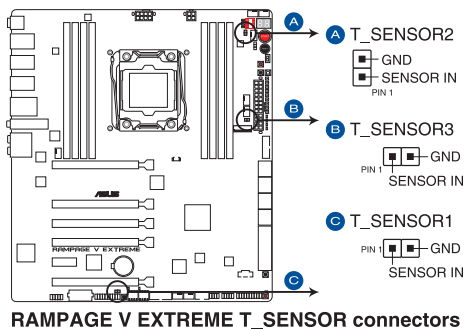

To monitor the temperature at the BIOS, go to BIOS>Monitor>Temperature Monitor.

5. USB 3.0 connector (20-1 pin USB3_12, USB3_34)

This connector is for the additional USB 3.0 ports, and complies with the USB 3.0 specification that supports up to 4.8Gbps connection speed. If the USB 3.0 front panel cable is available in your system chassis, with this USB 3.0 connector, you can have a front panel USB 3.0 solution.

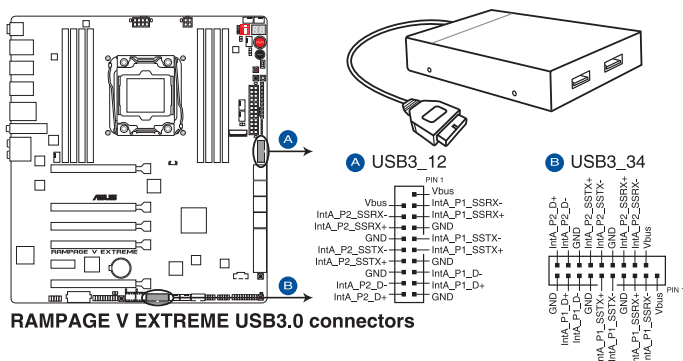

- The USB 3.0 module is purchased separately.
- These connectors are based on xHCI specification. We recommend you to install the related driver to fully use the USB 3.0 ports under Windows® 7.

6. USB 2.0 connectors (10-1 pin USB1112; USB1314)

These connectors are for USB 2.0 ports. Connect the USB module cable to any of these connectors, then install the module to a slot opening at the back of the system chassis. These USB connectors comply with USB 2.0 specification that support up to 480 Mbps connection speed.

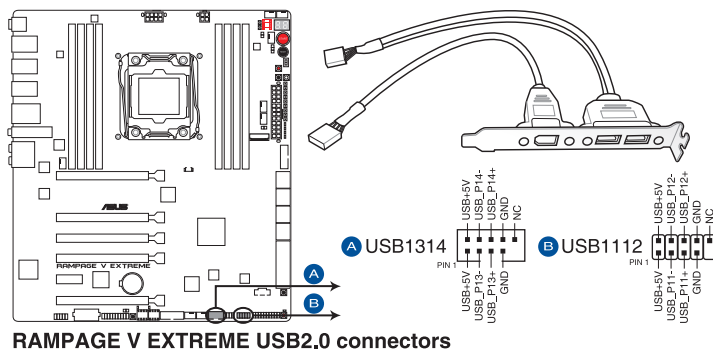

Never connect a 1394 cable to the USB connectors. Doing so will damage the motherboard!



You can connect the front panel USB cable to the ASUS Q-Connector (USB) first, and then install the Q-Connector (USB) to the USB connector onboard if your chassis supports front panel USB ports.



The USB 2.0 module is purchased separately.

7. CPU and chassis fan connectors (4-pin CPU_FAN; 4-pin CPU_OPT; 4-pin CHA_FAN1A-3A; 4-pin CHA_FAN1B-3B)

Connect the fan cables to the fan connectors on the motherboard, ensuring that the black wire of each cable matches the ground pin of the connector.

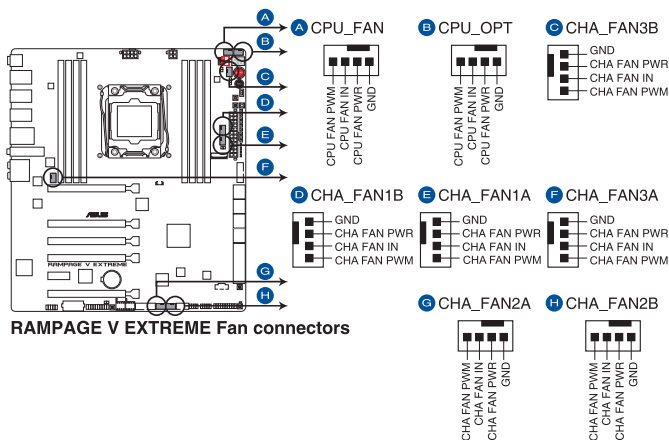

Do not forget to connect the fan cables to the fan connectors. Insufficient air flow inside the system may damage the motherboard components. These are not jumpers! Do not place jumper caps on the fan connectors!



The CPU_FAN connector supports the CPU fan of maximum 1A (12 W) fan power.

8. Front panel audio connector (10-1 pin AAFP)

This connector is for a chassis-mounted front panel audio I/O module that supports either HD Audio or legacy AC'97 audio standard. Connect one end of the front panel audio I/O module cable to this connector.

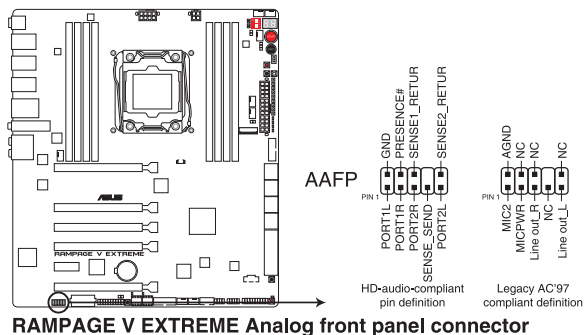

- We recommend that you connect a high-definition front panel audio module to this connector to take advantage of the motherboard's high-definition audio capability.
- If you want to connect a high-definition front panel audio module to this connector, set the **Front Panel Type** item in the BIOS setup to **[HD]**; if you want to connect an AC'97 front panel audio module to this connector, set the item to **[AC97]**. By default, this connector is set to **[HD]**.

9. TPM connector (20-1 pin TPM)

This connector supports a Trusted Platform Module (TPM) system, which securely store keys, digital certificates, passwords and data. A TPM system also helps enhance the network security, protects digital identities, and ensures platform integrity.

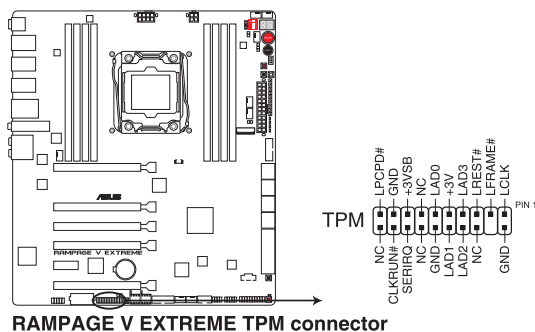

10. Thunderbolt header (5-pin TB_HEADER)

This connector is for the add-on Thunderbolt I/O card that supports Intel's Thunderbolt Technology, allowing you to connect up to six Thunderbolt-enabled devices and a DisplayPort-enabled display in a daisy-chain configuration.

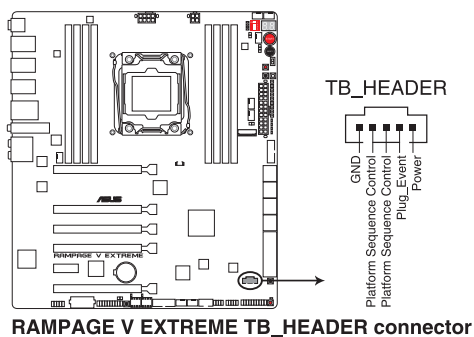

11. M.2 connector

The M.2 (Socket 3) with M Key supports type 2260 (22 mm x 60 mm), 2280 (22 mm x 80 mm), and 22110 (22 mm x 110 mm) PCIe interface storage devices.

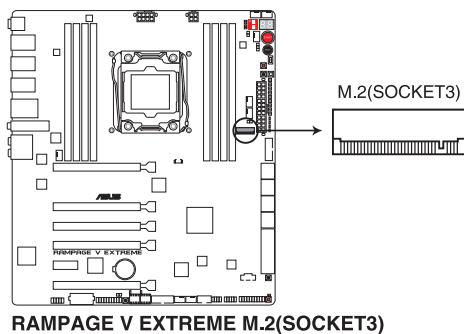

The PCIE_X8_4 slot shares bandwidth with M.2 x4. When PCIE_X8_4 is occupied, the M.2 will be disabled.

12. ATX power connectors (24-pin EATXPWR; 4-pin EATX12V_1; 8-pin EATX12V_2; 4-pin EZ_PLUG)

These connectors are for ATX power supply plugs. The power supply plugs are designed to fit these connectors in only one orientation. Find the proper orientation and push down firmly until the connectors completely fit.

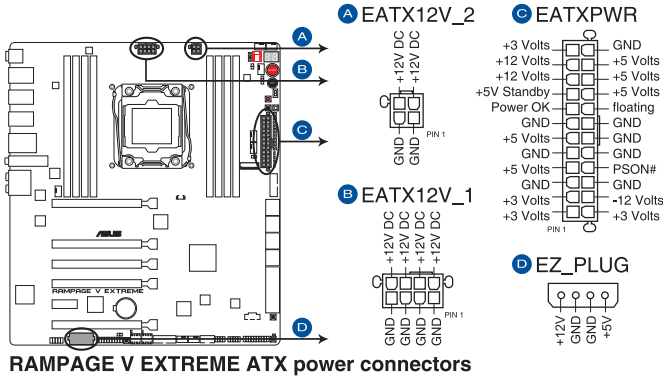

- For a fully configured system, we recommend that you use a power supply unit (PSU) that complies with ATX 12 V Specification 2.0 (or later version) and provides a minimum power of 450 W.
- Do not forget to connect the 4-pin/8-pin EATX12 V power plug; otherwise, the system will not boot.
- Connect the 4-pin EZ_PLUG power plugs to ensure sufficient power when you install multiple graphics cards.
- Use of a PSU with higher power output is recommended when configuring a system with more power-consuming devices. The system may become unstable or may not boot up if the power is inadequate.
- If you want to use two or more high-end PCI Express x16 cards, use a PSU with at least 1000W of output power to ensure system stability.

13. System panel connector (20-8 pin PANEL)

This connector supports several chassis-mounted functions.

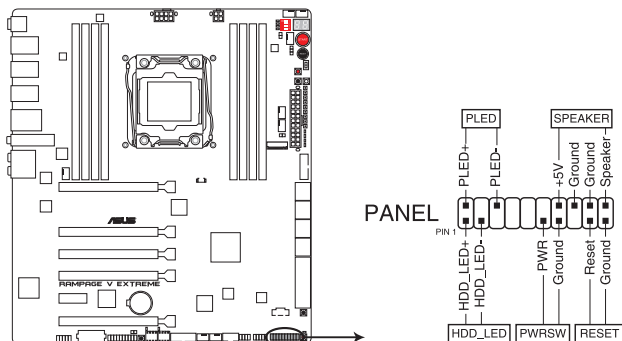

RAMPAGE V EXTREME System panel connector

- **System power LED (2-pin PLED)**

This 2-pin connector is for the system power LED. Connect the chassis power LED cable to this connector. The system power LED lights up when you turn on the system power, and blinks when the system is in sleep mode.

- **Hard disk drive activity LED (2-pin HDD_LED)**

This 2-pin connector is for the HDD Activity LED. Connect the HDD Activity LED cable to this connector. The IDE LED lights up or flashes when data is read from or written to the HDD.

- **System warning speaker (4-pin SPEAKER)**

This 4-pin connector is for the chassis-mounted system warning speaker. The speaker allows you to hear system beeps and warnings.

- **ATX power button/soft-off button (2-pin PWRSW)**

This connector is for the system power button. Pressing the power button turns the system on or puts the system in sleep or soft-off mode depending on the BIOS settings. Pressing the power switch for more than four seconds while the system is ON turns the system OFF.

- **Reset button (2-pin RESET)**

This 2-pin connector is for the chassis-mounted reset button for system reboot without turning off the system power.

14. ROG Logo LED connector (3-pin ROG)

This connector is for the box (labelled **Republic of Gamers**) below the CPU socket. Connect the box's cable to this connector. The box lights up when you turn on the system.

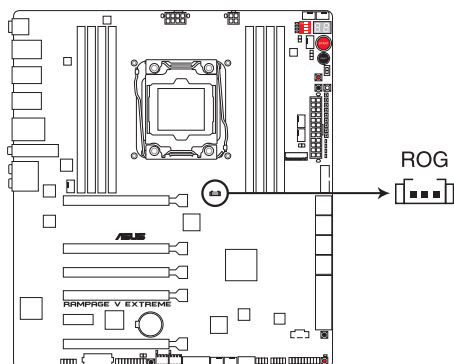

RAMPAGE V EXTREME ROG connector

1.2.10 Probelst

The ROG Probelst allows you to detect your system's current voltage and OC settings. Use a multimeter to measure the Probelst points even during overlocking.

See the illustration below to locate the respective Probelst points.

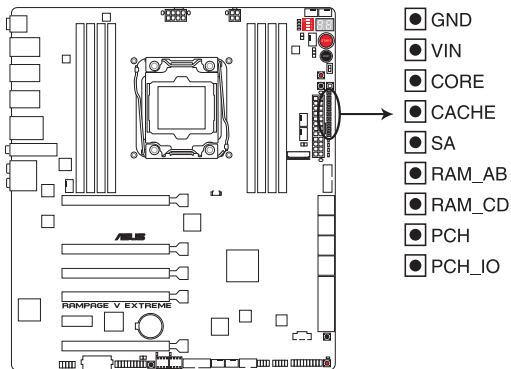

RAMPAGE V EXTREME Probelst

Using Probelst

You can connect the multimeter to the motherboard as shown on the following figure.

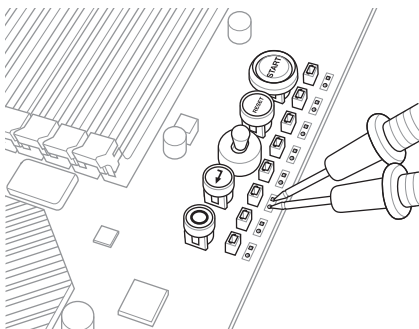

The illustration above are for reference only, the actual motherboard layout and measure points location may differ by models.

Basic installation

2.1 Building your PC system

2.1.1 Motherboard installation



The diagrams in this section are for reference only. The motherboard layout may vary with models, but the installation steps are the same for all models.

1. Install the ASUS Q-Shield to the chassis rear I/O panel.

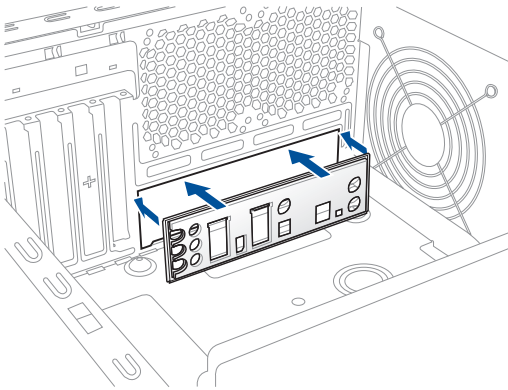

2. Place the motherboard into the chassis ensuring that its rear I/O ports are aligned to the chassis' rear I/O panel.

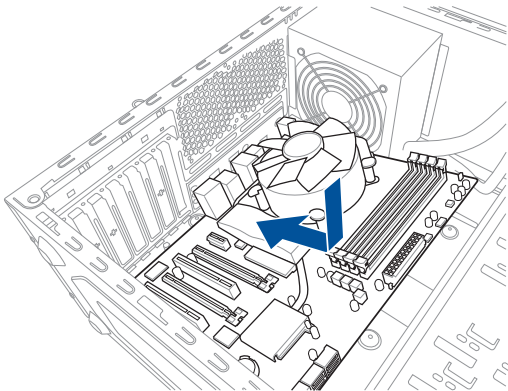

3. Place nine screws into the holes indicated by circles to secure the motherboard to the chassis.

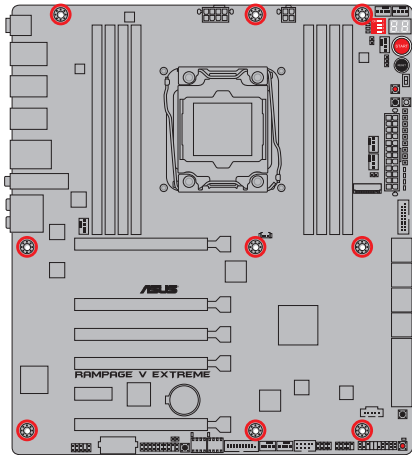
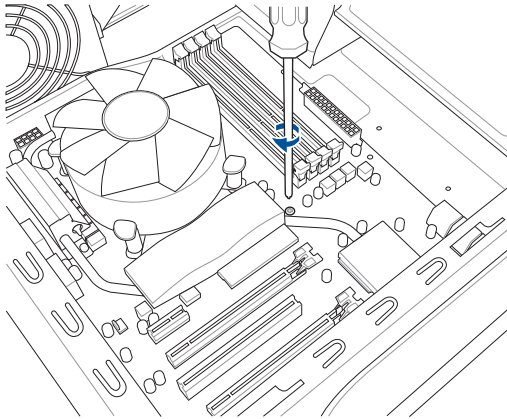

DO NOT overtighten the screws! Doing so can damage the motherboard.

2.1.2 CPU installation



Ensure that you install the correct CPU designed for LGA2011-v3 socket only. DO NOT install a CPU designed for LGA1150, LGA1155, and LGA1156 sockets on the LGA2011-v3 socket.

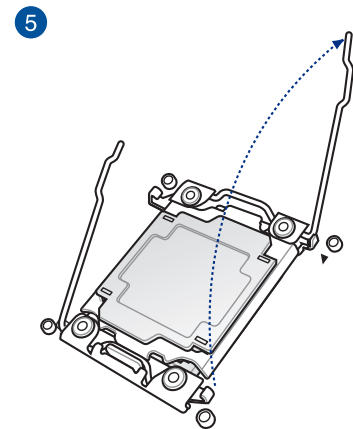
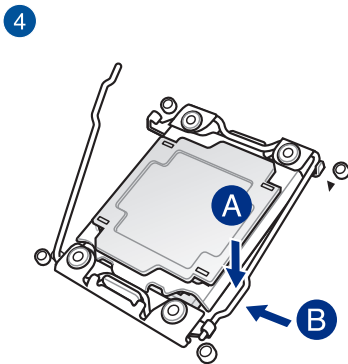
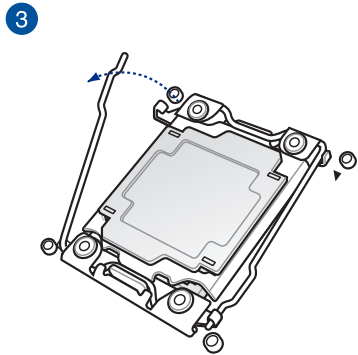
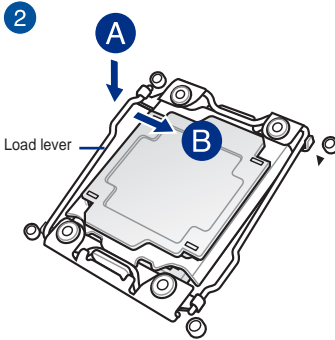
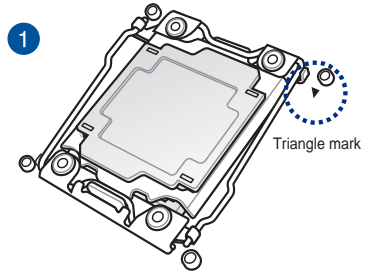
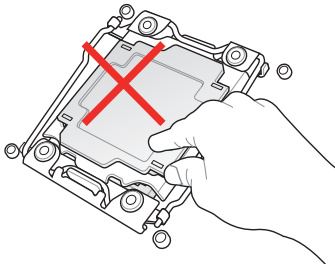

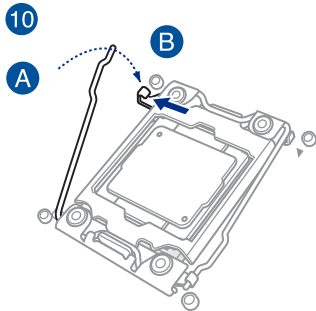
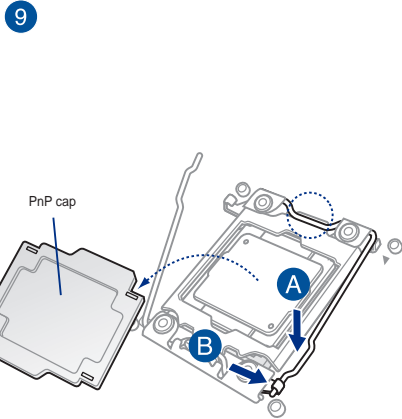
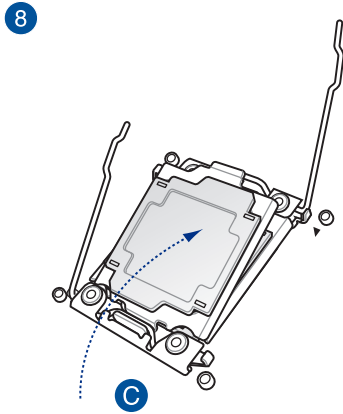
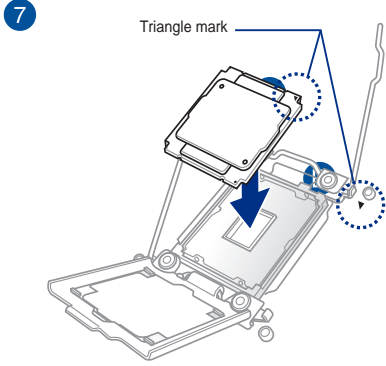
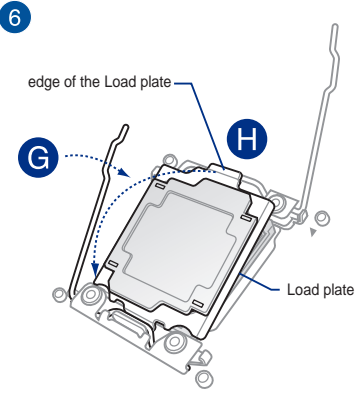

2.1.3 CPU heatsink and fan assembly installation

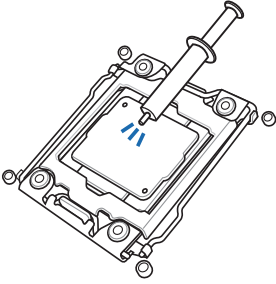

Apply the thermal interface material to the CPU heatsink and CPU before you install the heatsink and fan, if necessary.

Installing the CPU heatsink and fan assembly

1

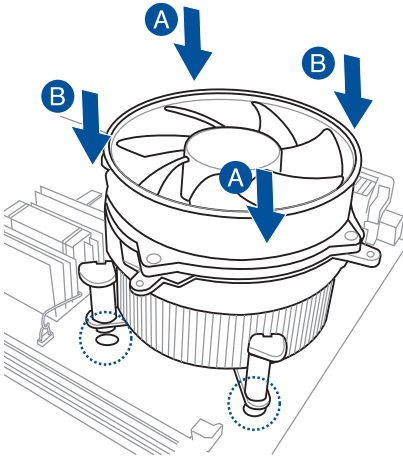

2

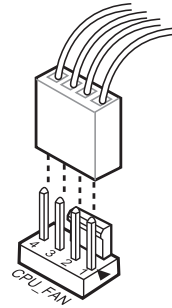

3

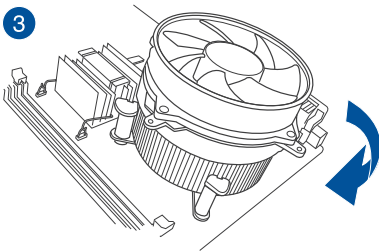

4

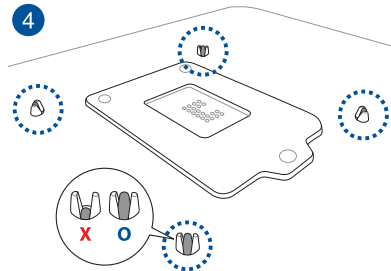

Uninstalling the CPU heatsink and fan assembly

1

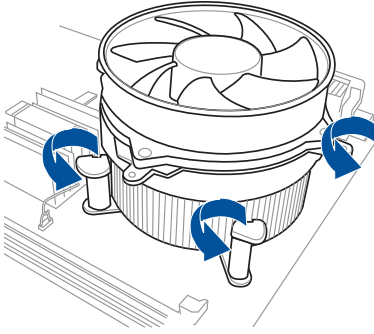

2

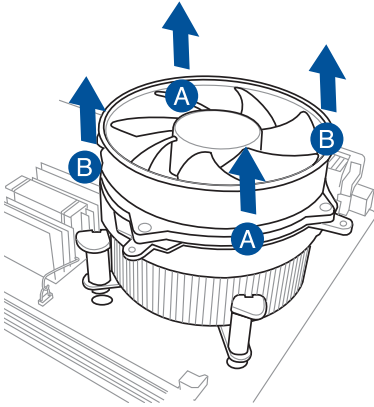

Replacing the LGA2011-v3 CPU pad (X-Socket 2)



The X-Socket 2 is a unique ROG feature that allows the user to use their LN2 pot on the LGA 2011-v3 motherboard.

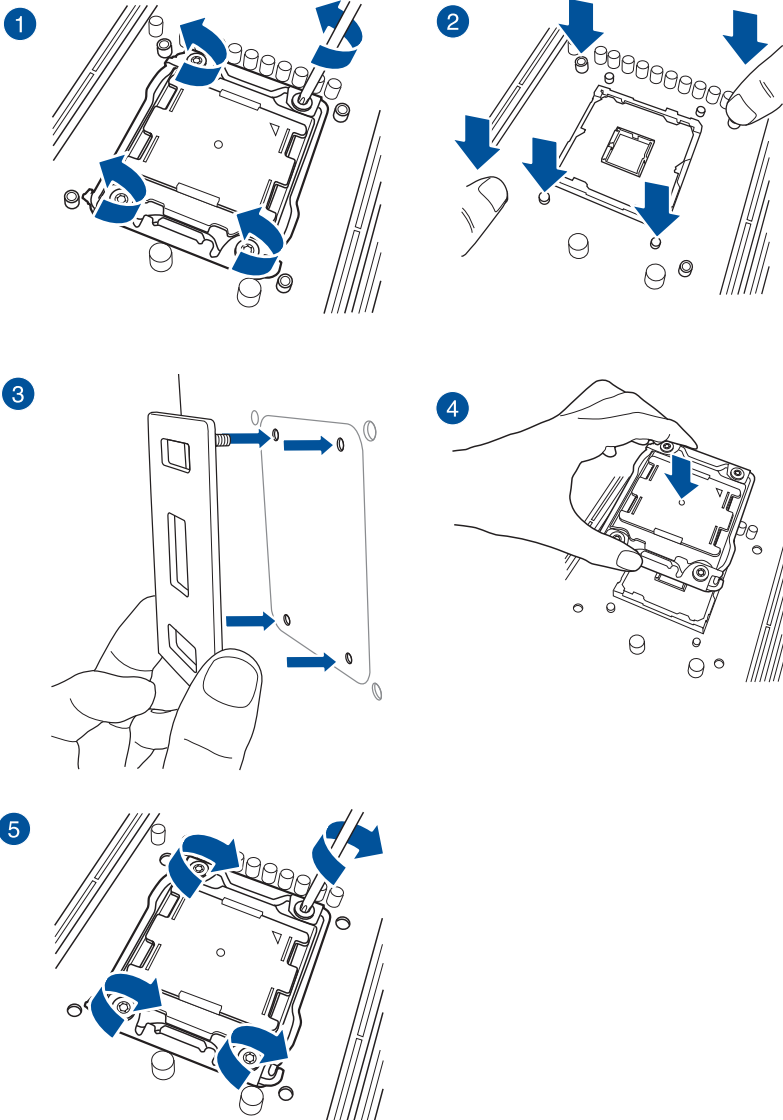

2.1.4 DIMM installation

1

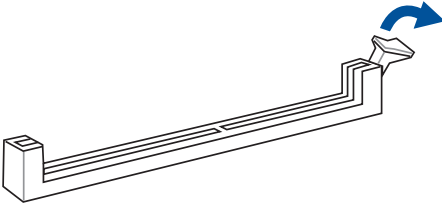

2

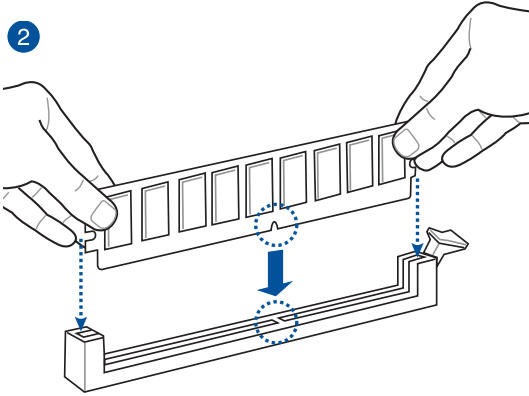

3

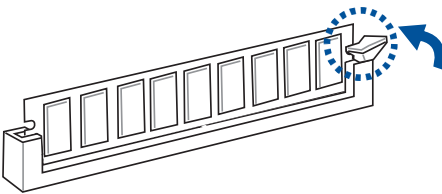

To remove a DIMM

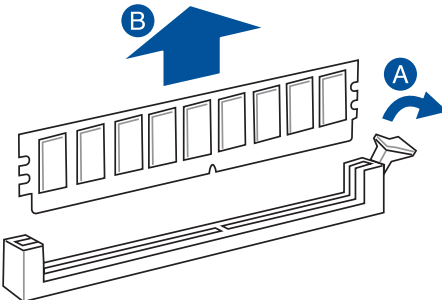

2.1.5 ATX Power connection

1

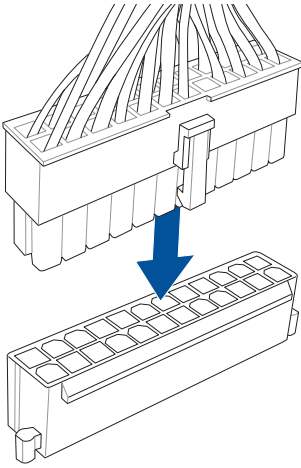

2

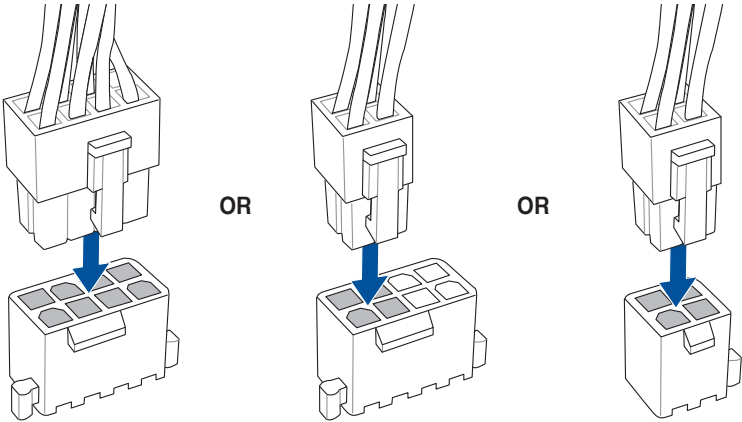

2.1.6 SATA device connection

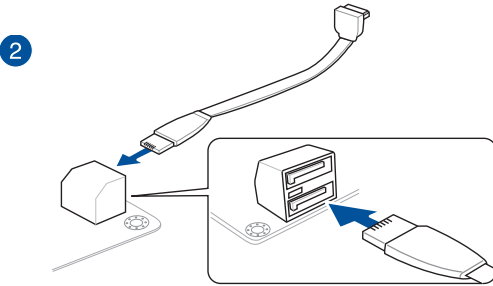
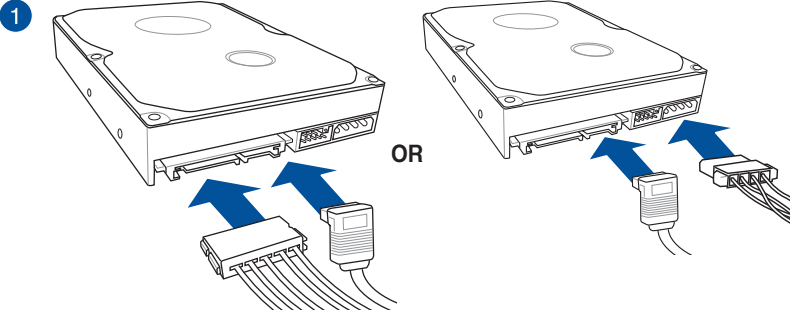

OR

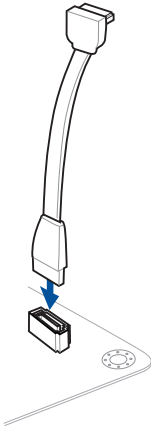

2.1.7 Front I/O Connector

Installing the ASUS Q-Connector

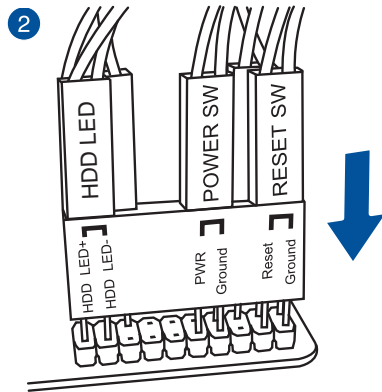
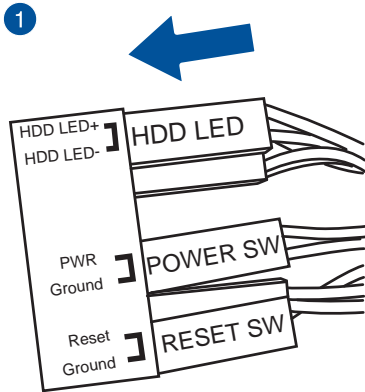

Installing the USB 2.0 connector

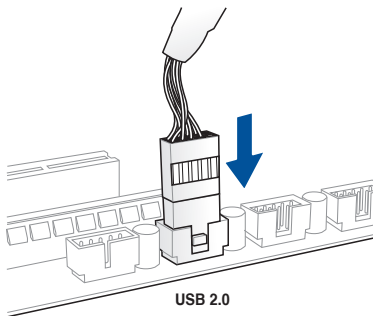

Installing the front panel audio connector

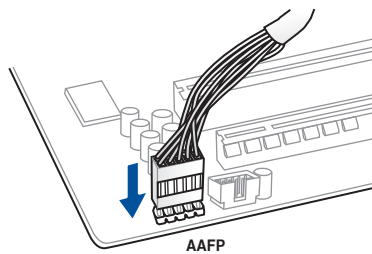

Installing the USB 3.0 connector

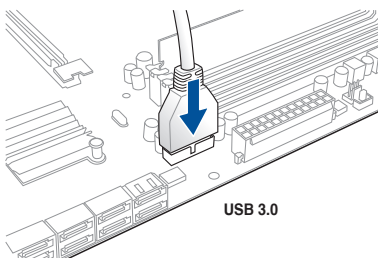

2.1.8 Expansion Card installation

Installing the PCIe x16 cards

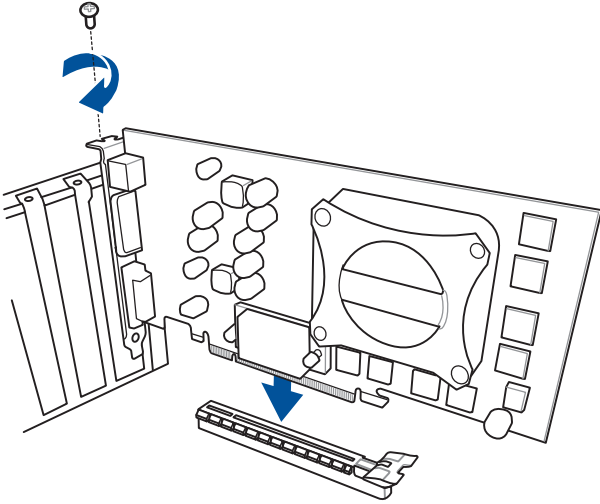

Installing the PCIe x1 cards

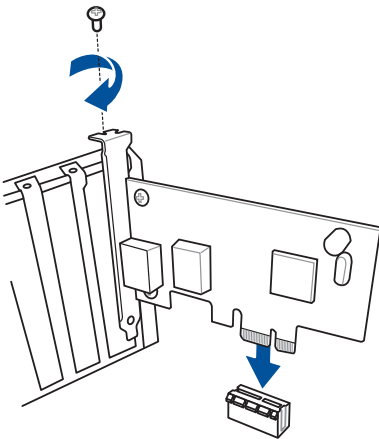

2.1.9 Wi-Fi antenna installation

Installing the ASUS 3T3R dual band Wi-Fi antenna

To install the ASUS 3T3R dual band Wi-Fi antenna, connect the bundled ASUS 3T3R dual band Wi-Fi antenna connector to the Wi-Fi ports at the back of the chassis.

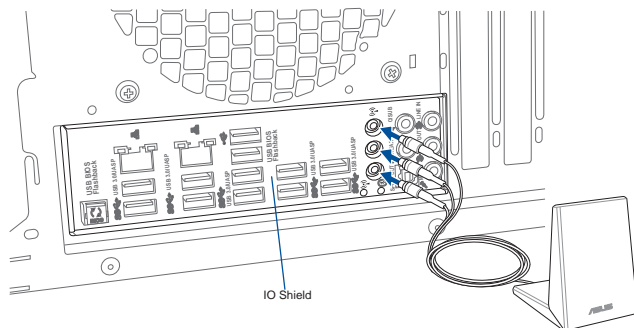

- Ensure that the ASUS 3T3R dual band Wi-Fi antenna is securely installed to the Wi-Fi ports.
- Ensure to install the Bluetooth driver before installing the Wi-Fi GO! software.



The illustration above is for reference only. The I/O port layout may vary with models, but the Wi-Fi antenna installation procedure is the same for all models.

2.2 BIOS update utility

USB BIOS Flashback

USB BIOS Flashback allows you to easily update the BIOS without entering the existing BIOS or operating system. Simply insert a USB storage device to the USB port specially allocated for the USB BIOS Flashback feature then press the ROG Connect button for three seconds. The BIOS will be updated automatically.

To use USB BIOS Flashback:

1. Download the latest BIOS file from the ASUS website
2. Extract and rename the BIOS image file to **R5E.CAP**.
3. Copy **R5E.CAP** to the root directory of the USB flash disk drive.
4. Turn off the system and insert the USB storage device to the ROG Connect port.
5. Press the ROG Connect button and release when a flashing light appears, which indicates that the BIOS Flashback function is enabled.
6. Wait until the light goes out, indicating that the BIOS updating process is completed.

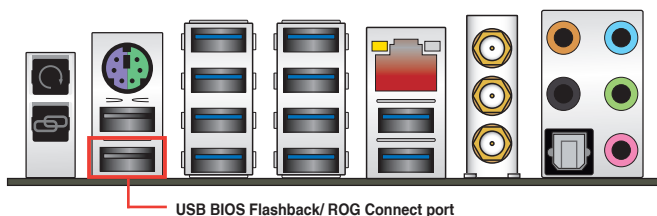

For more BIOS update utilities in BIOS setup, refer to the **Updating BIOS** section in Chapter 3.



- DO NOT unplug portable disk, power system, or press the CLR_CMOS button while the BIOS update is ongoing, otherwise the update will be interrupted. In case of interruption, please follow the steps again.
 - Updating the BIOS may have risks. If the BIOS program is damaged during the process and results in the system's failure to boot up, please contact your local ASUS Service Center.
-

2.3 Motherboard rear and audio connections

2.3.1 Rear I/O connection

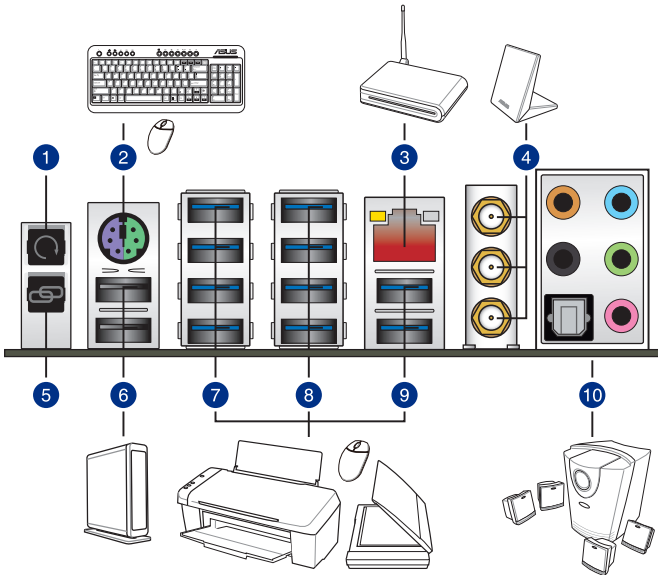

Rear panel connectors

1. Clear CMOS button
2. PS/2 mouse/keyboard port
3. Intel® LAN (RJ-45) port*
4. Wi-Fi 802.11 a/b/g/n/ac Bluetooth V4.0**
5. ROG Connect button
6. USB 2.0 ports 7 and 8.
7. USB 3.0 ports E1, E2, E3, and E4. Supports ASUS 3.0 Boost Turbo Mode.
8. USB 3.0 ports E5, E6, E7, and E8. Supports ASUS 3.0 Boost Turbo Mode.
9. USB 3.0 ports E9 and E10. Supports ASUS 3.0 Boost Turbo Mode.
10. Audio I/O ports with Optical S/PDIF Out port***

*, **, and ***: Refer to the tables on the next page for Bluetooth/Wi-Fi module LEDs, LAN port LEDs, and audio port definitions.



The PCIE_X4_1 (gray) slot shares bandwidth with the PCIE_X1_1 slot, USB3_E910, and SATAExpress_E1 connector. When the PCIE_X4_1 slot is occupied by an X1 or X2 device, the SATAEXPRESS_E1 will be disabled. When the PCIE_X4_1 slot is occupied by X4 device, both the SATAEXPRESS_E1, USB3_E910 ports, and the PCIE_X1_1 slot will be disabled.



- We strongly recommend that you connect USB 3.0 devices to USB 3.0 ports for faster and better performance for your USB 3.0 devices.
- When using the external SATA port, ensure to use a compatible connector.

* LAN ports LED indications

Activity Link LED		Speed LED	
Status	Description	Status	Description
Off	No link	Off	10 Mbps connection
Orange	Linked	Orange	100 Mbps connection
Orange (Blinking)	Data activity	Green	1 Gbps connection
Orange (Blinking then steady)	Ready to wake up from S5 mode		

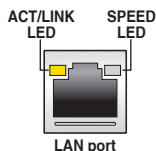

You can disable the LAN controllers in BIOS. Due to hardware design, the LAN1 port's LEDs may continue to blink even when disabled.

** Bluetooth and Wi-Fi module LED indications

Wi-Fi LED		Bluetooth LED	
Status	Description	Status	Description
Off	No link	Off	No link
Green	Linked	Blue	Linked
		Blinking	Data activity

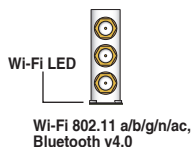

The Bluetooth word mark and logos are owned by Bluetooth SIG, Inc. and any use of such mark by ASUSTeK Computer Inc. is under license. Other trademarks and trade names are those of their respective owners.

*** Audio 2, 4, 6 or 8-channel configuration

Port	Headset 2-channel	4-channel	6-channel	8-channel
Light Blue	Line In	Line In	Line In	Side Speaker Out
Lime	Line Out	Front Speaker Out	Front Speaker Out	Front Speaker Out
Pink	Mic In	Mic In	Mic In	Mic In
Orange	–	–	Center/Subwoofer	Center/Subwoofer
Black	–	Rear Speaker Out	Rear Speaker Out	Rear Speaker Out

2.3.2 Audio I/O connections

Audio I/O ports

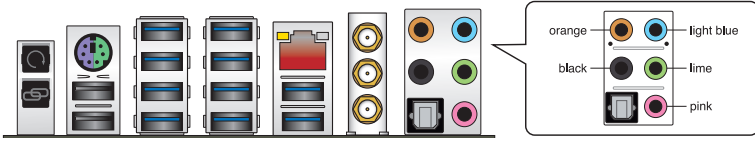

Connect to Headphone and Mic



Connect to Stereo Speakers

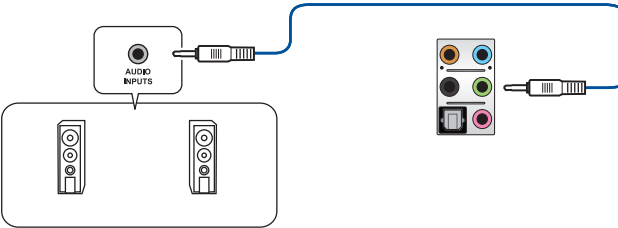

Connect to 2.1 channel Speakers

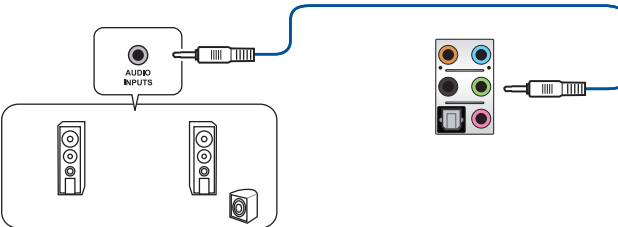

Connect to 4.1 channel Speakers

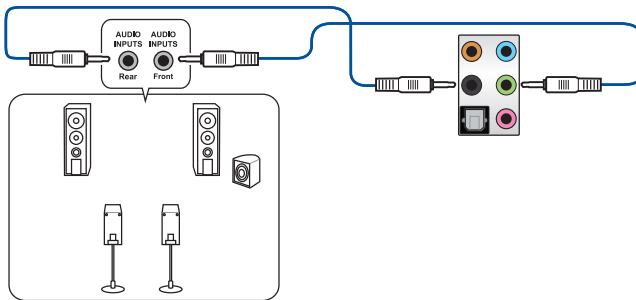

Connect to 5.1 channel Speakers

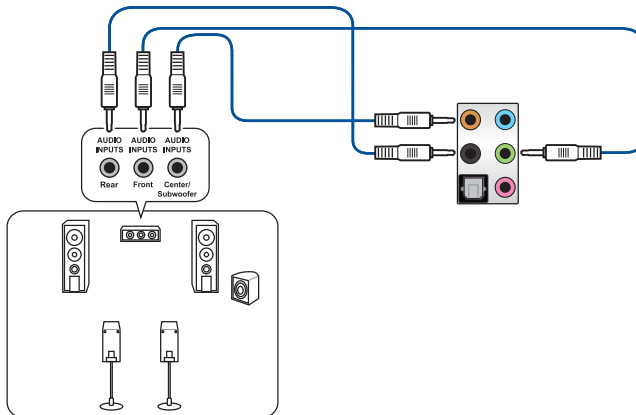

Connect to 7.1 channel Speakers

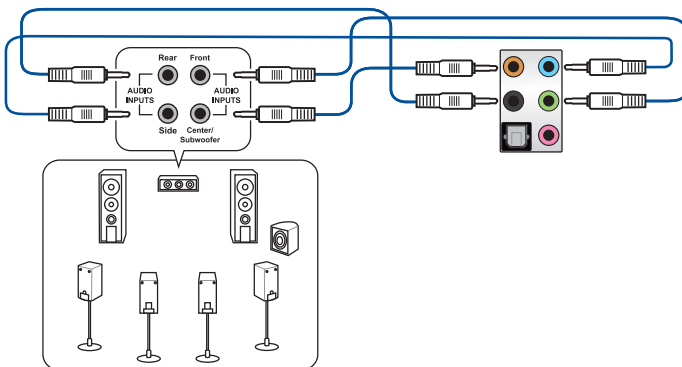

2.4 OC Panel

The OC Panel is a device that allows you to overclock your PC without the need to go to the BIOS settings or use software utilities. You can setup the OC Panel in an available 5.25-inch drive bay on your computer chassis (Normal Mode) or as an external handheld console on an “open-air” OC test bench (Extreme Mode).

These modes are further explained in the succeeding subsections.



- Ensure that your system has adequate cooling designed for overclocking before using the OC Panel.
- Ensure to update your OC Panel's firmware. Visit www.asus.com for the latest firmware and updates about the OC Panel.
- Ensure that you have installed ROG Connect Plus driver for the NORMAL Mode of the OC Panel.

2.4.1 OC Panel Overview

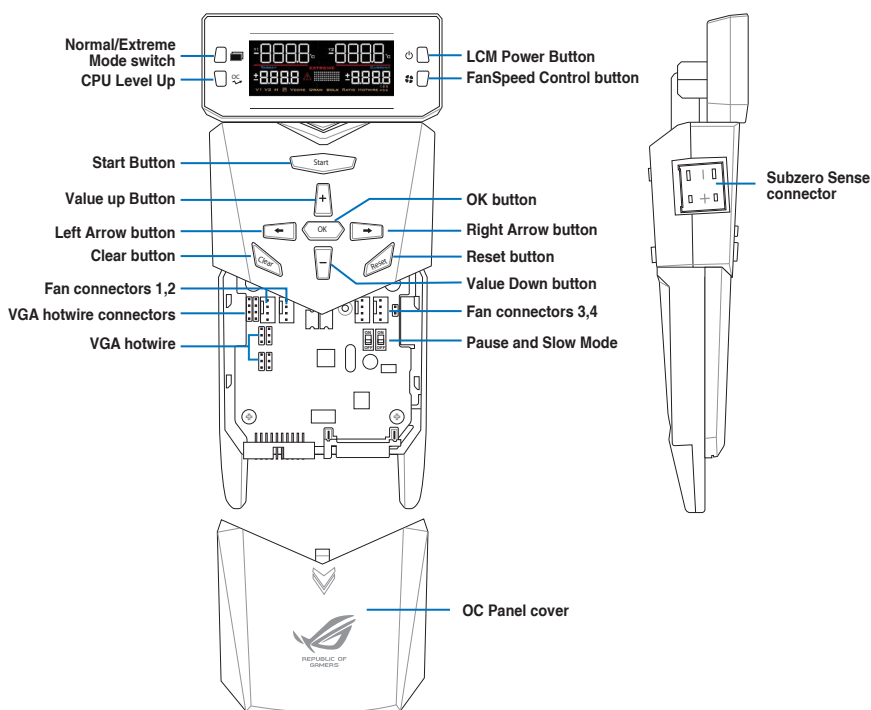

OC Panel LCM Display in Normal Mode

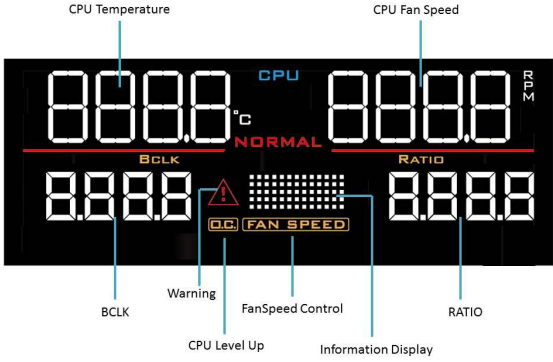

OC Panel LCM Display in Extreme Mode

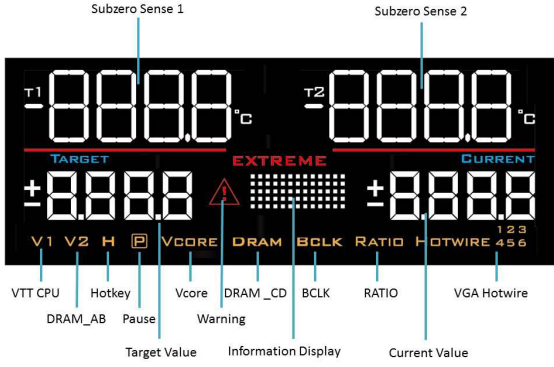

Extreme Mode capabilities including V1, V2, DRAM, and other voltage definitions vary by chipset. Please refer to your motherboard manual for details.

2.4.2 Setting up your OC Panel in Normal Mode



Ensure that you have installed ROG Connect Plus driver for the NORMAL Mode of the OC Panel.

The OC Panel in Normal Mode mainly provides easy access buttons for increasing your CPU's frequency level, adjusting fan speeds, and customizing overclocking profiles. It also displays vital information about your computer's CPU temperature, ratio, base clock, and CPU fan speed (RPM).

To set up your OC Panel in Normal Mode:

1. Tilt the OC Panel LCM display until it is perpendicular to the body of OC Panel.
2. Prepare the bundled OC Panel 5.25-inch drive bay metal case and set of two (2) screws.
3. Align and insert the OC Panel into the OC Panel 5.25-inch drive bay metal case.

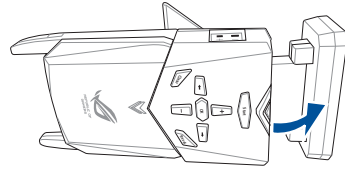

The OC Panel fits in one orientation only. If it does not fit, try reversing it.

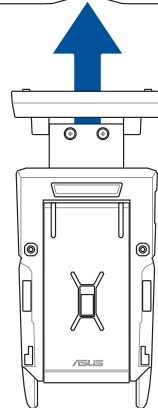
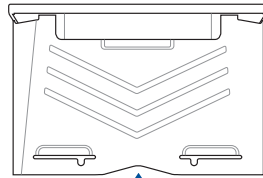

- Secure the OC Panel to the OC Panel 5.25-inch drive bay metal case with the two (2) screws.



Ensure that the OC Panel fits snugly into the OC Panel 5.25-inch drive bay metal case.

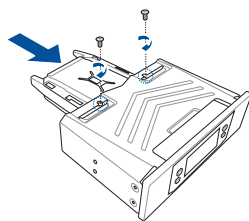

- Shut down your computer.
- Open your computer chassis and remove the front cover of an available 5.25-inch drive bay.
- Align and insert the OC Panel and the OC Panel 5.25-inch drive bay metal case assembly into the drive bay.
- Secure the OC Panel and the OC Panel 5.25-inch drive bay metal case assembly into the drive bay with four (4) screws.
- Connect the OC Panel data cable (A) and a SATA Power cable (B) to the OC Panel.

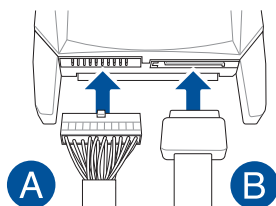
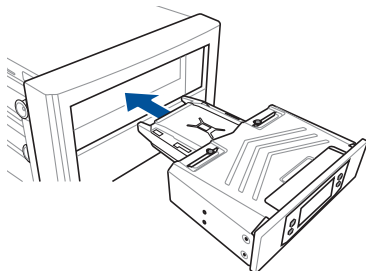

- Locate the ROG_EXT connector on the motherboard and connect the OC Panel cable.

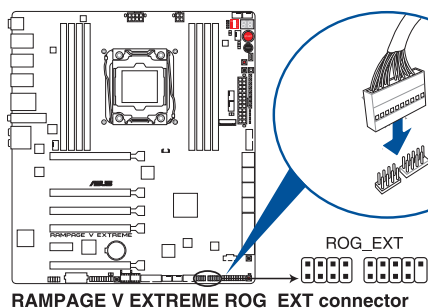

- Boot your computer.
- Press the OC Panel LCM Power button to turn on the OC Panel LCM display.

2.4.3 Setting up your OC Panel in Extreme Mode

The OC Panel in Extreme Mode is set up with an open chassis system or “open-air” OC test bed assembly and enjoyed as a handheld console to perform overclocking and voltage tuning.

When in Extreme Mode, you can utilize more features such as Subzero Sense and VGA Hotwire. It also comes with some of the most commonly used voltage tuning presets that are preconfigured for the optimum overclocking experience at your convenience.



Extreme Mode capabilities including V1, V2, DRAM, and other voltage definitions vary by chipset. Please refer to your motherboard manual for details.

To setup the OC Panel in Extreme Mode:

1. Shut down your computer.
2. Connect the OC Panel cable (A) and a SATA Power cable (B) to the OC Panel.
3. Locate the ROG_EXT connector on the motherboard and connect the OC Panel cable.

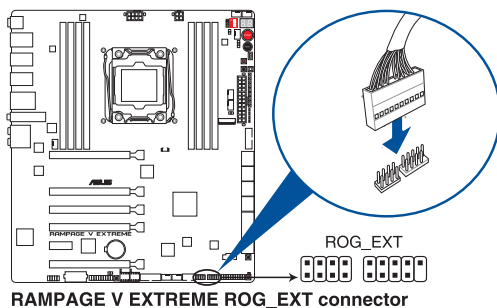
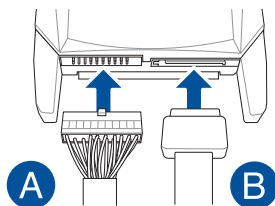

4. Boot your computer.
5. Press the OC Panel power button to turn on the OC Panel LCM display.

2.5 Starting up for the first time

1. After making all the connections, replace the system case cover.
2. Ensure that all switches are off.
3. Connect the power cord to the power connector at the back of the system chassis.
4. Connect the power cord to a power outlet that is equipped with a surge protector.
5. Turn on the devices in the following order:
 - a. Monitor
 - b. External SCSI devices (starting with the last device on the chain)
 - c. System power
6. After applying power, the system power LED on the system front panel case lights up. For systems with ATX power supplies, the system LED lights up when you press the ATX power button. If your monitor complies with the green standards or if it has a power standby feature, the monitor LED may light up or change from orange to green after the system LED turns on.

The system then runs the power-on self tests (POST). While the tests are running, the BIOS beeps (refer to the BIOS beep codes table) or additional messages may appear on the screen. If you do not see anything within 30 seconds from the time you turned on the power, the system may have failed a power-on test. Check the jumper settings and connections or call your retailer for assistance.

BIOS Beep	Description
One short beep	VGA detected Quick boot set to disabled No keyboard detected
One continuous beep followed by two short beeps then a pause (repeated)	No memory detected
One continuous beep followed by three short beeps	No VGA detected
One continuous beep followed by four short beeps	Hardware component failure

7. Hold down the <Delete> key during power on to enter the BIOS Setup. Follow the instructions in Chapter 3.

2.6 Turning off the computer

While the system is ON, press the power button for less than four seconds to put the system to sleep mode or soft-off mode, depending on the BIOS setting. Press the power switch for more than four seconds to let the system enter the soft-off mode regardless of the BIOS setting.

BIOS setup

3.1 Knowing BIOS



The new ASUS UEFI BIOS is a Unified Extensible Interface that complies with UEFI architecture, offering a user-friendly interface that goes beyond the traditional keyboard-only BIOS controls to enable a more flexible and convenient mouse input. You can easily navigate the new UEFI BIOS with the same smoothness as your operating system. The term "BIOS" in this user manual refers to "UEFI BIOS" unless otherwise specified.

BIOS (Basic Input and Output System) stores system hardware settings such as storage device configuration, overclocking settings, advanced power management, and boot device configuration that are needed for system startup in the motherboard CMOS. In normal circumstances, the default BIOS settings apply to most conditions to ensure optimal performance. **DO NOT change the default BIOS settings** except in the following circumstances:

- An error message appears on the screen during the system bootup and requests you to run the BIOS Setup.
- You have installed a new system component that requires further BIOS settings or update.



Inappropriate BIOS settings may result in instability or boot failure. **We strongly recommend that you change the BIOS settings only with the help of a trained service personnel.**



When downloading or updating the BIOS file, rename it as **R5E.CAP** for this motherboard.

3.2 BIOS setup program

Use the BIOS Setup to update the BIOS or configure its parameters. The BIOS screen includes navigation keys and a brief on-screen tip to help guide you in using the BIOS Setup program.

Entering BIOS at startup

To enter BIOS Setup at startup, press <Delete> during the Power-On Self Test (POST). If you do not press <Delete>, the computer continues to boot normally.

Entering BIOS Setup after POST

To enter BIOS Setup after POST:

- Press <Ctrl>+<Alt>+<Delete> simultaneously.
- Press the reset button on the system chassis.
- Press the DirectKey button on the motherboard. You can perform this option if the DirectKey item is enabled in the BIOS Setup. See the section about **Boot Menu** on **Chapter 3** for more information in enabling the DirectKey function in BIOS.
- Press the power button to turn the system off then back on. Do this option only if you failed to enter BIOS Setup using the previous options.



-
- The BIOS setup screens shown in this section are for reference purposes only, and may not exactly match what you see on your screen.
 - Ensure that a USB mouse is connected to your motherboard if you want to use the mouse to control the BIOS setup program.
 - If the system becomes unstable after changing any BIOS setting, load the default settings to ensure system compatibility and stability. Select the Load Optimized Defaults item under the Exit menu or press hotkey <F5>. See the section about Exit menu on Chapter 3 for more information.
 - If the system fails to boot after changing any BIOS setting, use the Safe-Mode button first before trying to clear the CMOS and resetting the motherboard to the default value. For more information about the Safe-Mode button, see the Onboard buttons and switches section on Chapter 1 of this user guide. For the Clear CMOS button, see the section about Rear I/O Connection on Chapter 2.
 - The BIOS setup program does not support bluetooth devices.
-

BIOS menu screen

The BIOS Setup program can be used under two modes: **EZ Mode** and **Advanced Mode**. You can change modes from the **Exit** menu or from the **Exit/Advanced Mode** screen.

3.2.1 EZ Mode

EZ Mode provides you with an overview of the basic system information and allows you to select the display language, system performance mode, and boot device priority. To access the Advanced Mode, click **Exit/Advanced Mode**, then select **Advanced Mode** or press the <F7> hot key for the advanced BIOS settings.



The default screen for entering the BIOS setup program can be changed. For more information, see the Setup Mode item of the Boot menu section on Chapter 3.

The screenshot shows the ASUS UEFI BIOS Utility - EZ Mode interface. The top bar displays the date (08/06/2014), time (14:00), language (English), and EZ Tuning Wizard (F11). The main area is divided into several sections: Information (RAM, CPU, Memory), CPU Temperature (41°C), CPU Core Voltage (0.992 V), Motherboard Temperature (31°C), DRAM Status, SATA Information, Intel Rapid Storage Technology (On), CPU Fan speed (1566 RPM), and EZ System Tuning (Normal). The bottom right section shows Boot Priority with items like Windows Boot Manager and P9: ST3160812AS. At the bottom, there are buttons for Default (F5), Save & Exit (F10), and Advanced Mode (F7).

Callouts and their descriptions:

- Displays the system properties of the selected mode. Click "<" or ">" to switch EZ System Tuning modes.** (Points to the EZ System Tuning section)
- Displays the CPU/motherboard temperature, CPU voltage output, CPU/chassis/power fan speed, and SATA information** (Points to the Information and Temperature sections)
- Selects the display language of the BIOS setup program** (Points to the English language selector)
- Creates storage RAID and configures system overclocking** (Points to the Intel Rapid Storage Technology section)
- Displays the CPU Fan's speed. Click the button to manually tune the fans** (Points to the CPU Fan section)
- Enables or disables the Intel Rapid Storage Technology** (Points to the Intel Rapid Storage Technology section)
- Saves the changes and resets the system** (Points to the Save & Exit (F10) button)
- Click to go to Advanced Mode** (Points to the Advanced Mode (F7) button)
- Click to display boot devices** (Points to the Boot Priority section)
- Selects the boot device priority** (Points to the Boot Priority section)



- The boot device options vary depending on the devices you installed to the system.
- The **Boot Menu (F8)** button is available only when a boot device is installed to the system.

3.2.2 Advanced Mode

Advanced Mode provides advanced options for experienced end-users to configure the BIOS settings. The figure below shows an example of Advanced Mode. Refer to the following sections for the detailed configurations.



To access the Advanced Mode, click **Exit**, then select **Advanced Mode** or press **F7** hotkey.

Labels in the image:

- Pop-up Menu
- Configuration fields
- Menu bar
- Language
- MyFavorite(F3)
- Qfan Control(F6)
- EZ Tuning Wizard(F11)
- Quick Note (F9)
- Scroll bar
- Hot Keys
- Sub-menu item
- Menu items
- General help
- Last modified settings
- Goes back to EZ Mode

Menu bar

The menu bar on top of the screen has the following main items:

My Favorites	For saving the frequently-used system settings and configuration
Main	For changing the basic system configuration
Extreme Tweaker	For changing the overclocking settings
Advanced	For changing the advanced system settings
Monitor	For displaying the system temperature, power status, and changing the fan settings
Boot	For changing the system boot configuration
Tool	For configuring options for special functions
Exit	For selecting the exit options and loading default settings

Menu items

The highlighted item on the menu bar displays the specific items for that menu. For example, selecting **Main** shows the Main menu items.

The other items (My Favorites, Extreme Tweaker, Advanced, Monitor, Boot, Tool, and Exit) on the menu bar have their respective menu items.

Back button

This button appears when entering a sub menu. Press <Esc> or use the USB mouse to click this button and return to the previous menu screen.

Sub menu items

A greater than sign (>) before each item on any menu screen means that the item has a sub menu. To display the sub menu, select the item and press <Enter>.

Pop-up window

Select a menu item and press <Enter> to display a pop-up window with the configuration options for that item.

Scroll bar

A scroll bar appears on the right side of a menu screen when there are items that do not fit on the screen. Press the Up/Down arrow keys or <Page Up> / <Page Down> keys to display the other items on the screen.

Navigation keys

At the bottom right corner of the menu screen are the navigation keys for the BIOS setup program. Use the navigation keys to select items in the menu and change the settings.



If you delete all shortcut items from the F3: Shortcut list, the default shortcut items will reappear after your next startup.

General help

At the top right corner of the menu screen is a brief description of the selected item. Use <F12> key to capture the BIOS screen and save it to the removable storage device.

Configuration fields

These fields show the values for the menu items. If an item is user-configurable, you can change the value in the field opposite the item. You cannot select an item that is not user-configurable.

A configurable field is highlighted when selected. To change the value of a field, select it and press <Enter> to display a list of options.

Quick Note button

This button allows you to enter notes of any modifications you have made in BIOS.



-
- The Quick Note function does not support the following keyboard functions: delete, cut, copy, and paste.
 - You can only use the alphanumeric characters to enter your notes.
-

Last Modified button

This button shows the items that you last modified and saved in BIOS Setup.

3.3 My Favorites

My Favorites is your personal space where you can easily save and access your favorite BIOS items.

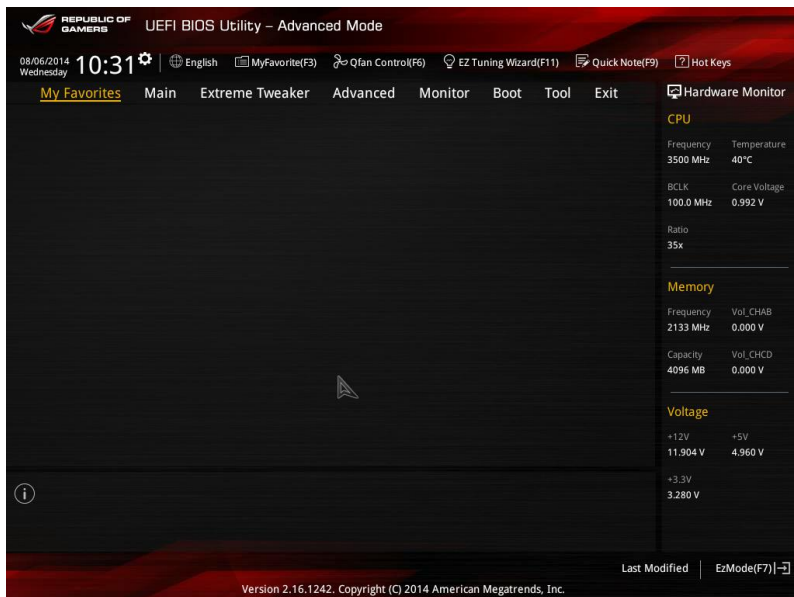

Adding items to My Favorites

To add frequently-used BIOS items to My Favorites:

1. Use the arrow keys to select an item that you want to add. When using a mouse, hover the pointer to the item.
2. Press <F4> on your keyboard or right-click on your mouse to add the item to My Favorites page.



You cannot add the following items to My Favorites:

- Items with sub menu options
- User-configurable items such as language and boot device order
- Configuration items such as Memory SPD Information, system time, and date

3.4 Main menu

The Main menu screen appears when you enter Advanced Mode in the BIOS Setup program. The Main menu provides you an overview of the basic system information, and allows you to set the system date, time, language, and security settings.

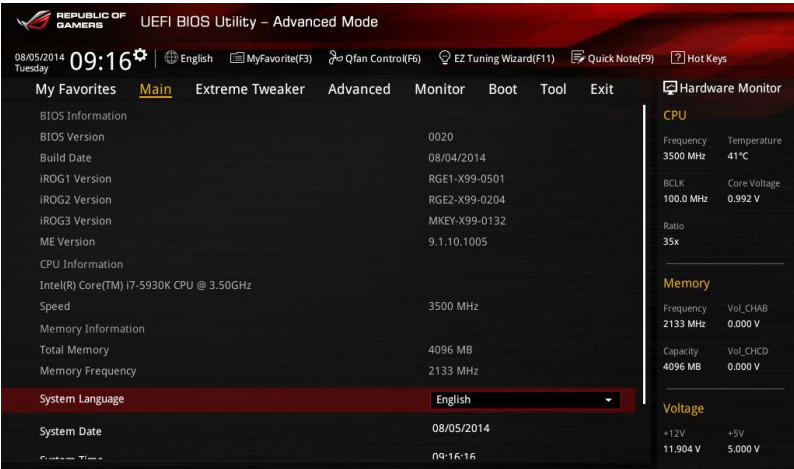

Security

The Security menu items allow you to change the system security settings.

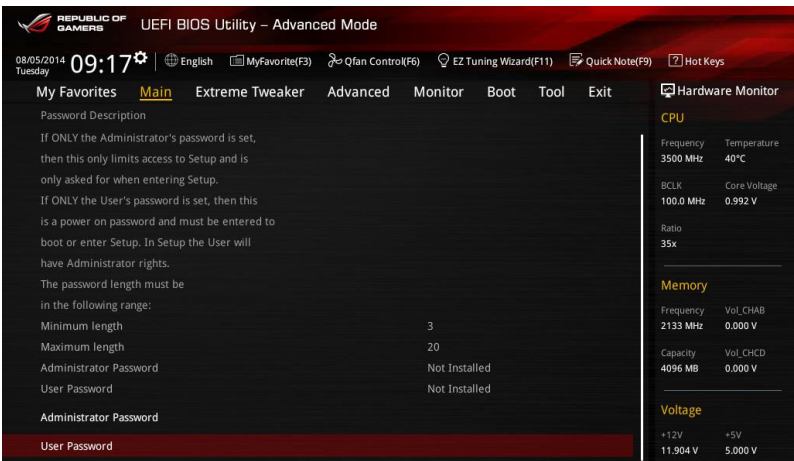

- If you have forgotten your BIOS password, erase the CMOS Real Time Clock (RTC) RAM to clear the BIOS password. See the section about **Rear I/O Connection** in **Chapter 2** for more information.
- The Administrator or User Password items on top of the screen show the default [Not Installed]. After you set a password, these items will be displayed as [Installed].

Administrator Password

If you have set an administrator password, we recommend that you enter the administrator password when accessing the system. Otherwise, you may be restricted from viewing or modifying certain fields in the BIOS Setup program.

To set an administrator password:

1. Select the **Administrator Password** item and press <Enter>.
2. From the **Create New Password** box, key in a password then press <Enter>.
3. Confirm the password when prompted.

To change an administrator password:

1. Select the **Administrator Password** item and press <Enter>.
2. From the **Enter Current Password** box, key in the current password then press <Enter>.
3. From the **Create New Password** box, key in a new password then press <Enter>.
4. Confirm the password when prompted.

To clear the administrator password, follow the same steps as in changing an administrator password, but press <Enter> when prompted to create/confirm the password. After you clear the password, the Administrator Password item on top of the screen will show as **Not Installed**.

User Password

If you have set a user password, you must enter the user password when accessing the system. The User Password item on top of the screen shows the default Not Installed. After you set a password, this item will show **Installed**.

To set a user password:

1. Select the **User Password** item and press <Enter>.
2. From the **Create New Password** box, key in a password then press <Enter>.
3. Confirm the password when prompted.

To change a user password:

1. Select the **User Password** item and press <Enter>.
2. From the **Enter Current Password** box, key in the current password then press <Enter>.
3. From the **Create New Password** box, key in a new password then press <Enter>.
4. Confirm the password when prompted.

To clear the user password, follow the same steps as in changing the user password, but press <Enter> when prompted to create/confirm the password. After you clear the password, the **User Password** item on top of the screen will show **Not Installed**.

3.5 Extreme Tweaker menu

The Extreme Tweaker menu items allow you to configure overclocking-related items.



Be cautious when changing the settings of the Extreme Tweaker menu items. Incorrect field values can cause the system to malfunction.



The configuration options for this section vary depending on the CPU and DIMM model you installed on the motherboard.

Scroll down to display other BIOS items.

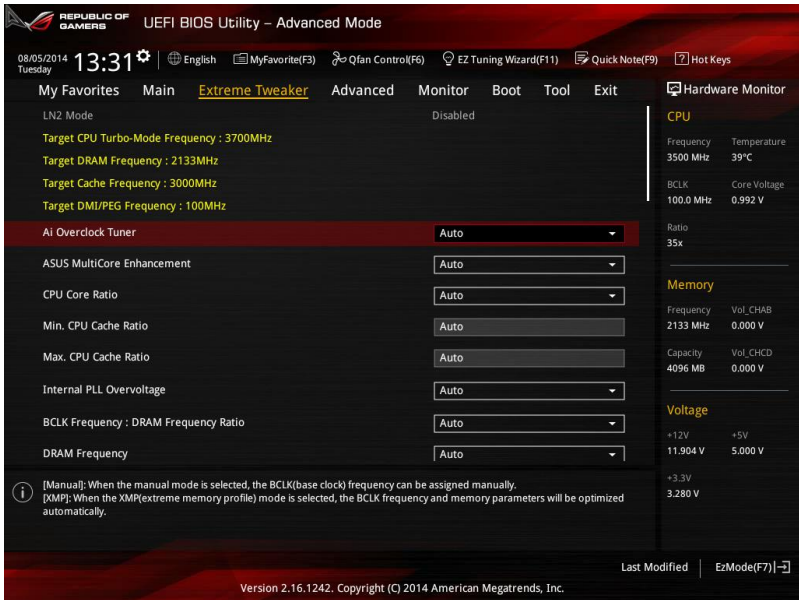

Ai Overclock Tuner [Auto]

Allows you to select the CPU overclocking options to achieve the desired CPU internal frequency. Select any of these preset overclocking configuration options:

- [Auto] Loads the optimal settings for the system.
- [Manual] Allows you to individually set overclocking parameters.
- [X.M.P.] If you install memory modules supporting the eXtreme Memory Profile (X.M.P.) Technology, choose this item to set the profiles supported by your memory modules for optimizing the system performance.



The [X.M.P.] configuration option appears only when you install memory modules supporting the eXtreme Memory Profile (X.M.P.) Technology.

ASUS MultiCore Enhancement [Auto]

Allows you to enable or disable the MultiCore Enhancement feature.

Configuration options: [Disabled] [Auto]

CPU Core Ratio [Auto]

Allows you to set the CPU ratio and sync automatically, per core or all cores.

Configuration options: [Auto] [Sync All Cores] [Per Core]



When the CPU Core Ratio is set to **[Sync All Cores]**, the following item appears.

1-Core Ratio Limit [Auto]

Allows you to set the 1-Core Ratio Limit.

- [Auto] Select to apply the CPU default Turbo Ratio setting.
- [Manual] Select to manually assign a value for the 1-Core Ratio limit. The values of 2-core, 3-core, 4-core, 5-core, and 6-core ratio limits will be automatically set to be lower than or equal to the value of the 1-core Ratio limit.



When the CPU Core Ratio is set to **[Per Core]**, the following item appears:

1-Core Ratio Limit [Auto]

Allows you to set the 1-Core Ratio Limit.

- [Auto] Select to apply the CPU default Turbo Ratio setting.
- [Manual] Select to manually assign a 1-Core Ratio Limit value that is higher than or equal to the 2-Core Ratio Limit.

2-Core Ratio Limit [Auto]

Allows you to set the 2-Core Ratio Limit.

- [Auto] Select to apply the CPU default Turbo Ratio setting.
- [Manual] Select to manually assign a 2-Core Ratio Limit value that is higher than or equal to the 3-Core Ratio Limit. 1-Core Limit must not be set to [Auto].

3-Core Ratio Limit [Auto]

Allows you to set the 3-Core Ratio Limit.

[Auto] Select to apply the CPU default Turbo Ratio setting.

[Manual] Select to manually assign a 3-Core Ratio Limit value that is higher than or equal to the 4-Core Ratio Limit. 1-Core/2-Core Ratio Limit must not be set to [Auto].

4-Core Ratio Limit [Auto]

Allows you to set the 4 Core Ratio Limit

[Auto] Select to apply the CPU default Turbo Ratio setting

[Manual] Select to manually assign a 4-Core Ratio Limit value that is higher than or equal to the 3-Core Ratio Limit. 1-Core/2-Core/3-Core Limit must not be set to [Auto].

5-Core Ratio Limit [Auto]

Allows you to set the 5-Core Ratio Limit.

[Auto] Select to apply the CPU default Turbo Ratio setting.

[Manual] Select to manually assign a 5-Core Ratio Limit value that is higher than or equal to the 4-Core Ratio Limit. 1-Core/2-Core/3-Core/4-Core Ratio Limit must not be set to [Auto].

6-Core Ratio Limit [Auto]

Allows you to set the 6 Core Ratio Limit

[Auto] Select to apply the CPU default Turbo Ratio setting

[Manual] Select to manually assign a 6-Core Ratio Limit value that is higher than or equal to the 5-Core Ratio Limit. 1-Core/2-Core/3-Core /4-Core/5-Core Limit must not be set to [Auto].

Min. CPU Cache Ratio [Auto]

Allows you to set the minimum possible ratio on the Uncore part of the processor. Use the <+> or <-> keys to adjust the value. The values depend on the CPU installed.

Max. CPU Cache Ratio [Auto]

Allows you to set the maximum possible ratio on the Uncore part of the processor. Use the <+> or <-> keys to adjust the value. The values depend on the CPU installed.

Internal PLL Overvoltage [Auto]

Allows you to enable the internal PLL voltage for unlocked CPUs to get extreme overclocking capabilities.

Configuration options: [Auto] [Enabled] [Disabled]

BCLK Frequency : DRAM Frequency Ratio [Auto]

Allows you to set the BCLK frequency to DRAM frequency ratio.

[Auto] The BCLK frequency to DRAM frequency is set to the optimized settings.

[100:133] The BCLK frequency to DRAM frequency ratio is set to 100:133.

[100:100] The BCLK frequency to DRAM frequency ratio is set to 100:100.

DRAM Frequency [Auto]

Allows you to set the memory operating frequency. The configuration options vary with the BCLK/CPU Strap Frequency item settings.

Xtreme Tweaking [Disabled]

Helps improve benchmark performance.

Configuration options: [Disabled] [Enabled]

CPU Level Up [Auto]

Allows you to overclock the CPU at a certain frequency.

Configuration options: [Auto] [4.4000G] [4.2000G] [4.0000G]

EPU Power Saving Mode [Disabled]

Allows you to enable or disable the EPU power saving function.

Configuration options: [Disabled] [Enabled]



The following item only appears when you set EPU Power Saving Mode to **[Enabled]**.

EPU Setting [Auto]

Allows you to select the EPU power saving function.

Configuration options: [Auto] [Light Power Saving] [Medium Power Saving]
[Max Power Saving]

DRAM Timing Control

The subitems in this menu allow you to set the DRAM timing control features. Use the <+> and <-> keys to adjust the value. To restore the default setting, type [auto] using the keyboard and press the <Enter> key.

Rampage Tweak [Auto]

This item allows you to specify the Rampage Tweak operation mode to find to the DRAM. Mode 1 helps you with the DRAM performance and Mode 2 helps you in overclocking and system performance.

[Auto] Automatically selects the mode.

[Mode 1] Memory compatibility.

[Mode 2] Overclocking and performance.

Memory Presets

This item allows you to select and load a memory preset or timing profile from a redefined list. The configurations of the memory presets are provided by the ROG OC expert team. Users can load the profiles before performing overclocking or DRAM tweaking.



Changing the values in this menu may cause the system to become unstable! If this happens, revert to the default settings.

Primary Timings

DRAM CAS# Latency [Auto]

Configuration options: [Auto] [1] – [31]

DRAM RAS# to CAS# Delay [Auto]

Configuration options: [Auto] [1] – [31]

DRAM RAS# PRE Time [Auto]

Configuration options: [Auto] [1] – [15]

DRAM RAS# ACT Time [Auto]

Configuration options: [Auto] [1] – [63]

DRAM Command Rate [Auto]

Configuration options: [Auto] [1] – [3]

Secondary Timings

DRAM RAS# to RAS# Delay [Auto]

Configuration options: [Auto] [1] – [7]

DRAM RAS# to RAS# Delay [Auto]

Configuration options: [Auto] [1] – [7]

DRAM REF Cycle Time [Auto]

Configuration options: [Auto] [1] – [511]

DRAM Refresh Interval [Auto]

Configuration options: [Auto] [1] – [32767]

DRAM WRITE Recovery Time [Auto]

Configuration options: [Auto] [1] – [31]

DRAM READ to PRE Time [Auto]

Configuration options: [Auto] [1] – [15]

DRAM FOUR ACT WIN Time [Auto]

Configuration options: [Auto] [1] – [63]

DRAM WRITE to READ Delay [Auto]

Configuration options: [Auto] [1] – [15]

DRAM CKE Minimum Pulse width [Auto]

Configuration options: [Auto] [1] – [15]

DRAM Write Latency [Auto]

Configuration options: [Auto] [1] – [15]

Third Timings

tRRDR [Auto]

Configuration options: [Auto] [0 DRAM Clock] – [7 DRAM Clock]

tRRDD [Auto]

Configuration options: [Auto] [0 DRAM Clock] – [7 DRAM Clock]

tWWDR [Auto]

Configuration options: [Auto] [0 DRAM Clock] – [7 DRAM Clock]

tWWDD [Auto]

Configuration options: [Auto] [0 DRAM Clock] – [7 DRAM Clock]

tRWDR [Auto]

Configuration options: [Auto] [0 DRAM Clock] – [15 DRAM Clock]

tWRDR [Auto]

Configuration options: [Auto] [0 DRAM Clock] – [15 DRAM Clock]

tWRDD [Auto]

Configuration options: [Auto] [0 DRAM Clock] – [15 DRAM Clock]

tRWSR [Auto]

Configuration options: [Auto] [0 DRAM Clock] – [15 DRAM Clock]

tCCD [Auto]

Configuration options: [Auto] [0 DRAM Clock] – [7 DRAM Clock]

tCCDWR [Auto]

Configuration options: [Auto] [0 DRAM Clock] – [7 DRAM Clock]

tUWRDR [Auto]

Configuration options: [Auto] [0 DRAM Clock] – [7 DRAM Clock]

tRWDR2 [Auto]

Configuration options: [Auto] [0 DRAM Clock] – [7 DRAM Clock]

tRWDD [Auto]

Configuration options: [Auto] [0 DRAM Clock] – [7 DRAM Clock]

tRWSR2 [Auto]

Configuration options: [Auto] [0 DRAM Clock] – [7 DRAM Clock]

tWRDD2 [Auto]

Configuration options: [Auto] [0 DRAM Clock] – [7 DRAM Clock]

tCCDWR [Auto]

Configuration options: [Auto] [0 DRAM Clock] – [7 DRAM Clock]

tCCD_L [Auto]

Configuration options: [Auto] [0 DRAM Clock] – [7 DRAM Clock]

RTL IOL control

- DRAM RTL INIT Value [Auto]**
Configuration options: [Auto] [1] - [127]
- DRAM RTL (CHA D0 R0) [Auto]**
Configuration options: [Auto] [1] - [127]
- DRAM RTL (CHA D0 R1) [Auto]**
Configuration options: [Auto] [1] - [127]
- DRAM RTL (CHA D1 R0) [Auto]**
Configuration options: [Auto] [1] - [127]
- DRAM RTL (CHA D1 R1) [Auto]**
Configuration options: [Auto] [1] - [127]
- DRAM RTL (CHB D0 R0) [Auto]**
Configuration options: [Auto] [1] - [127]
- DRAM RTL (CHB D0 R1) [Auto]**
Configuration options: [Auto] [1] - [127]
- DRAM RTL (CHB D1 R0) [Auto]**
Configuration options: [Auto] [1] - [127]
- DRAM RTL (CHB D1 R1) [Auto]**
Configuration options: [Auto] [1] - [127]
- DRAM RTL (CHC D0 R0) [Auto]**
Configuration options: [Auto] [1] - [127]
- DRAM RTL (CHC D0 R1) [Auto]**
Configuration options: [Auto] [1] - [127]
- DRAM RTL (CHC D1 R0) [Auto]**
Configuration options: [Auto] [1] - [127]
- DRAM RTL (CHC D1 R1) [Auto]**
Configuration options: [Auto] [1] - [127]
- DRAM RTL (CHD D0 R0) [Auto]**
Configuration options: [Auto] [1] - [127]
- DRAM RTL (CHD D0 R1) [Auto]**
Configuration options: [Auto] [1] - [127]
- DRAM RTL (CHD D1 R0) [Auto]**
Configuration options: [Auto] [1] - [127]
- DRAM RTL (CHD D1 R1) [Auto]**
Configuration options: [Auto] [1] - [127]
- DRAM IOL (CHA D0 R0) [Auto]**
Configuration options: [Auto] [1] - [255]
- DRAM IOL (CHA D0 R1) [Auto]**
Configuration options: [Auto] [1] - [255]
- DRAM IOL (CHA D1 R0) [Auto]**
Configuration options: [Auto] [1] - [255]
- DRAM IOL (CHA D1 R1) [Auto]**
Configuration options: [Auto] [1] - [255]
- DRAM IOL (CHB D0 R0) [Auto]**
Configuration options: [Auto] [1] - [255]

DRAM IOL (CHB D0 R1) [Auto]
Configuration options: [Auto] [1] - [255]

DRAM IOL (CHB D1 R0) [Auto]
Configuration options: [Auto] [1] - [255]

DRAM IOL (CHB D1 R1) [Auto]
Configuration options: [Auto] [1] - [255]

DRAM IOL (CHC D0 R0) [Auto]
Configuration options: [Auto] [1] - [255]

DRAM IOL (CHC D0 R1) [Auto]
Configuration options: [Auto] [1] - [255]

DRAM IOL (CHC D1 R0) [Auto]
Configuration options: [Auto] [1] - [255]

DRAM IOL (CHC D1 R1) [Auto]
Configuration options: [Auto] [1] - [255]

DRAM IOL (CHD D0 R0) [Auto]
Configuration options: [Auto] [1] - [255]

DRAM IOL (CHD D0 R1) [Auto]
Configuration options: [Auto] [1] - [255]

DRAM IOL (CHD D1 R0) [Auto]
Configuration options: [Auto] [1] - [255]

DRAM IOL (CHD D1 R1) [Auto]
Configuration options: [Auto] [1] - [255]

IO control

MC Vref(CHA) [Auto]
Configuration options: [Auto] [50] - [99.911]

MC Vref(CHB) [Auto]
Configuration options: [Auto] [50] - [99.911]

MC Vref(CHC) [Auto]
Configuration options: [Auto] [50] - [99.911]

MC Vref(CHD) [Auto]
Configuration options: [Auto] [50] - [99.911]

DRAM Vref (CHA) [Auto]
Configuration options: [Auto] [60] - [99]

DRAM Vref (CHB) [Auto]
Configuration options: [Auto] [60] - [99]

DRAM Vref (CHC) [Auto]
Configuration options: [Auto] [60] - [99]

DRAM Vref (CHD) [Auto]
Configuration options: [Auto] [60] - [99]

CTL Vref (CHAB) Sign [+]
Configuration options: [+] [-]

CTL Vref (CHAB) [Auto]
Configuration options: [Auto] [0.00] - [0.20]

CTL Vref (CHCD) Sign [+]

Configuration options: [+] [-]

CTL Vref (CHCD) [Auto]

Configuration options: [Auto] [0.00] - [0.20]

Receiver DQ Pre-emphasis [Auto]

Configuration options: [Auto] [0.90] - [1.60]

Receiver DQ De-emphasis [Auto]

Configuration options: [Auto] [0.90] - [1.60]

Transmitter DQ Pre-emphasis [Auto]

Configuration options: [Auto] [0.90] - [1.60]

Receiver DQS Pre-emphasis [Auto]

Configuration options: [Auto] [0.90] - [1.60]

Receiver DQS De-emphasis [Auto]

Configuration options: [Auto] [0.90] - [1.60]

Transmitter DQS Pre-emphasis [Auto]

Configuration options: [Auto] [0.90] - [1.60]

Receiver CMD Pre-emphasis [Auto]

Configuration options: [Auto] [0.90] - [1.60]

Receiver CMD De-emphasis [Auto]

Configuration options: [Auto] [0.90] - [1.60]

Transmitter CMD Pre-emphasis [Auto]

Configuration options: [Auto] [0.90] - [1.60]

Receiver CLK Pre-emphasis [Auto]

Configuration options: [Auto] [1.00] - [2.00]

Receiver CLK De-emphasis [Auto]

Configuration options: [Auto] [1.00] - [2.00]

Transmitter CLK Pre-emphasis [Auto]

Configuration options: [Auto] [1.00] - [2.00]

Receiver CTL Pre-emphasis [Auto]

Configuration options: [Auto] [1.00] - [1.60]

Receiver CTL De-emphasis [Auto]

Configuration options: [Auto] [1.00] - [1.60]

Transmitter CTL Pre-emphasis [Auto]

Configuration options: [Auto] [1.00] - [1.60]

Receiver ODT Pre-emphasis [Auto]

Configuration options: [Auto] [1.00] - [1.60]

Transmitter ODT Pre-emphasis [Auto]

Configuration options: [Auto] [1.00] - [1.60]

MISC

DRAM Eventual Voltage (CHA/CHB/CHC/CHD) [Auto]

Use <+> or <-> to adjust the eventual voltages of the DIMM slots. The values range from 0.8 V to 1.9 V with a 0.10 increment.

DQ/ DQS/ CMD/ CTL Sense Amp Sign [+]

Configuration options: [+] [-]

DQ/ DQS/ CMD/ CTL Sense Amp [Auto]

Configuration options: [Auto] [0] – [127]

DRAM CLK Period [Auto]

This item allows you to set a DRAM clock period.

Configuration options: [Auto] [1] – [19]

Memory optimize Control [Auto]

This item allows you to optimize the memory control.

Configuration options: [Auto] [Enabled] [Disabled]

Enhanced Training (CHA)/ (CHB)/ (CHC)/ (CHD) [Auto]

Configuration options: [Auto] [Enabled] [Disabled]

MemTest [Disabled]

Configuration options: [Auto] [Enabled] [Disabled]

Attempt Fast Boot [Auto]

Configuration options: [Auto] [Enabled] [Disabled]

DRAM Training [Auto]

Configuration options: [Auto] [Enabled] [Disabled]

MemTest on Fast Boot [Disabled]

Configuration options: [Auto] [Enabled] [Disabled]

External DIGI+ Power Control



Some of the following items are adjusted by typing the desired values using the numeric keypad and press the <Enter> key. You can also use the <+> and <-> keys to adjust the value. To restore the default setting, type [auto] using the keyboard and press the <Enter> key.

CPU Input Boot Voltage [Auto]

The voltage for CPU at initial Boot.

CPU Load-Line Calibration [Auto]

CPU Load-line is defined by Intel's VRM spec and affects CPU voltage. The CPU operating voltage will decrease proportionally to the CPU load. Higher load-line calibration would enable higher voltage for better overclocking performance, but decrease the CPU and VRM thermal. This item allows you to adjust the voltage range from the following percentages to boost the system performance: 0% (Regular), 25% (Medium), 50% (High), 75% (Ultra High) and 100% (Extreme).

Configuration options: [Auto] [Regular] [Medium] [High] [Ultra High] [Extreme]



The actual performance boost may vary depending on your CPU specification.

CPU VRM Switching Frequency [Auto]

This item affects the VRM transient response speed and the component thermal efficiency. Select [Manual] to configure a higher frequency for a quicker transient response speed.

Configuration options: [Auto] [Manual]



DO NOT remove the thermal module. The thermal conditions should be monitored.



The following item appears only when you set the CPU VRM Switching Frequency to [Manual].

VRM Spread Spectrum [Disabled]

Enable this item to enhance system stability.

Configuration options: [Disabled] [Enabled]

Active Frequency Mode [Disabled]

Enable this item to enhance the power saving condition.

Configuration options: [Disabled] [Enabled]



Do not remove the thermal module when manual mode is selected. The thermal conditions should be monitored.

CPU Power Phase Control [Auto]

Phase number is the number of active VRM phases. Increasing phase number under heavy system loading can achieve better transient and thermal performance. Reducing phase number under light system loading to increase VRM efficiency

[Standard] Proceeds phase control depending on the CPU loading.

[Optimized] Loads the ASUS optimized phase tuning profile.

[Extreme] Proceeds the full phase mode.

[Manual Adjustment] Allows manual adjustment.

CPU Power Duty Control [T.Probe]

DIGI + VRM Duty Control adjusts the current of every VRM phase and the thermal conditions of every phase component.

[T. Probe] Select to set the VRM thermal balance mode.

[Extreme] Select to set the VRM current balance mode.



DO NOT remove the thermal module. The thermal conditions should be monitored.

CPU Current Capability [Auto]

Allows you to adjust the total power range for DRAM overclocking.

Configuration options: [100%] [110%] [120%] [130%] [140%] [240%]

CPU Power Thermal Control [135]

Allows you to set a higher temperature to extend the overclocking tolerance and at the same time increase the overclocking potential.

DRAM Current Capability(CHA, CHB)/ (CHC, CHD) [100%]

Allows you to adjust the total power range for DRAM overclocking. A higher value provides a wider total power range and extends the overclocking frequency range simultaneously.

Configuration options: [100%] [110%] [120%] [130%] [140%] [240%]

DRAM Switching Frequency(CHA, CHB)/ (CHC, CHD) [Auto]

DRAM switching affects the overclocking range and the system stability. Configure a higher frequency to increase the overclocking range or a lower frequency to enhance the system stability.

Configuration options: [Auto] [Manual]



The following item appears only when you set the DRAM Switching Frequency to [Manual].

Fixed DRAM Switching Frequency (KHz) [300]

This item allows you to set a higher frequency for an increased overclocking range or a lower frequency for an enhanced system stability. Use the <+> or <-> to adjust the value. The values range from 300 KHz to 500 KHz with an interval of 50 KHz.

DRAM Power Phase Control (CHA, CHB)/ CHC, CHD) [Optimized]

Allows you to enable or disable the DRAM CD settings.

[Optimized] Set to the optimized ASUS phase tuning profile.

[Standard] The phase control will be based on the CPU command.

[Extreme] Set to the full phase mode.

Tweaker's Paradise

BCLK Amplitude [Auto]

This item allows you to adjust the magnitude of the BCLK.
Configuration options: [Auto] [Lower] [Normal] [Higher]

ICC Ringback Canceller [Disabled]

Allows you to enable the ICC Ringback Canceller.
Configuration options: [Auto] [Enabled] [Disabled]

Cross-Talk Cancellation Voltage [Disabled]

Configuration options: [Auto] [Enabled] [Disabled]

ICC Ringback Canceller [Auto]

Allows you to enable the ICC Ringback Canceller.

Gen3 Preset [Auto]

Selecting different presets can improve the stability of PCIe 3.0/
Configuration options: [Auto] [Preset1] [Preset] Preset3

PCIe Clock Amplitude [Auto]

Enable this item to enhance the power saving condition.
Configuration options: [Auto] [Normal] [Higher]



Do not remove the thermal module when the manual mode is selected. The thermal conditions should be monitored.

Internal CPU Power Management

Enhanced Intel SpeedStep Technology [Enabled]

This item allows your system to adjust the CPU's voltage and cores frequency, resulting in decreased power consumption and heat production.

[Disabled] The CPU runs at its default speed.

[Enabled] The system controls the CPU speed.

Turbo Mode [Enabled]

Enable this item for the operating system to dynamically adjust the CPU voltage and frequency, resulting in a decreased average power consumption and a decreased average heat production.

Configuration options: [Enabled] [Disabled]

Long Duration Package Power Limit [Auto]

The default value will be the TDP (thermal design power). The turbo ratio can be maintained for a duration to exceed the TDP for the maximum system performance.

Configuration options: [1] - [4095]

Package Power Time Window [Auto]

The value indicates the maintained duration for the turbo ratio to exceed the TDP (Thermal design power).

Configuration options: [1] - [127]

Short Duration Package Power Limit [Auto]

It is the second power limit to provide a rapid protection when the package power exceeds power limit 1. The default setting is 1.25 times the power limit 1.

Configuration options: [1] - [4095]



According to Intel, the platform must be capable of supporting the duration for up to 10 msec. when the turbo ratio exceeds the power limit 2. ASUS motherboards can support the duration for longer time.

CPU Intergrated VR Current Limit [Auto]

This item allows you to configure a higher current limit to prevent a frequency or power throttling when overclocking.

Configuration options: [0.125] - [1023.875]

CPU Intergrated Fault Management [Auto]

Disable this item to prevent the FIVR (fully integrated voltage regulator) from tripping when doing over-voltage. It is recommended to disable this item when overclocking.

Configuration options: [Auto] [Enabled] [Disabled]

CPU Intergrated VR Efficiency Management [Auto]

Select the balanced mode to improve power saving when the CPU is in a low power state. Select the high performance mode to make the FIVR (fully integrated voltage regulator) work in a high performance at all times.

Configuration options: [Auto] [Enabled] [Disabled]

CPU Core Voltage [Auto]

This item allows you to configure the amount of voltage fed to the CPU cores. Increase the voltage when configuring a high CPU core frequency.

Configuration options: [Auto] [Manual Mode] [Offset Mode] [Adaptive Mode]



The following item appears only when you set the CPU Core Voltage to [Manual Mode].

CPU Core Voltage Override [Auto]

This item allows you to configure the CPU core voltage. Use<+> or <-> key to adjust the value. The values range from 0.001V to 1.920V at 0.001V increment.



The following items appear only when you set the CPU Core Voltage to [Offset Mode] or [Adaptive Mode].

Offset Mode Sign [+]

[+] To offset the voltage by a positive value.

[-] To offset the voltage by a negative value.

CPU Core Voltage Offset [Auto]

This item allows you to configure the CPU core voltage offset value. Use<+> or <-> key to adjust the value. The values range from 0.001V to 0.999V at 0.001V increment.



The following items appear only when you set the CPU Core Voltage to [Adaptive Mode].

Offset Mode Sign [+]

[+] To offset the voltage by a positive value.

[-] To offset the voltage by a negative value.

CPU Core Voltage Offset [Auto]

This item allows you to configure the CPU core voltage offset value. Use<+> or <-> key to adjust the value. The values range from 0.001V to 0.999V at 0.001V increment.

Additional Turbo Mode CPU Core Voltage [Auto]

This item allows you to set the amount of voltage fed to the CPU cores when running in turbo mode. Increase the voltage when configuring a high CPU core frequency. The voltage you set is affected by the offset value. Use the <+> or <-> keys to adjust the value. The values range from 0.001V to 1.920 V with a 0.001 V interval.

CPU Cache Voltage [Auto]

This item allows you to configure the amount of voltage fed to the CPU uncores including it is cache. Increase the voltage when configuring a high CPU cache frequency.

Configuration options: [Auto] [Manual Mode] [Offset Mode] [Adaptive Mode]



The following item appears only when you set the CPU Cache Voltage to **[Manual Mode]**.

CPU Cache Voltage Override [Auto]

This item allows you to configure the CPU cache voltage. Use<+> or <-> key to adjust the value. The values range from 0.001V to 1.920V at 0.001V increment.



The following items appear only when you set the CPU Core Voltage to **[Offset Mode]**.

Offset Mode Sign [+]

[+] To offset the voltage by a positive value.

[-] To offset the voltage by a negative value.

CPU Cache Voltage Offset [Auto]

This item allows you to configure the CPU cache voltage offset value. Use<+> or <-> key to adjust the value. The values range from 0.001V to 0.999V at 0.001V increment.



The following items appear only when you set the CPU Core Voltage to **[Adaptive Mode]**.

Offset Mode Sign [+]

[+] To offset the voltage by a positive value.

[-] To offset the voltage by a negative value.

CPU Cache Voltage Offset [Auto]

This item allows you to configure the CPU cache voltage offset value. Use<+> or <-> key to adjust the value. The values range from 0.001V to 0.999V at 0.001V increment.

Additional Turbo Mode CPU Cache Voltage [Auto]

This item allows you to set the amount of voltage fed to the CPU cores when running in turbo mode. Increase the voltage when configuring a high CPU core frequency. The voltage you set is affected by the offset value. Use the <+> or <-> keys to adjust the value. The values range from 0.001V to 1.920 V with a 0.001 V interval.

CPU System Agent Voltage Offset Mode Sign [+]

- [+] To offset the voltage by a positive value.
- [-] To offset the voltage by a negative value.

CPU System Agent Voltage Offset [Auto]

This item allows you to set the amount of voltage fed to the system agent of the processor including its PCIe controller and power control unit (PCU). Setting a high system agent voltage may enhance the overclocking capability. Use the <+> or <-> key to adjust the value. The values range from 0.001V to 0.999V at 0.001V increment.

CPU SVID Support [Auto]

Set this item to stop the CPU from communicating with the external voltage regulator. Disable this item when you overclock your system.

Configuration options: [Auto] [Disabled] [Enabled]

CPU Input Voltage [Auto]

This item allows you to set the input voltage for the processor by the external voltage regulator. Use the <+> or <-> key to adjust the value.

Configuration options: [0.800V] - [3.400V]

DRAM SVID Support [Auto]

Set this item to stop the CPU from communicating with the external voltage regulator. Disable this item when you overclock your system.

Configuration options: [Auto] [Disabled] [Enabled]

DRAM Voltage (CHA, CHB) / (CHC, CHD) [Auto]

This item allows you to set the voltage for the system memory. Use the <+> or <-> key to adjust the value. The values range from 0.80V to 1.90V at 0.010V increment.



According to Intel® CPU specifications, DIMMs with voltage requirement over 1.65 V may damage the CPU permanently. We recommend that you install the DIMMs with the voltage requirement below 1.65 V.

PCH Core Voltage [Auto]

This item allows you to configure the core voltage for the PCH (platform controller hub). Use the <+> or <-> key to adjust the value. The values range from 0.70V to 1.80V at 0.00635V increment.

PCH I/O Voltage [Auto]

This item allows you to configure the I/O voltage for the PCH (platform controller hub). Use the <+> or <-> key to adjust the value. The values range from 1.20V to 2.20V at 0.00635V increment.

VCCIO CPU 1.05V Voltage [Auto]

This item allows you to set the main power supply for the CPU REF. Use the <+> or <-> key to adjust the value. The values range from 0.7000V to 1.8000V at 0.00625V increment.

VCCIO PCH 1.05V Voltage [Auto]

This item allows you to set the main power supply for the PCH REF. Use the <+> or <-> key to adjust the value. The values range from 0.2000V to 1.0000V at 0.00625V increment.

VTTDR Voltage (CHA, CHB) [Auto]

This item allows you to set the termination voltage for the DRAM on the left. Use the <+> or <-> key to adjust the value. The values range from 0.2000V to 1.0000V at 0.00625V increment.

VTTDR Voltage (CHC, CHD) [Auto]

This item allows you to set the termination voltage for the DRAM on the left. Use the <+> or <-> key to adjust the value. The values range from 0.2000V to 1.0000V at 0.00625V increment.

PLL Termination Voltage [Auto]

This item allows you to terminate the PLL Voltage. You can use the <+> or <-> keys to adjust the value. The values range from 0.20000V to 3.098278 V with a 0.006602 V interval.

PLL Reference Offset Mode Sign [+]

- [+] To offset the voltage by a positive value.
- [-] To offset the voltage by a negative value.

PLL Reference Offset Value [Auto]

This item allows you to configure the PLL reference value. You can use the <+> or <-> keys to adjust the value.

Configuration options: [Auto] [1] - [20]

CPU Spread Spectrum [Auto]

This item allows you to enhance the BCLK overclocking capability or reduce the EMI (electromagnetic disturbance) generated by the BCLK. Set this item to [Enabled] for EMI reduction, or set this item to [Disabled] to enhance BCLK overclocking.

Configuration options: [Auto] [Disabled] [Enabled]

BCLK Recovery [Enabled]

This item allows you to enable or disable BCLK Recovery.

Configuration options: [Disabled] [Enabled] [Ignore]

3.6 Advanced menu

The items in Advanced menu allow you to change the settings of the CPU and other system devices.



Be cautious when changing the settings of the items in Advanced menu. Incorrect field values can cause the system to malfunction.

REPUBLIC OF GAMERS UEFI BIOS Utility – Advanced Mode

08/05/2014 Tuesday 17:15 English MyFavorite(F3) Qfan Control(F6) EZ Tuning Wizard(F11) Quick Note(F9) Hot Keys

My Favorites Main Extreme Tweaker **Advanced** Monitor Boot Tool Exit Hardware Monitor

- > CPU Configuration
- > PCH Configuration
- > PCH Storage Configuration
- > System Agent Configuration
- > USB Configuration
- > Platform Misc Configuration
- > Onboard Devices Configuration
- > APM Configuration
- > Network Stack Configuration
- > Trusted Computing
- > ROG Effects

① CPU Configuration Parameters

CPU

Frequency	Temperature
3500 MHz	39°C
BCLK	Core Voltage
100.0 MHz	0.592 V
Ratio	
35x	

Memory

Frequency	Vol_CHAB
2133 MHz	0.000 V
Capacity	Vol_CHCD
4096 MB	0.000 V

Voltage

+12V	+5V
11.904 V	5.000 V
+3.3V	
3.296 V	

Last Modified | EzMode(F7) |

Version 2.16.1242. Copyright (C) 2014 American Megatrends, Inc.

3.6.1 CPU Configuration

The items in this menu show the CPU-related information that the BIOS automatically detects.



The items in this menu may vary based on the CPU installed.

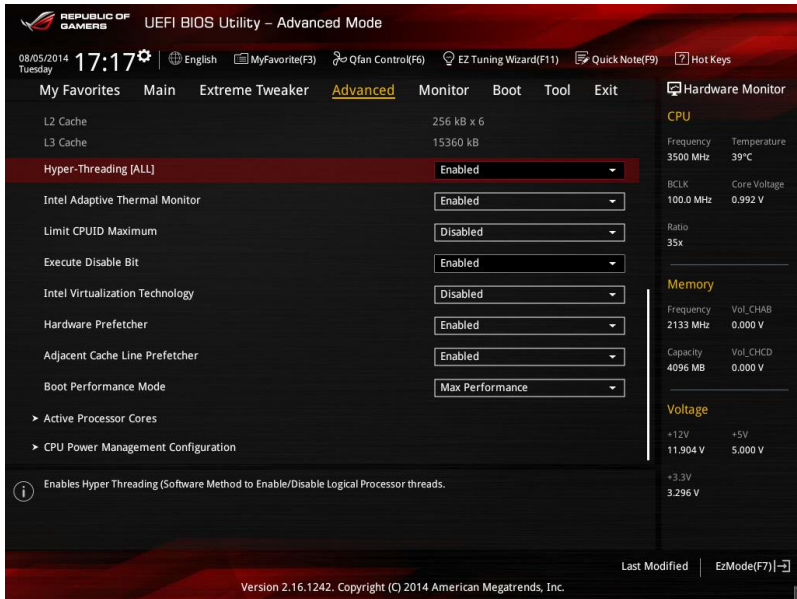

Hyper-Threading [ALL] [Enabled]

This item allows you to enable/disable the Hyper-Threading for logical processor threads.

Configuration options: [Enabled] [Disabled]

Intel Adaptive Thermal Monitor [Enabled]

This item allows you to protect the CPU by decreasing its frequency as it reaches the thermal throttle point. The thermal monitor includes TM1 (Thermal monitor 1), TM2 (Thermal monitor 2), and EMTTM (Enhanced Multi-threaded Thermal Monitoring).

Configuration options: [Disabled] [Enabled]

Limit CPUID Maximum [Disabled]

When set to [Enabled], this item allows the legacy OS to boot even without support for CPUs with extended CPUID functions.

Configuration options: [Disabled] [Enabled]

Execute Disable Bit [Enabled]

Execute Disable prevents certain classes of malicious buffer overflow attacks when combined with a supporting OS (SuSE Linux 9.2, RedHat Enterprise 3 Update 3).

Configuration options: [Disabled] [Enabled]

Intel Virtualization Technology [Disabled]

When set to **[Enabled]**, a VMM can utilize the additional hardware capabilities provided by Vanderpool Technology.

Configuration options: [Disabled] [Enabled]

Hardware Prefetcher [Enabled]

This item allows the CPU to prefetch commands and data in the L2 cache, reducing the DRAM loading time and improving system performance.

Configuration options: [Disabled] [Enabled]

Adjacent Cache Line Prefetcher [Enabled]

This item allows the mid level cache (L2) to prefetch adjacent cache lines, reducing the DRAM loading time and improving system performance.

Configuration options: [Disabled] [Enabled]

Boot Performance Mode [Max Performance]

This item allows you to select the CPU performance state during system boot before the operating system takes control. The CPU runs at a selected performance ratio based on CPU configuration.

Configuration options: [Max Non-Turbo Performance] [Max Battery] [Turbo Performance]

Active Processor Cores

The items in this menu allow you to enable/disable the cores of your CPU.

Active Processor Core (0-5) [Enabled]

Configuration options: [Enabled] [Disabled]

CPU Power Management Configuration

This item allows you to manage and configure the CPU's power management system.

Enhanced Intel SpeedStep Technology [Enabled]

This item allows your system to adjust the CPU's voltage and cores' frequency, resulting in decreased power consumption and heat production.

[Disabled] The CPU runs at its default speed.

[Enabled] The system controls the CPU speed.

Turbo Mode [Enabled]

This item allows you to automatically set the CPU cores to run faster than the base operating frequency when it is below the operating power, current, and temperature specification limits.

Configuration options: [Enabled] [Disabled]

CPU C-States [Auto]

This item allows you to set the power saving options of the CPU states.

Configuration options: [Auto] [Disabled] [Enabled]



The following items appear only when you set the CPU C-States to **[Enabled]**.

Enhanced C1 state [Enabled]

This item allows your CPU to reduce power consumption when the system is in idle mode.

Configuration options: [Enabled] [Disabled]

CPU C3 Report [Disabled]

This item allows you to disable or enable the CPU C3 report to the operating system.

Configuration options: [Enabled] [Disabled]

CPU C6 Report [Enabled]

This item allows you to disable or enable the CPU C6 report to the operating system.

Configuration options: [Enabled] [Disabled]

Package C State Support [Auto]

This item allows you to set the a C-state support for the CPU package.

Configuration options: [Auto] [C0/C1 state] [C2 state] [C6(non Retention) state] [C6(Retention) state]

3.6.2 PCH Configuration

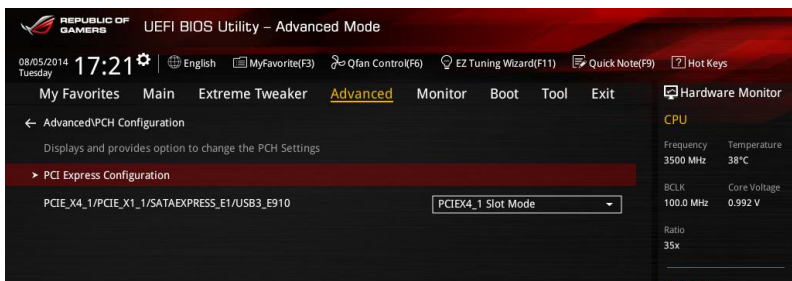

PCI Express Configuration

This item allows you to configure the PCI Express slots.

PCI-E Speed [Auto]

This item allows your system to automatically select the PCI Express port speed. When set to [Gen1], the PCI-E port runs at PCI-E 1.0 speed. When set to [Gen2], the PCI-E port runs at PCI-E 2.0 speed.

Configuration options: [Auto] [Gen1] [Gen2]

PCIEX4_1/PCIE_X1_1/SATAEXPRESS_E1/USB3_E910 [PCIEX4_1 Slot Mode]

- | | |
|-----------------------|--|
| [PCIEX4_1 Slot Mode] | If PCIE_X4_1 is occupied by an X1 or X2 device, SATAEXPRESS_E1 will be disabled. If PCIE_X4_1 slot is occupied by an X4 device, SATAEXPRESS_E1, PCIE_X1_1, and USB3_E910 will be disabled. |
| [PCIE_X1_1 Slot Mode] | PCIE_X1_1 is enabled. PCIE_X4_1 is limited to X2 bandwidth and when PCIE_X4_1 is occupied, SATAEXPRESS_E1 will be disabled. |
| [USB3_E910 Mode] | USB3_E910 is enabled and PCIE_X1_1 is disabled. The PCIE_X4_1 is limited to X2 bandwidth and when it is occupied, SATAEXPRESS_E1 is disabled. |

3.6.3 PCH Storage Configuration

While entering Setup, the BIOS automatically detects the presence of SATA devices. The SATA Port items show Empty if no SATA device is installed to the corresponding SATA port. Scroll down to display the other BIOS items.

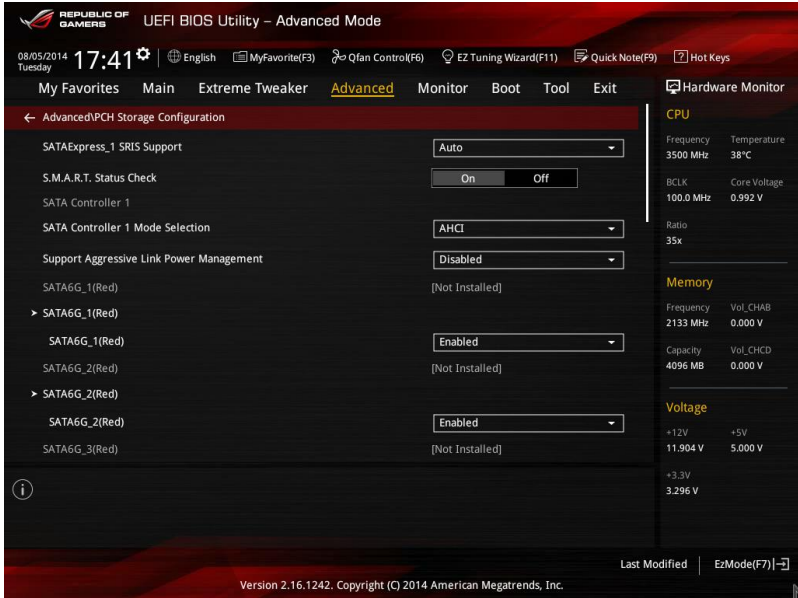

SATAExpress_1 SRIS Support [Auto]

- [Auto] The system automatically adjusts the SRIS support for connected SATAEXPRESS devices.
- [Disabled] Select this option for ASUS RUNWAY SATA Express bridge card.

S.M.A.R.T. Status Check [On]

S.M.A.R.T. (Self-Monitoring, Analysis and Reporting Technology) is a monitoring system that shows a warning message during POST (Power-on Self Test) when an error occurs in the hard disks. Press <Enter> to set this item On or Off.

Configuration options: [On] [Off]

SATA Mode 1/2 Selection [AHCI]

This item allows you to set the SATA configuration.

- [Disabled] Disables the SATA function.
- [IDE] Set to [IDE] when you want to use the Serial ATA hard disk drives as Parallel ATA physical storage devices.
- [AHCI] Set to [AHCI] when you want the SATA hard disk drives to use the AHCI (Advanced Host Controller Interface). The AHCI allows the onboard storage driver to enable advanced Serial ATA features that increases storage performance on random workloads by allowing the drive to internally optimize the order of commands.
- [RAID] Set to [RAID] when you want to create a RAID configuration from the SATA hard disk drives.



The following item appears only when you set the SATA Mode Selection to [RAID].

Alternate ID [Disabled]

This item allows you to enable or disable Report alternate ID.
Configuration options: [Disabled] [Enabled]

Support Aggressive Link Power Management [Disabled]

This item is designed for LPM (link power management) support with a better energy saving conditions. When set to [Enabled], the hot plug function of SATA ports are disabled.

Configuration options: [Disabled] [Enabled]

SATA6G_1 - SATA6G_6 (Red) / SATA6G_7 - SATA6G_10 (Red)

Press <Enter> to rename the Intel SATA ports.

SATA6G_1 - SATA6G_6 (Red) / SATA6G_1 - SATA6G_6 (Red) [Enabled]

This item allows you to enable or disable the selected SATA port.
Configuration options: [Disabled] [Enabled]

Hot Plug [Disabled]

These items appears only when the SATA Mode Selection is set to [AHCI] and allows you to enable or disable SATA Hot Plug Support.
Configuration options: [Disabled] [Enabled]

3.6.4 System Agent Configuration

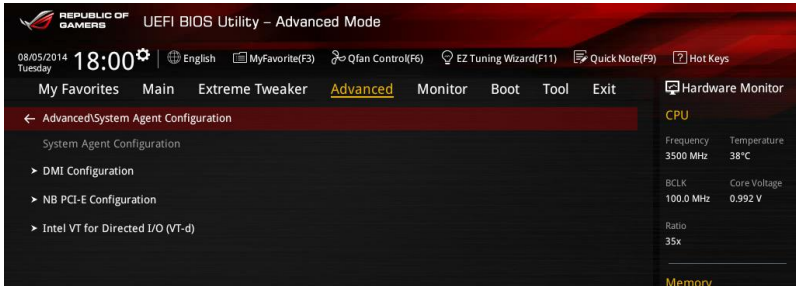

DMI Configuration

DMI Gen 2 [Enabled]

Enable this item for the DMI (direct media interface) to run at PCI-E 2.0 speed.
Configuration options: [Disabled] [Enabled]

NB PCI-E Configuration

The items in this menu allow you to select the operating speeds of the PCIe slots.

PCIEX16_1 Link Speed [Auto]

This item allows you to select the operating speed of the PCIEX16_1 slot.
Configuration options: [Auto] [Gen1] [Gen2] [Gen3]

PCIEX8_2 Link Speed [Auto]

This item allows you to select the operating speed of the PCIEX8_2 slot.
Configuration options: [Auto] [Gen1] [Gen2] [Gen3]

PCIEX16_3 Link Speed [Auto]

This item allows you to select the operating speed of the PCIEX16_3 slot.
Configuration options: [Auto] [Gen1] [Gen2] [Gen3]

PCIEX8_4 Link Speed [Auto]

This item allows you to select the operating speed of the PCIEX8_4 slot.
Configuration options: [Auto] [Gen1] [Gen2] [Gen3]

Intel VT for Directed I/O (VT-d)

The items in this menu allow you to configure the Intel® Virtualization Technology for Directed I/O (VT-d).

VTd Azalea VCp Optimizations [Disabled]

This item allows you to enable/disable the Azalea VCp Optimizations.
Configuration options: [Enabled] [Disabled]

Intel VT for Directed I/O (VT-d) [Disabled]

This item allows you to enable/disable the Intel Virtualization Technology for Directed I/O (VT-d) by reporting the I/O device assignment to VMM through DMAR ACPI Tables.
Configuration options: [Enabled] [Disabled]

3.6.5 USB Configuration

The items in this menu allow you to change the USB-related features.

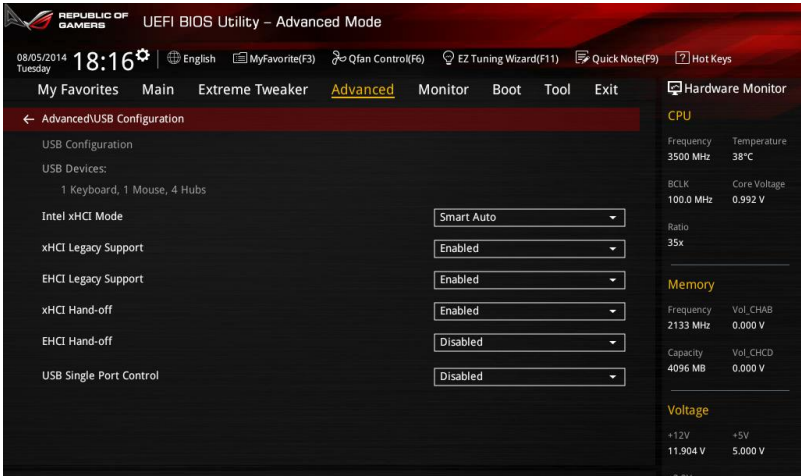

The **USB Devices** item shows the auto-detected values. If no USB device is detected, the item shows **None**.

Intel xHCI Mode [Smart Auto]

- [Smart Auto] Once the xHCI driver has been detected, the USB 3.0 mode will be supported during both POST and operating system.
- [Auto] xHCI controller will be enabled and run at USB 3.0 mode when the xHCI driver is installed in the operating system.
- [Enabled] Enables the xHCI controller.
- [Disabled] Disables the xHCI controller.

xHCI Legacy Support [Enabled]

- [Disabled] The USB 3.0 devices can be used for the BIOS setup only and cannot be recognized in the boot devices list.
- [Enabled] Support USB 3.0 devices in legacy operating systems (OS).
- [Auto] The system will automatically detect the presence of USB 3.0 devices at startup. If any USB 3.0 device is detected, the xHCI legacy support will be enabled.

EHCI Legacy Support [Enabled]

- [Disabled] The USB 2.0 devices can be used only for the BIOS setup only and cannot be recognized in the boot devices list.
- [Enabled] Support USB 2.0 devices in legacy operating systems (OS).
- [Auto] The system will automatically detect the presence of USB 2.0 devices at startup. If any USB 2.0 device is detected, the xHCI legacy support will be enabled.

EHCI Hand-off [Disabled]



This item is set to [Disabled] by default for the EHCI (enhanced host controller interface) support by EHCI drivers in operating systems.

- [Disabled] Support for EHCI using the EHCI drivers for operating systems with EHCI support.
- [Enabled] Support for EHCI using the BIOS for operating systems without EHCI support.

USB Single Port Control [Disabled]

Allows you to enable or disable the individual USB ports.

Configuration options: [Enabled] [Disabled]



Refer to the Motherboard layout section for the location of the USB ports.

3.6.6 Platform Miscellaneous Configuration

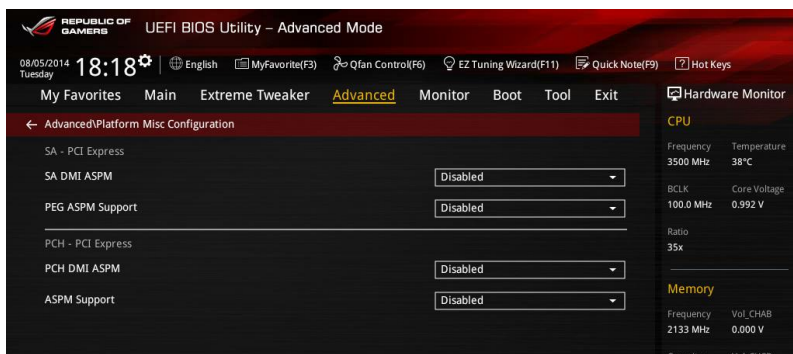

SA DMI ASPM [Disabled]

Allows you to enable or disable the ASPM (L1) support for the downstream devices.
Configuration options: [Auto] [Disabled] [L1 only]

PEG ASPM Support [Disabled]

Allows you to enable or disable the ASPM support for all downstream devices.
Configuration options: [Disabled] [L1 only]

PCH DMI ASPM [Disabled]

Allows you to enable or disable the PCH DMI ASPM setting.
Configuration options: [Enabled] [Disabled]

ASPM Support [Disabled]

This option allows you to enable or disable the ASPM support for all downstream devices.
Configuration options: [Disabled] [L1 only]

3.6.7 Onboard Devices Configuration

Scroll down to view the other BIOS items.

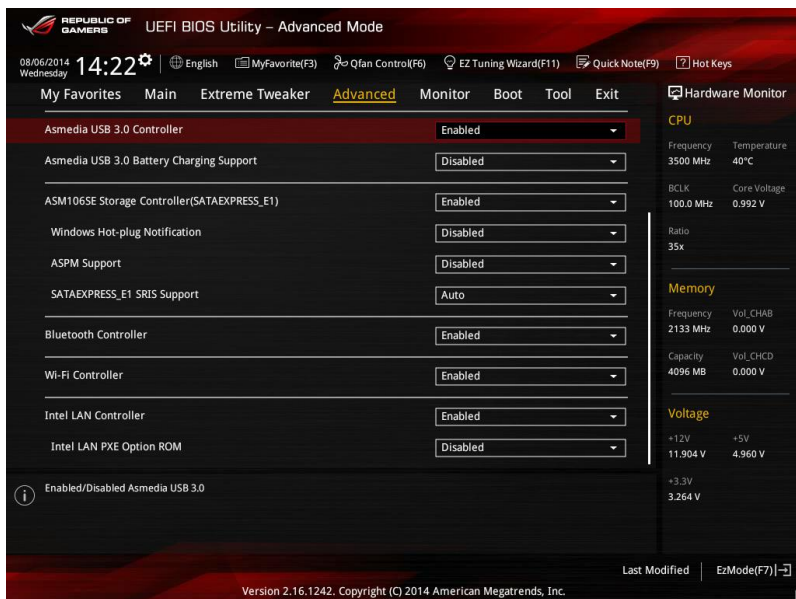

HD Audio Controller [Enabled]

[Disabled] Disables the controller.

[Enabled] Enables the High Definition Audio Controller.

SATA EXPRESS or PCIE x4 [Auto]

Allows you to select between SATA EXPRESS or PCIE X4.

Configuration options: [Auto] [SATA EXPRESS] [PCIE X4]

PCIEx8 and M.2 Configuration [Auto]

The system will automatically detect the connected SATA Express or M.2 devices and set a higher priority for M.2 than SATA Express interface. The connected device will then run at PCI-E mode first then on SATA mode. The SATA devices are available when no PCIEx8_4 or M.2 devices are installed.

Configuration options: [Auto] [M.2]

ASMedia USB 3.0 Controller [Enabled]

This item allows you to enable the ASMedia® USB 3.0 controller of your system.

Configuration options: [Disabled] [Enabled]



The following item appears only when you set the ASMedia USB 3.0 Controller to **[Enabled]**.

ASMedia USB 3.0 Battery Charging Support [Disabled]

This item allows you to enable the ASMedia® USB 3.0 battery charging support of your system.

Configuration options: [Disabled] [Enabled]

ASM106SE Storage Controller (SATAEXPRESS_E1) [Enabled]

This item allows you to enable or disable the ASMedia storage controller.

Configuration options: [Disabled] [Enabled]



The following items appear only when you set the ASM1061 Storage Controller to **[Enabled]**.

Windows Hot-plug Notification [Enabled]

This item allows you to enable or disable the Hot Plug support for SATA6G_E12.

Configuration options: [Disabled] [Enabled]

ASPM Support [Enabled]

This item allows you to enable or disable the ASPM controller to save energy when using the ASMedia Storage Controller.

Configuration options: [Disabled] [Enabled]

SATAEXPRESS_E1 SRIS Support [Auto]

[Auto] The system automatically adjusts the SRIS support for connected SATAEXPRESS devices.

[Disabled] Select this option for ASUS RUNWAY SATA Express bridge card.

Bluetooth Controller [Enabled]

Allows you to enable or disable the Bluetooth controller.

Configuration options: [Enabled] [Disabled]

Wi-Fi Controller [Enabled]

Allows you to enable or disable the Wi-Fi controller.

Configuration options: [Enabled] [Disabled]

Intel LAN Controller [Enabled]

[Enabled] Enables the GbE controller.

[Disabled] Disables the controller.

Intel PXE OPROM [Disabled]

This item appears only when you set the Intel LAN Controller to [Enabled]. It allows you to enable or disable the PXE Option ROM of the Intel LAN's controller.

Configuration options: [Enabled] [Disabled]

3.6.8 APM

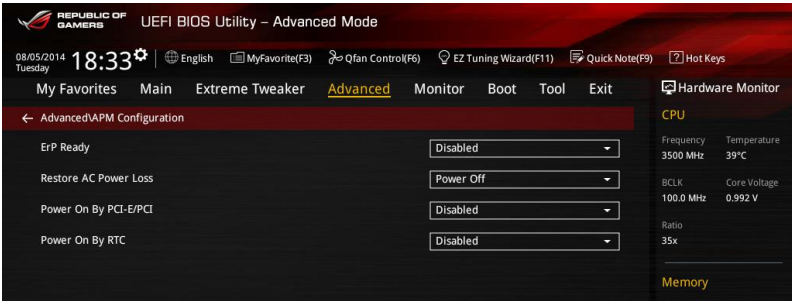

ErP Ready [Disabled]

Allows you to switch off some power at S4+S5 or S5 to get the system ready for ErP requirement. When set to [Enabled], all other PME options will be switched off.

Configuration options: [Disabled] [Enabled (S4+S5)] [Enabled (S5)]

Restore AC Power Loss [Power Off]

[Power On] The system goes into the ON state after AC power loss.

[Power Off] The system goes into the OFF state after AC power loss.

[Last State] The system goes into either the OFF or ON state, depending on the system state prior to AC power loss.

Power On By PCI-E/PCI [Disabled]

[Disabled] Disables the PCIE/PCI devices to generate a wake-on-LAN feature of the Intel®/Realtek LAN device or other installed PCIE LAN devices.

[Enabled] Enables the PCIE/PCI devices to generate a wake-on-LAN feature of the PCIE LAN devices.

Power On By RTC [Disabled]

[Disabled] Prevents the RTC from generating a wake event.

[Enabled] When set to [Enabled], the items **RTC Alarm Date (Days)** and **Hour/Minute/Second** will become user-configurable with set values.

3.6.9 Network Stack Configuration

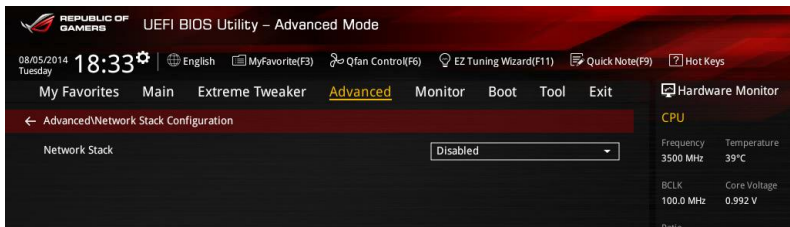

Network Stack [Disabled]

This item allows you to disable or enable the UEFI network stack.

Configuration options: [Disabled] [Enabled]



The following items appear only when you set the Network Stack to [Enabled].

Ipv4 / Ipv6 PXE Support [Enabled]

Allows you to enable or disable the Ipv4/Ipv6 PXE boot option.

Configuration options: [Disabled] [Enabled]

3.6.10 ROG Effects

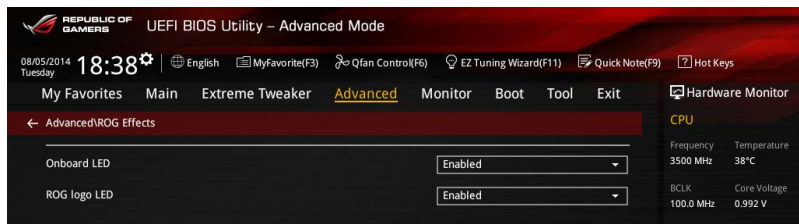

Onboard LED [Enabled]

This switch enables you to turn on/off all the onboard LEDs.

Configuration options: [Disabled] [Enabled]

ROG logo LED [Enabled]

This item allows you to enable or disable the ROG logo LED.

Configuration options: [Disabled] [Enabled]

CPU Q-Fan Control [Auto]

Allows you to set the CPU Q-Fan operating mode.

- | | |
|------------|---|
| [Disabled] | Disables the CPU Q-Fan control feature. |
| [Auto] | Detects the type of CPU fan installed and automatically switches the mode control. When a 3-pin CPU fan is installed, select this mode for the DC mode Q-Fan control. |
| [DC Mode] | Enables the CPU Q-Fan control feature in DC mode for 3-pin CPU fan. |
| [PWM Mode] | Enables the CPU Q-Fan control feature in PWM mode for 4-pin CPU fan. |



The following items appear only when you set the CPU Fan Profile to [Manual], [DC Mode] or [PWM Mode].

CPU Fan Speed Low Limit [300 RPM]

Allows you to disable or set the CPU fan warning speed.

Configuration options: [Ignore] [200 RPM] [300 RPM] [400 RPM] [500 RPM] [600 RPM]

CPU Fan Profile [Standard]

Allows you to set the appropriate performance level of the CPU fan.

- | | |
|------------|--|
| [Standard] | Set to make the CPU fan adjust automatically depending on the CPU temperature. |
| [Silent] | Set to minimize the fan speed for quiet CPU fan operation. |
| [Turbo] | Set to achieve maximum CPU fan speed. |
| [Manual] | Set to assign the detailed fan speed control parameters. |



The following items appear only when you set the CPU Fan Profile to [Manual].

CPU Upper Temperature [70]

Use the <+> and <-> keys to adjust the upper limit of the CPU temperature. The values range from 20°C to 75°C.

CPU Fan Max. Duty Cycle (%) [100]

Use the <+> and <-> keys to adjust the maximum CPU fan duty cycle. The values range from 40% to 100%. When the CPU temperature reaches the upper limit, the CPU fan will operate at the maximum duty cycle.

CPU Middle Temperature (%) [25]

Use the <+> and <-> keys to adjust the maximum CPU fan duty cycle. The values range from 40% to 100%. When the CPU temperature reaches the upper limit, the CPU fan will operate at the maximum duty cycle.

CPU Fan Middle. Duty Cycle (%) [20]

Use the <+> and <-> keys to adjust the maximum CPU fan duty cycle. The values range from 40% to 100%. When the CPU temperature reaches the upper limit, the CPU fan will operate at the maximum duty cycle.

CPU Lower Temperature [20]

Displays the lower limit of the CPU temperature.

CPU Fan Min. Duty Cycle (%) [20]

Use the <+> and <-> keys to adjust the minimum CPU fan duty cycle. The values range from 40% to 100%. When the CPU temperature is under its CPU lower temperature setting, the CPU fan will operate at the minimum duty cycle.

Chassis Fan 1 A/B Q-Fan Control; Chassis Fan 2 A/B Q-Fan Control; Chassis Fan 3 A/B Q-Fan Control [DC Mode]

- [Disabled] Disables the Chassis Q-Fan control feature.
 [DC mode] Enable the chassis Q-Fan control in DC mode for 3-pin chassis fan.
 [PWM mode] Enable the chassis Q-Fan control in PWM mode for 4-pin chassis fan.

Chassis Fan 1 A/B Q-Fan Source; Chassis Fan 2 A/B Q-Fan Source; Chassis Fan 3 A/B Q-Fan Source [CPU]

The assignment fan will be controlled according to the selected temperature source. Configuration options: [CPU] [MB] [VRM] [MB] [T_SENSOR1] [EXT_SENSOR1] [EXT_SENSOR2] [EXT_SENSOR3]



For T_SENSOR1, connect a Thermistor cable to the T_SENSOR1 header then place the other end to a component to get the temperature.

Chassis Fan 1 A/B Fan Speed Low Limit; Chassis Fan 2 A/B Fan Speed Low Limit; Chassis Fan 3 A/B Fan Speed Low Limit [300 RPM]

This item appears only when you enable the Chassis Q-Fan Control feature and allows you to disable or set the chassis fan warning speed.

Configuration options: [Ignore] [200 RPM] [300 RPM] [400 RPM] [500 RPM] [600 RPM]



The following items appear only when you set the Chassis1/Chassis2/Chassis3 Q-Fan Control feature to [Enabled].

Chassis Fan 1 A/B Profile; Chassis Fan 2 A/B Profile; Chassis Fan 3 A/B Profile [Standard]

This item allows you to set the appropriate performance level of the chassis fan.

- [Standard] Sets to [Standard] to make the chassis fan automatically adjust depending on the chassis temperature.
 [Silent] Sets to [Silent] to minimize the fan speed for quiet chassis fan operation.
 [Turbo] Sets to [Turbo] to achieve maximum chassis fan speed.
 [Manual] Sets to [Manual] to assign detailed fan speed control parameters.



The following items appear only when you set Chassis Fan 1 A/B Profile, Chassis Fan 2 A/B Profile, Chassis Fan 3 A/B Profile to [Manual].

Chassis Fan 1/2/3 Upper Temperature [70]

Use the <+> or <-> keys to adjust the upper limit of the CPU temperature. The values range from 20°C to 75°C.

Chassis Fan 1/2/3 Max. Duty Cycle (%) [100]

Use the <+> or <-> keys to adjust the maximum CPU fan duty cycle. The values range from 20% to 100%. When the CPU temperature reaches the upper limit, the CPU fan will operate at the maximum duty cycle.

Chassis Fan 1/2/3 Middle Temperature [45]

Displays the lower limit of the CPU temperature.

Chassis Fan 1/2/3 Fan Middle. Duty Cycle (%) [60]

Use the <+> or <-> keys to adjust the maximum CPU fan duty cycle. The values range from 20% to 100%. When the CPU temperature reaches the upper limit, the CPU fan will operate at the maximum duty cycle.

Chassis Fan 1/2/3 Lower Temperature [40]

Displays the lower limit of the CPU temperature.

Chassis Fan 1/2/3 Min. Duty Cycle (%) [60]

Use the <+> and <-> keys to adjust the minimum chassis fan duty cycle. The values range from 60% to 100%. When the chassis temperature is under 40°C, the chassis fan will operate at the minimum duty cycle.

Allow Fan Stop [Disabled]

This function allows the fan to run at 0% duty cycle when the temperature of the source is dropped below the lower temperature. Configuration options: [Disabled] [Enabled]

Anti Surge Support [On]

This item allows you to turn on/off the OVP (Over Voltage Protection) and UVP (Under Voltage Protection) functions. This causes the system to automatically shut down when the voltage exceeds the safe range that protects the motherboard's components.

Configuration options: [On] [Off]

3.8 Boot menu

The Boot menu items allow you to change the system boot options. Scroll down to display the other BIOS items.

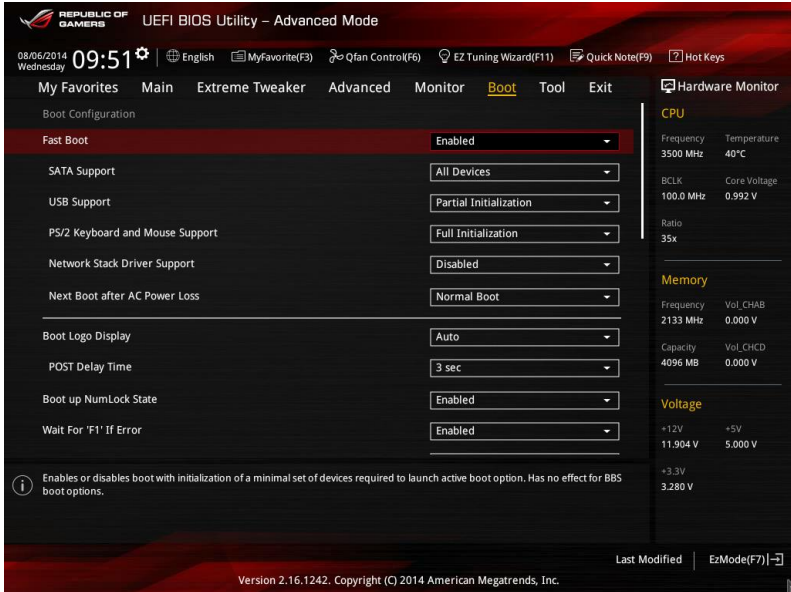

Fast Boot [Disabled]

- [Disabled] Allows your system to go back to its normal boot speed.
- [Enabled] Allows your system to accelerate the boot speed.



The following items appear only when you set the Fast Boot to **[Enabled]**.

SATA Support [All Devices]

- [All Devices] All devices connected to SATA ports will be available during POST.
- [Hard Drive Only] Only hard drives connected to SATA ports will be detected during POST.
- [Boot Drive Only] Only boot drive connected to SATA ports will be detected during POST.

USB Support [Partial Initialization]

- [Disabled] All USB devices will not be available until OS boot up for a fastest POST time.
- [Full Initialization] All USB devices will be available during POST. This process will extend the POST time.
- [Partial Initialization] For a faster POST time, only USB ports with keyboard and mouse connections will be detected.

P/2 Keyboard and Mouse Support [Full Initialization]

Allows you to disable or have full system control of the PS/2 devices' availability during POST.

Configuration options: [Disabled] [Full Initialization] [Auto]

Network Stack Driver Support [Disabled]

This item allows you to enable or disable the Network Stack Driver Support function.

Configuration options: [Disabled] [Enabled]

Next Boot after AC Power Loss [Normal Boot]

- [Normal Boot] Returns to normal boot on the next boot after AC power loss.
- [Fast Boot] Accelerates the boot speed on the next boot after AC power loss.

Boot Logo Display [Auto]

- [Auto] Auto adjusts the Boot Logo size for Windows requirements.
- [Full Screen] Maximizes the Boot Logo size.
- [Disabled] Hides the boot logo during POST.



The following items appears only when you set the Boot Logo Display item to **[Auto]** or **[Full Screen]**.

POST Delay Time [3 sec]

This item allows you to select a desired additional POST waiting time to easily enter the BIOS Setup. You can only execute the POST delay time during normal boot. The values range from 0 to 10 seconds. This feature will only work when set under normal boot.



The following items appears only when you set the Boot Logo Display item to **[Disabled]**.

POST Report [5 sec]

This item allows you to select a desired POST report waiting time.

Configuration options: [1 sec] - [2 sec] [Until Press ESC]

Bootup NumLock State [On]

- [On] Set the power-on state of the NumLock to [On].
 [Off] Set the power-on state of the NumLock to [Off].

Wait For 'F1' If Error [Enabled]

- [Disabled] Disables the function.
 [Enabled] The system waits for the <F1> key to be pressed if an error occurs.

Option ROM Messages [Force BIOS]

This item allows you to set the display mode for Option ROM.

Configuration options: [Force BIOS] [Keep Current]

INT19 Trap Response [Immediate]

- [Immediate] Executes the trap for INT19 immediately.
 [Postponed] Executes the trap during legacy boot.

Above 4G Decoding [Disabled]

This item allows you to decode the 64-bit capable devices above 4G address space. Ensure that your system supports 64-bit PCI decoding.

Configuration options: [Disabled] [Enabled]

Setup Mode [Advanced Mode]

- [Advanced Mode] This item allows you to go to Advanced Mode of the BIOS after POST.
 [EZ Mode] This item allows you to go to EZ Mode of the BIOS after POST.

CSM (Compatibility Support Module)

Allows you to configure the CSM (Compatibility Support Module) items to fully support the various VGA, bootable devices and add-on devices for better compatibility.

Launch CSM [Enabled]

- [Auto] The system automatically detects bootable and add-on devices.
 [Enabled] For better compatibility, enable the CSM to fully support the non-UEFI driver add-on devices or the Windows® UEFI mode.
 [Disabled] Disable the CSM to fully support the non-UEFI driver add-on devices or the Windows® UEFI mode.



The following items appear when you set the Launch CSM to [Enabled].

Boot Device Control [UEFI and Legacy]

This item allows you to select the type of devices that you want to boot.

Configuration options: [UEFI and Legacy] [Legacy OpROM only] [UEFI only]

Boot from Network Devices [Legacy OpROM first]

This item allows you to select the type of network devices that you want to launch.
Configuration options: [Ignore] [Legacy OpROM first] [UEFI driver first]

Boot from Storage Devices [Legacy OpROM first]

This item allows you to select the type of storage devices that you want to launch.
Configuration options: [Both, Legacy OpROM first] [Both, UEFI first] [Legacy OpROM first] [UEFI driver first] [Ignore]

Boot from PCI-E/PCI Expansion Devices [Legacy OpROM first]

This item allows you to select the type of PCIe/PCI expansion devices that you want to launch.
Configuration options: [Legacy OpROM first] [UEFI driver first]

Secure Boot menu

This item allows you to configure the Windows® Secure Boot settings and manage its keys to protect the system from unauthorized access and malwares during POST.

OS Type [Windows UEFI Mode]

[Windows UEFI Mode]	This item allows you to select your installed operating system. Execute the Microsoft® Secure Boot check. Only select this option when booting on Windows® UEFI mode or other Microsoft® Secure Boot compliant OS.
[Other OS]	Get the optimized function when booting on Windows® non-UEFI mode. Microsoft® Secure Boot only supports Windows® UEFI mode.

Key Management

This item allows you to manage the Secure Boot keys.

Install Default Secure Boot keys

This item allows you to immediately load the default Security Boot keys, Platform key (PK), Key-exchange Key (KEK), Signature database (db), and Revoked Signatures (dbx). When the default Secure boot keys are loaded, the PK state will change from Unloaded mode to loaded mode.

Clear Secure Boot keys

This item appears only when you load the default Secure Boot keys. This item allows you to clear all default Secure Boot keys.

Save Secure Boot Keys

This item allows you to save the PK (Platform Keys) to a USB storage device.

PK Management

The Platform Key (PK) locks and secures the firmware from any permissible changes. The system verifies the PK before your system enters the OS.

Delete PK

This item allows you to delete the PK from your system. Once the PK is deleted, all the system's Secure Boot keys will not be active.

Configuration options: [Yes] [No]

Load PK from File

This item allows you to load the downloaded PK from a USB storage device.



The PK file must be formatted as a UEFI variable structure with time-based authenticated variable.

KEK Management

The KEK (Key-exchange Key or Key Enrollment Key) manages the Signature database (db) and Revoked Signature database (dbx).



Key-exchange Key (KEK) refers to Microsoft® Secure Boot Key-Enrollment Key (KEK).

Delete the KEK

This item allows you to delete the KEK from your system.

Configuration options: [Yes] [No]

Load KEK from File

This item allows you to load the downloaded KEK from a USB storage device.

Append KEK from File

This item allows you to load the additional KEK from a storage device for an additional db and dbx loaded management.



The KEK file must be formatted as a UEFI variable structure with time-based authenticated variable.

DB Management

The db (Authorized Signature database) lists the signers or images of UEFI applications, operating system loaders, and UEFI drivers that you can load on the single computer.

Delete the db

This item allows you to delete the DB file from your system.

Configuration options: [Yes] [No]

Load db from File

This item allows you to load the downloaded DB from a USB storage device.

Append db from File

This item allows you to load the additional DB from a storage device so that more images can be loaded securely.



The dbx file must be formatted as a UEFI variable structure with time-based authenticated variable.

DBX Management

The dbx (Revoked Signature database) lists the forbidden images of db items that are no longer trusted and cannot be loaded.

Delete the dbx

This item allows you to delete the dbx file from your system.

Load dbx from File

This item allows you to load the downloaded dbx from a USB storage device.

Configuration options: [Yes] [No]

Append dbx from File

This item allows you to load the additional dbx from a storage device so that more db's images cannot be loaded.



The dbx file must be formatted as a UEFI variable structure with time-based authenticated variable.

Boot Option Priorities

These items specify the boot device priority sequence from the available devices. The number of device items that appears on the screen depends on the number of devices installed in the system.



- To access Windows® OS in Safe Mode, press <F8 > after POST (Windows® 8 not supported).
 - To select the boot device during system startup, press <F8> when ASUS Logo appears.
-

Boot Override

This item displays the available devices. The number of device items that appear on the screen depends on the number of devices installed in the system. Click an item to start booting from the selected device.

3.9 Tool menu

The Tool menu items allow you to configure options for special functions. Select an item then press <Enter> to display the sub menu.

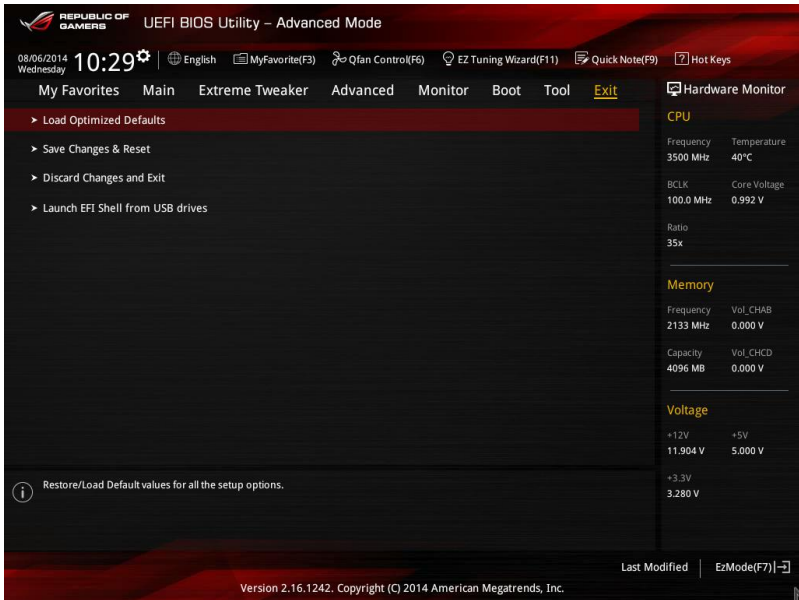

GPU Post

This function allows you to enable the GPU Post feature.

ASUS EZ Flash 2 Utility

Allows you to run ASUS EZ Flash 2. When you press <Enter>, a confirmation message appears. Use the left/right arrow key to select between [Yes] or [No], then press <Enter> to confirm your choice.



For more information, see the **ASUS EZ Flash 2 Utility** section.

ASUS Overclocking Profile

This item allows you to store or load multiple BIOS settings.

Load from Profile

This item allows you to load the previous BIOS settings saved in the BIOS Flash. Key in the profile number that saved your BIOS settings, press <Enter>, and then select **Yes**.



-
- DO NOT shut down or reset the system while updating the BIOS to prevent the system boot failure!
 - We recommend that you update the BIOS file only coming from the same memory/CPU configuration and BIOS version.
-

Profile Name

This item allows you to key in a profile name.

Save to Profile

This item allows you to save the current BIOS settings to the BIOS Flash, and create a profile. Key in a profile number from one to eight, press <Enter>, and then select **Yes**.

Load/Save Profile from/to USB Drive

This item allows you to load or save profile from your USB drive, load and save profile to your USB drive.

BIOS Flashback

Allows you to select between BIOS1 and BIOS2. Provides boot selection utility.

Force BIOS1/BIOS2 Boot

Select [Yes] to force the boot using BIOS2.

COPY BIOS1/BIOS2 to BIOS2/BIOS1

Select [Yes] to copy the content of BIOS1 to BIOS2.

ASUS DRAM SPD Information

This item allows you to view the DRAM SPD information.

DIMM Slot Number

Allows you to view the information about the installed DIMMS when selected.

3.10 Exit menu

The Exit menu items allow you to load the optimal default values for the BIOS items, and save or discard your changes to the BIOS items. You can access the EZ Mode from the Exit menu.

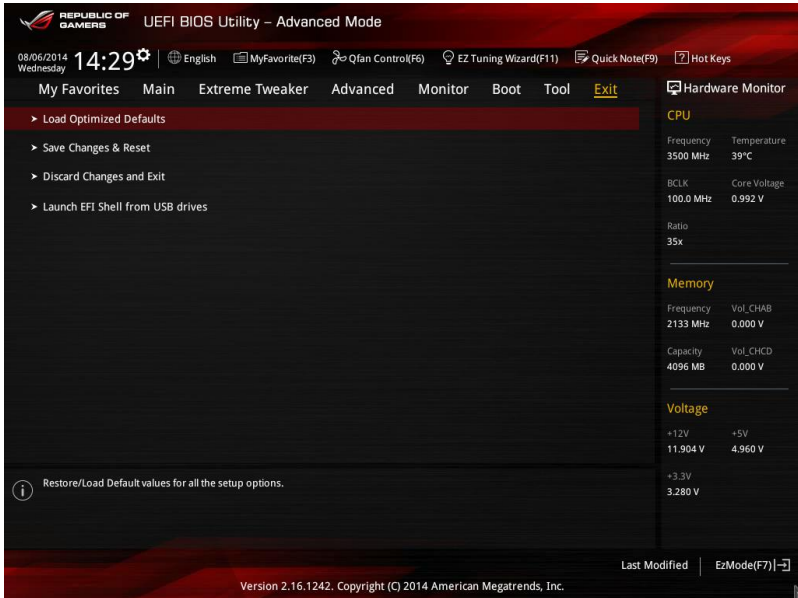

Load Optimized Defaults

This option allows you to load the default values for each of the parameters on the Setup menus. When you select this option or if you press <F5>, a confirmation window appears. Select **OK** to load the default values.

Save Changes & Reset

Once you are finished making your selections, choose this option from the Exit menu to ensure the values you selected are saved. When you select this option or if you press <F10>, a confirmation window appears. Select **OK** to save changes and exit.

Discard Changes & Exit

This option allows you to exit the Setup program without saving your changes. When you select this option or if you press <Esc>, a confirmation window appears. Select **Yes** to discard changes and exit.

Launch EFI Shell from USB drives

This option allows you to attempt to launch the EFI Shell application (shellx64.efi) from one of the available filesystem devices.

3.11 Updating BIOS

The ASUS website publishes the latest BIOS versions to provide enhancements on system stability, compatibility, or performance. However, BIOS updating is potentially risky. If there is no problem using the current version of BIOS, DO NOT manually update the BIOS. Inappropriate BIOS updating may result in the system's failure to boot. Carefully follow the instructions of this chapter to update your BIOS if necessary.



Visit the ASUS website at www.asus.com to download the latest BIOS file for this motherboard.

The following utilities allow you to manage and update the motherboard BIOS setup program.

1. EZ Update: Updates the BIOS in Windows® environment.
2. ASUS EZ Flash 2: Updates the BIOS using a USB flash drive.
3. ASUS CrashFree BIOS 3: Restores the BIOS using the motherboard support DVD or a USB flash drive when the BIOS file fails or gets corrupted.
4. ASUS BIOS Updater: Updates and back ups the BIOS in DOS environment using the motherboard support DVD and a USB flash disk drive.

3.11.1 EZ Update

The EZ Update is a utility that allows you to update the motherboard BIOS in Windows® environment.



-
- EZ Update requires an Internet connection either through a network or an ISP (Internet Service Provider).
 - This utility is available in the support DVD that comes with the motherboard package. Refer to the documentation that came with the support DVD.
-

3.11.2 ASUS EZ Flash 2

ASUS EZ Flash 2 allows you to update the BIOS without having to use a bootable floppy disk or an OS-based utility.



Before you start using this utility, download the latest BIOS from the ASUS website at www.asus.com.

To update the BIOS using EZ Flash 2:

1. Insert the USB flash disk that contains the latest BIOS file to the USB port.
2. Enter the Advanced Mode of the BIOS setup program. Go to the Tool menu to select ASUS EZ Flash Utility and press <Enter> to enable it.

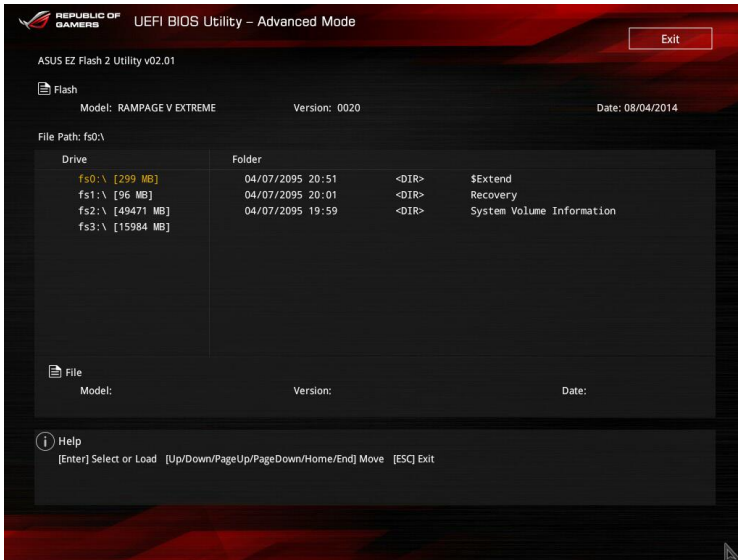

3. Press <Tab> to switch to the Drive field.
4. Press the Up/Down arrow keys to find the USB flash disk that contains the latest BIOS, and then press <Enter>.
5. Press <Tab> to switch to the Folder Info field.
6. Press the Up/Down arrow keys to find the BIOS file, and then press <Enter> to perform the BIOS update process. Reboot the system when the update process is done.



-
- This function can support devices such as a USB flash disk formatted in FAT 32/16 format and a single partition only.
 - DO NOT shut down or reset the system while updating the BIOS to prevent system boot failure!
-



Ensure to load the BIOS default settings to ensure system compatibility and stability. Select the Load Optimized Defaults item under the Exit menu. See the section **Exit Menu** on Chapter 3 for details.

3.11.3 ASUS CrashFree BIOS 3

The ASUS CrashFree BIOS 3 utility is an auto recovery tool that allows you to restore the BIOS file when it fails or gets corrupted during the updating process. You can restore a corrupted BIOS file using the motherboard support DVD or a USB flash drive that contains the BIOS file.



The BIOS file in the motherboard support DVD may be older than the BIOS file published on the ASUS official website. If you want to use the newer BIOS file, download the file at support.asus.com and save it to a USB flash drive.

Recovering the BIOS

To recover the BIOS:

1. Turn on the system.
2. Insert the motherboard support DVD to the optical drive, or the USB flash drive containing the BIOS file to the USB port.
3. The utility automatically checks the devices for the BIOS file. When found, the utility reads the BIOS file and enters ASUS EZ Flash 2 automatically.
4. The system requires you to enter BIOS Setup to recover the BIOS setting. To ensure system compatibility and stability, we recommend that you press <F5> to load default BIOS values.



DO NOT shut down or reset the system while updating the BIOS! Doing so can cause system boot failure!

3.11.4 ASUS BIOS Updater

The ASUS BIOS Updater allows you to update the BIOS in DOS environment. This utility also allows you to copy the current BIOS file so that you can use it as a backup when the BIOS fails or gets corrupted during the update process.



The succeeding utility screens are for reference only. The actual utility screen displays may not be same as shown.

Before updating BIOS

1. Prepare the motherboard support DVD and a USB flash drive in FAT32/16 format and single partition.
2. Download the latest BIOS file and BIOS Updater from the ASUS website at <http://support.asus.com> and save them on the USB flash drive.



- NTFS is not supported in the DOS environment. Do not save the BIOS file and BIOS Updater to a hard disk drive or USB flash drive in NTFS format.
- Do not save the BIOS file to a floppy disk due to low disk capacity.

3. Turn off the computer and disconnect all SATA hard disk drives (optional).

Booting the system in DOS environment

1. Insert the USB flash drive with the latest BIOS file and BIOS Updater to the USB port.
2. Boot your computer then press <F8> to launch the select boot device screen.
3. When the select boot device screen appears, insert the Support DVD into the optical drive then select the optical drive as the boot device.

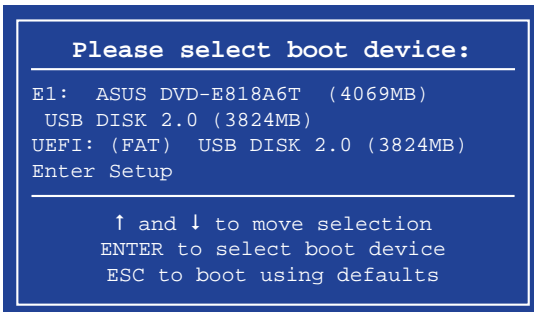

- When the booting message appears, press <Enter> within five (5) seconds to enter FreeDOS prompt.

```
ISOLINUX 3.20 2006-08-26 Copyright (C) 1994-2005 H. Peter Anvin
A Bootable DVD/CD is detected. Press ENTER to boot from the DVD/CD.
If no key is pressed within 5 seconds, the system will boot next priority
device automatically. boot:
```

- On the FreeDOS prompt, type `d:` then press <Enter> to switch the disk from Drive C (optical drive) to Drive D (USB flash drive).

```
Welcome to FreeDOS (http://www.freedos.org)!
C:/> d:
D:/>
```

Updating the BIOS file

To update the BIOS file using BIOS Updater:

- On the FreeDOS prompt, type `bupdater /pc /g` and press <Enter>.

```
D:/> bupdater /pc /g
```

- On the BIOS Updater screen, press <Tab> to switch from Files panel to Drives panel then select **D:**.

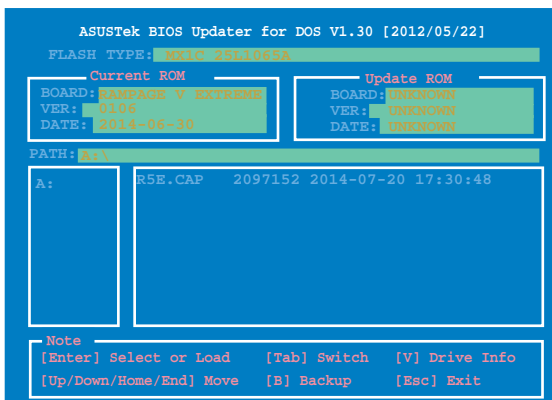

3. Press <Tab> to switch from Drives panel to Files panel then press <Up/Down or Home/End> keys to select the BIOS file and press <Enter>.
4. After the BIOS Updater checks the selected BIOS file, select **Yes** to confirm the BIOS update.



5. Select **Yes** then press <Enter>. When the BIOS update is complete, press <ESC> to exit BIOS Updater.
6. Restart your computer.



DO NOT shut down or reset the system while updating the BIOS to prevent system boot failure.



Ensure to load the BIOS default settings to ensure system compatibility and stability. Select **Load Optimized Defaults** item under the **Exit BIOS menu**. See section **3.10 Exit menu** for details.

Software support

4.1 Installing an operating system



- This motherboard supports Windows® 8/ Windows® 8.1 32/64-bit and Windows® 7 32/64-bit operating systems (OS).
- Motherboard settings and hardware options vary. Use the setup procedures presented in this chapter for reference only. Refer to your OS documentation for detailed information.

4.2 Support DVD information



The contents of the support DVD are subject to change at any time without notice. Visit the ASUS website at www.asus.com for updates.

4.2.1 Running the support DVD



Ensure that you have an Administrator account before running the support DVD in Windows® 7 or Windows® 8/ Windows® 8.1 OS.

To run the support DVD:

1. Place the Support DVD into the optical drive.
2. In the **AutoPlay** dialog box, click **Run ASSETUP.exe**.



If the **AutoPlay** dialog box does not appear, browse the contents of the support DVD and double-click or tap **\\bin\ASSETUP.EXE** to launch the **ASUS motherboard support DVD** main menu.

Support DVD main menu



- 1 Drivers menu**
Click to display the available device drivers for system-detected devices. Install the necessary drivers to use for the installed devices.
- 2 Utilities menu**
Click to display the list of applications and other software that the motherboard supports.
- 3 Manual menu**
Click to see the list of supplementary user manuals. Click an item to open the folder of the user manual.
- 4 Video menu**
Click to see ROG product related videos.
- 5 Contact menu**
Click to display the ASUS contact information.
- 6 Specials menu**
Click to see ASUS related product information.

4.2.2 Obtaining the software manuals

The software manuals are included in the support DVD. Follow the instructions below to get the necessary software manuals.



The software manual files are in Portable Document Format (PDF). Install the Adobe® Acrobat® Reader from the **Utilities** tab before opening the files.

To read about your motherboard's utility guide:

1. Click or tap **Manual** tab > **ASUS Motherboard Utility Guide**.

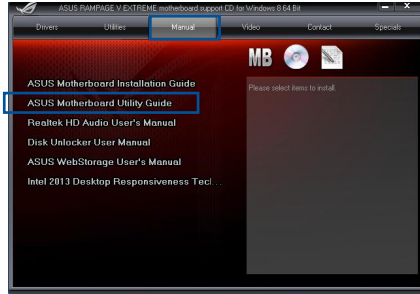

2. From the **Manual** folder, open the folder of the software manual that you wish to read.

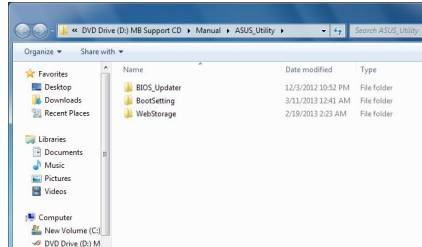

3. Some software manuals are provided in different languages. Open the language's folder to view the software manual.

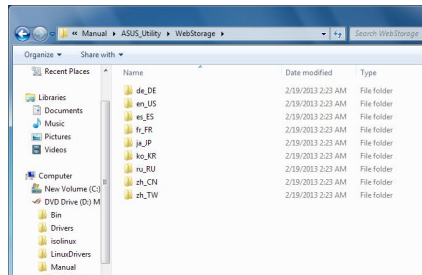

The screenshots in this section are for reference only. The actual software manuals containing in the support DVD vary by models.

4.3 Software information

Most of the applications in the support DVD have wizards that will conveniently guide you through the installation. View the online help or readme file that came with the software application for more information.

4.4 AI Suite 3

AI Suite 3 is an all-in-one interface that integrates several ASUS utilities and allows you to launch and operate these utilities simultaneously.

Installing AI Suite 3



- Ensure that you have an Administrator account before installing AI Suite 3 in Windows® 7 or Windows® 8 / Windows® 8.1 OS.
- To install the Wi-Fi-enabled features of AI Suite 3, ensure that you install the Wi-Fi module and its latest driver from the bundled support DVD. To do this, go to **Drivers** tab > **ASUS Bluetooth 4.0 Wi-Fi Driver** and follow the succeeding onscreen instructions.

To install AI Suite 3 on your computer:

Windows® 7 OS

1. Place the Support DVD into the optical drive.
2. In the **AutoPlay** dialog box, click **Run ASSETUP.exe** then select the **Utilities** tab.



3. From the **Utilities** tab, click **AI Suite 3** then follow the succeeding onscreen instructions.

Windows® 8 / Windows® 8.1 OS

1. Place the Support DVD into the optical drive then follow onscreen instructions.
2. From the **ASUS motherboard support DVD** main menu, select the **Utilities** tab and click **AI Suite 3**.
3. Follow the succeeding onscreen instructions.

If the **ASUS motherboard support DVD** main menu did not appear, try the following steps:

- a. Go to the **Start Screen** then click or tap the **Desktop** app.
- b. On the lower left corner of the Desktop, click or tap **File Explorer**  then select your DVD drive and tap or double-click the **Setup** application.

Launching AI Suite 3

Windows® 7 OS

From the Desktop, click **Start > All Programs > ASUS > AI Suite 3 > AI Suite 3**.

You can also launch AI Suite 3 in Windows® 7 by clicking  on the Notification area.

Windows® 8 / Windows® 8.1 OS

To launch AI Suite 3 in Windows® 8, tap the **AI Suite 3** app on the Start Screen (or if you're using a mouse, click the **AI Suite 3** app on the Start screen).

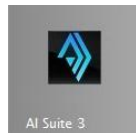

AI Suite 3 Main menu

The AI Suite 3 main menu gives you easy-access controls and insight to what's going on with your computer - allowing you to optimize performance settings while at the same time ensuring system stability.

The AI Suite main menu includes a quick-access menu bar that allows you to swiftly launch any of the integrated ASUS utilities. Click or tap  on the top-right corner of the menu to launch the menu bar.



The AI Suite 3 screenshots in this section are for reference only and can vary depending on motherboard model.

Click or tap to launch AI Suite 3 menu bar



AI Suite 3 main menu bar

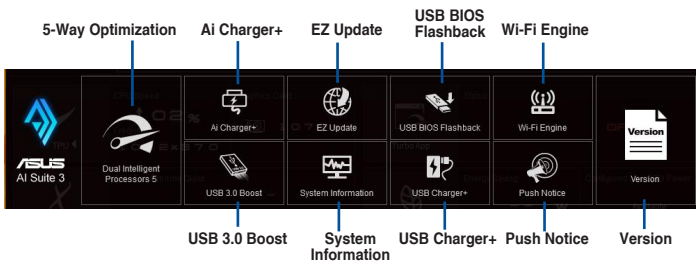

- Some functions in the AI Suite 3 main menu in this user guide may vary depending on the motherboard model.
- Refer to the software manual in the support DVD or visit the ASUS website at www.asus.com for detailed software configuration.

4.5 Dual Intelligent Processors 5

ASUS Dual Intelligent Processors 5 combines TPU, EPU, DIGI+ Power Control, Fan Xpert 3, and Turbo App functions to push the system's performance to its optimal potential. It automatically balances the system's performance, power saving, levels, and fan settings via the user-friendly AI Suite 3 utility.

5-Way Optimization

The 5-Way Optimization function dynamically optimizes your PC based on real-time usage to provide the best system status. It covers the essential areas such as CPU performance, energy saving, stable digital power, cool and quiet fan control, and includes tailored settings for your apps to ensure your PC is ready for gaming, entertainment, productivity, or just about anything.

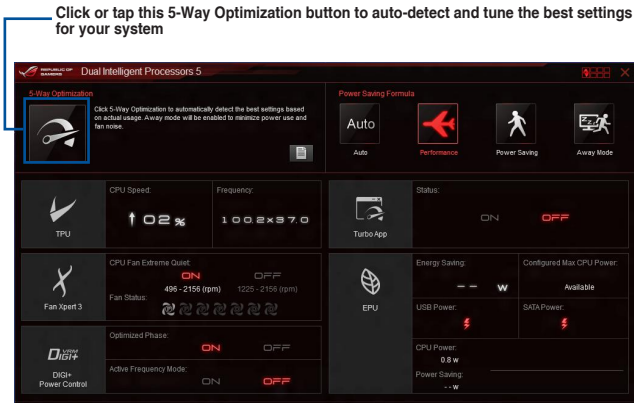

DO NOT remove your fan during the tuning process.

Turbo Processing Unit (TPU)

TPU allows you to manually adjust the CPU frequency, CPU cache, core frequencies, DRAM frequency, and related voltages for enhanced system stability and a performance boost.



Refer to the CPU documentation before adjusting CPU voltage settings. Setting a high voltage may damage the CPU permanently and setting a low voltage may lead to an unstable system.



For system stability, the TPU settings are not saved in the BIOS and are not loaded during system bootup. Save your overclocking settings as a TPU profile and manually load this profile after system bootup.

Using TPU

CPU Frequency

Click or tap ◀ or ▶ or move the sliders to adjust the BCLK Frequency, Ratio, and CPU Cache Ratio

Click or tap ◀ or ▶ to select the number of cores to adjust

Tick to enable Group Tuning

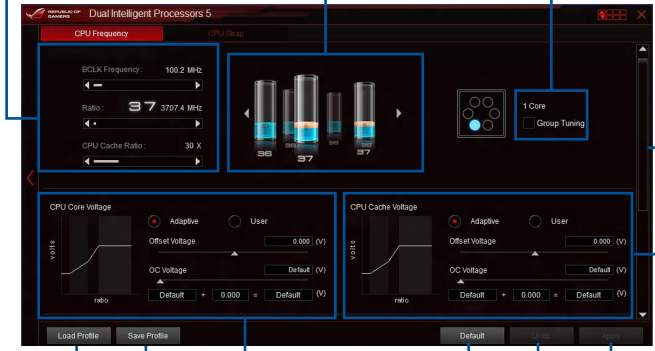

Scroll down to view other items

CPU Cache Voltage adjustments

Click or tap to load the saved profile

CPU Core Voltage adjustments

Click or tap to load the default values

Click or tap to apply the adjustments

Click or tap to save the adjustment into a profile

Click or tap to undo the adjustments



- Set the CPU Ratio Setting item in BIOS to [Auto] before using the CPU Frequency in TPU. Refer to the BIOS chapter of your motherboard's user guide for details.
- The CPU Frequency bars show the status of the CPU cores, which vary with your CPU model.

CPU Strap

Move the slider to adjust the CPU Strap's BCLK (base clock) frequency

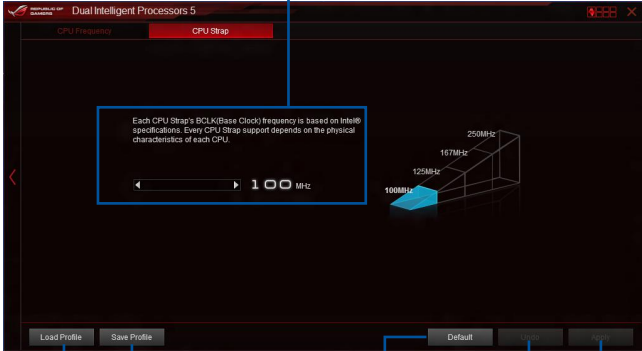

Click or tap to load the saved profile

Click or tap to save the adjustment into a profile

Click or tap to apply the default settings

Click to undo the adjustments

Click or tap to apply the adjustments

Fan Xpert 3

ASUS Fan Xpert 3 provides customizable settings of your fans for a cooler and quieter computing environment. With its automatic fan tuning feature, ASUS Fan Xpert 3 automatically tweaks the settings of CPU and chassis fans to create the best cooling profiles. ASUS Fan Xpert 3 also supports hardware level PWM/DC combo mode for the CPU and chassis fans. You can also reduce the CPU fan speed below the default minimum for a noiseless operation during light loads.

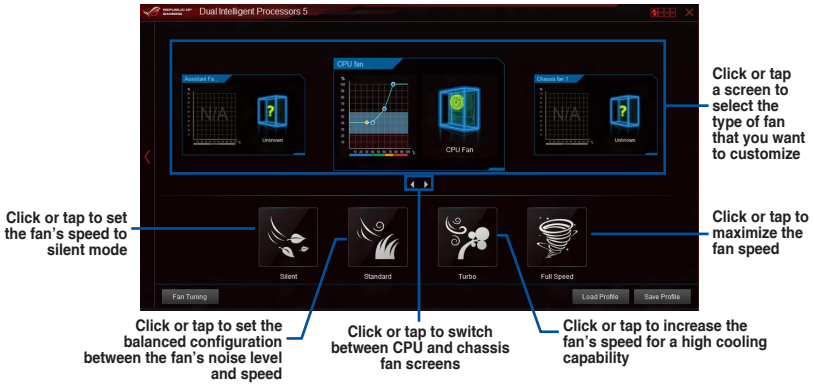

DIGI+ Power Control

ASUS DIGI+ Power Control features the revolutionary and innovative digital VRM and DRAM voltage controllers. These controllers offer ultra-precise memory and voltage tuning for optimal system efficiency, stability, and performance.



The following screens are for reference only. Configuration options varies depending on the motherboard model.

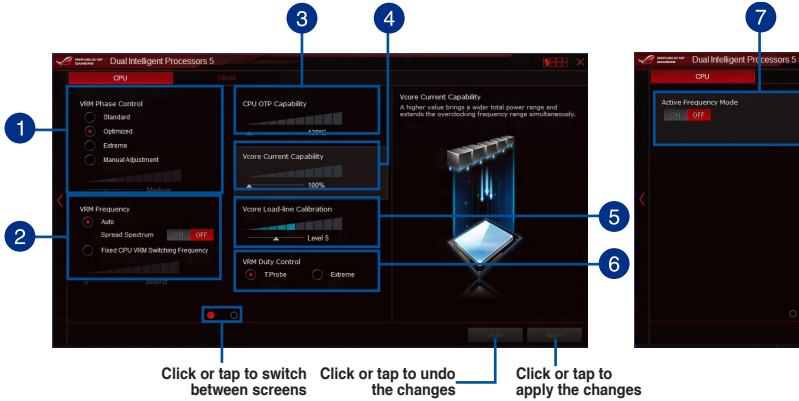

- 1 VRM Phase Control**
Increase the number of active phases under a heavy system load to get better transient and thermal performance. Reduce the number of active phases under a light system load to increase efficiency.
- 2 VRM Frequency**
Enables spread spectrum to enhance system stability.
- 3 CPU OTP Capability**
Increase the CPU's maximum operating temperature to extend the overclocking tolerance to increase overclocking potential.
- 4 Vcore Current Capability**
Vcore Current Capability allows users to control the total power range for overclocking. A higher value correlates to a wider total power range and extends the overclocking frequency range.
- 5 Vcore Load-line Calibration**
Vcore Load-line Calibration adjusts the voltage range of the CPU load-line. Increase the value for better performance and decrease the value for better efficiency.
- 6 VRM Duty Control**
VRM Duty Control adjusts the operating current and thermal condition of each phase component.
- 7 Active Frequency Mode**
Active Frequency Mode allows you to enhance the power saving condition of the CPU. Tick ON to get a quicker transient response while saving the CPU power.

Adjusting the DRAM Power

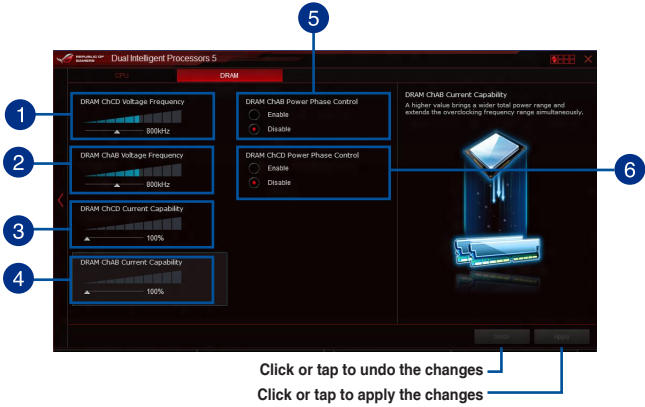

- 1 DRAM-chCD Voltage Frequency**
Allows you to adjust the DRAM switching frequencies for channels C and D of the DRAM.
- 2 DRAM-chAB Voltage Frequency**
Allows you to adjust the DRAM switching frequencies for channels A and B of the DRAM.
- 3 DRAM-chCD Current Capability**
DRAM-chCD Current Capability allows users to control the total power range for DRAM channels C and D. A higher value correlates to a wider total power range and extends the overclocking frequency range.
- 4 DRAM-chAB Current Capability**
DRAM-chCD Current Capability allows users to control the total power range for DRAM channels A and B. A higher value correlates to a wider total power range and extends the overclocking frequency range.
- 5 DRAM-chAB Power Phase Control**
Increase the number of active phases for DRAM channels A and B when under a heavy system load to get better transient and thermal performance. Reduce the number of active phases under a light system load to increase efficiency.
- 6 DRAM-chCD Power Phase Control**
Increase the number of active phases for DRAM channels C and D when under a heavy system load to get better transient and thermal performance. Reduce the number of active phases under a light system load to increase efficiency.



The actual performance boost may vary depending on your CPU specification.

Turbo App

Turbo App allows you customize the system performance, network priority, and audio setting of an application.

When an application is on the Turbo App List, you can set the CPU frequency, assign a network priority, and define the audio setting of the selected application.

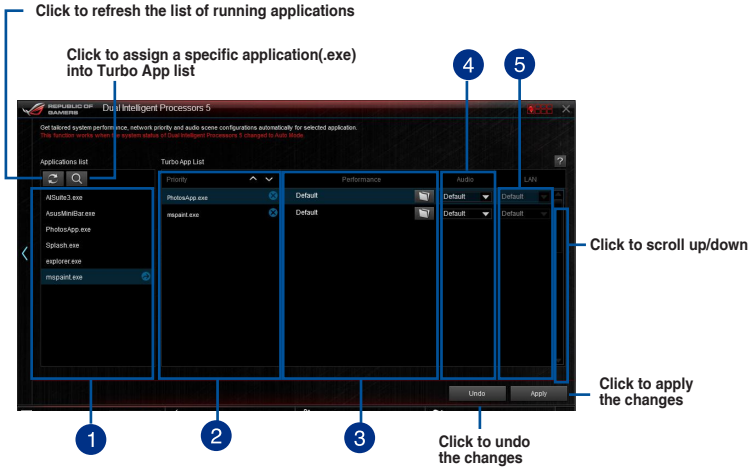

- 1 **Applications list pane**
Displays all the running applications on your system.
- 2 **Turbo App List pane**
Displays the applications added to the Turbo App List.

* Only applications on the Turbo App List can be configured.

- 3 **Performance pane**
Allows you to assign a CPU performance profile to a selected application.
- 4 **Audio pane**
Allows you to manually assign a preset audio configuration to a selected application.
- 5 **LAN pane**
Allows you assign a network priority to a selected application.

Energy Processing Unit (EPU)

EPU is a real-time system power-saving chip that automatically detects the current system load and intelligently moderates power usage. It offers system-wide energy optimization, reduces fan noise, and extends the lifespan of your hardware components.

Using EPU

Auto

Tick to select Voltage Decrement setting

Tick to enable Away Mode

Move the sliders to adjust monitor and system sleep time

Click or tap to select a fan profile

Click or tap to apply the adjustments

Click or tap to apply the default settings

Click or tap to undo the adjustments

Performance

Tick to enable Away Mode

Move the sliders to adjust monitor and system sleep time

Click or tap to apply the default settings

Click or tap to undo the adjustments

Click or tap to apply the adjustments

Power Saving

Tick to select Voltage Decrement setting

Move the sliders to adjust Configured Max CPU Power settings

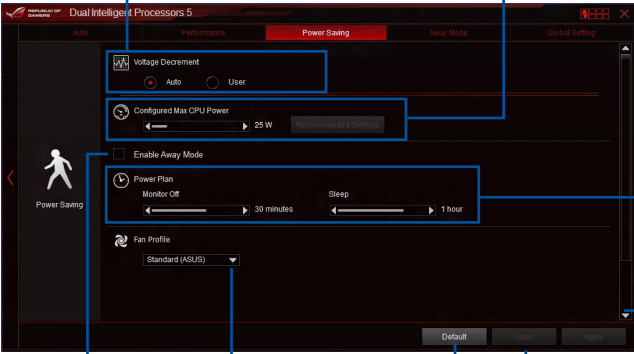

The screenshot shows the 'Power Saving' menu in the BIOS. It features several settings: 'Voltage Decrement' with 'Auto' and 'User' radio buttons; 'Configured Max CPU Power' with a slider set to 25 W and a 'Default' button; 'Enable Away Mode' with a checkbox; 'Power Plan' with 'Monitor Off' (30 minutes) and 'Sleep' (1 hour) sliders; and 'Fan Profile' with a dropdown menu set to 'Standard (ASUS)'. At the bottom are 'Default', 'Apply', and 'Undo' buttons. Blue lines and boxes connect these elements to text annotations.

Move the sliders to adjust monitor and system sleep time

Click or tap to apply the adjustments

Tick to enable Away Mode

Click or tap to apply the default settings

Click or tap to undo the adjustments

Click or tap to select a fan profile



- When you enable Configured Max CPU Power for the advanced energy saving condition, the CPU frequency may display 800 MHz in the Windows® OS information of your computer. However, the true CPU frequency varies depending on the wattage that you manually set. You can adjust the CPU wattage from the lowest based on your preferred default value.
- Configured Max CPU Power may decrease the total power delivery to the CPU and affects the CPU performance under system heavy load. To restore your system to its default settings, reboot your computer.

Away Mode

Tick to select a setting for Voltage Decrement

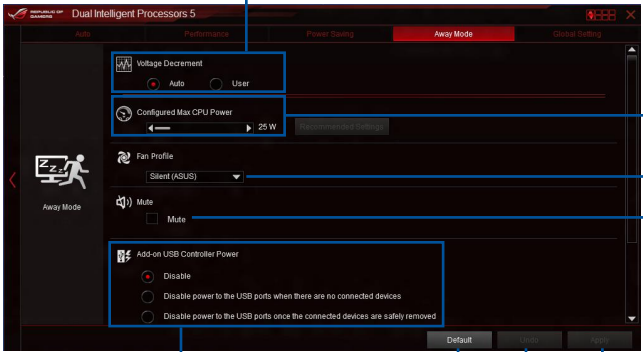

Move the sliders to adjust Configured Max CPU Power settings

Click or tap to select a fan profile

Tick to mute the system's sound option

Click to enable the default settings

Click to undo the adjustments

Click to apply the adjustments

Tick to select a setting for the add-on USB controller power

Global Setting

Toggle to set SATA Power on or off

Toggle to set Configured Max CPU Power on or off



Click to enable the default settings

Click to undo the settings

Click to apply the new settings

USB 3.0 Boost

USB 3.0 Boost technology supports UASP (USB Attached SCSI Protocol) that automatically speeds up the transfer rates of your USB storage devices.

Launching USB 3.0 Boost

To launch USB 3.0 Boost, click or tap  on the top-right corner of the AI Suite 3 main menu, then select **USB 3.0 Boost**.

Using USB 3.0 Boost



Click to select a USB device

Click to enable the USB device's normal data transfer rate

Click to enable UASP or Turbo Mode to the USB device for a faster data transfer rate



Ensure to connect your USB 3.0 device to the USB 3.0 ports that support USB 3.0 Boost. Refer to the **Rear I/O connection section** of your user guide for more details.



- USB 3.0 Boost automatically detects the USB 3.0 devices that support UASP. For a list of UASP-supported USB 3.0 devices, visit the ASUS website at www.asus.com.
- The data transfer speed varies with USB devices. For higher data transfer performance, use a USB 3.0 device.

EZ Update

EZ Update is a utility that allows you to automatically update your motherboard's software, drivers, or BIOS.

With this utility, you can also manually update the BIOS and select the boot logo that will display during POST.

Launching EZ Update

To launch EZ Update, click or tap  on the top-right corner of the AI Suite 3 main menu, then click **EZ Update** on the AI Suite 3 main menu bar.

EZ Update screen

Click or tap to automatically update your motherboard's driver, software, and firmware

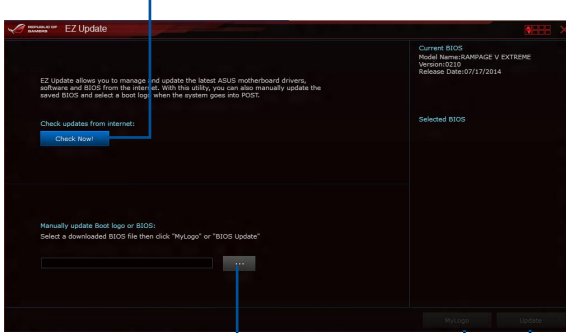

Click or tap to search and select the BIOS file

Click or tap to select a boot logo

Click or tap to update the BIOS

System Information

This utility displays the detailed information and settings of the installed motherboard, CPU, and memory.

Launching the System Information

To launch System Information, click or tap  on the top-right corner of the AI Suite 3 main menu, then select **System Information**.

Viewing the motherboard information

Click or tap the **MB** tab to view the motherboard's information.

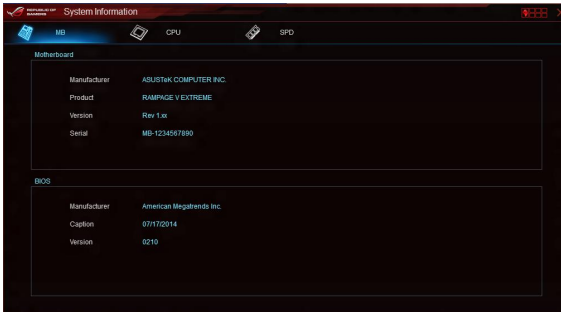

Viewing the CPU information

Click or tap the **CPU** tab to view the processor's information.

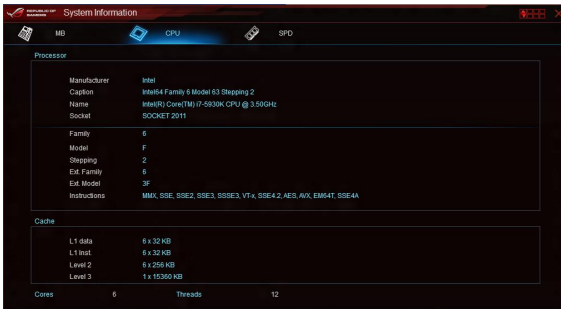

Viewing the SPD information

Click or tap the **SPD** tab to view the memory's information.



USB BIOS Flashback

USB BIOS Flashback allows you to check and save the latest BIOS version to a USB storage device. Use this utility to quickly check for the latest available BIOS and set the BIOS download schedule.

Launching USB BIOS Flashback

To launch USB BIOS Flashback, click or tap  on the top-right corner of the AI Suite 3 main menu, then select **USB BIOS Flashback**.



USB BIOS Flashback is available only in selected motherboard models.

Using USB BIOS Flashback



Set a schedule for the BIOS Update download

Click or tap to check for a new BIOS update available for download

Click or tap to cancel the download schedule setting

Click or tap to apply the download schedule setting

Scheduling the BIOS download

1. In the Download Setting field, tick **Schedule (days)** then select the number of days to change how frequently the software checks for an updated BIOS.
2. Click or tap **Apply** to save the BIOS download schedule. Click or tap **Cancel** to cancel the download schedule.

USB Charger+

USB Charger+ allows you to quick-charge your portable USB devices even if your computer is off, in sleep mode, or in hibernate mode.



Before using USB Charger+, ensure to disable the ErP Ready item in the BIOS. To do this, go to **Advanced > APM > ErP Ready** in the Advanced mode then set this item to [Disabled].



USB Charger+ is available only in selected motherboard models.

Launching USB Charger+

To launch USB Charger+, click or tap  on the top-right corner of the AI Suite 3 main menu, then select **USB Charger+**.

Using USB Charger+

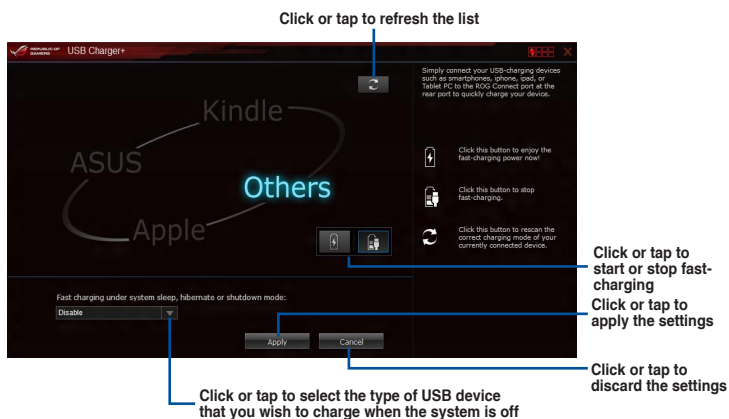

The screenshot shows the USB Charger+ utility window. At the top, there is a refresh button with the callout: "Click or tap to refresh the list". The main area displays a list of device categories: "ASUS", "Kindle", "Apple", and "Others". Below the list are icons for "Fast charging" and "Stop fast charging". To the right, there are three instructions: "Click this button to enjoy the fast-charging power now.", "Click this button to stop fast-charging.", and "Click this button to scan the correct charging mode of your currently connected device." At the bottom, there is a dropdown menu for "Fast charging under system sleep, hibernate or shutdown mode:" set to "Disable", with "Apply" and "Cancel" buttons. Callouts for the bottom controls are: "Click or tap to select the type of USB device that you wish to charge when the system is off" (pointing to the dropdown), "Click or tap to start or stop fast-charging" (pointing to the fast charging icon), "Click or tap to apply the settings" (pointing to the Apply button), and "Click or tap to discard the settings" (pointing to the Cancel button).



Ensure to connect your USB device into the USB port that supports this utility. Refer to the **Rear I/O connection** section of your user guide for more details.



- USB Charger+ does not support USB hubs, USB extension cables, and generic USB cables.
- USB Charger+ may not recognize some ASUS devices due to varying design.

Push Notice

This utility allows you view the detailed status of your system on your smart device. You can also send messages to your smart device using this utility.





Before using this utility, ensure that your computer is paired with your smart device. For more information on pairing, refer to the **Pairing your computer and smart device** section.

Launching Push Notice on your computer

To launch Push Notice, click or tap  on the top-right corner of the AI Suite 3 main menu, then select **Push Notice**.

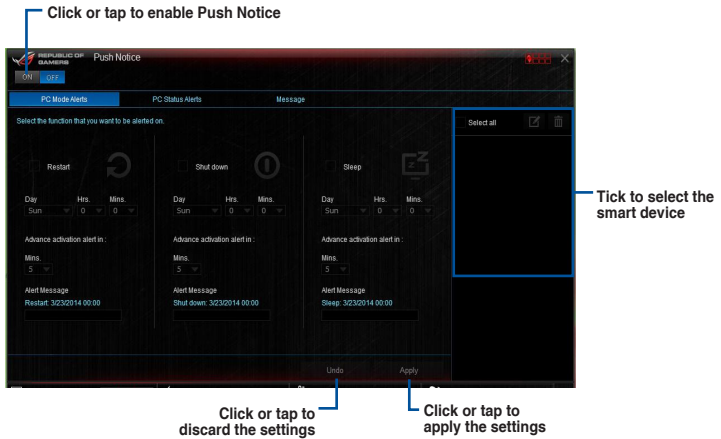
Push Notice screen



You can also enable the Push Notice via the Push Notice shortcut on the lower-right corner of your screen. To do this, click or tap << then click or tap  then select .

Pairing your computer and smart device

To pair your computer and smart device:

1. On your smart device, tap  to launch Push Notice.
2. Tap **Push Scan** then tap the name of your computer that you want to pair with.



To pair your computer and smart device, ensure that both are connected to the same wireless network.

Setting up PC Mode alerts of your computer

This feature allows you to restart, shut down, or put your computer to sleep mode and then sends an alert to your smart device.

Tick these to enable mode alerts

Set the day and time to enable the PC modes
Set the minutes to send the alert before the PC mode/s activation

Key in your messages for more information

Tick to select the smart device

Setting up PC Status alerts

This feature allows you to send alerts of the unusual activities of the voltage, temperature, and fan settings of your computer to your smart device.

Tick to select and send alerts to your smart device



Tick to select the smart device

Tick to send alert when the selected items are back to its normal status

Sending messages to your smart device

This feature allows you to send messages to your smart device.



You can also send messages via the Push Notice messaging shortcut on the lower-right corner of your screen. To do this, click or tap << then click or tap  then select .

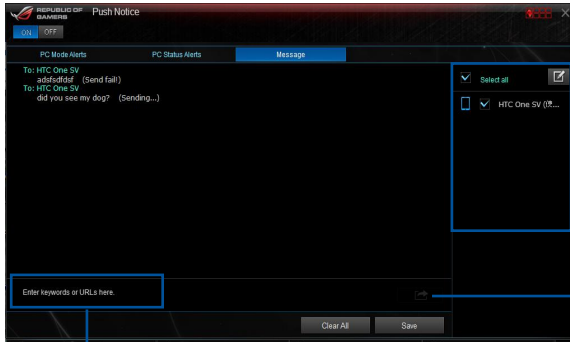

Tick to select the smart device

Click or tap to send your message

Click or tap to key in your message

Viewing your computer status on your smart device

Tap  on your smart device to launch Push Notice.

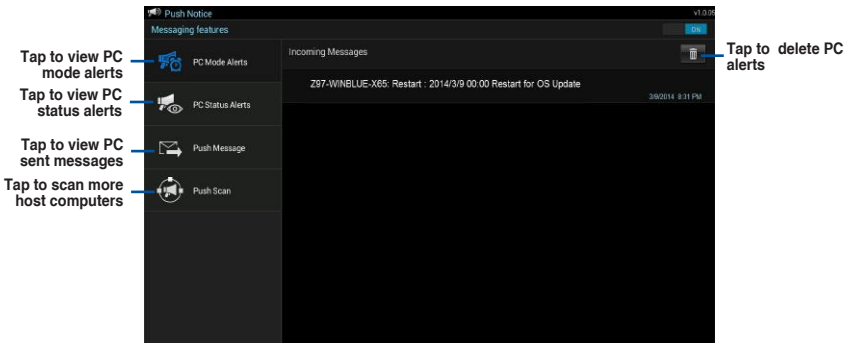

Tap to view PC mode alerts

Tap to view PC status alerts

Tap to view PC sent messages

Tap to scan more host computers

Tap to delete PC alerts

Ai Charger+

Ai Charger+ allows you to fast-charge your portable BC 1.1* mobile devices on your computer's USB port three times faster than the standard USB devices**.

Launching Ai Charger+

To launch Ai Charger+, click or tap  on the top-right corner of the AI Suite 3 main menu, then select **Ai Charger+**.



Ai Charger+ is available only in selected motherboard models.

Ai Charger+ screen

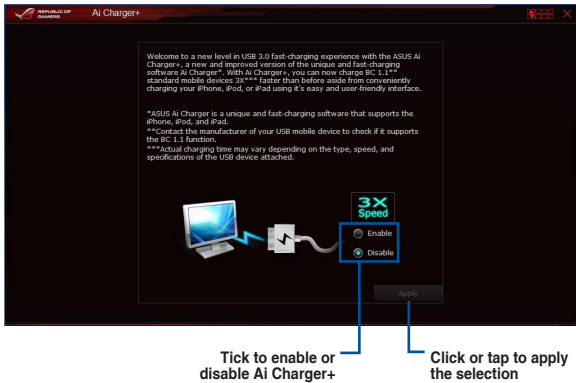

- * Check the manufacturer 's website to see if your USB device is a Battery Charging Specification 1.1 (BC 1.1) compliant or compatible device.
- ** Actual charging speeds may vary depending on the charging rate and specifications of your USB device.
- To ensure normal charging function, disconnect and reconnect your USB device every time you enable or disable Ai Charger+.
- Ai Charger+ does not support USB hubs, USB extension cables, and generic USB cables.

Wi-Fi Engine

Wi-Fi Engine allows you to connect to a wireless network and set up your computer as an access point for Internet connection sharing among other Wi-Fi enabled devices.

To use Wi-Fi Engine, click or tap the  on the top-right corner of the AI Suite 3 main menu, then select **Wi-Fi Engine**.



Wi-Fi Engine is available only in selected motherboard models.

Using Wi-Fi Engine

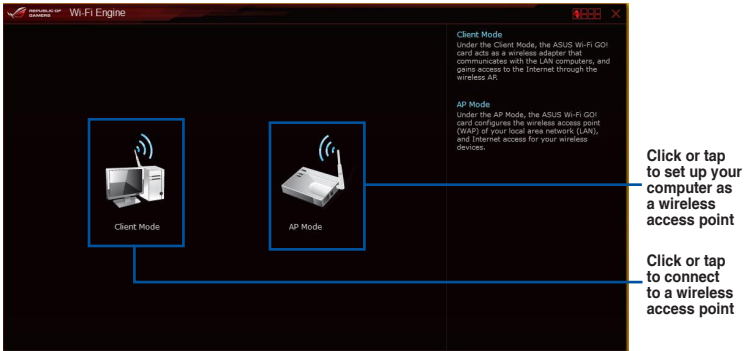

Using the Client Mode

The Client mode allows you to connect your system to a wireless network.

To use the client mode:

1. Click or tap **Client Mode** to launch Network Connections.
2. From the Network Connections window, select a network adapter.

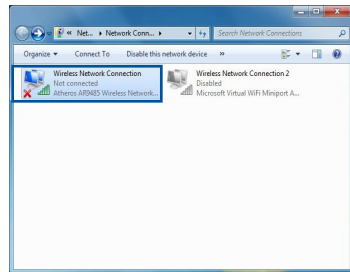

3. From the list of available networks, select a network that you want to connect to.



Some networks may require you to key in a password.



Using the AP Mode

The AP mode allows you to set your system as an access point for other wireless-enabled devices.

To use AP mode, click or tap **AP Mode** on the Wi-Fi Engine menu.

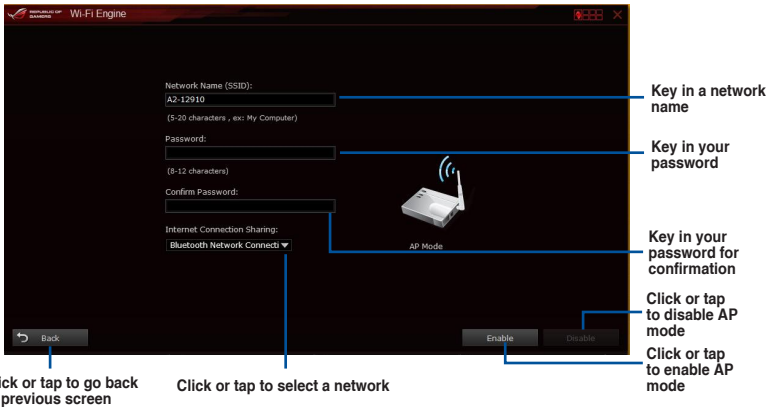

Wi-Fi GO! and Remote GO!

Wi-Fi GO! and Remote GO! are ASUS exclusive utilities that gives you complete control of your PC anytime and anywhere using your smart devices. You can manage all your public clouds, sync, and backup files among your PC and devices.



The user interface of your smart device may vary with the operating system and the screen resolution.

System requirements

System requirements	PC	Smart device
OS	Windows® 7/Windows® 8/ Windows® 8.1	Android 4.0 or higher versions iOS7 or later versions
Utilities	ASUS HomeCloud	ASUS Wi-Fi GO! & NFC Remote



- For Android devices, download the ASUS Wi-Fi GO! & NFC Remote from Google Play. For iOS devices, download it from App Store.
- Install the Wi-Fi GO! card driver and ASUS HomeCloud utility from the support DVD bundled with your ASUS motherboard or visit www.asus.com.
- If you upgrade from Windows® 8 to Windows® 8.1, ensure to reinstall the Wi-Fi GO! card driver to fully utilize the Wi-Fi GO! functions.

Smart device supported screen resolutions

Wi-Fi GO! & NFC Remote supports the following screen resolutions of smart devices:

Screen type	Low density (120 ldpi)	Medium density (160 mdpi)	High density (240 hdpi)	Extra high density (320 xhdpi)
Screen Resolution	1024 x 600	WXGA (1280 x 800)	1536 x 1152	2048 x 1536
		1024 x 768	1920 x 1152	2560 x 1536
		1280 x 768	1920 x 1200	2560 x 1600

ASUS Account Login

Wi-Fi GO! gives you complete control of your PC anytime and anywhere. Create and login the same ASUS Account on your PC and smart devices for public-to-private network functions.



- Remote Desktop and File Transfer support public-to-private networks feature.
- You can access the ASUS Account tab by clicking  from Wi-Fi GO! main page.

Creating an ASUS account



Ensure that you have an internet connection before you create an account.

To create a new ASUS account:

1. Click or tap Create a New Account on your PC or smart device.
The browser will direct you to the ASUS website (www.asus.com).
2. From the ASUS website, click or tap Sign Up then follow onscreen instructions to complete the registration.

Logging in

To log-in using your PC:

1. Launch Wi-Fi GO! on your PC.



A login notice is displayed when you launch Wi-Fi GO! for the first time on your PC. To stop this notice from appearing again, tick Don't remind me again then click Go to Login.

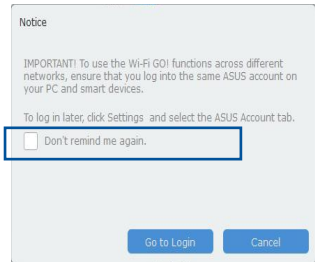

2. From the log-in window, key in your ASUS account and password (A) then click Login (B).

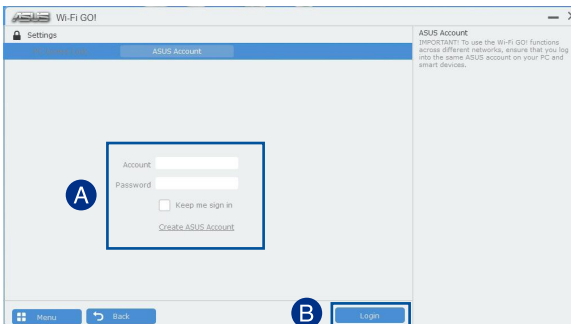

To log-in using your smart device:

1. Launch Wi-Fi GO! & NFC Remote on you smart device.
2. Tap ASUS Account (A), key in your ASUS Account and password, then click or tap Login (C).

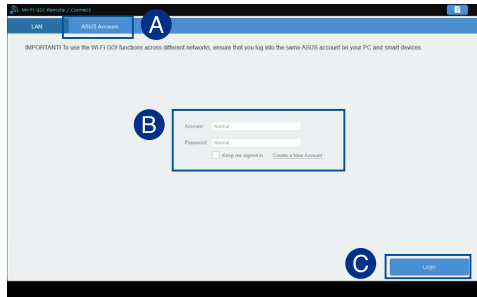



- PCs with the same ASUS account logged in will show up in the device list.
- The public-to-private network functions for the iOS system will be available from Wi-Fi GO! & NFC Remote V2.00.00 or later versions.

Using Wi-Fi GO!

To launch Wi-Fi GO!, click the ASUS HomeCloud shortcut on your desktop, then select Wi-Fi GO! from the mini bar.

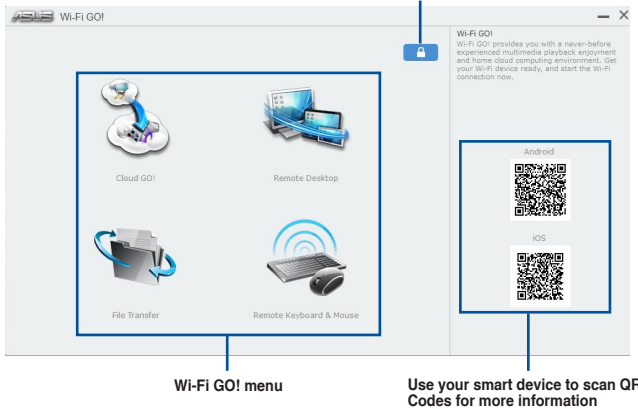
Click to set a password or log in using your ASUS Account



To protect your Wi-Fi utility from unauthorized remote access, click  then set a password.



Launch Wi-Fi GO! & NFC Remote on your smart device to use the Wi-Fi GO! & NFC remote control functions. For more details, refer to section Wi-Fi GO! & NFC Remote of this user manual for more details.

Wi-Fi GO! & NFC Remote (App for smart devices)

Using Wi-Fi GO! & NFC Remote

To use the Wi-Fi GO! & NFC Remote:

1. Connect your smart device to the same Wi-Fi network as your computer or log in on your computer and smart devices using the same ASUS account to fully utilize the Wi-Fi GO! functions across different networks.
2. On your smart device, tap  then tap Enter.
3. From the list of scanned PCs, tap the computer that you want to connect with your smart device.

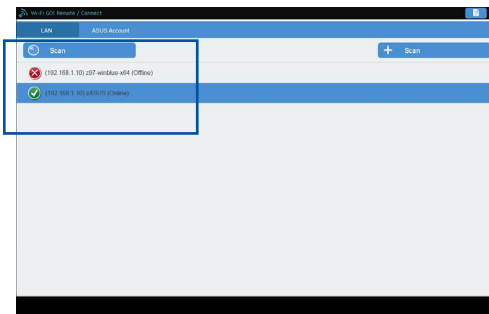

Wi-Fi GO! & NFC Remote interface main page

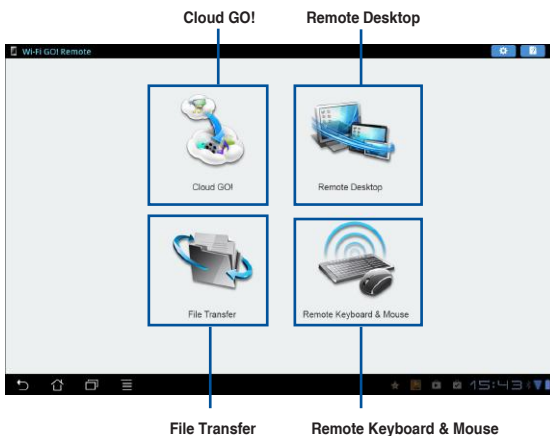

The screenshots are for reference only and vary with the type of smart device.

Using the Wake-on-LAN

If you want to wake up your computer using the smart device, ensure that you enable the computer's Wake-on-LAN settings.

To configure your computer's Wake-on-LAN settings:

1. From BIOS Setup, go to Advanced > APM Configuration then set Power On By PCI-E/PCI to [Enabled].
2. From Windows® OS, do the following:
 - a. On your desktop, click Start, right-click Computer > Manage to launch the Computer Management screen.
 - b. Click Device Manager to view all the installed devices.
 - c. Click Network Adapters, right-click the installed module card (Broadcom or Atheros) then click Properties > Power Management tab.
 - d. Tick these items Allow this device to wake up the computer and Only allow a magic packet to wake the computer.



For 802.11ac standard Wi-Fi GO! Card, the Wake-on-LAN function will be supported in the later version for Windows® 8 operating system.

Cloud GO!

Cloud GO! allows you to control and synchronize your files across multiple cloud services such as ASUS WebStorage, Dropbox®, Google Drive™, and SkyDrive®.



- Ensure to set the correct system date and time of your computer and smart device when using Cloud GO!
- Due to the cloud storage limitation, you can only upload or synchronize files with a maximum size of 100 MB.
- The synchronized files will be saved under the Wi-Fi GO! folder of each cloud storage. For the backed up files, you can find them in C://MyFavorites folder.
- Log into the cloud storages accounts first in your PC and stay signed in to allow smart device control.

To use Cloud GO!:

1. Click or tap Cloud GO!
2. Log in to your cloud account then click or tap Sign In.



To log in to your Google Drive, Dropbox, or SkyDrive accounts, click or tap Sign in. Cloud GO! directs you to the Google Drive, Dropbox, or SkyDrive website to log in to your account.

Click or tap a specific icon to move, upload, rename, create folder, download, delete or refresh your cloud contents

Click or tap to open a cloud storage account

Click to open the file directly

Click or tap to sign out

Click or tap to go back to the previous screen

Click or tap to synchronize cloud contents or to create a back up to your local drive

Click or tap to go back to Wi-Fi GO!/Remote GO! screen

Tick to select contents

Remote Desktop

Remote Desktop allows you to remotely control your desktop in real-time using your smart device.



The System User Account Control (UAC) will be set to Never Notify when using Remote Desktop function. The UAC level will return to your previous settings after you exit Remote Desktop.

To use Remote Desktop:

On your smart device, tap Remote Desktop.

Remote Desktop interface for Windows® 8

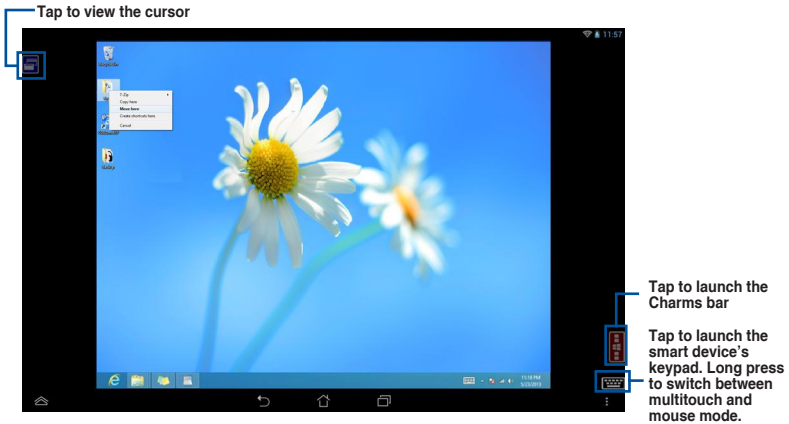

Select multitouch mode to support Microsoft multitouch functions on Windows® 8 / 8.1.

Select mouse mode to support zoom-in and normal mouse functions.

The Extended Mode support varies with the VGA driver installed in your computer.

Remote Desktop Control Notification

This function allows you to send the control authorization to a smart device and directly start using Remote Desktop in your device.

To use Remote Desktop Control Notification:

1. Click Select Device.

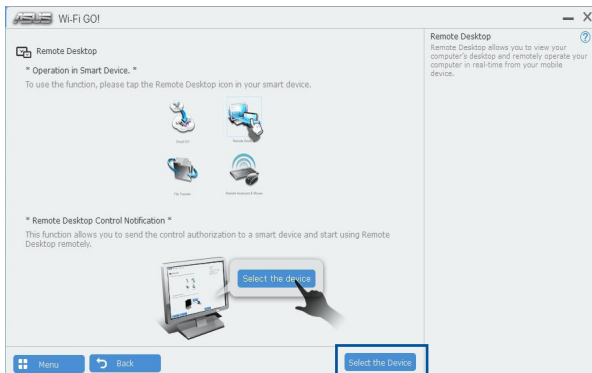

2. Select a device from the drop list.
3. Click Send to send the Remote Desktop control authorization to the selected device.

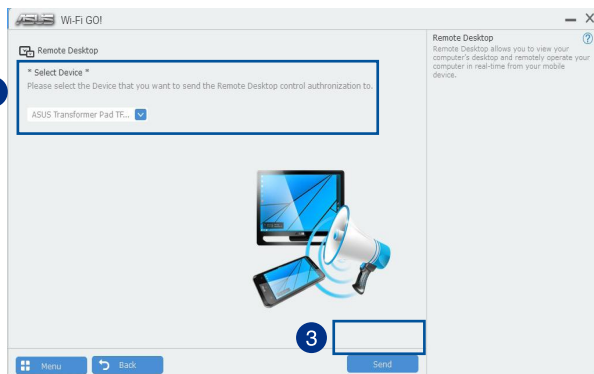

This function requires the Push Notice feature to be installed. You can get the PUSH Notice installer from the bundled support DVD or download the latest installer from www.asus.com.

File Transfer

File Transfer allows you to sync and share files between PCs and smart devices with just a click in public-to-private networks.

Transferring files from computer to smart device

To transfer files from computer to smart device:

1. Click or tap File Transfer .
2. Click or tap Setting to select the destination for your transferred files.
3. Right-click the file then select Send to > [Device Name].

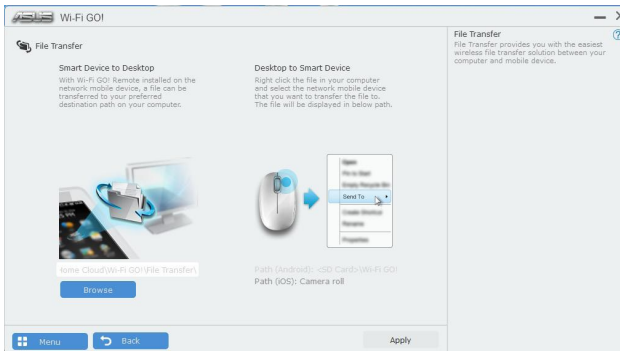

4. After the file transfer is complete, click or tap OK.



- To receive files on your iOS device, go to Settings > Privacy > Photos then turn on the Wi-Fi GO! & NFC Remote.
- Find your transferred files from <SD Card>Wi-Fi GO! for Android devices and Camera roll for iOS devices.

Transferring files from smart device to computer

To transfer files from smart device to computer:

1. Tap File Transfer > Enter.
2. Tick the files that you want to send to your computer, then tap Send.



- The files you transferred can be found on the location X:\Users\Documents\ASUS HomeCloud\Wi-Fi GO!\File Transfer\
- To select a new storage location, click Setting.



Another way to transfer files is to open the file directly, tick the file, tap the Share icon/ button then click the File Transfer app to start sending the file to the computer.

Remote Keyboard & Mouse

Remote Keyboard & Mouse allows you to use your smart device's touch panel as a remote keyboard and mouse for your computer.

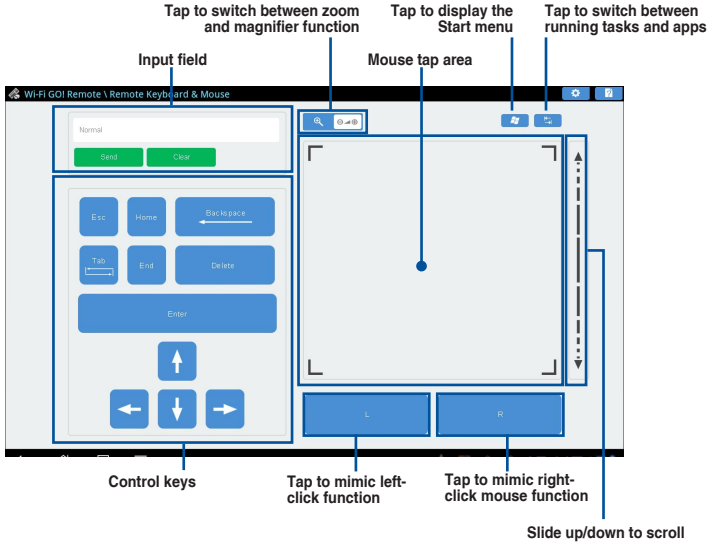

ASUS Media Streamer

The ASUS Media Streamer allows you to enjoy your PC's multimedia content anywhere. You can pipe music from your PC or stream your favorite movie to a smart TV using your PC or smart device.



- Ensure to enable the DLNA setting of your devices first.
- ASUS Media Streamer supports NFC function. Some functions may require you to install NFC EXPRESS 2. Visit www.asus.com for more information about NFC EXPRESS 2.



- The public-to-private network functions for the iOS system will be available from Media Streamer V2.00.00 or later versions.
- The iOS system only support photo and video streaming for Media Streamer.

System requirements

System requirements	PC	Smart device
OS	Windows® 7/Windows® 8/ Windows® 8.1	Android 4.0 or higher versions iOS7 or later versions
Utilities	ASUS HomeCloud	ASUS Media Streamer

To use ASUS Media Streamer:

On your computer, click ASUS HomeCloud then select Media Streamer from the mini bar. On your device, click or tap Media Streamer.



You can use Push Notice to receive a media link. The link can be clicked and allows you to play the file directly.

Click or tap to edit media files Click or tap to select media type

The screenshot shows the ASUS Media Streamer application interface. On the left is a sidebar with navigation options: PC, LAN, Cloud Storage (WebStorage, DropBox, SkyDrive, GoogleDrive), and ASUS ID (Login). The main area displays a file browser for 'ASUS (AMS Server)' with tabs for 'music', 'photo', and 'video'. A 'misc' folder is highlighted. A 'Play to: My PC' dropdown menu is visible. Annotations with blue lines point to the 'Login' button, the 'misc' folder, and the 'Play to: My PC' dropdown.

Log in ASUS account to stream play in different networks Click or tap a media file to play Select the device you want to stream to

Adding and deleting media files

Drag and drop or tick files to add or delete.

Click or tap to add or create a new folder

Click or tap to add the selected files

Click or tap to delete selected files

Click or tap to proceed with the deletion or addition of files

Click or tap to cancel changes



The following media formats are supported by Android and iOS devices:

- Android: .3gp, .mp4, .m4a, .aac, .ts, .flac, .mp3, .mid, .xmf, .mxmf, .rtttl, .rtx, .ota, .imy, .ogg, .mkv, .wav, .jpg, .gif, .png, .bmp, .webp, .webm
- iOS Supports the following media formats: .mov, .mp4, .mpv, .3gp.

4.6 ROG Audio features

Installing the Software

Follow the installation wizard to install the Realtek® Audio Manager driver from the support DVD that is bundled with the motherboard.

If the Realtek® audio software is correctly installed, you will find the Realtek® HD Audio Manager icon on the taskbar. Double-click or tap on the icon to display the Realtek® HD Audio Manager.



Sonic Studio

Sonic Studio is an audio suite that offers six audio controls: Reverb, Bass Boost, Equalizer, Voice Clarity, Smart EQ (Smart Volume), and Virtual Surround. Virtual Surround is dedicated for 2-channel headsets and offers optimized virtual surround technology for gaming.

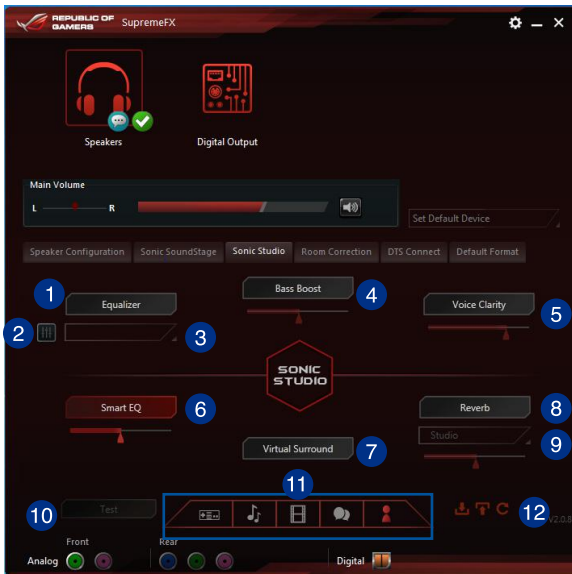

- 1 Equalizer switch**
Click to enable. This item allows you to adjust the parametric EQ settings according to your preference.
- 2 Equalizer advanced settings**
This item available only when the Equalizer switch is enabled. This item allows you to configure the Equalizer settings. You can manually set or customized your setting or choose from any of the preset equalizer settings available.
- 3 Equalizer presets**
Displays the current or selected equalizer preset.
- 4 Bass Boost switch**
Click to boosts the bass frequencies. Use the slider to adjust the intensity of the bass effect.
- 5 Voice Clarity switch**
Click to enable this item. Voice clarity extracts human voice for better dialog/audio communication or to hear vocals more clearly when listening to a music.
- 6 Smart EQ (Smart Volume) switch**
Dynamically adjust the EQ so you can hear more details.
- 7 Virtual Surround switch**
This item lets you experience 7.1 CH virtual surround from your headset when enabled.
- 8 Reverb switch**
The Reverb effect is part of the Virtual Sound Stage effects that lets you choose different reverb presets.
- 9 Reverb presets**
Click to choice and select a reverb effect from the different environmental spaces for reverb effects.

This item is only available when the Reverb switch is enabled.
- 10 Test tone**
Click this button to start the test for the selected preset profile.
- 11 Preset profiles**
Click any of the preset profiles. Choose from gaming, music, movie, or communication.
- 12 Profile import/export**
Allows you to import, export, or revert to the default setting of a profile.

Sonic SenseAmp

Sonic SenseAmp is an exclusive ROG invention that is a built-in headphone AMP on the onboard audio circuit with three AMP levels adjustment. It detects your headphone's impedance and adjusts the built-in AMP accordingly.



Sonic SenseAmp only works on front panel.

When you plug a headphone into the front headphone jack, Sonic SenseAmp displays a pop-up window that displays “Detecting headphone impedance”.

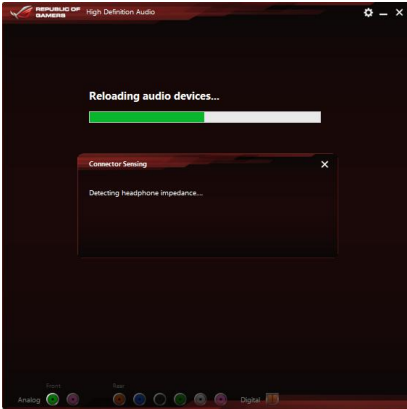

After detecting the headphone's impedance, Sonic SenseAmp displays another pop-up window similar to the one shown below.



Refer to the table below on the behavior of Sonic SenseAmp when adjusting the impedance of the detected headphone:

65 ohm or below	Amplify Level is automatically set at Performance
65 ohm to 150 ohm	Amplify Level is automatically set at Powerful
> 150 ohm	Amplify Level is automatically set at Extreme
Other device	The device plugged in detected as other device

After you close the pop-window, Sonic SenseAmp enters speaker configuration and displays the adjusted headphone impedance.

Click or tap to manually adjust the amplify level
Displays the impedance of your headphone

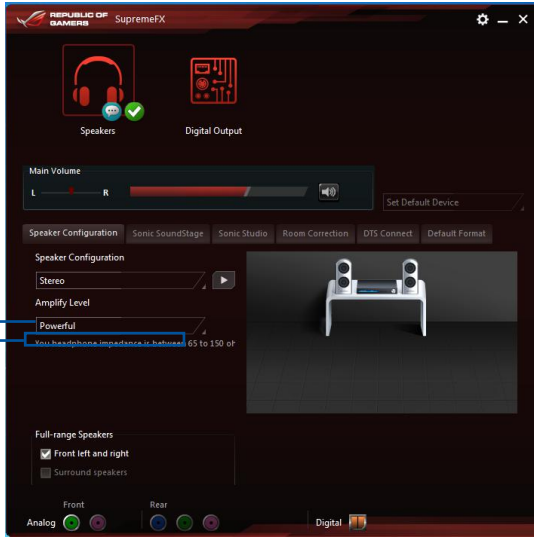

Sonic SoundStage

Sonic SoundStage is a hardware based sound solution for virtual Sound Stage that offers four preset gaming profiles: FPS, Racing, Fighting and Sports.



- This feature is only available for front panel Headphone output.
- You can enable this feature by enabling the dedicated SoundStage button on your motherboard. Refer to the **Onboard buttons** section on this user guide for more information.

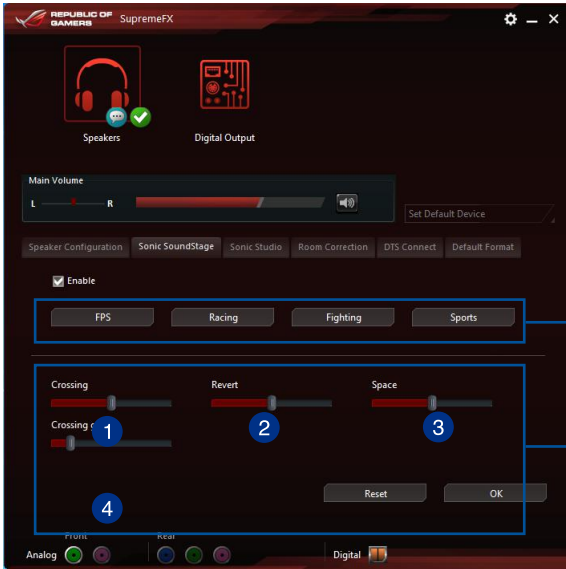

Click or tap any of the four preset gaming profiles

Use the slider to manually adjust the setting of an item

- 1 Crossing**
Move the slider to adjust the amount of cross channel mixing.
- 2 Revert**
Move the slider to revert the main audio source.
- 3 Space**
Move the slider to adjust and virtualize the space sound.
- 4 Crossing gain**
This item only works when Crossing and Revert is enabled. Move the slider to adjust the hardness of the wall.

DTS Connect

DTS Connect delivers excellent audio entertainment across all formats and works with 4, 5.1, and 7.1 channel surround sound . It also allows you to connect your PC to a home theatre system.

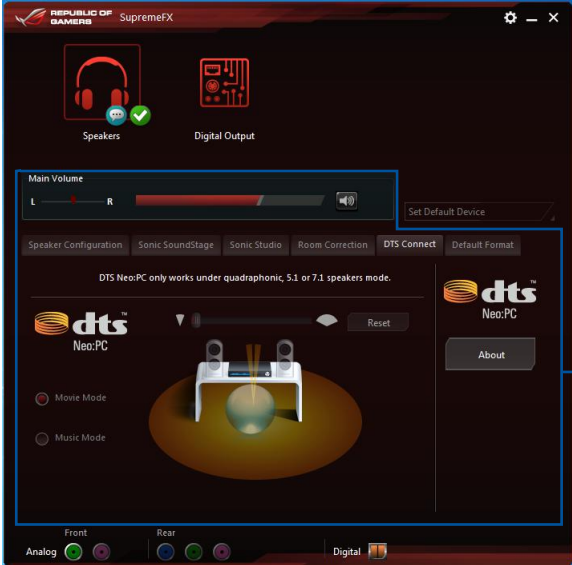

Control settings panel

4.7 Sonic Radar II

Sonic Radar II is designed for First Person Shooting (FPS) games and shows the precise direction and intensity of where a sound is coming from. It features a simple and friendly user-interface and also features sound enhancers to amplify desired sound effects.

Display Menu

Customize the settings for each game including Transparency, Signal, Size, and Remanency.

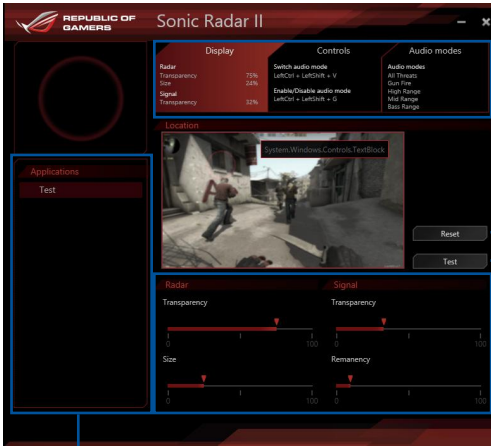

Displays the options available. Click a tab to select an option. Each option has its own settings and menus.

Click or tap to reset to the default settings
Click or tap to start the test tone

Use the sliders to adjust the settings

Displays the list of games

Control Menu

Allows you to configure shortcut keys.

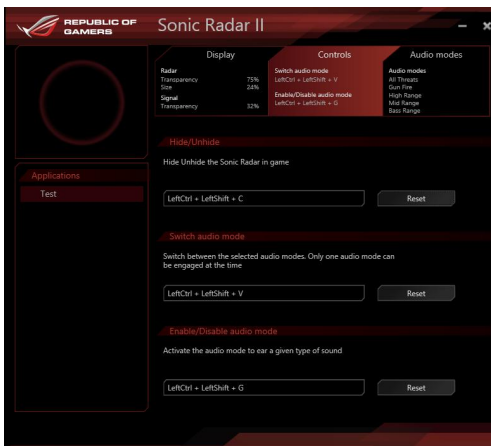

Audio Mode/Radar Selection menu

Allows you to configure the sound enhancers.

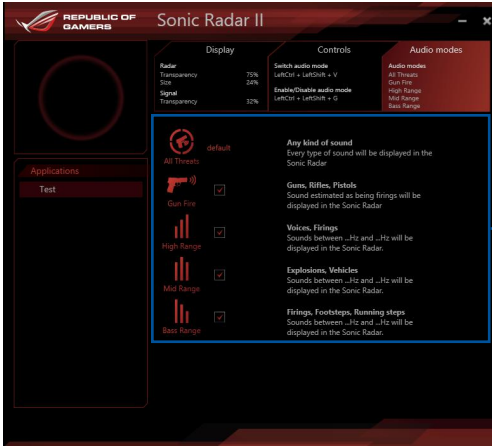

Tick to choose the desired sound enhancer



Audio Mode/Radar Selection are enabled with shortcut keys in the game. Refer to the **Controls** tab for more information about the shortcut key settings.

4.8 GameFirst III

GameFirst III is a network management software that features four preset packet prioritizing profiles (Optimization, Game, Media Streaming and File Sharing) facilitating different user scenarios. Users can also manually allocate bandwidth and adjust priority settings of each application to run faster and smoother.

To use GameFirst III, double-click  on the desktop.

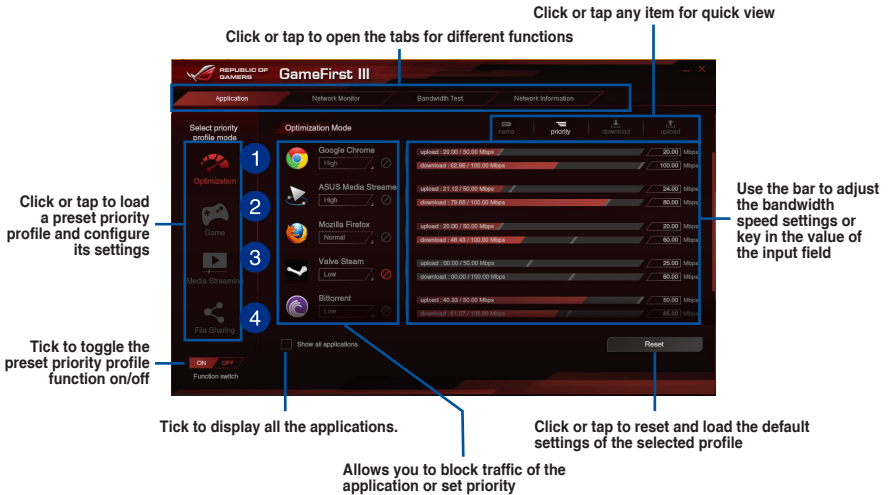

- 1 Optimization Mode**
Game packets are prioritized and other packets also optimized.
- 2 Game Mode**
Game packets given top priority.
- 3 Media Streaming Mode**
Media-streaming packets given top priority.
- 4 File Sharing Mode**
File-sharing packets given top priority.

Network Monitor

Top 5 application

Displays the top 5 bandwidth consuming applications currently used.

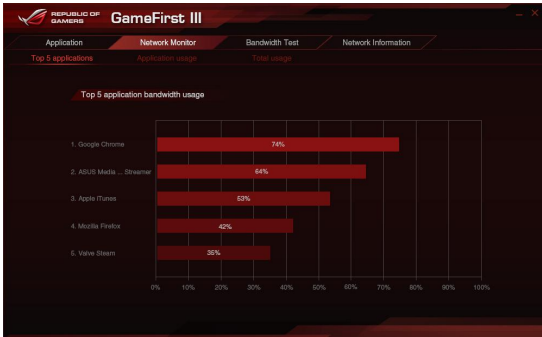

Application usage

Displays the individual downloading and uploading bandwidth of currently used applications.

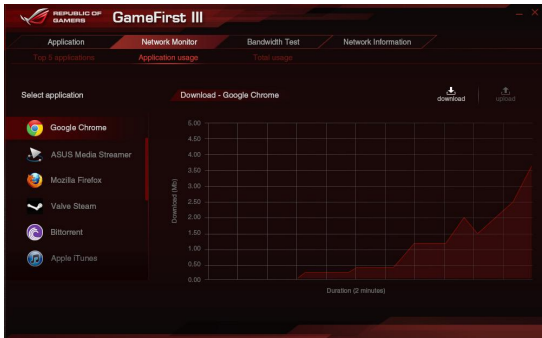

Total usage

Displays the total downloading and uploading bandwidth of the currently used applications.

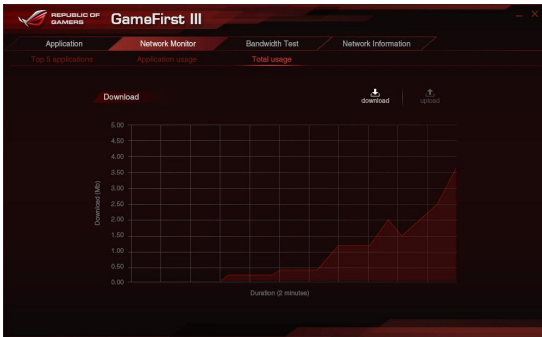

Bandwidth Test

You can use this feature to test the Internet Service Provider (ISP) speed or manually key in your ISP's uploading/downloading speed and apply the speed if needed.

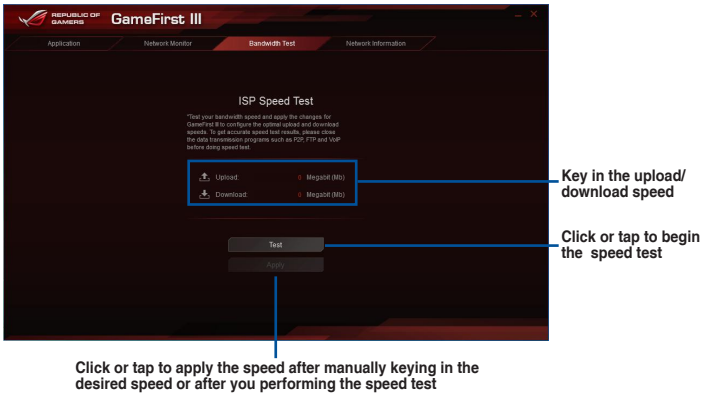

Using the Network Information

Displays information about the physical network card such as speed, physical address, IP address, subnet mask, and default gateway.



4.9 KeyBot

KeyBot is a built-in microprocessor that provides instant upgrade to your keyboard. You can configure and assign macros to specific keys on your keyboard to perform specific or several task at the same time. You can also configure your PC to wake up in CPU Level UP, XMP, or directly to BIOS mode.

To use KeyBot:

1. Press the KeyBot button on the motherboard.



The KeyBot feature is enabled when the KEYBOT_LED light is on.

2. Connect the USB keyboard into the dedicated KeyBot USB port.



Refer to the Rear I/O connection or the USB BIOS Flashback section for more information about the location of the KeyBot USB port.

3. Double-click  on the desktop to launch the KeyBot application on your PC.

Click or tap to import or export configuration files

Click or tap to configure Macro keys, Smart Input, Function keys, and Shortcut settings

Tick to toggle the KeyBot function on/off

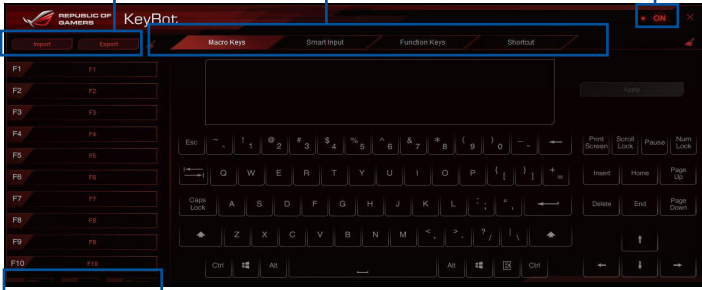

Click or tap any of the items to perform a specific tasks, or click their corresponding keys on the keyboard

Smart Input

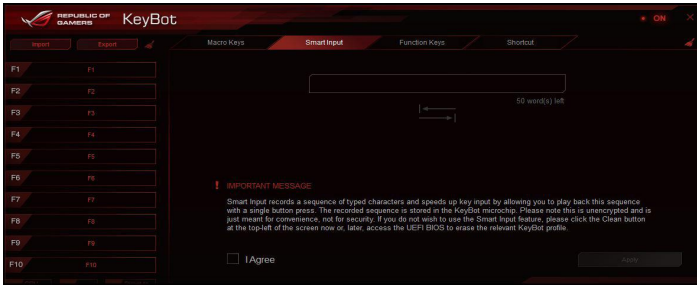

- Smart Input records a sequence of typed characters and speeds up key input by allowing you to play back this sequence with a press of a button. The recorded sequence is stored in the KeyBot microchip. Please note this is unencrypted and is meant for convenience, not for security.
- If you do not wish to use the Smart Input feature, click the Clean button at the top-left of the screen. Another option is to access the UEFI BIOS and erase the relevant KeyBot profile.

Function Keys

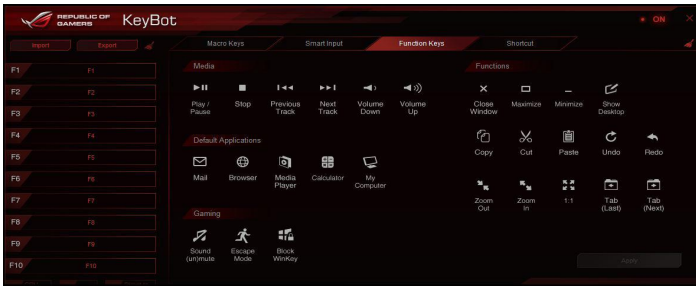

Shortcut

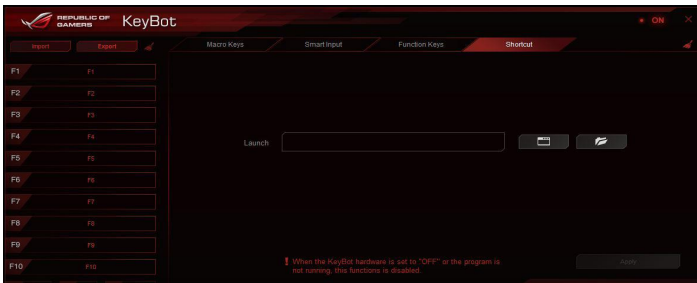

4.10 ASUS Disk Unlocker

This ASUS exclusive utility provides an easy-to-use interface to identify and utilize all drive space in hard disk drives (HDD).



ASUS Disk Unlocker is supported only on Windows® 7 and Windows® 8.



To launch ASUS Disk Unlocker, click .

Click or tap to open the help file that shows the detailed information on how to use ASUS Disk Unlocker



ASUS Disk Unlocker Help file

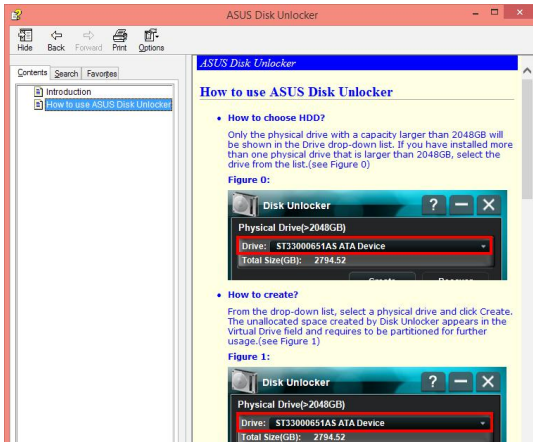

4.11 RAMDisk

RAMDisk is a data-storage software that reserves a part of your system's memory and turns it into a high-speed virtual drive where you can store cache files and game apps for instant access. The Dynamic Memory Allocation function can release the unused memory of RAMDisk back to the system when needed and helps extend the lifespan of your SSD or HDD.



The following folders are not suitable for RAMDisk optimization. Moving them into the RAMDisk might negatively affect the performance of your system.

- **Swap file/Page file:** The swap file is a permanent storage space used as the virtual memory expansion of the system memory. Moving the swap file into the RAM Disk simply defeats the purpose of having it and may decrease your system's performance.
- **Startup folders:** Since RAMDisk loads during boot up together with the contents of the Junction folders, changing the location of the startup folders may cause system error and disable loading your RAMDisk.



To launch RAMDisk, click .

Creating/Deleting a RAMDisk drive

Your RAMDisk drive allows you to place your favorite applications and files into RAM so you can utilize your RAM speed for better read/write performance. The files that are stored inside the RAMDisk are automatically backed up every time your PC is turned off.



The startup time may take a while, depending on the size of your RAMDisk drive.

To create RAMDisk drives:

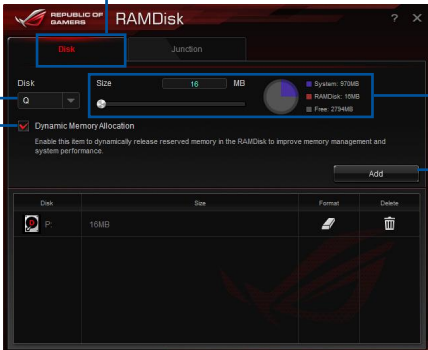

The screenshot shows the RAMDisk application window with the following annotations:

- Click or tap to create RAMDisk drives:** Points to the "Disk" button at the top left.
- Click or tap the drop-down arrow to choose a drive name for your RAMDisk:** Points to the "Q" dropdown menu.
- Move the slider to the right to set the size allocation:** Points to the "Size" slider set to 16 MB.
- Click or tap to finish creating the RAMDisk drive:** Points to the "Add" button.
- Tick to enable Dynamic Memory Allocation function:** Points to the checked checkbox for "Dynamic Memory Allocation".

Disk	Size	Format	Delete
Q	16MB		

To delete or format an existing RAMDisk drive:

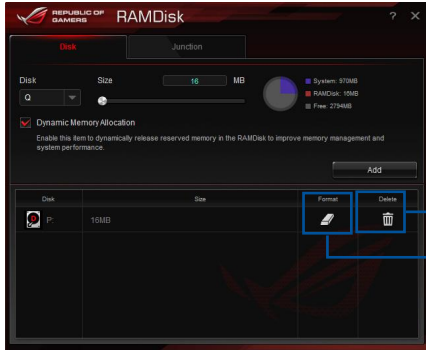

Click or tap to delete the existing RAMDisk drive

Click or tap to format the existing RAMDisk drive



The format function is available only if you enable the Dynamic Memory Allocation function on your disk.

Creating/Deleting a Junction Point

A junction point creates a link that remaps the original contents into the RAMDisk, enabling access to the desired application or data to be done purely within the original file location.

Select the Junction tab to create your junction point

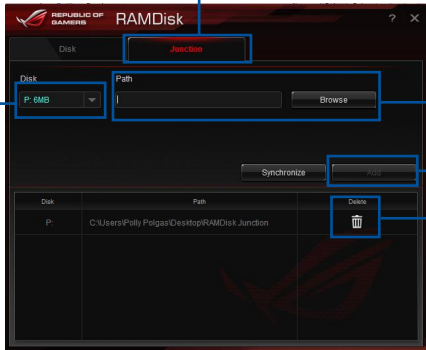

Click or tap the drop-down arrow to select your RAMDisk drive and its available storage space.

Click or tap to select where to create a junction point.

Click or tap to finish adding the new junction point.

Click or tap to delete the existing junction point.

Synchronizing backup files

After creating a junction point, RAMDisk automatically creates a backup folder in the file's original location. Use RAMDisk to manually synchronize updates with these backup files.

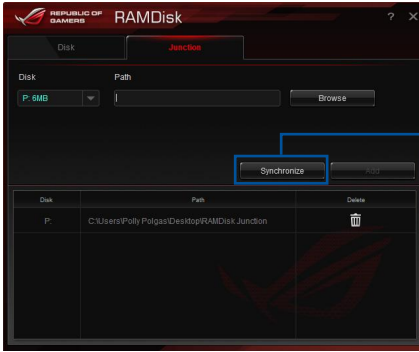

Click or tap Synchronize to update your files

4.12 MemTweakIt

MemTweakIt allows you to view all levels of memory timings. You can validate your MemTweakIt settings to generate a memory efficiency score that you can share and compare with other users on the ROG website.



MemTweakIt functions depends on the chipset on the motherboard. Each chipset has different options.

To use MemTweakIt, double-click  on the desktop.

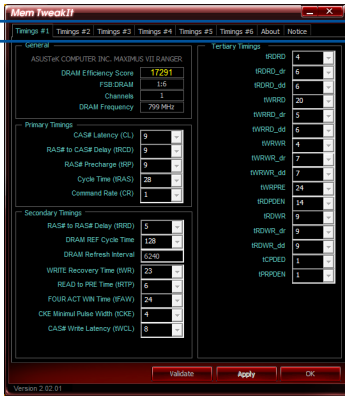

Click or tap a tab to configure the memory timing



Click or tap the About tab then click REPUBLIC OF GAMERS to access the official ROG website

Click or tap to exit MemTweakIt
 Click or tap to apply your settings
 Click or tap to validate your settings.

Validating and saving your MemTweakIt settings

To validate and save your configuration online:

1. Launch MemTweakIt and click **Validate**.
2. In **Online Mode**, key in your ASUS account ID and password, and click **Submit**.



Your configuration will be displayed in MemTweakIt webpage.

To validate and save your configuration manually:

1. Launch MemTweakIt and click **Validate**.
2. In **Manual Mode**, click **Save Validation File**.
3. Key in a file name for your configuration file and click **Submit**.
4. Click or tap **validation webpage**.

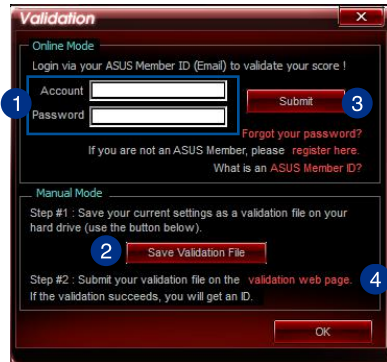

5. In the **MemTweakIt - Validation File Upload** window, key in your ASUS account ID and password.
6. Click or tap **Browse**, locate the saved .cvf file, and click **Open**.
7. Click or tap **Submit**.

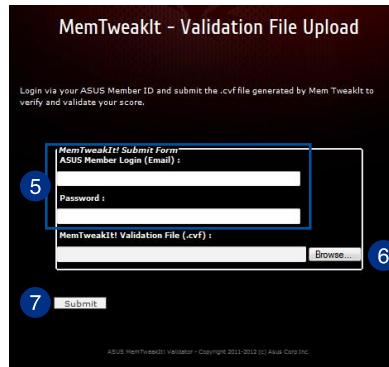

Your configuration will be displayed in MemTweakIt webpage.

4.13 ROG CPU-Z

This utility gathers information about the main devices installed in your system and displays it in an ROG custom layout. ROG CPU-Z provides you information and status of your CPU, motherboard, memory, graphics card, and other components installed in your system. You can generate a report about your system info and send or post it on the CPU-Z website.

To use ROG CPU-Z, double-click  on the desktop.

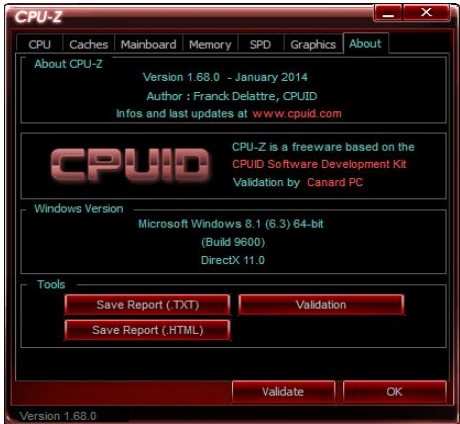
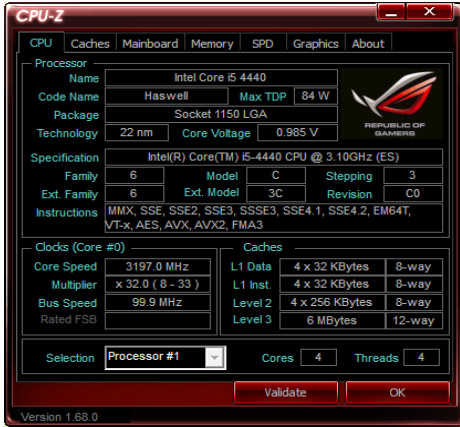

4.14 ROG Connect

ROG Connect allows you to monitor and adjust the local PC through your remote PC.

Setting up USB connection between your local and remote PC



- Install ROG Connect on the remote PC from the provided Support DVD before using ROG Connect.
- The ROG Connect cable is purchased separately.
- ROG Connect must work with ROG Connect Plus to avail full function. Ensure that you install ROG Connect Plus on your local PC from the provided Support DVD before using ROG Connect.

1. Connect the ROG Connect cable to the local PC and the remote PC.
2. Press the ROG Connect Button and it will light up into a stable glow.
3. Double-click the RC TweakIt shortcut on the remote PC to activate the function

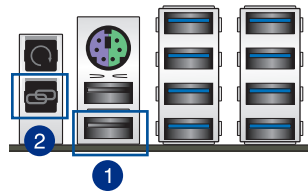

Using RC TweakIt

To use the RC TweakIt

1. Use the sliders and buttons to monitor or adjust your local PC.



2. Click Function to display more options.



RC Poster

RC Poster shows the status of the local system during the POST. You can switch the display mode between String and Code.



RC Remote

RC Remote allows you to operate your local system through the ROG Connect cable.



RC Diagram

RC Diagram allows you to monitor and record your local system status.

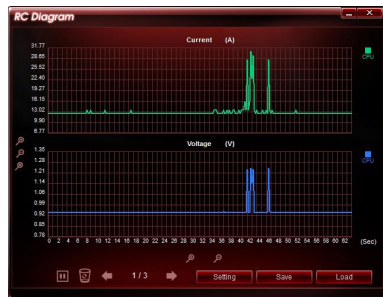

RAID support

5

5.1 RAID configurations

The motherboard comes with the Intel® Rapid Storage Technology that supports RAID 0, RAID 1, RAID 10, and RAID 5 configuration.



If you want to install a Windows® operating system to a hard disk drive included in a RAID set, you have to create a RAID driver disk and load the RAID driver during OS installation. Refer to section 5.2 **Creating a RAID driver disk** for details.

5.1.1 RAID definitions

RAID 0 (Data striping) optimizes two identical hard disk drives to read and write data in parallel, interleaved stacks. Two hard disks perform the same work as a single drive but at a sustained data transfer rate, double that of a single disk alone, thus improving data access and storage. Use of two new identical hard disk drives is required for this setup.

RAID 1 (Data mirroring) copies and maintains an identical image of data from one drive to a second drive. If one drive fails, the disk array management software directs all applications to the surviving drive as it contains a complete copy of the data in the other drive. This RAID configuration provides data protection and increases fault tolerance to the entire system. Use two new drives or use an existing drive and a new drive for this setup. The new drive must be of the same size or larger than the existing drive.

RAID 5 stripes both data and parity information across three or more hard disk drives. Among the advantages of RAID 5 configuration include better HDD performance, fault tolerance, and higher storage capacity. The RAID 5 configuration is best suited for transaction processing, relational database applications, enterprise resource planning, and other business systems. Use a minimum of three identical hard disk drives for this setup.

RAID 10 is data striping and data mirroring combined without parity (redundancy data) having to be calculated and written. With the RAID 10 configuration you get all the benefits of both RAID 0 and RAID 1 configurations. Use four new hard disk drives or use an existing drive and three new drives for this setup.

5.1.2 Installing Serial ATA hard disks

The motherboard supports Serial ATA hard disk drives. For optimal performance, install identical drives of the same model and capacity when creating a disk array.

To install the SATA hard disks for a RAID configuration:

1. Install the SATA hard disks into the drive bays.
2. Connect the SATA signal cables.
3. Connect a SATA power cable to the power connector on each drive.

5.1.3 Setting the RAID item in BIOS

You must enable the RAID function in the BIOS Setup before creating RAID sets using SATA HDDs. To do this:

1. Enter the BIOS Setup during POST.
2. Go to the **Advanced** menu > **SATA Configuration**, and then press <Enter>.
3. Set the SATA Mode item to [RAID Mode].
4. Save your changes, and then exit the BIOS Setup.



Refer to Chapter 3 for details on entering and navigating through the BIOS Setup



Due to chipset limitation, when SATA ports are set to RAID mode, all SATA ports run at RAID mode together.

5.1.4 Intel® Rapid Storage Technology Option ROM utility

To enter the Intel® Rapid Storage Technology Option ROM utility:

1. Turn on the system.
2. During POST, press <Ctrl> + <I> to display the utility main menu.

```
Intel(R) Rapid Storage Technology - Option ROM - v10.5.1.1070
Copyright(C) 2003-10 Intel Corporation. All Rights Reserved.

[ MAIN MENU ]
1. Create RAID Volume      4. Recovery Volume Options
2. Delete RAID Volume     5. Acceleration Options
3. Reset Disks to Non-RAID 6. Exit

[ DISK/VOLUME INFORMATION ]

RAID Volumes:
None defined.

Physical Devices:
Port Device Model      Serial #      Size  Type/Status(Vol ID)
0   ST3160812AS        9LS0HJA4    149.0GB Non-RAID Disk
1   ST3160812AS        9LS0F4HL    149.0GB Non-RAID Disk
2   ST3160812AS        3LS0JYL8    149.0GB Non-RAID Disk
3   ST3160812AS        9LS0BJ5H    149.0GB Non-RAID Disk

[↑↓]-Select      [ESC]-Exit      [ENTER]-Select Menu
```

The navigation keys at the bottom of the screen allow you to move through the menus and select the menu options.



The RAID BIOS setup screens shown in this section are for reference only and may not exactly match the items on your screen.



The utility supports maximum four hard disk drives for RAID configuration.

Creating a RAID set

To create a RAID set:

1. From the utility main menu, select **1. Create RAID Volume** and press <Enter>. The following screen appears:

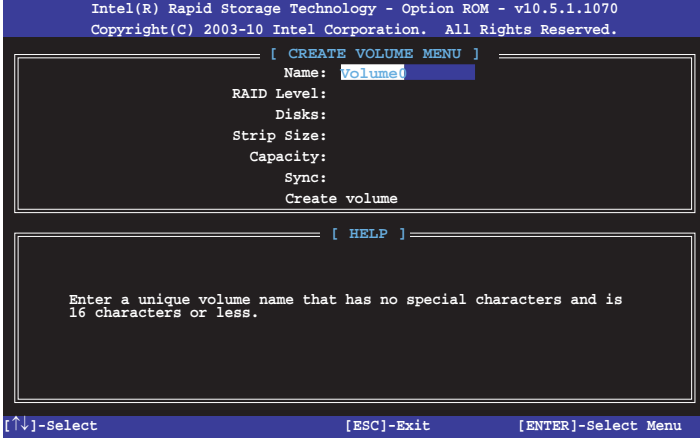

2. Enter a name for the RAID set and press <Enter>.
3. When the RAID Level item is selected, press the up/down arrow key to select a RAID level to create, and then press <Enter>.
4. When the Disks item is selected, press <Enter> to select the hard disk drives you want to include in the RAID set. The SELECT DISKS screen appears:

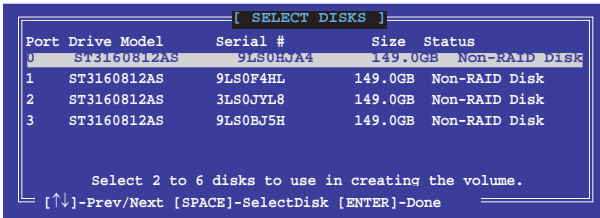

5. Use the up/down arrow key to select a drive, and then press <Space> to select. A small triangle marks the selected drive. Press <Enter> after completing your selection.
6. Use the up/down arrow key to select the stripe size for the RAID array (for RAID 0, 10 and 5 only), and then press <Enter>. The available stripe size values range from 4KB to 128KB. The following are typical values:
 - RAID 0: 128KB
 - RAID 10: 64KB
 - RAID 5: 64KB



We recommend a lower stripe size for server systems, and a higher stripe size for multimedia computer systems used mainly for audio and video editing.

7. When the **Capacity** item is selected, enter the RAID volume capacity that you want and press <Enter>. The default value indicates the maximum allowed capacity.
8. When the **Create Volume** item is selected, press <Enter>. The following warning message appears:

```
WARNING: ALL DATA ON SELECTED DISKS WILL BE LOST.  
Are you sure you want to create this volume? (Y/N):
```

9. Press <Y> to create the RAID volume and return to the main menu, or <N> to go back to the CREATE VOLUME menu.

Deleting a RAID set



Be cautious when deleting a RAID set. You will lose all data on the hard disk drives when you delete a RAID set.

To delete a RAID set:

1. From the utility main menu, select **2. Delete RAID Volume** and press <Enter>. The following screen appears:

```
[ DELETE VOLUME MENU ]
Name      Level      Drives  Capacity  Status  Bootable
Volume0   RAID0(Stripe)  2       298.0GB  Normal  Yes

[ HELP ]

Deleting a volume will reset the disks to non-RAID.

WARNING: ALL DISK DATA WILL BE DELETED.
(This does not apply to Recovery volumes)

[↑↓]-Select      [ESC]-Previous Menu  [DEL]-Delete Volume
```

2. Use the up/down arrow key to select the RAID set you want to delete, and then press <Delete>. The following warning message appears:

```
[ DELETE VOLUME VERIFICATION ]

ALL DATA IN THE VOLUME WILL BE LOST!
(This does not apply to Recovery volumes)

Are you sure you want to delete volume "Volume0"? (Y/N):
```

3. Press <Y> to delete the RAID set and return to the utility main menu, or press <N> to return to the DELETE VOLUME menu.

Exiting the Intel® Rapid Storage Technology Option ROM utility

To exit the utility:

1. From the utility main menu, select **5. Exit**, and then press <Enter>. The following warning message appears:

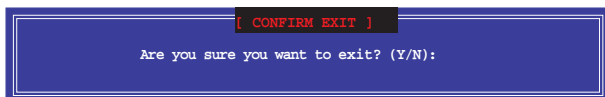

5.2 Creating a RAID driver disk

A floppy disk with the RAID driver is required when installing a Windows® operating system on a hard disk drive that is included in a RAID set.



The motherboard does not provide a floppy drive connector. You have to use a USB floppy disk drive when creating a SATA RAID driver disk.

5.2.1 Creating a RAID driver disk without entering the OS

To create a RAID driver disk without entering the OS:

1. Boot your computer.
2. Press <Delete> during POST to enter the BIOS setup utility.
3. Set the optical drive as the primary boot device.
4. Insert the support DVD into the optical drive.
5. Save changes and exit BIOS.
6. When the Make Disk menu appears, press <1> to create a RAID driver disk.
7. Insert a formatted floppy disk into the USB floppy disk drive, then press <Enter>.
8. Follow the succeeding screen instructions to complete the process.

5.2.2 Creating a RAID driver disk in Windows®

To create a RAID driver disk in Windows®:

1. Start Windows®.
2. Plug the USB floppy disk drive and insert a floppy disk.
3. Place the motherboard support DVD into the optical drive.
4. Go to the **Make Disk** menu, and then click **Intel AHCI/RAID Driver Disk** to create a RAID driver disk.
5. Select **USB floppy disk drive** as the destination disk.
6. Follow the succeeding screen instructions to complete the process.



Write-protect the floppy disk to avoid a computer virus infection.

5.2.3 Installing the RAID driver during Windows® OS installation

To install the RAID driver for Windows® 7 or later OS:

1. During the OS installation, click **Load Driver** to allow you to select the installation media containing the RAID driver.
2. Insert the USB flash drive with RAID driver into the USB port or the support DVD into the optical drive, and then click **Browse**.
3. Click the name of the device you've inserted, go to **Drivers > RAID**, and then select the RAID driver for the corresponding OS version. Click **OK**.
4. Follow the succeeding screen instructions to complete the installation.



Before loading the RAID driver from a USB flash drive, you have to use another computer to copy the RAID driver from the support DVD to the USB flash drive.

Appendices

Notices

Federal Communications Commission Statement

This device complies with Part 15 of the FCC Rules. Operation is subject to the following two conditions:

- This device may not cause harmful interference.
- This device must accept any interference received including interference that may cause undesired operation.

This equipment has been tested and found to comply with the limits for a Class B digital device, pursuant to Part 15 of the FCC Rules. These limits are designed to provide reasonable protection against harmful interference in a residential installation. This equipment generates, uses and can radiate radio frequency energy and, if not installed and used in accordance with manufacturer's instructions, may cause harmful interference to radio communications. However, there is no guarantee that interference will not occur in a particular installation. If this equipment does cause harmful interference to radio or television reception, which can be determined by turning the equipment off and on, the user is encouraged to try to correct the interference by one or more of the following measures:

- Reorient or relocate the receiving antenna.
- Increase the separation between the equipment and receiver.
- Connect the equipment to an outlet on a circuit different from that to which the receiver is connected.
- Consult the dealer or an experienced radio/TV technician for help.



The use of shielded cables for connection of the monitor to the graphics card is required to assure compliance with FCC regulations. Changes or modifications to this unit not expressly approved by the party responsible for compliance could void the user's authority to operate this equipment.

IC: Canadian Compliance Statement

Complies with the Canadian ICES-003 Class B specifications. This device complies with RSS 210 of Industry Canada. This Class B device meets all the requirements of the Canadian interference-causing equipment regulations.

This device complies with Industry Canada license exempt RSS standard(s). Operation is subject to the following two conditions: (1) this device may not cause interference, and (2) this device must accept any interference, including interference that may cause undesired operation of the device.

Cet appareil numérique de la Classe B est conforme à la norme NMB-003 du Canada. Cet appareil numérique de la Classe B respecte toutes les exigences du Règlement sur le matériel brouilleur du Canada.

Cet appareil est conforme aux normes CNR exemptes de licence d'Industrie Canada. Le fonctionnement est soumis aux deux conditions suivantes :

- (1) cet appareil ne doit pas provoquer d'interférences et
- (2) cet appareil doit accepter toute interférence, y compris celles susceptibles de provoquer un fonctionnement non souhaité de l'appareil.

Canadian Department of Communications Statement

This digital apparatus does not exceed the Class B limits for radio noise emissions from digital apparatus set out in the Radio Interference Regulations of the Canadian Department of Communications.

This class B digital apparatus complies with Canadian ICES-003.

VCCI: Japan Compliance Statement

Class B ITE

この装置は、クラスB情報技術装置です。この装置は、家庭環境で使用することを目的としていますが、この装置がラジオやテレビジョン受信機に近接して使用されると、受信障害を引き起こすことがあります。

取扱説明書に従って正しい取り扱いをして下さい。

VCCI-B

This is a Class B product based on the standard of the VCCI Council. If this is used near a radio or television receiver in a domestic environment, it may cause radio interference. Install and use the equipment according to the instruction manual.

KC: Korea Warning Statement

B급 기기 (가정용 방송통신기자재)

이 기기는 가정용(B급) 전자파적합기기로서 주로 가정에서 사용하는 것을 목적으로 하며, 모든 지역에서 사용할 수 있습니다.

*당해 무선설비는 전파혼신 가능성이 있으므로 인명안전과 관련된 서비스는 할 수 없습니다.

REACH

Complying with the REACH (Registration, Evaluation, Authorisation, and Restriction of Chemicals) regulatory framework, we published the chemical substances in our products at ASUS REACH website at <http://csr.asus.com/english/REACH.htm>.



DO NOT throw the motherboard in municipal waste. This product has been designed to enable proper reuse of parts and recycling. This symbol of the crossed out wheeled bin indicates that the product (electrical and electronic equipment) should not be placed in municipal waste. Check local regulations for disposal of electronic products.



DO NOT throw the mercury-containing button cell battery in municipal waste. This symbol of the crossed out wheeled bin indicates that the battery should not be placed in municipal waste.

ASUS Recycling/Takeback Services

ASUS recycling and takeback programs come from our commitment to the highest standards for protecting our environment. We believe in providing solutions for you to be able to responsibly recycle our products, batteries, other components as well as the packaging materials. Please go to <http://csr.asus.com/english/Takeback.htm> for detailed recycling information in different regions.

RF Equipment Notices

CE: European Community Compliance Statement

The equipment complies with the RF Exposure Requirement 1999/519/EC, Council Recommendation of 12 July 1999 on the limitation of exposure of the general public to electromagnetic fields (0–300 GHz). This wireless device complies with the R&TTE Directive.

Wireless Radio Use

This device is restricted to indoor use when operating in the 5.15 to 5.25 GHz frequency band.

Exposure to Radio Frequency Energy

The radiated output power of the Wi-Fi technology is below the FCC radio frequency exposure limits. Nevertheless, it is advised to use the wireless equipment in such a manner that the potential for human contact during normal operation is minimized.

FCC Bluetooth Wireless Compliance

The antenna used with this transmitter must not be colocated or operated in conjunction with any other antenna or transmitter subject to the conditions of the FCC Grant.

Bluetooth Industry Canada Statement

This Class B device meets all requirements of the Canadian interference-causing equipment regulations.

Cet appareil numérique de la Class B respecte toutes les exigences du Règlement sur le matériel brouilleur du Canada.

NCC: Taiwan Wireless Statement

無線設備的警告聲明

經型式認證合格之低功率射頻電機，非經許可，公司、商號或使用者均不得擅自變更射頻、加大功率或變更原設計之特性及功能。低功率射頻電機之使用不得影響飛航安全及干擾合法通信；經發現有干擾現象時，應立即停用，並改善至無干擾時方得繼續使用。前項合法通信指依電信法規定作業之無線通信。低功率射頻電機須忍受合法通信或工業、科學及醫療用電波輻射性電機設備之干擾。

於 5.25GHz 至 5.35GHz 區域內操作之
無線設備的警告聲明

工作頻率 5.250 ~ 5.350GHz 該頻段限於室內使用。

Japan RF Equipment Statement

この製品は、周波数帯域5.15~5.35GHzで動作しているときは、屋内においてのみ使用可能です。

KC (RF Equipment)

대한민국 규정 및 준수

방통위 고시에 따른 고지사항

해당 무선설비는 운용 중 전파혼신 가능성이 있음,

이 기기는 인명안전과 관련된 서비스에 사용할 수 없습니다.

ASUS contact information

ASUSTeK COMPUTER INC.

Address 15 Li-Te Road, Peitou, Taipei, Taiwan 11259
Telephone +886-2-2894-3447
Fax +886-2-2890-7798
E-mail info@asus.com.tw
Web site <http://www.asus.com>

Technical Support

Telephone +86-21-3842-9911
Fax +86-21-5866-8722, ext. 9101#
Online support <http://support.asus.com/techserv/techserv.aspx>

ASUS COMPUTER INTERNATIONAL (America)

Address 800 Corporate Way, Fremont, CA 94539, USA
Telephone +1-510-739-3777
Fax +1-510-608-4555
Web site <http://usa.asus.com>

Technical Support

Support fax +1-812-284-0883
General support +1-812-282-2787
Online support <http://support.asus.com/techserv/techserv.aspx>

ASUS COMPUTER GmbH (Germany and Austria)

Address Harkort Str. 21-23, 40880 Ratingen, Germany
Fax +49-2102-959931
Web site <http://www.asus.com/de>
Online contact <http://eu-rma.asus.com/sales>

Technical Support

Telephone +49-2102-5789555
Support Fax +49-2102-959911
Online support <http://support.asus.com/techserv/techserv.aspx>

DECLARATION OF CONFORMITY

Per FCC Part 2, Section 2.1077(a)



Responsible Party Name: **Asus Computer International**

Address: **800 Corporate Way, Fremont, CA 94539,**

Phone/Fax No: **(510)739-3777/(510)608-4555**

hereby declares that the product

Product Name : Motherboard

Model Number : RAMPAGE V EXTREME

Conforms to the following specifications:

FCC Part 15, Subpart B, Unintentional Radiators

Supplementary Information:

This device complies with part 15 of the FCC Rules. Operation is subject to the following two conditions: (1) This device may not cause harmful interference, and (2) this device must accept any interference received, including interference that may cause undesired operation.

Representative Person's Name : Steve Chang / President

Steve Chang

Signature :

Date : Aug. 22, 2014

Ver. 140331

EC Declaration of Conformity



We, the undersigned,

Manufacturer: **ASUSTeK COMPUTER INC.**
 4F, No. 150, LITE Rd., PEITOU, TAIPEI 112, TAIWAN
 Authorized representative in Europe: **ASUS COMPUTER GmbH**
 HARKORT STR. 7-23, 40880 RATINGEN
 Address, City: **GERMANY**
 Country:

declare the following apparatus:

Product name : **Motherboard**
 Model name : **RAMPAGE V EXTREME**

conform with the essential requirements of the following directives:

2004/108/EC EMC Directive
 EN 55022:2011/04/26:2011
 EN 61000-3-2:2009+A22:009
 EN 55013:2011/04/26:2009-04-26:2006
 EN 55022:2011/04/26:2011

2006/95/EC LVD Directive

EN 301 485-1 V1.6.1 (2007-12-09)
 EN 301 485-3 V1.4.1 (2002-08)
 EN 300 442-2 V1.4.1 (2010-08)
 EN 300 442-1 V1.6.1 (2010-08)
 EN 301 908-1 V5.2.1 (2011-05)
 EN 301 908-2 V5.2.1 (2011-07)
 EN 301 885-1 V2.2.1 (2007-11)
 EN 301 885-1 V2.2.1 (2007-11)
 EN 301 885-1 V2.2.1 (2007-09)
 EN 301 885-1 V2.2.1 (2007-09)
 EN 302 326-2 V1.2.2 (2007-06)
 EN 302 326-3 V1.3 (2007-09)
 EN 302 326-1 V1.1 (2005-01)
 EN 62479:2010
 EN 60885:2002
 EN 302 291-2 V1.1 (2005-07)
 EN 302 291-1 V1.1 (2005-07)

2006/95/EC LVD Directive

EN 60950-1:02:2011
 EN 60885:2002/A12:2011

2009/24/EC EIP Directive

Regulation (EC) No. 1275/2008
 Regulation (EC) No. 642/2009
 Regulation (EC) No. 278/2009
 Regulation (EC) No. 617/2003

2011/65/EU RoHS Directive

Ver. 140331



(EC conformity marking)

Position : **CEO**
 Name : **Jerry Shen**

Jerry Shen

Signature : _____

Declaration Date: **22/08/2014**
 Year to begin affixing CE marking: **2014**

DECLARATION OF CONFORMITY
Per FCC Part 2 Section 2.1077(a)



Responsible Party Name: **Asus Computer International**

Address: **800 Corporate Way, Fremont, CA 94539.**

Phone/Fax No: **(510)739-3777/(510)608-4555**

hereby declares that the product

Product Name : Motherboard OC accessory

Model Number : OC Panel

Conforms to the following specifications:

- FCC Part 15, Subpart B, Unintentional Radiators

Supplementary Information:

This device complies with part 15 of the FCC Rules. Operation is subject to the following two conditions: (1) This device may not cause harmful interference, and (2) this device must accept any interference received, including interference that may cause undesired operation.

Representative Person's Name : Steve Chinnz / President

Steve Chang

Signature : _____
Date : Apr. 16, 2013

Ver. 1206/01

EC Declaration of Conformity



We, the undersigned,

Manufacturer: **ASUSTEK COMPUTER INC.**
 Address: **JF. No. 150, LITE Rd., PEITOU, TAIPEI 112, TAIWAN**
 Country: **TAIWAN**
 Representative in Europe: **ASUS COMPUTER GmbH**
 Address: **MARKT STR. 21-23, 40880 RATINGEN**
 Country: **GERMANY**

declare the following apparatus:

Product name : **Motherboard OC accessory**
 Model name : **OC Panel**

conform with the essential requirements of the following directives:

2004/108/EC-EMC Directive

- EN 55022:2010
- EN 55024:2010
- EN 55013:2011
- EN 55020:2007

1999/5/EC-R&TTE Directive

- EN 300 328 V1.7 (10/06-10)
- EN 300 440-1 V1.6 (10/04-08)
- EN 300 511 V9.2 (20/09-03)
- EN 301 888-1 V6.2 (10/01-05)
- EN 301 888 V1.6 (10/01-11)
- EN 302 544 V1.1 (10/09-01)
- EN 302 544 V1.1 (10/09-01)
- EN 55082:2001
- EN 55082:2001
- EN 62311:2008
- EN 300 486-1 V1.9.2 (2011-09)
- EN 301 486-3 V1.4 (2002-08)
- EN 301 486-7 V1.3 (2005-11)
- EN 301 486-3 V1.4 (2007-11)
- EN 301 486-24 V1.5 (12/01-08)
- EN 302 536-5 V1.2.2 (2007-08)
- EN 301 357-2 V1.4 (2008-11)
- EN 302 281-2 V1.1 (2005-07)
- EN 302 281-2 V1.1 (2005-07)

2006/95/EC-LVD Directive

- EN 60950-1 :A12:2011

2009/125/EC-EP- Directive

- Regulation (EC) No. 1275/2008
- Regulation (EC) No. 642/2009

2011/65/EU-ROHS Directive

- CE marking**



(EC conformity marking)

Position : **CEO**
 Name : **Jerry Shen**

Jerry Shen

Declaration Date: **16/04/2013**
 Year to begin affixing CE marking: **2013**

Signature : _____

Ver. 1302/08

