

**SABERTOOTH
X58**

ASUS[®]

Motherboard

E5995

Second Edition (V2)
August 2010

Copyright © 2010 ASUSTeK COMPUTER INC. All Rights Reserved.

No part of this manual, including the products and software described in it, may be reproduced, transmitted, transcribed, stored in a retrieval system, or translated into any language in any form or by any means, except documentation kept by the purchaser for backup purposes, without the express written permission of ASUSTeK COMPUTER INC. ("ASUS").

Product warranty or service will not be extended if: (1) the product is repaired, modified or altered, unless such repair, modification of alteration is authorized in writing by ASUS; or (2) the serial number of the product is defaced or missing.

ASUS PROVIDES THIS MANUAL "AS IS" WITHOUT WARRANTY OF ANY KIND, EITHER EXPRESS OR IMPLIED, INCLUDING BUT NOT LIMITED TO THE IMPLIED WARRANTIES OR CONDITIONS OF MERCHANTABILITY OR FITNESS FOR A PARTICULAR PURPOSE. IN NO EVENT SHALL ASUS, ITS DIRECTORS, OFFICERS, EMPLOYEES OR AGENTS BE LIABLE FOR ANY INDIRECT, SPECIAL, INCIDENTAL, OR CONSEQUENTIAL DAMAGES (INCLUDING DAMAGES FOR LOSS OF PROFITS, LOSS OF BUSINESS, LOSS OF USE OR DATA, INTERRUPTION OF BUSINESS AND THE LIKE), EVEN IF ASUS HAS BEEN ADVISED OF THE POSSIBILITY OF SUCH DAMAGES ARISING FROM ANY DEFECT OR ERROR IN THIS MANUAL OR PRODUCT.

SPECIFICATIONS AND INFORMATION CONTAINED IN THIS MANUAL ARE FURNISHED FOR INFORMATIONAL USE ONLY, AND ARE SUBJECT TO CHANGE AT ANY TIME WITHOUT NOTICE, AND SHOULD NOT BE CONSTRUED AS A COMMITMENT BY ASUS. ASUS ASSUMES NO RESPONSIBILITY OR LIABILITY FOR ANY ERRORS OR INACCURACIES THAT MAY APPEAR IN THIS MANUAL, INCLUDING THE PRODUCTS AND SOFTWARE DESCRIBED IN IT.

Products and corporate names appearing in this manual may or may not be registered trademarks or copyrights of their respective companies, and are used only for identification or explanation and to the owners' benefit, without intent to infringe.

Offer to Provide Source Code of Certain Software

This product may contain copyrighted software that is licensed under the General Public License ("GPL") and under the Lesser General Public License Version ("LGPL"). The GPL and LGPL licensed code in this product is distributed without any warranty. Copies of these licenses are included in this product.

You may obtain the complete corresponding source code (as defined in the GPL) for the GPL Software, and/or the complete corresponding source code of the LGPL Software (with the complete machine-readable "work that uses the Library") for a period of three years after our last shipment of the product including the GPL Software and/or LGPL Software, which will be no earlier than December 1, 2011, either (1) for free by downloading it from <http://support.asus.com/download>;

or

(2) for the cost of reproduction and shipment, which is dependent on the preferred carrier and the location where you want to have it shipped to, by sending a request to:

ASUSTeK Computer Inc.
Legal Compliance Dept.
15 Li Te Rd.,
Beitou, Taipei 112
Taiwan

In your request please provide the name, model number and version, as stated in the About Box of the product for which you wish to obtain the corresponding source code and your contact details so that we can coordinate the terms and cost of shipment with you.

The source code will be distributed WITHOUT ANY WARRANTY and licensed under the same license as the corresponding binary/object code.

This offer is valid to anyone in receipt of this information.

ASUSTeK is eager to duly provide complete source code as required under various Free Open Source Software licenses. If however you encounter any problems in obtaining the full corresponding source code we would be much obliged if you give us a notification to the email address gpl@asus.com, stating the product and describing the problem (please do NOT send large attachments such as source code archives etc to this email address).

Contents

Contents.....	iii
Notices	viii
Safety information.....	ix
About this guide.....	x
SABERTOOTH X58 specifications summary.....	xii
Chapter 1: Product introduction	
1.1 Welcome!	1-1
1.2 Package contents.....	1-1
1.3 Special features.....	1-2
1.3.1 Product highlights.....	1-2
1.3.2 “TUF ENGINE!” Power Design.....	1-3
1.3.3 “Ultimate COOL!” Thermal Solutions	1-3
1.3.4 “Safe & Stable!” Guardian Angel	1-3
1.3.5 ASUS exclusive features.....	1-3
Chapter 2: Hardware information	
2.1 Before you proceed	2-1
2.2 Motherboard overview.....	2-2
2.2.1 Motherboard layout.....	2-2
2.2.2 Layout contents.....	2-3
2.2.3 Placement direction.....	2-4
2.2.4 Screw holes.....	2-4
2.3 Central Processing Unit (CPU)	2-5
2.3.1 Installing the CPU	2-5
2.3.2 Installing the CPU heatsink and fan	2-8
2.3.3 Uninstalling the CPU heatsink and fan.....	2-9
2.4 System memory	2-10
2.4.1 Overview	2-10
2.4.2 Memory configurations.....	2-11
2.4.3 Installing a DIMM	2-17
2.4.4 Removing a DIMM	2-17
2.5 Expansion slots.....	2-18
2.5.1 Installing an expansion card.....	2-18
2.5.2 Configuring an expansion card	2-18
2.5.3 Interrupt assignments.....	2-19
2.5.4 PCI slot.....	2-20
2.5.5 PCI Express x16 / x1 slots	2-20
2.5.6 PCI Express 2.0 x16 slots	2-20

Contents

- 2.6 Jumpers 2-22
- 2.7 Onboard switch 2-24
- 2.8 Connectors 2-25
 - 2.8.1 Rear panel connectors 2-25
 - 2.8.2 Audio I/O connections 2-26
 - 2.8.3 Internal connectors 2-29
 - 2.8.4. ASUS Q-Connector (system panel) 2-37
- 2.9 Onboard LEDs 2-38
- 2.10 Starting up for the first time 2-39
- 2.11 Turning off the computer 2-39

- Chapter 3: BIOS setup**
- 3.1 Knowing BIOS 3-1
- 3.2 Updating BIOS 3-1
 - 3.2.1 ASUS Update utility 3-2
 - 3.2.2 ASUS EZ Flash 2 utility 3-4
 - 3.2.3 ASUS CrashFree BIOS 3 utility 3-5
- 3.3 BIOS setup program 3-6
 - 3.3.1 BIOS menu screen 3-6
 - 3.3.2 Menu bar 3-6
 - 3.3.3 Navigation keys 3-7
 - 3.3.4 Menu items 3-7
 - 3.3.5 Submenu items 3-7
 - 3.3.6 Configuration fields 3-7
 - 3.3.7 Pop-up window 3-7
 - 3.3.8 Scroll bar 3-7
 - 3.3.9 General help 3-7
- 3.4 Main menu 3-8
 - 3.4.1 SATA 1–6 3-8
 - 3.4.2 Storage Configuration 3-10
 - 3.4.3 AHCI Configuration 3-11
 - 3.4.4 System Information 3-11
- 3.5 Ai Tweaker menu 3-12
 - 3.5.1 Ai Overclock Tuner 3-12
 - 3.5.2 CPU Ratio Setting 3-13
 - 3.5.3 Intel(R) SpeedStep(TM) Tech 3-13
 - 3.5.4 Intel(R) TurboMode Tech 3-13
 - 3.5.5 Xtreme Phase Full Power Mode 3-13

Contents

3.5.6	BCLK Frequency.....	3-13
3.5.7	PCIe Frequency.....	3-14
3.5.8	DRAM Frequency.....	3-14
3.5.9	UCLK Frequency.....	3-14
3.5.10	QPI Link Data Rate.....	3-14
3.5.11	ASUS/3rd Party UI Priority.....	3-14
3.5.12	DRAM Timing Contro.....	3-14
3.5.13	CPU Voltage Control.....	3-16
3.5.14	CPU Voltage.....	3-16
3.5.15	CPU PLL Voltage.....	3-16
3.5.16	QPI/DRAM Core Voltage.....	3-16
3.5.17	IOH Voltage.....	3-17
3.5.18	IOH PCIe Voltage.....	3-17
3.5.19	ICH Voltage.....	3-17
3.5.20	ICH PCIe Voltage.....	3-17
3.5.21	DRAM Bus Voltage.....	3-17
3.5.22	DRAM DATA REF Voltage on CHA/B/C.....	3-18
3.5.23	DRAM CTRL REF Voltage on CHA/B/C.....	3-18
3.5.24	Load-Line Calibration.....	3-18
3.5.25	CPU Differential Amplitude.....	3-18
3.5.26	CPU Clock Skew.....	3-18
3.5.27	CPU Spread Spectrum.....	3-18
3.5.28	IOH Clock Skew.....	3-18
3.5.29	PCIe Spread Spectrum.....	3-18
3.6	Advanced menu.....	3-19
3.6.1	CPU Configuration.....	3-19
3.6.2	Chipset.....	3-22
3.6.3	Onboard Devices Configuration.....	3-23
3.6.4	USB Configuration.....	3-25
3.6.5	PCIePnP.....	3-26
3.7	Power menu.....	3-27
3.7.1	Suspend Mode.....	3-27
3.7.2	Repost Video on S3 Resume.....	3-27
3.7.3	ACPI 2.0 Support.....	3-27
3.7.4	ACPI APIC Support.....	3-27
3.7.5	APM Configuration.....	3-28
3.7.6	Hardware Monitor.....	3-29
3.7.7	EuP Ready.....	3-30

Contents

- 3.8 Boot menu 3-31**
 - 3.8.1 Boot Device Priority..... 3-31
 - 3.8.2 Boot Settings Configuration 3-32
 - 3.8.3 Security 3-33
- 3.9 Tools menu 3-35**
 - 3.9.1 ASUS EZ Flash 2 3-35
 - 3.9.2 ASUS O.C. Profile..... 3-35
 - 3.9.3 AI NET 2..... 3-37
 - 3.9.4 Drive Xpert Configuration..... 3-37
- 3.10 Exit menu 3-39**

Chapter 4: Software support

- 4.1 Installing an operating system 4-1**
- 4.2 Support DVD information 4-1**
 - 4.2.1 Running the support DVD 4-1
 - 4.2.2 Obtaining the software manuals..... 4-2
- 4.3 Software information 4-3**
 - 4.3.1 ASUS PC Probe II..... 4-3
 - 4.3.2 ASUS Fan Xpert..... 4-4
 - 4.3.3 Audio configurations..... 4-5
- 4.4 RAID configurations 4-6**
 - 4.4.1 RAID definitions 4-6
 - 4.4.2 Installing Serial ATA hard disks 4-7
 - 4.4.3 Setting the RAID item in BIOS 4-7
 - 4.4.4 Intel® Matrix Storage Manager option ROM utility..... 4-7
 - 4.4.5 Marvell RAID utility..... 4-11
- 4.5 Creating a RAID driver disk..... 4-15**
 - 4.5.1 Creating a RAID driver disk without entering the OS 4-15
 - 4.5.2 Creating a RAID driver disk in Windows®..... 4-15
 - 4.5.3 Installing the RAID driver during Windows® OS installation 4-16
 - 4.5.4 Using a USB floppy disk drive..... 4-17

Chapter 5: Multiple GPU technology support

- 5.1 ATI® CrossFire™ technology 5-1**
 - 5.1.1 Requirements..... 5-1
 - 5.1.2 Before you begin..... 5-1
 - 5.1.3 Installing two CrossFire™ graphics cards 5-2
 - 5.1.4 Installing three CrossFire™ graphics cards..... 5-3

Contents

5.1.5	Installing the device drivers.....	5-4
5.1.6	Enabling the ATI® CrossFireX™ technology	5-4
5.2	NVIDIA® SLI™ technology	5-6
5.2.1	Requirements.....	5-6
5.2.2	Installing two SLI-ready graphics cards	5-6
5.2.3	Installing the device drivers.....	5-7
5.2.4	Enabling the NVIDIA® SLI™ technology	5-7

Notices

Federal Communications Commission Statement

This device complies with Part 15 of the FCC Rules. Operation is subject to the following two conditions:

- This device may not cause harmful interference, and
- This device must accept any interference received including interference that may cause undesired operation.

This equipment has been tested and found to comply with the limits for a Class B digital device, pursuant to Part 15 of the FCC Rules. These limits are designed to provide reasonable protection against harmful interference in a residential installation. This equipment generates, uses and can radiate radio frequency energy and, if not installed and used in accordance with manufacturer's instructions, may cause harmful interference to radio communications. However, there is no guarantee that interference will not occur in a particular installation. If this equipment does cause harmful interference to radio or television reception, which can be determined by turning the equipment off and on, the user is encouraged to try to correct the interference by one or more of the following measures:

- Reorient or relocate the receiving antenna.
- Increase the separation between the equipment and receiver.
- Connect the equipment to an outlet on a circuit different from that to which the receiver is connected.
- Consult the dealer or an experienced radio/TV technician for help.



The use of shielded cables for connection of the monitor to the graphics card is required to assure compliance with FCC regulations. Changes or modifications to this unit not expressly approved by the party responsible for compliance could void the user's authority to operate this equipment.

Canadian Department of Communications Statement

This digital apparatus does not exceed the Class B limits for radio noise emissions from digital apparatus set out in the Radio Interference Regulations of the Canadian Department of Communications.

This class B digital apparatus complies with Canadian ICES-003.

REACH

Complying with the REACH (Registration, Evaluation, Authorisation, and Restriction of Chemicals) regulatory framework, we published the chemical substances in our products at ASUS REACH website at <http://csr.asus.com/english/REACH.htm>.



DO NOT throw the motherboard in municipal waste. This product has been designed to enable proper reuse of parts and recycling. This symbol of the crossed out wheeled bin indicates that the product (electrical and electronic equipment) should not be placed in municipal waste. Check local regulations for disposal of electronic products.



DO NOT throw the mercury-containing button cell battery in municipal waste. This symbol of the crossed out wheeled bin indicates that the battery should not be placed in municipal waste.

Safety information

Electrical safety

- To prevent electrical shock hazard, disconnect the power cable from the electrical outlet before relocating the system.
- When adding or removing devices to or from the system, ensure that the power cables for the devices are unplugged before the signal cables are connected. If possible, disconnect all power cables from the existing system before you add a device.
- Before connecting or removing signal cables from the motherboard, ensure that all power cables are unplugged.
- Seek professional assistance before using an adapter or extension cord. These devices could interrupt the grounding circuit.
- Ensure that your power supply is set to the correct voltage in your area. If you are not sure about the voltage of the electrical outlet you are using, contact your local power company.
- If the power supply is broken, do not try to fix it by yourself. Contact a qualified service technician or your retailer.

Operation safety

- Before installing the motherboard and adding devices on it, carefully read all the manuals that came with the package.
- Before using the product, ensure all cables are correctly connected and the power cables are not damaged. If you detect any damage, contact your dealer immediately.
- To avoid short circuits, keep paper clips, screws, and staples away from connectors, slots, sockets and circuitry.
- Avoid dust, humidity, and temperature extremes. Do not place the product in any area where it may become wet.
- Place the product on a stable surface.
- If you encounter technical problems with the product, contact a qualified service technician or your retailer.

About this guide

This user guide contains the information you need when installing and configuring the motherboard.

How this guide is organized

This guide contains the following parts:

- **Chapter 1: Product introduction**
This chapter describes the features of the motherboard and the new technology it supports.
- **Chapter 2: Hardware information**
This chapter lists the hardware setup procedures that you have to perform when installing system components. It includes description of the switches, jumpers, and connectors on the motherboard.
- **Chapter 3: BIOS setup**
This chapter tells how to change system settings through the BIOS Setup menus. Detailed descriptions of the BIOS parameters are also provided.
- **Chapter 4: Software support**
This chapter describes the contents of the support DVD that comes with the motherboard package and the software.
- **Chapter 5: Multiple GPU technology support**
This chapter describes how to install and configure multiple ATI® CrossFireX™ and NVIDIA® SLI™ graphics cards.

Where to find more information

Refer to the following sources for additional information and for product and software updates.

1. **ASUS websites**
The ASUS website provides updated information on ASUS hardware and software products. Refer to the ASUS contact information.
2. **Optional documentation**
Your product package may include optional documentation, such as warranty flyers, that may have been added by your dealer. These documents are not part of the standard package.

Conventions used in this guide

To ensure that you perform certain tasks properly, take note of the following symbols used throughout this manual.



DANGER/WARNING: Information to prevent injury to yourself when trying to complete a task.



CAUTION: Information to prevent damage to the components when trying to complete a task.



IMPORTANT: Instructions that you **MUST** follow to complete a task.



NOTE: Tips and additional information to help you complete a task.

Typography

Bold text

Indicates a menu or an item to select.

Italics

Used to emphasize a word or a phrase.

<Key>

Keys enclosed in the less-than and greater-than sign means that you must press the enclosed key.

Example: <Enter> means that you must press the Enter or Return key.

<Key1> + <Key2> + <Key3>

If you must press two or more keys simultaneously, the key names are linked with a plus sign (+).

Example: <Ctrl> + <Alt> +

SABERTOOTH X58 specifications summary

CPU	LGA1366 socket for Intel® Core™ i7 Processor Extreme Edition / Core™ i7 Processors Supports Intel® Turbo Boost Technology * Refer to www.asus.com for Intel CPU support list
Chipset	Intel® X58 / ICH10R
System bus	Up to 6.4GT/s; Intel® QuickPath Interconnect
Memory	6 x DIMM, max. 24GB, DDR3 1866 / 1800 / 1600 / 1333 / 1066 MHz, non-ECC, un-buffered memory Triple channel memory architecture Supports Intel® Extreme Memory Profile (XMP) * Hyper DIMM support is subject to the physical characteristics of individual CPUs. ** Refer to www.asus.com or this user manual for the Memory QVL (Qualified Vendors Lists)
Expansion slots	2 x PCI Express 2.0 x16 slots (dual at x16 / x16 mode) 1 x PCI Express x16 slot (at x4 mode) 2 x PCI Express x1 slots 1 x PCI slot
Multi-GPU support	Supports NVIDIA® 2-Way SLI™ Technology Supports ATI® Quad-GPU CrossFireX™ Technology
Storage	Intel® ICH10R Southbridge <ul style="list-style-type: none"> - 6 x SATA 3.0 Gb/s ports (black) - Intel® Matrix Storage Technology supports SATA RAID 0, 1, 5, and 10 Marvell® 88SE9128 PCIe SATA 6.0 Gb/s controller (DriveXpert Technology) <ul style="list-style-type: none"> - 2 x SATA 6.0 Gb/s ports (gray) - Supports EZ Backup and SuperSpeed functions JMicron® JMB362 SATA controller <ul style="list-style-type: none"> - 1 x Power eSATA 3.0 Gb/s port (SATA On-the-Go) - 1 x eSATA 3.0 Gb/s port (SATA On-the-Go)
LAN	Realtek® 8110SC Gigabit LAN controller featuring AI NET2
USB	NEC® USB 3.0 controller <ul style="list-style-type: none"> - 2 x USB 3.0/2.0 ports (at back panel) Intel® ICH10R Southbridge <ul style="list-style-type: none"> - 12 x USB 2.0/1.1 ports (6 ports at midboard; 6 ports at back panel)
IEEE 1394	VIA® VT6308P controller supports 2 x IEEE 1394a ports (one at midboard, one at back panel)

(continued on the next page)

SABERTOOTH X58 specifications summary

Audio	Realtek®ALC892 8-channel High Definition Audio CODEC <ul style="list-style-type: none"> - Supports 192kHz/24bit BD Lossless Sound - Supports Jack-Detection, Multi-Streaming, and Front Panel Jack-Retasking - Optical S/PDIF Out port at back I/O - ASUS Noise Filter
Exclusive TUF features	<p> “TUF ENGINE!” Power Design <ul style="list-style-type: none"> - 8-phase CPU Power - 2-phase Memory Power - 2-phase VTT_CPU Power - E.S.P.: Efficient Switching Power Design - TUF Components (Choke, Cap. & MOSFET; certified by military-standard) </p> <p> “Ultimate COOL!” Thermal Solutions <ul style="list-style-type: none"> - CeraM!X Heatsink Coating Technology - ASUS Fan Xpert </p> <p> “Safe & Stable!” Guardian Angel <ul style="list-style-type: none"> - MemOK! </p>
Other special features	True USB 3.0 support True SATA 6.0 Gb/s RAID support ASUS Q-Connector ASUS Q-Shield ASUS Q-LED (CPU, DRAM, VGA, Boot Device LED) ASUS Q-Slot ASUS Q-DIMM ASUS CrashFree BIOS 3 ASUS EZ Flash 2 ASUS MyLogo 2™ ASUS O.C. Profile Multi-language BIOS
Back panel I/O ports	1 x PS/2 keyboard/mouse combo port 2 x USB 3.0/2.0 ports (blue) 6 x USB 2.0/1.1 ports 1 x Optical S/PDIF Out port 1 x IEEE 1394a port 1 x LAN (RJ-45) port 1 x Power eSATA 3.0 Gb/s port (green) 1 x eSATA 3.0 Gb/s port (red) 8-channel Audio I/O ports

(continued on the next page)

SABERTOOTH X58 specifications summary

Internal I/O connectors	3 x USB connectors support additional 6 USB 2.0/1.1 ports 2 x SATA 6.0 Gb/s connectors (gray) 6 x SATA 3.0 Gb/s connectors (black) 1 x CPU Fan connector (4-pin) 1 x NB Fan connector 3 x Chassis Fan connectors (1 x 4-pin, 2 x 3-pin) 1 x Power Fan connector 1 x IEEE1394a connector 1 x COM connector Front panel audio connector 1 x S/PDIF Out header 24-pin ATX Power connector 8-pin ATX 12V Power connector System Panel (Q-Connector) 1 x MemOK! button
BIOS features	16 Mb Flash ROM, AMI BIOS, PnP, DMI 2.0, WfM 2.0, SM BIOS 2.5, ACPI 2.0a, Multi-language BIOS, ASUS EZ Flash 2, ASUS CrashFree BIOS 3
Manageability	WfM 2.0, DMI 2.0, WOL by PME, WOR by PME, PXE
Support DVD contents	Drivers ASUS Utilities ASUS Update Anti-virus software (OEM version)
Form factor	ATX form factor: 12 in. x 9.6 in. (30.5 cm x 24.4 cm)

*Specifications are subject to change without notice.

Chapter 1

1.1 Welcome!





Thank you for buying an ASUS® SABERTOOTH X58 motherboard!

The motherboard delivers a host of new features and latest technologies, making it another standout in the long line of ASUS quality motherboards!

Before you start installing the motherboard, and hardware devices on it, check the items in your package with the list below.

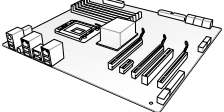
1.2 Package contents

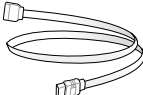
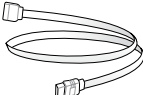
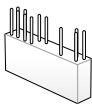
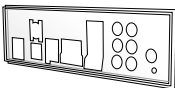
Check your motherboard package for the following items.

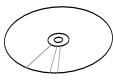
	
ASUS SABERTOOTH X58 motherboard	1 x ASUS SLI™ bridge connector
	
2 x Serial ATA 6.0 Gb/s cables with 6.0 Gb/s label	2 x Serial ATA 3.0 Gb/s cables
	
1 x 2-in-1 ASUS Q-Connector kit	1 x ASUS Q-Shield
	
User guide	Support DVD



- If any of the above items is damaged or missing, contact your retailer.
- The illustrated items above are for reference only. Actual product specifications may vary with different models.

1.3 Special features

1.3.1 Product highlights

Intel® Core™ i7 Processor Extreme Edition / Core™ i7 Processor support

This motherboard supports the latest Intel® Core™ i7 processors in LGA1366 package with integrated memory controller to support 3-channel (6 DIMMs) DDR3 memory. Supports Intel® QuickPath Interconnect (QPI) with a system bus of up to 6.4 GT/s and a max bandwidth of up to 25.6 GB/s. Intel® Core™ i7 processor is one of the most powerful and energy efficient CPUs in the world. Refer to page 2-5 for details.

Intel® X58 Chipset

The Intel® X58 Express Chipset is one of the most powerful chipset designed to support the Intel® Core™ i7 Processors with LGA1366 package and Intel® next generation system interconnect interface, Intel® QuickPath Interconnect (QPI), providing improved performance by utilizing serial point-to-point links, allowing increased bandwidth and stability. It also supports up to 36 PCI Express 2.0 lanes providing better graphics performance.

Triple-Channel DDR3 1866 / 1800 / 1600 / 1333 / 1066 support

The motherboard supports DDR3 memory that features data transfer rates of 1866 / 1800 / 1600 / 1333 / 1066 MHz to meet the higher bandwidth requirements of the latest 3D graphics, multimedia, and Internet applications. The triple-channel DDR3 architecture enlarges the bandwidth of your system memory to boost system performance. Refer to page 2-10 for details.

2-Way SLI™ and Quad-GPU CrossFireX™ support!

SABERTOOTH X58 brings you the multi-GPU choice of either SLI™ or CrossFireX™. The motherboard features the most powerful Intel® X58 platform to optimize PCIe allocation in multiple GPU configurations. Expect a brand-new gaming style you've never experienced before! Refer to Chapter 5 for details.

True USB 3.0 Support

Experience ultra-fast data transfers at 4.8 Gb/s with USB 3.0—the latest connectivity standard. Built to connect easily with next-generation components and peripherals, USB 3.0 transfers data 10X faster and is also backward compatible with USB 2.0 components. Refer to page 2-25 for details.

True Serial ATA 6.0 Gb/s RAID support

Supporting the next-generation Serial ATA (SATA) storage interface, this motherboard delivers up to 6.0 Gb/s data transfer rates. Additionally, get enhanced scalability, faster data retrieval, double the bandwidth of current bus systems. Refer to page 2-30 for details.

Green ASUS

This motherboard and its packaging comply with the European Union's Restriction on the use of Hazardous Substances (RoHS). This is in line with the ASUS vision of creating environment-friendly and recyclable products/packaging to safeguard consumers' health while minimizing the impact on the environment.

1.3.2 “TUF ENGINE!” Power Design

E.S.P. – Efficient Switching Power Design

Exclusively for this motherboard, the switching power design is provided not only for the CPU, but also for other key components such as chipsets. E.S.P. dramatically improves system efficiency and reduces heat generation.

TUF Components (Choke, Cap. & MOSFET; certified by military standard)

Get rugged performance even in the most challenging conditions with robust chokes, capacitors, and MOSFETs – certified through third-party, military-grade testing.

1.3.3 “Ultimate COOL!” Thermal Solutions

CeraM!X Heatsink Coating Technology

Innovative ceramics actively conducts heat away from the system. It replaces traditional antioxidants to dissipate heat better with its microscopic irregular surface and enlarged area. Better cooling leads to overall improvement in system stability.



DO NOT uninstall the heatsink module by yourself. Doing so may bend the tubing and affect the heat dissipation performance.

ASUS Fan Xpert

ASUS Fan Xpert intelligently allows you to adjust both the CPU and chassis fan speeds according to different ambient temperatures caused by different climate conditions in different geographic regions and your PC's loading. The built-in variety of useful profiles offer flexible controls of fan speed to achieve a quiet and cool environment. Refer to page 4-4 for details.

1.3.4 “Safe & Stable!” Guardian Angel

MemOK!

Memory compatibility is among the top concerns during computer upgrades. Worry no more. MemOK! is the fastest memory booting solution today. This remarkable memory rescue tool requires nothing but a push of a button to patch memory issues and get your system up and running in no time. The technology is able to determine failsafe settings that can dramatically improve your system booting success. Refer to page 2-24 for details.

1.3.5 ASUS exclusive features

ASUS Q-Design

ASUS Q-Design enhances your DIY experience. All of Q-LED, Q-Slot and Q-DIMM design speed up and simplify the DIY process!

ASUS Q-Shield

ASUS Q-Shield's special design makes it convenient and easy to install on your motherboard. With better electric conductivity, it ideally protects your motherboard against static electricity and shields it against Electronic Magnetic Interference (EMI).

ASUS Q-Connector

ASUS Q-Connector allows you to easily connect or disconnect the chassis front panel cables to the motherboard. This unique module eliminates the trouble of connecting the system panel cables one at a time and avoiding wrong cable connections. Refer to page 2-37 for details.

ASUS EZ-Flash 2

ASUS EZ Flash 2 is a user-friendly utility that allows you to update the BIOS without using a bootable floppy disk or an OS-based utility. Refer to page 3-4 for details.

ASUS O.C. Profile

The motherboard features the ASUS O.C. Profile that allows you to conveniently store or load multiple BIOS settings. The BIOS settings can be stored in the CMOS or a separate file, giving you the freedom to share and distribute your favorite settings. Refer to page 3-35 for details.

ASUS MyLogo2™

This feature allows you to convert your favorite photo into a 256-color boot logo for a more colorful and vivid image on your screen.

ASUS Multi-language BIOS

The multi-language BIOS allows you to select the language of your choice from the available options. The localized BIOS setup menu helps you configure your system easier and faster.

2.1 Before you proceed

Take note of the following precautions before you install motherboard components or change any motherboard settings.



-
- Unplug the power cord from the wall socket before touching any component.
 - Before handling components, use a grounded wrist strap or touch a safely grounded object or a metal object, such as the power supply case, to avoid damaging them due to static electricity.
 - Hold components by the edges to avoid touching the ICs on them.
 - Whenever you uninstall any component, place it on a grounded antistatic pad or in the bag that came with the component.
 - Before you install or remove any component, ensure that the ATX power supply is switched off or the power cord is detached from the power supply. Failure to do so may cause severe damage to the motherboard, peripherals, or components.
-

2.2 Motherboard overview

2.2.1 Motherboard layout

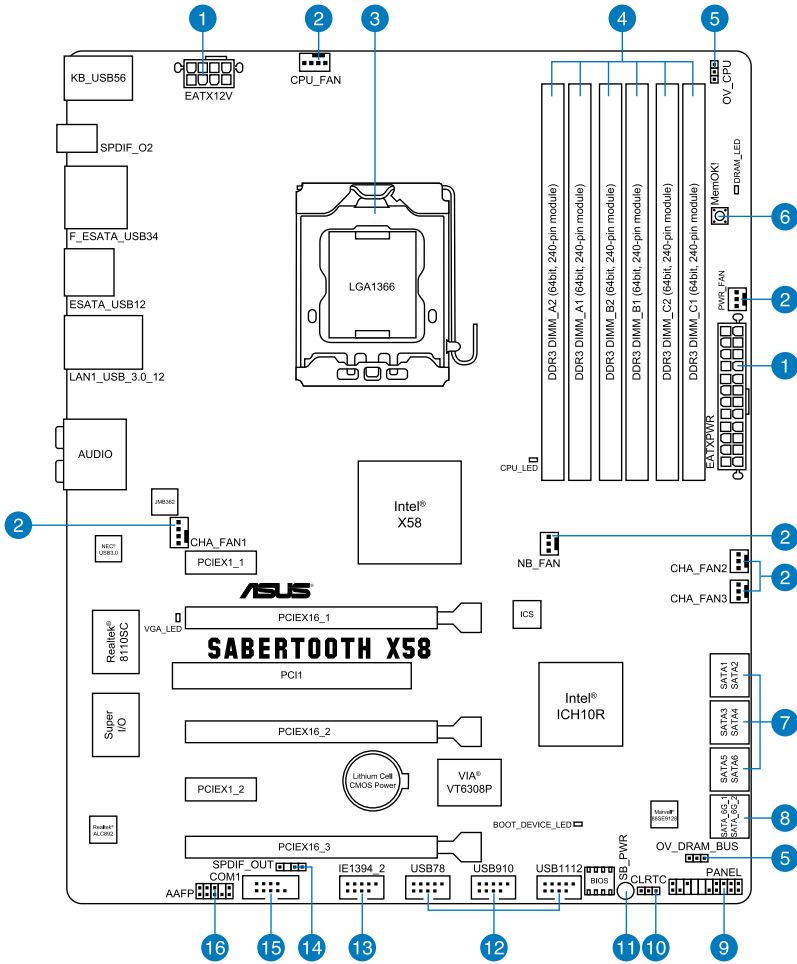

Refer to **2.8 Connectors** for more information about rear panel connectors and internal connectors.

2.2.2 Layout contents

Connectors/Jumpers/Slots	Page
1. ATX power connectors (24-pin EATXPWR, 8-pin EATX12V)	2-35
2. CPU, chassis, power, and NB fan connectors (4-pin CPU_FAN, 4-pin CHA_FAN1, 3-pin CHA_FAN2-3, 3-pin PWR_FAN, 3-pin NB_FAN)	2-33
3. LGA1366 CPU Socket	2-5
4. DDR3 DIMM slots	2-10
5. CPU / DRAM Bus overvoltage settings (3-pin OV_CPU, OV_DRAM_BUS)	2-23
6. MemOK! switch	2-24
7. Intel® ICH10R Serial ATA 3.0 Gb/s connectors (7-pin SATA1-6 [black])	2-29
8. Marvell® Serial ATA 6.0 Gb/s connectors (7-pin SATA_6G_1, 7-pin SATA_6G_2 [gray])	2-30
9. System panel connector (20-8 pin PANEL)	2-36
10. Clear RTC RAM (3-pin CLRTC)	2-22
11. Standby power LED (SB_PWR)	2-38
12. USB connectors (10-1 pin USB78, USB910, USB1112)	2-31
13. IEEE 1394a port connector (10-1 pin IE1394_2)	2-32
14. Digital audio connector (4-1 pin SPDIF_OUT)	2-34
15. Serial port connector (10-1 pin COM1)	2-32
16. Front panel audio connector (10-1 pin AAFP)	2-34

2.2.3 Placement direction

When installing the motherboard, ensure that you place it into the chassis in the correct orientation. The edge with external ports goes to the rear part of the chassis as indicated in the image below.

2.2.4 Screw holes

Place nine screws into the holes indicated by circles to secure the motherboard to the chassis.



DO NOT overtighten the screws! Doing so can damage the motherboard.

Place this side towards
the rear of the chassis

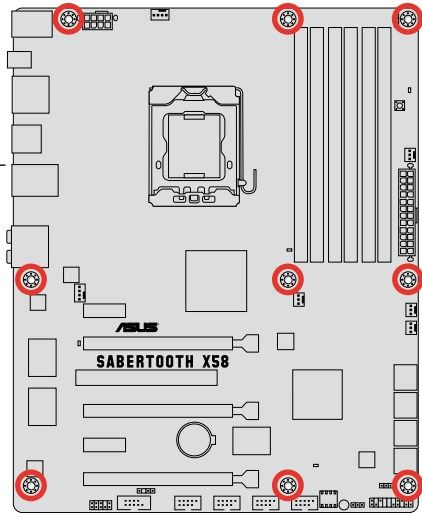

2.3 Central Processing Unit (CPU)

The motherboard comes with a surface mount LGA1366 socket designed for the Intel® Core™ i7 Processor Extreme Edition / Core™ i7 Processor.



Ensure that all power cables are unplugged before installing the CPU.



- Upon purchase of the motherboard, ensure that the PnP cap is on the socket and the socket contacts are not bent. Contact your retailer immediately if the PnP cap is missing, or if you see any damage to the PnP cap/socket contacts/motherboard components. ASUS will shoulder the cost of repair only if the damage is shipment/transit-related.
- Keep the cap after installing the motherboard. ASUS will process Return Merchandise Authorization (RMA) requests only if the motherboard comes with the cap on the LGA1366 socket.
- The product warranty does not cover damage to the socket contacts resulting from incorrect CPU installation/removal, or misplacement/loss/incorrect removal of the PnP cap.

2.3.1 Installing the CPU

To install a CPU:

1. Locate the CPU socket on the motherboard.

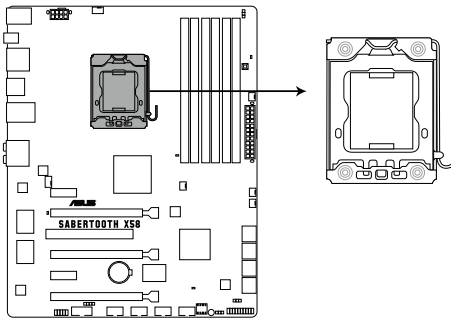

SABERTOOTH X58 CPU LGA1366 socket



Before installing the CPU, ensure that the cam box is facing towards you and the load lever is on your left.

2. Press the load lever with your thumb (A), then move it to the left (B) until it is released from the retention tab.



To prevent damage to the socket pins, do not remove the PnP cap unless you are installing a CPU.

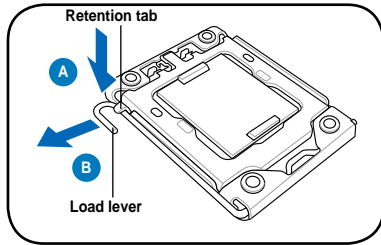

3. Lift the load lever in the direction of the arrow to a 135° angle.
4. Lift the load plate with your thumb and forefinger to a 100° angle.

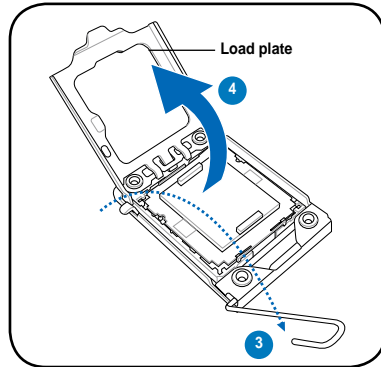

5. Remove the PnP cap from the CPU socket.

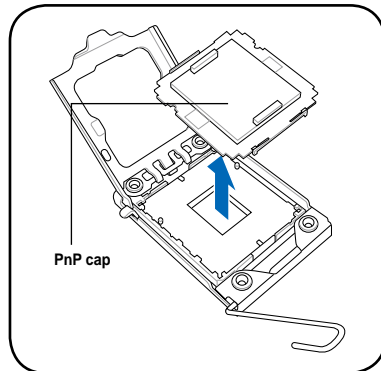

- Position the CPU over the socket, ensuring that the gold triangle is on the bottom-left corner of the socket, and then fit the socket alignment key into the CPU notch.



The CPU fits in only one correct orientation. **DO NOT** force the CPU into the socket to prevent bending the connectors on the socket and damaging the CPU!

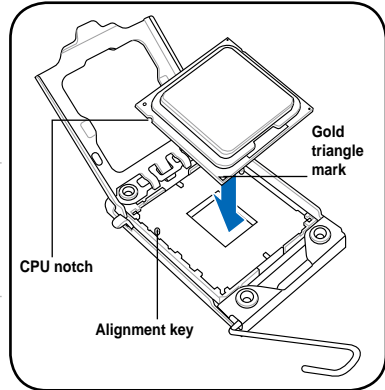

- Apply some Thermal Interface Material to the exposed area of the CPU that the heatsink will be in contact with, ensuring that it is spread in an even thin layer.



Some heatsinks come with pre-applied thermal paste. If so, skip this step.



The Thermal Interface Material is toxic and inedible. **DO NOT** eat it. If it gets into your eyes or touches your skin, wash it off immediately, and seek professional medical help.

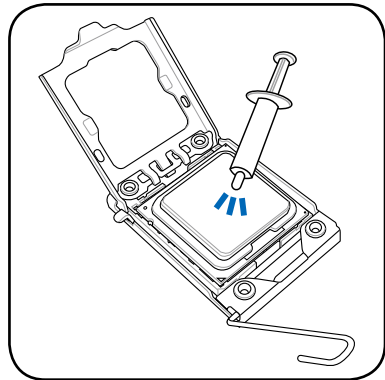

To prevent contaminating the paste, **DO NOT** spread the paste with your finger directly.

- Close the load plate (A), then push the load lever (B) until it snaps into the retention tab.

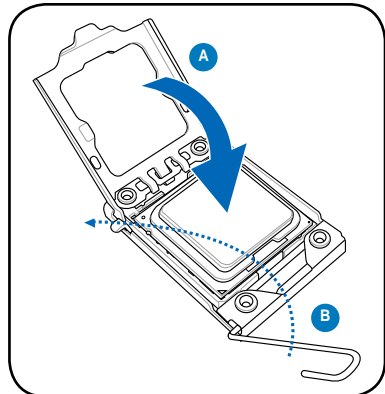

2.3.2 Installing the CPU heatsink and fan

The Intel® LGA1366 processor requires a specially designed heatsink and fan assembly to ensure optimum thermal condition and performance.



- When you buy a boxed Intel® processor, the package includes the CPU fan and heatsink assembly. If you buy a CPU separately, ensure that you use only Intel®-certified multi-directional heatsink and fan.
- Your Intel® LGA1366 heatsink and fan assembly comes in a push-pin design and requires no tool to install.



If you purchased a separate CPU heatsink and fan assembly, ensure that the Thermal Interface Material is properly applied to the CPU heatsink or CPU before you install the heatsink and fan assembly.



Ensure that you have installed the motherboard to the chassis before you install the CPU fan and heatsink assembly.

To install the CPU heatsink and fan:

1. Place the heatsink on top of the installed CPU, ensuring that the four fasteners match the holes on the motherboard.
2. Push down two fasteners at a time in a diagonal sequence to secure the heatsink and fan assembly in place.

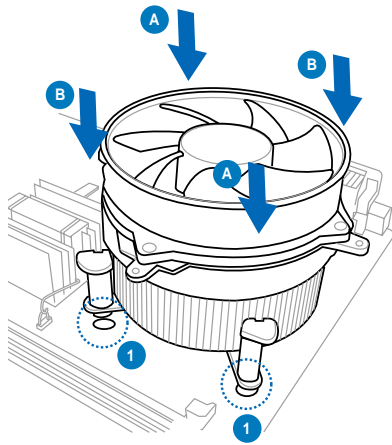
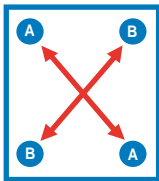

Orient the heatsink and fan assembly such that the CPU fan cable is closest to the CPU fan connector.

3. Connect the CPU fan cable to the connector on the motherboard labeled CPU_FAN.

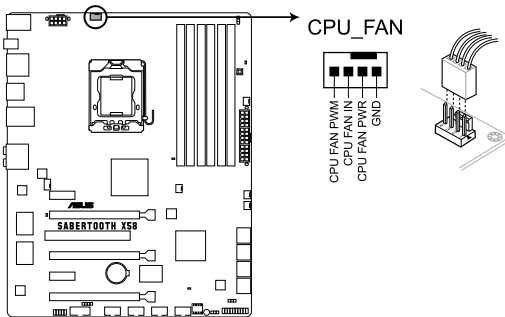

SABERTOOTH X58 CPU fan connector



DO NOT forget to connect the CPU fan connector! Hardware monitoring errors can occur if you fail to plug this connector.

2.3.3 Uninstalling the CPU heatsink and fan

To uninstall the CPU fan and fan:

1. Disconnect the CPU fan cable from the connector on the motherboard.
2. Rotate each fastener counterclockwise.
3. Pull up two fasteners at a time in a diagonal sequence to disengage the heatsink and fan assembly from the motherboard.

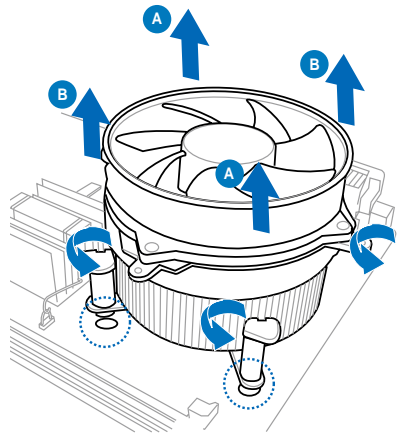
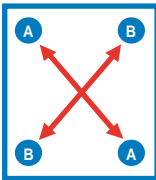

4. Carefully remove the heatsink and fan assembly from the motherboard.

2.4 System memory

2.4.1 Overview

The motherboard comes with six Double Data Rate 3 (DDR3) Dual Inline Memory Modules (DIMM) sockets.

A DDR3 module has the same physical dimensions as a DDR2 DIMM but is notched differently to prevent installation on a DDR2 DIMM socket. DDR3 modules are developed for better performance with less power consumption.

The figure illustrates the location of the DDR3 DIMM sockets:

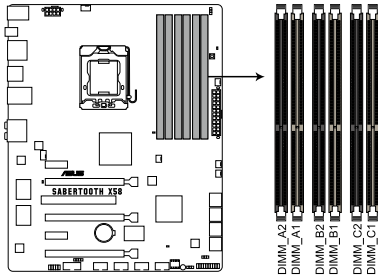

SABERTOOTH X58 240-pin DDR3 DIMM sockets

Recommended memory configurations

One DIMM:

You may install one memory module in slot A1, B1 or C1 as a single-channel operation.

Two DIMMs (dual-channel operation):

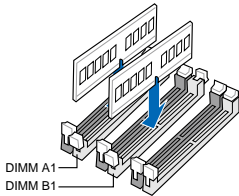

Three DIMMs (triple-channel operation):

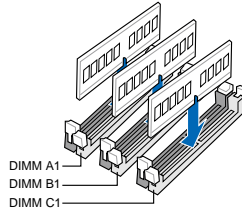

Four DIMMs (triple-channel operation):

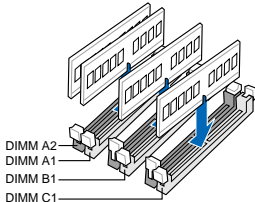

Six DIMMs (triple-channel operation):

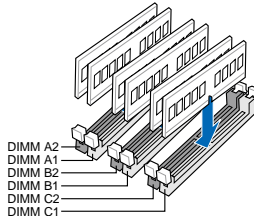

Due to Intel CPU spec definition, the system will not boot if only one DIMM is installed in DIMM slot A2, B2, or C2. Follow the illustrations above for recommended memory configuration.

2.4.2 Memory configurations

You may install 1GB, 2GB and 4GB unbuffered and non-ECC DDR3 DIMMs into the DIMM sockets.



- You may install varying memory sizes in Channel A, Channel B and Channel C. The system maps the total size of the lower-sized channel for the dual-channel or triple-channel configuration. Any excess memory from the higher-sized channel is then mapped for single-channel operation.
- Due to Intel spec definition, X.M.P. DIMMs and DDR3-1600 are supported for one DIMM per channel only.
- According to Intel® CPU spec, DIMM voltage below 1.65V is recommended to protect the CPU.
- Always install DIMMs with the same CAS latency. For optimum compatibility, we recommend that you obtain memory modules from the same vendor.
- Due to the memory address limitation on 32-bit Windows OS, when you install 4GB or more memory on the motherboard, the actual usable memory for the OS can be about 3GB or less. For effective use of memory, we recommend that you do any of the following:
 - Use a maximum of 3GB system memory if you are using a 32-bit Windows OS.
 - Install a 64-bit Windows OS when you want to install 4GB or more on the motherboard.For more details, refer to the Microsoft® support site at <http://support.microsoft.com/kb/929605/en-us>.
- This motherboard does not support DIMMs made up of 512Mb (64MB) chips or less (Memory chip capacity counts in Megabit, 8 Megabit/Mb = 1 Megabyte/MB).



- The default memory operation frequency is dependent on its Serial Presence Detect (SPD), which is the standard way of accessing information from a memory module. Under the default state, some memory modules for overclocking may operate at a lower frequency than the vendor-marked value. To operate at the vendor-marked or at a higher frequency, refer to section **3.5 Ai Tweaker menu** for manual memory frequency adjustment.
- For system stability, use a more efficient memory cooling system to support a full memory load (6 DIMMs) or overclocking condition.

SABERTOOTH X58 Motherboard Qualified Vendors Lists (QVL) DDR3-1866 MHz capability

Vendor	Part No.	Size	SS/DS	Chip Brand	Chip NO.	Timing Label(Bios)	Voltage	DIMM socket support (Optional)	
								A*	B*
CORSAIR	TR3X3G1866C9DVer4.1(XMP)	3GB(3 x 1GB)	SS	N/A	Heat-Sink Package	9-9-9-24(1866-9-9-9-24)	1.65	V	V
CORSAIR	TR3X6G1866C9DVer4.1(XMP)	6GB(3 x 2GB)	DS	N/A	Heat-Sink Package	9-9-9-24(1866-9-9-9-24)	1.65	V	V
G.SKILL	F3-15000CL9D-4GBRH (XMP)	4GB(2 x 2GB)	DS	N/A	Heat-Sink Package	9-9-9-24 (1333-9-9-9-24)	1.65		V
G.SKILL	F3-15000CL9D-4GBTD(XMP)	4GB(2 x 2GB)	DS	N/A	Heat-Sink Package	9-9-9-24 (1333-9-9-9-24)	1.65		V
KINGSTON	KHX1866C9D3T1K3/6GX(XMP)	6GB(3 x 2GB)	DS	N/A	Heat-Sink Package	9(1333-9-9-9-24)	1.65		V
OCZ	OCZ3RPR1866C9LV3GK	3GB(3 x 1GB)	SS	N/A	Heat-Sink Package	9-9-9(1066-7-7-7-20)	1.65	V	V
OCZ	OCZ3P1866LV4GK	4GB(2 x 2GB)	DS	N/A	Heat-Sink Package	9-9-9(1067-9-9-9-24)	1.65	V	V
OCZ	OCZ3P1866C9LV6GK	6GB(3 x 2GB)	DS	N/A	Heat-Sink Package	9-9-9(1066-7-7-7-20)	1.65	V	V
OCZ	OCZ3RPR1866C9LV6GK	6GB(3 x 2GB)	DS	N/A	Heat-Sink Package	9-9-9(1066-7-7-7-20)	1.65	V	V
Super Talent	W1866UX2GB(XMP)	2GB(2 x 1GB)	SS	N/A	Heat-Sink Package	8-8-8-24(1333-9-9-9-24)	N/A	V	
Patriot	PVS32G1866LKK(XMP)	2GB(2 x 1GB)	SS	N/A	Heat-Sink Package	8-8-8-24(1866-8-8-8-24)	1.9	V	V
Team	BoxP/N:TXD34096M1866HC7DC-L (TXD32048M1866HC7-L)(XMP)	4GB(2 x 2GB)	DS	N/A	Heat-Sink Package	7-7-7-21(1333-9-9-9-24)	1.65	V	V

SABERTOOTH X58 Motherboard Qualified Vendors Lists (QVL) DDR3-1800 MHz capability

Vendor	Part No.	Size	SS/DS	Chip Brand	Chip NO.	Timing Label(Bios)	Voltage	DIMM socket support (Optional)	
								A*	B*
CORSAIR	BoxP/N-TW3X4G1800C8DF (CM3X2G1800C8D)Ver4.1(XMP)	4GB(2 x 2GB)	DS	N/A	Heat-Sink Package	8-8-8-24	1.80	V	
KINGSTON	KHX1800C9D3T1K3/6GX(XMP)	6GB(3 x 2GB)	DS	N/A	Heat-Sink Package	(1333-9-9-9-24)	1.65-1.85	V	V
OCZ	OCZ3P18002GK	2GB(2 x 1GB)	SS	N/A	Heat-Sink Package	8	1.65-1.85	V	V
Transcend	TX1800KLU-2GK(XMP)	2GB(2 x 1GB)	SS	N/A	Heat-Sink Package	8	1.65-1.85	V	V
Patriot	PVS32G1800LLKN(EPP)	2GB(2 x 1GB)	SS	N/A	Heat-Sink Package	8-8-8-20(1066-7-7-7-20)	1.9	V	V

SABERTOOTH X58 Motherboard Qualified Vendors Lists (QVL)

DDR3-1600MHz capability

Vendor	Part No.	Size	SS/DS	Chip Brand	Chip NO.	Timing Table(Bios)	Voltage	DIMM socket support (Optional)			
								A*	B*	C*	D*
A-DATA	AD31600G001GMU	1GB	SS	N/A	Heat-Sink Package	9-9-9-24 (1333-8-8-8-24)	1.65-1.85	V	V	V	V
A-DATA	AX3U1600GB1G9-AG	2GB(2 x 1GB)	SS	N/A	Heat-Sink Package	9-9-9-24 (1333-8-8-8-24)	1.65-1.85	V	V	V	V
A-DATA	AX3U1600PB1G8-2P	2GB(2 x 1GB)	SS	N/A	Heat-Sink Package	8-8-8-24(1333-9-9-9-24)	1.65-1.85	V	V	V	V
A-DATA	AD31600E001GMU	3GB(3 x 1GB)	SS	N/A	Heat-Sink Package	8-8-8-24(1333-9-9-9-24)	1.65-1.85	V	V	V	V
A-DATA	AX3U1600GB1G9-3G	3GB(3 x 1GB)	SS	N/A	Heat-Sink Package	9-9-9-24 (1333-8-8-8-24)	1.65-1.85	V	V	V	V
A-DATA	AX3U1600PB1G8-3P	3GB(3 x 1GB)	SS	N/A	Heat-Sink Package	8-8-8-24(1333-9-9-9-24)	1.65-1.85	V	V	V	V
A-DATA	AX3U1600GB2G9-AG(XMP)	4GB(2 x 2GB)	DS	N/A	Heat-Sink Package	9-9-9-24 (1600-9-9-9-24)	1.65-1.85	V	V	V	V
A-DATA	AX3U1600XB2G7-EF(XMP)	4GB(2 x 2GB)	DS	N/A	Heat-Sink Package	7-7-7-20(1333-9-9-9-24)	1.75-1.85	V	V	V	V
A-DATA	AD31600F002GMU(XMP)	6GB(3 x 2GB)	DS	N/A	Heat-Sink Package	7-7-7-20(1333-9-9-9-24)	1.75-1.85	V	V	V	V
A-DATA	AX3U1600GB2G9-3G(XMP)	6GB(3 x 2GB)	DS	N/A	Heat-Sink Package	9-9-9-24 (1600-9-9-9-24)	1.65-1.85	V	V	V	V
A-DATA	AX3U1600GB2G9-3G(XMP)	6GB(3 x 2GB)	DS	N/A	Heat-Sink Package	9-9-9-24 (1600-9-9-9-24)	1.65-1.85	V	V	V	V
A-DATA	AX3U1600XB2G7-FF(XMP)	6GB(3 x 2GB)	DS	N/A	Heat-Sink Package	7-7-7-20(1333-9-9-9-24)	1.75-1.85	V	V	V	V
CORSAIR	TR3X3G1600C8D	3GB(3 x 1GB)	SS	N/A	Heat-Sink Package	8-8-8-24(1600-8-8-8-24)	1.65	V	V	V	V
CORSAIR	TR3X3G1600C8DVer2.1(XMP)	3GB(3 x 1GB)	SS	N/A	Heat-Sink Package	8-8-8-24(1601-8-8-8-24)	1.65	V	V	V	V
CORSAIR	TR3X3G1600C9Ver1.1(XMP)	3GB(3 x 1GB)	SS	N/A	Heat-Sink Package	9-9-9-24(1601-9-9-9-24)	1.65	V	V	V	V
CORSAIR	BoxP/N:TW3X4G1600C9DHXNV(CM3X2G1600C9DHXNV)Ver4.1	4GB(2 x 2GB)	DS	N/A	Heat-Sink Package	(1333-9-9-9-24)	1.80	V	V	V	V
CORSAIR	CMD4GX3M2A1600C8(XMP)	4GB(2 x 2GB)	DS	N/A	Heat-Sink Package	8-8-8-24(1333-9-9-9-24)	1.65	V	V	V	V
CORSAIR	TR3X6G1600C8D	6GB(3 x 2GB)	DS	N/A	Heat-Sink Package	8-8-8-24(1600-8-8-8-24)	1.65	V	V	V	V
CORSAIR	TR3X6G1600C8DVer2.1(XMP)	6GB(3 x 2GB)	DS	N/A	Heat-Sink Package	8-8-8-24(1601-8-8-8-24)	1.65	V	V	V	V
CORSAIR	TR3X6G1600C9Ver2.1(XMP)	6GB(3 x 2GB)	DS	N/A	Heat-Sink Package	9-9-9-24(1333-9-9-9-24)	1.65	V	V	V	V
Crucial	BL12864BA1608.8SFB(XMP)	1GB	SS	N/A	Heat-Sink Package	(1601-8-8-8-24)	1.8	V	V	V	V
Crucial	BL25664BN1608.16FF(XMP)	2GB	DS	N/A	Heat-Sink Package	8-8-8-24 (1333-9-9-9-24)	1.65	V	V	V	V
G.SKILL	F3-12800CL9D-2GBNQ	2GB(2 x 1GB)	SS	N/A	Heat-Sink Package	(1333-9-9-9-24)	1.6	V	V	V	V
G.SKILL	F3-12800CL9D-4GBRL	2GB(2 x 1GB)	SS	N/A	Heat-Sink Package	(1333-9-9-9-24)	1.6	V	V	V	V
G.SKILL	F3-12800CL7D-4GBRH(XMP)	4GB(2 x 2GB)	DS	N/A	Heat-Sink Package	7-7-7-24(1333-8-8-8-24)	1.65	V	V	V	V
G.SKILL	F3-12800CL8T-6GBHK(XMP)	6GB(3 x 2GB)	DS	N/A	Heat-Sink Package	8-8-8-21(1333-8-8-8-21)	1.6-1.65	V	V	V	V
G.SKILL	F3-12800CL8T-6GBPI(XMP)	6GB(3 x 2GB)	DS	N/A	Heat-Sink Package	8-8-8-21(1066-8-8-8-20)	1.6-1.65	V	V	V	V
G.SKILL	F3-12800CL9T-6GBNQ	6GB(3 x 2GB)	DS	N/A	Heat-Sink Package	9-9-9-24(1601-9-9-9-24)	1.5-1.6	V	V	V	V
GEMIL	GV34GB1600C8DC	4GB(2 x 2GB)	DS	N/A	Heat-Sink Package	8-8-8-28(1600-8-8-8-28)	1.6	V	V	V	V
KINGMAX	FLGD45F-B8K9G-NAES	1GB	SS	KINGMAX	KFB8FNGXF-ANX-12A	9(1600-9-9-9-28)	1.5	V	V	V	V
KINGMAX	FLGE85F-B8K9G-NEES	2GB	DS	KINGMAX	KFB8FNGXF-ANX-12A	9(1600-9-9-9-28)	1.5	V	V	V	V
KINGSTON	KHX1600C9D3K3/12GX(XMP)	12GB(3 x 4GB)	DS	N/A	Heat-Sink Package	(1066-7-7-7-20)	1.65	V	V	V	V
KINGSTON	KHX1600C8D3K3/4GX(XMP)	4GB(2 x 2GB)	DS	N/A	Heat-Sink Package	8(1333-9-9-9-24)	1.65	V	V	V	V
KINGSTON	KHX1600C9D3K3/6GX(XMP)	6GB(3 x 2GB)	DS	N/A	Heat-Sink Package	9(1333-9-9-9-24)	1.65	V	V	V	V
OCZ	OCZ3P1600EB1G	1GB	SS	N/A	Heat-Sink Package	7-6-6-24(1333-7-7-7-20)	N/A	V	V	V	V
OCZ	OCZ3G1600LV3GK	3GB(3 x 1GB)	SS	N/A	Heat-Sink Package	8-8-8(1066-7-7-7-20)	1.65	V	V	V	V
OCZ	OCZ3P1600LV3GK	3GB(3 x 1GB)	SS	N/A	Heat-Sink Package	7-7-7(1066-7-7-7-20)	1.65	V	V	V	V
OCZ	OCZ3P1600EB4GK	4GB(2 x 2GB)	DS	N/A	Heat-Sink Package	7-7-6(1333-7-7-7-20)	1.8	V	V	V	V
OCZ	OCZ3P1600LV4GK	4GB(2 x 2GB)	DS	N/A	Heat-Sink Package	7-7-7(1067-7-7-7-20)	1.65	V	V	V	V
OCZ	OCZ3X16004GK(XMP)	4GB(2 x 2GB)	DS	N/A	Heat-Sink Package	7-7-7(1066-7-7-7-16)	1.9	V	V	V	V
OCZ	OCZ3FXE1600C7LV6GK	6GB(3 x 2GB)	DS	N/A	Heat-Sink Package	7-7-7(1066-9-9-9-24)	1.65	V	V	V	V
OCZ	OCZ3G1600LV6GK	6GB(3 x 2GB)	DS	N/A	Heat-Sink Package	8-8-8(1066-7-7-7-20)	1.65	V	V	V	V
OCZ	OCZ3G1600LV6GK	6GB(3 x 2GB)	DS	N/A	Heat-Sink Package	8-8-8(1066-7-7-7-16)	1.65	V	V	V	V
OCZ	OCZ3X1600LV6GK(XMP)	6GB(3 x 2GB)	DS	N/A	Heat-Sink Package	8-8-8(1600-8-8-8-24)	1.65	V	V	V	V
OCZ	OCZ3X1600LV6GK(XMP)	6GB(3 x 2GB)	DS	N/A	Heat-Sink Package	8-8-8(1066-7-7-7-16)	1.65	V	V	V	V
Super Talent	WB160UV6GB(XMP)	6GB(3 x 2GB)	DS	N/A	Heat-Sink Package	(1333-8-8-8-24)	N/A	V	V	V	V
Cell Shock	CS322271	2GB(2 x 1GB)	DS	N/A	Heat-Sink Package	7-7-7-14(1066-7-7-7-20)	1.7-1.9	V	V	V	V
Elixir	M2F2G64CB84HAN-DG	2GB	DS	Elixir	N2CB1G80AN-DG	9(1333-9-9-9-28)	N/A	V	V	V	V
Elixir	M2Y2G64CB84HAN-DG(XMP)	2GB	DS	N/A	Heat-Sink Package	(1333-8-8-8-24)	N/A	V	V	V	V
Mushkin	998657	4GB(2 x 2GB)	DS	N/A	Heat-Sink Package	7-7-7-20	N/A	V	V	V	V
Mushkin	998659(XMP)	6GB(3 x 2GB)	DS	N/A	Heat-Sink Package	9-9-9-24(1333-9-9-9-24)	1.5-1.6	V	V	V	V
Patriot	PVT33G1600ELK	3GB(3 x 1GB)	SS	N/A	Heat-Sink Package	9-9-9-24(1066-7-7-7-20)	1.65	V	V	V	V
PATRIOT	PGS34G1600LLKA	4GB(2 x 2GB)	DS	N/A	Heat-Sink Package	7-7-7-20(1067-7-7-7-20)	1.7	V	V	V	V
Patriot	PVS34G1600ELK	4GB(2 x 2GB)	DS	N/A	Heat-Sink Package	9-9-9-24(1066-7-7-7-20)	1.8	V	V	V	V
Patriot	PVS34G1600LLK	4GB(2 x 2GB)	DS	N/A	Heat-Sink Package	7-7-7-20(1066-7-7-7-20)	2.0	V	V	V	V
Patriot	PVT36G1600ELK	6GB(3 x 2GB)	DS	N/A	Heat-Sink Package	9-9-9-24(1066-7-7-7-20)	1.65	V	V	V	V
Patriot	PVT36G1600ELK	6GB(3 x 2GB)	DS	N/A	Heat-Sink Package	9-9-9-24(1600-7-7-7-20)	1.65	V	V	V	V
Patriot	PVT36G1600LLK(XMP)	6GB(3 x 2GB)	DS	N/A	Heat-Sink Package	8-8-8-24(1067-7-7-7-20)	1.65	V	V	V	V

SABERTOOTH X58 Motherboard Qualified Vendors Lists (QVL) DDR3-1333MHz capability

Vendor	Part No.	Size	SS/DS	Chip Brand	Chip NO.	Timing Label(Bios)	Voltage	DIMM socket support (Optional)			
								A*	B*	C*	D*
A-DATA	AD3133301GOU	1GB	SS	A-DATA	AD30908C8D-15IG	(1333-9-9-9-24)	N/A	V	V	V	V
A-DATA	AD31333002GOU	2GB	DS	A-DATA	AD30908C8D-15IG	(1333-9-9-9-24)	N/A	V	V	V	V
A-DATA	AD3U1333B2G9-2	2GB	DS	A-DATA	AD30908C8D-15IG	(1333-9-9-9-24)	N/A	V	V	V	V
A-DATA	AX3U1333PB2G7-2P	4GB(2 x 2GB)	DS	N/A	Heat-Sink Package	7-7-7-20(1333-9-9-9-24)	1.65-1.85	V	V	V	V
A-DATA	AD3U1333C4G9-B	4GB	DS	Hynix	H5TQ2G83AFRH9C	1333-9-9-9-24	N/A	V	V	V	V
A-DATA	AD31333E002G0U	6GB(3 x 2GB)	DS	N/A	Heat-Sink Package	7-7-7-20(1333-9-9-9-24)	1.65-1.85	V	V	V	V
A-DATA	AX3U1333PB2G7-3P	6GB(3 x 2GB)	DS	N/A	Heat-Sink Package	7-7-7-20(1333-9-9-9-24)	1.65-1.85	V	V	V	V
CORSAIR	TR3X3G1333C9 (Ver2.1)	3GB(3 x 1GB)	SS	N/A	Heat-Sink Package	9-9-9-24(1333-9-9-9-24)	1.5	V	V	V	V
CORSAIR	CM3X1024-1333C9DHX	1GB	DS	N/A	Heat-Sink Package	(1333-9-9-9-24)	1.1	V	V		
CORSAIR	BoxPN.TW1N3X2048-1333C9 (CM3X1024-1333C9)Ver1.1	2GB(2 x 1GB)	DS	N/A	Heat-Sink Package	9-9-9-24(1066-7-7-7-20)	1.70	V	V	V	V
CORSAIR	BoxPN.TW1X34G1333C9DHX (CM3X2048-1333C9DHX)Ver3.2	4GB(2 x 2GB)	DS	N/A	Heat-Sink Package	9-9-9-24(1066-7-7-7-20)	1.70	V	V		
CORSAIR	TR3X6G1333C9 (Ver2.1)	6GB(3 x 2GB)	DS	N/A	Heat-Sink Package	9-9-9-24(1333-9-9-9-24)	1.5	V	V	V	V
Crucial	CT12864BA1339.8FF	1GB	SS	MICRON	D9KPT	9(1333-9-9-9-24)	N/A	V	V	V	V
Crucial	CT12864BA1339.8SFD	1GB	SS	MICRON	MT8JF12864AY-1G4D1	(1333-9-9-9-24)	N/A	V	V	V	V
Crucial	CT12872BA1339.9FF	1GB	SS	MICRON	D9KPT(ECC)	9(1333-9-9-9-24)	N/A	V	V	V	V
Crucial	BL25664BN1337.16FF(XMP)	2GB	DS	N/A	Heat-Sink Package	7-7-7-24 (1333-9-9-9-24)	1.65	V	V	V	
Crucial	CT25664BA1339.16FF	2GB	DS	MICRON	D9KPT	9(1333-9-9-9-24)	N/A	V	V	V	V
Crucial	CT25664BA1339.16SFD	2GB	DS	MICRON	D9JNM	(1333-9-9-9-24)	N/A	V	V	V	V
Crucial	CT25672BA1339.18FF	2GB	DS	MICRON	D9KPT(ECC)	9(1333-9-9-9-24)	N/A	V	V	V	V
Crucial	BL25664BA1336.16SFB1	4GB(2 x 2GB)	DS	NA	Heat-Sink Package	6-6-6-20(1333-9-9-9-24)	1.8	V	V	V	V
ELPIDA	EBJ10UE8BAWO-DJ-E	1GB	SS	ELPIDA	J1108BABG-DJ-E	9(1333-9-9-9-24)	N/A	V	V	V	V
ELPIDA	EBJ21UE8BAWO-DJ-E	2GB	DS	ELPIDA	J1108BABG-DJ-E	9(1333-9-9-9-24)	N/A	V	V	V	V
G.SKILL	F3-10600CL7D-2GBPI	2GB(2 x 1GB)	SS	N/A	Heat-Sink Package	(1337-7-7-7-18)	1.65	V	V		
G.SKILL	F3-10600CL8D-2GBHK	2GB(2 x 1GB)	SS	N/A	Heat-Sink Package	(1337-8-8-8-22)	1.65	V	V	V	V
G.SKILL	F3-10666CL7T-6GBPK(XMP)	2GB	DS	N/A	Heat-Sink Package	7-7-7-18(1333-7-7-7-18)	1.5-1.6	V	V	V	V
G.SKILL	F3-10666CL7D-4GBPI(XMP)	4GB(2 x 2GB)	DS	N/A	Heat-Sink Package	7-7-7-21(1333-9-9-9-24)	1.5	V	V	V	V
G.SKILL	F3-10666CL7D-4GBRH(XMP)	4GB(2 x 2GB)	DS	N/A	Heat-Sink Package	7-7-7-21(1333-9-9-9-24)	1.5	V	V	V	V
G.SKILL	F3-10666CL8D-4GBHK(XMP)	4GB(2 x 2GB)	DS	N/A	Heat-Sink Package	8-8-8-21(1333-7-7-7-20)	1.5-1.6	V	V	V	V
G.SKILL	F3-10666CL8D-4GBRM(XMP)	4GB(2 x 2GB)	DS	N/A	Heat-Sink Package	8-8-8-21(1333-7-7-7-20)	1.5-1.6	V	V	V	V
G.SKILL	F3-10666CL9D-4GBNQ	4GB(2 x 2GB)	DS	N/A	Heat-Sink Package	(1333-9-9-9-24)	1.65	V	V		
G.SKILL	F3-10666CL9D-4GBRL	4GB(2 x 2GB)	DS	N/A	Heat-Sink Package	(1333-9-9-9-24)	1.65	V	V		
G.SKILL	F3-10666CL9T-6GBNQ	6GB(3 x 2GB)	DS	N/A	Heat-Sink Package	9-9-9-24(1333-9-9-9-24)	1.5	V	V	V	V
GEIL	GG34GB1333C9DC	4GB(2 x 2GB)	DS	GEIL	GL1L128M88BA12N	9-9-9-24 (1333-9-9-9-24)	1.3	V	V	V	V
GEIL	GV34GB1333C7DC	4GB(2 x 2GB)	DS	N/A	Heat-Sink Package	7-7-7-24(1333-8-8-8-28)	1.5	V	V	V	V
Hynix	HMT112U6BFR8C-H9	1GB	SS	Hynix	H5TQ1G83BFR	9(1333-9-9-9-24)	N/A	V	V	V	V
Hynix	HMT125U6BFR8C-H9	2GB	DS	Hynix	H5TQ1G83BFR	9(1333-9-9-9-24)	N/A	V	V	V	V
Hynix	HMT125U6BFR8C-H9	2GB	DS	Hynix	H5TQ1G83BFRH9C	9(1333-9-9-9-24)	N/A	V	V	V	V
KINGMAX	FLFD45F-B8EE9	1GB	SS	ELPIDA	J1108BASE-DJ-E	(1333-9-9-9-24)	N/A	V	V	V	V
KINGSTON	KVR1333D3N9/1G	1GB	SS	Hynix	H5TQ1G83BFR	9(1333-9-9-9-24)	1.5	V	V	V	V
KINGSTON	KVR1333D3N9/1G	1GB	SS	ELPIDA	J1108BABG-DJ-E	9(1066-8-7-7-20)	1.5	V	V	V	V
KINGSTON	KVR1333D3N9/2G	2GB	DS	Qimonda	IDSH1G-03A1F1C-13H	9(1333-9-9-9-24)	1.5	V	V	V	V
KINGSTON	KVR1333D3N9/4G	4GB	DS	SAMSUNG	K4B2G0846B-HCH9	9(1333-9-9-9-24)	1.5	V	V	V	V
MICRON	MT8JTF12864AZ-1G4F1	1GB	SS	MICRON	9FF22 D9KPT	9(1066-8-8-8-20)	N/A	V	V	V	V
MICRON	MT8JTF12864AZ-1G4F1	1GB	SS	MICRON	D9KPT	9(1333-9-9-9-24)	N/A	V	V	V	V
MICRON	MT9JSF12872AZ-1G4F1	1GB	SS	MICRON	D9KPT(ECC)	9(1333-9-9-9-24)	N/A	V	V	V	V
MICRON	MT16JTF25664AZ-1G4F1	2GB	DS	MICRON	D9KPT	9(1333-9-9-9-24)	N/A	V	V	V	V
MICRON	MT16JTF25664AZ-1G4F1	2GB	DS	MICRON	9FF22 D9KPT	9(1066-8-8-8-20)	N/A	V	V	V	V
MICRON	MT18JSF25672AZ-1G4F1	2GB	DS	MICRON	D9KPT(ECC)	9(1333-9-9-9-24)	N/A	V	V	V	V
OCZ	OC23RXP1333EB2GK	1GB	SS	N/A	Heat-Sink Package	(1066-6-5-5-20)	N/A	V	V	V	V
OCZ	OC23G1333LV3GK	3GB(3 x 1GB)	SS	N/A	Heat-Sink Package	9-9-9(1066-7-7-7-20)	1.65	V	V		
OCZ	OC23P1333LV3GK	3GB(3 x 1GB)	SS	N/A	Heat-Sink Package	7-7-7(1066-7-7-7-16)	1.65	V	V	V	V
OCZ	OC23P1333ZGK	1GB	DS	N/A	Heat-Sink Package	7-7-7-20(1333-9-9-9-24)	N/A	V	V		
OCZ	OC23P1333AGK	4GB(2 x 2GB)	DS	N/A	Heat-Sink Package	7(1333-7-7-7-20)	1.8	V	V	V	V
OCZ	OC23P1333LV4GK	4GB(2 x 2GB)	DS	N/A	Heat-Sink Package	7-7-7(1067-9-9-9-24)	1.65	V	V		

SABERTOOTH X58 Motherboard Qualified Vendors Lists (QVL) DDR3-1333MHz capability (continued)

Vendor	Part No.	Size	SS/ DS	Chip Brand	Chip NO.	Timing Table(Bios)	Voltage	DIMM socket support (Optional)					
								A*	B*	C*	D*		
OCZ	OCZ3RXP1333EB4GK	4GB(2 x 2GB)	DS	N/A	Heat-Sink Package	(1066-6-5-5)	1.85	V	V				
OCZ	OCZ3G1333LV6GK	6GB(3 x 2GB)	DS	N/A	Heat-Sink Package	9-9-9(1066-7-7-7-20)	1.65	V	V	V			
OCZ	OCZ3P1333LV6GK	6GB(3 x 2GB)	DS	N/A	Heat-Sink Package	7-7-7(1066-7-7-7-20)	1.65	V	V	V			
OCZ	OCZ1333LV6GK(XMP)	6GB(3 x 2GB)	DS	NA	Heat-Sink Package	8-8-8(1066-7-7-7-16)	1.6	V	V	V	V		
SAMSUNG	M378B2873DZ1-CH9	1GB	SS	SAMSUNG	K4B1G0846D	9(1333-9-9-9-24)	N/A	V	V	V	V		
SAMSUNG	M378B2873EH1-CH9	1GB	SS	SAMSUNG	K4B1G0846E	(1066-8-7-7-20)	N/A	V	V	V	V		
SAMSUNG	M391B2873DZ1-CH9	1GB	SS	SAMSUNG	K4B1G0846D(ECC)	9(1333-9-9-9-24)	N/A	V	V	V	V		
SAMSUNG	M378B5673DZ1-CH9	2GB	DS	SAMSUNG	K4B1G0846D	9(1333-9-9-9-24)	N/A	V	V	V	V		
SAMSUNG	M378B5673EH1-CH9	2GB	DS	SAMSUNG	K4B1G0846E	(1066-8-7-7-20)	N/A	V	V	V	V		
SAMSUNG	M391B5673DZ1-CH9	2GB	DS	SAMSUNG	K4B1G0846D(ECC)	9(1333-9-9-9-24)	N/A	V	V	V	V		
SAMSUNG	M378B5273BH1-CH9	4GB	DS	SAMSUNG	K4B2G0846B-HCH9	9(1333-9-9-9-24)	N/A	V	V	V	V		
Super Talent	W1333UX2GB(XMP)	2GB(2 x 1GB)	SS	N/A	Heat-Sink Package	8(1333-8-8-8-24)	1.8	V	V	V	V		
Transcend	TS128MLK64V3U	1GB	SS	SAMSUNG	K4B1G0846D	9(1333-9-9-9-24)	N/A	V	V	V	V		
Transcend	TS256MLK64V3U	2GB	DS	SAMSUNG	K4B1G0846D	9(1333-9-9-9-24)	N/A	V	V	V	V		
Asint	SLY3128M8-EDJ	1GB	SS	Asint	DDRIII1208-DJ	(9-9-9-24)	N/A	V	V	V	V		
Asint	SLY3128M8-EDJE	1GB	SS	ELPIDA	J1108BASE-DJ-E	(1066-8-8-8-20)	N/A	V	V	V	V		
Asint	SLZ3128M8-EDJ	2GB	DS	Asint	DDRIII1208-DJ	(9-9-9-24)	N/A	V	V	V	V		
Asint	SLZ3128M8-EDJE	2GB	DS	ELPIDA	J1108BASE-DJ-E	(1066-8-8-8-20)	N/A	V	V	V	V		
ASUS	N/A	1GB	DS	N/A	Heat-Sink Package	(1333-9-9-9-24)	N/A	V	V	V	V		
ATP	AQ28M64A8BJH9S	1GB	SS	SAMSUNG	K4B1G0846E	(1333-9-9-9-24)	N/A	V	V	V	V		
ATP	AQ28M72D8BJH9S	1GB	SS	SAMSUNG	K4B1G0846D(ECC)	(1333-9-9-9-24)	N/A	V	V	V	V		
ATP	AQ56M64B8BJH9S	2GB	DS	SAMSUNG	K4B1G0846D	(1333-9-9-9-24)	N/A	V	V	V	V		
ATP	AQ56M72E8BJH9S	2GB	DS	SAMSUNG	K4B1G0846D(ECC)	(1333-9-9-9-24)	N/A	V	V	V	V		
BUFFALO	FSX1333D3G-1G	1GB	SS	N/A	Heat-Sink Package	(1066-7-7-7-20)	N/A	V	V	V	V		
BUFFALO	FSH1333D3G-T3G(XMP)	3GB(3 x 1GB)	SS	N/A	Heat-Sink Package	7-7-7-20(1066-8-7-7-20)	N/A	V	V	V	V		
BUFFALO	FSX1333D3G-2G	2GB	DS	N/A	Heat-Sink Package	(1066-7-7-7-20)	N/A	V	V	V	V		
Elixir	M2Y2G64CB8HA9N-CG	2GB	DS	N/A	Heat-Sink Package	(1333-7-7-7-20)	N/A	V	V	V	V		
Patriot	PDC32G1333LLK	1GB	SS	PATRIOT	Heat-Sink Package	7(1337-7-7-7-20)	1.7	V	V	V	V		
Patriot	PVT33G1333ELK	3GB(3 x 1GB)	SS	N/A	Heat-Sink Package	9-9-9-24(1066-7-7-7-20)	1.65	V	V	V	V		
Patriot	PVS34G1333ELK	4GB(2 x 2GB)	DS	N/A	Heat-Sink Package	9-9-9-24(1066-7-7-7-20)	1.5	V	V	V	V		
Patriot	PVS34G1333LLK	4GB(2 x 2GB)	DS	N/A	Heat-Sink Package	7-7-7-20(1066-7-7-7-20)	1.7	V	V	V	V		
Patriot	PVT36G1333ELK	6GB(3 x 2GB)	DS	N/A	Heat-Sink Package	9-9-9-24(1066-7-7-7-20)	1.65	V	V	V	V		
Silicon Power	SP001GBLTU133S02	1GB	SS	S-POWER	I0YT3E0	9(1333-9-9-9-24)	N/A	V	V	V	V		
Silicon Power	SP002GBLTU133S02	2GB	DS	S-POWER	I0YT3E0	9(1333-9-9-9-24)	N/A	V	V	V	V		

SABERTOOTH X58 Motherboard Qualified Vendors Lists (QVL) DDR3-1066MHz capability

Vendor	Part No.	Size	SS/ DS	Chip Brand	Chip NO.	Timing Table(Bios)	Voltage	DIMM socket support (Optional)			
								A*	B*	C*	D*
CORSAIR	CM3X1024-1066C7	1GB	DS	N/A	Heat-Sink Package	7	1.1	V	V	V	
Crucial	CT12864BA1067.8FF	1GB	SS	MICRON	D9KPT	7(1066-7-7-7-20)	N/A	V	V	V	V
Crucial	CT12864BA1067.8SFD	1GB	SS	MICRON	D9JNL	7	N/A	V	V	V	V
Crucial	CT12872BA1067.9FF	1GB	SS	MICRON	D9KPT(ECC)	7(1066-9-9-9-25)	N/A	V	V	V	V
Crucial	CT25664BA1067.16FF	2GB	DS	MICRON	D9KPT	7(1066-7-7-7-20)	N/A	V	V	V	
Crucial	CT25664BA1067.16SFD	2GB	DS	MICRON	D9JNL	7	N/A	V	V	V	V
Crucial	CT25672BA1067.18FF	2GB	DS	MICRON	D9KPT(ECC)	7(1066-7-7-7-20)	N/A	V	V		
ELPIDA	EBJ10UE8BAW0-AE-E	1GB	SS	ELPIDA	J1108BABG-DJ-E	7(1066-7-7-7-20)	N/A	V	V	V	V
ELPIDA	EBJ11RD8BAFA-AE-E	1GB	DS	ELPIDA	J5308BASE-AC-E(ECC)	7	N/A	V	V	V	V
ELPIDA	EBJ11UD8BAFA-AG-E	1GB	DS	ELPIDA	J5308BASE-AC-E	8	N/A	V	V	V	
ELPIDA	EBJ21UE8BAW0-AE-E	2GB	DS	ELPIDA	J1108BABG-DJ-E	7(1066-7-7-7-20)	N/A	V	V	V	V
Hynix	HMT112U6AFP8C-G7N0	1GB	SS	HYNIX	H5TQ1G83AFP7G7C	7	N/A	V	V	V	V
Hynix	HYMT112U64ZNF8-G7	1GB	SS	HYNIX	HY5TQ1G831ZNF7P-G7	7	N/A	V	V		
Hynix	HMT125U6AFP8C-G7N0	2GB	DS	HYNIX	H5TQ1G83AFP7G7C	7	N/A	V	V	V	V
Hynix	HYMT125U64ZNF8-G7	2GB	DS	HYNIX	HY5TQ1G831ZNF7P-G7	7	N/A	V	V	V	
KINGSTON	KVR1066D3N7/1G	1GB	SS	KINGSTON	D1288JEKAPA7U	7(1067-7-7-7-20)	1.5	V	V	V	V
KINGSTON	KVR1066D3N7/1G	1GB	SS	ELPIDA	J1108BABG-DJ-E	(1066-7-7-7-20)	1.5	V	V	V	V
KINGSTON	KVR1066D3N7/2G	2GB	DS	KINGSTON	D1288JEKAPA7U	7(1067-7-7-7-20)	1.5	V	V	V	V
KINGSTON	KVR1066D3N7/2G	2GB	DS	ELPIDA	J1108BABG-DJ-E	(1066-7-7-7-20)	1.5	V	V	V	V
KINGSTON	KVR1066D3N7/4G	4GB	DS	SAMSUNG	K4B2G0846B-HCF8	(1066-7-7-7-20)	1.5	V	V	V	V
MICRON	MT8JTF12864AY-1G1D1	1GB	SS	MICRON	7VD22	7	N/A	V	V	V	V
MICRON	MT8JTF12864AZ-1G1F1	1GB	SS	MICRON	8ZF22 D9KPV	7(1066-7-7-7-20)	N/A	V	V	V	V
MICRON	MT8JTF12864AZ-1G1F1	1GB	SS	MICRON	D9KPT	7(1066-7-7-7-20)	N/A	V	V	V	V
MICRON	MT9JSF12872AZ-1G1F1	1GB	SS	MICRON	D9KPT(ECC)	7(1066-9-9-9-25)	N/A	V	V	V	V
MICRON	MT16JTF25664AY-1G1D1	2GB	DS	MICRON	7VD22	7	N/A	V	V	V	V
MICRON	MT16JTF25664AZ-1G1F1	2GB	DS	MICRON	8ZF22 D9KPV	7(1066-7-7-7-20)	N/A	V	V	V	V
MICRON	MT16JTF25664AZ-1G1F1	2GB	DS	MICRON	D9KPT	7(1066-7-7-7-20)	N/A	V	V	V	
MICRON	MT18JSF25672AZ-1G1F1	2GB	DS	MICRON	D9KPT(ECC)	7(1066-7-7-7-20)	N/A	V	V		
SAMSUNG	M378B5273BH1-CF8	4GB	DS	SAMSUNG	K4B2G0846B-HCF8	8(7-7-7-20)	1.5	V	V	V	V
Transcend	TS256MLK64V1U	2GB	DS	ELPIDA	J1108BABG-AE-E	7(1066-7-7-7-20)	N/A	V	V	V	V
Asint	SLY3128M8-EAE	1GB	SS	Asint	DDRIII1208-AE	(7-7-7-20)	N/A	V	V	V	V
Asint	SLZ3128M8-EAE	2GB	DS	Asint	DDRIII1208-AE	(7-7-7-20)	N/A	V	V	V	V
Elitix	M2Y2G64C88HA9N-BE	2GB	DS	N/A	Heat-Sink Package	(1066-7-7-7-20)	N/A	V	V	V	V
WINTEC	3DU3191A-10	1GB	DS	Qimonda	IDSH51-03A1F1C-10F	7	N/A	V	V		



Side(s): SS - Single-sided DS - Double-sided DIMM support:

- **A*:** Supports two (2) modules inserted into slot A1 and B1 as one pair of Dual-channel memory configuration.
- **B*:** Supports three (3) modules inserted into the beige slots (A1, B1 and C1) as one set of Triple-channel memory configuration.
- **C*:** Supports four (4) modules inserted into the beige slots (A1, B1 and C1) and the brown slot A2 as one set of Triple-channel memory configuration.
- **D*:** Supports six (6) modules inserted into both the beige slots and the brown slots as two sets of Triple-channel memory configuration.



- ASUS exclusively provides hyper DIMM support function.
- Hyper DIMM support is subject to the physical characteristics of individual CPUs. Load the X.M.P. or D.O.C.P. settings in the BIOS for the hyper DIMM support.
- Visit the ASUS website for the latest QVL.

2.4.3 Installing a DIMM



Ensure to unplug the power supply before adding or removing DIMMs or other system components. Failure to do so may cause severe damage to both the motherboard and the components.

1. Unlock a DIMM socket by pressing the retaining clip outward.
2. Align a DIMM on the socket such that the notch on the DIMM matches the DIMM slot key on the socket.

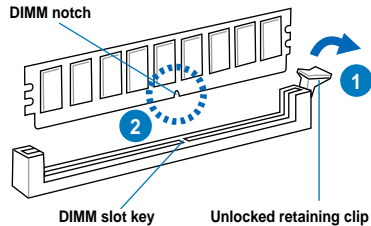

A DIMM is keyed with a notch so that it fits in only one direction. **DO NOT** force a DIMM into a socket in the wrong direction to avoid damaging the DIMM.

3. Hold the DIMM by both of its ends, then insert the DIMM vertically into the socket. Apply force to both ends of the DIMM simultaneously until the retaining clip snaps back into place, and the DIMM cannot be pushed in any further to ensure proper sitting of the DIMM.

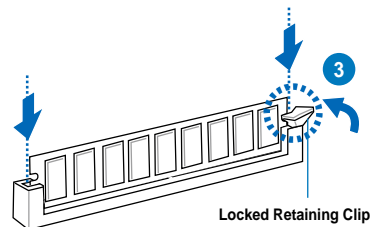

Always insert the DIMM into the socket **VERTICALLY** to prevent DIMM notch damage.

2.4.4 Removing a DIMM

1. Press the retaining clip outward to unlock the DIMM.
2. Remove the DIMM from the socket.

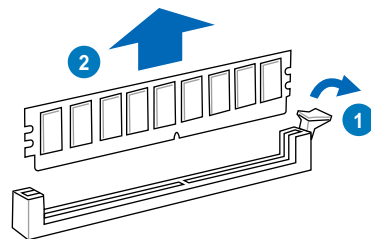

2.5 Expansion slots

In the future, you may need to install expansion cards. The following subsections describe the slots and the expansion cards that they support.



Ensure to unplug the power cord before adding or removing expansion cards. Failure to do so may cause you physical injury and damage motherboard components.

2.5.1 Installing an expansion card

To install an expansion card:

1. Before installing the expansion card, read the documentation that came with it and make the necessary hardware settings for the card.
2. Remove the system unit cover (if your motherboard is already installed in a chassis).
3. Remove the bracket opposite the slot that you intend to use. Keep the screw for later use.
4. Align the card connector with the slot and press firmly until the card is completely seated on the slot.
5. Secure the card to the chassis with the screw you removed earlier.
6. Replace the system cover.

2.5.2 Configuring an expansion card

After installing the expansion card, configure it by adjusting the software settings.

1. Turn on the system and change the necessary BIOS settings, if any. See Chapter 3 for information on BIOS setup.
2. Assign an IRQ to the card. Refer to the tables on the next page.
3. Install the software drivers for the expansion card.



When using PCI cards on shared slots, ensure that the drivers support “Share IRQ” or that the cards do not need IRQ assignments. Otherwise, conflicts will arise between the two PCI groups, making the system unstable and the card inoperable. Refer to the table on the next page for details.

2.5.3 Interrupt assignments

Standard interrupt assignments

IRQ	Priority	Standard function
0	1	System Timer
1	2	Keyboard Controller
2	–	Redirect to IRQ#9
4	12	Communications Port (COM1)*
5	13	IRQ Holder for PCI Steering*
6	14	Reserved
7	15	Reserved
8	3	System CMOS/Real Time Clock
9	4	IRQ Holder for PCI Steering*
10	5	IRQ Holder for PCI Steering*
11	6	IRQ Holder for PCI Steering*
12	7	Reserved
13	8	Numeric Data Processor
14	9	Primary IDE Channel

* These IRQs are usually available for PCI devices.

IRQ assignments for this motherboard

IOH

	24	25	26	27	28	29	30	31
NEC USB 3.0	–	–	–	–	–	shared	–	–
Marvell 9128	–	–	–	–	shared	–	–	–
PCIe16_1	shared	–	–	–	–	–	–	–
PCIe16_2	–	–	–	–	–	–	shared	–

ICH

	A	B	C	D	E	F	G	H
PCIe16_3	shared	–	–	–	–	–	–	–
PCIe1_1	–	shared	–	–	–	–	–	–
PCIe1_2	–	–	–	shared	–	–	–	–
LAN1	–	–	–	shared	–	–	–	–
PCI_1	shared	–	–	–	–	–	–	–
USB_1	–	–	–	–	–	–	–	shared
USB_2	–	–	–	shared	–	–	–	–
USB_3	–	–	shared	–	–	–	–	–
USB_4	shared	–	–	–	–	–	–	–
USB_5	–	–	–	–	–	shared	–	–
USB_6	shared	–	–	–	–	–	–	–
USB 2.0_1	–	–	–	–	–	–	–	shared
USB 2.0_2	–	–	shared	–	–	–	–	–
SATA_1	–	–	shared	–	–	–	–	–
SATA_2	–	–	–	–	shared	–	–	–
Audio	–	–	–	–	–	–	shared	–

2.5.4 PCI slot

The PCI slot supported cards such as a LAN card, SCSI card, USB card, and other cards that comply with PCI specifications. Refer to the figure below for the location of the slot.

2.5.5 PCI Express x16 / x1 slots

This motherboard supports PCI Express x16 / x1 network cards, SCSI cards and other cards that comply with the PCI Express specifications. Refer to the figure below for the location of the slots.

2.5.6 PCI Express 2.0 x16 slots

This motherboard has two PCI Express 2.0 x16 slots that support PCI Express 2.0 x16 graphics cards complying with the PCI Express specifications. Refer to the figure below for the location of the slots.

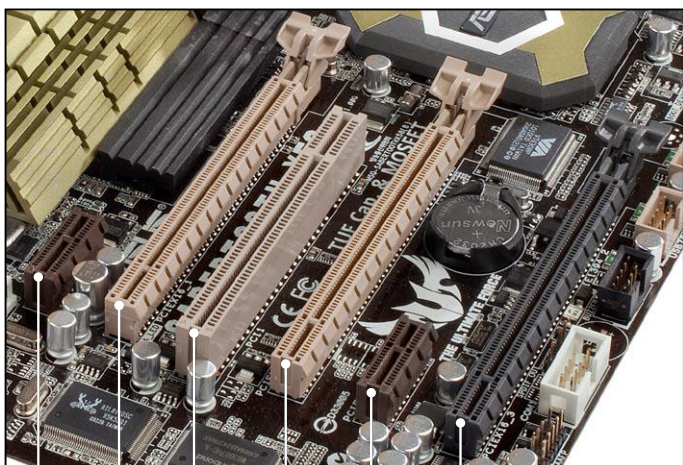

PCI Express x1_1 slot

PCI Express 2.0 x16_1 slot (beige, dual at x16 link)

PCI slot 1

PCI Express 2.0 x16_2 slot (beige, dual at x16 link)

PCI Express x1_2 slot

PCI Express x16 slot 1 (black, at x4 link)

VGA configuration	PCI Express operating mode		
	PCIe 2.0 x16_1	PCIe 2.0 x16_2	PCIe x16_3
Single VGA/PCIe card	x16 (Recommend for single VGA)	x16 (Single VGA)	N/A
Dual VGA/PCIe card	x16	x16	N/A
Triple VGA/PCIe card	x16	x16	x4 or x1 (when PCI Express x1_2 slot is occupied)



- In single VGA card mode, use first the PCIe 2.0 x16_1 slot (beige) for a PCI Express x16 graphics card to get better performance.
- In CrossFireX™ or SLI™ mode, use the PCIe 2.0 x16_1 (beige) and PCIe 2.0 x16_2 (beige) slots for PCI Express x16 graphics cards to get better performance.
- When the PCI Express x1_2 slot is occupied, the PCI Express x16 slot (black) will work at x1 link.
- When using the triple VGA card mode, we recommend that you use the PCI Express x1_1 slot to install a PCIe x1 device to get better performance.
- We recommend that you provide sufficient power when running CrossFireX™ or SLI™ mode. See page 2-35 for details.
- Connect a chassis fan to the motherboard connector labeled CHA_FAN1/2/3 when using multiple graphics cards for better thermal environment. See page 2-33 for details.

2.6 Jumpers

1. Clear RTC RAM (3-pin CLRRTC)

This jumper allows you to clear the Real Time Clock (RTC) RAM in CMOS. You can clear the CMOS memory of date, time, and system setup parameters by erasing the CMOS RTC RAM data. The onboard button cell battery powers the RAM data in CMOS, which include system setup information such as system passwords.

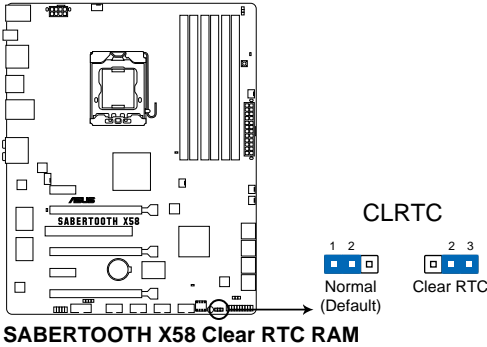

SABERTOOTH X58 Clear RTC RAM

To erase the RTC RAM

1. Turn OFF the computer and unplug the power cord.
2. Move the jumper cap from pins 1-2 (default) to pins 2-3. Keep the cap on pins 2-3 for about 5–10 seconds, then move the cap back to pins 1-2.
3. Plug the power cord and turn ON the computer.
4. Hold down the key during the boot process and enter BIOS setup to re-enter data.



Except when clearing the RTC RAM, never remove the cap on CLRRTC jumper default position. Removing the cap will cause system boot failure!



- If the steps above do not help, remove the onboard battery and move the jumper again to clear the CMOS RTC RAM data. After the CMOS clearance, reinstall the battery.
 - You do not need to clear the RTC when the system hangs due to overclocking. For system failure due to overclocking, use the C.P.R. (CPU Parameter Recall) feature. Shut down and reboot the system so the BIOS can automatically reset parameter settings to default values.
 - Due to the chipset behavior, AC power off is required to enable C.P.R. function. You must turn off and on the power supply or unplug and plug the power cord before rebooting the system.
-

2. CPU / DRAM Bus overvoltage settings (3-pin OV_CPU, 3-pin OV_DRAM_BUS)

These jumpers allow you to enable or disable the advanced CPU and DRAM Bus overvoltage settings in BIOS. Read the following information before you change the jumper settings.

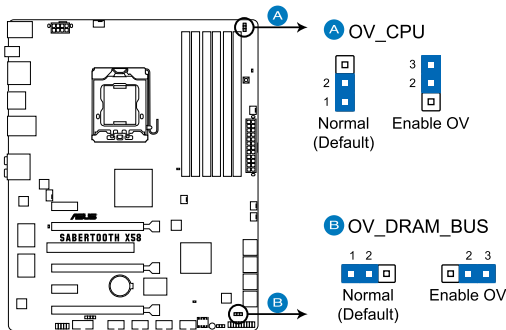

SABERTOOTH X58 CPU/DRAM BUS overvoltage settings

	OV_CPU	OV_DRAM_BUS
Pins 1-2 (Default)	up to 1.70V	up to 2.00V
Pins 2-3 (OV Enabled)	up to 2.10V	up to 2.46V



- Before you change the jumper settings for extra-high overvoltage ability, use the BIOS items first to adjust the desired CPU and DRAM performance. Ensure that your system functions well under the highest BIOS voltage settings before you change the setting of these jumpers.
- DO NOT set the OV_CPU jumper to pins 2–3 when you install a new CPU and have not booted for the first time. Doing so may cause the system to halt. For system failure due to the wrong setting of the OV_CPU jumper, shut down the computer and move the cap back to pins 1–2.
- According to Intel CPU spec, DIMMs with voltage requirement over 1.65V may damage the CPU permanently. We recommend you install the DIMMs with the voltage requirement below 1.65V.
- The system may need a better cooling system (for example, a water-cooling system) to work stably under high voltage settings.

2.7 Onboard switch

The onboard switch allows you to fine-tune performance when working on a bare or open-case system. This is ideal for overclockers and gamers who continually change settings to enhance system performance.

MemOK! switch

Installing DIMMs that are incompatible with the motherboard may cause system boot failure, and the DRAM_LED near the MemOK! switch lights continuously. Press and hold the MemOK! switch until the DRAM_LED starts blinking to begin automatic memory compatibility tuning for successful boot.

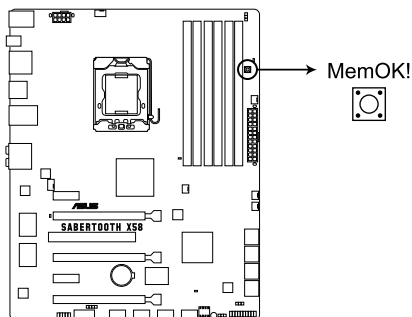

SABERTOOTH X58 MemOK! switch



- Refer to section **2.9 Onboard LEDs** for the exact location of the DRAM_LED.
- The DRAM_LED also lights when the DIMM is not properly installed. Turn off the system and reinstall the DIMM before using the MemOK! function.
- Press the MemOK! switch under Windows® OS environment will reboot the computer and start memory tuning.
- During the tuning process, the system loads and tests failsafe memory settings. It takes about 30 seconds for the system to test one set of failsafe settings. If the test fails, the system reboots and test the next set of failsafe settings. The blinking speed of the DRAM_LED increases, indicating different test processes.
- Due to memory tuning requirement, the system automatically reboots when each timing set is tested. If the installed DIMMs still fail to boot after the whole tuning process, the DRAM_LED lights continuously. Replace the DIMMs with ones recommended in the Memory QVL (Qualified Vendors Lists) in this user manual or on the ASUS website at www.asus.com.
- If you turn off the computer and replace DIMMs during the tuning process, the system continues memory tuning after turning on the computer. To stop memory tuning, turn off the computer and unplug the power cord for about 5–10 seconds.
- If your system fail to boot due to BIOS overclocking, press the MemOK! switch to boot and load BIOS default settings. A message will appear during POST reminding you that the BIOS has been restored to its default settings.
- We recommend that you download and update to the latest BIOS version from the ASUS website at www.asus.com after using the MemOK! function.

2.8 Connectors

2.8.1 Rear panel connectors

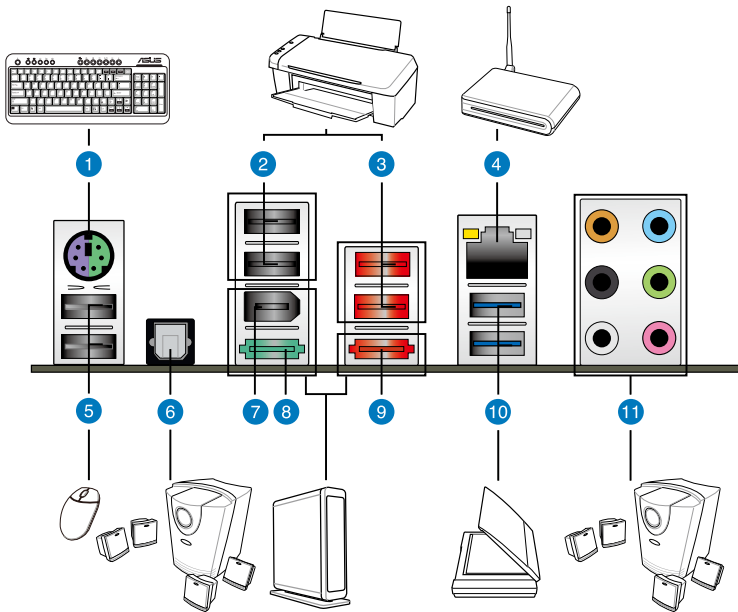

Rear panel connectors

1. PS/2 keyboard/mouse combo port	7. IEEE 1394a port
2. USB 2.0 ports 3 and 4	8. Power External SATA port
3. USB 2.0 ports 1 and 2	9. External SATA port
4. LAN (RJ-45) port*	10. USB 3.0 ports 1 and 2
5. USB 2.0 ports 5 and 6	11. Audio I/O ports**
6. Optical S/PDIF Out port	

*and **: Refer to the tables on the next page for LAN port and audio port definitions.



- DO NOT insert a different connector to the external SATA port.
- Due to USB 3.0 controller limitation, USB 3.0 devices can only be used under Windows® OS environment and after the USB 3.0 driver installation.
- USB 3.0 devices can only be used as data storage only.
- We strongly recommend that you connect USB 3.0 devices to USB 3.0 ports for faster and better performance for your USB 3.0 devices.
- If you want to use the hot-plug function of the external SATA ports, you have to set the **JMB 36x ATA Controller** item in the BIOS setting to [Enabled] and install the **JMicron JMB36X Controller Driver** from the motherboard support DVD. Refer to **section 3.6.3 Onboard Devices Configuration** for details.

*** LAN port LED indications**

Activity Link LED		Speed LED	
Status	Description	Status	Description
OFF	No link	OFF	10 Mbps connection
ORANGE	Linked	ORANGE	100 Mbps connection
BLINKING	Data activity	GREEN	1 Gbps connection

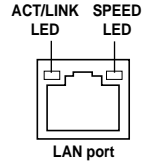

**** Audio 2, 4, 6, or 8-channel configuration**

Port	Headset 2-channel	4-channel	6-channel	8-channel
Light Blue	Line In	Line In	Line In	Line In
Lime	Line Out	Front Speaker Out	Front Speaker Out	Front Speaker Out
Pink	Mic In	Mic In	Mic In	Mic In
Orange	-	-	Center/Subwoofer	Center/Subwoofer
Black	-	Rear Speaker Out	Rear Speaker Out	Rear Speaker Out
Gray	-	-	-	Side Speaker Out

2.8.2 Audio I/O connections

Audio I/O ports

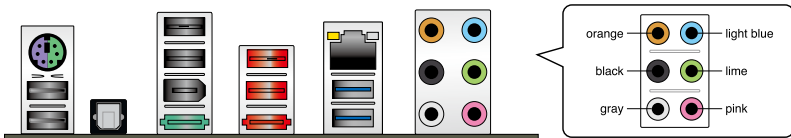

Connect to Headphone and Mic

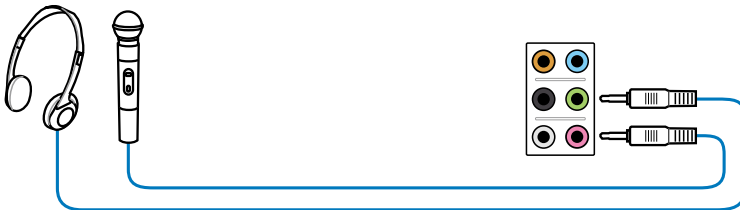

Connect to Stereo Speakers

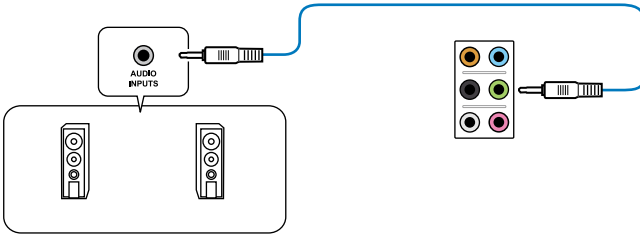

Connect to 2.1 channel Speakers

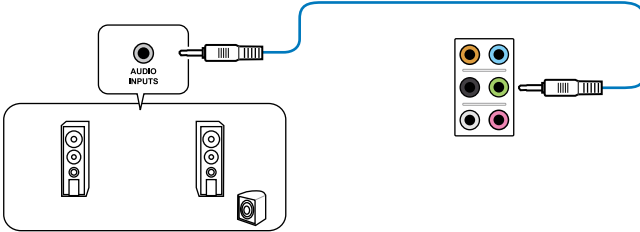

Connect to 4.1-channel Speakers

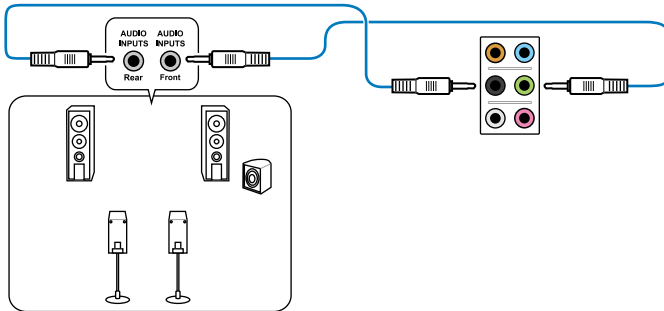

Connect to 5.1-channel Speakers

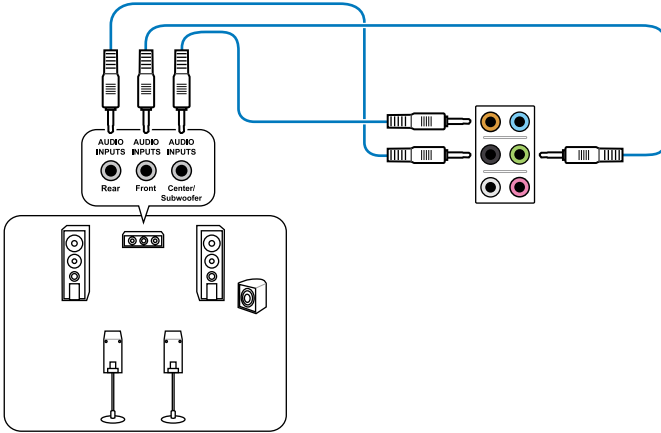

Connect to 7.1-channel Speakers

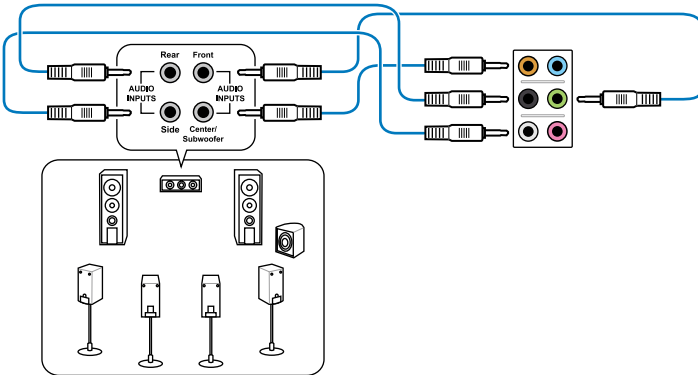

2.8.3 Internal connectors

1. Intel® ICH10R Serial ATA 3.0 Gb/s connectors (7-pin SATA 1-6 [black])

These connectors are for the Serial ATA 3.0 Gb/s signal cables for Serial ATA hard disk drives and optical disc drives.

If you installed Serial ATA hard disk drives, you can create a RAID 0, 1, 5, and 10 configuration with the Intel® Matrix Storage Technology through the onboard Intel® ICH10R controller.

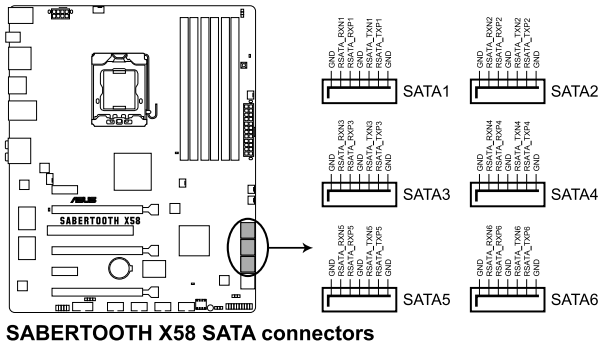

SABERTOOTH X58 SATA connectors

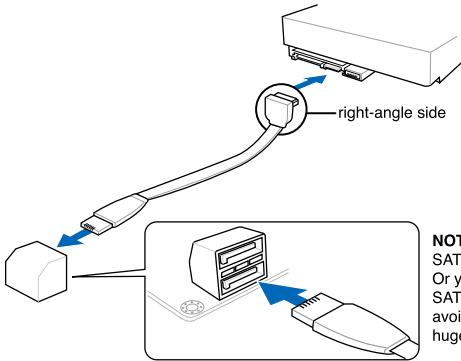

NOTE: Connect the right-angle side of SATA signal cable to SATA device. Or you may connect the right-angle side of SATA cable to the onboard SATA port to avoid mechanical conflict with huge graphics cards.



- These connectors are set to Standard IDE mode by default. In Standard IDE mode, you can connect Serial ATA boot/data hard disk drives to these connectors. If you intend to create a Serial ATA RAID set using these connectors, set the **Configure SATA** as item in the BIOS to [RAID]. See section 3.4.2 **Storage Configuration** for details.
- Before creating a RAID set, refer to section 4.4 **RAID configurations** or the manual bundled in the motherboard support DVD.
- You must install Windows® XP Service Pack 2 or later version before using Serial ATA hard disk drives. The Serial ATA RAID feature is available only if you are using Windows® XP SP 2 or later version.
- When using hot-plug and NCQ, set the **Configure SATA** as in the BIOS to [AHCI]. See section 3.4.2 **Storage Configuration** for details.

2. Marvell® Serial ATA 6.0 Gb/s connectors (7-pin SATA_6G_1, 7-pin SATA_6G_2 [gray])

These connectors are for the Serial ATA 6.0 Gb/s signal cables for Serial ATA 6.0 Gb/s hard disk drives.

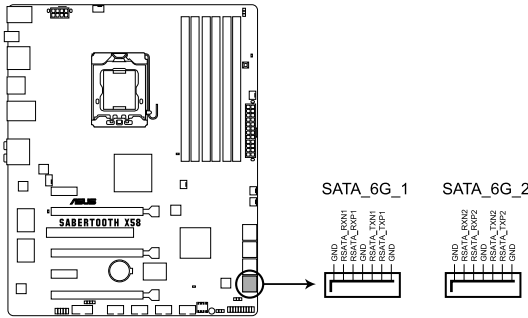

SABERTOOTH X58 SATA 6G connectors



- These connectors are set to IDE Mode by default. When using hot-plug and NCQ, set the **Marvell 9128 Controller** item in the BIOS to [AHCI Mode]. Refer to section **3.6.3 Onboard Devices Configuration** for details.
- You must install Windows® XP Service Pack 2 or later versions before using Serial ATA hard disk drives.
- Press <Ctrl> + <M> during POST to enter the Marvell RAID utility to create or delete a RAID configuration.
- If you want to install a Windows operating system to a RAID configuration created using the Marvell SATA controller, you have to create a RAID driver disk using the motherboard support DVD and load the driver during OS installation. For 32/64bit Windows XP OS, load first the **Marvell shared library driver**, and then load **Marvell 91xx SATA Controller Driver**. For Windows Vista / Windows 7 OS, load only the **Marvell 91xx SATA Controller Driver**.

3. USB connectors (10-1 pin USB78; USB910; USB1112)

These connectors are for USB 2.0 ports. Connect the USB module cable to any of these connectors, then install the module to a slot opening at the back of the system chassis. These USB connectors comply with USB 2.0 specification that supports up to 480 Mbps connection speed.

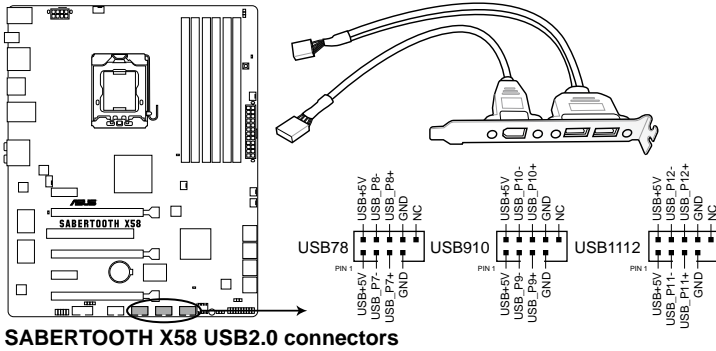

Never connect a 1394 cable to the USB connectors. Doing so will damage the motherboard!



You can connect the front panel USB cable to the ASUS Q-Connector (USB, blue) first, and then install the Q-Connector (USB) to the USB connector onboard if your chassis supports front panel USB ports.

4. IEEE 1394a port connector (10-1 pin IE1394_2)

This connector is for an IEEE 1394a port. Connect the IEEE 1394a module cable to this connector, then install the module to a slot opening at the back of the system chassis.

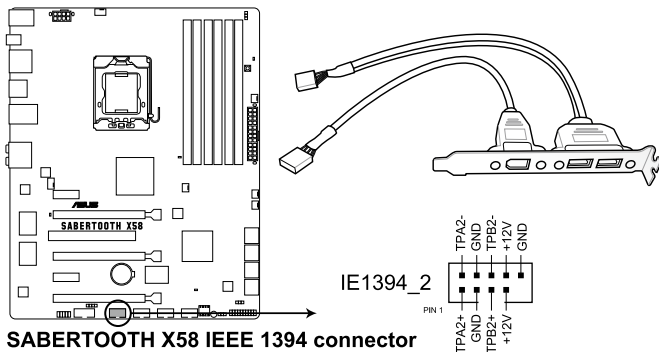

SABERTOOTH X58 IEEE 1394 connector



Never connect a USB cable to the IEEE 1394a connector. Doing so will damage the motherboard!



The IEEE 1394a module is purchased separately.

5. Serial port connector (10-1 pin COM1)

This connector is for a serial (COM) port. Connect the serial port module cable to this connector, then install the module to a slot opening at the back of the system chassis.

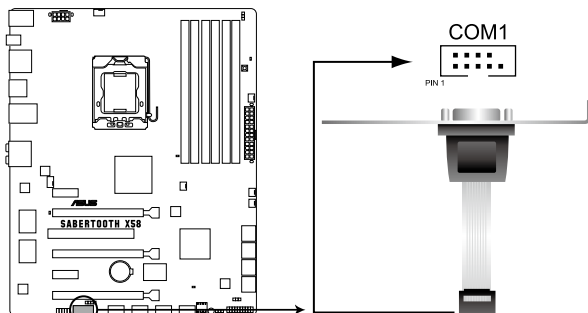

SABERTOOTH X58 port (COM1) connector



The COM module is purchased separately.

6. CPU, chassis, power, and NB fan connectors (4-pin CPU_FAN; 4-pin CHA_FAN1; 3-pin CHA_FAN2-3; 3-pin PWR_FAN; 3-pin NB_FAN)

Connect the fan cables to the fan connectors on the motherboard, ensuring that the black wire of each cable matches the ground pin of the connector.

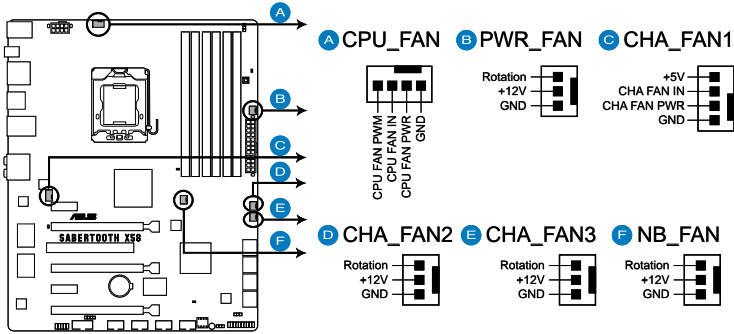

SABERTOOTH X58 Fan connectors



Do not forget to connect the fan cables to the fan connectors. Insufficient air flow inside the system may damage the motherboard components. These are not jumpers! Do not place jumper caps on the fan connectors!



- The CPU_FAN connector supports the CPU fan of maximum 2A (24 W) fan power.
- Only the CPU_FAN, CHA_FAN1 and CHA_FAN2 connectors support the ASUS Fan Xpert feature.
- If you install two VGA cards, we recommend that you plug the rear chassis fan cable to the motherboard connector labeled CHA_FAN1/2/3 for better thermal environment.

7. Digital audio connector (4-1 pin SPDIF_OUT)

This connector is for an additional Sony/Philips Digital Interface (S/PDIF) port. Connect the S/PDIF Out module cable to this connector, then install the module to a slot opening at the back of the system chassis.

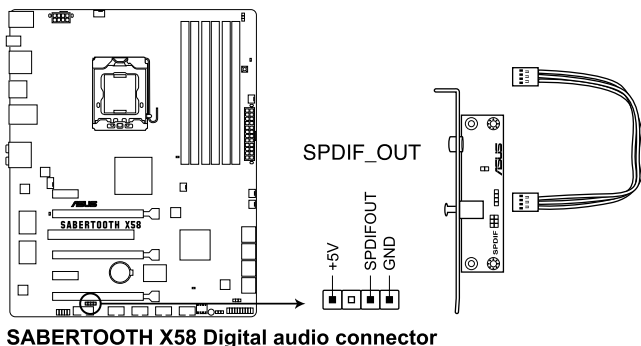

SABERTOOTH X58 Digital audio connector



The S/PDIF module is purchased separately.

8. Front panel audio connector (10-1 pin AAFP)

This connector is for a chassis-mounted front panel audio I/O module that supports either HD Audio or legacy AC'97 audio standard. Connect one end of the front panel audio I/O module cable to this connector.

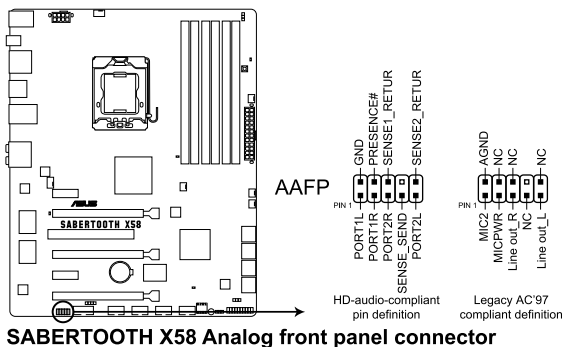

SABERTOOTH X58 Analog front panel connector



- We recommend that you connect a high-definition front panel audio module to this connector to avail of the motherboard's high-definition audio capability.
- If you want to connect a high-definition front panel audio module to this connector, set the **Front Panel Type** item in the BIOS setup to [HD Audio]; if you want to connect an AC'97 front panel audio module to this connector, set the item to [AC97]. By default, this connector is set to [HD Audio].

9. ATX power connectors (24-pin EATXPWR; 8-pin EATX12V)

These connectors are for ATX power supply plugs. The power supply plugs are designed to fit these connectors in only one orientation. Find the proper orientation and push down firmly until the connectors completely fit.

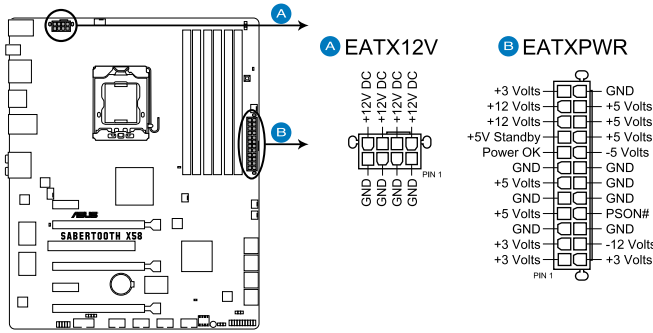

SABERTOOTH X58 ATX power connectors



- For a fully configured system, we recommend that you use a power supply unit (PSU) that complies with ATX 12 V Specification 2.0 (or later version) and provides a minimum power of 350 W.
- Do not forget to connect the 8-pin EATX12 V power plug; otherwise, the system will not boot.
- We recommend that you use a PSU with higher power output when configuring a system with more power-consuming devices. The system may become unstable or may not boot up if the power is inadequate.
- If you want to use two or more high-end PCI Express x16 cards, use a PSU with 1000W power or above to ensure the system stability.
- If you are uncertain about the minimum power supply requirement for your system, refer to the Recommended Power Supply Wattage Calculator at <http://support.asus.com/PowerSupplyCalculator/PSCalculator.aspx?SLanguage=en-us> for details.

PSU suggested list:

Seventeam ST-522HLP	OCZ OCZGXS850	Seasonic SS-500HM
Seventeam ST550EAJ-05F	OCZ OCZ1000PXS	Seasonic SS-550HT
Antec SG-850	Seasonic SS-850EM	Seasonic SS-600HT
ASUS P-50GA	Silverstone SST-ST85F	Seventeam ST-420BKP
ASUS U-75HA	Tagan TG1100-U33	Snake PSH500V
Be quiet P6-PRO-850W	Thermaltake W0132RE	Silverstone SST-ST50EF
Be quiet BN077	Thermaltake W0133RU	Silverstone PSU ST56ZF
CoolerMaster RS-850EMBA	Aelita GPS-550AB	T.C.STAR D420
Corsair CMPSU-620HX	Antec EA-380	Thermaltake TWV500W-AP
EnerMAX EGX1000EWL	OCZ OCZ780MXS	Thermaltake PUREPower-600AP
HECHUAN ST-ATX330	Seasonic SS-351HT	Zalman ZM600-HP
HUNTKEY 磐石500	Seasonic SS-460HS	Zippy HP2-6500PE (G1)
Be quiet P6-PRO-850W	Seasonic SS-500GB	Zippy PSL6720P

10. System panel connector (20-8 pin PANEL)

This connector supports several chassis-mounted functions.

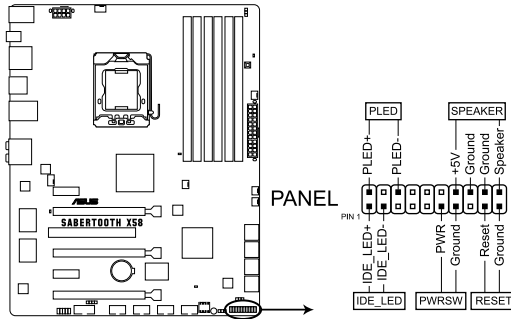

SABERTOOTH X58 System panel connector

- **System power LED (2-pin PLED)**

This 2-pin connector is for the system power LED. Connect the chassis power LED cable to this connector. The system power LED lights up when you turn on the system power, and blinks when the system is in sleep mode.

- **Hard disk drive activity LED (2-pin IDE_LED)**

This 2-pin connector is for the HDD Activity LED. Connect the HDD Activity LED cable to this connector. The IDE LED lights up or flashes when data is read from or written to the HDD.

- **System warning speaker (4-pin SPEAKER)**

This 4-pin connector is for the chassis-mounted system warning speaker. The speaker allows you to hear system beeps and warnings.

- **ATX power button/soft-off button (2-pin PWRSW)**

This connector is for the system power button. Pressing the power button turns the system on or puts the system in sleep or soft-off mode depending on the BIOS settings. Pressing the power switch for more than four seconds while the system is ON turns the system OFF.

- **Reset button (2-pin RESET)**

This 2-pin connector is for the chassis-mounted reset button for system reboot without turning off the system power.

2.8.4. ASUS Q-Connector (system panel)

Use the ASUS Q-Connector to connect/disconnect the chassis front panel cables.

To install the ASUS Q-Connector:

1. Connect the front panel cables to the ASUS Q-Connector.

Refer to the labels on the Q-Connector to know the detailed pin definitions, and then match them to their respective front panel cable labels.



The labels on the front panel cables may vary depending on the chassis model.

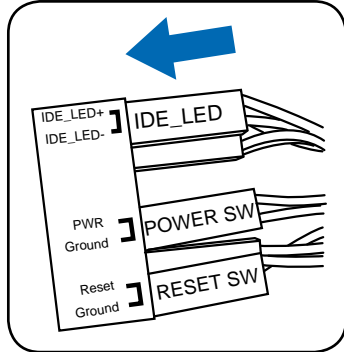

2. Install the ASUS Q-Connector to the system panel connector, ensuring the orientation matches the labels on the motherboard.

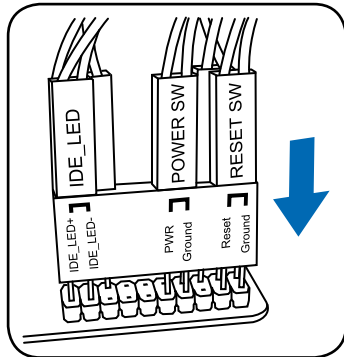

3. The front panel functions are now enabled. The figure shows the Q-Connector is properly installed on the motherboard.

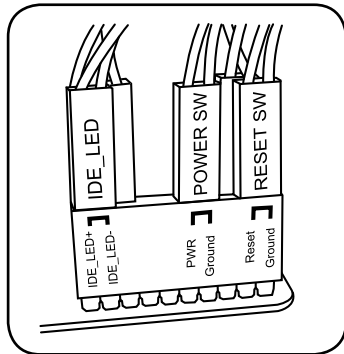

2.9 Onboard LEDs

1. Standby Power LED

The motherboard comes with a standby power LED. The green LED lights up to indicate that the system is ON, in sleep mode, or in soft-off mode. This is a reminder that you should shut down the system and unplug the power cable before removing or plugging in any motherboard component. The illustration below shows the location of the onboard LED.

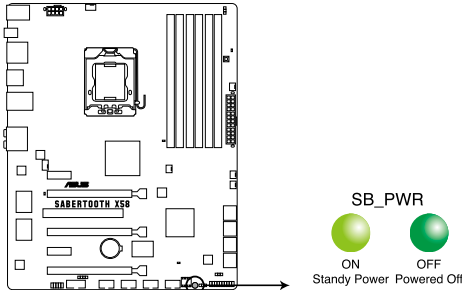

SABERTOOTH X58 Standby power LED

2. POST State LEDs

POST State LEDs check key components (CPU, DRAM, VGA card, and HDD) in sequence during motherboard booting process. If an error is found, the LED next to the error device will continue lighting until the problem is solved. This user-friendly design provides an intuitive way to locate the root problem within a second.

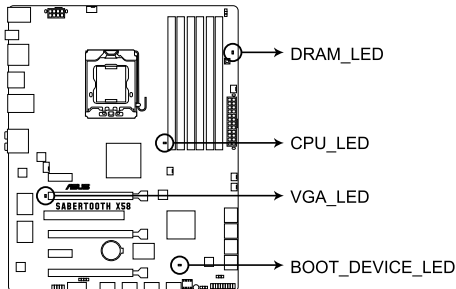

**SABERTOOTH X58 CPU/ DRAM/
BOOT_DEVICE/ VGA LED**

2.10 Starting up for the first time

1. After making all the connections, replace the system case cover.
2. Be sure that all switches are off.
3. Connect the power cord to the power connector at the back of the system chassis.
4. Connect the power cord to a power outlet that is equipped with a surge protector.
5. Turn on the devices in the following order:
 - a. Monitor
 - b. External SCSI devices (starting with the last device on the chain)
 - c. System power
6. After applying power, the system power LED on the system front panel case lights up. For systems with ATX power supplies, the system LED lights up when you press the ATX power button. If your monitor complies with the “green” standards or if it has a “power standby” feature, the monitor LED may light up or change from orange to green after the system LED turns on.

The system then runs the power-on self tests or POST. While the tests are running, the BIOS beeps (see the BIOS beep codes table below) or additional messages appear on the screen. If you do not see anything within 30 seconds from the time you turned on the power, the system may have failed a power-on test. Check the jumper settings and connections or call your retailer for assistance.

BIOS Beep	Description
One short beep	VGA detected Quick boot set to disabled No keyboard detected
One continuous beep followed by two short beeps then a pause (repeated)	No memory detected
One continuous beep followed by three short beeps	No VGA detected
One continuous beep followed by four short beeps	Hardware component failure

7. At power on, hold down the <Delete> key to enter the BIOS Setup. Follow the instructions in Chapter 3.

2.11 Turning off the computer

While the system is ON, pressing the power switch for less than four seconds puts the system on sleep mode or soft-off mode, depending on the BIOS setting. Pressing the power switch for more than four seconds lets the system enter the soft-off mode regardless of the BIOS setting. Refer to section **3.7 Power menu** in Chapter 3 for details.

3.1 Knowing BIOS

BIOS (Basic Input and Output System) stores system hardware settings such as storage device configuration, overlocking settings, advanced power management, and boot device configuration that are needed for system startup in the motherboard CMOS. In normal circumstances, the default BIOS settings apply to most conditions to ensure optimum performance. **We recommend that you not change the default BIOS settings** except in the following circumstances:

- An error message appears on the screen during the system bootup and requests you to run the BIOS Setup.
- You have installed a new system component that requires further BIOS settings or update.



Inappropriate settings of the BIOS may result to instability or failure to boot. **We strongly recommend that you change the BIOS settings only with the help of a trained service personnel.**

3.2 Updating BIOS

The ASUS website publishes the latest BIOS versions to provide enhancements on system stability, compatibility, or performance. However, BIOS updating is potentially risky. If there is no problem using the current version of BIOS, **DO NOT manually update the BIOS.** Inappropriate BIOS updating may result in the system's failure to boot. Carefully follow the instructions of this chapter to update your BIOS if necessary.



Visit the ASUS website (www.asus.com) to download the latest BIOS file for this motherboard.

The following utilities allow you to manage and update the motherboard BIOS setup program.

1. **ASUS Update:** Updates the BIOS in Windows® environment.
2. **ASUS EZ Flash 2:** Updates the BIOS using a USB flash drive.
3. **ASUS CrashFree BIOS 3 utility:** Restores the BIOS using the motherboard support DVD or a USB flash drive when the BIOS file fails or gets corrupted.

Refer to the corresponding sections for details on these utilities.



Save a copy of the original motherboard BIOS file to a USB flash disk in case you need to restore the BIOS in the future. Copy the original motherboard BIOS using the **ASUS Update** utility.

3.2.1 ASUS Update utility

The ASUS Update is a utility that allows you to manage, save, and update the motherboard BIOS in Windows® environment. The ASUS Update utility allows you to:

- Save the current BIOS file
- Download the latest BIOS file from the Internet
- Update the BIOS from an updated BIOS file
- Update the BIOS directly from the Internet
- View the BIOS version information

This utility is available in the support DVD that comes with the motherboard package.



ASUS Update requires an Internet connection either through a network or an Internet Service Provider (ISP).

Installing ASUS Update

To install ASUS Update:

1. Place the support DVD in the optical drive.
2. From the **Main** menu, click the **Utilities** tab, then click **Install ASUS Update VX.XX.XX**.
3. The ASUS Update utility is copied to your system.



Quit all Windows® applications before you update the BIOS using this utility.

Updating the BIOS through the Internet

To update the BIOS through the Internet:

1. From the Windows® desktop, click **Start > Programs > ASUS > ASUSUpdate > ASUSUpdate**. The ASUS Update main window appears.
2. Select **Update BIOS from the Internet** from the drop-down menu, and then click **Next**.

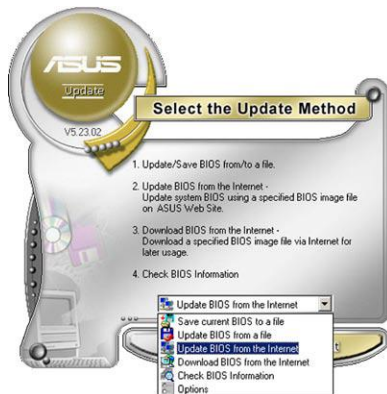
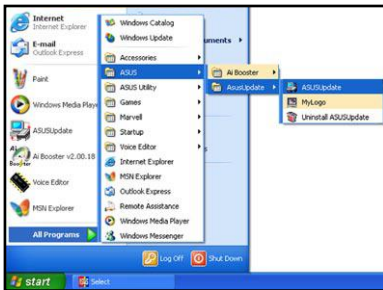

3. Select the ASUS FTP site nearest you to avoid network traffic, or click **Auto Select**. Click **Next**.



4. From the FTP site, select the BIOS version that you wish to download. Click **Next**.



5. Follow the onscreen instructions to complete the update process.



The ASUS Update utility is capable of updating itself through the Internet. Always update the utility to avail all its features.

Updating the BIOS through a BIOS file

To update the BIOS through a BIOS file:

1. From the Windows® desktop, click **Start > Programs > ASUS > Start > Programs > ASUS > ASUSUpdate > ASUSUpdate**. The ASUS Update main window appears.
2. Select **Update BIOS from a file** from the dropdown menu, then click **Next**.
3. Locate the BIOS file from the Open window, then click **Open**.
4. Follow the onscreen instructions to complete the update process.

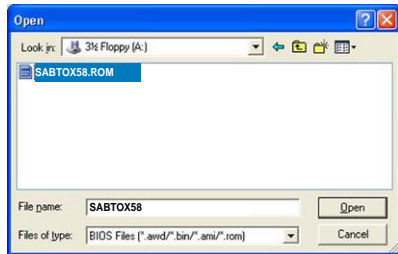
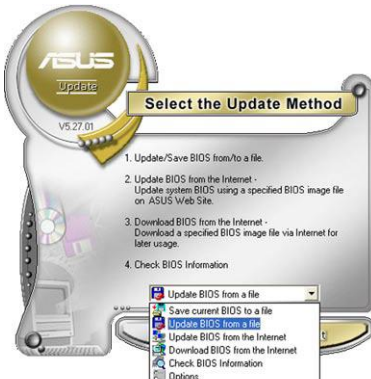

Ensure to load the BIOS default settings to ensure system compatibility and stability. Select the **Load Setup Defaults** item under the Exit menu. See section 3.10 **Exit Menu** for details.

3.2.2 ASUS EZ Flash 2 utility

The ASUS EZ Flash 2 feature allows you to update the BIOS without having to use a bootable floppy disk or an OS-based utility.



Before you start using this utility, download the latest BIOS from the ASUS website at www.asus.com.

To update the BIOS using EZ Flash 2:

1. Insert the USB flash disk that contains the latest BIOS file to the USB port, and then launch EZ Flash 2 in any of these two ways:
 - Press <Alt> + <F2> during POST to display the following.
 - Enter the BIOS setup program. Go to the **Tools** menu to select **EZ Flash 2** and press <Enter> to enable it.

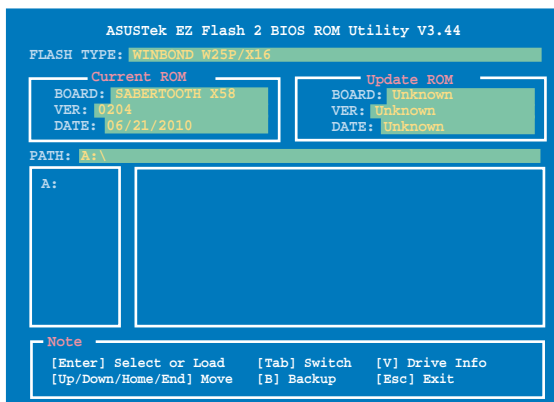

2. Press <Tab> to switch between drives until the correct BIOS file is found. When the correct BIOS file is found, EZ Flash 2 performs the BIOS update process and automatically reboots the system when done.



- This function can support devices such as a USB flash disk with FAT 32/16 format and single partition only.
- DO NOT shut down or reset the system while updating the BIOS to prevent system boot failure!



Ensure to load the BIOS default settings to ensure system compatibility and stability. Select the **Load Setup Defaults** item under the **Exit** menu. See section 3.10 **Exit Menu** for details.

3.2.3 ASUS CrashFree BIOS 3 utility

The ASUS CrashFree BIOS 3 utility is an auto recovery tool that allows you to restore the BIOS file when it fails or gets corrupted during the updating process. You can restore a corrupted BIOS file using the motherboard support DVD or a USB flash drive that contains the BIOS file.



The BIOS file in the motherboard support DVD may be older than the BIOS file published on the ASUS official website. If you want to use the newer BIOS file, download the file at support.asus.com and save it to a USB flash drive.

Recovering the BIOS

To recover the BIOS:

1. Turn on the system.
2. Insert the motherboard support DVD to the optical drive, or the USB flash drive containing the BIOS file to the USB port.
3. The utility automatically checks the devices for the BIOS file. When found, the utility reads the BIOS file and starts flashing the corrupted BIOS file.
4. Turn off the system after the utility completes the updating process and power on again.
5. The system requires you to enter BIOS Setup to recover BIOS setting. To ensure system compatibility and stability, we recommend that you press <F2> to load default BIOS values.



DO NOT shut down or reset the system while updating the BIOS! Doing so can cause system boot failure!

3.3 BIOS setup program

A BIOS Setup program is provided for BIOS item modification. When you start up the computer, the system provides you with the opportunity to run this program. Press during the Power-On Self-Test (POST) to enter the Setup utility. Otherwise, POST continues with its test routines.

If you wish to enter Setup after POST, restart the system by pressing <Ctrl> + <Alt> + <Delete>, or by pressing the reset button on the system chassis. You can also restart by turning the system off and then back on. Do this last option only if the first two failed.

The Setup program is designed to make it as easy to use as possible. Being a menu-driven program, it lets you scroll through the various submenus and select from the available options using the navigation keys.



- The BIOS setup screens shown in this section are for reference purposes only, and may not exactly match what you see on your screen.
- If the system becomes unstable after changing any BIOS setting, load the default settings to ensure system compatibility and stability. Select the **Load Setup Defaults** item under the **Exit** menu. See section 3.10 **Exit Menu** for details.
- If the system fails to boot after changing any BIOS setting, try to clear the CMOS and reset the motherboard to the default value. See section 2.6 **Jumpers** for information on how to erase the RTC RAM.

3.3.1 BIOS menu screen

3.3.2 Menu bar

The menu bar on top of the screen has the following main items:

Main	For changing the basic system configuration
Ai Tweaker	For changing the overclocking settings
Advanced	For changing the advanced system settings
Power	For changing the advanced power management (APM) configuration
Boot	For changing the system boot configuration
Tools	For configuring options for special functions
Exit	For selecting the exit options and loading default settings

3.3.3 Navigation keys

At the bottom right corner of a menu screen are the navigation keys for that particular menu. Use the navigation keys to select items in the menu and change the settings.



The navigation keys may differ from one screen to another.

3.3.4 Menu items

The highlighted item on the menu bar displays the specific items for that menu. For example, selecting **Main** shows the Main menu items.

The other items (Ai Tweaker, Advanced, Power, Boot, Tools, and Exit) on the menu bar have their respective menu items.

3.3.5 Submenu items

A solid triangle before each item on any menu screen means that the item has a submenu. To display the submenu, select the item and press <Enter>.

3.3.6 Configuration fields

These fields show the values for the menu items. If an item is user-configurable, you can change the value of the field opposite the item. You cannot select an item that is not user-configurable.

A configurable field is enclosed in brackets, and is highlighted when selected. To change the value of a field, select it and press <Enter> to display a list of options. Refer to **3.3.7 Pop-up window**.

3.3.7 Pop-up window

Select a menu item and press <Enter> to display a pop-up window with the configuration options for that item.

3.3.8 Scroll bar

A scroll bar appears on the right side of a menu screen when there are items that do not fit on the screen. Press the Up/Down arrow keys or <Page Up> / <Page Down> keys to display the other items on the screen.

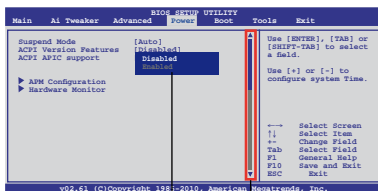

Pop-up window
Scroll bar

3.3.9 General help

At the top right corner of the menu screen is a brief description of the selected item.

3.4 Main menu

When you enter the BIOS Setup program, the Main menu screen appears, giving you an overview of the basic system information. Select an item and press <Enter> to display the submenu.



Refer to **section 3.3.1 BIOS menu screen** for information on the menu screen items and how to navigate through them.

The screenshot shows the 'Main' menu of the SABERTOOTH X58 BIOS Setup. The menu items are: System Time [15:57:25], System Date [Wed 06/30/2010], Language [English], SATA1 [HDT722516DLA380], SATA2 [Not Detected], SATA3 [Not Detected], SATA4 [Not Detected], SATA5 [Not Detected], SATA6 [Not Detected], Storage Configuration, and System Information. A legend on the right lists navigation keys: left arrow for Select Screen, up/down arrows for Select Item, +/- for Change Field, Tab for Select Field, F1 for General Help, F10 for Save and Exit, and ESC for Exit. The bottom of the screen displays 'v02.61 (C)Copyright 1985-2010, American Megatrends, Inc.'

3.4.1 SATA 1-6

While entering Setup, the BIOS automatically detects the presence of SATA devices. There is a separate submenu for each SATA device. Select a device item and press <Enter> to display the SATA device information.

The screenshot shows the 'SATA 1' submenu of the SABERTOOTH X58 BIOS Setup. It displays device information: Device: Hard Disk, Vendor: HDT722516DLA380, Size: 164.7GB, LBA Mode: Supported, Block Mode: 16Sectors, PIO Mode: 4, Async DMA: MultiWord DMA-2, Ultra DMA: Ultra DMA-6, SMART Monitoring: Supported. Below this, there are dimmed items: Type [Auto], LBA/Large Mode [Auto], Block(Multi-Sector Transfer)M [Auto], PIO Mode [Auto], DMA Mode [Auto], SMART Monitoring [Auto], and 32Bit Data Transfer [Enabled]. A legend on the right lists navigation keys: left arrow for Select Screen, up/down arrows for Select Item, +/- for Change Field, F1 for General Help, F10 for Save and Exit, and ESC for Exit. The bottom of the screen displays 'v02.61 (C)Copyright 1985-2010, American Megatrends, Inc.'

The BIOS automatically detects the values opposite the dimmed items (Device, Vendor, Size, LBA Mode, Block Mode, PIO Mode, Async DMA, Ultra DMA, and SMART Monitoring). These values are not user-configurable. These items show **N/A** if no SATA device is installed in the system.

Type [Auto]

Allows you to select the type of device installed.

- [Not Installed] Select this option if no device is installed.
- [Auto] Allows automatic selection of the appropriate device type.
- [CDROM] Select this option if you are specifically configuring a CD-ROM drive.
- [ARMD] Select [ARMD] (ATAPI Removable Media Device) if your device is either a ZIP, LS-120, or MO drive.

LBA/Large Mode [Auto]

- [Auto] Select [Auto] to enable the LBA mode (Logical Block Addressing mode) if the device supports this mode, and if the device was not previously formatted with LBA mode disabled.
- [Disabled] Disables this function.

Block (Multi-Sector Transfer) M [Auto]

- [Auto] When set to [Auto], the data transfer from and to the device occurs in multiple sectors at a time if the device supports multi-sector transfer feature.
- [Disabled] When set to [Disabled], the data transfer from and to the device occurs one sector at a time.

PIO Mode [Auto]

- [Auto] Allows automatic selection of the PIO (Programmed input/output) modes, which correspond to different data transfer rates.
- [0] [1] [2] [3] [4] Sets the PIO mode to Mode 0, 1, 2, 3, or 4.

DMA Mode [Auto]

DMA (Direct Memory Access) allows your computer to transfer data to and from the hardware devices installed with much less CPU overhead.

The DMA mode consists of SDMA (single-word DMA), MDMA (multi-word DMA), and UDMA (Ultra DMA). Setting to [Auto] allows automatic selection of the DMA mode.

SMART Monitoring [Auto]

- [Auto] Allows automatic selection of the S.M.A.R.T (Smart Monitoring, Analysis, and Reporting Technology).
- [Enabled] Enables the S.M.A.R.T feature.
- [Disabled] Disables the S.M.A.R.T feature.

32Bit Data Transfer [Enabled]

- [Enabled] Sets the controller to combine two 16-bit reads from the hard disk into a single 32-bit double word transfer to the processor. This makes more efficient use of the PCI bus as fewer transactions are needed for the transfer of a particular amount of data.
- [Disabled] Disables this function.

3.4.2 Storage Configuration

The Storage Configuration menu allows you to configure your storage devices. Select an item then press <Enter> to display the submenu.

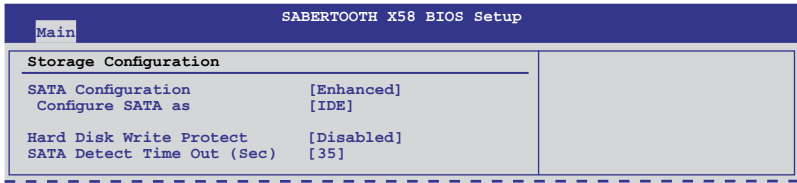

SATA Configuration [Enhanced]

Configuration options: [Disabled] [Compatible] [Enhanced]

Configure SATA as [IDE]

Allows you to set the SATA configuration. This item appears only when you set the **SATA Configuration** item to [Enhanced] or [Compatible].

- [IDE] Set to [IDE] when you want to use the Serial ATA hard disk drives as Parallel ATA physical storage devices.
- [RAID] Set to [RAID] when you want to create a RAID configuration from the SATA hard disk drives.
- [AHCI] Set to [AHCI] when you want the SATA hard disk drives to use the AHCI (Advanced Host Controller Interface). The AHCI allows the onboard storage driver to enable advanced Serial ATA features that increases storage performance on random workloads by allowing the drive to internally optimize the order of commands.

Hard Disk Write Protect [Disabled]

- [Enabled] Enables device write protection. This function will be effective only if the device is accessed through BIOS.
- [Disabled] Disables this function.

SATA Detect Time Out (Sec) [35]

Selects the time out value for detecting ATA/ATAPI devices from the following options: [0] [5] [10] [15] [20] [25] [30] [35]

3.4.3 AHCI Configuration

This menu is the section for AHCI configuration. It appears only when you set the item **Configure SATA as** from the submenu of **SATA Configuration** to [AHCI].

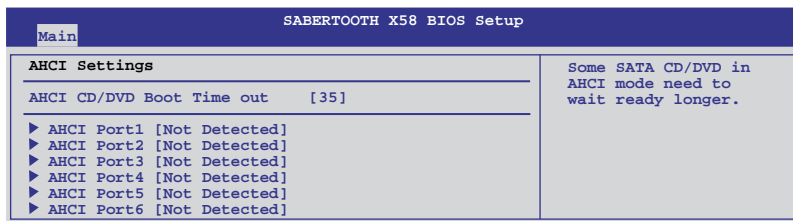

AHCI CD/DVD Boot Time out [35]

Selects the boot time out value for SATA CD/DVD devices in AHCI mode from the following options: [0] [5] [10] [15] [20] [25] [30] [35]

SATA Port1-6 [XXXX]

Displays the status of auto-detection of SATA devices.

SATA Port1-6 [Auto]

[Auto] Allows automatic selection of the device type connected to the system.

[Not Installed] Selects this option if no SATA devices are installed.

SMART Monitoring [Enabled]

S.M.A.R.T. (Self-Monitoring, Analysis and Reporting Technology) is a monitor system. When read/write of your hard disk errors occur, this feature allows the hard disk to report warning messages during the POST.

[Enabled] Enables the SMART monitoring feature.

[Disabled] Disables the SMART monitoring feature.

3.4.4 System Information

This menu gives you an overview of the general system specifications. The BIOS automatically detects the BIOS information, CPU specification, and system memory in this menu.

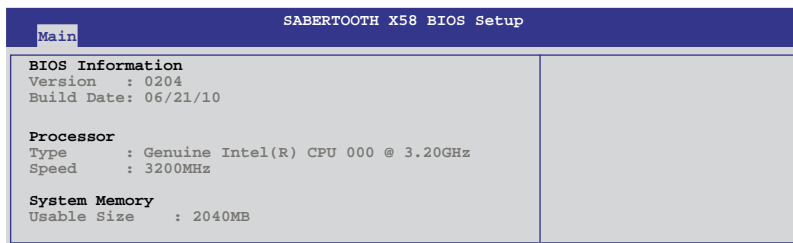

3.5 Ai Tweaker menu

The Ai Tweaker menu items allow you to configure overclocking-related items.



Be cautious when changing the settings of the Ai Tweaker menu items. Incorrect field values can cause the system to malfunction.



The configuration options for this chapter vary depending on the CPU and DIMM model you installed on the motherboard.

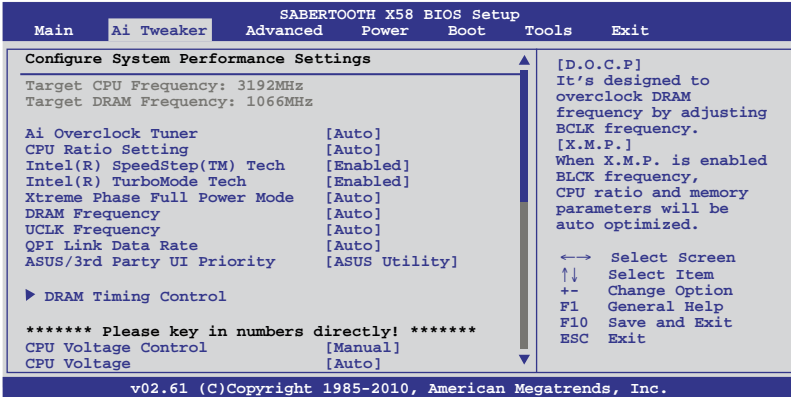

Scroll down to display the following items:

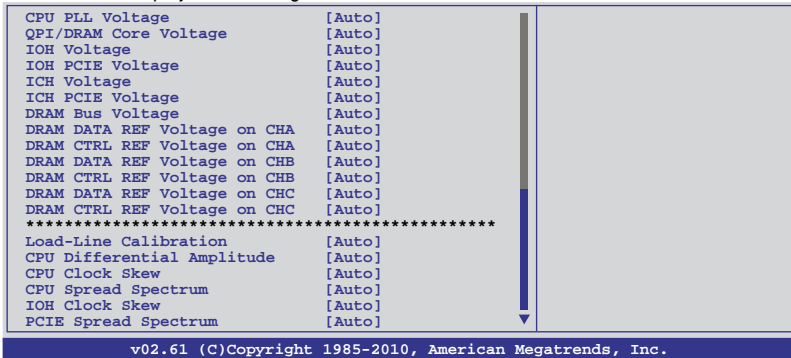

3.5.1 Ai Overclock Tuner [Auto]

Allows you to select the CPU overclocking options to achieve the desired CPU internal frequency. Select any of these preset overclocking configuration options:

Manual	Allows you to individually set overclocking parameters.
Auto	Loads the optimal settings for the system.
D.O.C.P	Overclocks DRAM frequency by adjusting BCLK frequency.
X.M.P.	If you install memory modules supporting the eXtreme Memory Profile (X.M.P.) Technology, choose this item to set the profiles supported by your memory modules for optimizing the system performance.



The configuration options for the following sub-items vary depending on the DIMMs you install on the motherboard.

DRAM O.C. Profile [DDR3-1805MHz]

This item appears only when you set the **Ai Overclock Tuner** item to [D.O.C.P.] and allows you to select a DRAM O.C. profile, which applies different settings to DRAM frequency, DRAM timing and DRAM voltage. Configuration options: [DDR3-1805MHz] [DDR3-2006MHz]

eXtreme Memory Profile [Disabled]

This item appears only when you set the **Ai Overclock Tuner** item to [X.M.P.] and allows you to select the X.M.P. mode supported by your memory module.

[Disabled] You are not allowed to select the memory profile.

[High Performance] Allows your memory to work in high performance.

[High Frequency] Allows your memory to work in high frequency.



To obtain the best performance of the X.M.P. DIMM or 1600MHz DIMM, install only one DIMM on each memory channel.

3.5.2 CPU Ratio Setting [Auto]

Allows you to set the ratio between the CPU Core Clock and the BCLK Frequency. Use <+> and <-> keys to adjust the ratio. The valid value ranges vary according to your CPU model.

3.5.3 Intel(R) SpeedStep(TM) Tech [Enabled]

[Enabled] The CPU speed is controlled by the operating system.

[Disabled] The CPU runs at its default speed.

3.5.4 Intel(R) TurboMode Tech [Enabled]

[Enabled] Allows processor cores to run faster than marked frequency in specific condition.

[Disabled] Disables this function.

3.5.5 Xtreme Phase Full Power Mode [Auto]

[Auto] Automatic configuration.

[Enabled] Enables Full Power Mode to ensure the best CPU overclocking performance.



The following two items appear only when you set the Ai Overclock Tuner item to [Manual], [D.O.C.P.] or [X.M.P.].

3.5.6 BCLK Frequency [XXX]

Allows you to adjust the CPU operating frequency to enhance the system performance. Use the <+> and <-> keys to adjust the value. You can also key in the desired value using the numeric keypad. The values range from 100 to 500.

3.5.7 PCIE Frequency [XXX]

Allows you to set the PCI Express frequency. Use the <+> and <-> keys to adjust the PCIE frequency. You can also key in the desired value using the numeric keypad. The values range from 100 to 200.

3.5.8 DRAM Frequency [Auto]

Allows you to set the DDR3 operating frequency. The configuration options vary with the **BCLK Frequency** item settings.



Selecting a very high DRAM frequency may cause the system to become unstable! If this happens, revert to the default setting.

3.5.9 UCLK Frequency [XXX]

Allows you to set the CPU Uncore frequency to increase the transmission bandwidth between the memory controller and memory modules. The configuration options vary with the **DRAM Frequency** item settings.

3.5.10 QPI Link Data Rate [Auto]

Allows you to set the QuickPath Interconnect (QPI) frequency to enhance the system performance. Configuration options: [Auto] [Slow Mode] [4800MT/s] [5866MT/s] [6400MT/s]

3.5.11 ASUS/3rd Party UI Priority [ASUS Utility]

[ASUS Utility] Prioritizes the usage of ASUS utilities. Other 3rd party OC utilities may not be full-functioned.

[3rd Party Utility] Prioritizes 3rd party OC utilities. ASUS utilities can't be launched.

3.5.12 DRAM Timing Control [Auto]

The items in this menu allow you to set the DRAM timing control features.



The configuration options for some of the following items vary depending on the DIMMs you install on the motherboard.

1st Information: 9-9-9-24-4-74-11-7-20-0

The values vary depending on your settings of the following sub-items:

DRAM CAS# Latency [Auto]

Configuration options: [Auto] [3 DRAM Clock] [4 DRAM Clock] – [10 DRAM Clock] [11 DRAM Clock]

DRAM RAS# to CAS# Delay [Auto]

Configuration options: [Auto] [3 DRAM Clock] [4 DRAM Clock] – [14 DRAM Clock] [15 DRAM Clock]

DRAM RAS# PRE Time [Auto]

Configuration options: [Auto] [3 DRAM Clock] [4 DRAM Clock] – [14 DRAM Clock] [15 DRAM Clock]

DRAM RAS# ACT Time [Auto]

Configuration options: [Auto] [3 DRAM Clock] [4 DRAM Clock] – [30 DRAM Clock]
[31 DRAM Clock]

DRAM RAS# to RAS# Delay [Auto]

Configuration options: [Auto] [1 DRAM Clock] – [7 DRAM Clock]

DRAM REF Cycle Time [Auto]

Configuration options: [Auto] [30 DRAM Clock] [36 DRAM Clock]
[48 DRAM Clock] [60 DRAM Clock] [72 DRAM Clock] [82 DRAM Clock]
[88 DRAM Clock] [90 DRAM Clock] [100 DRAM Clock] [110 DRAM Clock]
[124 DRAM Clock] [132 DRAM Clock] [140 DRAM Clock] [150 DRAM Clock]
[160 DRAM Clock]

DRAM WRITE Recovery Time [Auto]

Configuration options: [Auto] [1 DRAM Clock] – [15 DRAM Clock]

DRAM READ to PRE Time [Auto]

Configuration options: [Auto] [3 DRAM Clock] – [15 DRAM Clock]

DRAM FOUR ACT WIN Time [Auto]

Configuration options: [Auto] [1 DRAM Clock] – [63 DRAM Clock]

DRAM Back-To-Back CAS# Delay [Auto]

Configuration options: [Auto] [4 DRAM Clock] – [32 DRAM Clock]

2nd Information: 1N-60-0-0

The values vary depending on your settings of the following sub-items:

DRAM Timing Mode [Auto]

Configuration options: [Auto] [1N] [2N] [3N]

DRAM Round Trip Latency on CHA/B/C [Auto]

Configuration options: [Auto] [1 DRAM Clock] – [175 DRAM Clock]

3rd Information: 5-5-16-10-10-11-7-6-4-7-7-4

The values vary depending on your settings of the following sub-items:

DRAM WRITE to READ Delay(DD) [Auto]

Configuration options: [Auto] [1 DRAM Clock] – [8 DRAM Clock]

DRAM WRITE to READ Delay(DR) [Auto]

Configuration options: [Auto] [1 DRAM Clock] – [8 DRAM Clock]

DRAM WRITE to READ Delay(SR) [Auto]

Configuration options: [Auto] [10 DRAM Clock] – [22 DRAM Clock]

DRAM READ to WRITE Delay(DD) [Auto]

Configuration options: [Auto] [2 DRAM Clock] – [14 DRAM Clock]

DRAM READ to WRITE Delay(DR) [Auto]

Configuration options: [Auto] [2 DRAM Clock] – [14 DRAM Clock]

DRAM READ to WRITE Delay(SR) [Auto]

Configuration options: [Auto] [2 DRAM Clock] – [14 DRAM Clock]

DRAM READ to READ Delay(DD) [Auto]

Configuration options: [Auto] [2 DRAM Clock] – [9 DRAM Clock]

DRAM READ to READ Delay(DR) [Auto]

Configuration options: [Auto] [2 DRAM Clock] – [9 DRAM Clock]

DRAM READ to READ Delay(SR) [Auto]

Configuration options: [Auto] [4 DRAM Clock] [6 DRAM Clock]

DRAM WRITE to WRITE Delay(DD) [Auto]

Configuration options: [Auto] [2 DRAM Clock] – [9 DRAM Clock]

DRAM WRITE to WRITE Delay(DR) [Auto]

Configuration options: [Auto] [2 DRAM Clock] – [9 DRAM Clock]

DRAM WRITE to WRITE Delay(SR) [Auto]

Configuration options: [Auto] [4 DRAM Clock] [6 DRAM Clock]

3.5.13 CPU Voltage Control [Manual]

[Manual] Allows you to set a fixed CPU voltage.

[Offset] Allows you to set the Offset voltage.



The following ten (10) items are adjusted by typing the desired values using the numeric keypad and press the <Enter> key. You can also use the <+> and <-> keys to adjust the value. To restore the default setting, type [auto] using the keyboard and press the <Enter> key.

3.5.14 CPU Voltage [Auto]

Allows you to set the CPU VCore voltage. The values range from 0.85000V to 2.10000V* with a 0.00625V interval.



- Refer to the CPU documentation before setting the CPU Vcore voltage. Setting a high VCore voltage may damage the CPU permanently, and setting a low VCore voltage may make the system unstable.
 - The value [2.10000V] of the CPU Voltage item is supported only if the **OV_CPU** jumper is enabled. Otherwise the maximum voltage supported is [1.70000V]. See **CPU / DRAM Bus overvoltage settings** on page 2-23 for details.
-

3.5.15 CPU PLL Voltage [Auto]

Allows you to set the CPU PLL voltage. The values range from 1.80V to 2.50V with a 0.02V interval.

3.5.16 QPI/DRAM Core Voltage [Auto]

Allows you to set the QPI/DRAM Core voltage. The values range from 1.20000V to 1.60000V with a 0.00625V interval.

3.5.17 IOH Voltage [Auto]

Allows you to set the I/O Hub (IOH) voltage. The values range from 1.10V to 1.70V with a 0.02V interval.

3.5.18 IOH PCIE Voltage [Auto]

Allows you to set the IOH PCIE voltage. The values range from 1.50V to 2.76V with a 0.02V interval.

3.5.19 ICH Voltage [Auto]

Allows you to set the I/O Controller Hub (ICH) voltage. The values range from 1.10V to 1.40V with a 0.10V interval.

3.5.20 ICH PCIE Voltage [Auto]

Allows you to set the ICH PCIE voltage. The values range from 1.50V to 1.80V with a 0.10V interval.

3.5.21 DRAM Bus Voltage [Auto]

Allows you to set the DRAM voltage. The values range from 1.50V to 2.46V* with a 0.01V interval.



- The value [2.46V] of the **DRAM Bus Voltage** item is supported only if the **OV_DRAM_BUS** jumper is enabled, otherwise the maximum voltage supported is [2.0V]. See **CPU / DRAM Bus overvoltage settings** on page 2-23 for details.
- According to Intel CPU spec, DIMMs with voltage requirement over 1.65V may damage the CPU permanently. We recommend you install the DIMMs with the voltage requirement below 1.65V.
- The values of the **CPU Voltage**, **CPU PLL Voltage**, **QPI/DRAM Core Voltage**, **IOH Voltage**, **IOH PCIE Voltage**, **ICH Voltage**, **ICH PCIE Voltage**, and **DRAM Bus Voltage** items are labeled in different color, indicating the risk levels of high voltage settings. Refer to the table below for details.
- The system may need better cooling system to work stably under high voltage settings.

	Blue	Yellow	Purple	Red
CPU Voltage	0.85000V– 1.22500V	1.23125V– 1.29375V	1.30000V– 1.35000V	1.35625V 1.70000V
CPU PLL Voltage	1.80V–1.90V	1.92V–2.00V	2.02V–2.10V	2.12V–2.50V
QPI/DRAM Core Voltage	1.20000V– 1.26875V	1.27500V– 1.32500V	1.33125V– 1.40000V	1.40625V– 1.60000V
IOH Voltage	1.10V–1.18V	1.20V–1.24V	1.26V–1.30V	1.32V–1.70V
IOH PCIE Voltage	1.50V–1.58V	1.60V–1.66V	1.68V–1.74V	1.76V–2.76V
ICH Voltage	1.10V–1.20V	1.30V–1.40V	N/A	N/A
ICH PCIE Voltage	1.50V–1.60V	1.70V–1.80V	N/A	N/A
DRAM Bus Voltage	1.50V–1.64V	N/A	N/A	1.66V–2.46V

3.5.22 DRAM DATA REF Voltage on CHA/B/C [Auto]

Allows you to set the DRAM DATA Reference Voltage on Channel A/B/C. The values range from 0.395x to 0.630x with a 0.005x interval. Different ratio might enhance DRAM overclocking ability.

3.5.23 DRAM CTRL REF Voltage on CHA/B/C [Auto]

Allows you to set the DRAM Control Reference Voltage on Channel A/B/C. The values range from 0.395x to 0.630x with a 0.005x interval. Different ratio might enhance DRAM overclocking ability.

3.5.24 Load-Line Calibration [Auto]

[Auto] BIOS automatically adjusts the voltage.

[Disabled] Follows the Intel specifications.

[Enabled] Improves the CPU VDrop directly.

3.5.25 CPU Differential Amplitude [Auto]

Different AMP might enhance BCLK overclocking ability.

Configuration options: [Auto] [700mV] [800mV] [900mV] [1000mV]

3.5.26 CPU Clock Skew [Auto]

Adjusting this item may help enhancing BCLK overclocking ability. You may need to adjust the **IOH Clock Skew** item at the same time.

Configuration options: [Auto] [Normal] [Delay 100ps] [Delay 200ps] – [Delay 1400ps] [Delay 1500ps]

3.5.27 CPU Spread Spectrum [Auto]

Set to [Disabled] to enhance BCLK overclocking ability or [Auto] for EMI control.

Configuration options: [Auto] [Disabled] [Enabled]

3.5.28 IOH Clock Skew [Auto]

Adjusting this item may help enhancing BCLK overclocking ability. You may need to adjust the **CPU Clock Skew** item at the same time.

Configuration options: [Auto] [Normal] [Delay 100ps] [Delay 200ps] – [Delay 1400ps] [Delay 1500ps]

3.5.29 PCIE Spread Spectrum [Auto]

Set to [Disabled] to enhance PCIE overclocking ability or [Auto] for EMI control.

Configuration options: [Auto] [Disabled] [Enabled]

3.6 Advanced menu

The Advanced menu items allow you to change the settings for the CPU and other system devices.



Be cautious when changing the settings of the Advanced menu items. Incorrect field values can cause the system to malfunction.

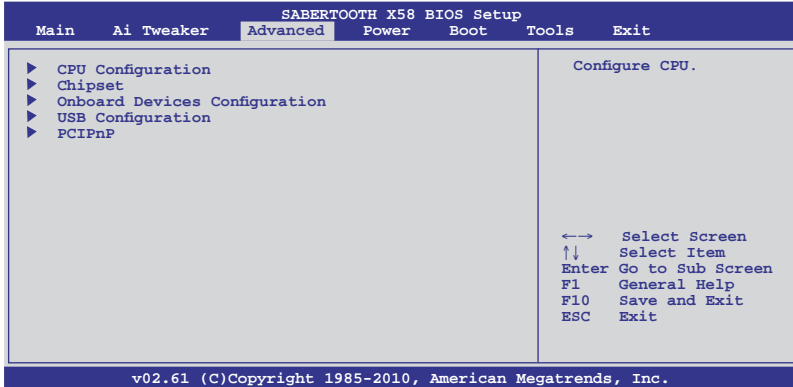

3.6.1 CPU Configuration

The items in this menu show the CPU-related information that the BIOS automatically detects.



The items shown in this screen may be different due to the CPU you installed.

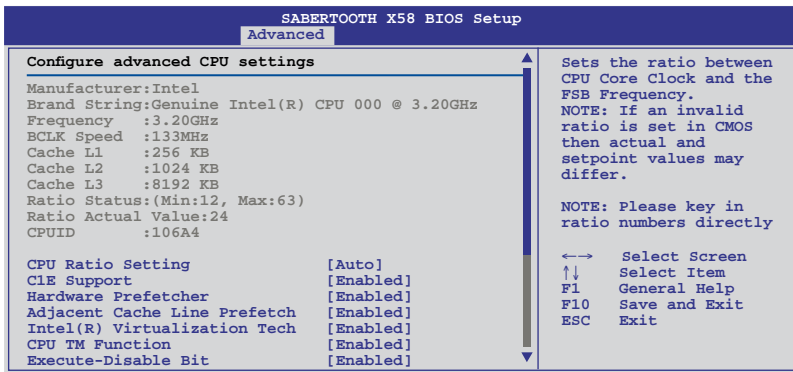

Scroll down to display the following items:

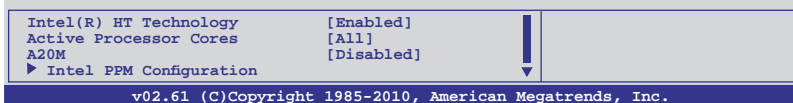

CPU Ratio Setting [Auto]

Allows you to set the ratio between the CPU Core Clock and the BCLK Frequency. Use <+> and <-> keys to adjust the ratio. The valid value ranges vary according to your CPU model.

C1E Support [Enabled]

[Enabled] Enables the C1E support function. This item should be enabled in order to enable the Enhanced Halt State.

[Disabled] Disables this function.

Hardware Prefetcher [Enabled]

[Enabled] The processor fetches data and instructions from the memory into the cache that are likely to be required in the near future. This reduces the latency associated with memory reads.

[Disabled] Disables this function.

Adjacent Cache Line Prefetch [Enabled]

[Enabled] The processor fetches the currently requested cache line, as well as the subsequent cache line. This reduces the cache latency by making the next cache line immediately available if the processor requires it as well.

[Disabled] The processor fetches only the currently requested cache line.

Intel(R) Virtualization Tech [Enabled]

[Enabled] Allows a hardware platform to run multiple operating systems separately and simultaneously, enabling one system to virtually function as several systems.

[Disabled] Disables this function.

CPU TM function [Enabled]

[Enabled] Enables the overheated CPU to throttle its clock speed to cool down.

[Disabled] Disables this function.

Execute Disable Bit [Enabled]

[Enabled] Enables the No-Execution Page Protection Technology.

[Disabled] Forces the XD feature flag to always return to zero (0).

Intel(R) HT Technology [Enabled]

The Intel Hyper-Threading Technology allows a hyper-threading processor to appear as two logical processors to the operating system, allowing the operating system to schedule two threads or processes simultaneously.

[Enabled] Two threads per activated core are enabled.

[Disabled] Only one thread per activated core is enabled.

Active Processor Cores [All]

Allows you to choose the number of CPU cores to activate in each processor package. Configuration options: [All] [1] [2]

A20M [Disabled]

[Enabled] Allows Legacy OSEs to be compatible with APs.

[Disabled] Disables this function.

Intel PPM Configuration

Configure CPU EIST and C-state function.

Intel(R) SpeedStep(TM) Tech [Enabled]

[Enabled] The CPU speed is controlled by the operating system.

[Disabled] The CPU runs at its default speed.

Intel(R) TurboMode Tech [Enabled]

This item appears only when you enable the **Intel(R) SpeedStep(TM) Tech** item.

[Enabled] Allows processor cores to run faster than marked frequency in specific condition.

[Disabled] Disables this function.



Intel® Turbo Mode function support depends on CPU types.

Turbo Ratio Limit Program [Enabled]

This item appears only when you enable the **Intel(R) TurboMode Tech** item.

[Enabled] Enables the turbo mode ration programming function.

[Disabled] Disables this function.

1/2/3/4-Core Ratio Limit [XX]

These items appear only when you enable the **Intel(R) Turbo Ratio Limit Program** item and allow you to set the ratio limit for the individual CPU core. The valid value ranges vary according to your CPU model. The selected value will be programmed into the Turbo Ratio Limit register.

TDC Limit Override [Enabled]

[Enabled] Enables the TDC Limit Override function that allows the motherboard to provide the current higher than the factory default Thermal Design Current (TDC) to the CPU while using Intel TurboMode.

[Disabled] Disables this function.

TDC Limit value [XXX]

This item appear only when you enable the **TDC Limit Override** item and allows you to set the TDC threshold while using Intel TurboMode. The valid value ranges vary according to your CPU model.

TDP Limit Override [Enabled]

[Enabled] Enables the TDP Limit Override function that allows the motherboard to provide the power higher than the factory default Thermal Design Power (TDP) to the CPU while using Intel TurboMode.

[Disabled] Disables this function.

TDP Limit value [XXX]

This item appear only when you enable the **TDP Limit Override** item and allows you to set the TDP threshold while using Intel TurboMode. The valid value ranges vary according to your CPU model.

Intel(R) C-STATE Tech [Disabled]

The Intel® C-State Technology allows the CPU to save more power under idle mode.

[Enabled] Enable this item only when you install a C-State Technology-supported CPU.

[Disabled] Disables this function.

C State package limit setting [Auto]

This item appears only when you set the **Intel(R) C-STATE Tech** item to [Enabled]. We recommend that you set this item to [Auto] for BIOS to automatically detect the C-State mode supported by your CPU. Configuration options: [Auto] [C1] [C3] [C6]

C1 Auto Demotion [Enabled]

This item appears only when you set the **Intel(R) C-STATE Tech** item to [Enabled].

[Enabled] When enabled, CPU will conditionally demote C3/C6/C7 requests to C1 based on uncore auto-demote information.

[Disabled] Disables this function.

C3 Auto Demotion [Enabled]

This item appears only when you set the **Intel(R) C-STATE Tech** item to [Enabled].

[Enabled] When enabled, CPU will conditionally demote C6/C7 requests to C3 based on uncore auto-demote information.

[Disabled] Disables this function.

3.6.2 Chipset

The Chipset menu allows you to change the advanced chipset settings. Select an item and press <Enter> to display the submenu.

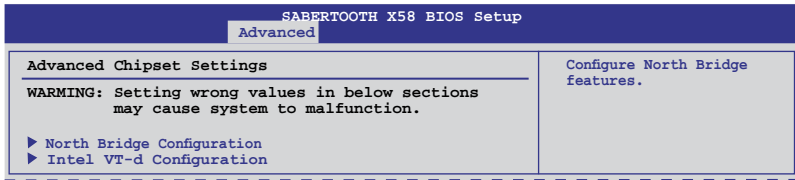

NorthBridge Chipset Configuration

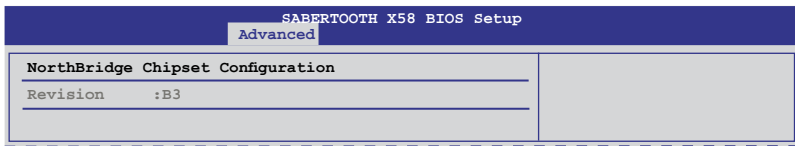

Intel VT-d Configuration

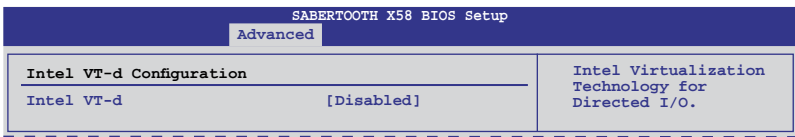

Intel VT-d [Disabled]

Allows you to enable or disable the Intel Virtualization Technology for Directed I/O.

Configuration options: [Disabled] [Enabled]

3.6.3 Onboard Devices Configuration

SABERTOOTH X58 BIOS Setup	
Advanced	
Onboard Devices Configuration	Options
High Definition Audio	[Enabled]
Front Panel Type	[HD Audio]
SPDIF OUT Mode Setting	[SPDIF]
RTL8110SC LAN	[Enabled]
LAN Boot ROM	[Disabled]
Onboard 1394 Controller	[Enabled]
Marvell 9128 Controller	[IDE Mode]
JMB 36x ATA Controller	[Enabled]
JMB 36x OptionRom	[Enabled]
OptionRom Display in POST	[Enabled]
OptionRom Detect Time Out	[Auto]
Serial Port1 Address	[3F8/IRQ4]

High Definition Audio [Enabled]

[Enabled] Enables the High Definition Audio Controller.

[Disabled] Disables the controller.



The following item appears only when you set the **High Definition Audio** item to [Enabled].

Front Panel Type [HD Audio]

Allows you to set the front panel audio connector (AAFP) mode to legacy AC'97 or high-definition audio depending on the audio standard that the front panel audio module supports.

[AC97] Sets the front panel audio connector (AAFP) mode to legacy AC'97

[HD Audio] Sets the front panel audio connector (AAFP) mode to high definition audio.

SPDIF OUT Mode Setting [SPDIF]

[SPDIF] Sets to [SPDIF] for SPDIF audio output.

[HDMI] Sets to [HDMI] for HDMI audio output.

RTL8110SC LAN [Enabled]

[Enabled] Enables the Realtek LAN controller.

[Disabled] Disables the controller.

LAN Boot ROM [Disabled]

This item appears only when you set the previous item to [Enabled].

[Enabled] Enables the LAN Boot ROM.

[Disabled] Disables the LAN Boot ROM.

Onboard 1394 Controller [Enabled]

[Enabled] Enables the onboard IEEE 1394a controller.

[Disabled] Disables the controller.

Marvell 9128 Controller [IDE Mode]

Allows you to select the Marvell 9128 controller operating mode.

- [Disabled] Disables the controller.
- [IDE Mode] Set to [IDE Mode] when you want to use the Serial ATA hard disk drives as Parallel ATA physical storage devices.
- [AHCI Mode] Set to [AHCI Mode] when you want the SATA hard disk drives to use the AHCI (Advanced Host Controller Interface). The AHCI allows the onboard storage driver to enable advanced Serial ATA features that increases storage performance on random workloads by allowing the drive to internally optimize the order of commands.

JMB 36x ATA Controller [Enabled]

Allows you to enable or disable the JMB 36x ATA controller.

Configuration options: [Disabled] [Enabled]



If you want to use the full function of the JMB 36x ATA controller (ex. AHCI), we recommend that you set this item to [Enabled] and install the **JMicron JMB36X Controller Driver** from the motherboard support DVD.

JMB 36x OptionRom [Enabled]

This item appears only when you set the previous item to [Enabled] and allows you to enable or disable the OptionRom of the JMB 36x ATA controller.

Configuration options: [Enabled] [Disabled]

OptionRom Display in POST [Enabled]

This item appears only when you set the **JMB 36x OptionRom** item to [Enabled] and allows you to display or hide the OptionRom of the JMB 36x ATA controller during POST. Configuration options: [Enabled] [Disabled]

OptionRom Detect Time Out [Auto]

This item appears only when you set the **JMB 36x OptionRom** item to [Enabled] and allows you to select the time out value for detecting the OptionRom.

Configuration options: [Auto] [1 Sec] [2 Sec] [6 Sec]

Serial Port1 Address [3F8/IRQ4]

Allows you to select the Serial Port1 base address.

Configuration options: [Disabled] [3F8/IRQ4] [2F8/IRQ3] [3E8/IRQ4] [2E8/IRQ3]

3.6.4 USB Configuration

The items in this menu allow you to change the USB-related features. Select an item and press <Enter> to display the configuration options.

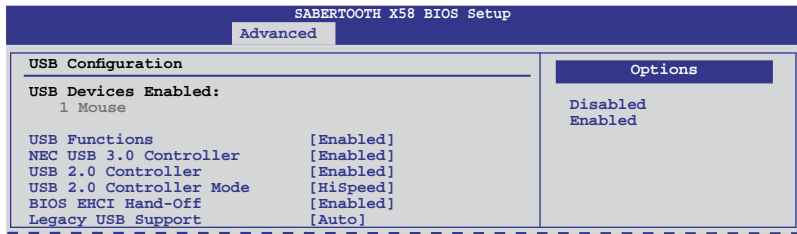

The **USB Devices Enabled** item shows the auto-detected values. If no USB device is detected, the item shows **None**.

USB Functions [Enabled]

[Enabled] Enables the USB Host Controllers.

[Disabled] Disables the controllers.

NEC USB 3.0 Controller [Enabled]

[Enabled] Enables the USB 3.0 controller.

[Disabled] Disables the controller.



The following two items appear only when you set **USB Functions** to [Enabled].

USB 2.0 Controller [Enabled]

[Enabled] Enables the USB 2.0 controller.

[Disabled] Disables the controller.

USB 2.0 Controller Mode [HiSpeed]

[FullSpeed] Sets the USB 2.0 controller mode to FullSpeed (12 Mbps).

[HiSpeed] Sets the USB 2.0 controller mode to HiSpeed (480 Mbps).

BIOS EHCI Hand-off [Enabled]

[Enabled] Enables the support for operating systems without an EHCI hand-off feature.

[Disabled] Disables the function.



The following item appears only when you set **USB Functions** to [Enabled].

Legacy USB Support [Auto]

- [Auto] Allows the system to detect the presence of USB devices at startup. If detected, the USB controller legacy mode is enabled. If no USB device is detected, the legacy USB support is disabled.
- [Enabled] Enables the support for USB devices on legacy operating systems (OS).
- [Disabled] Disables the function.

3.6.5 PCIPnP

The PCI PnP menu items allow you to change the advanced settings for PCI/PnP devices.

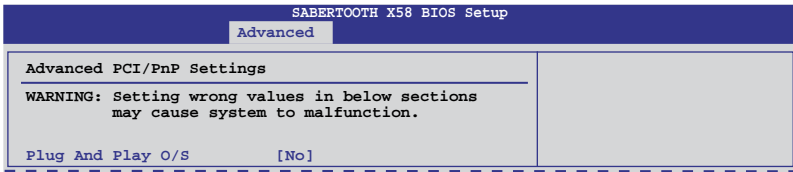

Plug And Play O/S [No]

- [Yes] When set to [Yes] and if you install a Plug and Play operating system, the operating system configures the Plug and Play devices not required for boot.
- [No] When set to [No], BIOS configures all the devices in the system.

3.7 Power menu

The Power menu items allow you to change the settings for the Advanced Power Management (APM). Select an item then press <Enter> to display the configuration options.

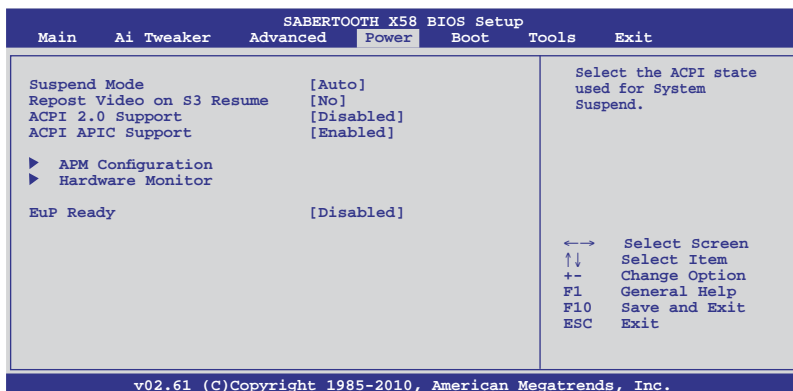

3.7.1 Suspend Mode [Auto]

Allows you to select the Advanced Configuration and Power Interface (ACPI) state to be used for system suspend.

- [S1 (POS) only] Sets the ACPI suspend mode to S1/POS (Power On Suspend).
- [S3 only] Sets the ACPI suspend mode to S3/STR (Suspend To RAM).
- [Auto] The system automatically configures the ACPI suspend mode.

3.7.2 Repost Video on S3 Resume [No]

Determines whether to invoke VGA BIOS POST on S3/STR resume.

- [No] The system will not invoke VGA BIOS POST on S3/STR resume.
- [Yes] The system invokes VGA BIOS POST on S3/STR resume.

3.7.3 ACPI 2.0 Support [Disabled]

- [Disabled] The system will not add additional tables as per ACPI 2.0 specifications.
- [Enabled] The system adds additional tables as per ACPI 2.0 specifications.

3.7.4 ACPI APIC Support [Enabled]

- [Disabled] The system disables the Advanced Configuration and Power Interface (ACPI) support in the Advanced Programmable Interrupt Controller (APIC).
- [Enabled] The ACPI APIC table pointer is included in the RSDT pointer list.

3.7.5 APM Configuration

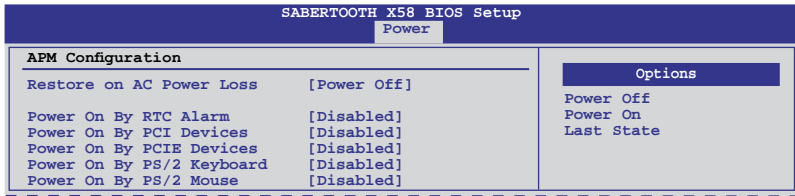

Restore On AC Power Loss [Power Off]

- [Power Off] The system goes into off state after an AC power loss.
- [Power On] The system goes into on state after an AC power loss.
- [Last State] The system goes into either off or on state, whatever the system state was before the AC power loss.

Power On By RTC Alarm [Disabled]

- [Disabled] Disables RTC to generate a wake event.
- [Enabled] When set to [Enabled], the items **RTC Alarm Date (Days)** and **System Time** will become user-configurable with set values.

Power On By PCI Devices [Disabled]

- [Disabled] Disables the PME to wake up from S5 by PCI devices.
- [Enabled] Allows you to turn on the system through a PCI LAN or modem card. This feature requires an ATX power supply that provides at least 1A on the +5VSB lead.

Power On By PCIE Devices [Disabled]

- [Disabled] Disables the PCIE devices to generate a wake event.
- [Enabled] Enables the PCIE devices to generate a wake event.

Power On By PS/2 Keyboard [Disabled]

- [Disabled] Disables the Power On by a PS/2 keyboard.
- [Space Bar] Sets the Space Bar on the PS/2 keyboard to turn on the system.
- [Ctrl-Esc] Sets the Ctrl+Esc key on the PS/2 keyboard to turn on the system.
- [Power Key] Sets Power key on the PS/2 keyboard to turn on the system. This feature requires an ATX power supply that provides at least 1A on the +5VSB lead.



This feature requires an ATX power supply that provides at least 1A on the +5VSB lead.

Power On By PS/2 Mouse [Disabled]

- [Disabled] Disables the Power On by a PS/2 mouse.
- [Enabled] Enables the Power On by a PS/2 mouse. This feature requires an ATX power supply that provides at least 1A on the +5VSB lead.

3.7.6 Hardware Monitor

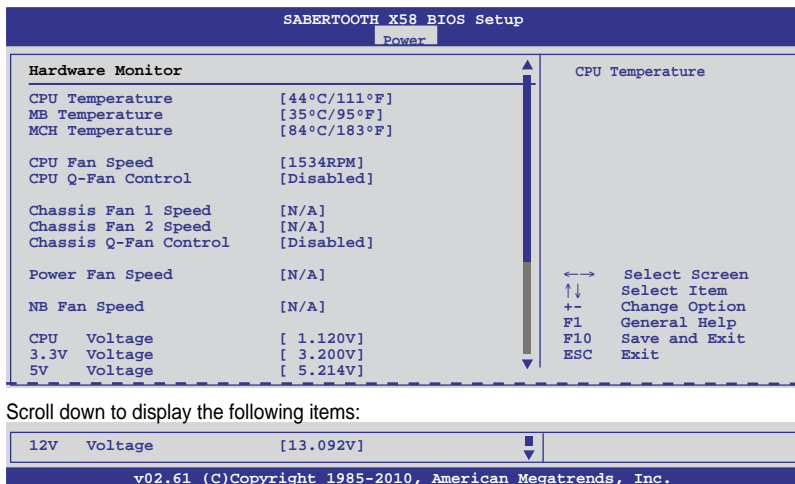

Scroll down to display the following items:

CPU/MB/MCH Temperature [xxx°C/xxx°F]

The onboard hardware monitor automatically detects and displays the CPU/motherboard/MCH temperatures. Select **Ignored** if you do not wish to display the detected temperatures.

CPU Fan Speed [xxxxRPM] or [Ignored] / [N/A]

Chassis Fan 1/2 Speed [xxxxRPM] or [Ignored] / [N/A]

Power Fan Speed [xxxxRPM] or [Ignored] / [N/A]

NB Fan Speed [xxxxRPM] or [Ignored] / [N/A]

The onboard hardware monitor automatically detects and displays the CPU, chassis, power, and northbridge fan speed in rotations per minute (RPM). If the fan is not connected to the motherboard, the field shows **N/A**. Select **Ignored** if you do not wish to display the detected speed.

CPU Q-Fan Control [Disabled]

[Disabled] Disables the CPU Q-Fan control feature.

[Enabled] Enables the CPU Q-Fan control feature.

CPU Fan Profile [Standard]

This item appears only when you enable the **CPU Q-Fan Control** feature and allows you to set the appropriate performance level of the CPU fan.

[Standard] Sets to [Standard] to make the CPU fan automatically adjust depending on the CPU temperature.

[Silent] Sets to [Silent] to minimize the fan speed for quiet CPU fan operation.

[Turbo] Sets to [Turbo] to achieve maximum CPU fan speed.

[Manual] Sets to [Manual] to assign detailed fan speed control parameters.



The following items appear only when you set the **CPU Q-Fan Profile** item to [Manual].

CPU Upper Temperature [70°C/158°F]

Sets the upper limit of the CPU temperature.

Configuration options: [40°C/104°F] [50°C/122°F] [60°C/140°F] [70°C/158°F] [80°C/176°F] [90°C/194°F]

CPU Fan Max. Duty Cycle [100%]

Sets the maximum CPU fan duty cycle. When the CPU temperature reaches the upper limit, the CPU fan will operate at the maximum duty cycle.

Configuration options: [20%] [30%] [40%] [50%] [60%] [70%] [80%] [90%] [100%]

CPU Lower Temperature [40°C/104°F]

Displays the lower limit of the CPU temperature.

CPU Fan Min. Duty Cycle [20%]

Sets the minimum CPU fan duty cycle. When the CPU temperature is under 40°C/104°F, the CPU fan will operate at the minimum duty cycle.

Configuration options: [00%] [10%] [20%] [30%] [40%] [50%] [60%] [70%] [80%] [90%] [100%]

Chassis Q-Fan Control [Disabled]

[Disabled] Disables the Chassis Q-Fan control feature.

[Enabled] Enables the Chassis Q-Fan control feature.

Chassis Fan Profile [Standard]

This item appears only when you enable the **Chassis Q-Fan Control** feature and allows you to set the appropriate performance level of the chassis fan.

[Standard] Sets to [Standard] to make the chassis fan automatically adjust depending on the chassis temperature.

[Silent] Sets to [Silent] to minimize the fan speed for quiet chassis fan operation.

[Turbo] Sets to [Turbo] to achieve maximum chassis fan speed.

CPU Voltage, 3.3V Voltage, 5V Voltage, 12V Voltage

The onboard hardware monitor automatically detects the voltage output through the onboard voltage regulators. Select **Ignored** if you do not want to detect this item.

3.7.7 EuP Ready [Disabled]

[Disabled] Disables the Energy Using Products (EuP) Ready function.

[Enabled] Allows BIOS to switch off some power at S5 state to get system ready for the EuP requirement. When set to [Enabled], power for WOL, WO_USB, audio and onboard LEDs will be switched off at S5 state.

3.8 Boot menu

The Boot menu items allow you to change the system boot options. Select an item then press <Enter> to display the submenu.

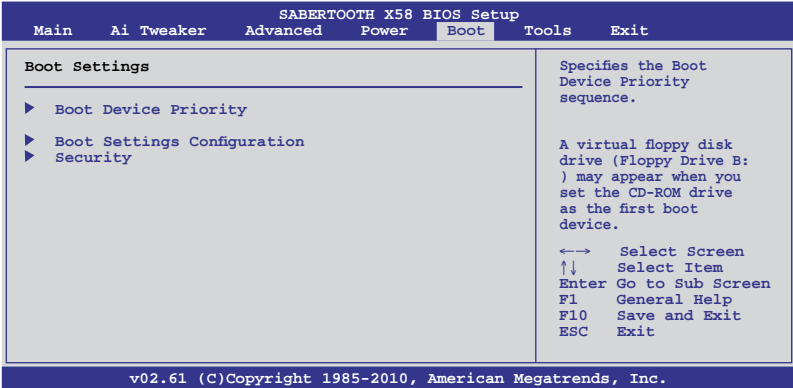

3.8.1 Boot Device Priority

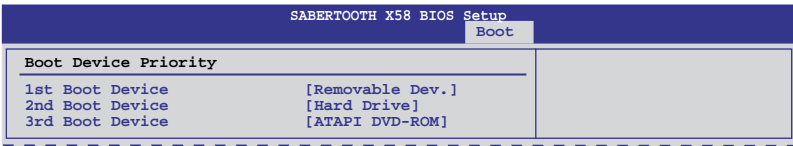

1st – xxth Boot Device [Removable Dev.]

These items specify the boot device priority sequence from the available devices. The number of device items that appears on the screen depends on the number of devices installed in the system.

Configuration options: [Removable Dev.] [Hard Drive] [ATAPI CD-ROM] [Disabled]



- To select the boot device during system startup, press <F8> when ASUS Logo appears.
- To access Windows® OS in Safe Mode, do any of the following:
 - Press <F5> when ASUS Logo appears
 - Press <F8> after POST.

3.8.2 Boot Settings Configuration

SABERTOOTH X58 BIOS Setup		
Boot		
Boot Settings Configuration		
Quick Boot	[Enabled]	Allows BIOS to skip certain tests while booting. This will decrease the time needed to boot the system.
Full Screen Logo	[Enabled]	
AddOn ROM Display Mode	[Force BIOS]	
Bootup Num-Lock	[On]	
Wait For 'F1' If Error	[Enabled]	
Hit 'DEL' Message Display	[Enabled]	

Quick Boot [Enabled]

- [Disabled] When set to [Disabled], BIOS performs all the POST items.
- [Enabled] When set to [Enabled], BIOS skips some power on self tests (POST) while booting to decrease the time needed to boot the system.

Full Screen Logo [Enabled]

- [Enabled] Enables the full screen logo display feature.
- [Disabled] Disables the full screen logo display feature.



Set this item to [Enabled] to use the ASUS MyLogo 2™ feature.

AddOn ROM Display Mode [Force BIOS]

- [Force BIOS] The third-party ROM messages will be forced to display during the boot sequence.
- [Keep Current] The third-party ROM messages will be displayed only if the third-party manufacturer had set the add-on device to do so.

Bootup Num-Lock [On]

- [Off] Sets the power-on state of the NumLock to [Off].
- [On] Sets the power-on state of the NumLock to [On].

Wait For 'F1' If Error [Enabled]

- [Disabled] Disables this function.
- [Enabled] The system waits for the <F1> key to be pressed when error occurs.

Hit 'DEL' Message Display [Enabled]

- [Disabled] Disables this function.
- [Enabled] The system displays the message "Press DEL to run Setup" during POST.

3.8.3 Security

The Security menu items allow you to change the system security settings. Select an item and press <Enter> to display the configuration options.

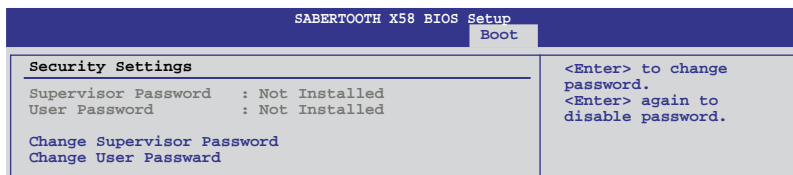

Change Supervisor Password

Select this item to set or change the supervisor password. The **Supervisor Password** item on top of the screen shows the default **Not Installed**. After you set a password, this item shows **Installed**.

To set a Supervisor Password:

1. Select the **Change Supervisor Password** item and press <Enter>.
2. From the password box, key in a password composed of at least six letters and/or numbers, then press <Enter>.
3. Confirm the password when prompted.

The message **Password Installed** appears after you successfully set your password.

To change the supervisor password, follow the same steps as in setting a user password.

To clear the supervisor password, select the **Change Supervisor Password** then press <Enter>. The message **Password Uninstalled** appears.



If you have forgotten your BIOS password, you can clear it by erasing the CMOS Real Time Clock (RTC) RAM. See section 2.6 **Jumpers** for information on how to erase the RTC RAM.

After you have set a supervisor password, the other items appear to allow you to change other security settings.

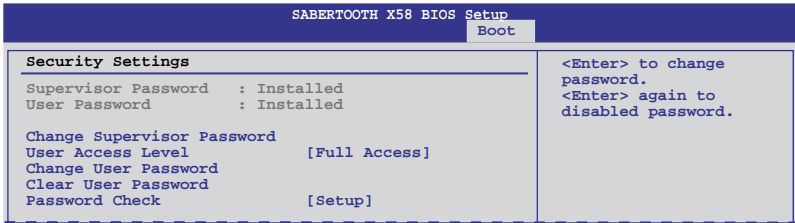

User Access Level [Full Access]

This item allows you to select the access restriction to the Setup items.

- [No Access] Prevents user access to the Setup utility.
- [View Only] Allows access but does not allow change to any field.
- [Limited] Allows changes only to selected fields, such as Date and Time.
- [Full Access] Allows viewing and changing all the fields in the Setup utility.

Change User Password

Select this item to set or change the user password. The **User Password** item on top of the screen shows the default **Not Installed**. After you set a password, this item shows Installed.

To set a User Password:

1. Select the **Change User Password** item and press <Enter>.
2. On the password box that appears, type a password composed of at least six letters and/or numbers, then press <Enter>.
3. Confirm the password when prompted.

The message **Password Installed** appears after you set your password successfully.

To change the user password, follow the same steps as in setting a user password.

Clear User Password

Select this item to clear the user password.

Password Check [Setup]

- [Setup] BIOS checks for user password when accessing the Setup utility.
- [Always] BIOS checks for user password both when accessing Setup and booting the system.

3.9 Tools menu

The Tools menu items allow you to configure options for special functions. Select an item then press <Enter> to display the submenu.

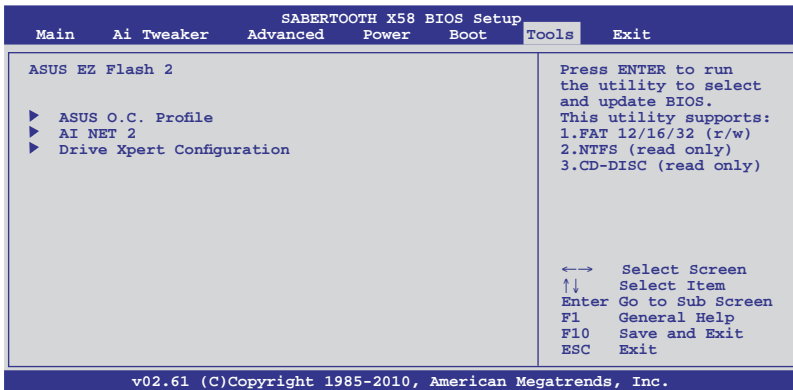

3.9.1 ASUS EZ Flash 2

Allows you to run ASUS EZ Flash 2. When you press <Enter>, a confirmation message appears. Use the left/right arrow key to select between [Yes] or [No], then press <Enter> to confirm your choice.



For more details, refer to [section 3.2.2 ASUS EZ Flash 2 utility](#).

3.9.2 ASUS O.C. Profile

This item allows you to store or load multiple BIOS settings.

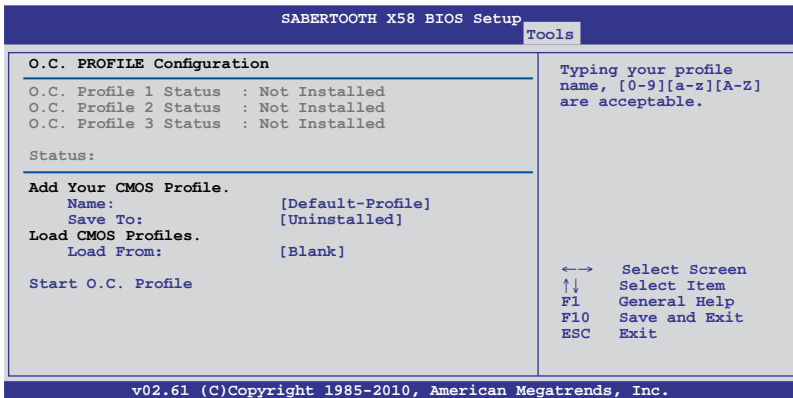

Add Your CMOS Profile

Allows you to save the current BIOS file to the BIOS Flash. In the Name sub-item, key in your profile name and press <Enter>, and then choose a profile number to save your CMOS settings in the **Save to** sub-item.

Load CMOS Profiles.

Allows you to load the previous BIOS settings saved in the BIOS Flash. Press <Enter> to load the file.

Start O.C. Profile

Allows you to run the utility to save and load CMOS. Press <Enter> to run the utility.

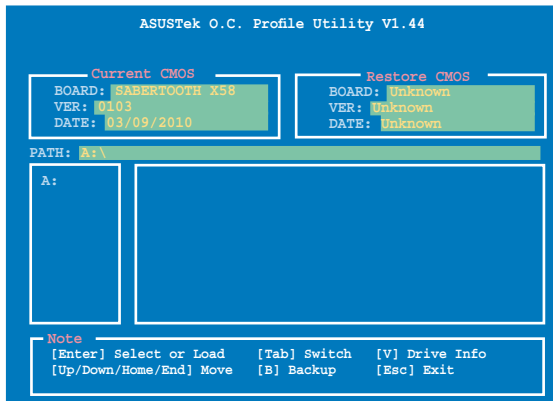

- This function can support devices such as a USB flash disk with FAT 32/16 format and single partition only.
- DO NOT shut down or reset the system while updating the BIOS to prevent the system boot failure!
- We recommend that you update the BIOS file only coming from the same memory/CPU configuration and BIOS version.
- Only the CMO file can be loaded.

3.9.3 AI NET 2

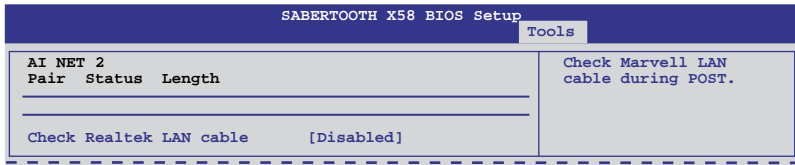

Check Realtek LAN cable [Disabled]

- [Disabled] BIOS will not check the Realtek LAN cable during the Power-On Self-Test (POST).
- [Enabled] BIOS checks the Realtek LAN cable during the Power-On Self-Test (POST).

3.9.4 Drive Xpert Configuration

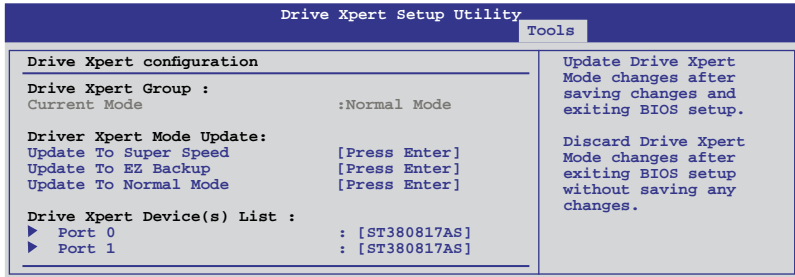

- Before using the Drive Xpert function, ensure that you have connected the SATA signal cables and installed SATA hard disk drives to the SATA_6G_1 and SATA_6G_2 connectors.
- You can only make one Drive Xpert change a time before you save BIOS settings and restart the computer.

Drive Xpert Group:

Current Mode

Displays the current Drive Xpert mode.

Changed Mode

This item appears only when you select a Drive Xpert mode to update and displays the Drive Xpert mode that you have changed.

Drive Xpert Mode Update:

Update To Super Speed [Press Enter]

Allows you to use the **Super Speed** function that combines two hard drives as one single drive partition.



All original data of the two hard drives will be erased for Super Speed setup.

Update To EZ Backup [Press Enter]

Allows you to use the **EZ Backup** function that copies and maintains an identical image of data from the SATA_6G_1 drive to the SATA_6G_2 drive.



All original data of the SATA_6G_2 hard disk will be erased for EZ Backup setup.

Update To Normal Mode [Press Enter]

Allows you to use the SATA_6G_1 and SATA_6G_2 connectors as normal SATA connectors.



When using only one hard disk in **Normal Mode**, connect the hard disk to the SATA_6G_1 connector on the motherboard.

Drive Xpert Device(s) List:

Port 0 / Port 1

Press <Enter> to display the information of the hard disks which are connected to the SATA_6G_1 and SATA_6G_2 connectors on the motherboard.

3.10 Exit menu

The Exit menu items allow you to load the optimal or failsafe default values for the BIOS items, and save or discard your changes to the BIOS items.

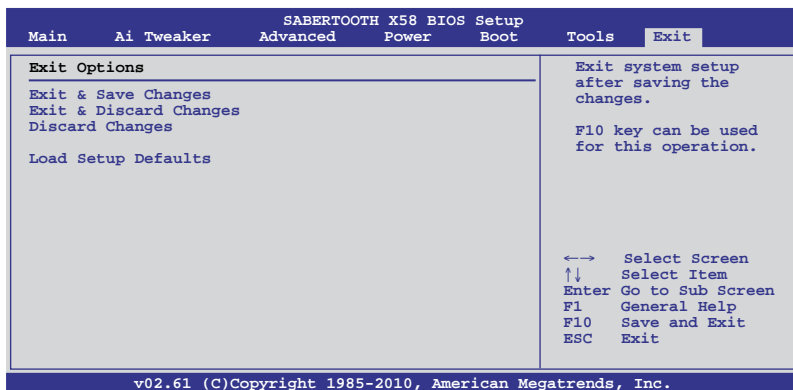

Pressing <Esc> does not immediately exit this menu. Select one of the options from this menu or <F10> from the legend bar to exit.

Exit & Save Changes

Once you are finished making your selections, choose this option from the Exit menu to ensure the values you selected are saved to the CMOS RAM. An onboard backup battery sustains the CMOS RAM so it stays on even when the PC is turned off. When you select this option, a confirmation window appears. Select **Ok** to save changes and exit.



If you attempt to exit the Setup program without saving your changes, the program prompts you with a message asking if you want to save your changes before exiting. Press <Enter> to save the changes while exiting.

Exit & Discard Changes

Select this option only if you do not want to save the changes that you made to the Setup program. If you made changes to fields other than System Date, System Time, and Password, the BIOS asks for a confirmation before exiting.

Discard Changes

This option allows you to discard the selections you made and restore the previously saved values. After selecting this option, a confirmation appears. Select **Ok** to discard any changes and load the previously saved values.

Load Setup Defaults

This option allows you to load the default values for each of the parameters on the Setup menus. When you select this option or if you press <F5>, a confirmation window appears. Select **Ok** to load default values. Select **Exit & Save Changes** or make other changes before saving the values to the non-volatile RAM.

Chapter 4

4.1 Installing an operating system

This motherboard supports Windows® XP/ 64-bit XP/ Vista / 64-bit Vista / 7 / 64-bit 7 operating systems (OS). Always install the latest OS version and corresponding updates to maximize the features of your hardware.



- Motherboard settings and hardware options vary. Use the setup procedures presented in this chapter for reference only. Refer to your OS documentation for detailed information.
- Ensure that you install the Windows® XP Service Pack 2 or later versions before installing the drivers for better compatibility and system stability.

4.2 Support DVD information

The support DVD that comes with the motherboard package contains the drivers, software applications, and utilities that you can install to avail all motherboard features.



The contents of the support DVD are subject to change at any time without notice. Visit the ASUS website at www.asus.com for updates.

4.2.1 Running the support DVD

Place the support DVD into the optical drive. The DVD automatically displays the Drivers menu if Autorun is enabled in your computer. Click each menu tab and select the items you want to install.

The Drivers menu shows the available device drivers if the system detects installed devices. Install the necessary drivers to use the devices.

The Make Disk menu contains items to create the RAID/AHCI driver disk.

The Manual menu contains the list of supplementary user manuals. Click an item to open the folder of the user manual.

The Utilities menu shows the applications and other software that the motherboard supports.

Click an item to install



Click the Contact tab to display the ASUS contact information.

Click an icon to display DVD/ motherboard information



If Autorun is NOT enabled in your computer, browse the contents of the support DVD to locate the file ASSETUP.EXE from the BIN folder. Double-click the ASSETUP.EXE to run the DVD.

4.2.2 Obtaining the software manuals

The software manuals are included in the support DVD. Follow the instructions below to get the necessary software manuals.



The software manual files are in Portable Document Format (PDF). Install the Adobe® Acrobat® Reader from the Utilities menu before opening the files.

1. Click the **Manual** tab. Click **ASUS Motherboard Utility Guide** from the manual list on the left.



2. The **Manual** folder of the support DVD appears. Double-click the folder of your selected software.

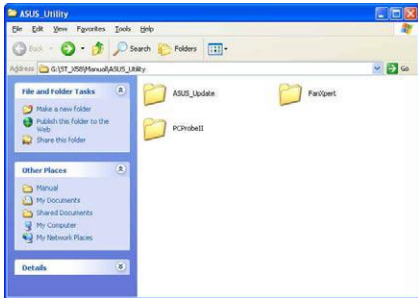

3. Some software manuals are provided in different languages. Double-click the language to show the software manual.

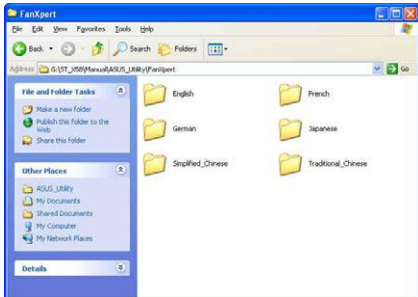

The screenshots in this section are for reference only. The actual software manuals containing in the support DVD vary by models.

4.3 Software information

Most of the applications in the support DVD have wizards that will conveniently guide you through the installation. View the online help or readme file that came with the software application for more information.

4.3.1 ASUS PC Probe II

PC Probe II is a utility that monitors the computer's vital components, and detects and alerts you of any problem with these components. PC Probe II senses fan rotations, CPU temperature, and system voltages, among others. Because PC Probe II is software-based, you can start monitoring your computer the moment you turn it on. With this utility, you are assured that your computer is always at a healthy operating condition.

Launching PC Probe II

1. Install PC Probe II from the motherboard support DVD.
2. Launch PC Probe II by clicking **Start > All Programs > ASUS > PC Probe II > PC Probe II v1.xx.xx**. The PC Probe II main window appears.
3. The PC Probe II icon appears in the Windows® notification area. Click this icon to close or restore the application.

PC Probe II main window



Button	Function
	Opens the Configuration window
	Opens the Report window
	Opens the Desktop Management Interface window
	Opens the Peripheral Component Interconnect window
	Opens the Windows Management Instrumentation window
	Opens the hard disk drive, memory, CPU usage window
	Shows/Hides the Preference section
	Minimizes the application
	Closes the application



Refer to the software manual in the support DVD or visit the ASUS website at www.asus.com for detailed software configuration.

4.3.2 ASUS Fan Xpert

Asus Fan Xpert allows you to adjust both the CPU and chassis fan speeds according to different ambient temperatures and your PC's system loading. The various fan profiles offer flexible controls of fan speeds to achieve a quiet and cool system environment.

Launching Fan Xpert

1. Install Fan Xpert from the motherboard support DVD.
2. Click **Start > All Programs > ASUS > Fan Xpert > Fan Xpert v1.xx.xx**.

Using Fan Xpert



Fan profiles

- **Disable:** disables the **Fan Xpert** function.
- **Standard:** adjusts fan speed in a moderate pattern.
- **Silent:** minimizes fan speed for quiet fan operation.
- **Turbo:** maximizes the fan speed for the best cooling effect.
- **Intelligent:** automatically adjusts the CPU fan speed according to the ambient temperature.
- **Stable:** fixes the CPU fan speed to avoid noise caused by the unsteady fan rotation. The fan will speed up when the temperature exceeds 70°C.
- **User:** allows you to configure the CPU fan profile under certain limitations.



Refer to the software manual in the support DVD or visit the ASUS website at www.asus.com for detailed software configuration.

4.3.3 Audio configurations

The Realtek® audio CODEC provides 8-channel audio capability to deliver the ultimate audio experience on your computer. The software provides Jack-Detection function, S/PDIF Out support, and interrupt capability. The CODEC also includes the Realtek® proprietary UAJ® (Universal Audio Jack) technology for all audio ports, eliminating cable connection errors and giving users plug and play convenience.

Follow the installation wizard to install the Realtek® Audio Driver from the support DVD that came with the motherboard package.

If the Realtek audio software is correctly installed, you will find the **Realtek HD Audio Manager** icon on the taskbar. Double-click on the icon to display the Realtek HD Audio Manager.



Realtek HD Audio Manager

A. Realtek HD Audio Manager for Windows® Vista™ / Windows® 7™



B. Realtek HD Audio Manager for Windows XP



4.4 RAID configurations

The motherboard comes with the Intel® ICH10R Southbridge controller that allows you to configure Serial ATA hard disk drives as RAID sets. The motherboard supports the following RAID configurations: RAID 0, RAID 1, RAID 10 and RAID 5.



- You must install Windows® XP Service Pack 2 or later versions before using Serial ATA hard disk drives. The Serial ATA RAID feature is available only if you are using Windows® XP SP2 or later versions.
- Due to Windows® XP / Vista limitation, a RAID array with the total capacity over 2TB cannot be set as a boot disk. A RAID array over 2TB can only be set as a data disk only.
- If you want to install a Windows® operating system to a hard disk drive included in a RAID set, you have to create a RAID driver disk and load the RAID driver during OS installation. Refer to section 4.5 **Creating a RAID driver disk** for details.

4.4.1 RAID definitions

RAID 0 (Data striping) optimizes two identical hard disk drives to read and write data in parallel, interleaved stacks. Two hard disks perform the same work as a single drive but at a sustained data transfer rate, double that of a single disk alone, thus improving data access and storage. Use of two new identical hard disk drives is required for this setup.

RAID 1 (Data mirroring) copies and maintains an identical image of data from one drive to a second drive. If one drive fails, the disk array management software directs all applications to the surviving drive as it contains a complete copy of the data in the other drive. This RAID configuration provides data protection and increases fault tolerance to the entire system. Use two new drives or use an existing drive and a new drive for this setup. The new drive must be of the same size or larger than the existing drive.

RAID 5 stripes both data and parity information across three or more hard disk drives. Among the advantages of RAID 5 configuration include better HDD performance, fault tolerance, and higher storage capacity. The RAID 5 configuration is best suited for transaction processing, relational database applications, enterprise resource planning, and other business systems. Use a minimum of three identical hard disk drives for this setup.

RAID 10 is data striping and data mirroring combined without parity (redundancy data) having to be calculated and written. With the RAID 10 configuration you get all the benefits of both RAID 0 and RAID 1 configurations. Use four new hard disk drives or use an existing drive and three new drives for this setup.

Intel® Matrix Storage. The Intel® Matrix Storage technology supported by the ICH10R chip allows you to create a RAID 0, RAID 1, RAID 5, and RAID 10 functions to improve both system performance and data safety. You can also combine two RAID sets to get higher performance, capacity, or fault tolerance provided by the difference RAID function. For example, RAID 0 and RAID 1 set can be created by using only two identical hard disk drives.

4.4.2 Installing Serial ATA hard disks

The motherboard supports Serial ATA hard disk drives. For optimal performance, install identical drives of the same model and capacity when creating a disk array.

To install the SATA hard disks for a RAID configuration:

1. Install the SATA hard disks into the drive bays.
2. Connect the SATA signal cables.
3. Connect a SATA power cable to the power connector on each drive.

4.4.3 Setting the RAID item in BIOS

You must enable the RAID function in the BIOS Setup before creating RAID set(s) using SATA HDDs. To do this:

1. Enter the BIOS Setup during POST.
2. Go to the **Main** menu > **Storage Configuration**, and then press <Enter>.
3. Set the **Configure SATA as** item to [RAID].
4. Save your changes, and then exit the BIOS Setup.



Refer to Chapter 3 for details on entering and navigating through the BIOS Setup.



Due to chipset limitation, when set any of SATA ports to RAID mode, all SATA ports run at RAID mode together.

4.4.4 Intel® Matrix Storage Manager option ROM utility

To enter the Intel® Matrix Storage Manager option ROM utility:

1. Turn on the system.
2. During POST, press <Ctrl> + <I> to display the utility main menu.

```
Intel(R) Matrix Storage Manager option ROM v8.0.0.1038 ICH10R wRAID5
Copyright(C) 2003-08 Intel Corporation. All Rights Reserved.

[ MAIN MENU ]
1. Create RAID Volume
2. Delete RAID Volume
3. Reset Disks to Non-RAID
4. Exit

[ DISK/VOLUME INFORMATION ]

RAID Volumes:
None defined.

Physical Disks:
Port Drive Model Serial # Size Type/Status(Vol ID)
0 ST3160812AS 9LS0H7A4 149.0GB Non-RAID Disk
1 ST3160812AS 9LS0F4HL 149.0GB Non-RAID Disk
2 ST3160812AS 3LS0JYL8 149.0GB Non-RAID Disk
3 ST3160812AS 9LS0B75H 149.0GB Non-RAID Disk

[↑↓]-Select [ESC]-Exit [ENTER]-Select Menu
```

The navigation keys at the bottom of the screen allow you to move through the menus and select the menu options.



The RAID BIOS setup screens shown in this section are for reference only and may not exactly match the items on your screen.



The utility supports maximum four hard disk drives for RAID configuration.

Creating a RAID set

To create a RAID set:

1. From the utility main menu, select **1. Create RAID Volume** and press <Enter>. The following screen appears:

```
Intel(R) Matrix Storage Manager option ROM v8.0.0.1038 ICH10R wRAID5
Copyright(C) 2003-08 Intel Corporation. All Rights Reserved.

-----[ CREATE VOLUME MENU ]-----
Name: Volume0
RAID Level: RAID0(Stripe)
Disks: Select Disks
Strip Size: 128KB
Capacity: 0.0 GB

Create Volume

-----[ HELP ]-----

Enter a unique volume name that has no special characters and is
16 characters or less.

[↑↓]Change [TAB]-Next [ESC]-Previous Menu [ENTER]-Select
```

2. Enter a name for the RAID set and press <Enter>.
3. When the **RAID Level** item is selected, press the up/down arrow key to select a RAID level to create, and then press <Enter>.
4. When the **Disks** item is selected, press <Enter> to select the hard disk drives you want to include in the RAID set. The **SELECT DISKS** screen appears:

```
[ SELECT DISKS ]
Port Drive Model Serial # Size Status
0 ST3160812AS 9LS0H4X1 149.0GB Non-RAID Disk
1 ST3160812AS 9LS0F4HL 149.0GB Non-RAID Disk
2 ST3160812AS 3LS0JYL8 149.0GB Non-RAID Disk
3 ST3160812AS 9LS0BJ5H 149.0GB Non-RAID Disk

Select 2 to 6 disks to use in creating the volume.

[↑↓]-Prev/Next [SPACE]-SelectDisk [ENTER]-Done
```

5. Use the up/down arrow key to select a drive, and then press <Space> to select. A small triangle marks the selected drive. Press <Enter> after completing your selection.
6. Use the up/down arrow key to select the stripe size for the RAID array (for RAID 0, 10 and 5 only), and then press <Enter>. The available stripe size values range from 4KB to 128KB. The following are typical values:
RAID 0: 128KB
RAID 10: 64KB
RAID 5: 64KB



We recommend a lower stripe size for server systems, and a higher stripe size for multimedia computer systems used mainly for audio and video editing.

7. When the **Capacity** item is selected, enter the RAID volume capacity that you want and press <Enter>. The default value indicates the maximum allowed capacity.
8. When the **Create Volume** item is selected, press <Enter>. The following warning message appears:

WARNING: ALL DATA ON SELECTED DISKS WILL BE LOST.
Are you sure you want to create this volume? (Y/N):

9. Press <Y> to create the RAID volume and return to the main menu, or <N> to go back to the **CREATE VOLUME** menu.

Deleting a RAID set



Take caution when deleting a RAID set. You will lose all data on the hard disk drives when you delete a RAID set.

To delete a RAID set:

1. From the utility main menu, select **2. Delete RAID Volume** and press <Enter>. The following screen appears:

```
Intel(R) Matrix Storage Manager option ROM v8.0.0.1038 ICH10R wRAID5
Copyright(C) 2003-08 Intel Corporation. All Rights Reserved.

[ DELETE VOLUME MENU ]

Name      Level      Drives  Capacity  Status  Bootable
Volume0   RAID0(Stripe)  2       298.0GB  Normal  Yes

[ HELP ]

Deleting a volume will reset the disks to non-RAID.
WARNING: ALL DISK DATA WILL BE DELETED.

[↑↓]-Select      [ESC]-Previous Menu  [DEL]-Delete Volume
```

2. Use the up/down arrow key to select the RAID set you want to delete, and then press . The following warning message appears:

```
[ DELETE VOLUME VERIFICATION ]

ALL DATA IN THE VOLUME WILL BE LOST!

Are you sure you want to delete volume "Volume0"? (Y/N):
```

3. Press <Y> to delete the RAID set and return to the utility main menu, or press <N> to return to the **DELETE VOLUME** menu.

Exiting the Intel® Matrix Storage Manager

To exit the utility:

1. From the utility main menu, select **4. Exit**, and then press <Enter>. The following warning message appears:

```
[ CONFIRM EXIT ]

Are you sure you want to exit? (Y/N):
```

2. Press <Y> to exit or press <N> to return to the utility main menu.

4.4.5 Marvell RAID utility

The onboard Marvell 9128 SATA 6.0 Gb/s controller allows you to create a RAID 0 or RAID 1 array using two SATA hard disk drives. Refer to Chapter 2 of your motherboard user manual for the exact location of the Marvell 9128 SATA 6.0 Gb/s connector.

To enter the Marvell utility, press **<Ctrl> + <M>** during POST.



All existing data on the hard disk drives will be erased when creating or deleting a RAID array. Ensure that you have back up all your data in your hard disk drives before making any change to the drive status.

```
Marvell BIOS Setup (c) 2009 Marvell Technology Group Ltd.
-----
Topology                                Information
-----
HBA 0: Marvell 0                          Vendor ID      : 1B4B
  Virtual Disks                             Device ID     : 91A3
  Free Physical Disks                       Revision ID   : B1
    PD 0: ST3160812AS                       BIOS Version  : 0.0.0000
    PD 8: ST3160812AS                       Firmware Version: 2.1.0.1410
                                             PCIe Speed Rate : 5.0Gbps
                                             Configure SATA as: IDE Mode

Help
-----
Marvell RAID on chip controller.
ENTER: Operation  F10: Exit/Save  ESC: Return
```

Create a RAID Array

1. Move the selection bar to **HBA 0: Marvell 0** and press **<Enter>**.
2. Select **Configuration Wizard** and press **<Enter>**.

```
Marvell BIOS Setup (c) 2009 Marvell Technology Group Ltd.
-----
Configure->Select free disks
-----
HBA 0: Marvell 0                          Port ID       : 0
  Virtual Disks                             PD ID        : 0
  Free Physical Disks                       Type         : SATA PD
    * PD 0: ST3160812AS                     Status       : Unconfigured
    PD 8: ST3160812AS                       Size         : 152626MB
                                             Feature Support: MCQ 3G 48Bits
                                             Current Speed : 3G
                                             Model        : ST3160812AS
                                             Serial       : 9LS0F4HL
                                             FW Version  : 3.AAE

Help
-----
Use space bar to select the free disks to be used in the array.
ENTER: Operation  SPACE: Select  F10: Exit/Save  ESC: Return
```

3. Press **<Space>** to select the hard drives to be included in the RAID array. An asterisk (*) appears in front of the selected hard drive. After selecting all the drives needed for the RAID array, press **<Enter>** to continue.

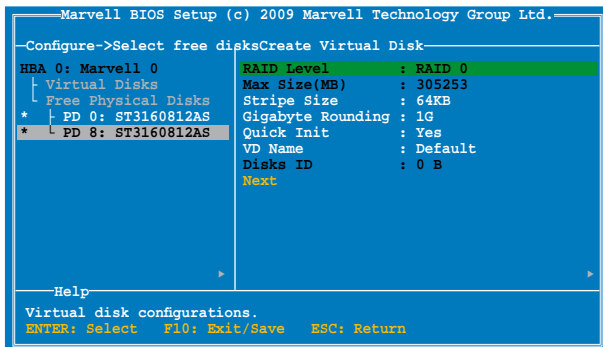

- Use the up or down arrow key to move the selection bar and press <Enter> to configure further RAID settings.

RAID Level: Select a RAID Level. Configuration options: [RAID 0] [RAID 1]

Stripe Size: Specifies the size of single data block on the virtual disk. In general, a larger stripe size is recommended for applications requiring large data transfers such as audio, video, and graphics. A smaller stripe size is better for applications with content in much smaller size, such as e-mails and documents.

Configuration options: [32K] [64K]

Gigabyte Rounding: In the event of a single physical disk failure in a RAID 1 virtual disk, Gigabyte Rounding allows the replacement physical disk to be of a size slightly smaller than the existing physical disk. The capacity of the rebuilt virtual disk equals to the size of the smaller physical disk included in the RAID 1 array. The configuration options represent the tolerance value of drive capacity difference.

Configuration options: [None] [1G] [10G]

Quick Init: Enables or disables quick initialization of the virtual disk.

Configuration options: [Yes] [No]

VD Name: Enter a name with 1–10 letters (no special characters) for the RAID array.

- Move the selection bar to **Next** and press <Enter>. The following warning message appears:

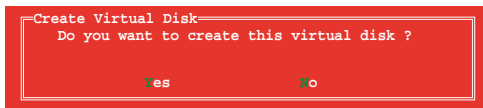

Press <Y> to create the RAID array, or press <N> to cancel. The new RAID array appears under Virtual Disks, as shown in the image below.

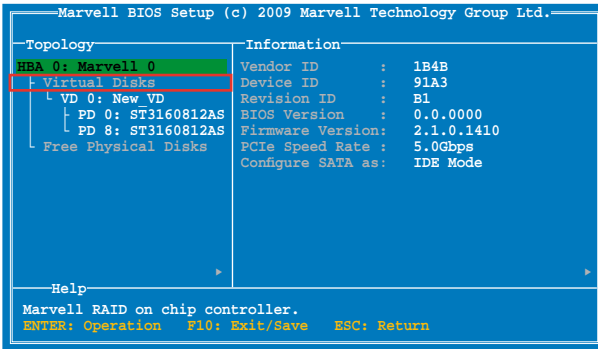

- Press <F10>. The following warning message appears:



Press <Y> to save the RAID setting and exit the Marvell RAID utility.

Delete an existing RAID Array

- Select the RAID array to delete and press <Enter>. Select **Delete** and press <Enter>.

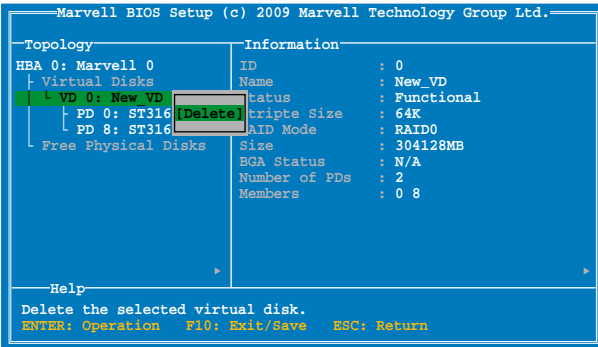

2. The following warning message appears:



Press <Y> to delete the selected RAID array. The following warning message appears:



Press <Y> to delete the Master Boot Record (MBR) from the selected RAID array.

3. Press <F10>. The following warning message appears:



Press <Y> to save the RAID setting and exit the Marvell RAID utility.

4.5 Creating a RAID driver disk

A floppy disk with the RAID driver is required when installing a Windows® operating system on a hard disk drive that is included in a RAID set.



- **The motherboard does not provide a floppy drive connector.** You have to use a USB floppy disk drive when creating a **SATA** RAID driver disk.
- Windows® XP may not recognize the USB floppy disk drive due to Windows® XP limitation. To work around this OS limitation, refer to section **4.5.4 Using a USB floppy disk drive.**

4.5.1 Creating a RAID driver disk without entering the OS

To create a RAID/SATA driver disk without entering the OS

1. Boot your computer.
2. Press during POST to enter the BIOS setup utility.
3. Set the optical drive as the primary boot device.
4. Insert the support DVD into the optical drive.
5. Save changes and exit BIOS.
6. When the **Make Disk** menu appears, press <a> or to create a 32/64bit **Intel ICH10R RAID driver disk.**
7. Insert a formatted floppy disk into the USB floppy disk drive, then press <Enter>.
8. Follow the succeeding screen instructions to complete the process.

4.5.2 Creating a RAID driver disk in Windows®

To create a RAID driver disk in Windows®

1. Start Windows®.
2. Plug the USB floppy disk drive and insert a floppy disk.
3. Place the motherboard support DVD into the optical drive.
4. Go to the **Make disk** menu, and then click **Intel ICH10R 32/64 bit RAID Driver Disk** to create an Intel® ICH10R RAID driver disk.
5. Select USB floppy disk drive as the destination disk.
6. Follow the succeeding screen instructions to complete the process.



Write-protect the floppy disk to avoid a computer virus infection.

4.5.3 Installing the RAID driver during Windows® OS installation

To install the RAID driver in Windows® XP

1. During the OS installation, the system prompts you to press the F6 key to install third-party SCSI or RAID driver.
2. Press <F6>, and then insert the floppy disk with RAID driver into the USB floppy disk drive.
3. When prompted to select the SCSI adapter to install, select the RAID driver for the corresponding OS version.
4. Follow the succeeding screen instructions to complete the installation.

To install the RAID driver for Windows® Vista or later OS

1. During the OS installation, click **Load Driver** to allow you to select the installation media containing the RAID driver.
2. Insert the USB flash drive with RAID driver into the USB port or the support DVD into the optical drive, and then click **Browse**.
3. Click the name of the device you've inserted, go to **Drivers > RAID**, and then select the RAID driver for the corresponding OS version. Click **OK**.
4. Follow the succeeding screen instructions to complete the installation.



Before loading the RAID driver from a USB flash drive, you have to use another computer to copy the RAID driver from the support DVD to the USB flash drive.

4.5.4 Using a USB floppy disk drive

Due to OS limitation, Windows® XP may not recognize the USB floppy disk drive when you install the RAID driver from a floppy disk during the OS installation.

To solve this issue, add the USB floppy disk drive's Vendor ID (VID) and Product ID (PID) to the floppy disk containing the RAID driver. Refer to the steps below:

1. Using another computer, plug the USB floppy disk drive, and insert the floppy disk containing the RAID driver.
2. Right-click **My Computer** on the Windows® desktop or **start** menu, and then select **Manage** from the pop-up window.

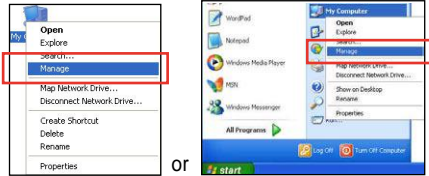

3. Select **Device Manager**. From the **Universal Serial Bus controllers**, right-click **xxxxxx USB Floppy**, and then select **Properties** from the pop-up window.



The name of the USB floppy disk drive varies with different vendors.

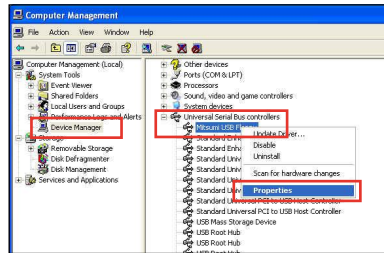

4. Click **Details** tab. The Vendor ID (VID) and Product ID (PID) are displayed.

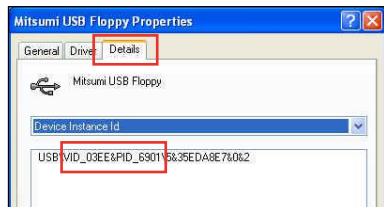

5. Browse the contents of the RAID driver disk to locate the file **txtsetup.oem**.
6. Double-click the file. A window appears, allowing you to select the program for opening the oem file.

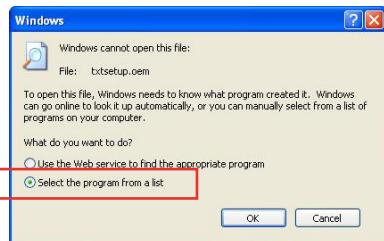

7. Use Notepad to open the file.

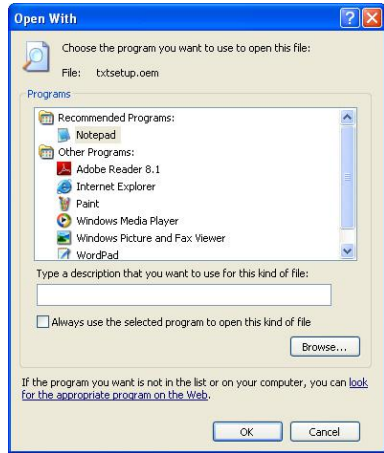

8. Find the **[HardwareIds.scsi.iaAHCI_ICH10R]** and **[HardwareIds.scsi.iastor_ICH8RICH9RICH10RDO]** sections in the **txtsetup.oem** file.
9. Type the following line to the bottom of the two sections:
id = "USB\VID_03EE&PID_6901", "usbstor"

```
[HardwareIds.scsi.iaAHCI_ICH10R]
id = "PCI\VEN_8086&DEV_3A22&CC_0106", "iastor"
id = "USB\VID_03EE&PID_6901", "usbstor" #--Mitsumi

[HardwareIds.scsi.iastor_ICH8RICH9RICH10RDO]
id = "PCI\VEN_8086&DEV_2822&CC_0104", "iastor"
id = "USB\VID_03EE&PID_6901", "usbstor" #--Mitsumi
```



Add the same line to both sections.

The VID and PID vary with different vendors.

10. Save and exit the file.

5.1 ATI® CrossFireX™ technology

The motherboard supports the ATI® CrossFireX™ technology that allows you to install multi-graphics processing units (GPU) graphics cards. Follow the installation procedures in this section.

5.1.1 Requirements

- In Dual CrossFireX mode, you should have two identical CrossFireX-ready graphics cards or one CrossFireX-ready dual-GPU graphics card that are ATI® certified.
- In Triple CrossFireX mode, you should have three identical CrossFireX-ready graphics cards that are ATI® certified.
- Ensure that your graphics card driver supports the ATI CrossFireX technology. Download the latest driver from the AMD website (www.amd.com).
- Ensure that your power supply unit (PSU) can provide at least the minimum power required by your system. See Chapter 2 for details.



-
- We recommend that you install additional chassis fans for better thermal environment.
 - The ATI Triple CrossFireX technology is currently supported by Windows® Vista operating system only.
 - Visit the ATI Game website (<http://game.amd.com>) for the latest certified graphics card and the supported 3D application list.
-

5.1.2 Before you begin

For ATI CrossFireX to work properly, you have to uninstall all existing graphics card drivers before installing ATI CrossFireX graphics cards to your system.

To uninstall existing graphics card drivers:

1. Close all current applications.
2. For Windows XP, go to **Control Panel > Add/Remove Programs**.
For Windows Vista, go to **Control Panel > Programs and Features**.
3. Select your current graphics card driver/s.
4. For Windows XP, select **Add/Remove**.
For Windows Vista, select **Uninstall**.
5. Turn off your computer.

5.1.3 Installing two CrossFire™ graphics cards



The following pictures are for reference only. The graphics cards and the motherboard layout may vary with models, but the installation steps remain the same.

1. Prepare two CrossFireX-ready graphics cards.
2. Insert the two graphics card into the PCIEX16 slots. If your motherboard has more than two PCIEX16 slots, refer to Chapter 2 in this user manual for the locations of the PCIEX16 slots recommended for multi-graphics card installation.
3. Ensure that the cards are properly seated on the slots.
4. Align and firmly insert the CrossFireX bridge connector to the goldfingers on each graphics card. Ensure that the connector is firmly in place.

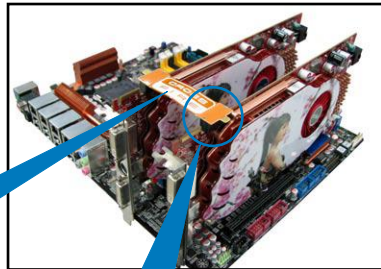
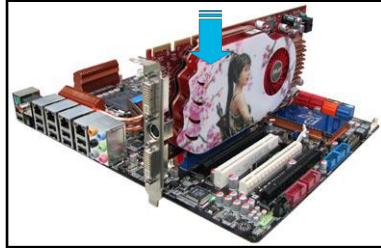

CrossFireX bridge
(bundled with
graphics cards)

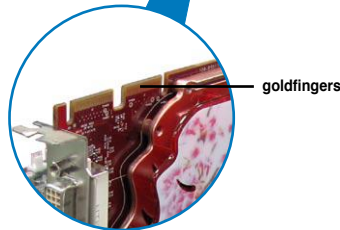

5. Connect two independent auxiliary power sources from the power supply to the two graphics cards separately.
6. Connect a VGA or a DVI cable to the graphics card.

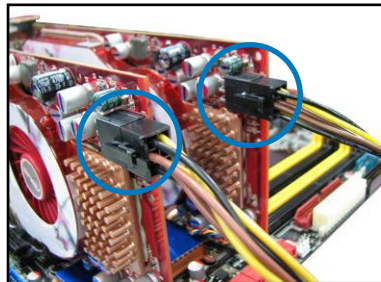

5.1.4 Installing three CrossFire™ graphics cards

1. Prepare three CrossFireX-ready graphics cards.
2. Insert the three graphics card into the PCIEX16 slots. If your motherboard has more than three PCIEX16 slots, refer to Chapter 2 in this user manual for the locations of the PCIEX16 slots recommended for multi-graphics card installation.
3. Ensure that the cards are properly seated on the slots.
4. Align and firmly insert the two CrossFireX bridge connectors to the goldfingers on each graphics card. Ensure that the connectors are firmly in place.

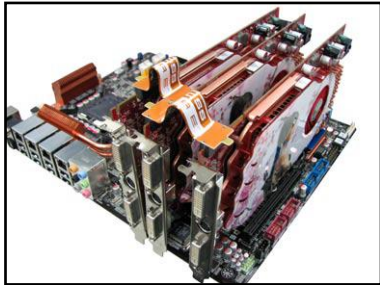

5. Connect three independent auxiliary power sources from the power supply to the three graphics cards separately.
6. Connect a VGA or a DVI cable to the graphics card.

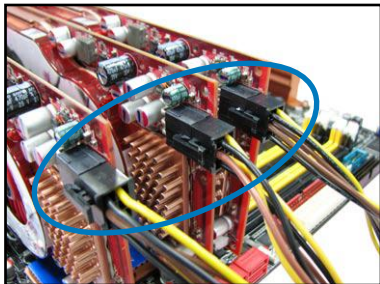

5.1.5 Installing the device drivers

Refer to the documentation that came with your graphics card package to install the device drivers.



- Ensure that your PCI Express graphics card driver supports the ATI® CrossFireX™ technology. Download the latest driver from the AMD website (www.amd.com).
- If you are using a Triple CrossFireX system, ensure to install the ATI Catalyst® driver under Windows® Vista™ OS. The ATI Triple CrossFireX technology is currently supported by Windows® Vista™ only.

5.1.6 Enabling the ATI® CrossFireX™ technology

After installing your graphics cards and the device drivers, enable the CrossFireX™ feature through the ATI Catalyst™ Control Center in Windows environment.

Launching the ATI Catalyst Control Center

To launch the ATI Catalyst Control Center:

1. Right-click on the Windows® desktop and select **Catalyst(TM) Control Center**. You can also right-click the ATI icon in the Windows notification area and select **Catalyst Control Center**.

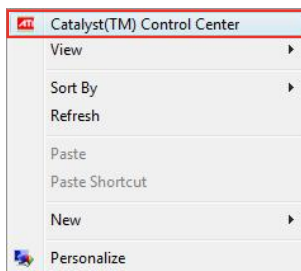

2. The **Catalyst Control Center Setup Assistant** appears when the system detects the existence of multi-graphics cards. Click **Go** to continue to the **Catalyst Control Center Advanced View** window.

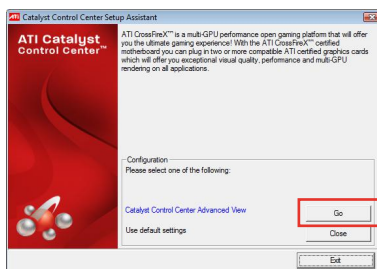

Enabling Dual CrossFireX technology

1. In the Catalyst Control Center window, click **Graphics Settings > CrossFireX > Configure**.
2. From the Graphics Adapter list, select the graphics card to act as the display GPU.
3. Select **Enable CrossFireX**.
4. Click **Apply**, and then click **OK** to exit the window.



Enabling Triple CrossFireX technology

1. In the Catalyst Control Center window, click **Graphics Settings > CrossFireX > Configure**.
2. From the Graphics Adapter list, select the graphics card to act as the display GPU.
3. Select **Enable CrossFireX**.
4. From the list, select the appropriate GPU combination to apply the CrossFireX technology.
5. Click **Apply**, and then click **OK** to exit the window.



5.2 NVIDIA® SLI™ technology

The motherboard supports the NVIDIA® SLI™ (Scalable Link Interface) technology that allows you to install multi-graphics processing units (GPU) graphics cards. Follow the installation procedures in this section.

5.2.1 Requirements

- In SLI mode, you should have two identical SLI-ready graphics cards that are NVIDIA® certified.
- Ensure that your graphics card driver supports the NVIDIA SLI technology. Download the latest driver from the NVIDIA website (www.nvidia.com).
- Ensure that your power supply unit (PSU) can provide at least the minimum power required by your system. See Chapter 2 for details.



- We recommend that you install additional chassis fans for better thermal environment.
- Visit the NVIDIA zone website (<http://www.nzone.com>) for the latest certified graphics card and supported 3D application list.

5.2.2 Installing two SLI-ready graphics cards



The following pictures are for reference only. The graphics cards and the motherboard layout may vary with models, but the installation steps remain the same.

1. Prepare two SLI-ready graphics cards.
2. Insert the two graphics card into the PCIEX16 slots. If your motherboard has more than two PCIEX16 slots, refer to Chapter 2 in this user manual for the locations of the PCIEX16 slots recommended for multi-graphics card installation.
3. Ensure that the cards are properly seated on the slots.

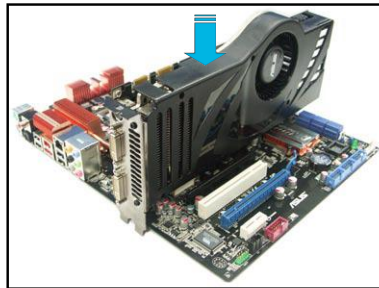

4. Align and firmly insert the SLI bridge connector to the goldfingers on each graphics card. Ensure that the connector is firmly in place.
5. Connect two independent auxiliary power sources from the power supply to the two graphics cards separately.
6. Connect a VGA or a DVI cable to the graphics card.

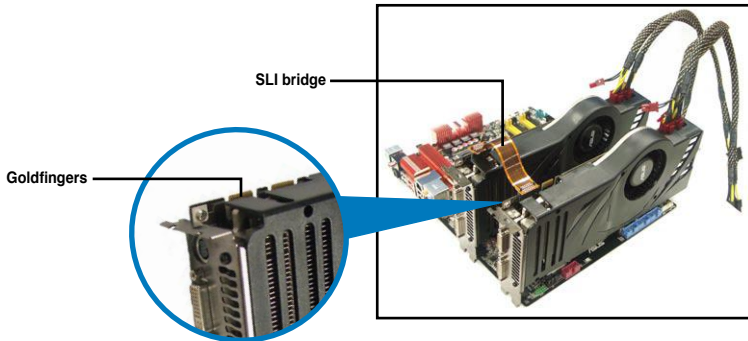

5.2.3 Installing the device drivers

Refer to the documentation that came with your graphics card package to install the device drivers.



Ensure that your PCI Express graphics card driver supports the NVIDIA® SLI™ technology. Download the latest driver from the NVIDIA website (www.nvidia.com).

5.2.4 Enabling the NVIDIA® SLI™ technology

After installing your graphics cards and the device drivers, enable the SLI feature in NVIDIA® Control Panel under the Windows® Vista™ operating system.

Launching the NVIDIA Control Panel

You can launch the NVIDIA Control Panel by the following two methods.

- A. Right click on the empty space of the Windows® desktop and select **NVIDIA Control Panel**.

The NVIDIA Control Panel window appears (See Step B5).



- B1. If you cannot see the NVIDIA Control Panel item in step (A), select **Personalize**.

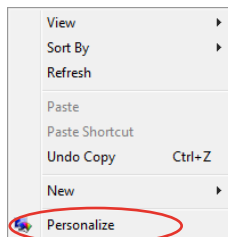

- B2. From the **Personalization** window, select **Display Settings**.

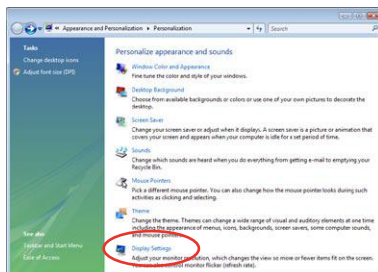

- B3. From the Display Settings dialog box, click **Advanced Settings**.

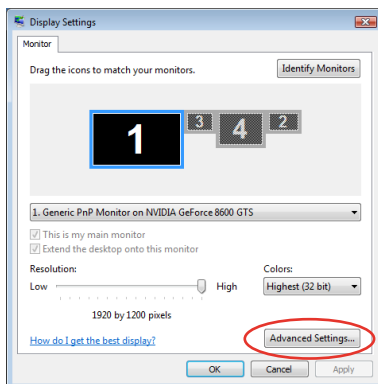

- B4. Select the NVIDIA GeForce tab, and then click **Start the NVIDIA Control Panel**.

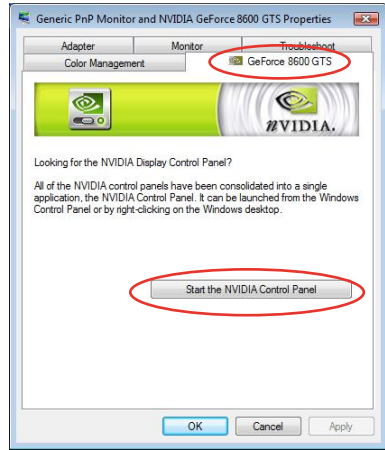

- B5. The NVIDIA Control Panel window appears.

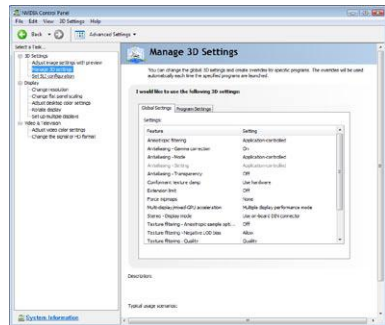

Enabling SLI settings

From the NVIDIA Control Panel window, select **Set SLI Configuration**. Click **Enable SLI** and set the display for viewing SLI rendered content. When done, click **Apply**.

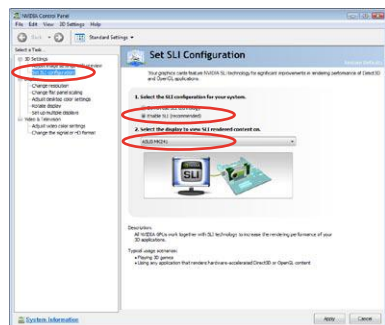

ASUS contact information

ASUSTeK COMPUTER INC.

Address	15 Li-Te Road, Peitou, Taipei, Taiwan 11259
Telephone	+886-2-2894-3447
Fax	+886-2-2890-7798
E-mail	info@asus.com.tw
Web site	www.asus.com.tw

Technical Support

Telephone	+86-21-38429911
Online support	support.asus.com

ASUS COMPUTER INTERNATIONAL (America)

Address	800 Corporate Way, Fremont, CA 94539, USA
Telephone	+1-812-282-3777
Fax	+1-510-608-4555
Web site	usa.asus.com

Technical Support

Telephone	+1-812-282-2787
Support fax	+1-812-284-0883
Online support	support.asus.com

ASUS COMPUTER GmbH (Germany and Austria)

Address	Harkort Str. 21-23, D-40880 Ratingen, Germany
Fax	+49-2102-959911
Web site	www.asus.de
Online contact	www.asus.de/sales

Technical Support

Telephone	+49-1805-010923*
Support Fax	+49-2102-9599-11
Online support	support.asus.com

* EUR 0.14/minute from a German fixed landline; EUR 0.42/minute from a mobile phone.

DECLARATION OF CONFORMITY
Per FCC Part 2 Section 2.1077(a)



Responsible Party Name: **Asus Computer International**

Address: **800 Corporate Way, Fremont, CA 94539.**

Phone/Fax No: **(510)739-3777/(510)608-4555**

hereby declares that the product

Product Name : Motherboard

Model Number : SABERTOOTH X58

Conforms to the following specifications:

- FCC Part 15, Subpart B, Unintentional Radiators
- FCC Part 15, Subpart C, Intentional Radiators
- FCC Part 15, Subpart E, Intentional Radiators

Supplementary Information:

This device complies with part 15 of the FCC Rules. Operation is subject to the following two conditions: (1) This device may not cause harmful interference, and (2) this device must accept any interference received, including interference that may cause undesired operation.

Representative Person's Name : Steve Chang / President

Signature :

Date : Jul. 21, 2010

EC Declaration of Conformity



We, the undersigned,

Manufacturer: **ASUSTeK COMPUTER INC.**
 Address, City: **No. 150, LI-TE RD., PEITOU, TAIPEI 112, TAIWAN R.O.C.**
 Country: **TAIWAN**
 Authorized representative in Europe: **ASUS COMPUTER GmbH**
 Address, City: **HARKORT STR. 21-23, 40880 RATINGEN**
 Country: **GERMANY**

declare the following apparatus:

Product name : **Motherboard**
 Model name : **SABERTOOTH X58**

conform with the essential requirements of the following directives:

- 2004/108/EC-EMC Directive**
- EN 55022:2006+A1:2007
- EN 61000-3-2:2006
- EN 55013:2001+A1:2003+A2:2006
- EN 55024:1998+A1:2001+A2:2003
- EN 61000-3-3:2008
- EN 55020:2007

1999/5/EC-R & TTE Directive

- EN 300 328 V1.7.1(2006-05)
- EN 300 342 V1.2(2006-05)
- EN 300 440-2 V1.2.1(2006-05)
- EN 300 511 V9.0.2(2003-03)
- EN 301 908-1 V3.2.1(2007-05)
- EN 301 908-2 V3.2.1(2007-05)
- EN 301 908-3 V1.1(2006-05)
- EN 60960:2001
- EN 50371:2002
- EN 301 488-1 V1.8.1(2008-04)
- EN 301 488-2 V1.8.1(2008-04)
- EN 301 488-3 V1.3.1(2005-24)
- EN 301 489-7 V1.3.1(2005-11)
- EN 301 489-9 V1.4.1(2007-11)
- EN 301 488-17 V1.3.2(2008-04)
- EN 301 488-18 V1.3.2(2008-04)
- EN 302 326-2 V1.2.2(2007-09)
- EN 302 326-3 V1.3.1(2007-09)

2006/95/EC-LVD Directive

- EN 60950-1:2001+A11:2004
- EN 60950-1:2006
- EN 60950-1:2006+A11:2009

2005/52/EC-EUP Directive

- Regulation (EC) No. 1275/2008
- Regulation (EC) No. 279/2009
- EN 62301:2005

CE marking



(EC conformity marking)

Position : **CEO**
 Name : **Jerry Shen**

Signature : _____

Declaration Date: Jul. 21, 2010
Year to begin affixing CE marking: 2010