

**acer**  
*explore beyond limits™*

**Iconia** | A3



© 2013. All Rights Reserved.  
Acer Iconia User Guide  
Model: A3-A11  
This revision: 10/2013

Acer Iconia  
Model number: .....  
Serial number: .....  
Date of purchase: .....  
Place of purchase:.....

# Table of contents

---

<b>Getting to know your tablet</b>	<b>4</b>	Composing an email .....	25
Features and functions .....	4	Setting up the Email application .....	25
Product registration .....	4	Online applications .....	25
<b>Setting up</b>	<b>5</b>	<b>Playing music and video</b>	<b>30</b>
Unpacking your tablet .....	5	Multimedia playback .....	30
Getting to know your tablet .....	5	<b>Managing people and contacts</b>	<b>32</b>
<b>Using your tablet</b>	<b>8</b>	<b>Using the camera and camcorder</b>	<b>35</b>
Charging your tablet .....	8	Camera icons and indicators .....	35
Turning on for the first time .....	9	Taking a photo .....	38
Using the touchscreen .....	10	Camcorder icons and indicators .....	38
The Home screen .....	10	Shooting a video .....	39
The onscreen keyboard .....	16	<b>Advanced settings</b>	<b>41</b>
Editing text .....	17	Wireless & Networks .....	41
Shutting down your tablet .....	20	Device .....	42
<b>Connecting devices to your tablet</b>	<b>21</b>	Personal .....	43
Connecting to AC power .....	21	System .....	44
Inserting a microSD card (optional) .....	21	Updating your tablet's operating system .....	45
Transferring files between your tablet and a PC .....	21	Resetting your tablet .....	45
Connecting a Bluetooth device .....	22	<b>FAQ and troubleshooting</b>	<b>46</b>
Accessories .....	22	Other sources of help .....	47
<b>Going online</b>	<b>23</b>	<b>Specifications</b>	<b>48</b>
Managing Wi-Fi connections .....	23	<b>End user license agreement</b>	<b>51</b>
Browsing the Internet .....	23		
Setting up Gmail .....	24		

# Getting to know your tablet

---

## Features and functions

Your new tablet offers leading, easy-to-access multimedia and entertainment features. You can:

- Connect to the Internet.
- Access your email while on the move.
- Keep in touch with your friends via your People and social networking applications.

## Product registration

When using your product for the first time, it is recommended that you immediately register it. This will give you access to useful benefits, such as:

- Faster service from our trained representatives.
- Membership in the Acer community: receive promotions and participate in customer surveys.
- The latest news from Acer.

Hurry and register, as other advantages await you!

## How to register

To register your Acer product, please visit [www.acer.com](http://www.acer.com). Click **Registration** and follow the simple instructions.

You can also register directly from your tablet by tapping the **Registration** icon.

After we receive your product registration, you will be sent a confirmation email with important data that you should keep in a safe place.

# Setting up

---

## Unpacking your tablet

Your new tablet comes packed in a protective box. Carefully unpack the box and remove the contents. If any of the following items is missing or damaged, contact your dealer immediately:

- Acer Iconia A3 tablet
- Setup poster
- USB cable
- AC adapter
- Warranty card

## Getting to know your tablet

### Views

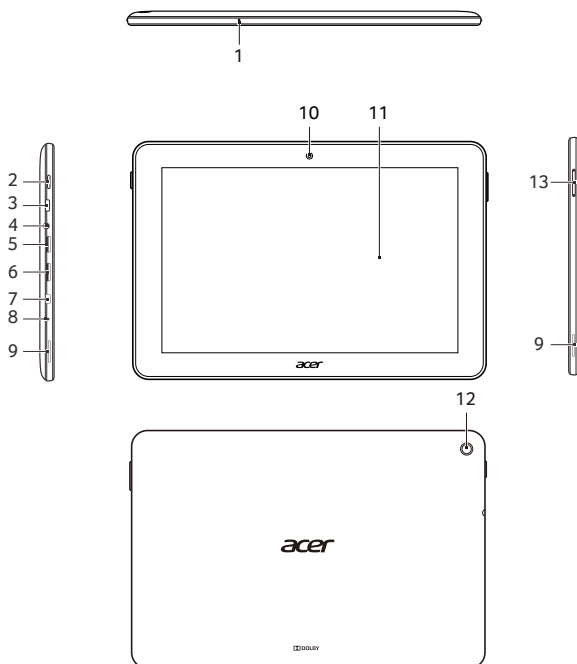

No.	Item	Description
1	Microphone	Receives audio for video chats and Internet calls.
2	Power button	Press and hold to turn the tablet on, press briefly to turn the screen on/off or enter sleep mode; press and hold to turn the tablet off.
3	Micro USB port (Slave)	Connects to a computer via a USB cable. Also serves as the charging port for the AC adapter. For more information, see <b>"Charging your tablet" on page 8.</b>
4	3.5 mm headphone jack	Connects to stereo headphones.
5	microSD card slot	Accepts a microSD card up to 32 GB (supports SDHC).
6	SIM card slot	Insert a micro SIM card into the slot (see <b>"Inserting a SIM card" on page 7.</b> )
7	HDMI Micro connector	External display and audio connector.
8	Shutdown pinhole	Insert a small thin object (such as a paperclip) into the hole to shut down the tablet.
9	Stereo speakers	Emit audio.
10	Front-facing camera	A 0.3-megapixel camera for video chats and self-portrait images.
11	Touchscreen	10.1-inch, 1280 x 800 pixel capacitive touchscreen.
12	Rear-facing camera	A 5-megapixel camera.
13	Volume control button	Increases or decreases the speaker volume.

## Inserting a SIM card

---

**Warning: Do not force the SIM card. If it does not fit, ensure you have the SIM card properly oriented. Trying to force the SIM into the slot when it is incorrectly oriented may damage the SIM and/or your tablet.**

---

Your tablet is equipped with a micro SIM card slot. To insert a micro SIM card, insert the card with the gold-colored contacts facing downwards and the cut-off corner towards the top of the tablet.

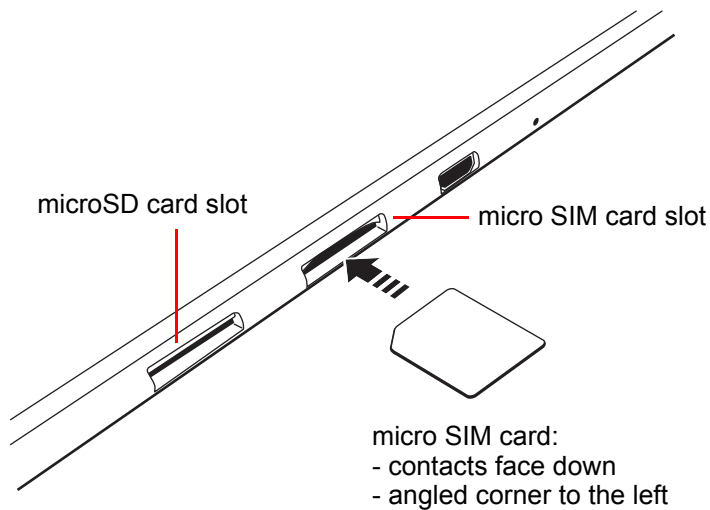

## Using your tablet

---

### Charging your tablet

For first-time use, you need to charge your tablet for four hours. After that you can recharge the battery as needed.

**Note:** *Charger illustration is for reference only. Actual configuration may vary.*

### Assembling the power adapter

Slide the plug fitting into the power adapter body until it clicks into place.

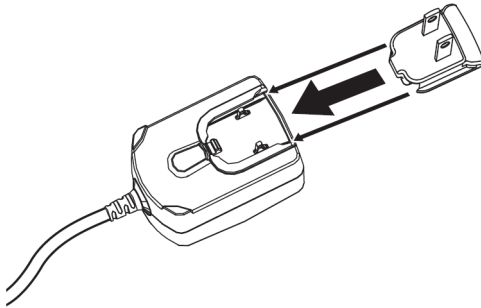

### Connecting power

Connect the power connector to your tablet and plug the AC adapter side into any AC outlet.

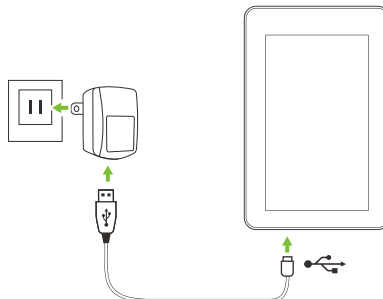

**Note:** *It is normal for the tablet surface to become warm during charging or long periods of use.*

---

**Warning:** *Only use the bundled power adapter to charge your device.*

---



## Turning on for the first time

To turn on your tablet, press and hold the power button until you see the Acer logo. Wait a moment for your tablet to boot up. You will then be asked some questions before you can use your tablet.

To start, tap to select your language then tap **Start**. Follow the rest of the instructions as they are displayed.

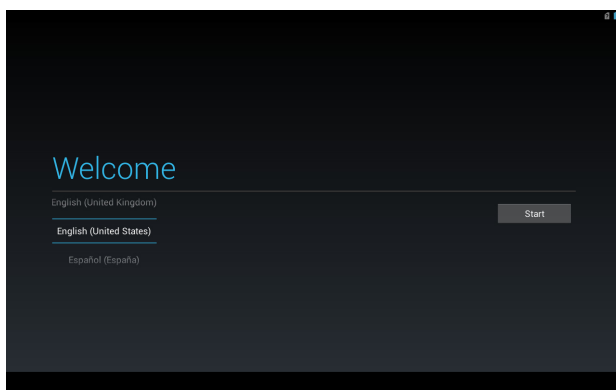

**Note:** If the tablet's screen turns off, it has entered sleep mode. Briefly press the power button to wake it up. For more information, see "**Waking your tablet**" on page 19

## Sign in to or create a Google account

If you have Internet access, your tablet allows you to synchronize information with a Google account.

During the start-up process, you may create or sign in to an account, which will be used to synchronize your contact list, email, calendar and other information. If you do not yet have Internet access, or do not want to use this feature, then tap **Skip**.

**Important: You must sign in to a Google Account to use Gmail, Google Talk, Google Calendar, and other Google Apps; to download applications from Google Play; to back up your settings to Google servers; and to take advantage of other Google services on your tablet.**

**If you want to restore existing settings from another device with Android 2.0 (or later) installed, you must sign in to your Google account during setup. If you wait until after setup is complete, your settings will not be restored.**

**Note:** If you have multiple Google accounts, such as separate accounts for personal and business contacts, you can access and synchronize them from the Accounts settings section. See **"Multiple Google accounts" on page 44.**

## Using the touchscreen

Your tablet uses a touchscreen for selecting items and entering information. Use your finger to tap the screen.

**Tap:** Touch the screen once to open items and select options.

**Drag:** Hold your finger on the screen and drag across the screen to select text and images.

**Tap and hold:** Tap and hold an item to see a list of actions available for that item. On the pop-up menu that appears, tap the action you want to perform.

**Scroll:** To scroll up or down the screen, simply drag your finger up or down the screen in the direction that you want to scroll.

## The Home screen

When you start your tablet, or wake it from power saving, it will display the Home screen. This screen gives you quick access to information and simple controls with widgets or shortcuts. These display information such as the time and weather, or provide additional controls and direct access to applications. Some have been pre-installed on your tablet, while others may be downloaded from Google Play.

The Home screen already features some useful controls and information.

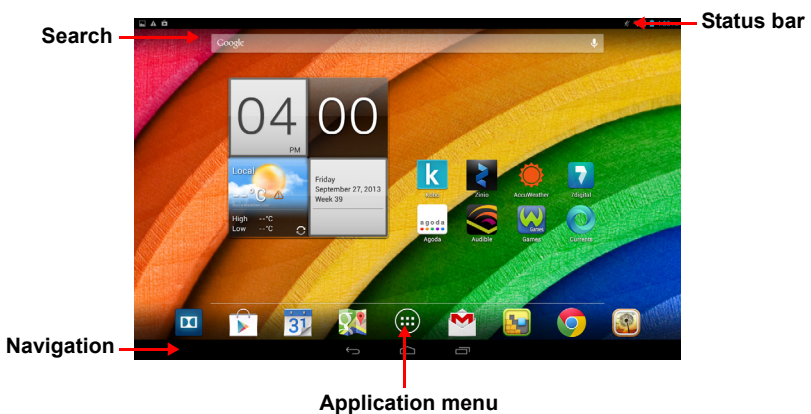

**Note:** Bundled apps differ depending on region and configuration.

## Search

To search for applications, files or for information on the Internet, tap the **Google** icon in the top-left corner.



Simply enter the text you want to find. Tap the arrow or Enter key to search the Internet, or tap one of the suggestions, applications or files shown in the list.

## Voice search

If voice search is available, tap the microphone and speak your search request. **"Voice Search" on page 24.**



## Navigation

To navigate through menus and options, use the three icons which display in the black bar across the bottom of the screen.



### Back

Tap this icon to go to the previous page, or to go up one level in a menu. This icon may be replaced with the *hide* icon in certain cases (such as if the keyboard or list of recent applications is shown).

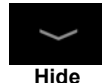

### Home

Tap this icon to go directly to the Home screen.

### Recent

Tap this icon to see recently opened applications. Tap an application to open it, or tap anywhere on the screen to return to the Home screen.

## The extended Home screen

The Home screen area extends to either side of the central Home screen, giving you more room to add widgets or organize shortcuts. To view the extended Home screen, swipe your finger to the left or right.

Four more pages are available, two to the left and two to the right. To change or add widgets on any of the screens see **"Personalizing the Home screen" on page 14.**



## The application menu

The application menu displays applications and widgets available on your tablet.

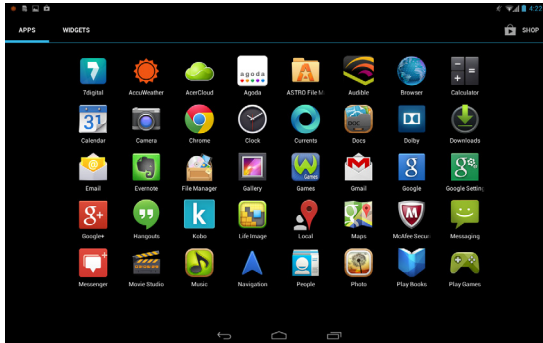

Applications are displayed in alphabetical order. If more applications are available, an outline of the second page will be shown on the side of the screen. Swipe the outline towards the center of the screen to switch pages.

Otherwise swipe to the left to see more Applications. When you are on the last page of applications, swipe to the left to see widgets available on your tablet.

### **"Personalizing the Home screen" on page 14.**

Tap the **Play Store** icon to open Google Play.

***Note:** All images are for reference only. The applications installed on your tablet can be different from the applications shown in illustrations.*

## Adding an application to a Home screen

Tap and hold an icon to add a shortcut to one of your Home screens. When you select an icon, you are taken to the initial Home screen. You can drag the selected icon to any extended home screen.

## Status and notification areas

The upper right corner of the screen displays a clock, battery charge status and network signal strength in the status bar the runs across the top edge of the screen. Status and notification information are in two pull-down panels that drop from the top edge of the screen near the left and right corners.

The right panel has a several icons that display the function status of a number of tablet features, some of which you can turn on and off. The left panel displays various system notifications.

Swipe down from the top of the screen to display a panel, either from the left or right end of the status bar.

### Notifications

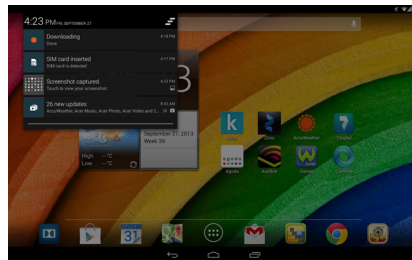

### Function status

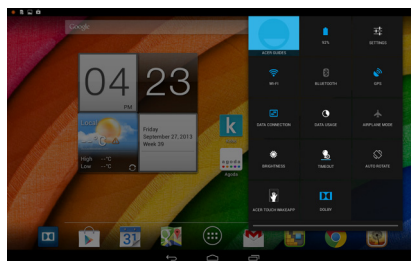





Icon	Description	Icon	Description
	Locks/unlocks screen rotation.		Opens the Settings menu





### Status and notification icons

#### Connection icons

**Note:** The icons displayed on your device vary depending on your connection.



















Icon	Description	Icon	Description
	Wireless network status, switch on/off		Bluetooth off
	Airplane mode (wireless connectivity disconnected)		Connected to a Bluetooth device

Battery status icons

Icon	Description	Icon	Description
	Battery is very low		Battery is full
	Battery is low		Battery is charging
	Battery is partially drained		

**Note:** If your device's battery is getting too hot, you will be notified and advised to turn off the device. If you fail to turn it off, it will shut down automatically.

Other Notification icons

Icon	Description	Icon	Description
	Alarm is set		Speaker is silenced
	New Gmail message		Tablet microphone is off
	New Google Talk message		GPS is on
	Upcoming event		Receiving location data from GPS
	Song is playing		Syncing data
	SD card or USB storage is full		Sync is on
	Tablet is connected to PC via USB		Problem with sign-in or sync
	Application update available		Uploading data
	System update available		Downloading data
	Virtual private network (VPN) status		

## Personalizing the Home screen

You may personalize your Home screen by adding or removing application shortcuts or widgets, and by changing the wallpaper.

## Adding or removing shortcuts or widgets

To add shortcuts or widgets tap the **APPS** icon in the bottom-center of the Home screen.

The **APPS** menu contains a list of shortcuts to applications you can drag to a Home screen.

Tap **WIDGETS** to see small applications and links (such as custom shortcuts, contacts or bookmarks) that you can add to a Home screen. Widgets are small applications that display constantly-updated information or quick shortcuts to applications or special functions.

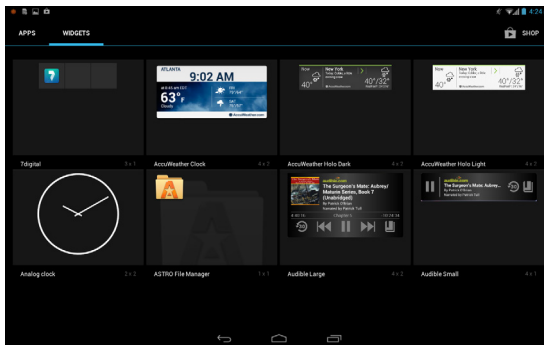

To move an App or Widget to the Home screen, tap and hold an item until it is selected. The Home screen will open. Drag the item to any free area on the screen. To view information about the App or Widget, drag it to the icon at the top of the screen.



To move the item to a different Home screen, drag it to the side of the screen, the Home screen will switch to the screen in that direction. Release the item when it is positioned correctly.

### Resizing a Widget

Most Widgets can be made larger, so you can give more space to information that is important to you. After placing a Widget on the Home screen, tap and hold to select it. Four diamonds will appear on each side, tap and drag the diamond until the Widget is the correct size. Tap **Back** to finish.

***Note:** Not all Widgets can be resized.*

### Removing an item from the Home screen



To remove an item from the Home screen, tap and hold the item until the **Remove** option appears at the top of the screen. Simply drag the item to the **Remove** option.

### Changing the Home screen image

Tap and hold any open space on the Home screen. You can choose from a set of pre-formatted wallpapers, images stored in the Gallery, selected Wallpapers, or Live wallpapers that feature animated or interactive backgrounds.

## The onscreen keyboard

When you tap a text box to enter text, an onscreen keyboard will appear. Simply tap on keys to enter text.

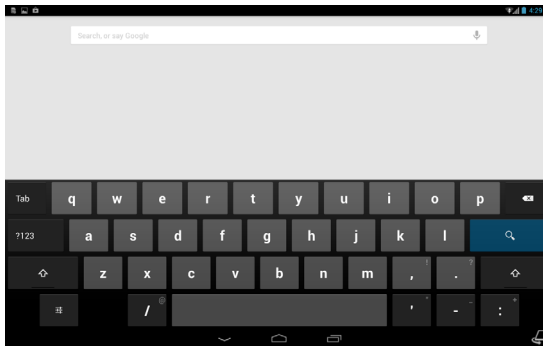

Tap the **?123** button to see numbers and special characters, and then tap the **~\{** key to see more options. Tap and hold a key to select alternative



characters (if available for that key), such as letters with accents or related symbols.

The layout of the keyboard varies slightly, depending on the application and information that is required.

## Changing Google keyboard settings

To use a different keyboard language or change settings, tap the **Input options** key, then select either **Input languages** or **Google keyboard settings**. These settings include auto-correction and keyboard sounds.



## Predictive text or auto correction

The Android keyboard can provide predictive text input. As you tap the letters of a word, a selection of words are displayed that continue the sequence of letters tapped, or are a close match allowing for errors. The word list changes after every key press. If the word you need is displayed, you can tap on it to insert it into your text.

To turn predictive text on or off with the Google keyboard, tap the **Input options** key, and then **Google keyboard settings**. Tap **Auto-correction** or **Show correction suggestions** and select one of the options.

## Editing text

You can select and edit text in certain applications, such as text you have entered in a text field. Selected text can be cut or copied and later pasted within the same application, or to a different application.

**Note:** *Certain applications may not support text selection, or only support it in certain areas. Other applications may offer specialized commands to select text.*

## Selecting text

To select text that you want to cut, copy, delete or replace:

1. Tap the text you want to select. If you can select this text, a cursor is inserted below the text.

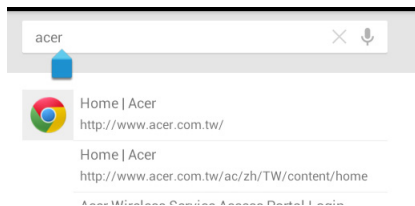

**Note:** *The cursor indicates where text you type or paste will be inserted.*

2. Tap and hold the text or word you want to select. The selected text is highlighted, with a tab at each end of the selection.

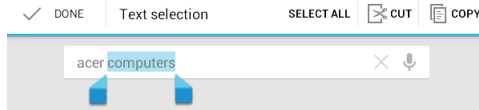

3. Drag either tab to expand or reduce the amount of selected text, or tap **Select all**.
4. To cut or copy the text, tap the **CUT** or **COPY** button.

## Inserting text

To type new text or add text that you have copied:

1. Tap the text you want to select. If you can select this text, a cursor is inserted below the text.

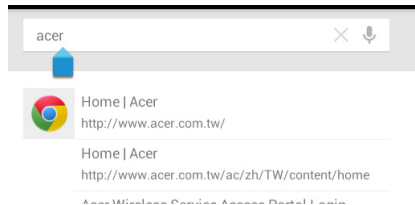

**Note:** The cursor indicates where text you type or paste will be inserted.

2. If the cursor is not in the desired position, simply drag it to the correct position.

**Note:** If you previously copied (see below) text, tap where you want to insert the text. A **PASTE** button appears briefly below the cursor. Tap the button to paste the text.

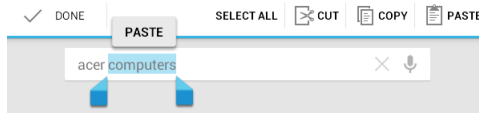

**Note:** To replace a word, double tap the word. A **PASTE** button appears above the word. Tap the button to paste to replace the text.

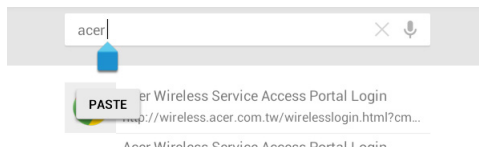

3. Modify the text: Type, paste or delete text.
4. Tap  on the keyboard.

## Waking your tablet

If the screen is off and the tablet does not react to any taps on the screen, then it has been locked and is in sleep mode.

To wake your tablet, press the power button. Your tablet will display the Lock screen. To unlock the screen, tap the lock button and drag it in any direction until it turns white and displays the unlocked icon.

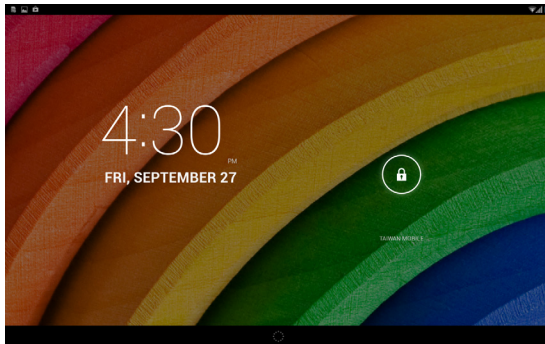

## Adjusting Touch WakeApp settings

1. Pull down the **status and settings** panel.
2. Tap the **Touch WakeApp** icon to display the *Gesture Configuration* options.
3. Tap **ON** to enable the function you want to activate.
4. Tap the item you have enabled (2-thumb or 5-finger gesture) to bring up the app list.

**Note:** Hold the tablet with both thumbs near the edge of the screen to wake up your tablet.



5. Select your app and Tap **OK**.

## Lock screen apps

To activate frequently used applications, press the lock button and drag to one of four Lock screen apps on the left side of the circle. This unlocks the tablet and opens that application immediately.

***Note:** Open **APPS > Settings > Lock screen apps** to change these applications.*

## Security Options

For additional security, you can set a PIN number that must be entered to access the tablet, or choose an unlock Pattern (a set of dots that must be connected in the correct order). Other options include Face Unlock and Password. The default setting is Slide where you swipe the on-screen lock icon in any direction to unlock the tablet. From the Home screen tap **APPS > Settings > Security > Screen lock** to select an option.

***Note:** If you forget an unlock pattern, please refer to "**Unlock pattern**" on page 47.*

## Shutting down your tablet

If you won't use your tablet for an extended period of time, turn it off to save battery power. To turn off your tablet (even when locked), press and hold the power button for one second. Tap **Power off** and confirm the shut down. To force a shutdown, press and hold the power button for four seconds.

## Connecting devices to your tablet

### Connecting to AC power

"Charging your tablet" on page 8.

### Inserting a microSD card (optional)

You may install a microSD Card to expand your device's storage space. Ensure that the microSD Card is inserted all the way into the card slot.

**Note:** Your tablet only supports microSD Cards that use the FAT or FAT32 file system.

Check card capacity in the **External SD card** section of **APPS > Settings > Storage**.

### Transferring files between your tablet and a PC

Your tablet and any connected storage devices can be accessed from a PC with a USB connection.

### Connecting to a PC as a USB storage device

Download and install the latest USB driver on your computer before connecting your tablet to the computer. Visit **www.acer.com** for the latest drivers: Select **Support > DRIVERS AND MANUALS**. Select your tablet model, and then the **Driver** tab, select **USB** and accept the download.

This allows you to transfer your personal data to or from your PC, using your PC's file explorer.

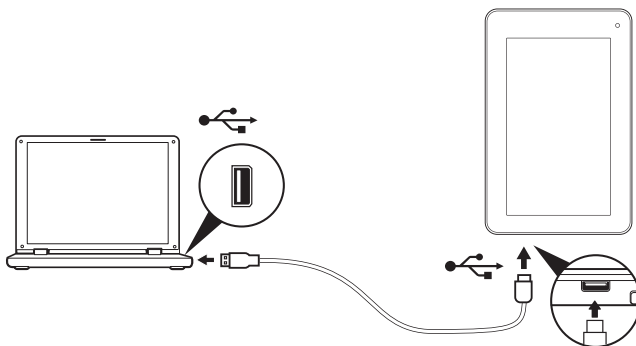

Using the micro USB to USB cable, connect the micro end into your tablet and the other end into your computer.

After a short delay, your tablet's internal memory will be visible as a **Portable Device** in your PC's file explorer. Select the **Acer Iconia Tab** icon to see your tablet's internal memory and any additional memory (microSD Card) available to your tablet.

## Connecting a Bluetooth device

Only A2DP stereo headsets (playback only, no microphone) are supported. Please check for updates to the tablet's software which may add support for additional Bluetooth devices.

For Bluetooth settings, tap **APPS > Settings**, then under **WIRELESS & NETWORKS** tap Bluetooth.

Turn Bluetooth on and tap **Search for devices** to scan for nearby devices.

***Note:** Please check for updates to the tablet's software that may add support for additional Bluetooth devices. See "**Updating your tablet's operating system**" on page 45.*

## Accessories

For a complete list of accessories, visit [store.acer.com](http://store.acer.com).

## Going online

---

### Managing Wi-Fi connections

If you did not connect to a Wi-Fi network when you first started your tablet, or want to connect to a new network, tap **APPS** > **Settings** > **Wi-Fi** to manage your connection settings..

If Wi-Fi is not on, tap the Wi-Fi **ON** switch and wait for your tablet to detect nearby networks. Tap the name of your network and enter a security password, if needed. You can also turn the Wi-Fi connection on or off by tapping the Wi-Fi icon on the pull-down function status and controls panel in the upper-right corner of the Home screen. Swipe downward from the status bar to pull down the panel.

### Browsing the Internet

In order to browse the Internet with your tablet, you must be connected to a network with a connection to the Internet.

### Using the browser

To start browsing, tap the **Chrome** icon on the Home screen, or open the Application menu and select **Chrome**. To enter a website address, tap the address box at the top of the page. Enter the address using the onscreen keyboard and tap **Go**.

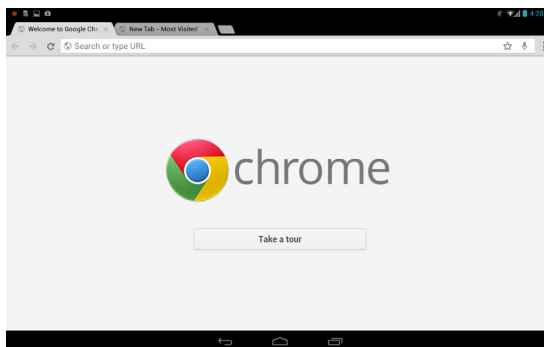

To view your browsing history, bookmarks or frequently visited sites, open the browser then tap the menu icon in the top-right corner.



You can open multiple tabs. When a page is open, tap the small **New tab** button. Simply tap one of the open tabs across the top of the screen to switch pages.

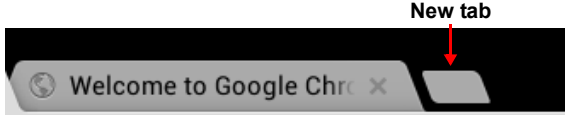

Pinch to zoom in or out of pages. Tap and hold an item on a page to open a contextual menu.

## Voice Search

With voice actions, you can send emails, find directions to locations, search the Internet and even send a note to yourself using your voice. Tap the microphone on the Home screen for voice searches. When the **Speak now** prompt is displayed, state your command or query.

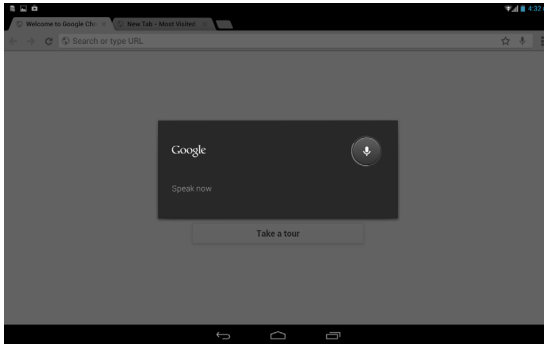

**Note:** Voice Search is available only in selected regions.

## Setting up Gmail

1. Make sure your tablet is connected to the Internet.
2. From the Applications menu tap **Gmail**.

If you did not enter a Gmail account address and password when you first started your tablet, follow the instructions.

**Note:** You need to activate a Google account before you can use Gmail.



## Composing an email

1. Make sure your tablet is connected to the Internet.
2. Open the application menu and tap **Gmail**.
3. Tap the **Compose** icon (shown right).
4. Enter the recipient's email address, the subject and message.
5. When you are finished composing your message, tap **Send**.



## Setting up the Email application

The Email application enables you to access email from most popular email providers. Most accounts can be set up in two steps. Open the application menu and then tap **Email** to start setting up your email access.





If necessary, enter your email address and tap **Manual setup** to enter the parameters manually. Tap **Next** to finish the setup process.







The combined inbox feature of your tablet allows you to view emails from multiple accounts in a single inbox.

## Online applications

Your tablet provides a variety of preinstalled applications. Many of these require some form of Internet access.

These applications may include:\*

Item	Description	
Google+	Stay in touch with friends and family, personalize your very own profile, and more with Google's social networking service.	
Google Now	Get the information that's important to you with "cards" that appear right when you need them (i.e. getting current traffic conditions when leaving work).	
Latitude	View where your friends are on Google Maps.	
Local	View places of interest and local businesses on Google Maps.	

Item	Description	
Maps	Get easy-to-follow directions using Google Maps.	
Messenger	Text a person or group of people from your Google+ account with this messaging service.	
Navigation	Turn-by-turn navigation with live traffic, multiple visible layers and text-to-speech take you where you want to go.	
People	Organize the people in your life with this contact manager, which syncs with your google mail account.	
Talk	Chat with your friends, with text, sound and video.	
YouTube	View users' video clips, and share and rate them on YouTube.	

**\*Note:** Applications installed may vary according to your region.

## Google Play

**Note:** Google Play may not be available in all countries and regions.

**Note:** You must activate a Google account before using Google Play. The first time you access Google Play, you must read and accept the Terms of Service.

Tap **Play Store** from the home screen or application menu to open Google Play. Here you can obtain a variety of add-on programs and applications to enhance the functionality of your tablet.

**Note:** The contents and design of Google Play varies by region. For example, in some regions, you can also browse for and purchase movies, books, magazines, or music. Updates may add new categories or change how to navigate Google Play at any time.

**Note:** For the best user experience, you are advised to not download apps that use 3D graphics.

You can browse Google Play by category or tap the search icon to search for a specific application.

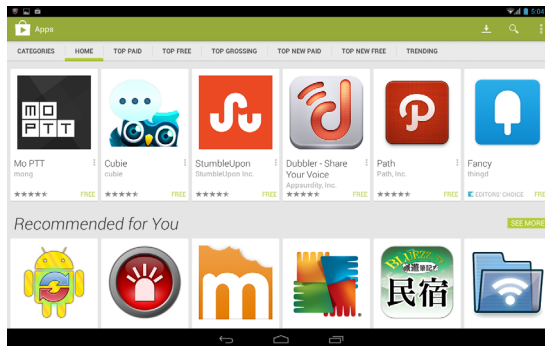

Once you have selected an application, tap the **Install** button to download and install the application. You will be told which services (contact information, wireless access, GPS, etc.) the application requires access to in order to function correctly. If none of these services seem unusual, tap **Accept & download** to proceed with the installation.

You may keep track of the download progress from both the app's page and the tablet's notifications panel.



**Important: Some applications may require payment before you can download them. You will need to have a Google Checkout account in order to pay for these applications.**

### Using downloaded applications

Once you've downloaded and installed an application, you may find it in the **APPS** or **WIDGETS** sections of the Application menu.

Certain applications provide both an App and widgets, or only provide a widget (with no application icon). See "**Personalizing the Home screen**" on **page 14**.

### Uninstalling downloaded applications

Once you've downloaded and installed an application, you may uninstall the application from the **APPS** menu by pressing and holding the application icon and dragging it to the **Uninstall** trash can located at the top-left of the Home screen.

***Note:** Deleting an app from the Home screen only deletes the shortcut. See "**Adding or removing shortcuts or widgets**" on **page 15**.*

Alternatively, you can go to **Settings** from the application menu and select **APPS**. Tap the application you wish to uninstall, tap **Uninstall** and confirm.

## Google Hangouts

**Note:** *Google Hangouts may not be available in all countries and regions. You need to activate a Google account before you can use Google Hangouts.*

Tap **Hangouts** from the application menu to open Google Hangouts. Here you can see a list of your contacts connected to Google Hangouts services. Tap on a contact to open a chat session. After you have connected, you can open a video chat session. Tap the menu bar icon in the upper-right corner to access Help information that explains all of the app's features in detail.

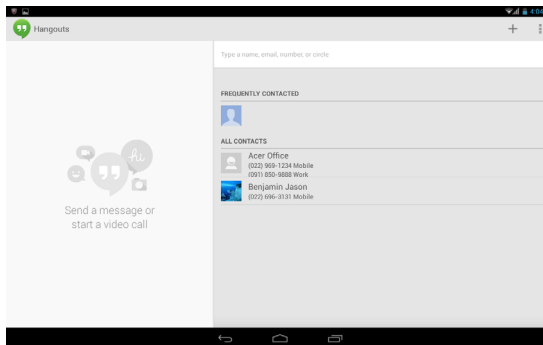

## Playing music and video

### Multimedia playback

Your tablet comes supplied with a variety of programs that you can use to enjoy multimedia content.

#### Play Music

Use **Play Music** to listen to music and other audio files that you download or copy from your computer, usb drive, or mass storage device, etc.



Tap **APPS > Play Music** to open the application.

**Note:** Controls in Play Music change slightly depending on screen orientation (i.e. portrait or landscape view).

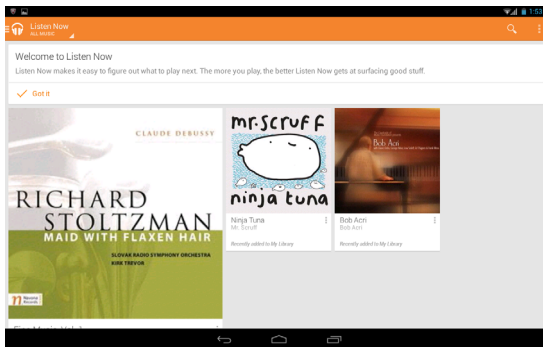

Tap the **Headphones** menu icon in the upper-left corner to bring up the catalog menu where you can select between Listen Now, My Library and Playlists. The default view is Listen Now mode. The other two modes allow you to organize and control your audio library and create and manage playlists. You can tap an album to view a list of tracks on it and again to play it, or tap **Shuffle** to play tracks in random order. You can play an individual track by tapping on it. Tap in the upper-left corner to return to the previous view. Tap the menu bar in the upper-right corner to access the **Help** information which explains all the app's features in detail.

**Note:** You can return to the tablet's Home page while playing music. The current track along with basic music controls appear in the notifications panel. See "**Status and notification areas**" on page 12.

## Adjusting audio settings using Dolby Digital Plus

Your tablet comes with Dolby Digital Plus audio enhancement features, which include Surround Virtualizer (for both headphones and the built-in speakers), Dialogue Enhancer, and Volume Leveler. You can select Movie, Music, Game and Voice presets which are optimized for each mode. You can also configure two custom modes.

1. Open the **Settings** app.
2. Tap **Dolby** in the Settings menu.
3. Tap **Dolby settings** on the right to load the Dolby Digital Plus controls.
4. Select your desired audio mode or make manual modifications.
5. Tap the navigation **Back** icon to exit the Dolby controls.

**Note:** A number of items have help information, identified by a boxed question mark beside the item. Tap one to pop up the help information for that item. You can also tap **Play Demo** to watch a video that demonstrates the audio effects.

You can turn Dolby mode on and off from the function status and controls panel in the Home screen.

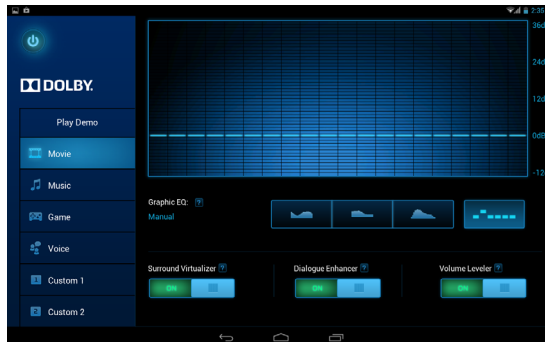

## Managing people and contacts

Your tablet features an address book that allows you to save contacts to the internal memory or your Google account.

Tap **People** from the Home screen or the application menu to view your contacts.

If you don't have any contacts stored on your tablet, you can sync with your Google account contacts, import contacts from a contact data file (vCard or csv) or add a new contact.

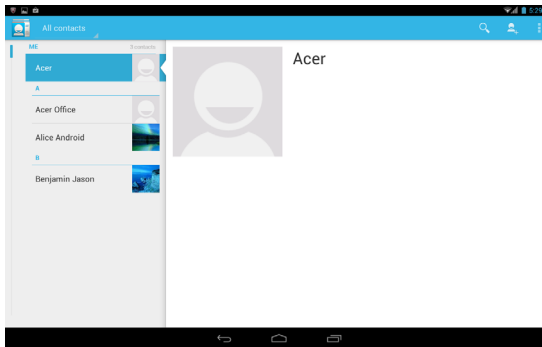

If you have activated a Google account that includes contacts, your contacts will be synchronized automatically. see "**Synchronization**" on page 43.

### Importing contacts

Tap the **Menu** button and select **Import/export**. Tap the option that describes where your contacts are stored. When the contacts are found, confirm to import the contacts in a new group.



### Adding a new contact

Tap **New** to add a new contact. If you have multiple accounts, you will be asked which account you want to use to store the contact. The contact will be synchronized with that account.



You may now edit the new contact entry.



## Editing a contact

If you have opened a new or existing contact, you can enter information about the contact:

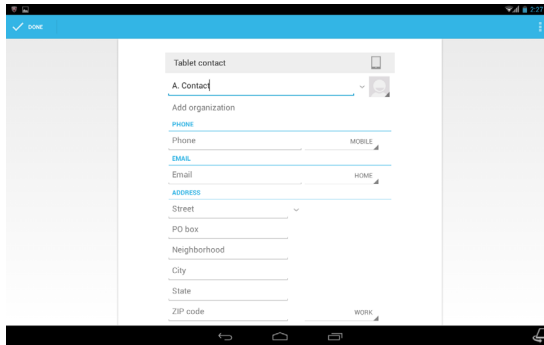

Simply tap on a box and type the appropriate information. Click on the arrow next to the name entry to see options, such as adding a name prefix or phonetic name.

To enter multiple entries, such as separate entries for mobile and home phone numbers, tap the plus sign to create a second entry. Tap the minus sign to remove an entry.

Tap **Add another field** for more categories.

To assign an image to your contact, tap the silhouette and select an image from your tablet's picture gallery (select **Gallery** if requested). You may also take and crop a new photo.

Tap **Done** (top-left corner) to finish and save the contact.

**Tip:** Set each phone number to match the type of network as this can determine some functions, i.e. certain applications only recognise 'Mobile' numbers as they require a function only available on a mobile network.

## Opening a contact

To see the information stored for a contact, tap on the contact's name in the list on the left.

Tap on an entry (such as an email address) to open the application linked to that type of entry. For example, tap an email address to open the **Gmail** application.

To add or change information, tap the pencil icon.

Tap **Done** to save changes, or **Cancel** to discard them.



## Starred contacts

You may quickly access your favorite contacts by adding a *star*. First open the contact, then tap the star next to the contact's name. Tap **All contacts** and select **Starred** to see only your favorite contacts.

## Editing a contact on your computer

If you have synchronized your Google account and contacts, you can use your computer to access and edit your contact list. Open the Internet browser on your computer and go to **contacts.google.com**. Sign in to your account then select and edit contacts from the list; the next time your tablet synchronizes with your computer, these changes will also be made to your tablet's contact list.

**Warning: Back up your contacts before making any changes.**

**Tap the *Menu* button and select Import/export. You can then tap Next at the bottom of the screen to access the options to select how to export your contact list, either to your tablet's internal memory, or other options depending on installed applications.**



## Using the camera and camcorder

Your tablet features both front and rear-facing digital cameras. This section will take you through the steps in taking photos and videos with your tablet.

**Note:** *It is recommended that you insert a microSD Card into the microSD slot before using the camera.*

*Please note you can only save photos and videos to internal memory or a microSD Card, not an external USB storage device.*

To activate the camera, open the application menu and tap **Camera**.

### Camera icons and indicators

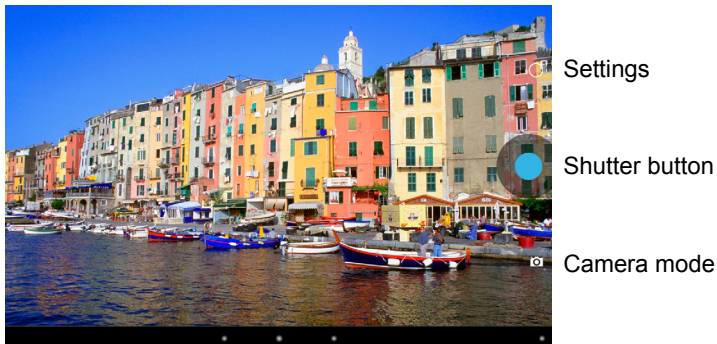

In the camera window, the controls at the bottom of the screen allow you to select the camera operating mode, take a picture or change settings.



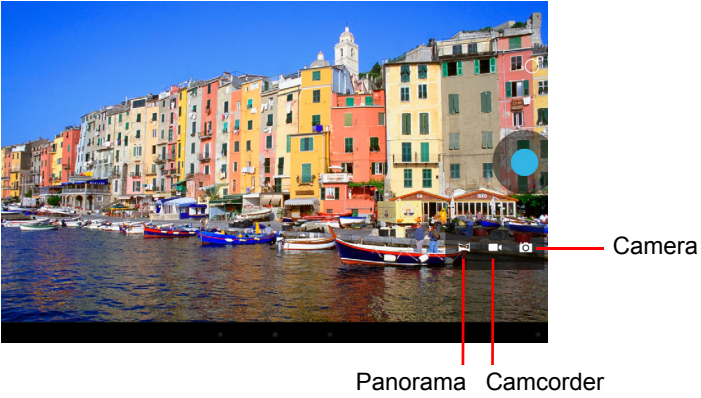

## Camera modes

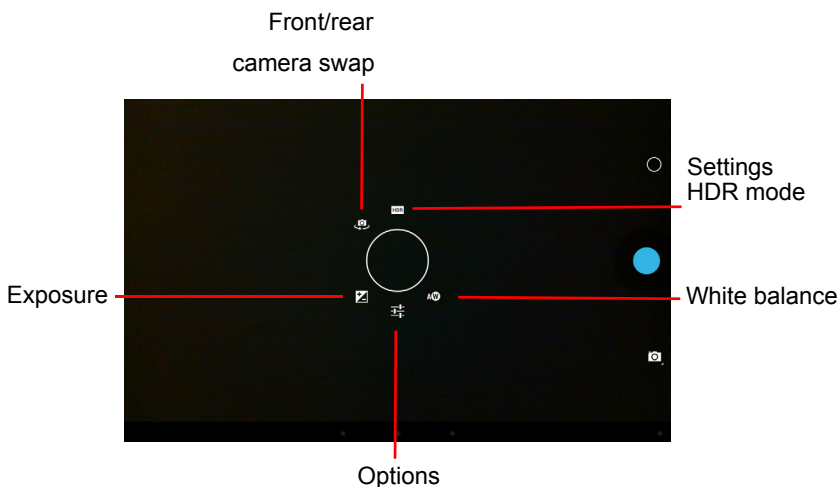

The panorama mode allows you to take multiple photos of a scene which are then "stitched" together to create a single photograph.

## Camera settings



Icon	Description
	<p>Exposure</p> <p>Increase or decrease image exposure: +1, 0, -1.</p>
	<p>Options</p> <ul style="list-style-type: none"> <li>• Select the scenery mode for Auto, Night, Sunset or Party.</li> <li>• Set if the location (from GPS) is stored in the image information.</li> <li>• Set the resolution of the image: Front:VGA, QVGA, Rear: 1 to 5MP.</li> </ul>
	<p>White balance</p> <p>Change the color balance to match the lighting: Auto, Incandescent, Daylight, Fluorescent or Cloudy.</p>
	<p>Front/rear camera swap</p> <p>Toggles between the front and rear camera.</p>
	<p>HDR mode</p> <p>Turns High Dynamic Range mode on/off. HDR mode takes multiple exposures and combines them to produce more vivid images.</p>

## Taking a photo

1. Ensure the options described above are set to your preferences.
2. Frame your subject and steady your tablet.
3. Pinch to zoom in or out as needed.

**Note:** When using zoom, the image on the screen does not represent the quality of the final image.

4. Tap the shutter button to take the photo.

After taking a photo, swipe across the screen from right to left to view the photo you took in the Gallery.

## Camcorder icons and indicators



Settings



Record button

Camcorder mode

Tap the camera mode icon and select camcorder to switch to camcorder mode to record video.

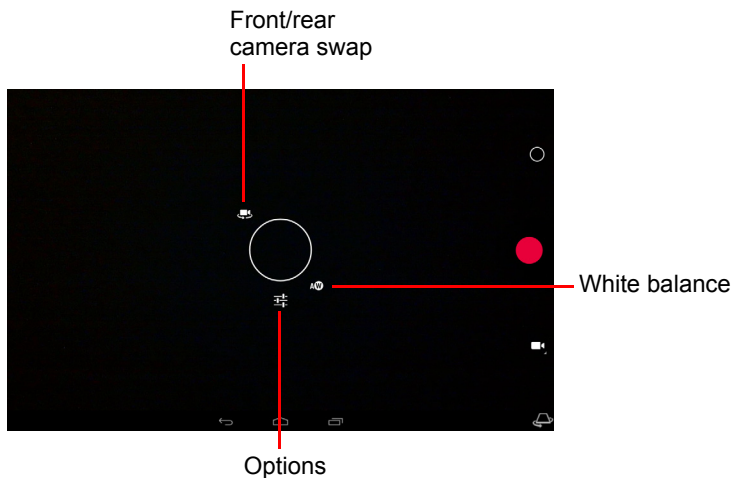
## Camcorder settings



Icon	Description
	<p>Options</p> <ul style="list-style-type: none"> <li>• Turn the <i>Time lapse</i> feature on or off, to shoot a slow motion video, set the interval between single frames in this menu.</li> <li>• Set if the location (from GPS) is stored in the video information.</li> </ul>
	<p>White balance</p> <p>Change the color balance to match the lighting: Auto, Incandescent, Daylight, Fluorescent or Cloudy.</p>
	<p>Front/rear camcorder swap</p> <p>Toggles between the front and rear camcorder.</p>

## Shooting a video

1. Ensure the options described above are set to your preferences.
2. Frame your subject and steady your tablet and zoom in or out as needed.
3. Tap the record icon to begin recording.
4. Tap the record icon again to stop recording.

## Supported formats

Type	Formats
Image	JPEG
Video	H.264 BP, MPEG-4 SP, H.263
Audio	AAC-LC, AMR-WB, AMR-NB

## Viewing photos and videos

After you have taken your photo or video, it is automatically saved; normally to internal memory. You can view it by tapping the thumbnail in the top-right corner of the screen. Alternatively, open the application menu and tap **Gallery**, then **Camera**. Select the photo or video you want to view (videos are marked with a small play symbol). From the Gallery you can share the file using various services. Tap **Menu** and then **Share**.

*Note: Share options vary depending on the file type.*



## Advanced settings

Access Settings from the Application menu. Tap **APPS**, then **Settings**.

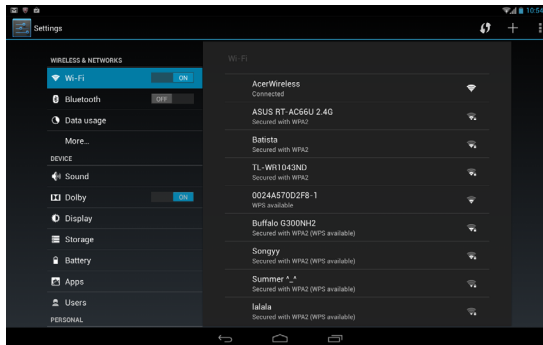

## Wireless & Networks

### Activating or deactivating connections

Tap **APPS > Settings**, then under **WIRELESS & NETWORKS** each connection has an ON/OFF switch that controls the connection. Tap an entry to manage your connection settings.

Alternatively, use the right side of the status bar to manage connection settings.

### Adjusting Bluetooth settings

You can use Bluetooth to exchange information between your tablet and other mobile devices.

### Bluetooth connections

For all Bluetooth settings, tap **APPS > Settings**, then under **WIRELESS & NETWORKS** tap **Bluetooth**. Here you can switch Bluetooth on or off, set the tablet name and discoverability. Tap **SEARCH FOR DEVICES** to scan for nearby devices.

To connect to a device, tap the device in the list of available devices. You may be asked to enter a PIN on both devices to establish the connection.

**Note:** Only A2DP stereo headsets (playback only, no microphone) are supported. Please check for updates to the tablet's software which may add support for additional Bluetooth devices.

## Data Usage

The Data Usage section shows how much data has been transmitted to your tablet, either in total or for each App. This information is useful if you are using a metered service.

## Putting your tablet in Airplane mode

You can enter Airplane mode (also known as flight mode) to turn off network and Bluetooth functions and use your tablet during a flight. Check with your airline to make sure this is permitted onboard.

Switch your tablet off during takeoff and landing as it may interfere with aircraft electronic systems.

**Note:** When Airplane mode is active, the ✈ icon is displayed in the status area.

To turn Airplane mode on or off, tap **Settings**, then under **WIRELESS & NETWORKS** tap **More... > Airplane mode**.

## Virtual Private Network (VPN)

This option enables you to connect to a private network, such as a secure work or office environment.

Add a VPN by tapping **Settings**, then under **WIRELESS & NETWORKS** tap **More... > VPN > Add VPN network**.

# Device

## Sound

Adjust the volume of your tablet using the volume buttons on the side of the tablet. Alternatively, you can adjust your tablet sound settings by tapping **APPS > Settings > Sound**.

Item	Description
Volumes	Sets volume for Media, Alarm, and Notifications.
Default notification	Sets a ringtone for Notifications.
Touch sounds	Plays a sound whenever a screen selection is made.
Screen lock sound	Plays a sound when locking and unlocking the screen.

## Display

You can adjust your tablet screen settings by tapping **APPS > Settings > Display**.

Item	Description
Wallpaper	Set the Home screen background image.
Brightness	Adjusts screen brightness.
Daydream	Adjusts what displays in Daydream screen saver mode.
Font size	Sets the font size so either more text is visible or the text is easier to read.
HDMI settings	Configures a display connected to the HDMI Micro port
Sleep	Sets a delay before the screen will be turned off.

## Apps

### Closing an application

To close an active application, go to **Settings > Apps**. Tap the **RUNNING** tab, then tap the program you wish to close. Select **Stop** to close the program.

### Uninstalling an application

You can remove programs installed on your tablet to free up extra storage memory. Tap and hold a program icon from the application menu and drag it into the **Uninstall** area in the top-left corner.

**Note:** *You cannot uninstall applications that were pre-loaded on your tablet.*

Alternatively, you can go to **APPS > Settings** and select **Apps**. Tap the application you wish to uninstall, tap **Uninstall** and confirm the uninstall.

**Warning!** **You should only remove programs if you are familiar with the Android operating system.**

## Personal

### Synchronization

You can configure synchronization options for many applications on your tablet. You can also configure what types of data you synchronize for each account.

Some applications, such as People, Gmail, and Calendar, can sync data from multiple accounts. Others sync data only from the first Google Account you sign in to on your tablet, or from an account associated specifically with that application.

For some applications, such as People or Calendar, all changes that you make on your tablet are made to the synchronised copy on the Internet. Other applications only copy information from account on the Internet; the information on your tablet cannot be changed directly, you must change the information stored in the Internet account.

Tap **APPS > Settings > [Account]** to manage the synchronization of individual accounts.

Some applications, such as Gmail and Calendar, have additional synchronization settings. Open the application and tap the *Menu* button (three dots) and then tap **Settings**.



## Multiple Google accounts

If you have multiple Google accounts, such as separate accounts for personal and business contacts, you can access and synchronize them from the Accounts settings section. Tap **APPS > Settings > Add account**.

## Changing language and text options

Set your location and language input preferences by tapping **APPS > Settings > Language & input**.

# System

## Setting the date and time

To set the date and time, tap **APPS > Settings > Date & time**.

***Tip:** If you travel frequently or live in an area that uses daylight saving time, and have mobile network access, activate **Automatic date & time** from this menu. Your tablet will set the date and time based on information it receives from the network.*

## Setting alarms

There are two predefined alarms on your tablet by default. To add or edit alarm settings, tap **Clock** in the application menu and tap **Set alarm**.

Tap **Add alarm** to create a new alarm, or tap the check box next to a preset alarm to turn it on or off.

Tap a preset alarm to edit it. You can:

- Turn the alarm on or off.

- Set the alarm time.
- Set which days to repeat the alarm.
- Set a ringtone.
- Enable or disable vibrate.
- Give it a label (i.e., a name).

## Updating your tablet's operating system

Your tablet can download and install system updates, adding support for new devices or expanding software options.

To check for updates, tap **APPS > Settings > About tablet > System updates > Check now**.

***Note:** Downloading new firmware can take up to 40 minutes, depending on your network speed. Do not press the power or reset button or access your tablet in any way during a system upgrade to prevent firmware installation failure.*

## Resetting your tablet

You may have to perform a reset if your tablet fails to respond when buttons are pressed or the screen is tapped. To reset your tablet use a small thin object (such as a paperclip) to press the recessed reset button above the power button.

***Note:** When using the reset hole to reset your device, it will be necessary to press the power button to turn your tablet back on.*

## Clean boot

A clean boot will restore your tablet to the factory settings.

**Warning! This will erase all your personal information, any contacts stored on your tablet and any programs you installed.**

Open **Settings** from the application menu, then tap **Backup & reset > Factory data reset**; click **Reset tablet** and then **Erase everything** to format your tablet.

## FAQ and troubleshooting

This section lists frequently asked questions that may arise during the use of your tablet, and gives easy answers and solutions to these questions.

Aspect	Question	Answer
Audio	Why is there no sound coming from the device?	If the headset is plugged into the device, the speaker is automatically shut off. Disconnect the headset. Check that the device volume setting is not muted. Check that the volume control is not at its lowest setting.
Memory	Why do I have less storage than the specifications say?	A small amount of memory is reserved for system security.
Multimedia files	Why can't I view my picture files?	You may be trying to view an image that is not supported. Refer to " <b>Supported formats</b> " on page 40 for more information.
	Why can't I view my video files?	You may be trying to view a video that is not supported. Refer to " <b>Multimedia</b> " on page 48 for more information.
	Why can't I play my music files?	You may be trying to play a file that is not supported. Refer to " <b>Multimedia</b> " on page 48 for more information.
System information and performance	How do I check the OS version of my device?	Tap <b>APPS &gt; Settings &gt; About tablet</b> to check the OS version (Kernel/build number) and other hardware and software information.
	Where can I find my serial number ID?	Tap <b>APPS &gt; Settings &gt; About tablet &gt; Device Information</b> .
Power	I couldn't turn on the device.	The battery power may be depleted. Recharge the device. Refer to " <b>Charging your tablet</b> " on page 8 for more information.

Aspect	Question	Answer
Storage	How do I check memory status?	To check storage status, go to <b>Settings &gt; Storage</b> .
	What do I do when my device's internal storage is full or almost full?	You may need to delete installed apps or move media files to the microSD card.
Unlock pattern	I forgot my unlock pattern.	<p>After five wrong entries, you can reset your unlock pattern. Tap <b>Forgotten pattern?</b> and enter your Google account username and password.</p> <p><b>Note:</b> <i>You must have an active Google account on the tablet and an Internet connection.</i></p> <p>If this option is not available, please contact your local Acer service center.</p>
Heat	The tablet heats up when charging or operating for a long period.	<p>It is normal for the device to heat up when charging. When charging is complete, it will return to its normal temperature.</p> <p>It is also normal for the tablet to heat up during long periods of use, such as watching a video or playing a game.</p> <p>All Acer tablets are factory-tested before release.</p>

## Other sources of help

For information on:	Refer to:
Up-to-date information regarding your tablet	<b><a href="http://www.acer.com">www.acer.com</a></b>
Service enquiries	<b><a href="http://support.acer.com">support.acer.com</a></b>

# Specifications

---

## Performance

- MTK MT8389W quad-core Cortex A7 1.2 GHz processor
- System memory:
  - 1 GB DDR3L RAM on-board
  - 16 or 32 GB of flash memory

Google Android™ 4.2 (Jelly Bean) operating system

## Display

- 10.1" display with IPS (In-Plane Switching) technology
- 1280 x 800 resolution

## Multimedia

- Stereo speakers with Dolby® Digital Plus audio enhancement
- Built-in microphone

Supported formats:

Type	Formats
Audio recording	AAC-LC, AMR-WB
Audio playback	AAC-LC, AAC, AAC+ (not raw AAC), AMR-NB, AMR-WB, MP3, OGG Vorbis, WAV
Video recording	H.264 HP, MPEG-4 MP
Video playback	H.264 BP, H.264 MP, H.264 HP, MPEG-4 SP, H.263 BP

## Connectors

- Micro USB 2.0 Type B, supports OTG
- HDMI® Micro Connector with HDCP support

## Power

- DC power in (5.35 V, 2 A)

## Connectivity

- Bluetooth® 4.0
- IEEE 802.11b/g/n Wi-Fi CERTIFIED™



- GSM / GPRS / EDGE: 850 / 900 / 1800 / 1900 MHz
- GPRS / EDGE: Multi-slot class 12
- WCDMA 1, 2, 5, 8: 850 / 900 / 1900 / 2100 MHz
- HSPA+: HSDPA up to 42 Mbps/ HSUPA up to 11 Mbps
- Non-standalone GPS

## Camera

- Front camera
  - 640 x 480 resolution, 0.3-megapixel
  - Fixed focus
- Rear camera
  - 2592 x 1944 resolution, 5-megapixel
  - 1080p Full HD audio/video recording

## Expansion

- microSD card up to 32 GB (SDHC 2.0 compatible)

## Battery

- 27 Wh 7300 mAh 3.7 V 2-cell Li-polymer battery pack, battery life: 11 hours

**Note:** *Length of battery operation will depend on power consumption which is based on system resource use. For example, constantly using the backlight or using power-demanding applications will shorten battery life between charges.*

## Dimensions

Height	260 mm
Width	175 mm
Thickness	10.15 mm
Weight	570 g

## Environment

### Temperature

Operating: 0 °C to 35 °C

Non-operating: -20 °C to 60 °C

### Humidity (non-condensing)

Operating: 20% to 80%

Non-operating: 20% to 80%

# End user license agreement

IMPORTANT - READ CAREFULLY: THIS END USER LICENSE AGREEMENT ("AGREEMENT") IS A LEGAL AGREEMENT BETWEEN YOU (EITHER AN INDIVIDUAL OR A SINGLE ENTITY), AND ACER INC. INCLUDING ITS SUBSIDIARIES ("ACER") FOR THE SOFTWARE (WHETHER PROVIDED BY ACER OR BY ACER'S LICENSORS OR SUPPLIERS) THAT ACCOMPANIES THIS AGREEMENT, INCLUDING ANY ASSOCIATED MEDIA, PRINTED MATERIALS AND RELATED USER ELECTRONIC DOCUMENTATION WHICH MAY BE BRANDED "ACER", "GATEWAY", "PACKARD BELL", OR "EMACHINES" ("SOFTWARE"). AGREEMENTS RELATING TO ANY OTHER PRODUCT OR TOPIC ARE NEITHER INTENDED NOR SHOULD THEY BE IMPLIED. BY INSTALLING THE ACCOMPANYING SOFTWARE OR ANY PORTION THEREOF, YOU AGREE TO BE BOUND BY THE TERMS AND CONDITIONS OF THIS AGREEMENT. IF YOU DO NOT AGREE TO ALL OF THE TERMS AND CONDITIONS OF THIS AGREEMENT, DO NOT CONTINUE THE INSTALLATION PROCESS AND IMMEDIATELY DELETE ALL INSTALLED FILES, IF ANY, OF THE ACCOMPANYING SOFTWARE FROM YOUR DEVICE.

IF YOU DO NOT HAVE A VALIDLY-LICENSED COPY OF THE APPLICABLE SOFTWARE, YOU ARE NOT AUTHORIZED TO INSTALL, COPY OR OTHERWISE USE THE SOFTWARE, AND HAVE NO RIGHTS UNDER THIS AGREEMENT.

The Software is protected by U.S. and international copyright laws and conventions as well as other intellectual property laws and treaties. The Software is licensed, not sold.

## GRANT OF LICENSE

Acer grants to you the following non-exclusive and non-transferable rights with respect to the Software. Under this Agreement, you may:

1. Install and use the Software only on a single designated device. A separate license is required for each device on which the Software will be used;
2. Make one copy of the Software solely for backup or archival purposes;
3. Make one hard copy of any electronic documents included in the Software, provided that you receive the documents electronically.

## RESTRICTIONS

You may NOT:

1. Use or copy the Software except as provided in this Agreement;
2. Rent or lease the Software to any third party;
3. Modify, adapt, or translate the Software in whole or in part;
4. Reverse engineer, decompile, or disassemble the Software or create derivative works based upon the Software;
5. Merge the Software with any other program or modify the Software, except for your personal use; and
6. Sublicense or otherwise make the Software available to third parties, except that you may, after prior written notification to Acer, transfer the Software as a whole to a third party so long as you do not retain any copies of the Software and such third party accepts the terms of this Agreement.
7. Transfer your rights under this Agreement to any third parties.
8. Export the Software in contravention of applicable export laws and regulations, or (i) sell, export, re-export, transfer, divert, disclose technical data, or dispose of, any Software to any prohibited person, entity, or destination including, without limitation, Cuba, Iran, North Korea, Sudan and Syria; or (ii) use any Software for any use prohibited by the laws or regulations of the United States.

## SUPPORT SERVICES

Acer is not obligated to provide technical or other support for the Software.

## ACER LIVE UPDATE

Certain software contains elements that enable the use of the Acer Live Update service, which allows for updates for such software to be automatically downloaded and installed on your device. By installing the software, you hereby agree and consent that Acer (or its licensors) may automatically check the version of such software that you are using on your device and may provide upgrades to such software that may be automatically downloaded on to your device.

#### OWNERSHIP AND COPYRIGHT

Title, ownership rights and intellectual property rights in and to the Software and all copies thereof shall remain with Acer or Acer's licensors or suppliers (as applicable). You do not have or shall not gain any proprietary interest in the Software (including any modifications or copies made by or for you) or any related intellectual property rights. Title and related rights in the content accessed through the Software is the property of the applicable content owner and may be protected by applicable law. This license gives you no rights to such contents. You hereby agree:

1. Not to remove any copyright or other proprietary notices from the Software;
2. To reproduce all such notices on any authorized copies you make; and
3. To use best efforts to prevent any unauthorized copying of the Software.

#### TRADEMARKS

This Agreement does not grant to you any rights in connection with any trademarks or service marks of Acer or of Acer's licensors or suppliers.

#### DISCLAIMER OF WARRANTIES

TO THE MAXIMUM EXTENT PERMITTED BY APPLICABLE LAW, ACER, ITS SUPPLIERS, AND ITS LICENSORS, PROVIDE THE SOFTWARE "AS IS" AND WITH ALL FAULTS, AND HEREBY DISCLAIM ALL OTHER WARRANTIES AND CONDITIONS, EITHER EXPRESS, IMPLIED OR STATUTORY, INCLUDING, BUT NOT LIMITED TO, ANY IMPLIED WARRANTIES, DUTIES OR CONDITIONS OF MERCHANTABILITY, OF FITNESS FOR A PARTICULAR PURPOSE, OF ACCURACY OR COMPLETENESS OF RESPONSES, OF RESULTS, OF WORKMANLIKE EFFORT, OF LACK OF VIRUSES, AND OF LACK OF NEGLIGENCE, ALL WITH REGARD TO THE SOFTWARE AND THE PROVISION OF OR FAILURE TO PROVIDE SUPPORT SERVICES. ALSO, THERE IS NO WARRANTY OR CONDITION OF TITLE, QUIET ENJOYMENT, QUIET POSSESSION, CORRESPONDENCE TO DESCRIPTION OR NON-INFRINGEMENT WITH REGARD TO THE SOFTWARE.

#### EXCLUSION OF INCIDENTAL, CONSEQUENTIAL AND CERTAIN OTHER DAMAGES

TO THE MAXIMUM EXTENT PERMITTED BY APPLICABLE LAW, IN NO EVENT SHALL ACER, ACER'S SUPPLIERS, OR ACER'S LICENSORS, BE LIABLE FOR ANY SPECIAL, INCIDENTAL, INDIRECT, PUNITIVE, OR CONSEQUENTIAL DAMAGES WHATSOEVER (INCLUDING, BUT NOT LIMITED TO, DAMAGES FOR LOSS OF PROFITS OR CONFIDENTIAL OR OTHER INFORMATION, FOR BUSINESS INTERRUPTION, FOR PERSONAL INJURY, FOR LOSS OF PRIVACY, FOR FAILURE TO MEET ANY DUTY INCLUDING OF GOOD FAITH OR OF REASONABLE CARE, FOR NEGLIGENCE, AND FOR ANY OTHER PECUNIARY OR OTHER LOSS WHATSOEVER) ARISING OUT OF OR IN ANY WAY RELATED TO THE USE OF OR INABILITY TO USE THE SOFTWARE, THE PROVISION OF OR FAILURE TO PROVIDE SUPPORT SERVICES, OR OTHERWISE UNDER OR IN CONNECTION WITH ANY PROVISION OF THIS AGREEMENT, EVEN IN THE EVENT OF THE FAULT, TORT (INCLUDING NEGLIGENCE), STRICT LIABILITY, BREACH OF CONTRACT OR BREACH OF WARRANTY OF ACER OR ITS SUPPLIERS OR LICENSORS, AND EVEN IF ACER AND ITS SUPPLIERS AND LICENSORS HAVE BEEN ADVISED OF THE POSSIBILITY OF SUCH DAMAGES.

#### LIMITATION OF LIABILITY AND REMEDIES

NOTWITHSTANDING ANY DAMAGES THAT YOU MIGHT INCUR FOR ANY REASON WHATSOEVER (INCLUDING, WITHOUT LIMITATION, ALL DAMAGES REFERENCED ABOVE AND ALL DIRECT OR GENERAL DAMAGES), THE ENTIRE LIABILITY OF ACER, ITS SUPPLIERS, AND ITS LICENSORS, UNDER ANY PROVISION OF THIS AGREEMENT, AND YOUR EXCLUSIVE REMEDY FOR ALL OF THE FOREGOING, SHALL BE LIMITED TO THE AGGREGATE AMOUNT PAID BY YOU FOR THE SOFTWARE. THE FOREGOING LIMITATIONS, EXCLUSIONS AND DISCLAIMERS (INCLUDING DISCLAIMER OF WARRANTIES AND EXCLUSION OF INCIDENTAL, CONSEQUENTIAL AND CERTAIN OTHER DAMAGES ABOVE) SHALL APPLY TO THE MAXIMUM

EXTENT PERMITTED BY APPLICABLE LAW, EVEN IF ANY REMEDY FAILS ITS ESSENTIAL PURPOSE; PROVIDED, HOWEVER, THAT BECAUSE SOME JURISDICTIONS DO NOT ALLOW THE EXCLUSION OR LIMITATION OR LIABILITY FOR CONSEQUENTIAL OR INCIDENTAL DAMAGES, THE ABOVE LIMITATION MAY NOT APPLY TO YOU.

#### TERMINATION

Without prejudice to any other rights, Acer may immediately terminate this Agreement without notice if you fail to comply with any terms and conditions of this Agreement.

In such event, you must:

1. Cease all use of the Software;
2. Destroy or return to Acer the original and all copies of the Software; and
3. Delete the Software from all devices on which it was resident.

All disclaimers of warranties and limitation of liability set forth in this Agreement shall survive termination of this Agreement.

#### GENERAL

This Agreement represents the complete agreement between you and Acer relating to this license for the Software and supersedes all prior agreements, communications, proposals and representations between the parties and prevails over any conflicting or additional terms of any quote, order, acknowledgement or similar communication. This Agreement may only be modified by a written document signed by both parties. If any provision of this Agreement is held by a court of competent jurisdiction to be contrary to law that provision will be enforced to the maximum extent permissible and the remaining provisions of this Agreement will remain in full force and effect.

#### ADDITIONAL PROVISIONS APPLICABLE TO THIRD PARTY SOFTWARE AND SERVICES

Software provided hereunder by Acer's licensors or suppliers ("Third Party Software") is made available to you for your personal, non-commercial use only. You may not use the Third Party Software in any manner that could damage, disable, overburden, or impair the services provided by Acer's licensors or suppliers hereunder ("Third Party Services"). Furthermore, you may not use the Third Party Software in any manner that could interfere with any other party's use and enjoyment of the Third Party Services, or the services and products of Acer's licensors' or suppliers' third party licensors. Your use of the Third Party Software and Third Party Services is also subject to additional terms and conditions and policies which can be accessed through our global website.

## Privacy policy

During registration you will be asked to submit some information to Acer. Please refer to Acer's privacy policy at [www.acer.com/worldwide/support/swa.htm](http://www.acer.com/worldwide/support/swa.htm) or your local Acer website.

## Trademark Information

**Manufactured under license from Dolby Laboratories. Dolby and the double-D symbol are trademarks of Dolby Laboratories.**