

# Ariens®

## Thank You

*Ariens outdoor power equipment is engineered to be the best from start to finish. We have one fundamental belief: Value is not measured solely by price; value is a durable, easy-to-use machine that performs season after season.*

*This manual and the engine manual are your guides. By following the instructions and procedures in them, your Ariens equipment will serve you well for many years. The care you give this equipment will determine your overall satisfaction and its service life.*

**Safety is up to you.** Obey all correct operating practices and procedures for this equipment. Prevent serious injury or death. Three reasons safety is important:

1. Accidents disable and kill.
2. Accidents can be avoided.
3. Accidents always cost.

*Ariens proudly offers one of the finest warranties in the business. Contact your Ariens Dealer with any questions, comments or orders. Ariens equipment for the world is made in the USA.*



**Crafted in  
America  
Since 1933**

## YOUR SATISFACTION IS IMPORTANT







Questions? Please follow these helpful steps:

1. **Always Refer to Your Owner/Operator or Engine Manual First.**
  - a) Its detail will guide you through safe and proper operation and maintenance.
  - b) It contains specifications on your model of equipment.
  - c) If your questions are not answered in these manuals, go to step number two.
2. **Contact Your Ariens Dealer.**
  - a) Our dealers will be happy to supply any service or advice required to keep your equipment operating at peak efficiency.
  - b) A factory trained staff is available to support your equipment needs. They stock genuine Ariens parts and lubricants; manufactured with the same precision and skill as the original equipment.
  - c) If your questions are not resolved by the support staff, ask for the manager or owner.
  - d) When contacting your Ariens Dealer supply your equipment or attachment model and serial numbers.

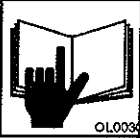

## WARNING

The engine exhaust from this product contains chemicals known to the State of California to cause cancer, birth defects or other reproductive harm.

SECTION	PAGE	SECTION	PAGE
Thank You .....	Inside cover		
<b>SECTION 1: INTRODUCTION</b>		<b>SECTION 5: GENERAL MAINTENANCE AND STORAGE</b>	
	<ul style="list-style-type: none"> <li>The Manual ..... 2</li> <li>Service and Replacement Parts ..... 2</li> <li>Product Registration ..... 2</li> <li>Disclaimer ..... 2</li> </ul>		<ul style="list-style-type: none"> <li>Service Position ..... 15</li> <li>Engine Cooling ..... 15</li> <li>Drive Belts and Brake ..... 16</li> <li>Chute Deflector ..... 17</li> <li>Transport ..... 17</li> <li>Storage ..... 17</li> <li>Maintenance Schedule ..... 18</li> </ul>
<b>SECTION 2: SAFETY</b>		<b>SECTION 6: SPECIFICATIONS</b>	
	<ul style="list-style-type: none"> <li>Safety Alert Symbol ..... 3</li> <li>Safety Words ..... 3</li> <li>Practices and Laws ..... 3</li> <li>Required Operator Training ..... 4</li> <li>Personal Safety ..... 4</li> <li>Operational Safety ..... 5</li> <li>Equipment Safety ..... 6</li> <li>Safety Decals and Locations ..... 6</li> </ul>		<ul style="list-style-type: none"> <li>Model Number ..... 19</li> <li>Engine ..... 19</li> <li>Snow Clearing Width ..... 19</li> <li>Fuel ..... 19</li> <li>Electric Start Option ..... 19</li> <li>Chute ..... 19</li> <li>Deluxe Hub Caps ..... 19</li> <li>Weight ..... 19</li> <li>Width ..... 19</li> <li>Length ..... 19</li> <li>Height ..... 19</li> <li>Handlebar ..... 19</li> <li>Chute Rotation Angle ..... 19</li> <li>Snow Throwing Distance ..... 19</li> <li>Impeller ..... 19</li> <li>Wheel Size ..... 19</li> <li>Mitten Grip Recoil Starter ..... 19</li> <li>Materials ..... 19</li> <li>Accessories ..... 20</li> <li>Models ..... 20</li> <li>Warranty ..... Inside back cover</li> </ul>
<b>SECTION 3: ASSEMBLY</b>			
	<ul style="list-style-type: none"> <li>Dealer Preparation ..... 7</li> </ul>		
<b>SECTION 4: OPERATION</b>			
	<ul style="list-style-type: none"> <li>Engine Fuel ..... 10</li> <li>Standard Controls ..... 10</li> <li>Starting ..... 11</li> <li>Recoil Starter ..... 11</li> <li>Features and Controls ..... 12</li> <li>Electric Starter ..... 13</li> <li>Operational Hazards ..... 13</li> <li>Chute Deflector ..... 14</li> <li>Discharge Chute Direction ..... 14</li> <li>Impeller Clutch Bail ..... 14</li> <li>Stopping ..... 14</li> </ul>		

© Copyright 1995 Ariens Company

All rights reserved. No part of this publication may be reproduced, transmitted, transcribed, stored in a retrieval system, or translated into any language in any form by any means without the written permission of Ariens Company

Printed in U.S.A.

## CONTENTS

- The Manual
- Service and Replacement Parts
- Product Registration
- Disclaimer

# Introduction

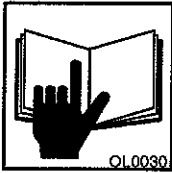

## THE MANUAL

Before you operate your equipment, carefully and completely read manuals supplied with equipment. The contents will provide you with an understanding

of safety instructions and controls during normal operation and maintenance of your equipment. Graphics are provided to help you understand the text.

All reference to left, right, front, or rear are given from operator standing in operation position and facing the direction of forward travel.



## SERVICE AND REPLACEMENT PARTS

When ordering replacement parts or making service inquiries, be prepared to supply the following information:

- Model and Serial numbers of equipment.
- Model and Serial numbers of engine.

Numbers are located on the product registration form in the equipment literature package. They are printed on a serial number label, located on the frame of your equipment. Know the Model number of your equipment. Follow the correct operating instructions for your particular equipment.

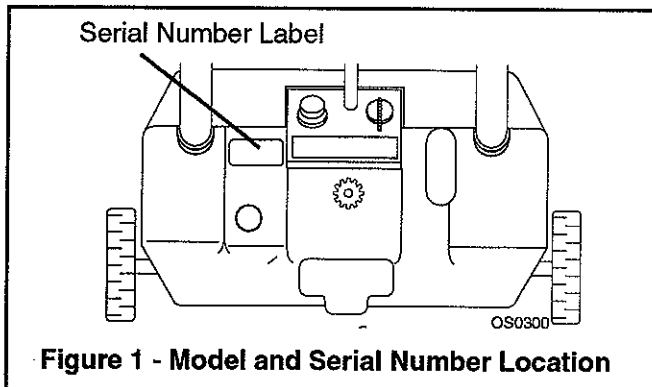

Figure 1 - Model and Serial Number Location

Record numbers on this page for convenience and quick reference.

### Model Numbers:

### Serial Numbers:

Transfer model & serial label from product registration here.



## PRODUCT REGISTRATION

A warranty registration card must be filled out by the Ariens dealer, signed, and returned at sale. This form activates the warranty. The

replacement of any part on this vehicle with anything other than an Ariens authorized replacement part may adversely affect the performance, durability, or safety of this equipment and may void the warranty. Claims meeting requirements during limited warranty period will be honored. To guarantee full warranty service, make sure your registration card has been returned to Ariens Company.

## DISCLAIMER

Ariens Company is hereinafter referred to as Ariens. Ariens reserves the right to discontinue, make changes to, and add improvements upon its products at any time without public notice or obligation. Ariens disclaims liability for any claims or damages, whether regarding property, personal injury or death arising out of the use of unauthorized replacement parts. The descriptions and specifications contained in this manual were in effect at printing. Equipment described within this manual may not be identified as either standard or optional. Illustrations may not be applicable to your unit.

# A SECTION 2: SAFETY

2

## CONTENTS

- Safety Alert Symbol
- Signal Words
- Practices and Laws
- Required Operator Training
- Personal Safety
- Operational Safety
- Machine Safety
- Safety Decals and Locations

# Safety

## SAFETY ALERT SYMBOL



This is a safety alert symbol. It means:

- **ATTENTION!**
- **YOUR SAFETY IS INVOLVED!**

When you see this symbol:

- **BECOME ALERT!**
- **OBEY ITS MESSAGE!**

## SIGNAL WORDS

The safety alert symbol is used with the following signal words and colors to alert you to safety messages. They are used in safety decals on the equipment and with proper operation and procedures in this manual. They alert you to the existence and relative degree of hazards. Understand the safety message. It contains important information about personal safety on or near the equipment.

 <b>DANGER</b>	<b>EXTREME HAZARD</b> <ul style="list-style-type: none"> <li>• <b>Avoid!</b></li> <li>• Act will result in serious injury or death.</li> </ul>
---	--

 <b>WARNING</b>	<b>HAZARD</b> <ul style="list-style-type: none"> <li>• <b>Avoid!</b></li> <li>• Act can result in serious injury or death.</li> </ul>
--	---





 <b>CAUTION</b>	<b>POTENTIAL HAZARD</b> <ul style="list-style-type: none"> <li>• <b>Avoid!</b></li> <li>• Act may result in injury.</li> </ul>
--	--

For your safety and the safety of others read and follow **▲ DANGER**, **▲ WARNING**, and **▲ CAUTION** messages found in manuals and on safety decals.

## Notations

**NOTE** : General reference information for proper operation and maintenance practices.

**IMPORTANT**: Specific procedures or information required to prevent damage to equipment or attachment.

 <b>WARNING</b>	
<p>Improper operation of this equipment can cause injury or death. Before starting the engine, follow these three steps:</p>	
 OL0030	1. Read this manual.
 OL1020	2. Read safety decals on equipment or attachment.
	3. Clear area before operation.

## PRACTICES AND LAWS

Practice usual and customary safe working precautions, for the benefit of yourself and others. Understand and follow all safety messages. Be alert to unsafe conditions and the possibility of minor, moderate, or serious injury or death.

Information in this manual does not replace any safety rules and laws in your area. Before operating this equipment, learn all rules and laws in your area.

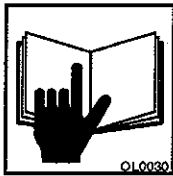

## REQUIRED OPERATOR TRAINING

Original purchaser of equipment was instructed by seller on safe and proper operation and use. If equipment is to be used by someone other than original purchaser:

- Loaned
- Rented
- Sold

always provide this manual and any needed safety training before operation.



## PERSONAL SAFETY

### Responsible Operators

- Only trained adults may operate equipment
- Training includes actual operation
- Clearly understand instructions
- Be alert! Conditions can change



NEVER operate equipment after or during the consumption of medication, drugs or alcohol. Safe operation requires your complete and unimpaired attention at all times. An operator on prescription or over-the-counter medication must consult a medical professional regarding any side effects of the medication that would hinder their ability to safely operate this equipment.

NEVER allow anyone to operate this equipment when their alertness or coordination is impaired.



### Clothing and Safety Gear

Wear adequate:

- Winter outer garments
- Gloves
- Rubber footwear
- Eye protection

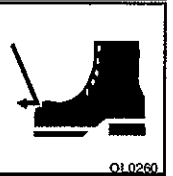
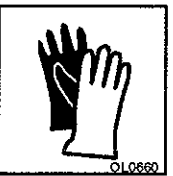

Safety goggles protect eyes from objects that may be thrown from equipment.



## Avoid Entanglement

DO NOT wear loose clothing or scarves that may get caught in rotating parts during operation. Keep clear of discharge opening during operation.



Rotating parts can amputate body parts. DO NOT place limbs near moving parts.

Stop engine, remove key and wait for moving parts to stop before leaving operator's position for any reason such as; unclogging impeller housing or discharge chute, when making any repairs, adjustments, inspections or cleaning equipment.

OL0870

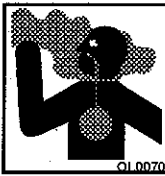

## CHEMICAL HAZARDS

### Exhaust Fumes

Fumes from the engine exhaust can cause injury or death.



### Good Ventilation

DO NOT run engine in an enclosed area. Always provide good ventilation and wait until the hazard has been removed.

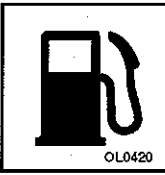

### Explosive Fuel

Gasoline is highly flammable and its vapors are explosive. Handle with care. Use an approved (RED) fuel container.



NEVER allow smoking materials, sparks or flame (match, pilot light, etc.) near equipment or fuel container.



Check fuel supply before starting engine. Fill fuel tank outdoors with extreme care; DO NOT fill fuel tank indoors, when engine is running or while engine is still hot from operation. Replace fuel cap securely and wipe spilled fuel before starting engine.



### Visual Obstruction

Dust, smoke, fog, etc. can reduce vision and cause an accident. Operate equipment only when there is good visibility and light.





## OPERATIONAL SAFETY

### Rules of Operation

Know the capacity and operating characteristics of your equipment.

DO NOT overload equipment capacity.  
DO NOT clear snow at too fast a rate.

Always shut off equipment when unattended

OL0610



Exercise extreme caution when operating on or crossing gravel drives, walks or roads. Stay alert for hazards and traffic. Loose gravel can be thrown out discharge chute causing damage or injury.

NEVER direct discharge of material toward bystanders nor allow anyone in front of equipment while equipment is in operation.

NEVER attempt to make any adjustments to equipment while engine is running (except where specifically recommended).

DO NOT touch equipment parts which might be hot from operation. Before attempting to maintain, adjust or service allow such parts to cool.



OL0720



OL0100

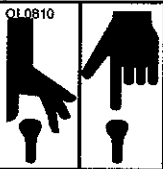

OL0810

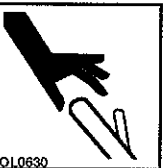

OL0630

### KNOW Your Equipment - Before Starting Engine

- How to operate all controls
- The functions of all controls
- How to Stop in an Emergency
- Speed ranges
- Braking & steering characteristics
- Turning radius and clearances

### Abnormal Vibrations

Prevent damage to your equipment. Disengage impeller clutch, stop engine immediately. Check for and repair any damage before restart.



OL0861



OL0830

### Clearances

Always check overhead and side clearances carefully before operation. Clearly mark potential obstructions before seasonal changes.



OL0390

### Transport

Disengage power to auger/impeller, and shut off engine when equipment is being transported.

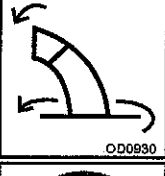
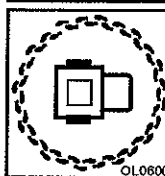

### Walk Around Inspection

Complete a walk-around inspection of equipment and work area to understand:

- Area of operation
- Your equipment
- All safety decals

### Work Area

Avoid slippery surfaces. Always be sure of your footing. Walk never run during operation of equipment.

NEVER allow children to operate, play on or near equipment.

Keep area of operation clear of all children, persons, pets, and debris.

Walk around the work area and inspect it. Look for hazards that may exist.

Check for weak spots on docks, ramps or floors.

### Avoid:

- Holes
- Obstacles
- Curbs
- Rough spots
- Ruts
- Deep mud
- Ditches
- Oil spills
- Drop-offs
- Slippery surfaces

Remove any debris and trash that may be thrown.

DO NOT operate equipment near glass enclosures, automobiles or window wells, etc. without proper adjustment of discharge direction and angle.

### Hazardous Slopes

Unexpected changes in slopes can cause tip over. Ascend or descend slopes slowly and with caution. Use extreme caution when changing direction on slopes.

- DO NOT clear snow across face of slopes.
- DO NOT attempt to clear steep slopes.
- DO NOT park the equipment on an incline and leave it unattended.

## EQUIPMENT SAFETY

Keep all safety devices and guards in position and operating properly. Avoid serious injury or death.

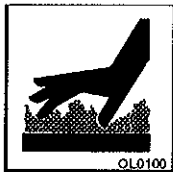

- Assure protective structures, guards, shields, screens, panels are in good repair, in place and securely fastened.



- NEVER remove or modify any safety components on your equipment. Replace damaged, missing or weakened components.



- NEVER modify, alter, or permit anyone to modify or alter the equipment or its components.

- Use attachments approved for your equipment only.

## SAFETY DECALS AND LOCATIONS

Refer to (Figure 2) to replace any missing or damaged Safety Decals.

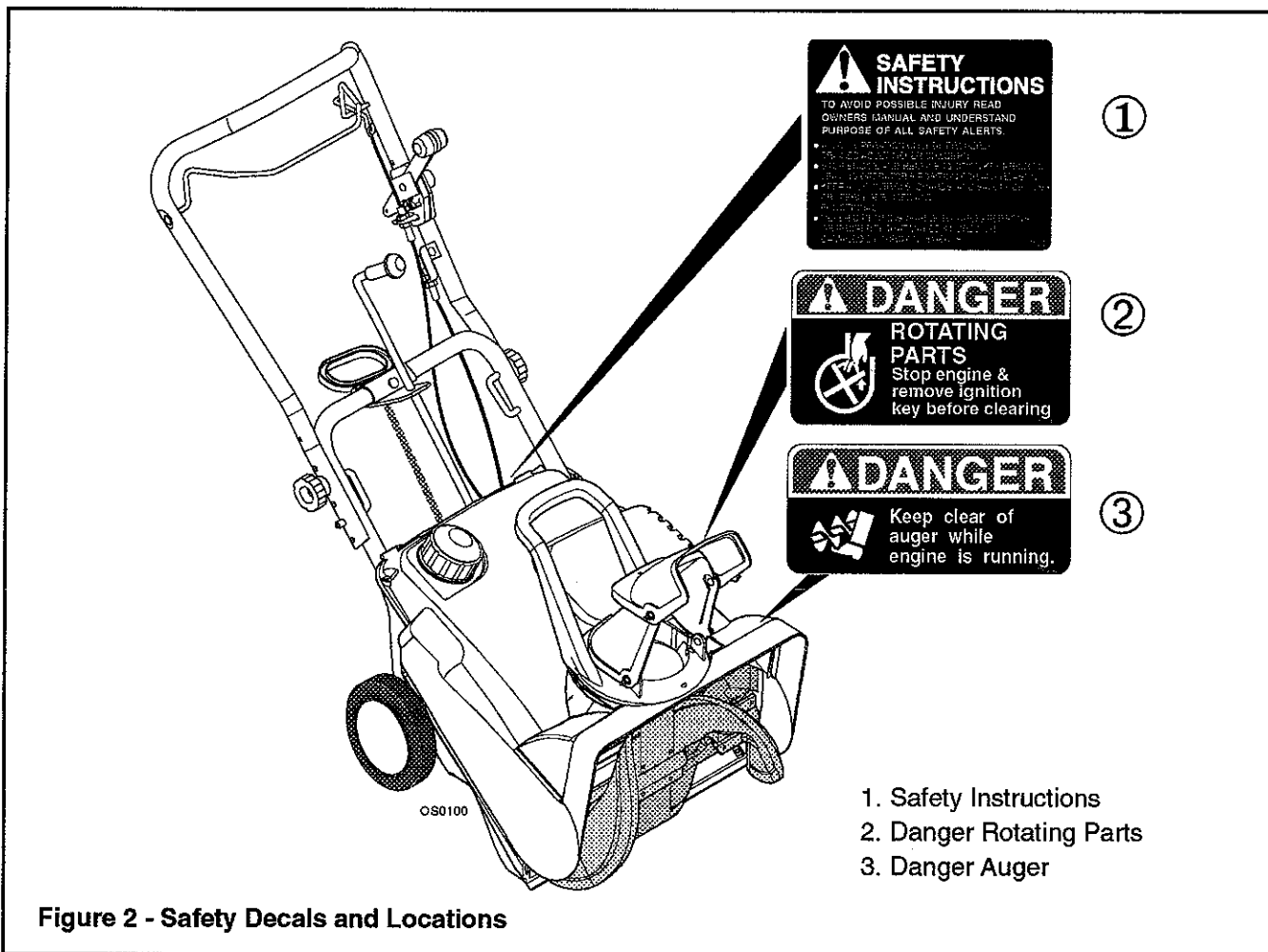

Figure 2 - Safety Decals and Locations

# A SECTION 3: ASSEMBLY

## 3

### CONTENTS

- Dealer Preparation
- Dealer Prep Check List

# Assembly

## DEALER PREPARATION

**Customer Note** – Your Ariens Dealer is expected to complete these preparation steps and review important information, including this manual, with you before or upon delivery of equipment or attachment.

The preparation information is included here so that you and your dealer may review it together.

### ⚠ WARNING



**ELECTRIC SHOCK** can cause personal injury and/or damage to equipment.

**DO NOT** remove wire from spark plug while engine is running.

### Tools Required

Philips screwdriver



Open-end wrench: 7/16"



Pliers

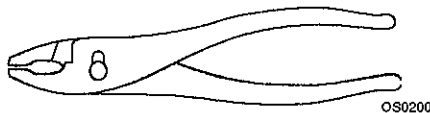

### Package Contents

Literature Package, Chute Crank Assembly Figure 3 and Ariens Sno-Thro Figure 4.

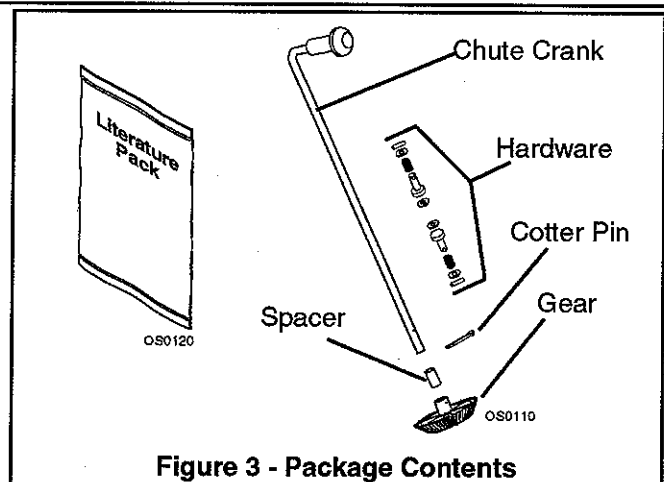

Figure 3 - Package Contents

### Handlebar

1. The Sno-Thro is in handlebar "fold" position for shipping. Figure 4.
2. Keep the customer in mind and adjust upper half of handlebar higher or lower by selecting alternate holes for the "J" bolts. Figure 4.

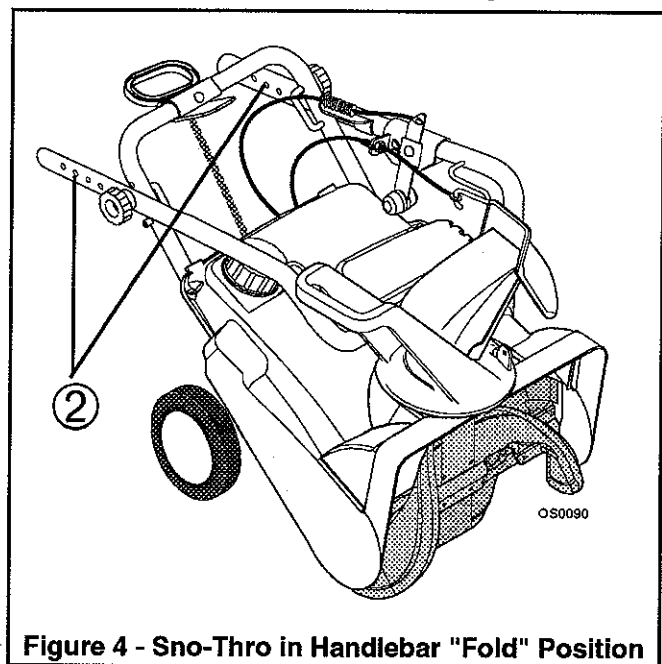

Figure 4 - Sno-Thro in Handlebar "Fold" Position



3. Unfold handlebar. Figure 5.
4. Tighten knobs to secure upper handlebar in place. Figure 5.
5. Check Attachment Brake and Clutch for proper function.

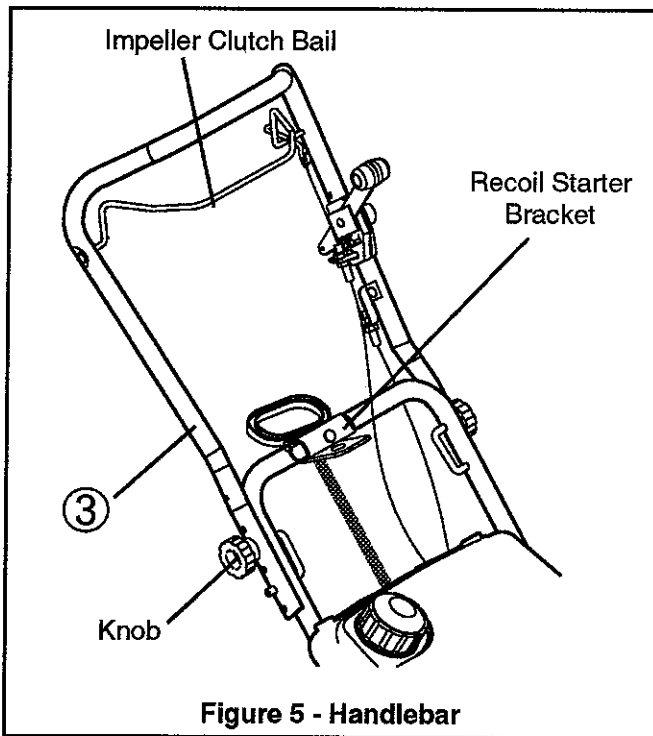

Figure 5 - Handlebar

### Discharge Chute

1. Remove rear cap screw and nut from rear of discharge chute.
2. Tip discharge chute up and install hardware just removed.
3. Tighten hardware at rear of discharge chute first, then at sides. Figure 6.

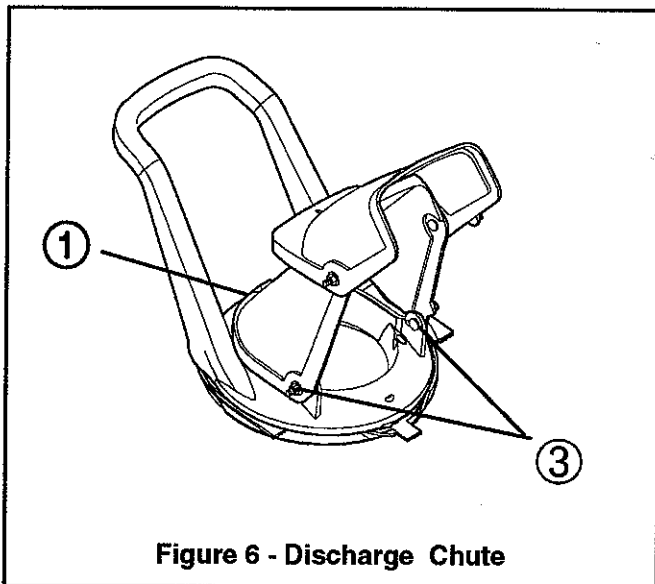

Figure 6 - Discharge Chute

### Discharge Chute Crank (When Used)

1. Remove 2 hold-down screws on back of cowl.
2. With discharge chute facing forward, remove engine cover.
3. Remove nut from bolt that holds recoil starter handle bracket in place. Figure 5.
4. Place spacer and 48T gear so that gear meshes with 12T pinion at tooth and space identification marks. Figure 7.
5. Insert chute crank assembly through hole in chassis, spacer and 48T gear so that knob points up. Figure 7.
6. Rotate the chute crank support to an inverted position.
7. Push the chute crank past installed position.
8. Support can be rotated upright and pulled back into position.
9. Reinstall the nut on the bolt previously removed.
10. Secure gear with cotter pin.
11. Replace engine cover and screws.

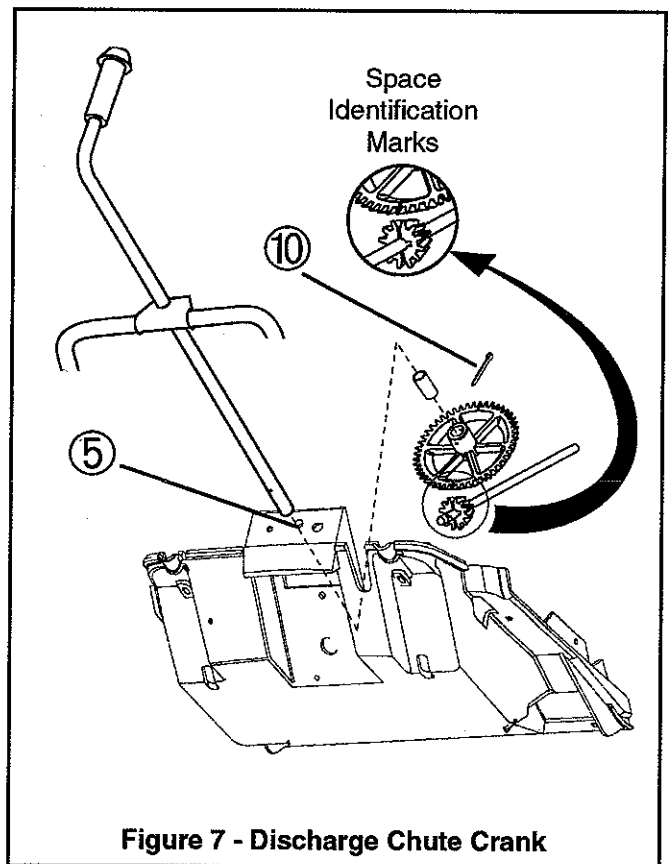

Figure 7 - Discharge Chute Crank



## Engine Fuel



## Warranty

Explain Ariens Limited Warranty Policy.

### **WARNING**



Gasoline is highly flammable and its vapors are explosive. Handle with care. Use an approved (RED) gasoline container.



**IMPORTANT** — 2 cycle engines require that oil be mixed with fuel. Use Ariens 2 cycle oil. (50 parts gasoline to 1 part oil ratio)



Fill fuel tank with unleaded gasoline and oil mixture. The tank capacity is 1.2 quart.



## Test Operation Of All Controls

Check clutch and brake function.

### **CAUTION**



Check function of all controls before starting engine. All safety devices and guards must be in position and operating properly or personal injury may result.

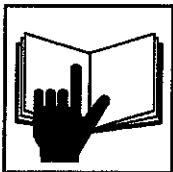

## Delivery

Using the Owner's Manual instruct the customer on controls and operation of equipment. Emphasize safety and discuss the Safety Precautions.



Give customer Owner's manual. Advise to thoroughly read and understand it.

Explain recommended lubrication and maintenance of equipment. Advise customer on adjustments.



Fill out Original Purchaser Registration Card and return to Ariens.

Place Model and Serial Number on page in the front of this manual.

### CONTENTS

- Engine Fuel
- Controls
- Starting
- Controls and Features
- Chute Deflector
- Discharge Chute Direction
- Impeller Clutch Bail
- Stopping

# Operation



## ENGINE FUEL

### WARNING



Gasoline is highly flammable and must be handled with care.

NO open flame



NO matches



NO smoking



Allow engine to cool several minutes before removing fuel tank cap. Never fill tank when engine is running or hot from operation.

**IMPORTANT:** Failure to mix oil with gasoline will result in seizure and severe damage to engine. DO NOT use gasohol or gasoline containing alcohol because alcohol will attack and cause internal parts to deteriorate.

**NOTE:** To prevent foreign particles from entering tank while filling; wipe snow, dust, dirt and debris from around cap before removing.



### CAUTION



When equipment is tipped up onto housing, remove enough fuel so it will not spill.

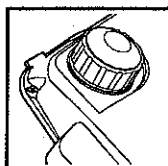

DO NOT overfill. Wipe up any spills and allow vapors to dissipate. Use approved (RED) gasoline container.

Ariens 2 cycle oil has been formulated to insure maximum engine performance and increased engine life. Premix Ariens oil (50 parts gasoline to 1 part oil ratio) per instructions on container. If Ariens oil is not available, select a quality 2 cycle oil BIATC (Boating Industry Association Two Cycle) approved oil and use unleaded gasoline.

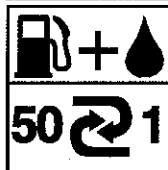

If oil manufacturer does not recommend mixing ratio, mix at the 50 to 1 ratio.

**NOTE:** After fuel mixture has been left standing for a prolonged time it will begin to separate, therefore thoroughly shake mixture before using.

## CONTROLS

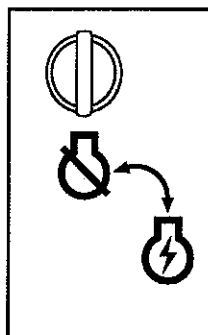

### Ignition Switch

Using the ignition switch key, the switch may be turned clockwise from the "OFF" position to the "RUN" position.

"OFF" Position: Ignition system is shut down.

"RUN" Position: All controls are operable.



## STARTING

### Primer Bulb

Push primer bulb two or three times when engine is cold.

When temperatures are below -15° F additional priming may be needed.

**NOTE:** Try out each control without running engine to see how they work and what they do.

To start engine, place Key in Switch and turn it clockwise to "RUN" position.

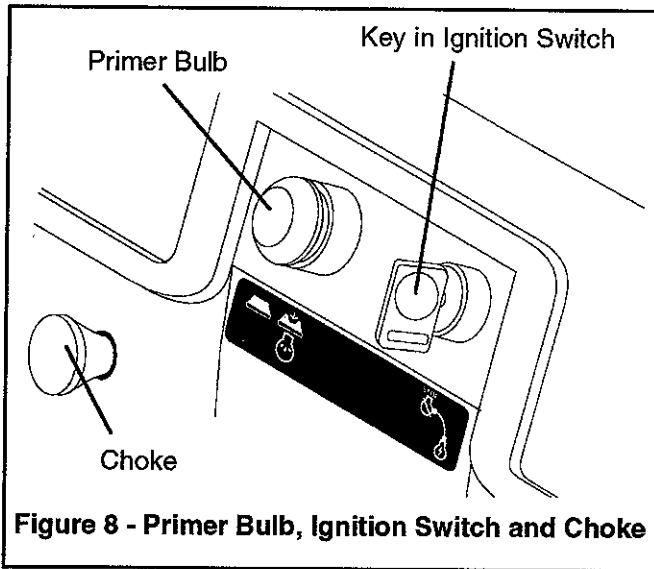
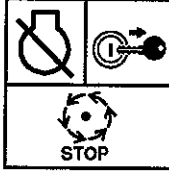
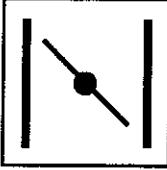

Figure 8 - Primer Bulb, Ignition Switch and Choke

**CAUTION**



Turn Key "OFF" and remove it before attempting any maintenance, adjustment or leaving equipment unattended.



### Choke

Pull choke control out to "Choke" position.

When engine has started, open choke gradually by pushing in.

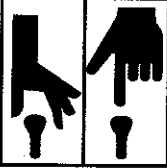

**NOTE:** A warm engine requires less choking than a cold engine.

**WARNING**



To prevent discharge toward operators' starting position, always turn discharge chute straight ahead for starting equipment.

**CAUTION**

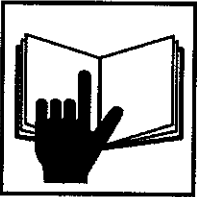

DO NOT attempt to start your engine at this time. Read this entire Owner's Manual and engine manufacturers operating instructions first.

**WARNING**

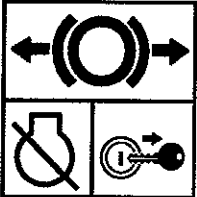

If equipment vibrates abnormally disengage attachment, stop engine at once, and remove key. Abnormal vibration is a warning of trouble.

Repair any damage before restarting equipment.

### Recoil Starter Handle

Stand behind equipment. Grasp starter handle and pull rope out slowly until it pulls harder, this is compression stroke, let rope rewind slowly. Figure 9.

Pull rope with a rapid continuous full arm stroke. Let rope rewind slowly.

**IMPORTANT:** DO NOT let starter handle snap against bracket.

Repeat until engine starts. (If engine does not start, refer to engine manual).

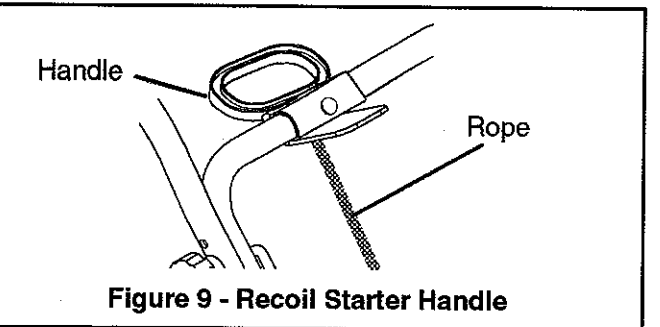
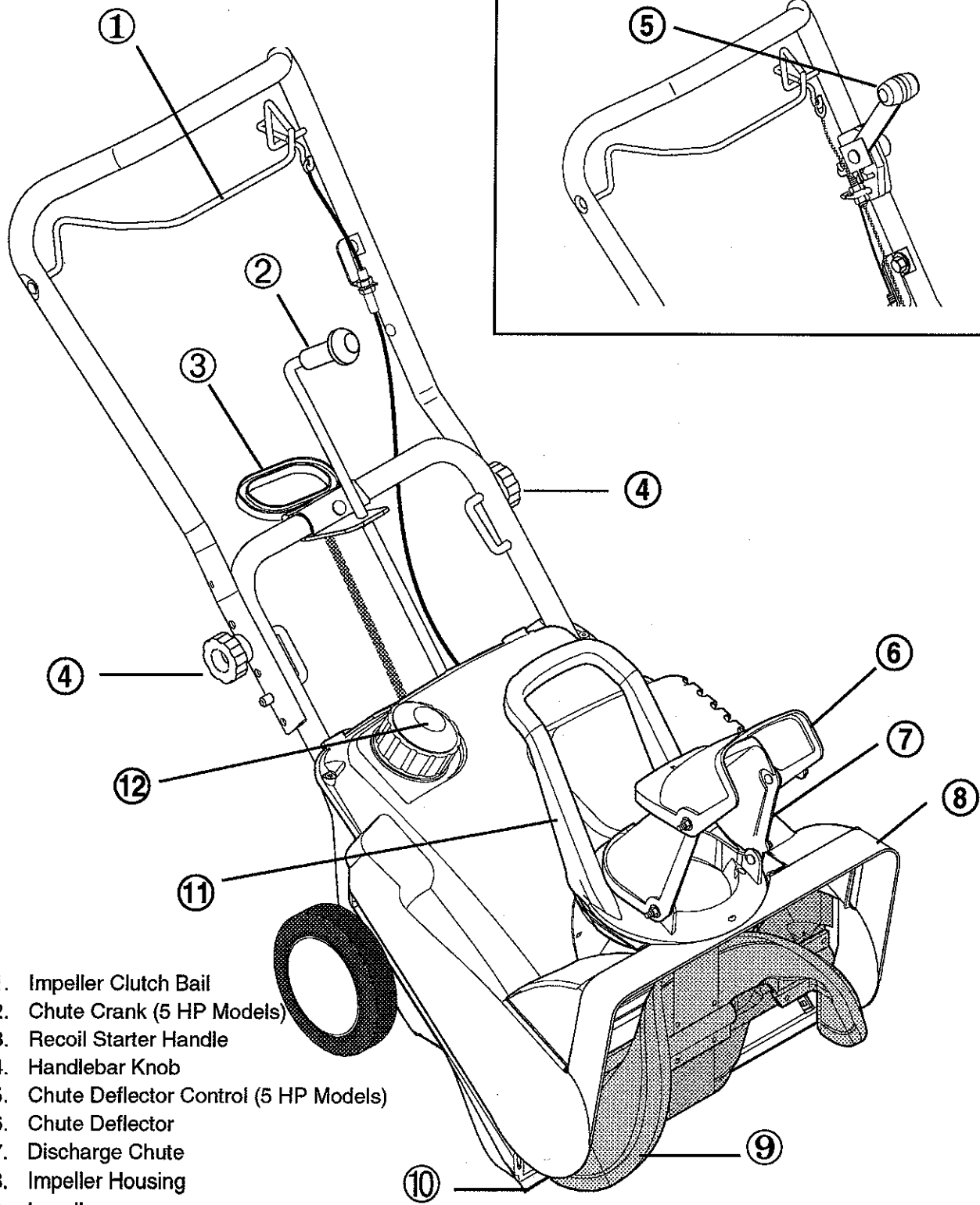

Figure 9 - Recoil Starter Handle

# CONTROLS AND FEATURES



- 1. Impeller Clutch Bail
- 2. Chute Crank (5 HP Models)
- 3. Recoil Starter Handle
- 4. Handlebar Knob
- 5. Chute Deflector Control (5 HP Models)
- 6. Chute Deflector
- 7. Discharge Chute
- 8. Impeller Housing
- 9. Impeller
- 10. Scraper Blade
- 11. Chute Rotation Control Handle (3 HP Models)
- 12. Fuel Tank and Cap

**Figure 10 - Controls and Feature Locations**

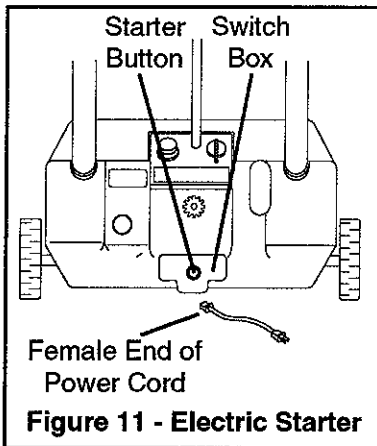

### Electric Starter (Standard or Optional Accessory)

1. Connect power cord to switch box.
2. Plug other end into 120 volt AC receptacle.
3. Push Starter Button to crank engine. Figure 11

**IMPORTANT:** This electric starter is not equipped with a thermal cutout switch. DO NOT crank engine for more than a total of 20 seconds without allowing electric starter to cool down for 10 minutes. Failure to do this can severely damage electric starter.

When engine starts, release starter button and disconnect power cord from receptacle first, then from switch box.

### Operational Hazards

After striking a foreign object, stop engine, remove key and wait for moving parts to stop before leaving operator's position.

Thoroughly inspect equipment for any damage and repair damage before restarting and operating equipment.

Run equipment a few minutes after throwing snow to prevent freeze up of impeller in housing.

Take all possible precautions when leaving equipment unattended. Disengaging power to impeller, stop engine and remove key to prevent unauthorized use.

**CAUTION**

DO NOT overload equipment capacity by attempting to clear snow at too fast a rate.

**CAUTION**

Operate equipment only with good visibility and light.

**CAUTION**

Stay alert for holes, rocks, roots and hidden hazards in area of operation. Exercise extreme caution when operating on or crossing gravel drives, walks or roads.

Stay alert for hidden hazards or traffic.

**WARNING**

Wear adequate winter outer garments and footwear which will improve footing on slippery surfaces.

Wear eye protection such as safety goggles to protect eyes from objects that may be thrown from equipment.

DO NOT wear loose clothing or scarves that may get caught in rotating parts of equipment.

**CAUTION**

Make sure all hardware is tight, all safety devices in place and all adjustments correct.

**IMPORTANT:** Check impeller to be sure it is not frozen. With key in its off position move clutch bail to engaged position, and pull recoil starter. If impeller is frozen, (can not pull recoil starter) move Sno-Thro to a heated area and thaw to prevent possible damage to equipment.

**NOTE:** This product is equipped with an internal combustion engine. DO NOT use equipment on or near any unimproved, forest-covered or brush-covered land unless exhaust system is equipped with a spark arrestor meeting applicable local, state or federal laws. A spark arrestor, if it is used, must be maintained in effective working order by operator.

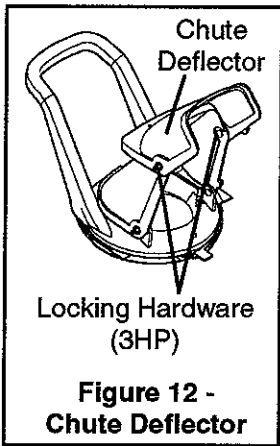

## CHUTE DEFLECTOR

Position deflector at desired height. **DO NOT** throw snow any higher than necessary. Use handle at rear of deflector on 3 HP models or chute deflector control on 5 HP models. Figure 12.

**NOTE:** Tighten locking hardware on chute deflector (3 HP) or chute deflector control (5HP) if it does not stay in set position. Figure 12.

Figure 12 - Chute Deflector

## DISCHARGE CHUTE DIRECTION

**WARNING**



**DO NOT** put hands or feet near or under rotating parts. Keep clear of discharge opening at all times.

**WARNING**

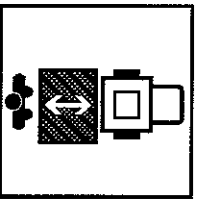

**NEVER** direct discharge of material toward bystanders. **DO NOT** allow anyone in front of equipment while it is in operation. Be familiar with area of operation.

**IMPORTANT:** **DO NOT** operate equipment near glass enclosures, automobiles, window wells, drop offs etc., Adjust discharge direction and angle.

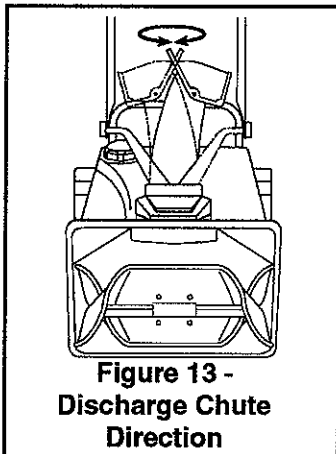

Figure 13 - Discharge Chute Direction

Direct snow away from area to be cleared and with direction of wind whenever possible.

Chute rotates 220°. Use chute handle on 3 HP models or chute crank on 5 HP models. Figure 13.



## IMPELLER CLUTCH BAIL

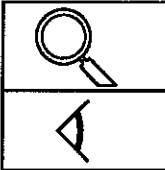

Stop engine after striking a foreign object. Thoroughly inspect sno-thro for any damage and repair damage before restarting and operating equipment.

Squeezing Clutch Bail against handlebar engages impeller so equipment will move forward and throw snow. Releasing Bail disengages impeller and brake stops rotation.

**IMPORTANT:** Check impeller to be sure it is not frozen. If belt squeals when Clutch Bail is engaged, impeller is frozen, release Clutch Bail and move equipment to a heated area to thaw.

Check clutch disengagement and engagement before each use. If impeller does not stop quickly, when the clutch bail is released or if there is no noticeable increase in bail force before contacting the handlebar upon engagement, adjust as directed in Section 5: Maintenance, or repair before operating equipment.

During snow removal, impeller propels equipment forward while collecting snow. The forward speed will vary according to snow depth and moisture content.

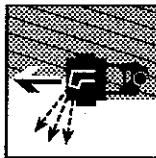

Efficient operation is best achieved by lifting the handlebar only high enough to propel the equipment forward but not so high as to allow snow to kick back from under the equipment.



To clear an area, run Sno-Thro in an overlapping series of paths. For large areas start in middle and throw snow to each side so you do not have to move snow more than once.

## STOPPING

**WARNING**

Disengage power to attachment, stop engine and remove key to prevent unauthorized use when leaving equipment unattended.



**IMPORTANT:** Run attachment a few minutes after throwing snow to prevent freeze-up of impeller. Release Clutch Bail and turn engine Ignition Key to "OFF".

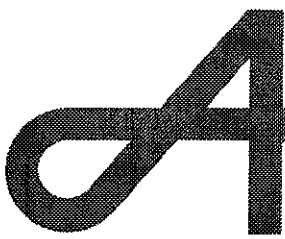

## SECTION 5: MAINTENANCE

# 5

### CONTENTS

- Service Position
- Engine Cooling
- Drive Belts and Brake
- Chute Deflector
- Transport
- Storage
- Maintenance Schedule

# Maintenance

Ariens Dealers will provide any service which may be required to keep your Sno-Thro operating at peak efficiency. Should engine service be required, it can be obtained from an Ariens dealer or an authorized engine manufacturer's service center.

**WARNING**

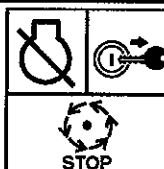

Stop engine, remove key and wait for moving parts to stop before attempting any maintenance procedures.

**CAUTION**

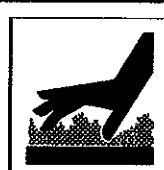

DO NOT touch engine or Sno-Thro drive parts which are hot from operation. Allow such parts to cool before servicing equipment.

**SERVICE POSITION**



Tip equipment forward onto front impeller housing for service position. Before placing in service position remove enough fuel so it will not spill.

**CAUTION**



For proper braking and drive belt engagement, with Clutch Bail disengaged, there must be slack in cable.

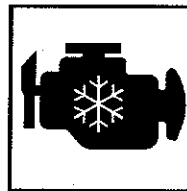

## ENGINE COOLING

Engine is air cooled. Air must circulate freely around engine from air intake screen, over cooling fins on cylinder head and block, to prevent overheating.

Every 100 operating hours or every 5 years (more often if conditions require) remove cooling shrouds and clean cooling fins. Also clean external surfaces of engine of dust, dirt and oil deposits which can contribute to improper cooling.

**IMPORTANT:** DO NOT operate engine with cooling shrouds removed, this will cause overheating and engine damage.

**WARNING**



Fuel is highly flammable and its vapors are explosive. Handle with care.

NO smoking

NO sparks

NO flames



## CAUTION



When equipment is tipped up onto housing, remove enough fuel so that no spillage will occur.

## DRIVE BELTS AND BRAKE

To replace drive belt, remove cowl and disconnect extension spring on idler arm.

Remove cap screw and washer from end of impeller shaft and pull off impeller drive pulley. Remove old belt and install new in its place.

Replace parts in reverse order checking to be sure there is 1/32 to 1/16 clearance between belt finger and back side of belt with clutch engaged and that impeller clutch cable is adjusted. Figure 14.

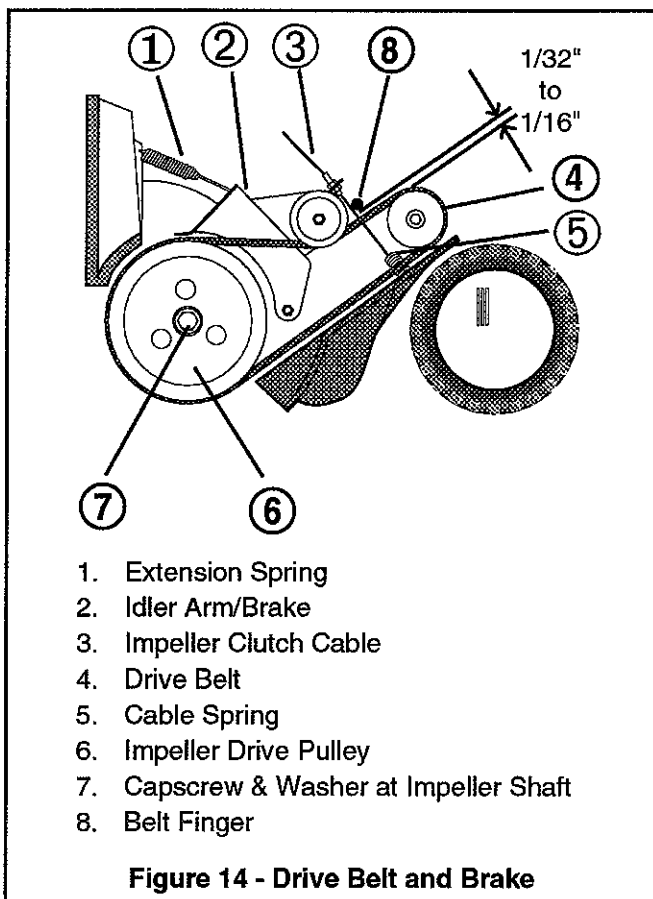

## CAUTION



For proper braking and drive belt engagement, with Clutch Bail disengaged, there must be slack in cable.

## WARNING

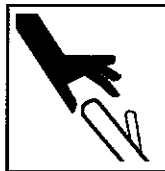

With improper use injury may result if clutch bail is released and brake DOES NOT STOP impeller within 5 seconds.

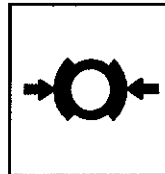

There should be 1/8" to 3/16" extension of cable spring when Clutch Bail is held against handlebar.

To adjust:

1. Remove cowl screws and cover for visibility.
2. Turn nuts on upper end of cable until there is the proper spring extension noted above. Figure 15 & 16.
3. Lock in position by adjusting and tightening nuts against bracket.
4. Replace cowl and screws.

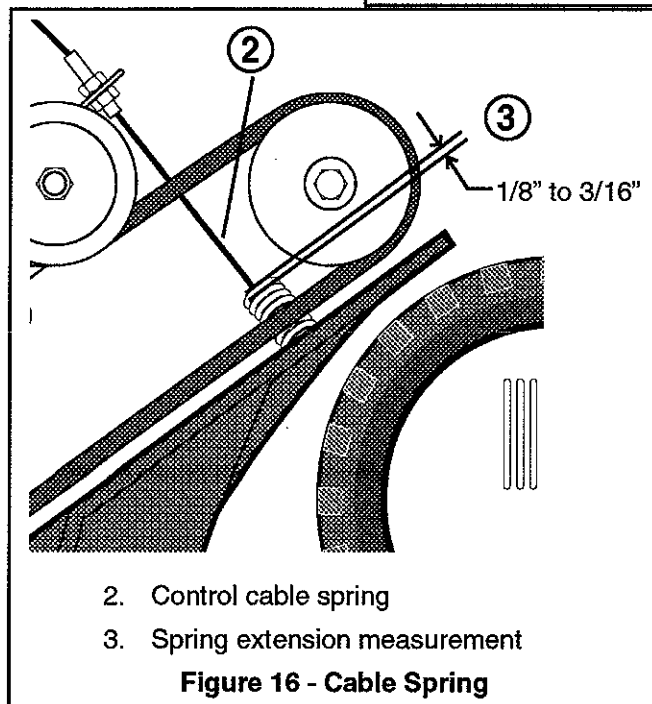
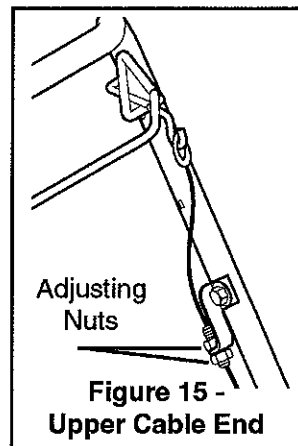

## CHUTE DEFLECTOR

### Low Control Forces

Factory adjustment is intended to be high enough to keep force of snow and/or return spring from changing chute deflector position during operation.

If discharge chute deflector does not stay in set position during operation adjust chute by:

#### 3 HP models

1. Tighten the two pivot bolt nuts evenly until it stays in position.

#### 5 HP models

1. Adjust chute deflector control lever pivot bolt nut until the control stays in position. Figure 17.
2. Chute deflector should hit its stop for maximum down deflection.
3. Chute deflector control lever should hit its stop on housing at the same time.
4. Lock in position by adjusting and tightening nuts against bracket. Figure 17.

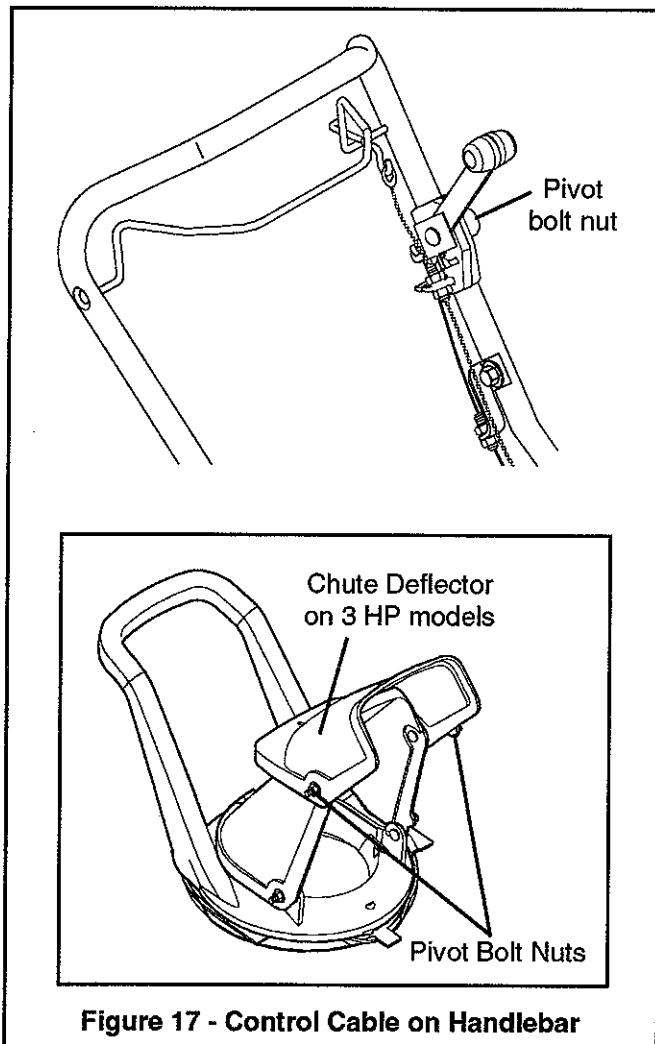

Figure 17 - Control Cable on Handlebar

## TRANSPORT

**NOTE:** Equipment should be shut off when transporting. To transport equipment to or from an area to be cleared, press down on handlebar enough to raise front of Sno-Thro slightly off surface and push or pull equipment.

## STORAGE

DO NOT change engine governor setting or over speed engine.

Keep all nuts, bolts and screws tight and be sure equipment is in safe working condition. Check all hardware at regular intervals.

Refer to Owner's Manual for important instructions if Sno-Thro is to be stored for extended periods.

Never store equipment with fuel in tank inside a building where fumes may reach an open flame or spark. Allow engine to cool before storing in any enclosure.

An accessory Bracket (P/N 738002) is available for hanging the equipment on a wall. Be sure to drain fuel or run the fuel tank dry before storing.

Run the equipment with impeller clutch engaged a few minutes following each time you use the machine to free any loose or melting snow.

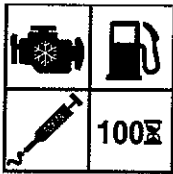

## MAINTENANCE SCHEDULE

The chart below shows the recommended service schedule that should be performed on a regular basis. More frequent service may be required due to working conditions. Heavy loads, high ambient temperatures, dusty conditions, or when airborne debris are present)

See the maintenance instructions in the engine manual.

MAINTENANCE SCHEDULE		
Service Performed	Time Intervals Between Service	
	Daily	25 hrs.
Check Air Intake and Cooling Fins		●
Check Fasteners		●
Remove Cooling Shrouds		●
Clean Cooling Fins		●

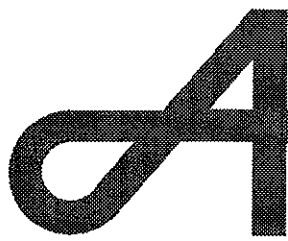

# SECTION 6: SPECIFICATIONS

## 6

### CONTENTS

- Specs
- Accessories
- Models
- Warranty

# Specifications

SPECS				
Model Number	938001	938002	938003	938004
Model Number	938301	938302		
Model Designation	SS322	SS522	SS322E	SS522E
Engine Power - HP (KW) - 2 Cycle	3 (2.24)	5 (3.73)	3 (2.24)	5 (3.73)
Snow Clearing Width - Cu. In. (CM.)	22 (56)	22 (56)	22 (56)	22 (56)
Engine Displacement - In. (CC)	6.0 (98)	8.46 (139)	6.0 (98)	8.46 (139)
Engine Operating Fast Idle Speed - RPM	4300	3600	4300	3600
Fuel	50:1	50:1	50:1	50:1
Fuel Tank Capacity - Qts (Liters)	1.2 (1.1)	1.2 (1.1)	1.2 (1.1)	1.2 (1.1)
120V Electric Start Option	Yes	Yes	Installed	Installed
Chute Rotation Control at Handlebar	No	Yes	No	Yes
Chute Deflector Control at Handlebar	No	Yes	No	Yes
Deluxe Hub Caps	No	Yes	No	Yes
Weight - Lbs (Kg)	64 (29.1)	74 (33.6)	68 (30.8)	79 (35.9)
Width - In (CM)	22 (56)	22 (56)	22 (56)	22 (56)
Length - In. (CM)	43.2 (110)	43.2 (110)	43.2 (110)	43.2 (110)
Handlebars Max. Extended Height - In. (CM)	40.8 (104)	40.8 (104)	40.8 (104)	40.8 (104)
Folding Handlebar	Yes	Yes	Yes	Yes
Minimum Folded Height - In. (CM)	25.8 (65.5)	25.8 (65.5)	25.8 (65.5)	25.8 (65.5)
Minimum Folded Length - In - (CM)	34.5 (87.6)	34.5 (87.6)	34.5 (87.6)	34.5 (87.6)
Handlebar Adjustable For Height	Yes	Yes	Yes	Yes
Chute Rotation Angle	220°	220°	220°	220°
Snow Throwing Distance Ft.	3-30	3-30	3-30	3-30
Snow Throwing Distance (Meters)	(0.9-9.1)	(0.9-9.1)	(0.9-9.1)	(0.9-9.1)
Impeller Dia - In. (CM)	9.0 (23)	9.0 (23)	9.0 (23)	9.0 (23)
Impeller Speed - RPM	1120	1100	1120	1100
Impeller Drive Belt	3L Section	3L Section	3L Section	3L Section
Single "V"	Yes	Yes	Yes	Yes
Construction	Raw Edge	Raw Edge	Raw Edge	Raw Edge
Material	Kevlar Cord	Kevlar Cord	Kevlar Cord	Kevlar Cord
Operator Present Impeller Clutch/Brake Control	Yes	Yes	Yes	Yes
Wheel Size - In.	7.0 x 1.5	7.0 x 1.5	7.0 x 1.5	7.0 x 1.5
Wheel Size - CM	(18 x 3.8)	(18 x 3.8)	(18 x 3.8)	(18 x 3.8)
Chute Inside Dia - In (CM)	6.0 (15.2)	6.0 (15.2)	6.0 (15.2)	6.0 (15.2)
Fuel Filler Neck Inside Dia. - In (CM)	2.8 (7.1)	2.8 (7.1)	2.8 (7.1)	2.8 (7.1)

## **ACCESSORIES**

P# 737001 and 737002 - Electric Start (3 HP)

P# 738001 - Electric Start (5HP)

P# 738002 - Hanger Bracket

## **MODELS**

Model 938001 (SS322)

3 HP 22" SINGLE STAGE SNO-THRO

SERIAL NO. 000101 AND UP

MODEL 938002 (SS522)

5HP 22" SINGLE STAGE SNO-THRO

SERIAL NO. 000101 AND UP

MODEL 938003 (SS322E)

3 HP 22" SINGLE STAGE ELECT START SNO-THRO

SERIAL NO. 000101 AND UP

MODEL 938004 (SS322E)

5 HP 22" SINGLE STAGE ELECT START SNO-THRO

SERIAL NO. 000101 AND UP

MODEL 938301 (SS322)

3 HP 22" SINGLE STAGE SNO-THRO

SERIAL NO. 000101 AND UP

MODEL 938302 (SS322)

5 HP 22" SINGLE STAGE SNO-THRO

SERIAL NO. 000101 AND UP

# QUALITY

# QUALITY

## PRODUCTS

Ariens Company hereby warrants to the original

consumer purchaser that products manufactured by Ariens Company will be free from defects



## GUARANTEE

in material and workmanship FOR A PERIOD OF FIVE (5)

YEARS FROM THE DATE OF PURCHASE, EXCEPT AS NOTED BELOW.



### PROTECTION PLAN

- The Company will provide for the replacement of any part found upon examination by the Company to be defective. Such repair or replacement will be free of charge to the purchaser (labor and parts) for two years (24 months) from the date of purchase. Ariens manufactured parts (but not labor) will be free of charge for an additional three years (36 months) thereafter.

*This warranty is subject to the following exceptions and limitations:*



### PURCHASER RESPONSIBILITIES

- Maintenance & minor adjustments per owners manual
- Notification of need for warranty service
- Transportation to/from place of warranty repair

### RENTAL USE - ALL PRODUCTS

- NINETY DAYS LABOR & PARTS



### PRODUCT REGISTRATION

Return of registration card required to validate warranty

### CONSUMER PRODUCT - PUT TO COMMERCIAL, INDUSTRIAL, INSTITUTIONAL USE

- NINETY DAYS LABOR & PARTS



### PURCHASED COMPONENTS & NORMAL WEAR

- Two year labor and parts on purchased components i.e., (tractor drive train components manufactured by Dana, Eaton, Foote, Sundstrand and any plastic and electrical components, wire harness, bags, boots, tubes, etc.).
- Two year labor and parts on normal wear items i.e., (belts and rubber components, bearings, cables, controls, clutches, tines, etc.).

### SERVICE PARTS & ACCESSORIES

- NINETY DAYS LABOR & PARTS

### SERVICE

- For warranty service, contact any Ariens Distributor or Dealer. For the name and location of the Ariens Distributor or Dealers in your area, and for further warranty information, write or call Ariens Company.



### BATTERY WARRANTY PRORATED

- One to six months - free replacement
- Seven to twelve months - 50% credit
- Thirteen to twenty-four months - 25% credit



### WARRANTY - COMMERCIAL PRODUCTS

- One year parts and labor
- Product labeled commercial/professional
- Household use - 5 year limited warranty applies

### ENGINES, ENGINE ACCESSORIES, & PEERLESS PRODUCTS

- Covered only by manufacturer's warranty

### EXCLUSIONS

- No warranty is extended to blades, mower vanes, skid shoes, runners, scraper blades, shear bolts, light bulbs, headlights and any equipment which has been altered, misused, misassembled, improperly adjusted, neglected, or damaged by accident.
- No warranty is extended for service completed by anyone other than an authorized distributor or dealer.
- No warranty is extended on any parts that are not genuine Ariens service parts.



Ariens Company reserves the right to incorporate any changes in design into its products without obligation to make such changes on products previously manufactured. **DISCLAIMER OF FURTHER WARRANTY**

There is no other express warranty. Implied warranties, including any warranty of merchantability or fitness for a particular purpose, are limited to the duration of this written warranty, and are excluded to the extent permitted by law. There are no warranties which extend beyond the description of the product contained herein.

In no event shall the company be liable for indirect, special or consequential damages (such as loss of anticipated profits) in connection with the consumer's use of the product.

This warranty gives you specific legal rights, and you may also have other rights which vary from state to state. Some states do not allow the exclusion of incidental or consequential damages, or limitations on how long an implied warranty lasts, so the above limitation and exclusions may not apply to you.



Crafted in America Since 1933

### Insertion Under Section 4:

Operation, page 14, under the **Important Note** in the second column, replace the existing paragraph with the following: Check clutch disengagement and engagement before each use. If impeller does not stop quickly, when the clutch bail is released or if there is no noticeable increase in bail force before contacting the handlebar upon engagement, adjust as directed in Section 5: Maintenance, or repair before operating equipment.

### Insertion Under Section 5:

Maintenance, page 16, under the **WARNING** box, replace the procedure shown with the following: There are two separate drive belt/brake adjustments for proper operation:

### Control Cable Adjustment (see Figure 15)

1. For proper impeller brake adjustment, there must **ALWAYS** be some slight noticeable slack in the control cable inner wire, with the bail in the disengaged position, against its stop at the handlebar. (4 - 1/2 to 5 inches of bail travel before handlebar contact) Lock in position after adjustment by tightening nuts against bracket.
2. For proper clutch adjustment there must be a noticeable increase in bail force before the bail contacts the handlebar. At factory adjustment, this increase normally occurs 1 to 1 1/2 inches before the bail contact and is caused by stretch of the spring on the control cable. As the belt seats in and wears, the increase in force will occur closer to bail contact. If no noticeable increase in force is felt before contact, the clutch must be re-adjusted by idler position adjustment.

### Idler Position Adjustment (see figure 14)

1. The cowl must be removed and replaced for this adjustment. Make certain control cable inner wire has slack in disengaged/brake-on position.
2. The idler arm is slotted so that the idler bolt can tighten the idler in different positions along the slot. The brake is not strong enough to stop the impeller if the idler position is allowing even slight pressure against the belt but the brake must stop the impeller for safe operation.
3. Do not make this adjustment with engine running. First make sure belt fingers are properly adjusted. Reposition the idler in small increments with engine stopped and then restart the engine after each position change in a trial and error process keeping body parts free of moving elements at all times. For proper clutch adjustment, the idler position must be as close as practical toward the belt while the idler arm is in the spring loaded disengaged/brake contact position, but not so close that it causes the impeller to rotate.
4. Now recheck and make control cable adjustment if necessary.
5. If adjustment can not be achieved, the belt should be replaced.