



870 Extreme3

User Manual

Version 1.0

Published April 2010

Copyright©2010 ASRock INC. All rights reserved.

Copyright Notice:

No part of this manual may be reproduced, transcribed, transmitted, or translated in any language, in any form or by any means, except duplication of documentation by the purchaser for backup purpose, without written consent of ASRock Inc.

Products and corporate names appearing in this manual may or may not be registered trademarks or copyrights of their respective companies, and are used only for identification or explanation and to the owners' benefit, without intent to infringe.

Disclaimer:

Specifications and information contained in this manual are furnished for informational use only and subject to change without notice, and should not be constructed as a commitment by ASRock. ASRock assumes no responsibility for any errors or omissions that may appear in this manual.

With respect to the contents of this manual, ASRock does not provide warranty of any kind, either expressed or implied, including but not limited to the implied warranties or conditions of merchantability or fitness for a particular purpose.

In no event shall ASRock, its directors, officers, employees, or agents be liable for any indirect, special, incidental, or consequential damages (including damages for loss of profits, loss of business, loss of data, interruption of business and the like), even if ASRock has been advised of the possibility of such damages arising from any defect or error in the manual or product.



This device complies with Part 15 of the FCC Rules. Operation is subject to the following two conditions:

- (1) this device may not cause harmful interference, and
- (2) this device must accept any interference received, including interference that may cause undesired operation.

CALIFORNIA, USA ONLY

The Lithium battery adopted on this motherboard contains Perchlorate, a toxic substance controlled in Perchlorate Best Management Practices (BMP) regulations passed by the California Legislature. When you discard the Lithium battery in California, USA, please follow the related regulations in advance.

"Perchlorate Material-special handling may apply, see www.dtsc.ca.gov/hazardouswaste/perchlorate"

ASRock Website: <http://www.asrock.com>

Contents

1. Introduction	5
1.1 Package Contents	5
1.2 Specifications	6
1.3 Motherboard Layout	11
1.4 I/O Panel	12
2. Installation	13
Pre-installation Precautions	13
2.1 CPU Installation	14
2.2 Installation of CPU Fan and Heatsink	14
2.3 Installation of Memory Modules (DIMM)	15
2.4 Expansion Slots (PCI and PCI Express Slots)	17
2.5 Surround Display Feature	18
2.6 CrossFireX™ and Quad CrossFireX™ Operation Guide	22
2.7 Jumpers Setup	23
2.8 Onboard Headers and Connectors	24
2.9 Smart Switches	28
2.10 Dr. Debug	29
2.11 Serial ATA3 (SATA3) Hard Disks Installation	32
2.12 Hot Plug and Hot Swap Functions for SATA3 HDDs	32
2.13 SATA3 HDD Hot Plug Feature and Operation Guide	33
2.14 Driver Installation Guide	35
2.15 Installing Windows® 7 / 7 64-bit / Vista™ / Vista™ 64-bit / XP / XP 64-bit With RAID Functions	35
2.15.1 Installing Windows® XP / XP 64-bit With RAID Functions	35
2.15.2 Installing Windows® 7 / 7 64-bit / Vista™ / Vista™ 64-bit With RAID Functions	36
2.16 Installing Windows® 7 / 7 64-bit / Vista™ / Vista™ 64-bit / XP / XP 64-bit Without RAID Functions	37
2.16.1 Installing Windows® XP / XP 64-bit Without RAID Functions	37
2.16.2 Installing Windows® 7 / 7 64-bit / Vista™ / Vista™ 64-bit Without RAID Functions	38
2.17 Untied Overclocking Technology	38

3. BIOS SETUP UTILITY	39
3.1 Introduction	39
3.1.1 BIOS Menu Bar	39
3.1.2 Navigation Keys	40
3.2 Main Screen	40
3.3 OC Tweaker Screen	41
3.4 Advanced Screen	49
3.4.1 CPU Configuration	50
3.4.2 Chipset Configuration	51
3.4.3 ACPI Configuration	52
3.4.4 Storage Configuration	53
3.4.5 PCIPnP Configuration	55
3.4.6 Super IO Configuration	56
3.4.7 USB Configuration	57
3.5 Hardware Health Event Monitoring Screen	58
3.6 Boot Screen	59
3.6.1 Boot Settings Configuration	59
3.7 Security Screen	60
3.8 Exit Screen	61
4. Software Support	62
4.1 Install Operating System	62
4.2 Support CD Information	62
4.2.1 Running Support CD	62
4.2.2 Drivers Menu	62
4.2.3 Utilities Menu	62
4.2.4 Contact Information	62

1. Introduction

Thank you for purchasing ASRock **870 Extreme3** motherboard, a reliable motherboard produced under ASRock's consistently stringent quality control. It delivers excellent performance with robust design conforming to ASRock's commitment to quality and endurance.

In this manual, chapter 1 and 2 contain introduction of the motherboard and step-by-step guide to the hardware installation. Chapter 3 and 4 contain the configuration guide to BIOS setup and information of the Support CD.



Because the motherboard specifications and the BIOS software might be updated, the content of this manual will be subject to change without notice. In case any modifications of this manual occur, the updated version will be available on ASRock website without further notice. You may find the latest VGA cards and CPU support lists on ASRock website as well. ASRock website <http://www.asrock.com>
If you require technical support related to this motherboard, please visit our website for specific information about the model you are using.
www.asrock.com/support/index.asp

1.1 Package Contents

ASRock **870 Extreme3** Motherboard

(ATX Form Factor: 12.0-in x 9.6-in, 30.5 cm x 24.4 cm)

ASRock **870 Extreme3** Quick Installation Guide

ASRock **870 Extreme3** Support CD

4 x Serial ATA (SATA) Data Cables (Optional)

1 x I/O Panel Shield

1.2 Specifications

Platform	<ul style="list-style-type: none">- ATX Form Factor: 12.0-in x 9.6-in, 30.5 cm x 24.4 cm- All Solid Capacitor design (100% Japan-made high-quality Conductive Polymer Capacitors)
CPU	<ul style="list-style-type: none">- Support for Socket AM3 processors: AMD Phenom™ II X4 / X3 / X2 (except 920 / 940) / Athlon II X4 / X3 / X2 / Sempron processors- Six-Core CPU Ready- Supports UCC feature (Unlock CPU Core) (see CAUTION 1)- V4 + 1 Power Phase Design- Supports CPU up to 140W- Supports AMD's Cool 'n' Quiet™ Technology- FSB 2600 MHz (5.2 GT/s)- Supports Untied Overclocking Technology (see CAUTION 2)- Supports Hyper-Transport 3.0 (HT 3.0) Technology
Chipset	<ul style="list-style-type: none">- Northbridge: AMD 870- Southbridge: AMD SB850
Memory	<ul style="list-style-type: none">- Dual Channel DDR3 Memory Technology (see CAUTION 3)- 4 x DDR3 DIMM slots- Support DDR3 1800(OC)/1600(OC)/1333/1066/800 non-ECC, un-buffered memory (see CAUTION 4)- Max. capacity of system memory: 16GB (see CAUTION 5)
Expansion Slot	<ul style="list-style-type: none">- 2 x PCI Express 2.0 x16 slot (Single at x16 or dual at x8/x8 mode)- 2 x PCI Express 2.0 x1 slots- 2 x PCI slots- Supports ATI™ Quad CrossFireX™ and CrossFireX™
Audio	<ul style="list-style-type: none">- 7.1 CH HD Audio with Content Protection (Realtek ALC892 Audio Codec)- Premium Blu-ray audio support
LAN	<ul style="list-style-type: none">- PCIe x1 Gigabit LAN 10/100/1000 Mb/s- Realtek RTL8111E- Supports Wake-On-LAN- Supports LAN Cable Detection
Rear Panel I/O	<p>I/O Panel</p> <ul style="list-style-type: none">- 1 x PS/2 Keyboard Port- 1 x Coaxial SPDIF Out Port- 1 x Optical SPDIF Out Port- 6 x Ready-to-Use USB 2.0 Ports

	<ul style="list-style-type: none"> - 1 x eSATAIII Connector - 2 x Ready-to-Use USB 3.0 Ports - 1 x RJ-45 LAN Port with LED (ACT/LINK LED and SPEED LED) - 1 x IEEE 1394 Port - 1 x Clear CMOS Switch with LED - HD Audio Jack: Side Speaker/Rear Speaker/Central/Bass/Line in/Front Speaker/Microphone (see CAUTION 6)
SATA3	- 5 x SATA3 6.0 Gb/s connectors, support RAID (RAID 0, RAID 1, RAID 0+1 and RAID 5), NCQ, AHCI and "Hot Plug" functions
USB 3.0	- 2 x USB 3.0 port by NEC MPD720200, support USB 1.0/2.0/3.0 up to 5Gb/s
Connector	<ul style="list-style-type: none"> - 5 x SATA3 6.0Gb/s connectors - 1 x IR header - 1 x COM port header - 1 x IEEE 1394 header - 1 x HDMI_SPDIF header - 1 x Power LED header - CPU/Chassis/Power FAN connector - 24 pin ATX power connector - 8 pin 12V power connector - Front panel audio connector - 3 x USB 2.0 headers (support 6 USB 2.0 ports) - 1 x Dr. Debug (7-Segment Debug LED)
Smart Switch	<ul style="list-style-type: none"> - 1 x Clear CMOS Switch with LED - 1 x Power Switch with LED - 1 x Reset Switch with LED
BIOS Feature	<ul style="list-style-type: none"> - 8Mb AMI BIOS - AMI Legal BIOS - Supports "Plug and Play" - ACPI 1.1 Compliance Wake Up Events - Supports jumperfree - SMBIOS 2.3.1 Support - CPU VID, VCCM, NB, SB Voltage Multi-adjustment
Support CD	- Drivers, Utilities, AntiVirus Software (Trial Version), AMD OverDrive™ Utility, AMD Fusion, AMD Fusion Media Explorer, ASRock Software Suite (CyberLink DVD Suite - OEM and Trial; Creative Sound Blaster X-Fi MB - Trial)
Unique Feature	<ul style="list-style-type: none"> - ASRock OC Tuner (see CAUTION 7) - Intelligent Energy Saver (see CAUTION 8) - Instant Boot - ASRock Instant Flash (see CAUTION 9)

	<ul style="list-style-type: none"> - ASRock OC DNA (see CAUTION 10) - Hybrid Booster: <ul style="list-style-type: none"> - CPU Frequency Stepless Control (see CAUTION 11) - ASRock U-COP (see CAUTION 12) - Boot Failure Guard (B.F.G.)
Hardware Monitor	<ul style="list-style-type: none"> - CPU Temperature Sensing - Chassis Temperature Sensing - CPU/Chassis/Power Fan Tachometer - CPU Quiet Fan - CPU/Chassis Fan Multi-Speed Control - Voltage Monitoring: +12V, +5V, +3.3V, Vcore
OS	<ul style="list-style-type: none"> - Microsoft® Windows® 7 / 7 64-bit / Vista™ / Vista™ 64-bit / XP / XP Media Center / XP 64-bit compliant
Certifications	<ul style="list-style-type: none"> - FCC, CE, WHQL - ErP/EuP Ready (ErP/EuP ready power supply is required) (see CAUTION 13)

* For detailed product information, please visit our website: <http://www.asrock.com>

WARNING

Please realize that there is a certain risk involved with overclocking, including adjusting the setting in the BIOS, applying Untied Overclocking Technology, or using the third-party overclocking tools. Overclocking may affect your system stability, or even cause damage to the components and devices of your system. It should be done at your own risk and expense. We are not responsible for possible damage caused by overclocking.

CAUTION!

1. ASRock UCC (Unlock CPU Core) feature simplifies AMD CPU activation. As long as a simple switch of the BIOS option "ASRock UCC", you can unlock the extra CPU core to enjoy an instant performance boost. When UCC feature is enabled, the dual-core or triple-core CPU will boost to the quad-core CPU, and some CPU, including quad-core CPU, can also increase L3 cache size up to 6MB, which means you can enjoy the upgrade CPU performance with a better price. Please be noted that UCC feature is supported with AM3 CPU only, and in addition, not every AM3 CPU can support this function because some CPU's hidden core may be malfunctioned.
2. This motherboard supports Untied Overclocking Technology. Please read "Untied Overclocking Technology" on page 38 for details.
3. This motherboard supports Dual Channel Memory Technology. Before you implement Dual Channel Memory Technology, make sure to read the installation guide of memory modules on page 15 for proper installation.
4. Whether 1800/1600MHz memory speed is supported depends on the AM3 CPU you adopt. If you want to adopt DDR3 1800/1600 memory module on this motherboard, please refer to the memory support list on our website for the compatible memory modules.
ASRock website <http://www.asrock.com>
5. Due to the operating system limitation, the actual memory size may be less than 4GB for the reservation for system usage under Windows® 7 / Vista™ / XP. For Windows® OS with 64-bit CPU, there is no such limitation.
6. For microphone input, this motherboard supports both stereo and mono modes. For audio output, this motherboard supports 2-channel, 4-channel, 6-channel, and 8-channel modes. Please check the table on page 12 for proper connection.
7. It is a user-friendly ASRock overclocking tool which allows you to surveil your system by hardware monitor function and overclock your hardware devices to get the best system performance under Windows® environment. Please visit our website for the operation procedures of ASRock OC Tuner. ASRock website: <http://www.asrock.com>
8. Featuring an advanced proprietary hardware and software design, Intelligent Energy Saver is a revolutionary technology that delivers unparalleled power savings. The voltage regulator can reduce the number of output phases to improve efficiency when the CPU cores are idle. In other words, it is able to provide exceptional power saving and improve power efficiency without sacrificing computing performance. To use Intelligent Energy Saver function, please enable Cool 'n' Quiet option in the BIOS setup in advance. Please visit our website for the operation procedures of Intelligent Energy Saver.
ASRock website: <http://www.asrock.com>

-
9. ASRock Instant Flash is a BIOS flash utility embedded in Flash ROM. This convenient BIOS update tool allows you to update system BIOS without entering operating systems first like MS-DOS or Windows®. With this utility, you can press <F6> key during the POST or press <F2> key to BIOS setup menu to access ASRock Instant Flash. Just launch this tool and save the new BIOS file to your USB flash drive, floppy disk or hard drive, then you can update your BIOS only in a few clicks without preparing an additional floppy diskette or other complicated flash utility. Please be noted that the USB flash drive or hard drive must use FAT32/16/12 file system.
 10. The software name itself – OC DNA literally tells you what it is capable of. OC DNA, an exclusive utility developed by ASRock, provides a convenient way for the user to record the OC settings and share with others. It helps you to save your overclocking record under the operating system and simplifies the complicated recording process of overclocking settings. With OC DNA, you can save your OC settings as a profile and share with your friends! Your friends then can load the OC profile to their own system to get the same OC settings as yours! Please be noticed that the OC profile can only be shared and worked on the same motherboard.
 11. Although this motherboard offers stepless control, it is not recommended to perform over-clocking. Frequencies other than the recommended CPU bus frequencies may cause the instability of the system or damage the CPU.
 12. While CPU overheat is detected, the system will automatically shutdown. Before you resume the system, please check if the CPU fan on the motherboard functions properly and unplug the power cord, then plug it back again. To improve heat dissipation, remember to spray thermal grease between the CPU and the heatsink when you install the PC system.
 13. EuP, stands for Energy Using Product, was a provision regulated by European Union to define the power consumption for the completed system. According to EuP, the total AC power of the completed system shall be under 1.00W in off mode condition. To meet EuP standard, an EuP ready motherboard and an EuP ready power supply are required. According to Intel's suggestion, the EuP ready power supply must meet the standard of 5v standby power efficiency is higher than 50% under 100 mA current consumption. For EuP ready power supply selection, we recommend you checking with the power supply manufacturer for more details.

1.3 Motherboard Layout

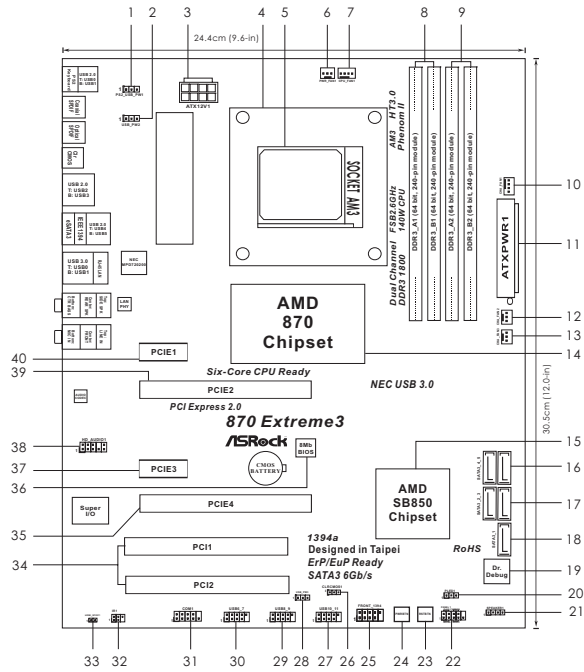

1	PS2_USB_PW1 Jumper	22	System Panel Header (PANEL1, White)
2	USB_PW2 Jumper	23	Reset Switch (RSTBTN)
3	ATX 12V Power Connector (ATX12V1)	24	Power Switch (PWRBTN)
4	CPU Heatsink Retention Module	25	Front Panel IEEE 1394 Header (FRONT_1394, White)
5	AM3 CPU Socket	26	Clear CMOS Jumper (CLRCMOS1)
6	Power Fan Connector (PWR_FAN1)	27	USB 2.0 Header (USB10_11, Blue)
7	CPU Fan Connector (CPU_FAN1)	28	USB_PW3 Jumper
8	2 x 240-pin DDR3 DIMM Slots (Dual Channel A: DDR3_A1, DDR3_B1; Blue)	29	USB 2.0 Header (USB8_9, Blue)
9	2 x 240-pin DDR3 DIMM Slots (Dual Channel B: DDR3_A2, DDR3_B2; White)	30	USB 2.0 Header (USB6_7, Blue)
10	Chassis Fan Connector (CHA_FAN1)	31	Serial Port Connector (COM1)
11	ATX Power Connector (ATXPWR1)	32	Infrared Module Header (IR1)
12	Chassis Fan Connector (CHA_FAN2)	33	HDMI_SPDIF Header (HDMI_SPDIF1, White)
13	Chassis Fan Connector (CHA_FAN3)	34	PCI Slots (PCI1-2)
14	Northbridge Controller	35	PCI Express 2.0 x16 Slot (PCIE4; Blue)
15	Southbridge Controller	36	SPI Flash Memory (8Mb)
16	SATA3 Connector (SATA3_4_5, White)	37	PCI Express 2.0 x1 Slot (PCIE3; White)
17	SATA3 Connector (SATA3_2_3, White)	38	Front Panel Audio Header (HD_AUDIO1, White)
18	SATA3 Connector (SATA3_1, White)	39	PCI Express 2.0 x16 Slot (PCIE2; Blue)
19	Dr. Debug (LED)	40	PCI Express 2.0 x1 Slot (PCIE1; White)
20	Power LED Header (PLED1)		
21	Chassis Speaker Header (SPEAKER 1, White)		

1.4 I/O Panel

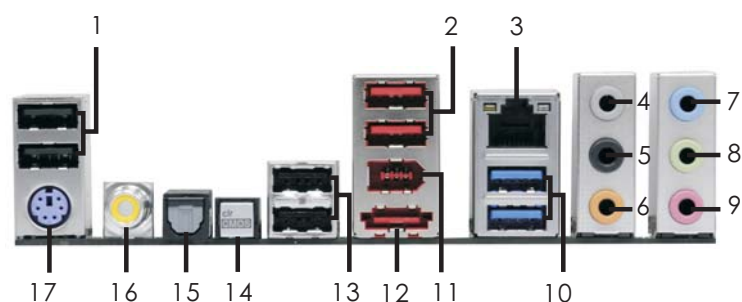

- | | | | |
|-----|-------------------------|----|-----------------------------|
| 1 | USB 2.0 Ports (USB01) | 10 | USB 3.0 Port (USB3_01) |
| 2 | USB 2.0 Ports (USB45) | 11 | IEEE 1394 Port (IEEE 1394) |
| *3 | LAN RJ-45 Port | 12 | eSATAIII Connector |
| 4 | Side Speaker (Gray) | 13 | USB 2.0 Ports (USB23) |
| 5 | Rear Speaker (Black) | 14 | Clear CMOS Switch (CLRCBTN) |
| 6 | Central / Bass (Orange) | 15 | Optical SPDIF Out Port |
| 7 | Line In (Light Blue) | 16 | Coaxial SPDIF Out Port |
| **8 | Front Speaker (Lime) | 17 | PS/2 Keyboard Port (Purple) |
| 9 | Microphone (Pink) | | |

* There are two LED next to the LAN port. Please refer to the table below for the LAN port LED indications.

LAN Port LED Indications

Activity/Link LED		SPEED LED		
Status	Description	Status	Description	<p>ACT/LINK LED SPEED LED</p> <p>LAN Port</p>
Off	No Link	Off	10Mbps connection	
Blinking	Data Activity	Orange	100Mbps connection	
On	Link	Green	1Gbps connection	

** If you use 2-channel speaker, please connect the speaker's plug into "Front Speaker Jack". See the table below for connection details in accordance with the type of speaker you use.

TABLE for Audio Output Connection

Audio Output Channels	Front Speaker (No. 8)	Rear Speaker (No. 5)	Central / Bass (No. 6)	Line In (No. 7)
2	V	--	--	--
4	V	V	--	--
6	V	V	V	--
8	V	V	V	V

To enable Multi-Streaming function, you need to connect a front panel audio cable to the front panel audio header. After restarting your computer, you will find "Mixer" tool on your system. Please select "Mixer ToolBox" , click "Enable playback multi-streaming", and click

"ok". Choose "2CH", "4CH", "6CH", or "8CH" and then you are allowed to select "Realtek HDA Primary output" to use Rear Speaker, Central/Bass, and Front Speaker, or select "Realtek HDA Audio 2nd output" to use front panel audio.

2. Installation

This is an ATX form factor (12.0-in x 9.6-in, 30.5 cm x 24.4 cm) motherboard.

Before you install the motherboard, study the configuration of your chassis to ensure that the motherboard fits into it.

Pre-installation Precautions

Take note of the following precautions before you install motherboard components or change any motherboard settings.



Before you install or remove any component, ensure that the power is switched off or the power cord is detached from the power supply. Failure to do so may cause severe damage to the motherboard, peripherals, and/or components.

1. Unplug the power cord from the wall socket before touching any component.
2. To avoid damaging the motherboard components due to static electricity, NEVER place your motherboard directly on the carpet or the like. Also remember to use a grounded wrist strap or touch a safety grounded object before you handle components.
3. Hold components by the edges and do not touch the ICs.
4. Whenever you uninstall any component, place it on a grounded anti-static pad or in the bag that comes with the component.
5. When placing screws into the screw holes to secure the motherboard to the chassis, please do not over-tighten the screws! Doing so may damage the motherboard.

2.1 CPU Installation

- Step 1. Unlock the socket by lifting the lever up to a 90° angle.
- Step 2. Position the CPU directly above the socket such that the CPU corner with the golden triangle matches the socket corner with a small triangle.
- Step 3. Carefully insert the CPU into the socket until it fits in place.



The CPU fits only in one correct orientation. DO NOT force the CPU into the socket to avoid bending of the pins.

- Step 4. When the CPU is in place, press it firmly on the socket while you push down the socket lever to secure the CPU. The lever clicks on the side tab to indicate that it is locked.

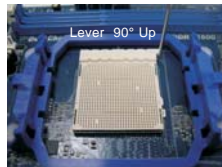

STEP 1:
Lift Up The Socket Lever

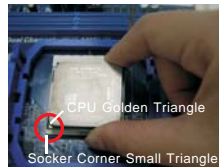

STEP 2 / STEP 3:
Match The CPU Golden Triangle
To The Socket Corner Small
Triangle



STEP 4:
Push Down And Lock
The Socket Lever

2.2 Installation of CPU Fan and Heatsink

After you install the CPU into this motherboard, it is necessary to install a larger heatsink and cooling fan to dissipate heat. You also need to spray thermal grease between the CPU and the heatsink to improve heat dissipation. Make sure that the CPU and the heatsink are securely fastened and in good contact with each other. Then connect the CPU fan to the CPU FAN connector (CPU_FAN1, see Page 11, No. 7). For proper installation, please kindly refer to the instruction manuals of the CPU fan and the heatsink.

2.3 Installation of Memory Modules (DIMM)

This motherboard provides four 240-pin DDR3 (Double Data Rate 3) DIMM slots, and supports Dual Channel Memory Technology. For dual channel configuration, you always need to install **identical** (the same brand, speed, size and chip-type) DDR3 DIMM pair in the slots of the same color. In other words, you have to install **identical** DDR3 DIMM pair in **Dual Channel A** (DDR3_A1 and DDR3_B1; Blue slots; see p.11 No.8) or **identical** DDR3 DIMM pair in **Dual Channel B** (DDR3_A2 and DDR3_B2; White slots; see p.11 No.9), so that Dual Channel Memory Technology can be activated. This motherboard also allows you to install four DDR3 DIMMs for dual channel configuration, and please install **identical** DDR3 DIMMs in all four slots. You may refer to the Dual Channel Memory Configuration Table below.

Dual Channel Memory Configurations

	DDR3_A1 (Blue Slot)	DDR3_B1 (Blue Slot)	DDR3_A2 (White Slot)	DDR3_B2 (White Slot)
(1)	Populated	Populated	-	-
(2)	-	-	Populated	Populated
(3)*	Populated	Populated	Populated	Populated

* For the configuration (3), please install **identical** DDR3 DIMMs in all four slots.



1. If you want to install two memory modules, for optimal compatibility and reliability, it is recommended to install them in the slots of the same color. In other words, install them either in the set of blue slots (DDR3_A1 and DDR3_B1), or in the set of white slots (DDR3_A2 and DDR3_B2).
2. If only one memory module or three memory modules are installed in the DDR3 DIMM slots on this motherboard, it is unable to activate the Dual Channel Memory Technology.
3. If a pair of memory modules is NOT installed in the same Dual Channel, for example, installing a pair of memory modules in DDR3_A1 and DDR3_A2, it is unable to activate the Dual Channel Memory Technology .
4. It is not allowed to install a DDR or DDR2 memory module into DDR3 slot; otherwise, this motherboard and DIMM may be damaged.
5. If you adopt DDR3 1800/1600 memory modules on this motherboard, it is recommended to install them on DDR3_A2 and DDR3_B2 slots.

Installing a DIMM



Please make sure to disconnect power supply before adding or removing DIMMs or the system components.

- Step 1. Unlock a DIMM slot by pressing the retaining clips outward.
- Step 2. Align a DIMM on the slot such that the notch on the DIMM matches the break on the slot.

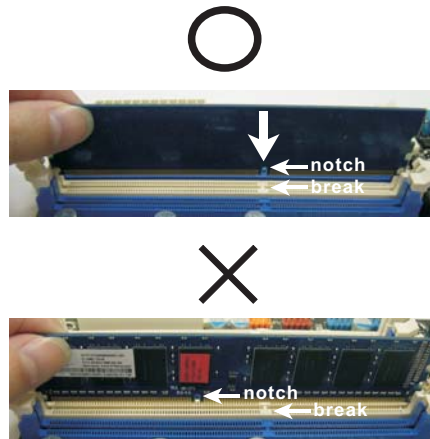

The DIMM only fits in one correct orientation. It will cause permanent damage to the motherboard and the DIMM if you force the DIMM into the slot at incorrect orientation.

- Step 3. Firmly insert the DIMM into the slot until the retaining clips at both ends fully snap back in place and the DIMM is properly seated.

2.4 Expansion Slots (PCI and PCI Express Slots)

There are 2 PCI slots and 4 PCI Express slots on this motherboard.

PCI Slots: PCI slots are used to install expansion cards that have the 32-bit PCI interface.

PCIe Slots:

PCIe1 / PCIe3 (PCIe x1 slot; White) is used for PCI Express cards with x1 lane width cards, such as Gigabit LAN card and SATA2 card.

PCIe2 / PCIe4 (PCIe x16 slot; Blue) is used for PCI Express x16 lane width graphics cards, or used to install PCI Express graphics cards to support CrossFireX™ function.



1. In single VGA card mode, it is recommended to install a PCI Express x16 graphics card on PCIe2 slot.
2. In CrossFireX™ mode, please install PCI Express x16 graphics cards on PCIe2 and PCIe4 slots. Therefore, both these two slots will work at x8 bandwidth.
3. Please connect a chassis fan to motherboard chassis fan connector (CHA_FAN1, CHA_FAN2 or CHA_FAN3) when using multiple graphics cards for better thermal environment.

Installing an expansion card

- Step 1. Before installing the expansion card, please make sure that the power supply is switched off or the power cord is unplugged. Please read the documentation of the expansion card and make necessary hardware settings for the card before you start the installation.
- Step 2. Remove the system unit cover (if your motherboard is already installed in a chassis).
- Step 3. Remove the bracket facing the slot that you intend to use. Keep the screws for later use.
- Step 4. Align the card connector with the slot and press firmly until the card is completely seated on the slot.
- Step 5. Fasten the card to the chassis with screws.
- Step 6. Replace the system cover.

2.5 CrossFireX™ and Quad CrossFireX™ Operation Guide

This motherboard supports CrossFireX™ and Quad CrossFireX™ feature.

CrossFireX™ technology offers the most advantageous means available of combining multiple high performance Graphics Processing Units (GPU) in a single PC. Combining a range of different operating modes with intelligent software design and an innovative interconnect mechanism, CrossFireX™ enables the highest possible level of performance and image quality in any 3D application. Currently CrossFireX™ feature is supported with Windows® XP with Service Pack 2 / Vista™ / 7 OS. Quad CrossFireX™ feature are supported with Windows® Vista™ / 7 OS only. Please check AMD website for ATI™ CrossFireX™ driver updates.



1. If a customer incorrectly configures their system they will not see the performance benefits of CrossFireX™. All three CrossFireX™ components, a CrossFireX™ Ready graphics card, a CrossFireX™ Ready motherboard and a CrossFireX™ Edition co-processor graphics card, must be installed correctly to benefit from the CrossFireX™ multi-GPU platform.
2. If you pair a 12-pipe CrossFireX™ Edition card with a 16-pipe card, both cards will operate as 12-pipe cards while in CrossFireX™ mode.

2.5.1 Graphics Card Setup



Different CrossFireX™ cards may require different methods to enable CrossFireX™ feature. In below procedures, we use Radeon HD 3870 as the example graphics card. For other CrossFireX™ cards that ATI™ has released or will release in the future, please refer to ATI™ graphics card manuals for detailed installation guide.

- Step 1. Insert one Radeon graphics card into PCIE2 slot and the other Radeon graphics card to PCIE4 slot. Make sure that the cards are properly seated on the slots.



-
- Step 2. Connect two Radeon graphics cards by installing CrossFire Bridge on CrossFire Bridge Interconnects on the top of Radeon graphics cards. (CrossFire Bridge is provided with the graphics card you purchase, not bundled with this motherboard. Please refer to your graphics card vendor for details.)



CrossFire Bridge

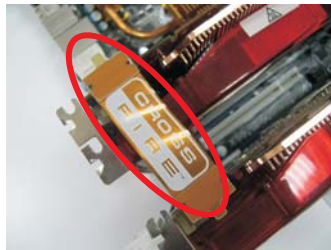

or

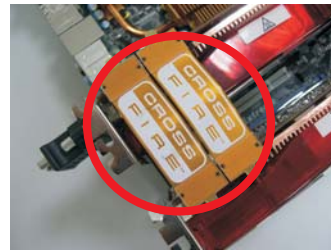

- Step 3. Connect the DVI monitor cable to the DVI connector on the Radeon graphics card on PCIE2 slot. (You may use the DVI to D-Sub adapter to convert the DVI connector to D-Sub interface, and then connect the D-Sub monitor cable to the DVI to D-Sub adapter.)

2.5.2 Driver Installation and Setup

- Step 1. Power on your computer and boot into OS.
- Step 2. Remove the ATI™ driver if you have any VGA driver installed in your system.



The Catalyst Uninstaller is an optional download. We recommend using this utility to uninstall any previously installed Catalyst drivers prior to installation. Please check AMD website for ATI™ driver updates.

- Step 3. Install the required drivers to your system.

For Windows® XP OS:

- A. ATI™ recommends Windows® XP Service Pack 2 or higher to be installed (If you have Windows® XP Service Pack 2 or higher installed in your system, there is no need to download it again):

<http://www.microsoft.com/windowsxp/sp2/default.msp>

- B. You must have Microsoft .NET Framework installed prior to downloading and installing the CATALYST Control Center. Please check Microsoft website for details.

For Windows® 7 / Vista™ OS:

Install the CATALYST Control Center. Please check AMD website for details.

- Step 4. Restart your computer.
- Step 5. Install the VGA card drivers to your system, and restart your computer. Then you will find “ATI Catalyst Control Center” on your Windows® taskbar.



ATI Catalyst Control Center

- Step 6. Double-click “ATI Catalyst Control Center”. Click “View”, select “CrossFireX™”, and then check the item “Enable CrossFireX™”. Select “2 GPUs” or “4 GPUs” and click “Apply”.

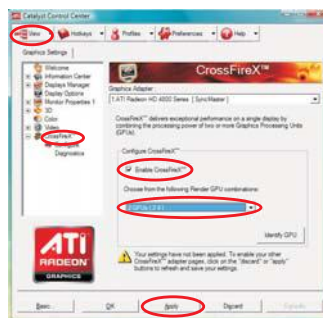



Although you have selected the option "Enable CrossFire™", the CrossFireX™ function may not work actually. Your computer will automatically reboot. After restarting your computer, please confirm whether the option "Enable CrossFire™" in "ATI Catalyst Control Center" is selected or not; if not, please select it again, and then you are able to enjoy the benefit of CrossFireX™ feature.

Step 7. You can freely enjoy the benefit of CrossFireX™ or Quad CrossFireX™ feature.

- * CrossFireX™ appearing here is a registered trademark of ATI™ Technologies Inc., and is used only for identification or explanation and to the owners' benefit, without intent to infringe.
- * For further information of ATI™ CrossFireX™ technology, please check AMD website for updates and details.



2.6 Surround Display Feature

This motherboard supports Surround Display upgrade. With the external add-on PCI Express VGA cards, you can easily enjoy the benefits of Surround Display feature. For the detailed instruction, please refer to the document at the following path in the Support CD:

..\ Surround Display Information



2.7 Jumpers Setup

The illustration shows how jumpers are setup. When the jumper cap is placed on pins, the jumper is “Short”. If no jumper cap is placed on pins, the jumper is “Open”. The illustration shows a 3-pin jumper whose pin1 and pin2 are “Short” when jumper cap is placed on these 2 pins.



Jumper	Setting	
PS2_USB_PW1 (see p.11, No. 1)		Short pin2, pin3 to enable +5VSB (standby) for PS/2 or USB01 wake up events.

Note: To select +5VSB, it requires 2 Amp and higher standby current provided by power supply.

USB_PW2 (see p.11, No. 43)		Short pin2, pin3 to enable +5V_DUAL for USB23/45 and USB3_01 wake up events.
-------------------------------	--	--

Note: To select +5V_DUAL, it requires 2 Amp and higher standby current provided by power supply. When you select +5V_DUAL, USB devices can wake up the system under S3 (Suspend to RAM) state. To support ErP/EuP requirement, please set this jumper to +5V.

USB_PW3 (see p.11, No. 27)		Short pin2, pin3 to enable +5VSB (standby) for USB6_7/8_9/10_11 wake up events.
-------------------------------	--	---

Note: To select +5VSB, it requires 2 Amp and higher standby current provided by power supply.

Clear CMOS Jumper (CLR CMOS1) (see p.11, No. 26)		
--	--	--

Note: CLR CMOS1 allows you to clear the data in CMOS. The data in CMOS includes system setup information such as system password, date, time, and system setup parameters. To clear and reset the system parameters to default setup, please turn off the computer and unplug the power cord from the power supply. After waiting for 15 seconds, use a jumper cap to short pin2 and pin3 on CLR CMOS1 for 5 seconds. However, please do not clear the CMOS right after you update the BIOS. If you need to clear the CMOS when you just finish updating the BIOS, you must boot up the system first, and then shut it down before you do the clear-CMOS action.

2.8 Onboard Headers and Connectors



Onboard headers and connectors are NOT jumpers. Do NOT place jumper caps over these headers and connectors. Placing jumper caps over the headers and connectors will cause permanent damage of the motherboard!

Serial ATA3 Connectors

(SATA3_1: see p.11, No. 20)

(SATA3_2_3: see p.11, No. 19)

(SATA3_4_5: see p.11, No. 18)



These five Serial ATA3

(SATA3) connectors support SATA data cables for internal storage devices. The current SATA3 interface allows up to 6.0 Gb/s data transfer rate.

Serial ATA (SATA)

Data Cable

(Optional)



Either end of the SATA data cable can be connected to the SATA3 hard disk or the SATA3 connector on this motherboard.

USB 2.0 Headers

(9-pin USB6_7)

(see p.11 No. 30)

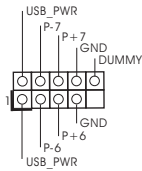

(9-pin USB8_9)

(see p.11 No. 29)

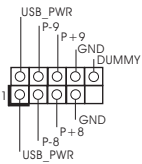

(9-pin USB10_11)

(see p.11 No. 27)

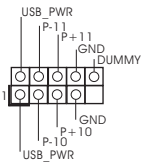

Besides six default USB 2.0 ports on the I/O panel, there are three USB 2.0 headers on this motherboard. Each USB 2.0 header can support two USB 2.0 ports.

Infrared Module Header

(5-pin IR1)

(see p.11 No. 32)

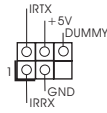

This header supports an optional wireless transmitting and receiving infrared module.

Front Panel Audio Header

(9-pin HD_AUDIO1)

(see p.11, No. 38)

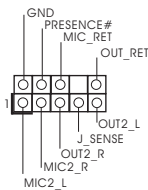

This is an interface for the front panel audio cable that allows convenient connection and control of audio devices.



1. High Definition Audio supports Jack Sensing, but the panel wire on the chassis must support HDA to function correctly. Please follow the instruction in our manual and chassis manual to install your system.
2. If you use AC'97 audio panel, please install it to the front panel audio header as below:
 - A. Connect Mic_IN (MIC) to MIC2_L.
 - B. Connect Audio_R (RIN) to OUT2_R and Audio_L (LIN) to OUT2_L.
 - C. Connect Ground (GND) to Ground (GND).
 - D. MIC_RET and OUT_RET are for HD audio panel only. You don't need to connect them for AC'97 audio panel.
 - E. To activate the front mic.
For Windows® XP / XP 64-bit OS:
Select "Mixer". Select "Recorder". Then click "FrontMic".
For Windows® 7 / 7 64-bit / Vista™ / Vista™ 64-bit OS:
Go to the "FrontMic" Tab in the Realtek Control panel. Adjust "Recording Volume".

System Panel Header

(9-pin PANEL1)

(see p.11 No. 22)

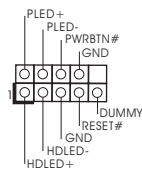

This header accommodates several system front panel functions.

Power LED Header

(3-pin PLED1)

(see p.11 No. 20)



Please connect the chassis power LED to this header to indicate system power status. The LED is on when the system is operating. The LED keeps blinking in S1 state. The LED is off in S3/S4 state or S5 state (power off).

Chassis Speaker Header
 (4-pin SPEAKER 1)
 (see p.11 No. 21)

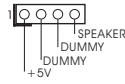

Please connect the chassis speaker to this header.

Chassis and Power Fan Connectors

(4-pin CHA_FAN1)
 (see p.11 No. 10)

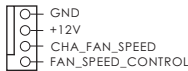

Please connect the fan cables to the fan connectors and match the black wire to the ground pin. CHA_FAN1/2/3 fan speed can be controlled through BIOS or OC Tuner utility.

(3-pin CHA_FAN2)
 (see p.11 No. 12)

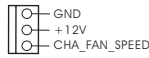

(3-pin CHA_FAN3)
 (see p.11 No. 13)

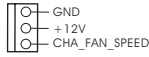

(3-pin PWR_FAN1)
 (see p.11 No. 6)

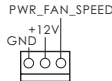

CPU Fan Connector

(4-pin CPU_FAN1)
 (see p.11 No. 7)

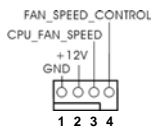

Please connect the CPU fan cable to this connector and match the black wire to the ground pin.



Though this motherboard provides 4-Pin CPU fan (Quiet Fan) support, the 3-Pin CPU fan still can work successfully even without the fan speed control function. If you plan to connect the 3-Pin CPU fan to the CPU fan connector on this motherboard, please connect it to Pin 1-3.

Pin 1-3 Connected ←



3-Pin Fan Installation

ATX Power Connector

(24-pin ATXPWR1)
 (see p.11 No. 11)

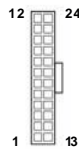

Please connect an ATX power supply to this connector.



Though this motherboard provides 24-pin ATX power connector, it can still work if you adopt a traditional 20-pin ATX power supply. To use the 20-pin ATX power supply, please plug your power supply along with Pin 1 and Pin 13.

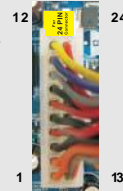

20-Pin ATX Power Supply Installation

ATX 12V Power Connector
 (8-pin ATX12V1)
 (see p.11 No. 3)



Please connect an ATX 12V power supply to this connector.



Though this motherboard provides 8-pin ATX 12V power connector, it can still work if you adopt a traditional 4-pin ATX 12V power supply. To use the 4-pin ATX power supply, please plug your power supply along with Pin 1 and Pin 5.

4-Pin ATX 12V Power Supply Installation



IEEE 1394 Header
 (9-pin FRONT_1394)
 (see p.11 No. 25)

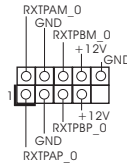

Besides one default IEEE 1394 port on the I/O panel, there is one IEEE 1394 header (FRONT_1394) on this motherboard. This IEEE 1394 header can support one IEEE 1394 port.

Serial port Header
 (9-pin COM1)
 (see p.11 No. 31)

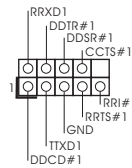

This COM1 header supports a serial port module.

HDMI_SPDIF Header
 (2-pin HDMI_SPDIF1)
 (see p.11 No. 33)



HDMI_SPDIF header, providing SPDIF audio output to HDMI VGA card, allows the system to connect HDMI Digital TV/projector/LCD devices. Please connect the HDMI_SPDIF connector of HDMI VGA card to this header.

2.9 Smart Switches

This motherboard has three smart switches: power switch, reset switch and clear CMOS switch, allowing users to quickly turn on/off or reset the system or clear the CMOS values.

Power Switch

(PWRBTN)

(see p.11 No. 24)



Power Switch is a smart switch, allowing users to quickly turn on/off the system.

Reset Switch

(RSTBTN)

(see p.11 No. 23)



Reset Switch is a smart switch, allowing users to quickly reset the system.

Clear CMOS Switch

(CLRCBTN)

(see p.12 No. 14)



Clear CMOS Switch is a smart switch, allowing users to quickly clear the CMOS values



You are not allowed to use Clear CMOS switch function if you set up the system password. If you want to clear the CMOS values, please clean your system password in advance or refer to page 23 "Clear CMOS jumper" description instead.

2.10 Dr. Debug

Dr. Debug is used to provide code information, which makes troubleshooting even easier. Please see the diagrams below for reading the Dr. Debug codes.

The Bootblock initialization code sets up the chipset, memory and other components before system memory is available. The following table describes the type of checkpoints that may occur during the bootblock initialization portion of the BIOS:

Checkpoint	Description
Before D1	Early chipset initialization is done. Early super I/O initialization is done including RTC and keyboard controller. NMI is disabled.
D1	Perform keyboard controller BAT test. Check if waking up from power management suspend state. Save power-on CPUID value in scratch CMOS.
D0	Go to flat mode with 4GB limit and GA20 enabled. Verify the bootblock checksum.
D2	Disable CACHE before memory detection. Execute full memory sizing module. Verify that flat mode is enabled.
D3	If memory sizing module not executed, start memory refresh and do memory sizing in Bootblock code. Do additional chipset initialization. Re-enable CACHE. Verify that flat mode is enabled.
D4	Test base 512KB memory. Adjust policies and cache first 8MB. Set stack.
D5	Bootblock code is copied from ROM to lower system memory and control is given to it. BIOS now executes out of RAM.
D6	Both key sequence and OEM specific method is checked to determine if BIOS recovery is forced. Main BIOS checksum is tested. If BIOS recovery is necessary, control flows to checkpoint E0.
D7	Restore CPUID value back into register. The Bootblock-Runtime interface module is moved to system memory and control is given to it. Determine whether to execute serial flash.
D8	The Runtime module is uncompressed into memory. CPUID information is stored in memory.
D9	Store the Uncompressed pointer for future use in PMM. Copying Main BIOS into memory. Leaves all RAM below 1MB Read-Write including E000 and F000 shadow areas but closing SMRAM.
DA	Restore CPUID value back into register. Give control to BIOS POST (ExecutePOSTKernel).

The POST code checkpoints are the largest set of checkpoints during the BIOS pre-boot process. The following table describes the type of checkpoints that may occur during the POST portion of the BIOS:

Checkpoint	Description
03	Disable NMI, Parity, video for EGA, and DMA controllers. Initialize BIOS, POST, Runtime data area. Also initialize BIOS modules on POST entry and GPNV area. Initialize CMOS as mentioned in the Kernel Variable "wCMOSFlags."
04	Check CMOS diagnostic byte to determine if battery power is OK and CMOS checksum is OK. Verify CMOS checksum manually by reading storage area. If the CMOS checksum is bad, update CMOS with power-on default values and clear passwords. Initialize status register A. Initialize data variables that are based on CMOS setup questions. Initialize both the 8259 compatible PICs in the system
05	Initializes the interrupt controlling hardware (generally PIC) and interrupt vector table.
06	Do R/W test to CH-2 count reg. Initialize CH-0 as system timer. Install the POSTINT1Ch handler. Enable IRQ-0 in PIC for system timer interrupt. Traps INT1Ch vector to "POSTINT1ChHandlerBlock."
08	Initializes the CPU. The BAT test is being done on KBC. Program the keyboard controller command byte is being done after Auto detection of KB/MS using AMI KB-5.
C0	Early CPU Init Start — Disable Cache - Init Local APIC
C1	Set up boot strap processor Information
C2	Set up boot strap processor for POST
C5	Enumerate and set up application processors
C6	Re-enable cache for boot strap processor
C7	Early CPU Init Exit
0A	Initializes the 8042 compatible Key Board Controller.
0B	Detects the presence of PS/2 mouse.
0C	Detects the presence of Keyboard in KBC port.
0E	Testing and initialization of different Input Devices. Also, update the Kernel Variables. Traps the INT09h vector, so that the POST INT09h handler gets control for IRQ1. Uncompress all available language, BIOS logo, and Silent logo modules.
13	Early POST initialization of chipset registers.
24	Uncompress and initialize any platform specific BIOS modules.
30	Initialize System Management Interrupt.
2A	Initializes different devices through DIM. See DIM Code Checkpoints section of document for more information.
2C	Initializes different devices. Detects and initializes the video adapter installed in the system that have optional ROMs.
2E	Initializes all the output devices.
31	Allocate memory for ADM module and uncompress it. Give control to ADM module for initialization. Initialize language and font modules for ADM. Activate ADM module.

33	Initializes the silent boot module. Set the window for displaying text information.
37	Displaying sign-on message, CPU information, setup key message, and any OEM specific information.
38	Initializes different devices through DIM.
39	Initializes DMAC-1 & DMAC-2.
3A	Initialize RTC date/time.
3B	Test for total memory installed in the system. Also, Check for DEL or ESC keys to limit memory test. Display total memory in the system.
3C	Mid POST initialization of chipset registers.
40	Detect different devices (Parallel ports, serial ports, and coprocessor in CPU, etc.) successfully installed in the system and update the BDA, EBDA, etc.
50	Programming the memory hole or any kind of implementation that needs an adjustment in system RAM size if needed.
52	Updates CMOS memory size from memory found in memory test. Allocates memory for Extended BIOS Data Area from base memory.
60	Initializes NUM-LOCK status and programs the KBD typematic rate.
75	Initialize Int-13 and prepare for IPL detection.
78	Initializes IPL devices controlled by BIOS and option ROMs.
7A	Initializes remaining option ROMs.
7C	Generate and write contents of ESCD in NVRam.
84	Log errors encountered during POST.
85	Display errors to the user and gets the user response for error.
87	Execute BIOS setup if needed / requested.
8C	Late POST initialization of chipset registers.
8D	Build ACPI tables (if ACPI is supported)
8E	Program the peripheral parameters. Enable/Disable NMI as selected
90	Late POST initialization of system management interrupt.
A0	Check boot password if installed.
A1	Clean-up work needed before booting to OS.
A2	Takes care of runtime image preparation for different BIOS modules. Fill the free area in F000h segment with 0FFh. Initializes the Microsoft IRQ Routing Table. Prepares the runtime language module. Disables the system configuration display if needed.
A4	Initialize runtime language module.
A7	Displays the system configuration screen if enabled. Initialize the CPU's before boot, which includes the programming of the MTRR's.
A8	Prepare CPU for OS boot including final MTRR values.
A9	Wait for user input at config display if needed.
AA	Uninstall POST INT1Ch vector and INT09h vector. Deinitializes the ADM module.
AB	Prepare BBS for Int 19 boot.
AC	End of POST initialization of chipset registers.
B1	Save system context for ACPI.
00	Passes control to OS Loader (typically INT19h).

2.11 Serial ATA3 (SATA3) Hard Disks Installation

This motherboard adopts AMD SB850 chipset that supports Serial ATA3 (SATA3) hard disks and RAID functions. You may install SATA3 hard disks on this motherboard for internal storage devices. This section will guide you to install the SATA3 hard disks.

STEP 1: Install the SATA3 hard disks into the drive bays of your chassis.

STEP 2: Connect the SATA power cable to the SATA3 hard disk.

STEP 3: Connect one end of the SATA data cable to the motherboard's SATA3 connector.

STEP 4: Connect the other end of the SATA data cable to the SATA3 hard disk.

2.12 Hot Plug Function for SATA3 HDDs

This motherboard supports Hot Plug and Hot Swap functions for SATA3 in RAID / AHCI mode. AMD SB850 chipset provides hardware support for Advanced Host controller Interface (AHCI), a new programming interface for SATA host controllers developed thru a joint industry effort.



NOTE

What is Hot Plug Function?

If the SATA3 HDDs are NOT set for RAID configuration, it is called "Hot Plug" for the action to insert and remove the SATA3 HDDs while the system is still power-on and in working condition.

However, please note that it cannot perform Hot Plug if the OS has been installed into the SATA3 HDD.

What is Hot Swap Function?

If SATA3 HDDs are built as RAID 1 or RAID 5 then it is called "Hot Swap" for the action to insert and remove the SATA3 HDDs while the system is still power-on and in working condition.

2.13 SATA3 HDD Hot Plug Feature and Operation Guide

This motherboard supports Hot Plug feature for SATA3 HDD in RAID / AHCI mode. Please read below operation guide of Hot Plug feature carefully. Before you process the SATA3 HDD Hot Plug, please check below cable accessories from the motherboard gift box pack.

A. 7-pin SATA data cable

B. SATA power cable with SATA 15-pin power connector interface

A. SATA data cable (Red)

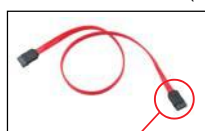

SATA 7-pin
connector

B. SATA power cable



The SATA 15-pin power
connector (Black) connect
to SATA3 HDD

1x4-pin conventional
power connector (White)
connect to power supply

Caution

1. Without SATA 15-pin power connector interface, the SATA3 Hot Plug cannot be processed.
2. Even some SATA3 HDDs provide both SATA 15-pin power connector and IDE 1x4-pin conventional power connector interfaces, the IDE 1x4-pin conventional power connector interface is definitely not able to support Hot Plug and will cause the HDD damage and data loss.

Points of attention, before you process the Hot Plug:

1. Below operation procedure is designed only for our motherboard, which supports SATA3 HDD Hot Plug.
 - * The SATA3 Hot Plug feature might not be supported by the chipset because of its limitation, the SATA3 Hot Plug support information of our motherboard is indicated in the product spec on our website: www.asrock.com
2. Make sure your SATA3 HDD can support Hot Plug function from your dealer or HDD user manual. The SATA3 HDD, which cannot support Hot Plug function, will be damaged under the Hot Plug operation.
3. Please make sure the SATA3 driver is installed into system properly. The latest SATA3 driver is available on our support website: www.asrock.com
4. Make sure to use the SATA power cable & data cable, which are from our motherboard package.
5. Please follow below instructions step by step to reduce the risk of HDD crash or data loss.

How to Hot Plug a SATA3 HDD:

Points of attention, before you process the Hot Plug:

Please do follow below instruction sequence to process the Hot Plug, improper procedure will cause the SATA3 HDD damage and data loss.

Step 1 Please connect SATA power cable 1x4-pin end (White) to the power supply 1x4-pin cable.

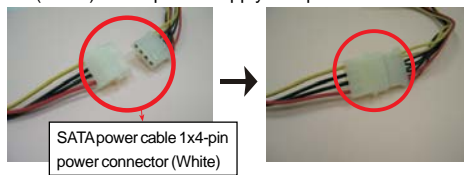

Step 2 Connect SATA data cable to the motherboard's SATA3 connector.



Step 3 Connect SATA 15-pin power cable connector (Black) end to SATA3 HDD.



Step 4 Connect SATA data cable to the SATA3 HDD.



How to Hot Unplug a SATA3 HDD:

Points of attention, before you process the Hot Unplug:

Please do follow below instruction sequence to process the Hot Unplug, improper procedure will cause the SATA3 HDD damage and data loss.

Step 1 Unplug SATA data cable from SATA3 HDD side.

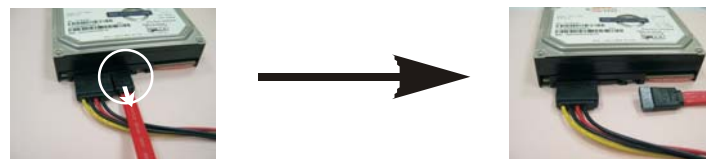

Step 2 Unplug SATA 15-pin power cable connector (Black) from SATA3 HDD side.

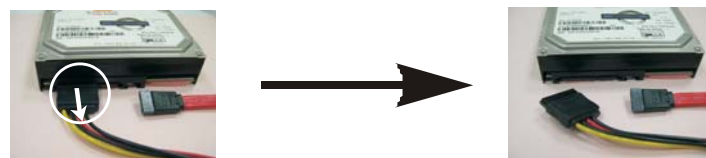

2.14 Driver Installation Guide

To install the drivers to your system, please insert the support CD to your optical drive first. Then, the drivers compatible to your system can be auto-detected and listed on the support CD driver page. Please follow the order from up to bottom side to install those required drivers. Therefore, the drivers you install can work properly.

2.15 Installing Windows® 7 / 7 64-bit / Vista™ / Vista™ 64-bit / XP / XP 64-bit With RAID Functions

If you want to install Windows® 7 / 7 64-bit / Vista™ / Vista™ 64-bit / XP / XP 64-bit on a RAID disk composed of 2 or more SATA3 HDDs with RAID functions, please follow below procedures according to the OS you install.

2.15.1 Installing Windows® XP / XP 64-bit With RAID Functions

If you want to install Windows® XP / XP 64-bit on a RAID disk composed of 2 or more SATA3 HDDs with RAID functions, please follow below steps.

STEP 1: Set up BIOS.

- A. Enter BIOS SETUP UTILITY → Advanced screen → Storage Configuration.
- B. Set the "SATA Operation Mode" option to [RAID].

STEP 2: Make a SATA3 Driver Diskette. (Please use USB floppy or floppy disk.)

- A. Insert the ASRock Support CD into your optical drive to boot your system.
- B. During POST at the beginning of system boot-up, press <F11> key, and then a window for boot devices selection appears. Please select CD-ROM as the boot device.
- C. When you see the message on the screen, "Generate Serial ATA driver diskette [Y/N]?", press <Y>.
- D. Then you will see these messages,
**All data in the disk will be destroyed,
proceed? [Y/N]**
Please insert a floppy diskette into the floppy drive, and press any key.
- E. The system will start to format the floppy diskette and copy SATA3 drivers into the floppy diskette.

STEP 3: Use “RAID Installation Guide” to set RAID configuration.

Before you start to configure RAID function, you need to check the RAID installation guide in the Support CD for proper configuration. Please refer to the BIOS RAID installation guide part of the document in the following path in the Support CD:

.. \ RAID Installation Guide

STEP 4: Install Windows® XP / XP 64-bit OS on your system.

After step 1, 2, 3, you can start to install Windows® XP / XP 64-bit OS on your system. At the beginning of Windows® setup, press F6 to install a third-party RAID driver. When prompted, insert the SATA3 driver diskette containing the AMD RAID driver. After reading the floppy disk, the driver will be presented. Select the driver to install according to the OS you install.

2.15.2 Installing Windows® 7 / 7 64-bit / Vista™ / Vista™ 64-bit With RAID Functions

If you want to install Windows® 7 / 7 64-bit / Vista™ / Vista™ 64-bit on a RAID disk composed of 2 or more SATA3 HDDs with RAID functions, please follow below steps.

STEP 1: Set up BIOS.

- A. Enter BIOS SETUP UTILITY → Advanced screen → Storage Configuration.
- B. Set the “SATA Operation Mode” option to [RAID].

STEP 2: Use “RAID Installation Guide” to set RAID configuration.

Before you start to configure RAID function, you need to check the RAID installation guide in the Support CD for proper configuration. Please refer to the BIOS RAID installation guide part of the document in the following path in the Support CD:

.. \ RAID Installation Guide

STEP 3: Make a SATA3 Driver Diskette.

Make a SATA3 driver diskette by following section 2.15.1 step 2 on page 35.

STEP 4: Install Windows® 7 / 7 64-bit / Vista™ / Vista™ 64-bit OS on your system.

2.16 Installing Windows® 7 / 7 64-bit / Vista™ / Vista™ 64-bit / XP / XP 64-bit Without RAID Functions

If you want to install Windows® 7 / 7 64-bit / Vista™ / Vista™ 64-bit / XP / XP 64-bit OS on your SATA3 HDDs without RAID functions, please follow below procedures according to the OS you install.

2.16.1 Installing Windows® XP / XP 64-bit Without RAID Functions

If you want to install Windows® XP / XP 64-bit on your SATA3 HDDs without RAID functions, please follow below steps.

Using SATA3 HDDs with NCQ and Hot Plug functions (AHCI mode)

STEP 1: Set Up BIOS.

- A. Enter BIOS SETUP UTILITY → Advanced screen → Storage Configuration.
- B. Set the "SATA Operation Mode" option to [AHCI].

STEP 2: Make a SATA3 Driver Diskette.

Make a SATA3 driver diskette by following section 2.15.1 step 2 on page 35.

STEP 3: Install Windows® XP / XP 64-bit OS on your system.

You can start to install Windows® XP / XP 64-bit OS on your system. At the beginning of Windows® setup, press F6 to install a third-party AHCI driver. When prompted, insert the SATA3 driver diskette containing the AMD AHCI driver. After reading the floppy disk, the driver will be presented. Select the driver to install according to the OS you install.

Using SATA3 HDDs without NCQ and Hot Plug functions (IDE mode)

STEP 1: Set up BIOS.

- A. Enter BIOS SETUP UTILITY → Advanced screen → Storage Configuration.
- B. Set the "SATA Operation Mode" option to [IDE].

STEP 2: Install Windows® XP / XP 64-bit OS on your system.

2.16.2 Installing Windows® 7 / 7 64-bit / Vista™ / Vista™ 64-bit Without RAID Functions

If you want to install Windows® 7 / 7 64-bit / Vista™ / Vista™ 64-bit on your SATA3 HDDs without RAID functions, please follow below steps.

Using SATA3 HDDs with NCQ and Hot Plug functions (AHCI mode)

STEP 1: Set Up BIOS.

- A. Enter BIOS SETUP UTILITY → Advanced screen → Storage Configuration.
- B. Set the “SATA Operation Mode” option to [AHCI].

STEP 2: Install Windows® 7 / 7 64-bit / Vista™ / Vista™ 64-bit OS on your system.

Using SATA3 HDDs without NCQ and Hot Plug functions (IDE mode)

STEP 1: Set up BIOS.

- A. Enter BIOS SETUP UTILITY → Advanced screen → Storage Configuration.
- B. Set the “SATA Operation Mode” option to [IDE].

STEP 2: Install Windows® 7 / 7 64-bit / Vista™ / Vista™ 64-bit OS on your system.

2.17 Untied Overclocking Technology

This motherboard supports Untied Overclocking Technology, which means during overclocking, FSB enjoys better margin due to fixed PCI / PCIE buses. Before you enable Untied Overclocking function, please enter “Overclock Mode” option of BIOS setup to set the selection from [Auto] to [CPU, PCIE, Async.]. Therefore, CPU FSB is untied during overclocking, but PCI / PCIE buses are in the fixed mode so that FSB can operate under a more stable overclocking environment.



Please refer to the warning on page 8 for the possible overclocking risk before you apply Untied Overclocking Technology.

3. BIOS SETUP UTILITY

3.1 Introduction

This section explains how to use the BIOS SETUP UTILITY to configure your system. The SPI Memory on the motherboard stores the BIOS SETUP UTILITY. You may run the BIOS SETUP UTILITY when you start up the computer. Please press <F2> or during the Power-On-Self-Test (POST) to enter the BIOS SETUP UTILITY, otherwise, POST will continue with its test routines.

If you wish to enter the BIOS SETUP UTILITY after POST, restart the system by pressing <Ctl> + <Alt> + <Delete>, or by pressing the reset button on the system chassis. You may also restart by turning the system off and then back on.



Because the BIOS software is constantly being updated, the following BIOS setup screens and descriptions are for reference purpose only, and they may not exactly match what you see on your screen.

3.1.1 BIOS Menu Bar

The top of the screen has a menu bar with the following selections:

- Main** To set up the system time/date information
- OC Tweaker** To set up overclocking features
- Advanced** To set up the advanced BIOS features
- H/W Monitor** To display current hardware status
- Boot** To set up the default system device to locate and load the Operating System
- Security** To set up the security features
- Exit** To exit the current screen or the BIOS SETUP UTILITY

Use <←> key or <→> key to choose among the selections on the menu bar, and then press <Enter> to get into the sub screen.

3.1.2 Navigation Keys

Please check the following table for the function description of each navigation key.

Navigation Key(s)	Function Description
← / →	Moves cursor left or right to select Screens
↑ / ↓	Moves cursor up or down to select items
+ / -	To change option for the selected items
<Enter>	To bring up the selected screen
<F1>	To display the General Help Screen
<F9>	To load optimal default values for all the settings
<F10>	To save changes and exit the BIOS SETUP UTILITY
<ESC>	To jump to the Exit Screen or exit the current screen

3.2 Main Screen

When you enter the BIOS SETUP UTILITY, the Main screen will appear and display the system overview.

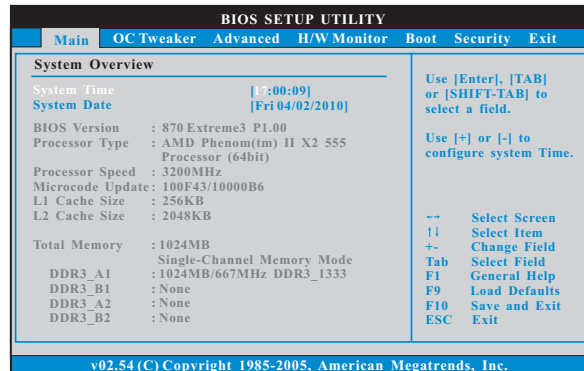

System Time [Hour:Minute:Second]

Use this item to specify the system time.

System Date [Day Month/Date/Year]

Use this item to specify the system date.

3.3 OC Tweaker Screen

In the OC Tweaker screen, you can set up overclocking features.

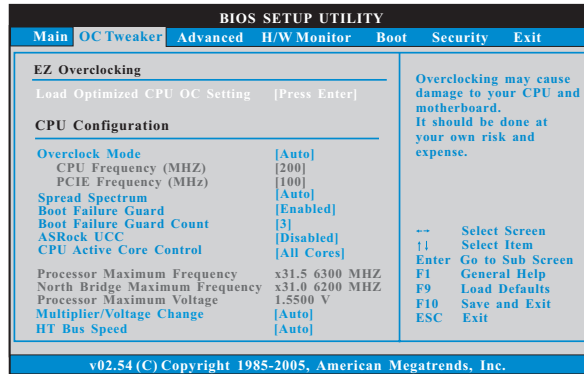

EZ Overclocking

Load Optimized CPU OC Setting

You can use this option to load the optimized CPU overclocking setting. Configuration options: [Press Enter], [Default], [5% (2625MHz)] to [50% (3750MHz)]. Please note that overclocking may cause damage to your CPU and motherboard. It should be done at your own risk and expense.

CPU Configuration

Overclock Mode

Use this to select Overclock Mode. The default value is [Auto]. Configuration options: [Auto], [CPU, PCIe, Sync.], [CPU, PCIe, Async.] and [Optimized].

CPU Frequency (MHz)

Use this option to adjust CPU frequency.

PCIe Frequency (MHz)

Use this option to adjust PCIe frequency.

Spread Spectrum

This item should always be [Auto] for better system stability.

Boot Failure Guard

Enable or disable the feature of Boot Failure Guard.

Boot Failure Guard Count

Enable or disable the feature of Boot Failure Guard Count.

ASRock UCC

ASRock UCC (Unlock CPU Core) feature simplifies AMD CPU activation. As long as a simple switch of the BIOS option "ASRock UCC", you can unlock the extra CPU core to enjoy an instant performance boost. When UCC feature is enabled, the dual-core or triple-core CPU will boost to the quad-core CPU, and some CPU, including quad-core CPU, can also increase L3 cache size up to 6MB, which means you can enjoy the upgrade CPU performance with a better price. Please be noted that UCC feature is supported with AM3 CPU only, and in addition, not every AM3 CPU can support this function because some CPU's hidden core may be malfunctioned.

CPU Active Core Control

This allows you to adjust CPU Active Core Control feature. The configuration options depend on the CPU core you adopt. The default value is [All Cores].

Processor Maximum Frequency

It will display Processor Maximum Frequency for reference.

North Bridge Maximum Frequency

It will display North Bridge Maximum Frequency for reference.

Processor Maximum Voltage

It will display Processor Maximum Voltage for reference.

Multiplier/Voltage Change

This item is set to [Auto] by default. If it is set to [Manual], you may adjust the value of Processor Frequency and Processor Voltage. However, it is recommended to keep the default value for system stability.

BIOS SETUP UTILITY						
Main	OC Tweaker	Advanced	H/W Monitor	Boot	Security	Exit
EZ Overclocking				Overclocking may cause damage to your CPU and motherboard. It should be done at your own risk and expense.		
Load Optimized CPU OC Setting [Press Enter]						
CPU Configuration						
Overclock Mode [Auto]						
CPU Frequency (MHZ) [200]						
PCIe Frequency (MHz) [100]						
Spread Spectrum [Auto]						
Boot Failure Guard [Enabled]						
Boot Failure Guard Count [3]						
ASRock UCC [Disabled]				-- Select Screen		
CPU Active Core Control [All Cores]				↑↓ Select Item		
Processor Maximum Frequency x31.5 6300 MHZ				Enter Go to Sub Screen		
North Bridge Maximum Frequency x31.0 6200 MHZ				F1 General Help		
Processor Maximum Voltage 1.5500 V				F9 Load Defaults		
Multiplier/Voltage Change [Manual]				F10 Save and Exit		
				ESC Exit		
v02.54 (C) Copyright 1985-2005, American Megatrends, Inc.						

CPU Frequency Multiplier

For safety and system stability, it is not recommended to adjust the value of this item.

CPU Voltage

It allows you to adjust the value of CPU voltage. However, for safety and system stability, it is not recommended to adjust the value of this item.

NB Frequency Multiplier

For safety and system stability, it is not recommended to adjust the value of this item.

NB Voltage

It allows you to adjust the value of NB voltage. However, for safety and system stability, it is not recommended to adjust the value of this item.

HT Bus Speed

This feature allows you selecting Hyper-Transport bus speed. Configuration options: [Auto], [x1 200MHz] to [x10 2000MHz].

HT Bus Width

This feature allows you selecting Hyper-Transport bus width. Configuration options: [Auto], [8 Bit] and [16 Bit].

Memory Configuration

Memory Clock

This item can be set by the code using [Auto]. You can set one of the standard values as listed: [400MHz DDR3_800], [533MHz DDR3_1066], [667MHz DDR3_1333] and [800MHz DDR3_1600].

DRAM Voltage

Use this to select DRAM voltage. Configuration options: [Auto], [1.337V] to [1.995V]. The default value is [Auto].

Memory Timing

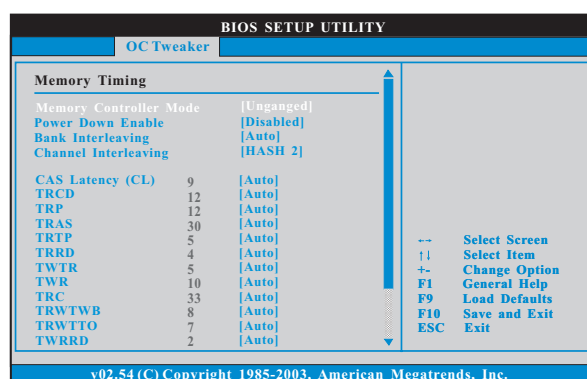

Memory Controller Mode

It allows you to adjust the memory controller mode. Configuration options: [Unganged] and [Ganged]. The default value is [Unganged].

Power Down Enable

Use this item to enable or disable DDR power down mode.

Bank Interleaving

Interleaving allows memory accesses to be spread out over banks on the same node, or across nodes, decreasing access contention.

Channel Interleaving

It allows you to enable Channel Memory Interleaving. Configuration options: [Disabled], [Address bits 6], [Address bits 12], [HASH 1] and [HASH 2]. The default value is [HASH 2].

CAS Latency (CL)

Use this item to adjust the means of memory accessing. Configuration options: [Auto], [4CLK] to [12CLK]. The default value is [Auto].

TRCD

Use this to adjust TRCD values. Configuration options: [Auto], [5CLK] to [12CLK]. The default value is [Auto].

TRP

Use this to adjust TRP values. Configuration options: [Auto], [5CLK] to [12CLK]. The default value is [Auto].

TRAS

Use this to adjust TRAS values. Configuration options: [Auto], [15CLK] to [30CLK]. The default value is [Auto].

TRTP

Use this to adjust TRTP values. Configuration options: [Auto], [4CLK] to [7CLK]. The default value is [Auto].

TRRD

Use this to adjust TRRD values. Configuration options: [Auto], [4CLK] to [7CLK]. The default value is [Auto].

TWTR

Use this to adjust TWTR values. Configuration options: [Auto], [4CLK] to [7CLK]. The default value is [Auto].

TWR

Use this to adjust TWR values. Configuration options: [Auto], [5CLK] to [12CLK]. The default value is [Auto].

TRC

Use this to adjust TRC values. Configuration options: [Auto], [11CLK] to [42CLK]. The default value is [Auto].

TRWTWB

Use this to adjust TRWTWB values. Configuration options: [Auto], [3CLK] to [18CLK]. The default value is [Auto].

TRWTTD

Use this to adjust TRWTTD values. Configuration options: [Auto], [3CLK] to [17CLK]. The default value is [Auto].

TWRRD

Use this to adjust TWRRD values. Configuration options: [Auto], [2CLK] to [10CLK]. The default value is [Auto].

TWRWR

Use this to adjust TWRWR values. Configuration options: [Auto], [2CLK] to [10CLK]. The default value is [Auto].

TRDRD

Use this to adjust TRDRD values. Configuration options: [Auto], [3CLK] to [10CLK]. The default value is [Auto].

TRFC0

Use this to adjust TRFC0 values. Configuration options: [Auto], [90ns], [110ns], [160ns], [300ns] and [350ns]. The default value is [Auto].

TRFC1

Use this to adjust TRFC1 values. Configuration options: [Auto], [90ns], [110ns], [160ns], [300ns] and [350ns]. The default value is [Auto].

MA Timing

Use this to adjust values for MA timing. Configuration options: [Auto], [2T], [1T]. The default value is [Auto].

CHA ADDR/CMD Delay

Use this to adjust values for CHA ADDR/CMD Delay feature. Configuration options: [Auto], [No Delay], [1/64CLK] to [31/64CLK]. The default value is [Auto].

CHA ADDR/CMD Setup

Use this to adjust values for CHA ADDR/CMD Setup feature. Configuration options: [Auto], [1/2CLK] and [1CLK]. The default value is [Auto].

CHA CS/ODT Delay

Use this to adjust values for CHA CS/ODT Delay feature. Configuration options: [Auto], [No Delay], [1/64CLK] to [31/64CLK]. The default value is [Auto].

CHA CS/ODT Setup

Use this to adjust values for CHA CS/ODT Setup feature. Configuration options: [Auto], [1/2CLK] and [1CLK]. The default value is [Auto].

CHB ADDR/CMD Delay

Use this to adjust values for CHB ADDR/CMD Delay feature. Configuration options: [Auto], [No Delay], [1/64CLK] to [31/64CLK]. The default value is [Auto].

CHB ADDR/CMD Setup

Use this to adjust values for CHB ADDR/CMD Setup feature. Configuration options: [Auto], [1/2CLK] and [1CLK]. The default value is [Auto].

CHB CS/ODT Delay

Use this to adjust values for CHB CS/ODT Delay feature. Configuration options: [Auto], [No Delay], [1/64CLK] to [31/64CLK]. The default value is [Auto].

CHB CS/ODT Setup

Use this to adjust values for CHB CS/ODT Setup feature. Configuration options: [Auto], [1/2CLK] and [1CLK]. The default value is [Auto].

CHA CKE Drive

Use this to adjust values for CHA CKE Drive. Configuration options: [Auto], [1.00x], [1.25x], [1.50x] and [2.00x]. The default value is [Auto].

CHA CS/ODT Drive

Use this to adjust values for CHA CS/ODT Drive. Configuration options: [Auto], [1.00x], [1.25x], [1.50x] and [2.00x]. The default value is [Auto].

CHA ADDR/CMD Drive

Use this to adjust values for CHA ADDR/CMD Drive. Configuration options: [Auto], [1.00x], [1.25x], [1.50x] and [2.00x]. The default value is [Auto].

CHA CLK Drive

Use this to adjust values for CHA CLK Drive. Configuration options: [Auto], [0.75x], [1.00x], [1.25x] and [1.50x]. The default value is [Auto].

CHA DATA Drive

Use this to adjust values for CHA DATA Drive. Configuration options: [Auto], [0.75x], [1.00x], [1.25x] and [1.50x]. The default value is [Auto].

CHA DQS Drive

Use this to adjust values for CHA DQS Drive. Configuration options: [Auto], [0.75x], [1.00x], [1.25x] and [1.50x]. The default value is [Auto].

CHA Processor ODT

Use this to adjust values for CHA Processor ODT. Configuration options: [Auto], [240 ohms], [120 ohms] and [60 ohms]. The default value is [Auto].

CHB CKE Drive

Use this to adjust values for CHB CKE Drive. Configuration options: [Auto], [1.00x], [1.25x], [1.50x] and [2.00x]. The default value is [Auto].

CHB CS/ODT Drive

Use this to adjust values for CHB CS/ODT Drive. Configuration options: [Auto], [1.00x], [1.25x], [1.50x] and [2.00x]. The default value is [Auto].

CHB ADDR/CMD Drive

Use this to adjust values for CHB ADDR/CMD Drive. Configuration options: [Auto], [1.00x], [1.25x], [1.50x] and [2.00x]. The default value is [Auto].

CHB CLK Drive

Use this to adjust values for CHB CLK Drive. Configuration options: [Auto], [0.75x], [1.00x], [1.25x] and [1.50x]. The default value is [Auto].

CHB DATA Drive

Use this to adjust values for CHB DATA Drive. Configuration options: [Auto], [0.75x], [1.00x], [1.25x] and [1.50x]. The default value is [Auto].

CHB DQS Drive

Use this to adjust values for CHB DQS Drive. Configuration options: [Auto], [0.75x], [1.00x], [1.25x] and [1.50x]. The default value is [Auto].

CHB Processor ODT

Use this to adjust values for CHB Processor ODT. Configuration options: [Auto], [240 ohms], [120 ohms] and [60 ohms]. The default value is [Auto].



Chipset Settings

HT Voltage

Use this to select Hyper-Transport voltage. Configuration options: [Auto], [1.200V] to [1.820V]. The default value is [Auto].

mGPU Voltage

Use this to select mGPU voltage. Configuration options: [Auto], [1.108V] to [1.794V]. The default value is [Auto].

SB Voltage

Use this to select SB voltage. Configuration options: [Auto], [1.10V] to [1.40V]. The default value is [Auto].

CPU VDDA Voltage

Use this to select CPU VDDA voltage. Configuration options: [Auto], [2.56V] and [2.70V]. The default value is [Auto].

PCIE VDDA Voltage

Use this to select PCIE VDDA voltage. Configuration options: [Auto], [1.81V] and [1.92V]. The default value is [Auto].

Would you like to save current setting user defaults?

In this option, you are allowed to load and save three user defaults according to your own requirements.



3.4 Advanced Screen

In this section, you may set the configurations for the following items: CPU Configuration, Chipset Configuration, ACPI Configuration, Storage Configuration, PCIPnP Configuration, SuperIO Configuration, and USB Configuration.

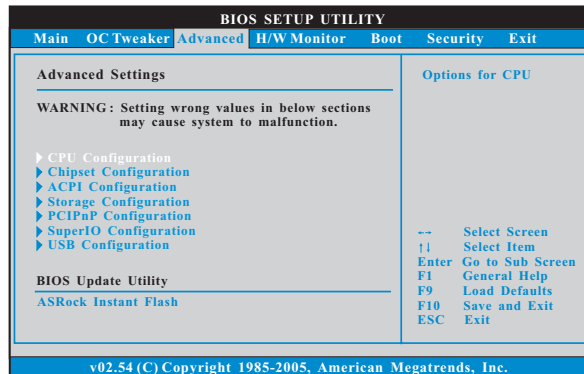

Setting wrong values in this section may cause the system to malfunction.

ASRock Instant Flash

ASRock Instant Flash is a BIOS flash utility embedded in Flash ROM. This convenient BIOS update tool allows you to update system BIOS without entering operating systems first like MS-DOS or Windows®. Just launch this tool and save the new BIOS file to your USB flash drive, floppy disk or hard drive, then you can update your BIOS only in a few clicks without preparing an additional floppy diskette or other complicated flash utility. Please be noted that the USB flash drive or hard drive must use FAT32/16/12 file system. If you execute ASRock Instant Flash utility, the utility will show the BIOS files and their respective information. Select the proper BIOS file to update your BIOS, and reboot your system after BIOS update process completes.

3.4.1 CPU Configuration

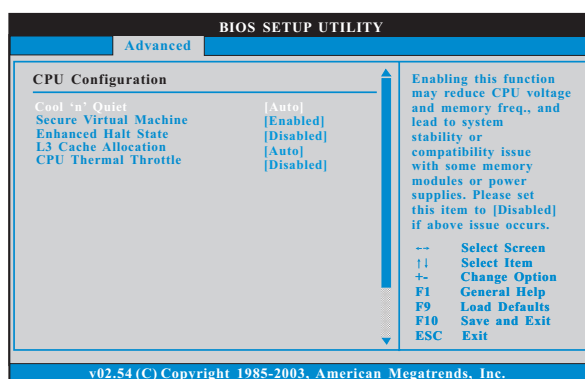

Cool 'n' Quiet

Use this item to enable or disable AMD's Cool 'n' Quiet™ technology. The default value is [Enabled]. Configuration options: [Auto], [Enabled] and [Disabled]. If you install Windows® Vista™ and want to enable this function, please set this item to [Enabled]. Please note that enabling this function may reduce CPU voltage and memory frequency, and lead to system stability or compatibility issue with some memory modules or power supplies. Please set this item to [Disable] if above issue occurs.

Secure Virtual Machine

When this option is set to [Enabled], a VMM (Virtual Machine Architecture) can utilize the additional hardware capabilities provided by AMD-V. The default value is [Enabled]. Configuration options: [Enabled] and [Disabled].

Enhance Halt State

All processors support the Halt State (C1). The C1 state is supported through the native processor instructions HLT and MWAIT and requires no hardware support from the chipset. In the C1 power state, the processor maintains the context of the system caches.

L3 Cache Allocation

The default value is [Auto]. Configuration options: [Auto], [BSP Only] and [All Cores].

CPU Thermal Throttle

Use this item to enable CPU internal thermal control mechanism to keep the CPU from overheated. Configuration options: [Disabled], [Auto], [12.5%], [25%], [37.5%], [50%], [62.5%], [75%] and [87.5%]. The default value is [Auto].

3.4.2 Chipset Configuration

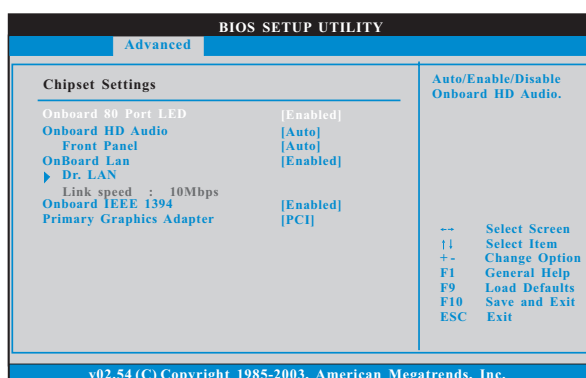

Onboard 80 Port LED

This allows you to enable or disable the onboard 80 port LED.

Onboard HD Audio

Select [Auto], [Enabled] or [Disabled] for the onboard HD Audio feature. If you select [Auto], the onboard HD Audio will be disabled when PCI Sound Card is plugged.

Front Panel

Select [Auto] or [Disabled] for the onboard HD Audio Front Panel.

OnBoard Lan

This allows you to enable or disable the onboard Lan feature.

Dr. LAN

This allows you to select "LAN Cable Detection" function.

Onboard IEEE 1394

This allows you to enable or disable the onboard IEEE 1394 feature.

Primary Graphics Adapter

This item will switch the PCI Bus scanning order while searching for video card. It allows you to select the type of Primary VGA in case of multiple video controllers. The default value of this feature is [PCI]. Configuration options: [PCI] and [PCI Express].

3.4.3 ACPI Configuration

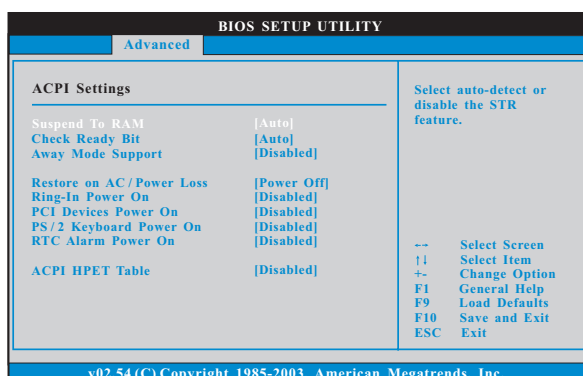

Suspend to RAM

Use this item to select whether to auto-detect or disable the Suspend-to-RAM feature. Select [Auto] will enable this feature if the OS supports it.

Check Ready Bit

Use this item to enable or disable the feature Check Ready Bit.

Away Mode Support

Use this item to enable or disable Away Mode support under Windows® XP Media Center OS. The default value is [Disabled].

Restore on AC/Power Loss

This allows you to set the power state after an unexpected AC/power loss. If [Power Off] is selected, the AC/power remains off when the power recovers. If [Power On] is selected, the AC/power resumes and the system starts to boot up when the power recovers.

Ring-In Power On

Use this item to enable or disable Ring-In signals to turn on the system from the power-soft-off mode.

PCI Devices Power On

Use this item to enable or disable PCI devices to turn on the system from the power-soft-off mode.

PS/2 Keyboard Power On

Use this item to enable or disable PS/2 keyboard to turn on the system from the power-soft-off mode.

RTC Alarm Power On

Use this item to enable or disable RTC (Real Time Clock) to power on the system.

ACPI HPET Table

Use this item to enable or disable ACPI HPET Table. The default value is [Disabled]. Please set this option to [Enabled] if you plan to use this motherboard to submit Windows® Vista™ certification.

3.4.4 Storage Configuration

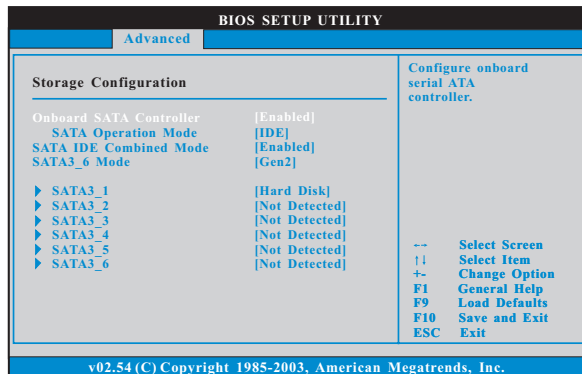

Onboard SATA Controller

Use this item to enable or disable the “Onboard SATA Controller” feature.

SATA Operation Mode

Use this item to adjust SATA Operation Mode. The default value of this option is [IDE]. Configuration options: [AHCI], [RAID] and [IDE].



If you set this item to RAID mode, it is suggested to install SATA ODD driver on SATA3_5 port.

SATA IDE Combined Mode

This item is for SATA3_5 and eSATA ports only. Use this item to enable or disable SATA IDE combined mode. The default value is [Enabled].



If you want to build RAID on SATA3_5 and eSATA ports, please disable this item.

SATA3_6 Mode

Use this item to select eSATA mode. Configuration mode: [Auto] and [Gen2]. The default value is [Gen2].

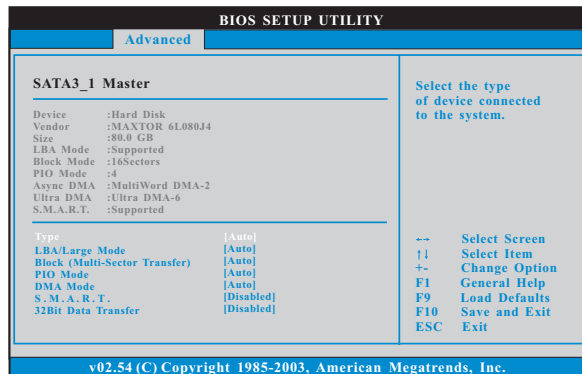

TYPE

Use this item to configure the type of the IDE device that you specify.

Configuration options: [Not Installed], [Auto], [CD/DVD], and [ARMD].

[Not Installed]: Select [Not Installed] to disable the use of IDE device.

[Auto]: Select [Auto] to automatically detect the hard disk drive.



After selecting the hard disk information into BIOS, use a disk utility, such as FDISK, to partition and format the new IDE hard disk drives. This is necessary so that you can write or read data from the hard disk. Make sure to set the partition of the Primary IDE hard disk drives to active.

[CD/DVD]: This is used for IDE CD/DVD drives.

[ARMD]: This is used for IDE ARMD (ATAPI Removable Media Device), such as MO.

LBA/Large Mode

Use this item to select the LBA/Large mode for a hard disk > 512 MB under DOS and Windows; for Netware and UNIX user, select [Disabled] to disable the LBA/Large mode.

Block (Multi-Sector Transfer)

The default value of this item is [Auto]. If this feature is enabled, it will enhance hard disk performance by reading or writing more data during each transfer.

PIO Mode

Use this item to set the PIO mode to enhance hard disk performance by optimizing the hard disk timing.

DMA Mode

DMA capability allows the improved transfer-speed and data-integrity for compatible IDE devices.

S.M.A.R.T.

Use this item to enable or disable the S.M.A.R.T. (Self-Monitoring, Analysis, and Reporting Technology) feature. Configuration options: [Disabled], [Auto], [Enabled].

32Bit Data Transfer

Use this item to enable 32-bit access to maximize the IDE hard disk data transfer rate.

3.4.5 PCIPnP Configuration

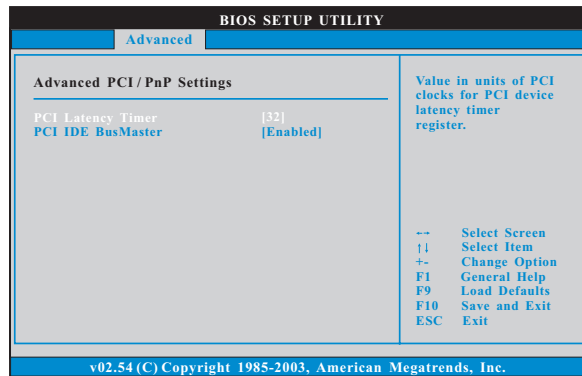

Setting wrong values in this section may cause the system to malfunction.

PCI Latency Timer

The default value is 32. It is recommended to keep the default value unless the installed PCI expansion cards' specifications require other settings.

PCI IDE BusMaster

Use this item to enable or disable the PCI IDE BusMaster feature.

3.4.6 Super IO Configuration

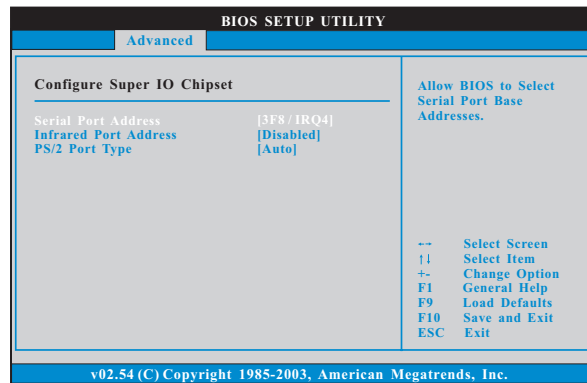

Serial Port Address

Use this item to set the address for the onboard serial port or disable it.
Configuration options: [Disabled], [3F8 / IRQ4], [2F8 / IRQ3], [3E8 / IRQ4], [2E8 / IRQ3].

Infrared Port Address

Use this item to set the address for the onboard infrared port or disable it.
Configuration options: [Disabled], [3F8 / IRQ4], [2F8 / IRQ3], [3E8 / IRQ4] and [2E8 / IRQ3].

PS/2 Port Type

Use this item to set the PS/2 port type.

3.4.7 USB Configuration

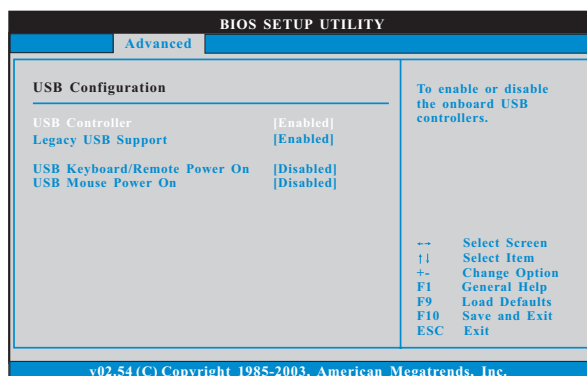

USB Controller

Use this item to enable or disable the use of USB controller.

Legacy USB Support

Use this option to select legacy support for USB devices. There are four configuration options: [Enabled], [Auto], [Disabled] and [BIOS Setup Only]. The default value is [Enabled]. Please refer to below descriptions for the details of these four options:

[Enabled] - Enables support for legacy USB.

[Auto] - Enables legacy support if USB devices are connected.

[Disabled] - USB devices are not allowed to use under legacy OS and BIOS setup when [Disabled] is selected. If you have USB compatibility issue, it is recommended to select [Disabled] to enter OS.

[BIOS Setup Only] - USB devices are allowed to use only under BIOS setup and Windows / Linux OS.

USB Keyboard/Remote Power On

Use this item to enable or disable USB Keyboard/Remote Power On on the system.

USB Mouse Power On

Use this item to enable or disable USB Mouse Power On on the system.

3.5 Hardware Health Event Monitoring Screen

In this section, it allows you to monitor the status of the hardware on your system, including the parameters of the CPU temperature, motherboard temperature, CPU fan speed, chassis fan speed, and the critical voltage.

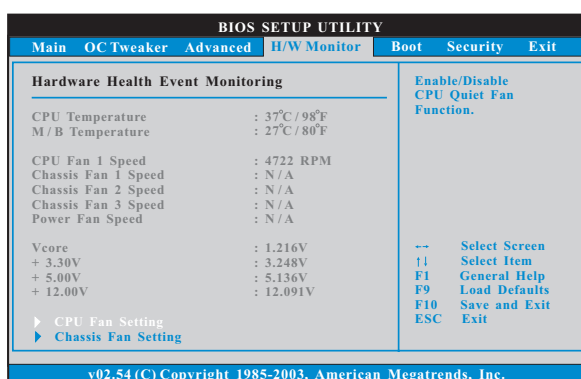

CPU Fan Setting

This allows you to set the CPU fan speed. Configuration options: [Full On] and [Automatic mode]. The default is value [Full On].

Chassis Fan 1 Setting

This allows you to set the chassis fan 1 speed. Configuration options: [Full On] and [Manual mode]. The default is value [Full On].

Chassis Fan 2 Setting

This allows you to set the chassis fan 2 speed. Configuration options: [Full On] and [Manual mode]. The default is value [Full On].

Chassis Fan 3 Setting

This allows you to set the chassis fan 3 speed. Configuration options: [Full On] and [Manual mode]. The default is value [Full On].

3.6 Boot Screen

In this section, it will display the available devices on your system for you to configure the boot settings and the boot priority.

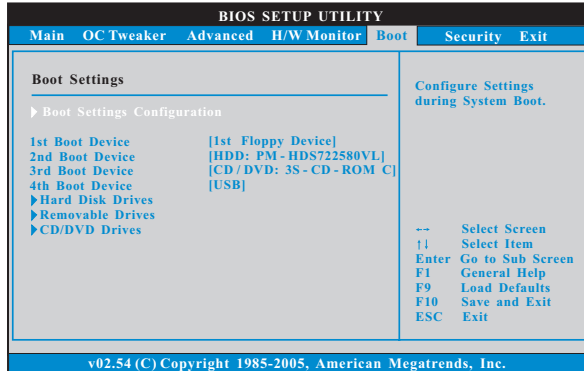

3.6.1 Boot Settings Configuration

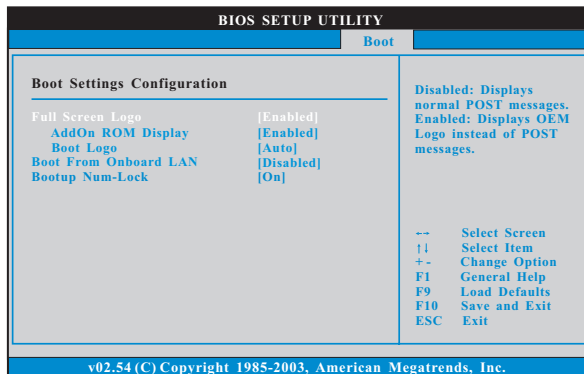

Full Screen Logo

Use this item to enable or disable OEM Logo. The default value is [Enabled].

AddOn ROM Display

Use this option to adjust AddOn ROM Display. If you enable the option "Full Screen Logo" but you want to see the AddOn ROM information when the system boots, please select [Enabled]. Configuration options: [Enabled] and [Disabled]. The default value is [Enabled].

Boot Logo

Use this option to select logo in POST screen. This option only appears when you enable the option "Full Screen Logo". Configuration options: [Auto], [EuP], [Scenery] and [ASRock]. The default value is [Auto]. Currently, the option [Auto] is set to Aircraft.

Boot From Onboard LAN

Use this item to enable or disable the Boot From Onboard LAN feature.

Boot Up Num-Lock

If this item is set to [On], it will automatically activate the Numeric Lock function after boot-up.

3.7 Security Screen

In this section, you may set or change the supervisor/user password for the system. For the user password, you may also clear it.

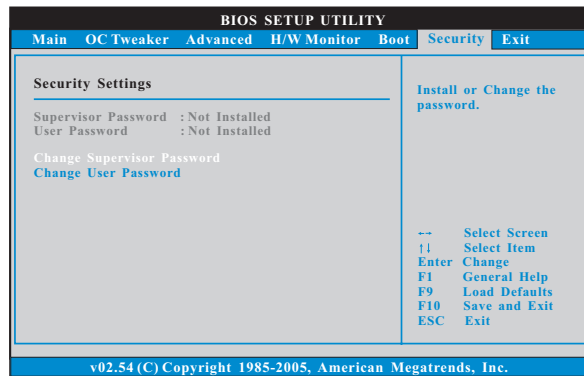

3.8 Exit Screen

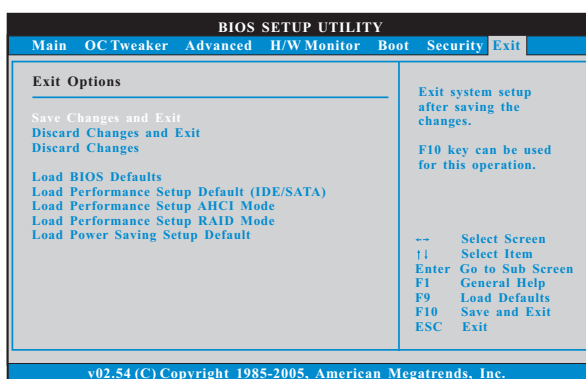

Save Changes and Exit

When you select this option, it will pop-out the following message, "Save configuration changes and exit setup?" Select [OK] to save the changes and exit the BIOS SETUP UTILITY.

Discard Changes and Exit

When you select this option, it will pop-out the following message, "Discard changes and exit setup?" Select [OK] to exit the BIOS SETUP UTILITY without saving any changes.

Discard Changes

When you select this option, it will pop-out the following message, "Discard changes?" Select [OK] to discard all changes.

Load BIOS Defaults

Load BIOS default values for all the setup questions. F9 key can be used for this operation.

Load Performance Setup Default (IDE/SATA)

This performance setup default may not be compatible with all system configurations. If system boot failure occurs after loading, please resume optimal default settings. F5 key can be used for this operation.

Load Performance Setup AHCI Mode

This performance setup AHCI mode may not be compatible with all system configurations. If system boot failure occurs after loading, please resume optimal default settings. F3 key can be used for this operation.

Load Performance Setup RAID Mode

This performance setup RAID mode may not be compatible with all system configurations. If system boot failure occurs after loading, please resume optimal default settings. F4 key can be used for this operation.

Load Power Saving Setup Default

Load power saving setup default. F6 key can be used for this operation.

4. Software Support

4.1 Install Operating System

This motherboard supports various Microsoft® Windows® operating systems: 7 / 7 64-bit / Vista™ / Vista™ 64-bit / XP / XP Media Center / XP 64-bit. Because motherboard settings and hardware options vary, use the setup procedures in this chapter for general reference only. Refer to your OS documentation for more information.

4.2 Support CD Information

The Support CD that came with the motherboard contains necessary drivers and useful utilities that enhance the motherboard features.

4.2.1 Running The Support CD

To begin using the support CD, insert the CD into your CD-ROM drive. The CD automatically displays the Main Menu if "AUTORUN" is enabled in your computer. If the Main Menu did not appear automatically, locate and double click on the file "ASSETUP.EXE" from the BIN folder in the Support CD to display the menus.

4.2.2 Drivers Menu

The Drivers Menu shows the available devices drivers if the system detects the installed devices. Please install the necessary drivers to activate the devices.

4.2.3 Utilities Menu

The Utilities Menu shows the applications software that the motherboard supports. Click on a specific item then follow the installation wizard to install it.

4.2.4 Contact Information

If you need to contact ASRock or want to know more about ASRock, welcome to visit ASRock's website at <http://www.asrock.com>; or you may contact your dealer for further information.