

User's Manual

*AudioCodes Gateway & Session Border Controller Series*

# Mediant 1000B Gateway and E-SBC

Version 7.2



 audiocodes

## Notice

Information contained in this document is believed to be accurate and reliable at the time of printing. However, due to ongoing product improvements and revisions, AudioCodes cannot guarantee accuracy of printed material after the Date Published nor can it accept responsibility for errors or omissions. Updates to this document can be downloaded from <https://www.audiocodes.com/library/technical-documents>.

This document is subject to change without notice.

Date Published: August-09-2020

## WEEE EU Directive

Pursuant to the WEEE EU Directive, electronic and electrical waste must not be disposed of with unsorted waste. Please contact your local recycling authority for disposal of this product.

## Customer Support

Customer technical support and services are provided by AudioCodes or by an authorized AudioCodes Service Partner. For more information on how to buy technical support for AudioCodes products and for contact information, please visit our website at <https://www.audiocodes.com/services-support/maintenance-and-support>.

## Documentation Feedback

AudioCodes continually strives to produce high quality documentation. If you have any comments (suggestions or errors) regarding this document, please fill out the Documentation Feedback form on our website at <https://online.audiocodes.com/documentation-feedback>.

## Stay in the Loop with AudioCodes



## Notes and Warnings



The device is an indoor unit and therefore, must be installed only **INDOORS**.



The scope of this document does not fully cover security aspects for deploying the device in your environment. Security measures should be done in accordance with your organization's security policies. For basic security guidelines, refer to the



*Recommended Security Guidelines* document.



Throughout this manual, unless otherwise specified, the term *device* refers to your AudioCodes product.



Before configuring the device, ensure that it is installed correctly as instructed in the *Hardware Installation Manual*.



**OPEN SOURCE SOFTWARE.** Portions of the software may be open source software and may be governed by and distributed under open source licenses, such as the terms of the GNU General Public License (GPL), the terms of the Lesser General Public License (LGPL), BSD and LDAP , which terms are located at <https://www.audiocodes.com/services-support/open-source> and all are incorporated herein by reference. If any open source software is provided in object code, and its accompanying license requires that it be provided in source code as well, Buyer may receive such source code by contacting AudioCodes , by following the instructions available on AudioCodes website.



- Some of the features described in this document are licensed features and are available only if the installed License Key contains these features.



- This device includes software developed by the OpenSSL Project for use in the OpenSSL Toolkit (<http://www.openssl.org/>).
- This device includes cryptographic software written by Eric Young ([ey@cryptsoft.com](mailto:ey@cryptsoft.com)).

## Related Documentation

Document Name
<a href="#">SBC-Gateway Series Release Notes for Latest Release Versions</a>
<a href="#">SBC-Gateway Series Release Notes for Long Term Support Versions</a>
<a href="#">Mediant 1000B Gateway and E-SBC Hardware Installation Manual</a>
<a href="#">Mediant 1000B Gateway &amp; E-SBC Quick Guide</a>
<b>Complementary Guides</b>
<a href="#">Gateway and SBC CLI Reference Guide</a>

Document Name
<a href="#">Mediant 1000B Gateway &amp; E-SBC SNMP Reference Guide</a>
<a href="#">IP-based Voice Mail Configuration Note</a>
<a href="#">Recommended Security Guidelines</a>
<a href="#">SIP Message Manipulation Syntax Reference Guide</a>
<a href="#">CAS Protocol Table Configuration Note</a>
<b>Utility Guides</b>
<a href="#">INI Viewer &amp; Editor Utility User's Guide</a>
<a href="#">DConvert User's Guide</a>
<a href="#">CLI Wizard User's Guide</a>

## Document Revision Record

LTRT	Description
27041	Initial document release for Version 7.2.
27043	<ul style="list-style-type: none"> <li>■ Updated to path version 7.20A.001.</li> <li>■ Updated sections: Computer Requirements (browser support); Accessing the Web Interface (autocompletion); Areas of the GUI (illustration); Searching for Configuration Parameters (IP address removed); CLI-Based Management (permissible user levels); Configuring TLS Certificate Contexts (TLS version); Configuring Physical Ethernet Ports (show command); Configuring Underlying Ethernet Devices (max. VLANs); InterfaceTable_ InterfaceName; SIP Signaling Messages; First Incoming Packet Mechanism (by Signaling); Viewing IDS Alarms (show command); Viewing and Deleting DHCP Clients (show command); Configuring the Device's LDAP Cache; Centralized Third-Party Routing Server (SIP messages, credentials for authentication); Configuring the SEM Server (port removed); Configuring Call Setup Rules (dial plan query); Call Setup Rule Examples; Three-Way Conferencing; Registration Refreshes; Enabling Interworking of SIP and SIP-I Endpoints (SPIROU, SIP header X-AC-Action); Configuring BroadSoft's Shared Phone Line Call Appearance for Survivability (procedure); User Information File; Automatic Provisioning (CLI Script file); Configuring RTCP XR (media</li> </ul>

LTRT	Description
	<p>segment, publication IP Group); Enabling Same Call Session ID over Multiple Devices (removed); FXS Line Testing (removed).</p> <ul style="list-style-type: none"> <li>■ New sections: Utilizing Gateway Channel Resources for SBC; Using Dial Plan Tags for IP-to-IP Routing (procedure); Using Dial Plan Tags for Call Setup Rules; Using Dial Plan Tags for Message Manipulation.</li> <li>■ Updated parameters: Web password; TLSContexts_TLSVersion; IPGroup_MediaRealm (Web name); CallSetupRules_AttributesToQuery (Web name); IPProfile_SBCRTCPFeedback; IpProfile_MediaIPVersionPreference; ForwardOnBusyTrunkDest_ForwardDestination; ConditionTable_Name (max. chars); Test_CallRouteBy (default); CLIPrivPass; NATMode (NAT by Signaling); SendAcSessionIDHeader (removed); QOEPort (removed); MaxGeneratedRegistersRate; EnableTCPConnectionReuse (Web name); RTCPXRESCTransportType (removed); RTCPXRESclP (removed); RTCPXRReportMode; PublicationIPGroupID; SBCUserRegistrationGraceTime; SBCKeepOriginalCallId.</li> <li>■ New parameters: <b>IPGroup_SBCKeepOriginalCallID</b>; <b>IPGroup_SBCDialPlanName</b>; <b>IPGroup_CallSetupRulesSetId</b>; CallSetupRules_QueryType; CallSetupRules_QueryTarget; <b>IpProfile_SBCISUPVariant</b>; WebLoginBlockAutoComplete; EnforcePasswordComplexity; AUPDCliScriptURL; GeneratedRegistersInterval.</li> </ul>
27045	<ul style="list-style-type: none"> <li>■ Updated sections: Changing Index Position of Table Rows; Changing Index Position of Table Rows (IPSec removed); Enabling the HTTP Proxy Application (license); FXS/FXO Coefficient Types (REN); Direct Media; Configuring SBC IP-to-IP Routing (IP Group load balancing); MAC Address Placeholder in Configuration File Name; Technical Specifications (AMR-WB removed).</li> <li>■ New sections: Configuring IP Group Sets.</li> <li>■ Updated parameters: <b>SIPInterface_SBCDirectMedia</b>; <b>IPProfile_SBCDirectMediaTag</b>; IpProfile_DisconnectOnBrokenConnection; IP2IPRouting_DestType; IPOutboundManipulation_PrivacyRestrictionMode; BrokenConnectionEventTimeout.</li> <li>■ New parameters: IP2IPRouting_IPGroupSetName; EnableNonCallCdr; PGroupSet; IPGroupSetMember; NoRTPDetectionTimeout.</li> </ul>
27047	<ul style="list-style-type: none"> <li>■ Patch version 7.20A.100.</li> </ul>

LTRT	Description
	<ul style="list-style-type: none"> <li data-bbox="419 286 1278 1070">■ Updated sections: CLI (telnet removed); Areas of the GUI (SBC Wizard); Assigning Rows from Other Tables (search, add new, and view); Invalid Value Indications; Creating a Login Welcome Message; Configuring Management User Accounts (CLI); Enabling SSH with RSA Public Key for CLI (public key); Configuring TLS Certificate Contexts (DTLS); Assigning CSR-based Certificates to TLS Contexts; Generating Private Keys for TLS Contexts; SRTP using DTLS Protocol; Building and Viewing your Network Topology; Enabling SIP-based Media Recording; Configuring SIP Recording Rules; Configuring Proxy Sets (keep-alive); FXS/FXO Coefficient Types; DID Wink; Pre-Configured IP Groups; Normal Mode (CRP); Emergency Mode (CRP); Auto Answer to Registrations (CRP); License Key; Viewing the License Key; Obtaining License Key for Feature Upgrade (removed); Installing the a New License Key; Installing License Key through Web Interface; Upgrading SBC Capacity Licenses by OVOC License Pool; Viewing Device Information; Viewing Call Routing Status (removed); Configuring RTCP XR (IP Group); Configuring RADIUS Accounting (typo for Accounting-Request); Configuring Multi-Line Extensions and Supplementary Services; Automatic Provisioning (Startup CLI Script File).</li> <li data-bbox="419 1104 1278 1368">■ New sections: Customizing the Web Interface; Replacing the Corporate Logo; Replacing the Corporate Logo with an Image; Replacing the Corporate Logo with Text; Customizing the Product Name; Customizing the Favicon; SRTP using DTLS Protocol; SBC Wizard; Viewing the Device's Product Key; Saving Configuration to a File; Loading a Configuration File; Viewing Proxy Set Status; Local Handling of BRI Call Forwarding.</li> <li data-bbox="419 1402 1278 1749">■ Updated parameters: TLSContexts_ServerCipherString; TLSContexts_ClientCipherString; NATTranslation_SourceStartPort; NATTranslation_SourceEndPort; NATTranslation_TargetStartPort; NATTranslation_TargetEndPort; SNMPSysOid; SNMPTrapEnterpriseOid; EnableCoreDump (typo); HTTPSCipherString (removed); SSHAdminKey; SessionExpiresDisconnectTime; <b>ISDNJapanNTTimerT3JA</b>; BrokenConnectionEventTimeout; RADIUSRetransmission (default); RadiusTO (default).</li> <li data-bbox="419 1783 1278 1962">■ New parameters: WebUsers_SSHPublicKey; TLSContexts_DTLSVersion; TLSContexts_DHKeySize; ProxySet_SuccessDetectionRetries; ProxySet_SuccessDetectionInterval; ProxySet_FailureDetectionRetransmissions; ProxySet_MinActiveServersLB; WebUsers; WebFaviconFileUrl; ISDNSuppServ_</li> </ul>

LTRT	Description
	CFB2PhoneNumber; ISDNSuppServ_CFNR2PhoneNumber; ISDNSuppServ_CFU2PhoneNumber; ISDNSuppServ_NoReplyTime; AUPDStartupScriptURL; BRICallForwardHandling.
27050	<ul style="list-style-type: none"> <li>■ Updated sections: Configuring VoIP LAN Interface for OAMP (Web/CLI); Configuring Management User Accounts (typo); Enabling SNMP; Configuring Physical Ethernet Ports (ports); Configuring Ethernet Port Groups (0/3); Configuring IP Network Interfaces; Configuring LDAP Servers (max. and cache); Configuring Call Setup Rules; Alternative Routing Based on IP Connectivity (Busy Out); Alternative Routing Based on SIP Responses (Busy Out); Fixed Mapping of SIP Response to ISDN Release Reason; Fixed Mapping of ISDN Release Reason to SIP Response; Configuring SBC IP-to-IP Routing (note); Configuring SIP Response Codes for Alternative Routing Reasons; Configuring Charge Codes; SBC Wizard (screens); Auxiliary Files (SBC Wizard); Viewing IP Connectivity (typo); Creating Core Dump and Debug Files upon Device Crash (reset); Technical Specifications (Eth interfaces)</li> <li>■ New sections: Debugging Remote HTTP Services</li> <li>■ Updated parameters: IpProfile_SBCUseSilenceSupp (removed); SIPRecRouting_SRSIPGroupName; SIPInterface_InterfaceName (max. char); ProxySet_ProxyName (max. char); MessageManipulations_ManipulationName (max. char); MessagePolicy_Name (max. char); AllowedAudioCodersGroups_Name (max. char); AllowedVideoCodersGroups_Name (max. char); TelProfile_ProfileName (max. char); PREFIX_RouteName (max. char); GWRoutingPolicy_Name; PstnPrefix_RouteName (max. char); _ManipulationName (max. char); SBCAdmissionControl_AdmissionControlName (max. char); Classification_ClassificationName (max. char); IP2IPRouting_RouteName (max. char); SBCRoutingPolicy_Name (max. char); IPGroupSet_Name (max. char); IPInboundManipulation_ManipulationName (max. char); IPOutboundManipulation_ManipulationName (max. char); TelProfile_ECNIpMode (2 removed); SBCAdmissionControl_Rate; <b>EnableWebAccessFromAllInterfaces; ResetWebPassword; DisableSNMP; EnableCoreDump; SSHMaxLoginAttempts; IgnoreAlertAfterEarlyMedia; EnableBusyOut; ECNLPMODE; ISDNInCallsBehavior (defaults); SecureCallsFromIP (note); AltRoutingTel2IPEnable (note); ProtocolType (BRI removed); EnablePulseDialDetection (removed)</b></li> <li>■ New parameters: HTTPProxySyslogDebugLevel; ChargeCode_ChargeCodeName</li> </ul>

LTRT	Description
27052	<ul style="list-style-type: none"> <li data-bbox="419 286 927 315">■ Updated with patch version 7.20A.150.</li> <li data-bbox="419 344 1283 1010">■ Updated sections: Areas of the GUI (Configuration Wizard button); Enabling Disabling SNMP; Viewing Certificate Information (screen); Assigning Externally Created Private Keys to TLS Contexts (pass-phrase); Generating Private Keys for TLS Contexts (pass-phrase); Importing Certificates into Trusted Certificate Store (bulk import); Configuring Underlying Ethernet Devices (MTU); Configuring Firewall Settings (note); SIP-based Media Recording (max.); Configuring Remote Web Services (QoS routing); Centralized Third-Party Routing Server (QoS); Configuring Proxy Sets; Configuring CAS State Machines (note); Alternative Routing Based on IP Connectivity; Configuring SBC IP-to-IP Routing; Configuring IP Group Sets (dial plan tags); Configuring Dial Plans; Software Upgrade; Installing License Key through Web Interface; Upgrading SBC Capacity Licenses by OVOC License Pool; WizardSBC Configuration Wizard; Configuring RADIUS Accounting (typo); Configuring DTMF Tones for Test Calls; Configuring Basic Test Calls; Configuring SBC Test Call with External Proxy (removed); Channel Capacity.</li> <li data-bbox="419 1039 1283 1346">■ New sections: Configuring QoS-Based Routing by Routing Server; Microsoft Skype for Business Presence of Third-Party Endpoints; Registrar Stickiness; Configuring Pre-Parsing Manipulation Rules; Configuring Private Wire Interworking; Configuring Rerouting of Calls to Fax Destinations; Using Dial Plan Tags for Routing Destinations; FXS Line Testing; Disconnecting and Reconnecting HA; Viewing the License Key; Viewing the Device's Product Key; Debugging Web Services.</li> <li data-bbox="419 1375 1283 1839">■ Updated parameters: AccessList_Source_IP; AccessList_Source_Port; AccessList_Start_Port; AccessList_End_Port; HTTPRemoteServices_HTTPType (option 5); IPGroup_SBCDialPlanName (note); ProxySet_IsProxyHotSwap; ProxyIp_IpAddress; IpProfile_SBCRemoteReferBehavior (4); IpProfile_SBCPlayHeldTone; IP2IPRouting_Trigger (6); IP2IPRouting_DestType (12); DialPlanRule_Tag; SBCCDRFormat_FieldType (818); Test_Call_RouteBy; Test_Call_Play (tone); KeepAliveTrapPort (default); SBCtestID (removed); ProxyIPListRefreshTime; RegistrationRetryTime (note); EnableReansweringINFO; EnablePChargingVector (note); EnableTDMoverIP (2); EnableSBCApplication (default).</li> <li data-bbox="419 1868 1283 1973">■ New parameters: DeviceTable_MTU; SRD_SBCDialPlanName; SIPInterface_PreParsingManSetName; IPGroup_Tags; Account_RegistrarStickiness; Account_RegistrarSearchMode; Account_</li> </ul>



LTRT	Description
	<p>RegEventPackageSubscription; IpProfile_SBCFaxReroutingMode; IP2IPRouting_RoutingTagName; IP2IPRouting_InternalAction; IPGroupSet_Tags; CustomerSN; MaxRegistrationBackoffTime; MaxSDPSessionVersionId; UseRandomUser; UnregisterOnStartup; PresencePublishIPGroupId; EnableMSPresence; PreParsingManipulationSets; PreParsingManipulationRules; HookFlashFromMediaIP; MWINotificationTimeout; EnableTDMOverIPforTrunk; CASOrientedBoard; RoutingServerQualityStatus; RoutingServerQualityStatusRate; TelProfile_MWINotificationTimeout.</p>
27053	<ul style="list-style-type: none"> <li>■ Updated with patch Version 7.20A.152.</li> <li>■ Updated sections: Configuring the LDAP Search Filter Attribute (Web path); Enabling LDAP Searches for Numbers with Characters; Microsoft Skype for Business Presence of Third-Party Endpoints; Configuring the Device for Skype for Business Presence (example); Configuring Media Realm Extensions; Configuring SBC IP-to-IP Routing (back to the sender); Prerecorded Tones File; Loading a Configuration File (note)</li> <li>■ Updated parameters: SNMPReadOnlyCommunityString (max. chars); SNMPReadWriteCommunityString (max. chars); SNMPTrapCommunityString (max. chars); MediaRealmExtension_IPv4IF; MediaRealmExtension_IPv6IF; ProxySet_EnableProxyKeepAlive; PstnPrefix_SourceAddress; SIPSDPSessionOwner; AddPrefix2ExtLine</li> <li>■ New parameters: IPGroup_SBCUserStickiness; IPProfile_LocalRingbackTone; IPProfile_LocalHeldTone</li> </ul>
27055	<ul style="list-style-type: none"> <li>■ Updated with patch Version 7.20A.154.007</li> <li>■ Updated sections: Silence Suppression (removed); Fax / Modem Transparent Mode (silnce suppression removed); Configuring SIP Recording Rules (view sessions in CLI); Centralized Third-Party Routing Server (call preemption added); Pre-empting Existing Calls for E911 IP-to-Tel Calls; Locking and Unlocking the Device (typos); Viewing Active Alarms (max display); Technical Specifications (FXS)</li> <li>■ New sections: Configuring Additional Management Interfaces; Configuring Specific UDP Ports using Tag-based Routing</li> <li>■ Updated parameters: WebUsers_Password (note); InterfaceTable_ApplicationTypes; ProxySet_SuccessDetectionRetries (max); ProxySet_SuccessDetectionInterval (max); Account_</li> </ul>

LTRT	Description
	<p>RegistrarSearchMode (phys link); AudioCoders_Sce (global parameter removed); IpProfile_SCE (removed); IpProfile_SBCRemoteReferBehavior (new option 5); IPProfile_SBCRemoteHoldFormat (new option 6); IP2IPRouting_ InternalAction; SBCCDRFormat_Title (max. char.); WebUsers (CLI name); EnableWebAccessFromAllInterfaces; FaxBypassPayloadType; ModemBypassPayloadType; EnableSilenceCompression (removed)</p> <ul style="list-style-type: none"> <li>■ New parameters: SIPInterface_AdditionalUDPPorts; IPProfile_SBCSupportMultipleDTMFMethods; AdditionalManagementInterfaces; EnableWebAccessFromAllInterfaces; DefaultTerminalWindowHeight; ActiveAlarmTableMaxSize; SBCRemoveSIPSFFromNonSecuredTransport</li> </ul>
27056	<ul style="list-style-type: none"> <li>■ Updated with patch Version 7.20A.156.009</li> <li>■ Updated sections: Configuring Management User Accounts; Device Located behind NAT; Configuring a Static NAT IP Address for All Interfaces (removed); Configuring an HTTP-based OVOC Service; Configuring the OVOC Server (note re report mode); Configuring Call Setup Rules (ENUM); Call Setup Rule Examples (e.g., 5); Interworking SIP Early Media (figure); Prerecorded Tones File; Automatic Configuration Methods; DHCP-based Provisioning (note re resets); Viewing Device Status on Monitor Page (analog status)</li> <li>■ New sections: Using the Proprietary SIP X-AC-Action Header; Provisioning the Device using DHCP Option 160; Enabling SIP Call Flow Diagrams in OVOC</li> <li>■ Updated parameters: WebUsers_SessionLimit; WebUsers_SessionTimeout; <b>SRD_BlockUnRegUsers (option 2 updated); SIPInterface_AdditionalUDPPorts; SIPInterface_BlockUnRegUsers; IPGroup_SIPConnect;</b> CallSetupRules_QueryType (OPTION 3); CallSetupRules_QueryTarget; CallSetupRules_AttributesToQuery; CallSetupRules_Condition; <b>IpProfile_SBCSDPTimeAnswer; IpProfile_SBCPreferredPTime; IpProfile_SBCRemoteRepresentationMode (0 updated);</b> DialPlanRule_Tag; LoggingFilters_LogDestination (new option 3); LoggingFilters_CaptureType (new option 6); WebSessionTimeout (range); <b>StaticNatIP (removed); BriTEIAssignTrigger; BriTEIRemoveTrigger;</b> EnableSilenceDisconnect; FarEndDisconnectSilencePeriod; FarEndDisconnectSilenceMethod; FarEndDisconnectSilenceThreshold;</li> </ul>

LTRT	Description
	<p>BrokenConnectionDuringSilence;                      UseDisplayNameAsSourceNumber; SecureCallsFromIP;                      SBCDBRoutingSearchMode; SBCKeepContactUserinRegister</p> <ul style="list-style-type: none"> <li>■ New parameters: WebUsers_CliSessionLimit; IPGroup_UserUDPPortAssignment; NoAlarmForDisabledPort; CallFlowReportMode; DhcpOption160Support</li> <li>■ Miscellaneous: EMS/SEM replaced with One Voice Operations Center (OVOC) – text and screenshots</li> </ul>
27059	<ul style="list-style-type: none"> <li>■ Updated with Patch Version 7.20A.158</li> <li>■ Updated sections: Replacing the Corporate Logo with an Image (logo width removed); Replacing the Corporate Logo with Text; Customizing the Favicon (default); Creating a Login Welcome Message (no reset); Configuring Secured (HTTPS) Web; Disabling SNMP (reset); Configuring Underlying Ethernet Devices (Ethernet Output Device field); Configuring NAT Translation per IP Interface; Configuring Media (SRTP) Security (validation, no reset); Configuring Invalid RTP Packet Handling; LDAP-based Management and SIP Services (managed services); Configuring LDAP Server Groups (managed services); Configuring Registration Accounts; Configuring Rerouting of Calls to Fax Destinations; Configuring Call Preemption for SBC Emergency Calls (note removed); Configuring Call Survivability Mode (path); Configuring PSTN Fallback; Automatic Update from Remote Servers (AutoUpdatePredefinedTime); Viewing Gateway CDR History; Viewing SBC CDR History; CDR Field Description; CDR Fields for SBC Signaling (removed); Customizing CDRs for Gateway Calls; Configuring CDR Reporting; Storing CDRs on the Device; Enabling SIP Call Flow Diagrams in OVOC (note)</li> <li>■ New sections: Restoring the Default Corporate Logo Image; Customizing the Browser Tab Label; Configuring SNMP for OVOC; Enabling Same Call Session ID over Multiple Devices</li> <li>■ Updated parameters: LdapServerGroups_ServerType (2); SIPInterface_AdditionalUDPPorts; IPGroup_AuthenticationMode; ProxySet_ProxyName (forward slash); IpProfile_TranscodingMode ; IP2IPRouting_DestType (note); IP2IPRouting_DestIPGroupName (note); GWCDRFormat_FieldType (442); SBCCDRFormat_FieldType (442, 635); TelnetServerEnable; DisableSNMP; EnableLanWatchDog (removed); CDRLocalMaxFileSize (name change, max.); CDRLocalMaxNumOfFiles (name change); CDRLocalInterval (name change); SyslogOptimization (def); EnableMediaSecurity (no reset); EnableBusyOut (cable disconnect removed); TrunkLifeLineType</li> </ul>

LTRT	Description
	<p>(description); LifeLineType</p> <ul style="list-style-type: none"> <li>■ New parameters: Account_RegByServedIPG; Account_UDPPortAssignment; IpProfile_SBCAdaptRFC2833BWToVoiceCoderBW; TimeZoneFormat; CallDurationUnits; SendAcSessionIDHeader; SRTPTunnelingValidateRTPRxAuthentication; SRTPTunnelingValidateRTCPRxAuthentication; RTPFWInvalidPacketHandling; RtpFWNonConfiguredPTHHandling</li> <li>■ Miscellaneous: New AudioCodes logo; '.content' removed from manipulation syntax</li> </ul>
27061	<ul style="list-style-type: none"> <li>■ Updated to Patch Version 7.20A.200.019</li> <li>■ Updated Sections: Default OAMP IP Address; Configuring Management User Accounts (max.); Assigning CSR-based Certificates to TLS Contexts (SAN); Creating Self-Signed Certificates for TLS Contexts (SAN); DNS; Configuring Remote Web Services (Capture removed); HTTP-based Proxy Services; Debugging Remote HTTP Services; Configuring an HTTP-based OVOC Service; Configuring User Information; Configuring SBC User Info Table from a Loadable File; Configuring SIP Message Manipulation (max.); Configuring Tel-to-IP Routing Rules (dial plan tags); Configuring IP-to-Tel Routing Rules (sorcer IP Group); Interworking Media Security Protocols; Utilizing Gateway Channel Resources for SBC; Enabling the SBC Application (removed); Configuring Admission Control; Enabling the CRP Application (removed); Auxiliary Files (User Info): User Information File; Viewing the License Key; Upgrading SBC Capacity Licenses by OVOC License Pool; Restoring Factory Defaults through CLI (keep-network); Viewing Active Alarms (refresh and order); Viewing History Alarms (refresh and order); Viewing Proxy Set Status (name); Configuring RTCP XR (note); Configuring Reporting of Management User Activities (select all); Configuring Test Call Endpoints (max.)</li> <li>■ New Sections: Configuring Default DNS Servers; Configuring a DNS Server for HTTP Services; Configuring HTTP Proxy Servers; Configuring HTTP Locations; Configuring TCP/UDP Proxy Servers; Configuring Upstream Groups; Configuring Upstream Hosts; Configuring HTTP Directive Sets; Configuring HTTP Directives; Troubleshooting NGINX; Using Dial Plans for IP-to-Tel or Tel-to-IP Call Routing; Configuring MoH from External Audio Source; Configuring SBC MoH from External Media Source; Saving and Loading an ini Configuration to a File; Viewing IDS Active Blacklist; Saving and</li> </ul>

LTRT	Description
	<p>Loading a Configuration Package File</p> <ul style="list-style-type: none"> <li>■ Updated Parameters: WebUsers_SessionLimit (max/def); HTTPRemoteServices_HTTPType (Capture removed); CallSetupRules_AttributesToQuery; CallSetupRules_Condition; CallSetupRules_ActionSubject; CallSetupRules_ActionValue; MessageManipulations_MessageType; MessageManipulations_Condition; MessageManipulations_ActionValue; ConditionTable_Condition; PreParsingManipulationRules_MessageType; PreParsingManipulationRules_ReplaceWith; AudioCoders_Sce; IpProfile_SBCMediaSecurityMethod (2 removed); IPProfile_SBCRemoteHoldFormat; IPProfile_ReliableHoldToneSource; IpProfile_SBCPlayHeldTone; IP2IPRouting_InternalAction; TelProfile_IP2TelCutThroughCallBehavior (3); MaliciousSignatureDB_Pattern; SSHServerEnable (def); IsCiscoSCEMode (Gateway); NoRTPDetectionTimeout; SBCAdmissionControl (removed); DialPlanRule; HTTPProxySyslogDebugLevel (options); MediaChannels</li> <li>■ New Parameters: SRD_AdmissionProfile; MessageManipulations_ActionSubject SIPInterface_AdmissionProfile; IPGroup_AdmissionProfile; PREFIX_DestTags; PREFIX_SrcTags; PstnPrefix_SrcTags; PstnPrefix_DestTags; SBCAdmissionRule_MaxBurstPerUser; Rate Per User; GWUserInfoFileUrl; SBCUserInfoFileUrl; UserInfoFileURL; ConfPackageURL; DefaultPrimaryDnsServerIp; DefaultSecondaryDnsServerIp; MaxStreamingCalls; GWUserInfoTable; Tel2IPDialPlanName; IP2TelDialPlanName; SBCAdmissionProfile; SBCAdmissionRule; SBCUserInfoTable; ExternalMediaSource; HTTPPrimaryDNS; HTTPSecondaryDNS; HTTPServer; HTTPLocation; TcpUdpServer; UpstreamGroup; UpstreamHost; HTTPDirectiveSets; HTTPDirectives; OVOCService; MaxStreamingCalls</li> </ul>
27062	<ul style="list-style-type: none"> <li>■ Updated to Patch Version 7.20A.200.112</li> <li>■ Updated Sections: Accessing the Web Interface (remember me); Configuring Additional Management Interfaces (CLI removed); Configuring TLS Server Certificate Expiry Check (acCertificateExpiryAlarm); Fax / Modem NSE Mode (Gateway only); Building and Viewing SIP Entities in Topology View (access via logo); Remotely Resetting Device using SIP NOTIFY (SBC also); Locking and Unlocking the Device (cancel); License Key (floating); Viewing the License Key (floating / Device Type / License Server Status / Remote License Server Status – deleted / Remote License Server IP –</li> </ul>

LTRT	Description
	<p>deleted); Local License Key; SBC Capacity Licenses from Fixed License Pool; Saving and Loading an ini File (License Key of Redundant); Saving and Loading a Configuration Package File (SFTP); Triggers for Automatic Update (NOTIFY for SBC also); Viewing Active Alarms (format); Viewing History Alarms (format); CDR Field Description (Alerting Time [443]); Patterns for Denoting Phone Numbers and SIP URIs</p> <ul style="list-style-type: none"> <li>■ New Sections: Remotely Disconnecting Calls using SIP NOTIFY; SBC Capacity Licenses from Floating License; Applying Downloaded ini File after Graceful Timeout; Debug Recording on VoIP Interfaces</li> <li>■ Updated Parameters: SNMPUsers_PrivProtocol (4 and 5 removed); InterfaceTable_InterfaceName (default); "Prefix" replaced with "Pattern" for Web parameters and CLI commands and descriptions updated; CpMediaRealm_MediaRealmName (range); CpMediaRealm_PortRangeStart (note); MediaRealmExtension_PortRangeStart (note); SIPInterface_UDPPort (note); SIPInterface_TCPPort (note); SIPInterface_TLSPort (note); SIPInterface_AdditionalUDPPorts (note); IPGroup_ContactUser (val); IPGroup_Username (max. val); Account_ContactUser (max. val); GWUserInfoTable_Username (max. val); SBCUserInfoTable_LocalUser (max value); SBCUserInfoTable_Username (max. val); IpProfile_SBCMediaSecurityMethod (Both value added); IpProfile_SBCRemoteUpdateSupport (option 3 added); TrunkGroupSettings_ContactUser (max. val); PstnPrefix_SourceAddress (asterisk); ISDNSuppServ_UserId (max val); SBCAdmissionRule_RequestType; IP2IPRouting_DestType (Internal rules); GWCDFRFormat_FieldType (443); SBCCDFRFormat_FieldType (443); Test_Call_UserName (max. values); Test_Call_Play (note removed); <b>UserName (max. val); EnableForward;</b> UseRandomUser (description); MgmtUseLocalUsersDatabase (description); EnableSIPRemoteReset; SBCRandomizeExpires (description); TLSExpiryCheckStart; MediaChannels</li> <li>■ New Parameters: IpProfile_SBCRemoveUnKnownCrypto; DisableDualImageFeature; AdminStateLockControl; EnableFloatingLicense; AllocationProfile; AllocationRegisteredUsers; AllocationMediaSessions; AllocationSignalingSessions; LimitRegisteredUsers; LimitMediaSessions; LimitSignalingSessions; LimitTranscodingSessions; AupdGracefulShutdown; RetryAfterMode; SIPDigestAuthorizationURIMode</li> </ul>
27063	<ul style="list-style-type: none"> <li>■ Updated to Patch Version 7.20A.204.015</li> </ul>

LTRT	Description
	<ul style="list-style-type: none"> <li data-bbox="419 286 1278 712">■ Updated Sections: TLS for SIP Clients (no reset); First Incoming Packet Mechanism; Configuring TLS for SIP; Enabling IDS (no reset); Configuring Proxy Sets; Configuring Call Setup Rules (max.); Supported Audio Coders (G.722); Alternative Routing Based on SIP Responses; Advice of Charge Services for Euro ISDN; Configuring Charge Codes; Classification and Routing of Registered Users; Configuring Call Preemption for SBC Emergency Calls; Configuring Firewall Allowed Rules; Locking and Unlocking the Device (TLS sockets); SBC Capacity Licenses from Floating License; Viewing Average Call Duration; Event Representation in Syslog Messages; Creating Core Dump and Debug Files upon Device Crash</li> <li data-bbox="419 741 1278 891">■ New Sections: Configuring CSRF Protection; Configuring Firewall Rules to Allow Incoming OVOC Traffic; Configuring an HTTP GET Web Service; Configuring Classification Based on Tags; Viewing Floating License Reports; Configuring CDR Reporting to REST Server</li> <li data-bbox="419 920 1278 1507">■ Updated Parameters: EtherGroupTable_Mode; HTTPRemoteServices_HTTPType (8); HTTPRemoteServices_Policy; HTTPRemoteServices_PersistentConnection; HTTPRemoteServices_NumOfSockets (removed); HTTPRemoteServices_LoginNeeded (removed); <b>IPGroup_Tags</b>; ProxySet_EnableProxyKeepAlive; ProxySet_ProxyRedundancyMode; ProxySet_IsProxyHotSwap; ProxySet_ProxyLoadBalancingMethod; ProxySet_DNSResolveMethod; CallSetupRules_RulesSetID; CallSetupRules_QueryType (4); CallSetupRules_QueryTarget; TelProfile_EnableDigitDelivery (no reset); IPGroupSet_Tags; IPOutboundManipulation_SrcTags; TelnetServerIdleDisconnect; SNMPEngineIDString; NATMode (4); SIPSRequireClientCertificate (no reset); EnableIDS (no reset); EnableDigitDelivery2IP (no reset); <b>IdleABCDPattern</b>; EnableSIPRec (removed); <b>IpProfile_SBCRFC2833Behavior</b>; <b>IpProfile_SBCAlternativeDTMFMethod</b></li> <li data-bbox="419 1536 1278 1962">■ New Parameters: HTTPRemoteServices_BetweenGroupsPolicy; AdditionalUDPPortsMode; SIPInterface_CallSetupRulesSetId; ProxyKeepAliveUsingIPG; ProxyIp_Priority; ProxyIp_Weight; ChargeCode_Currency; ChargeCode_Multiplier; Classification_IPGroupSelection; Classification_IPGroupTagName; AdminState; AdminStateRestrictConnections; CSRFProtection; RestCdrReportLevel; RestCdrHttpServer; SSHRedundantProxyPort; AdditionalOutOfBandDtmfFormat; ISDNAoCAmountPerInterval; ISDNAoCMinIntervalGeneration; SBCURIComparisonExcludedParams; SbcRoutingTimeout; HTTPRemoteHosts_GroupID; HTTPRemoteHosts_PriorityInGroup</li> </ul>

LTRT	Description
27064	<ul style="list-style-type: none"> <li>■ Updated to Patch Version 7.20A.204.108</li> <li>■ Updated Sections: Enabling SSH with RSA Public Key for CLI (Admin key removed); Interfaces Table Configuration Guidelines (31); Device Located behind NAT; Configuring Firewall Rules to Allow Incoming OVOC Traffic (note); Enabling the User Info Table; Configuring SBC User Information (note); Call Setup Rule Examples (ENUM); Using the Proprietary SIP X-AC-Action Header (REFER); Configuring Voice Mail; Call Processing of SIP Dialog Requests; RADIUS-based Management User Authentication (CLI); Enabling LDAP-based Web/CLI User Login Authentication and Authorization; Media Cluster (time); Collecting Debug Recording Messages; Viewing SBC Registered Users; Interworking SIP Diversion and History-Info Headers</li> <li>■ New Sections: Configuring a Static NAT IP Address for All Interfaces (returned)</li> <li>■ Updated Parameters: WebUsers_Password (\); WebUsers_SSHPublicKey; InterfaceTable_PrefixLength (31); InterfaceTable_Gateway; IPGroup_AuthenticationMode; IPGroup_Username; IPGroup_Password; ProxySet_ProxyRedundancyMode (note); CallSetupRules_QueryType (ENUM address); CallSetupRules_QueryTarget (ENUM); IpProfile_SBCRemoteReferBehavior; IP2IPRouting_DestType (note); SSHAdminKey (removed); SSHRequirePublicKey; BriTEIConfigP2P_x; BriLayer2Mode; BriTEIConfigP2MP_x; BriTEIAssignTrigger_x; BriTEIRemoveTrigger_x; DisableICMPUnreachable; IpProfile_SBCISUPBodyHandling (new value); LogoWidth (removed); GWInboundManipulationSet; GWOutboundManipulationSet</li> <li>■ New Parameters: StaticNatIP; ISDNIgnore18xWithoutSDP; ISDNSENDProgressForTE; ForceGenerateToTag; LdapConfiguration_NoOpTimeout</li> </ul>
27066	<p>Updated for software update Version 7.20A.250.</p> <ul style="list-style-type: none"> <li>■ Updated sections: Alternative Routing Based on SIP Responses (806 updated); CDR Field Description (SIP Local/Remote Tag); CLI-Based Management (user levels); Configuring Charge Codes (CLI command); Accessing Web (Log In button name); Configuring Management User Accounts (user level descriptions); Configuring Media (SRTP) Security (AES-256); Configuring Media Realms (max); Configuring SIP Recording Rules (note for SRTP-SRTP recording); Configuring the Internal DNS Table (note); Configuring the Internal</li> </ul>



LTRT	Description
	<p>SRV Table (max); Configuring Default DNS Servers; Configuring the Trunk Group Settings Table (max); Event Detection and Notification using X-Detect Header (note re CPT); HTTP Proxy Parameters (CLI); Prerecorded Tones File ("acUserDefine" and description); Restoring Factory Defaults through Web Interface (check box name); Three-Way Conferencing (3WayConfNoneAllocateablePorts added); Viewing Device Information (device uptime format); WebRTC (sessions); Configuring Trunk Groups (max); Configuring HTTP Directive Sets (values changed of limit_conn and limit_rate); File Location for Automatic Update (username-password); Configuring Source-Destination Number Manipulation Rules (TON-NPI)</p> <ul style="list-style-type: none"> <li>■ New sections: Configuring a Public IP Address for NGINX NAT Traversal; Configuring SIP Response Codes to Exclude from IDS; Configuring the Best Impedance Level; Debugging PSTN Calls through CLI; Displaying Line Impedance Test Results; FXO Line Impedance Matching Testing; Running the Line Impedance Test</li> <li>■ Updated parameters: CliScriptURL (typo); CLIScriptURL (typo); AccessList_Protocol ("sip" removed); IDSRule_Reason (CAC, exclusion of SIP cause codes); IPGroup_SIPConnect (options and descriptions); IPGroup_MethodList ("setup-invite"); IpProfile_SBCRemote3xxBehavior (new options 3 and 4); IPProfile_LocalRingbackTone (PRT userdefine); IPProfile_LocalHeldTone (PRT userdefine); LoggingFilters_CaptureType (option 7 added, note added for option 4); WebUsers_PwAgeInterval (description and note); ProxySet_ClassificationInput (note); ProxySet_ClassificationInput (note and example); ProxySet_DNSResolveMethod (max. hostnames); ProxyIp_IpAddress (note for IP addresses); HTTPRemoteServices_KeepAliveTimeOut (description and note removed); RTCPIInterval (Web name changed); SIPInterface_PreClassificationManipulationSet (note if classification fails); GWCDRFormat_FieldType (445 and 446 added); SBCCDRFormat_FieldType (445 and 446 added); GWInboundManipulationSet (CLI); GWOutboundManipulationSet (CLI); NTPServerUTCOffset (range); UdpPortSpacing (default); T38FaxMaxBufferSize (default); VQMonEnable (reset M1K); NumOfSubscribes (note removed); SBCServerAuthMode (note re IPGroup_TypeSBCServerAuthType); SRTPOfferedSuites (AES-256); TDMBusFallbackClock (removed); TelnetServerEnable (note); AUPDDigestUsername (removed); AUPDDigestPassword (removed); EnablePulseDialGeneration (removed); PulseDialGenerationBreakTime (removed); PulseDialGenerationMakeTime (removed);</li> </ul>

LTRT	Description
	<p>PulseDialGenerationInterDigitTime (removed); Account_RegistrarStickiness; IP2IPRouting_RequestType (note); ActivityListToLog (ard removed)</p> <ul style="list-style-type: none"> <li>■ New parameters: CallSetupRules_RulesSetName; IPGroup_TypeSBCServerAuthType; IPGroup_OAuthHTTPService; Account_AccountName; SBCAlternativeRoutingReasons_AltReasonName; PPreferredIdListMode; HttpProxyGlobalAddress; NoSdpForIsdnPi; 3WayConfNoneAllocateablePorts (old); DialPlanCSVFileUrl; Account_ReRegisterOnInviteFailure; AccountInviteFailureTriggerCodes</li> </ul>
27067	<p>Updated to Patch Version 7.20A.252.011.</p> <ul style="list-style-type: none"> <li>■ Updated sections: Areas of the GUI (password on toolbar and hostname); Assigning CSR-based Certificates to TLS Contexts; Assigning Externally Created Private Keys to TLS Contexts (Status field); Assigning IDS Policies (fields renamed); CDR Field Description (Media List and Call Success added); Centralized Third-Party Routing Server (Call Forking added); Configuring Call Admission Control (note); Configuring Basic Test Calls (note); Configuring Call Setup Rules (HTTP Post Notification); Configuring CDR Filters and Report Level (CDR End parameters); Configuring Classification Rules (capacity); Configuring Coder Groups (note re G.729ab); Configuring Dial Plans (capacity and range); Configuring Ethernet Port Groups (device reset); Configuring Physical Ethernet Ports (device reset); Configuring Gateway User Information Table through Web Interface (table name); Configuring ICMP Messages (parameter names); Configuring IDS Policies (editable defaults/WebSocket failures); Configuring IP Groups (capacity); Configuring Management User Accounts; Configuring Media Realm Extensions (removed); Configuring Password Display in ini File; Configuring Proxy Sets (edit and capacity); Configuring SBC Routing Policy Rules (capacity); Configuring SIP Interfaces (capacity); Configuring SIP Response Codes for Alternative Routing Reasons; Configuring SNMP Trap Destinations with IP Addresses; Configuring SRDs (capacity); Configuring Static IP Routes (reset removed); Configuring Syslog Debug Level (typo); Configuring Test Call Endpoints; Configuring the Device's LDAP Cache (typo); Configuring the OVOC Server for QoE (table renamed); Configuring the Syslog Server Address (path); Configuring TLS Certificate Contexts; Configuring Trunk Settings; Creating Core Dump and Debug Files upon Device Crash (note); Creating Self-Signed Certificates for TLS Contexts (CN); CRP Configuration (note); Customizing CDRs for Gateway Calls (JSON); Customizing CDRs for SBC Calls and Test Calls (JSON); Dial Plan</li> </ul>

LTRT	Description
	<p>(backward compatibility sections removed); Enabling SIP Call Flow Diagrams in OVOC; Enabling Syslog (path); Initial Registration Request Processing; Installing a License Key String; No-Op Packets (DSP note removed); Saving and Loading CLI Script Files (optional reset); Saving and Loading a Configuration Package File; Saving and Loading an ini Configuration File; SBC Capacity Licenses from Floating License (note on ignore licenses); Viewing Gateway CDR History (test calls removed); Viewing IDS Alarms (WebSocket failures); Viewing Logged-In User Information; Changing OAMP Address through Web Interface</p> <ul style="list-style-type: none"> <li>■ New sections: Changing Login Password by All User Levels; Configuring a Hostname for the Device; Configuring Password Display in CLI; Configuring User-Defined Performance Monitoring MIBs; Configuring Syslog Message Severity Level; Customizing Access Levels per Web Page; Customizing SNMP Alarm Severity; Exporting Dial Plans; Idle CLI Session Timeout for RS-232 Connections; Importing Dial Plans; Miscellaneous CDR Configuration; Syslog Message Description for CPU Overload; Viewing CDR History of SBC and Test Calls</li> <li>■ New parameters: MatrixCsvFileUrl; IpProfile_CreatedByRoutingServer; HTTPRemoteServices_LoginNeeded; HTTPRemoteServices_VerifyCertificateSubjectName; Test_Call_OfferedCodersGroupName; Test_Call_AllowedAudioCodersGroupName; Test_Call_AllowedCodersMode; Test_Call_MediaSecurityMode; Test_Call_PlayDTMFMethod; Test_Call_MediaSecurityMode; QOESettings_VerifyCertificateSubjectName; Hostname; ShortCallSeconds; FXSOffhookTimeoutAlarm; SyslogLogLevel; CallEndCDRSIPReasonsFilter; CallEndCDRZeroDurationFilter; KeyPortConfigure; CLIEnableModePassword; CliObscuredPassword</li> <li>■ Updated parameters: CallSetupRules_QueryType (HTTP POST Query / HTTP POST Notification); CallSetupRules_QueryTarget (Web name changed); CallSetupRules_AttributesToQuery (Web name changed); CallSetupRules_ActionType (None value added); InterfaceTable_PrefixLength (values); IpProfile_SBCRemoteReferBehavior (Keep URI (user@host)); IpProfile_AMDMaxPostSilenceGreetingTime (default); LoggingFilters_Value (Any removed); LoggingFilters_CaptureType (note added to 2 and 4); WebUsers_Password (note); IP2IPRouting_DestTyp (Gateway value update); SNMPTrapCommunityStringPassword (name change); SNMPReadWriteCommunityStringsPassword (name change);</li> </ul>

LTRT	Description
	<p>SNMPReadOnlyCommunityStringsPassword (name change); Test_Call_RouteBy (Tel-to-IP removed); Test_Call_DestTransportType (SCTP added); Test_Call_PlayDTMFMethod (In Band value); Test_Call_Play (PRT and NetAnn); QOESettings (parameters renamed); TLSContexts_ServerCipherString (default); TLSContexts_ClientCipherString (default); ProgressIndicator2ISDN (2 added); GWCDRFormat_CDRTYPE (JSON Gateway added); GWCDRFormat_FieldType (447); GracefulBusyOutTimeout (range); ntpAuthMd5KeyPassword (renamed); PM_EnableThresholdAlarms</p>
27068	<p>Updated to Patch Version 7.20A.254.202.</p> <ul style="list-style-type: none"> <li>■ Updated sections: Configuring Allowed Video Coder Groups (typo); Filtering IP Network Traces (IPv6); Starting the SBC Configuration Wizard (screenshot and typos); CDR Field Description (codes for termination reasons; RELEASE_BECAUSE_ACCOUNT_NOT_REGISTERED removed); Viewing Tel-to-IP and IP-to-Tel Call Counters (page title); Configuring Call Setup Rules (False/True value); Customizing the Product Name (no reset); Configuring TLS for SIP (figure updated); ; Configuring SIP Response Codes for Alternative Routing Reasons; Configuring Message Session Relay Protocol</li> <li>■ New sections: Customizing CDR Indication for Call Success or Failure based on Responses; Configuring Video Recording Synchronization; Enabling DNS Rebinding Protection</li> <li>■ Updated parameters: IpProfile_SbcPrackMode (new options 0 and 4); SIP Group Name; TLSContexts_TLSVersion (option [5] TLSv1.0 and TLSv1.2 removed); IsUserPhone (Gateway only); NoOpInterval (range and default); ShortCallSeconds (Web parameter); InterfaceTable_PrefixLength (range for IPv6); IpProfile_SBCMediaSecurityBehaviour (values renamed); IPGroup_DTLSContext (Web name change);</li> <li>■ New parameters: IPGroup_TopologyHidingHeaderList; CallSuccessSIPReasons; CallFailureSIPReasons; CallSuccessInternalReasons; CallFailureInternalReasons; NoUserResponseBeforeConnectSuccess; NoUserResponseAfterConnectSuccess; CallTransferredBeforeConnectSuccess; CallTransferredAfterConnectSuccess; VideoRecordingSyncTimeout; SIPInterface_SCTPPort; SBCAltRoutingReasonsSet; SBCAltRoutingReasonsList; IPGroup_SBCAltRouteReasonsSetName; MFTransportType; ; DNSrebindingProtectionEnabled; IpProfile_SBCMSRPOfferSetupRole; IpProfile_</li> </ul>

LTRT	Description
	<p>SBCMSRPreinviteUpdateSupport; IpProfile_DataDiffServ; CpMediaRealm_TCPPortRangeStart; CpMediaRealm_TCPPortRangeEnd</p>
27069	<p>Updated to Version 7.20A.254.375</p> <ul style="list-style-type: none"> <li>■ Updated sections: Syslog Message Format; Configuring Message Session Relay Protocol (MSRP Empty Message Format parameter); Configuring Web Session and Access Settings (Password Change Interval updated); Configuring SIP Response Codes for Alternative Routing Reasons (18x followed by failure response); Obtaining License Key for Initial Activation (removed)</li> <li>■ Updated parameters: WebUserPassChangeInterval (changed to WebPassChangeInterval and description); TargetOfChannel_HotLineToneDuration (CLI command typo); QSIGTunnelingMode (CLI command added); SelectSourceHeaderForCalledNumber (Web name added and value typos); IpProfile_SBCRemoteUpdateSupport (Web name changed); IPProfile_LocalRingbackTone (Web name typo)</li> <li>■ New parameters: IPProfile_SBCMSRPEmpMsg; SecondCallingNumberSource</li> </ul>
27070	<ul style="list-style-type: none"> <li>■ Updated to Version 7.20A.254.475</li> <li>■ Updated sections: CDR Field Description (CALL_CONNECT); Saving and Loading ini Configuration File (file contents); Adding ELINs to the Location Information Server (ELIN tag); Direct Media or Media Bypass (transfer termination note)</li> <li>■ New parameters: IpProfile_SBCMmultipleCoders; FailedOptionsRetryTime; MinWebPasswordLen; IPGroup_TeamsMediaOptimization; IPGroup_InternalMediaRealm; FormatDestPhoneNumber; SBC100TryingUponReinvite; TLSContexts_TlsRenegotiation; IpProfile_SBCMmultipleCoders; SecondCallingNumberSource; FormatDestPhoneNumber; SBC100TryingUponReinvite</li> <li>■ Updated parameters: DialPlanRule_Prefix (max digits); Answer Detector parameters removed (EnableAnswerDetector, AnswerDetectorActivityDelay, AnswerDetectorSilenceTime, AnswerDetectorRedirection, AnswerDetectorSensitivity); SBCSessionExpires (Web name updated); UseGatewayNameForOptions; SIPGatewayName; EtherGroupTable_Mode (typo values 0 and 1)</li> </ul>

LTRT	Description
27071	<p>Updated to Version 7.20A.256.024.</p> <ul style="list-style-type: none"> <li>■ New sections: Configuring Push Notification Service; Configuring Push Notification Servers; Remote Monitoring of Device behind NAT</li> <li>■ Updated sections: Customizing Access Levels per Web Page (note for pages can't be customized); Disabling Guarantee of DSPs on SDP Offer; Centralized Third-Party Routing Server (routing fallback); Accessing the Web Interface (remember username); CDR Field Description; Customizing CDRs for SBC Calls and Test Calls</li> <li>■ New parameters: ScreeningInd2ISDN1; ScreeningInd2ISDN2; SystemLogSize; IPGroup_SIPSourceHostName; SIPTopologyHidingMode; IPProfile_SBCIceMode; ReserveDSPOnSDPOffer; PushNotificationServers; PNSReminderPeriod; PNSRegisterTimeout; IPGroup_TeamsMOInitialBehavior; FailedOptionsRetryTime; RemoteMonitoringEnable; RemoteMonitoringPeriod; RemoteMonitoringDeviceEnable; RemoteMonitoringAlarmsEnable; RemoteMonitoringPMEable; RemoteMonitoringSIPUsersEnable</li> <li>■ Updated parameters: FailedOptionsRetryTime; ScreeningInd2ISDN; ResetWebPassword; SBCAdmissionRule_MaxBurst (typo); PREFIX_DestAddress (* /x wildcards removed); DNSRebindingProtectionEnabled (Web name); ShortCallSeconds (Web name); IPGroup_TopologyHidingHeaderList (removed); DialPlanRule_Prefix (max); DialPlanRule_Tag (max); HTTPRemoteServices_HTTPType (Remote Monitoring); ProxySet_EnableProxyKeepAlive (Using OPTIONS on Active Server)</li> </ul>
27072	<p>Updated to Version 7.20A.256.366.</p> <ul style="list-style-type: none"> <li>■ New sections: Flex License Model; Viewing Flex License Utilization and Status Configuring WebSocket Tunnel with OVOC; SIP-to-ISDN Disconnect Release Cause Code Mapping</li> <li>■ Updated sections: Replacing the Corporate Logo with Text (CMD Shell removed); License Key (Flex License); V.150.1 Modem Relay (removed); Simultaneous Negotiation of Fax (T.38) and Modem (V.150.1) Relay (removed)</li> <li>■ New parameters: ISDNJapanNttTimerT305</li> <li>■ Updated parameters: WSTunServer; WSTunServerPath; WSTunUsername; WSTunPassword; WSTunSecured; WSTunVerifyPeer; V.150.1 parameters removed (V1501AllocationProfile, V1501SSEPayloadTypeRx,</li> </ul>

LTRT	Description
	<p>V1501SSERedundancyDepth,  V1501SPRTTransportChannel0MaxPayloadSize,  V1501SPRTTransportChannel2MaxPayloadSize,  V1501SPRTTransportChannel2MaxWindowSize,  V1501SPRTTransportChannel3MaxPayloadSize)</p>
27073	Updated section: Trunk Group and Routing Parameters (was missing)
27075	<ul style="list-style-type: none"> <li>■ Updated sections: Configuring User-Defined Performance Monitoring MIBs (CLI added); Web Login Authentication using Smart Cards (Web parameter added); Fixed License Pool Model; Floating License Model (example); Viewing Syslog Messages (Syslog Viewer added); Viewing Device Status on Monitor Page (stats screenshot)</li> <li>■ Updated parameters: EnableMgmtTwoFactorAuthentication (Web name); WSTunServerPath (default); WSTunUsername (default); WSTunPassword (default); AuthenticationMode (Web name and description)</li> <li>■ New parameters: CIDNotification;</li> </ul>
27076	<p>Updated to Version 7.20A.256.713.</p> <ul style="list-style-type: none"> <li>■ New sections: Hiding Caller and Callee CDR Field Values.</li> <li>■ Updated sections: Coder Transcoding (MediaChannels note removed); Generating Private Keys for TLS Contexts (private key size values); Viewing Device Status on Monitor Page (acPMSBCRegisteredUsersTable); Configuring an HTTP-based OVOC Service (ini names and CLI changed); Configuring Secured (HTTPS) Web (default OAMP and Additional Management Interfaces); Configuring TLS Certificate Contexts (ID 0 for all; default OAMP only 0); Configuring User-Defined Performance Monitoring MIBs (removed); Microsoft Teams with Local Media Optimization (name changed); removed all "SSL" and replaced with "TLS"; Transcoding by OVOC license (removed); Configuring RTP Base UDP Port (port range increased and range formula).</li> <li>■ Updated parameters: SCTPHeartbeatInterval (ranges); SCTPInitialRTO (range); SCTPMinimumRTO (range); SCTPMaximumRTO (range); SCTPMaxPathRetransmit (range); SCTPMaxAssociationRetransmit (range); SCTPMaxDataTxBurst (range); SCTPMaxDataChunksBeforeSACK (range); SCTPTimeoutBeforeSACK (range); TLSContexts_TLSVersion (values added); TLSContexts_ServerCipherString (default); TLSContexts_</li> </ul>

LTRT	Description
	<p>ClientCipherString (default); TLSContexts_DHKeySize (3072 added and default); MediaChannels; IpProfile_SBCEnhancedPlc (description); LdapConfiguration_LdapConfPassword (typo); LdapConfiguration_LdapConfBindDn (typo); UserDefinedFailurePM (removed); BaseUDPport (max ports); SBCUserRegistrationGraceTime (max); FakeTCPalias (RFC added/web param removed).</p> <ul style="list-style-type: none"> <li>■ New parameters: TLSContexts_KeyExchangeGroups; TLSContexts_ServerCipherTLS13String; TLSContexts_ClientCipherTLS13String; CDRHistoryPrivacy; FXOVoiceDelayon200OK</li> </ul>
27077	<p>Updated to Ver. 7.20A.256.721.</p> <ul style="list-style-type: none"> <li>■ Updated parameters: IPGroup_TeamsMediaOptimization (Web/CLI/INI name changed); IPGroup_TeamsMOInitialBehavior (Web/CLI/INI name changed)</li> </ul>
27078	<p>Updated to Ver. 7.20A.258.006.</p> <ul style="list-style-type: none"> <li>■ New sections: TLS Context Parameters Relevancy per Application; Out-of-Service Physical Reasons for FXS Port</li> <li>■ Updated sections: CDR Field Description Voice AI Connector ID/820, Voice AI Connector Name/821); Customizing CDRs for SBC Calls and Test Calls Voice AI Connector ID/820, Voice AI Connector Name/821); Restoring Default Corporate Logo (removed); Customizing the Favicon (restoring default removed); Configuring RTP Base UDP Port (sentence relating to old equation removed); Viewing Device Status on Monitor Page (typo with PM_gwINVITEDialogs); Direct Media or Media Bypass (note for ports)</li> <li>■ Updated parameters: WSTunServerPath (default); LifeLineType (note that one value only); InterfaceTable_IPAddress (description); SIPInterface_TCPPort / SIPInterface_TLSPort (different ports); SIPT38Version (Version 3 removed); SIPTCPTimeout (max)</li> <li>■ New parameters: ContextEngineID; StaticRouteTable_PreferredSourceInterfaceName</li> </ul>
27079	<p>Updated to Ver. 7.20A.260.005.</p> <ul style="list-style-type: none"> <li>■ New sections: On-Demand SIPRec Sessions; Example of Call Variables for CDR Customization</li> <li>■ Updated sections: CDR Field Description (Var Call User Defined added); Direct Media or Media Bypass (features not supported updated); Configuring HTTP POST Web Service (correction);</li> </ul>



LTRT	Description
	<p>Configuring an HTTP GET Web Service (correction); Collecting Debug Recording Messages (Wireshark improvements); Customizing CDRs for SBC Calls and Test Calls (Var Call User Defined and RADIUS CDR note); Configuring RADIUS Accounting (acct-status-type and acct-session-id); Third-Party Routing Server or AudioCodes Routing Manager (ARM Authentication)</p> <ul style="list-style-type: none"> <li>■ Updated parameters: DialPlanRule_Prefix (case-sensitive); DialPlanRule_Tag (no spaces); SIPInterface_CallSetupRulesSetId (note for CSR with HTTP GET); IPGroup_TypeSBCServerAuthType (ARM Authentication option added)</li> </ul>
29220	<ul style="list-style-type: none"> <li>■ Updated to Ver. 7.20A.258.119.</li> <li>■ Updated sections: CDR Field Description (Call Start for Var Call User Defined); Configuring Media (SRTP) Security ('a-crypto'); Coder Transcoding (CLI command for transcoding sessions); Configuring WebSocket Tunnel with OVOC (AWS only)</li> <li>■ Updated parameters: AMDTimeout (CLI command); SBCAltRoutingReasonsList_ReleaseCauseCode (805 Admission Failure removed); SBCRemoveSIPsFromNonSecuredTransport (web and CLI added); ENABLERAI (only Gateway), RAIHIGHTHRESHOLD (only Gateway), RAILOWTHRESHOLD (only Gateway)</li> <li>■ New parameters: WSTunServerPath (description); WSTunUsername (description); WSTunPassword (description); WSTunVerifyPeer (description)</li> </ul>

---

## Table of Contents

---

<b>1 Introduction</b> .....	<b>1</b>
Product Overview .....	1
Typographical Conventions .....	2
Getting Familiar with Configuration Concepts and Terminology .....	3
SBC Application .....	3
Gateway Application .....	8
<b>Part I</b> .....	<b>11</b>
<b>Getting Started with Initial Connectivity</b> .....	<b>11</b>
<b>2 Introduction</b> .....	<b>12</b>
<b>3 Default IP Address</b> .....	<b>13</b>
<b>4 Configuring VoIP LAN Interface for OAMP</b> .....	<b>14</b>
Changing OAMP Address through Web Interface .....	14
Changing OAMP Address through CLI .....	16
Changing OAMP Address through ini File .....	17
<b>Part II</b> .....	<b>19</b>
<b>Management Tools</b> .....	<b>19</b>
<b>5 Introduction</b> .....	<b>20</b>
<b>6 Web-Based Management</b> .....	<b>21</b>
Getting Acquainted with the Web Interface .....	21
Computer Requirements .....	21
Accessing the Web Interface .....	21
Areas of the GUI .....	23
Accessing Configuration Pages from Navigation Tree .....	26
Configuring Stand-alone Parameters .....	28
Configuring Table Parameters .....	29
Adding Table Rows .....	31
Assigning Rows from Other Tables .....	31
Modifying Table Rows .....	33
Deleting Table Rows .....	33
Invalid Value Indications .....	34
Viewing Table Rows .....	36
Sorting Tables by Column .....	37
Changing Index Position of Table Rows .....	38
Searching Table Entries .....	38
Searching for Configuration Parameters .....	39
Getting Help .....	40
Logging Off the Web Interface .....	41
Customizing the Web Interface .....	41
Replacing the Corporate Logo .....	41

Replacing the Corporate Logo with an Image .....	42
Replacing Corporate Logo with Text .....	43
Replacing Text with Corporate Logo .....	43
Customizing the Browser Tab Label .....	43
Customizing the Product Name .....	44
Customizing the Favicon .....	45
Creating a Login Welcome Message .....	46
Configuring Additional Management Interfaces .....	47
Configuring Management User Accounts .....	49
Customizing Access Levels per Web Page .....	57
Displaying Login Information upon Login .....	60
Viewing Logged-In User Information .....	61
Configuring Web Session and Access Settings .....	61
Changing Login Password by All User Levels .....	62
Configuring Secured (HTTPS) Web .....	64
Enabling CSRF Protection .....	65
Enabling DNS Rebinding Protection .....	66
Web Login Authentication using Smart Cards .....	66
Configuring Web and Telnet Access List .....	67
<b>7 CLI-Based Management .....</b>	<b>69</b>
Enabling CLI .....	69
Enabling Telnet for CLI .....	69
Enabling SSH with RSA Public Key for CLI .....	70
Configuring Maximum Telnet/SSH Sessions .....	72
Establishing a CLI Session .....	73
Viewing Current CLI Sessions .....	74
Terminating a User's CLI Session .....	74
Configuring Displayed Output Lines in CLI Terminal Window .....	75
Idle CLI Session Timeout for RS-232 Connections .....	76
Configuring Password Display in CLI .....	76
<b>8 SNMP-Based Management .....</b>	<b>77</b>
Disabling SNMP .....	77
Configuring SNMP Community Strings .....	77
Configuring SNMP Trap Destinations with IP Addresses .....	80
Configuring an SNMP Trap Destination with FQDN .....	82
Configuring SNMP Trusted Managers .....	83
Enabling SNMP Traps for Web Activity .....	83
Configuring SNMP V3 Users .....	84
Customizing SNMP Alarm Severity .....	86
Configuring SNMP for OVOC Connectivity .....	88
Configuring WebSocket Tunnel with OVOC .....	90
<b>9 INI File-Based Management .....</b>	<b>93</b>

INI File Format .....	93
Configuring Individual ini File Parameters .....	93
Configuring Table ini File Parameters .....	93
General ini File Formatting Rules .....	95
Configuring an ini File .....	96
Loading an ini File to the Device .....	96
Secured Encoded ini File .....	97
Configuring Password Display in ini File .....	97
INI Viewer and Editor Utility .....	98
<b>10 REST-Based Management .....</b>	<b>99</b>
<b>Part III .....</b>	<b>101</b>
<b>General System Settings .....</b>	<b>101</b>
<b>11 Date and Time .....</b>	<b>102</b>
Configuring Automatic Date and Time through SNTP .....	102
Configuring Manual Date and Time .....	103
Configuring the Time Zone .....	104
Configuring Daylight Saving Time .....	104
<b>12 Configuring a Hostname for the Device .....</b>	<b>106</b>
<b>Part IV .....</b>	<b>107</b>
<b>General VoIP Configuration .....</b>	<b>107</b>
<b>13 Network .....</b>	<b>108</b>
Building and Viewing your Network Topology .....	108
Configuring Physical Ethernet Ports .....	112
Configuring Ethernet Port Groups .....	114
Configuring Underlying Ethernet Devices .....	117
Configuring IP Network Interfaces .....	121
Networking Configuration Examples .....	127
Configuring Static IP Routes .....	130
Configuration Example of Static IP Routes .....	133
Troubleshooting the Static Routes Table .....	134
Network Address Translation Support .....	135
Device Located behind NAT .....	135
Configuring a Static NAT IP Address for All Interfaces .....	136
Configuring NAT Translation per IP Interface .....	136
Remote UA behind NAT .....	138
SIP Signaling Messages .....	138
Media (RTP/RTCP/T.38) .....	139
Robust Receipt of Media Streams by Media Latching .....	142
Configuring Quality of Service .....	143
Configuring Class-of-Service QoS .....	143
Configuring DiffServ-to-VLAN Priority Mapping .....	145

Configuring ICMP Messages .....	146
DNS .....	147
Configuring Default DNS Servers .....	148
Configuring the Internal DNS Table .....	148
Configuring the Internal SRV Table .....	150
Open Solution Network (OSN) Server .....	152
Configuring Native VLAN for OSN Server .....	152
Disabling Internal Switch Port for OSN .....	153
IP Multicasting .....	153
<b>14 Security .....</b>	<b>154</b>
Configuring TLS Certificates .....	154
Configuring TLS Certificate Contexts .....	154
Assigning CSR-based Certificates to TLS Contexts .....	160
TLS Context Parameters Relevancy per Application .....	162
Viewing Certificate Information .....	163
Assigning Externally Created Private Keys to TLS Contexts .....	164
Generating Private Keys for TLS Contexts .....	166
Creating Self-Signed Certificates for TLS Contexts .....	167
Importing Certificates into Trusted Root Certificate Store .....	168
Configuring TLS Server Certificate Expiry Check .....	170
Configuring TLS for Secured SIP .....	170
Configuring Mutual TLS Authentication .....	172
TLS for SIP Clients .....	172
TLS for Remote Device Management .....	173
Configuring Firewall Rules .....	173
Configuring Firewall Rules to Allow Incoming OVOC Traffic .....	178
Intrusion Detection System .....	180
Enabling IDS .....	181
Configuring IDS Policies .....	181
Assigning IDS Policies .....	187
Viewing IDS Alarms .....	189
Configuring SIP Response Codes to Exclude from IDS .....	192
<b>15 Media .....</b>	<b>194</b>
Configuring Voice Settings .....	194
Configuring Voice Gain (Volume) Control .....	194
Configuring Echo Cancellation .....	194
Fax and Modem Capabilities .....	195
Fax and Modem Operating Modes .....	196
Fax and Modem Transport Modes .....	196
T.38 Fax Relay Mode .....	197
G.711 Fax and Modem Transport Mode .....	200
Fax Fallback .....	201
Fax and Modem Bypass Mode .....	201
Fax and Modem NSE Mode .....	203

Fax and Modem Transparent with Events Mode .....	204
Fax / Modem Transparent Mode .....	205
RFC 2833 ANS Report upon Fax and Modem Detection .....	206
V.34 Fax Support .....	206
Bypass Mechanism for V.34 Fax Transmission .....	207
Relay Mode for T.30 and V.34 Faxes .....	207
V.152 Support .....	208
Configuring RTP/RTCP Settings .....	209
Configuring the Dynamic Jitter Buffer .....	209
Comfort Noise Generation .....	210
Configuring DTMF Transport Types .....	211
Configuring RFC 2833 Payload .....	213
Configuring RTP Base UDP Port .....	214
Configuring Invalid RTP/RTCP Packet Handling .....	215
Event Detection and Notification using X-Detect Header .....	215
SIT Event Detection .....	218
Detecting Answering Machine Beeps .....	219
SIP Call Flow Examples of Event Detection and Notification .....	220
Answering Machine Detection (AMD) .....	223
Configuring AMD .....	226
Enabling IP-to-Tel Call Disconnection upon Detection of Answering Machine .....	227
Automatic Gain Control (AGC) .....	228
Configuring Ground- or Loop-Start Signaling per Analog Port .....	229
Configuring DSP Templates .....	230
DSP Channel Resources for Transcoding .....	230
Configuring Media (SRTP) Security .....	232
<b>16 Services .....</b>	<b>235</b>
DHCP Server Functionality .....	235
Configuring the DHCP Server .....	235
Configuring the Vendor Class Identifier .....	241
Configuring Additional DHCP Options .....	242
Configuring Static IP Addresses for DHCP Clients .....	245
Viewing and Deleting DHCP Clients .....	246
On-Demand SIPRec Sessions .....	247
RADIUS-based Services .....	249
Enabling RADIUS Services .....	249
Configuring RADIUS Servers .....	249
Configuring Interface for RADIUS Communication .....	252
Configuring RADIUS Packet Retransmission .....	253
Configuring the RADIUS Vendor ID .....	253
RADIUS-based Management User Authentication .....	254
Setting Up a Third-Party RADIUS Server .....	255
Configuring RADIUS-based User Authentication .....	256
Securing RADIUS Communication .....	257

RADIUS-based User Authentication in URL .....	257
RADIUS-based CDR Accounting .....	258
LDAP-based Management and SIP Services .....	258
Enabling the LDAP Service .....	260
Enabling LDAP-based Web/CLI User Login Authentication and Authorization .....	261
Configuring LDAP Server Groups .....	261
Configuring LDAP Servers .....	264
Configuring LDAP DN's (Base Paths) per LDAP Server .....	270
Configuring the LDAP Search Filter Attribute .....	271
Configuring Access Level per Management Groups Attributes .....	272
Configuring the Device's LDAP Cache .....	274
Refreshing the LDAP Cache .....	276
Clearing the LDAP Cache .....	278
Configuring Local Database for Management User Authentication .....	278
LDAP-based Login Authentication Example .....	279
Enabling LDAP Searches for Numbers with Characters .....	283
AD-based Routing for Microsoft Skype for Business .....	284
Querying the AD and Routing Priority .....	284
Configuring AD-Based Routing Rules .....	288
Querying the AD for Calling Name .....	291
Least Cost Routing .....	292
Overview .....	292
Configuring LCR .....	295
Configuring Cost Groups .....	296
Assigning Cost Groups to Routing Rules .....	299
Remote Web Services .....	299
Configuring Remote Web Services .....	299
Configuring Remote HTTP Hosts .....	307
Enabling Topology Status Services .....	310
Enabling Registration Status Services .....	311
Third-Party Routing Server or AudioCodes Routing Manager .....	311
Configuring QoS-Based Routing by Routing Server .....	316
Configuring an HTTP GET Web Service .....	317
Configuring HTTP POST Web Service .....	319
HTTP-based Proxy Services .....	321
Enabling the HTTP Proxy Application .....	323
Debugging Remote HTTP Services .....	323
Configuring a DNS Server for HTTP Services .....	324
Configuring HTTP Proxy Servers .....	324
Configuring HTTP Locations .....	328
Configuring TCP-UDP Proxy Servers .....	333
Configuring Upstream Groups .....	336
Configuring Upstream Hosts .....	339
Configuring HTTP Directive Sets .....	341
Configuring HTTP Directives .....	342

Configuring an HTTP-based OVOC Service .....	343
Troubleshooting NGINX Configuration .....	348
Configuring a Public IP Address for NGINX NAT Traversal .....	349
<b>E9-1-1 Support for Microsoft Teams and Skype for Business .....</b>	<b>350</b>
About E9-1-1 Services .....	350
Microsoft Skype for Business and E9-1-1 .....	351
Gathering Location Information of Skype for Business Clients for 911 Calls .....	352
Adding ELINs to the Location Information Server .....	354
Passing Location Information to the PSTN Emergency Provider .....	354
AudioCodes ELIN Device for Teams / Skype for Business E9-1-1 Calls to PSTN .....	356
Detecting and Handling E9-1-1 Calls .....	357
Pre-empting Existing Calls for E9-1-1 Calls .....	359
PSAP Callback for Dropped E9-1-1 Calls .....	360
Selecting ELIN for Multiple Calls within Same ERL .....	361
Location Based Emergency Routing .....	361
Configuring AudioCodes ELIN Device .....	362
Enabling the E9-1-1 Feature .....	362
Configuring the E9-1-1 Callback Timeout .....	362
Configuring the SIP Release Cause Code for Failed E9-1-1 Calls .....	363
Configuring SBC IP-to-IP Routing Rule for E9-1-1 .....	363
Configuring Location-Based Emergency Routing .....	364
Viewing the ELIN Table .....	365
Microsoft Skype for Business Presence of Third-Party Endpoints .....	366
Configuring Skype for Business Server for Presence .....	368
Configuring the Device for Skype for Business Presence .....	370
Microsoft Teams with Local Media Optimization .....	372
<b>17 Quality of Experience .....</b>	<b>374</b>
Reporting Voice Quality of Experience to OVOC .....	374
Configuring OVOC for Quality of Experience .....	374
Configuring Clock Synchronization between Device and OVOC .....	378
Configuring Firewall Rules for OVOC Traffic .....	378
Enabling RTCP XR Reporting to OVOC .....	378
Configuring Quality of Experience Profiles .....	378
Configuring Bandwidth Profiles .....	385
Configuring Quality of Service Rules .....	390
<b>18 Core Entities .....</b>	<b>395</b>
Configuring Media Realms .....	395
Configuring Remote Media Subnets .....	400
Configuring SRDs .....	403
Filtering Tables in Web Interface by SRD .....	411
Multiple SRDs for Multi-tenant Deployments .....	411
Cloning SRDs .....	414
Color-Coding of SRDs in Web Interface .....	415
Automatic Configuration based on SRD .....	415



Configuring SIP Interfaces .....	415
Configuring IP Groups .....	431
Configuring Proxy Sets .....	463
Building and Viewing SIP Entities in Topology View .....	479
<b>19 Coders and Profiles .....</b>	<b>487</b>
Configuring Coder Groups .....	487
Supported Audio Coders .....	490
Configuring Allowed Audio Coder Groups .....	494
Configuring Allowed Video Coder Groups .....	497
Configuring IP Profiles .....	499
Configuring Tel Profile .....	563
<b>20 SIP Definitions .....</b>	<b>583</b>
Configuring Registration Accounts .....	583
Regular Registration Mode .....	593
Single Registration for Multiple Phone Numbers using GIN .....	594
Registrar Stickiness .....	595
Configuring Proxy and Registration Parameters .....	595
SIP Message Authentication Example .....	596
Configuring User Information .....	599
Enabling the User Information Table .....	599
Gateway User Information for PBX Extensions and "Global" Numbers .....	599
Configuring Gateway User Information Table through Web Interface .....	600
Configuring Gateway User Information Table through CLI .....	602
Configuring Gateway User Information Table from a Loadable File .....	604
Configuring SBC User Information .....	605
Configuring SBC User Information Table through Web Interface .....	606
Configuring SBC User Information Table through CLI .....	608
Configuring SBC User Information Table from a Loadable File .....	610
Configuring Call Setup Rules .....	611
Call Setup Rule Examples .....	620
Configuring Dial Plans .....	624
Importing Dial Plans .....	632
Creating Dial Plan Files .....	633
Exporting Dial Plans .....	634
Using Dial Plan Tags for SBC IP-to-IP Routing .....	635
Using Dial Plan Tags for Matching Routing Rules .....	635
Using Dial Plan Tags for Routing Destinations .....	636
Dial Plan Backward Compatibility .....	639
Using Dial Plan Tags for SBC Outbound Manipulation .....	641
Using Dial Plan Tags for Call Setup Rules .....	641
Using Dial Plans for IP-to-Tel or Tel-to-IP Call Routing .....	641
Using Dial Plan Tags for Message Manipulation .....	644
Configuring Push Notification Servers .....	644

<b>21 SIP Message Manipulation</b> .....	<b>647</b>
Configuring SIP Message Manipulation .....	647
Configuring Message Condition Rules .....	655
Configuring SIP Message Policy Rules .....	657
Configuring Pre-Parsing Manipulation Rules .....	660
<b>Part V</b> .....	<b>664</b>
<b>Gateway Application</b> .....	<b>664</b>
<b>22 Introduction</b> .....	<b>665</b>
Call Processing Summary .....	665
<b>23 Digital PSTN</b> .....	<b>668</b>
Configuring Trunk Settings .....	668
TDM and Timing .....	698
TDM Bus Clock Settings .....	698
Recovering Clock from PSTN Line Interface .....	699
Configuring Internal Clock as Clock Source .....	700
Configuring CAS State Machines .....	700
Configuring Digital Gateway Parameters .....	703
Tunneling Applications .....	703
TDM Tunneling .....	703
DSP Pattern Detector .....	708
Configuring Private Wire Interworking .....	708
QSIG Tunneling .....	714
ISDN Non-Facility Associated Signaling (NFAS) .....	715
NFAS Interface ID .....	716
Working with DMS-100 Switches .....	717
Creating an NFAS-Related Trunk Configuration .....	718
Performing Manual D-Channel Switchover in NFAS Group .....	718
ISDN Overlap Dialing .....	719
Collecting ISDN Digits and Sending Complete Number in SIP .....	719
Interworking ISDN Overlap Dialing with SIP According to RFC 3578 .....	720
Redirect Number and Calling Name (Display) .....	721
<b>24 Trunk Groups</b> .....	<b>723</b>
Configuring Trunk Groups .....	723
Configuring Trunk Group Settings .....	725
<b>25 Routing</b> .....	<b>734</b>
Configuring Tel-to-IP Routing Rules .....	734
Configuring IP-to-Tel Routing Rules .....	747
Configuring a Gateway Routing Policy Rule .....	754
Alternative Routing for Tel-to-IP Calls .....	756
IP Destinations Connectivity Feature .....	756
Alternative Routing Based on IP Connectivity .....	757

Alternative Routing Based on SIP Responses .....	760
Alternative Routing upon SIP 3xx with Multiple Contacts .....	763
PSTN Fallback .....	764
Alternative Routing for IP-to-Tel Calls .....	764
Alternative Routing to Trunk upon Q.931 Call Release Cause Code .....	764
Alternative Routing to an IP Destination upon a Busy Trunk .....	766
Alternative Routing upon ISDN Disconnect .....	768
Alternative Routing from FXO to IP .....	769
<b>26 Manipulation .....</b>	<b>770</b>
Configuring Redirect Reasons .....	770
Configuring Source-Destination Number Manipulation Rules .....	770
Manipulating Number Prefix .....	778
SIP Calling Name Manipulations .....	780
Configuring Redirect Number Manipulation .....	784
Manipulating Redirected and Diverted Numbers for Call Diversion .....	790
Mapping NPI/TON to SIP Phone-Context .....	791
Configuring Release Cause Mapping .....	794
SIP-to-ISDN Release Cause Mapping .....	794
Configuring SIP-to-ISDN Release Cause Mapping .....	794
Fixed Mapping of SIP Response to ISDN Release Reason .....	795
SIP-to-ISDN Disconnect Release Cause Code Mapping .....	797
ISDN-to-SIP Release Cause Mapping .....	800
Configuring ISDN-to-SIP Release Cause Mapping .....	800
Fixed Mapping of ISDN Release Reason to SIP Response .....	801
Configuring ISDN-to-ISDN Release Cause Mapping .....	806
SIP Reason Header for Release Cause .....	807
Mapping PSTN Release Cause to SIP Response for Analog Interfaces .....	808
Numbering Plans and Type of Number .....	808
<b>27 Configuring DTMF and Dialing .....</b>	<b>810</b>
Dialing Plan Features .....	810
Digit Mapping .....	810
Dial Plan Rules .....	811
Interworking Keypad DTMFs for SIP-to-ISDN Calls .....	812
Configuring Hook Flash .....	812
<b>28 Configuring Supplementary Services .....</b>	<b>814</b>
Call Hold and Retrieve .....	814
Configuring MoH from External Audio Source .....	816
Call Pickup .....	819
BRI Suspend and Resume .....	820
Consultation Feature .....	820
Call Transfer .....	820
Consultation Call Transfer .....	820
Consultation Transfer for QSIG Path Replacement .....	822

Blind Call Transfer .....	822
Call Forward .....	823
Enabling Call Forwarding .....	824
Call Forward Reminder Ring .....	824
Call Forward Reminder (Off-Hook) Special Dial Tone .....	825
Call Forward Reminder Dial Tone (Off-Hook) upon Spanish SIP Alert-Info .....	826
Remote Handling of BRI Call Forwarding .....	827
Local Handling of BRI Call Forwarding .....	829
Enabling Call Waiting .....	831
Message Waiting Indication .....	832
Caller ID .....	834
Enabling Caller ID Generation and Detection on Tel Side .....	834
Debugging a Caller ID Detection on FXO .....	835
Caller ID on IP Side .....	836
Three-Way Conferencing .....	837
Emergency E911 Phone Number Services .....	840
FXS Device Emulating PSAP using DID Loop-Start Lines .....	841
FXO Device Interworking SIP E911 Calls from Service Provider's IP Network to PSAP DID Lines .....	844
Pre-empting Existing Calls for E911 IP-to-Tel Calls .....	848
Multilevel Precedence and Preemption .....	849
MLPP Preemption Events in SIP Reason Header .....	852
Precedence Ring Tone .....	853
Denial of Collect Calls .....	853
Configuring Multi-Line Extensions and Supplementary Services .....	854
Detecting Collect Calls .....	859
Advice of Charge Services for Euro ISDN .....	859
Configuring Charge Codes .....	862
Configuring Voice Mail .....	866
Converting Accented Characters from IP to Tel .....	868
<b>29 Analog Gateway .....</b>	<b>871</b>
Configuring Keypad Features .....	871
Configuring Metering Tones .....	872
Configuring FXO Settings .....	873
Configuring Authentication .....	873
Configuring Automatic Dialing .....	875
Configuring Caller Display Information .....	877
Configuring Call Forward .....	879
Configuring Caller ID Permissions .....	882
Configuring Call Waiting .....	883
Rejecting Anonymous Calls .....	885
Configuring FXS Distinctive Ringing and Call Waiting Tones per Source/Destination Number .....	885
Analog Coefficient Types .....	887

FXO Operating Modes .....	888
FXO Operations for IP-to-Tel Calls .....	888
One-Stage Dialing .....	889
Two-Stage Dialing .....	890
DID Wink .....	890
FXO Operations for Tel-to-IP Calls .....	891
Automatic Dialing .....	891
Collecting Digits Mode .....	892
FXO Supplementary Services .....	893
Call Termination on FXO Devices .....	893
Calls Termination by PBX .....	893
Call Termination before Call Establishment .....	894
Ring Detection Timeout .....	895
Remote PBX Extension between FXO and FXS Devices .....	895
Dialing from Remote Extension (Phone at FXS) .....	896
Dialing from PBX Line or PSTN .....	896
Message Waiting Indication for Remote Extensions .....	897
Call Waiting for Remote Extensions .....	897
FXS Gateway Configuration .....	898
FXO Gateway Configuration .....	898
<b>Part VI .....</b>	<b>900</b>
<b>Session Border Controller Application .....</b>	<b>900</b>
<b>30 SBC Overview .....</b>	<b>901</b>
Feature List .....	901
B2BUA and Stateful Proxy Operating Modes .....	903
Call Processing of SIP Dialog Requests .....	905
User Registration .....	908
Initial Registration Request Processing .....	909
Classification and Routing of Registered Users .....	910
General Registration Request Processing .....	911
Registration Refreshes .....	911
Registration Restriction Control .....	912
Deleting Registered Users .....	913
Media Handling .....	913
Media Anchoring .....	914
Direct Media Calls .....	915
Restricting Audio Coders .....	918
Coder Transcoding .....	918
Transcoding Mode .....	922
Prioritizing Coder List in SDP Offer .....	922
Allocating DSPs on SDP Offer or Answer .....	923
SRTP-RTP and SRTP-SRTP Transcoding .....	924
Multiple RTP Media Streams per Call Session .....	924
Interworking Miscellaneous Media Handling .....	925

Interworking DTMF Methods .....	925
Interworking RTP Redundancy .....	925
Interworking RTCP Attribute in SDP .....	925
Interworking Crypto Lifetime Field .....	926
Interworking ICE Lite for NAT Traversal .....	926
Fax Negotiation and Transcoding .....	926
SBC Authentication .....	927
SIP Authentication Server Functionality .....	927
RADIUS-based User Authentication .....	928
OAuth2-based User Authentication .....	928
Interworking SIP Signaling .....	932
Interworking SIP 3xx Redirect Responses .....	933
Resultant INVITE Traversing Device .....	933
Local Handling of SIP 3xx .....	934
Interworking SIP Diversion and History-Info Headers .....	935
Interworking SIP REFER Messages .....	937
Interworking SIP PRACK Messages .....	938
Interworking SIP Session Timer .....	938
Interworking SIP Early Media .....	938
Interworking SIP re-INVITE Messages .....	941
Interworking SIP UPDATE Messages .....	941
Interworking SIP re-INVITE to UPDATE .....	942
Interworking Delayed Offer .....	942
Interworking Call Hold .....	942
Interworking SIP Via Headers .....	943
Interworking SIP User-Agent Headers .....	943
Interworking SIP Record-Route Headers .....	943
Interworking SIP To-Header Tags in Multiple SDP Answers .....	943
Interworking In-dialog SIP Contact and Record-Route Headers .....	943
<b>31 Utilizing Gateway Channel Resources for SBC .....</b>	<b>944</b>
<b>32 Configuring General SBC Settings .....</b>	<b>945</b>
Interworking Dialog Information in SIP NOTIFY Messages .....	945
<b>33 Configuring Call Admission Control .....</b>	<b>947</b>
<b>34 Routing SBC .....</b>	<b>954</b>
Configuring Classification Rules .....	954
Classification Based on URI of Selected Header Example .....	963
Configuring Classification Based on Tags .....	964
Configuring SBC IP-to-IP Routing .....	966
Configuring Rerouting of Calls to Fax Destinations .....	985
Configuring Specific UDP Ports using Tag-based Routing .....	987
Configuring a Routing Response Timeout .....	992
Configuring SIP Response Codes for Alternative Routing Reasons .....	992
Configuring SBC Routing Policy Rules .....	996

Configuring IP Group Sets .....	1001
<b>35 SBC Manipulations .....</b>	<b>1006</b>
Configuring IP-to-IP Inbound Manipulations .....	1009
Configuring IP-to-IP Outbound Manipulations .....	1014
Using the Proprietary SIP X-AC-Action Header .....	1022
<b>36 Configuring Malicious Signatures .....</b>	<b>1025</b>
<b>37 Advanced SBC Features .....</b>	<b>1028</b>
Configuring Call Preemption for SBC Emergency Calls .....	1028
Configuring Message Session Relay Protocol .....	1030
Emergency Call Routing using LDAP to Obtain ELIN .....	1034
Configuring Dual Registration for SIP Entity .....	1035
Handling Registered AORs with Same Contact URIs .....	1039
Enabling Interworking of SIP and SIP-I Endpoints .....	1040
Call Forking .....	1042
Initiating SIP Call Forking .....	1042
Configuring SIP Forking Initiated by SIP Proxy .....	1043
Configuring Call Forking-based IP-to-IP Routing Rules .....	1044
Call Survivability .....	1044
Enabling Auto-Provisioning of Subscriber-Specific Information of BroadWorks Server for Survivability .....	1044
Configuring BroadSoft's Shared Phone Line Call Appearance for Survivability .....	1045
Configuring Call Survivability for Call Centers .....	1047
Enabling Survivability Display on Aastra IP Phones .....	1049
Alternative Routing on Detection of Failed SIP Response .....	1050
Configuring Push Notification Service .....	1050
Limiting SBC Call Duration .....	1053
<b>Part VII .....</b>	<b>1055</b>
<b>Cloud Resilience Package .....</b>	<b>1055</b>
<b>38 CRP Overview .....</b>	<b>1056</b>
<b>39 CRP Configuration .....</b>	<b>1058</b>
Configuring Call Survivability Mode .....	1058
Pre-Configured IP Groups .....	1060
Pre-Configured IP-to-IP Routing Rules .....	1060
Normal Mode .....	1060
Emergency Mode .....	1061
Auto Answer to Registrations .....	1062
Configuring PSTN Fallback .....	1063
<b>Part VIII .....</b>	<b>1065</b>
<b>Maintenance .....</b>	<b>1065</b>
<b>40 Basic Maintenance .....</b>	<b>1066</b>

Resetting the Device .....	1066
Remotely Resetting Device using SIP NOTIFY .....	1067
Locking and Unlocking the Device .....	1067
Saving Configuration .....	1069
<b>41 Replacing Modules .....</b>	<b>1070</b>
<b>42 Channel Maintenance .....</b>	<b>1072</b>
Resetting an Analog Channel .....	1072
Restarting a B-Channel .....	1072
Locking and Unlocking Trunk Groups .....	1072
Disconnecting Active Calls .....	1074
Remotely Disconnecting Calls using SIP NOTIFY .....	1074
Configuring Names for Telephony Ports .....	1075
<b>43 Upgrading the Device's Software .....</b>	<b>1076</b>
<b>44 Loading Auxiliary Files .....</b>	<b>1081</b>
Loading Auxiliary Files through Web Interface .....	1082
Loading Auxiliary Files through CLI .....	1083
Deleting Auxiliary Files .....	1084
Call Progress Tones File .....	1084
Distinctive Ringing .....	1088
Prerecorded Tones File .....	1090
Voice Prompts File .....	1092
CAS Files .....	1092
AMD Sensitivity File .....	1093
User Info File .....	1093
<b>45 License Key .....</b>	<b>1094</b>
Viewing the License Key .....	1094
Local License Key .....	1096
Installing License Key through Web Interface .....	1096
Installing a License Key String .....	1097
Installing a License Key File .....	1099
Installing License Key String through CLI .....	1100
Verifying Installed License Key .....	1100
Backing up Local License Key .....	1101
OVOC-Managed SBC Capacity Licenses .....	1101
Fixed License Pool Model .....	1101
Floating License Model .....	1104
Flex License Model .....	1106
Enabling Floating or Flex License .....	1108
Viewing Flex License Utilization and Status .....	1110
Configuring Floating or Flex License Allocation Profiles .....	1111
Viewing Floating or Flex License Reports .....	1112
Viewing the Device's Product Key .....	1113



<b>46</b>	<b>Configuration File</b> .....	<b>1114</b>
	Downloading and Loading ini Configuration File .....	1114
	Saving and Loading CLI Script Files .....	1115
	Saving and Loading a Configuration Package File .....	1116
<b>47</b>	<b>Automatic Provisioning</b> .....	<b>1119</b>
	Automatic Configuration Methods .....	1119
	DHCP-based Provisioning .....	1119
	Provisioning from HTTP Server using DHCP Option 67 .....	1120
	Provisioning from TFTP Server using DHCP Option 66 .....	1122
	Provisioning the Device using DHCP Option 160 .....	1122
	HTTP-based Provisioning .....	1124
	FTP-based Provisioning .....	1125
	Provisioning through OVOC .....	1125
	HTTP/S-Based Provisioning using the Automatic Update Feature .....	1125
	Files Provisioned by Automatic Update .....	1126
	File Location for Automatic Update .....	1127
	MAC Address Placeholder in Configuration File Name .....	1128
	File Template for Automatic Provisioning .....	1128
	Triggers for Automatic Update .....	1130
	Applying Downloaded ini File after Graceful Timeout .....	1131
	Access Authentication with HTTP Server .....	1132
	Querying Provisioning Server for Updated Files .....	1133
	File Download Sequence .....	1136
	Cyclic Redundancy Check on Downloaded Configuration Files .....	1137
	Automatic Update Configuration Examples .....	1137
	Automatic Update for Single Device .....	1138
	Automatic Update from Remote Servers .....	1140
	Automatic Update for Mass Deployment .....	1142
<b>48</b>	<b>SBC Configuration Wizard</b> .....	<b>1145</b>
	Starting the SBC Configuration Wizard .....	1145
	General Setup Page .....	1147
	System Page .....	1148
	Interfaces Page .....	1150
	IP-PBX Page .....	1151
	SIP Trunk Page .....	1152
	Number Manipulation Page .....	1154
	Remote Users or Users Page .....	1156
	Summary Page .....	1157
	Congratulations Page .....	1157
<b>49</b>	<b>Restoring Factory Defaults</b> .....	<b>1159</b>
	Restoring Factory Defaults through CLI .....	1159
	Restoring Factory Defaults through Web Interface .....	1160

Restoring Defaults using Hardware Reset Button .....	1160
Restoring Defaults through ini File .....	1161
<b>Part IX .....</b>	<b>1162</b>
<b>Status, Performance Monitoring and Reporting .....</b>	<b>1162</b>
<b>50 System Status .....</b>	<b>1163</b>
Viewing Device Information .....	1163
Viewing Device Status on Monitor Page .....	1165
Viewing Voice Port Information .....	1169
<b>51 Viewing Carrier-Grade Alarms .....</b>	<b>1176</b>
Viewing Active Alarms .....	1176
Viewing History Alarms .....	1177
<b>52 Viewing Management User Activity Logs .....</b>	<b>1179</b>
<b>53 Viewing Performance Monitoring .....</b>	<b>1180</b>
Viewing Call Success and Failure Ratio .....	1180
Viewing Average Call Duration .....	1181
Viewing Trunk Utilization .....	1182
Configuring Performance Profiles .....	1184
<b>54 Viewing VoIP Status .....</b>	<b>1190</b>
Viewing Tel-to-IP and IP-to-Tel Call Counters .....	1190
Viewing SBC Registered Users .....	1192
Viewing Proxy Set Status .....	1194
Viewing Registration Status .....	1196
Viewing IP Connectivity .....	1197
Viewing Gateway CDR History .....	1199
Viewing CDR History of SBC and Test Calls .....	1200
<b>55 Viewing PSTN Status .....</b>	<b>1203</b>
Viewing Trunks & Channels Status .....	1203
Viewing NFAS Groups and D-Channel Status .....	1205
<b>56 Viewing Network Status .....</b>	<b>1206</b>
Viewing Active IP Interfaces .....	1206
Viewing Ethernet Device Status .....	1206
Viewing Ethernet Port Information .....	1206
Viewing Static Routes Status .....	1207
Viewing IDS Active Blacklist .....	1208
<b>57 Reporting Information to External Party .....</b>	<b>1210</b>
Configuring RTCP XR .....	1210
Call Detail Records .....	1217
Enabling CDR Generation and Configuring the CDR Server Address .....	1217
Configuring CDR Filters and Report Level .....	1218

Configuring CDR Reporting to REST Server .....	1219
Miscellaneous CDR Configuration .....	1219
Storing CDRs on the Device .....	1220
CDR Field Description .....	1222
Customizing CDRs for Gateway Calls .....	1273
Customizing CDRs for SBC Calls and Test Calls .....	1279
Example of Call Variables for CDR Customization .....	1285
Customizing CDR Indication for Call Success or Failure based on Responses .....	1286
Hiding Caller and Callee CDR Field Values .....	1288
Configuring RADIUS Accounting .....	1289
Querying Device Channel Resources using SIP OPTIONS .....	1298
<b>58 Remote Monitoring of Device behind NAT .....</b>	<b>1299</b>
<b>Part X .....</b>	<b>1301</b>
<b>Diagnostics .....</b>	<b>1301</b>
<b>59 Syslog and Debug Recording .....</b>	<b>1302</b>
Configuring Log Filter Rules .....	1302
Filtering IP Network Traces .....	1309
Debugging PSTN Calls through CLI .....	1311
Configuring Syslog .....	1312
Syslog Message Format .....	1312
Event Representation in Syslog Messages .....	1315
Syslog Fields for Answering Machine Detection (AMD) .....	1317
SNMP Alarms in Syslog Messages .....	1318
Enabling Syslog .....	1318
Configuring the Syslog Server Address .....	1319
Configuring Syslog Message Severity Level .....	1319
Configuring Syslog Debug Level .....	1320
Reporting Management User Activities .....	1321
Viewing Syslog Messages .....	1323
Syslog Message Description for CPU Overload .....	1326
Configuring Debug Recording .....	1328
Configuring the Debug Recording Server Address .....	1328
Collecting Debug Recording Messages .....	1329
Debug Capturing on Physical VoIP Interfaces .....	1331
Debug Capturing on VoIP Interfaces .....	1332
<b>60 Self-Testing .....</b>	<b>1334</b>
<b>61 Creating Core Dump and Debug Files upon Device Crash .....</b>	<b>1335</b>
<b>62 Debugging Web Services .....</b>	<b>1338</b>
<b>63 Enabling SIP Call Flow Diagrams in OVOC .....</b>	<b>1339</b>
<b>64 Enabling Same Call Session ID over Multiple Devices .....</b>	<b>1341</b>
<b>65 Analog Line Testing .....</b>	<b>1342</b>

FXO Line Testing .....	1342
FXS Line Testing .....	1342
FXO Line Impedance Matching Testing .....	1343
Running the Line Impedance Test .....	1344
Displaying Line Impedance Test Results .....	1345
Configuring the Best Impedance Level .....	1346
<b>66 Out-of-Service Physical Reasons for FXS Port .....</b>	<b>1347</b>
<b>67 Testing SIP Signaling Calls .....</b>	<b>1348</b>
Configuring Test Call Endpoints .....	1348
Starting and Stopping Test Calls .....	1359
Viewing Test Call Status .....	1359
Viewing Test Call Statistics .....	1360
Configuring DTMF Tones for Test Calls .....	1362
Configuring Basic Test Calls .....	1363
Test Call Configuration Examples .....	1364
<b>68 Pinging a Remote Host or IP Address .....</b>	<b>1367</b>
<b>Part XI .....</b>	<b>1368</b>
<b>Appendix .....</b>	<b>1368</b>
<b>69 Patterns for Denoting Phone Numbers and SIP URIs .....</b>	<b>1369</b>
<b>70 Configuration Parameters Reference .....</b>	<b>1372</b>
Management Parameters .....	1372
General Parameters .....	1372
Web Parameters .....	1376
Telnet and CLI Parameters .....	1381
ini File Parameters .....	1383
SNMP Parameters .....	1384
WebSocket Tunneling with OVOC Parameters .....	1391
Serial Parameters .....	1393
Auxiliary and Configuration File Name Parameters .....	1394
Automatic Update Parameters .....	1396
Networking Parameters .....	1410
Ethernet Parameters .....	1410
Multiple VoIP Network Interfaces and VLAN Parameters .....	1411
Routing Parameters .....	1411
Open Solution Network (OSN) Parameters .....	1412
Quality of Service Parameters .....	1413
NAT and STUN Parameters .....	1414
DNS Parameters .....	1417
DHCP Parameters .....	1418
Clock (Date and Time) Synchronization Parameters .....	1419
Debugging and Diagnostics Parameters .....	1421
General Parameters .....	1421

SIP Test Call Parameters .....	1425
Syslog, CDR and Debug Parameters .....	1425
Resource Allocation Indication Parameters .....	1442
Security Parameters .....	1443
General Security Parameters .....	1443
HTTPS Parameters .....	1444
SRTP Parameters .....	1445
TLS Parameters .....	1449
SSH Parameters .....	1453
IDS Parameters .....	1454
OCSP Parameters .....	1455
Proxy, Registration and Authentication Parameters .....	1456
Network Application Parameters .....	1475
General SIP Parameters .....	1476
Channel Parameters .....	1525
Voice Parameters .....	1525
Coder Parameters .....	1528
DTMF Parameters .....	1530
RTP, RTCP and T.38 Parameters .....	1532
Gateway Application Parameters .....	1540
Fax and Modem Parameters .....	1540
DTMF and Hook-Flash Parameters .....	1549
Digit Collection and Dial Plan Parameters .....	1557
Voice Mail Parameters .....	1561
Supplementary Services Parameters .....	1570
Caller ID Parameters .....	1570
Call Waiting Parameters .....	1576
Call Forwarding Parameters .....	1579
Message Waiting Indication Parameters .....	1580
Call Hold Parameters .....	1583
Call Transfer Parameters .....	1585
Three-Way Conferencing Parameters .....	1589
MLPP and Emergency Call Parameters .....	1593
Call Cut-through Parameters .....	1603
Direct Inward Dialing Parameters .....	1603
ISDN BRI Parameters .....	1605
PSTN Parameters .....	1607
General Parameters .....	1607
TDM Bus and Clock Timing Parameters .....	1614
CAS Parameters .....	1617
ISDN Parameters .....	1620
ISDN and CAS Interworking Parameters .....	1623
Tone Parameters .....	1643
Telephony Tone Parameters .....	1643
Tone Detection Parameters .....	1652

Metering Tone Parameters .....	1654
Telephone Keypad Key Sequence Parameters .....	1657
FXO and FXS Parameters .....	1664
Trunk Group and Routing Parameters .....	1669
IP Connectivity Parameters .....	1679
Alternative Routing Parameters .....	1681
Number Manipulation Parameters .....	1683
Answer and Disconnect Supervision Parameters .....	1699
SBC Parameters .....	1709
Supplementary Services .....	1738
IP Media Parameters .....	1739
Services .....	1747
RADIUS and LDAP Parameters .....	1747
General Parameters .....	1748
RADIUS Parameters .....	1749
LDAP Parameters .....	1752
HTTP-based Services .....	1754
HTTP Proxy Parameters .....	1757
<b>71 Capacity for Signaling, Media and User Registrations .....</b>	<b>1759</b>
<b>72 Technical Specifications .....</b>	<b>1760</b>

# 1 Introduction

This User's Manual describes how to configure and manage your AudioCodes Mediant 1000B Gateway and E-SBC (hereafter, referred to as *device*).



Some features described in this *User's Manual* may only be supported by Latest Release (LR) software versions (i.e., 7.20A.254.xxx and later), and not by Long Term Support (LTS) software versions (i.e., 7.20A.204.xxx). For new features supported by each software version type, refer to the relevant Release Note:

- **LTS Versions:** [SBC-Gateway Series Release Notes for Long Term Support Versions 7.2](#)
- **LR Versions:** [SBC-Gateway Series Release Notes for Latest Release Versions 7.2](#)

## Product Overview

AudioCodes Mediant 1000B Gateway and E-SBC, hereafter referred to as *device*, offers a complete connectivity solution for small-to-medium sized enterprises. The device connects IP-PBXs to any SIP trunking service provider. It offers superior performance in connecting any SIP to SIP environment, legacy TDM-based PBX systems to IP networks, and IP-PBXs to the PSTN in a modular 1U platform.

The device supports a wide range of voice coders and is capable of transcoding between narrowband and wideband voice coders, providing SIP normalization, fax handling, gain control and numerous additional media processing features. It offers certified interoperability with leading unified communications solutions and SIP trunking providers.

The device provides robust protection for IP communications infrastructure, preventing Denial of Service, fraud and service theft and guarding against cyber-attacks and other service-impacting events.

The device maintains high voice quality to deliver reliable enterprise VoIP communications. Advanced call routing mechanisms, network voice quality monitoring and branch survivability capabilities (including PSTN fallback with E911) result in minimum communications downtime.

Typical applications:

- SIP trunking
- Hosted PBX & UC as a Service
- IP contact centers
- Remote and mobile worker support
- SIP mediation between UC and IP-PBX systems

Benefits:

- Fully integrated device for secured SIP trunking and PSTN access

- Hybrid SBC and Media Gateway platform lowers CAPEX and reduces space and power footprints
- Scalable “pay-as-you-grow” modular architecture
- Extensive interoperability and partnerships that extend across multiple vendor devices and protocol implementations
- Offers comprehensive security, interoperability and reliability
- Delivers high service performance and voice quality
- Branch office survivability in the event of a WAN outage

Key features:

- Rich and powerful SIP normalization and routing mechanisms for seamless interoperability
- Hybrid SBC enables seamless migration and PSTN fallback
- Modular support for analog and digital TDM interfaces
- Perimeter defense against denial of service, fraud and eavesdropping
- VoIP quality monitoring and enforcement • Media Processing for Transcoding, Gain Control, DTMF/Fax, etc.
- Optional Open Solution Network (OSN) server module for hosting value-added applications



## Typographical Conventions

This document uses the following typographical conventions to convey information:

**Table 1-1: Typographical Conventions**

Convention	Description	Example
Text enclosed by a single quotation mark ('...')	Indicates Web interface parameters.	From the 'Debug Level' drop-down list, select <b>Basic</b> .
<b>Boldface font</b>	Indicates one of the following Web-based management interface elements: <ul style="list-style-type: none"> <li>■ A button</li> <li>■ A selectable value</li> <li>■ The navigational path to a Web page</li> </ul>	Click the <b>Add</b> button.
Text enclosed by double quotation marks ("...")	Indicates values that you need to enter (type) in the Web interface.	In the 'IP Address' field, enter "10.10.1.1".



Convention	Description	Example
Courier font	Indicates CLI commands or ini-based file configuration.	At the CLI prompt, type the following: <pre># configure system</pre>
Text enclosed by square brackets [...]	Indicates ini file parameters and values.	Configure the [GWDebugLevel] parameter to [1].
	Indicates a note bulletin providing important or useful information.	-
	Indicates a warning bulletin alerting you to potentially serious problems if a specific action is not taken.	-

## Getting Familiar with Configuration Concepts and Terminology

Before using your device, it is recommended that you familiarize yourself with the basic configuration concepts and terminology. An understanding of the basic concepts and terminology will help you configure and manage your device more effectively and easily.

### SBC Application

The objective of your configuration is to enable the device to forward calls between telephony endpoints in the SIP-based Voice-over-IP (VoIP) network. The endpoints (SIP entities) can be servers such as SIP proxy servers and IP PBXs, or end users such as IP phones. In the SIP world, the endpoints are referred to as SIP user agents (UA). The UA that initiates the call is referred to as the user agent client (UAC); the UA that accepts the call is referred to as the user-agent server (UAS).

The following table describes the main configuration concepts and terminology.

**Table 1-2: Configuration Concepts and Terminology**

Configuration Terms	Description
IP Group	The IP Group is a logical representation of the SIP entity (UA) with which the device receives and sends calls. The SIP entity can be a server (e.g., IP PBX or SIP Trunk) or it can be a group of users (e.g., LAN IP phones). For servers, the IP Group is typically used to define the address of the entity (by its associated Proxy Set). IP Groups are used in IP-to-IP routing rules

Configuration Terms	Description
	to denote the source and destination of the call.
Proxy Set	<p>The Proxy Set defines the actual address (IP address or FQDN) of SIP entities that are servers (e.g., IP PBX). As the IP Group represents the SIP entity, to associate an address with the SIP entity, the Proxy Set is assigned to the IP Group. You can assign the same Proxy Set to multiple IP Groups (belonging to the same SRD).</p>
SIP Interface	<p>The SIP Interface represents a Layer-3 network. It defines a local listening port for SIP signaling traffic on a local, logical IP network interface. The term <i>local</i> implies that it's a logical port and network interface on the device. The SIP Interface is used to receive and send SIP messages with a specific SIP entity (IP Group). Therefore, you can create a SIP Interface for each SIP entity in the VoIP network with which your device needs to communicate. For example, if your VoIP network consists of three SIP entities -- a SIP Trunk, a LAN IP PBX, and remote WAN users -- a SIP Interface can be created for each of these Layer-3 networks.</p> <p>The SIP Interface is associated with the SIP entity, by assigning it to an SRD that is in turn, assigned to the IP Group of the SIP entity.</p>
Media Realm	<p>The Media Realm defines a local UDP port range for RTP (media) traffic on any one of the device's logical IP network interfaces. The Media Realm is used to receive and send media traffic with a specific SIP entity (IP Group).</p> <p>The Media Realm can be associated with the SIP entity, by assigning the Media Realm to the IP Group of the SIP entity, or by assigning it to the SIP Interface associated with the SIP entity.</p>
SRD	<p>The SRD is a logical representation of your entire SIP-based VoIP network (Layer 5) containing groups of SIP users and servers. The SRD is in effect, the foundation of your configuration to which all other previously mentioned configuration entities are associated. For example, if your VoIP network consists of three SIP entities -- a SIP Trunk, a LAN IP PBX, and remote WAN users -- the three SIP Interfaces defining these Layer-3 networks would all assigned to the same SRD.</p> <p>Typically, only a single SRD is required and this is the recommended configuration topology. As the device provides a default SRD, in a single SRD topology, the device automatically assigns the SRD to newly created configuration entities. Thus, in such scenarios, there is no need to get involved with SRD configuration.</p> <p>Multiple SRDs are required only for multi-tenant deployments, where it "splits" the device into multiple logical devices. For multiple SRDs, the</p>

Configuration Terms	Description
	<p>SRD can be configured with a Sharing Policy. The Sharing Policy simply means whether the SRD's resources (SIP Interfaces, IP Groups, and Proxy Sets) can be used by other SRDs. For example, if all tenants route calls with the same SIP Trunking service provider, the SRD of the SIP Trunk would be configured as a <i>Shared</i> Sharing Policy. SRDs whose resources are not shared, would be configured with an <i>Isolated</i> Sharing Policy.</p>
IP Profile	<p>The IP Profile is an optional configuration entity that defines a wide range of call settings for a specific SIP entity (IP Group). The IP Profile includes signaling and media related settings, for example, jitter buffer, silence suppression, voice coders, fax signaling method, SIP header support (local termination if not supported), and media security method. The IP Profile is in effect, the interoperability "machine" of the device, enabling communication between SIP endpoints that "speak" different call "languages".</p> <p>The IP Profile is associated with the SIP entity, by assigning the IP Profile to the IP Group of the SIP entity.</p>
Classification	<p>Classification is the process that identifies the incoming call (SIP dialog request) as belonging to a specific SIP entity (IP Group).</p> <p>There are three chronological classification stages, where each stage is done only if the previous stage fails. The device first attempts to classify the SIP dialog by checking if it belongs to a user that is already registered in the device's registration database. If this stage fails, the device checks if the source IP address is defined for a Proxy Set and if yes, it classifies it to the IP Group associated with the Proxy Set. If this fails, the device classifies the SIP dialog using the Classification table, which defines various characteristics of the incoming dialog that if matched, classifies the call to a specific IP Group. The main characteristics of the incoming call is the SIP Interface that is associated with the SRD for which the Classification rule is configured.</p>
IP-to-IP Routing	<p>IP-to-IP routing rules define the routes for routing calls between SIP entities. As the SIP entities are represented by IP Groups, the routing rules typically employ IP Groups to denote the source and destination of the call. For example, to route calls from the IP PBX to the SIP Trunk, the routing rule can be configured with the IP PBX as the source IP Group and the SIP Trunk as the destination IP Group.</p> <p>Instead of IP Groups, various other source and destination methods can be used. For example, the source can be a source host name while the destination can be an IP address or based on an LDAP query.</p>

Configuration Terms	Description
Inbound and Outbound Manipulation	<p>Inbound and Outbound Manipulation lets you manipulate the user part of the SIP URI in the SIP message for a specific entity (IP Group). Inbound manipulation is done on messages received from the SIP entity; outbound manipulation is done on messages sent to the SIP entity.</p> <p>Inbound manipulation lets you manipulate the user part of the SIP URI for source (e.g., in the SIP From header) and destination (e.g., in the Request-URI line) in the incoming SIP dialog request. Outbound manipulation lets you manipulate the user part of the Request-URI for source (e.g., in the SIP From header) or destination (e.g., in the SIP To header) or calling name, in outbound SIP dialog requests.</p> <p>The Inbound and Outbound manipulation are associated with the SIP entity, by configuring the rules with incoming characteristics such as source IP Group and destination host name. The manipulation rules are also assigned a Routing Policy, which in turn, is assigned to IP-to-IP routing rules. As most deployments require only one Routing Policy, the default Routing Policy is automatically assigned to the manipulation rules and to the routing rules.</p>
Routing Policy	<p>Routing Policy logically groups routing and manipulation (inbound and outbound) rules to a specific SRD. It also enables Least Cost Routing (LCR) for routing rules and associates an LDAP server for LDAP-based routing. However, as multiple Routing Policies are required only for multi-tenant deployments, for most deployments only a single Routing Policy is required. When only a single Routing Policy is required, handling of this configuration entity is not required as a default Routing Policy is provided, which is automatically associated with all relevant configuration entities.</p>
Call Admission Control	<p>Call Admission Control (CAC) lets you configure the maximum number of permitted concurrent calls (SIP dialogs) per IP Group, SIP Interface, SRD, or user.</p>
Accounts	<p>Accounts are used to register or authenticate a "served" SIP entity (e.g., IP PBX) with a "serving" SIP entity (e.g., a registrar or proxy server). The device does this on behalf of the "served" IP Group. Authentication (SIP 401) is typically relevant for INVITE messages forwarded by the device to a "serving" IP Group. Registration is for REGISTER messages, which are initiated by the device on behalf of the "serving" SIP entity.</p>

The associations between the configuration entities are summarized in the following figure:

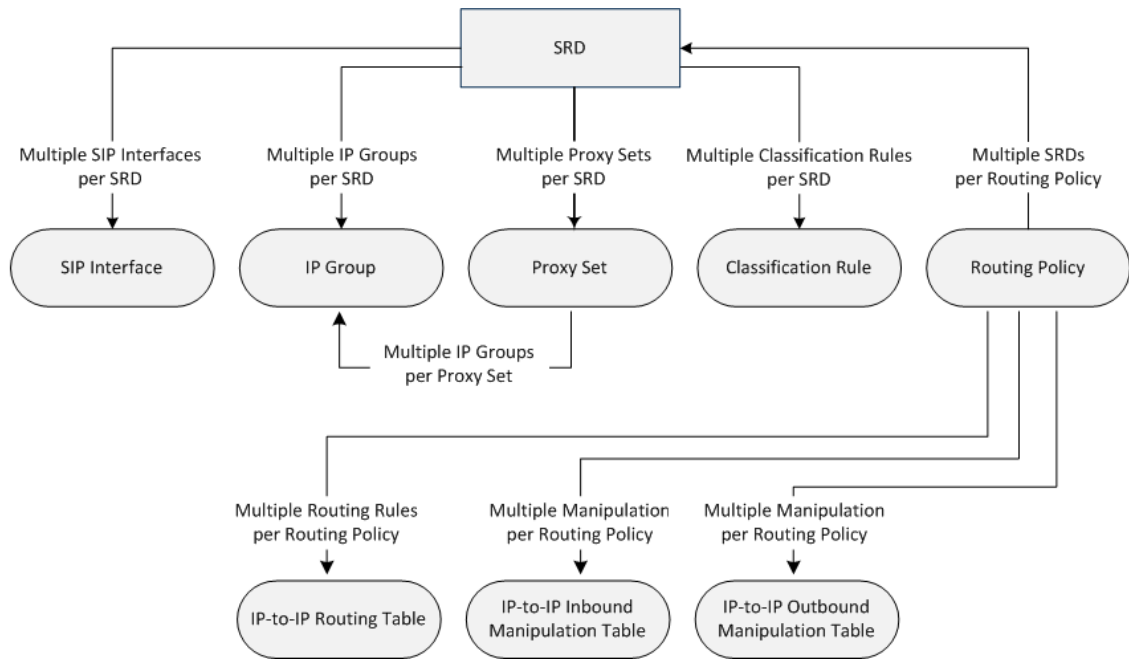

The main configuration entities and their involvement in the call processing is summarized in following figure. The figure is used only as an example to provide basic understanding of the configuration terminology. Depending on configuration and network topology, the call process may include additional stages or a different order of stages.

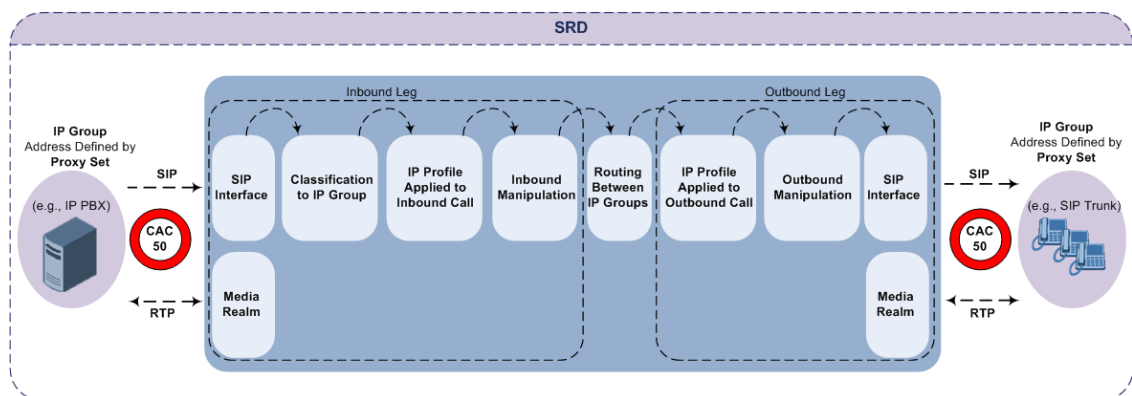

1. The device determines the SIP Interface on which the incoming SIP dialog is received and thus, determines its associated SRD.
2. The device classifies the dialog to an IP Group (origin of dialog), using a specific Classification rule that is associated with the dialog's SRD and that matches the incoming characteristics of the incoming dialog defined for the rule.
3. IP Profile and inbound manipulation can be applied to incoming dialog.
4. The device routes the dialog to an IP Group (destination), using the IP-to-IP Routing table. The destination SRD (and thus, SIP Interface and Media Realm) is the one assigned to the IP Group. Outbound manipulation can be applied to the outgoing dialog.

## Gateway Application

The objective of your configuration is to enable the device to forward calls between the IP-based endpoints and PSTN-based endpoints. The PSTN-based endpoints can be analog endpoints such as FXS (plain old telephone service or POTS) or FXO (e.g., PBX) or digital endpoints such as ISDN trunks. The IP-based endpoints (SIP entities) can be servers such as SIP proxy servers and IP PBXs, or end users such as LAN IP phones. In the SIP world, the endpoints are referred to as SIP user agents (UA). The UA that initiates the call is referred to as the user agent client (UAC); the UA that accepts the call is referred to as the user-agent server (UAS).

The following table describes the main configuration concepts and terminology.

**Table 1-3: Configuration Concepts and Terminology**

Configuration Terms	Description
IP Groups	The IP Group is a logical representation of the SIP entity (UA) with which the device receives and sends calls. The SIP entity can be a server (e.g., IP PBX or SIP Trunk) or it can be a group of users (e.g., LAN IP phones). For servers, the IP Group is typically used to define the address of the entity (by its associated Proxy Set). IP Groups are typically used in Tel-to-IP routing rules to denote the destination of the call.
Proxy Sets	The Proxy Set defines the actual address (IP address or FQDN) of SIP entities that are servers (e.g., IP PBX). As the IP Group represents the SIP entity, to associate an address with the SIP entity, the Proxy Set is assigned to the IP Group.
SIP Interfaces	The SIP Interface represents a Layer-3 network for the IP-based SIP entity. It defines a local listening port for SIP signaling traffic on a local, logical IP network interface. The term <i>local</i> implies that it's a logical port and network interface on the device. The SIP Interface is used to receive and send SIP messages with a specific SIP entity (IP Group). Therefore, you can create a SIP Interface for each SIP entity in the VoIP network with which your device needs to communicate.  The SIP Interface is associated with the SIP entity, by assigning the SIP Interface to an SRD that is in turn, assigned to the IP Group of the SIP entity.
Media Realms	The Media Realm defines a local UDP port range for RTP (media) traffic on any one of the device's logical IP network interfaces. The Media Realm is used to receive and send media traffic with a specific SIP entity (IP Group).  The Media Realm can be associated with the SIP entity, by

Configuration Terms	Description
	<p>assigning the Media Realm to the IP Group of the SIP entity, or by assigning it to the SIP Interface associated with the SIP entity.</p>
SRDs	<p>The SRD is a logical representation of your entire VoIP network. The SRD is in effect, the foundation of your configuration to which all other previously mentioned configuration entities are associated.</p> <p>Typically, only a single SRD is required and this is the recommended configuration topology. As the device provides a default SRD, in a single SRD topology, the device automatically assigns the SRD to newly created configuration entities. Thus, in such scenarios, there is no need to get involved with SRD configuration.</p> <p>Multiple SRDs are required only for multi-tenant deployments.</p>
IP Profiles	<p>The IP Profile is an optional configuration entity that defines a wide range of call settings for a specific SIP entity (IP Group). The IP Profile includes signaling and media related settings, for example, jitter buffer, silence suppression, voice coders, fax signaling method, SIP header support (local termination if not supported), and media security method. The IP Profile is in effect, the interoperability "machine" of the device, enabling communication with SIP endpoints supporting different call "languages".</p> <p>The IP Profile is associated with the SIP entity, by assigning the IP Profile to the IP Group of the SIP entity.</p>
Tel Profiles	<p>The Tel Profile is an optional configuration entity that defines a wide range of call settings for a specific PSTN-based endpoint. The IP Profile includes settings such as message waiting indication (MWI), input gain, voice volume and fax signaling method.</p> <p>The Tel Profile is associated with the PSTN-based endpoint, by assigning it to the Trunk Group belonging to the endpoint.</p>
Tel-to-IP Routing Rules	<p>Tel-to-IP routing rules are used to route calls from PSTN-based endpoints to an IP destination (SIP entity). The PSTN side can be denoted by a specific Trunk Group, or calling or called telephone number prefix and suffix. The SIP entity can be denoted by an IP Group or other IP destinations such as IP address, FQDN, E.164 Telephone Number Mapping (ENUM service), and Lightweight Directory Access Protocol (LDAP).</p>

Configuration Terms	Description
IP-to-Tel (Trunk Group) Routing Rules	IP-to-Tel routing rules are used to route incoming IP calls to Trunk Groups. The specific channel pertaining to the Trunk Group to which the call is routed can also be configured.
Accounts	Accounts are used to register or authenticate PSTN-based endpoints with a SIP entity (e.g., a registrar or proxy server). The device does this on behalf of the PSTN-based endpoint. Authentication (SIP 401) is typically relevant for INVITE messages forwarded by the device to a SIP entity. Registration is for REGISTER messages, which are initiated by the device on behalf of the PSTN-based endpoint.

The following figure shows the main configuration entities and their involvement in call processing. The figure is used only as an example to provide basic understanding of the configuration terminology. Depending on configuration and network topology, the call process may include additional stages or a different order of stages.

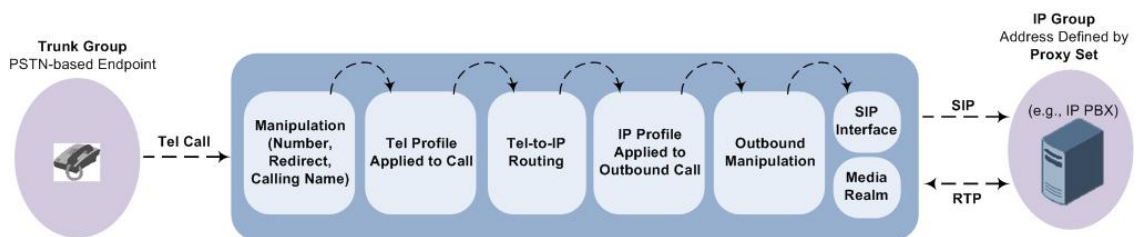



# Part I

## Getting Started with Initial Connectivity

## 2 Introduction

This part describes how to initially access the device's management interface and change its default IP address to correspond with your networking scheme.

### 3 Default IP Address

The device is shipped with a factory default networking address for operations, administration, maintenance, and provisioning (OAMP), through its LAN interface, as shown in the table below. You can use this address to initially access the device from any of its management tools (embedded Web server, OVOC, or Telnet/SSH). You can also access the device through the console CLI, by connecting the device's serial (RS-232) port to a PC.

**Table 3-1: Default VoIP LAN IP Address for OAMP**

IP Address	Value
IP Address	192.168.0.2
Prefix Length	24 (255.255.255.0)
Default Gateway	0.0.0.0
VLAN	1
Ethernet Group / Port	GROUP_1 / GE_0_1 or GE_0_2

## 4 Configuring VoIP LAN Interface for OAMP

You can change the device's default OAMP IP address, using any of the following methods:

- Embedded HTTP/S-based Web server (see [Web Interface](#))
- Embedded CLI (see [CLI](#))
- ini file (see [Changing OAMP Address through ini File](#) on page 17)

### Changing OAMP Address through Web Interface

You can change the device's default OAMP networking address through the Web-based management tool (Web interface). The default IP address is used to initially access the device.

➤ **To change the default OAMP network address through Web interface:**

1. Connect Ethernet port 0/1 or 0/2 located on the CPU module directly to the network interface of your computer, using a straight-through Ethernet cable.

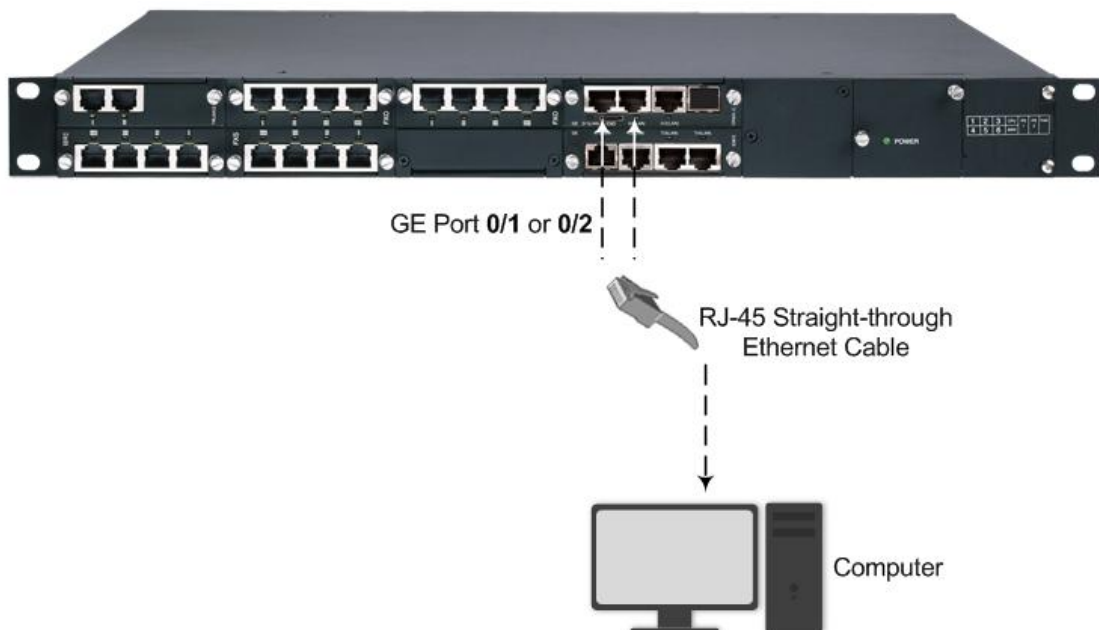

2. Change the IP settings of your computer to correspond with the default OAMP IP address and subnet mask of the device.
3. Access the Web interface:
  - a. On your computer, start a Web browser and in the URL address field, enter the default IP address of the device; the Web interface's Web Login screen appears:



7. Access the device using the new OAMP IP address, and then on the Web interface's toolbar, click the **Save** button.
8. Re-cable the device to the desired network. You can now access the device's management interfaces using the new OAMP address.

## Changing OAMP Address through CLI

You can change the default OAMP IP address through the device's CLI. The procedure uses the regular CLI commands. Alternatively, you can use the CLI Wizard utility to set up your device with the initial OAMP settings. The utility provides a fast-and-easy method for initial configuration of the device through CLI. For more information, refer to the *CLI Wizard User's Guide*.

### ➤ To configure the OAMP IP address through CLI:

1. Connect the RS-232 port of the device to the serial communication port on your computer. For more information, refer to the Hardware Installation Manual.

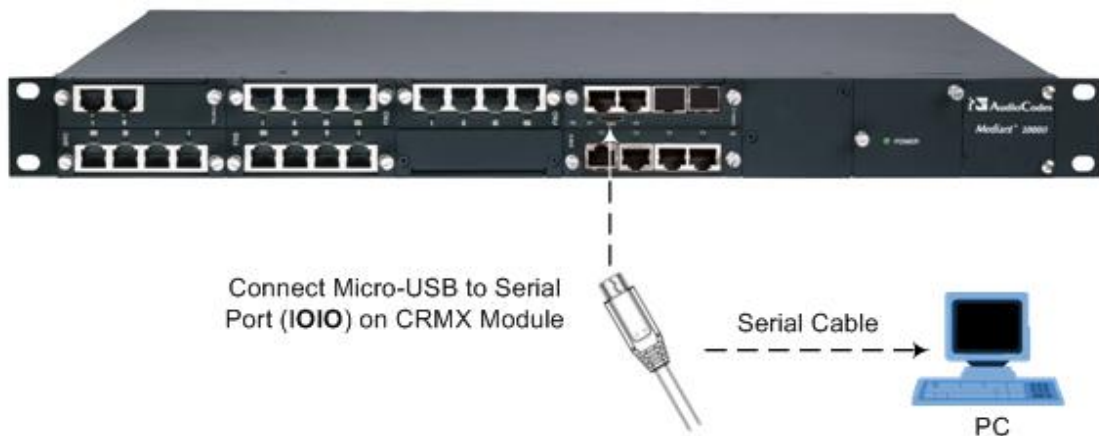

2. Establish serial communication with the device using a terminal emulator program such as HyperTerminal, with the following communication port settings:
  - Baud Rate: 115,200 bps
  - Data Bits: 8
  - Parity: None
  - Stop Bits: 1
  - Flow Control: None
3. At the CLI prompt, type the username (default is "Admin" - case sensitive):

```
Username: Admin
```

4. At the prompt, type the password (default is "Admin" - case sensitive):

```
Password: Admin
```

- At the prompt, type the following:

```
enable
```

- At the prompt, type the password again:

```
Password: Admin
```

- Access the Network configuration mode:

```
# configure network
```

- Access the IP Interfaces table:

```
(config-network)# interface network-if 0  
(network-if-0)#
```

- Configure the IP address:

```
(network-if-0)# ip-address <IP address>
```

- Configure the prefix length:

```
(network-if-0)# prefix-length <prefix length / subnet mask, e.g., 16>
```

- Configure the Default Gateway address:

```
(network-if-0)# gateway <IP address>
```

- Apply your settings:

```
(network-if-0)# activate
```

- Cable the device to your network. You can now access the device's management interface using this new OAMP IP address.

## Changing OAMP Address through ini File

You can change the device's default OAMP networking address by loading an ini file with the new OAMP address, through the device's Web interface.

➤ **To change the default OAMP network address through ini file:**

1. Create an ini file using a regular text-based editor program (such as Notepad) and save it with the file extension name **.ini** (e.g., myfile.ini).
2. Copy-and-paste the below ini file table parameter (InterfaceTable) into the ini file:

```
[ InterfaceTable ]
FORMAT InterfaceTable_Index = InterfaceTable_ApplicationTypes,
InterfaceTable_InterfaceMode, InterfaceTable_IPAddress, InterfaceTable_
PrefixLength, InterfaceTable_Gateway, InterfaceTable_InterfaceName,
InterfaceTable_PrimaryDNSServerIPAddress, InterfaceTable_
SecondaryDNSServerIPAddress, InterfaceTable_UnderlyingDevice;
InterfaceTable 0 = 6, 10, <IP Address>, <Prefix Length>, <Default Gateway>,
"O+M+C", 0.0.0.0, 0.0.0.0, "vlan 1";
[ \InterfaceTable ]
```

3. Modify the <IP Address>, <Prefix Length>, and <Default Gateway> parameters (but remove the angle brackets).
4. Save the file.
5. Connect to the device's Web interface using the default OAMP address (see [Changing OAMP Address through Web Interface](#) on page 14).
6. Open the Configuration File page (**Setup** menu > **Administration** tab > **Maintenance** folder > **Configuration File**).
7. Under the INI File group, click the **Browse** button to select the file, and then click **Load INI File**; the device loads the file and saves the configuration to flash memory with a device reset.
8. Disconnect the device from your PC and re-connect it to your network.
9. Access the device using the new OAMP interface address.



# Part II

## Management Tools

## 5 Introduction

This part describes the various management tools that you can use to configure the device:

- Embedded HTTP/S-based Web server - see [Web-based Management](#)
- Embedded Command Line Interface (CLI) - see [CLI-Based Management](#)
- Simple Network Management Protocol (SNMP) - see [SNMP-Based Management](#)
- Configuration *ini* file - see [INI File-Based Management](#)
- REST API - see [REST-Based Management](#) on page 99



- Some configuration settings can only be done using a specific management tool.
- For a list and description of all the configuration parameters, see [Configuration Parameters Reference](#).

## 6 Web-Based Management

The device provides an embedded Web server (hereafter referred to as *Web interface*), supporting fault management, configuration, accounting, performance, and security (FCAPS). The Web interface provides a user-friendly, graphical user interface (GUI), which can be accessed using any standard Web browser. Access to the Web interface can be controlled by various security mechanisms such as login username and password, read-write privileges, and limiting access to specific IP addresses.



- The Web interface allows you to configure most of the device's settings. However, additional configuration parameters may exist that are not available in the Web interface and which can only be configured using other management tools.
- Some Web interface pages and parameters are available only for certain hardware configurations or software features. The software features are determined by the installed License Key (see [License Key](#)).

### Getting Acquainted with the Web Interface

This section provides a description of the Web interface's graphical user interface (GUI).

#### Computer Requirements

The client computer accessing the device's Web interface requires the following prerequisites:

- A network connection to the device.
- One of the following Web browsers:
  - Microsoft™ Internet Explorer™ (Version 11.0.13 or later)
  - Mozilla Firefox® (Version 5.02 or later)
  - Google Chrome (Version 50 or later)



The Web browser must be JavaScript-enabled.

- Recommended screen resolutions: 1024 x 768 pixels, or 1280 x 1024 pixels.

#### Accessing the Web Interface

The following procedure describes how to access the Web interface.

➤ **To access the Web interface:**

1. Open a standard Web browser.
2. In the Web browser, enter the device's OAMP IP address (e.g., `http://10.1.10.10`); the Web interface's Web Login window appears:

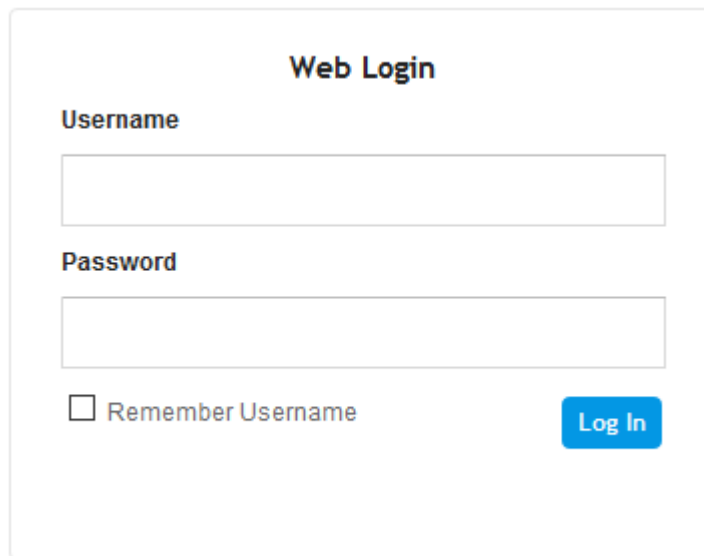

**Web Login**

**Username**

**Password**

Remember Username

3. In the 'Username' and 'Password' fields, enter your username and password, respectively.
4. If you want the Web browser to remember your username for future logins, select the 'Remember Username' check box. On your next login attempt, the 'Username' field will be automatically populated with your username.
5. Click **Log In**.

By default, autocompletion of the login username is enabled, whereby the 'Username' field predicts the rest of the username while you are typing, by displaying a drop-down list with previously entered usernames, as shown in the example below. To disable autocompletion, use the [WebLoginBlockAutoComplete] ini file parameter.

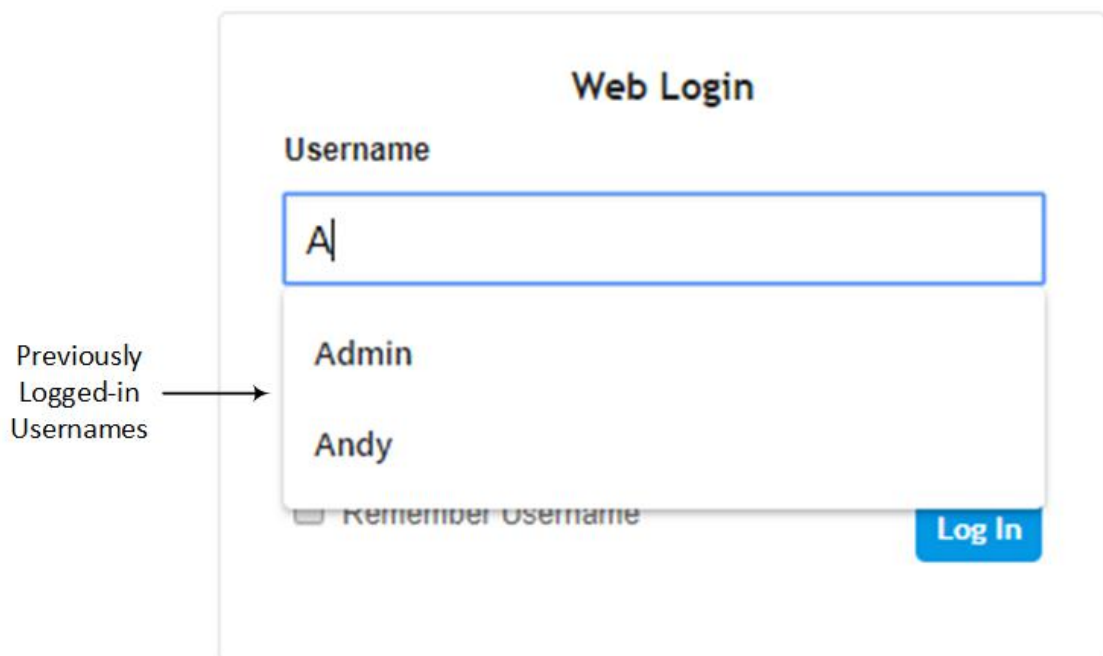

**Web Login**

**Username**

- Admin
- Andy

Remember Username

Previously Logged-in Usernames →



- The default login username and password is **Admin** and **Admin**, respectively. To



change the login credentials, see [Configuring Management User Accounts](#).

- The username and password is case-sensitive.
- By default, Web access is only through the IP address of the OAMP interface. However, you can allow access from all of the device's IP network interfaces, by setting the EnableWebAccessFromAllInterfaces parameter to 1.
- Depending on your Web browser's settings, a security warning box may be displayed. The reason for this is that the device's certificate is not trusted by your PC. The browser may allow you to install the certificate, thus skipping the warning box the next time you connect to the device. If you are using Windows Internet Explorer, click **View Certificate**, and then **Install Certificate**. The browser also warns you if the host name used in the URL is not identical to the one listed in the certificate. To resolve this, add the IP address and host name (ACL\_nnnnnn, where nnnnnn is the serial number of the device) to your hosts file, located at /etc/hosts on UNIX or C:\Windows\System32\Drivers\ETC\hosts on Windows; then use the host name in the URL (e.g., https://ACL\_280152). Below is an example of a host file:  
 127.0.0.1 localhost  
 10.31.4.47 ACL\_280152

### Areas of the GUI

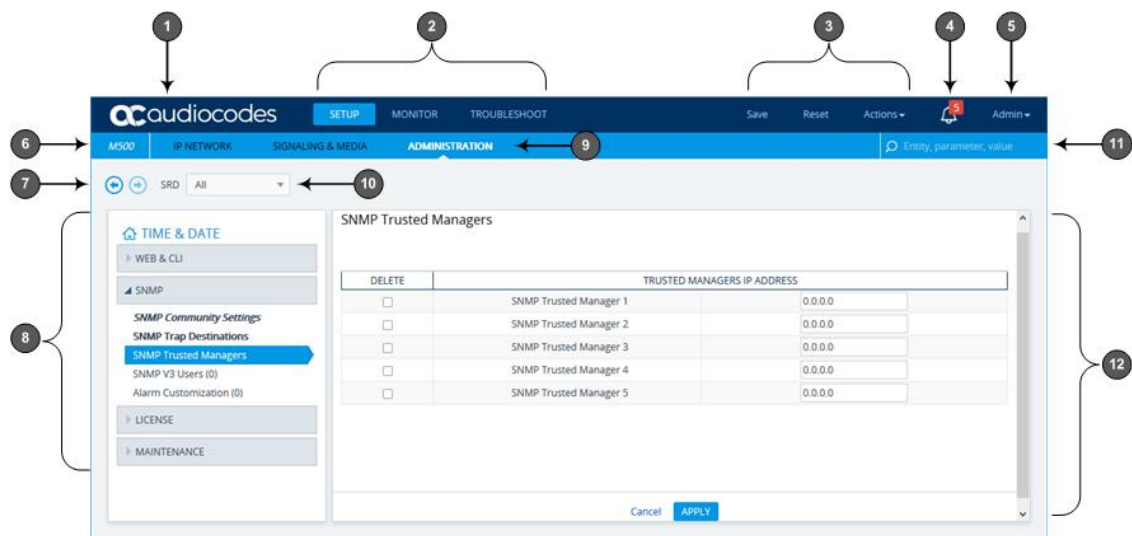

The areas of the Web interface's GUI are shown in the figure below and described in the subsequent table.



**Table 6-1: Description of the Web GUI Areas**

Item#	Description
1	Company logo. To customize the logo, see <a href="#">Replacing the Corporate Logo</a> . If you click the logo, the Topology View page opens (see <a href="#">Building and Viewing SIP Entities in Topology View</a> on page 479).
2	Menu bar containing the menus.

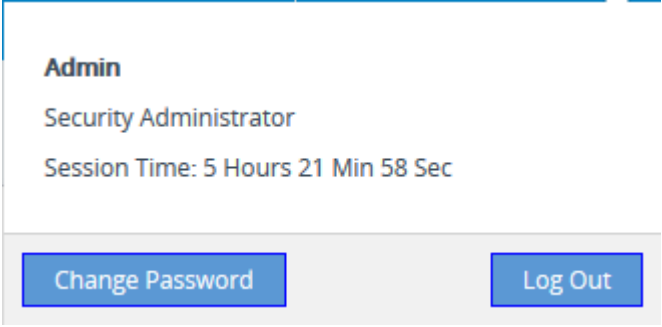
Item#	Description
3	<p>Toolbar providing frequently required command buttons.</p> <ul style="list-style-type: none"> <li>■ <b>Save:</b> Saves configuration changes to the device's flash memory (without resetting the device). If you make a configuration change, the button is surrounded by a red-colored border as a reminder to save your settings to flash memory.</li> <li>■ <b>Reset:</b> Opens the Maintenance Actions page, which is used for performing various maintenance procedures such as resetting the device (see <a href="#">Basic Maintenance</a>). If you make a configuration change that takes effect only after a device reset, the button is surrounded by a red-colored border as a reminder; otherwise, your changes revert to previous settings if the device resets or powers off.</li> <li>■ <b>Actions:</b> <ul style="list-style-type: none"> <li>✓ <b>Configuration File:</b> Opens the Configuration File page, which is used for saving the <i>ini</i> file to a folder on your PC, or for loading an ini file to the device (see <a href="#">Configuration File</a>).</li> <li>✓ <b>Auxiliary Files:</b> Opens the Auxiliary Files page, which is used for loading Auxiliary files to the device (see <a href="#">Loading Auxiliary Files through Web Interface</a>).</li> <li>✓ <b>License Key:</b> Opens the License Key page, which is used for installing a new License Key file (see <a href="#">Installing License Key through Web Interface</a>).</li> <li>✓ <b>Software Upgrade:</b> Starts the Software Upgrade Wizard for upgrading the device's software (see <a href="#">Software Upgrade</a>).</li> <li>✓ <b>Configuration Wizard:</b> Opens the SBC Configuration Wizard, which is used for quick-and-easy configuration of the device (see <a href="#">SBC Configuration Wizard</a>).</li> </ul> </li> </ul>
4	<p>Alarm bell icon displaying the number of active alarms generated by the device. The color of the number indicates the highest severity of an active alarm. If you click the icon, the Active Alarms table is displayed. For more information, see <a href="#">Viewing Active Alarms</a>.</p>
5	<p>Button displaying the username of the currently logged in user. If you click the button, a drop-down box appears:</p> <ul style="list-style-type: none"> <li>■ Displays information of the currently logged-in user (see <a href="#">Viewing Logged-In User Information</a>)</li> <li>■ <b>Change Password</b> button to change your login password (see <a href="#">Changing Login Password by All User Levels</a> on page 62)</li> <li>■ <b>Log Out</b> button to log out the Web session (see <a href="#">Logging Off the Web</a>)</li> </ul>

Item#	Description
	<p><a href="#">Interface</a>)</p> 
6	<p>Product name of device.</p> <p><b>Note:</b></p> <ul style="list-style-type: none"> <li>■ If you configure a hostname for the device (see <a href="#">Configuring a Hostname for the Device</a> on page 106), the hostname is displayed instead of the product name.</li> <li>■ You can customize the product name, as described in <a href="#">Customizing the Product Name</a> on page 44.</li> </ul>
7	<p>Back and Forward buttons that enable quick-and-easy navigation through previously opened pages. This is especially useful when you find that you need to return to a previously accessed page, and then need to go back to the page you just left.</p> <ul style="list-style-type: none"> <li>■  Back button: Goes back to the previously accessed page.</li> <li>■  Forward button: Opens the page that you initially left using the back button. The button is available only if you have used the Back button.</li> </ul>
8	<p>Navigation pane displaying the Navigation tree containing the commands (items) for opening the configuration pages (see <a href="#">Navigation Tree</a>).</p>
9	<p>Tab bar containing tabs pertaining to the selected menu:</p> <ul style="list-style-type: none"> <li>■ Setup menu: <ul style="list-style-type: none"> <li>✓ IP Network tab</li> <li>✓ Signaling &amp; Media tab</li> <li>✓ Administration tab</li> </ul> </li> <li>■ Monitor menu: Monitor tab</li> <li>■ Troubleshoot menu: Troubleshoot tab</li> </ul>
10	<p>SRD filter. When your configuration includes multiple SRDs, you can filter tables</p>

Item#	Description
	in the Web interface by SRD. For more information, see <a href="#">Filtering Tables in Web Interface by SRD</a> .
11	Search box for searching parameter names and values (see <a href="#">Searching for Configuration Parameters</a> ).
12	Work pane where configuration pages are displayed.

## Accessing Configuration Pages from Navigation Tree

Accessing configuration pages is a three-fold process that consists of selecting a menu on the menu bar, a tab on the tab bar, and then a page item in the Navigation pane. The Navigation pane provides the Navigation tree, which is a tree-like structure of folders and page items that open configuration pages in the Work pane. The hierarchical structure and organization of the items in the Navigation tree allow you to easily drill-down and locate the required item.

The Navigation tree consists of the following areas:

- **Home**  : (Callout #1) First ("home") page displayed when a menu-tab combination is initially selected. For example, the home page of the **Setup** menu - **Administration** tab combination is the Time & Date page.
- **Folders**: (Callout #2) Folders group items of similar functionality. To open and close a folder, simply click the folder name.
- **Items**: (Callout #3) Items open configuration pages. In some cases, an item may be listed under a sub-item. An item can open a page containing stand-alone parameters or a table. If it opens a page with stand-alone parameters, the item is displayed in italics. If it opens a page with a table, the item is displayed in regular font, or bold font to indicate an item that is commonly required.

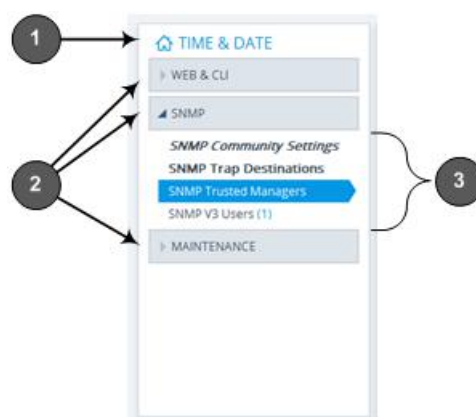

The items of the Navigation tree depend on the menu-tab combination, selected from the menu bar and tab bar, respectively. The menus and their respective tabs are listed below:

- **Setup menu:**



- **IP Network** tab
- **Signaling & Media** tab
- **Administration** tab

■ **Monitor menu:** Monitor tab

■ **Troubleshoot menu:** Troubleshoot tab

When you open the Navigation tree, folders containing commonly required items are opened by default, allowing quick access to their pages.

Items that open pages containing tables provide the following indications in the Navigation tree:

- **Number of configured rows.** For example, the item below indicates that two rows have been configured:

**Ethernet Groups (2)**

If you have filtered the Web interface display by SRD, the number reflects only the rows that are associated with the filtered SRD.

- **Invalid row configuration.** If you have configured a row with at least one invalid value, a red-colored icon is displayed next to the item, as shown in the following example:

**Ethernet Groups (2) ●**

If you hover your cursor over the icon, it displays the number of invalid rows (*lines*).

- **Association with an invalid row:** If you have associated a parameter of a row with a row of a different table that has an invalid configuration, the item appears with an arrow and a red-colored icon, as shown in the following example:

**Ethernet Devices (2) →●**

If you hover your cursor over the icon, it displays the number of rows in the table that are associated with invalid rows.



- **Folder containing an item with an invalid row:** If a folder contains an item with an invalid row (or associated with an invalid row), the closed folder displays a red-colored icon, as shown in the following example:

▶ CORE ENTITIES ●



If you hover your cursor over the icon, it displays the names of the items that are configured with invalid values. If you have filtered the Web interface display by SRD, only items with invalid rows that are associated with the filtered SRD are displayed.

➤ **To open a configuration page:**

1. On the menu bar, click the required menu.

2. On the tab bar, click the required tab; the Navigation tree displays the items pertaining to the selected menu-tab combination.
3. In the Navigation pane, open the folder in which the required item is located. The folders are opened and closed by clicking the title of the folder. When opened, the folder's arrow is displayed as ; when closed, the arrow is displayed as .
4. In the folder, click the required item; the page is displayed in the Work pane.

You can also easily navigate through previously accessed pages, using the **Back** and **Forward** buttons located above the Navigation pane:

-  **Back** button: Click to go back to the previously accessed page or keep on clicking until you reach any other previously accessed page.
-  **Forward** button: Click to open the page that you just left as a result of clicking the **Back** button.

These buttons are especially useful when you find that you need to return to a previously accessed page, and then need to go back to the page you just left.



Depending on the access level (e.g., Monitor level) of your Web user account, certain pages may not be accessible or may be read-only (see [Configuring Management User Accounts](#)). For read-only privileges:

- Read-only pages with stand-alone parameters: "Read Only Mode" is displayed at the bottom of the page.
- Read-only pages with tables: Configuration buttons (e.g., **New** and **Edit**) are missing.

## Configuring Stand-alone Parameters

Parameters that are not contained in a table are referred to as *stand-alone* parameters.

- If you change the value of a parameter (before clicking **Apply**), the parameter's field is highlighted, as shown in the example below:

6010

- If you change the value of a parameter from its default value and then click **Apply**, a dot appears next to the parameter's field, as shown in the example below:

• 6010

- If you change the value of a parameter that is displayed with a lightning-bolt  icon (as shown in the example below), you must save your settings to flash memory with a device reset for your changes to take effect. When you change such a parameter and then click **Apply**, the **Reset** button on the toolbar is encircled by a red border. If you click the button, the Maintenance Actions page opens, which provides commands for doing this (see [Basic Maintenance](#)).



- Typically required parameters are displayed in bold font.
- If you enter an invalid value for a parameter and then click **Apply**, a message box appears notifying you of the invalid value. Click **OK** to close the message. The parameter reverts to its previous value and the field is surrounded by a colored border, as shown in the figure below:



- To get help on a parameter, simply hover your mouse over the parameter's field and a pop-up help appears, displaying a brief description of the parameter.

The following procedure describes how to configure stand-alone parameters.

➤ **To configure a stand-alone parameter:**

1. Modify the parameter's value as desired.
2. Click **Apply**; the changes are saved to the device's volatile memory (RAM).
3. Save the changes to the device's non-volatile memory (flash):
  - If a device reset is not required:
    - i. On the toolbar, click **Save**; a confirmation message box appears:

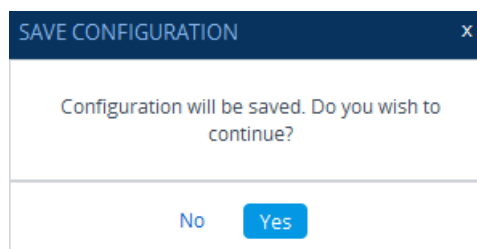

- ii. Click **Yes** to confirm; the changes are save to flash memory.
- If a device reset is required:
  - i. On the toolbar, click **Reset**; the Maintenance Actions page opens.
  - ii. Click **Reset**; the device saves the changes to flash memory and then resets.



When you click **Apply**, your changes are saved only to the device's volatile memory and thus, revert to their previous settings if the device later undergoes a hardware reset, a software reset (without saving to flash) or powers down. Therefore, make sure that you save your configuration to the device's flash memory.

## Configuring Table Parameters

A typical configuration table is shown below and subsequently described:

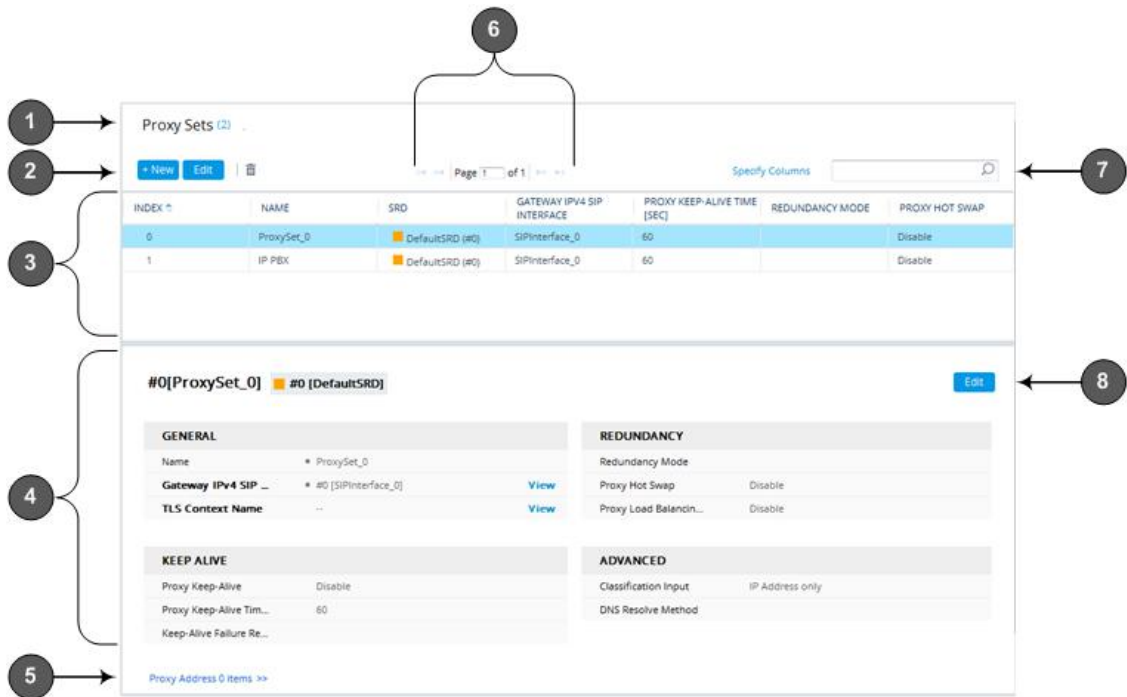



Table 6-2: General Description of Configuration Tables

Item#	Button	Description
1	-	Page title (i.e., name of table). The page title also displays the number of configured rows as well as the number of invalid rows. For more information on invalid rows, see <a href="#">Invalid Value Indications</a> .
2		Adds a new row to the table (see <a href="#">Adding Table Rows</a> ).
		Modifies the selected row (see <a href="#">Modifying Table Rows</a> ).
		Adds a new row with similar settings as the selected row (i.e., clones the row). For more information, see <a href="#">Cloning SRDs</a> . <b>Note:</b> The button appears only in the SRDs table.
		Deletes the selected row (see <a href="#">Deleting Table Rows</a> ).
		Changes the index position of a selected row (see <a href="#">Changing Index Position of Table Rows</a> ).
	<b>Action</b>	Drop-down menu providing commands (e.g., <b>Register</b> and <b>Un-Register</b> ). <b>Note:</b> The button appears only in certain tables (e.g., Accounts table).
3	-	Added table rows displaying only some of the table parameters (columns).

Item#	Button	Description
4	-	Detailed view of a selected row, displaying all parameters.
5	-	Link to open the "child" table of the "parent" table. A link appears only if the table has a "child" table. The "child" table is opened for the selected row.
6	-	Navigation bar for scrolling through the table's pages (see <a href="#">Viewing Table Rows</a> ).
7	-	Search tool for searching parameters and values (see <a href="#">Searching Table Entries</a> ).
8		Modifies the selected row (see <a href="#">Modifying Table Rows</a> ).

### Adding Table Rows

The following procedure describes how to add table rows. Before adding rows, the following GUI conventions are used:

- Commonly required parameters are displayed in **bold** font.
- If you change the value of a parameter (before clicking **Apply**), the parameter's field is highlighted, as shown in the example below:

6010

- For indications of invalid values, see [Invalid Value Indications](#).

#### ➤ To add a row:

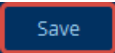
1. Click the **New**  button, located on the table's toolbar; a dialog box appears.
2. Configure the parameters of the row as desired. For information on configuring parameters that are assigned a value which is a row referenced from another table, see [Assigning Rows from Other Tables](#).
3. Click **Apply** to add the row to the table or click **Cancel** to ignore your configuration.
4. If the **Save**  button is surrounded by a red border, you must save your settings to flash memory, otherwise they are discarded if the device resets (without a save to flash) or powers off.

### Assigning Rows from Other Tables

Some tables contain parameters whose value is an assigned row (referenced-row) from another table (referenced-table). For example, the IP Groups table contains the 'Proxy Set' parameter whose value is an assigned Proxy Set, configured in the Proxy Sets table. These

parameter types provide a drop-down list for selecting the value and a **View** button, as shown in the example below:

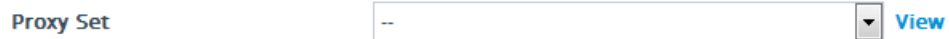

You can assign a referenced-row using one of the following methods:

■ **Selecting a referenced-row from the drop-down list:**

- Scroll down to the desired item and click it.
- Search for the item by entering in the field the first few characters of the desired row, and then clicking it. The figure below shows an example of searched results for items (Proxy Sets) that begin with the letter "i":



■ **Selecting an existing referenced-row directly from the referenced-table:**

- Click **View**; the table (e.g., IP Groups table) and dialog box in which the button was clicked is minimized to the bottom-left corner of the Web interface and the referenced-table (e.g., Proxy Sets table) opens.
- Add a new row, if required; otherwise, skip this step.
- Select the desired row in the row-referenced table, and then click **Use selected row** located on the top-right of the table, as shown in the example below:

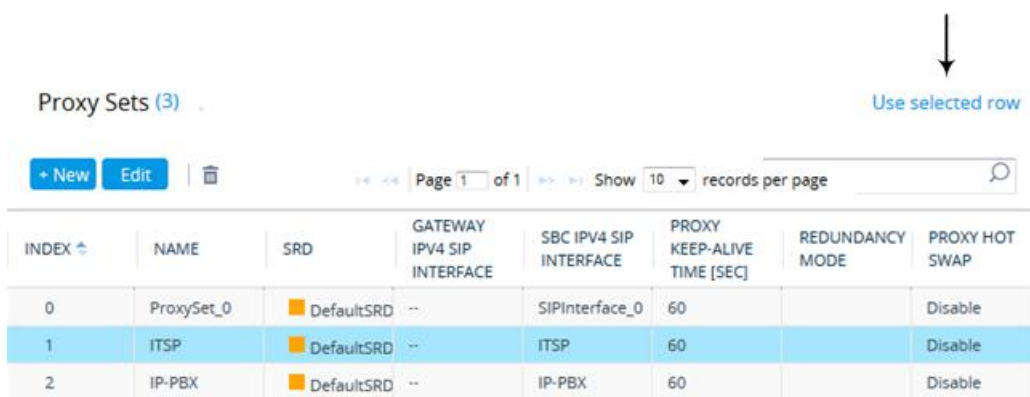

■ **Adding a new referenced-row:**

- From the drop-down list, select the **Add new** option; as shown in the example below:

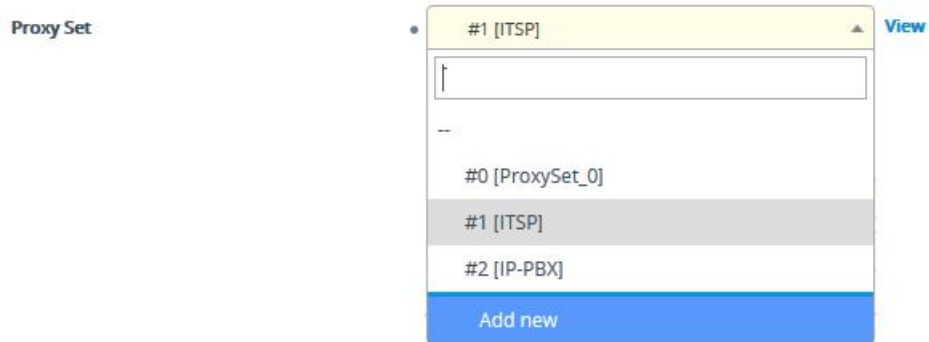

The table (e.g., IP Groups table) and dialog box in which the **Add new** option was selected is minimized to the bottom-left corner of the Web interface and a dialog box appears for adding a new row in the referenced-table (e.g., Proxy Sets table).

- b. Configure the referenced-row and click **Apply**; the referenced-table (e.g., Proxy Sets table) closes and you are returned to the dialog box in which you selected the **Add new** option (e.g., IP Groups table), where the newly added row now appears selected.

You may want to access the referenced-table (e.g., Proxy Sets table) to simply view all its configured rows and their settings, without selecting one. To do this, click the **View** button. To return to the dialog box of the table (e.g., IP Groups table) in which you are making your configuration, click the arrow ↗ icon on the minimized dialog box to restore it to its previous size.

### Modifying Table Rows

The following procedure describes how to modify (edit) the configuration of an existing table row. Remember that a gray-colored dot • icon displayed next to a parameter's value (as shown in the example below), indicates that it was changed from its default value:

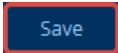

#### ➤ To edit a table row:

1. Select the row that you want to edit.
2. Click the **Edit**  button, located on the table's toolbar; a dialog appears displaying the current configuration settings of the row.
3. Make your changes as desired, and then click **Apply**; the dialog box closes and your new settings are applied.
4. If the **Save**  button is surrounded by a red border, you must save your settings to flash memory, otherwise they are discarded if the device resets (without a save to flash) or powers off.

### Deleting Table Rows

The following procedure describes how to delete a row from a table.

➤ **To delete a table row:**

1. Select the row that you want to delete.
2. Click the delete  icon, located on the table's toolbar; a confirmation message box appears requesting you to confirm deletion, as shown in the example below:

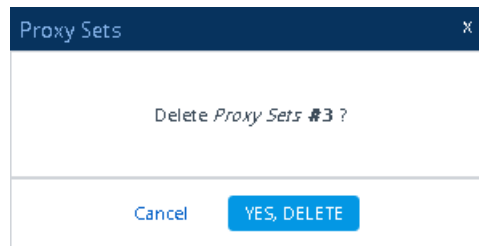

3. Click **Yes, Delete**; the row is removed from the table and the total number of configured rows that is displayed next to the page title and page item in the Navigation tree is updated to reflect the deletion.



If the deleted row (e.g., a Proxy Set) was referenced in another table (e.g., IP Group), the reference is removed and replaced with an empty field. In addition, if the reference in the other table is for a mandatory parameter, the invalid  icon is displayed where relevant. For example, if you delete a SIP Interface that you have assigned to a Proxy Set, the invalid icon appears alongside the **Proxy Sets** item in the Navigation tree as well as on the Proxy Sets page.

### Invalid Value Indications

The Web interface provides the following indications of invalid values when configuring table rows:

- **Parameters configured with invalid values:** An invalid value is a value that is not permissible for the parameter. This can include incorrect syntax (string, numeral, or character) or an out-of-range value. If you enter an invalid value and then click **Apply**, the field is surrounded by a colored border, as shown in the example below.

60000000

If you hover your mouse over the field, a pop-up message appears providing the valid values. If you enter a valid value, the colored border is removed from the field. If you leave the parameter at the invalid value and click **Apply**, the parameter reverts to its previous value.

- **Mandatory parameters that reference rows of other configuration tables:**

- **Adding a row:** If you do not configure the parameter and you click **Apply**, an error message is displayed at the bottom of the dialog box. If you click **Cancel**, the dialog box closes and the row is not added to the table. For example, if you do not configure the 'SIP Interface' field (mandatory) for a Proxy Set (in the Proxy Sets table), the below message appears:



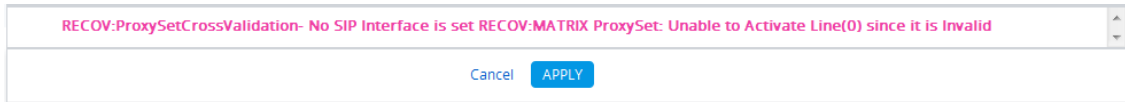

- **Editing a row:** If you modify the parameter so that it's no longer referencing a row of another table (i.e., blank value), when you close the dialog box, the **Invalid Line** ● icon appears in the following locations:
  - ◆ 'Index' column of the row.
  - ◆ Page title of the table. The total number of invalid rows in the table is also displayed with the icon.
  - ◆ Item in the Navigation tree that opens the table.

For example, if you do not configure the 'SIP Interface' field (mandatory) for Proxy Set #0, the **Invalid Line** ● icon is displayed for the Proxy Sets table, as shown below:

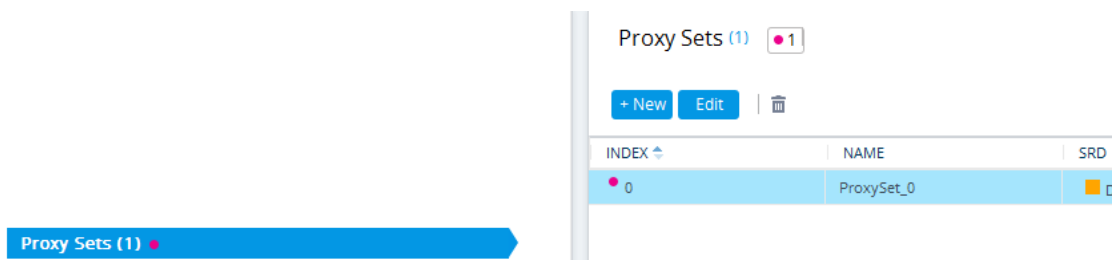

- **Parameters that reference rows of other configuration tables that are configured with invalid values:** If a row has a parameter that references a row of another table that has a parameter with an invalid value, the **Invalid Reference Line** →● icon is displayed in the following locations:

- 'Index' column of the row.
- Page title of the table. The total number of invalid rows in the table is also displayed with the icon.
- Item in the Navigation tree that opens the table.

For example, if you configure IP Group #0 (in the IP Groups table) with a parameter that references Proxy Set #0, which is configured with an invalid value, **Invalid Reference Line** →● icons are displayed for the IP Groups table, as shown below:

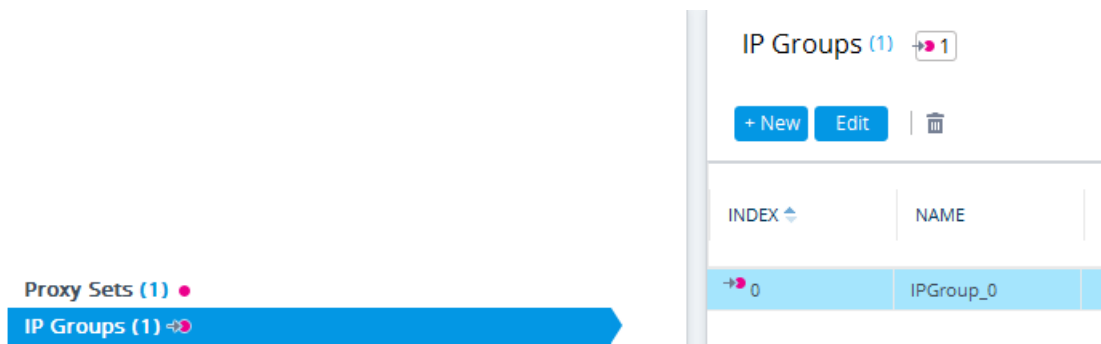

- **Invalid icon display in drop-down list items of parameters that reference rows of other tables:**

- If the row has an invalid line (see description above), the **Invalid Line** ● icon appears along side the item.
- If the row has an invalid reference line (see description above), the **Invalid Reference Line** →● icon appears along side it.

For example, when configuring an IP Group, the 'Proxy Set' parameter's drop-down list displays items: Proxy Set #0 with ● indicating that it has an invalid parameter value, and Proxy Set #1 with →● indicating that it has a parameter that is referenced to a row of another table that has an invalid value:

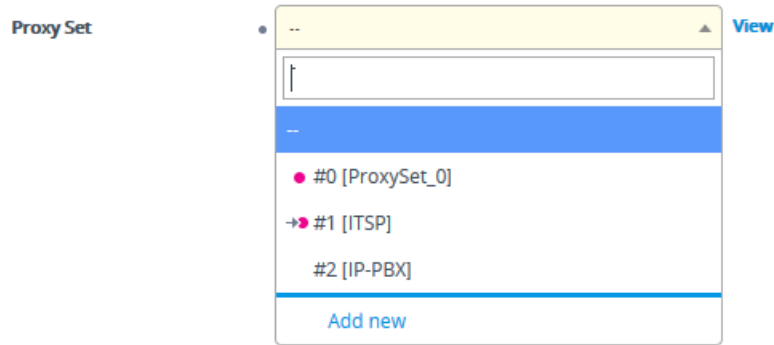

 If you assign a non-mandatory parameter with a referenced row and then later delete the referenced row (in the table in which the row is configured), the parameter's value automatically changes to an empty field (i.e., no row assigned). Therefore, make sure that you are aware of this and if necessary, assign a different referenced row to the parameter. Only if the parameter is mandatory is the **Invalid Line** ● icon displayed for the table in which the parameter is configured.

### Viewing Table Rows

Tables display a certain number of rows per page. If you have configured more than this number, you can use the table's navigation bar to scroll through the table pages, as shown below and described in the subsequent table:

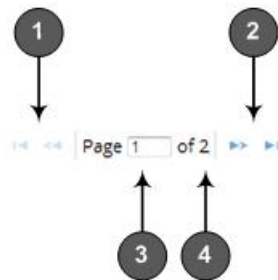

**Table 6-3: Table Navigation Bar Description**

Item	Description
1	Navigation buttons to view previous table rows:  << Displays the previous table page

Item	Description
	<ul style="list-style-type: none"> <li>■ ◀ Displays the first table page (i.e., page with at least the first index row)</li> </ul>
2	Navigation buttons to view the next table rows: <ul style="list-style-type: none"> <li>■ ▶ Displays the next table page</li> <li>■ ▶▶ Displays the last table page (i.e., page with last index row)</li> </ul>
3	Currently displayed table page. To open a specific table page, enter the page number and then press the Enter key.
4	Total number of table pages.

### Sorting Tables by Column

You can sort table rows by any column and in ascending order (e.g., 1, 2 and 3 / a, b, and c) or descending order (e.g., 3, 2, and 1 / c, b, and a). By default, most tables are sorted by the Index column and in ascending order.

#### ➤ To sort table rows by column:

1. Click the name of the column by which you want to sort the table rows; the up-down ↕ arrows appear alongside the column name and the up button is displayed in a darker shade of color, indicating that the column is sorted in ascending order:

INDEX ↕
0
1
2
3
4

2. To sort the column in descending order, click the column name again; only the down arrow is displayed in a darker shade of color, indicating that the column is sorted in descending order:

INDEX ↓
4
3
2
1
0

### Changing Index Position of Table Rows

You can change the position (index) of rows in tables. This is done by using the up-down ↑ ↓ arrows located on the table's toolbar.



- Changing row position can only be done when the table is sorted by the 'Index' column and in ascending order; otherwise, the buttons are grayed out. For sorting table columns, see [Sorting Tables by Column](#).
- Changing row position is supported only by certain tables (e.g., IP-to-IP Routing table).

➤ **To change the position of a row:**

1. Click the 'Index' column header so that the rows are sorted in ascending order (e.g., 0, 1, 2, and so on).
2. Select the row that you want to move.
3. Do one of the following:
  - To move one index up (e.g., from Index 3 to 2): Click the up ↑ arrow; the row moves one index up in the table (e.g., to 2) and the row that originally occupied the index is moved one index down (e.g., to 3). In other words, the rows have swapped positions.
  - To move one index down (e.g., from Index 3 to Index 4): Click the down ↓ arrow; the row moves one index down in the table (e.g., to 4) and the row that originally occupied the index is moved one index up (e.g., to 3). In other words, the rows have swapped positions.
4. Continue clicking the required arrow until the row has moved to the desired location in the table.

### Searching Table Entries

You can search for any parameter value (alphanumeric) in configuration tables, using the Search tool. The Search tool, located above each table, is shown below and described in the subsequent table:

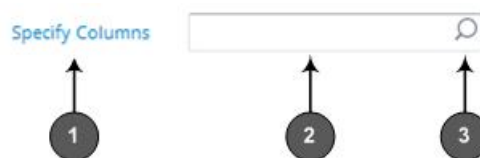



**Table 6-4: Table Search Tool Description**

Item#	Description
1	'Specify Columns' drop-down list for selecting the table column (parameter) in which to do the search. By default, the search is done in all columns.

Item#	Description
2	Search box to enter your search key (parameter value).
3	Magnifying-glass icon which when clicked performs the search.

➤ **To search for a table value:**

1. If you want to perform the search on all table columns, skip this step; otherwise, from the 'Specify Columns' drop-down list, select the table column in which you want to perform the search; the name of the drop-down list changes to the name of the selected column.
2. In the Search box, enter the value for which you want to search.
3. Click the magnifying-glass  icon to run the search. If the device finds the value, the table displays only the rows in which the value was found. You can then select any row and modify it by clicking the **Edit** button. If the search is unsuccessful, no rows are displayed.
4. To quit the Search tool and continue configuring rows, click the  icon located in the Search box.

## Searching for Configuration Parameters

You can search in the Web interface for parameter names (standalone or table parameters) and values. The search key can include the full parameter name (Web or ini file name) or a substring of it. If you search for a substring, all parameters containing the substring in their names are listed in the search result. For example, to search for the parameter 'Telnet Server TCP Port', you can use any of the following search keys:

- "Telnet Server TCP Port" (Web name)
- "TelnetServerPort" (ini file name)
- "Telnet"
- "Port"

The search key for a parameter value can include alphanumeric characters and certain characters (see note below). The key can be a complete value or a partial value. The following are examples of search keys for searching values:

- "10.102.1.50"
- "10.15."
- "abc.com"
- "ITSP ABC"

When the device completes the search, it displays a list of found results based on the search key. Each possible result, when clicked, opens the page on which the parameter or value is located. You need to click the most appropriate result.



The search key can include only alphanumeric characters, periods, and spaces. The use of other characters are invalid.

➤ **To search for a parameter:**

1. In the search box, enter the search key (parameter name or value).
2. Click the search  icon; the Search Result window appears, listing found parameters based on your search key. Each searched result displays the following:
  - Navigation path (link) to the page on which the parameter appears
  - Parameter's name
  - Parameter's value
  - Brief description of parameter

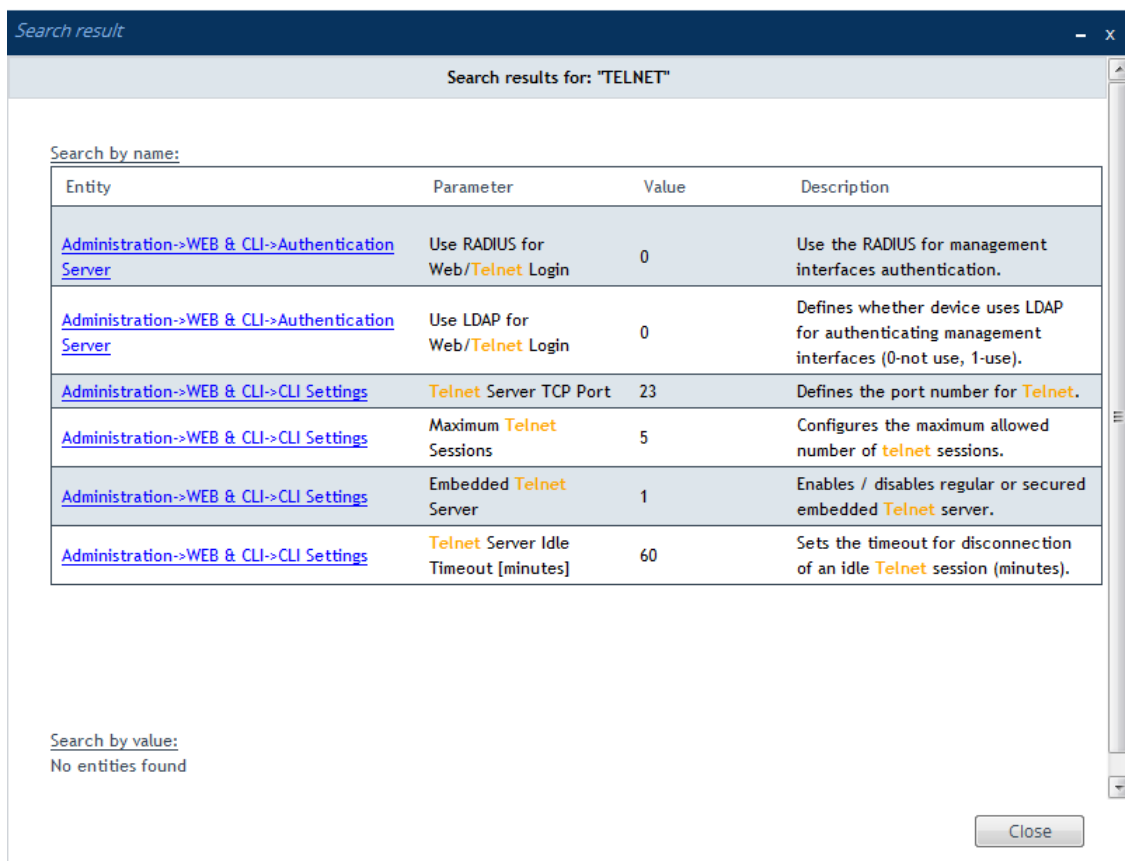

The screenshot shows a window titled "Search result" with a search bar containing "TELNET". Below the search bar, there is a table of search results. The table has four columns: Entity, Parameter, Value, and Description. The results are as follows:

Entity	Parameter	Value	Description
<a href="#">Administration-&gt;WEB &amp; CLI-&gt;Authentication Server</a>	Use RADIUS for Web/Telnet Login	0	Use the RADIUS for management interfaces authentication.
<a href="#">Administration-&gt;WEB &amp; CLI-&gt;Authentication Server</a>	Use LDAP for Web/Telnet Login	0	Defines whether device uses LDAP for authenticating management interfaces (0-not use, 1-use).
<a href="#">Administration-&gt;WEB &amp; CLI-&gt;CLI Settings</a>	Telnet Server TCP Port	23	Defines the port number for Telnet.
<a href="#">Administration-&gt;WEB &amp; CLI-&gt;CLI Settings</a>	Maximum Telnet Sessions	5	Configures the maximum allowed number of telnet sessions.
<a href="#">Administration-&gt;WEB &amp; CLI-&gt;CLI Settings</a>	Embedded Telnet Server	1	Enables / disables regular or secured embedded Telnet server.
<a href="#">Administration-&gt;WEB &amp; CLI-&gt;CLI Settings</a>	Telnet Server Idle Timeout [minutes]	60	Sets the timeout for disconnection of an idle Telnet session (minutes).

Below the table, there is a section for "Search by value:" which shows "No entities found". A "Close" button is located at the bottom right of the window.

3. Click the link of the navigation path corresponding to the required found parameter to open the page on which the parameter appears.

## Getting Help

The Web interface provides you with context-sensitive pop-up help of standalone parameters. When you hover your mouse over a parameter's field, a pop-up appears with a short description of the parameter, as shown in the following example:

SIP Transport Type

U Enable SIP secured URI usage

## Logging Off the Web Interface

The following procedure describes how to log off the Web interface.

### ➤ To log off the Web interface:

1. On the menu bar, from the 'Admin' drop-down list, click **Log Out**; the following confirmation message box appears:

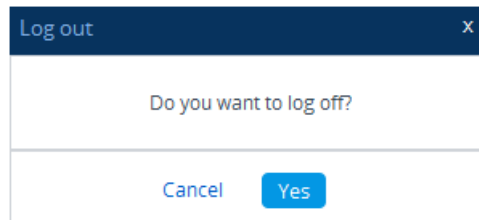

2. Click **Yes**; you are logged off the Web session and the Web Login window appears enabling you to re-login, if required.

## Customizing the Web Interface

You can customize the following elements of the device's Web interface (GUI):

- Corporate logo (see [Replacing the Corporate Logo](#))
- Device's (product) name (see [Customizing the Product Name](#))
- Web browser tab label (see [Customizing the Browser Tab Label](#) on page 43)
- Web browser Favicon (see [Customizing the Favicon](#))
- Login welcome message (see [Creating a Login Welcome Message](#))



- The product name also affects other management interfaces.
- In addition to Web-interface customization, you can customize the following to reference your company instead of AudioCodes:
  - ✓ SNMP Interface: Product system OID (see the `SNMPSysOid` parameter) and trap Enterprise OID (see the `SNMPTrapEnterpriseOid` parameter).
  - ✓ SIP Messages: User-Agent header (see the `UserAgentDisplayInfo` parameter), SDP "o" line (see the `SIPSDPSessionOwner` parameter), and Subject header (see the `SIPSubject` parameter).

## Replacing the Corporate Logo

You can replace the default corporate logo image (i.e., AudioCodes logo) that is displayed in the Web interface. The logo appears in the following Web areas:

- **Web Login screen:**



■ **Menu bar:**



You can replace the logo with one of the following:

- A different image (see [Replacing the Corporate Logo with an Image](#))
- Text (see [Replacing the Corporate Logo with Text](#))

**Replacing the Corporate Logo with an Image**

You can replace the default corporate logo with a different image.



- The logo image file type can be GIF, PNG, JPG, or JPEG.
- The logo image must have a fixed height of 24 pixels. The width can be up to 199 pixels (default is 145).
- The maximum size of the image file can be 64 Kbytes.

➤ **To replace the logo:**

1. Save your new logo image file in a folder on the same PC that you are using to access the device's Web interface.
2. In your browser's URL address field, append the case-sensitive suffix "/AdminPage" to the device's IP address (e.g., http://10.1.229.17/AdminPage).
3. Log in with your credentials; the Admin page appears.
4. On the left pane, click **Image Load to Device**; the right pane displays the following:

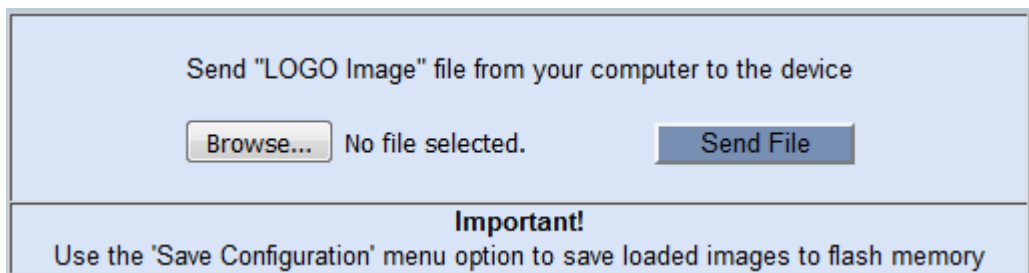



5. Use the **Browse** button to select your logo file, and then click **Send File**; the device loads the file.
6. On the left pane, click **Back to Main** to exit the Admin page.
7. Reset the device with a save-to-flash for your settings to take effect.

### Replacing Corporate Logo with Text

You can replace the logo with text. The following figure displays an example where the logo is replaced with the text, "My Text":



#### ➤ To replace logo with text:

1. Create an ini file that includes the following parameter settings:

```
UseWebLogo = 1
WebLogoText = <your text, for example, My Text>
```

2. Load the ini file using the Auxiliary Files page (see [Loading Auxiliary Files](#)).
3. Reset the device with a save-to-flash for your settings to take effect.

### Replacing Text with Corporate Logo

If you have replaced the logo with text (as described in [Replacing Corporate Logo with Text](#) above), you can return the logo as described below.

#### ➤ To replace text with logo:

1. Create an ini file that includes the following parameter settings:

```
UseWebLogo = 0
```

2. Load the ini file using the Auxiliary Files page (see [Loading Auxiliary Files](#)).
3. Reset the device with a save-to-flash for your settings to take effect.

### Customizing the Browser Tab Label

You can customize the label that appears on the tab of the Web browser that you use to open the device's Web interface. By default, the tab displays "AudioCodes". You can change this to display either the IP address of the device or any customized text.



- You can customize the tab to display the device's IP address. This is applicable only if a logo image is used in the Web interface (see [Replacing the Corporate Logo](#)



with an Image on the previous page).

- If you are using the default AudioCodes corporate logo image in the Web interface, you can only customize the tab to display "AudioCodes" or the IP address.
- You can customize the tab to display text other than "AudioCodes", only if you are using a non-AudioCodes logo image in the Web interface.
- If you have replaced the corporate logo image with text (see [Replacing Corporate Logo with Text](#) on the previous page), the same text is used for the tab.

➤ **To replace the browser tab label with the device's IP address:**

1. Create an ini file that includes the following parameter settings:

```
UseWebLogo = 1
WebLogoText =
```



If you have never configured the [WebLogoText] parameter, you can omit it from the ini file. If you have configured it before, then set it to an empty value, as shown above.

2. Load the ini file using the Auxiliary Files page (see [Loading Auxiliary Files](#)).
3. Reset the device with a save-to-flash for your settings to take effect.

➤ **To customize the text of the browser tab label:**

1. Create an ini file that includes the following parameter settings:
  - To replace the default text:

```
UseWebLogo = 1
WebLogoText = <your text, for example, Hello>
```

- To restore the default text ("AudioCodes"):

```
UseWebLogo = 0
```

2. Load the ini file using the Auxiliary Files page (see [Loading Auxiliary Files](#)).
3. Reset the device with a save-to-flash for your settings to take effect.

## Customizing the Product Name

You can customize the device's product name. The name is displayed in various places in the management interfaces, as shown below using the example of the customized product name "Product":

■ **Web Login screen:**

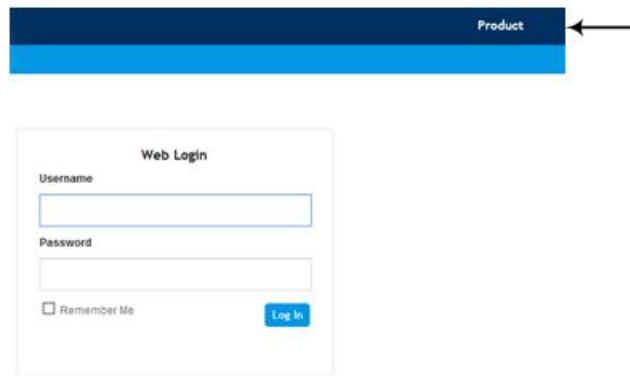

#### ■ Web tab bar:



#### ■ ini file "Board" field:

```
;Board: Product
```

#### ■ CLI prompt:

```
Product(config-system)#
```

#### ➤ To customize the device's product name:

1. Create an ini file (\*.ini) that includes the following parameter settings:

```
UseProductName = 1
UserProductName = < name >
```

2. Load the ini file using the Auxiliary Files page (see [Loading Auxiliary Files](#)).
3. Click the **Save** button on the toolbar to save your settings to flash memory.

## Customizing the Favicon

You can replace the default favicon with your own personalized favicon. Depending on the browser, the favicon is displayed in various areas of your browser, for example, in the URL address bar, on the page tab, and when bookmarked.

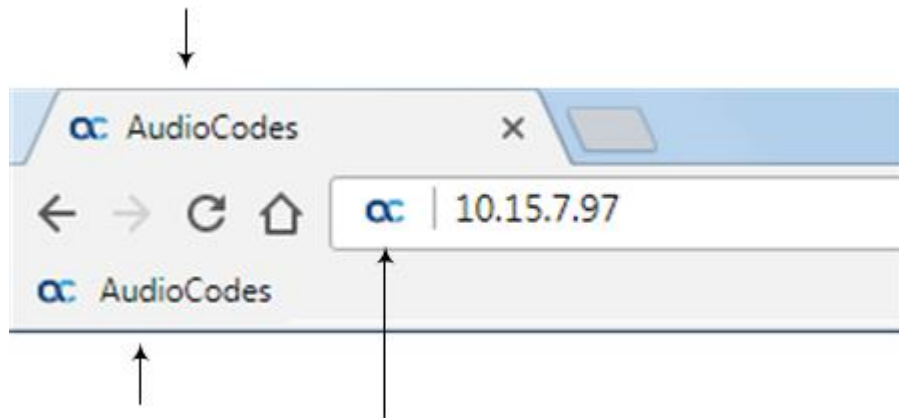

- The logo image file type can be ICO, GIF, or PNG.
- The maximum size of the image file can be 16 Kbytes.

#### ➤ To customize the favicon:

1. Save your new favicon file in a folder on the same PC that you are using to access the device's Web interface.
2. In your browser's URL address field, append the case-sensitive suffix "/AdminPage" to the device's IP address (e.g., http://10.1.229.17/AdminPage).
3. Log in with your credentials; the Admin page appears.
4. On the left pane, click **Image Load to Device**; the right pane displays the following:

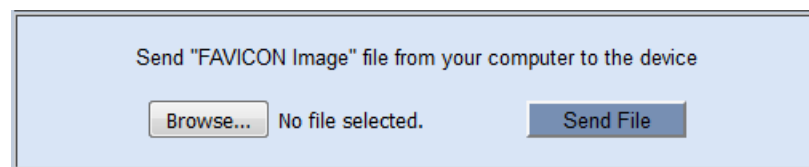

5. Use the **Browse** button to select your favicon file, and then click **Send File**; the device loads the image file.
6. On the left pane, click **Back to Main** to exit the Admin page.
7. Reset the device with a save-to-flash for your settings to take effect.

## Creating a Login Welcome Message

You can create a personalized welcome message that is displayed on the Web Login screen. The message always begins with the title "Note" and has a color background, as shown in the example below:

**Note**

```
*****
** This is a Welcome message! **
*****
```

**Web Login**

**Username**

**Password**

Remember Me Login

➤ **To create a login welcome message:**

1. Create an ini file that includes the WelcomeMessage table parameter. Use the parameter to configure your message, where each index row is a line in your message, for example:

```
[WelcomeMessage ]
FORMAT WelcomeMessage_Index = WelcomeMessage_Text;
WelcomeMessage 1 = "*****",
WelcomeMessage 2 = "*** This is a Welcome message! **",
WelcomeMessage 3 = "*****",
[WelcomeMessage]
```

2. Load the ini file using the Auxiliary Files page (see [Loading Auxiliary Files](#)).
3. Save your settings to flash (not need for a device reset).

➤ **To remove the welcome message:**

1. Load an empty ini file, using the Auxiliary Files page.
2. Reset the device with a save-to-flash for your settings to take effect.

## Configuring Additional Management Interfaces

The Additional Management Interfaces table lets you configure up to 16 management interfaces, in addition to the **OAMP** management interface configured in the IP Interfaces table. Multiple management interfaces lets you remotely access the device's management interfaces (see note below) through different IP addresses. Each additional management

interface can be configured to use a specific network interface (Control or Media type, or both) and TLS Context, and can be configured to restrict access through HTTPS only.



- The feature is applicable only to the device's Web- and REST-based management interfaces.
- To allow access to the device's management interfaces through all network interfaces configured in the IP Interfaces table, see the [EnableWebAccessFromAllInterfaces] parameter. This parameter does not specify a TLS Context nor a connectivity protocol (HTTP or HTTPS).
- For secured management of the default management network interface (i.e., **OAMP** Application Type in the IP Interfaces table), the device uses the default TLS Context (Index #0 and named "default").

The following procedure describes how to configure additional management interfaces through the Web interface. You can also configure it through ini file [AdditionalManagementInterfaces] or CLI (`configure system > additional-mgmt-if`).

➤ **To configure additional management interfaces:**

1. Open the Additional Management Interfaces table (**Setup** menu > **Administration** tab > **Web & CLI** folder > **Additional Management Interfaces**).
2. Click **New**; the following dialog box is displayed:

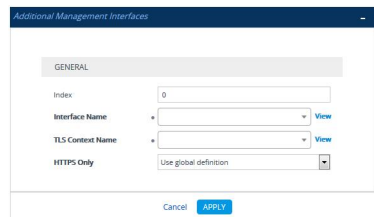

3. Configure an additional management interface according to the parameters described in the table below.
4. Click **Apply**, and then save your settings to flash memory.

**Table 6-5: Additional Management Interfaces Table Parameter Descriptions**

Parameter	Description
General	
'Index' [AdditionalManagementInterfaces_ Index]	Defines an index number for the new table row. <b>Note:</b> Each row must be configured with a unique index.
'Interface Name' interface-name [AdditionalManagementInterfaces_	Assigns an IP network interface (from the IP Interfaces table) to the management interface. For more information on IP network interfaces, see <a href="#">Configuring IP Network Interfaces</a> .

Parameter	Description
InterfaceName]	<p><b>Note:</b></p> <ul style="list-style-type: none"> <li>■ Only Control- and/or Media-type IP network interfaces can be associated with additional management interfaces.</li> <li>■ An IP network interface can be associated with only <b>one</b> additional management interface.</li> </ul>
'TLS Context Name' tls-context-name [AdditionalManagementInterfaces_ TLSContextName]	<p>Assigns a TLS Context (from the TLS Contexts table) to the management interface. A TLS Context provides secure TLS-based management access. For more information on TLS Contexts, see <a href="#">Configuring TLS Certificate Contexts</a>.</p>
'HTTPS Only' https-only-val [AdditionalManagementInterfaces_ HTTPSOnly]	<p>Defines the protocol required for accessing the management interface.</p> <ul style="list-style-type: none"> <li>■ [0] <b>HTTP and HTTPS</b> = The management interface can be accessed over a secured (HTTPS) and an unsecured (HTTP) connection.</li> <li>■ [1] <b>HTTPS Only</b> = The management interface can be accessed only over a secured (HTTPS) connection.</li> <li>■ [2] <b>Use global definition</b> = The type of management connection (HTTP and HTTPS, or HTTPS Only) depends on the configuration of the global parameter [HTTPSOnly], as described in <a href="#">Configuring Secured (HTTPS) Web</a>.</li> </ul>

## Configuring Management User Accounts

The Local Users table lets you configure up to 20 management user accounts for the device's Web interface and CLI. You configure each user account with login credentials (username and password) and a management user level which defines the level of read and write privileges. The table below describes the different types of user levels:

**Table 6-6: Description of Management User Levels**

User Level	Numeric Representation in RADIUS	Privileges
<b>Security</b>	200	Read-write privileges for all Web pages. This user level

User Level	Numeric Representation in RADIUS	Privileges
<b>Administrator</b>		<p>can also access the CLI's Privileged mode.</p> <p>This user level can create all other user levels and is the only one that can create the first Master user.</p> <p><b>Note:</b> At least one Security Administrator user must exist.</p>
<b>Master</b>	220	<p>Read-write privileges for all Web pages. This user level can also access the CLI's Privileged mode.</p> <p>This user level can create all user levels, including additional Master users and Security Administrators. It can delete all users except the last Security Administrator.</p> <p><b>Note:</b> Only Master users can delete Master users. If only one Master user exists, it can be deleted only by itself.</p>
<b>Administrator</b>	100	<p>Read-write privileges for all Web pages, except security-related pages (including the Local Users table) where this user has read-only privileges.</p> <p><b>Note:</b> This user level can access only the CLI's Basic mode (not Privileged mode).</p>
<b>Monitor</b>	50	<p>Read-only privileges and access to security-related pages (including the Local Users table) is blocked.</p> <p><b>Note:</b> This user level can access only the CLI's Basic mode (not Privileged mode).</p>



- Only Security Administrator and Master users can configure users in the Local Users table.
- Regardless of user level, all users can change their login password as described in [Changing Login Password by All User Levels](#) on page 62.
- You can change the read-write and read-only privileges per Web page for Monitor, Administrator, and Security Administrator user levels. For more information, see [Customizing Access Levels per Web Page](#) on page 57.

The device provides the following two default user accounts:



Table 6-7: Default User Accounts

User Level	Username (Case-Sensitive)	Password (Case-Sensitive)
Security Administrator	"Admin"	"Admin"
Monitor	"User"	"User"



- For security, it's recommended that you change the default username and password of the default users.
- To restore the device to these default users (and with their default usernames and passwords), configure the [ResetWebPassword] parameter to [1]. All other configured accounts are deleted.
- If you delete a user who is currently in an active Web session, the user is immediately logged off the device.
- Up to five users can be concurrently logged in to the Web interface; they can all be the same user.
- You can set the entire Web interface to read-only (regardless of Web user access levels), using the [DisableWebConfig] parameter (see [Web and Telnet Parameters](#)).
- You can configure additional Web user accounts using a RADIUS server (see [RADIUS Authentication](#)).

The following procedure describes how to configure user accounts through the Web interface. You can also configure it through ini file [WebUsers] or CLI (`configure system > user`).

➤ **To configure management user accounts:**

1. Open the Local Users table (**Setup** menu > **Administration** tab > **Web & CLI** folder > **Local Users**).
2. Click **New**; the following dialog box is displayed:

3. Configure a user account according to the parameters described in the table below.
4. Click **Apply**, and then save your settings to flash memory.

**Table 6-8: Local Users Table Parameter Descriptions**

Parameter	Description
General	
'Index' [WebUsers_Index]	Defines an index number for the new table row. <b>Note:</b> Each row must be configured with a unique index.
'Username' user [WebUsers_Username]	Defines the Web user's username. The valid value is a string of up to 40 alphanumeric characters, including the period ".", underscore "_", and hyphen "-" signs.
'Password' password [WebUsers_Password]	<p>Defines the Web user's password. The valid value is a string of 8 to 40 ASCII characters. To ensure strong passwords, adhere to the following password complexity requirements:</p> <ul style="list-style-type: none"> <li>■ The password should contain at least eight characters.</li> <li>■ The password should contain at least two uppercase letters (e.g., A).</li> <li>■ The password should contain at least two lowercase letters (e.g., a).</li> <li>■ The password should contain at least two numbers (e.g., 4).</li> <li>■ The password should contain at least two symbols (non-alphanumeric characters, e.g., \$, #, %).</li> <li>■ The password must not contain any spaces.</li> <li>■ The password should contain at least four new characters that were not used in the previous password.</li> </ul> <p>To <b>enforce</b> password complexity requirements as listed above, configure the [EnforcePasswordComplexity] to [1]. If you enable password complexity, you can also configure the minimum length (number of characters) of the password, using the [MinWebPasswordLen] parameter.</p> <p><b>Note:</b></p> <ul style="list-style-type: none"> <li>■ The password must <b>not</b> contain a backslash (\).</li> <li>■ For security, password characters are not shown in the Web interface and ini file. In the Web interface, they are displayed as dots when you enter the password and then once applied, the password is displayed as an asterisk (*) in the table. In the ini file, they are displayed as an encrypted</li> </ul>

Parameter	Description
	<p>string.</p> <ul style="list-style-type: none"> <li>■ To enforce obscured (encrypted) passwords when configuring the Local Users table through the CLI, see the [CliObscuredPassword] parameter.</li> <li>■ The password cannot be configured with wide characters.</li> </ul>
<p>'User Level' privilege [WebUsers_UserLevel]</p>	<p>Defines the user's access level.</p> <ul style="list-style-type: none"> <li>■ <b>Monitor</b> = (Default) Read-only user. This user can only view Web pages and access to security-related pages is denied.</li> <li>■ <b>Administrator</b> = Read/write privileges for all pages except security-related pages including the Local Users table where this user has read-only privileges.</li> <li>■ <b>Security Administrator</b> = Full read/write privileges for all pages.</li> <li>■ <b>Master</b> = Read/write privileges for all pages. This user also functions as a security administrator.</li> </ul> <p><b>Note:</b></p> <ul style="list-style-type: none"> <li>■ At least one Security Administrator must exist. You cannot delete the last remaining Security Administrator.</li> <li>■ The first Master user can be added only by a Security Administrator user.</li> <li>■ Additional Master users can be added, edited and deleted only by Master users.</li> <li>■ If only one Master user exists, it can be deleted only by itself.</li> <li>■ Master users can add, edit, and delete Security Administrators (except the last Security Administrator).</li> <li>■ Only Security Administrator and Master users can add, edit, and delete Administrator and Monitor users.</li> </ul>
<p>'SSH Public Key' public-key [WebUsers_SSHPublicKey]</p>	<p>Defines a Secure Socket Shell (SSH) public key for RSA public-key authentication (PKI) of the remote user when logging into the device's CLI through SSH. Connection to the CLI is established only when a successful handshake with the user's private key occurs.</p> <p>The valid value is a string of up to 512 characters. By default, no value is defined.</p>

Parameter	Description
	<p><b>Note:</b></p> <ul style="list-style-type: none"> <li>■ For more information on SSH and for enabling SSH, see <a href="#">Enabling SSH with RSA Public Key for CLI</a>.</li> <li>■ To configure whether SSH public keys are optional or mandatory, use the SSHRequirePublicKey parameter.</li> </ul>
<p>'Status' status [WebUsers_Status]</p>	<p>Defines the status of the user.</p> <ul style="list-style-type: none"> <li>■ <b>New</b> = (Default) User is required to change its password on the next login. When the user logs in to the Web interface, the user is immediately prompted to change the current password.</li> <li>■ <b>Valid</b> = User can log in to the Web interface as normal.</li> <li>■ <b>Failed Login</b> = The state is automatically set for users that exceed a user-defined number of failed login attempts, set by the 'Deny Access on Fail Count' parameter (see <a href="#">Configuring Web Session and Access Settings</a>). These users can log in only after a user-defined timeout configured by the 'Block Duration' parameter (see below) or if their status is changed (to New or Valid) by a Security Administrator or Master.</li> <li>■ <b>Inactivity</b> = The state is automatically set for users that have not accessed the Web interface for a user-defined number of days, set by the 'User Inactivity Timer' (see <a href="#">Configuring Web Session and Access Settings</a>). These users can only log in to the Web interface if their status is changed (to New or Valid) by a System Administrator or Master.</li> </ul> <p><b>Note:</b></p> <ul style="list-style-type: none"> <li>■ The Inactivity status is applicable only to Administrator and Monitor users; Security Administrator and Master users can be inactive indefinitely.</li> <li>■ For security, it is recommended to set the status of a newly added user to <b>New</b> in order to enforce password change.</li> </ul>
Security	
<p>'Password Age' password-age [WebUsers_</p>	<p>Defines the duration (in days) of the validity of the password. When the duration elapses (i.e., password expires), when attempting to log in, the user is prompted to change the</p>

Parameter	Description
<p>PwAgeInterval]</p>	<p>password (shown below), and then log in with the new password; otherwise, access to the Web interface is blocked.</p> <div data-bbox="644 371 1385 1025" style="border: 1px solid #ccc; padding: 10px; margin: 10px 0;"> <p style="text-align: center;"><b>Change Password</b></p> <p style="text-align: center;"><b>You must change your password to continue</b></p> <p><b>Current Password</b></p> <input style="width: 100%; height: 20px;" type="text"/> <p><b>New Password</b></p> <input style="width: 100%; height: 20px;" type="text"/> <p><b>Confirm Password</b></p> <input style="width: 100%; height: 20px;" type="text"/> <div style="text-align: right; margin-top: 10px;"> <input style="margin-right: 10px;" type="button" value="Cancel"/> <input type="button" value="Change"/> </div> </div> <p>The valid value is 0 to 10000, where 0 means that the password is always valid. The default is 90.</p> <p><b>Note:</b> After logging in with your new password, you must save your settings, by clicking the <b>Save</b> button on the Web interface's toolbar. If not, the next time you attempt to log in, you will be prompted again to change the expired password.</p>
<p>'Web Session Limit' session-limit [WebUsers_ SessionLimit]</p>	<p>Defines the maximum number of concurrent Web interface and REST sessions allowed for the specific user account. For example, if configured to 2, the user account can be logged into the device's Web interface (i.e., same username-password combination) from two different management stations (i.e., IP addresses) or Web browsers at the same time. Once the user logs in, the session is active until the user logs off or until the session expires if the user is inactive for a user-defined duration (see the 'Web Session Timeout' parameter below).</p> <p>The valid value is 0 to 10. The default is 5.</p> <p><b>Note:</b></p> <ul style="list-style-type: none"> <li>■ Closing the Web browser's window (by clicking the window's x button) does not end the session. Therefore, whenever you finish using the Web interface, it is</li> </ul>

Parameter	Description
	<p>recommended that you log out of the Web interface so that your session ends.</p> <ul style="list-style-type: none"> <li>■ If the number of concurrently logged-in users is at the configured maximum, the device allows an additional user to log in through REST.</li> </ul>
<p>'CLI Session Limit' cli-session-limit [WebUsers_CliSessionLimit]</p>	<p>Defines the maximum number of concurrent CLI sessions allowed for the specific user. For example, if configured to 2, the same user account can be logged into the device's CLI (i.e., same username-password combination) from two different management stations (i.e., IP addresses) at any one time. Once the user logs in, the session is active until the user logs off or until the session expires if the user is inactive for a user-defined duration (see the 'Web Session Timeout' parameter below).</p> <p>The valid value is -1, or 0 to 100. The default is -1, which means that the limit is according to the global parameters, 'Maximum Telnet Sessions' (TelnetMaxSessions) or 'Maximum SSH Sessions' (SSHMaxSessions).</p>
<p>'Web Session Timeout' session-timeout [WebUsers_SessionTimeout]</p>	<p>Defines the duration (in minutes) of inactivity of a logged-in user in the Web interface, after which the user is automatically logged off the Web session. In other words, the session expires when the user has not performed any operations (activities) in the Web interface for the configured timeout duration.</p> <p>The valid value is 0, or to 100000. A value of 0 means no timeout. The default value is according to the settings of the WebSessionTimeout global parameter (see <a href="#">Configuring Web Session and Access Settings</a>).</p>
<p>'Block Duration' block-duration [WebUsers_BlockTime]</p>	<p>Defines the duration (in seconds) for which the user is blocked when the user exceeds a user-defined number of failed login attempts.</p> <p>The valid value is 0 to 100000, where 0 means that the user can do as many login failures without getting blocked. The default is according to the settings of the 'Deny Authentication Timer' parameter (see <a href="#">Configuring Web Session and Access Settings</a>).</p> <p><b>Note:</b></p> <ul style="list-style-type: none"> <li>■ To enable this feature, see the 'Deny Access On Fail Count' parameter in <a href="#">Configuring Web Session and Access Settings</a>.</li> </ul>

Parameter	Description
	<ul style="list-style-type: none"> <li>The 'Deny Authentication Timer' parameter relates to failed Web logins from specific IP addresses.</li> </ul>

## Customizing Access Levels per Web Page

The Customize Access Level table lets you configure up to 100 customized access rules. These rules assign read-write (view and configure) or read-only (view) privileges to management user levels (Monitor, Administrator, or Security Administrator) per page in the device's Web interface. These rules override the default read-write and read-only privileges of these user levels (as described in [Configuring Management User Accounts](#) on page 49). Whatever user level is specified, the rule applies to that level and all levels that are higher than that level (Security Administrator is the highest user level and Monitor is the lowest user level). If you attempt to open a page for which you don't have access privileges, the page displays the message "Your access level does not allow you to view this page".



For security reasons, some pages (e.g., the TLS Contexts page) cannot be customized in this table.

The following table provides a few configuration examples to facilitate your understanding of assigning read-write and read-only privileges to user levels per Web page.

Page Name	Read-Write Access Level	Read-Only Access Level	Description
CLI Settings	Monitor	Monitor	Assigns read-write (and read-only) privileges to Monitor users for the CLI Settings page. As this is the lowest user level, it means that all higher user levels (i.e., Administrator and Security Administrator) are also assigned full read-write privileges.

Page Name	Read-Write Access Level	Read-Only Access Level	Description
Firewall	Security Administrator	Monitor	<p>Assigns read-write privileges to Security Administrator users for the Firewall page. As this is the highest user level, only Security Administrator users have write privileges for this page. In addition, as this rule assigns read-only privileges to Monitor users, which is the lowest user level, all higher user levels (i.e., Administrator and Security Administrator) are also assigned read-only privileges.</p>
TLS Contexts	Security Administrator	Security Administrator	<p>Assigns read-write privileges to Security Administrator users for the TLS Contexts page. As this is the highest user level, no other user level can access (read) or</p>



Page Name	Read-Write Access Level	Read-Only Access Level	Description
			configure (write) this page.

The following procedure describes how to configure customized access level rules through the Web interface. You can also configure it through ini file [WebPagesAccessLevel].

➤ **To customize access levels:**

1. Open the Customize Access Level table (**Setup** menu > **Administration** tab > **Web & CLI** folder > **Customize Access Level**).
2. Click **New**; the following dialog box is displayed:

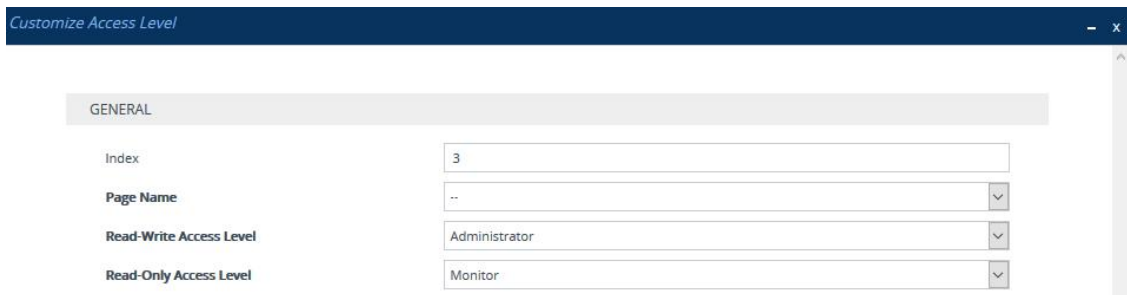

3. Configure the rule according to the parameters described in the table below.
4. Click **Apply**, and then save your settings to flash memory.

**Table 6-9: Customize Access Level Table Parameter Descriptions**

Parameter	Description
'Index' [WebPagesAccessLevel_Index]	Defines an index number for the new table row. <b>Note:</b> Each row must be configured with a unique index.
'Page Name' [WebPagesAccessLevel_PageNameFromTree]	Defines the Web page whose access level you want to customize. <b>Note:</b> For security reasons, some pages are not listed under this parameter and therefore, cannot be customized.
'Read-Write Access Level' [WebPagesAccessLevel_RWAccessLevel]	Defines the <b>minimum</b> user level to which you want to assign read-write access privileges for the selected Web page.  ■ [50] <b>Monitor</b>

Parameter	Description
	<ul style="list-style-type: none"> <li>■ [100] <b>Administrator</b> (default)</li> <li>■ [200] <b>Security Administrator</b></li> </ul>
'Read-Only Access Level' [WebPagesAccessLevel_ ROAccessLevel]	<p>Defines the <b>minimum</b> user level to which you want to assign read-only access privileges for the selected Web page.</p> <ul style="list-style-type: none"> <li>■ [50] <b>Monitor</b> (default)</li> <li>■ [100] <b>Administrator</b></li> <li>■ [200] <b>Security Administrator</b></li> </ul> <p><b>Note:</b> The user level must be the same or lower than the user level you configured in the 'Read-Write Access Level' parameter. For example, you cannot assign read-only privileges to the Security Administrator if you have assigned read-write privileges to the Administrator.</p>

## Displaying Login Information upon Login

You can enable the device to display login information immediately upon Web login.

### ➤ To enable display of user login information upon login:

1. Open the Web Settings page (**Setup** menu > **Administration** tab > **Web & CLI** folder > **Web Settings**).
2. Under the **Security** group, from the 'Display Last Login Information' drop-down list, select **Enable**.
3. Click **Apply**.

Once enabled, each time you login to the device, the Login Information window is displayed, as shown in the example below:

Login Information	
Last Login Privilege	Security Administrator
Last Failed Login Time	-
Last Failed Login Date	-
Last Failed Login IP	-
Login Attempts Since Last Success	0
Last Success Login Time	16:15:19
Last Success Login Date	16/01/10
Last Success Login IP	10.13.2.51

Close

To close the window, click **Close**.

## Viewing Logged-In User Information

The username of the currently logged in user is displayed in the top-right corner of the Web interface. If you click the username (e.g., "Admin"), a drop-down box appears, for example:

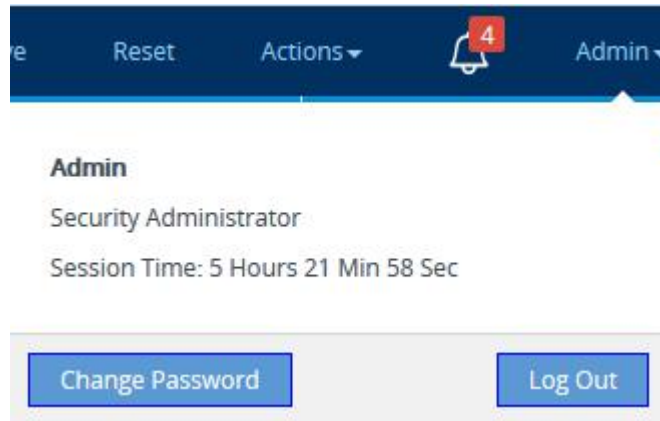

The following information is displayed:

- Username (e.g., Admin) of currently logged-in user
- User level (e.g., Security Administrator) of currently logged-in user
- Duration of the current Web session (starting from login)

The following buttons are also displayed:

- **Log Out:** Logs you out of the Web session (see [Logging Off the Web Interface](#))
- **Change Password:** Allows you to change your login password (see [Changing Login Password by All User Levels](#) on the next page)

## Configuring Web Session and Access Settings

The following procedure describes how to configure security features related to Web user sessions and access.



You can only perform the configuration described in this section if you are a management user with Security Administrator level or Master level. For more information, see [Configuring Management User Accounts](#).

### ➤ To configure Web user sessions and access security:

1. Open the Web Settings page (**Setup** menu > **Administration** tab > **Web & CLI** folder > **Web Settings**).
2. Under the **Session** group, configure the following parameters:

SESSION	
Password Change Interval (minutes)	1440
User Inactivity Timeout (days)	90
Session Timeout (minutes)	60

- 'Password Change Interval': Defines the minimum duration (in minutes) between login password changes. Only if this duration has elapsed can you change the password again.
- 'User Inactivity Timeout': If the user has not logged into the Web interface within this duration, the status of the user becomes inactive and the user can no longer access the Web interface. The user can only log in to the Web interface if its status is changed (to **New** or **Valid**) by a Security Administrator or Master user (see [Configuring Management User Accounts](#)).
- 'Session Timeout': Defines the duration (in minutes) of inactivity (i.e., no actions are performed in the Web interface) of a logged-in user, after which the Web session expires and the user is automatically logged off the Web interface and needs to log in again to continue the session. You can also configure the functionality per user in the Local Users table (see [Configuring Management User Accounts](#)), which overrides this global setting.

3. Under the **Security** group, configure the following parameters:

<b>Secured Web Connection (HTTPS)</b>	HTTPS Only	
Require Client Certificates for HTTPS connection	Enable	

- 'Deny Authentication Timer': Interval (in seconds) that the user needs to wait before logging in from the same IP address after reaching the maximum number of failed login attempts (see next step).
- 'Deny Access On Fail Count': Number of failed login attempts (e.g., incorrect username or password) after which the device blocks access to the user for a user-defined duration (previous step).

4. Click **Apply**.

For a detailed description of the above parameters, see [Web Parameters](#).

## Changing Login Password by All User Levels

Regardless of your user level (e.g., Monitor or Administrator), you can change your login password through the Change Password dialog box, accessed from the Web interface's top bar.



- Users with Security Administrator level or Master level can also change passwords for themselves and for other user levels in the Local Users table (see [Configuring Management User Accounts](#)).
- For valid passwords, see the 'Password' parameter in the Local Users table.
- You can only change the password if the duration configured by the 'Password Change Interval' parameter has elapsed since the last password change (see [Configuring Web Session and Access Settings](#)).

➤ **To change the login password:**

1. On the top bar of the Web interface, click the username that is displayed for the currently logged-in user (e.g., "Admin"); the following appears:

A dropdown menu for the user 'Admin'. The menu is white with a light blue border. It contains the following text: 'Admin' (bold), 'Security Administrator', and 'Session Time: 5 Hours 21 Min 58 Sec'. At the bottom of the menu are two blue buttons: 'Change Password' and 'Log Out'.

2. Click **Change Password**; the following appears:

A dialog box titled 'Change Password' with a close button (X) in the top right corner. The dialog has a dark blue header. It contains three input fields: 'Current Password', 'New Password', and 'Confirm Password'. At the bottom of the dialog are two buttons: 'Cancel' and 'Change'.

3. In the 'Current Password' field, enter your current login password.
4. In the 'New Password' field, enter your new password.
5. In the 'Confirm Password' field, enter your new password again.
6. Click **Change**; you are logged off the Web session and prompted to log in again with your new password.

## Configuring Secured (HTTPS) Web

By default, the device allows remote management (client) through HTTP and HTTPS. However, you can enforce secure Web access communication by configuring the device to accept only HTTPS requests.

By default, servers using TLS provide one-way authentication. The client is certain that the identity of the server is authentic. However, when an organizational Public Key Infrastructure (PKI) is used, two-way authentication (TLS mutual authentication) may be desired; both client and server should be authenticated using X.509 certificates. This is achieved by installing a client certificate on the management PC and loading the Certification Authority's (CA) root certificate to the device's Trusted Certificates table (certificate root store). The Trusted Root Certificate file may contain more than one CA certificate combined, using a text editor.



For secured management through the device's default management network interface (i.e., **OAMP** Application Type in the IP Interfaces table), the device uses the default TLS Context (Index #0 and named "default"). However, for secured Web- and REST-based management through Additional Management Interfaces (configured in [Configuring Additional Management Interfaces](#) on page 47), you can use any TLS Context.

### ➤ To configure secure (HTTPS) Web access:

1. Open the Web Settings page (**Setup** menu > **Administration** tab > **Web & CLI** folder > **Web Settings**), and then do the following.
  - From the 'Secured Web Connection (HTTPS)' drop-down list, select **HTTPS Only**.
  - To enable two-way authentication whereby both management client and server are authenticated using X.509 certificates, from the 'Require Client Certificates for HTTPS connection' drop-down list, select **Enable**.

Secured Web Connection (HTTPS)	HTTPS Only	⌵ ⚡
Require Client Certificates for HTTPS connection	Enable	⌵

2. If you want to configure secured management through an Additional Management Interface (i.e., not through the default management network interface called **OAMP** in the IP Interfaces table), then configure an Additional Management Interface as described in [Configuring Additional Management Interfaces](#) on page 47. Assign it a TLS Context and enable it for **HTTPS Only**.
3. **(TLS Mutual Authentication Only)** In the TLS Contexts table (see [Configuring TLS Certificate Contexts](#)), select the required TLS Context (see following note), and then click the **Trusted Root Certificates** link located below the table; the Trusted Certificates table appears.



If you are securing management through the default management network interface (i.e., **OAMP** in the IP Interfaces table), then you need to select the default TLS Context (Index #0, which is named "default"). If you are securing management through an Additional Management Interface, then select the TLS Context that you assigned the Additional Management Interface (in [Configuring Additional Management Interfaces](#) on page 47).

4. **(TLS Mutual Authentication Only)** Click the **Import** button, and then select the certificate file that was issued by the CA and which you want to import into the device's Trusted Root Certificates store.
5. Reset the device with a save-to-flash for your settings to take effect.

When a user connects to the secured Web interface of the device:

- If the user has a client certificate from a CA that is listed in the device's Trusted Root Certificate file, the connection is accepted and the user is prompted for the login password.
- If both the CA certificate and the client certificate appear in the Trusted Root Certificate file, the user is not prompted for a password. Therefore, this provides a single-sign-on experience; authentication is performed using the X.509 digital signature.
- If the user does not have a client certificate from a listed CA or does not have a client certificate, connection is rejected.



- The process of installing a client certificate on your PC is beyond the scope of this document. For more information, refer to your operating system documentation and consult with your security administrator.
- The root certificate can also be loaded through the device's Auto-Update mechanism, by using the [HTTPSRootFileName] parameter.
- You can enable the device to check whether a peer's certificate has been revoked by an OCSP server per TLS Context (see [Configuring TLS Certificate Contexts](#)).

## Enabling CSRF Protection

The device's embedded Web server provides support for cross-site request forgery (CSRF) protection. CSRF prevents malicious exploits of a website, whereby unauthorized commands are transmitted from a user that the website trusts (i.e., authenticated user). Whenever a user opens (i.e., GET method) one of the device's Web pages, the device automatically generates a CSRF "token" (unique number). When the user performs actions (i.e., POST method) on that page (e.g., configures parameters), the token is included to verify that the authenticated user is the one performing the actions.

### ➤ To enable CSRF protection:

- Load the device with an ini file containing the following parameter setting:

```
CSRFProtection = 1
```

## Enabling DNS Rebinding Protection

The device provides protection against DNS rebinding attacks. DNS rebinding allows attackers to access and attack your device and internal network, by remapping hostname-to-IP address lookups. This may occur when you device use a hostname to access the device (see [Configuring a Hostname for the Device](#) on page 106) instead of its IP address. When the device blocks a DNS rebinding attack, it sends an HTTP 400 Bad Request response and logs the attack in Syslog.

### ➤ To enable DNS rebinding protection:

1. Open the Web Settings page (**Setup** menu > **Administration** tab > **Web & CLI** folder > **Web Settings**).
2. From the 'DNS Rebinding Protection' drop-down list, select **Enable**.

DNS Rebinding Protection

3. Click **Apply**.

## Web Login Authentication using Smart Cards

You can enable Web login authentication using certificates from a third-party, common access card (CAC) or smart card with user identification. When a user attempts to access the device through the Web browser (HTTPS), the device retrieves the Web user's login username (and other information, if required) from the CAC, and automatically displays it in the 'Username' field (read-only) on the Web Login screen. The user attempting to access the device is now only required to provide the login password.

Typically, a TLS connection is established between the CAC and the device's Web interface, and a RADIUS server is implemented to authenticate the password with the username. Therefore, this feature implements a two-factor authentication - what the user has (i.e., the physical card) and what the user knows (i.e., the login password).



For specific integration requirements for implementing a third-party smart card for Web login authentication, contact the sales representative of your purchased device.

### ➤ To log in and enable Web login authentication using CAC:

1. Open the Security Settings page (**Setup** menu > **IP Network** tab > **Security** folder > **Security Settings**).
2. From the 'Enable Management Two Factor Authentication' [EnableMgmtTwoFactorAuthentication] drop-down list, select **Enable**.



**Enable Management Two Factor Authentication** •  

3. Insert the Common Access Card into your card reader.
4. Enter the password only. As some browsers may require a username, it's recommended to enter a username with an arbitrary value.

## Configuring Web and Telnet Access List

The Access List table lets you restrict access to the device's management interfaces (Web and CLI) by specifying IP addresses (up to ten) of management clients that are permitted to access the device. Access to the device's management interfaces from undefined IP addresses is denied (rejected with an HTTP 403 Forbidden response). If you don't specify any IP addresses, this security feature is inactive and the device can be accessed from any IP address.

The following procedure describes how to configure the Access List through the Web interface. You can also configure it through ini file [WebAccessList\_x] or CLI (`configure system > mgmt-access-list`).



- Configure the IP address of the computer from which you are currently logged into the device as the first authorized IP address in the Access List. If you configure any other IP address, access from your computer will be immediately denied.
- If you configure network firewall rules in the Firewall table (see [Configuring Firewall Rules](#)), you must configure a firewall rule that permits traffic from IP addresses configured in the Access List table.

### ➤ To add IP addresses to the Access List:

1. Open the Access List table (**Setup** menu > **Administration** tab > **Web & CLI** folder > **Access List**).

Access List

Add an authorized IP address

2. In the 'Add an authorized IP address' field, configure an IP address, and then click **Add New Entry**; the IP address is added to the table.

DELETE ROW		AUTHORIZED IP ADDRESS
1	<input type="checkbox"/>	10.13.2.51

If you have configured IP addresses in the Access List and you no longer want to restrict access to the management interface based on the Access List, delete all the IP addresses in the table, as described in the following procedure.



When deleting all the IP addresses in the Access List table, make sure that you delete the IP address of the computer from which you are currently logged into the device, **last**; otherwise, access from your computer will be immediately denied.

➤ **To delete an IP address from the Access List:**

1. Select the Delete Row check box corresponding to the IP address that you want to delete.
2. Click **Delete Selected Addresses**.

## 7 CLI-Based Management

This chapter provides an overview of the CLI-based management and provides configuration relating to CLI management.



- By default, CLI is disabled for security purposes.
- The CLI provides two access modes - Basic mode (basic commands) and Privileged mode (all commands). Access to these modes depends on management user level:
  - ✓ Monitor user level: Basic mode only
  - ✓ Administrator user level: Basic mode only
  - ✓ Security Administrator user level: Basic and Privileged modes
  - ✓ Master user level: Basic and Privileged modes
- For a description of the CLI commands, refer to the CLI Reference Guide.

### Enabling CLI

By default, access to the device's CLI through Telnet and SSH is disabled. This section describes how to enable these protocols.

### Enabling Telnet for CLI

The device provides an embedded Telnet server, which allows you to access its CLI from a remote Telnet client using the Telnet application protocol. By default, the Telnet server is enabled, but for unsecured Telnet connections whereby information is transmitted in clear text. Optionally, you can disable Telnet connectivity, or enable secured Telnet connections. If you enable secured Telnet connectivity, the device uses the TLS security protocol, whereby information is transmitted encrypted. For TLS, the device uses the TLS settings of the TLS Context at Index #0 ("default"). A special Telnet client is required on your PC to connect to the Telnet interface over the TLS connection, for example, C-Kermit for UNIX and Kermit-95 for Windows. For more information on TLS, see [Configuring TLS Certificates](#) on page 154.

For security, some organizations require the display of a proprietary notice upon starting a Telnet session. To configure such a message, see [Creating a Login Welcome Message](#).

#### ➤ To enable Telnet:

1. Open the CLI Settings page (**Setup** menu > **Administration** tab > **Web & CLI** folder > **CLI Settings**).

TELNET	
Embedded Telnet Server	Enable Unsecured ▼
Telnet Server TCP Port	23
Telnet Server Idle Timeout [minutes]	5 ⚡
Maximum Telnet Sessions	5

2. From the 'Embedded Telnet Server' drop-down list, select **Enable Unsecured** or **Enable Secured** (i.e, TLS) to enable Telnet.
3. In the 'Telnet Server TCP Port' field, enter the port number of the embedded Telnet server.
4. In the 'Telnet Server Idle Timeout' field, enter the duration of inactivity in the Telnet session after which the session automatically ends.
5. Click **Apply**, and then reset the device with a save-to-flash for your settings to take effect.

For a detailed description of the Telnet parameters, see [Telnet and CLI Parameters](#).

## Enabling SSH with RSA Public Key for CLI

Unless configured for TLS, Telnet is not secure as it requires passwords to be transmitted in clear text. To overcome this, you can use Secure SHell (SSH) which is the de-facto standard for secure CLI. SSH 2.0 is a protocol built above TCP providing methods for key exchange, authentication, encryption, and authorization. SSH requires appropriate client software for the management PC. Most Linux distributions have OpenSSH pre-installed; Windows-based PCs require an SSH client software such as PuTTY. By default, SSH uses the same username and password as the device's Telnet and Web server. SSH supports 1024/2048-bit RSA public keys, providing carrier-grade security.

Follow the instructions below to configure the device with an administrator RSA key as a means of strong authentication.

### ➤ To enable SSH and configure RSA public keys for Windows (using PuTTY SSH software):

1. Start the PuTTY Key Generator program, and then do the following:
  - a. Under the Parameters group, do the following:
    - ◆ Select the **SSH-2 RSA** option.
    - ◆ In the 'Number of bits in a generated key' field, enter "1024" bits.
  - b. Under the Actions group, click **Generate** and then follow the on-screen instructions.
  - c. Under the Actions group, click **Save private key** to save the new private key to a file (\*.ppk) on your PC.
  - d. Under the Key group, select and copy the displayed encoded text (public key) between "ssh-rsa" and "rsa-key-....", as shown in the example below:

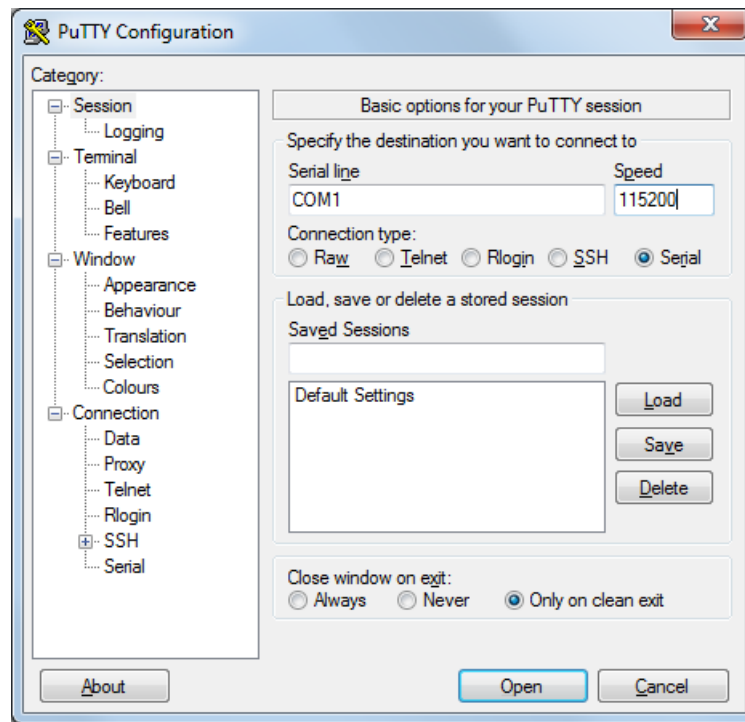

2. Open the Local Users table (see [Configuring Management User Accounts](#)), and then for the required user, paste the public key that you copied in Step 1.d into the 'SSH Public Key' field, as shown below:

GENERAL		SECURITY	
Index	<input type="text" value="0"/>	Password Age	<input type="text" value="0"/>
Username	<input type="text" value="Admin"/>	Session Limit	<input type="text" value="5"/>
Password	<input type="password" value="•"/>	Session Timeout	<input type="text" value="60"/>
User Level	<input type="text" value="Security Administrator"/>	Block Duration	<input type="text" value="60"/>
SSH public key	<input type="text" value="AAAANzaC1yc2EAAAABJQAAAIBhs4d5kz"/>		
Status	<input type="text" value="Valid"/>		



The public key cannot be configured with wide characters.

3. On the CLI Settings page, do the following:
  - a. From the 'Enable SSH Server' drop-down list, select **Enable**.
  - b. For additional security, you can configure the 'Public Key' field to **Enable**. This ensures that SSH access is only possible by using the RSA key and not by username and password.

Public Key

- c. Configure the other SSH parameters as required. For a description of these parameters, see [SSH Parameters](#).

- d. Click **Apply**.
4. Start the PuTTY Configuration program, and then do the following:
  - a. In the 'Category' tree, drill down to **Connection**, then **SSH**, and then **Auth**; the 'Options controlling SSH authentication' pane appears.
  - b. Under the 'Authentication parameters' group, click **Browse** and then locate the private key file that you created and saved in Step 4.
5. Connect to the device with SSH using the username "Admin"; RSA key negotiation occurs automatically and no password is required.

➤ **To configure RSA public keys for Linux (using OpenSSH 4.3):**

1. Run the following command to create a new key in the admin.key file and to save the public portion to the admin.key.pub file:

```
ssh-keygen -f admin.key -N "" -b 1024
```

2. Open the admin.key.pub file, and then copy the encoded string from "ssh-rsa" to the white space.
3. Open the Local Users table (see [Configuring Management User Accounts](#)), and then for the required user, paste the public key that you copied in Step 2 into the 'SSH Public Key' field.
4. Connect to the device with SSH, using the following command (where xx.xx.xx.xx is the device's IP address):

```
ssh -i admin.key xx.xx.xx.xx
```

RSA-key negotiation occurs automatically and no password is required.

## Configuring Maximum Telnet/SSH Sessions

You can configure the maximum number of concurrent Telnet and SSH sessions permitted on the device.



- Before changing the setting, make sure that not more than the number of sessions that you want to configure are currently active; otherwise, the new setting will not take effect.
- The device supports up to five concurrent Telnet and SSH sessions.

➤ **To configure the maximum number of concurrent Telnet and SSH sessions:**

1. Open the CLI Settings page (**Setup** menu > **Administration** tab > **Web & CLI** folder > **CLI Settings**).

2. **For Telnet:** Under the **Telnet** group, in the 'Maximum Telnet Sessions' field, enter the maximum number of concurrent sessions.
3. **For SSH:** Under the **SSH** group, in the 'Maximum SSH Sessions' field, enter the maximum number of concurrent sessions.
4. Click **Apply**.

## Establishing a CLI Session

You can access the device's CLI using any of the following methods:

- **RS-232:** The device can be accessed through its RS-232 serial port, by connecting a VT100 terminal to it or using a terminal emulation program (e.g., HyperTerminal) with a PC. For connecting to the CLI through RS-232, see [CLI](#).
- **Secure SHell (SSH):** The device can be accessed through its Ethernet interface by the SSH protocol using SSH client software. A popular and freeware SSH client software is Putty, which can be downloaded from <http://www.chiark.greenend.org.uk/~sgtatham/putty/download.html>.
- **Telnet:** The device can be accessed through its Ethernet interface by the Telnet protocol using Telnet client software.

The following procedure describes how to access the CLI through Telnet/SSH.



The CLI login credentials are the same as all the device's other management interfaces (such as Web interface). The default username and password is "Admin" and "Admin" (case-sensitive), respectively. To configure login credentials and management user accounts, see [Configuring Management User Accounts](#).

### ➤ To establish a CLI session through Telnet or SSH:

1. Connect the device to the network.
2. Establish a Telnet or SSH session using the device's OAMP IP address.
3. Log in to the session using the username and password assigned to the Admin user of the Web interface:
  - a. At the Username prompt, type the username, and then press Enter:

```
Username: Admin
```

- b. At the Password prompt, type the password, and then press Enter:

```
Password: Admin
```

- c. At the prompt, type the following, and then press Enter:

```
> enable
```

- d. At the prompt, type the password again, and then press Enter:

```
Password: Admin
```

## Viewing Current CLI Sessions

You can view users that are currently logged in to the device's CLI. This applies to users logged in to the CLI through RS-232 (console), Telnet, or SSH. For each logged-in user, the following is displayed: the type of interface (console, Telnet, or SSH), username, remote IP address from where the user logged in, and the duration (days and time) of the session. Each user is displayed with a unique index (session ID).

### ➤ To view currently logged-in CLI users:

1. Establish a CLI session with the device.
2. Run the following command:

```
# show users
[0] console Admin local 0d00h03m15s
[1] telnet John 10.4.2.1 0d01h03m47s
[2]* ssh Alex 192.168.121.234 12d00h02m34s
```

The current session from which this show command was run is displayed with an asterisk (\*).



The device can display management sessions of up to 24 hours. After this time, the duration counter is reset.

## Terminating a User's CLI Session

You can terminate users that are currently logged in to the device's CLI. This applies to users logged in to the CLI through RS-232 (console), Telnet, or SSH.

### ➤ To terminate the CLI session of a specific CLI user:

1. Establish a CLI session with the device.
2. Run the following command:

```
# clear user <session ID>
```



Where *<session ID>* is a unique identification of each currently logged in user. You can view the session ID by running the **show users** command (see [Viewing Current CLI Sessions](#)).



The session in which the command is run cannot be terminated.

## Configuring Displayed Output Lines in CLI Terminal Window

You can configure the maximum number of lines (height) displayed in the terminal window for the output of CLI commands (Telnet and SSH). The number of displayed lines can be from 0 to 65,535, or determined by re-sizing the terminal window by mouse-dragging the window's border.

### ➤ To specify the number of displayed output lines:

1. Establish a CLI session with the device.
2. Access the System menu:

```
# configure system
```

3. At the prompt, type the following command:

```
(config-system)# cli-terminal
```

4. At the prompt, type the following command:

```
<cli-terminal># window-height [0-65535]
```

If window-height is set to 0, the entire command output is displayed. In other words, even if the output extends beyond the visible terminal window length, the --MORE-- prompt is not displayed.

### ➤ To configure the number of displayed output lines by dragging terminal window:

1. Establish a CLI session with the device.
2. Access the System menu:

```
# configure system
```

3. At the prompt, type the following command:

```
(config-system)# cli-terminal
```

4. At the prompt, type the following command:

```
<cli-terminal># window-height automatic
```

When this mode is configured, each time you change the height of the terminal window using your mouse (i.e., dragging one of the window's borders or corners), the number of displayed output command lines is changed accordingly.

## Idle CLI Session Timeout for RS-232 Connections

If you have established a CLI session (successfully logged in) with the device through an RS-232 serial interface and you don't perform any actions in the CLI session for five minutes, the device automatically logs you out the session. In such a scenario, you need to log in to the CLI again if you want to continue using the CLI. This idle session timeout is not configurable.

## Configuring Password Display in CLI

You can enable the device to display passwords in the CLI's `show running-config` output in encrypted (obscured) format instead of in plain text. When passwords are displayed encrypted, the word "obscured" appears after the password.

### ➤ To enable obscured password display in CLI:

```
(config-system)# cli-settings  
(cli-settings)# password-obscurity on
```

Below shows two examples of password display (obscured and plain text) in the `show running-config` output for a password configured for a Remote Web Service:

- Password displayed in encrypted (obscured) format:

```
rest-password 8ZybmJHEXMTM obscured
```

- Password displayed in plain text:

```
rest-password John1234
```

## 8 SNMP-Based Management

The device provides an embedded SNMP agent that lets you manage it using AudioCodes One Voice Operations Center (OVOC) or a third-party SNMP manager. The SNMP agent supports standard and proprietary Management Information Base (MIBs). All supported MIB files are supplied to customers as part of the release. The SNMP agent can send unsolicited SNMP trap events to the SNMP manager.



- By default, SNMP-based management is enabled.
- For more information on the device's SNMP support such as SNMP trap alarms and events, refer to the *SNMP Reference Guide*.
- For more information on OVOC, refer to the *OVOC User's Manual*.

### Disabling SNMP

By default, SNMP is enabled. However, you can disable it as described in the following procedure.

#### ➤ To disable SNMP:

1. Open the SNMP Community Settings page (**Setup** menu > **Administration** tab > **SNMP** folder > **SNMP Community Settings**).
2. From the 'Disable SNMP' drop-down list (DisableSNMP parameter), select **Yes**:

MISC. SETTINGS

Disable SNMP

3. Click **Apply**, and then reset the device with a save-to-flash for your settings to take effect.

### Configuring SNMP Community Strings

SNMP community strings determine the access privileges (read-only and read-write) of SNMP clients with the device's SNMP agent. You can configure up to five read-only SNMP community strings and up to five read-write SNMP community strings. The device's SNMP agent accepts SNMP Get (read-only) and Set (read-write) requests only if the correct community string is used in the request.

You can also configure a unique password-like community string used for sending SNMP traps. The device sends the traps with the community string.



- SNMP community strings are applicable only to SNMPv1 and SNMPv2c; SNMPv3 uses username-password authentication along with an encryption key (see [Configuring SNMP V3 Users](#)).



- You can enhance security by configuring Trusted Managers (see [Configuring SNMP Trusted Managers](#)). A Trusted Manager is an IP address from which the SNMP agent accepts Get and Set requests.

For detailed descriptions of the SNMP parameters, see [SNMP Parameters](#).

➤ **To configure SNMP community strings:**

- Open the SNMP Community Settings page (**Setup** menu > **Administration** tab > **SNMP** folder > **SNMP Community Settings**).
- Configure SNMP community strings for access privileges:

GENERAL SETTINGS		MISC. SETTINGS	
<b>Disable SNMP</b>	<input type="text" value="No"/>	<b>Trap Community String</b>	<input type="text" value="trapuser"/>
		Trap Manager Host Name	<input type="text"/>
<b>READ-ONLY COMMUNITY STRINGS</b>		Activity Trap	<input type="text" value="Disable"/>
Read-Only 1	<input type="text"/>		
Read-Only 2	<input type="text"/>		
Read-Only 3	<input type="text"/>		
Read-Only 4	<input type="text"/>		
Read-Only 5	<input type="text"/>		
<b>READ-WRITE COMMUNITY STRINGS</b>			
Read-Write 1	<input type="text"/>		
Read-Write 2	<input type="text"/>		
Read-Write 3	<input type="text"/>		
Read-Write 4	<input type="text"/>		
Read-Write 5	<input type="text"/>		

- Under the **Read Only Community Strings** group, configure read-only community strings (see the table below).
  - Under the **Read/Write Community Strings** group, configure read-write community strings (see the table below).
- Configure a community string for SNMP traps: Under the **Misc. Settings** group, in the 'Trap Community String' field, configure a community string (see the table below).

**Trap Community String**

- Click **Apply**, and then reset the device with a save-to-flash for your settings to take effect.

To delete a community string, delete the configured string, click **Apply**., and then reset the device with a save-to-flash for your settings to take effect.

**Table 8-1: SNMP Community String Parameter Descriptions**

Parameter	Description
<p>'Read-Only Community Strings'</p> <pre>configure system &gt; snmp settings &gt; ro-community-string</pre> <p>[SNMPReadOnlyCommunityStringsPassword_x]</p>	<p>Defines read-only SNMP community strings. Up to five read-only community strings can be configured.</p> <p>The valid value is a string of up to 30 characters that can include only the following:</p> <ul style="list-style-type: none"> <li>■ Upper- and lower-case letters (a to z, and A to Z)</li> <li>■ Numbers (0 to 9)</li> <li>■ Hyphen (-)</li> <li>■ Underline (_)</li> </ul> <p>For example, "Public-comm_string1". The default is "public".</p> <p><b>Note:</b></p> <ul style="list-style-type: none"> <li>■ The parameter cannot be configured with wide characters.</li> <li>■ For ini file configuration, x is 0 for the 'Read-Only 1' parameter.</li> </ul>
<p>'Read-Write Community Strings'</p> <pre>configure system &gt; snmp settings &gt; rw-community-string</pre> <p>[SNMPReadWriteCommunityStringsPassword_x]</p>	<p>Defines read-write SNMP community strings. Up to five read-write community strings can be configured.</p> <p>The valid value is a string of up to 30 characters that can include only the following:</p> <ul style="list-style-type: none"> <li>■ Upper- and lower-case letters (a to z, and A to Z)</li> <li>■ Numbers (0 to 9)</li> <li>■ Hyphen (-)</li> <li>■ Underline (_)</li> </ul> <p>For example, "Private-comm_string1". The default is "private".</p> <ul style="list-style-type: none"> <li>■ The parameter cannot be configured with wide characters.</li> <li>■ For ini file configuration, x is 0 for the</li> </ul>

Parameter	Description
	'Read-Write 1' parameter.
'Trap Community String' <pre>configure system &gt; snmp trap &gt; community-string</pre> [SNMPTrapCommunityStringPassword]	Defines the community string for SNMP traps. The valid value is a string of up to 30 characters that can include only the following: <ul style="list-style-type: none"> <li>■ Upper- and lower-case letters (a to z, and A to Z)</li> <li>■ Numbers (0 to 9)</li> <li>■ Hyphen (-)</li> <li>■ Underline (_)</li> </ul> For example, "Trap-comm_string1". The default is "trapuser". <b>Note:</b> The parameter cannot be configured with wide characters.

## Configuring SNMP Trap Destinations with IP Addresses

The SNMP Trap Destinations table lets you configure up to five SNMP trap managers to receive traps sent by the device. The SNMP manager is defined by IP address and port. You can associate a trap destination with SNMPv2 users and specific SNMPv3 users. Associating a trap destination with SNMPv3 users sends encrypted and authenticated traps to the SNMPv3 destination. By default, traps are sent unencrypted using SNMPv2.

The following procedure describes how to configure SNMP trap destinations through the Web interface. You can also configure it through ini file [SNMPManager] or CLI (`configure system > snmp trap-destination`).

### ➤ To configure SNMP trap destinations:

1. Open the SNMP Trap Destinations table (**Setup** menu > **Administration** tab > **SNMP** folder > **SNMP Trap Destinations**).

	NAME	IP ADDRESS	TRAP PORT	TRAP USER	TRAP ENABLE
<input type="checkbox"/>	SNMP Manager 1	0.0.0.0	162	v2cParams	Enable
<input type="checkbox"/>	SNMP Manager 2	0.0.0.0	162	v2cParams	Enable
<input type="checkbox"/>	SNMP Manager 3	0.0.0.0	162	v2cParams	Enable
<input type="checkbox"/>	SNMP Manager 4	0.0.0.0	162	v2cParams	Enable
<input type="checkbox"/>	SNMP Manager 5	0.0.0.0	162	v2cParams	Enable

2. Configure the SNMP trap manager according to the table below.

3. Select the check boxes corresponding to the configured SNMP managers that you want to enable.
4. Click **Apply**.



- Rows whose corresponding check boxes are cleared revert to default settings when you click **Apply**.
- To enable the sending of the trap event, acPerformanceMonitoringThresholdCrossing, which is sent whenever a threshold (high or low) of a performance monitored SNMP MIB object is crossed, configure the ini file parameter [PM\_EnableThresholdAlarms] to [1]. Once enabled, you can change its default low and high threshold values. For more information, see the *SNMP Reference Guide for Gateways-SBCs-MSBRs*.
- Instead of configuring SNMP trap managers with an IP address in dotted-decimal notation, you can configure a single SNMP trap manager with an FQDN (see [Configuring an SNMP Trap Destination with FQDN](#)).

**Table 8-2: SNMP Trap Destinations Table Parameters Description**

Parameter	Description
(check box) [SNMPManagerIsUsed_x]	<p>Enables the SNMP manager to receive traps and checks the validity of the configured destination (IP address and port number).</p> <ul style="list-style-type: none"> <li>■ [0] (check box cleared) = (Default) Disables SNMP manager</li> <li>■ [1] (check box selected) = Enables SNMP manager</li> </ul>
'IP Address' [SNMPManagerTableIP_x]	<p>Defines the IP address of the remote host used as the SNMP manager. The device sends its SNMP traps to this IP address.</p> <p>The valid value is an IPv4 address (in dotted-decimal notation, e.g., 108.10.1.255)</p> <p><b>Note:</b> If you are using a WebSocket tunnel connection between the device and OVOC, then configure the parameter to the IP address mentioned in <a href="#">Configuring WebSocket Tunnel with OVOC</a> on page 90</p>
'Trap Port' [SNMPManagerTrapPort_x]	<p>Defines the port number of the remote SNMP manager. The device sends SNMP traps to this port.</p> <p>The valid value range is 100 to 4000. The default is 162.</p>

Parameter	Description
'Trap User' [SNMPManagerTrapUser]	Associates a trap user (SNMPv2 or SNMPv3) with the trap destination. This determines the trap format, authentication level, and encryption level. <ul style="list-style-type: none"> <li>■ <b>v2cParams</b> = (Default) SNMPv2 user community string</li> <li>■ SNMPv3 user configured in <a href="#">Configuring SNMP V3 Users</a></li> </ul>
'Trap Enable' [SNMPManagerTrapSendingEnable_x]	Activates the sending of traps to the SNMP Manager. <ul style="list-style-type: none"> <li>■ [0] <b>Disable</b></li> <li>■ [1] <b>Enable</b> (default)</li> </ul>

## Configuring an SNMP Trap Destination with FQDN

Instead of configuring SNMP trap destinations (managers) with IP addresses in the SNMP Trap Destinations table (see [Configuring SNMP Trap Destination with IP Addresses](#)), you can configure a single SNMP trap manager with an FQDN (e.g., mngr.corp.mycompany.com). The device sends the traps to the DNS-resolved IP address. The resolved IP address replaces the IP address of the last row (SNMP Manager 5) in the SNMP Trap Destinations table (and the last trap manager entry in the snmpTargetAddrTable in the snmpTargetMIB).



- If you configure an FQDN for an SNMP trap manager, the device ignores your configuration in the SNMP Trap Destinations table.
- If you configure an FQDN for an SNMP trap manager, only one SNMP trap manager can be configured.
- To resolve the FQDN into an IP address, the device uses the DNS server that is configured in the IP Interfaces table for the IP Interface whose 'Application Type' is **OAMP**.

### ➤ To configure an SNMP trap destination with an FQDN:

1. Open the SNMP Community Settings page (**Setup** menu > **Administration** tab > **SNMP** folder > **SNMP Community Settings**).
2. Under the **Misc. Settings** group, in the 'Trap Manager Host Name' field [SNMPTrapManagerHostName], enter the FQDN.

Trap Manager Host Name

3. Click **Apply**.



## Configuring SNMP Trusted Managers

The SNMP Trusted Managers table lets you configure up to five SNMP Trusted Managers. By default, the SNMP agent accepts SNMP Get and Set requests from any IP address as long as the correct community string is used in the request (see [Configuring SNMP Community Strings](#)). You can enhance security by configuring Trusted Managers, which is an IP address from which the device's SNMP agent accepts and processes SNMP requests. If no SNMP Trusted Manager is configured, any SNMP manager can access the device (as long as the community string is correct).

The following procedure describes how to configure SNMP Trusted Managers through the Web interface. You can also configure it through ini file [SNMPTrustedMgr\_x] or CLI (`configure system > snmp settings > trusted-managers`).

### ➤ To configure SNMP Trusted Managers:

1. Open the SNMP Trusted Managers table (**Setup** menu > **Administration** tab > **SNMP** folder > **SNMP Trusted Managers**).

DELETE	TRUSTED MANAGERS IP ADDRESS	
<input type="checkbox"/>	SNMP Trusted Manager 1	<input type="text" value="0.0.0.0"/>
<input type="checkbox"/>	SNMP Trusted Manager 2	<input type="text" value="0.0.0.0"/>
<input type="checkbox"/>	SNMP Trusted Manager 3	<input type="text" value="0.0.0.0"/>
<input type="checkbox"/>	SNMP Trusted Manager 4	<input type="text" value="0.0.0.0"/>
<input type="checkbox"/>	SNMP Trusted Manager 5	<input type="text" value="0.0.0.0"/>

2. Configure an IP address (in dotted-decimal notation) for one or more SNMP Trusted Managers.
3. Select the check boxes corresponding to the configured SNMP Trusted Managers that you want to enable.
4. Click **Apply**, and then reset the device with a save-to-flash for your settings to take effect.

## Enabling SNMP Traps for Web Activity

You can enable the device to send SNMP traps to notify of management users' activities in the Web interface. A trap is sent each time an activity is done by a user. To configure the types of Web activities that you want reported, see [Configuring Reporting of Management User Activities](#).

### ➤ To enable traps to SNMP manager for Web activity:

1. Open the SNMP Community Settings page (**Setup** menu > **Administration** tab > **SNMP** folder > **SNMP Community Settings**).
2. Under the **Misc. Settings** group, from the 'Activity Trap' drop-down list (EnableActivityTrap), select **Enable**.

Activity Trap

Enable 

3. Click **Apply**.

## Configuring SNMP V3 Users

The SNMPv3 Users table lets you configure up to 10 SNMP v3 users for authentication and privacy.

The following procedure describes how to configure SNMP v3 users through the Web interface. You can also configure it through ini file [SNMPUsers] or CLI (`configure system > snmp v3-users`).



If you delete a user that is associated with a trap destination (see [Configuring SNMP Trap Destinations with IP Addresses](#)), the trap destination becomes disabled and the trap user reverts to default (i.e., SNMPv2).

### ➤ To configure an SNMP v3 user:

1. Open the SNMPv3 Users table (**Setup** menu > **Administration** tab > **SNMP** folder > **SNMP V3 Users**).
2. Click **New**; the following dialog box appears:

3. Configure the SNMP V3 parameters according to the table below.
4. Click **Apply**, and then reset the device with a save-to-flash for your settings to take effect.

**Table 8-3: SNMPv3 Users Table Parameters Description**

Parameter	Description
'Index' [SNMPUsers_ Index]	Defines an index number for the new table row. <b>Note:</b> Each row must be configured with a unique index.
'User Name' username [SNMPUsers_ Username]	Name of the SNMP v3 user. The name must be unique.
'Authentication Protocol' auth- protocol [SNMPUsers_ AuthProtocol]	Authentication protocol of the SNMP v3 user. <ul style="list-style-type: none"> <li>■ [0] <b>None</b> (default)</li> <li>■ [1] <b>MD5</b></li> <li>■ [2] <b>SHA-1</b></li> </ul>
'Privacy Protocol' priv- protocol [SNMPUsers_ PrivProtocol]	Privacy protocol of the SNMP v3 user. <ul style="list-style-type: none"> <li>■ [0] <b>None</b> (default)</li> <li>■ [1] <b>DES</b></li> <li>■ [2] <b>3DES</b></li> <li>■ [3] <b>AES-128</b></li> </ul>
'Authentication Key' auth-key [SNMPUsers_ AuthKey]	Authentication key. Keys can be entered in the form of a text password or long hex string. Keys are always persisted as long hex strings and keys are localized. The value must be at least six characters (preferably 8 characters). <b>Note:</b> The parameter cannot be configured with wide characters.
'Privacy Key' priv-key [SNMPUsers_ PrivKey]	Privacy key. Keys can be entered in the form of a text password or long hex string. Keys are always persisted as long hex strings and keys are localized.
'Group' group [SNMPUsers_ Group]	The group with which the SNMP v3 user is associated. <ul style="list-style-type: none"> <li>■ [0] <b>Read-Only</b></li> <li>■ [1] <b>Read-Write</b> (default)</li> <li>■ [2] <b>Trap</b></li> </ul> <b>Note:</b> All groups can be used to send traps.

## Customizing SNMP Alarm Severity

The Alarms Customization table lets you configure up to 150 Alarm Customization rules. The table allows you to customize the severity levels of the device's SNMP trap alarms. The table also allows you to disable (*suppress*) an alarm all together or a specific alarm severity. For example, by default, when an alarm cannot be entered in the Active Alarms table due to it being full, the device sends the `acActiveAlarmTableOverflow` alarm with a severity level of Major. By using this table, you can customize this alarm condition and change the severity level to Warning, for example.



- If you have customized an alarm that has subsequently been sent by the device and you then delete the rule when the alarm is still active, the device doesn't send the alarm again for that instance. For example, assume that you customize the severity of the `acBoardEthernetLinkAlarm` alarm to **Warning** and the Ethernet cable is subsequently disconnected. If you then delete the rule while this condition still exists (i.e., cable still disconnected), the device does not re-send the `acBoardEthernetLinkAlarm` alarm (with the default severity level – Major or Minor).
- If you configure multiple Alarm Customization rules for the **same** alarm, out of all these same rules the device applies only the rule that you configured first (i.e., listed highest in the table – with lowest Index) and ignores the others.

The following procedure describes how to customize alarm severity levels through the Web interface. You can also configure it through ini file [AlarmSeverity] or CLI (`configure system > snmp alarm-customization`).

### ➤ To customize SNMP alarm severity levels:

1. Open the Alarms Customization table (**Setup** menu > **Administration** tab > **SNMP** folder > **Alarm Customization**).

The screenshot shows a web browser window titled "Alarms Customization [acBoardFatalError]". The interface has a dark blue header with the title and window controls. Below the header is a light gray box labeled "GENERAL". Underneath, there are four rows of configuration fields:

Index	<input type="text" value="0"/>
Name	<input type="text" value="acBoardFatalError"/> ▼
Original Severity	<input type="text" value="Default"/> ▼
Customized Severity	<input type="text" value="Indeterminate"/> ▼

2. Configure a rule according to the parameters described in the table below.
3. Click **Apply**, and then reset the device with a save-to-flash for your settings to take effect.

**Table 8-4: Alarms Customization Parameter Descriptions**

Parameter	Description
Index [AlarmSeverity_Index]	Defines an index number for the new table row. <b>Note:</b> Each row must be configured with a unique index.
Name name [AlarmSeverity_Name]	Defines the SNMP alarm that you want to customize. <b>Note:</b> The CLI and ini file use the last digits of the alarm's OID as the name. For example, configure the parameter to "12" for the acActiveAlarmTableOverflow alarm (OID is 1.3.6.1.4.15003.9.10.1.21.2.0.12). For alarm OIDs, refer to the <i>SNMP Reference Guide for Gateways-SBCs-MSBRs</i> .
Original Severity alarm-original-severity [AlarmSeverity_OriginalSeverity]	Defines the original severity level of the alarm, according to the MIB. <ul style="list-style-type: none"> <li>■ [0] <b>Default</b> = (Default) All supported severity levels of the alarm. If you select this option, the alarm and its' severity depends on the 'Original Severity' parameter:               <ul style="list-style-type: none"> <li>✓ If configured to <b>Suppressed</b>, the device doesn't send the alarm at all.</li> <li>✓ If configured to any value other than <b>Suppressed</b>, the device always sends the alarm with the configured severity (regardless of condition).</li> </ul> </li> <li>■ [1] <b>Indeterminate</b></li> <li>■ [2] <b>Warning</b></li> <li>■ [3] <b>Minor</b></li> <li>■ [4] <b>Major</b></li> <li>■ [5] <b>Critical</b></li> </ul>
Customized Severity alarm-customized-severity [AlarmSeverity_CustomizedSeverity]	Defines the new (customized) severity of the alarm. This severity replaces the alarm's original severity that you specified in the 'Original Severity' parameter. For example, if you want to change the severity of the acCertificateExpiryAlarm alarm from Minor to Major, then configure the 'Original Severity' parameter to <b>Minor</b> and the 'Customized Severity' parameter to <b>Major</b> . <ul style="list-style-type: none"> <li>■ [0] <b>Suppressed</b> = Disables (suppresses) the alarm or a specified severity, depending on the 'Original Severity' parameter:</li> </ul>

Parameter	Description
	<ul style="list-style-type: none"> <li data-bbox="756 286 1390 555">✓ To suppress an alarm: Configure the 'Original Severity' parameter to <b>Default</b>, or if the alarm has only one severity level, configure the 'Original Severity' parameter to this severity. For example, as the acBoardConfigurationError alarm is only sent with Critical severity, configure the 'Original Severity' parameter to <b>Critical</b>.</li> <li data-bbox="756 584 1378 931">✓ To suppress the sending of a specific alarm severity: If the alarm has multiple severity levels (based on conditions), configure the 'Original Severity' parameter to the severity that you don't want the device to send. For example, if you don't want the device to send the acProxyConnectionLost alarm when its' severity is Minor, configure the 'Original Severity' parameter to <b>Minor</b>.</li> </ul> <ul style="list-style-type: none"> <li data-bbox="707 958 1075 992">■ [1] <b>Indeterminate</b> (default)</li> <li data-bbox="707 1016 895 1050">■ [2] <b>Warning</b></li> <li data-bbox="707 1075 868 1108">■ [3] <b>Minor</b></li> <li data-bbox="707 1133 868 1167">■ [4] <b>Major</b></li> <li data-bbox="707 1191 879 1225">■ [5] <b>Critical</b></li> </ul>

## Configuring SNMP for OVOC Connectivity

Connection between the device and OVOC is through SNMP. Once connected, the device can send SNMP traps to OVOC, and OVOC can perform various operations on the device such as maintenance actions, and fault and performance management.



- Make sure that the SNMP settings on the device and on OVOC are **identical**.
- OVOC uses the following default settings:
  - ✓ Trap port: **162** (configured in the SNMP Trap Destinations table, as described below).
  - ✓ SNMPv2: **public** for the read-community string, **private** for read-write community string, and **trapuser** for the trap community string (configured on the SNMP Community Settings page, as described below).
  - ✓ SNMPv3: **OVOCUser** for user name; **SHA-1** for authentication protocol; **AES-128** for privacy protocol; **123456789** for the 'Authentication Key' and 'Privacy Key' password (configured in the SNMPv3 Users table, as described below).
- If the device is located behind NAT and you have added it to OVOC by serial number or by auto-detection, you also need to configure (through ini file) the device



to send NAT keep-alive traps to the OVOC port to keep the NAT pinhole open for SNMP messages sent from OVOC to the device:

- ✓ [SendKeepAliveTrap] = [1]
- ✓ [KeepAliveTrapPort] = [1161]
- ✓ [NatBindingDefaultTimeout] = [30]

➤ **To configure SNMP for device-OVOC connectivity:**

1. Make sure that SNMP is enabled, which it is by default (see [Disabling SNMP](#) on page 77).
2. Configure the local SNMP port (for Get/Set commands) on the device to 161, using the [SNMPPort] parameter.
3. Configure an SNMPv2 or SNMPv3 user:
  - **For SNMPv2 user:**
    - i. Open the SNMP Community Settings page ([Configuring SNMP Community Strings](#) on page 77).
    - ii. In the 'Read-Only 1' parameter [SNMPReadCommunity], configure the SNMP read-only community string.
    - iii. In the 'Read-Write 1' parameter [SNMPWriteCommunity], configure the SNMP read-write community string.
    - iv. In the 'Trap Community String' parameter [SNMPTrapCommunityStringPassword], configure the community string for SNMP traps.
  - **For SNMPv3 users:**
    - i. Open the SNMPv3 Users table (see [Configuring SNMP V3 Users](#) on page 84).
    - ii. In the 'User Name' parameter, configure the name of the SNMP v3 user.
    - iii. From the 'Authentication Protocol' drop-down list, select the authentication protocol.
    - iv. From the 'Privacy Protocol' drop-down list, select the privacy protocol.
    - v. In the 'Authentication Key' and 'Privacy Key' parameters, configure the password.
4. Configure the device to send its traps to OVOC (acting as an SNMP Manager), in the SNMP Trap Destinations table (see [Configuring SNMP Trap Destinations with IP Addresses](#) on page 80):
  - a. In the 'IP Address' parameter, configure the OVOC IP address.
  - b. In the 'Trap Port' parameter, configure the OVOC port.
  - c. From the 'Trap User' drop-down list, select a trap user (SNMPv2 or SNMPv3) for this trap destination.
  - d. From the 'Trap Enable' drop-down list, select **Enable**.

Below shows an example where OVOC is configured as an SNMP Manager with IP address:port 172.17.118.219:162 and using an SNMPv3 user:

	NAME	IP ADDRESS	TRAP PORT	TRAP USER	TRAP ENABLE
<input checked="" type="checkbox"/>	SNMP Manager 1	172.17.118.219	162	OVOC	Enable



If the OVOC address is an FQDN, instead of configuring the SNMP Manager (OVOC) above with an IP address in dotted-decimal notation, you can configure a single SNMP trap manager with an FQDN, as described in [Configuring an SNMP Trap Destination with FQDN](#).

5. If the device is located behind NAT and you have added the device to OVOC by its serial number or using auto-detection, you also need to configure (through ini file) the device to send NAT keep-alive traps to the OVOC port to keep the NAT pinhole open for SNMP messages sent from OVOC to the device:
  - a. Enable the sending of NAT keep-alive traps to OVOC, by configuring the [SendKeepAliveTrap] parameter to [1].
  - b. Define the OVOC port to where the device sends the NAT keep-alive traps, by using the [KeepAliveTrapPort] parameter.
  - c. Define the interval between each sent NAT keep-alive trap, by using the [NatBindingDefaultTimeout] parameter.
6. Reset the device with a save-to-flash for your settings to take effect.

## Configuring WebSocket Tunnel with OVOC

When OVOC is deployed in a public cloud environment (e.g., Amazon Web Services), it can manage devices that are located **behind NAT**, by implementing WebSocket tunneling (over HTTP/S). All communication and management traffic (e.g., HTTP-based file download, NTP, Syslog, debug recording, and SNMP) between the device and OVOC flows through this WebSocket tunnel. In this tunneling application, the device is the WebSocket client and OVOC is the WebSocket server.

WebSocket tunnel has many advantages over the alternative method for connecting OVOC to the device when located behind NAT (refer to [One Voice Operations Center IOM Manual](#) for more information). It easily resolves NAT traversal problems and requires minimal amount of configuration - no need for port forwarding, no need for firewall settings to allow certain traffic, etc..

The WebSocket tunnel connection between the device and OVOC is secure (HTTPS). When the device initiates a WebSocket tunnel connection, it verifies that the TLS certificate presented by OVOC is signed by one of the CAs in the trusted root store of its default TLS Context (ID #0). The device authenticates itself with OVOC using a username and password. These must be the same credentials as configured on OVOC.

The device establishes the WebSocket connection using its regular OAMP IP interface. The device keeps the WebSocket tunnel connection open (i.e., persistent), allowing it to send and



receive future management traffic through it. The connection only closes before the device (or OVOC) restarts.



- Currently, this feature may not be supported by OVOC. To check if it is supported, please refer to the [OVOC Release Notes](#).
- To check if supported on additional cloud platforms, please refer to the [OVOC documentation](#).
- If you configure the address of the WebSocket tunnel server (see the 'Address' parameter below) as a domain name, you also need to configure the address of the DNS server that you want to use for resolving the domain name into an IP address. This is configured in the IP Interfaces table for the device's **OAMP** IP interface type, using the 'Primary DNS' parameter and optionally, the 'Secondary DNS' parameter (see [Configuring IP Network Interfaces](#) on page 121).
- When the device is configured for WebSocket tunneling with OVOC, the SBC Configuration Wizard (see [SBC Configuration Wizard](#) on page 1145) is not supported (and not accessible from the Web interface).

The following procedure describes how to configure WebSocket tunneling on the device through the Web interface. You can also configure it through CLI (`configure network > ovoc-tunnel-settings`).

➤ **To configure WebSocket tunneling with OVOC on the device:**

1. Obtain the OVOC server's default certificate (trusted root certificate) for Managed Devices, and then import (see [Importing Certificates into Trusted Root Certificate Store](#) on page 168) the certificate into the device's Trusted Root store of the default TLS Context (ID #0).
2. Open the Web Service Settings page (**Setup** menu > **IP Network** tab > **Web Services** folder > **Web Service Settings**), and then under the OVOC Tunnel group, configure the following parameters:

OVOC TUNNEL	
OVOC WebSocket Tunnel Server Address	<input type="text" value="0.0.0.0"/> ⚡
Path	<input type="text"/> ⚡
Username	<input type="text"/> ⚡
Password	<input type="password" value="....."/> ⚡
Secured (HTTPS)	<input checked="" type="checkbox"/> ⚡
Verify Certificate	<input checked="" type="checkbox"/> ⚡

- 'OVOC WebSocket Tunnel Server Address' [WSTunServer]: Configure it to the IP address or hostname of the OVOC server.
- 'Path' [WSTunServerPath]: Configure it to "tun" (without quotation marks) to match the default OVOC configuration.

- 'Username' [WSTunUsername]: Configure it to match the WebSocket Tunnel username configured on OVOC. The default username is "VPN" (without quotation marks).
  - 'Password' [WSTunPassword]: Configure it to match the WebSocket Tunnel password configured on OVOC. The default password is "123456" (without quotation marks).
  - 'Secured (HTTPS)' [WSTunSecured]: Enable the parameter to use secure (HTTPS) transport for the WebSocket tunnel connection.
  - 'Verify Certificate' [WSTunVerifyPeer]: Enable the parameter so that the device verifies the TLS certificate presented by OVOC during the establishment of the WebSocket tunnel connection.
3. Open the SNMP Trap Destinations table (see [Configuring SNMP Trap Destinations with IP Addresses](#) on page 80), and then configure an SNMP trap manager with IP address 169.254.0.1.

	NAME	IP ADDRESS	TRAP PORT	TRAP USER	TRAP ENABLE
<input checked="" type="checkbox"/>	SNMP Manager 1	169.254.0.1	162	v2cParams ▾	Enable ▾



IP address 169.254.0.1 represents the OVOC server in the WebSocket tunnel overlay network.

4. For sending Quality of Experience (QoE) voice metric reports to OVOC, open the Quality of Experience Settings table (see [Configuring OVOC for Quality of Experience](#) on page 374), and then configure the 'Primary OVOC Address' parameter to IP address 169.254.0.1.



To configure WebSocket tunneling on OVOC, refer to [One Voice Operations Center IOM Manual](#).

## 9 INI File-Based Management

You can configure the device through an ini file, which is a text-based file with an \*.ini file extension name, created using any standard text-based editor such as Notepad. Once you have created an ini file with all your configuration settings, you need to install (load) it to the device to apply the configuration. For a list of the *ini* file parameters, see [Configuration Parameters Reference](#).

### INI File Format

There are two types of *ini* file parameters:

- Individual parameters - see [Configuring Individual ini File Parameters](#)
- Table parameters - see [Configuring Table ini File Parameters](#)

### Configuring Individual ini File Parameters

The syntax for configuring individual *ini* file parameters in the ini file is as follows:

- An optional, subsection name (or group name) enclosed in square brackets "[...]". This is used to conveniently group similar parameters by their functionality.
- Parameter name, followed by an equal "=" sign and then its value.
- Comments must be preceded by a semicolon ";".

```
[optional subsection name]
parameter name = value
parameter name = value
; this is a comment line
```

```
; for example:
[System Parameters]
SyslogServerIP = 10.13.2.69
EnableSyslog = 1
```

For general *ini* file formatting rules, see [General ini File Formatting Rules](#).

### Configuring Table ini File Parameters

Table ini file parameters allow you to configure tables, which include multiple parameters (*columns*) and row entries (*indices*). The table ini file parameter is composed of the following elements:

- **Table title:** The name of the table in square brackets, e.g., [MY\_TABLE\_NAME].

- **Format line:** Specifies the columns of the table (by their string names) that are to be configured.
  - The first word of the Format line must be "FORMAT", followed by the Index field name and then an equal "=" sign. After the equal sign, the names of the columns are listed.
  - Columns must be separated by a comma ",".
  - The Format line must only include columns that can be modified (i.e., parameters that are not specified as read-only). An exception is Index fields, which are mandatory.
  - The Format line must end with a semicolon ";".
- **Data line(s):** Contain the actual values of the columns (parameters). The values are interpreted according to the Format line.
  - The first word of the Data line must be the table's string name followed by the Index field.
  - Columns must be separated by a comma ",".
  - A Data line must end with a semicolon ";".
- **End-of-Table Mark:** Indicates the end of the table. The same string used for the table's title, preceded by a backslash "\", e.g., [\MY\_TABLE\_NAME].

The following displays an example of the structure of a table ini file parameter:

```
[Table_Title]
; This is the title of the table.
FORMAT Index = Column_Name1, Column_Name2, Column_Name3;
; This is the Format line.
Index 0 = value1, value2, value3;
Index 1 = value1, $$, value3;
; These are the Data lines.
[\Table_Title]
; This is the end-of-the-table-mark.
```

- The table ini file parameter formatting rules are listed below:
- Indices (in both the Format and the Data lines) must appear in the same order. The Index field must never be omitted.
- The Format line can include a subset of the configurable fields in a table. In this case, all other fields are assigned with the pre-defined default values for each configured line.
- The order of the fields in the Format line isn't significant (as opposed to the Index fields). The fields in the Data lines are interpreted according to the order specified in the Format line.
- The double dollar sign (\$\$) in a Data line indicates the default value for the parameter.
- The order of the Data lines is insignificant.

- Data lines must match the Format line, i.e., it must contain exactly the same number of Indices and Data fields and must be in exactly the same order.
- A row in a table is identified by its table name and Index field. Each such row may appear only once in the *ini* file.
- Table dependencies: Certain tables may depend on other tables. For example, one table may include a field that specifies an entry in another table. This method is used to specify additional attributes of an entity, or to specify that a given entity is part of a larger entity. The tables must appear in the order of their dependency (i.e., if Table X is referred to by Table Y, Table X must appear in the *ini* file before Table Y).

The table below displays an example of a table ini file parameter:

```
[ CodersGroup0 ]
FORMAT CodersGroup0_Index = CodersGroup0_Name, CodersGroup0_pTime,
CodersGroup0_rate, CodersGroup0_PayloadType, CodersGroup0_Sce,
CodersGroup0_CoderSpecific;
CodersGroup0 0 = g711Alaw64k, 20, 0, 255, 0, 0;
CodersGroup0 1 = eg711Ulaw, 10, 0, 71, 0, 0;
[ \CodersGroup0 ]
```



Do not include read-only parameters in the table ini file parameter. This can cause an error when loading the file to the device.

## General ini File Formatting Rules

The *ini* file must adhere to the following formatting rules:

- The *ini* file name must not include hyphens "-" or spaces; if necessary, use an underscore "\_" instead.
- Lines beginning with a semi-colon ";" are ignored. These can be used for adding remarks in the *ini* file.
- A carriage return (i.e., Enter) must be done at the end of each line.
- The number of spaces before and after the equals sign "=" is irrelevant.
- Subsection names for grouping parameters are optional.
- If there is a syntax error in the parameter name, the value is ignored.
- Syntax errors in the parameter's value can cause unexpected errors (parameters may be set to the incorrect values).
- Parameter string values that denote file names (e.g., CallProgressTonesFileName) must be enclosed with inverted commas, e.g., CallProgressTonesFileName = 'cpt\_usa.dat'.
- The parameter name is not case-sensitive.

- The parameter value is not case-sensitive, except for coder names.
- The *ini* file must end with at least one carriage return.

## Configuring an ini File

There are different methods that you can use for configuring an ini file before you load it to the device.

- Modifying the device's current ini file: This method is recommended if you mainly need to change the settings of parameters that you have previously configured.
  - a. Save the device's current configuration as an *ini* file on your computer, using the Web interface (see [Saving Configuration](#)).
  - b. Open the file using a text file editor, and then modify the *ini* file as required.
  - c. Save and close the file.
  - d. Load the file to the device.
- Creating a new ini file that includes only updated configuration:
  - a. Open a text file editor such as Notepad.
  - b. Add only the required parameters and their settings.
  - c. Save the file with the ini file extension name (e.g., myconfiguration.ini).
  - d. Load the file to the device.

For loading ini files to the device, see [Loading an ini File to the Device](#).



- If you save an ini file from the device and a table row is configured with invalid values, the ini file displays the row prefixed with an exclamation mark (!), for example:

```
!CpMediaRealm 1 = "ITSP", "Voice", "", 60210, 2, 6030, 0, "", "";
```

- To restore the device to default settings through the *ini* file, see [Restoring Factory Defaults](#).

## Loading an ini File to the Device

You can load an *ini* file to the device using the following methods:

- CLI:
  - Configuration:
    - ◆ To apply the parameter settings of the file and restore parameters that are not included in the file to default settings:

```
# copy ini-file from <URL>
```

- ◆ To apply the parameter settings of the file and keep the current settings of parameters that are not included in the file:

```
# copy incremental-ini-file from <URL>
```

■ Web interface:

- Auxiliary Files page (see [Loading Auxiliary Files](#)): The device updates its configuration according to the loaded ini file while preserving the remaining current configuration.
- Configuration File page (see [Configuration File](#)): The device updates its configuration according to the loaded ini file and applies default values to parameters that were not included in the loaded ini file.

When you load an ini file to the device, its configuration settings are saved to the device's non-volatile memory (flash).



Before you load an *ini* file to the device, make sure that the file extension name is *\*.ini*.

## Secured Encoded ini File

The *ini* file contains sensitive information that is required for the functioning of the device. The file may be loaded to the device using HTTP. These protocols are not secure and are vulnerable to potential hackers. To overcome this security threat, the AudioCodes DConvert utility allows you to binary-encode (encrypt) the *ini* file before loading it to the device. For more information, refer to the *DConvert Utility User's Guide*.



If you save an ini file from the device to a folder on your PC, an *ini* file that was loaded to the device encoded is saved as a regular *ini* file (i.e., unencoded).

## Configuring Password Display in ini File

Passwords can be displayed in the ini file (saved from the Web interface or CLI) as obscured (encrypted) or hidden:

- Obscured: (Default) The password characters are concealed and displayed as encoded. The password is displayed using the syntax,  $\$1\$<obscured\ password>$ , for example,  $\$1\$S3p+fno=$ .
- Hidden: the password is replaced with an asterisk (\*).

To configure the desired format, use the [INIPasswordsDisplayType] parameter.



- When you load an ini file to the device containing obscured passwords, the passwords are parsed and applied to the device.



- When you load an ini file to the device containing hidden passwords, the passwords are ignored.
- By default, the format is obscured passwords, thus enabling their full recovery in case of configuration restore or copy to another device.
- Regardless of the configured password display format, the View mode in the INI Viewer & Editor utility also displays the passwords in plain text (in parenthesis), as shown in the below example:

#### **[SNMP Params]**

```
SnmpReadWriteCommunityStringsPassword_0 = $1$+JKWkpXNz83L (john1234)
```

## INI Viewer and Editor Utility

For more information, refer to the *INI Viewer & Editor User's Guide*.



## 10 REST-Based Management

You can manage the device through the Representational State Transfer (REST) architecture. REST is a Web-based access service, allowing you to access the device's management interface over HTTP/S. Developers can use the device's REST API to integrate the device into their solution and allow administrators to perform management and configuration tasks through automation scripts. The REST API also displays performance monitoring counters.

The REST API relies on a simple pre-defined URL path (**<device's OAMP IP address>/api/v1**) through which device resources can be accessed. Each resource represents a specific device management element (e.g., file upload), state object (e.g., alarms), or maintenance action (e.g., reset). The REST API uses the standard HTTP/1.1 protocol. Standard HTTP methods (GET, PUT, POST and DELETE) are used to read the resource's state and to create, update, and delete the resources, respectively. Resource state is described in JSON format and included in the HTTP request or response bodies. For security, it is recommended to secure REST traffic by using HTTPS.

### ➤ To access the REST API:

1. Open a standard Web browser, and then in the URL field, enter the device's OAMP IP address followed by `"/api/v1"` (e.g., `10.15.7.95/api/v1`); you are prompted to enter your login credentials.
2. Enter your login username and password, and then click **Sign In**; the device's REST interface appears, showing the URL paths of the different resource items:

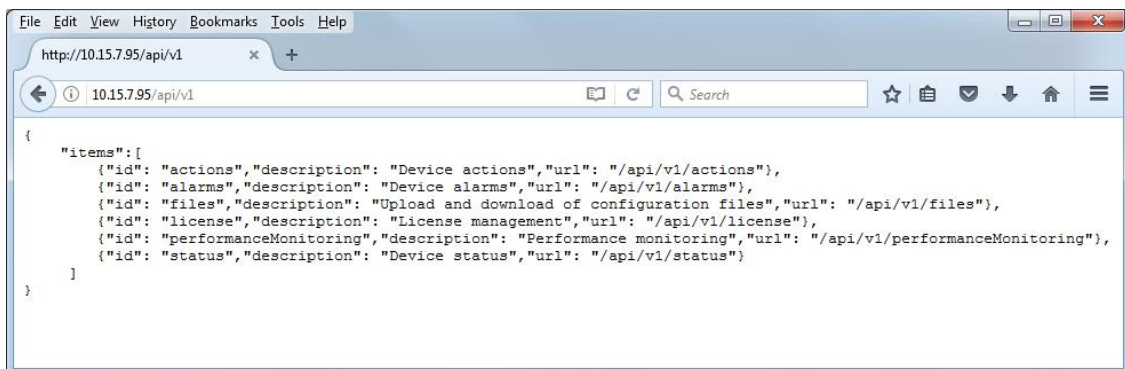

3. Access the required resource item using the shown URL. For example, to access the device's alarms resource, append `"/alarms"` to the URL (i.e. `10.15.7.95/api/v1/alarms`). Some items have sub-resources such as the alarms item. When you access the alarms item, the URLs to the active and history alarms resources are shown.

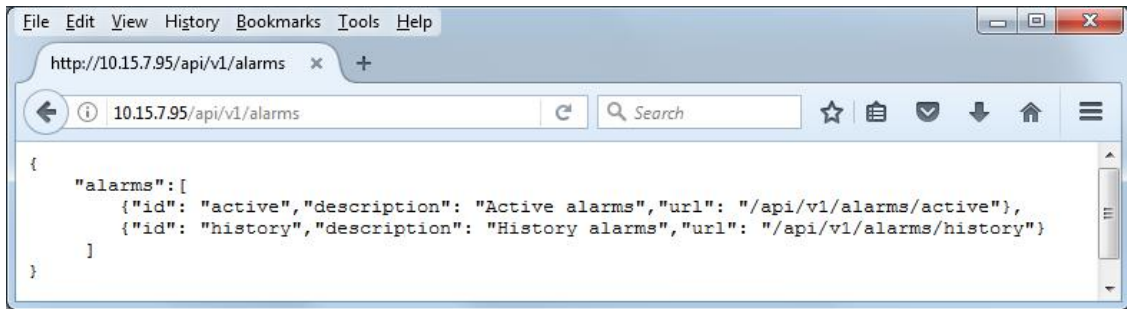

```

{
  "alarms": [
    {
      "id": "active", "description": "Active alarms", "url": "/api/v1/alarms/active"},
    {
      "id": "history", "description": "History alarms", "url": "/api/v1/alarms/history"}
  ]
}

```

4. To access a sub-resource (e.g., active alarms) if exists, use the shown URL. For example, to access the active alarms resource, append `"/active"` to the URL (i.e. `10.15.7.95/api/v1/alarms/active`).

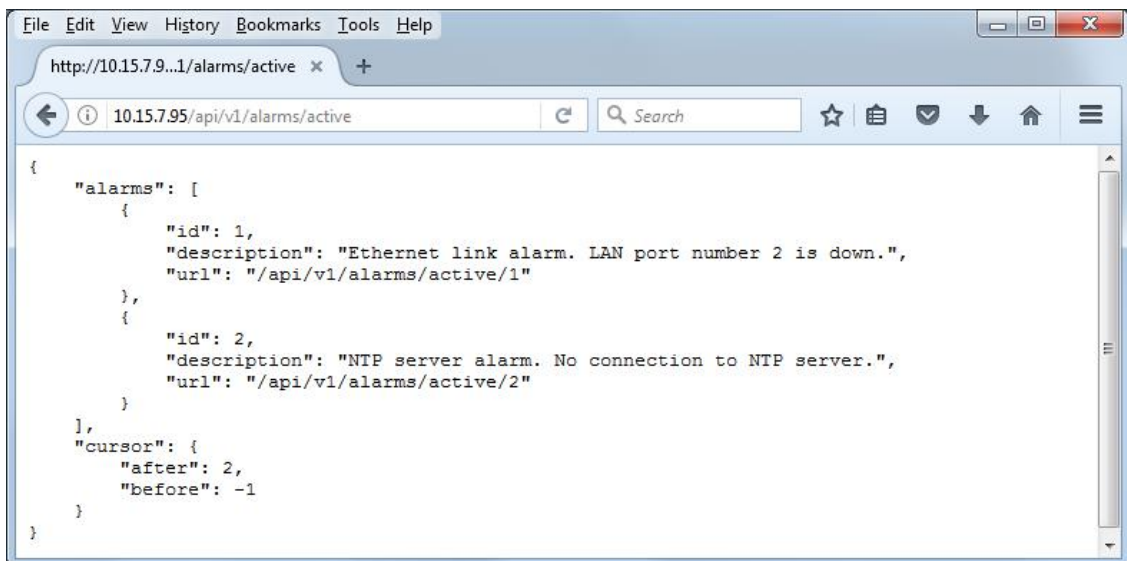

```

{
  "alarms": [
    {
      "id": 1,
      "description": "Ethernet link alarm. LAN port number 2 is down.",
      "url": "/api/v1/alarms/active/1"
    },
    {
      "id": 2,
      "description": "NTP server alarm. No connection to NTP server.",
      "url": "/api/v1/alarms/active/2"
    }
  ],
  "cursor": {
    "after": 2,
    "before": -1
  }
}

```



- If you know the URL of the resource, instead of accessing each resource menu, you can access it directly using the full URL path (e.g., `/api/v1/alarms/active`).
- For more information on REST API, refer to the document [REST API for Mediant Devices](#).
- When accessing the device's REST interface, you are prompted for your management user credentials (username and password).

# Part III

## General System Settings

# 11 Date and Time

The device's internal clock (date and time) can be set using one of the following methods:

- Automatically synchronized using a third-party, remote Simple Network Time Protocol (SNTP) server (see [Configuring Automatic Date and Time through SNTP](#) below)
- Manually (see [Configuring Manual Date and Time](#) on the next page)

## Configuring Automatic Date and Time through SNTP

The device's Simple Network Time Protocol (SNTP) client functionality generates requests and reacts to the resulting responses using the NTP Version 3 protocol definitions (according to RFC 1305). Through these requests and responses, the device, as an NTP client, synchronizes the system time to a time source within the network, thereby eliminating any potential issues should the local system clock "drift" during operation. The NTP client follows a simple process in managing system time: 1) the NTP client requests an NTP update, 2) receives an NTP response and then 3) updates the local system clock based on an NTP server within the network. The client requests a time update from the user-defined NTP server (IP address or FQDN) at a user-defined update interval. Typically, the update interval is every 24 hours based on when the system was restarted.

You can also configure the device to authenticate and validate NTP messages received from the NTP server. Authentication is done using an authentication key with the MD5 cryptographic hash algorithm. When this feature is enabled, the device ignores NTP messages received without authentication.

The following procedure describes how to configure SNTP through the Web interface. For detailed descriptions of the configuration parameters, see [NTP and Daylight Saving Time Parameters](#).

### ➤ To configure SNTP through the Web interface:

1. Open the Time & Date page (**Setup** menu > **Administration** tab > **Time & Date**), and then scroll down to the NTP Server group:

NTP SERVER	
Primary NTP Server Address (IP or FQDN)	<input type="text" value="0.0.0.0"/>
Secondary NTP Server Address (IP or FQDN)	<input type="text"/>
NTP Update Interval	Hours: <input type="text" value="24"/> Minutes: <input type="text" value="0"/>
NTP Authentication Key Identifier	<input type="text" value="0"/>
NTP Authentication Secret Key	<input type="text"/>

2. Configure the NTP server address:
  - In the 'Primary NTP Server Address' [NTPServerIP] field, configure the primary NTP server's address (IP or FQDN).

- (Optional) In the 'Secondary NTP Server Address' [NTPSecondaryServerIP] field, configure the backup NTP server.
3. In the 'NTP Updated Interval' [NTPUpdateInterval] field, configure the period after which the date and time of the device is updated.
  4. Configure NTP message authentication:
    - In the 'NTP Authentication Key Identifier' field, configure the NTP authentication key identifier.
    - In the 'NTP Authentication Secret Key' field, configure the secret authentication key shared between the device and the NTP server.
  5. Click **Apply**.
  6. Verify that the device has received the correct date and time from the NTP server. The date and time is displayed in the 'UTC Time' read-only field under the Time Zone group.



If the device does not receive a response from the NTP server, it polls the NTP server for 10 minutes. If there is still no response after this duration, the device declares the NTP server as unavailable and raises an SNMP alarm [acNTPServerStatusAlarm]. The failed response could be due to incorrect configuration.

## Configuring Manual Date and Time

You can manually configure the date and time of the device instead of using an NTP server (as described in [Configuring Automatic Date and Time using SNTP](#)).

### ➤ To manually configure the device's date and time through the Web interface:

1. Open the Time & Date page (**Setup** menu > **Administration** tab > **Time & Date**), and then scroll down to the Local Time group:

#### LOCAL TIME

Local Time	Year	Month	Day	Hours	Minutes	Seconds
	2010	1	24	15	27	45

2. Configure the current date and time of the geographical location in which the device is installed:
  - Date:
    - ◆ 'Year' in *yyyy* format (e.g., "2015")
    - ◆ 'Month' in *mm* format (e.g., "3" for March)
    - ◆ 'Day' in *dd* format (e.g., "27")
  - Time:
    - ◆ 'Hours' in 24-hour format (e.g., "4" for 4 am)

- ◆ 'Minutes' in *mm* format (e.g., "57")
- ◆ 'Seconds' in *ss* format (e.g., "45")

3. Click **Apply**; the date and time is displayed in the 'UTC Time' read-only field.



- If the device is configured to obtain date and time from an NTP server, the fields under the Local Time group are read-only, displaying the date and time received from the NTP server.
- After performing a hardware reset, the date and time are returned to default values and thus, you should subsequently update the date and time.

## Configuring the Time Zone

You can configure the time zone in which the device is deployed. This is referred to as the Coordinated Universal Time (UTC) time offset and defines how many hours the device is from Greenwich Mean Time (GMT). For example, Germany Berlin is one hour ahead of GMT (UTC/GMT is +1 hour) and therefore, you would configure the offset to "1". USA New York is five hours behind GMT (UTC/GMT offset is -5 hours) and therefore, you would configure the offset as a minus value "-5".

### ➤ To configure the time zone:

1. Open the Time & Date page (**Setup** menu > **Administration** tab > **Time & Date**), and then scroll down to the Time Zone group:

UTC Time	14 Nov, 2018 16:24:31	
UTC Offset	Hours: <input style="width: 50px; border: 1px solid #ccc;" type="text" value="0"/>	Minutes: <input style="width: 50px; border: 1px solid #ccc;" type="text" value="0"/>

2. In the 'UTC Offset' fields (NTPServerUTCOffset), configure the time offset in relation to the UTC. For example, if your region is GMT +1 (an hour ahead), enter "1" in the 'Hours' field.
3. Click **Apply**; the updated time is displayed in the 'UTC Time' read-only field and the fields under the Local Time group.

## Configuring Daylight Saving Time

You can apply daylight saving time (DST) to the date and time of the device. DST defines a date range in the year (summer) where the time is brought forward so that people can experience more daylight. DST applies an offset of up to 60 minutes (default) to the local time. For example, Germany Berlin has DST from 30 March to 26 October, where the time is brought forward by an hour (e.g., 02:00 to 03:00 on 30 March). Therefore, you would configure the DST offset to 60 minutes (one hour).

➤ **To configure DST through the Web interface:**

1. Open the Time & Date page (**Setup** menu > **Administration** tab > **Time & Date**), and then scroll down to the Time Zone group:

<b>Day Light Saving Time</b>	Disable
DST Mode	Day of year
Start Time	Jan 01 0 : 0
End Time	Jan 01 0 : 0
Offset [min]	60
Day of Month Start	Jan Sunday First 0 : 0
Day of Month End	Jan Sunday First 0 : 0

2. From the 'Day Light Saving Time' (DayLightSavingTimeEnable) drop-down list, select **Enable**.
3. From the 'DST Mode' drop-down list, select the range type for configuring the start and end dates for DST:
  - **Day of year:** The range is configured by exact date (day number of month), for example, from March 30 to October 30. If 'DST Mode' is set to **Day of year**, in the 'Start Time' (DayLightSavingTimeStart) and 'End Time' (DayLightSavingTimeEnd) drop-down lists, configure the period for which DST is relevant.
  - **Day of month:** The range is configured by month and day type, for example, from the last Sunday of March to the last Sunday of October. If 'DST Mode' is set to **Day of month**, in the 'Day of Month Start' and 'Day of Month End' drop-down lists, configure the period for which DST is relevant.
4. In the 'Offset' (DayLightSavingTimeOffset) field, configure the DST offset in minutes.
5. If the current date falls within the DST period, verify that it has been successful applied to the device's current date and time. You can view the device's date and time in the 'UTC Time' read-only field.

## 12 Configuring a Hostname for the Device

You can configure a hostname (FQDN) for the device. This hostname should also be defined at a DNS server so that when queried, the DNS can resolve the hostname into the device's correct IP address.

A configured hostname affects the following:

- The device's Web interface and CLI (remotely using Telnet/SSH) can be accessed (logged in) using the hostname (instead of the OAMP IP address). For example, when logging into the Web interface through HTTP, you would enter the hostname in your Web browser like this: `http://<hostname>`.
  - Web: The toolbar displays the hostname (first 16 characters only) instead of the device type
  - CLI: The CLI prompt displays the hostname instead of the device type.
- The device's SNMP interface's SysName object (under MIB-2) is set to the hostname.
- TLS certificates used by the device for HTTPS-based communication with AudioCodes OVOC are issued with a hostname (instead of an IP address). For certificate signing requests (CSR) with a Certification Authority (CA), the hostname is used as the Common Name (CN or Subject Name) and Subject Alternative Name (SAN). For configuring CSRs, see [Assigning CSR-based Certificates to TLS Contexts](#) on page 160.

➤ **To configure a hostname for the device:**

1. Open the Network Settings page (**Setup** menu > **IP Network** tab > **Advanced** folder > **Network Settings**).
2. In the 'Host Name' field [Hostname], enter the hostname.

**Host Name** •

3. Click **Apply**.



If you configure the device with a hostname, you can protect the device against DNS rebinding attacks whenever you access the device with the hostname. For more information, see [Enabling DNS Rebinding Protection](#) on page 66.



# Part IV

## General VoIP Configuration

## 13 Network

This section describes network-related configuration.

### Building and Viewing your Network Topology

The Network view lets you easily build and view your voice network topology entities, including IP network interfaces, Ethernet Devices (VLANs), Ethernet Groups, and physical Ethernet ports. The Topology view graphically displays these entities and the associations between them, giving you a better understanding of your network topology and configuration. You can use the Network view as an alternative to configuring the entities in their respective Web pages or you can use it in combination.

#### ➤ To access the Network view:



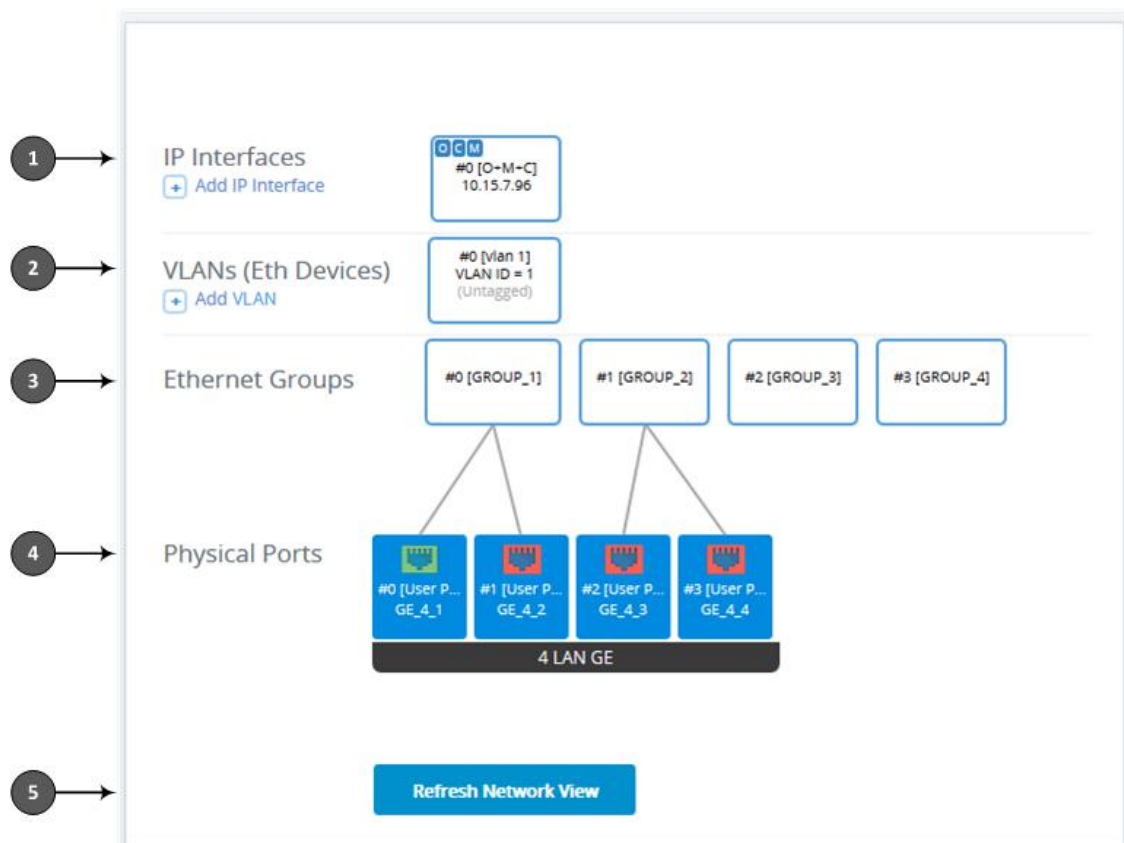

- Click the Network View home  icon (**Setup** menu > **IP Network** tab > **Network View**).

The areas of the Network view is shown in the example below and described in the subsequent table.





The figure above is used only as an example; your device may show different Ethernet Groups and Ethernet ports.

**Table 13-1: Description of Network View**

Item	Description
1	<p>Configures and displays IP Interfaces.</p> <p>The IP Interface appears as an icon, displaying the application type ("OCM" for OAMP, "C" for Control, and "M" for Media), row index number, name, and IP address, as shown in the example below:</p>  <p>If you click the icon, a drop-down menu appears listing the following commands:</p>  <ul style="list-style-type: none"> <li>■ <b>Edit:</b> Opens a dialog box in the IP Interfaces table to modify the IP Interface.</li> <li>■ <b>View List:</b> Opens the IP Interfaces table, allowing you to configure IP Interfaces.</li> <li>■ <b>Delete:</b> Opens the IP Interfaces table where you are prompted to confirm deletion of the IP Interface.</li> </ul> <p><b>To add an IP Interface:</b></p> <ol style="list-style-type: none"> <li>1. Click  <b>Add IP Interface</b>; the IP Interfaces table opens with a new dialog box for adding an IP Interface to the next available index row.</li> <li>2. Configure the IP Interface as desired, and then click <b>Apply</b>; the IP Interfaces table closes and you are returned to the Network View, displaying the newly added IP Interface.</li> </ol> <p>For more information on configuring IP Interfaces, see <a href="#">Configuring IP Network Interfaces</a>.</p>
2	<p>Configures and displays Ethernet Devices.</p> <p>The Ethernet Device appears as an icon, displaying the row index number, name, VLAN ID and whether its tagged or untagged, as shown in the example below:</p>  <p>If you click the icon, a drop-down menu appears listing the following commands:</p>

Item	Description
	<div data-bbox="826 280 963 456" style="border: 1px solid gray; padding: 5px; margin-bottom: 10px;"> <p style="text-align: center;">EDIT</p> <hr style="width: 50%; margin: 0 auto;"/> <p style="text-align: center;">VIEW LIST</p> <hr style="width: 50%; margin: 0 auto;"/> <p style="text-align: center;">DELETE</p> </div> <ul style="list-style-type: none"> <li data-bbox="400 495 1374 562">■ <b>Edit:</b> Opens a dialog box in the Ethernet Devices table to modify the Ethernet Device.</li> <li data-bbox="400 591 1326 658">■ <b>View List:</b> Opens the Ethernet Devices table, allowing you to configure all Ethernet Devices.</li> <li data-bbox="400 687 1374 754">■ <b>Delete:</b> Opens the Ethernet Devices table where you are prompted to confirm deletion of the Ethernet Device.</li> </ul> <p data-bbox="400 784 740 813"><b>To add an Ethernet Device:</b></p> <ol style="list-style-type: none"> <li data-bbox="400 842 1374 909">1. Click  <b>Add VLAN</b>; the Ethernet Devices table opens with a new dialog box for adding an Ethernet Device to the next available index row.</li> <li data-bbox="400 938 1374 1050">2. Configure the Ethernet Devices as desired, and then click <b>Apply</b>; the Ethernet Devices table closes and you are returned to the Network View, displaying the newly added Ethernet Device.</li> </ol> <p data-bbox="400 1079 1394 1146">For more information on configuring Ethernet Devices, see <a href="#">Configuring Underlying Ethernet Devices</a>.</p>
3	<p data-bbox="400 1196 903 1225">Configures and displays Ethernet Groups.</p> <p data-bbox="400 1240 1390 1308">The Ethernet Groups appear as icons, displaying the row index number and name, as shown in the example below:</p> <div data-bbox="823 1323 967 1413" style="border: 1px solid gray; padding: 5px; margin: 10px auto; width: fit-content;"> <p style="text-align: center;">#1 [GROUP_2]</p> </div> <p data-bbox="400 1442 1374 1509">Ethernet ports associated with Ethernet Groups are indicated by lines connecting between them, as shown in the example below:</p> <div data-bbox="635 1525 1155 1850" style="text-align: center; margin: 10px auto;"> <p>The diagram shows two Ethernet Group icons at the top: #0 [GROUP_1] on the left and #1 [GROUP_2] on the right. Below them are four Ethernet port icons labeled #0 [User P... GE_4_1], #1 [User P... GE_4_2], #2 [User P... GE_4_3], and #3 [User P... GE_4_4]. Lines connect #0 [GROUP_1] to #0 [User P... GE_4_1] and #1 [GROUP_2] to #1 [User P... GE_4_2].</p> </div> <p data-bbox="400 1879 740 1908"><b>To edit an Ethernet Group:</b></p> <ol style="list-style-type: none"> <li data-bbox="400 1937 1350 1966">1. Click the Ethernet Group icon, and then from the drop-down menu, choose</li> </ol>

Item	Description
	<p><b>Edit</b>; the Ethernet Groups table opens with a dialog box for editing the Ethernet Group.</p> <p>2. Configure the Ethernet Group as desired, and then click <b>Apply</b>; the Ethernet Groups table closes and you are returned to the Network View.</p> <p>For more information on configuring IP Interfaces, see <a href="#">Configuring Ethernet Port Groups</a>.</p> <p>To open the Ethernet Groups table, click any Ethernet Group icon, and then from the drop-down menu, choose <b>View List</b>. You can then view and edit all the Ethernet Groups in the table.</p>
4	<p>Configures and displays the device's Ethernet ports.</p> <p><b>To configure an Ethernet port:</b></p> <p>1. Click the required port icon, and then from the drop-down menu, choose <b>Edit</b>; the Physical Ports table opens with a dialog box for editing the Ethernet port.</p> <p>2. Configure the Ethernet Port as desired, and then click <b>Apply</b>; the Physical Ports table closes and you are returned to the Network View.</p> <p>For more information on configuring Ethernet ports, see <a href="#">Configuring Underlying Ethernet Devices</a>.</p> <p>The Ethernet ports appear as icons, displaying the row index number, description, and port string number, as shown in the example below:</p> <div data-bbox="842 1182 948 1301" data-label="Image"> </div> <p>The connectivity status of the port is indicated by the color of the icon:</p> <ul style="list-style-type: none"> <li>■  Green: Network connectivity exists through port (port connected to network).</li> <li>■  Red: No network connectivity through port (e.g., cable disconnected).</li> </ul> <p>To refresh the status indication, click the <b>Refresh Network View</b> button (described below in Item #5).</p> <p>To open the Physical Ports table, click any port icon, and then from the drop-down menu, choose <b>View List</b>. You can then view and edit all the ports in the table.</p>
5	<p>If you keep the Network view page open for a long time, you may want to click the <b>Refresh Network View</b> button to refresh the connectivity status display of the Ethernet ports.</p>

## Configuring Physical Ethernet Ports

The Physical Ports table lets you configure the device's Ethernet ports. This includes configuring port speed and duplex mode (half or full), and a brief description of the port. The table also displays the status of the port as well as the port group (*Ethernet Group*) to which the port belongs. For more information on Ethernet Groups, see [Configuring Ethernet Port Groups](#).

The names of the ports displayed in the device's management tools (e.g., Web interface) are different to the labels of the physical ports on the chassis. The figure below shows the mapping between the two:

**Figure 13-1: Ethernet Port String Names**

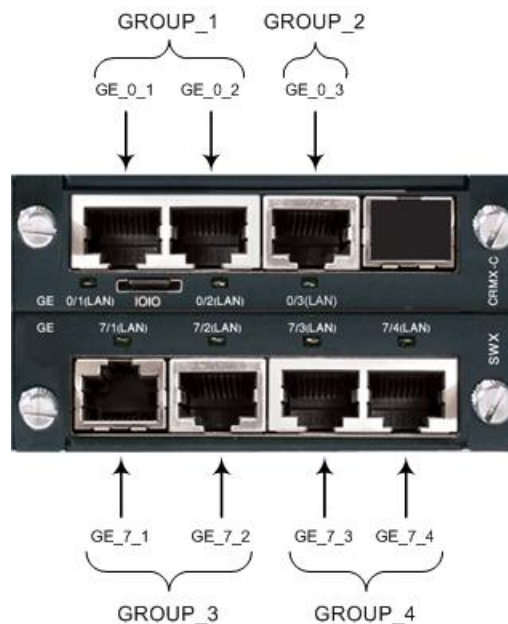

You can also view the mapping of the ports, using the following CLI command:

```
# show network physical-port
```



- All LAN ports (including those of the optional SWX Expansion module) have the same MAC address, which is the MAC address of the device.
- Each Ethernet Group must have a unique VLAN ID in scenarios where the ports of multiple Ethernet Groups are connected to the same switch.
- If your device is housed with the SWX module, the device's management interfaces do not display the GE\_0\_3 port (of the CRMX module) correctly. Instead, the GE\_7\_4 port is duplicated (row index 6). To resolve this problem, please load an ini file with the following Physical ports table settings:

```
[ PhysicalPortsTable ]
```

```
FORMAT PhysicalPortsTable_Index = PhysicalPortsTable_Port, PhysicalPortsTable_Mode, PhysicalPortsTable_SpeedDuplex, PhysicalPortsTable_PortDescription,
```

```

! PhysicalPortsTable_GroupMember, PhysicalPortsTable_GroupStatus;
PhysicalPortsTable 0 = "GE_0_1", 1, 4, "User Port #0", "GROUP_1", "Active";
PhysicalPortsTable 1 = "GE_0_2", 1, 4, "User Port #1", "None", " ";
PhysicalPortsTable 2 = "GE_0_3", 1, 4, "User Port #2", "None", " ";
PhysicalPortsTable 3 = "GE_7_1", 1, 4, "User Port #3", "GROUP_2", "Active";
PhysicalPortsTable 4 = "GE_7_2", 1, 4, "User Port #4", "None", " ";
PhysicalPortsTable 5 = "GE_7_3", 1, 4, "User Port #5", "None", " ";
PhysicalPortsTable 6 = "GE_7_4", 1, 4, "User Port #6", "None", " ";
[ \PhysicalPortsTable ]
    
```

The following procedure describes how to configure Ethernet ports through the Web interface. You can also configure it through ini file [PhysicalPortsTable] or CLI (configure network > physical-port).

➤ **To configure the physical Ethernet ports:**

1. Open the Physical Ports table (**Setup** menu > **IP Network** tab > **Core Entities** folder > **Physical Ports**).
2. Select a port that you want to configure, and then click **Edit**; the following dialog box appears:

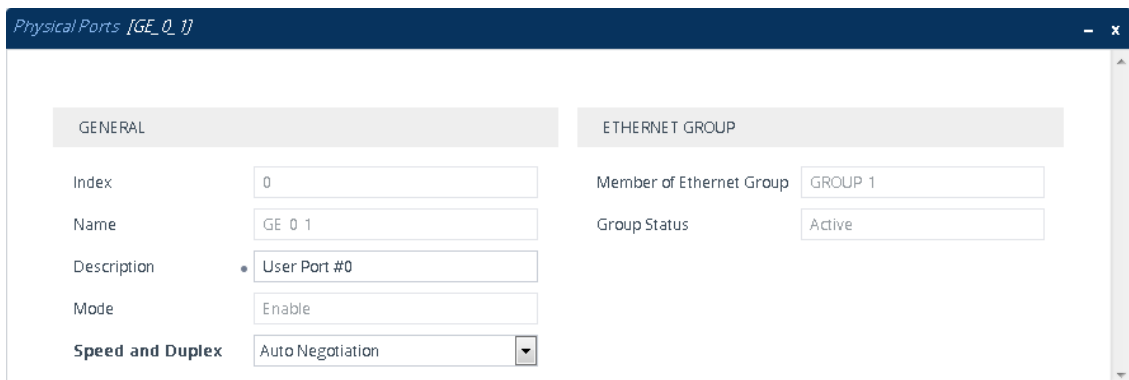

3. Configure the port according to the parameters described in the table below.
4. Click **Apply**, and then reset the device with a burn-to-flash for your settings to take effect.

**Table 13-2: Physical Ports Table Parameter Descriptions**

Parameter	Description
<b>General</b>	
'Index'	(Read-only) Displays the index number for the table row.
'Name' port [PhysicalPortsTable_ Port]	(Read-only) Displays the Ethernet port number. See the figure in the beginning of this section for the mapping between the GUI port number and the physical port on the chassis.

Parameter	Description
'Description' port- description [PhysicalPortsTable_ PortDescription]	Defines a description of the port. By default, the value is "User Port #<row index>". <b>Note:</b> Each row must be configured with a unique name.
'Mode' mode [PhysicalPortsTable_ Mode]	(Read-only) Displays the mode of the port.  <ul style="list-style-type: none"> <li>■ [0] <b>Disable</b></li> <li>■ [1] <b>Enable</b> (default)</li> </ul>
'Speed and Duplex' speed-duplex [PhysicalPortsTable_ SpeedDuplex]	Defines the speed and duplex mode of the port.  <ul style="list-style-type: none"> <li>■ [0] <b>10BaseT Half Duplex</b></li> <li>■ [1] <b>10BaseT Full Duplex</b></li> <li>■ [2] <b>100BaseT Half Duplex</b></li> <li>■ [3] <b>100BaseT Full Duplex</b></li> <li>■ [4] <b>Auto Negotiation</b> (default)</li> <li>■ [6] <b>1000BaseT Half Duplex</b></li> <li>■ [7] <b>1000BaseT Full Duplex</b></li> </ul>
<b>Ethernet Group</b>	
'Member of Ethernet Group' group-member [PhysicalPortsTable_ GroupMember]	(Read-only) Displays the Ethernet Group to which the port belongs.  To assign the port to a different Ethernet Group, see <a href="#">Configuring Ethernet Port Groups</a> .
'Group Status' group-status [PhysicalPortsTable_ GroupStatus]	(Read-only) Displays the status of the port:  <ul style="list-style-type: none"> <li>■ "Active": Active port. When the Ethernet Group includes two ports and their transmit/receive mode is configured to <b>2RX 1TX</b> or <b>2RX 2TX</b>, both ports show "Active".</li> </ul>

## Configuring Ethernet Port Groups

The Ethernet Groups table lets you configure Ethernet Groups. An Ethernet Group represents a physical Ethernet port(s) on the device. You can assign an Ethernet Group with one, two, or no ports (*members*). When two ports are assigned to an Ethernet Group, 1+1 Ethernet port redundancy can be implemented in your network. In such a configuration, one port can be



active while the other standby or both ports can be active, depending on the ports' transmit (Tx) and receive (Rx) settings. This provides port redundancy within the Ethernet Group, whereby if a port is disconnected the device switches over to the other port in the Ethernet Group. If you configure an Ethernet Group with only one port, the Ethernet Group operates as a single port (no redundancy).

The Ethernet Groups table also lets you configure the transmit (Tx) and receive (Rx) settings of the Ethernet ports per Ethernet Group. The Tx/Rx setting is applicable only to Ethernet Groups that contain two ports. This setting determines if both ports or only one of the ports can receive and transmit traffic.

The maximum number of Ethernet Groups that you can configure is the same as the number of Ethernet ports provided by the device. Thus, the device supports up to seven Ethernet Groups. You can assign one or two ports to an Ethernet Group. By default, each Ethernet Group is assigned two ports (Ethernet Group 2 which is assigned only port 0/3); the other Ethernet Groups are empty. For default port assignment to Ethernet Groups, see [Configuring Physical Ethernet Ports](#).

You can assign Ethernet ports to IP network interfaces. This is done by first configuring an Ethernet Device with the required Ethernet Group containing the port or ports (see [Configuring Underlying Ethernet Devices](#)). Then by assigning the Ethernet Device to the IP network interface in the IP Interfaces table (see [Configuring IP Network Interfaces](#)). This enables physical separation of network interfaces, providing a higher level of segregation of sub-networks. Equipment connected to different physical ports is not accessible to one another; the only connection between them can be established by cross connecting them with media streams (VoIP calls).

The port names (strings) displayed in the Ethernet Groups table represent the physical ports on the device. For the mapping of these strings to the physical ports, see [Configuring Physical Ethernet Ports](#).



- The SWX LAN Expansion module is a customer-ordered item. For more information, contact the sales representative of your purchased device.
- If you want to assign a port to a different Ethernet Group, you must first remove the port from its current Ethernet Group. To remove the port, configure the 'Member' field so that no port is selected or select a different port.
- As all ports have the same MAC address, you must connect each port to a different Layer-2 switch.
- When implementing 1+1 Ethernet port redundancy, each port in the Ethernet Group (port pair) must be connected to a different switch (but in the same subnet).

The following procedure describes how to configure Ethernet Groups through the Web interface. You can also configure it through ini file [EtherGroupTable] or CLI (`configure network > ether-group`).

➤ **To configure Ethernet Groups:**

1. Open the Ethernet Groups table (**Setup** menu > **IP Network** tab > **Core Entities** folder > **Ethernet Groups**).
2. Select the Ethernet Group that you want to configure, and then click **Edit**; the following dialog box appears:

3. Configure the Ethernet Group according to the parameters described in the table below.
4. Click **Apply**, and then reset the device with a burn-to-flash for your settings to take effect.

**Table 13-3: Ethernet Groups Table Parameter Descriptions**

Parameter	Description
'Index'	(Read-only) Displays the index number for the table row.
'Name' group [EtherGroupTable_ Group]	(Read-only) Displays the Ethernet Group number.
'Mode' mode [EtherGroupTable_ Mode]	<p>Defines the mode of operation of the ports in the Ethernet Group. This applies only to Ethernet Groups containing two ports.</p> <ul style="list-style-type: none"> <li>■ [0] <b>None</b> = Select this option to remove all ports from the Ethernet Group.</li> <li>■ [1] <b>Single</b> = Select this option if the Ethernet Group contains only one port.</li> <li>■ [2] <b>1RX/1TX</b> = (Default) At any given time, only one of the ports in the Ethernet Group transmits and receives packets. If a link exists on both ports, the active one is</li> </ul>

Parameter	Description
	<p>either the first to have a link up or the lower-numbered port if both have the same link up from start.</p> <ul style="list-style-type: none"> <li>■ [3] <b>2RX/1TX</b> = Both ports in the Ethernet Group can receive packets, but only one port can transmit. The transmitting port is determined arbitrarily by the device. If the selected port fails at a later stage, a switchover to the redundant port is done, which begins to transmit and receive.</li> <li>■ [4] <b>2RX/2TX</b> = Both ports in the Ethernet Group can receive and transmit packets.</li> </ul> <p><b>Note:</b></p> <ul style="list-style-type: none"> <li>■ Currently, the optional value <b>2RX/2TX</b> is not supported.</li> </ul>
'Member 1' member1 [EtherGroupTable_ Member1]	<p>Assigns the first port to the Ethernet Group. To assign no port, set this field to <b>None</b>.</p> <p><b>Note:</b> Before you can re-assign a port to a different Ethernet Group, you must first remove the port from its current Ethernet Group. To remove the port, either set this field to <b>None</b> or to a different port.</p>
'Member 2' member2 [EtherGroupTable_ Member2]	<p>Assigns the second port to the Ethernet Group. To assign no port, set this field to <b>None</b>.</p> <p><b>Note:</b> Before you can re-assign a port to a different Ethernet Group, you must first remove the port from its current Ethernet Group. To remove the port, either set this field to <b>None</b> or to a different port.</p>

## Configuring Underlying Ethernet Devices

The Ethernet Devices table lets you configure up to 16 *Ethernet Devices*. An Ethernet Device represents a Layer-2 bridging device and is assigned a VLAN ID and an Ethernet Group (Ethernet port group). Multiple Ethernet Devices can be associated with the same Ethernet Group. The Ethernet Device (VLAN) can be configured with a VLAN tagging policy, which determines whether the Ethernet Device accepts tagged or untagged packets received on the Ethernet port associated with the Ethernet Device.

Once configured, assign the Ethernet Device to an IP network interface in the IP Interfaces table ('Underlying Device' field) and/or with a static route in the Static Routes table ('Ethernet Output Device' field). You can assign the same Ethernet Device to multiple IP network interfaces and thereby, implement multi-homing (multiple addresses on the same interface/VLAN).

By default, the device provides a pre-configured Ethernet Device at Index 0 with the following settings:

- Name: "vlan 1"
- VLAN ID: 1
- Ethernet Group: GROUP 1
- Tagging Policy: Untagged
- MTU: 1500

The pre-configured Ethernet Device is associated with the default IP network interface (ie., OAMP) in the IP Interfaces table. The Untagged policy of the pre-configured Ethernet Device enables you to connect to the device using the default OAMP interface.

You can view configured Ethernet Devices that have been successfully applied to the device (saved to flash) in the Ethernet Device Status table. This page is accessed by clicking the **Ethernet Device Status Table** button located at the bottom of the Ethernet Devices table. The Ethernet Device Status table can also be accessed from the Navigation tree (see [Viewing Ethernet Device Status](#)).



You cannot delete an Ethernet Device that is associated with an IP network interface (in the IP Interfaces table). You can only delete it once you have disassociated it from the IP network interface.

The following procedure describes how to configure Ethernet Devices through the Web interface. You can also configure it through ini file [DeviceTable] or CLI (`configure network > network-dev`).

➤ **To configure an Ethernet Device:**

1. Open the Ethernet Devices table (**Setup** menu > **IP Network** tab > **Core Entities** folder > **Ethernet Devices**).
2. Click **New**; the following dialog box appears:

3. Configure an Ethernet Device according to the parameters described in the table below.
4. Click **Apply**.

**Table 13-4: Ethernet Devices Table Parameter Descriptions**

Parameter	Description
'Index' [DeviceTable_Index]	Defines an index number for the new table row. <b>Note:</b> Each row must be configured with a unique index.
'Name' name [DeviceTable_DeviceName]	Defines a name for the Ethernet Device. The name is used to associate the Ethernet Device with an IP network interface in the IP Interfaces table ('Underlying Device' field - see <a href="#">Configuring IP Network Interfaces</a> ) and/or with a static route in the Static Routes table ('Ethernet Output Device' field - see <a href="#">Configuring Static IP Routing</a> ).
'VLAN ID' vlan-id [DeviceTable_VlanID]	Defines a VLAN ID for the Ethernet Device. The valid value is 1 to 3999. The default is 1. <b>Note:</b> Each Ethernet Device must be configured with a unique VLAN ID.
'Underlying Interface' underlying-if [DeviceTable_UnderlyingInterface]	Assigns an Ethernet Group to the Ethernet Device. To configure Ethernet Groups, see <a href="#">Configuring Ethernet Port Groups</a> . <b>Note:</b> The parameter is mandatory.
'Tagging' tagging [DeviceTable_	Defines VLAN tagging for the Ethernet Device. <b>■ [0] Untagged</b> = (Default for pre-configured Ethernet Device)

Parameter	Description
Tagging]	<p>The Ethernet Device accepts untagged packets and packets with the same VLAN ID as the Ethernet Device. Incoming untagged packets are assigned the VLAN ID of the Ethernet Device. The Ethernet Device sends these VLAN packets untagged (i.e., removes the VLAN ID).</p> <ul style="list-style-type: none"> <li>■ [1] <b>Tagged</b> = (Default for new Ethernet Devices) The Ethernet Device accepts packets that have the same VLAN ID as the Ethernet Device and sends packets with this VLAN ID. For all Ethernet Devices that are associated with the same Ethernet Group (see 'Underlying Interface' parameter above) and configured to <b>Tagged</b>, incoming untagged packets received on this Ethernet Group are discarded.</li> </ul> <p><b>Note:</b> Only one Ethernet Device can be configured as Untagged per associated Ethernet Group. In other words, if multiple Ethernet Devices are associated with the same Ethernet Group, only one of these Ethernet Devices can be configured to <b>Untagged</b>; all the others must be configured to <b>Tagged</b>.</p>
'MTU' mtu [DeviceTable_MTU]	<p>Defines the Maximum Transmission Unit (MTU) in bytes per VLAN (Ethernet Device).</p> <p>The valid value is 68 to 1,500. The default is 1,500.</p> <p><b>Note:</b></p> <ul style="list-style-type: none"> <li>■ MTU is not applicable to SBC Direct Media traffic and to debug recording traffic.</li> <li>■ If your first Ethernet Device is configured with an untagged VLAN, its MTU value is the maximum MTU that can be configured for all other Ethernet Devices that are associated with the same Ethernet Group. In other words, if you configure additional Ethernet Devices (tagged VLANs) that are associated with the same Ethernet Group, their MTUs must be equal to or less than the MTU of the first Ethernet Device (untagged VLAN). For example, if the untagged VLAN is configured with MTU of 100 bytes, you can configure a tagged VLAN with an MTU value of either 100 bytes or less.</li> <li>■ If your first Ethernet Device is configured with a tagged VLAN and you later configure an additional Ethernet Device with an untagged VLAN that is associated with the same Ethernet Group, the MTU of the untagged VLAN must be equal to or greater than the highest MTU value configured out of all the Ethernet Devices (VLANs) associated with the Ethernet Group.</li> </ul>

Parameter	Description
	For example, if VLAN 1 is configured with the highest MTU (100 bytes) out of all your VLANs, you can configure an untagged VLAN with an MTU value of either 100 bytes or greater.

## Configuring IP Network Interfaces

You can configure a single VoIP network interface for all applications, including OAMP (management traffic), call control (SIP signaling messages), and media (RTP traffic), or you can configure multiple logical, IP network interfaces for these applications. You may need to logically separate network segments for these applications for administration and security. This can be achieved by employing Layer-2 VLANs and Layer-3 subnets. The figure below illustrates a typical network architecture where the device is configured with three network interfaces, each representing the OAMP, call control, and media applications. The device is connected to a VLAN-aware switch for directing traffic from and to the device to the three separated Layer-3 broadcast domains according to VLAN tags (middle pane).

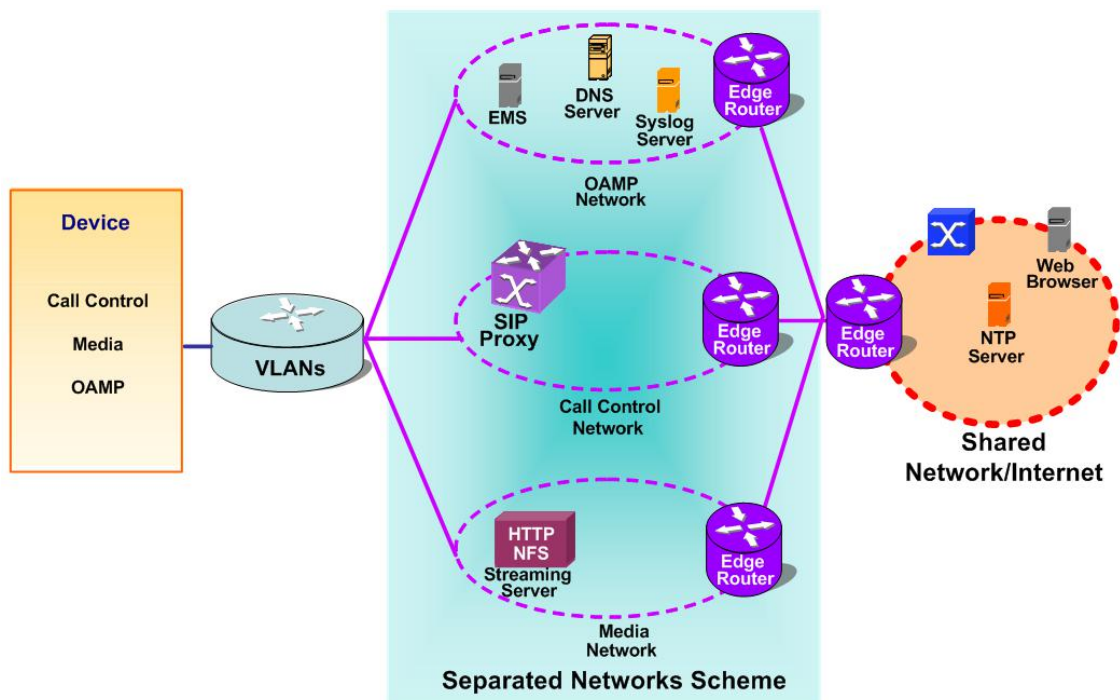

The device is shipped with a default OAMP interface (see [Default IP Address](#)). The IP Interfaces table lets you change this OAMP interface and configure additional network interfaces for control and media, if necessary. You can configure up to 12 interfaces, consisting of up to 11 Control and Media interfaces including 1 OAMP interface. Each IP interface is configured with the following:

- Application type allowed on the interface:
  - Control: call control signaling traffic (i.e., SIP)
  - Media: RTP traffic

- Operations, Administration, Maintenance and Provisioning (OAMP): management (i.e., Web, CLI, and SNMP based management)
- IP address (IPv4 or IPv6) and subnet mask (prefix length)
- Default Gateway: Traffic from this interface destined to a subnet that does not meet any of the routing rules (local or static) are forwarded to this gateway.
- (Optional) Primary and secondary domain name server (DNS) addresses for resolving FQDNs into IP addresses.
- Ethernet Device: Layer-2 bridging device and assigned a VLAN ID. As the Ethernet Device is associated with an Ethernet Group, this is useful for setting trusted and un-trusted networks on different physical Ethernet ports. Multiple entries in the IP Interfaces table may be associated with the same Ethernet Device, providing multi-homing IP configuration (i.e., multiple IP addresses on the same interface/VLAN).

Complementing the IP Interfaces table is the Static Routes table, which lets you configure static routing rules for non-local hosts/subnets. For more information, see [Configuring Static IP Routing](#).

Before configuring the IP network interfaces, read the following guidelines:

- **One** OAMP IP interface must be configured and this **must** be an IPv4 address. The OAMP interface can be combined with Media and Control.
- At least one Media-type interface **must** be configured.
- At least one Control-type interface **must** be configured.
- Multiple Control- and Media-type IP interfaces can be configured with overlapping IP addresses and subnets.
- The prefix length replaces the dotted-decimal subnet mask presentation and **must** have a value of 0-31 for IPv4 addresses, and a value of 64 for IPv6 addresses.
- Multiple Media- and Control-type interfaces can be configured with an IPv6 address.
- IP interface types can be combined:
  - Example 1:
    - ◆ One combined OAMP-Media-Control interface with an IPv4 address
  - Example 2:
    - ◆ One OAMP-type interface with an IPv4 address
    - ◆ One or more Control-type interfaces with IPv4 addresses
    - ◆ One or more Media-type interfaces with IPv4 interfaces
  - Example 3:
    - ◆ One OAMP-type with an IPv4 address
    - ◆ One combined Media-Control-type interface with IPv4 address



- ◆ One combined Media-Control-type interface with IPv6 address
- Each IP interface can be configured with a Default Gateway. The address of the Default Gateway **must** be in the same subnet as the associated interface. Additional static routing rules can be configured in the Static Routes table.
- The interface name **must** be configured (mandatory) and must be unique for each interface.
- Each network interface must be assigned an Ethernet Device.
- For IPv4 addresses, the 'Interface Mode' column must be set to IPv4 Manual. For IPv6 addresses, this column must be set to IPv6 Manual or IPv6 Manual Prefix.



- Upon device start up, the IP Interfaces table is parsed and passes A comprehensive validation test. If any errors occur during this validation phase, the device sends an error message to the Syslog server and falls back to a "safe mode", using a single interface without VLANs. Ensure that you view the Syslog messages that the device sends in system startup to see if any errors occurred.
- You can associate the Network Time Protocol (NTP) application with the OAMP or Control type IP network interface, using the EnableNTPasOAM ini file parameter. For more information on NTP, see [Configuring Automatic Date and Time using SNTP](#).

The following procedure describes how to configure IP network interfaces through the Web interface. You can also configure it through ini file [InterfaceTable] or CLI (`configure network > interface network-if`).

➤ **To configure IP network interfaces:**

1. Open the IP Interfaces table (**Setup** menu > **IP Network** tab > **Core Entities** folder > **IP Interfaces**).
2. Click **New**; the following dialog box appears:

GENERAL		IP ADDRESS	
Index	1	Interface Mode	IPv4 Manual
Name	Unknown	IP Address	0.0.0.0
Application Type	OAMP + Media + Control	Prefix Length	16
Ethernet Device	-- View	Default Gateway	0.0.0.0
DNS			
Primary DNS	0.0.0.0		
Secondary DNS	0.0.0.0		

3. Configure the IP network interface according to the parameters described in the table below.
4. Click **Apply**.



- When you change the device's OAMP interface address and then click **Apply**, connectivity with the device is lost. You need to re-access the device using the new address, and then click the **Save** button on the toolbar for the new address to take effect.
- If you edit or delete an IP interface, current calls using the interface are immediately terminated.
- If you delete an IP interface, rows configured in other tables (e.g., Media Realms table) that are associated with the deleted IP interface, lose their association with the IP interface ('Interface Name' field displays "None") and the rows become invalid.

To view configured IP network interfaces that are currently active, click the **IP Interface Status Table** link located at the bottom of the table. For more information, see [Viewing Active IP Interfaces](#).

**Table 13-5: IP Interfaces Table Parameters Description**

Parameter	Description
General	
'Index' network-if [InterfaceTable_Index]	Defines an index number for the new table row. <b>Note:</b> Each row must be configured with a unique index.
'Name' name [InterfaceTable_InterfaceName]	Defines a name for the interface. The valid value is a string of up to 16 characters. The default (if no name is configured) is "Interface_n", where <i>n</i> is the row index number. <b>Note:</b> <ul style="list-style-type: none"> <li>■ Each row must be configured with a unique name.</li> <li>■ The parameter value cannot contain a forward slash (/).</li> </ul>
'Application Type' application-type [InterfaceTable_ApplicationTypes]	Defines the applications allowed on the IP interface. <ul style="list-style-type: none"> <li>■ [0] <b>OAMP</b> = Operations, Administration, Maintenance and Provisioning (OAMP) applications (e.g., Web, Telnet, SSH, and SNMP).</li> <li>■ [1] <b>Media</b> = Media (i.e., RTP streams of voice).</li> <li>■ [2] <b>Control</b> = Call Control applications (e.g., SIP).</li> <li>■ [3] <b>OAMP + Media</b> = OAMP and Media applications.</li> <li>■ [4] <b>OAMP + Control</b> = OAMP and Call Control</li> </ul>

Parameter	Description
	<p>applications.</p> <ul style="list-style-type: none"> <li>■ [5] <b>Media + Control</b> = Media and Call Control applications.</li> <li>■ [6] <b>OAMP + Media + Control</b> = All application types are allowed on the interface.</li> </ul> <p>.</p> <p><b>Note:</b></p> <ul style="list-style-type: none"> <li>■ Only one IP network interface can be configured with OAMP in this table. To configure additional management interfaces, see <a href="#">Configuring Additional Management Interfaces</a>.</li> </ul>
'Ethernet Device' underlying-dev [InterfaceTable_UnderlyingDevice]	<p>Assigns an Ethernet Device to the IP interface. An Ethernet Device is a VLAN associated with a physical Ethernet port (Ethernet Group). To configure Ethernet Devices, see <a href="#">Configuring Underlying Ethernet Devices</a>. By default, no value is defined.</p> <p>Note: The parameter is mandatory.</p>
IP Address	
'Interface Mode' mode [InterfaceTable_InterfaceMode]	<p>Defines the method that the interface uses to acquire its IP address.</p> <ul style="list-style-type: none"> <li>■ [3] <b>IPv6 Manual Prefix</b> = IPv6 manual prefix IP address assignment. The IPv6 prefix (higher 64 bits) is set manually while the interface ID (the lower 64 bits) is derived from the device's MAC address.</li> <li>■ [4] <b>IPv6 Manual</b> = IPv6 manual IP address (128 bits) assignment.</li> <li>■ [10] <b>IPv4 Manual</b> = (Default) IPv4 manual IP address (32 bits) assignment.</li> </ul>
'IP Address' ip-address [InterfaceTable_IPAddress]	<p>Defines an IP address.</p> <p>The valid value is an IPv4 address (in dotted-decimal notation) or an IPv6 address (see RFC 4291). By default, no value is defined.</p> <p><b>Note:</b> The parameter is mandatory.</p>
'Prefix Length' prefix-length	<p>Defines the prefix length of the related IP address. This</p>

Parameter	Description
[InterfaceTable_PrefixLength]	<p>is a Classless Inter-Domain Routing (CIDR)-style representation of a dotted-decimal subnet notation. The CIDR-style representation uses a suffix indicating the number of bits which are set in the dotted-decimal format. For example, 192.168.0.0/16 is synonymous with 192.168.0.0 and subnet 255.255.0.0. This CIDR lists the number of '1' bits in the subnet mask (i.e., replaces the standard dotted-decimal representation of the subnet mask for IPv4 interfaces). For example, a subnet mask of 255.0.0.0 is represented by a prefix length of 8 (i.e., 11111111 00000000 00000000 00000000) and a subnet mask of 255.255.255.252 is represented by a prefix length of 30 (i.e., 11111111 11111111 11111111 11111100).</p> <p>The prefix length is a Classless Inter-Domain Routing (CIDR) style presentation of a dotted-decimal subnet notation. The CIDR-style presentation is the latest method for interpretation of IP addresses. Specifically, instead of using eight-bit address blocks, it uses the variable-length subnet masking technique to allow allocation on arbitrary-length prefixes.</p> <p>The valid value of the prefix length depends on the IP address version:</p> <ul style="list-style-type: none"> <li>■ IPv4: 0 to 31</li> <li>■ IPv6: Depends on the settings of the 'Interface Mode' parameter (above): <ul style="list-style-type: none"> <li>✓ <b>IPv6 Manual Prefix:</b> 64</li> <li>✓ <b>IPv6 Manual:</b> Up to 126</li> </ul> </li> </ul>
'Default Gateway' gateway [InterfaceTable_Gateway]	<p>Defines the IP address of the default gateway for the IP interface. When traffic is sent from this interface to an unknown destination (i.e., not in the same subnet and not defined for any static routing rule), it is forwarded to this default gateway.</p> <p>By default, no value is defined.</p> <p>When configuring a prefix length value of 31 (for IPv4 point-to-point connections), configure the peer IP address as the Default Gateway IP address.</p>
DNS	

Parameter	Description
'Primary DNS' primary-dns [InterfaceTable_ PrimaryDNSServerIPAddress]	Defines the primary DNS server's IP address (in dotted-decimal notation), which is used for translating domain names into IP addresses for the interface. By default, no IP address is defined.
'Secondary DNS' secondary-dns [InterfaceTable_ SecondaryDNSServerIPAddress]	Defines the secondary DNS server's IP address (in dotted-decimal notation), which is used for translating domain names into IP addresses for the interface. By default, no IP address is defined.

## Networking Configuration Examples

Examples of IP network interface configuration are listed below:

### ■ Single IP network interface for all applications:

The IP Interfaces table is configured with a single interface for OAMP, Media and Control:

Index	Name	Application Type	Ethernet Device	Interface Mode	IP Address	Prefix Length	Default Gateway
0	myInterface	OAMP + Media + Control	1	IPv4 Manual	192.168.0. 2	16	192.168.0. 1

Two routes are configured in the **Static Routes table** for directing traffic for subnet 201.201.0.0/16 to 192.168.11.10, and all traffic for subnet 202.202.0.0/16 to 192.168.11.1:

Index	Destination	Prefix Length	Gateway
0	201.201.0.0	16	192.168.11.10
1	202.202.0.0	16	192.168.11.1

The NTP applications remain with their default application types.

### ■ Multiple interfaces, one per application type:

The IP Interfaces table is configured with three interfaces, each for a different application type (one for OAMP, one for Call Control, and one for RTP Media), and each with a different VLAN ID and default gateway:

Index	Name	Application Type	Ethernet Device	Interface Mode	IP Address	Prefix Length	Default Gateway
0	ManagementIF	OAMP	1	IPv4 Manual	192.168.0.2	16	192.168.0.1
1	myControlIF	Control	200	IPv4 Manual	200.200.85.14	24	200.200.85.1
2	myMediaIF	Media	211	IPv4 Manual	211.211.85.14	24	211.211.85.1

A routing rule in the Static Routes table is required to allow remote management from a host in 176.85.49.0/24:

Index	Destination	Prefix Length	Gateway
0	176.85.49.0	24	192.168.11.1

All other parameters are set to their respective default values. The NTP application remains with its default application types.

#### ■ Multiple interfaces with combined application types:

- A single interface for OAMP.
- Interfaces for Call Control and Media applications, where two of them are IPv4 interfaces and one is an IPv6 interface.

The IP Interfaces table is configured as follows:

Index	Name	Application Type	Ethernet Device	Interface Mode	IP Address	Prefix Length	Default Gateway
0	Mgmt	OAMP	1	IPv4 Manual	192.168.0.2	16	192.168.0.1
1	MediaCntrl1	Media + Control	201	IPv4 Manual	200.200.85.14	24	200.200.85.1
2	MediaCntrl2	Media + Control	202	IPv4 Manual	200.200.86.14	24	200.200.86.1

Index	Name	Application Type	Ethernet Device	Interface Mode	IP Address	Prefix Length	Default Gateway
3	V6CntrlMedia2	Media + Control	202	IPv6 Manual	2000::1:200:200:86:14	64	::

1. A routing rule in the Static Routes table is required to allow remote management from a host in 176.85.49.0/24:

Index	Destination	Prefix Length	Gateway
0	176.85.49.0	24	192.168.0.10

The NTP application is configured (through the ini file) to serve as OAMP applications:

```
EnableNTPasOAM = 1
```

Configure Layer-2 QoS mapping in the QoS Mapping table. Packets sent with the configured DiffServ get the configured VLAN priority:

Index	Differentiated Services	VLAN Priority
0	46	6
1	40	6
2	26	4
3	10	2

Configure Layer-3 QoS in the QoS Settings table:

- 'Media Premium QoS' - the default DiffServ value is 46
- 'Control Premium QoS' - the default DiffServ value is 24
- 'Gold QoS' - the default DiffServ value is 26
- 'Bronze QoS' - the default DiffServ value is 10

#### ■ IP Network Interfaces and Multiple Default Gateways:

This example includes a different Default Gateway per IP network interface. The Default Gateway of the OAMP interface is 192.168.0.1 and of the Media and Control is 200.200.85.1. The configuration in the IP Interfaces table is shown below:

Index	Name	Application Type	Ethernet Device	Interface Mode	IP Address	Prefix Length	Default Gateway
0	Mgmt	OAMP	100	IPv4 Manual	192.168.0.2	16	192.168.0.1
1	CntrlMedia	Media & Control	200	IPv4 Manual	200.200.85.14	24	200.200.85.1

Configuring the following static routing rules in the Static Routes table enables OAMP applications to access peers on subnet 17.17.0.0 through the Default Gateway 192.168.10.1 and Media + Control applications to access peers on subnet 171.79.39.0 through Default Gateway 200.200.85.10 (which is not the default gateway of the interface).

Index	Destination	Prefix Length	Ethernet Output Device	Gateway
0	17.17.0.0	16	100	192.168.10.1
1	171.79.39.0	24	200	200.200.85.10

## Configuring Static IP Routes

The Static Routes table lets you configure up to 30 static IP routing rules. Static routes let you communicate with LAN networks that are not located behind the Default Gateway that is specified for an IP network interface in the IP Interfaces table, from which the packets are sent. Before sending an IP packet, the device searches the Static Routes table for an entry that matches the requested destination host/network. If an entry is found, the device sends the packet to the gateway that is configured for the static route. If no explicit entry is found, the packet is sent to the Default Gateway as configured for the IP interface in the IP Interfaces table.

You can view the status of configured static routes in the IP Routing Status table. This table can be accessed by clicking the **Static Routes Status Table** link located at the bottom of the Static Routes table (see [Viewing Static Routes Status](#)).

The following procedure describes how to configure static routes through the Web interface. You can also configure it through ini file [StaticRouteTable] or CLI (`configure network > static`).

### ➤ To configure static IP routes:

1. Open the Static Routes table (**Setup** menu > **IP Network** tab > **Core Entities** folder > **Static Routes**).
2. Click **New**; the following dialog box appears:



3. Configure a static route according to the parameters described in the table below. The address of the host/network you want to reach is determined by an AND operation that is applied to the fields 'Destination' and 'Prefix Length'. For example, to reach network 10.8.x.x, enter "10.8.0.0" in the 'Destination' field and "16" in the 'Prefix Length'. As a result of the AND operation, the value of the last two octets in the 'Destination' field are ignored. To reach a specific host, enter its IP address in the 'Destination' field and "32" in the 'Prefix Length' field.
4. Click **Apply**, and then save your settings to flash memory.



You can only delete static routing rules that are inactive.

**Table 13-6: Static Routes Table Parameter Descriptions**

Parameter	Description
'Index' [StaticRouteTable_Index]	Defines an index number for the new table row. The valid value is 0 to 29. <b>Note:</b> Each row must be configured with a unique index.
'Destination' destination [StaticRouteTable_Destination]	Defines the IP address of the destination host/network. The destination can be a single host or a whole subnet, depending on the prefix length configured for this routing rule.
'Preferred Source' preferred-source- interface-name [StaticRouteTable_ PreferredSourceInterfaceName]	Defines a specific local source IP address for outgoing packets using the static route. This is done by assigning the rule a local source IP interface (from the IP Interfaces table, described in <a href="#">Configuring IP Network Interfaces</a> ). This parameter can be used when the device sends packets to a specific destination that requires a specific source address, for example, when using

Parameter	Description
	<p>multi-homing (multiple IP addresses configured on the same VLAN device). This feature also provides predictability and consistency of locally-generated traffic, which is useful (or even needed) for firewalls, monitoring or reporting, and various other use cases.</p> <p>If the parameter is not configured (default), the device sets the source address of the outgoing packet to the address of the IP Interface that is associated with the static route's VLAN (see the 'Ethernet Output Device' parameter below).</p>
<p>'Prefix Length'  <code>prefix-length</code>            [StaticRouteTable_PrefixLength]</p>	<p>Defines the Classless Inter-Domain Routing (CIDR)-style representation of a dotted-decimal subnet notation of the destination host/network. The CIDR-style representation uses a suffix indicating the number of bits that are set in the dotted-decimal format. For example, the value 16 represents subnet 255.255.0.0</p> <p>The valid value depends on the IP address version:</p> <ul style="list-style-type: none"> <li>■ IPv4: 0 to 32</li> <li>■ IPv6: 0 to 128</li> </ul>
<p>'Ethernet Output Device'  <code>device-name</code>            [StaticRouteTable_DeviceName]</p>	<p>Associates an IP network interface through which the static route's Gateway is reached. The association is done by assigning the parameter the same Ethernet Device that is assigned to the IP network interface in the IP Interfaces table ('Ethernet Device' parameter). To configure IP network interface, see <a href="#">Configuring IP Network Interfaces</a>. To configure Ethernet Devices, see <a href="#">Configuring Underlying Ethernet Devices</a>.</p>
<p>'Gateway'  <code>gateway</code>            [StaticRouteTable_Gateway]</p>	<p>Defines the IP address of the Gateway (next hop) used for traffic destined to the subnet/host defined in the 'Destination' / 'Prefix Length' field.</p> <p><b>Note:</b></p> <ul style="list-style-type: none"> <li>■ The Gateway's address must be in the same subnet as the IP address of the network interface that is associated with the static</li> </ul>

Parameter	Description
	<p>route (using the 'Ethernet Output Device' parameter - see above).</p> <ul style="list-style-type: none"> <li>The IP network interface associated with the static route must be of the same IP address family (IPv4 or IPv6).</li> </ul>
'Description' description [StaticRouteTable_Description]	<p>Defines a name for the rule.</p> <p>The valid value is a string of up to 20 characters.</p>

### Configuration Example of Static IP Routes

An example of the use for static routes is shown in the figure below. In the example, the device needs to communicate with a softswitch at IP address 10.1.1.10. However, the IP network interface from which packets destined for 10.1.1.10 is sent, is configured to send the packets to a Default Gateway at 10.15.0.1. Therefore, the packets do not reach the softswitch. To resolve this problem, a static route is configured to specify the correct gateway (10.15.7.22) in order to reach the softswitch.

Note the following configuration:

- The static route is configured with a subnet mask of 24 (255.255.255.0), enabling the device to use the static route to send all packets destined for 10.1.1.x to this gateway and therefore, to the network in which the softswitch resides.
- The static route in the Static Routes table must be associated with the IP network interface in the IP Interfaces table. This is done by configuring the 'Ethernet Output Device' field in the Static Routes table to the same value as configured in the 'Ethernet Device' field in the IP Interfaces table.
- The static route's Gateway address in the Static Routes table is in the same subnet as the IP address of the IP network interface in the IP Interfaces table.

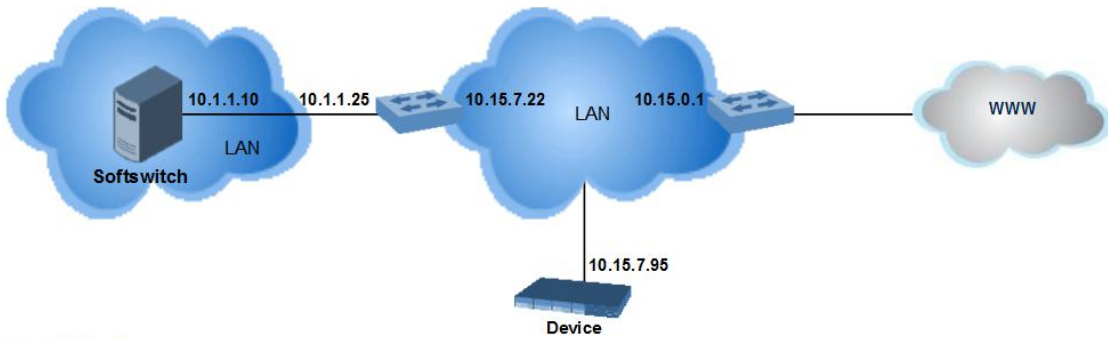

**No Static Route:**

The device sends packets to 10.15.0.1, which is the Default Gateway defined for this IP network interface in the IP Interfaces table. Therefore, the device will not succeed in reaching the softswitch.

INDEX	NAME	APPLICATION TYPE	INTERFACE MODE	IP ADDRESS	PREFIX LENGTH	DEFAULT GATEWAY	PRIMARY DNS	SECONDARY DNS	ETHERNET DEVICE
0	O+M+C	OAMP + Media	IPv4 Manual	10.15.7.95	16	10.15.0.1	0.0.0.0	0.0.0.0	vlan 1

**Static Route Configured:**

A static route with the correct gateway is needed for routing to the softswitch. The device communicates with the softswitch (10.1.1.0/24) using the gateway 10.15.7.22. Note that the device first searches for a matching route in the Static Routes table. If not found, it uses the default gateway defined in the IP Interfaces table.

INDEX	DESTINATION	PREFIX LENGTH	ETHERNET OUTPUT DEVICE	GATEWAY	DESCRIPTION
0	10.1.1.0	24	vlan 1	10.15.7.22	Softswitch

## Troubleshooting the Static Routes Table

When adding a new static route to the Static Routes table, the added rule passes a validation test. If errors are found, the static route is rejected and not added to the table. Failed static route validations may result in limited connectivity (or no connectivity) to the destinations specified in the incorrect static route. For any error found in the Static Routes table or failure to configure a static route, the device sends a notification message to the Syslog server reporting the problem.

Common static routing configuration errors may include the following:

- The IP address specified in the 'Gateway' field is unreachable from the IP network interface associated with the static route.
- The same destination has been configured in two different static routing rules.
- More than 30 static routes have been configured.



If a static route is required to access OAMP applications (for remote management, for example) and the route is not configured correctly, the route is not added and the device is not accessible remotely. To restore connectivity, the device must be accessed locally from the OAMP subnet and the required routes be configured.

## Network Address Translation Support

Network Address Translation (NAT) is a mechanism that maps internal IP addresses (and ports) used within a private network to global IP addresses and vice versa, providing transparent routing to end hosts. The primary advantages of NAT include (1) reduction in the number of global IP addresses required in a private network (global IP addresses are only used to connect to the Internet) and (2) better network security by hiding the internal architecture.

The design of SIP creates a problem for VoIP traffic to pass through NAT. SIP uses IP addresses and port numbers in its message body. However, the NAT server is unable to modify the SIP messages and thus, can't change local addresses to global addresses.

This section discusses the device's solutions for overcoming NAT traversal issues.

### Device Located behind NAT

Two different streams of traffic traverse through NAT - signaling and media. A device located behind NAT that initiates a signaling path has problems receiving incoming signaling responses, as they are blocked by the NAT server. Therefore, the initiating device must inform the receiving device where to send the media. To resolve this NAT problem, the device provides the following solutions (listed in priority of the method used):

- (Gateway Application Only) If configured, uses the single Static NAT IP address for all interfaces - see [Configuring a Static NAT IP Address for All Interfaces](#) on the next page
- NAT Translation table, which configures NAT per IP network interface - see [Configuring NAT Translation per IP Interface](#).

If NAT is not configured, the device sends the packet according to its IP address configured in the IP Interfaces table.

The figure below illustrates the NAT problem faced by SIP networks when the device is located behind a NAT:

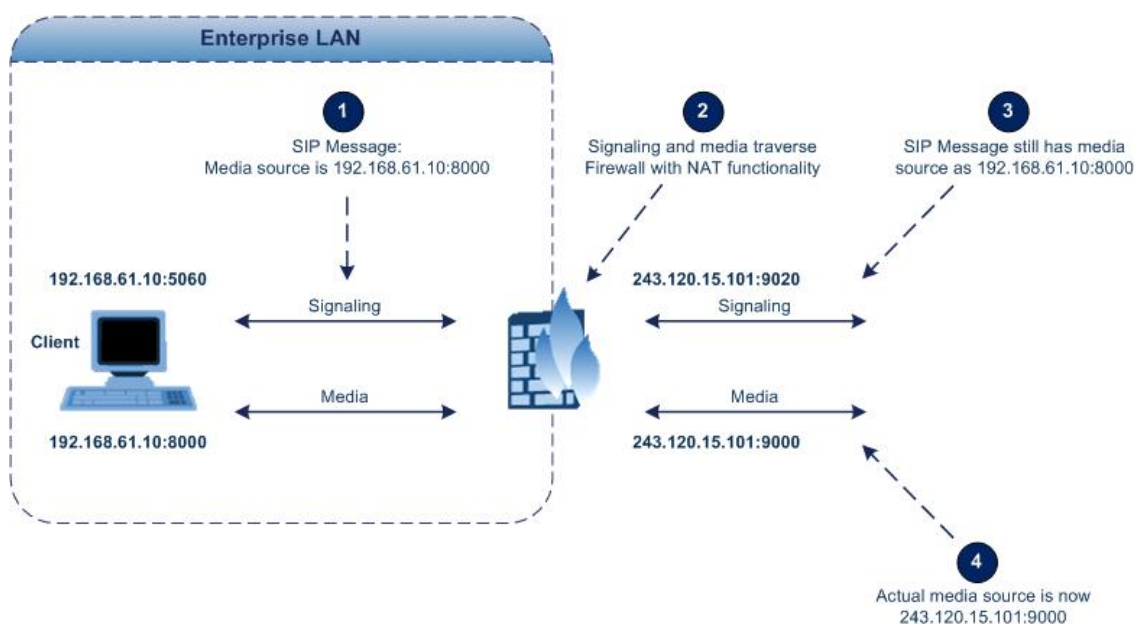

## Configuring a Static NAT IP Address for All Interfaces

You can configure a global (public) IP address of the router to enable static NAT between the device and the Internet for all network interfaces. The device replaces the source IP address for media of all outgoing SIP messages sent on any of its network interfaces to this public IP address.

The following procedure describes how to configure a static NAT address through the Web interface. You can also configure it through ini file [StaticNATIP] or CLI (`configure voip > sip-definition settings > nat-ip-addr`).

### ➤ To configure a single static NAT IP address:

1. Open the Gateway General Settings page (**Setup** menu > **Signaling & Media** tab > **Gateway** folder > **Gateway General Settings**).
2. In the 'NAT IP Address' field, enter the NAT IP address in dotted-decimal notation.

**Figure 13-2: Configuring Static NAT IP Address**

NAT IP Address

3. Click **Apply**.



The feature is applicable only to the Gateway application.

## Configuring NAT Translation per IP Interface

The NAT Translation table lets you configure up to 32 network address translation (NAT) rules for translating source IP addresses into NAT IP addresses (*global - public*) when the device is located behind NAT. The device's NAT traversal mechanism replaces the source IP address of SIP messages sent from a specific VoIP interface (Control and/or Media) in the IP Interfaces table to a public IP address. This allows, for example, the separation of VoIP traffic between different ITSPs and topology hiding of internal IP addresses from the “public” network. Each IP network interface (configured in the IP Interfaces table) can be associated with a NAT rule, translating the source IP address and port of the outgoing packet into the NAT address (IP address and port range).

The following procedure describes how to configure NAT translation rules through the Web interface. You can also configure it through ini file [NATTranslation] or CLI (`configure network > nat-translation`).

### ➤ To configure NAT translation rules:

1. Open the NAT Translation table (**Setup** menu > **IP Network** tab > **Core Entities** folder > **NAT Translation**).
2. Click **New**; the following dialog box appears:

3. Configure a NAT translation rule according to the parameters described in the table below.
4. Click **Apply**, and then save your settings to flash memory.

**Table 13-7: NAT Translation Table Parameter Descriptions**

Parameter	Description
<b>Source</b>	
'Index' index [NATTranslation_Index]	Defines an index number for the new table row. <b>Note:</b> Each row must be configured with a unique index.
'Source Interface' src-interface-name [NATTranslation_SrcIPInterfaceName]	Assigns an IP network interface (configured in the IP Interfaces table) to the rule. Outgoing packets sent from the specified network interface are NAT'ed. By default, no value is defined. To configure IP network interfaces, see <a href="#">Configuring IP Network Interfaces</a> .
'Source Start Port' src-start-port [NATTranslation_SourceStartPort]	Defines the optional starting port range (0-65535) of the IP interface, used as matching criteria for the NAT rule. If not configured, the match is done on the entire port range. Only IP addresses and ports of matched source ports will be replaced.
'Source End Port' src-end-port [NATTranslation_SourceEndPort]	Defines the optional ending port range (0-65535) of the IP interface, used as matching criteria for the NAT rule. If not configured, the match is done on the entire port range. Only IP addresses and ports of matched source ports will be replaced.
<b>Target</b>	
'Target IP Address' target-ip-address [NATTranslation_	Defines the global (public) IP address. The device adds the address in the outgoing packet to the SIP Via header, Contact header, 'o=' SDP field, and 'c=' SDP

Parameter	Description
TargetIPAddress]	field.
'Target Start Port' target-start-port [NATTranslation_ TargetStartPort]	Defines the optional starting port range (0-65535) of the global address. If not configured, the ports are not replaced. Matching source ports are replaced with the target ports. This address is set in the SIP Via and Contact headers and in the 'o=' and 'c=' SDP fields.
'Target End Port' target-end-port [NATTranslation_ TargetEndPort]	Defines the optional ending port range (0-65535) of the global address. If not configured, the ports are not replaced. Matching source ports are replaced with the target ports. This address is set in the SIP Via and Contact headers and in the 'o=' and 'c=' SDP fields.

## Remote UA behind NAT

This section describes configuration for scenarios where the device sends signaling and media packets to a remote UA that is located behind NAT.

### SIP Signaling Messages

By default, the device resolves NAT issues for SIP signaling, using its NAT Detection mechanism. The NAT Detection mechanism checks whether the endpoint is located behind NAT by comparing the source IP address of the incoming UDP/TCP packet (in which the SIP message is received) with the IP address in the SIP Contact header. If the packet's source IP address is a public address and the Contact header's IP address is a local address, the device considers the endpoint as located behind NAT. In this case, the device sends the SIP messages to the endpoint using the packet's source IP address. Otherwise (or if you have disabled the NAT Detection mechanism), the device sends the SIP messages according to the SIP standard (RFC 3261), where requests within the SIP dialog are sent using the IP address in the Contact header and responses to INVITEs are sent using the IP address in the Via header.

If necessary, you can also configure the device to always consider incoming SIP INVITE messages as sent from endpoints that are located behind NAT. When this is enabled, the device sends responses to the INVITE (to the endpoint) using the the source IP address of the packet (INVITE) initially received from the endpoint. This is useful in scenarios where the endpoint is located behind a NAT firewall and the device (for whatever reason) is unable to identify NAT using its regular NAT Detection mechanism. This feature is enabled per specific calls using the 'Always Use Source Address' parameter in the IP Groups table (see [Configuring IP Groups](#)). If this feature is disabled, the device's NAT detection is according to the settings of the global parameter, 'SIP NAT Detection' parameter (see below procedure).



➤ **To enable the NAT Detection feature (global):**

1. Open the Transport Settings page (**Setup** menu > **Signaling & Media** tab > **SIP Definitions** folder > **Transport Settings**).
2. From the 'SIP NAT Detection' drop-down list (SIPNatDetection), select **Enable**:

GENERAL

SIP NAT Detection

3. Click **Apply**.

### Media (RTP/RTCP/T.38)

When a remote UA initiates a call and is not located behind a NAT server, the device sends the media (RTP, RTCP, and T.38) packets to the remote UA using the IP address:port (UDP) indicated in the SDP body of the SIP message received from the UA. However, if the UA is located behind NAT, the device sends the RTP with the IP address of the UA (i.e., private IP address) as the destination instead of that of the NAT server. Thus, the RTP will not reach the UA. To resolve this NAT traversal problem, the device offers the following features:

- First Incoming Packet Mechanism - see [First Incoming Packet Mechanism](#)
- RTP No-Op packets according to the avt-rtp-noop draft - see [No-Op Packets](#)

The figure below illustrates a typical network architecture where the remote UA is located behind NAT:

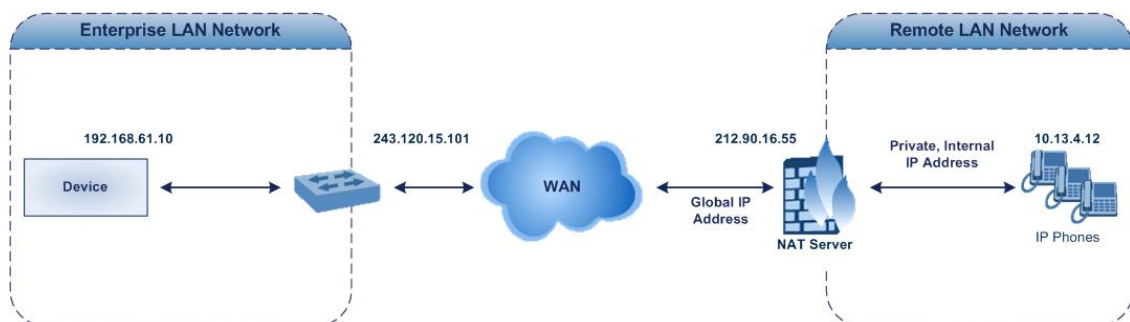

### First Incoming Packet Mechanism

In scenarios where the remote user agent (UA) resides behind a NAT server, it's possible that the device, if not configured for NAT traversal, will send the media (RTP, RTCP and T.38) streams to an invalid IP address and UDP port. In other words, it will send the media to the private IP address:port of the UA and not the public address (of the NAT server) and therefore, the media will not reach the UA. When the UA is located behind NAT, although the UA sends its private IP address:port in the original SIP message (INVITE), the device receives the media packets with a source address of a public IP address:port (i.e., allocated by the NAT server). Therefore, to ensure that the media reaches the UA, the device must send it to the public address.

The device identifies whether the UA is located behind NAT by comparing the source IP address of the first received media packet with the IP address and UDP port of the first received SIP message (INVITE) when the SIP session was started. This is done for each media type--RTP, RTCP and T.38--and therefore, they can have different destination IP addresses and UDP ports than one another.

The device supports various NAT traversal methods, which you can configure using the 'NAT Traversal' (NATMode) parameter. For more information on the different options provided by this parameter, see [NAT and STUN Parameters](#) on page 1414.

➤ **To enable NAT resolution using the First Incoming Packet mechanism:**

1. Open the Media Settings page (**Setup** menu > **Signaling & Media** tab > **Media** folder > **Media Settings**).
2. From the 'NAT Traversal' drop-down list (NATMode), select the required NAT option.

**NAT Traversal**

• NAT by Signaling Restricted

3. Click **Apply**.

### No-Op Packets

The device can send No-Op packets to verify Real-Time Transport Protocol (RTP) and T.38 connectivity, and to keep NAT bindings and Firewall pinholes open. The No-Op packets can be sent in RTP and T.38 formats:

- **RTP No-Op:** The RTP No-Op support complies with IETF Internet-Draft draft-wing-avt-rtp-noop-03 ("A No-Op Payload Format for RTP"). The IETF document defines a No-Op payload format for RTP. The draft defines the RTP payload type as dynamic. You can configure the payload type as described in the following procedure (default is 120).
- **T.38 No-Op:** T.38 No-Op packets are sent only while a T.38 session is activated. Sent packets are a duplication of the previously sent frame (including duplication of the sequence number).

➤ **To configure the No-Op packet feature:**

1. Enable the feature, using the [NoOpEnable] parameter.
2. Configure the interval between each No-Op packet sent by the device during the silence period (i.e., no RTP or T.38 traffic), using the [NoOpInterval] parameter.
3. For RTP No-Op packets, configure the payload type of the No-Op packets, using the [RTPNoOpPayloadType] parameter.



The receipt of No-Op packets is always supported.

### Fax Transmission behind NAT

The device supports transmission from fax machines (connected to the device) located inside (behind) NAT. Generally, the firewall blocks T.38 (and other) packets received from the WAN, unless the device behind the NAT sends at least one IP packet from the LAN to the WAN through the firewall. If the firewall blocks T.38 packets sent from the termination IP fax, the fax fails. To overcome this problem, the device sends No-Op ("no-signal") packets to open a pinhole in the NAT for the answering fax machine. The originating fax does not wait for an answer, but immediately starts sending T.38 packets to the terminating fax machine upon receipt of a re-INVITE with T.38 only in the SDP, or T.38 and audio media in the SDP. This feature is configured using the [T38FaxSessionImmediateStart] parameter. The No-Op packet feature is enabled using the [NoOpEnable] and [NoOpInterval] parameters.

### ICE Lite

The device supports Interactive Connectivity Establishment (ICE) Lite for SBC calls. ICE is a methodology for NAT traversal, enabling VoIP interoperability across networks to work better across NATs and firewalls. It employs Session Traversal Utilities for NAT (STUN) and Traversal Using Relays around NAT (TURN) protocols to provide a peer with a public IP address and port that can be used to connect to a remote peer. Therefore, for some applications such as when the device operates in Microsoft Teams Direct Routing (media bypass) environments, ICE Lite is required.



ICE Lite is applicable only to the SBC application.

In order for clients behind NATs and/or firewalls to send media (RTP) between one another, they need to discover each others IP address and port as seen by the "outside" world. If both peers are located in different private networks behind a NAT, the peers must coordinate to determine the best communication path between them.

ICE first tries to make a connection using the client's private local address. If that fails (which it will for clients behind NAT), ICE obtains an external (public) address using a STUN server. If that fails, traffic is routed through a TURN relay server (which has a public address).

These addresses:ports (local, STUN, TURN and any other network address) of the client are termed "candidates". Each client sends its' candidates to the other in the SDP body of the INVITE message. Peers then perform connectivity checks per candidate of the other peer, using STUN binding requests sent on the RTP and RTCP ports. ICE tries each candidate and selects the one that works (i.e., media can flow between the clients). The following figure shows a simple illustration of ICE:

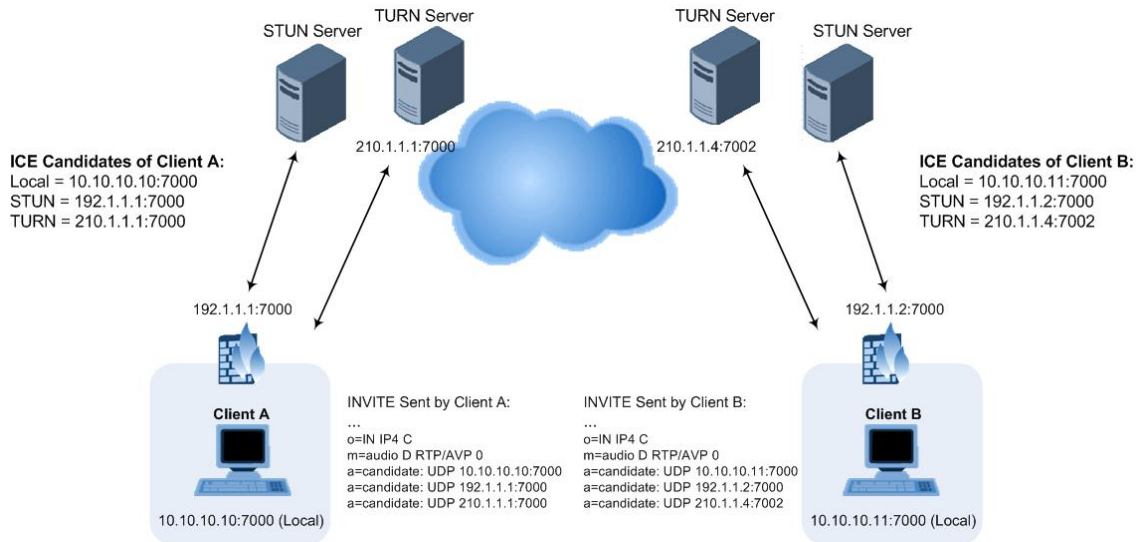

The device's support for ICE-Lite means that it does not initiate the ICE process. Instead, it supports remote endpoints that initiate ICE to discover their workable public IP address with the device. Therefore, the device supports the receipt of STUN binding requests for connectivity checks of ICE candidates and responds to them with STUN responses. Note that in the response to the INVITE message received from the remote endpoint, the device sends only a single candidate for its' own IP address. This is the IP address of the device that the client uses. To support ICE, the SBC leg interfacing with the ICE-enabled client (SIP entity) must be enabled for ICE. This is done using the IP Profile parameter [IPProfile\_SBCIceMode] - see [Configuring IP Profiles](#).

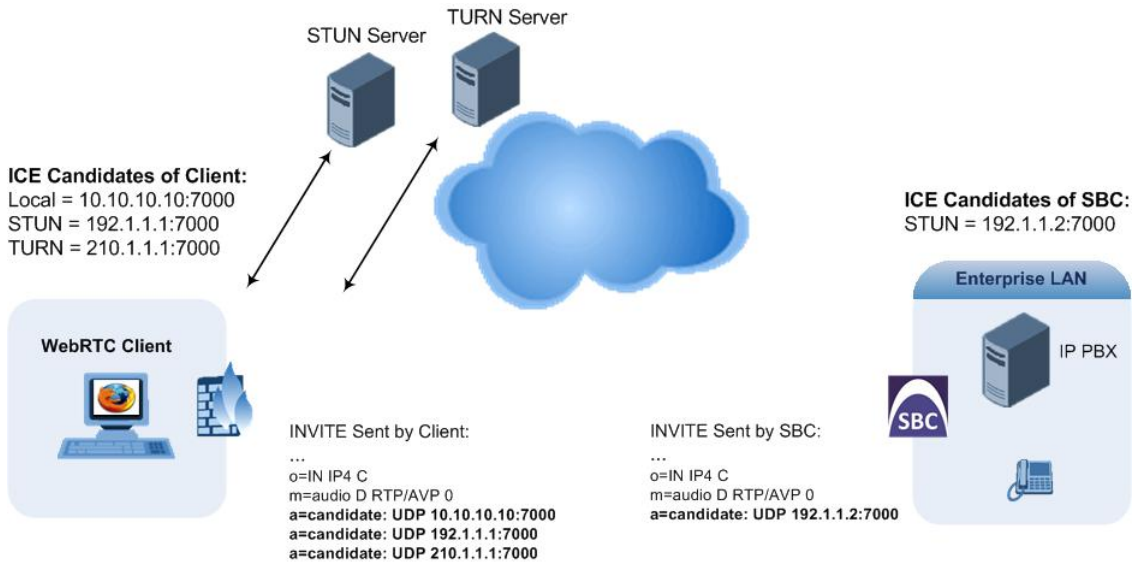

## Robust Receipt of Media Streams by Media Latching

The device's Robust Media feature (or media latching) filters out unwanted media (RTP, RTCP, SRTP, SRTCP, and T.38) streams that are sent to the same port number of the device. Media ports may receive additional multiple unwanted media streams (from multiple sources of traffic) as result of traces of previous calls, call control errors, or deliberate malicious attacks (e.g., Denial of Service). When the device receives more than one media stream on the same

port, the Robust Media mechanism detects the valid media stream and ignores the rest. Thus, this can prevent an established call been stolen by a malicious attacker on the media stream.

## Configuring Quality of Service

This section describes how to configure Layer-2 and Layer-3 Quality of Service (QoS).

### Configuring Class-of-Service QoS

The QoS Settings page lets you configure Layer-3 Class-of-Service Quality of Service (QoS). This configures Differentiated Services (DiffServ) values for each CoS. DiffServ is an architecture providing different types or levels of service for IP traffic. DiffServ (according to RFC 2474), prioritizes certain traffic types based on priority, accomplishing a higher-level QoS at the expense of other traffic types. By prioritizing packets, DiffServ routers can minimize transmission delays for time-sensitive packets such as VoIP packets.

You can assign DiffServ to the following class of services (CoS):

- Media Premium: RTP packets sent to the LAN
- Control Premium: Control protocol (SIP) packets sent to the LAN
- Gold: HTTP streaming packets sent to the LAN
- Bronze: OAMP packets sent to the LAN

The mapping of an application to its CoS and traffic type is shown in the table below:

**Table 13-8: Traffic/Network Types and Priority**

Application	Traffic / Network Types	Class-of-Service (Priority)
Debugging interface	Management	Bronze
Telnet	Management	Bronze
Web server (HTTP)	Management	Bronze
SNMP GET/SET	Management	Bronze
Web server (HTTPS)	Management	Bronze
RTP traffic	Media	Media Premium
RTCP traffic	Media	Media Premium
T.38 traffic	Media	Media Premium
SIP	Control	Control Premium

Application	Traffic / Network Types	Class-of-Service (Priority)
SIP over TLS (SIPS)	Control	Control Premium
Syslog	Management	Bronze
SNMP Traps	Management	Bronze
DNS client	Varies according to DNS settings: <ul style="list-style-type: none"> <li>■ OAMP</li> <li>■ Control</li> </ul>	Depends on traffic type: <ul style="list-style-type: none"> <li>■ Control: Control Premium</li> <li>■ Management: Bronze</li> </ul>
NTP	Varies according to the interface type associated with NTP (see Assigning NTP Services to Application Types): <ul style="list-style-type: none"> <li>■ OAMP</li> <li>■ Control</li> </ul>	Depends on traffic type: <ul style="list-style-type: none"> <li>■ Control: Control Premium</li> <li>■ Management: Bronze</li> </ul>

➤ **To configure DiffServ (Layer-3 QoS) values per CoS:**

1. Open the QoS Settings page (**Setup** menu > **IP Network** tab > **Quality** folder > **QoS Settings**).
2. Click **New**; the following dialog box appears:

**GENERAL**

<b>Media Premium QoS</b>	46
<b>Control Premium QoS</b>	40
Gold QoS	26
Bronze QoS	10

3. Configure DiffServ values per CoS according to the parameters described in the table below.
4. Click **Apply**, and then save your settings to flash memory.

**Table 13-9: QoS Settings Parameter Descriptions**

Parameter	Description
'Media Premium QoS' media-qos [PremiumServiceClassMediaDiffServ]	Defines the DiffServ value for Premium Media CoS content.  The valid range is 0 to 63. The default is 46. <b>Note:</b> You can also configure the the parameter per IP Profile (IpProfile_IPDiffServ) or Tel Profile (TelProfile_IPDiffServ).
'Control Premium QoS' control-qos [PremiumServiceClassControlDiffServ]	Defines the DiffServ value for Premium Control CoS content (Call Control applications).  The valid range is 0 to 63. The default is 24. <b>Note:</b> You can also configure the the parameter per IP Profile (IpProfile_SigIPDiffServ) or Tel Profile (TelProfile_SigIPDiffServ).
'Gold QoS' gold-qos [GoldServiceClassDiffServ]	Defines the DiffServ value for Gold CoS content (streaming applications).  The valid range is 0 to 63. The default is 26.
'Bronze QoS' bronze-qos [BronzeServiceClassDiffServ]	Defines the DiffServ value for Bronze CoS content (OAMP applications).  The valid range is 0 to 63. The default is 10.

## Configuring DiffServ-to-VLAN Priority Mapping

The QoS Mapping table lets you configure up to 64 DiffServ-to-VLAN priority mapping for Layer 3 and Layer-2 Quality of Service (QoS). For each packet sent to the LAN, the VLAN Priority of the packet is set according to the DiffServ value in the IP header of the packet. Layer-2 802.1Q frames have a 2-byte field called Tag Control Information. The three most significant bits of this 2-byte field represents the Class of Service (CoS) value. Layer-2 QoS is represented by this CoS value which is from 0 to 7 (thus 8 values). Layer-2 QoS parameters define the values for the 3 priority bits in the VLAN tag according to the value of the DiffServ field in the packet IP header (according to the IEEE 802.1p standard). Differentiated Services (DiffServ) is an architecture providing different types or levels of service for IP traffic. DiffServ (according to RFC 2474), prioritizes certain traffic types based on priority, accomplishing a higher-level QoS at the expense of other traffic types. By prioritizing packets, DiffServ routers can minimize transmission delays for time-sensitive packets such as VoIP packets.

The following procedure describes how to configure DiffServ-to-VLAN priority mapping through the Web interface. You can also configure it through ini file [DiffServToVlanPriority] or CLI (configure network > qos vlan-mapping).

➤ **To configure DiffServ-to-VLAN priority mapping:**

1. Open the QoS Mapping table (**Setup** menu > **IP Network** tab > **Quality** folder > **QoS Mapping**).
2. Click **New**; the following dialog box appears:

The screenshot shows a dialog box titled "QoS Mapping" with a "GENERAL" tab. The dialog contains three input fields:

- Index:** 1
- Differentiated Services:** 0
- VLAN Priority:** 0

3. Configure a DiffServ-to-VLAN priority mapping rule according to the parameters described in the table below.
4. Click **Apply**, and then save your settings to flash memory.

**Table 13-10:QoS Mapping Table Parameter Descriptions**

Parameter	Description
'Index'	Defines an index number for the new table row. <b>Note:</b> Each row must be configured with a unique index.
'Differentiated Services' diff-serv [DiffServToVlanPriority_DiffServ]	Defines a DiffServ value. The valid value is 0 to 63. The default is 0.
'VLAN Priority' vlan-priority [DiffServToVlanPriority_VlanPriority]	Defines the VLAN priority level. The valid value is 0 to 7. The default is 0.

## Configuring ICMP Messages

Internet Control Message Protocol (ICMP) is one of the core protocols of the Internet Protocol suite. It is used by network devices such as routers to send error messages indicating, for example, that a requested service is unavailable.

You can configure the device to handle ICMP messages as follows:

- Send and receive ICMP Redirect messages.



- Send ICMP Destination Unreachable messages. The device sends this message in response to a packet that cannot be delivered to its destination for reasons other than congestion. The device sends a Destination Unreachable message upon any of the following:

- Address unreachable
- Port unreachable

This feature is applicable to IPv4 and IPv6 addressing schemes.

➤ **To configure handling of ICMP messages:**

1. Open the Network Settings page (**Setup** menu > **IP Network** tab > **Advanced** folder > **Network Settings**).
2. Under the ICMP group, do the following:
  - To enable sending and receipt of ICMP Redirect messages, configure the 'Send and Received ICMP Redirect Messages' [DisableICMPRedirects] parameter to **Enable**.
  - To enable sending of ICMP Destination Unreachable messages, configure the 'Don't Send ICMP Unreachable Messages' [DisableICMPUnreachable] parameter to **Disable**.

The screenshot shows the ICMP configuration section. It has a title bar 'ICMP'. Below it are two rows of configuration options, each with a label and a dropdown menu. The first row is 'Send and Receive ICMP Redirect Messages' with a dropdown menu showing 'Enable'. The second row is 'Don't Send ICMP Unreachable Messages' with a dropdown menu showing 'Disable'.

3. Click **Apply**.

## DNS

If you are using fully qualified domain names (FQDN) instead of IP addresses for some of your device configuration, the domain names need to be resolved into IP addresses by Domain Name System servers. The device provides various ways to do this:

- External, third-party DNS servers:
  - Default DNS servers (see [Configuring Default DNS Servers](#) on the next page)
  - DNS servers configured for the associated IP network interface (see [Configuring IP Network Interfaces](#) on page 121)
- Device's embedded DNS (and SRV) server:
  - Internal DNS table (see [Configuring the Internal DNS Table](#))
  - Internal SRV table ([Configuring the Internal SRV Table](#))

## Configuring Default DNS Servers

The device provides two default DNS server addresses (primary and secondary), which you can modify. The default primary DNS server's address is 8.8.8.8 and the default secondary DNS server's address is 8.8.4.4. The default DNS servers ensure that applications (for example, Automatic Update feature) that may require DNS lookups run seamlessly when you have not configured any DNS servers in the Internal DNS table and IP Interfaces table. In other words, the device uses the default DNS server as the last resort. For example, if you are pinging a destination that is configured as an FQDN, the device searches for a DNS server in the following order:

1. DNS configured for the associated IP interface in the IP Interfaces table (see [Configuring IP Network Interfaces](#) on page 121)
2. Default DNS server (this section)



The default DNS servers are used only for certain applications such as Configuration Wizard, CLI ping command, and the Automatic Update feature. It is not used for call routing.

### ➤ To modify the default DNS server addresses:

1. Open the DNS Settings page (**Setup** menu > **IP Network** tab > **DNS** folder > **DNS Settings**).

**Default Primary DNS Server IP**

**Default Secondary DNS Server IP**

2. In the 'Default Primary DNS Server IP' field, configure the address of the default primary DNS server.
3. In the 'Default Secondary DNS Server IP' field, configure the address of the default secondary DNS server.
4. Click **Apply**.

## Configuring the Internal DNS Table

The Internal DNS table, similar to a DNS resolution can translate up to 20 host (domain) names into IP addresses. This functionality can be used when a domain name (FQDN) is configured as an IP destination in a routing rule. For the Gateway application, this is typically used for alternative Tel-to-IP call routing. Up to three different IP addresses can be assigned to the same host name.

The device attempts to resolve a domain name into an IP address in the following order:

1. The device first checks the Internal DNS table for a matching domain name and if found, resolves the domain name into the corresponding IP address(es).

- If no matching domain name exists in the Internal DNS table, the device performs a DNS query with an external third-party DNS server whose address is configured for the associated IP network interface in the IP Interfaces table (see [Configuring IP Network Interfaces](#)).



The device uses the Internal DNS table only for call routing, for example:

- Call routing according to a SIP Request-URI that contains a hostname.
- Call routing by destination address that is configured as a hostname.
- Call routing by ENUM and the result of the ENUM query is a hostname.
- DNS resolution of proxy servers in a Proxy Set that are configured with an FQDN.
- Registering a user agent whose REGISTER message has a Contact header that is a hostname.

The following procedure describes how to configure the DNS table through the Web interface. You can also configure it through ini file [DNS2IP] or CLI (`configure network > dns dns-to-ip`).

➤ **To configure the device's DNS table:**

- Open the Internal DNS table (**Setup** menu > **IP Network** tab > **DNS** folder > **Internal DNS**).
- Click **New**; the following dialog box appears:

- Configure a DNS rule according to the parameters described in the table below.
- Click **Apply**.

**Table 13-11:Internal DNS Table Parameter Description**

Parameter	Description
'Index'	Defines an index number for the new table row. <b>Note:</b> Each row must be configured with a unique index.

Parameter	Description
'Domain Name' domain-name [Dns2Ip_ DomainName]	Defines the host name to be translated. The valid value is a string of up to 31 characters.
'First IP Address' first-ip-address [Dns2Ip_ FirstIpAddress]	Defines the first IP address (in dotted-decimal format notation) to which the host name is translated. The IP address can be configured as an IPv4 and/or IPv6 address.
'Second IP Address' second-ip-address [Dns2Ip_ SecondIpAddress]	Defines the second IP address (in dotted-decimal format notation) to which the host name is translated.
'Third IP Address' third-ip-address [Dns2Ip_ ThirdIpAddress]	Defines the third IP address (in dotted-decimal format notation) to which the host name is translated.

## Configuring the Internal SRV Table

The Internal SRV table lets you configure up to 10 SRV rows. The table is used to resolve hostnames into DNS A-Records. You can assign three different A-Records per hostname, where each A-Record includes the hostname, priority, weight, and port.

The device first attempts to resolve a domain name using this table. If the domain name is not configured in this table, the device performs an SRV resolution using an external DNS server whose address is configured for the associated IP network interface in the IP Interfaces table. If the IP network interface is not configured with a DNS address, the device performs an SRV resolution with the default external DNS server (see [Configuring Default DNS Servers](#) on page 148).

The following procedure describes how to configure the Internal SRV table through the Web interface. You can also configure it through ini file [SRV2IP] or CLI (`configure network > dns srv2ip`).

### ➤ To configure the device's SRV table:

1. Open the Internal SRV table (**Setup** menu > **IP Network** tab > **DNS** folder > **Internal SRV**).

2. Click **New**; the following dialog box appears:

The screenshot shows a configuration window titled "Internal SRV". It is divided into four main sections:

- GENERAL:** Contains fields for "Index" (value: 0), "Domain Name" (empty), and "Transport Type" (dropdown menu showing "UDP").
- 1ST ENTRY:** Contains fields for "DNS Name 1" (empty), "Priority 1" (value: 0), "Weight 1" (value: 0), and "Port 1" (value: 0).
- 2ND ENTRY:** Contains fields for "DNS Name 2" (empty), "Priority 2" (value: 0), "Weight 2" (value: 0), and "Port 2" (value: 0).
- 3RD ENTRY:** Contains fields for "DNS Name 3" (empty), "Priority 3" (value: 0), "Weight 3" (value: 0), and "Port 3" (value: 0).

3. Configure an SRV rule according to the parameters described in the table below.

4. Click **Apply**, and then save your settings to flash memory.

**Table 13-12: Internal SRV Table Parameter Descriptions**

Parameter	Description
<b>General</b>	
'Index'	Defines an index number for the new table row. <b>Note:</b> Each row must be configured with a unique index.
'Domain Name' domain-name [Srv2Ip_ InternalDomain]	Defines the hostname to be translated. The valid value is a string of up to 31 characters. By default, no value is defined.
'Transport Type' transport-type [Srv2Ip_ TransportType]	Defines the transport type. <ul style="list-style-type: none"> <li>■ [0] <b>UDP</b> (default)</li> <li>■ [1] <b>TCP</b></li> <li>■ [2] <b>TLS</b></li> </ul>
<b>1st/2nd/3rd Entry</b>	
'DNS Name (1-3)' dns-name-	Defines the first, second or third DNS A-Record to which the hostname is translated.

Parameter	Description
1   2   3 [Srv2Ip_Dns1/2/3]	By default, no value is defined.
'Priority (1-3)' priority- 1   2   3 [Srv2Ip_ Priority1/2/3]	Defines the priority of the target host. A lower value means that it is more preferred.  By default, no value is defined.
'Weight (1-3)' weight-1   2   3  [Srv2Ip_ Weight1/2/3]	Defines a relative weight for records with the same priority.  By default, no value is defined.
'Port (1-3)' port-1   2   3 [Srv2Ip_Port1/2/3]	Defines the TCP or UDP port on which the service is to be found.  By default, no value is defined.

## Open Solution Network (OSN) Server

This section describes various networking settings for the OSN server.



- The OSN is a customer-ordered item.
- For information on cabling the OSN, refer to the device's *Hardware Installation Manual*.

## Configuring Native VLAN for OSN Server

You can configure a VLAN ID associated with any application type (Media, Control, or OAMP) to access the Open Solution Network (OSN) server through the device's internal port switch. By default, access to the OSN is from the OAMP interface VLAN ID 1. Configuring a Native VLAN is useful, for example, to separate traffic within the device - between the OSN (i.e., application traffic) and voice traffic.

This feature is applicable only if you connect to the OSN through one of the device's VoIP LAN ports (on the front panel). If you are connecting to the OSN through the OSN's Gigabit Ethernet port (on the rear panel), this feature is not applicable.

### ➤ To configure a Native VLAN for the OSN:

1. Open the Network Settings page (**Setup** menu > **IP Network** tab > **Advanced** folder > **Network Settings**).

2. Scroll down to the OSN group:

The screenshot shows a configuration page for OSN. At the top, there is a header 'OSN'. Below it, there is a field labeled 'OSN Native VLAN ID' with a text input box containing the value '0'.

3. In the 'OSN Native VLAN ID' field, configure the VLAN ID, and then click **Apply**.

When configured to 0 (default), the OSN uses the OAMP VLAN ID. When set to any other value, it specifies a VLAN configured in the Ethernet Devices table (see [Configuring Underlying Ethernet Devices](#)), which is assigned to a Media and/or Control application in the IP Interfaces table.

## Disabling Internal Switch Port for OSN

You can enable or disable the Ethernet port of the device's internal switch, which interfaces with the OSN server. If the port is not blocked, you can optionally access the OSN server through any Ethernet port on the device's front panel (instead of through the OSN module's Ethernet ports located on the rear panel). If you block the port, then you can access the OSN server **only** through the Ethernet ports on the OSN module.

You can also view the status of the port (Up or Down), by running the following CLI command:

```
# show system interface osn
```

### ➤ To enable / disable the internal switch's Ethernet port interfacing with OSN:

1. Open the Network Settings page (**Setup** menu > **IP Network** tab > **Advanced** folder > **Network Settings**).
2. From the 'Block OSN Port' drop-down list, select **Enable** or **Disable**:

The screenshot shows a configuration field labeled 'Block OSN Port'. To its right is a drop-down menu with 'Enable' selected.

3. Click **Apply**.

## IP Multicasting

The device supports IP Multicasting level 1, according to RFC 2236 (i.e., IGMP version 2) for RTP channels. The device is capable of transmitting and receiving multicast packets.

## 14 Security

This section describes the VoIP security-related configuration.

### Configuring TLS Certificates

The TLS Contexts table lets you configure X.509 certificates which are used for secure management of the device, secure SIP transactions, and other security applications.



- The device is shipped with an active, default TLS setup (TLS Context ID 0, named "default"). Therefore, configure certificates only if required.
- Since X.509 certificates have an expiration date and time, you must configure the device to use Network Time Protocol (NTP) to obtain the current date and time from an NTP server. Without the correct date and time, client certificates cannot work. To configure NTP, see [Configuring Automatic Date and Time using SNTP](#).
- Only **Base64 (PEM)** encoded X.509 certificates can be loaded to the device.

### Configuring TLS Certificate Contexts

The TLS Contexts table lets you configure up to 15 TLS Contexts. A TLS Context defines Transport Layer Security (TLS) settings (e.g., TLS certificates). The TLS protocol provides confidentiality, integrity, and authenticity between two communicating applications over TCP/IP. You can use TLS for the following:

- To secure device management communication, for example, HTTPS-based Web sessions, Telnet sessions and SSH sessions.
- To secure SIP signaling connections, referred to as SIP Secure (SIPS) or SIP over TLS.
- To secure various other network applications supported by the device, for example, communication with a remote LDAP server used for LDAP-based user management authentication and authorization.

The device is shipped with a default TLS Context (Index #0 and named "default"), which includes a self-generated random private key and a self-signed server certificate. The Common Name (CN or subject name) of the default certificate is "ACL\_nnnnnnn", where *nnnnnnn* denotes the serial number of the device. If the default self-signed certificate is about to expire (less than a day), the device automatically re-generates a new self-signed certificate.



- The default TLS Context cannot be deleted.
- For secure management through the default management network interface (i.e., **OAMP** Application Type in the IP Interfaces table), the device uses the default TLS Context. However, for secure Web- and REST-based management through Additional Management Interfaces (configured in [Configuring Additional Management Interfaces](#) on page 47), you can use any TLS Context.
- If a TLS Context for an existing TLS connection is changed during the call by the user agent, the device ends the connection.





- For more information on secured management, see [Configuring Secured \(HTTPS\) Web](#) on page 64.

You can configure each TLS Context with the following TLS settings:

- TLS version (TLS 1.0, TLS 1.1, TLS 1.2, and TLS 1.3).
- DTLS version (DTLS 1.0 and DTLS 1.2).
- TLS cipher suites for server and client roles (per OpenSSL syntax).
- Diffie-Hellman (DH) key size used by the device if it acts as a TLS server and DH is used for key exchange.
- TLS certificate expiry check, whereby the device periodically checks the validation date of the installed TLS server certificates and sends an SNMP trap event if a certificate is nearing expiry. To configure TLS certificate expiry check, see [Configuring TLS Server Certificate Expiry Check](#).
- Online Certificate Status Protocol (OCSP). Some Public-Key Infrastructures (PKI) can revoke a certificate after it has been issued. You can configure the device to check if a peer's certificate has been revoked, using the OCSP. When OCSP is enabled, the device queries the OCSP server for revocation information whenever a peer certificate is received (TLS client mode, or TLS server mode with mutual authentication).



- The device does not query OCSP for its own certificate.
- Some PKIs do not support OCSP, but generate Certificate Revocation Lists (CRLs). For such scenarios, set up an OCSP server such as OCSPD.

- Private key - externally created and then uploaded to device.
- Different levels of security strength (key size) per TLS certificate.
- X.509 certificates - self-signed certificates or signed as a result of a certificate signing request (CSR).
- Trusted root certificate authority (CA) store (for validating certificates).



- When creating a TLS Context, you should create a certificate as described in [Creating Self-Signed Certificates for TLS Contexts](#) on page 167, and then check that the certificate is "Ok" as described in [Viewing Certificate Information](#) on page 163.
- For secure SIP messaging (SIP Secure or SIPS) using TLS, see [TLS for SIP Clients](#) on page 172 (two-way authentication) and [Configuring TLS for Secured SIP](#) on page 170.

The following procedure describes how to configure a TLS Context through the Web interface. You can also configure it through ini file [TLSContexts] or CLI (`configure network > tls`).

➤ **To configure a TLS Context:**

1. Open the TLS Contexts table (**Setup** menu > **IP Network** tab > **Security** folder > **TLS Contexts**).
2. Click **New** to add a new TLS Context or **Edit** to modify the default TLS Context at Index 0; the following dialog box appears:

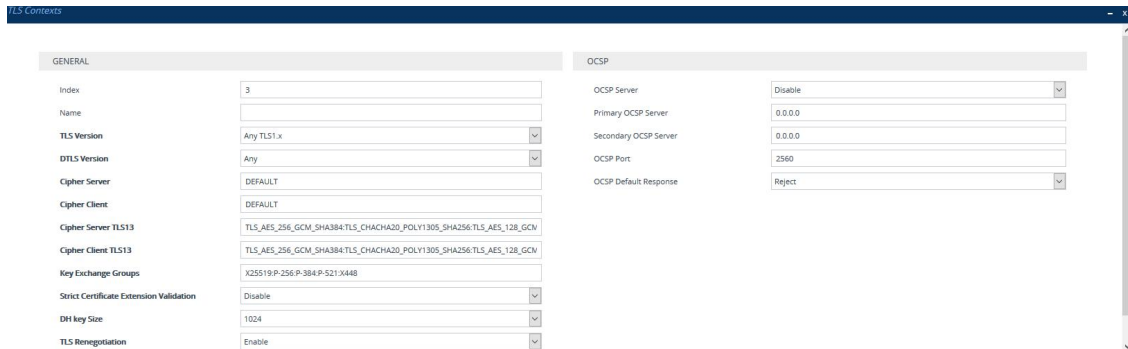

3. Configure the TLS Context according to the parameters described in the table below.
4. Click **Apply**, and then reset the device with a save-to-flash for your settings to take effect.

**Table 14-1: TLS Contexts Parameter Descriptions**

Parameter	Description
<b>General</b>	
'Index' tls [TLSContexts_Index]	Defines an index number for the new table row. <b>Note:</b> <ul style="list-style-type: none"> <li>Each row must be configured with a unique index.</li> <li>Index 0 ("default") is the default TLS Context.</li> </ul>
'Name' name [TLSContexts_Name]	Defines a descriptive name, which is used when associating the row in other tables. The valid value is a string of up to 31 characters. <b>Note:</b> <ul style="list-style-type: none"> <li>The parameter value cannot contain a forward slash (/).</li> <li>The default TLS Context (Index 0) is named "default".</li> </ul>
'TLS Version' tls-version [TLSContexts_TLSVersion]	Defines the supported TLS protocol version. Clients attempting to communicate with the device using a different TLS version are rejected. <ul style="list-style-type: none"> <li>[0] <b>Any TLS1.x</b> = (Default) TLSv1.0, TLSv1.1, TLSv1.2, and TLSv1.3 are supported.</li> <li>[1] <b>TLSv1.0</b> = Only TLS 1.0.</li> </ul>

Parameter	Description
	<ul style="list-style-type: none"> <li>■ [2] <b>TLSv1.1</b> = Only TLS 1.1.</li> <li>■ [3] <b>TLSv1.0 and TLSv1.1</b> = Only TLS 1.0 and TLS 1.1.</li> <li>■ [4] <b>TLSv1.2</b> = Only TLS 1.2.</li> <li>■ [6] <b>TLSv1.1 and TLSv1.2</b> = Only TLS 1.1 and TLS 1.2.</li> <li>■ [7] <b>TLSv1.0 TLSv1.1 and TLSv1.2</b> = Only TLS 1.0, TLS 1.1, and TLS 1.2.</li> <li>■ [8] <b>TLSv1.3</b> = Only TLS 1.3.</li> <li>■ [12] <b>TLSv1.2 and TLSv1.3</b> = Only TLS 1.2 and 1.3.</li> <li>■ [14] <b>TLSv1.1 TLSv1.2 and TLSv1.3</b> = Only TLS 1.1, TLS 1.2, and TLS 1.3.</li> <li>■ [15] <b>TLSv1.0 TLSv1.1 TLSv1.2 and TLSv1.3</b> = Only TLS 1.0, TLS 1.1, TLS 1.2, and TLS 1.3.</li> </ul>
'DTLS Version' [TLSContexts_ DTLSVersion]	<p>Defines the Datagram Transport Layer Security (DTLS) version, which is used to negotiate keys for WebRTC calls.</p> <ul style="list-style-type: none"> <li>■ [0] <b>Any</b> (default)</li> <li>■ [1] <b>DTLSv1.0</b></li> <li>■ [2] <b>DTLSv1.2</b></li> </ul> <p>For more information on WebRTC, see WebRTC.</p> <p><b>Note:</b> The parameter is applicable only to the SBC application.</p>
'Cipher Server' ciphers-server [TLSContexts_ ServerCipherString]	<p>Defines the supported cipher suite for the TLS server (in OpenSSL cipher list format) when the TLS version is 1.2 or earlier.</p> <p>For possible values and additional details, visit the OpenSSL website at <a href="https://www.openssl.org/docs/man1.0.2/apps/ciphers.html">https://www.openssl.org/docs/man1.0.2/apps/ciphers.html</a>. The default is "DEFAULT".</p> <p><b>Note:</b> The parameter is applicable only to TLS 1.2 and earlier.</p>
'Cipher Client' ciphers-client [TLSContexts_ ClientCipherString]	<p>Defines the supported cipher suite for TLS clients when the TLS version is 1.2 or earlier.</p> <p>For possible values and additional details, visit the OpenSSL website at <a href="https://www.openssl.org/docs/man1.0.2/apps/ciphers.html">https://www.openssl.org/docs/man1.0.2/apps/ciphers.html</a>. The default is "DEFAULT".</p>

Parameter	Description
	<p><b>Note:</b> The parameter is applicable only to TLS 1.2 and earlier.</p>
<p>'Cipher Server TLS1.3' ciphers-server-tls13 [TLSContexts_ServerCipherTLS13String]</p>	<p>Defines the supported cipher suite for the TLS 1.3 server (in OpenSSL cipher list format). For possible values and additional details, visit the OpenSSL website at <a href="https://www.openssl.org/docs/man1.1.1/man1/ciphers.html">https://www.openssl.org/docs/man1.1.1/man1/ciphers.html</a>. The default is "TLS_AES_256_GCM_SHA384:TLS_CHACHA20_POLY1305_SHA256:TLS_AES_128_GCM_SHA256".</p> <p><b>Note:</b> The parameter is applicable only to TLS 1.3.</p>
<p>'Cipher Client TLS1.3' ciphers-client-tls13 [TLSContexts_ClientCipherTLS13String]</p>	<p>Defines the supported cipher suite for TLS 1.3 clients. For possible values and additional details, visit the OpenSSL website at <a href="https://www.openssl.org/docs/man1.1.1/man1/ciphers.html">https://www.openssl.org/docs/man1.1.1/man1/ciphers.html</a>. The default is "TLS_AES_256_GCM_SHA384:TLS_CHACHA20_POLY1305_SHA256:TLS_AES_128_GCM_SHA256".</p> <p><b>Note:</b> The parameter is applicable only to TLS 1.3.</p>
<p>'Key Exchange Groups' key-exchange-groups [TLSContexts_KeyExchangeGroups]</p>	<p>Defines the groups that are supported for key exchange, ordered from most preferred to least preferred. The valid value is any combination of the following strings:</p> <ul style="list-style-type: none"> <li>■ X25519</li> <li>■ P-256</li> <li>■ P-384</li> <li>■ X448</li> </ul> <p>The default is "X25519:P-256:P-384:X448" (without quotation marks). When configuring the parameter with multiple values, separate each with a colon. In addition, the order of the values determines the group preference. For example, the value "P-384:P-256:X25519" (without quotation marks) gives preference to P-384. The TLS client uses the first configured value (e.g., P-384) as its group trial, while the TLS server uses the whole list to try and match the client's trial.</p> <p><b>Note:</b> The parameter is applicable to all TLS versions.</p>
<p>'Strict Certificate Extension Validation' require-strict-</p>	<p>Enables the validation of the extensions (keyUsage and extendedKeyUsage) of peer certificates. The validation ensures that the signing CA is authorized to sign certificates</p>

Parameter	Description
cert [TLSContexts_RequireStrictCert]	and that the end-entity certificate is authorized to negotiate a secure TLS connection.  <ul style="list-style-type: none"> <li>■ [0] <b>Disable</b> (default)</li> <li>■ [1] <b>Enable</b></li> </ul>
'DH Key Size' dh-key-size [TLSContexts_DHKeySize]	Defines the Diffie-Hellman (DH) key size (in bits). DH is an algorithm used mainly for exchanging cryptography keys used in symmetric encryption algorithms such as AES.  <ul style="list-style-type: none"> <li>■ [1024] <b>1024 - Not Recommended</b></li> <li>■ [2048] <b>2048</b> (default)</li> </ul> <p><b>Note:</b> 1024-bit key size is not recommended.</p>
'TLS Renegotiation' tls-renegotiation [TLSContexts_TlsRenegotiation]	Enables TLS renegotiations (handshakes) initiated by the client (peer) with the device.  <ul style="list-style-type: none"> <li>■ [0] <b>Disable</b> = The device blocks client-initiated TLS renegotiations and allows only one TLS handshake process. This is useful, for example, for preventing Denial-of-Service (DoS) attacks on the device caused by multiple TLS renegotiations per second by an attacker.</li> <li>■ [1] <b>Enable</b> (default)</li> </ul>
OCSP	
'OCSP Server' ocsp-server [TLSContexts_OcspEnable]	Enables or disables certificate checking using OCSP.  <ul style="list-style-type: none"> <li>■ [0] <b>Disable</b> (default)</li> <li>■ [1] <b>Enable</b></li> </ul>
'Primary OCSP Server' ocsp-server-primary [TLSContexts_OcspServerPrimary]	Defines the IP address (in dotted-decimal notation) of the primary OCSP server. The default is 0.0.0.0.
'Secondary OCSP Server' ocsp-server-secondary [TLSContexts_OcspServerSecondary]	Defines the IP address (in dotted-decimal notation) of the secondary OCSP server (optional). The default is 0.0.0.0.

Parameter	Description
'OCSP Port' ocsp-port [TLSContexts_ OcspsServerPort]	Defines the OCSP server's TCP port number. The default port is 2560.
'OCSP Default Response' ocsp-default- response [TLSContexts_ OcspsDefaultResponse]	Determines whether the device allows or rejects peer certificates if it cannot connect to the OCSP server.  <ul style="list-style-type: none"> <li>■ [0] <b>Reject</b> (default)</li> <li>■ [1] <b>Allow</b></li> </ul>

## Assigning CSR-based Certificates to TLS Contexts

You can request a digitally signed certificate from a Certification Authority (CA) for a TLS Context. This process is referred to as a certificate signing request (CSR) and is required if your organization employs a Public Key Infrastructure (PKI) system. The CSR contains information identifying the device such as a Distinguished Name (DN) or subject alternative names in the case of an X.509 certificate.

### ➤ To assign a CSR-based certificate to a TLS Context:

1. Open the TLS Contexts table (see [Configuring TLS Certificate Contexts](#)).
2. In the table, select the required TLS Context, and then click the **Change Certificate** link located below the table; the Change Certificates page appears.
3. Under the **Certificate Signing Request** group, fill in the following information:
  - a. Distinguished Name (DN) fields (uniquely identifies the device):
    - ◆ In the 'Common Name [CN]' field, enter the common name.
    - ◆ (Optional) In the 'Organizational Unit [OU]' field, enter the section of the organization.
    - ◆ (Optional) In the 'Company name [O]' field, enter the legal name of your organization.
    - ◆ (Optional) In the 'Locality or city name [L]' field, enter the city where your organization is located.
    - ◆ (Optional) In the 'State [ST]' field, enter the state or province where your organization is located.
    - ◆ (Optional) In the 'Country code [C]' field, enter the two-letter ISO abbreviation for your country.
  - b. If you want to generate a CSR for SAN (with multiple subject alternate names), then from the 'Subject Alternative Name [SAN]' drop-down list, select the type of SAN (e-

mail address, DNS hostname, URI, or IP address), and then enter the relevant value. You can configure multiple SAN names, using the 1st to 5th 'Subject Alternative Name [SAN]' fields.

- c. From the 'Signature Algorithm' drop-down list, select the hash function algorithm (SHA-1, SHA-256, or SHA-512) with which to sign the certificate.



- Fill in the fields according to your security provider's instructions.
- If you leave the 'Common Name [CN]' field empty, the device generates the CSR with the default Common Name (**CN=ACL\_<6-digit serial number of device>**).

4. Click the **Create CSR** button; a textual certificate signing request is displayed in the area below the button:

CERTIFICATE SIGNING REQUEST

Common Name [CN]	<input type="text"/>
Organizational Unit [OU] <i>(optional)</i>	<input type="text" value="Headquarters"/>
Company name [O] <i>(optional)</i>	<input type="text" value="Corporate"/>
Locality or city name [L] <i>(optional)</i>	<input type="text" value="Poughkeepsie"/>
State [ST] <i>(optional)</i>	<input type="text" value="New York"/>
Country code [C] <i>(optional)</i>	<input type="text" value="US"/>
1st Subject Alternative Name [SAN]	EMAI <input type="text"/>
2nd Subject Alternative Name [SAN]	EMAI <input type="text"/>
3rd Subject Alternative Name [SAN]	EMAI <input type="text"/>
4th Subject Alternative Name [SAN]	EMAI <input type="text"/>
5th Subject Alternative Name [SAN]	EMAI <input type="text"/>
Signature Algorithm	SHA-256 <input type="button" value="v"/>

After creating the CSR, copy the text below (including the BEGIN/END lines) and send it to your Certification Authority for signing.

```
-----BEGIN CERTIFICATE REQUEST-----
MIIBxDCCAS0CAQMwYjEVMBMGA1UECwwMSGVhZHF1YXJ0ZXJzMRIwEAYDVQQKDA1D
b3Jwb3JhdGUxFTATBgNVBACMDFBvdWdoe2V1cHNpZTERMA8GA1UECAwITmV3IF1v
cm5xZzA1BjBqNVBAYTA1VTMIGfMA0GCSqGSIb3DQEBAQUAA4GNADCBiQKBgQDUZ2c6
DLHOnfvvcTJpN0w7jEK/SgeogcEf5Vnt1+XMS+saD3iF/dy8X4tOxFc675KR146
LLOJrhfZSTVy2NLjIA5PgIXqIyxxvQcC8Krl+Fgx2+d1TvKOIxhp6qW1G11PkC8G
ZnzFaAQxqdXmPXHIRJDVK2Gp8cp4wwd8IT6BxQIDAQABoCIwIAYJKoZIhvcNAQkO
MRMwETAPBgNVHRECDAGggRtaWt1MA0GCSqGSIb3DQEBCwUAA4GBAF6aJangHqJP
VtjXn8sPh2/4h43dpzUJ62Dz/FM4ezsvgC3/Rx6JVFuaRPMuiXve4BrTNNI2O78r
+yu+9IkwWzGNNXLv4Tr8yLSyqznAzwfAack4RCAbefYvny3M072QQHpWBhKPNn
S5pfdyhPqZhrJZun4krpt0mA/+vc7SC/
-----END CERTIFICATE REQUEST-----
```

5. Copy the text and send it to your security provider (CA) to sign this request.
6. When the CA sends you a server certificate, save the certificate to a file (e.g., cert.txt). Make sure that the file is a plain-text file containing the "BEGIN CERTIFICATE" header.

7. Scroll down to the **Upload Certificates Files From Your Computer** group, click the **Browse** button corresponding to the 'Send Device Certificate...' field, navigate to the cert.txt file, and then click **Load File**:

Send **Device Certificate** file from your computer to the device.  
The file must be in textual PEM format.

No file selected.

8. Wait for the certificate to successfully load to the device.
9. Save configuration with a device reset.
10. Verify that the private key is correct:
  - a. Open the TLS Contexts table, and then select the TLS Context.
  - b. Click the **Certificate Information** link located below the table.
  - c. Make sure that the 'Status' field displays "OK"; otherwise, consult with your security administrator:

#### PRIVATE KEY

Key size: 2048 bits

Status: OK



- The certificate replacement process can be repeated whenever necessary (e.g., when the new certificate expires).
- You can also load the certificate through the device's Automatic Provisioning mechanism, using the [HTTPSCertFileName] parameter.

## TLS Context Parameters Relevancy per Application

The following table shows the parameters of the TLS Context table that are used when establishing a TLS connection per SBC application.

Application / TLS Context Parameter	'TLS Version'	'Cipher Server'	'Cipher Client'	'Cipher Server TLS1.3'	'Cipher Client TLS1.3'	'Key Exchange Groups'	'Strict Certificate Extension Validation'	'DH Key Size'	'TLS Renegotiation'
Web / REST Server	✓	✓	✓	✓	✓	✓	✓	✓	✓
Automatic	✓	-	✓	-	✓	-	-	-	-



Application / TLS Context Parameter	'TLS Version'	'Cipher Server'	'Cipher Client'	'Cipher Server TLS1.3'	'Cipher Client TLS1.3'	'Key Exchange Groups'	'Strict Certificate Extension Validation'	'DH Key Size'	'TLS Renegotiation'
Update									
CLI <code>copy</code> Commands	✓	-	✓	-	✓	-	-	-	-
Sending CDRs to Remote Server	✓	-	✓	-	✓	-	-	-	-
HTTPS Proxy	✓	✓	✓	-	-	-	-	-	-
Secure Communication with OVOC	✓	✓	✓	✓	✓	✓	✓	✓	✓
WebSocket Tunnel with OVOC	✓	-	✓	-	✓	✓	✓	-	-
Secured LDAP Client	✓	✓	✓	✓	✓	✓	✓	✓	✓
Secured SCTP	✓	✓	✓	✓	✓	✓	✓	✓	✓
TR-069	✓	✓	✓	✓	✓	✓	✓	✓	✓
ZeroConf Provisioning	✓	✓	✓	✓	✓	✓	✓	✓	✓

## Viewing Certificate Information

You can view information of TLS certificates installed on the device per TLS Context.

➤ **To view certificate information:**

1. Open the TLS Contexts table (see [Configuring TLS Certificate Contexts](#)).
2. Select a TLS Context, and then click the **Certificate Information** link located below the table; the Certificate Information page appears, showing the certificate information. The following figure shows an example (but cropped due to space).

← TLS Context [#1] > Certificate Information

**PRIVATE KEY**

Key size:	2048 bits
Status:	OK

**CERTIFICATE**

Certificate:  
 Data:  
 Version: 1 (0x0)  
 Serial Number: 0 (0x0)  
 Signature Algorithm: sha256WithRSAEncryption  
 Issuer: CN=ACL\_5967925  
 Validity  
 Not Before: Mar 3 05:17:44 2020 GMT  
 Not After : Feb 27 05:17:44 2040 GMT  
 Subject: CN=ACL\_5967925  
 Subject Public Key Info:  
 Public Key Algorithm: rsaEncryption  
 RSA Public-Key: (2048 bit)  
 Modulus:  
 00:e7:ce:d6:9c:64:92:e1:b9:39:92:5d:fe:fc:39:  
 24:71:0a:4f:3d:91:c4:36:ef:56:51:49:3a:25:3f:  
 4e:66:56:7c:f4:78:69:20:e2:a5:cb:a0:90:9b:68:  
 e7:0f:de:61:01:8f:a6:11:d1:7d:7f:f5:3c:02:e0:  
 b2:de:3f:30:d9:79:e0:25:a0:81:49:6c:65:26:09:  
 55:4e:ff:10:db:62:50:ca:a3:04:0c:6f:0e:dc:6A:

## Assigning Externally Created Private Keys to TLS Contexts

The following procedure describes how to assign an externally created private key to a TLS Context.

➤ **To assign an externally created private key to a TLS Context:**

1. Obtain a private key in either textual PEM (PKCS #7) or PFX (PKCS #12) format (typically provided by your security administrator). The file may be encrypted with a short passphrase.

2. Open the TLS Contexts table (see [Configuring TLS Certificate Contexts](#)).
3. In the table, select the required TLS Context, and then click the **Change Certificate** link located below the table; the Change Certificates page appears.
4. Scroll down to the **Upload Certificate Files From Your Computer** group.
  - a. (Optional) In the 'Private key pass-phrase' field, enter the password (passphrase) of the encrypted private key file. The default passphrase is "audc". The passphrase can be up to 32 characters. If there is no passphrase, leave the field blank.

Private key pass-phrase *(optional)*



The passphrase cannot be configured with wide characters.

- b. Load the private key file (see Step 1), by selecting it using the **Browse** button corresponding to the '**Send Private Key file ...**' text, and then clicking **Load File**.

Send **Private Key** file from your computer to the device.  
The file must be in either PEM or PFX (PKCS#12) format.

No file selected.

- c. If your security administrator has provided you with a device certificate file, load it by selecting the file using the **Browse** button corresponding to the '**Send Device Certificate file ...**' text, and then clicking **Load File**.

Send **Device Certificate** file from your computer to the device.  
The file must be in textual PEM format.

No file selected.

5. After the files successfully load to the device, save the configuration with a device reset.
6. Verify that the private key is correct:
  - a. Open the TLS Contexts table.
  - b. Select the required TLS Context index row.
  - c. Click the **Certificate Information** link located below the table.
  - d. Make sure that the 'Status' field displays "OK"; otherwise (i.e., displays "Does not match certificate"), consult with your security administrator:

#### PRIVATE KEY

Key size:	2048 bits
Status:	OK

## Generating Private Keys for TLS Contexts

The device can generate the private key for a TLS Context. The private key can be generated for CSR or self-signed certificates.

➤ **To generate a new private key for a TLS Context:**

1. Open the TLS Contexts table (see [Configuring TLS Certificate Contexts](#)).
2. In the table, select the required TLS Context index row, and then click the **Change Certificates** link located below the table; the Change Certificates page appears.
3. Scroll down to the **Generate New Private Key and Self-signed Certificate** group:

GENERATE NEW PRIVATE KEY AND SELF-SIGNED CERTIFICATE

Private Key Size

Private key pass-phrase *(optional)*

Press the "Generate Private Key" button to create new private key.  
 Press the "Generate Self-Signed Certificate" button to create self-signed certificate.  
 Note that the certificate will use the subject name configured in "Certificate Signing Request" box.  
**Important: generation of private key is a lengthy operation during which the device service may be affected.**

Generate Private-Key
Generate Self-Signed Certificate

4. From the 'Private Key Size' drop-down list, select the private key size (in bits) for RSA public-key encryption for newly self-signed generated keys:
  - **1024 - Not Recommended**
  - **2048** (default)
5. (Optional) In the 'Private key pass-phrase' field, enter a password (passphrase) to encrypt the private key file. The default passphrase is "audc". The passphrase can be up to 32 characters. If you don't want to encrypt the file, leave the field blank.



The passphrase cannot be configured with wide characters.

6. Click **Generate Private-Key**; a message appears requesting you to confirm key generation.
7. Click **OK** to confirm key generation; the device generates a new private key, indicated by a message in the **Certificate Signing Request** group:

## ⏪ TLS Context [#1] > Change Certificates

➔ A new 2048-bits Private-Key was generated for Context-ID=1  
Please save the configuration.

### CERTIFICATE SIGNING REQUEST

Common Name [CN]

8. Continue with certificate configuration by creating a CSR or generating a new self-signed certificate.
9. Save configuration with a device reset for the new certificate to take effect.

## Creating Self-Signed Certificates for TLS Contexts

You can assign a certificate that is digitally signed by the device itself to a TLS Context (i.e., self-signed certificate). In other words, the device acts as a CA. The Issuer (e.g., "Issuer: CN=ACL\_5967925") and Subject (e.g., " Subject: CN=ACL\_5967925") fields of the self-signed certificate have the same value.



- The device is shipped with a default TLS Context (Index 0 and named "default"), which includes a self-generated random private key and a self-signed server certificate. The Common Name (CN or subject name) of the default certificate is "ACL\_nnnnnnn", where *nnnnnn* denotes the serial number of the device.
- If the default self-signed certificate is about to expire (less than a day) or has expired, the device automatically re-generates a new self-signed certificate.

You can configure each TLS Context with the following:

### ➤ To assign a self-signed certificate to a TLS Context:

1. Before you begin, make sure of the following:
  - You have a unique DNS name for the device (e.g., dns\_name.corp.customer.com). The name is used to access the device and therefore, must be listed in the server certificate.
  - No traffic is running on the device. The certificate generation process is disruptive to traffic and should be done during maintenance time.
2. Open the TLS Contexts table (see [Configuring TLS Certificate Contexts](#)).
3. In the table, select the required TLS Context index row, and then click the **Change Certificate** link located below the table; the Change Certificates page appears.
4. Under the **Certificate Signing Request** group, in the 'Common Name [CN]' field, enter the fully-qualified DNS name (FQDN) as the certificate subject. Alternatively (or in addition), if you want to generate a self-signed SAN certificate (with multiple subject alternate names),

then from the 'Subject Alternative Name [SAN]' drop-down list, select the type of SAN (e-mail address, DNS hostname, URI, or IP address), and then enter the relevant value. You can configure multiple SANs, using the 1st to 5th 'Subject Alternative Name [SAN]' fields.

5. Scroll down the page to the **Generate New Private Key and Self-signed Certificate** group:

GENERATE NEW PRIVATE KEY AND SELF-SIGNED CERTIFICATE

Private Key Size 2048

Private key pass-phrase *(optional)* ••••

Press the "Generate Private Key" button to create new private key.  
Press the "Generate Self-Signed Certificate" button to create self-signed certificate.  
Note that the certificate will use the subject name configured in "Certificate Signing Request" box.  
**Important: generation of private key is a lengthy operation during which the device service may be affected.**

Generate Private-Key
Generate Self-Signed Certificate

6. Click **Generate Self-Signed Certificate**; a message appears requesting you to confirm generation.
7. Click **OK** to confirm generation; the device generates a new self-signed certificate displaying the new subject name, indicated by a message in the **Certificate Signing Request** group:

+ TLS Context [#0] > Change Certificates

→ A new self-signed certificate was generated for Context-ID=0 with subject name: audio.com

In order to complete certificate replacement, please, close current browser session and open a new one.

CERTIFICATE SIGNING REQUEST

Common Name [CN] audio.com

8. Save the configuration with a device reset for the new certificate to take effect.

## Importing Certificates into Trusted Root Certificate Store

The device provides its own Trusted Root Certificate store. This lets you manage certificate trust. You can import up to 20 certificates to the store per TLS Context (but this may be less depending on certificate file size).

The store can also be used for certificate chains. A certificate chain is a sequence of certificates where each certificate in the chain is signed by the subsequent certificate. The last certificate in the list of certificates is the Root CA certificate, which is self-signed. The purpose of a certificate chain is to establish a chain of trust from a child certificate to the trusted root CA certificate. The CA vouches for the identity of the child certificate by signing it. A client certificate is considered trusted if one of the CA certificates up the certificate chain is found in the server certificate directory. For the device to trust a whole chain of certificates per TLS Context, you need to import them into the device's Trusted Certificates Store, as described below.

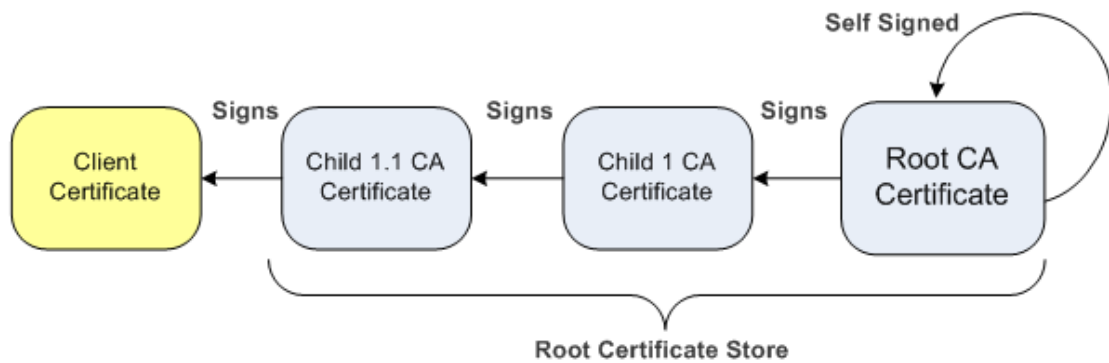

You can also import multiple TLS root certificates in bulk from a single file. Each certificate in the file must be Base64 encoded (PEM). When copying-and-pasting the certificates into the file, each Base64 ASCII encoded certificate string must be enclosed between "-----BEGIN CERTIFICATE-----" and "-----END CERTIFICATE-----".



Only Base64 (PEM) encoded X.509 certificates can be loaded to the device.

➤ **To import certificates into the Trusted Root Certificate Store:**

1. Open the TLS Contexts table (see [Configuring TLS Certificate Contexts](#)).
2. In the table, select the required TLS Context, and then click the **Trusted Root Certificates** link located below the table; the Trusted Certificates table appears.
3. Click the **Import** button, and then browse to and select the certificate file.

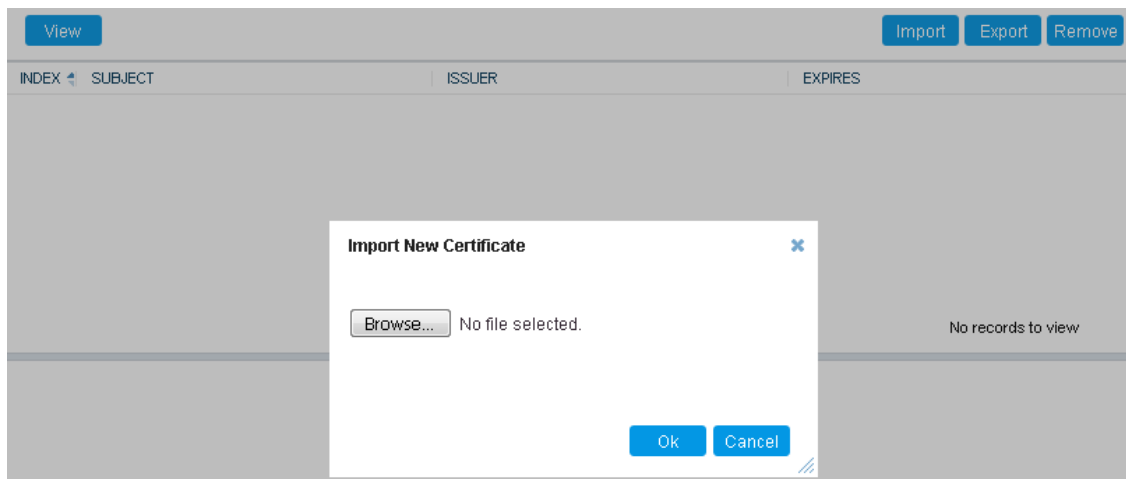

4. Click **OK**; the certificate is loaded to the device and listed in the Trusted Certificates store.

You can also do the following with certificates that are in the Trusted Certificates store:

- Delete certificates: Select the required certificate, click **Remove**, and then in the Remove Certificate dialog box, click **Remove**.
- Save certificates to a folder on your PC: Select the required certificate, click **Export**, and then in the Export Certificate dialog box, browse to the folder on your PC where you want to save the file and click **Export**.

## Configuring TLS Server Certificate Expiry Check

You can configure the TLS Server Certificate Expiry Check feature per TLS Context, whereby the device periodically checks the validation date of installed TLS server certificates. You can also configure the device to send an SNMP alarm (acCertificateExpiryAlarm) at a user-defined number of days before the installed TLS server certificate is to expire. The alarm indicates the TLS Context to which the certificate belongs.



If the device's default self-signed certificate (at TLS Context Index 0 and named "default") is about to expire (less than a day) or has expired, the device automatically re-generates a new self-signed certificate. The configuration described in this section does not apply to this mechanism (occurs regardless).

### ➤ To configure TLS certificate expiry checks and notification:

1. Open the TLS Contexts table (see [Configuring TLS Certificate Contexts](#)).
2. Select the required TLS Context index row, and then click the **Change Certificate** link located below the table; the Change Certificates page appears.
3. Scroll down the page to the **TLS Expiry Settings** group:

TLS EXPIRY SETTINGS	
TLS Expiry Check Start (days)	<input type="text" value="60"/>
TLS Expiry Check Period (days)	<input type="text" value="7"/>
<input type="button" value="Submit TLS Expiry Settings"/>	

4. In the 'TLS Expiry Check Start' field, enter the number of days before the installed TLS server certificate is to expire when the device sends an SNMP trap event to notify of this.
5. In the 'TLS Expiry Check Period' field, enter the periodical interval (in days) for checking the TLS server certificate expiry date. By default, the device checks the certificate every 7 days.
6. Click the **Submit TLS Expiry Settings** button.

## Configuring TLS for Secured SIP

The device uses TLS over TCP to encrypt and optionally, authenticate SIP messages. This is referred to as SIP Secure (SIPS). SIPS uses the X.509 certificate exchange process. For configuring TLS (TLS Context), see [Configuring TLS Certificates](#) on page 154.

To use a TLS Context for SIPS, you need to assign it to a Proxy Set or SIP Interface (or both) that is associated with the IP Group for which you want to employ TLS. When the device establishes a TLS connection (handshake) with a SIP user agent (UA), the TLS Context is determined as follows:

### ■ Incoming calls:



- a. Proxy Set: If the incoming call is successfully classified to an IP Group based on Proxy Set (i.e., IP address of calling party) and the Proxy Set is configured for TLS ('Transport Type' parameter is set to **TLS**), the TLS Context assigned to the Proxy Set is used. To configure Proxy Sets, see [Configuring Proxy Sets](#).
- b. SIP Interface: If the Proxy Set is either not configured for TLS (i.e., the 'Transport Type' parameter is set to **UDP**) or not assigned a TLS Context, and/or classification to a Proxy Set fails, the device uses the TLS Context assigned to the SIP Interface used for the call. To configure SIP Interfaces, see [Configuring SIP Interfaces](#).
- c. Default TLS Context (Index #0): If the SIP Interface is not assigned a TLS Context or no SIP Interface is used for the call, the device uses the default TLS Context.

#### ■ Outgoing calls:

- a. Proxy Set: If the outgoing call is sent to an IP Group associated with a Proxy Set that is assigned a TLS Context and the Proxy Set is configured for TLS (i.e., 'Transport Type' parameter is set to **TLS**), the TLS Context is used. If the 'Transport Type' parameter is set to **UDP**, the device uses UDP to communicate with the proxy and no TLS Context is used.
- b. SIP Interface: If the Proxy Set is not assigned a TLS Context, the device uses the TLS Context assigned to the SIP Interface used for the call.
- c. Default TLS Context (Index #0): If the SIP Interface is not assigned a TLS Context or no SIP Interface is used for the call, the device uses the default TLS Context.



- When a TLS connection with the device is initiated by a SIP client, the device also responds using TLS, regardless of whether or not TLS was configured.
- The device regulates the number of new concurrent TLS connections that can be established per second. This protects the device from flooding (avalanches) of new TLS connections which may be caused from TLS-based malicious attacks or distributed denial-of-service (DDoS) attacks.
- To configure two-way (mutual) TLS authentication, see [TLS for SIP Clients](#) on the next page.

#### ➤ To configure SIPs:

1. Configure a TLS Context (see [Configuring TLS Certificate Contexts](#)).
2. Assign the TLS Context to a Proxy Set or SIP Interface (see [Configuring Proxy Sets](#) and [Configuring SIP Interfaces](#), respectively).
3. Configure the SIP Interface with a TLS port number.
4. Configure various SIPs parameters in the Security Settings page (**Setup** menu > **IP Network** tab > **Security** folder > **Security Settings**). For a description of the below TLS parameters, see [TLS Parameters](#).

SIP OVER TLS		TLS GENERAL	
TLS Client Re-Handshake Interval	<input type="text" value="0"/>	Strict Certificate Extension Validation	<input type="text" value="Disable"/>
<b>TLS Mutual Authentication</b>	<input type="text" value="Disable"/>	TLS Expiry Check Start (days)	<input type="text" value="60"/>
Peer Host Name Verification Mode	<input type="text" value="Disable"/>	TLS Expiry Check Period (days)	<input type="text" value="7"/>
<b>TLS Client Verify Server Certificate</b>	<input type="text" value="Disable"/>		
TLS Remote Subject Name	<input type="text"/>		
MANAGEMENT		ADVANCED	
<b>Enable Management Two Factor Authentication</b>	<input type="text" value="Disable"/>	FIPS140 Mode	<input type="text" value="Disable"/>

- By default, the device initiates a TLS connection only for the next network hop. To enable TLS all the way to the destination (**over multiple hops**), open the Transport Settings page (**Setup** menu > **Signaling & Media** tab > **SIP Definitions** folder > **Transport Settings**), and then configure the 'SIPS' [EnableSIPS] parameter to **Enable**:

SIPS

## Configuring Mutual TLS Authentication

This section describes how to configure mutual (two-way) TLS authentication.

### TLS for SIP Clients

When Secure SIP (SIPS) is implemented using TLS, it is sometimes required to use two-way (mutual) authentication between the device and a SIP user agent (client). When the device acts as the TLS server in a specific connection, the device demands the authentication of the SIP client's certificate. Both the device and the client use certificates from a CA to authenticate each other, sending their X.509 certificates to one another during the TLS handshake. Once the sender is verified, the receiver sends its' certificate to the sender for verification. SIP signaling starts when authentication of both sides completes successfully.

TLS mutual authentication can be configured for calls by enabling mutual authentication on the SIP Interface associated with the calls. The TLS Context associated with the SIP Interface or Proxy Set belonging to these calls are used.



SIP mutual authentication can also be configured globally for all calls, using the 'TLS Mutual Authentication' (SIPSRequireClientCertificate) parameter (see [Configuring TLS for SIP](#)).

#### ➤ To configure mutual TLS authentication for SIP messaging:

- Enable two-way authentication on the specific SIP Interface: In the SIP Interfaces table (see [Configuring SIP Interfaces](#)), configure the 'TLS Mutual Authentication' parameter to **Enable** for the specific SIP Interface.
- Configure a TLS Context with the following certificates:

- Import the certificate of the CA that signed the certificate of the SIP client into the Trusted Certificates table (certificate root store) so that the device can authenticate the client (see [Importing Certificates into Trusted Root Certificate Store](#)).
- Make sure that the TLS certificate is signed by a CA that the SIP client trusts so that the client can authenticate the device.

### TLS for Remote Device Management

For a description of secured device management by mutual TLS authentication, see [Configuring Secured \(HTTPS\) Web](#) on page 64.

## Configuring Firewall Rules

The Firewall table lets you configure up to 50 firewall rules, which define network traffic filtering rules (*access list*) for incoming (ingress) traffic. The access list offers the following firewall possibilities:

- Blocking traffic from known malicious sources
- Allowing traffic only from known "friendly" sources, while blocking all other traffic
- Mixing allowed and blocked network sources
- Limiting traffic to a user-defined rate (blocking the excess)
- Limiting traffic to specific protocols and specific port ranges on the device

For each packet received on the network interface, the device searches the table from top to bottom until the first matching rule is found. The matched rule can permit (*allow*) or deny (*block*) the packet. Once a rule in the table is located, subsequent rules further down the table are ignored. If the end of the table is reached without a match, the packet is accepted.



- The rules configured by the Firewall table apply to a very low-level network layer and overrides all other security-related configuration. Thus, if you have configured higher-level security features (e.g., on the Application level), you must also configure firewall rules to permit this necessary traffic. For example, if you have configured IP addresses to access the device's Web and Telnet management interfaces in the Access List table (see [Configuring Web and Telnet Access List](#)), you must configure a firewall rule that permits traffic from these IP addresses.
- Only users with Security Administrator or Master access levels can configure firewall rules.
- The device supports dynamic firewall pinholes for media (RTP/RTCP) traffic negotiated in the SDP offer-answer of SIP calls. The pinhole allows the device to ignore its firewall and accept the traffic on the negotiated port. The device automatically closes the pinhole once the call terminates. Therefore, it is unnecessary to configure specific firewall rules to allow traffic through specific ports. For example, if you have configured a firewall rule to block all media traffic in the port range 6000 to 7000 and a call is negotiated to use the local port 6010, the device automatically opens port 6010 to allow the call.



- Setting the 'Prefix Length' field to **0** means that the rule applies to **all** packets, regardless of the defined IP address in the 'Source IP' field. Thus, it is highly recommended to set the parameter to a value other than 0.
- It is recommended to add a rule at the end of your table that blocks all traffic and to add firewall rules above it that allow required traffic (with bandwidth limitations). To block all traffic, use the following firewall rule:
  - ✓ Source IP: 0.0.0.0
  - ✓ Prefix Length: 0 (i.e., rule matches all IP addresses)
  - ✓ Start Port - End Port: 0-65535
  - ✓ Protocol: **Any**
  - ✓ Action Upon Match: **Block**
- If the device needs to communicate with AudioCodes OVOC, you must also add rules to allow incoming traffic from OVOC. For more information, see [Configuring Firewall Rules to Allow Incoming OVOC Traffic](#) on page 178.

The following procedure describes how to configure firewall rules through the Web interface. You can also configure it through ini file [AccessList] or CLI (`configure network > access-list`).

➤ **To configure a firewall rule:**

1. Open the Firewall table (**Setup** menu > **IP Network** tab > **Security** folder > **Firewall**).
2. Click **New**; the following dialog box appears:

3. Configure a firewall rule according to the parameters described in the table below.
4. Click **Apply**, and then reset the device with a save-to-flash for your settings to take effect.

**Table 14-2: Firewall Table Parameter Descriptions**

Parameter	Description
Match	
'Index'	Defines an index number for the new table row.

Parameter	Description
	<b>Note:</b> Each row must be configured with a unique index.
'Source IP' source-ip [AccessList_Source_IP]	Defines the IP address (or DNS name) or a specific host name of the source network from where the device receives the incoming packet. The default is 0.0.0.0.
'Source Port' src-port [AccessList_Source_Port]	Defines the source UDP/TCP ports of the remote host from where the device receives the incoming packet. The valid range is 0 to 65535. The default is 0. <b>Note:</b> When set to 0, this field is ignored and any source port matches the rule.
'Prefix Length' prefixLen [AccessList_PrefixLen]	<b>(Mandatory)</b> Defines the IP network mask - 32 for a single host or the appropriate value for the source IP addresses. <ul style="list-style-type: none"> <li>■ A value of 8 corresponds to IPv4 subnet class A (network mask of 255.0.0.0).</li> <li>■ A value of 16 corresponds to IPv4 subnet class B (network mask of 255.255.0.0).</li> <li>■ A value of 24 corresponds to IPv4 subnet class C (network mask of 255.255.255.0).</li> </ul> <p>The IP address of the sender of the incoming packet is trimmed in accordance with the prefix length (in bits) and then compared to the parameter 'Source IP'.</p> <p>The default is 0 (i.e., applies to all packets). You <b>must</b> change this value to any of the above options.</p> <p><b>Note:</b> A value of 0 applies to <b>all</b> packets, regardless of the defined IP address. Therefore, you must set the parameter to a value other than 0.</p>
'Start Port' start-port [AccessList_Start_Port]	Defines the first UDP/TCP port in the range of ports on the device on which the incoming packet is received. From the perspective of the remote IP entity, this is the destination port. To configure the last port in the range, see the 'End Port' parameter (below). The valid range is 0 to 65535. <b>Note:</b> When the protocol type isn't TCP or UDP, the entire range must be provided.
'End Port' end-port	Defines the last UDP/TCP port in the range of ports on the device on which the incoming packet is received. From

Parameter	Description
[AccessList_End_Port]	<p>the perspective of the remote IP entity, this is the destination port. To configure the first port in the range, see the 'Start Port' parameter (above).</p> <p>The valid range is 0 to 65535 (default).</p> <p><b>Note:</b> When the protocol type isn't TCP or UDP, the entire range must be provided.</p>
'Protocol' protocol [AccessList_Protocol]	<p>Defines the protocol type (e.g., <b>UDP</b>, <b>TCP</b>, <b>ICMP</b>, <b>ESP</b> or <b>Any</b>) or the IANA protocol number in the range of 0 (Any) to 255. The default is <b>Any</b>.</p> <p><b>Note:</b></p> <ul style="list-style-type: none"> <li>■ The parameter also accepts the string value "HTTP", which implies selection of the TCP or UDP protocols and the appropriate port numbers as defined on the device.</li> <li>■ To specify SIP ports, configure rules with the UDP and TCP protocols for the required SIP Interfaces.</li> </ul>
'Use Specific Interface' use-specific-interface [AccessList_Use_Specific_Interface]	<p>Determines whether you want to apply the rule to a specific network interface defined in the IP Interfaces table (i.e., packets received from that defined in the Source IP field and received on this network interface):</p> <ul style="list-style-type: none"> <li>■ [0] <b>Disable</b> = (Default) The rule applies to all interfaces.</li> <li>■ [1] <b>Enable</b> = The rule applies to a specific interface as specified in the 'Interface Name' field (see below).</li> </ul>
'Interface Name' network-interface-name [AccessList_Interface_x]	<p>Defines the network interface to which you want to apply the rule. This is applicable if you enabled the 'Use Specific Interface' field. The list displays interface names as defined in the IP Interfaces table in <a href="#">Configuring IP Network Interfaces</a>.</p>
Action	
'Action Upon Match' allow-type [AccessList_Allow_Type]	<p>Defines the firewall action to be performed upon rule match.</p> <ul style="list-style-type: none"> <li>■ <b>Allow</b> = (Default) Permits the packets.</li> <li>■ <b>Block</b> = Rejects the packets</li> </ul>
'Packet Size' packet-size	<p>Defines the maximum allowed packet size.</p> <p>The valid range is 0 to 65535.</p>

Parameter	Description
[AccessList_Packet_Size]	<b>Note:</b> When filtering fragmented IP packets, this field relates to the overall (re-assembled) packet size, and not to the size of each fragment.
'Byte Rate' byte-rate [AccessList_Byte_Rate]	<p>Defines the expected traffic rate (bytes per second), i.e., the allowed bandwidth for the specified protocol. In addition to this field, the 'Burst Bytes' field provides additional allowance such that momentary bursts of data may utilize more than the defined byte rate, without being interrupted.</p> <p>For example, if 'Byte Rate' is set to 40000 and 'Burst Bytes' to 50000, then this implies the following: the allowed bandwidth is 40000 bytes/sec with extra allowance of 50000 bytes; if, for example, the actual traffic rate is 45000 bytes/sec, then this allowance would be consumed within 10 seconds, after which all traffic exceeding the allocated 40000 bytes/sec is dropped. If the actual traffic rate then slowed to 30000 bytes/sec, then the allowance would be replenished within 5 seconds.</p>
'Burst Bytes' byte-burst [AccessList_Byte_Burst]	<p>Defines the tolerance of traffic rate limit (number of bytes).</p> <p>The default is 0.</p>
Statistics	
'Match Count' [AccessList_MatchCount]	(Read-only) Displays the number of packets accepted or rejected by the rule.

The table below provides an example of configured firewall rules:

**Table 14-3: Configuration Example of Firewall Rules**

Parameter	Firewall Rule				
	1	2	3	4	5
'Source IP'	12.194.231.76	12.194.230.7	0.0.0.0	192.0.0.0	0.0.0.0
'Prefix Length'	16	16	0	8	0
'Start Port and End Port'	0-65535	0-65535	0-65535	0-65535	0-65535

Parameter	Firewall Rule				
'Protocol'	Any	Any	icmp	Any	Any
'Use Specific Interface'	<b>Enable</b>	<b>Enable</b>	<b>Disable</b>	<b>Enable</b>	<b>Disable</b>
'Interface Name'	WAN	WAN	None	Voice-Lan	None
'Byte Rate'	0	0	40000	40000	0
'Burst Bytes'	0	0	50000	50000	0
'Action Upon Match'	<b>Allow</b>	<b>Allow</b>	<b>Allow</b>	<b>Allow</b>	<b>Block</b>

The firewall rules in the above configuration example do the following:

- **Rules 1 and 2:** Typical firewall rules that allow packets ONLY from specified IP addresses (e.g., proxy servers). Note that the prefix length is configured.
- **Rule 3:** A more "advanced" firewall rule - bandwidth rule for ICMP, which allows a maximum bandwidth of 40,000 bytes/sec with an additional allowance of 50,000 bytes. If, for example, the actual traffic rate is 45,000 bytes/sec, then this allowance would be consumed within 10 seconds, after which all traffic exceeding the allocated 40,000 bytes/sec is dropped. If the actual traffic rate then slowed to 30,000 bytes/sec, the allowance would be replenished within 5 seconds.
- **Rule 4:** Allows traffic from the LAN voice interface and limits bandwidth.
- **Rule 5:** Blocks all other traffic.

## Configuring Firewall Rules to Allow Incoming OVOC Traffic

If the device needs to communicate with AudioCodes OVOC, you need to configure the device's firewall (Firewall table) with the below "allow" firewall rules to permit incoming traffic from OVOC.



These OVOC-related firewall rules are required only if you have configured other various firewall rules. If you are not using the device's firewall, the device allows all traffic by default and the below firewall configuration is not required.



Table 14-4: Firewall Rules to Allow Traffic from OVOC

Index	Source IP	Source Port	Prefix Length	Start Port	End Port	Protocol	Use Specific Interface	Interface Name	Action Upon Match	Packet Size	Byte Rate	Byte Burst
0	Various rules for basic traffic.											
...												
N												
N+1 (SNMP)	<OVOC IP address>	1161	32	161	161	udp	Enable	OAM_IF	Allow	0	0	0
N+2 (NTP)	<OVOC IP address>	123	32	0	0	udp	Enable	<interface configured for NTP>	Allow	0	0	0
N+3 (HTTP)	<OVOC IP address>	80	32	0	0	tcp	Enable	<interface configured for file transfer>	Allow	0	0	0
N+4 (HTTPS)	<OVOC IP address>	443	32	0	0	tcp	Enable	<interface configured for file transfer>	Allow	0	0	0
N+5 (Qo)	<OVOC IP address>	5000	32	0	0	tcp	Enable	<interface>	Allow	0	0	0

Index	Source IP	Source Port	Prefix Length	Start Port	End Port	Protocol	Use Specific Interface	Interface Name	Action Upon Match	Packet Size	Byte Rate	Byte Burst
E)	address>							configured for QoE>				
N+6 (QoE-secured)	<OVOC IP address>	5001	32	0	0	tcp	Enable	<interface configured for QoE>	Allow	0	0	0
N+7 (default-dropt)	0.0.0.0	0	0	0	65535	Any	Disable	--	Block	0	0	0

## Intrusion Detection System

The device's Intrusion Detection System (IDS) feature detects malicious attacks on the device and reacts accordingly. A remote host is considered malicious if it reaches or exceeds a user-defined threshold (counter) of specified malicious attack types.

If malicious activity is detected, the device can do the following:

- Block (blacklist) remote hosts (IP addresses / ports) considered by the device as malicious. The device automatically blacklists the malicious source for a user-defined period, after which it is removed from the blacklist.
- Send SNMP traps to notify of malicious activity and/or whether an attacker has been added to or removed from the blacklist. For more information, see [Viewing IDS Alarms](#).

IDS is an important feature as it ensures legitimate calls are not being adversely affected by attacks, and prevents Theft of Service and unauthorized access.

There are many types of malicious attacks, the most common being:

- **Denial of service:** This can be Denial of Service (DoS) where an attacker wishing to prevent a server from functioning correctly directs a large amount of requests – sometimes meaningless and sometimes legitimate, or it can be Distributed Denial of Service (DDoS)

where the attacker controls a large group of systems to coordinate a large scale DoS attack against a system:

- **Message payload tampering:** Attacker may inject harmful content into a message, e.g., by entering meaningless or wrong information, with the goal of exploiting a buffer overflow at the target. Such messages can be used to probe for vulnerabilities at the target.
  - **Message flow tampering:** This is a special case of DoS attacks. These attacks disturb the ongoing communication between users. An attacker can then target the connection by injecting fake signaling messages into the communication channel (such as CANCEL messages).
  - **Message Flooding:** The most common DoS attack is where an attacker sends a huge amount of messages (e.g., INVITEs) to a target. The goal is to overwhelm the target's processing capabilities, thereby rendering the target inoperable.
- **SPAM over Internet Telephony (SPIT):** VoIP spam is unwanted, automatically dialed, pre-recorded phone calls using VoIP. It is similar to e-mail spam.
  - **Theft of Service (ToS):** Service theft can be exemplified by phreaking, which is a type of hacking that steals service (i.e., free calls) from a service provider, or uses a service while passing the cost to another person.

The IDS configuration is based on IDS Policies, where each policy can be configured with a set of IDS rules. Each rule defines a type of malicious attack to detect and the number of attacks during an interval (threshold) before an SNMP trap is sent. Each policy is then applied to a target under attack (SIP Interface) and/or source of attack (Proxy Set and/or subnet address).

## Enabling IDS

By default, IDS is disabled. You can enable it, as described below.

### ➤ To enable IDS:

1. Open the IDS General Settings page (**Setup** menu > **Signaling & Media** tab > **Intrusion Detection** folder > **IDS General Settings**).

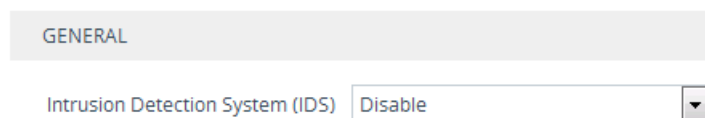

2. From the 'Intrusion Detection System' drop-down list, select **Enable**.
3. Click **Apply**.

## Configuring IDS Policies

An IDS Policy is configured using two tables with "parent-child" type relationship:

- **IDS Policies table ("parent"):** Defines a name and provides a description for the IDS Policy. You can configure up to 20 IDS Policies.
- **IDS Rules table ("child"):** Defines the actual rules for the IDS Policy. Each IDS Policy can be configured with up to 20 rules.



A maximum of 100 IDS rules can be configured (regardless of how many rules are assigned to each policy).

The device provides the following pre-configured IDS Policies that can be used in your deployment (if they meet your requirements):

- "DEFAULT\_FEU": IDS Policy for far-end users in the WAN
- "DEFAULT\_PROXY": IDS Policy for proxy server
- "DEFAULT\_GLOBAL": IDS Policy with global thresholds



- You can edit and delete the default IDS Policies.
- If the IDS Policies table is empty (i.e., you have deleted all IDS Policies) and you want to return the default IDS Policies, disable IDS and then enable it again.

The following procedure describes how to configure IDS Policies through the Web interface. You can also configure it through ini file or CLI:

- IDS Policy table: IDSPolicy (ini file) or configure voip > ids policy (CLI)
- IDS Rules table: IDSRule (ini file) or configure voip > ids rule (CLI)

#### ➤ To configure an IDS Policy:

1. Open the IDS Policies table (**Setup** menu > **Signaling & Media** tab > **Intrusion Detection** folder > **IDS Policies**); the table displays the pre-configured IDS policies:

INDEX ↕	NAME	DESCRIPTION
0	DOS	dos-attacks
1	DEFAULT_FEU	Default policy for FEU
2	DEFAULT_PROXY	Default policy for proxies
3	DEFAULT_GLOBAL	Default policy for global scope

2. Click **New**; the following dialog box appears:

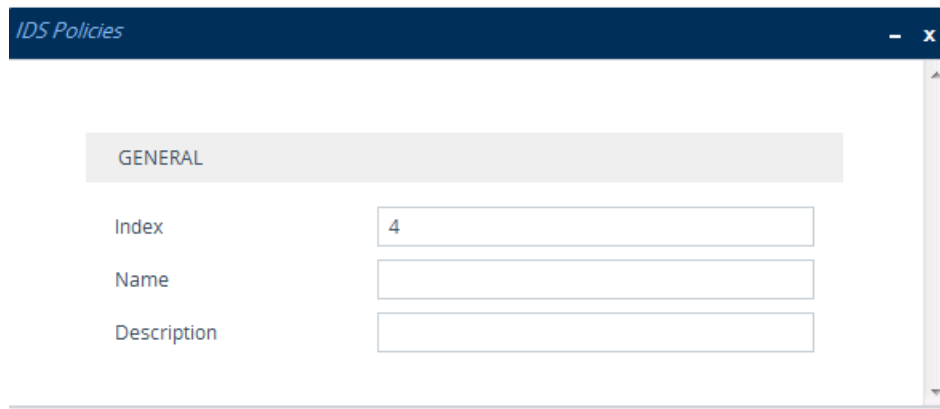

The screenshot shows a window titled "IDS Policies" with a "GENERAL" tab. The form contains three input fields: "Index" with the value "4", "Name" (empty), and "Description" (empty).

3. Configure an IDS Policy name according to the parameters described in the table below.
4. Click **Apply**.

**Table 14-5: IDS Policies Table Parameter Descriptions**

Parameter	Description
'Index' policy [IDSPolicy_Index]	Defines an index number for the new table row. <b>Note:</b> Each row must be configured with a unique index.
'Name' rule [IDSPolicy_Name]	Defines a descriptive name, which is used when associating the row in other tables. The valid value is a string of up to 40 characters. <b>Note:</b> The parameter value cannot contain a forward slash (/).
'Description' description [IDSPolicy_Description]	Defines a brief description for the IDS Policy. The valid value is a string of up to 100 characters.

5. In the IDS Policies table, select the required IDS Policy row, and then click the **IDS Rule** link located below the table; the IDS Rule table opens.
6. Click **New**; the following dialog box appears:

IDS Rule
— x

GENERAL

Index

Reason

Threshold Scope

Threshold Window

ALARMS

Minor-Alarm Threshold

Major-Alarm Threshold

Critical-Alarm Threshold

DENY

Deny Threshold

Deny Period

The figure above shows a configuration example: If 15 malformed SIP messages ('Reason') are received within a period of 30 seconds ('Threshold Window'), a minor alarm is sent ('Minor-Alarm Threshold'). Every 30 seconds, the rule's counters are cleared ('Threshold Window'). If more than 25 malformed SIP messages are received within this period, the device blacklists for 60 seconds the remote IP host ('Deny Threshold') from where the messages were received.

7. Configure an IDS Rule according to the parameters described in the table below.
8. Click **Apply**, and then save your settings to flash memory.

**Table 14-6: IDS Rule Table Parameter Descriptions**

Parameter	Description
General	
'Index' rule-id [IDSRule_RuleID]	Defines an index number for the new table record.
'Reason' reason [IDSRule_Reason]	<p>Defines the type of intrusion attack (malicious event).</p> <ul style="list-style-type: none"> <li>■ [0] <b>Any</b> = All events listed below are considered as attacks and are counted together.</li> <li>■ [1] <b>Connection abuse</b> = (Default) Connection failures, which includes the following:                             <ul style="list-style-type: none"> <li>✓ Incoming TLS authentication (handshake) failure</li> <li>✓ Incoming WebSocket connection establishment failure</li> </ul> </li> <li>■ [2] <b>Malformed message</b> = Malformed SIP messages, which includes the following:</li> </ul>

Parameter	Description
	<ul style="list-style-type: none"> <li>✓ Message exceeds a user-defined maximum message length (50K)</li> <li>✓ Any SIP parser error</li> <li>✓ Message Policy match (see <a href="#">Configuring SIP Message Policy Rules</a>)</li> <li>✓ Basic headers not present</li> <li>✓ Content length header not present (for TCP)</li> <li>✓ Header overflow</li> <li>■ [3] <b>Authentication failure</b> = SIP authentication failure, which includes the following: <ul style="list-style-type: none"> <li>✓ Local authentication ("Bad digest" errors)</li> <li>✓ Remote authentication (SIP 401/407 is sent if original message includes authentication)</li> </ul> </li> <li>■ [4] <b>Dialog establish failure</b> = SIP dialog establishment (e.g., INVITE) failure, which includes the following: <ul style="list-style-type: none"> <li>✓ Classification failure (see <a href="#">Configuring Classification Rules</a>).</li> <li>✓ Call Admission Control (CAC) threshold exceeded (see <a href="#">Configuring Call Admission Control</a> on page 947)</li> <li>✓ Routing failure (i.e., no routing rule was matched)</li> <li>✓ Local reject by device (prior to SIP 180 response): REGISTER not allowed due to IP Group's 'RegistrationMode' parameter, or SIP requests rejected based on a registered users policy (configured by the SRD_BlockUnRegUsers or SIPInterface_BlockUnRegUsersblocks parameters).</li> <li>✓ No user found when routing to a User-type IP Group (similar to a SIP 404)</li> <li>✓ Remote rejects (prior to SIP 18x response). To specify SIP response codes to exclude from the IDS count, see <a href="#">Configuring SIP Response Codes to Exclude from IDS</a> on page 192.</li> <li>✓ Malicious signature pattern detected (see <a href="#">Configuring Malicious Signatures</a>)</li> </ul> </li> <li>■ [5] <b>Abnormal flow</b> = SIP call flow that is abnormal, which</li> </ul>

Parameter	Description
	<p>includes the following:</p> <ul style="list-style-type: none"> <li>✓ Requests and responses without a matching transaction user (except ACK requests)</li> <li>✓ Requests and responses without a matching transaction (except ACK requests)</li> </ul>
<p>'Threshold Scope' threshold-scope [IDSRule_ThresholdScope]</p>	<p>Defines the source of the attacker to consider in the device's detection count.</p> <ul style="list-style-type: none"> <li>■ [0] <b>Global</b> = All attacks regardless of source are counted together during the threshold window.</li> <li>■ [2] <b>IP</b> = Attacks from each specific IP address are counted separately during the threshold window.</li> <li>■ [3] <b>IP+Port</b> = Attacks from each specific IP address:port are counted separately during the threshold window. This option is useful for NAT servers, where numerous remote machines use the same IP address but different ports. However, it is not recommended to use this option as it may degrade detection capabilities.</li> </ul>
<p>'Threshold Window' threshold-window [IDSRule_ThresholdWindow]</p>	<p>Defines the threshold interval (in seconds) during which the device counts the attacks to check if a threshold is crossed. The counter is automatically reset at the end of the interval. The valid range is 1 to 1,000,000. The default is 1.</p>
<b>Alarms</b>	
<p>'Minor-Alarm Threshold' minor-alm-thr [IDSRule_MinorAlarmThreshold]</p>	<p>Defines the threshold that if crossed a minor severity alarm is sent.</p> <p>The valid range is 1 to 1,000,000. A value of 0 or -1 means not defined.</p>
<p>'Major-Alarm Threshold' major-alm-thr [IDSRule_MajorAlarmThreshold]</p>	<p>Defines the threshold that if crossed a major severity alarm is sent.</p> <p>The valid range is 1 to 1,000,000. A value of 0 or -1 means not defined.</p>
<p>'Critical-Alarm Threshold' critical-alm-thr [IDSRule_CriticalAlarmThreshold]</p>	<p>Defines the threshold that if crossed a critical severity alarm is sent.</p> <p>The valid range is 1 to 1,000,000. A value of 0 or -1 means not defined.</p>



Parameter	Description
Deny	
'Deny Threshold' deny-thr [IDSRule_DenyThreshold]	Defines the threshold that if crossed, the device blocks (blacklists) the remote host (attacker). The default is -1 (i.e., not configured). <b>Note:</b> The parameter is applicable only if the 'Threshold Scope' parameter is set to <b>IP</b> or <b>IP+Port</b> .
'Deny Period' deny-period [IDSRule_DenyPeriod]	Defines the duration (in sec) to keep the attacker on the blacklist, if configured using the 'Deny Threshold' parameter. The valid range is 0 to 1,000,000. The default is -1 (i.e., not configured). <b>Note:</b> The parameter is applicable only if the 'Threshold Scope' parameter is set to <b>IP</b> or <b>IP+Port</b> .

## Assigning IDS Policies

The IDS Matches table lets you implement your configured IDS Policies. You do this by assigning IDS Policies to any, or a combination of the following configuration entities:

- **SIP Interface:** For detection of malicious attacks on specific SIP Interface(s). To configure SIP Interfaces, see [Configuring SIP Interfaces](#).
- **Proxy Sets:** For detection of malicious attacks from specified Proxy Set(s). To configure Proxy Sets, see [Configuring Proxy Sets](#).
- **Subnet addresses:** For detection of malicious attacks from specified subnet addresses.

You can configure up to 20 IDS Policy-Matching rules.

The following procedure describes how to configure the IDS Match table through the Web interface. You can also configure it through ini file [IDSMatch] or CLI (`configure voip > ids match`).

### ➤ To configure an IDS Policy-Matching rule:

1. Open the IDS Matches table (**Setup** menu > **Signaling & Media** tab > **Intrusion Detection** folder > **IDS Matches**).
2. Click **New**; the following dialog box appears:

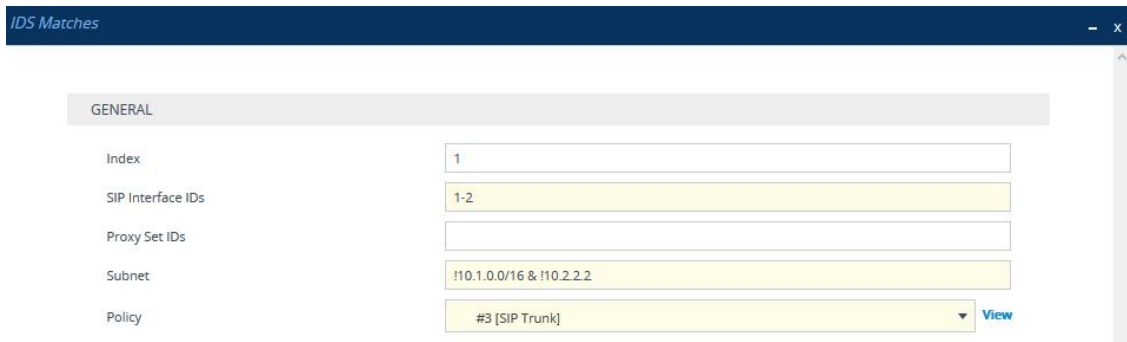

The figure above shows a configuration example where the IDS Policy "SIP Trunk" is applied to SIP Interfaces 1 and 2, and to all source IP addresses outside of subnet 10.1.0.0/16 and IP address 10.2.2.2.

3. Configure a rule according to the parameters described in the table below.
4. Click **Apply**, and then save your settings to flash memory.

**Table 14-7: IDS Matches Table Parameter Descriptions**

Parameter	Description
'Index' [IDSMatch_Index]	Defines an index number for the new table record.
'SIP Interface IDs' sip-interface [IDSMatch_SIPInterface]	<p>Assigns a SIP Interface(s) to the IDS Policy. This indicates the SIP Interfaces that are being attacked.</p> <p>The valid value is the ID of the SIP Interface. The following syntax is supported:</p> <ul style="list-style-type: none"> <li>■ A comma-separated list of SIP Interface IDs (e.g., 1,3,4)</li> <li>■ A hyphen (-) indicates a range of SIP Interfaces (e.g., 3,4-7 means IDs 3, and 4 through 7)</li> <li>■ A prefix of an exclamation mark (!) means negation of the set (e.g., !3,4-7 means all indexes excluding 3, and excluding 4 through 7)</li> </ul>
'Proxy Set IDs' proxy-set [IDSMatch_ProxySet]	<p>Assigns a Proxy Set(s) to the IDS Policy. This indicates the Proxy Sets from where the attacks are coming from. The following syntax is supported:</p> <ul style="list-style-type: none"> <li>■ A comma-separated list of Proxy Set IDs (e.g., 1,3,4)</li> <li>■ A hyphen (-) indicates a range of Proxy Sets (e.g., 3,4-7 means IDs 3, and 4 through 7)</li> <li>■ A prefix of an exclamation mark (!) means negation of the set (e.g., !3,4-7 means all indexes excluding 3, and excluding 4 through 7)</li> </ul>

Parameter	Description
	<p><b>Note:</b></p> <ul style="list-style-type: none"> <li>■ Only the IP address of the Proxy Set is considered (not port).</li> <li>■ If a Proxy Set has multiple IP addresses, the device considers the Proxy Set as one entity and includes all its IP addresses in the same IDS count.</li> </ul>
<p>'Subnet' subnet [IDSMatch_Subnet]</p>	<p>Defines the subnet to which the IDS Policy is assigned. This indicates the subnets from where the attacks are coming from. The following syntax can be used:</p> <ul style="list-style-type: none"> <li>■ Basic syntax is a subnet in CIDR notation (e.g., 10.1.0.0/16 means all sources with IP address in the range 10.1.0.0–10.1.255.255)</li> <li>■ An IP address can be specified without the prefix length to refer to the specific IP address.</li> <li>■ Each subnet can be negated by prefixing it with (!), which means all IP addresses outside that subnet.</li> <li>■ Multiple subnets can be specified by separating them with "&amp;" (and) or " " (or) operations (without quotation marks), for example: <ul style="list-style-type: none"> <li>✓ 10.1.0.0/16   10.2.2.2: includes subnet 10.1.0.0/16 and IP address 10.2.2.2.</li> <li>✓ !10.1.0.0/16 &amp; !10.2.2.2: includes all addresses except those of subnet 10.1.0.0/16 and IP address 10.2.2.2. Note that the exclamation mark (!) appears before each subnet.</li> <li>✓ 10.1.0.0/16 &amp; !10.1.1.1: includes subnet 10.1.0.0/16, except IP address 10.1.1.1.</li> </ul> </li> </ul>
<p>'Policy' policy [IDSMatch_Policy]</p>	<p>Assigns an IDS Policy (configured in <a href="#">Configuring IDS Policies</a>).</p>

## Viewing IDS Alarms

For the IDS feature, the device sends the following SNMP traps:

- Traps that notify the detection of malicious attacks:

- **acIDSPolicyAlarm:** The device sends this alarm whenever a threshold of a specific IDS Policy rule is crossed. The trap displays the crossed severity threshold (Minor or Major), IDS Policy and IDS Rule, and the IDS Policy-Match index.
- **acIDSThresholdCrossNotification:** The device sends this event for each scope (IP address) that crosses the threshold. In addition to the crossed severity threshold (Minor or Major) of the IDS Policy-Match index, this event shows the IP address (or IP address:port) of the malicious attacker.

If the severity level is raised, the alarm of the former severity is cleared and the device sends a new alarm with the new severity. The alarm is cleared after a user-defined timeout during which no thresholds have been crossed.

➤ **To configure IDS alarm cleared timeout:**

1. Open the IDS General Settings page (**Setup** menu > **Signaling & Media** tab > **Intrusion Detection** folder > **IDS General Settings**).
2. From the 'IDS Alarm Clear Period' field (IDSAlarmClearPeriod), enter the timeout (in seconds) after which the alarm is cleared if no IDS thresholds have been crossed during the timeout.

**IDS Alarm Clear Period [sec]**

3. Click **Apply**.

However, this "quiet" timeout period must be at least twice the 'Threshold Window' value (configured in [Configuring IDS Policies](#)). For example, if you set IDSAlarmClearPeriod to 20 sec and 'Threshold Window' to 15 sec, the IDSAlarmClearPeriod parameter is ignored and the alarm is cleared only after 30 seconds (2 x 15 sec).

The figure below displays an example of IDS alarms in the Active Alarms table ([Viewing Active Alarms](#)). In this example, a Minor threshold alarm is cleared and replaced by a Major threshold alarm:

17	Minor	Board#1/IDSMatch#2/IDSRule#0	Policy 2 (Proxy): minor thershold (5) of signaling-msg cross in ip scope	24.10.2012 , 9:48:53
18	cleared	Board#1/IDSMatch#2/IDSRule#0	Alarm cleared: Policy 2 (Proxy): minor thershold (5) of signaling-msg cross in ip scope	24.10.2012 , 9:48:53
19	Major	Board#1/IDSMatch#2/IDSRule#0	Policy 2 (Proxy): major thershold (10) of signaling-msg cross in ip scope	24.10.2012 , 9:48:53

- acIDSBlacklistNotification event: The device sends this event whenever an attacker (remote host at IP address and/or port) is added to or removed from the blacklist.

You can also view IDS alarms through CLI:

- To view all active IDS alarms:

```
# show voip ids active-alarm all
```

- To view all IP addresses that have crossed the threshold for an active IDS alarm:

```
# show voip ids active-alarm match <IDS Match Policy ID> rule <IDS Rule ID>
```

The IP address is displayed only if the 'Threshold Scope' parameter is set to IP or IP+Port; otherwise, only the alarm is displayed.

- To view the blacklist, see [Viewing IDS Active Blacklist](#) on page 1208

The device also sends IDS notifications and alarms in Syslog messages to a Syslog server. This occurs only if you have configured Syslog (see [Enabling Syslog](#)). An example of a Syslog message with IDS alarms and notifications is shown below:

```
[S=92159] [SID:438286865] ( lgr_ids)97420 ) IDS Event: reason=establish-fail,event=14003(establish-classify-fail),ip=10.13.45.200:5060(SII),transport=udp
[S=92160] [SID:438286865] ( lgr_ids)97421 ) IDS Counter (0,19995): IDSMatch#0/IDSRule#0,policy=3(TEST),reason=establish-fail,scope=ip,scope-val=10.13.45.200(SII),value=6
[S=92161] [SID:438286865] ( lgr_ids)97422 ) ?? [WARNING] IDS Rule (0): Threshold cross. IDSMatch#0/IDSRule#0,policy=3(TEST),value=6,severity=2(major)
[S=92162] [SID:438286865] ( lgr_ids)97423 ) ?? [WARNING] IDS Rule (0): Threshold cross. IDSMatch#0/IDSRule#0,policy=3(TEST),value=6,severity=4(blacklist)
[S=92163] [SID:438286865] ( lgr_ids)97424 ) ?? [WARNING] IDS Blacklist: Added IP 10.13.45.200(NE0) to blacklist
[S=92164] [SID:438286865] ( lgr_psbrdxf)97425 ) SNMP EVENT: IDS_BLACKLIST_NOTIFY "Added IP 10.13.45.200(NE0) to blacklist"
[S=92165] RAISE-ALARM:acIDSblacklistNotification; Textual Description: Added IP 10.13.45.200(NE0) to blacklist; Severity:indeterminate; Source; Unique ID:30;
[S=92166] [SID:438286865] ( lgr_psbrdxf)97426 ) InsertBoardEvent- event ADD BLACKLIST EV inserted channel -100
```

The table below lists the Syslog text messages per malicious event:

**Table 14-8: Types of Malicious Events and Syslog Text String**

Reason	
Description	Syslog String
<b>Connection Abuse</b>	
TLS authentication failure	abuse-tls-auth-fail
WebSocket establishment failure	abuse-websocket-fail
<b>Malformed Messages</b>	
Message exceeds a user-defined maximum message length (50K)	malformed-invalid-msg-len
Any SIP parser error	malformed-parse-error
Message policy match	malformed-message-policy
Basic headers not present	malformed-miss-header
Content length header not present (for TCP)	malformed-miss-content-len
Header overflow	malformed-header-overflow
<b>Authentication Failure</b>	
Local authentication ("Bad digest" errors)	auth-establish-fail
Remote authentication (SIP 401/407 is sent if	auth-reject-response

Reason	
Description	Syslog String
original message includes authentication)	
Dialog Establishment Failure	
Classification failure	establish-classify-fail
Routing failure (no matched routing rule)	establish-route-fail
Other local rejects (prior to SIP 180 response)	establish-local-reject
Remote rejects (prior to SIP 180 response)	establish-remote-reject
Malicious signature pattern detected	establish-malicious-signature-db-reject
CAC threshold exceeded	establish-cac-reject
Abnormal Flow	
Requests and responses without a matching transaction user (except ACK requests)	flow-no-match-tu
Requests and responses without a matching transaction (except ACK requests)	flow-no-match-transaction

## Configuring SIP Response Codes to Exclude from IDS

You can specify SIP response codes (reject reasons) that you want the IDS mechanism to ignore in its' count as reasons for SIP-dialog establishment failures.

### ➤ To configure SIP responses to exclude from IDS:

1. Open the IDS General Settings page (**Setup** menu > **Signaling & Media** tab > **Intrusion Detection** folder > **IDS General Settings**).
2. In the 'Excluded Response Codes' field, enter the SIP response codes that you want ignored by IDS.

**Figure 14-1: Configuring SIP Response Codes to Exclude from IDS**

Excluded Response Codes

3. Click **Apply**.



- The parameter applies only to rejected responses received from the upstream



- server; not rejected responses generated by the device (except for 404).
- The response codes 401 and 407 are considered authentication failures and thus, are not applicable to this parameter.

## 15 Media

This section describes media-related configuration.

### Configuring Voice Settings

The section describes various voice-related configuration such as voice volume, silence suppression, and DTMF transport type. For a detailed description of these parameters, see [Configuration Parameters Reference](#).

### Configuring Voice Gain (Volume) Control

The device allows you to configure the level of the received (input gain) Tel-to-IP or IP-to-IP signal and the level of the transmitted (output gain) IP-to-Tel or IP-to-IP signal. The gain can be set between -32 and 31 decibels (dB).

➤ **To configure gain control through the Web interface:**

1. Open the Voice Settings page (**Setup** menu > **Signaling & Media** tab > **Media** folder > **Voice Settings**).

Voice Volume (-32 to 31 dB)	<input type="text" value="0"/>
Input Gain (-32 to 31 dB)	<input type="text" value="0"/>

2. Configure the following parameters:
  - 'Voice Volume' (*VoiceVolume*): Defines the voice gain control (in decibels) of the transmitted signal.
  - 'Input Gain' (*InputGain*): Defines the PCM input gain control (in decibels) of the received signal.
3. Click **Apply**.

### Configuring Echo Cancellation

The device supports adaptive linear (line) echo cancellation according to G.168-2002. Echo cancellation is a mechanism that removes echo from the voice channel. Echoes are reflections of the transmitted signal.

In this line echo, echoes are generated when two-wire telephone circuits (carrying both transmitted and received signals on the same wire pair) are converted to a four-wire circuit. Echoes are reflections of the transmitted signal, which result from impedance mismatch in the hybrid (bi-directional 2-wire to 4-wire converting device).

An estimated echo signal is built by feeding the decoder output signal to an RLS-like adaptive filter, which adapts itself to the characteristics of the echo path. The 'estimated echo signal' (the output of this filter) is then subtracted from the input signal (which is the sum of the desired input signal and the undesired echo) to provide a clean signal. To suppress the





remaining residual echo, a Non Linear Processor (NLP) is used, as well as a double-talk (two people speak at the same time) detector that prevents false adaptation during near-end speech.

The following procedure describes how to configure echo cancellation through the Web interface:

➤ **To configure echo cancellation:**

1. Configure line echo cancellation:

- a. Open the Voice Settings page (**Setup** menu > **Signaling & Media** tab > **Media** folder > **Voice Settings**).

NETWORK ECHO SUPPRESSOR	
Network Echo Suppressor Enable	Disable  
Attenuation Intensity	0
Max ERL Threshold - DB	0
Min Reference Delay x10 msec	0
Max Reference Delay x10 msec	40

- b. From the 'Echo Canceller' drop-down list (*EnableEchoCanceller*), select **Enable**.
- c. Open the Media Settings page (Setup menu > Signaling & Media tab > Media folder > Media Settings).
- d. From the 'Max Echo Canceller Length' drop-down list (*MaxEchoCancellerLength*), select the maximum echo path delay (tail length) for the echo canceller.



The following additional echo cancellation parameters are configurable only through the *ini* file:

- *ECHybridLoss* - defines the four-wire to two-wire worst-case Hybrid loss
- *ECNLPMode* - defines the echo cancellation Non-Linear Processing (NLP) mode
- *EchoCancellerAggressiveNLP* - enables Aggressive NLP at the first 0.5 second of the call

## Fax and Modem Capabilities

This section describes the device's fax and modem capabilities and corresponding configuration. Fax and modem configuration is done on the Fax/Modem/CID Settings page.



- Unless otherwise specified, parameters mentioned in this section are available on this page. For a detailed description of these fax and modem parameters, see [Configuration Parameters Reference](#).



- Some SIP parameters override these fax and modem parameters. For example, the [IsFaxUsed] parameter and V.152 parameters in Section [V.152 Support](#).

➤ **To access the fax and modem parameters:**

- Open the Fax/Modem/CID Settings page (**Setup** menu > **Signaling & Media** tab > **Media** folder > **Fax/Modem/CID Settings**).

GENERAL		FAX RELAY	
Fax Transport Mode	T.38 Relay	Fax Relay Redundancy Depth	0
T.38 Version	T.38 version 0	Fax Relay Enhanced Redundancy Depth	4
Caller ID Transport Type	Mute	Fax Relay ECM Enable	Enable
Caller ID Type	Standard Bellcore	Fax Relay Max Rate (bps)	14400bps
V.21 Modem Transport Type	Disable	Fax Relay Rx/Tx Timeout (sec)	10
V.22 Modem Transport Type	Enable Bypass	<b>FAX/MODEM BYPASS</b>	
V.23 Modem Transport Type	Enable Bypass	Fax/Modem Bypass Coder Type	G711Alaw_64
V.32 Modem Transport Type	Enable Bypass	Fax/Modem Bypass Packing Factor	1
V.34 Modem Transport Type	Enable Bypass	Fax Bypass Output Gain	0
Fax CNG Mode	Doesn't send T.38 re-INV	Modem Bypass Output Gain	0
CNG Detector Mode	Disable		

## Fax and Modem Operating Modes

The device supports two modes of operation:

- Fax/modem negotiation that is **not** performed during call establishment.
- Voice-band data (VBD) mode for V.152 implementation (see [V.152 Support](#)): Fax/modem capabilities are negotiated between the device and the remote endpoint during call establishment. During a call, when a fax/modem signal is detected, transition from voice to VBD (or T.38) is automatically performed and no additional SIP signaling is required. If negotiation fails (i.e., no match is achieved for any of the transport capabilities), fallback to existing logic occurs (according to the parameter IsFaxUsed).

## Fax and Modem Transport Modes

The device supports the following transport modes for fax per modem type (V.22/V.23/Bell/V.32/V.34):

- T.38 fax relay (see [T.38 Fax Relay Mode](#))
- G.711 Transport: switching to G.711 when fax/modem is detected (see [G.711 Fax / Modem Transport Mode](#))
- Fax fallback to G.711 if T.38 is not supported (see [Fax Fallback](#))
- Fax and modem bypass: a proprietary method that uses a high bit rate coder (see [Fax/Modem Bypass Mode](#))

- NSE Cisco's Pass-through bypass mode for fax and modem (see [Fax / Modem NSE Mode](#))
- Transparent with events: passing the fax / modem signal in the current voice coder with adaptations (see [Fax / Modem Transparent with Events Mode](#))
- Transparent: passing the fax / modem signal in the current voice coder (see [Fax / Modem Transparent Mode](#))
- RFC 2833 ANS Report upon Fax/Modem Detection (see [RFC 2833 ANS Report upon Fax/Modem Detection](#))

'Adaptations' refer to automatic reconfiguration of certain DSP features for handling fax/modem streams differently than voice.

### T.38 Fax Relay Mode

In Fax Relay mode, fax signals are transferred using the T.38 protocol. T.38 is the ITU standard for sending fax across IP networks in real-time mode. The device currently supports only the T.38 UDP syntax.

T.38 can be configured in the following ways:

- Switching to T.38 mode using SIP re-INVITE messages (see [Switching to T.38 Mode using SIP Re-INVITE](#))
- Automatically switching to T.38 mode without using SIP re-INVITE messages (see [Automatically Switching to T.38 Mode without SIP Re-INVITE](#))

When fax transmission ends, the reverse switching from fax relay to voice is automatically performed at both the local and remote endpoints.

You can change the fax rate declared in the SDP, using the 'Fax Relay Max Rate' parameter [FaxRelayMaxRate]. The parameter does not affect the actual transmission rate. You can also enable or disable Error Correction Mode (ECM) fax mode using the 'Fax Relay ECM Enable' parameter [FaxRelayECMEnable].

When using T.38 mode, you can define a redundancy feature to improve fax transmission over congested IP networks. This feature is activated using the 'Fax Relay Redundancy Depth' parameter [FaxRelayRedundancyDepth] and the 'Fax Relay Enhanced Redundancy Depth' parameter [FaxRelayEnhancedRedundancyDepth]. Although this is a proprietary redundancy scheme, it should not create problems when working with other T.38 decoders.

#### Switching to T.38 Mode using SIP re-INVITE

In the Switching to T.38 mode using the SIP re-INVITE, upon detection of a fax signal, the terminating device negotiates T.38 capabilities using a re-INVITE message. If the far-end device doesn't support T.38, the fax fails. In this mode, the 'Fax Transport Mode' parameter [FaxTransportMode] is ignored.

➤ **To configure T.38 mode using SIP re-INVITE messages:**

1. Open the Gateway General Settings page (**Setup** menu > **Signaling & Media** tab > **Gateway** folder > **Gateway General Settings**), and then from the 'Fax Signaling Method' drop-down list [IsFaxUsed], select **T.38 Relay**:

Fax Signaling Method

2. On the Fax/Modem/CID Settings page, configure the following optional parameters:
  - 'Fax Relay Redundancy Depth' [FaxRelayRedundancyDepth]
  - 'Fax Relay Enhanced Redundancy Depth' [FaxRelayEnhancedRedundancyDepth]
  - 'Fax Relay ECM Enable' [FaxRelayECMEnable]
  - 'Fax Relay Max Rate' [FaxRelayMaxRate]



The terminating gateway sends T.38 packets immediately after the T.38 capabilities are negotiated in SIP. However, the originating device by default, sends T.38 (assuming the T.38 capabilities are negotiated in SIP) only after it receives T.38 packets from the remote device. This default behavior cannot be used when the originating device is located behind a firewall that blocks incoming T.38 packets on ports that have not yet received T.38 packets from the internal network. To resolve this problem, you should configure the device to send CNG packets in T.38 upon CNG signal detection [CNGDetectorMode = 1].

**Automatically Switching to T.38 Mode without SIP re-INVITE**

In the Automatically Switching to T.38 mode without SIP re-INVITE, when a fax signal is detected, the channel automatically switches from the current voice coder to answer tone mode and then to T.38-compliant fax relay mode.

➤ **To configure Automatic T.38 mode:**

1. Open the Gateway General Settings page (**Setup** menu > **Signaling & Media** tab > **Gateway** folder > **Gateway General Settings**), and then from the 'Fax Signaling Method' drop-down list (IsFaxUsed), select **No Fax**:

Fax Signaling Method

2. On the Fax/Modem/CID Settings page, configure the 'Fax Transport Mode' parameter to **T.38 Relay** [FaxTransportMode = 1].
3. Configure the following optional parameters:
  - 'Fax Relay Redundancy Depth' [FaxRelayRedundancyDepth]
  - 'Fax Relay Enhanced Redundancy Depth' [FaxRelayEnhancedRedundancyDepth]
  - 'Fax Relay ECM Enable' [FaxRelayECMEnable]

- 'Fax Relay Max Rate' [FaxRelayMaxRate]

### Fax over IP using T.38 Transmission over RTP

The device supports Fax-over-IP (FoIP) transmission using T.38 over RTP, whereby the T.38 payload is encapsulated in the RTP packet instead of being sent in dedicated T.38 packets (out-of-band). To support this feature, configure the coder type to T.38 Over RTP.

To indicate T.38 over RTP, the SDP body uses "udptl" (Facsimile UDP Transport Layer) in the 'a=fmtp' line. The device supports T.38 over RTP according to this standard and according to the AudioCodes proprietary method:

- **Call Parties belong to AudioCodes Devices:** T.38-over-RTP method is used, whereby the device encapsulates the entire T.38 packet (payload with all its headers) in the sent RTP. For T.38 over RTP, AudioCodes devices use the proprietary identifier "AcUdptl" in the 'a=fmtp' line of the SDP. For example:

```
v=0
o=AudioCodesGW 1357424688 1357424660 IN IP4 10.8.6.68
s=Phone-Call
c=IN IP4 10.8.6.68
t=0 0
m=audio 6080 RTP/AVP 18 100 96
a=ptime:20
a=sendrecv
a=rtpmap:18 G729/8000
a=fmtp:18 annexb=no
a=rtpmap:100 t38/8000
a=fmtp:100 T38FaxVersion=0
a=fmtp:100 T38MaxBitRate=0
a=fmtp:100 T38FaxMaxBuffer=3000
a=fmtp:100 T38FaxMaxDatagram=122
a=fmtp:100 T38FaxRateManagement=transferredTCF
a=fmtp:100 T38FaxUdpEC=t38UDPRedundancy
a=fmtp:100 AcUdptl
a=rtpmap:96 telephone-event/8000
a=fmtp:96 0-15
```

- **AudioCodes Call Party with non-AudioCodes Party:** The device uses the standard T.38-over-RTP method, which encapsulates the T.38 payload only, without its headers (i.e., includes only fax data) in the sent RTP packet (RFC 4612).

The T.38-over-RTP method also depends on the initiator of the call:

- **Device initiates a call:** The device always sends the SDP offer with the proprietary token "AcUdpTI" in the 'fmtp' attribute. If the SDP answer includes the same token, the device employs the proprietary T.38-over-RTP mode; otherwise, the standard mode is used.

- **Device answers a call:** If the SDP offer from the remote party contains the 'fmt' attribute with "AcUdpTI", the device answers with the same attribute and employs the proprietary T.38-over-RTP mode; otherwise, the standard mode is used.



If both T.38 (regular) and T.38 Over RTP coders are negotiated between the call parties, the device uses T.38 Over RTP.

### G.711 Fax and Modem Transport Mode

In this mode, when the terminating device detects fax or modem signals (CED or AnsAM), it sends a re-INVITE message to the originating device, requesting it to re-open the channel in G.711 VBD with the following adaptations:

- Echo Canceller = off
- Silence Compression = off
- Echo Canceller Non-Linear Processor Mode = off
- Dynamic Jitter Buffer Minimum Delay = 40
- Dynamic Jitter Buffer Optimization Factor = 13

After a few seconds upon detection of fax V.21 preamble or super G3 fax signals, the device sends a second re-INVITE enabling the echo canceller (the echo canceller is disabled only on modem transmission).

A 'gpmd' attribute is added to the SDP according to the following format:

- **For G.711 A-law:**

```
a=gpmd:0 vbd=yes;ecan=on (or off for modems)
```

- **For G.711  $\mu$ -law:**

```
a=gpmd:8 vbd=yes;ecan=on (or off for modems)
```

The following parameters are ignored and automatically set to **Events Only**:

- 'Fax Transport Mode' [FaxTransportMode]
- 'Vxx ModemTransportType' [VxxModemTransportType]

#### ➤ To configure fax / modem transparent mode:

1. Open the Gateway General Settings page (**Setup** menu > **Signaling & Media** tab > **Gateway** folder > **Gateway General Settings**), and then from the 'Fax Signaling Method' drop-down list (IsFaxUsed), select **G.711 Transport**:

Fax Signaling Method

G.711 Transport ▼

2. Click **Apply**.

### Fax Fallback

In this mode, when the terminating device detects a fax signal, it sends a re-INVITE message to the originating device with T.38. If the remote device doesn't support T.38 (replies with SIP response 415 "Media Not Supported"), the device sends a new re-INVITE with G.711 VBD with the following adaptations:

- Echo Canceller = on
- Silence Compression = off
- Echo Canceller Non-Linear Processor Mode = off
- Dynamic Jitter Buffer Minimum Delay = 40
- Dynamic Jitter Buffer Optimization Factor = 13



This section is applicable only to the Gateway application.

When the device initiates a fax session using G.711, a 'gpmd' attribute is added to the SDP according to the following format:

- **For G.711A-law:**

```
a=gpmd:8 vbd=yes;ecan=on
```

- **For G.711  $\mu$ -law:**

```
a=gpmd:0 vbd=yes;ecan=on
```

In this mode, the 'Fax Transport Mode' [FaxTransportMode] parameter is ignored and automatically set to **Disable** (transparent mode).

#### ➤ To configure fax fallback mode:

1. Open the Gateway General Settings page (**Setup** menu > **Signaling & Media** tab > **Gateway** folder > **Gateway General Settings**), and then from the 'Fax Signaling Method' drop-down list (IsFaxUsed), select **Fax Fallback**:

Fax Signaling Method Fax Fallback ▼

2. Click **Apply**.

### Fax and Modem Bypass Mode

In this proprietary mode, when fax or modem signals are detected, the channel automatically switches from the current voice coder to a high bit-rate coder, according to the 'Fax/Modem

Bypass Coder Type' parameter [FaxModemBypassCoderType]. The channel is also automatically reconfigured with the following fax / modem adaptations:

- Disables silence suppression
- Enables echo cancellation for fax
- Disables echo cancellation for modem
- Performs certain jitter buffering optimizations

The network packets generated and received during the bypass period are regular voice RTP packets (per the selected bypass coder), but with a different RTP payload type according to the following parameters:

- 'Fax Bypass Payload Type' [FaxBypassPayloadType]
- [ModemBypassPayloadType]

During the bypass period, the coder uses the packing factor, configured by the 'Fax/Modem Bypass Packing Factor' parameter [FaxModemBypassM]. The packing factor determines the number of coder payloads (each the size of [FaxModemBypassBasicRTTPacketInterval]) that are used to generate a single fax/modem bypass packet. When fax/modem transmission ends, the reverse switching, from bypass coder to regular voice coder is performed.

➤ **To configure fax / modem bypass mode:**

1. Open the Gateway General Settings page (**Setup** menu > **Signaling & Media** tab > **Gateway** folder > **Gateway General Settings**), and then from the 'Fax Signaling Method' drop-down list [IsFaxUsed], select **No Fax**.
2. On the Fax/Modem/CID Settings page, do the following:
  - Configure the 'Fax Transport Mode' parameter to **Bypass** [FaxTransportMode = 2].
  - Configure the 'V.21 Modem Transport Type' parameter to **Enable Bypass** [V21ModemTransportType = 2].
  - Configure the 'V.22 Modem Transport Type' parameter to **Enable Bypass** [V22ModemTransportType = 2].
  - Configure the 'V.23 Modem Transport Type' parameter to **Enable Bypass** [V23ModemTransportType = 2].
  - Configure the 'V.32 Modem Transport Type' parameter to **Enable Bypass** [V32ModemTransportType = 2].
  - Configure the 'V.34 Modem Transport Type' parameter to **Enable Bypass** [V34ModemTransportType = 2].
3. Configure the [BellModemTransportType] parameter to 2 (Bypass).
4. Configure the following optional parameters:
  - 'Fax/Modem Bypass Coder Type' [FaxModemBypassCoderType]
  - 'Fax Bypass Payload Type' [FaxBypassPayloadType]



- [ModemBypassPayloadType]
- [FaxModemBypassBasicRTPPacketInterval]
- [FaxModemBypasDJBufMinDelay]



- When the device is configured for modem bypass and T.38 fax, V.21 low-speed modems are not supported and fail as a result.
- When the remote (non-AudioCodes) gateway uses the G.711 coder for voice and doesn't change the coder payload type for fax or modem transmission, it is recommended to use the Bypass mode with the following configuration:
  - ✓ [EnableFaxModemInbandNetworkDetection = 1].
  - ✓ 'Fax/Modem Bypass Coder Type' = same coder used for voice.
  - ✓ 'Fax/Modem Bypass Packing Factor'[FaxModemBypassM] = same interval as voice.
  - ✓ [ModemBypassPayloadType = 8] if voice coder is A-Law or 0 if voice coder is Mu-Law.

### Fax and Modem NSE Mode

In this mode, fax and modem signals are transferred using Cisco-compatible Pass-through bypass mode. Upon detection of fax or modem answering tone signal, the terminating device sends three to six special NSE RTP packets (configured by the [NSEpayloadType] parameter; usually to 100). These packets signal the remote device to switch to G.711 coder, according to the 'Fax/Modem Bypass Packing Factor' parameter. After a few NSE packets are exchanged between the devices, both devices start using G.711 packets with standard payload type (8 for G.711 A-Law and 0 for G.711 Mu-Law). In this mode, no re-INVITE messages are sent. The voice channel is optimized for fax/modem transmission (same as for usual bypass mode).

The following parameters that configure the payload type for the AudioCodes proprietary Bypass mode are not used with NSE Bypass: 'Fax Bypass Payload Type' and [ModemBypassPayloadType].

When configured for NSE mode, the device includes the following line in the SDP, where *100* is the NSE payload type:

```
a=rtpmap:100 X-NSE/8000
```

The Cisco gateway must include the following definition:

```
modem passthrough nse payload-type 100 codec g711alaw
```

#### ➤ To configure NSE mode:

1. Open the Gateway General Settings page (**Setup** menu > **Signaling & Media** tab > **Gateway** folder > **Gateway General Settings**), and then from the 'Fax Signaling Method' drop-down list (IsFaxUsed), select **No Fax**.

2. On the Fax/Modem/CID Settings page, do the following:
  - Configure the 'Fax Transport Mode' parameter to **Bypass** [FaxTransportMode = 2].
  - Configure the 'V.21 Modem Transport Type' parameter to **Enable Bypass** [V21ModemTransportType = 2].
  - Configure the 'V.22 Modem Transport Type' parameter to **Enable Bypass** [V22ModemTransportType = 2].
  - Configure the 'V.23 Modem Transport Type' parameter to **Enable Bypass** [V23ModemTransportType = 2].
  - Configure the 'V.32 Modem Transport Type' parameter to **Enable Bypass** [V32ModemTransportType = 2].
  - Configure the 'V.34 Modem Transport Type' parameter to **Enable Bypass** [V34ModemTransportType = 2].
3. Configure the [BellModemTransportType] parameter to [2] (Bypass).
4. Configure the [NSEMode] parameter to [1] (enables NSE).
5. parameter the [NSEPayloadType] parameter to [100].

### Fax and Modem Transparent with Events Mode

In this mode, fax and modem signals are transferred using the current voice coder with the following automatic adaptations:

- Echo Cancellor = on (or off for modems)
- Echo Cancellor Non-Linear Processor Mode = off
- Jitter buffering optimizations

#### ➤ To configure fax / modem transparent with events mode:

1. Open the Gateway General Settings page (**Setup** menu > **Signaling & Media** tab > **Gateway** folder > **Gateway General Settings**), and then from the 'Fax Signaling Method' drop-down list (IsFaxUsed), select **No Fax**.
2. On the Fax/Modem/CID Settings page, do the following:
  - Configure the 'Fax Transport Mode' parameter to **Events Only** [FaxTransportMode = 3].
  - Configure the 'V.21 Modem Transport Type' parameter to **Events Only** [V21ModemTransportType = 3].
  - Configure the 'V.22 Modem Transport Type' parameter to **Events Only** [V22ModemTransportType = 3].
  - Configure the 'V.23 Modem Transport Type' parameter to **Events Only** [V23ModemTransportType = 3].

- Configure the 'V.32 Modem Transport Type' parameter to **Events Only** [V32ModemTransportType = 3].
  - Configure the 'V.34 Modem Transport Type' parameter to **Events Only** [V34ModemTransportType = 3].
3. Configure the [BellModemTransportType] parameter to [3] (transparent with events).

### Fax / Modem Transparent Mode

In this mode, fax and modem signals are transferred using the current voice coder without notifications to the user and without automatic adaptations. It's possible to use Profiles (see [Coders and Profiles](#)) to apply certain adaptations to the channel used for fax / modem. For example, to use the coder G.711, to set the jitter buffer optimization factor to 13, and to enable echo cancellation for fax and disable it for modem.

#### ➤ To configure fax / modem transparent mode:

1. Open the Gateway General Settings page (**Setup** menu > **Signaling & Media** tab > **Gateway** folder > **Gateway General Settings**), and then from the 'Fax Signaling Method' drop-down list (IsFaxUsed), select **No Fax**.
2. On the Fax/Modem/CID Settings page, do the following:
  - Configure the 'Fax Transport Mode' parameter to **Disable** (FaxTransportMode = 0).
  - Configure the 'V.21 Modem Transport Type' parameter to **Disable** [V21ModemTransportType = 0].
  - Configure the 'V.22 Modem Transport Type' parameter to **Disable** [V22ModemTransportType = 0].
  - Configure the 'V.23 Modem Transport Type' parameter to **Disable** [V23ModemTransportType = 0].
  - Configure the 'V.32 Modem Transport Type' parameter to **Disable** [V32ModemTransportType = 0].
  - Configure the 'V.34 Modem Transport Type' parameter to **Disable** [V34ModemTransportType = 0].
3. Configure the [BellModemTransportType] parameter to [0] (transparent mode).
4. Configure the following optional parameters:
  - Coders in the Coders table - see [Configuring Coder Groups](#).
  - 'Dynamic Jitter Buffer Optimization Factor' [DJBufOptFactor] - [Configuring the Dynamic Jitter Buffer](#).
  - 'Echo Cancellor' [EnableEchoCancellor] - see [Configuring Echo Cancellation](#).



This mode can be used for fax, but is not recommended for modem transmission.



Instead, use the Bypass (see [Fax/Modem Bypass Mode](#)) or Transparent with Events modes (see [Fax / Modem Transparent with Events Mode](#)) for modem.

### RFC 2833 ANS Report upon Fax and Modem Detection

The device (terminator gateway) sends RFC 2833 ANS/ANSam events upon detection of fax and/or modem answer tones (i.e., CED tone). This causes the originator to switch to fax/modem. The parameter is applicable only when the fax or modem transport type is set to bypass, Transparent-with-Events, V.152 VBD, or G.711 transport. When the device is located on the originator side, it ignores these RFC 2833 events.

#### ➤ To configure RFC 2833 ANS Report upon fax/modem detection:

1. Open the Gateway General Settings page (**Setup** menu > **Signaling & Media** tab > **Gateway** folder > **Gateway General Settings**), and then from the 'Fax Signaling Method' drop-down list (IsFaxUsed), select **No Fax** or **Fax Fallback**.
2. On the Fax/Modem/CID Settings page, do the following:
  - Configure the 'Fax Transport Mode' parameter to **Bypass** [FaxTransportMode = 2].
  - Configure the 'V.xx Modem Transport Type' parameters to **Enable Bypass** [VxxModemTransportType = 2].
3. Configure the [FaxModemNTMode] parameter to [1] (enables this feature).

### V.34 Fax Support

V.34 fax machines can transmit data over IP to the remote side using various methods. The device supports the following modes for transporting V.34 fax data over IP:

- Bypass mechanism for V.34 fax transmission (see [Bypass Mechanism for V.34 Fax Transmission](#))
- T.38 Version 0 relay mode, i.e., fallback to T.38 (see [Relay Mode for T.30 and V.34 Faxes](#))

To configure whether to pass V.34 over T.38 fax relay, or use Bypass over the High Bit Rate coder (e.g. PCM A-Law), use the 'V.34 Fax Transport Type' parameter (V34FaxTransportType).

You can use the 'SIP T.38 Version' parameter (SIPT38Version) to configure:

- Use Fax-over-T.38 fallback to T.30, using up to 14,400 bps ('SIP T.38 Version' is set to Version 0).



- The CNG detector is disabled in all the subsequent examples. To disable the CNG detector, set the 'CNG Detector Mode' parameter (CNGDetectorMode) to **Disable**.

### Bypass Mechanism for V.34 Fax Transmission

In this proprietary scenario, the device uses bypass (or NSE) mode to transmit V.34 faxes, enabling the full utilization of its speed.

➤ **To use bypass mode for T.30 and V.34 faxes:**

1. On the Fax/Modem/CID Settings page, do the following:
  - Set the 'Fax Transport Mode' parameter to **Bypass** [FaxTransportMode = 2].
  - Set the 'V.22 Modem Transport Type' parameter to **Enable Bypass** [V22ModemTransportType = 2].
  - Set the 'V.23 Modem Transport Type' parameter to **Enable Bypass** [V23ModemTransportType = 2].
  - Set the 'V.32 Modem Transport Type' parameter to **Enable Bypass** [V32ModemTransportType = 2].
  - Set the 'V.34 Modem Transport Type' parameter to **Enable Bypass** [V34ModemTransportType = 2].
2. Configure the [V34FaxTransportType] parameter to [2] (Bypass).

➤ **To use bypass mode for V.34 faxes, and T.38 for T.30 faxes:**

1. On the Fax/Modem/CID Settings page, do the following:
  - Set the 'Fax Transport Mode' parameter to **T.38 Relay** [FaxTransportMode = 1].
  - Set the 'V.22 Modem Transport Type' parameter to **Enable Bypass** [V22ModemTransportType = 2].
  - Set the 'V.23 Modem Transport Type' parameter to **Enable Bypass** [V23ModemTransportType = 2].
  - Set the 'V.32 Modem Transport Type' parameter to **Enable Bypass** [V32ModemTransportType = 2].
  - Set the 'V.34 Modem Transport Type' parameter to **Enable Bypass** [V34ModemTransportType = 2].
2. Configure the [V34FaxTransportType] parameter to [2] (Bypass).

### Relay Mode for T.30 and V.34 Faxes

In this scenario, V.34 fax machines are forced to use their backward compatibility with T.30 faxes and operate in the slower T.30 mode.

➤ **To use T.38 mode for V.34 and T.30 faxes:**

1. On the Fax/Modem/CID Settings page, do the following:
  - Set the 'Fax Transport Mode' parameter to **T.38 Relay** (FaxTransportMode = 1).

- Set the 'V.22 Modem Transport Type' parameter to **Disable** (V22ModemTransportType = 0).
  - Set the 'V.23 Modem Transport Type' parameter to **Disable** (V23ModemTransportType = 0).
  - Set the 'V.32 Modem Transport Type' parameter to **Disable** (V32ModemTransportType = 0).
  - Set the 'V.34 Modem Transport Type' parameter to **Disable** (V34ModemTransportType = 0).
2. Configure the [V34FaxTransportType] parameter to [1] (Relay).
- **To force V.34 fax machines to use their backward compatibility with T.30 faxes and operate in the slower T.30 mode:**
- Set the 'SIP T.38 Version' parameter to Version 0 (SIPT38Version = 0).

## V.152 Support

The device supports the ITU-T recommendation V.152 (Procedures for Supporting Voice-Band Data over IP Networks). Voice-band data (VBD) is the transport of modem, facsimile, and text telephony signals over a voice channel of a packet network with a codec appropriate for such signals.

For V.152 capability, the device supports T.38 as well as VBD codecs (i.e., G.711 A-law and G.711  $\mu$ -law). The selection of capabilities is performed using the Coder Groups table (see [Configuring Coder Groups](#)).

When in VBD mode for V.152 implementation, support is negotiated between the device and the remote endpoint at the establishment of the call. During this time, initial exchange of call capabilities is exchanged in the outgoing SDP. These capabilities include whether VBD is supported and associated RTP payload types ('gpmd' SDP attribute), supported codecs, and packetization periods for all codec payload types ('ptime' SDP attribute). After this initial negotiation, no Re-INVITE messages are necessary as both endpoints are synchronized in terms of the other side's capabilities. If negotiation fails (i.e., no match was achieved for any of the transport capabilities), fallback to existing logic occurs (according to the parameter IsFaxUsed).

Below is an example of media descriptions of an SDP indicating support for V.152. In the example, V.152 implementation is supported (using the dynamic payload type 96 and G.711  $\mu$ -law as the VBD codec) as well as the voice codecs G.711  $\mu$ -law and G.729.

```
v=0
o=- 0 0 IN IPV4 <IPAddress>
s=-
t=0 0
p=+1
c=IN IP4 <IPAddress>
```

```
m=audio <udpPort A> RTP/AVP 18 0
a=ptime:10
a=rtpmap:96 PCMU/8000
a=gpmid: 96 vbd=yes
```

Instead of using VBD transport mode, the V.152 implementation can use alternative relay fax transport methods (e.g., fax relay over IP using T.38). The preferred V.152 transport method is indicated by the SDP 'pmft' attribute. Omission of this attribute in the SDP content means that VBD mode is the preferred transport mechanism for voice-band data.

## Configuring RTP/RTCP Settings

This section describes configuration relating to Real-Time Transport Protocol (RTP) and RTP Control Protocol (RTCP).

### Configuring the Dynamic Jitter Buffer

Voice frames are transmitted at a fixed rate. If the frames arrive at the other end at the same rate, voice quality is perceived as good. However, some frames may arrive slightly faster or slower than the other frames. This is called jitter (delay variation) and degrades the perceived voice quality. To minimize this problem, the device uses a jitter buffer. The jitter buffer collects voice packets, stores them and sends them to the voice processor in evenly spaced intervals.

The device uses a dynamic jitter buffer that can be configured with the following:

- **Minimum delay:** Defines the starting jitter capacity of the buffer. For example, at 0 msec, there is no buffering at the start. At the default level of 10 msec, the device always buffers incoming packets by at least 10 msec worth of voice frames.
- **Optimization Factor:** Defines how the jitter buffer tracks to changing network conditions. When set at its maximum value of 12, the dynamic buffer aggressively tracks changes in delay (based on packet loss statistics) to increase the size of the buffer and doesn't decay back down. This results in the best packet error performance, but at the cost of extra delay. At the minimum value of 0, the buffer tracks delays only to compensate for clock drift and quickly decays back to the minimum level. This optimizes the delay performance but at the expense of a higher error rate.

The default settings of 10 msec Minimum delay and 10 Optimization Factor should provide a good compromise between delay and error rate. The jitter buffer 'holds' incoming packets for 10 msec before making them available for decoding into voice. The coder polls frames from the buffer at regular intervals in order to produce continuous speech. As long as delays in the network do not change (jitter) by more than 10 msec from one packet to the next, there is always a sample in the buffer for the coder to use. If there is more than 10 msec of delay at any time during the call, the packet arrives too late. The coder tries to access a frame and is not able to find one. The coder must produce a voice sample even if a frame is not available. It therefore compensates for the missing packet by adding a Bad-Frame-Interpolation (BFI) packet. This loss is then flagged as the buffer being too small. The dynamic algorithm then

causes the size of the buffer to increase for the next voice session. The size of the buffer may decrease again if the device notices that the buffer is not filling up as much as expected. At no time does the buffer decrease to less than the minimum size configured by the Minimum delay parameter.

In certain scenarios, the **Optimization Factor is set to 13**: One of the purposes of the Jitter Buffer mechanism is to compensate for clock drift. If the two sides of the VoIP call are not synchronized to the same clock source, one RTP source generates packets at a lower rate, causing under-runs at the remote Jitter Buffer. In normal operation (optimization factor 0 to 12), the Jitter Buffer mechanism detects and compensates for the clock drift by occasionally dropping a voice packet or by adding a BFI packet.

Fax and modem devices are sensitive to small packet losses or to added BFI packets. Therefore, to achieve better performance during modem and fax calls, the Optimization Factor should be set to 13. In this special mode the clock drift correction is performed less frequently - only when the Jitter Buffer is completely empty or completely full. When such condition occurs, the correction is performed by dropping several voice packets simultaneously or by adding several BFI packets simultaneously, so that the Jitter Buffer returns to its normal condition.

The following procedure describes how to configure the jitter buffer using the Web interface.

➤ **To configure jitter buffer using the Web interface:**

1. Open the RTP/RTCP Settings page (**Setup** menu > **Signaling & Media** menu > **Media** folder > **RTP/RTCP Settings**). The relevant parameters are listed under the General group, as shown below:

<b>Dynamic Jitter Buffer Minimum Delay</b>	<input type="text" value="10"/>
<b>Dynamic Jitter Buffer Optimization Factor</b>	<input type="text" value="10"/>

2. Set the 'Dynamic Jitter Buffer Minimum Delay' parameter (DJBufMinDelay) to the minimum delay (in msec) for the Dynamic Jitter Buffer.
3. Set the 'Dynamic Jitter Buffer Optimization Factor' parameter (DJBufOptFactor) to the Dynamic Jitter Buffer frame error/delay optimization factor.
4. Click **Apply**.

## Comfort Noise Generation

The device can generate artificial background noise, called *comfort* noise, in the voice channel during periods of silence (i.e. when no call party is speaking) for Gateway calls. This is useful in that it reassures the call parties that the call is still connected. The device detects silence using its Voice Activity Detection (VAD) mechanism. When the Comfort Noise Generation is enabled and silence is detected, the device transmits Silence Identifier Descriptors (SIDs) parameters to reproduce the local background noise at the remote (receiving) side. The Comfort Noise Generation support also depends on the silence suppression (SCE) setting for the coder used



in the voice channel. For more information, see the description of the Comfort Noise Generation related parameters.



This feature is applicable only to the Gateway application.

The following procedure describes how to configure Comfort Noise Generation through the Web interface.

#### ➤ To configure Comfort Noise Generation:

1. Open the RTP/RTCP Settings page (**Setup** menu > **Signaling & Media** menu > **Media** folder > **RTP/RTCP Settings**). The relevant parameters are listed under the General group, as shown below:

Comfort Noise Generation Negotiation

2. Set the 'Comfort Noise Generation Negotiation' parameter (ComfortNoiseNegotiation) to **Enable**.
3. Click **Apply**.

## Configuring DTMF Transport Types

The device supports various methods for transporting DTMF digits over the IP network to the remote endpoint for Gateway calls.



This feature is applicable only to the Gateway application.

The methods and their configuration can be configured on the DTMF & Dialing page (**Setup** menu > **Signaling & Media** tab > **Gateway** folder > **DTMF & Supplementary** > **DTMF & Dialing**):

Declare RFC 2833 in SDP

1st Tx DTMF Option

2nd Tx DTMF Option

RFC 2833 Payload Type

- **Using INFO message according to Nortel IETF draft:** DTMF digits are sent to the remote side in INFO messages. To enable the mode:
  - a. Configure the 'Declare RFC 2833 in SDP' parameter to **No** (RxDTMFOption = 0).
  - b. Configure the 'First Tx DTMF Option' parameter to **INFO Nortel** (FirstTxDTMFOption = 1).



DTMF digits are removed from the audio stream (and the 'DTMF Transport Type' parameter is automatically set to **Mute DTMF**).

- **Using INFO message according to Cisco's mode:** DTMF digits are sent to the remote side in INFO messages. To enable the mode:
  - a. Configure the 'Declare RFC 2833 in SDP' parameter to **No** (RxDTMFOption = 0).
  - b. Configure the 'First Tx DTMF Option' parameter to **INFO Cisco** (FirstTxDTMFOption = 3).



DTMF digits are removed from the audio stream (and the 'DTMF Transport Type' parameter is automatically set to **Mute DTMF**).

- **Using NOTIFY messages according to IETF Internet-Draftdraft-mahy-sipping-signaled-digits-01:** DTMF digits are sent to the remote side using NOTIFY messages. To enable the mode:
  - a. Configure the 'Declare RFC 2833 in SDP' parameter to **No** (RxDTMFOption = 0).
  - b. Configure the 'First Tx DTMF Option' parameter to **NOTIFY** (FirstTxDTMFOption = 2).



DTMF digits are removed from the audio stream (and the 'DTMF Transport Type' parameter is automatically set to **Mute DTMF**).

- **Using RFC 2833 relay with Payload type negotiation:** DTMF digits are sent to the remote side as part of the RTP stream according to RFC 2833. To enable the mode:
  - a. Configure the 'Declare RFC 2833 in SDP' parameter to **Yes** (RxDTMFOption = 3).
  - b. Configure the 'First Tx DTMF Option' parameter to **RFC 2833** (FirstTxDTMFOption = 4).



To set the RFC 2833 payload type with a value other than its default, use the RFC2833PayloadType parameter. The device negotiates the RFC 2833 payload type using local and remote SDP and sends packets using the payload type from the received SDP. The device expects to receive RFC 2833 packets with the same payload type as configured by the parameter. If the remote side doesn't include 'telephony-event' in its SDP, the device sends DTMF digits in transparent mode (as part of the voice stream).

- **Sending DTMF digits (in RTP packets) as part of the audio stream (DTMF Relay is disabled):** This method is typically used with G.711 coders. With other low-bit rate (LBR) coders, the quality of the DTMF digits is reduced. To enable the mode:
  - a. Configure the 'Declare RFC 2833 in SDP' parameter to **No** (RxDTMFOption = 0).
  - b. Configure the 'First Tx DTMF Option' parameter to **Not Supported** (FirstTxDTMFOption = 0).

- c. Configure the ini file parameter [DTMFTransportType] to [2] (i.e., transparent).
- **Using INFO message according to Korea mode:** DTMF digits are sent to the remote side in INFO messages. To enable this mode:
  - a. Configure the 'Declare RFC 2833 in SDP' parameter to **No** (RxDTMFOption = 0).
  - b. Configure the 'First Tx DTMF Option' parameter to **INFO Cisco** (FirstTxDTMFOption = 3).



DTMF digits are removed from the audio stream (and the 'DTMF Transport Type' parameter is automatically set to **Mute DTMF**).



- The device is always ready to receive DTMF packets over IP in all possible transport modes: INFO messages, NOTIFY, and RFC 2833 (in proper payload type) or as part of the audio stream.
- To exclude RFC 2833 Telephony event parameter from the device's SDP, configure the 'Declare RFC 2833 in SDP' parameter to **No**.
- You can use the following parameters to configure DTMF digit handling:
  - ✓ [FirstTxDTMFOption], [SecondTxDTMFOption], [RxDTMFOption], [RFC2833TxPayloadType], and [RFC2833RxPayloadType]
  - ✓ [MGCPDTMFDetectionPoint], [DTMFVolume], [DTMFTransportType], [DTMFDigitLength], and [DTMFInterDigitInterval]

## Configuring RFC 2833 Payload

You can configure the RFC 2833 payload.

### ➤ To configure RFC 2833 payload:

1. Open the RTP/RTCP Settings page (**Setup** menu > **Signaling & Media** tab > **Media** folder > **RTP/RTCP Settings**).
2. Configure the following parameters:
  - 'RTP Redundancy Depth' (RTPRedundancyDepth) - enables the device to generate RFC 2198 redundant packets.
  - **For Gateway application only:** 'Enable RTP Redundancy Negotiation' (EnableRTPRedundancyNegotiation) - enables the device to include the RTP redundancy dynamic payload type in the SDP, according to RFC 2198.
  - 'RFC 2833 TX Payload Type' (RFC2833TxPayloadType) - defines the Tx RFC 2833 DTMF relay dynamic payload type.
  - 'RFC 2833 RX Payload Type' (RFC2833RxPayloadType) - defines the Rx RFC 2833 DTMF relay dynamic payload type.
  - 'RFC 2198 Payload Type' (RFC2198PayloadType) - defines the RTP redundancy packet payload type according to RFC 2198.

3. Click **Apply**.

## Configuring RTP Base UDP Port

You can configure the range (pool) of local UDP ports from which the device allocates ports to media (RTP, RTCP, and T.38) channels (legs). The maximum range of UDP ports is from 6,000 through to 65,535.

The consecutive port offset from the RTP port for RTCP and T.38 traffic is one and two, respectively. For example, if the voice session uses RTP port 6000, the device allocates ports 6001 and 6002 for RTCP and T.38, respectively. However, you can configure the device to use the same port for RTP and T.38 packets, by configuring the [T38UseRTPPort] parameter to 1.

Within the port range, the device allocates the UDP ports per media channel (leg) in "jumps" (spacing) of 10. For example, if the port range starts at 6000 and the UDP port spacing is 10, the available ports are 6000, 6010, 6020, 6030, and so on. Within the port range, the device assigns these ports **randomly** to the different media channels. For example, it allocates port 6000 to leg 1, port 6030 to leg 2, and port 6010 to leg 3.

You can configure the starting port (lower boundary) of the port range (default is 6000), using the 'RTP Base UDP Port' [BaseUDPPort] parameter. Once configured, the port range is according to the following equation:

<BaseUDPPort parameter value> to

For example: If you configure the 'RTP Base UDP Port' parameter to 6000, the port range is 6000 to 65,535.

You can also configure specific port ranges for specific SIP user agents (UAs), using Media Realms (see [Configuring Media Realms](#)). You can configure each Media Realm with a different UDP port range and then assign the Media Realm to a specific IP Group, for example. However, the port range of the Media Realm **must be within the range** configured by the 'RTP Base UDP Port' parameter.

The following procedure describes how to configure the RTP base UDP port through the Web interface.

### ➤ To configure the RTP base UDP port:

1. Open the RTP/RTCP Settings page (**Setup** menu > **Signaling & Media** tab > **Media** folder > **RTP/RTCP Settings**).
2. In the 'RTP Base UDP Port' field, configure the lower boundary of the UDP port range.

RTP Base UDP Port

6000



3. Click **Apply**, and then reset the device with a save-to-flash for your settings to take effect.



- The RTP port must be different from ports configured for SIP signaling traffic (i.e., ports configured for SIP Interfaces). For example, if the RTP port range is 6000 to 6999, the SIP port must either be less than 6000 or greater than 6999.
- The base UDP port number must be greater than the highest UDP port configured for a SIP Interface (see [Configuring SIP Interfaces](#)). For example, if your highest configured UDP port for a SIP Interface is 6060, you must configure the 'RTP Base UDP Port' parameter to any value greater than 6060.

## Configuring Invalid RTP/RTCP Packet Handling

You can configure the way the device handles incoming invalid RTP and RTCP packets. This is applicable only if you configure the IP Profile parameter, 'Mediation Mode' (IpProfile\_TranscodingMode) to **RTP Forwarding**.

### ➤ To configure invalid packet handling:

1. Open the RTP/RTCP Settings page (**Setup** menu > **Signaling & Media** tab > **Media** folder > **RTP/RTCP Settings**).
2. From the 'Forward Unknown RTP Payload Types' drop-down list, select the required handling for RTP packets with unknown payload types.
3. From the 'Forward Invalid RTP Packets' drop-down list, select the required handling for invalid RTP and RTCP packets.

Forward Unknown RTP Payload Types •

Forward Invalid RTP Packets •

4. Click **Apply**.



Invalid packet handling configuration is applicable only to the SBC application.

## Event Detection and Notification using X-Detect Header

The device can detect certain events in the media stream and notify of their detection to a remote application server, using the SIP X-Detect header. The request for event notification is done by the application server when establishing a SIP dialog (i.e., INVITE message) or during an already established call using a re-INVITE message. The device can detect the following event types:

- **Answering Machine Detection (AMD):** Detects events that are related to the AMD feature. AMD detects whether an answering machine or live voice has answered the call. It can also be used to detect silence, or the beep sound played by an answering machine to indicate the end of the greeting message after which a voice message can be left. For more information on AMD, see [Answering Machine Detection \(AMD\)](#).

- Call Progress Tone (CPT): Detects whether a specific tone, defined in the installed CPT file is received from the call. It can be used to detect the beep sound played by an answering machine (as mentioned above), Special Information Tones (SIT) which indicate call failure with a recorded announcement describing the call failure (Gateway application only), and the busy, reorder and ring tones.
- (Gateway application only) Fax/modem machine: Detects whether a fax has answered the call (preamble, CED, CNG, and modem).
- (Gateway application only) PTT : Detects the start and end of voice.



- Currently, PTT is supported only for Gateway calls.
- Fax and SIT event detection is applicable only to Gateway calls.
- Event detection on SBC calls for CPT is supported only for calls using the G.711 coder.

The X-Detect header is used for event detection as follows:

- X-Detect header in the INVITE message received from the application server requesting a specific event detection:

```
X-Detect: Request=[event type to detect]
```

- X-Detect header in the SIP response message -- SIP 183 (for early dialogs) or 200 OK (for confirmed dialogs) -- sent by the device to the application server specifying which of the requested events it can detect (absence of the X-Detect header indicates that the device cannot detect any of the events):

```
X-Detect: Response=[supported event types]
```

- Each time the device detects the supported event, it sends an INFO message to the remote party with the following message body:

```
Content-Type: Application/X-Detect
Type = [event type]
Subtype = [subtype of each event type]
```

The table below lists the event types and subtypes that can be detected by the device. The text shown in the table are the strings used in the X-Detect header. The table also provides a summary of the required configuration.

For SBC calls, event detection is enabled using the IPProfile\_SBCHandleXDetect parameter in the IP Profiles table (see [Configuring IP Profiles](#)).

**Table 15-1: Supported X-Detect Event Types**

Event Type	Subtype	Description and Required Configuration
AMD	<ul style="list-style-type: none"> <li>■ Voice (live voice)</li> <li>■ Automata (answering machine)</li> <li>■ Silence (no voice)</li> <li>■ Unknown</li> <li>■ Beep (greeting message of answering machine)</li> </ul>	Event detection using the AMD feature. For more information, see <a href="#">Answering Machine Detection (AMD)</a> .
CPT	<ul style="list-style-type: none"> <li>■ SIT-NC</li> <li>■ SIT-IC</li> <li>■ SIT-VC</li> <li>■ SIT-RO</li> <li>■ Busy</li> <li>■ Reorder</li> <li>■ Ringtone</li> <li>■ Beep (greeting message of answering message)</li> </ul>	<p>Event detection of tones using the CPT file.</p> <ol style="list-style-type: none"> <li>1. Create a CPT file with the required tone types of the events that you want to detect.</li> <li>2. Install the CPT file on the device.</li> <li>3. For SIT detection: <ul style="list-style-type: none"> <li>✓ Set the SITDetectorEnable parameter to 1.</li> <li>✓ Set the UserDefinedToneDetectorEnable parameter to 1.</li> </ul> </li> </ol> <p><b>Note:</b></p> <ul style="list-style-type: none"> <li>■ For more information on SIT detection, see <a href="#">SIT Event Detection</a>.</li> <li>■ To configure beep detection, see <a href="#">Detecting Answering Machine Beep</a>.</li> </ul>
FAX	CED	<ul style="list-style-type: none"> <li>■ Set the IsFaxUsed parameter to any value other than 0.</li> </ul> <p style="text-align: center;">- or -</p> <ul style="list-style-type: none"> <li>■ Set the IsFaxUsed parameter to 0 and the FaxTransportMode parameter to any value other than 0.</li> </ul> <p><b>Note:</b> Applicable only to the Gateway application.</p>
	modem	Set the VxxModemTransportType parameter to 3.

Event Type	Subtype	Description and Required Configuration
		<b>Note:</b> Applicable only to the Gateway application.
PTT	<ul style="list-style-type: none"> <li>■ voice-start</li> <li>■ voice-end</li> </ul>	Set the EnableDSPIPMDetectors parameter to 1.

## SIT Event Detection

The device can detect and report the following Special Information Tones (SIT) types from the PSTN:

- SIT-NC (No Circuit found)
- SIT-IC (Operator Intercept)
- SIT-VC (Vacant Circuit - non-registered number)
- SIT-RO (Reorder - System Busy)

There are additional three SIT tones that are detected as one of the above SIT tones:

- The NC\* SIT tone is detected as NC
- The RO\* SIT tone is detected as RO
- The IO\* SIT tone is detected as VC

The device can map these SIT tones to a Q.850 cause and then map them to SIP 5xx/4xx responses, using the parameters SITQ850Cause, SITQ850CauseForNC, SITQ850CauseForIC, SITQ850CauseForVC, and SITQ850CauseForRO.



This feature is applicable only to the Gateway application.

**Table 15-2: SIT Reported by the Device**

Special Information Tones (SITs) Name	Description	First Tone		Second Tone		Third Tone	
		Frequency	Duration	Frequency	Duration	Frequency	Duration
		(Hz)	(ms)	(Hz)	(ms)	(Hz)	(ms)
NC1	No circuit found	985.2	380	1428.5	380	1776.7	380
IC	Operator intercept	913.8	274	1370.6	274	1776.7	380



Special Information Tones (SITs) Name	Description	First Tone		Second Tone		Third Tone	
		Frequency	Duration	Frequency	Duration	Frequency	Duration
VC	Vacant circuit (non registered number)	985.2	380	1370.6	274	1776.7	380
RO1	Reorder (system busy)	913.8	274	1428.5	380	1776.7	380
NC*	-	913.8	380	1370.6	380	1776.7	380
RO*	-	985.2	274	1370.6	380	1776.7	380
IO*	-	913.8	380	1428.5	274	1776.7	380

The following example shows a SIP INFO message sent by the device to a remote application server notifying it that SIT detection has been detected:

```
INFO sip:5001@10.33.2.36 SIP/2.0
Via: SIP/2.0/UDP 10.33.45.65;branch=z9hG4bKac2042168670
Max-Forwards: 70
From: <sip:5000@10.33.45.65;user=phone>;tag=1c1915542705
To: <sip:5001@10.33.2.36;user=phone>;tag=WQJNIDDPKAPIDSCOTG
Call-ID: AIFHPETLLMVVFWPDXUHD@10.33.2.36
CSeq: 1 INFO
Contact: <sip:2206@10.33.45.65>
Supported: em,timer,replaces,path,resource-priority
Content-Type: application/x-detect
Content-Length: 28
Type= CPT
SubType= SIT-IC
```

## Detecting Answering Machine Beeps

The device can detect the "beep" sound played by an answering machine that indicates the end of the answering machine's greeting message. This is useful in that the device can then notify, for example, a third-party, application server that it can now leave a voice message on the answering machine. The device supports the following methods for detecting and reporting beeps:

- **AMD-based Detection:** The device uses its beep detector that is integrated in the AMD feature. You can configure the beep detection timeout and beep detection sensitivity level (for more information, see [Configuring AMD](#)). To enable the AMD beep detection, the received INVITE message must contain an X-Detect header with the value "Request=AMD",

```
X-Detect: Request=AMD
```

and the [AMDBeepDetectionMode] parameter must be configured to [1] or [2]. If configured to [1], the beep is detected only after the answering machine is detected. If configured to [2], the beep is detected even if the answering machine was not detected.

- **Tone-based Detection (Call Progress Tone):** The device detects the beep according to a call progress tone (CPT). This is enabled if the device receives a specific beep tone (Tone Type #46) that is also defined in the installed CPT file and the received INVITE message contains an X-Detect header with the value "Request=CPT":

```
X-Detect: Request=CPT
```

For more information on the CPT file, see [Call Progress Tones File](#).

The device reports beep detections to application servers, by sending a SIP INFO message that contains a body with one of the following values, depending on the method used for detecting the beep:

- AMD-detected Beep:

```
Type= AMD  
SubType= Beep
```

- CPT-detected Beep:

```
Type= CPT  
SubType=Beep
```

## SIP Call Flow Examples of Event Detection and Notification

Two SIP call flow examples are provided below of event detection and notification:

- **Example 1:** This example shows a SIP call flow of the device's AMD and event detection feature, whereby the device detects an answering machine and the subsequent start and end of the greeting message, enabling the third-party application server to know when to play a recorded voice message to an answering machine:
  - a. Upon detection of the answering machine, the device sends the following SIP INFO message to the application server:

```

INFO sip:sipp@172.22.2.9:5060 SIP/2.0
Via: SIP/2.0/UDP 172.22.168.249;branch=z9hG4bKac1566945480
Max-Forwards: 70
From: sut <sip:3000@172.22.168.249:5060>;tag=1c1505895240
To: sipp <sip:sipp@172.22.2.9:5060>;tag=1
Call-ID: 1-29758@172.22.2.9
CSeq: 1 INFO
Contact: <sip:56700@172.22.168.249>
Supported: em,timer,replaces,path,resource-priority
Allow:
REGISTER,OPTIONS,INVITE,ACK,CANCEL,BYE,NOTIFY,PRACK,REFER,INFO,SUBSCRIBE,UPDATE
User-Agent: AudioCodes-Sip-Gateway/7.20A.260.005
Content-Type: application/x-detect
Content-Length: 30
Type= AMD
SubType= AUTOMATA

```

- b. Upon detection of the start of voice (i.e., the greeting message of the answering machine), the device sends the following INFO message to the application server:

```

INFO sip:sipp@172.22.2.9:5060 SIP/2.0
Via: SIP/2.0/UDP 172.22.168.249;branch=z9hG4bKac482466515
Max-Forwards: 70
From: sut <sip:3000@172.22.168.249:5060>;tag=1c419779142
To: sipp <sip:sipp@172.22.2.9:5060>;tag=1
Call-ID: 1-29753@172.22.2.9
CSeq: 1 INFO
Contact: <sip:56700@172.22.168.249>
Supported: em,timer,replaces,path,resource-priority
Allow:
REGISTER,OPTIONS,INVITE,ACK,CANCEL,BYE,NOTIFY,PRACK,REFER,INFO,SUBSCRIBE,UPDATE
User-Agent: AudioCodes-Sip-Gateway/7.20A.260.005
Content-Type: application/x-detect
Content-Length: 34
Type= PTT
SubType= SPEECH-START

```

- c. Upon detection of the end of voice (i.e., end of the greeting message of the answering machine), the device sends the following INFO message to the application server:

```

INFO sip:sipp@172.22.2.9:5060 SIP/2.0
Via: SIP/2.0/UDP 172.22.168.249;branch=z9hG4bKac482466515
Max-Forwards: 70

```

```

From: sut <sip:3000@172.22.168.249:5060>;tag=1c419779142
To: sipp <sip:sipp@172.22.2.9:5060>;tag=1
Call-ID: 1-29753@172.22.2.9
CSeq: 1 INFO
Contact: <sip:56700@172.22.168.249>
Supported: em,timer,replaces,path,resource-priority
Allow:
REGISTER,OPTIONS,INVITE,ACK,CANCEL,BYE,NOTIFY,PRACK,REFER,INFO,SUBSCRIBE,UPDATE
User-Agent: AudioCodes-Sip-Gateway/7.20A.260.005
Content-Type: application/x-detect
Content-Length: 34
Type= PTT
SubType= SPEECH-END

```

- d. The application server sends its message to leave on the answering message.

■ **Example 2:** This example shows a SIP call flow for event detection and notification of the beep of an answering machine:

- a. The device receives a SIP message containing the X-Detect header from the remote application requesting beep detection:

```

INVITE sip:101@10.33.2.53;user=phone SIP/2.0
Via: SIP/2.0/UDP 10.33.2.53;branch=z9hG4bKac5906
Max-Forwards: 70
From: "anonymous" <sip:anonymous@anonymous.invalid>;tag=1c25298
To: <sip:101@10.33.2.53;user=phone>
Call-ID: 11923@10.33.2.53
CSeq: 1 INVITE
Contact: <sip:100@10.33.2.53>
X-Detect: Request=AMD,CPT

```

- b. The device sends a SIP response message to the remote party, listing the events in the X-Detect header that it can detect:

```

SIP/2.0 200 OK
Via: SIP/2.0/UDP 10.33.2.53;branch=z9hG4bKac5906
From: "anonymous" <sip:anonymous@anonymous.invalid>;tag=1c25298
To: <sip:101@10.33.2.53;user=phone>;tag=1c19282
Call-ID: 11923@10.33.2.53
CSeq: 1 INVITE
Contact: <sip:101@10.33.2.53>
X-Detect: Response=AMD,CPT

```

- c. The device detects the beep of an answering machine and sends an INFO message to the remote party:

```
INFO sip:101@10.33.2.53;user=phone SIP/2.0
Via: SIP/2.0/UDP 10.33.2.53;branch=z9hG4bKac5906
Max-Forwards: 70
From: "anonymous" <sip:anonymous@anonymous.invalid>;tag=1c25298
To: <sip:101@10.33.2.53;user=phone>
Call-ID: 11923@10.33.2.53
CSeq: 1 INVITE
Contact: <sip:100@10.33.2.53>
X-Detect: Response=AMD,CPT
Content-Type: Application/X-Detect
Content-Length: xxx
Type = CPT
Subtype = Beep
```

## Answering Machine Detection (AMD)

The device's Answering Machine Detection (AMD) feature can detect whether an outbound call has been answered by a human (including fax) or an answering machine. The device analyzes the sound (speech) patterns received in the first few seconds of the call to determine whether a human (live person) or machine has answered the call. Typically, when a human answers the call, there is a short "hello ..." followed by silence to wait for the other party to respond. In contrast, when an answering machine answers the call, there is constant speech (answering message) followed by a beep to leave a voice-mail message.

When the device detects what answered the call (human or machine), it can notify this detection type to, for example, a third-party application server used for automatic dialing applications. The X-Detect SIP header is used for requesting event detection and notification. For more information, see [Event Detection and Notification using X-Detect Header](#). The device can also detect beeps played by an answering machine at the end of its greeting message. For more information, see [Detecting Answering Machine Beeps](#).

For the Gateway application, you can also configure the device to disconnect IP-to-Tel calls upon detection of an answering machine on the Tel side. For more information, see [Enabling IP-to-Tel Call Disconnection upon Detection of Answering Machine](#).

The device's default AMD feature is based on voice detection for North American English (see note below). It uses sophisticated speech detection algorithms which are based on hundreds of real-life recordings of answered calls by live voice and answering machines in English. The algorithms are used to detect whether it's human or machine based on voice and silence duration as well as speech patterns. The algorithms of the language-based recordings are compiled into a file called AMD Sensitivity. This file is provided by default, pre-installed on the device.



As the main factor (algorithm) for detecting human and machine is the voice pattern and silence duration, the language on which the detection algorithm is based, is in most cases not important as these factors are similar across most languages. Therefore, the default, pre-installed AMD Sensitivity file, which is based on North American English, may suffice your deployment even if the device is located in a region where a language other than English is used.

However, if (despite the information stated in the note above) you wish to implement AMD in a different language or region, or if you wish to fine-tune the default AMD algorithms to suit your specific deployment, please contact the sales representative of your purchased device for more information on this service. You will be typically required to provide AudioCodes with a database of recorded voices (calls) in the language on which the device's AMD feature can base its voice detector algorithms. The data needed for an accurate calibration should be recorded under the following guidelines:

- **Statistical accuracy:** The number of recorded calls should be as high as possible (at least 100) and varied. The calls must be made to different people. The calls must be made in the specific location in which the device's AMD feature is to operate.
- **Real-life recording:** The recordings should simulate real-life answering of a called person picking up the phone, and without the caller speaking.
- **Normal environment interferences:** The environment in which the recordings are done should simulate real-life scenarios, in other words, not sterile but not too noisy either. Interferences, for example, could include background noises of other people talking, spikes, and car noises.

Once you have provided AudioCodes with your database of recordings, AudioCodes compiles it into a loadable file. For a brief description of the file format and for installing the file on the device, see [AMD Sensitivity File](#).

The device supports up to eight AMD algorithm suites called *Parameter Suites*, where each suite defines a range of detection sensitivity levels. Sensitivity levels refer to how accurately the device's voice detection algorithms can detect if a human or machine has answered the call. Each level supports a different detection sensitivity to human and machine. For example, a specific sensitivity level may be more sensitive to detecting human than machine. In deployments where the likelihood of a call answered by an answering machine is low, it would be advisable to configure the device to use a sensitivity level that is more sensitive to human than machine. In addition, this allows you to tweak your sensitivity to meet local regulatory rules designed to protect consumers from automatic dialers (where, for example, the consumer picks up the phone and hears silence). Each suite can support up to 16 sensitivity levels (0 to 15), except for Parameter Suite 0, which supports up to 8 levels (0 to 7). The default, pre-installed AMD Sensitivity file, based on North American English, provides the following Parameter Suites:

- **Parameter Suite 0 (normal sensitivity)** - contains 8 sensitivity detection levels
- **Parameter Suite 1 (high sensitivity)** - contains 16 sensitivity detection levels

As Parameter Suite 1 provides a greater range of detection sensitivity levels (i.e., higher detection resolution), this may be the preferable suite to use in your deployment. The detected AMD type (human or machine) and success of detecting it correctly are sent in CDR and Syslog messages. For more information, see [Syslog Fields for Answering Machine Detection \(AMD\)](#).

The Parameter Suite and sensitivity level can be applied globally for all calls, or for specific calls using IP Profiles. For enabling AMD and selecting the Parameter Suite and sensitivity level, see [Configuring AMD](#).

The tables below show the success rates of the default, pre-installed AMD Sensitivity file (based on North American English) for correctly detecting "live" human voice and answering machine:

**Table 15-3: Approximate AMD Normal Detection Sensitivity - Parameter Suite 0 (Based on North American English)**

AMD Detection Sensitivity Level	Performance	
	Success Rate for Live Calls	Success Rate for Answering Machine
<b>0</b> (Best for Answering Machine)	-	-
<b>1</b>	82.56%	97.10%
<b>2</b>	85.87%	96.43%
<b>3</b>	88.57%	94.76%
<b>4</b>	88.94%	94.31%
<b>5</b>	90.42%	91.64%
<b>6</b>	90.66%	91.30%
<b>7</b> (Best for Live Calls)	94.72%	76.14%

**Table 15-4: Approximate AMD High Detection Sensitivity - Parameter Suite 1 (Based on North American English)**

AMD Detection Sensitivity Level	Performance	
	Success Rate for Live Calls	Success Rate for Answering Machine

AMD Detection Sensitivity Level	Performance	
<b>0</b> (Best for Answering Machine)	72%	97%
<b>1</b>	77%	96%
<b>2</b>	79%	95%
<b>3</b>	80%	95%
<b>4</b>	84%	94%
<b>5</b>	86%	93%
<b>6</b>	87%	92%
<b>7</b>	88%	91%
<b>8</b>	90%	89%
<b>9</b>	90%	88%
<b>10</b>	91%	87%
<b>11</b>	94%	78%
<b>12</b>	94%	73%
<b>13</b>	95%	65%
<b>14</b>	96%	62%
<b>15</b> (Best for Live Calls)	97%	46%

## Configuring AMD

You can configure AMD for all calls using global AMD parameters or for specific calls using IP Profiles. The procedure below describes how to configure AMD for all calls. To configure AMD for specific calls, use the AMD parameters in the IP Profiles table (see [Configuring IP Profiles](#))

For the Gateway application, you can configure AMD per call based on the called number or Trunk Group. This is done by configuring AMD for a specific IP Profile and then assigning the IP Profile to a Trunk Group in the IP-to-Tel Routing table (see [Configuring IP-to-Tel Routing Rules](#)).



➤ **To configure AMD for all calls:**

1. Open the DSP Settings page (**Setup** menu > **Signaling & Media** tab > **Media** folder > **DSP Settings**):
2. From the 'IPMedia Detectors' drop-down list (EnableDSIPMDetectors), select **Enable**.

**IPMedia Detectors**

Enable

3. Scroll down to the Answer Machine Detector group:

ANSWER MACHINE DETECTOR

Answer Machine Detector Sensitivity Parameter Suite	0
Answer Machine Detector Sensitivity	3
Answer Machine Detector Sensitivity Level	8
Answer Machine Detector Beep Detection Timeout	200
Answer Machine Detector Beep Detection Sensitivity	0

4. Select the AMD algorithm suite:
  - a. In the 'Answer Machine Detector Sensitivity Parameter Suite' field, select the required Parameter Suite included in the installed AMD Sensitivity file.
  - b. In the 'Answer Machine Detector Sensitivity' field, enter the required detection sensitivity level of the selected Parameter Suite.
5. Configure the answering machine beep detection:
  - a. In the 'Answer Machine Detector Beep Detection Timeout' field [AMDBeepDetectionTimeout], enter the duration that the beep detector operates from when detection is initiated.
  - b. In the 'Answer Machine Detector Beep Detection Sensitivity' field [AMDBeepDetectionSensitivity], enter the AMD beep detection sensitivity level.
6. Click **Apply**, and then reset the device with a save-to-flash for your settings to take effect.

For a complete list of AMD-related parameters, see [IP Media Parameters](#).

## Enabling IP-to-Tel Call Disconnection upon Detection of Answering Machine

The device can disconnect an IP-to-Tel call upon detection of an answering machine on the Tel side. Once detected, the device disconnects the call after the receipt of an ISDN Connect from the Tel side and then sends a SIP BYE message to the IP side to disconnect the call. You can enable this feature for all calls (globally) using the [AMDmode] parameter (see procedure below) or for specific calls using IP Profiles where the IP Profile parameter 'AMD Mode' [IpProfile\_AmdMode] is configured to [1] **Disconnect on AMD** (see [Configuring IP Profiles](#)).



This feature is applicable only to the Gateway application (digital interfaces).

➤ **To enable disconnection of IP-to-Tel call upon detection of answering machine:**

1. Open the Gateway Advanced Settings page (**Setup** menu > **Signaling & Media** tab > **Gateway** folder > **Gateway Advanced Settings**).

AMD Mode

Disconnect on AMD

2. From the 'AMD Mode' drop-down list, select **Disconnect on AMD**, and then click **Apply**.

## Automatic Gain Control (AGC)

Automatic Gain Control (AGC) adjusts the energy of the output signal to a required level (volume). This feature compensates for near-far gain differences. AGC estimates the energy of the incoming signal from the IP or Tel side, determined by the 'AGC Redirection' parameter, calculates the essential gain, and then performs amplification. Feedback ensures that the output signal is not clipped. You can configure the required Gain Slope in decibels per second using the 'AGC Slope' parameter and the required signal energy threshold using the 'AGC Target Energy' parameter.

When the AGC first detects an incoming signal, it begins operating in Fast Mode, which allows the AGC to adapt quickly when a conversation starts. This means that the Gain Slope is 8 dB/sec for the first 1.5 seconds. After this period, the Gain Slope is changed to the user-defined value. You can disable or enable the AGC's Fast Mode feature, using the 'AGC Disable Fast Adaptation' parameter. After Fast Mode is used, the signal should be off for two minutes in order to have the feature turned on again.



This feature is applicable only to digital interfaces.

➤ **To configure AGC:**

1. Open the DSP Settings page (**Setup** menu > **Signaling & Media** tab > **Media** folder > **DSP Settings**).
2. From the 'IPMedia Detectors' drop-down list [EnableDSPIPMDetectors], select **Enable**.

IPMedia Detectors

Enable

3. Configure the following AGC parameters:
  - 'Enable AGC' [EnableAGC] - enables the AGC mechanism.
  - 'AGC Slope' [AGCGainSlope] - defines the AGC convergence rate.
  - 'AGC Redirection' [AGCRedirection] - defines the AGC direction.

- 'AGC Target Energy' - defines the signal energy value (dBm) that the AGC attempts to attain.
- 'AGC Minimum Gain' [AGCMinGain] - defines the minimum gain (in dB) by the AGC when activated.
- 'AGC Maximum Gain' [AGCMaxGain] - defines the maximum gain (in dB) by the AGC when activated.
- 'AGC Disable Fast Adaptation' [AGCDisableFastAdaptation] - enables the AGC Fast Adaptation mode.

AGC	
Enable AGC	Disable <input type="button" value="v"/>
AGC Slope	3 <input type="text"/>
AGC Redirection	0 <input type="button" value="v"/>
AGC Target Energy	19 <input type="text"/>
AGC Minimum Gain	20 <input type="text"/> ⚡
AGC Maximum Gain	15 <input type="text"/> ⚡
AGC Disable Fast Adaptation	Disable <input type="button" value="v"/> ⚡

4. Configure the 'Transcoding Mode' [TranscodingMode] parameter to **Force** when using AGC for SBC calls. You can configure this using the global parameter or per IP Profile.
5. Click **Apply**.

## Configuring Ground- or Loop-Start Signaling per Analog Port

The Port Ground Start table lets you configure the signaling control method per analog (FXS or FXO) port. You can set the port to ground-start or loop-start signaling.



- For ground-start signaling, make sure that the device's chassis houses the FXO G module (and not the regular FXO module).
- To support FXO ground-start signaling, set the following additional parameters:
  - ✓ EnableCurrentDisconnect to 1
  - ✓ FXOBetweenRingTime to 300
- The FXS ground-start interface does not generate a ringing voltage; the FXS interface initiates the signaling by grounding the TIP lead.

The following procedure describes how to configure the Port Ground Start table through the Web interface. You can also configure it through ini file (GroundKeyDetection\_x).

### ➤ To configure signaling method per port:

1. Open the Port Ground Start table (**Configuration** tab > **VoIP** menu > **Media** > **Port Ground Start Table**).

	Ground Start
Port no. 1	Enable ▾
Port no. 2	Disable ▾
Port no. 5	Disable ▾
Port no. 6	Disable ▾

- For each port, select one of the following from the Ground Start drop-down list:
  - [0] **Disable** = (Default) Port uses loop-start signaling.
  - [1] **Enable** = Port uses ground-start signaling.
- Click **Apply**, and then reset the device with a save-to-flash for your settings to take effect.

## Configuring DSP Templates

The DSP Template determines the coders that can be used by the device and various other functionalities. For a list of DSP templates and the maximum number of channels supported by each coder, see [Channel Capacity](#). You can select a single DSP Template.



- If you do not configure a DSP template, the device uses the default DSP template (i.e., Template 0).

The following procedure describes how to configure a DSP template through the Web interface. You can also configure it through ini file [DSPVersionTemplateName] or CLI (`configure voip > media settings > DSP-version-template-number`).

### ➤ To select a DSP Template:

- Open the Media Settings page (**Setup** menu > **Signaling & Media** tab > **Media** folder > **Media Settings**).

DSP Version Template Number

- In the 'DSP Version Template Number' field, enter the required DSP Template number.
- Click **Apply**, and then reset the device with a save-to-flash for your settings to take effect.

## DSP Channel Resources for Transcoding

In addition to DSP resources (channels) required for PRI trunk interfaces, the device provides flexibility in providing additional DSP resources for SBC functionality (such as transcoding). This is achieved by the following:

- Obtaining DSP resources from the Media Processing Module (MPM)
- "Borrowing" DSP resources from PRI interfaces

To support these capabilities and to allow optimal management of the required DSP resources, you need to ensure suitable hardware and software configuration, as described below:

■ **Hardware Configuration:** The device can obtain DSP resources using one of the following hardware configurations:

- **MPM Modules:** MPM modules provide additional DSP resources for the SBC application and/or IP media functionality such as detection (e.g., Answer Machine Detection). The device can house up to four MPM modules. When the MPM modules are installed in chassis slots #2, #3, #4, and #5, the device supports up to 192 DSP resources (i.e., 96 transcoding sessions), where each module provides up to 48 DSP resources.



MPM modules can only be installed in slots #1, #2, #3, #4, or #5. For guidelines on MPM slot assignment, refer to the *Hardware Installation Manual*.

- **PRI Modules:** DSP resources can be obtained from installed PRI modules. When this occurs, some trunk span interfaces are "disabled" due to unavailable DSPs.



DSP resources cannot be "borrowed" from CAS span interfaces.

- **Combination of MPM and PRI Modules:** DSP resources can be obtained from both MPM and PRI modules. For example, to achieve 140 channels (with IP media features), you need to use two MPM modules (installed in slots #4 and #5) and one PRI module providing two PRI spans (installed in Slot #1).

■ **Software Configuration:**

- Configure the [MediaChannels] parameter to the maximum number of required IP media channels, regardless of the module from where the channels are obtained.



Configuring the [MediaChannels] parameter to a value that is greater than the available DSP resources that is provided by the MPM module(s) can result in the "stealing" of DSP resources from the B-channels of the PRI spans.

- Configure the [IPmediaChannels] parameter to the number of DSP channels that you want to "borrow" (use) from each PRI module. The setting below shows an example of borrowing DSP channels from PRI modules #1 and #2:

```
[IPMediaChannels]
FORMAT IPMediaChannels_Index = IPMediaChannels_ModuleID,
IPMediaChannels_DSPChannelsReserved;
IPMediaChannels 1 = 1, 15;
IPMediaChannels 2 = 2, 10;
[/IPMediaChannels]
```



- The value of [IPMediaChannels\_DSPChannelsReserved] must be in multiples of 5.
- By default, the MPM module is set to the maximum number of IP media channels. Therefore, there is no need to define it with the [IPmediaChannels] parameter.
- By default, the [IPMediaChannels\_DSPChannelsReserved] parameter for all PRI modules is set to 0 (i.e., no "borrowing" of IP media channels).

## Configuring Media (SRTP) Security

The device supports Secured RTP (SRTP) according to RFC 3711. SRTP is used to encrypt RTP and RTCP transport for protecting VoIP traffic. SRTP requires a cryptographic key exchange mechanism to negotiate the keys. To negotiate the keys, the device supports the Session Description Protocol Security Descriptions (SDES) protocol (according to RFC 4568). The key exchange is done by adding the 'a=crypto' attribute to the SDP. This attribute is used (by both sides) to declare the various supported cipher suites and to attach the encryption key. If negotiation of the encryption data is successful, the call is established. Typically, 'a=crypto' is included in secured media (RTP/SAVP). However, there is also support for including 'a=crypto' in non-secured media (RTP/AVP). In such cases, the media is handled as if the device received two identical media: one secured and one not.

SRTP supports the following cipher suites (all other suites are ignored):

- AES\_CM\_128\_HMAC\_SHA1\_32
- AES\_CM\_128\_HMAC\_SHA1\_80
- AES\_256\_CM\_HMAC\_SHA1\_32 (RFC 6188)
- AES\_256\_CM\_HMAC\_SHA1\_80 (RFC 6188)

When the device is the offering side (SDP offer), it can generate a Master Key Identifier (MKI). You can configure the MKI size globally (by the [SRTPTxPacketMKISize] parameter) or per SIP entity (by the IP Profile parameter [IpProfile\_MKISize]). The length of the MKI is limited to four bytes. If the remote side sends a longer MKI, the key is ignored.



- Gateway application: The device only initiates the MKI size.
- SBC application: The device can forward MKI size transparently for SRTP-to-SRTP media flows or override the MKI size during negotiation (inbound or outbound leg).

The key lifetime field is not supported. However, if it is included in the key it is ignored and the call does not fail. For SBC calls belonging to a specific SIP entity, you can configure the device to remove the lifetime field in the 'a=crypto' attribute (by the IP Profile parameter [IpProfile\_SBCRemoveCryptoLifetimeInSDP]).

For SDES, the keys are sent in the SDP body ('a=crypto') of the SIP message and are typically secured using SIP over TLS (SIPS). The encryption of the keys is in plain text in the SDP. The device supports the following session parameters:

- UNENCRYPTED\_SRTP
- UNENCRYPTED\_SRTCP
- UNAUTHENTICATED\_SRTP

Session parameters should be the same for the local and remote sides. When the device is the offering side, the session parameters are configured by the following parameters - 'Authentication on Transmitted RTP Packets', 'Encryption on Transmitted RTP Packets, and 'Encryption on Transmitted RTCP Packets'. When the device is the answering side, the device adjusts these parameters according to the remote offering. Unsupported session parameters are ignored, and do not cause a call failure.

Below is an example of crypto attributes usage:

```
a=crypto:1 AES_CM_128_HMAC_SHA1_80
inline:PsKoMpHICg+b5X0YLuSvNrlmEh/dAe
a=crypto:2 AES_CM_128_HMAC_SHA1_32
inline:lsPtLoGkBf9a+c6XVzRuMqHIDnEiAd
```

The device also supports symmetric MKI negotiation, whereby it can forward the MKI size received in the SDP offer 'a=crypto' line in the SDP answer. You can enable symmetric MKI globally (by the [EnableSymmetricMKI] parameter) or per SIP entity (using the IP Profile parameter [IpProfile\_EnableSymmetricMKI] and for SBC calls, [IpProfile\_SBCEnforceMKISize]). For more information on symmetric MKI, see [Configuring IP Profiles](#).

You can configure the enforcement policy of SRTP, by the [EnableMediaSecurity] parameter and [IpProfile\_SBCMediaSecurityBehaviour] parameter for SBC calls. For example, if negotiation of the cipher suite fails or if incoming calls exclude encryption information, the device can be configured to reject the calls.

You can also enable the device to validate the authentication of packets for SRTP tunneling for RTP and RTCP. This applies only to SRTP-to-SRTP SBC calls and where the endpoints use the same key. This is configured using the 'SRTP Tunneling Authentication for RTP' and 'SRTP Tunneling Authentication for RTCP' parameters.



- For a detailed description of the SRTP parameters, see [Configuring IP Profiles](#) and [SRTP Parameters](#).
- When SRTP is used, channel capacity may be reduced.

The procedure below describes how to configure SRTP through the Web interface.

➤ **To enable and configure SRTP:**

1. Open the Media Security page (**Setup** menu > **Signaling & Media** tab > **Media** folder > **Media Security**).

GENERAL		AUTHENTICATION & ENCRYPTION	
Media Security	Enable	Authentication on Transmitted RTP Packets	Active
Media Security Behavior	Preferable	Encryption on Transmitted RTP Packets	Active
Offered SRTP Cipher Suites	AES-256-CM-HMAC-SHA1-3	Encryption on Transmitted RTCP Packets	Active
MASTER KEY IDENTIFIER		SRTP Tunneling Authentication for RTP	Disable
Master Key Identifier (MKI) Size	0	SRTP Tunneling Authentication for RTCP	Disable
Symmetric MKI	Disable	GATEWAY SETTINGS	
		Enable Rekey After 181	Disable

- From the 'Media Security' drop-down list [EnableMediaSecurity], select **Enable** to enable SRTP.
- From the 'Offered SRTP Cipher Suites' drop-down list [SRTPofferedSuites], select the supported cipher suite.
- Configure the other SRTP parameters as required.
- Click **Apply**, and then reset the device with a save-to-flash for your settings to take effect.



## 16 Services

This section describes configuration for various supported services.

### DHCP Server Functionality

The device can serve as a Dynamic Host Configuration Protocol (DHCP) server that assigns and manages IP addresses from a user-defined address pool for DHCP clients. The DHCP server can also be configured to supply additional information to the requesting client such as the IP address of the TFTP server, DNS server, NTP server, and default router (gateway). The DHCP server functionality complies with IETF RFC 2131 and RFC 2132.

The DHCP server can service up to 600 DHCP clients. The DHCP clients are typically IP phones that are connected to the device's LAN port.

The DHCP server is activated when you configure a valid entry in the DHCP Servers table (see [Configuring the DHCP Server](#)) and associate it with an active IP network interface listed in the IP Interfaces table. When an IP phone on the LAN requests an IP address, the DHCP server allocates one from the address pool. In scenarios of duplicated IP addresses on the LAN (i.e., an unauthorized network device using one of the IP addresses of the DHCP address pool), the DHCP server detects this condition using an Address Resolution Protocol (ARP) request and temporarily blacklists the duplicated address.

You can also configure the DHCP server to respond **only** to DHCPDiscover requests from DHCP clients that contain a specific value for Option 60 (Vendor Class Identification). For more information, see [Configuring the Vendor Class Identifier](#).

### Configuring the DHCP Server

The DHCP Servers table lets you configure the device's DHCP server (only one). The DHCP Server table configures the DHCP server implementation. This includes configuring the DHCP IP address pool from where IP addresses are allocated to requesting DHCP clients, as well as configuring other information such as IP addresses of the DNS server, NTP server, default router (gateway), and SIP proxy server. The DHCP server sends the information in DHCP Options. The table below lists the DHCP Options that the DHCP server sends to the DHCP client and which are configurable in the DHCP Servers table.

**Table 16-1: Configurable DHCP Options in DHCP Servers Table**

DHCP Option Code	DHCP Option Name
Option 53	DHCP Message Type
Option 54	DHCP Server Identifier
Option 51	IP Address Lease Time

DHCP Option Code	DHCP Option Name
Option 1	Subnet Mask
Option 3	Router
Option 6	Domain Name Server
Option 44	NetBIOS Name Server
Option 46	NetBIOS Node Type
Option 42	Network Time Protocol Server
Option 2	Time Offset
Option 66	TFTP Server Name
Option 67	Boot file Name
Option 120	SIP Server

Once you have configured the DHCP server, you can configure the following:

- DHCP Vendor Class Identifier names (DHCP Option 60) - see [Configuring the Vendor Class Identifier](#)
- Additional DHCP Options - see [Configuring Additional DHCP Options](#)
- Static IP addresses for DHCP clients - see [Configuring Static IP Addresses for DHCP Clients](#)



If you configure additional DHCP Options in the DHCP Option table, they override the default ones, which are configured in the DHCP Servers table. For example, if you configure Option 67 in the DHCP Option table, the device uses the value configured in the DHCP Option table instead of the value configured in the DHCP Servers table.

To view and delete currently serviced DHCP clients, see [Viewing and Deleting DHCP Clients](#).

The following procedure describes how to configure the DHCP server through the Web interface. You can also configure it through ini file [DhcpServer] or CLI (`configure network > dhcp-server server <index>`).

➤ **To configure the device's DHCP server:**

1. Open the DHCP Servers page (**Setup** menu > **IP Network** tab > **Advanced** folder > **DHCP Servers**).
2. Click **New**; the following dialog box appears:

The screenshot shows the 'DHCP Servers' configuration window with the following sections and values:

- GENERAL**
  - Index: 0
  - Interface Name: -- (with a 'View' link)
  - Start IP Address: 192.168.0.100
  - End IP Address: 192.168.0.149
  - Subnet Mask: 255.255.255.0
  - Lease Time: 1440
- DNS**
  - DNS Server 1: 0.0.0.0
  - DNS Server 2: 0.0.0.0
- TIME AND DATE**
  - NTP Server 1: 0.0.0.0
  - NTP Server 2: 0.0.0.0
  - Time Offset: 0
- BOOT FILE**
  - TFTP Server Name: (empty)
  - Boot File Name: (empty)
  - Expand Boot-File Name: Yes
- ROUTER**
  - Override Router: 0.0.0.0

3. Configure a DHCP server according to the parameters described in the table below.
4. Click **Apply**.

**Table 16-2: DHCP Servers Table Parameter Descriptions**

Parameter	Description
<b>General</b>	
'Index' dhcp server <index>	Defines an index number for the new table row. <b>Note:</b> <ul style="list-style-type: none"> <li>Each row must be configured with a unique index.</li> <li>Currently, only one index row can be configured.</li> </ul>
'Interface Name' network-if [DhcpServer_ InterfaceName]	Associates an IP network interface on which the DHCP server operates. The IP interfaces are configured in the IP Interfaces table (see <a href="#">Configuring IP Network Interfaces</a> ). By default, no value is defined.
'Start IP Address' start-address [DhcpServer_ StartIPAddress]	Defines the starting IP address (IPv4 address in dotted-decimal format) of the IP address pool range used by the DHCP server to allocate addresses. The default value is 192.168.0.100. <b>Note:</b> The IP address must belong to the same subnet as the associated interface's IP address.

Parameter	Description
'End IP Address' end-address [DhcpServer_ EndIPAddress]	<p>Defines the ending IP address (IPv4 address in dotted-decimal format) of the IP address pool range used by the DHCP server to allocate addresses.</p> <p>The default value is 192.168.0.149.</p> <p><b>Note:</b> The IP address must belong to the same subnet as the associated interface's IP address and must be "greater or equal" to the starting IP address defined in 'Start IP Address'.</p>
'Subnet Mask' subnet-mask [DhcpServer_ SubnetMask]	<p>Defines the subnet mask (for IPv4 addresses) for the DHCP client. The value is sent in DHCP Option 1 (Subnet Mask).</p> <p>The default value is 0.0.0.0.</p> <p><b>Note:</b> The value must be "narrower" or equal to the subnet mask of the associated interface's IP address. If set to "0.0.0.0", the subnet mask of the associated interface is used.</p>
'Lease Time' lease-time [DhcpServer_ LeaseTime]	<p>Defines the duration (in minutes) of the lease time to a DHCP client for using an assigned IP address. The client needs to request a new address before this time expires. The value is sent in DHCP Option 51 (IP Address Lease Time).</p> <p>The valid value range is 0 to 214,7483,647. The default is 1440. When set to 0, the lease time is infinite.</p>
DNS	
'DNS Server 1' dns-server-1 [DhcpServer_ DNSServer1]	<p>Defines the IP address (IPv4) of the primary DNS server that the DHCP server assigns to the DHCP client. The value is sent in DHCP Option 6 (Domain Name Server).</p> <p>The default value is 0.0.0.0.</p>
'DNS Server 2' dns-server-2 [DhcpServer_ DNSServer2]	<p>Defines the IP address (IPv4) of the secondary DNS server that the DHCP server assigns to the DHCP client. The value is sent in DHCP Option 6 (Domain Name Server).</p> <p>The default value is 0.0.0.0.</p>
NetBIOS	
'NetBIOS Name Server' netbios-server [DhcpServer_ NetbiosNameServer]	<p>Defines the IP address (IPv4) of the NetBIOS WINS server that is available to a Microsoft DHCP client. The value is sent in DHCP Option 44 (NetBIOS Name Server).</p> <p>The default value is 0.0.0.0.</p>
'NetBIOS Node Type'	Defines the node type of the NetBIOS WINS server for a

Parameter	Description
netbios-node-type [DhcpServer_ NetbiosNodeType]	Microsoft DHCP client. The value is sent in DHCP Option 46 (NetBIOS Node Type). <ul style="list-style-type: none"> <li>■ [0] <b>Broadcast</b> (default)</li> <li>■ [1] <b>peer-to-peer</b></li> <li>■ [4] <b>Mixed</b></li> <li>■ [8] <b>Hybrid</b></li> </ul>
<b>Time and Date</b>	
'NTP Server 1' ntp-server-1 [DhcpServer_ NTPServer1]	Defines the IP address (IPv4) of the primary NTP server that the DHCP server assigns to the DHCP client. The value is sent in DHCP Option 42 (Network Time Protocol Server). The default value is 0.0.0.0.
'NTP Server 2' ntp-server-2 [DhcpServer_ NTPServer2]	Defines the IP address (IPv4) of the secondary NTP server that the DHCP server assigns to the DHCP client. The value is sent in DHCP Option 42 (Network Time Protocol Server). The default value is 0.0.0.0.
'Time Offset' time-offset [DhcpServer_ TimeOffset]	Defines the Greenwich Mean Time (GMT) offset (in seconds) that the DHCP server assigns to the DHCP client. The value is sent in DHCP Option 2 (Time Offset). The valid range is -43200 to 43200. The default is 0.
<b>Boot File</b>	
'TFTP Server Name' tftp-server-name [DhcpServer_ TftpServer]	Defines the IP address or name of the TFTP server that the DHCP server assigns to the DHCP client. The TFTP server typically stores the boot file image, defined in the 'Boot file name' parameter (see below). The value is sent in DHCP Option 66 (TFTP Server Name). The valid value is a string of up to 80 characters. By default, no value is defined.
'Boot File Name' boot-file-name [DhcpServer_ BootFileName]	Defines the name of the boot file image for the DHCP client. The boot file stores the boot image for the client. The boot image is typically the operating system the client uses to load (downloaded from a boot server). The value is sent in DHCP Option 67 (Bootfile Name). To define the server storing the file, use the 'TFTP Server' parameter (see above). The valid value is a string of up to 256 characters. By default, no

Parameter	Description
	<p>value is defined.</p> <p>The name can also include the following case-sensitive placeholder strings that are replaced with actual values if the 'Expand Boot-file Name' parameter is set to <b>Yes</b>:</p> <ul style="list-style-type: none"> <li>■ &lt;MAC&gt;: Replaced by the MAC address of the client (e.g., <i>boot_&lt;MAC&gt;.ini</i>). The MAC address is obtained in the client's DHCP request.</li> <li>■ &lt;IP&gt;: Replaced by the IP address assigned by the DHCP server to the client.</li> </ul>
<p>'Expand Boot-File Name'</p> <p>expand-boot-file-name</p> <p>[DhcpServer_ExpandBootfileName]</p>	<p>Enables the use of the placeholders in the boot file name, defined in the 'Boot file name' parameter.</p> <ul style="list-style-type: none"> <li>■ [0] <b>No</b></li> <li>■ [1] <b>Yes</b> (default)</li> </ul>
<b>Router</b>	
<p>'Override Router'</p> <p>override-router-address</p> <p>[DhcpServer_OverrideRouter]</p>	<p>Defines the IP address (IPv4 in dotted-decimal notation) of the default router that the DHCP server assigns the DHCP client. The value is sent in DHCP Option 3 (Router).</p> <p>The default value is 0.0.0.0. If not specified (empty or "0.0.0.0"), the IP address of the default gateway configured in the IP Interfaces table for the IP network interface that you associated with the DHCP server (see the 'Interface Name' parameter above) is used.</p>
<b>SIP</b>	
<p>'SIP Server'</p> <p>sip-server</p> <p>[DhcpServer_SipServer]</p>	<p>Defines the IP address or DNS name of the SIP server that the DHCP server assigns the DHCP client. The client uses this SIP server for its outbound SIP requests. The value is sent in DHCP Option 120 (SIP Server). After defining the parameter, use the 'SIP server type' parameter (see below) to define the type of address (FQDN or IP address).</p> <p>The valid value is a string of up to 256 characters. The default is 0.0.0.0.</p>
<p>'SIP Server Type'</p> <p>sip-server-type</p>	<p>Defines the type of SIP server address. The actual address is defined in the 'SIP server' parameter (see above). Encoding is done per SIP Server Type, as defined in RFC 3361.</p>

Parameter	Description
[DhcpServer_ SipServerType]	<ul style="list-style-type: none"> <li>■ [0] <b>DNS names</b> = (Default) The 'SIP server' parameter is configured with an FQDN of the SIP server.</li> <li>■ [1] <b>IP address</b> = The 'SIP server' parameter configured with an IP address of the SIP server.</li> </ul>

## Configuring the Vendor Class Identifier

The DHCP Vendor Class table lets you configure up to 10 Vendor Class Identifier (VCI) names (DHCP Option 60). When the table is configured, the device's DHCP server responds only to DHCPDiscover requests that contain Option 60 and that match one of the DHCP VCIs configured in the table. If you have not configured any entries in the table, the DHCP server responds to all DHCPDiscover requests, regardless of the VCI.

The VCI is a string that identifies the vendor and functionality of a DHCP client to the DHCP server. For example, Option 60 can show the unique type of hardware (e.g., "AudioCodes 440HD IP Phone") or firmware of the DHCP client. The DHCP server can then differentiate between DHCP clients and process their requests accordingly.

The following procedure describes how to configure the DHCP VCIs through the Web interface. You can also configure it through ini file [DhcpVendorClass] or CLI (`configure network > dhcp-server vendor-class`).

### ➤ To configure DHCP Vendor Class Identifiers:

1. Open the DHCP Servers table (see [Configuring the DHCP Server](#)).
2. Select the row of the desired DHCP server for which you want to configure VCIs, and then click the **DHCP Vendor Class** link located below the table; the DHCP Vendor Class table opens.
3. Click **New**; the following dialog box appears:

4. Configure a VCI for the DHCP server according to the parameters described in the table below.

5. Click **Apply**.**Table 16-3: DHCP Vendor Class Table Parameter Descriptions**

Parameter	Description
'Index' dhcp vendor- class <index> [DhcpVendorClass_ Index]	Defines an index number for the new table row. <b>Note:</b> Each row must be configured with a unique index.
'DHCP Server Index' dhcp-server- number [DhcpVendorClass_ DhcpServerIndex]	Associates the VCI table entry with a DHCP server that you configured in <a href="#">Configuring the DHCP Server</a> . <b>Note:</b> Currently, only one DHCP server (Index 0) can be configured and therefore, the parameter is always set at 0.
'Vendor Class Identifier' vendor-class [DhcpVendorClass_ VendorClassId]	Defines the value of the VCI DHCP Option 60. The valid value is a string of up to 80 characters. By default, no value is defined.

## Configuring Additional DHCP Options

The DHCP Option table lets you configure up to 10 additional DHCP Options that the DHCP server can use to service the DHCP client. These DHCP Options are included in the DHCP Offer response sent by the DHCP server.

The following procedure describes how to configure DHCP Options through the Web interface. You can also configure it through ini file [DhcpOption] or CLI (`configure network > dhcp-server option`).



The additional DHCP Options configured in the DHCP Option table override the default ones, which are configured in the DHCP Servers table. In other words, if you configure Option 67 in the DHCP Option table, the device uses the value configured in the DHCP Option table instead of the value configured in the DHCP Servers table.

### ➤ To configure DHCP Options:

1. Open the DHCP Servers table (see [Configuring the DHCP Server](#)).
2. Select the row of the desired DHCP server for which you want to configure additional DHCP Options, and then click the **DHCP Option** link located below the table; the DHCP Option table opens.
3. Click **New**; the following dialog box appears:



The screenshot shows a configuration window titled "DHCP Option". It has a "GENERAL" tab selected. The fields and their values are as follows:

- Index:** 0
- DHCP Server Index:** -- (with a "View" link next to it)
- Option:** 159
- Type:** ASCII
- Value:** (empty text box)
- Expand Value:** Yes

4. Configure additional DHCP Options for the DHCP server according to the parameters described in the table below.
5. Click **Apply**.

**Table 16-4: DHCP Option Table Parameter Descriptions**

Parameter	Description
'Index' dhcp option [DhcpOption_Index]	Defines an index number for the new table row. <b>Note:</b> Each row must be configured with a unique index.
'DHCP Server Index' dhcp-server-number [DhcpOption_DhcpServerIndex]	Associates the DHCP Option table entry with a DHCP server that you configured in <a href="#">Configuring the DHCP Server</a> . <b>Note:</b> Currently, only one DHCP server (Index 0) can be configured and therefore, the parameter is always set at 0.
'Option' option [DhcpOption_Option]	Defines the code of the DHCP Option. The valid value is 1 to 254. The default is 159. For example, for DHCP Option 150 (Cisco proprietary for defining multiple TFTP server IP addresses), enter the value 150.
'Type' type [DhcpOption_Type]	Defines the format (type) of the DHCP Option value that is configured in the 'Value' parameter (see below). <ul style="list-style-type: none"><li>■ [0] <b>ASCII</b> = (Default) Plain-text string (e.g., when the value is a domain name).</li></ul>

Parameter	Description
	<ul style="list-style-type: none"> <li>■ [1] <b>IP address</b> = IPv4 address.</li> <li>■ [2] <b>Hexadecimal</b> = Hexadecimal-encoded string.</li> </ul> <p>For example, if you configure the 'Value' parameter to "company.com" (without quotation marks), you need to configure the 'Type' parameter to <b>ASCII</b>.</p>
'Value' value [DhcpOption_Value]	<p>Defines the value of the DHCP Option. For example, if you are using Option 66, the parameter is used for specifying the TFTP provisioning server (e.g., <code>http://192.168.3.155:5000/provisioning/</code>).</p> <p>The valid value is a string of up to 256 characters. By default, no value is defined. For IP addresses, the value can be one or more IPv4 addresses, each separated by a comma (e.g., <code>192.168.10.5,192.168.10.20</code>). For hexadecimal values, the value is a hexadecimal string (e.g., <code>c0a80a05</code>).</p> <p>You can also configure the parameter with case-sensitive placeholder strings that are replaced with actual values if the 'Expand Value' parameter (see below) is set to <b>Yes</b>:</p> <ul style="list-style-type: none"> <li>■ &lt;MAC&gt;: Replaced by the MAC address of the client. The MAC address is obtained from the client's DHCP request. For example, the parameter can be set to: <code>http://192.168.3.155:5000/provisioning/cfg_&lt;MAC&gt;.txt</code></li> <li>■ &lt;IP&gt;: Replaced by the IP address assigned by the DHCP server to the client. For example, the parameter can be set to: <code>http://192.168.3.155:5000/provisioning/cfg_&lt;IP&gt;.txt</code></li> </ul>
'Expand Value' expand-value [DhcpOption_ExpandValue]	<p>Enables the use of the special placeholder strings, "&lt;MAC&gt;" and "&lt;IP&gt;" for configuring the 'Value' parameter (see above).</p> <ul style="list-style-type: none"> <li>■ [0] <b>No</b></li> <li>■ [1] <b>Yes</b> (default)</li> </ul> <p><b>Note:</b> The parameter is applicable only to values of type ASCII (see the 'Type' parameter, above).</p>

## Configuring Static IP Addresses for DHCP Clients

The DHCP Static IP table lets you configure up to 100 DHCP clients with static IP addresses. The static IP address is a "reserved" IP address for a specified DHCP client defined by MAC address. In other words, instead of assigning the DHCP client with a different IP address upon each IP address lease renewal request, the DHCP server assigns the client the same IP address. For DHCP clients that are not listed in the table, the DHCP server assigns a random IP address from its address pool, as in normal operation.

The following procedure describes how to configure static IP addresses for DHCP clients through the Web interface. You can also configure it through ini file [DhcpStaticIP] or CLI (`configure network > dhcp-server static-ip <index>`).

### ➤ To configure static IP addresses for DHCP clients:

1. Open the DHCP Servers table (see [Configuring the DHCP Server](#)).
2. Select the row of the desired DHCP server for which you want to configure static IP addresses for DHCP clients, and then click the **DHCP Static IP** link located below the table; the DHCP Static IP table opens.
3. Click **New**; the following dialog box appears:

4. Configure a static IP address for a specific DHCP client according to the parameters described in the table below.
5. Click **Apply**.

**Table 16-5: DHCP Static IP Table Parameter Descriptions**

Parameter	Description
'Index' <code>dhcp static-ip &lt;index&gt;</code>	Defines an index number for the new table row. <b>Note:</b> Each row must be configured with a unique index.

Parameter	Description
[DhcpStaticIP_Index]	
'DHCP Server Index' dhcp-server-number [DhcpStaticIP_DhcpServerIndex]	Associates the DHCP Static IP table entry with a DHCP server that you configured in <a href="#">Configuring the DHCP Server</a> . <b>Note:</b> Currently, only one DHCP server (Index 0) can be configured and therefore, the parameter is always set at 0.
'IP Address' ip-address [DhcpStaticIP_IPAddress]	Defines the "reserved", static IP address (IPv4) to assign the DHCP client. The default is 0.0.0.0.
'MAC Address' mac-address [DhcpStaticIP_MACAddress]	Defines the DHCP client by MAC address (in hexadecimal format). The valid value is a string of up to 20 characters. The format includes six groups of two hexadecimal digits, each separated by a colon. The default MAC address is 00:90:8f:00:00:00.

## Viewing and Deleting DHCP Clients

The DHCP Clients table lets you view currently serviced DHCP clients by the DHCP server. The table also lets you delete DHCP clients. If you delete a client, the DHCP server ends the lease of the IP address to the client and the IP address becomes available for allocation by the DHCP server to another client.

The following procedure describes how to view DHCP clients through the Web interface. You can also view this through CLI:

- To view DHCP clients:

```
# show network dhcp clients
```

- To view DHCP clients according to IP address:

```
# show network dhcp ip
```

- To view DHCP clients according to MAC address:

```
# show network dhcp mac
```

- To view DHCP clients that have been blacklisted from DHCP implementation (due to duplicated IP addresses in the network, where another device is using the same IP address as the one assigned to the client):

```
# show network dhcp black-list
```

➤ **To view or delete DHCP clients:**

1. Open the DHCP Servers table (see [Configuring the DHCP Server](#)).
2. Select the row of the desired DHCP server for which you want to view DHCP clients, and then click the **DHCP Clients** link located below the table; the DHCP Clients table opens:

INDEX ↕	DHCP SERVER INDEX	IP ADDRESS	MAC ADDRESS	LEASE EXPIRATION
---------	-------------------	------------	-------------	------------------

The table displays the following per client:

- **Index:** Table index number.
  - **DHCP Server Index:** The index number of the configured DHCP server scope in the DHCP Server table (see [Configuring the DHCP Server](#)) with which the client is associated.
  - **IP Address:** IP address assigned to the DHCP client by the DHCP server.
  - **MAC Address:** MAC address of the DHCP client.
  - **Lease Expiration:** Date on which the lease of the DHCP client's IP address obtained from the DHCP server expires.
3. To delete a client:
    - a. Select the table row index of the DHCP client that you want to delete.
    - b. Click the **Action** button, and then from the drop-down menu, choose **Delete**; a confirmation message appears.
    - c. Click **OK** to confirm deletion.

## On-Demand SIPRec Sessions

The device supports on-demand SIPRec sessions. It can be triggered to start or stop recording at any stage of a connected call. In other words, it can perform multiple recordings per call.

Starting and stopping recording is triggered by the receipt of a SIP INFO message containing AudioCodes' proprietary X-AC-Action header with the 'start-siprec' parameter for starting recording, or 'stop-siprec' for stopping recording. The following shows an example of an incoming SIP INFO message that triggers a SIPRec session:

```
INFO sip:alice@pc33.example.com SIP/2.0
Via: SIP/2.0/UDP 192.0.2.2:5060;branch=z9hG4bKnabcdf
To: Bob <sip:bob@example.com>;tag=a6c85cf
```

```
From: Alice <sip:alice@example.com>;tag=1928301774
Call-Id: a84b4c76e66710@pc33.example.com
CSeq: 314333 INFO
X-AC-Action: start-siprec
Content-Length: 0
```

The only required configuration is to add a Message Manipulation rule that adds the IP Group of the SRS to the X-AC-Action header in the incoming SIP INFO message, using the 'recording-ip-group' parameter:

```
X-AC-Action: start-siprec;recording-ip-group="<SRS IP Group>"
```

- or -

```
X-AC-Action: start-siprec;recording-ip-group="<SRS IP Group>";recorded-
side=peer
```

Where:

- 'recording-ip-group' indicates the name of the recording IP Group (i.e., SRS). The value of this parameter can be enclosed in quotes or without quotes.
- 'recorded-side=peer' is an optional parameter that indicates recording should be done on the peer side (i.e., not the side receiving the X-AC-Action header).

Configure the Message Manipulation rule in the Message Manipulations table (see [Configuring SIP Message Manipulation](#) on page 647) as follows:

- 'Name': IP Group of SRS for Start SIPREC
- 'Manipulation Set ID': 0
- 'Message Type': **Info**
- 'Condition': **Header.X-AC-Action contains 'start-siprec'**
- 'Action Subject': **Header.X-AC-Action**
- 'Action Type': **Modify**
- 'Action Value': **'start-siprec;recording-ip-group=\"IPGroup\_2\"'**

Assign the above Message Manipulation Set ID to the IP Group of the sender of the SIP INFO message (i.e., not the SRS IP Group).



- The feature is applicable only to the SBC application.
- You don't need to configure anything in the SIP Recording Rules table for this feature.



- The device rejects the INFO message (with a 500 response) if any of the following scenarios exist (call is not affected):
  - ✓ The 'recording-ip-group' parameter doesn't exist.
  - ✓ The X-AC-Action header contains no parameters.
  - ✓ The X-AC-Action header contains the 'stop-siprec' parameter even though SIP recording was not started.
  - ✓ The X-AC-Action header contains the 'start-siprec' parameter on a recorded-side while there is an active SIPRec session on the other side.
  - ✓ Three recording sessions are already in progress (maximum).
- The device forwards information in SIP INFO messages such as the transcript of the call from the SRS to the initiator of the on-demand SIPRec session.

## RADIUS-based Services

The device supports Remote Authentication Dial In User Service (RADIUS) by acting as a RADIUS client. You can use RADIUS for the following:

- Authentication and authorization of management users (login username and password) to gain access to the device's management interface.
- Accounting where the device sends accounting data of SIP calls as call detail records (CDR) to a RADIUS Accounting server (for third-party billing purposes).

## Enabling RADIUS Services

Before you can implement any RADIUS services, you must enable the RADIUS feature, as described in the procedure below.

### ➤ To enable RADIUS:

1. Open the Authentication Server page (**Setup** menu > **Administration** tab > **Web & CLI** folder > **Authentication Server**).



2. Under the RADIUS group, from the 'Enable RADIUS Access Control' drop-down list, select **Enable**.
3. Click **Apply**, and then reset the device with a save-to-flash for your settings to take effect.

## Configuring RADIUS Servers

The RADIUS Servers table lets you configure up to three RADIUS servers. You can use RADIUS servers for RADIUS-based management-user login authentication and/or RADIUS-based accounting (sending of SIP CDRs to the RADIUS server).

When multiple RADIUS servers are configured, RADIUS server redundancy can be implemented. When the primary RADIUS server is down, the device sends a RADIUS request twice (one retransmission) and if both fail (i.e., no response), the device considers the server as down and attempts to send requests to the next server. The device continues sending RADIUS requests to the redundant RADIUS server even if the primary server returns to service later on. However, if a device reset occurs, the device sends RADIUS requests to the primary RADIUS server. By default, the device waits for up to two seconds (i.e., timeout) for a response from the RADIUS server for RADIUS requests and retransmission before it considers the server as down.

For each RADIUS server, the IP address, port, and shared secret can be configured. Each RADIUS server can be defined for RADIUS-based login authentication and/or RADIUS-based accounting. By setting the relevant port (authentication or accounting) to "0" disables the corresponding functionality. If both ports are configured, the RADIUS server is used for authentication and accounting. All servers configured with non-zero Authorization ports form an Authorization redundancy group and the device sends authorization requests to one of them, depending on their availability. All servers configured with non-zero Accounting ports form an Accounting redundancy group and the device sends accounting CDRs to one of them, depending on their availability. Below are example configurations:

- Only one RADIUS server is configured and used for authorization and accounting purposes (no redundancy). Therefore, both the Authorization and Accounting ports are defined.
- Three RADIUS servers are configured:
  - Two servers are used for authorization purposes only, providing redundancy. Therefore, only the Authorization ports are defined, while the Accounting ports are set to 0.
  - One server is used for accounting purposes only (i.e., no redundancy). Therefore, only the Accounting port is defined, while the Authorization port is set to 0.
- Two RADIUS servers are configured and used for authorization and accounting purposes, providing redundancy. Therefore, both the Authorization and Accounting ports are defined.

The status of the RADIUS servers can be viewed through CLI:

```
# show system radius servers status
```

The example below shows the status of two RADIUS servers in redundancy mode for authorization and accounting:

```
servers 0
ip-address 10.4.4.203
auth-port 1812
auth-ha-state "ACTIVE"
acc-port 1813
acc-ha-state "ACTIVE"
```



```
servers 1
ip-address 10.4.4.202
auth-port 1812
auth-ha-state "STANDBY"
acc-port 1813
acc-ha-state "STANDBY"
```

Where *auth-ha-state* and *acc-ha-state* display the authentication and accounting redundancy status respectively. "ACTIVE" means that the server was used for the last sent authentication or accounting request; "STANDBY" means that the server was not used in the last sent request.



- To enable and configure RADIUS-based accounting, see [Configuring RADIUS Accounting](#).
- The device can send up to 201 concurrent RADIUS requests per RADIUS service type (Accounting or Authentication), per RADIUS server (up to three servers per service type), and per local port (up to 1 local port).

The following procedure describes how to configure a RADIUS server through the Web interface. You can also configure it through ini file [RadiusServers] or CLI (`configure system > radius servers`).

➤ **To configure a RADIUS server:**

1. Open the RADIUS Servers table (**Setup** menu > **IP Network** tab > **RADIUS & LDAP** folder > **RADIUS Servers**).
2. Click **New**; the following dialog box appears:

GENERAL	
Index	1
IP Address	0.0.0.0
Authentication Port	1645
Accounting Port	1646
Shared Secret	

3. Configure a RADIUS server according to the parameters described in the table below.
4. Click **Apply**.

Table 16-6: RADIUS Servers Table Parameter Descriptions

Parameter	Description
'Index' [RadiusServers_ Index]	Defines an index number for the new table row. <b>Note:</b> Each row must be configured with a unique index.
'IP Address' ip-address [RadiusServers_ IPAddress]	Defines the IP address of the RADIUS server (in dotted-decimal notation).
'Authentication Port' auth-port [RadiusServers_ AuthenticationPort]	Defines the port of the RADIUS Authentication server for authenticating the device with the RADIUS server. When set to any value other than 0, the RADIUS server is used by the device for RADIUS-based management-user login authentication. When set to 0, RADIUS-based login authentication is not implemented. The valid value is 0 to any integer. The default is 1645.
'Accounting Port' acc-port [RadiusServers_ AccountingPort]	Defines the port of the RADIUS Accounting server to where the device sends accounting data of SIP calls as call detail records (CDR). When set to any value other than 0, the RADIUS server is used by the device for RADIUS-based accounting (CDR). When set to 0, RADIUS-based accounting is not implemented. The valid value is 0 to any integer. The default is 1646.
'Shared Secret' shared-secret [RadiusServers_ SharedSecret]	Defines the shared secret (password) for authenticating the device with the RADIUS server. This should be a cryptically strong password. The shared secret is also used by the RADIUS server to verify the authentication of the RADIUS messages sent by the device (i.e., message integrity). The valid value is up to 48 characters. By default, no value is defined. <b>Note:</b> The password cannot be configured with wide characters.

## Configuring Interface for RADIUS Communication

The device can communicate with the RADIUS server through its' OAMP (default) or SIP Control network interface. To change the interface for RADIUS traffic, use the [RadiusTrafficType] parameter.



- If you configure the parameter to Control, make sure that only one Control interface is configured in the IP Interfaces table (see [Configuring IP Network Interfaces](#));



otherwise, RADIUS communication fails.

## Configuring RADIUS Packet Retransmission

You can configure the device to resend packets to the RADIUS server if no response is received from the server. This functionality is applicable to RADIUS-based user authentication and RADIUS-based accounting.

### ➤ To configure RADIUS packet retransmission:

1. Open the Authentication Server page (**Setup** menu > **Administration** tab > **Web & CLI** folder > **Authentication Server**).

RADIUS Response Timeout [sec]	<input type="text" value="2"/>
RADIUS Packets Retransmission	<input type="text" value="1"/>

2. Under the RADIUS group, do the following:
  - In the 'RADIUS Packets Retransmission' field (RADIUSRetransmission), enter the maximum number of RADIUS retransmissions that the device performs if no response is received from the RADIUS server.
  - In the 'RADIUS Response Time Out' field (RadiusTO), enter the interval (in seconds) that the device waits for a response before sending a RADIUS retransmission.
3. Click **Apply**.

## Configuring the RADIUS Vendor ID

The vendor-specific attribute (VSA) identifies the device to the RADIUS server using the Vendor ID (as registered with the Internet Assigned Numbers Authority or IANA). The device's default vendor ID is 5003 which can be changed, as described in the following procedure. For an example of using the Vendor ID, see [Setting Up a Third-Party RADIUS Server](#). The procedure is applicable to both RADIUS-based user authentication and RADIUS-based accounting.



The Vendor ID must be the same as the Vendor ID set on the third-party RADIUS server. See the example for setting up a third-party RADIUS server in [Setting Up a Third-Party RADIUS Server](#).

### ➤ To configure the RADIUS Vendor ID:

1. Open the Authentication Server page (**Setup** menu > **Administration** tab > **Web & CLI** folder > **Authentication Server**).

RADIUS VSA Vendor ID	<input type="text" value="5003"/>
----------------------	-----------------------------------

2. Under the RADIUS group, in the 'RADIUS VSA Vendor ID' field, enter the **same** vendor ID number as set on the third-party RADIUS server.
3. Click **Apply**.

## RADIUS-based Management User Authentication

You can enhance security for your device by implementing Remote Authentication Dial-In User Service (RADIUS per RFCs 2865) for authenticating multiple management user accounts of the device's embedded Web and Telnet (CLI) servers. Thus, RADIUS also prevents unauthorized access to your device.

When RADIUS authentication is not used, the user's login username and password are locally authenticated by the device using the Local Users table (see [Configuring Management User Accounts](#)). However, you can configure the device to use the Local Users table as a fallback mechanism if the RADIUS server does not respond.



If you enable RADIUS-based user login authentication, when users with Security Administrator privilege level log in to the device's CLI, they are automatically given access to the CLI privileged mode (“#”). For all other user privilege levels, the user needs to run the **enable** command and then enter the password to access the CLI privileged mode.

When RADIUS authentication is used, the RADIUS server stores the user accounts - usernames, passwords, and access levels (authorization). When a management user (client) tries to access the device, the device sends the RADIUS server the user's username and password for authentication. The RADIUS server replies with an acceptance or a rejection notification. During the RADIUS authentication process, the device's Web interface is blocked until an acceptance response is received from the RADIUS server. Communication between the device and the RADIUS server is done using a shared secret, which is not transmitted over the network.

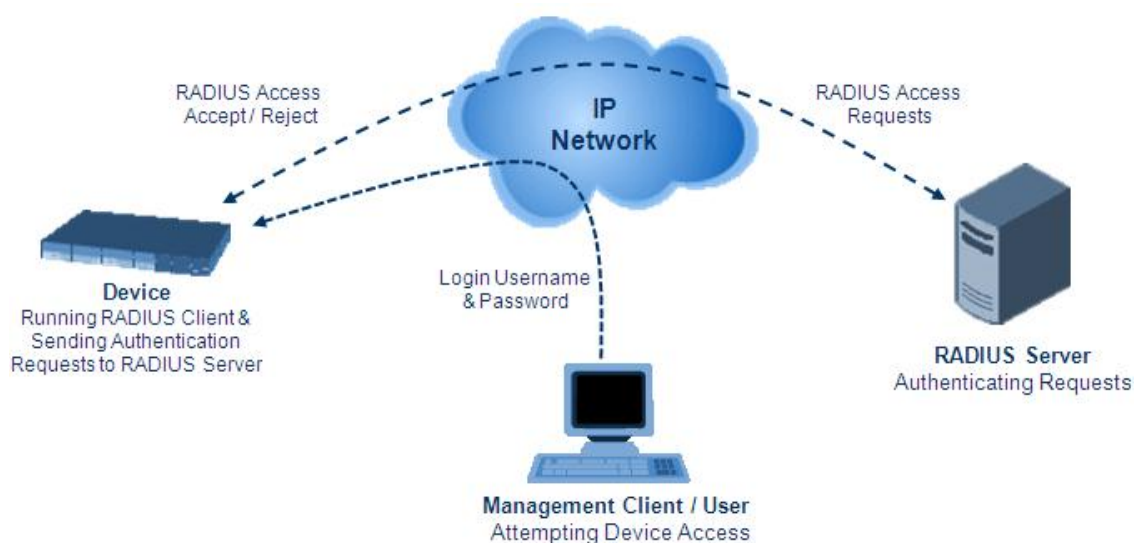

To implement RADIUS, you need to do the following:

- Set up a RADIUS server (third-party) to communicate with the device - see [Setting Up a Third-Party RADIUS Server](#)
- Configure the device as a RADIUS client for communication with the RADIUS server - see [Configuring RADIUS Authentication](#)

### Setting Up a Third-Party RADIUS Server

The following procedure provides an example for setting up a third-party RADIUS sever, *FreeRADIUS* which can be downloaded from [www.freeradius.org](http://www.freeradius.org). Follow the instructions on this Web site for installing and configuring the server. If you use a RADIUS server from a different vendor, refer to its appropriate documentation.

#### ➤ To set up a third-party RADIUS server (e.g., *FreeRADIUS*):

1. Define the device as an authorized client of the RADIUS server, with the following:
  - Predefined *shared secret* (password used to secure communication between the device and the RADIUS server)
  - Vendor ID (configured on the device in [Configuring the RADIUS Vendor ID](#))

Below is an example of the *clients.conf* file (FreeRADIUS client configuration):

```
#
# clients.conf - client configuration directives
#
client 10.31.4.47 {
    secret      = FutureRADIUS
    shortname   = audc_device
}
```

2. If access levels are required, set up a Vendor-Specific Attributes (VSA) dictionary for the RADIUS server and select an attribute ID that represents each user's access level. The example below shows a dictionary file for FreeRADIUS that defines the attribute "ACL-Auth-Level" with "ID=35". For the device's user access levels and their corresponding numeric representation in RADIUS servers, see [Configuring Management User Accounts](#).

```
#
# AudioCodes VSA dictionary
#
VENDOR AudioCodes 5003
ATTRIBUTE ACL-Auth-Level 35 integer AudioCodes
VALUE ACL-Auth-Level ACL-Auth-UserLevel 50
VALUE ACL-Auth-Level ACL-Auth-AdminLevel 100
VALUE ACL-Auth-Level ACL-Auth-SecurityAdminLevel 200
```

3. Define the list of users authorized to use the device, using one of the password authentication methods supported by the server implementation. The example below shows a user configuration file for FreeRADIUS using a plain-text password:

```
# users - local user configuration database
john Auth-Type := Local, User-Password == "qwerty"
  Service-Type = Login-User,
  ACL-Auth-Level = ACL-Auth-SecurityAdminLevel
sue Auth-Type := Local, User-Password == "123456"
  Service-Type = Login-User,
  ACL-Auth-Level = ACL-Auth-UserLevel
```

4. Record and retain the IP address, port number, shared secret code, vendor ID, and VSA access level identifier (if access levels are implemented) used by the RADIUS server.

### Configuring RADIUS-based User Authentication

The following procedure describes how to configure RADIUS-based login authentication. For a detailed description of the RADIUS parameters, see [RADIUS Parameters](#).

#### ➤ To configure RADIUS-based login authentication:

1. Open the Authentication Server page (**Setup** menu > **Administration** tab > **Web & CLI** folder > **Authentication Server**).
2. From the 'Use RADIUS for Web/Telnet Login' drop-down list, select **Enable** to enable RADIUS authentication for Web and Telnet login:

Use RADIUS for Web/Telnet Login

3. When implementing Web user access levels, do one of the following:
  - **If the RADIUS server response includes the access level attribute:** In the 'RADIUS VSA Access Level Attribute' field, enter the code that indicates the access level attribute in the VSA section of the received RADIUS packet. For defining the RADIUS server with access levels, see [Setting Up a Third-Party RADIUS Server](#).

RADIUS VSA Access Level Attribute

- **If the RADIUS server response does not include the access level attribute:** In the 'Default Access Level' field, enter the default access level that is applied to all users authenticated by the RADIUS server.

Default Access Level

4. Configure RADIUS timeout handling:
  - a. From the 'Behavior upon Authentication Server Timeout' drop-down list, select the option if the RADIUS server does not respond within five seconds:

- ◆ **Deny Access:** device denies user login access.
  - ◆ **Verify Access Locally:** device checks the username and password configured locally for the user in the Local Users table (see [Configuring Management User Accounts](#)), and if correct, allows access.
- b. In the 'Password Local Cache Timeout' field, enter a time limit (in seconds) after which the username and password verified by the RADIUS server becomes invalid and a username and password needs to be re-validated with the RADIUS server.
  - c. From the 'Password Local Cache Mode' drop-down list, select the option for the local RADIUS password cache timer:
    - ◆ **Reset Timer Upon Access:** upon each access to a Web page, the timer resets (reverts to the initial value configured in the previous step).
    - ◆ **Absolute Expiry Timer:** when you access a Web page, the timer doesn't reset, but continues its count down.

Use RADIUS for Web/Telnet Login

5. Configure when the Local Users table must be used to authenticate login users. From the 'Use Local Users Database' drop-down list, select one of the following:
  - **When No Auth Server Defined (default):** When no RADIUS server is configured or if a server is configured but connectivity with the server is down (if the server is up, the device authenticates the user with the server).
  - **Always:** First attempts to authenticate the user using the Local Users table, but if not found, it authenticates the user with the RADIUS server.

Use Local Users Database

6. Click **Apply**, and then reset the device with a save-to-flash for your settings to take effect.

## Securing RADIUS Communication

RADIUS authentication requires HTTP basic authentication (according to RFC 2617). However, this is insecure as the usernames and passwords are transmitted in clear text over plain HTTP. Thus, as digest authentication is not supported with RADIUS, it is recommended that you use HTTPS with RADIUS so that the usernames and passwords are encrypted. To enable the device to use HTTPS, configure the 'Secured Web Connection (HTTPS)' parameter to **HTTPS Only** (see [Configuring Secured \(HTTPS\) Web](#)).

## RADIUS-based User Authentication in URL

RADIUS authentication of the management user is typically done after the user accesses the Web interface by entering only the device's IP address in the Web browser's URL field (for example, http://10.13.4.12/) and then entering the username and password credentials in the Web interface's login screen. However, authentication with the RADIUS server can also be done immediately after the user enters the URL, if the URL also contains the login credentials.

For example: `http://10.4.4.112/Form-s/RADIUSAuthentication?WSBackUserName=John&WSBackPassword=1234.`



This feature allows up to five simultaneous users only.

## RADIUS-based CDR Accounting

Once you have configured a RADIUS server(s) for accounting in [Configuring RADIUS Servers](#), you need to enable and configure RADIUS-based CDR accounting (see [Configuring RADIUS Accounting](#)).

## LDAP-based Management and SIP Services

The device supports the Lightweight Directory Access Protocol (LDAP) application protocol and can operate with third-party, LDAP-compliant servers such as Microsoft Active Directory (AD).

You can use LDAP for the following LDAP services:

- **SIP-related (Control) LDAP Queries:** LDAP can be used for routing and manipulation (e.g., calling name and destination address).

The device connects and binds to the remote LDAP server (IP address or DNS/FQDN) during the service's initialization (at device start-up) or whenever you change the LDAP server's IP address and port. Binding to the LDAP server is based on username and password (Bind DN and Password). Service makes 10 attempts to connect and bind to the remote LDAP server, with a timeout of 20 seconds between attempts. If connection fails, the service remains in disconnected state until the LDAP server's IP address or port is changed. If connection to the LDAP server later fails, the service attempts to reconnect.

For the device to run a search, the path to the directory's subtree, known as the distinguished name (DN), where the search is to be done must be configured (see [Configuring LDAP DNs \(Base Paths\) per LDAP Server](#)). The search key (filter), which defines the exact DN to search and one or more attributes whose values must be returned to the device must also be configured. For more information on configuring these attributes and search filters, see [AD-based Routing for Microsoft Skype for Business](#).

The device can store recent LDAP queries and responses in its local cache. The cache is used for subsequent queries and/or in case of LDAP server failure. For more information, see [Configuring the Device's LDAP Cache](#).

If connection with the LDAP server disconnects (broken), the device sends the SNMP alarm, `acLDAPLostConnection`. Upon successful reconnection, the alarm clears. If connection with the LDAP server is disrupted during the search, all search requests are dropped and an alarm indicating a failed status is sent to client applications.

- **Management-related LDAP Queries:** LDAP can be used for authenticating and authorizing management users (Web and CLI) and is based on the user's login username and password (credentials) when attempting login to one of the device's management platforms. When configuring the login username (LDAP Bind DN) and password (LDAP



Password) to send to the LDAP server, you can use templates based on the dollar (\$) sign, which the device replaces with the actual username and password entered by the user during the login attempt. You can also configure the device to send the username and password in clear-text format or encrypted using TLS (SSL).

The device connects to the LDAP server (i.e., an LDAP session is created) only when a login attempt occurs. The LDAP Bind operation establishes the authentication of the user based on the username-password combination. The server typically checks the password against the userPassword attribute in the named entry. A successful Bind operation indicates that the username-password combination is correct; a failed Bind operation indicates that the username-password combination is incorrect.

Once the user is successfully authenticated, the established LDAP session may be used for further LDAP queries to determine the user's management access level and privileges (Operator, Admin, or Security Admin). This is known as the user authorization stage. To determine the access level, the device searches the LDAP directory for groups of which the user is a member, for example:

```
CN=\# Support Dept,OU=R&D
Groups,OU=Groups,OU=APC,OU=Japan,OU=ABC,DC=corp,DC=abc,DC=
com
CN=\#AllCellular,OU=Groups,OU=APC,OU=Japan,OU=ABC,DC=corp,DC=
abc,DC=com
```

The device then assigns the user the access level configured for that group (in [Configuring Access Level per Management Groups Attributes](#)). The location in the directory where you want to search for the user's member group(s) is configured using the following:

- Search base object (distinguished name or DN, e.g., "ou=ABC,dc=corp,dc=abc,dc=com"), which defines the location in the directory from where the LDAP search begins and is configured in [Configuring LDAP DNS \(Base Paths\) per LDAP Server](#).
- Search filter, for example, (&(objectClass=person)(sAMAccountName=JohnD)), which filters the search in the subtree to include only the specific username. The search filter can be configured with the dollar (\$) sign to represent the username, for example, (sAMAccountName=\$). To configure the search filter, see [Configuring the LDAP Search Filter Attribute](#).
- Management attribute (e.g., memberOf), from where objects that match the search filter criteria are returned. This shows the user's member groups. The attribute is configured in the LDAP Servers table (see [Configuring LDAP Servers](#)).

If the device finds a group, it assigns the user the corresponding access level and permits login; otherwise, login is denied. Once the LDAP response has been received (success or failure), the device ends the LDAP session.

- **LDAP-based Management services:** This LDAP service works together with the LDAP-based management account (described above), allowing you to use different LDAP service accounts for user authentication and user authorization:

- Management-type LDAP server: This LDAP server account is used only for user authentication. For more information about how it works, see Management-related LDAP Queries, above.
- Management Service-type LDAP server: This LDAP server account is used only for user authorization (i.e., the user's management access level and privileges). The device has an always-on connection with the LDAP server and uses a configured (fixed) LDAP username (Bind Name) and password. Only if user authentication succeeds, does the device query this Management Service-type LDAP server account for user authorization. Thus, management groups and DNs are configured only for this LDAP server account (instead of for the regular LDAP-based management account).

Therefore, user authorization is done only by a specific LDAP "administrator", which has a fixed username and password. In contrast, user authentication is done by the user itself (i.e., binding to the LDAP account with each user's username and password). Having a dedicated LDAP account for user authorization may provide additional security to the network by preventing users from accessing the authorization settings in the LDAP server.

For all the previously discussed LDAP services, the following additional LDAP functionality is supported:

- Search method for searching DN object records between LDAP servers and within each LDAP server (see [Configuring LDAP Search Methods](#)).
- Default access level that is assigned to the user if the queried response does not contain an access level.
- Local Users table for authenticating users instead of the LDAP server (for example, when a communication problem occurs with the server). For more information, see [Configuring Local Database for Management User Authentication](#).

## Enabling the LDAP Service

Before you can configure LDAP support, you need to enable the LDAP service.

### ➤ To enable LDAP:

1. Open the LDAP Settings page (**Setup** menu > **IP Network** tab > **RADIUS & LDAP** folder > **LDAP Settings**).

LDAP Service • Enable  ⚡

2. From the 'LDAP Service' drop-down list, select **Enable**.
3. Click **Apply**, and then reset the device with a save-to-flash for your settings to take effect.

## Enabling LDAP-based Web/CLI User Login Authentication and Authorization

The LDAP service can be used for authenticating and authorizing device management users (Web and CLI) based on the user's login username and password (credentials). At the same time, it can also be used to determine users' management access levels (privileges). Before you can configure LDAP-based login authentication, you must enable this type of LDAP service.



If you enable LDAP-based user login authentication, when users with Security Administrator privilege level log in to the device's CLI, they are automatically given access to the CLI privileged mode (“#”). For all other user privilege levels, the user needs to run the **enable** command and then enter the password to access the CLI privileged mode.

### ➤ To enable LDAP-based login authentication:

1. Open the Authentication Server page (**Setup** menu > **Administration** tab > **Web & CLI** folder > **Authentication Server**).

2. Under the LDAP group, from the 'Use LDAP for Web/Telnet Login' drop-down list, select **Enable**.
3. Click **Apply**, and then reset the device with a save-to-flash for your settings to take effect.

## Configuring LDAP Server Groups

The LDAP Server Groups table lets you configure up to 41 LDAP Server Groups. An LDAP Server Group is a logical configuration entity that contains up to two LDAP servers. LDAP servers are assigned to LDAP Server Groups in the LDAP Servers table (see [Configuring LDAP Servers](#)). To use a configured LDAP server, you must assign it to an LDAP Server Group. You can configure the following types of LDAP Server Groups (configured by the 'Type' parameter described below):

- **Control:** To use an LDAP server for call routing, you need to configure the LDAP Server Group as a **Control** type, and then assign the LDAP Server Group to a Routing Policy. The Routing Policy in turn needs to be assigned to the relevant routing rule(s). You can assign a Routing Policy to only one LDAP Server Group. Therefore, for multi-tenant deployments where multiple Routing Policies are employed, each tenant can be assigned a specific LDAP Server Group through its unique Routing Policy.
- **Management:** To use an LDAP server for management where it does user login authentication and user authorization, you need to configure the LDAP Server Group as a **Management** type. Additional LDAP-based management parameters need to be

configured, as described in [Enabling LDAP-based Web/CLI User Login Authentication and Authorization](#) and [Configuring LDAP Servers](#).

- **Management Service:** To use two different LDAP server accounts for management where one LDAP account does user authentication and the other LDAP account does user authorization, you need to configure two LDAP Server Groups. Configure the LDAP Server Group for user authentication as a **Management** type and the LDAP Server Group for user authorization as a **Management Service** type. In this setup, configure all the user-authorization settings (i.e., Management LDAP Groups and LDAP Server Search Base DN) only for the Management Service-type LDAP Server Group (instead of for the Management-type LDAP Server Group).

The following procedure describes how to configure an LDAP Server Group through the Web interface. You can also configure it through ini file [LDAPServerGroups] or CLI (`configure system > ldap ldap-server-groups`).



The device provides a preconfigured LDAP Server Group ("DefaultCTRLServersGroupin") in the LDAP Server Groups table, which can be modified or deleted.

➤ **To configure an LDAP Server Group:**

1. Open the LDAP Server Groups table (**Setup** menu > **IP Network** tab > **RADIUS & LDAP** folder > **LDAP Server Groups**).
2. Click **New**; the following dialog box appears:

3. Configure an LDAP Server Group according to the parameters described in the table below.
4. Click **Apply**.

**Table 16-7: LDAP Server Groups Table Parameter Descriptions**

Parameter	Description
General	
'Index' [LdapServerGroups_Index]	Defines an index number for the new table row. <b>Note:</b> Each row must be configured with a unique index.

Parameter	Description
'Name' name [LdapServerGroups_Name]	<p>Defines a descriptive name, which is used when associating the row in other tables.</p> <p>The valid value is a string of up to 20 characters.</p> <p><b>Note:</b></p> <ul style="list-style-type: none"> <li>■ Each row must be configured with a unique name.</li> <li>■ The parameter value cannot contain a forward slash (/).</li> </ul>
'Type' server-type [LdapServerGroups_ServerType]	<p>Defines whether the servers in the group are used for SIP-related LDAP queries (Control) or management login authentication-related LDAP queries (Management).</p> <ul style="list-style-type: none"> <li>■ [0] <b>Control</b> (default)</li> <li>■ [1] <b>Management</b></li> <li>■ [2] <b>Management Service</b></li> </ul> <p>For more information on the different optional LDAP services, see <a href="#">LDAP-based Management and SIP Services</a> on page 258.</p> <p><b>Note:</b></p> <ul style="list-style-type: none"> <li>■ For table row Index #0, the parameter can only be configured to <b>Control</b>.</li> <li>■ Only one LDAP Server Group can be configured for management.</li> </ul>
'Server Search Method' server-search-method [LdapServerGroups_SearchMethod]	<p>Defines the method for querying between the two LDAP servers in the group.</p> <ul style="list-style-type: none"> <li>■ [0] <b>Parallel</b> = (Default) The device queries the LDAP servers at the same time.</li> <li>■ [1] <b>Sequential</b> = The device first queries one of the LDAP servers and if the DN object is not found or the search fails, it queries the second LDAP server.</li> </ul>
'DN Search Method' search-dn-method [LdapServerGroups_SearchDnsMethod]	<p>Defines the method for querying the Distinguished Name (DN) objects within each LDAP server.</p> <ul style="list-style-type: none"> <li>■ [0] <b>Sequential</b> = (Default) The query is done in each DN object, one by one, until a result is returned. For example, a search for the DN object record "JohnD" is first run in DN object "Marketing" and if a result is not found, it searches in "Sales", and if not found, it</li> </ul>

Parameter	Description
	<p>searches in "Administration", and so on.</p> <ul style="list-style-type: none"> <li>■ [1] <b>Parallel</b> = The query is done in all DN objects at the same time. For example, a search for the DN object record "JohnD" is done at the same time in the "Marketing", "Sales" and "Administration" DN objects.</li> </ul>
Cache	
'Cache Entry Timeout' cache-entry-timeout [LdapServersGroups_ CacheEntryTimeout]	<p>Defines the duration (in minutes) that an entry in the device's LDAP cache is valid. If the timeout expires, the cached entry is used only if there is no connectivity with the LDAP server.</p> <p>The valid range is 0 to 35791. The default is 1200. If set to 0, the LDAP entry is always valid.</p>
'Cache Entry Removal Timeout' cache-entry-removal-timeout [LdapServerGroups_ CacheEntryRemovalTimeout]	<p>Defines the duration (in hours) after which the LDAP entry is deleted from the device's LDAP cache.</p> <p>The valid range is 0 to 596. The default is 0 (i.e., the entry is never deleted).</p>

## Configuring LDAP Servers

The LDAP Servers table lets you configure up to 82 LDAP servers. The table defines the address and connectivity settings of the LDAP server. The LDAP server can be configured for SIP-related queries (e.g., routing and manipulation) or LDAP-based management user login authentication and authorization (username-password).

The following procedure describes how to configure an LDAP server through the Web interface. You can also configure it through ini file [LdapConfiguration] or CLI (`configure system > ldap ldap-configuration`).



When you configure an LDAP server, you need to assign it an LDAP Server Group. Therefore, before you can configure an LDAP server in the table, you must first configure at least one LDAP Server Group in the LDAP Server Groups table (see [Configuring LDAP Server Groups](#)).

### ➤ To configure an LDAP server:

1. Open the LDAP Servers table (**Setup** menu > **IP Network** tab > **RADIUS & LDAP** folder > **LDAP Servers**).

2. Click **New**; the following dialog box appears:

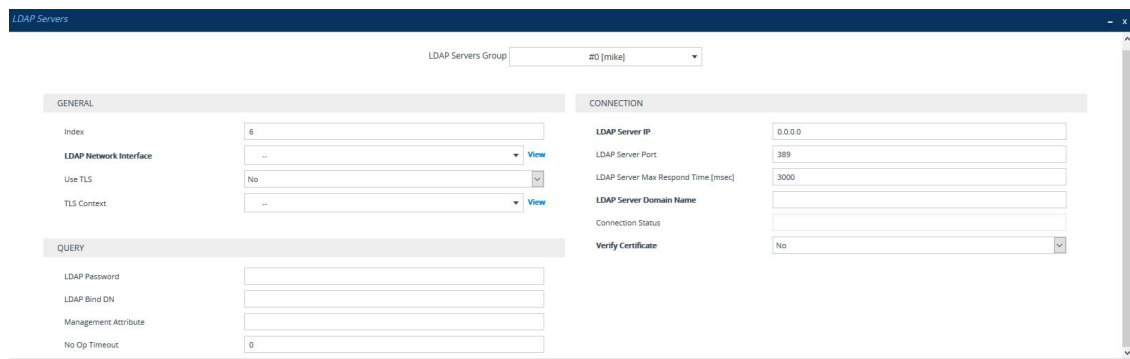

3. Configure an LDAP server according to the parameters described in the table below.

4. Click **Apply**.

**Table 16-8: LDAP Servers Table Parameter Descriptions**

Parameter	Description
<b>General</b>	
'Index' [LdapConfiguration_Index]	Defines an index number for the new table row. <b>Note:</b> Each row must be configured with a unique index.
'LDAP Servers Group' server-group [LdapConfiguration_Group]	Assigns the LDAP server to an LDAP Server Group, configured in the LDAP Server Groups table (see <a href="#">Configuring LDAP Server Groups</a> ). <b>Note:</b> <ul style="list-style-type: none"> <li>■ The parameter is mandatory and must be set before configuring the other parameters in the table.</li> <li>■ Up to two LDAP servers can be assigned to the same LDAP Server Group.</li> </ul>
'LDAP Network Interface' interface-type [LdapConfiguration_Interface]	Assigns one of the device's IP network interfaces through which communication with the LDAP server is done. By default, no value is defined and the device uses the OAMP network interface, configured in the IP Interfaces table. To configure IP network interfaces, see <a href="#">Configuring IP Network Interfaces</a> . <b>Note:</b> The parameter is mandatory.

Parameter	Description
'Use TLS' use-tls [LdapConfiguration_useTLS]	<p>Enables the device to encrypt the username and password (for Control and Management related queries) using TLS when sending them to the LDAP server.</p> <ul style="list-style-type: none"> <li>■ [0] <b>No</b> = (Default) Username and password are sent in clear-text format.</li> <li>■ [1] <b>Yes</b></li> </ul>
'TLS Context' tls-context [LdapConfiguration_ContextName]	<p>Assigns a TLS Context (TLS configuration) for the connection with the LDAP server.</p> <p>By default, no value is defined and the device uses the default TLS Context (ID 0).</p> <p>To configure TLS Contexts, see <a href="#">Configuring TLS Certificates</a> on page 154.</p> <p><b>Note:</b> The parameter is applicable only if the 'Use TLS' parameter is configured to <b>Yes</b>.</p>
Connection	
'LDAP Server IP' server-ip [LdapConfiguration_LdapConfServerIp]	<p>Defines the IP address of the LDAP server (in dotted-decimal notation, e.g., 192.10.1.255).</p> <p>By default, no IP address is defined.</p> <p><b>Note:</b></p> <ul style="list-style-type: none"> <li>■ The parameter is mandatory.</li> <li>■ If you want to use an FQDN for the LDAP server, leave the parameter undefined and configure the FQDN in the 'LDAP Server Domain Name' parameter (see below).</li> </ul>
'LDAP Server Port' server-port [LdapConfiguration_LdapConfServerPort]	<p>Defines the port number of the LDAP server.</p> <p>The valid value range is 0 to 65535. The default port number is 389.</p>
'LDAP Server Max Respond Time' max-respond-time [LdapConfiguration_LdapConfServerMaxResponse]	<p>Defines the duration (in msec) that the device waits for LDAP server responses.</p> <p>The valid value range is 0 to 86400. The default is 3000.</p> <p><b>Note:</b> If the response time expires, you can configure the device to use the Local Users table for authenticating the user. For more information, see</p>



Parameter	Description
	<a href="#">Configuring Local Database for Management User Authentication.</a>
'LDAP Server Domain Name' domain-name [LdapConfiguration_ LdapConfServerDomainName]	<p>Defines the domain name (FQDN) of the LDAP server. The device tries to connect to the LDAP server according to the IP address listed in the received DNS query. If there is no connection to the LDAP server or the connection to the LDAP server fails, the device tries to connect to the LDAP server with the next IP address in the DNS query list.</p> <p><b>Note:</b> If the 'LDAP Server IP' parameter is configured, the 'LDAP Server Domain Name' parameter is ignored. Thus, if you want to use an FQDN, leave the 'LDAP Server IP' parameter undefined.</p>
'Verify Certificate' verify-certificate [LdapConfiguration_ VerifyCertificate]	<p>Enables certificate verification when the connection with the LDAP server uses TLS.</p> <ul style="list-style-type: none"> <li>■ [0] <b>No</b> = (Default) No certificate verification is done.</li> <li>■ [1] <b>Yes</b> = The device verifies the authentication of the certificate received from the LDAP server. The device authenticates the certificate against the trusted root certificate store associated with the associated TLS Context (see 'TLS Context' parameter above) and if ok, allows communication with the LDAP server. If authentication fails, the device denies communication (i.e., handshake fails). The device can also authenticate the certificate by querying with an Online Certificate Status Protocol (OCSP) server whether the certificate has been revoked. This is also configured for the associated TLS Context.</li> </ul> <p><b>Note:</b> The parameter is applicable only if the 'Use TLS' parameter is configured to <b>Yes</b>.</p>
'Connection Status' connection-status [LdapConfiguration_ ConnectionStatus]	<p>(Read-only) Displays the connection status with the LDAP server.</p> <ul style="list-style-type: none"> <li>■ "Not Applicable"</li> <li>■ "LDAP Connection Broken"</li> <li>■ "Connecting"</li> </ul>

Parameter	Description
	<ul style="list-style-type: none"> <li>■ "Connected"</li> </ul> <p>For more information about a disconnected LDAP connection, see your Syslog messages generated by the device.</p>
<b>Query</b>	
<p>'LDAP Password'</p> <p>password</p> <p>[LdapConfiguration_ LdapConfPassword]</p>	<p>Defines the user password for accessing the LDAP server during connection and binding operations.</p> <ul style="list-style-type: none"> <li>■ LDAP-based SIP queries: The parameter is the password used by the device to authenticate itself, as a client, to obtain LDAP service from the LDAP server.</li> <li>■ LDAP-based user login authentication: The parameter represents the login password entered by the user during a login attempt. You can use the \$ (dollar) sign in this value to enable the device to automatically replace the \$ sign with the user's login password in the search filter, which it sends to the LDAP server for authenticating the user's username-password combination. For example, \$.</li> </ul> <p><b>Note:</b></p> <ul style="list-style-type: none"> <li>■ The parameter is mandatory.</li> <li>■ By default, the device sends the password in clear-text format. You can enable the device to encrypt the password using TLS (see the 'Use TLS' parameter in this table).</li> <li>■ The password cannot be configured with wide characters.</li> </ul>
<p>'LDAP Bind DN'</p> <p>bind-dn</p> <p>[LdapConfiguration_ LdapConfBindDn]</p>	<p>Defines the LDAP server's bind Distinguished Name (DN) or username.</p> <ul style="list-style-type: none"> <li>■ LDAP-based SIP queries: The DN is used as the username during connection and binding to the LDAP server. The DN is used to uniquely name an AD object. Below are example parameter settings:</li> </ul> <p>✓ cn=administrator,cn=Users,dc=domain,dc=co</p>

Parameter	Description
	<p>m</p> <ul style="list-style-type: none"> <li>✓ administrator@domain.com</li> <li>✓ domain\administrator</li> </ul> <p>■ LDAP-based user login authentication: The parameter represents the login username entered by the user during a login attempt. You can use the \$ (dollar) sign in this value to enable the device to automatically replace the \$ sign with the user's login username in the search filter, which it sends to the LDAP server for authenticating the user's username-password combination. An example configuration for the parameter is \$@sales.local, where the device replaces the \$ with the entered username, for example, JohnD@sales.local. The username can also be configured with the domain name of the LDAP server.</p> <p><b>Note:</b> By default, the device sends the username in clear-text format. You can enable the device to encrypt the username using TLS (see the 'Use TLS' parameter in this table).</p>
'Management Attribute' mgmt-attr [LdapConfiguration_ MngmAuthAtt]	<p>Defines the LDAP attribute name to query, which contains a list of groups to which the user is a member. For Active Directory, this attribute is typically "memberOf". The attribute's values (groups) are used to determine the user's management access level; the group's corresponding access level is configured in <a href="#">Configuring Access Level per Management Groups Attributes</a>.</p> <p><b>Note:</b></p> <ul style="list-style-type: none"> <li>■ The parameter is applicable only to LDAP-based login authentication and authorization (i.e., the 'Type' parameter is set to <b>Management</b>).</li> <li>■ If this functionality is not used, the device assigns the user the configured default access level. For more information, see <a href="#">Configuring Access Level per Management Groups Attributes</a>.</li> </ul>
'No Op Timeout'	Defines the timeout (in minutes) of inactivity in the

Parameter	Description
noop-timeout [LdapConfiguration_ NoOpTimeout]	<p>connection between the device and the LDAP server, after which the device sends an LDAP "abandon" request to keep the LDAP connection alive (i.e., LDAP persistent connection).</p> <p>The valid value to enable this feature is any value greater than 0. The default is 0 (i.e., if there is no activity on the connection, the device does not send "abandon" requests and the LDAP server may disconnect).</p> <p><b>Note:</b> The parameter is applicable only to LDAP connections that are used for routing (i.e., the 'Type' parameter is configured to <b>Control</b>).</p>

## Configuring LDAP DNs (Base Paths) per LDAP Server

The LDAP Search DN table lets you configure LDAP base paths. The table is a "child" of the LDAP Servers table (see [Configuring LDAP Servers](#)) and configuration is done per LDAP server. For the device to run a search using the LDAP service, the base path to the directory's subtree, referred to as the distinguished name object (or DN), where the search is to be done must be configured. For each LDAP server, you can configure up to three base paths.

The following procedure describes how to configure DNs per LDAP server through the Web interface. You can also configure it through ini file [LdapServersSearchDNs] or CLI (configure system > ldap ldap-servers-search-dns).

### ➤ To configure an LDAP base path per LDAP server:

1. Open the LDAP Servers table (**Setup** menu > **IP Network** tab > **RADIUS & LDAP** folder > **LDAP Servers**).
2. In the table, select the row of the LDAP server for which you want to configure DN base paths, and then click the **LDAP Servers Search Based DNs** link located below the table; the LDAP Server Search Base DN table opens.
3. Click **New**; the following dialog box appears:

The screenshot shows a dialog box titled "LDAP Server Search Base DN". It has a "GENERAL" tab selected. There are two input fields: "Index" with the value "1" and "Base DN" which is currently empty.

4. Configure an LDAP DN base path according to the parameters described in the table below.
5. Click **Apply**, and then save your settings to flash memory.

**Table 16-9: LDAP Server Search Base DN Table Parameter Descriptions**

Parameter	Description
'Index' set internal-index [LdapServersSearchDNs_Index]	Defines an index number for the new table row. <b>Note:</b> Each row must be configured with a unique index.
'Base DN' set base-path [LdapServersSearchDNs_Base_Path]	Defines the full path (DN) to the objects in the AD where the query is done. The valid value is a string of up to 256 characters. For example: OU=NY,DC=OCSR2,DC=local. In this example, the DN path is defined by the LDAP names, OU (organizational unit) and DC (domain component).

## Configuring the LDAP Search Filter Attribute

When the LDAP-based login username-password authentication succeeds, the device searches the LDAP server for all groups of which the user is a member. The LDAP query is based on the following LDAP data structure:

- **Search base object (distinguished name or DN, e.g., "ou=ABC,dc=corp,dc=abc,dc=com"):** The DN defines the location in the directory from which the LDAP search begins and is configured in [Configuring LDAP DNs \(Base Paths\) per LDAP Server](#).
- **Filter (e.g., "(&(objectClass=person)(sAMAccountName=johnd))"):** This filters the search in the subtree to include only the login username (and excludes others). This is configured by the 'LDAP Authentication Filter' parameter, as described in the following procedure. You can use the dollar (\$) sign to represent the username. For example, the filter can be configured as "(sAMAccountName=\$)", where if the user attempts to log in with the username "SueM", the LDAP search is done only for the attribute sAMAccountName that equals "SueM".
- **Attribute (e.g., "memberOf") to return from objects that match the filter criteria:** The attribute is configured by the 'Management Attribute' parameter in the LDAP Servers table (see [Configuring LDAP Servers](#)).

Therefore, the LDAP response includes only the groups of which the specific user is a member.



- The search filter is applicable only to LDAP-based login authentication and authorization queries.
- The search filter is a global setting that applies to all LDAP-based login authentication and authorization queries, across all configured LDAP servers.

### ➤ To configure the LDAP search filter for management users:

1. Open the LDAP Settings page (**Setup** menu > **IP Network** tab > **RADIUS & LDAP** folder > **LDAP Settings**).
2. In the 'LDAP Authentication Filter' field, enter the LDAP search filter attribute for searching the login username for user authentication:

LDAP Authentication Filter

3. Click **Apply**.

## Configuring Access Level per Management Groups Attributes

The Management LDAP Groups table lets you configure LDAP group objects and their corresponding management user access level. The table is a "child" of the LDAP Servers table (see [Configuring LDAP Servers](#)) and configuration is done per LDAP server. For each LDAP server, you can configure up to three table row entries of LDAP group(s) and their corresponding access level.



- The Management LDAP Groups table is applicable only to LDAP-based login authentication and authorization queries.
- If the LDAP response received by the device includes multiple groups of which the user is a member and you have configured different access levels for some of these groups, the device assigns the user the highest access level. For example, if the user is a member of two groups where one has access level "Monitor" and the other "Administrator", the device assigns the user the "Administrator" access level.
- When the access level is unknown, the device assigns the default access level to the user, configured by the 'Default Access Level' parameter as used also for RADIUS (see [Configuring RADIUS-based User Authentication](#)). This can occur in the following scenarios:
  - ✓ The user is not a member of any LDAP group.
  - ✓ The group of which the user is a member is not configured on the device (as described in this section).
  - ✓ The device is not configured to query the LDAP server for a management attribute (see [Configuring LDAP Servers](#)).

Group objects represent groups in the LDAP server of which the user is a member. The access level represents the user account's permissions and rights in the device's management interface (e.g., Web and CLI). The access level can either be Monitor, Administrator, or Security

Administrator. For an explanation on the privileges of each level, see [Configuring Management User Accounts](#).

When the username-password authentication with the LDAP server succeeds, the device searches the LDAP server for all groups of which the user is a member. The LDAP query is based on the following LDAP data structure:

- Search base object (distinguished name or DN, e.g., "ou=ABC,dc=corp,dc=abc,dc=com"), which defines the location in the directory from which the LDAP search begins. This is configured in [Configuring LDAP DNs \(Base Paths\) per LDAP Server](#).
- Filter (e.g., "(&(objectClass=person)(sAMAccountName=johnd))"), which filters the search in the subtree to include only the login username (and excludes others). For configuration, see [Configuring the LDAP Search Filter Attribute](#).
- Attribute (e.g., "memberOf") to return from objects that match the filter criteria. This attribute is configured by the 'Management Attribute' parameter in the LDAP Servers table.

The LDAP response includes all the groups of which the specific user is a member, for example:

```
CN=\# Support Dept,OU=R&D Groups,OU-  
U=Groups,OU=APC,OU=Japan,OU=ABC,DC=corp,DC=abc,DC=com  
CN=\#AllCellular,OU=Groups,OU=APC,OU=Japan,OU=ABC,DC=corp,DC=abc,DC=com
```

The device searches this LDAP response for the group names that you configured in the Management LDAP Groups table in order to determine the user's access level. If the device finds a group name, the user is assigned the corresponding access level and login is permitted; otherwise, login is denied. Once the LDAP response has been received (success or failure), the LDAP session terminates.

The following procedure describes how to configure an access level per management groups through the Web interface. You can also configure it through ini file [MgmtLDAPGroups] or CLI (`configure system > ldap mgmt-ldap-groups`).

➤ **To configure management groups and corresponding access level:**

1. Open the LDAP Servers table (**Setup** menu > **IP Network** tab > **RADIUS & LDAP** folder > **LDAP Servers**).
2. In the table, select the row of the LDAP server for which you want to configure management groups with a corresponding access level, and then click the **Management LDAP Groups** link located below the table; the Management LDAP Groups table opens.
3. Click **New**; the following dialog box appears:

The screenshot shows a configuration window titled "Management LDAP Groups". Under the "GENERAL" tab, there are three input fields: "Index" containing the number "1", "Level" with a dropdown menu currently showing "Monitor", and "Groups" which is an empty text box.

4. Configure a group name(s) with a corresponding access level according to the parameters described in the table below.
5. Click **Apply**, and then save your settings to flash memory.

**Table 16-10: Management LDAP Groups Table Parameter Descriptions**

Parameter	Description
'Index' [MgmtLDAPGroups_ GroupIndex]	Defines an index number for the new table row. <b>Note:</b> Each row must be configured with a unique index.
'Level' level [MgmtLDAPGroups_ Level]	Defines the access level of the group(s). <ul style="list-style-type: none"> <li>■ [0] <b>Monitor</b> (Default)</li> <li>■ [1] <b>Admin</b></li> <li>■ [2] <b>Security Admin</b></li> </ul>
'Groups' groups [MgmtLDAPGroups_ Group]	Defines the attribute names of the groups in the LDAP server. The valid value is a string of up to 256 characters. To define multiple groups, separate each group name with a semicolon (;).

## Configuring the Device's LDAP Cache

The device can optionally store LDAP queries of LDAP Attributes for a searched key with an LDAP server and the responses (results) in its local cache. The cache is used for subsequent queries and/or in case of LDAP server failure. The benefits of this feature include the following:

- Improves routing decision performance by using local cache for subsequent LDAP queries
- Reduces number of queries performed on an LDAP server and corresponding bandwidth consumption
- Provides partial survivability in case of intermittent LDAP server failure (or network isolation)



The handling of LDAP queries using the device's LDAP cache is shown in the flowchart below:

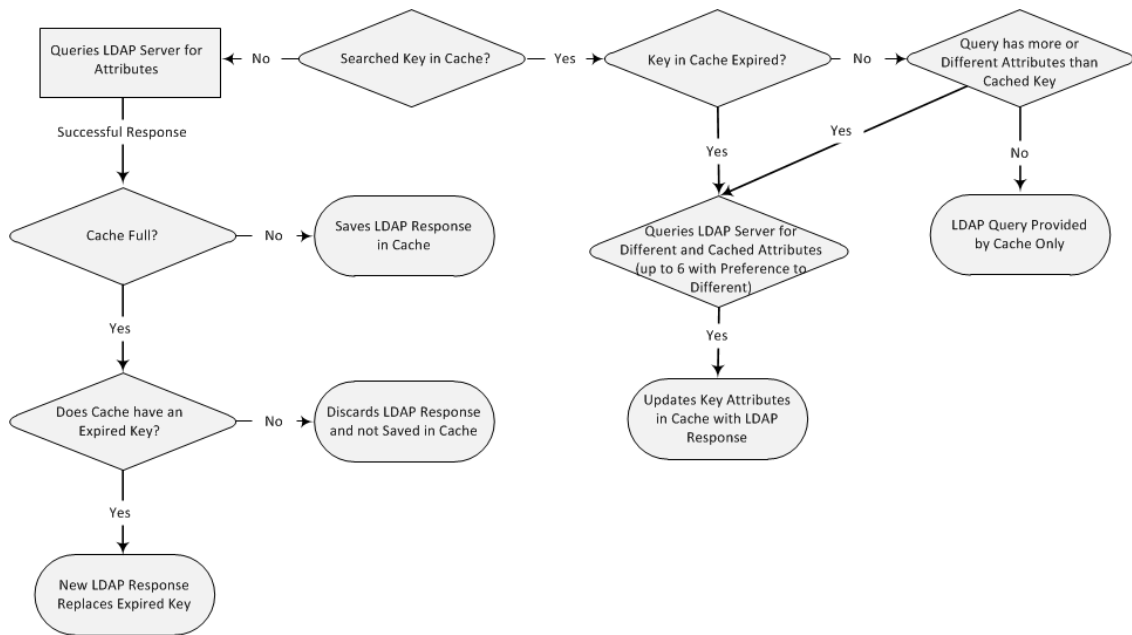

If an LDAP query is required for an Attribute of a key that is already cached with that same Attribute, instead of sending a query to the LDAP server, the device uses the cache. However, if an LDAP query is required for an Attribute that does not appear for the cached key, the device queries the LDAP server, and then saves the new Attribute (and response) in the cache for that key.

If the device queries the LDAP server for different Attributes for a cached key, the device also includes already cached Attributes of the key, while adhering to the maximum number of allowed saved Attributes (see note below), with preference to the different Attributes. In other words, if the cached key already contains the maximum Attributes and an LDAP query is required for a different Attribute, the device sends an LDAP query to the server for the different Attribute and for the five **most recent** Attributes already cached with the key. Upon the LDAP response, the new Attribute replaces the **oldest** cached Attribute while the values of the other Attributes are refreshed with the new response.

The following table shows an example of different scenarios of LDAP queries of a cached key whose cached Attributes include *a*, *b*, *c*, and *d*, where *a* is the oldest and *d* the most recent Attribute:

**Table 16-11: Example of LDAP Query for Cached Attributes**

Attributes Requested in New LDAP Query for Cached Key	Attributes Sent in LDAP Query to LDAP Server	Attributes Saved in Cache after LDAP Response
e	e, a, b, c, d	e, a, b, c, d
e, f	e, f, a, b, c, d	e, f, a, b, c, d
e, f, g, h, i	e, f, g, h, i, d	e, f, g, h, i, d

Attributes Requested in New LDAP Query for Cached Key	Attributes Sent in LDAP Query to LDAP Server	Attributes Saved in Cache after LDAP Response
e, f, g, h, i, j	e, f, g, h, i, j	e, f, g, h, i, j



- The LDAP Cache feature is applicable only to LDAP-based SIP queries (Control).
- The maximum LDAP cache size is 10,000 entries.
- The device can save up to six LDAP Attributes in the cache per searched LDAP key.
- The device also saves in the cache queried Attributes that do not have any values in the LDAP server.

The following procedure describes how to configure the device's LDAP cache through the Web interface. For a full description of the cache parameters, see [LDAP Parameters](#).

➤ **To enable and configure the LDAP cache:**

1. Open the LDAP Settings page (**Setup** menu > **IP Network** tab > **RADIUS & LDAP** folder > **LDAP Settings**).

CACHE

LDAP Cache Service	• Enable <span style="float: right;">⌵ ⚡</span>
LDAP Cache Entry Timeout	<input style="width: 80%;" type="text" value="1200"/>
LDAP Cache Entry Removal Timeout	<input style="width: 80%;" type="text" value="0"/>

2. From the 'LDAP Cache Service' drop-down list, select **Enable** to enable LDAP cache.
3. In the 'LDAP Cache Entry Timeout' field, enter the duration (in minutes) for which an entry in the LDAP cache is valid.
4. In the 'LDAP Cache Entry Removal Timeout' field, enter the duration (in hours) after which the device removes the LDAP entry from the cache.
5. Click **Apply**, and then reset the device with a save-to-flash for your settings to take effect.

### Refreshing the LDAP Cache

You can refresh values of LDAP Attributes associated with a specified LDAP search key that are stored in the device's LDAP cache. The device sends an LDAP query to the LDAP server for the cached Attributes of the specified search key and replaces the old values in the cache with the new values received in the LDAP response.

For example, assume the cache contains a previously queried LDAP Attribute "telephoneNumber=1004" whose associated Attributes include "displayName", "mobile" and "ipPhone". If you perform a cache refresh based on the search key "telephoneNumber=1004", the device sends an LDAP query to the server requesting values for the "displayName",

"mobile" and "ipPhone" Attributes of this search key. When the device receives the LDAP response, it replaces the old values in the cache with the new values received in the LDAP response.

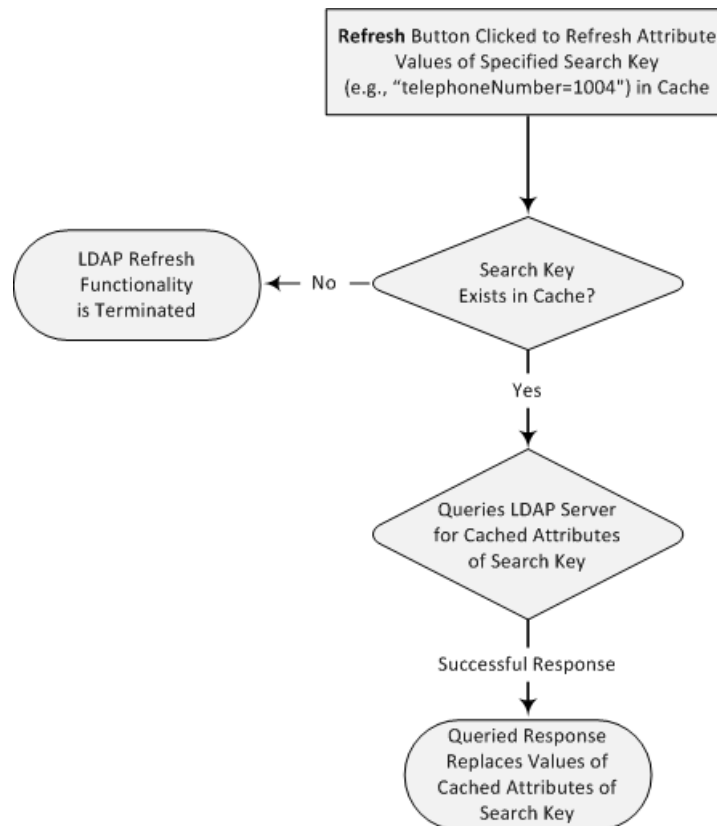

➤ **To refresh the LDAP cache per LDAP Server Group:**

1. Open the LDAP Settings page (**Setup** menu > **IP Network** tab > **RADIUS & LDAP** folder > **LDAP Settings**).

CACHE ACTIONS	
LDAP Group Index	1
LDAP Refresh Cache by Key	telephoneNumber= Refresh

2. Under the Cache Actions group, do the following:
  - a. From the 'LDAP Group Index' drop-down list, select the required LDAP Server Group (see [Configuring LDAP Server Groups](#)).
  - b. In the 'LDAP Refresh Cache by Key' field, enter the LDAP search key that you want to refresh (e.g., telephoneNumber=1004).
  - c. Click **Refresh**; if a request with the specified key exists in the cache, a request is sent to the LDAP server for the Attributes associated in the cache with the search key.

## Clearing the LDAP Cache

You can remove (clear) all LDAP entries in the device's LDAP cache for a specific LDAP Server Group, as described in the following procedure.

### ➤ To clear the LDAP cache:

1. Open the LDAP Settings page (**Setup** menu > **IP Network** tab > **RADIUS & LDAP** folder > **LDAP Settings**).
2. Under the Cache Actions group, do the following:
  - a. From the 'LDAP Group Index' drop-down list, select the required LDAP Server Group (see [Configuring LDAP Server Groups](#)).
  - b. Click **Clear Group**.

## Configuring Local Database for Management User Authentication

You can configure the device to use the Local Users table (local database) to authenticate management users based on username-password combination. You can configure the device to use the Local Users table (see [Configuring Management User Accounts](#)) upon the following scenarios:

- LDAP or RADIUS server is not configured (or broken connection) or always use the Local Users table and only if the user is not found, to use the server.
- Connection with the LDAP or RADIUS server fails due to a timeout. In such a scenario, the device can deny access or verify the user's credentials (username-password) locally in the Local Users table.

If user authentication using the Local Users table succeeds, the device grants management access to the user; otherwise access is denied. The access level assigned to the user is also determined by the Local Users table.



- This feature is applicable to LDAP and RADIUS.
- This feature is applicable only to user management authentication.

### ➤ To use the Local Users table for authenticating management users:

1. Open the Authentication Server page (**Setup** menu > **Administration** tab > **Web & CLI** folder > **Authentication Server**).

Use Local Users Database

When No Auth Server Defined  ⚡

Behavior upon Authentication Server Timeout

Verify Access Locally  ⚡

2. Under the General group, do the following:

- a. Configure when the Local Users table must be used to authenticate login users. From the 'Use Local Users Database' drop-down list, select one of the following:
    - ◆ **When No Auth Server Defined (default):** When no LDAP/RADIUS server is configured or if a server is configured but connectivity with the server is down (if the server is up, the device authenticates the user with the server).
    - ◆ **Always:** First attempts to authenticate the user using the Local Users table, but if not found, it authenticates the user with the LDAP/RADIUS server.
  - b. Configure whether the Local Users table must be used to authenticate login users upon connection timeout with the server. From the 'Behavior upon Authentication Server Timeout' drop-down list, select one of the following:
    - ◆ **Deny Access:** User is denied access to the management platform.
    - ◆ **Verify Access Locally (default):** The device verifies the user's credentials in the Local Users table.
3. Click **Apply**, and then reset the device with a save-to-flash for your settings to take effect.

### LDAP-based Login Authentication Example

To facilitate your understanding on LDAP entry data structure and how to configure the device to use and obtain information from this LDAP directory, a brief configuration example is described in this section. The example applies to LDAP-based user login authentication and authorization (access level), and assumes that you are familiar with other aspects of LDAP configuration (e.g., LDAP server's address).

The LDAP server's entry data structure schema in the example is as follows:

- **DN (base path):** OU=testMgmt,OU=QA,DC=testqa,DC=local. The DN path to search for the username in the directory is shown below:

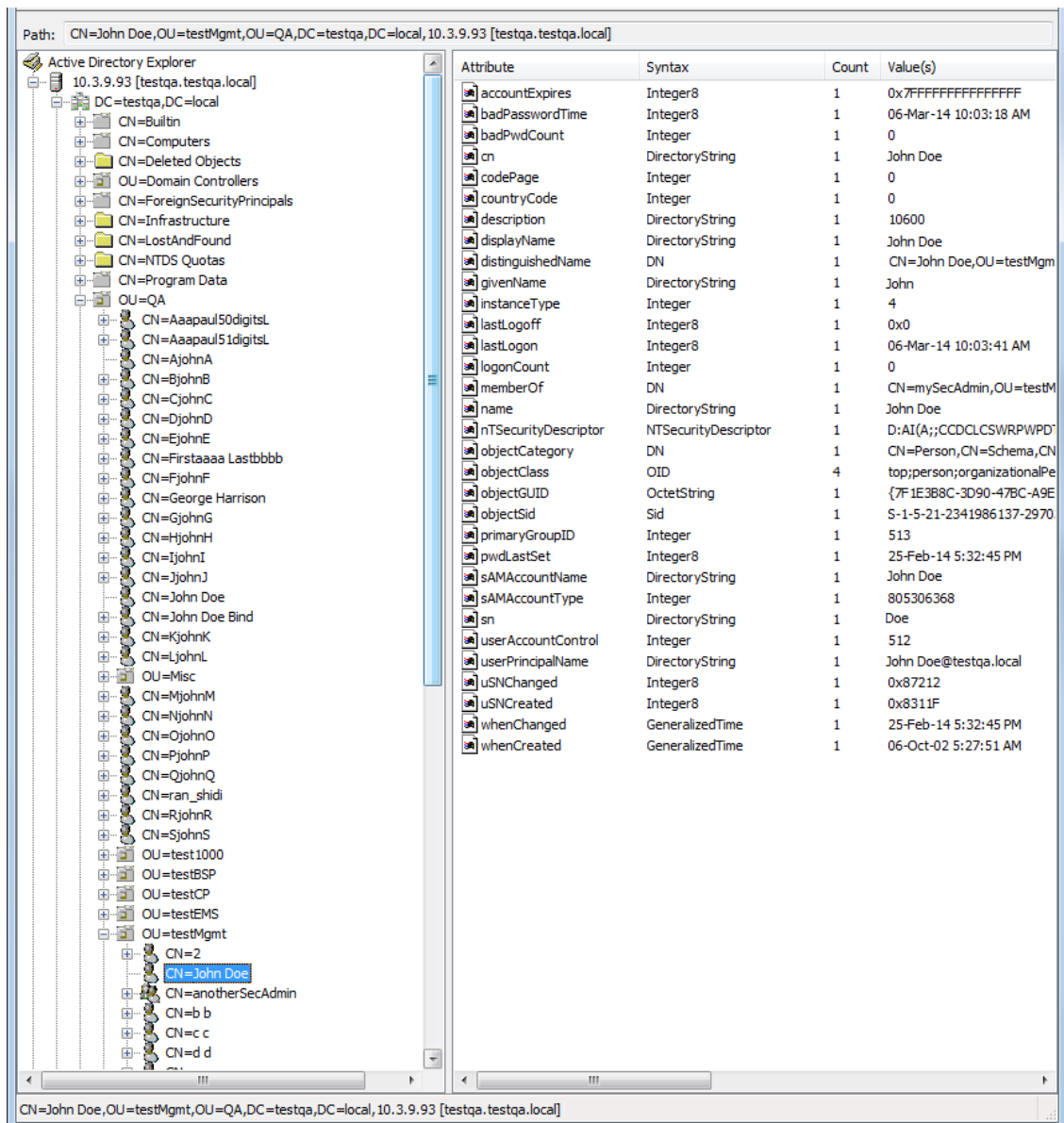

- **Search Attribute Filter:** (`sAMAccountName=$`). The login username is found based on this attribute (where the attribute's value equals the username):

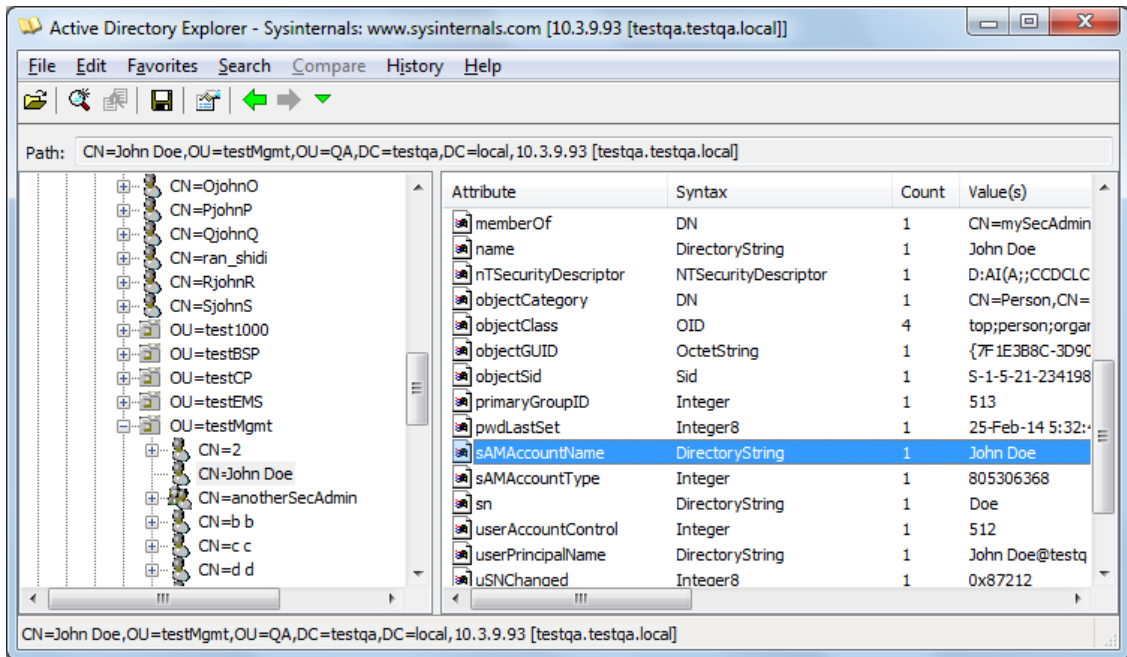

- **Management Attribute:** memberOf. The attribute contains the member groups of the user:

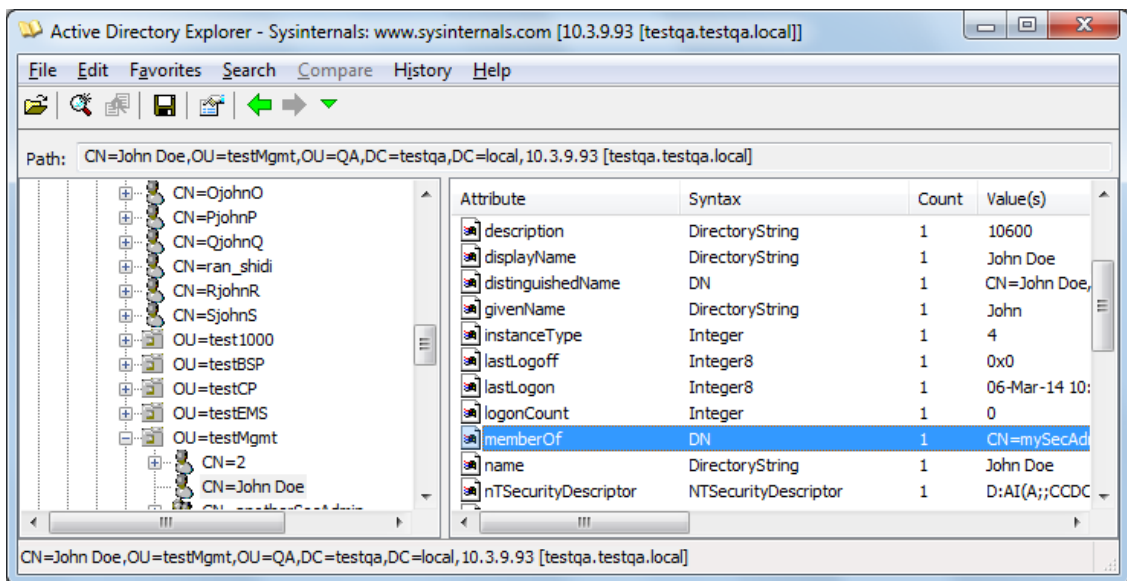

- **Management Group:** mySecAdmin. The group to which the user belongs, as listed under the memberOf attribute:

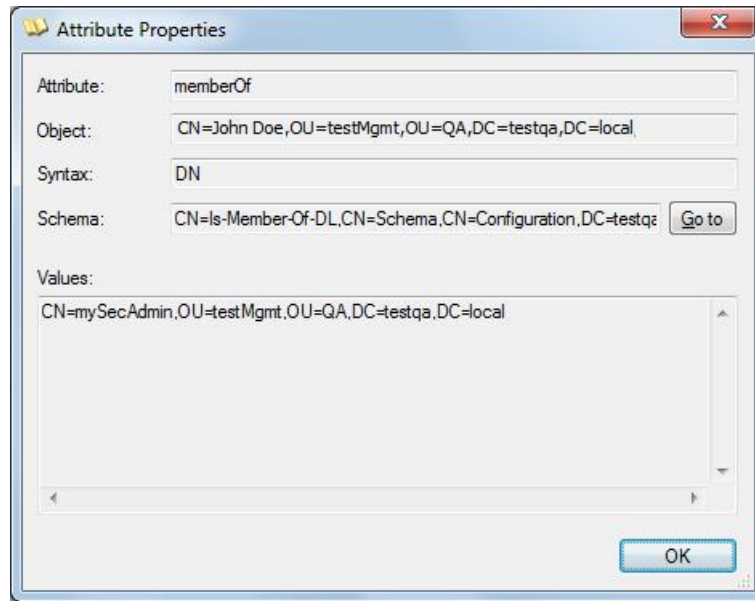

The configuration to match the above LDAP data structure schema is as follows:

- LDAP-based login authentication (management) is enabled in the LDAP Server Groups table (see [Configuring LDAP Server Groups](#)):

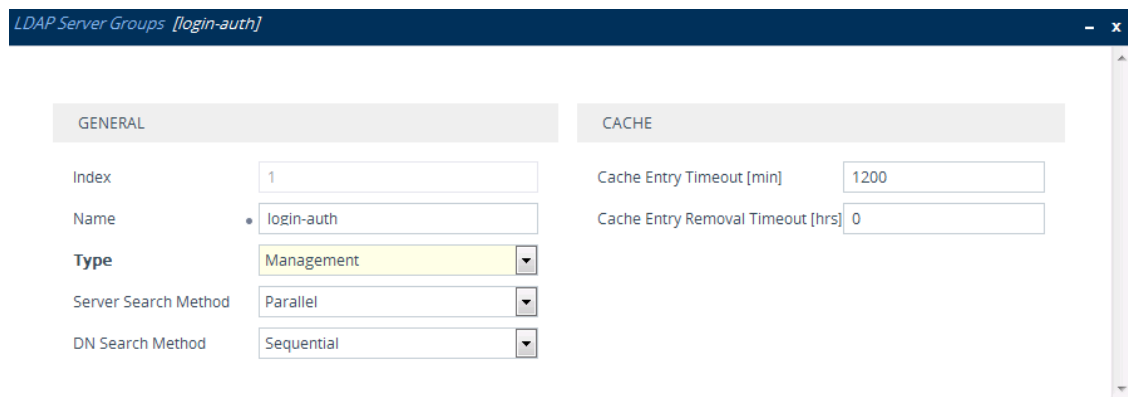

- The DN is configured in the LDAP Server Search Base DN table (see [Configuring LDAP DNs \(Base Paths\) per LDAP Server](#)):

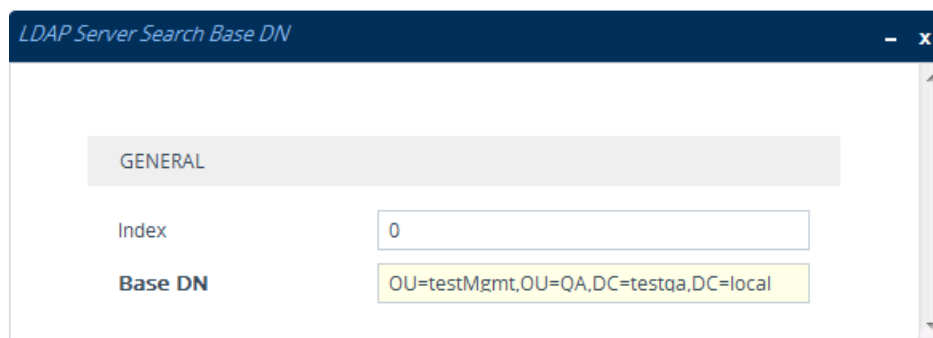

- The search attribute filter based on username is configured by the 'LDAP Authentication Filter' parameter (see [Configuring the LDAP Search Filter Attribute](#)):



**GENERAL**

**LDAP Service** • Enable

**LDAP Authentication Filter**

- The group management attribute is configured by the 'Management Attribute' parameter in the LDAP Servers table:

*LDAP Servers*

LDAP Servers Group #1 [login-auth]

GENERAL	CONNECTION
Index: 0	LDAP Server IP: 10.3.9.93
LDAP Network Interface: #0 [O+M+C] <a href="#">View</a>	LDAP Server Port: 389
Use TLS: No	LDAP Server Max Respond Time [msec]: 3000
TLS Context: -- <a href="#">View</a>	LDAP Server Domain Name: <input type="text"/>
	Connection Status: <input type="text"/>
	Verify Certificate: No
<b>QUERY</b>	
LDAP Password: <input type="text"/>	
LDAP Bind DN: \$@testqa.local	
Management Attribute: memberOf	

- The management group and its corresponding access level is configured in the Management LDAP Groups table (see [Configuring Access Level per Management Groups Attributes](#)):

*Management LDAP Groups*

**GENERAL**

Index: 0

Level: Security Admin

Groups: mySecAdmin

### Enabling LDAP Searches for Numbers with Characters

Typically, the device performs LDAP searches in the AD for complete numbers where the digits are adjacent to one another (e.g., 5038234567). However, if the number is defined in the AD with characters (such as spaces, hyphens and periods) separating the digits (e.g., 503-823 4567), the LDAP query returns a failed result.

To enable the device to search the AD for numbers that may contain characters between its digits, you need to specify the Attribute (up to five) for which you want to apply this functionality, using the `LDAPNumericAttributes` parameter. For example, the `telephoneNumber` Attribute could be defined in AD with the telephone number "503-823-4567" (i.e., hyphens), "503.823.4567" (i.e., periods) or "503 823 4567" (i.e., spaces). If the device performs an LDAP search on this Attribute for the number 5038234567, the LDAP query will return results only if you configure the `LDAPNumericAttributes` parameter with the `telephoneNumber` Attribute (e.g., `LDAPNumericAttributes=telephoneNumber`). To search for the number with characters, the device inserts the asterisk (\*) wildcard between all digits in the LDAP query (e.g., `telephoneNumber = 5*0*3*8*2*3*4*5*6*7`). As the AD server recognizes the \* wildcard as representing any character, it returns all possible results to the device. Note that the wildcard represents only a character; a query result containing a digit in place of a wildcard is discarded and the device performs another query for the same Attribute. For example, it may return the numbers 533-823-4567 (second digit "3" and hyphens) and 503-823-4567. As the device discards query results where the wildcard results in a digit, it selects 503-823-4567 as the result. The correct query result is cached by the device for subsequent queries and/or in case of LDAP server failure.

## AD-based Routing for Microsoft Skype for Business

Typically, companies wishing to deploy Microsoft® Skype for Business (formerly known as Lync) are faced with a complex, call routing dial plan when migrating users from their existing PBX or IP PBX to the Skype for Business platform. As more and more end-users migrate to the new voice system, dialing plan management and PBX link capacity can be adversely impacted. To resolve this issue, companies can employ Microsoft's Active Directory (AD), which provides a central database to manage and maintain information regarding user's availability, presence, and location.

The device supports outbound IP call routing decisions based on information stored on the AD. Based on queries sent to the AD, the device can route the call to one of the following IP domains:

- Skype for Business client - users connected to Skype for Business through the Mediation Server
- PBX or IP PBX - users not yet migrated to Skype for Business
- Mobile - mobile number
- Private - private telephone line for Skype for Business users (in addition to the primary telephone line)

## Querying the AD and Routing Priority

The device queries the AD using the initial destination number (i.e., called number). The query can return up to four user phone numbers, each pertaining to one of the IP domains (i.e., private number, Skype for Business number, PBX / IP PBX number, and mobile number). The configuration parameters listed in the table below are used to configure the query attribute keys that defines the AD attribute that you wish to query in the AD:

Table 16-12: Parameters for Configuring Query Attribute Key

Parameter	Queried User Domain (Attribute) in AD	Query or Query Result Example
<b>MSLDAPPBXNumAttributeName</b>	PBX or IP PBX number (e.g., "telephoneNumber" - default)	telephoneNumber=+3233554447
<b>MSLDAPOCSNumAttributeName</b>	Mediation Server / Skype for Business client number (e.g., "msRTCSIP-Line")	msRTCSIP-Line=john.smith@company.com
<b>MSLDAPMobileNumAttributeName</b>	Mobile number (e.g., "mobile")	mobile=+3247647156
<b>MSLDAPPrivateNumAttributeName</b>	Any attribute (e.g., "msRTCSIP-PrivateLine") <b>Note:</b> Used only if set to same value as Primary or Secondary key.	msRTCSIP-PrivateLine=+3233554480
<b>MSLDAPPrimaryKey</b>	Primary Key query search instead of PBX key - can be any AD attribute	msRTCSIP-PrivateLine=+3233554480
<b>MSLDAPSecondaryKey</b>	Secondary Key query key search if Primary Key fails - can be any attribute	-

The process for querying the AD and subsequent routing based on the query results is as follows:

1. If the Primary Key is configured, it uses the defined string as a primary key instead of the one defined in `MSLDAPPBXNumAttributeName`. It requests the attributes which are described below.

2. If the primary query is not found in the AD and the Secondary Key is configured, it does a second query for the destination number using a second AD attribute key name, configured by the MSLDAPSecondaryKey parameter.
3. If none of the queries are successful, it routes the call to the original dialed destination number according to the routing rule matching the "LDAP\_ERR" destination prefix number value, or rejects the call with a SIP 404 "Not Found" response.
4. For each query (primary or secondary), it queries the following attributes (if configured):
  - MSLDAPPBXNumAttributeName
  - MSLDAPOCSNumAttributeName
  - MSLDAPMobileNumAttributeName

In addition, it queries the special attribute defined in MSLDAPPrivateNumAttributeName, only if the query key (primary or secondary) is equal to its value.

5. If the query is found: The AD returns up to four attributes - Skype for Business, PBX / IP PBX, private (only if it equals Primary or Secondary key), and mobile.
6. The device adds unique prefix keywords to the query results in order to identify the query type (i.e., IP domain). These prefixes are used as the prefix destination number value in the Tel-to-IP Routing table to denote the IP domains:
  - "PRIVATE" (PRIVATE:<private\_number>): used to match a routing rule based on query results of the private number (MSLDAPPrivateNumAttributeName)
  - "OCS" (OCS:<Skype for Business\_number>): used to match a routing rule based on query results of the Skype for Business client number (MSLDAPOCSNumAttributeName)
  - "PBX" (PBX:<PBX\_number>): used to match a routing rule based on query results of the PBX / IP PBX number (MSLDAPPBXNumAttributeName)
  - "MOBILE" (MOBILE:<mobile\_number>): used to match a routing rule based on query results of the mobile number (MSLDAPMobileNumAttributeName)
  - "LDAP\_ERR": used to match a routing rule based on a failed query result when no attribute is found in the AD



These prefixes are involved only in the routing and manipulation processes; they are not used as the final destination number.

7. The device uses the Tel-to-IP Routing table to route the call based on the LDAP query result. The device routes the call according to the following priority:
  - a. **Private line:** If the query is done for the private attribute and it's found, the device routes the call according to this attribute.

- b. Mediation Server SIP address (Skype for Business):** If the private attribute does not exist or is not queried, the device routes the call to the Mediation Server (which then routes the call to the Skype for Business client).
- c. PBX / IP PBX:** If the Skype for Business client is not found in the AD, it routes the call to the PBX / IP PBX.
- d. Mobile number:** If the Skype for Business client (or Mediation Server) is unavailable (e.g., SIP response 404 "Not Found" upon INVITE sent to Skype for Business client), and the PBX / IP PBX is also unavailable, the device routes the call to the user's mobile number (if exists in the AD).
- e. Alternative route:** If the call routing to all the above fails (e.g., due to unavailable destination - call busy), the device can route the call to an alternative destination if an alternative routing rule is configured.
- f. "Redundant" route:** If the query failed (i.e., no attribute found in the AD), the device uses the routing rule matching the "LDAP\_ERR" prefix destination number value.



For digital interfaces (Gateway application): For Enterprises implementing a PBX / IP PBX system, but yet to migrate to Skype for Business, if the PBX / IP PBX system is unavailable or has failed, the device uses the AD query result for the user's mobile phone number, routing the call through the PSTN to the mobile destination.

The flowchart below summarizes the device's process for querying the AD and routing the call based on the query results:

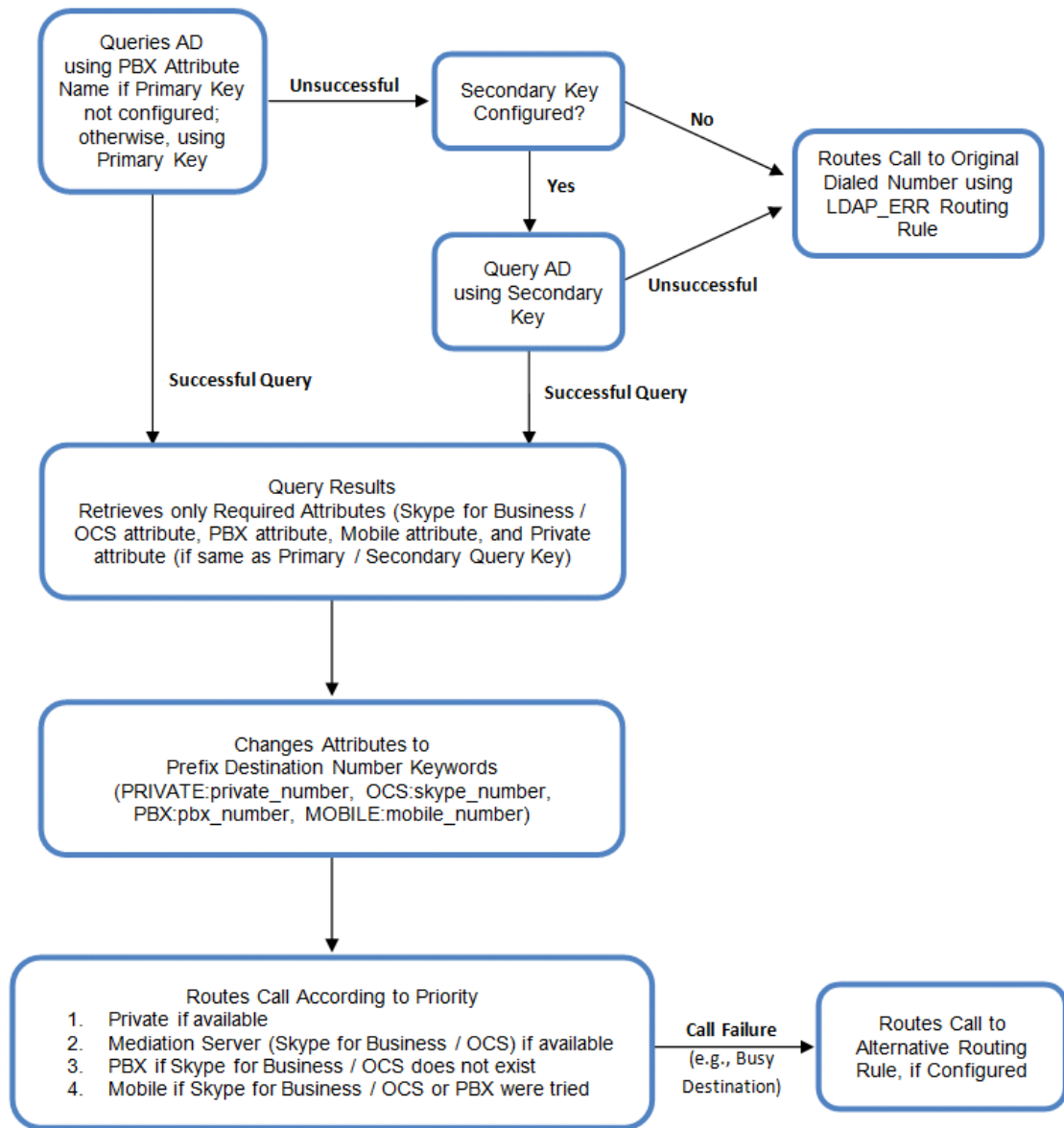

If you are using the device's local LDAP cache, see [Configuring the Device's LDAP Cache](#) for the LDAP query process.

## Configuring AD-Based Routing Rules

The following procedure describes how to configure outbound IP routing based on LDAP queries.

### ➤ To configure LDAP-based IP routing for Skype for Business:

1. Configure the LDAP server parameters, as described in [Configuring LDAP Servers](#).
2. Configure the AD attribute names used in the LDAP query:
  - a. Open the SIP Definitions General Settings page (**Setup** menu > **Signaling & Media** tab > **SIP Definitions** folder > **SIP Definitions General Settings**).

ACTIVE DIRECTORY	
<b>LDAP Numeric Attributes</b>	<input type="text"/>
LDAP OCS Number Attribute Name	<input type="text" value="msRTCSIP-Line"/>
MS LDAP PBX Number Attribute Name	<input type="text" value="telephoneNumber"/>
LDAP MOBILE Number Attribute Name	<input type="text" value="mobile"/>
LDAP DISPLAY Name Attribute Name	<input type="text" value="displayName"/>
LDAP PRIVATE Number Attribute Name	<input type="text" value="msRTCSIP-PrivateLine"/>
LDAP Primary Key	<input checked="" type="radio"/> <input type="text" value="telephoneNumber"/>
LDAP Secondary Key	<input type="text"/>

- b. Configure the LDAP attribute names as desired.
3. Gateway application: Configure AD-based Tel-to-IP routing rules:
  - a. Open the Tel-to-IP Routing table (see [Configuring Tel-to-IP Routing Rules](#)).
  - b. Configure query-result routing rules for each IP domain (private, PBX / IP PBX, Skype for Business clients, and mobile), using the LDAP keywords (case-sensitive) for the prefix destination number:
    - ◆ PRIVATE: Private number
    - ◆ OCS: Skype for Business client number
    - ◆ PBX: PBX / IP PBX number
    - ◆ MOBILE: Mobile number
    - ◆ LDAP\_ERR: LDAP query failure
  - c. Configure a routing rule for routing the initial Tel call to the LDAP server, using the value "LDAP" (without quotation marks) for denoting the IP address of the LDAP server.
  - d. For alternative routing, enable the alternative routing mechanism and configure corresponding SIP reasons for alternative routing. For this feature, alternative routing starts from the table row located under the LDAP query row.
4. SBC application: Configure AD-based IP-to-IP routing rules:
  - a. Open the IP-to-IP Routing table (see [Configuring SBC IP-to-IP Routing Rules](#)).
  - b. Configure query-result routing rules for each IP domain (private, PBX / IP PBX, Skype for Business clients, and mobile), using the LDAP keywords (case-sensitive) in the 'Destination Username Pattern' field:
    - ◆ PRIVATE: Private number
    - ◆ OCS: Skype for Business client number
    - ◆ PBX: PBX / IP PBX number

- ◆ MOBILE: Mobile number
  - ◆ LDAP\_ERR: LDAP query failure
- c. Configure a routing rule for routing the initial call (LDAP query) to the LDAP server, by setting the 'Destination Type' field to LDAP for denoting the IP address of the LDAP server.
  - d. For alternative routing, enable the alternative routing mechanism and configure corresponding SIP reasons for alternative routing. For this feature, alternative routing starts from the table row located under the LDAP query row.

The table below shows an example for configuring AD-based Tel-to-IP routing rules in the Tel-to-IP Routing table:

**Table 16-13:AD-Based Tel-to-IP Routing Rule Configuration Examples**

Index	Destination Phone Prefix	Destination IP Address
1	PRIVATE:	10.33.45.60
2	PBX:	10.33.45.65
3	OCS:	10.33.45.68
4	MOBILE:	10.33.45.100
5	LDAP_ERR	10.33.45.80
6	*	LDAP
7	*	10.33.45.72

The table below shows an example for configuring AD-based SBC routing rules in the IP-to-IP Routing Table:

**Table 16-14:AD-Based SBC IP-to-IP Routing Rule Configuration Examples**

Index	Destination Username Pattern	Destination Type	Destination Address
1	PRIVATE:	Dest Address	10.33.45.60
2	PBX:	Dest Address	10.33.45.65
3	OCS:	Dest Address	10.33.45.68
4	MOBILE:	Dest Address	10.33.45.100
5	LDAP_ERR	Dest Address	10.33.45.80
6	*	LDAP	-



Index	Destination Username Pattern	Destination Type	Destination Address
7	*	Dest Address	10.33.45.72

The configured routing rule example is explained below:

- **Rule 1:** Sends call to private telephone line (at 10.33.45.60) upon successful AD query result for the private attribute.
- **Rule 2:** Sends call to IP PBX (at 10.33.45.65) upon successful AD query result for the PBX attribute.
- **Rule 3:** Sends call to Skype for Business client (i.e., Mediation Server at 10.33.45.68) upon successful AD query result for the Skype for Business attribute.
- **Rule 4:** Sends call to user's mobile phone number (to PSTN through the device's IP address at 10.33.45.100) upon successful AD query result for the Mobile attribute.
- **Rule 5:** Sends call to IP address of device (10.33.45.80) if AD query failure (e.g., no response from LDAP server or attribute not found).
- **Rule 6:** Sends query for original destination number of received call to the LDAP server.
- **Rule 7:** Alternative routing rule that sends the call of original dialed number to IP destination 10.33.45.72. This rule is applied in any of the following cases
  - LDAP functionality is disabled.
  - LDAP query is successful but call fails (due to, for example, busy line) to all the relevant attribute destinations (private, Skype for Business, PBX, and mobile), and a relevant Tel-to-IP Release Reason (see [Alternative Routing for Tel-to-IP Calls](#)) or SBC Alternative Routing Reason (see [Configuring SIP Response Codes for Alternative Routing Reasons](#)) has been configured.

Once the device receives the original incoming call, the first rule that it uses is Rule 6, which queries the AD server. When the AD replies, the device searches the table, from the first rule down, for the matching destination phone prefix (i.e., "PRIVATE:", "PBX:", "OCS:", "MOBILE:", and "LDAP\_ERR:"), and then sends the call to the appropriate destination.

### Querying the AD for Calling Name

The device can retrieve the calling name (display name) from an LDAP-compliant server (for example, Microsoft Active Directory / AD) for Tel-to-IP calls that are received without a calling name.

The device uses the calling number (PBX or mobile number) for the LDAP query. Upon an incoming INVITE, the device queries the AD based on the Calling Number search key (tries to match the calling number with the appropriate "telephoneNumber" or "mobile" number AD attribute entry). It then searches for the corresponding calling name attribute, configured by the MSLDAPDisplayNameAttributeName parameter (e.g., "displayName"). The device uses the

resultant calling name as the display name parameter in the SIP From header of the outgoing INVITE message.

To configure this feature, the following keywords are used in the Calling Name Manipulation for Tel-to-IP Calls table for the 'Prefix/Suffix to Add' fields, which can be combined with other characters:

- "\$LDAP-PBX": LDAP query using the MSLDAPPBXAttrName parameter as the search key
- "\$LDAP-MOBILE": LDAP query using MSLDAPMobileAttrName parameter as the search key

If the source (calling) number of the Tel-to-IP call matches the PBX / MOBILE (e.g., "telephoneNumber" and "mobile") number in the AD server, the device uses the resultant Display Name instead of the keyword(s).

For example, assume the following configuration in the Calling Name Manipulation for Tel-to-IP Calls table:

- 'Source Phone Pattern' field is set to "4".
- 'Prefix to Add' field is set to "\$LDAP-PBX Office".

If the calling number is 4046 and the resultant LDAP query display name is "John Doe", the device sends the INVITE message with the following From header:

```
From: John Doe <sip:4064@company.com>
```



- The Calling Name Manipulation for Tel-to-IP Calls table uses the numbers before manipulation, as inputs.
- The LDAP query uses the calling number after source number manipulation, as the search key value.
- This feature is applicable only to the Gateway application.

## Least Cost Routing

This section describes the device's Least Cost Routing (LCR) feature.

### Overview

The LCR feature enables the device to choose the outbound IP destination routing rule based on lowest call cost. This is useful in that it enables service providers to optimize routing costs for customers. For example, you may wish to define different call costs for local and international calls or different call costs for weekends and weekdays (specifying even the time of call). The device sends the calculated cost of the call to a Syslog server (as Information messages), thereby enabling billing by third-party vendors.

LCR is implemented by defining Cost Groups and assigning them to routing rules in the Tel-to-IP Routing table (for Gateway calls) or IP-to-IP Routing table (for SBC calls). The device searches the routing table for matching routing rules and then selects the rule with the lowest call cost.

If two routing rules have identical costs, the rule appearing higher up in the table is used (i.e., first-matched rule). If the selected route is unavailable, the device selects the next least-cost routing rule.

Even if a matched routing rule is not assigned a Cost Group, the device can select it as the preferred route over other matched rules that are assigned Cost Groups. This is determined according to the settings of the 'Default Call Cost' parameter configured for the Routing Policy (associated with the routing rule for SBC calls). To configure the Routing Policy, for Gateway calls see [Configuring a Gateway Routing Policy Rule](#); for SBC calls, see [Configuring SBC Routing Policy Rules](#).

The Cost Group defines a fixed connection cost (*connection cost*) and a charge per minute (*minute cost*). Cost Groups can also be configured with time segments (*time bands*), which define connection cost and minute cost based on specific days of the week and time of day (e.g., from Saturday through Sunday, between 6:00 and 18:00). If multiple time bands are configured per Cost Group and a call spans multiple time bands, the call cost is calculated using only the time band in which the call was initially established.

In addition to Cost Groups, the device can calculate the call cost using an optional, user-defined average call duration value. The logic in using this option is that a Cost Group may be cheap if the call duration is short, but due to its high minute cost, may prove very expensive if the duration is lengthy. Thus, together with Cost Groups, the device can use this option to determine least cost routing. The device calculates the Cost Group call cost as follows:

$$\text{Total Call Cost} = \text{Connection Cost} + (\text{Minute Cost} * \text{Average Call Duration})$$

The below table shows an example of call cost when taking into consideration call duration. This example shows four defined Cost Groups and the total call cost if the average call duration is 10 minutes:

**Table 16-15: Call Cost Comparison between Cost Groups for different Call Durations**

Cost Group	Connection Cost	Minute Cost	Total Call Cost per Duration	
			1 Minute	10 Minutes
A	1	6	7	61
B	0	10	10	100
C	0.3	8	8.3	80.3
D	6	1	7	16

If four matching routing rules are located in the routing table and each one is assigned a different Cost Group as listed in the table above, then the rule assigned Cost Group "D" is selected. Note that for one minute, Cost Groups "A" and "D" are identical, but due to the average call duration, Cost Group "D" is cheaper. Therefore, average call duration is an important factor in determining the cheapest routing role.

Below are a few examples of how you can implement LCR:

- **Example 1:** This example uses two different Cost Groups for routing local calls and international calls:

Two Cost Groups are configured as shown below:

Cost Group	Connection Cost	Minute Cost
1. "Local Calls"	2	1
2. "International Calls"	6	3

The Cost Groups are assigned to routing rules for local and international calls:

Routing Index	Dest Phone Prefix	Destination IP	Cost Group ID
1	2000	x.x.x.x	1 "Local Calls"
2	00	x.x.x.x	2 "International Calls"

- **Example 2:** This example shows how the device determines the cheapest routing rule in the Tel-to-IP Routing table:

The 'Default Call Cost' parameter in the Routing Policy rule is configured to **Lowest Cost**, meaning that if the device locates other matching routing rules (with Cost Groups assigned), the routing rule without a Cost Group is considered the lowest cost route.

- The following Cost Groups are configured:

Cost Group	Connection Cost	Minute Cost
1. "A"	2	1
2. "B"	6	3

- The Cost Groups are assigned to routing rules:

Routing Index	Dest Phone Prefix	Destination IP	Cost Group
1	201	x.x.x.x	"A"
2	201	x.x.x.x	"B"
3	201	x.x.x.x	0
4	201	x.x.x.x	"B"

The device calculates the optimal route in the following index order: 3, 1, 2, and then 4, due to the following logic:

- Index 1 - Cost Group "A" has the lowest connection cost and minute cost

- Index 2 - Cost Group "B" takes precedence over Index 4 entry based on the first-matched method rule
- Index 3 - no Cost Group is assigned, but as the 'Default Call Cost' parameter is configured to **Lowest Cost**, it is selected as the cheapest route
- Index 4 - Cost Group "B" is only second-matched rule (Index 1 is the first)

■ **Example 3:** This example shows how the cost of a call is calculated if the call spans over multiple time bands:

Assume a Cost Group, "CG Local" is configured with two time bands, as shown below:

Cost Group	Time Band	Start Time	End Time	Connection Cost	Minute Cost
CG Local	TB1	16:00	17:00	2	1
	TB2	17:00	18:00	7	2

Assume that the call duration is 10 minutes, occurring between 16:55 and 17:05. In other words, the first 5 minutes occurs in time band "TB1" and the next 5 minutes occurs in "TB2", as shown below:

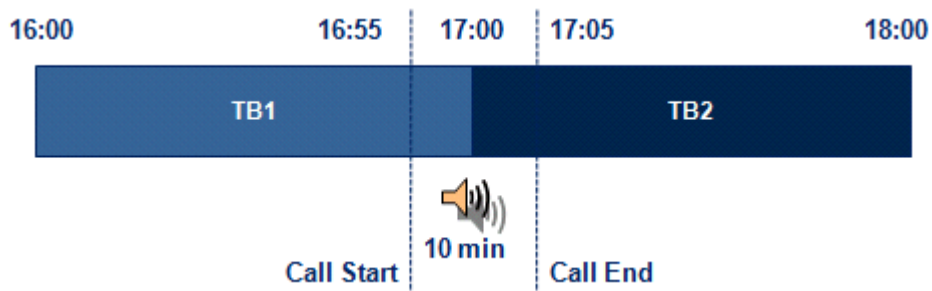

The device calculates the call using the time band in which the call was initially established, regardless of whether the call spans over additional time bands:

**Total call cost** = "TB1" Connection Cost + ("TB1" Minute Cost x call duration) = 2 + 1 x 10 min = 12

## Configuring LCR

To configure LCR, perform the following main steps:

1. Enable LCR:
  - Gateway application: see [Configuring a Gateway Routing Policy Rule](#)
  - SBC application: [Configuring SBC Routing Policy Rules](#)
2. Configure Cost Groups - see [Configuring Cost Groups](#).
3. Configure Time Bands for a Cost Group - see [Configuring Time Bands for Cost Groups](#).
4. Assign Cost Groups to outbound IP routing rules - see [Assigning Cost Groups to Routing Rules](#).

## Configuring Cost Groups

The Cost Groups table lets you configure up to 10 Cost Groups. A Cost Group defines a fixed call connection cost and a call rate (charge per minute). Once configured, you can configure Time Bands per Cost Group.

The following procedure describes how to configure Cost Groups through the Web interface. You can also configure it through ini file [CostGroupTable] or CLI (`configure voip > sip-definition least-cost-routing cost-group`).

### ➤ To configure a Cost Group:

1. Open the Cost Groups table (**Setup** menu > **Signaling & Media** tab > **SIP Definitions** folder > **Least Cost Routing** > **Cost Groups**).
2. Click **New**; the following dialog box appears:

3. Configure a Cost Group according to the parameters described in the table below.
4. Click **Apply**, and then save your settings to flash memory.

**Table 16-16: Cost Groups Table Parameter Descriptions**

Parameter	Description
'Index' [CostGroupTable_Index]	Defines an index number for the new table row. <b>Note:</b> Each row must be configured with a unique index.
'Name' cost-group-name [CostGroupTable_ CostGroupName]	Defines a descriptive name, which is used when associating the row in other tables. The valid value is a string of up to 40 characters. <b>Note:</b> <ul style="list-style-type: none"> <li>■ Each row must have a unique name.</li> <li>■ The parameter value cannot contain a forward slash (/).</li> </ul>

Parameter	Description
'Default Connection Cost' default-connection-cost [CostGroupTable_ DefaultConnectionCost]	Defines the call connection cost (added as a fixed charge to the call) for a call outside the time bands. The valid value range is 0-65533. The default is 0. <b>Note:</b> When calculating the cost of a call, if the current time of the call is not within a time band configured for the Cost Group, then this default connection cost is used.
'Default Minute Cost' default-minute-cost [CostGroupTable_ DefaultMinuteCost]	Defines the call charge per minute for a call outside the time bands. The valid value range is 0-65533. The default is 0. <b>Note:</b> When calculating the cost of a call, if the current time of the call is not within a time band configured for the Cost Group, then this default charge per minute is used.

### Configuring Time Bands for Cost Groups

The Time Band table lets you configure Time Bands per Cost Group. A Time Band defines a day and time range (e.g., from Saturday 05:00 to Sunday 24:00) and a fixed call connection charge and call rate per minute for this interval. You can configure up to 70 Time Bands, where up to 21 Time Bands can be assigned to each Cost Group.



- You cannot configure overlapping Time Bands.
- If a Time Band is not configured for a specific day and time range, the default connection cost and default minute cost configured for the Cost Group in the Cost Groups table is applied.

The following procedure describes how to configure Time Bands per Cost Group through the Web interface. You can also configure it through ini file [CostGroupTimebands] or CLI (configure voip > sip-definition least-cost-routing cost-group-time-bands).

#### ➤ To configure a Time Band per Cost Group:

1. Open the Cost Groups table (**Setup** menu > **Signaling & Media** tab > **SIP Definitions** folder > **Least Cost Routing** > **Cost Groups**).
2. Select a Cost Group for which you want to assign Time Bands, and then click the **Time Band** link located below the table; the Time Band table for the selected Cost Group appears.
3. Click **New**; the following dialog box appears:

4. Configure a Time Band according to the parameters described in the table below.
5. Click **Apply**, and then save your settings to flash memory.

**Table 16-17:Time Band Table Description**

Parameter	Description
'Index' timeband-index [CostGroupTimebands_ TimebandIndex]	Defines an index number for the new table row. <b>Note:</b> Each row must be configured with a unique index.
'Start Time' start-time [CostGroupTimebands_ StartTime]	Defines the day and time of day from when this time band is applicable. The format is DDD:hh:mm, where: <ul style="list-style-type: none"> <li>■ <i>DDD</i> is the day of the week, represented by the first three letters of the day in uppercase (i.e., SUN, MON, TUE, WED, THU, FRI, or SAT).</li> <li>■ <i>hh</i> and <i>mm</i> denote the time of day, where <i>hh</i> is the hour (00-23) and <i>mm</i> the minutes (00-59)</li> </ul> For example, SAT:22:00 denotes Saturday at 10 pm.
'End Time' end-time [CostGroupTimebands_ EndTime]	Defines the day and time of day until when this time band is applicable. For a description of the valid values, see the parameter above.
'Connection Cost' connection-cost [CostGroupTimebands_ ConnectionCost]	Defines the call connection cost during the time band. This is added as a fixed charge to the call. The valid value range is 0-65533. The default is 0. <b>Note:</b> The entered value must be a whole number (i.e., not a decimal).



Parameter	Description
'Minute Cost' minute-cost [CostGroupTimebands_ MinuteCost]	Defines the call cost per minute charge during the time band. The valid value range is 0-65533. The default is 0. <b>Note:</b> The entered value must be a whole number (i.e., not a decimal).

### Assigning Cost Groups to Routing Rules

To use your configured Cost Groups, you need to assign them to routing rules:

- Gateway application: Tel-to-IP Routing table - see [Configuring Tel-to-IP Routing Rules](#) on page 734
- SBC application: IP-to-IP Routing table - see [Configuring SBC IP-to-IP Routing](#) on page 966

## Remote Web Services

This section describes configuration for remote Web services.



To debug remote Web services, see [Debugging Web Services](#).

### Configuring Remote Web Services

The Remote Web Services table lets you configure up to seven Web-based (HTTP/S) services (*Remote Web Services*) provided by third-party, remote HTTP/S hosts (*HTTP Remote Hosts*). The following types of services can be offered by the remote hosts: Routing service, Call Status service, Topology Status service, QoS service, General service, and Registration Status service. For more information on these services, see the description of the 'Type' parameter below.

A Remote Web Service is configured using two tables with "parent-child" relationship:

- Remote Web Services table ("parent"): Defines the name of the Remote Web Service as well as other settings (e.g., type of service). This table is described below.
- HTTP Remote Hosts table ("child"): Defines remote HTTP hosts (e.g., IP address) per Remote Web Service. For more information, see [Configuring Remote HTTP Hosts](#) on page 307.



- You can configure only **one** Remote Web Service for each of the following service types: **Routing**, **Call Status**, **Topology Status**, **QoS**, **Registration Status**, and **Remote Monitoring**.
- The Routing service also includes the Call Status and Topology Status services.
- The device supports HTTP redirect responses (3xx) only during connection establishment with the host. Upon receipt of a redirect response, the device



attempts to open a new socket with the host and if this is successful, closes the current connection.

The following procedure describes how to configure Remote Web Services through the Web interface. You can also configure it through ini file [HTTPRemoteServices] or CLI (`configure system > http-services > http-remote-services`).

➤ **To configure a remote Web service:**

1. Open the Remote Web Services table (**Setup** menu > **IP Network** tab > **Web Services** folder > **Remote Web Services**).
2. Click **New**; the following dialog box appears:

3. Configure a remote Web service according to the parameters described in the table below.
4. Click **Apply**, and then save your settings to flash memory.

**Table 16-18: Remote Web Services Table Parameter Descriptions**

Parameter	Description
<b>General</b>	
'Index' [HTTPRemoteServices_Index]	Defines an index number for the new table row. <b>Note:</b> <ul style="list-style-type: none"> <li>■ Each row must be configured with a unique index.</li> <li>■ The parameter is mandatory.</li> </ul>
'Name' rest-name [HTTPRemoteServices_Name]	Defines a descriptive name, which is used when associating the row in other tables. The valid value is a string of up to 40 characters. <b>Note:</b> <ul style="list-style-type: none"> <li>■ Each row must be configured with a unique name.</li> <li>■ The parameter is mandatory.</li> </ul>

Parameter	Description
'Type' rest-message-type [HTTPRemoteServices_ HTTPType]	<ul style="list-style-type: none"> <li>■ The parameter value cannot contain a forward slash (/).</li> </ul> <p>Defines the type of service provided by the HTTP remote host:</p> <ul style="list-style-type: none"> <li>■ [0] <b>Routing</b> = (Default) This option provides a call routing service, whereby the host (e.g., Routing server) determines the next hop of an incoming call on the path to its final destination. For more information on employing a third-party, routing server, see <a href="#">Centralized Third-Party Routing Server</a>. This option also includes the services provided by the <b>Call Status</b> and <b>Topology Status</b> options.</li> <li>■ [1] <b>Call Status</b> = This option provides a call status service for calls processed by the device. The device provides call status to the host by sending CDRs.</li> <li>■ [2] <b>Topology Status</b> = This option provides a topology status service, which refers to all device configuration changes (add, edit and delete actions). The device sends topology status to the HTTP host, using the REST API command, TopologyStatus. For this service to be functional, you also need to enable the Topology Status service as described in <a href="#">Enabling Topology Status Services</a>.</li> </ul> <p>Topology status includes the following:</p> <ul style="list-style-type: none"> <li>✓ IP Group Connectivity: Status is reported when the keep-alive mechanism, enabled for the associated Proxy Set, detects that the IP Group is unavailable, or when CAC thresholds (configured in the Admission Control table) associated with the IP Group are crossed.</li> <li>✓ Trunk Group Availability: Status is reported when the trunk's physical state indicates that the trunk is unavailable. (Applicable only to the Gateway application.)</li> <li>✓ Configuration Status: Status is reported when IP Groups, Trunk Groups, (Gateway application only) or SIP Interfaces that are configured to be used by remote Web-based services (i.e., the UsedByRoutingServer parameter is set to 1 -</li> </ul>

Parameter	Description
	<p>Used) are created or deleted. If you subsequently change the settings of the UsedByRoutingServer parameter or the 'Name' parameter, the device reports the change as a creation or deletion of the corresponding configuration entity.</p> <ul style="list-style-type: none"> <li>■ [5] <b>QoS</b> = This option provides a call routing service based on Quality of Service (QoS). For more information, see <a href="#">Configuring QoS-Based Routing by Routing Server</a>.</li> <li>■ [8] <b>General</b> = This option can be used for the following services: <ul style="list-style-type: none"> <li>✓ Generating and sending CDRs to a REST server through REST API. The REST server is configured as an HTTP-based server (Remote Web Service). For more information, see <a href="#">Configuring CDR Reporting to REST Server</a> on page 1219.</li> <li>✓ Querying (GET) HTTP servers using Call Setup Rules. The response from the server can be used for various functionality such as tag-based classification and routing. When configuring the Call Setup Rule, you need to configure the 'Request Target' parameter to the name of this Remote Web Service. For more information on Call Setup Rules, see <a href="#">Configuring Call Setup Rules</a> on page 611.</li> <li>✓ Requesting a Push Notification Server to wake a SIP user agent (typically, a mobile device) that is registered with the server for Push Notification Service, through REST API. The REST server (Push Notification Server) is configured as an HTTP-based server (Remote Web Service). For more information, see <a href="#">Configuring Push Notification Service</a> on page 1050.</li> </ul> </li> <li>■ [9] <b>Registration Status</b> = This option provides a call routing service based on registration status. The device periodically synchronizes its database of registered user agents (endpoints) with the third-party Routing server (HTTP host) to keep it up to date, enabling the Routing server to use this information to perform correct and optimal routing</li> </ul>

Parameter	Description
	<p>decisions. For this service to be functional, you also need to enable the Registration Status service as described in <a href="#">Enabling Registration Status Services</a> on page 311.</p> <ul style="list-style-type: none"> <li>■ [10] <b>Remote Monitoring</b> = This option provides a remote monitoring of the device service when the device is located behind a NAT. The device sends its monitoring reports to this Remote Web Service (HTTP host). To enable remote monitoring and to select the report types that you want sent, see <a href="#">Remote Monitoring of Device behind NAT</a> on page 1299.</li> </ul> <p><b>Note:</b></p> <ul style="list-style-type: none"> <li>■ You can configure only one Remote Web Service for each of the following service types: <b>Routing, Call Status, Topology Status, QoS, Registration Status, and Remote Monitoring.</b></li> <li>■ The <b>Routing</b> option also includes the Call Status and Topology Status services.</li> <li>■ If you don't configure the parameter to <b>QoS</b>, the device sends QoS reports to the Topology server.</li> <li>■ For the Registration Status service, if you have not configured the parameter to <b>Registration Status</b> for any Remote Web Service, the device provides the service to the Remote Web Service for which you have configured the parameter to <b>Topology Status.</b></li> </ul>
<p>'Path' rest-path [HTTPRemoteServices_Path]</p>	<p>Defines the path (prefix) to the REST APIs. The valid value is a string of up to 80 characters. The default is "api".</p>
Policy	
<p>'Policy in Group' http-policy [HTTPRemoteServices_Policy]</p>	<p>Defines the mode of operation between hosts in a group, which are configured in the HTTP Remote Hosts table for the specific remote Web service.</p> <ul style="list-style-type: none"> <li>■ [0] <b>Round Robin</b> = (Default) The device does load balancing of traffic across all the hosts in the group. Every consecutive message is sent to the next available host. The priority of the hosts determines the order in which the device sends the traffic.</li> </ul>

Parameter	Description
	<ul style="list-style-type: none"> <li data-bbox="703 286 1394 555">■ [1] <b>Sticky Primary</b> = The device always attempts to send traffic to the host that has the highest priority in the group. If the host does not respond, the device sends the traffic to the next available host that has the highest priority. If the host that has the highest priority becomes available again, the device sends the traffic to this host.</li> <li data-bbox="703 584 1394 853">■ [2] <b>Sticky Next</b> = The device initially attempts to send traffic to the host that has the highest priority in the group. If this host becomes unavailable (or is initially unavailable), the device sends the traffic to the next available host that has the highest priority and continues sending traffic to this host even if the highest-priority host later becomes available again.</li> </ul> <p data-bbox="703 882 1394 1106"><b>Note:</b> If you have configured multiple hosts with the same priority, their priority is determined by their order of appearance in the HTTP Remote Hosts table. For example, if two hosts are configured in rows Index 0 and Index 1 with priority 0, the host in Index 0 is considered higher priority.</p>
<p data-bbox="312 1151 596 1182">'Policy between Groups'</p> <p data-bbox="312 1196 564 1263">http-policy-between-groups</p> <p data-bbox="312 1285 587 1352">[HTTPRemoteServices_BetweenGroupsPolicy]</p>	<p data-bbox="703 1151 1394 1263">Defines the mode of operation between groups of hosts, which are configured in the HTTP Remote Hosts table for the specific remote Web service.</p> <ul style="list-style-type: none"> <li data-bbox="703 1285 1394 1644">■ [1] <b>Sticky Primary</b> = (Default) The device always attempts to send traffic to the group that has the highest priority (e.g., Group 0). If none of the hosts in this group respond, the device attempts to send traffic to a host in a group that has the next highest priority (e.g., Group 1), and so on. Whenever a host in the group that has the highest priority (e.g., Group 0) becomes available again, the device sends the traffic to the host in this group.</li> <li data-bbox="703 1666 1394 1980">■ [2] <b>Sticky Next</b> = The device initially attempts to send traffic to the group of hosts that has the highest priority (e.g., Group 0). If none of the hosts in the group respond, the device attempts to send traffic to a host in a group that has the next highest priority (e.g., Group 1). Even if the group of hosts that has the highest priority (e.g., Group 0) becomes available again, the device continues sending traffic to this</li> </ul>

Parameter	Description
	lower priority group (e.g., Group 1) .
'Automatic Reconnect' http-persistent-connection [HTTPRemoteServices_PersistentConnection]	<p>Defines whether the HTTP connection with the host remains open or is only opened per request.</p> <ul style="list-style-type: none"> <li>■ [0] <b>Disable</b> = The HTTP connection is created per client (user) request and remains connected until the server closes the connection.</li> <li>■ [1] <b>Enable</b> = (Default) The device creates the HTTP connection once you have configured the service. If the server closes the connection, the device re-opens it. If the keep-alive timeout is configured, the device uses HTTP keep-alive messages to keep the connection open all the time.</li> </ul>
Login Needed http-login-needed [HTTPRemoteServices_LoginNeeded]	<p>Enables the use of the AudioCodes proprietary REST API Login and Logout commands for connecting to the remote host. The commands verify specific information (e.g., software version) before allowing connectivity with the device.</p> <ul style="list-style-type: none"> <li>■ [0] <b>Disable</b> = Commands are not used.</li> <li>■ [1] <b>Enable</b> (default)</li> </ul> <p><b>Note:</b> The parameter is applicable only if you configure the 'Type' parameter to any value other than <b>General</b>.</p>
Authentication	
'Username' rest-user-name [HTTPRemoteServices_AuthUserName]	<p>Defines the username for HTTP authentication.</p> <p>The valid value is a string of up to 80 characters. The default is "user".</p>
'Password' rest-password [HTTPRemoteServices_AuthPassword]	<p>Defines the password for HTTP authentication.</p> <p>The valid value is a string of up to 80 characters. The default is "password".</p> <p><b>Note:</b> The password cannot be configured with wide characters.</p>
Security	
'TLS Context' rest-tls-context	<p>Assigns a TLS Context (TLS configuration) for connection with the remote host.</p>

Parameter	Description
[HTTPRemoteServices_TLSTContext]	<p>By default, no value is defined.</p> <p>To configure TLS Contexts, see <a href="#">Configuring TLS Certificates</a> on page 154.</p> <p><b>Note:</b> The parameter is applicable only if the connection is HTTPS.</p>
'Verify Certificate' rest-verify-certificates [HTTPRemoteServices_VerifyCertificate]	<p>Enables certificate verification when connection with the host is based on HTTPS.</p> <ul style="list-style-type: none"> <li>■ [0] <b>Disable</b> = (Default) No certificate verification is done.</li> <li>■ [1] <b>Enable</b> = The device verifies the authentication of the certificate received from the HTTPS peer. The device authenticates the certificate against the trusted root certificate store associated with the associated TLS Context (see 'TLS Context' parameter above) and if ok, allows communication with the HTTPS peer. If authentication fails, the device denies communication (i.e., handshake fails). The device can also authenticate the certificate by querying with an Online Certificate Status Protocol (OCSP) server whether the certificate has been revoked. This is also configured for the associated TLS Context.</li> </ul> <p><b>Note:</b> The parameter is applicable only if the connection is HTTPS.</p>
'Verify Certificate Subject Name' verify-cert-subject-name [HTTPRemoteServices_VerifyCertificateSubjectName]	<p>Enables the verification of the TLS certificate subject name (Common Name / CN or Subject Alternative Name / SAN) when connection with the host is based on HTTPS.</p> <ul style="list-style-type: none"> <li>■ [0] <b>Off</b> = (Default) No verification is done.</li> <li>■ [1] <b>On</b> = The device verifies the subject name of the certificate received from the HTTPS peer. If the server's URL contains a hostname, it verifies the certificate against the hostname; otherwise, it verifies the certificate against the server's IP address. If authentication fails, the device denies communication (i.e., handshake fails).</li> </ul> <p><b>Note:</b> The parameter is applicable only if the connection is HTTPS.</p>



Parameter	Description
Timeouts	
'Response Timeout' <code>rest-timeout</code> [HTTPRemoteServices_ TimeOut]	Defines the TCP response timeout (in seconds) from the remote host. If one of the remote hosts does not respond to a request within the specified timeout, the device closes the corresponding socket and attempts to connect to the next remote host.  The valid value is 1 to 65535. The default is 5.
'Keep-Alive Timeout' <code>rest-ka-timeout</code> [HTTPRemoteServices_ KeepAliveTimeOut]	Defines the duration/timeout (in seconds) in which HTTP-REST keep-alive messages are sent by the device if no other messages are sent. Keep-alive messages may be required for HTTP services that expire upon inactive sessions. For Remote Web Service whose 'Type' is <b>Routing, Call Status, Topology Status, or QoS</b> , proprietary keep-alive messages are sent. For 'Type' that is <b>General</b> , HTTP OPTIONS keep-alive messages are sent.  The valid value is 0 to 65535. The default is 0 (i.e., no keep-alive messages are sent).
Status	
'Status'	(Read-only) Displays the status of the host associated with the Web service.  <ul style="list-style-type: none"> <li>■ "Connected": At least one of the hosts is connected.</li> <li>■ "Disconnected": All hosts are disconnected.</li> </ul>
'Active Group'	(Read-only) Displays the currently active Group (by ID) that is associated with the Web service. This is the host group to where the device is currently sending traffic.
'Active Host'	(Read-only) Displays the currently active host (by name) that is associated with the Web service. This is the host (within the active group) to where the device is currently sending traffic.  <b>Note:</b> If traffic is sent to the hosts in a round-robin fashion (i.e., 'Policy in Group' parameter is configured to <b>Round Robin</b> ), then this field displays "NA".

### Configuring Remote HTTP Hosts

The HTTP Remote Hosts table lets you configure up to 10 remote HTTP hosts per Remote Web Service. The HTTP Remote Hosts table is a "child" of the Remote Web Services table

(configured in [Configuring Remote Web Services](#)).

The following procedure describes how to configure HTTP Remote hosts through the Web interface. You can also configure it through ini file [HTTPRemoteHosts] or CLI (`configure system > http-services > http-remote-hosts`).

➤ **To configure a remote HTTP host:**

1. Open the Remote Web Services table (**Setup** menu > **IP Network** tab > **Web Services** folder > **Remote Web Services**).
2. In the table, select the required remote Web service index row, and then click the **HTTP Remote Hosts** link located below the table; the HTTP Remote Hosts table appears.
3. Click **New**; the following dialog box appears:

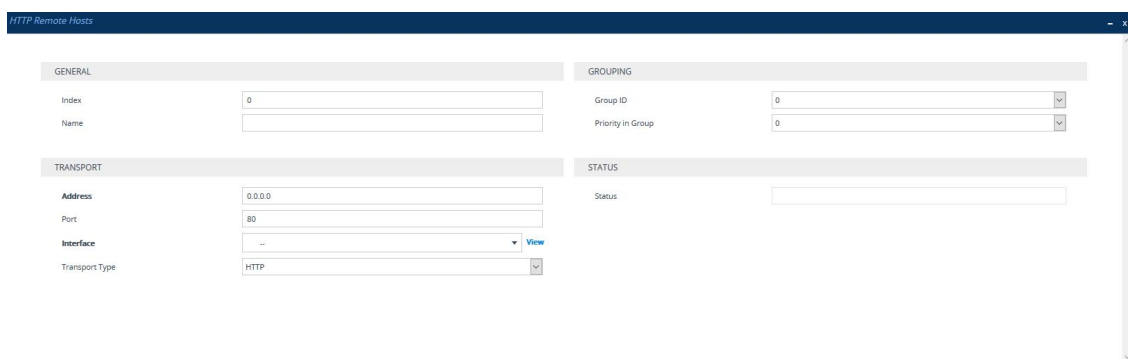

4. Configure an HTTP remote host according to the parameters described in the table below.
5. Click **Apply**, and then save your settings to flash memory.

**Table 16-19: HTTP Remote Hosts Table Parameter Descriptions**

Parameter	Description
<b>General</b>	
'Index' rest-servers [HTTPRemoteHosts_ RemoteHostindex]	<p>Defines an index number for the new table row.</p> <p><b>Note:</b></p> <ul style="list-style-type: none"> <li>■ Each row must be configured with a unique index.</li> <li>■ The parameter is mandatory.</li> </ul>
'Name' [HTTPRemoteHosts_ Name]	<p>Defines a descriptive name, which is used when associating the row in other tables.</p> <p>The valid value is a string of up to 40 characters. By default, no value is defined.</p> <p><b>Note:</b></p> <ul style="list-style-type: none"> <li>■ Each row must be configured with a unique name.</li> <li>■ The parameter is mandatory.</li> </ul>

Parameter	Description
Transport	
'Address' <code>rest-address</code> [HTTPRemoteHosts_ Address]	Defines the address (IP address or FQDN) of the remote host. The valid value is a string of up to 80 characters. <b>Note:</b> <ul style="list-style-type: none"> <li>■ An IPv6 address can only be configured if the interface is a CONTROL type.</li> <li>■ If the address is an FQDN and the DNS resolution results in multiple IP addresses, the device device attempts to establish multiple connections (sessions) for each IP address. Only the first 10 resolved IP addresses are used regardless of the number of hosts.</li> <li>■ FQDN resolution is also performed (immediately) when connection is subsequently "closed" (by timeout or by the remote host) and connections are updated accordingly. In addition, the device periodically (every 15 minutes) performs DNS name resolution to ensure that the list of resolved IP addresses has not changed. If a change is detected, the device updates its' list of IP addresses and re-establishes connections accordingly.</li> <li>■ In addition to multiple HTTP sessions, the device establishes multiple (TCP) connections per session, thereby enhancing data exchange capabilities with the host.</li> </ul>
'Port' <code>rest-port</code> [HTTPRemoteHosts_ Port]	Defines the port of the host. The valid value is 0 to 65535. The default is 80.
'Interface' <code>rest-interface</code> [HTTPRemoteHosts_ Interface]	Assigns one of the device's IP network interfaces through which communication with the remote host is done. By default, no value is defined and the OAMP interface is used.
'Transport Type' <code>rest-transport-type</code> [HTTPRemoteHosts_ HTTPTransportType]	Defines the protocol for communicating with the remote host: <ul style="list-style-type: none"> <li>■ [0] HTTP (default)</li> <li>■ [1] HTTPS</li> </ul>

Parameter	Description
Grouping	
'Group ID' group-id [HTTPRemoteHosts_GroupID]	<p>Defines the host's group ID. The group number (ID) reflects the priority of the group. The device sends traffic to host groups according to the configuration of the 'Policy between Groups' parameter in the Remote Web Services table.</p> <p>The valid value is 0 to 4, where 0 is the highest priority and 4 the lowest. The default is 0.</p>
'Priority in Group' host-priority-in-group [HTTPRemoteHosts_PriorityInGroup]	<p>Defines the priority level of the host within the assigned group. The device sends traffic to hosts within the group according to the configuration of the 'Policy in Group' parameter in the Remote Web Services table.</p> <p>The valid value is 0 to 9, where 0 is the highest priority and 9 the lowest. The default is 0.</p> <p><b>Note:</b> If you have configured multiple hosts in the group with the same priority, their priority is determined by their order of appearance in the table. For example, if two hosts are configured in rows Index 0 and Index 1 with priority 0, the host in Index 0 is considered higher priority.</p>
Status	
'Status'	<p>(Read-only) Displays the status of the connection with the remote host.</p> <ul style="list-style-type: none"> <li>■ "Connected": The host is connected.</li> <li>■ "Disconnected": The host is disconnected.</li> </ul>

## Enabling Topology Status Services

You can enable the device to send device configuration (topology) status (add, edit and delete) for Web-based services (Remote Web Services). Once enabled, you need to add a Remote Web Service with the 'Type' parameter configured to **Topology Status** (see [Configuring Remote Web Services](#)).

### ➤ To enable Topology Status services:

1. Open the Web Service Settings page (**Setup** menu > **IP Network** tab > **Web Services** folder > **Web Service Settings**).
2. From the 'Topology Status' drop-down list [RoutingServerGroupStatus], select **Enable**:

GENERAL	
Topology Status	Enable <input type="button" value="v"/>

3. Click **Apply**.

## Enabling Registration Status Services

You can enable the device to periodically synchronize its registration database of SIP user agents (endpoints) with a third-party Routing server (Remote Web Service). The Routing server can then use this information for routing decisions. Once enabled, you need to add a Remote Web Service with the 'Type' parameter configured to **Registration Status** (see [Configuring Remote Web Services](#)).

### ➤ To enable Registration Status services:

1. Open the Web Service Settings page (**Setup** menu > **IP Network** tab > **Web Services** folder > **Web Service Settings**).
2. From the 'Routing Server Registration Status' drop-down list [RoutingServerRegistrationStatus], select **Enable**:

<b>Routing Server Registration Status</b>	Enable <input type="button" value="v"/>
---	---

3. Click **Apply**.

## Third-Party Routing Server or AudioCodes Routing Manager

You can employ a remote, third-party routing server (*Remote Web Service* configuration entity) or AudioCodes Routing Manager (ARM) to handle call routing decisions in deployments consisting of multiple AudioCodes devices. The routing server can be used to handle SBC, Tel-to-IP, and IP-to-Tel calls. Employing a routing server replaces the need for the device's routing tables--IP-to-IP Routing table for SBC calls, and Tel-to-IP Routing table and IP-to-Tel Routing table for Tel-to-IP and IP-to-Tel calls respectively--to determine call destination.



For more information on ARM, refer to the *ARM User's Manual* and *ARM Installation Manual*, which can be downloaded from AudioCodes [website](#).

For SBC calls, when the device receives an incoming call (SIP INVITE, NOTIFY or MESSAGE), it searches the IP-to-IP Routing table for a matching routing rule. If the routing rule is configured to use a Routing server ('Destination Type' parameter is configured to **Routing Server**), the device sends a request to the routing server for an appropriate destination.

For Gateway calls, when the device receives an incoming call (SIP INVITE, NOTIFY or MESSAGE), it disregards the routing tables and instead, immediately sends a request to the routing server for an appropriate destination.

The request is sent to the routing server using an HTTP Get Route message. The request contains information about the call (SIP message) and for IP-to-Tel calls, the source IP Group based on the associated Proxy Set.

The routing server uses its own algorithms and logic in determining the best route path. The routing server manages the call route between devices in "hops", which may be spread over different geographical locations. The destination to each hop (device) can be an IP address (with a port) or IP Group or Trunk Group. If the destination is an IP address, even though the destination type (in the IP-to-IP Routing table) is an IP Group, the device only uses the IP Group for profiling (i.e., associated IP Profile etc.). If multiple devices exist in the call routing path, the routing server sends the IP address only to the last device ("node") in the path.

Once the device receives the resultant destination hop from the routing server, it sends the call to that destination. The routing server can provide the device with an appropriate route or reject the call. However, if for the **initial** request (first sent Get Route request for the call), the routing server cannot find an appropriate route for the call or it does not respond, for example, due to connectivity loss (i.e., the routing server sends an HTTP 404 "Not Found" message), the device routes the call using its routing tables. If the Get Route request is not the first one sent for the call (e.g., in call forwarding or alternative routing) and the routing server responds with an HTTP 404 "Not Found" message, the device rejects the call.

This HTTP request-response transaction for the routing path occurs between Routing server and each device in the route path (hops) as the call traverses the devices to its final destination. Each device in the call path connects to the routing server, which responds with the next hop in the route path. Each device considers the call as an incoming call from an IP Group or Trunk Group. The session ID (SID) is generated by the first device in the path and then passed unchanged down the route path, enabling the routing server to uniquely identify requests belonging to the same call session.

Communication between the device and routing server is through the device's embedded Representational State Transfer (RESTful) API. The RESTful API is used to manage the routing-related information exchanged between the routing server (RESTful server) and the device (RESTful client). When you have configured the device with connection settings of the routing sever and the device starts-up, it connects to the routing server and activates the RESTful API, which triggers the routing-related API commands.

The following figure provides an example of information exchange between devices and a routing server for routing calls:

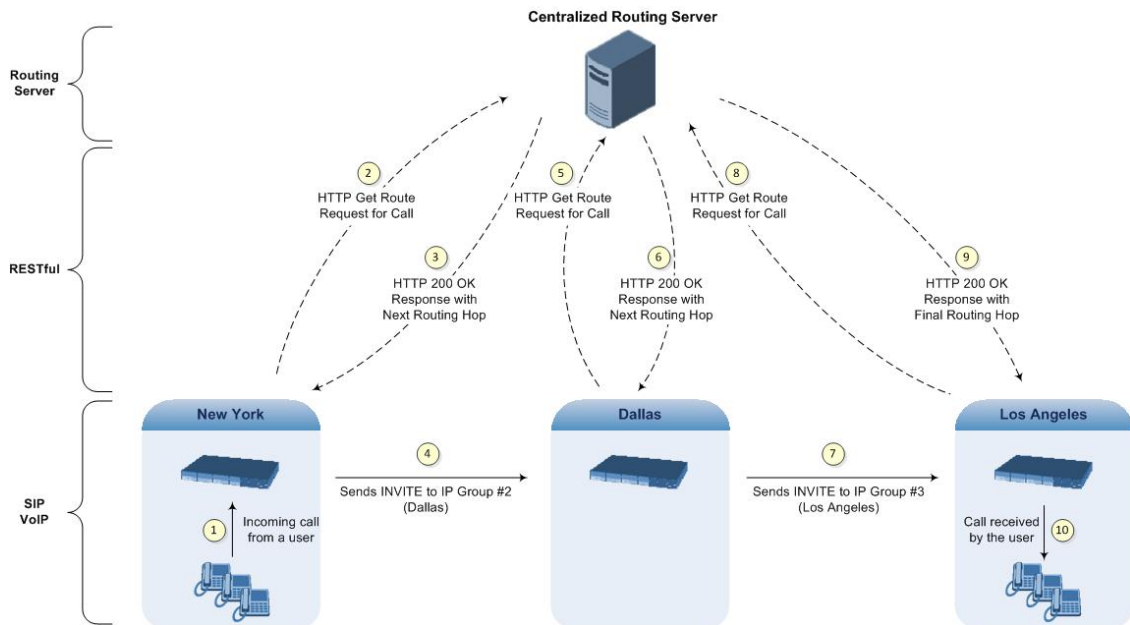

The routing server can also manipulate call data such as calling name, if required. It can also create new IP Groups and associated configuration entities, if necessary for routing. Multiple routing servers can also be employed, whereby each device in the chain path can use a specific routing server. Alternatively, a single routing server can be employed and used for all devices ("stateful" routing server).

The device automatically updates (sends) the routing server with its' configuration topology regarding SIP routing-related entities (Trunk Groups, SRDs, SIP Interfaces, and IP Groups) that have been configured for use by the routing server. For example, if you add a new IP Group and enable it for use by the routing server, the device sends this information to the routing server. Routing of calls associated with routing-related entities that are disabled for use by the routing server (default) are handled only by the device (not the routing server).

In addition to regular routing, the routing server also supports the following:

- Alternative Routing:** If a call fails to be established, the device "closest" to the failure and configured to send "additional" routing requests (through REST API - "additionalRoute" attribute in HTTP Get Route request) to the routing server, sends a new routing request to the routing server. The routing server may respond with a new route destination, thereby implementing alternative routing. Alternatively, it may enable the device to return a failure response to the previous device in the route path chain and respond with an alternative route to this device. Therefore, alternative routing can be implemented at any point in the route path. If the routing server sends an HTTP 404 "Not Found" message for an alternative route request, the device rejects the call. If the routing server is configured to handle alternative routing, the device does not make any alternative routing decisions based on its alternative routing tables.

If the device sends an HTTP Get Route request and the Routing server responds with a REST API attribute "action" that is set to the value 'continue', the device routes the call using its IP-to-IP Routing table. It uses the routing rule located after the original routing rule used to query the routing server ('Destination Type' set to **Routing Server**) whose 'Alternative Route Options' parameter is configured to **Route Row**. This routing can be

used at any stage of the call (e.g., after alternative routing failure by the routing server or after receiving a REFER/3xx).

- **Call Forking:** The device can fork calls according to the routing server. When the device finds a matching routing rule in the IP-to-IP Routing table that is configured with the **Routing Server** destination, it sends an HTTP Get Route request to the routing server. When it receives a successful response from the server, the device sends an INVITE message to a destination based on the response. If the routingMethod in the response from the routing server is "fork", the device sends another HTTP Get Route request to the server and upon a successful response, sends another INVITE to another destination based on the response, and so on. This call forking process continues until no routingMethod is received from the server or it is set to "seq", or there is a failed response from the server. If all the contacts fail (4xx), the device falls back to an alternative route, if exists, from the routing server. If 3xx is received for any of the forked destinations, the device handles it after all the forked INVITEs have been terminated.
- **Call Status:** The device can report call status to the routing server to indicate whether a call has successfully been established or failed (disconnected). The device can also report when an IP Group (Proxy Set) is unavailable, detected by the keep-alive mechanism, or when the CAC thresholds permitted per IP Group have been crossed. For Trunk Groups, the device reports when the trunk's physical state indicates that the trunk is unavailable.
- **Credentials for Authentication:** The routing server can provide user (e.g., IP Phone caller) credentials (username-password) in the Get Route response, which can be used by the device to authenticate outbound SIP requests if challenged by the outbound peer, for example, Microsoft Skype for Business (per RFC 2617 and RFC 3261). If multiple devices exist in the call routing path, the routing server sends the credentials only to the last device ("node") in the path.

Alternatively, the device can authenticate incoming SIP requests (INVITE or REGISTER) from User-type IP Groups, by first obtaining (REST-based API query) the user's password from the routing server where it is stored. When this feature is enabled and the device receives an incoming SIP dialog-initiating request, it sends the REST API command getCredentials in the Get request to the routing server. The name of the user whose credentials are requested is obtained from the SIP From header when authenticating an INVITE message, and from the To header when authenticating a REGISTER message. The routing server sends a 200 response to the device containing the password (if the requested user exists). The device then sends the challenge back to the user. The user resends the request with a SIP Authorization header (containing a response to the challenge), and the authentication process continues in the usual manner. If the device doesn't receive a password, it rejects the incoming dialog (SIP 404). To enable this authentication type, you need to configure the IP Group's 'SBC Server Authentication Type' parameter to **ARM Authentication** (see [Configuring IP Groups](#) on page 431). Note that the routing server does not authenticate users, but only helps the device to process the SIP Digest authentication by providing the user credentials.



- **QoS:** The device can report QoS metrics per IP Group to the routing server which it can use to determine the best route (i.e., QoS-based routing). For more information, see [Configuring QoS-Based Routing by Routing Server](#).
- **Call Preemption for Emergency Calls:** If you enable call preemption for emergency calls (e.g., 911) on the device, the routing server determines whether or not the incoming call is an emergency call and if so, handles the routing decision accordingly (i.e., preempts a non-emergency call if the maximum call capacity of the device is reached in order to allow the emergency call to be routed). To enable call preemption for emergency calls, use the [SBCPreemptionMode] parameter for SBC calls and the [CallPriorityMode] parameter for Gateway calls.
- **Registration status:** The device can periodically synchronize its registration database of SIP user agents (endpoints) with the routing server to keep it up to date, enabling the routing server to use this information to perform correct and optimal routing decisions. To enable this functionality, see [Enabling Registration Status Services](#) on page 311.

➤ **To configure routing based on Routing server:**

1. For each configuration entity (e.g., IP Group) that you want routing done by the routing server, configure the entity's 'Used By Routing Server' parameter to **Used**:

Used By Routing Server     

2. Configure an additional Security Administrator user account in the Local Users table (see [Configuring Management User Accounts](#)) that is used by the routing server (REST client) to log in to the device's management interface.
3. Configure the address and connection settings of the routing server, referred to as a *Remote Web Service* and an HTTP remote host (see [Configuring Remote Web Services](#)). You must configure the 'Type' parameter of the Remote Web Service to **Routing**, as shown in the example:

*Remote Web Services*

GENERAL	
Index	<input type="text" value="0"/>
Name	<input type="text" value="Routing Server"/>
Type	<input type="text" value="Routing"/>

4. (SBC Application Only) In the IP-to-IP Routing table, configure the 'Destination Type' parameter of the routing rule to **Routing Server** (see [Configuring SBC IP-to-IP Routing Rules](#)):

ACTION	
Destination Type	Routing Server

- (Gateway Application Only) Enable routing based on routing server, by configuring the [GWRoutingServer] parameter to [1].

## Configuring QoS-Based Routing by Routing Server

You can configure the device to allow the routing server to route calls based on QoS metrics (media and signaling). The device collects QoS metrics per IP Group that you have configured to operate with the routing server ('Used by Routing Server' parameter configured to **Used** in the IP Groups table). The metrics include the following:

- **Signaling:** ASR, NER, and ACD
- **Media:** Packet loss (Rx/Tx), packet delay (local/remote), jitter (local/remote), MOS (local/remote), audio bandwidth (Rx/Tx), video bandwidth (Rx/Tx), and total bandwidth (Rx/Tx)

The device collects QoS metrics for both incoming call traffic and outgoing traffic from the remote endpoint. It sends the QoS reports to the routing server, where each report can contain the status of up to 100 IP Groups. If more than 100 IP Groups exist, the device sends multiple QoS reports (sequentially) to the routing server. The device sends the reports every user-defined period. The routing logic of where to route calls based on QoS ("good", "fair", and "bad") is configured on the routing server.



For media metrics calculations, the device's License Key must include voice quality monitoring and RTCP XR.

### ➤ To configure the device for QoS-based routing by routing server:

- Open the Web Service Settings page (**Setup** menu > **IP Network** tab > **Web Services** folder > **Web Service Settings**), and then do the following:
  - From the 'Quality Status' [RoutingServerQualityStatus] drop-down list, select **Enable** to enable QoS-based routing.
  - In the 'Quality Status Rate' field (RoutingServerQualityStatusRate), enter the rate (in sec) at which the device sends QoS reports.

Quality Status	• Enable
Quality Status Rate (sec)	• 50

- Click **Apply**.
- Open the Remote Web Services table (see [Configuring Remote Web Services](#)), and then for the Remote Web Service entry that you configured for the routing server, do the following:

- a. From the 'Type' [HTTPRemoteServices\_HTTPType] drop-down list, select **QoS**.
  - b. Click **Apply**.
3. Enable voice quality monitoring and RTCP XR, using the 'Enable RTCP XR' [VQMonEnable] parameter (see [Configuring RTCP XR](#)).

## Configuring an HTTP GET Web Service

You can query (HTTP GET) an HTTP server and use the response for various functionality such as SIP message manipulations, tag-based classification and routing. To configure this, you need to configure a Remote Web Service to represent the HTTP server and a Call Setup Rule to define the search query and the action you want done based on the HTTP response. The following example queries an HTTP server (at IP address 52.7.189.10) using the caller's (source) user name in the server's path */v3/phone*. When a response is received from the HTTP server, the device adds the value of the HTTP response body ("Alice") to the From header in the outgoing SIP message.

### ➤ To configure an HTTP GET operation:

1. Open the Remote Web Services table, and then configure a Remote Web Service for the HTTP server:
  - 'Name': **MyHTTP**
  - 'Type': **General**
  - 'Path': **v3/phone**
  - 'Username': **adminuser1**
  - 'Password': **1234**
2. Open the HTTP Remote Hosts table of the Remote Web Service that you configured in Step 1, and then configure the following:
  - 'Name': **MyHTTPHost**
  - 'Address': **52.7.189.10**
3. Open the Call Setup Rules table, and then configure the following rule:
  - 'Rule Set ID': **1**
  - 'Request Type': **HTTP GET**
  - 'Request Target': **MyHTTP**
  - 'Request Key': **Param.Call.Src.User+'?account\_sid=SID&auth\_token=TOKEN'**
  - 'Action Subject': **Param.Call.Src.Name**
  - 'Action Type': **Modify**
  - 'Action Value': **HTTP.Response.Body**
4. Assign your Call Setup Rule to the relevant SIP Interface, for example.

An example of the HTTP and SIP messages of the above configuration is shown below:

1. Incoming SIP message:

```
INVITE sip:2000@10.7.7.246;user=phone SIP/2.0
Via: SIP/2.0/UDP 10.7.2.15;branch=z9hG4bKLRGQTOQHILSSMGAQJQSU
From: <sip:
15551234567
@10.7.2.15;user=phone>;tag=RJFNXMKDOHELDUMEWWGH
To: <sip:2000@10.7.7.246;user=phone>
Call-ID: UBBKFKBCXFPESMYOPDTB@10.7.2.15
CSeq: 1 INVITE
Contact: <sip:1000@10.7.2.15>
Supported: em,100rel,timer,replaces
Allow:
REGISTER,OPTIONS,INVITE,ACK,CANCEL,BYE,NOTIFY,PRACK,REFER,
INFO,SUBSCRIBE
User-Agent: Sip Message Generator V1.0.0.5
```

2. Outgoing HTTP GET:

```
Header=GET /v3/phone/15551234567?account_sid=SID&auth_
token=TOKEN HTTP/1.1
Content-Type: html/text
Host: 52.7.189.114
Connection: keep-alive
Content-Length: 0
Cache-Control: no-cache
User-Agent: 1
```

3. Incoming HTTP response:

```
HTTP/1.1 200 OK
Access-Control-Allow-Origin: *
Cache-Control: max-age=0
Content-Type: text/html
Date: Thu, 07 Dec 2017 14:35:21 GMT
Server: nginx/1.8.1
Content-Length: 6
Connection: keep-alive

Alice
```

4. Outgoing SIP message:

```
INVITE sip:2000@10.7.7.246;user=phone SIP/2.0
Via: SIP/2.0/UDP 10.7.7.246:5060;branch=z9hG4bKac1693897511
Max-Forwards: 70
From: Alice
<sip:+15551234567@10.7.2.15;user=phone>;tag=1c1900944531
To: <sip:2000@10.7.7.246;user=phone>
Call-ID: 17651812441120101654@10.7.7.246
CSeq: 1 INVITE
Contact: <sip:1000@10.7.7.246:5060>
Supported: em,100rel,timer,replaces,sdp-anat
```

## Configuring HTTP POST Web Service

You can use HTTP POST messages to simply notify an HTTP server about a call, and use HTTP POST messages for querying information like HTTP GET messages. The example provided in this section describes how to configure the device to send HTTP POSTs to notify an HTTP server of incoming 911 calls. You need to configure a Remote Web Service to represent the HTTP server (IP address 52.7.189.10). You also need to configure Call Setup Rules that instruct the device to send an HTTP POST message, containing the 911 caller's user name and host name, to the server (at path */path/query/notify-emergency-call*) if a 911 call is received.

### ➤ To configure an HTTP POST notification operation:

1. Open the Remote Web Services table, and then configure a Remote Web Service for the HTTP server:
  - 'Name': **MyHTTP**
  - 'Type': **General**
  - 'Username': **adminuser1**
  - 'Password': **1234**
2. Open the HTTP Remote Hosts table of the Remote Web Service that you configured in Step 1, and then configure the following:
  - 'Name': **MyHTTPHost**
  - 'Address': **52.7.189.10**
3. Open the Call Setup Rules table, and then configure the following rules (Rule Set ID 1):
  - If the destination number of the incoming call is not 911, then don't process these Call Setup Rules:
    - ◆ 'Index': **1**
    - ◆ 'Rule Set ID': **1**
    - ◆ 'Condition': **Param.Call.Dst.User != '911'**
    - ◆ 'Action Type': **Exit**

- ◆ 'Action Value': **True**
  - Set the Content-Type header in the HTTP POST message to the value "application/json":
    - ◆ 'Index': **2**
    - ◆ 'Rule Set ID': **1**
    - ◆ 'Action Subject': **HTTP.Request.Content-Type**
    - ◆ 'Action Type': **Modify**
    - ◆ 'Action Value': **'application/json'**
  - Add JSON parameters to the body of the HTTP POST message so that it includes the 911 caller's (source) number and host name:
    - ◆ 'Index': **3**
    - ◆ 'Rule Set ID': **1**
    - ◆ 'Action Subject': **HTTP.Request.Body**
    - ◆ 'Action Type': **Add**
    - ◆ 'Action Value': **'{ "user": ""+Param.Call.Src.User+", "host": ""+Param.Call.Src.Host+" }'**
  - Send the HTTP POST message to the specified server and folder path:
    - ◆ 'Index': **4**
    - ◆ 'Rule Set ID': **1**
    - ◆ 'Request Type': **HTTP POST Notification**
    - ◆ 'Request Target': **MyHTTP**
    - ◆ 'Request Key': **'/path/query/notify-emergency-call'**
- 4.** Assign your Call Setup Rules (i.e., Rule Set ID 1) to the relevant SIP Interface (for example).

An example of the HTTP and SIP messages of the above configuration is shown below:

- 1.** Incoming SIP message from 911 caller:

```
INVITE sip:911@10.7.7.246;user=phone SIP/2.0
Via: SIP/2.0/UDP 10.7.2.15;branch=z9hG4bKLRGQTOQHILSSMGAQJQSU
From: <sip:15551234567@10.7.2.15;user=phone>;tag=RJFNXMKDOHELDUMEWWG
H
To: <sip:911@10.7.7.246;user=phone>
Call-ID: UBBKFKBCXFPESMYOPDTB@10.7.2.15
CSeq: 1 INVITE
Contact: <sip:1000@10.7.2.15>
```

```
Supported: em,100rel,timer,replaces
Allow:
REGISTER,OPTIONS,INVITE,ACK,CANCEL,BYE,NOTIFY,PRACK,REFER,INFO,SUBSCRIBE
User-Agent: Sip Message Generator V1.0.0.5
```

2. Outgoing HTTP POST message notifying server of 911 call:

```
Header=POST /path/query/notify-emergency-call HTTP/1.1
Content-Type: application/json
Host: 52.7.189.114
Connection: keep-alive
Content-Length: 47
Cache-Control: no-cache
User-Agent: 1

{ "user": "15551234567", "host": "10.7.2.15" }
```

## HTTP-based Proxy Services

The device can be configured as an HTTP Proxy (or a non-HTTP Proxy) to intermediate between clients (e.g., HTTP requests) and servers (hosts). The client sends an HTTP GET request specifying the destination (URL), and the device (acting as an HTTP Proxy), forwards it to the host, and vice versa.

This feature integrates the NGINX platform, which is an open source proxy server. When you enable the HTTP Proxy application, the NGINX daemon is launched. When you then configure the various HTTP Proxy tables, the configuration is reflected in the NGINX configuration file (nginx.conf). Each parameter has its own NGINX Directive notation syntax, which is shown in the nginx.conf file. For example, if you have configured an Upstream Host (discussed later in this section), it is displayed in the NGINX file as "server host:port". You can also configure and apply additional NGINX Directives that do not have any corresponding parameters in the device's Web interface. For more information, see [Configuring HTTP Directive Sets](#) on page 341.

The device supports the following proxy services:

- **HTTP Reverse Proxy for managing equipment behind NAT:** You can configure the device to function as a Reverse HTTP Proxy server. You can use this for many HTTP-based applications. For example, you can use it to intermediate between REST API clients and a REST server.

Another example is to use the HTTP Proxy to intermediate between IP Phones and remote servers for file download. The figure below illustrates this example where IP Phones (clients) retrieve their configuration and firmware files from remote file servers (Upstream Hosts) and where the device (HTTP Proxy) intermediates between the two. The HTTP hosts

are located in the cloud and the clients are located behind NAT. The HTTP Proxy listens for incoming HTTP requests (Listening Interface and HTTP/S Listening Port) from the clients and then forwards the requests to the relevant HTTP host, based on the URL (HTTP Location) in the incoming HTTP GET request. If the URL matches the pattern `"/firmware/"`, the HTTP Proxy sends the request to the firmware file server; if the URL matches the pattern `"/ipp/*.cfg"`, the requests are sent to the configuration file server. In addition, customized NGINX directives have been configured for each HTTP Location to define the maximum time to wait for an HTTP connection.

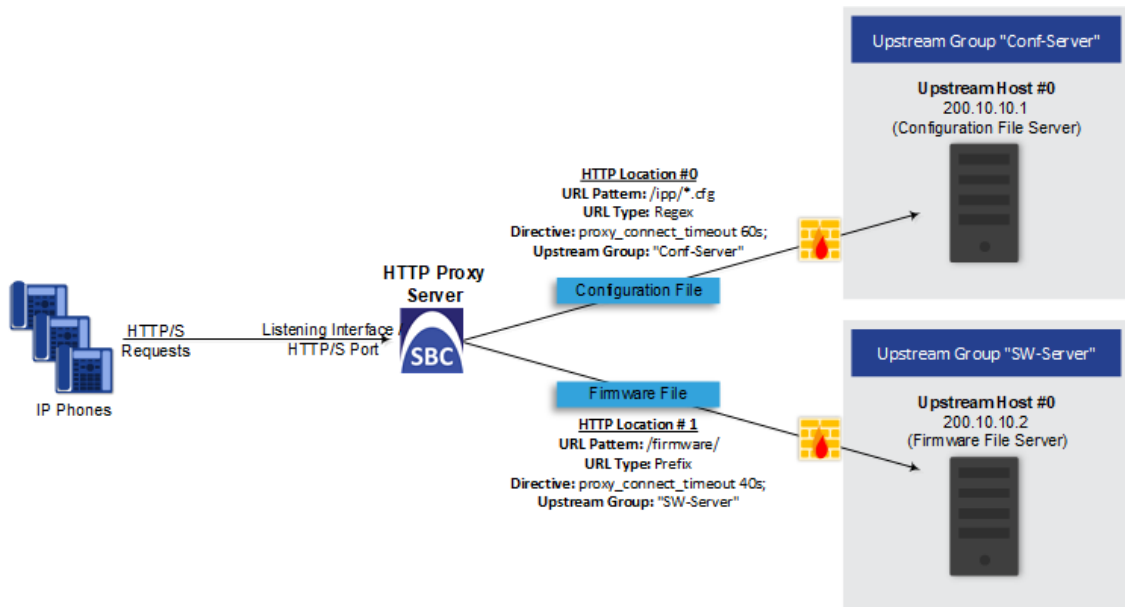

A summary of the required configuration for this example is listed below:

- Enable the HTTP Proxy application (see [Enabling the HTTP Proxy Application](#) on the next page).
- Configure two Upstream Groups, where each is configured with an Upstream Host that defines the IP address of the HTTP host (i.e., firmware and configuration file servers). See [Configuring Upstream Groups](#) on page 336.
- Configure two NGINX directives for proxy timeout connection (see [Configuring HTTP Directive Sets](#) on page 341).
- Configure a local, listening IP network interface for the leg interfacing with the HTTP clients (see [Configuring IP Network Interfaces](#) on page 121) or use the default.
- Configure a local, IP network interface for the outbound leg interfacing with the HTTP hosts (or use the default).
- Configure the HTTP Proxy server, by assigning it the listening IP network interface and configuring a listening HTTP/S port (see [Configuring HTTP Proxy Servers](#) on page 324).
- Configure two HTTP Locations for the HTTP Proxy server, where each is configured with a URL pattern to match the incoming HTTP requests for determining the destination



host (Upstream Group-Upstream Host). In addition, assign it the relevant HTTP Directive Set. See [Configuring HTTP Locations](#) on page 328.

- **Non-HTTP Proxy (referred to as TCP/UDP Proxy Server):** The device can serve as a proxy for other applications that are not based on HTTP. For example, it can be used to intermediate between clients and a DNS server for DNS lookup, or between clients and an NTP server for clock synchronization. For more information, see [Configuring TCP-UDP Proxy Servers](#) on page 333.
- **HTTP-based OVOC service for AudioCodes equipment located behind NAT that are managed by the AudioCodes OVOC server:** For more information, see [Configuring an HTTP-based OVOC Service](#) on page 343

## Enabling the HTTP Proxy Application

Before you can configure HTTP-based proxy services, you must enable the HTTP Proxy application, as described in the following procedure. Once enabled, the Web interface displays menus in the Navigation pane that are relevant to the HTTP Proxy application.



The HTTP Proxy application is a license-based feature and is available only if it is included in the License Key installed on the device. For ordering the feature, please contact the sales representative of your purchased device. For installing a new License Key, see [License Key](#).

### ➤ To enable the HTTP Proxy application:

1. Open the General Settings page (**Setup** menu > **IP Network** tab > **HTTP Proxy** folder > **General Settings**).



2. From the 'HTTP Proxy Application' drop-down list, select **Enable**.
3. Click **Apply**, and then reset the device with a save-to-flash for your settings to take effect.

## Debugging Remote HTTP Services

You can enable the device to generate debug messages for remote Web (HTTP) services and have them sent to a Syslog server.

### ➤ To enable debugging of HTTP services:

1. Open the General Settings page (**Setup** menu > **IP Network** tab > **HTTP Proxy** folder > **General Settings**):

GENERAL	
HTTP Proxy Debug Level	• Basic ▼

- From the 'HTTP Proxy Debug Level' drop-down list, select a debug level.
- Click **Apply**.

## Configuring a DNS Server for HTTP Services

You can configure the DNS server (primary and secondary for redundancy) that you want to use for your HTTP services. If you configure a proxy server with an FQDN, this is the DNS server that the device uses for resolving the domain name into an IP address.

### ➤ To configure DNS servers for HTTP services:

- Open the General Settings page (**Setup** menu > **IP Network** tab > **HTTP Proxy** folder > **General Settings**):

DNS	
Primary DNS Server IP	0.0.0.0
Secondary DNS Server IP	0.0.0.0

- In the 'Primary DNS Server IP' field, enter the IP address of your main DNS server.
- (Optional) In the 'Secondary DNS Server IP' field, enter the IP address of the secondary DNS server.
- Click **Apply**.

## Configuring HTTP Proxy Servers

The HTTP Proxy Servers table lets you configure up to 10 HTTP Proxy servers. Once configured, you can configure HTTP Locations for the HTTP Proxy Server (see [Configuring HTTP Locations](#) on page 328).

The following procedure describes how to configure HTTP Proxy Servers through the Web interface. You can also configure it through ini file [HTTPServer] or CLI (`configure network > http-proxy > http-server`).

### ➤ To configure an HTTP Proxy Server:

- Enable the HTTP Proxy application, as described in [Enabling the HTTP Proxy Application](#) on the previous page.
- Open the HTTP Proxy Server table (**Setup** menu > **IP Network** tab > **HTTP Proxy** folder > **HTTP Proxy Servers**).
- Click **New**; the following dialog box appears:

The screenshot shows a configuration window titled "HTTP Proxy Servers" with a "GENERAL" tab. The fields are as follows:

- Index:** Text input field containing "0".
- Name:** Text input field.
- Domain Name:** Text input field.
- Listening Interface:** Dropdown menu showing "--" with a "View" link.
- HTTP Listening Port:** Text input field.
- HTTPS Listening Port:** Text input field.
- TLS Context:** Dropdown menu showing "--" with a "View" link.
- Verify Client Certificate:** Dropdown menu showing "No".
- Additional Directive Set:** Dropdown menu showing "--" with a "View" link.

4. Configure an HTTP Proxy server according to the parameters described in the table below.
5. Click **Apply**, and then save your settings to flash memory.

**Table 16-20: HTTP Proxy Servers Table Parameter Descriptions**

Parameter	Description
'Index' [HTTPServer_Index]	<p>Defines an index number for the new table row.</p> <p><b>Note:</b></p> <ul style="list-style-type: none"> <li>■ Each row must be configured with a unique index.</li> <li>■ The parameter is mandatory.</li> </ul>
'Name' name [HTTPServer_ServiceName]	<p>Defines a descriptive name, which is used when associating the row in other tables. The valid value is a string of up to 40 characters. By default, no value is defined.</p> <p><b>Note:</b></p> <ul style="list-style-type: none"> <li>■ Each row must be configured with a unique name.</li> <li>■ The parameter is mandatory.</li> <li>■ The parameter value cannot contain a forward slash (/).</li> </ul>

Parameter	Description
'Domain Name' domain-name [HTTPServer_ DomainName]	Defines a domain name (FQDN). This is configured only when multiple DNS domains share the same IP address. <b>Note:</b> The NGINX directive for this parameter is "server_name".
'Listening Interface' listening-int [HTTPServer_ ListeningInterface]	Assigns an IP Interface to the HTTP Proxy service. To configure IP Interfaces, see <a href="#">Configuring IP Network Interfaces</a> on page 121. <b>Note:</b> <ul style="list-style-type: none"> <li>■ The parameter is mandatory.</li> <li>■ The NGINX directive for this parameter is "listen ip".</li> </ul>
'HTTP Listening Port' http-port [HTTPServer_ HTTPListeningPort]	Defines the HTTP listening port, which is the local port for incoming packets for the HTTP service. <b>Note:</b> <ul style="list-style-type: none"> <li>■ The port number must not conflict with the ports used for the Web interface, which is usually 80 for HTTP and 443 for HTTPS.</li> <li>■ You must configure at least one port (HTTP or HTTPS port).</li> <li>■ The NGINX directive for this parameter is "listen ip:port".</li> </ul>
'HTTPS Listening Port' https-port [HTTPServer_ HTTPSListeningPort]	Defines the HTTPS listening port, which is the local port for incoming packets for the HTTP service. <b>Note:</b> <ul style="list-style-type: none"> <li>■ The port number must not conflict with the ports used for the Web interface, which is usually 80 for HTTP and 443 for HTTPS.</li> <li>■ You must configure at least one port (HTTP or HTTPS port).</li> <li>■ The NGINX directive for this</li> </ul>

Parameter	Description
	parameter is "listen ip:port ssl".
'TLS Context' tls-context [HTTPServer_ TLSContext]	<p>Assigns a TLS Context (TLS configuration). This is required if you have specified an HTTPS listening port (see the 'HTTPS Listening Port' parameter above). To configure TLS Contexts, see <a href="#">Configuring TLS Certificate Contexts</a> on page 154.</p> <p><b>Note:</b> The NGINX directives for this parameter is "tls-context", "ssl_certificate", "ssl_certificate_key", "ssl_ciphers", "ssl_protocols", and "ssl_password_file".</p>
Verify Client Certificate verify-client-cert [HTTPServer_ VerifyCertificate]	<p>Enables the verification of the client TLS certificate, where the client is the device or user that issues the HTTPS request.</p> <ul style="list-style-type: none"> <li>■ [0] <b>No</b> = (Default) No certificate verification is done.</li> <li>■ [1] <b>Yes</b> = The device verifies the authentication of the certificate received from the HTTPS client. The device authenticates the certificate against the trusted root certificate store associated with the assigned TLS Context (see 'TLS Context' parameter above) and if ok, allows communication with the HTTPS client. If authentication fails, the device denies communication (i.e., handshake fails). The device can also authenticate the certificate by querying with an Online Certificate Status Protocol (OCSP) server whether the certificate has been revoked. This is also configured for the associated TLS Context.</li> </ul>
'Additional Directive Set' directive-set [HTTPServer_	Assigns an NGINX Directive Set for the HTTP service. To configure HTTP Directive Sets, see <a href="#">Configuring HTTP Directive Sets</a> on page 341.

Parameter	Description
AdditionalDirectiveSet]	
'URL Prefix' url-prefix [HTTPProxyService_ URLPrefix]	Defines the URL prefix that is used to access the managed equipment's embedded Web server. The URL prefix is matched against the target of the HTTP requests sent by the client (such as GET and POST). If a match is located in the table, the device removes the prefix from the request and then forwards the HTTP request to the managed equipment without the prefix. For example, for the URL of GET /home/index.html HTTP/1.1 (which is part of the URL http://10.20.30.40/home/index.html), a URL prefix of "/home" can be configured. To match all URLs, configure the parameter to "/" (default).
'Keep-Alive Mode' keep-alive-mode [HTTPProxyService_ KeepAliveMode]	Enables a keep-alive mechanism with the managed equipment: <ul style="list-style-type: none"> <li>■ [0] <b>Disable</b></li> <li>■ [1] <b>Options</b> = (Default) Enables keep-alive by sending HTTP OPTIONS messages. If no response is received from the HTTP host, the device stops forwarding HTTP requests to the host and raises an SNMP alarm (acHTTPProxyServiceAlarm). If you configured the address of the host as an FQDN (see <a href="#">Configuring HTTP Proxy Hosts</a>) and the DNS resolution results in multiple IP addresses, when no response is received from the keep-alive, the device checks connectivity with the next resolved IP address and so on, until a response is received.</li> </ul>

### Configuring HTTP Locations

The HTTP Locations table lets you configure up to 40 HTTP Locations. Locations are specified for each HTTP proxy server to map the incoming requests received by that server. Mapping is

based on matching the URL in the request. Each location specifies the URL prefix or pattern to match and the target Upstream Group to which the request is to be forwarded to.

The HTTP Locations table is a "child" of the HTTP Proxy Servers table (see [Configuring HTTP Proxy Servers](#) on page 324), reflecting the nesting of Location contexts within Server contexts in the NGINX configuration file. This may be used to specify unique handling of URLs by file type (using a regex pattern) or by pathname (using a Prefix or Exact Match pattern).

The following procedure describes how to configure HTTP Locations through the Web interface. You can also configure it through ini file [HTTPLocation] or CLI (`configure network > http-proxy > location`).

➤ **To configure an HTTP Location:**

1. Enable the HTTP Proxy application, as described in [Enabling the HTTP Proxy Application](#) on page 323.
2. Open the HTTP Proxy Servers table (**Setup** menu > **IP Network** tab > **HTTP Proxy** folder > **HTTP Proxy Servers**).
3. In the table, select the required HTTP Proxy Server, and then click the **HTTP Locations** link located below the table; the HTTP Locations table appears.
4. Click **New**; the following dialog box appears:

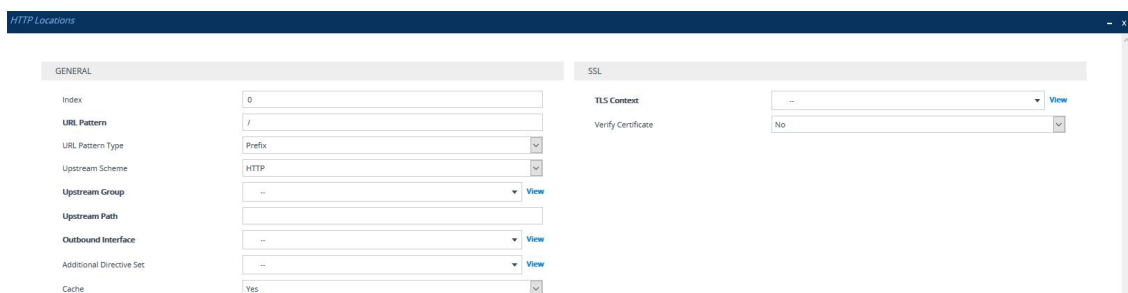

5. Configure an HTTP Location according to the parameters described in the table below.
6. Click **Apply**, and then save your settings to flash memory.

**Table 16-21: HTTP Locations Table Parameter Descriptions**

Parameter	Description
General	
'Index' [HTTPLocation_Index]	Defines an index number for the new table row. <b>Note:</b> <ul style="list-style-type: none"> <li>■ Each row must be configured with a unique index.</li> <li>■ The parameter is mandatory.</li> </ul>
'URL Pattern' url-pattern	Defines the URL pattern. Received GET or POST requests are matched against the locations in the HTTP Locations table by

Parameter	Description
[HTTPLocation_URLEPattern]	<p>matching the URL in the received request to the URL configured by this parameter. If there is a match, the prefix is stripped from the request and then forwarded in the outgoing HTTP request.</p> <p><b>Note:</b></p> <ul style="list-style-type: none"> <li>■ The pattern must be based on the pattern type configured in the 'URL Pattern Type' parameter (see below).</li> <li>■ The NGINX directive for this parameter is "location modifier pattern".</li> </ul>
'URL Pattern Type' url-pattern-type [HTTPLocation_URLEPatternType]	<p>Defines the type of URL pattern used for configuring the 'URL Pattern' parameter (see above).</p> <ul style="list-style-type: none"> <li>■ [0] <b>Prefix</b> = For Example, "/" matches any URL beginning with a forward slash "/". For NGINX, this option has no modifier.</li> <li>■ [1] <b>Exact</b> = Defines an exact pattern to match, for example, "/abc/def" matches only the file "/abc/def". For NGINX, this option is specified using the "=" modifier.</li> <li>■ [2] <b>Regex</b> = Regex-based pattern (case sensitive), for example, "/files/*.img" matches all files ending in .img in the directory /files. For NGINX, this option is specified using the "~" modifier.</li> <li>■ [3] <b>Case-Insensitive Regex</b> = Regex-based pattern that is case-insensitive, for example, "*.img" matches abc.IMG as well as xyz.img. For NGINX, this option is specified using the "~*" modifier.</li> <li>■ [4] <b>Prefix Ignore Regex</b> = For NGINX, this option is specified using the "^~" modifier.</li> </ul> <p>For example, assume that you have configured the following URL patterns for four HTTP Locations:</p> <ul style="list-style-type: none"> <li>■ 1) /files – <b>Prefix</b> pattern type</li> <li>■ 2) /files/phone – <b>Prefix</b> pattern type</li> <li>■ 3) /files/firmware -- <b>Prefix-Ignore-Regex</b> pattern type</li> <li>■ 4) *.jpg – <b>Regex</b> pattern type</li> </ul> <p>Therefore, the request URL "/files/phone/aaa" matches Location 2 and the request URL "/files/phone/logo.jpg" matches Location 4. The request URL "/files/firmware/logo.jpg" matches Location 3 (and not Location 4).</p>



Parameter	Description
	<p><b>Note:</b> The NGINX directive for this parameter is "location modifier pattern". For more information on NGINX modifiers, see <a href="#">ngx_http_core_module.html</a>.</p>
'Upstream Scheme' upstream-scheme [HTTPLocation_ UpstreamScheme]	<p>Defines the protocol for sending requests to the Upstream Group.</p> <ul style="list-style-type: none"> <li>■ [0] HTTP (default)</li> <li>■ [1] HTTPS</li> </ul> <p><b>Note:</b> The NGINX directive for this parameter is "proxy_pass scheme://upstream".</p>
'Upstream Group' upstream-group [HTTPLocation_ UpstreamGroup]	<p>Assigns a group of servers (Upstream Group) to handle the HTTP requests. To configure Upstream Groups, see <a href="#">Configuring Upstream Groups</a> on page 336.</p> <p><b>Note:</b> The NGINX directive for this parameter is "proxy_pass scheme://upstream".</p>
'Upstream Path' upstream-path [HTTPLocation_ UpstreamPath]	<p>Defines a path to prepend to the URL before sending the request to the Upstream Group.</p> <p><b>Note:</b> The NGINX directive for this parameter is "proxy_pass scheme://upstream/path".</p>
'Outbound Interface' outbound-intfc [HTTPLocation_ OutboundInterface]	<p>Assigns a local, IP network interface for sending requests to the Upstream Group. To configure IP network interfaces, see <a href="#">Configuring IP Network Interfaces</a> on page 121.</p> <p>By default, no value is defined.</p> <p><b>Note:</b></p> <ul style="list-style-type: none"> <li>■ The parameter is mandatory.</li> <li>■ The NGINX directive for this parameter is "proxy_bind".</li> </ul>
'Additional Directive Set' directive-set [HTTPLocation_ AdditionalDirectiveSet]	<p>Assigns an NGINX directive set for the HTTP location. To configure NGINX directives, see <a href="#">Configuring HTTP Directive Sets</a> on page 341.</p>
'Cache' cache [HTTPLocation_Cache]	<p>Enables the caching of files in this location.</p> <ul style="list-style-type: none"> <li>■ [0] No</li> <li>■ [1] Yes (default)</li> </ul>

Parameter	Description
	<p><b>Note:</b></p> <ul style="list-style-type: none"> <li>■ Currently, this feature is not supported.</li> <li>■ The NGINX directive for this parameter is "proxy_cache zone off".</li> </ul>
<b>SSL</b>	
<p>'TLS Context' tls-context [HTTPLocation_ TLSContext]</p>	<p>Assigns a TLS Context for the TLS connection with the HTTP location.</p> <p>To configure TLS Contexts, see <a href="#">Configuring TLS Certificates</a> on page 154.</p> <p><b>Note:</b></p> <ul style="list-style-type: none"> <li>■ The parameter is applicable only if the connection protocol is HTTPS (configured in the 'Upstream Scheme' parameter, above).</li> <li>■ The NGINX directives for this parameter are "proxy_ssl_certificate", "proxy_ssl_certificate_key", "proxy_ssl_ciphers", "proxy_ssl_protocols", and "proxy_ssl_password_file".</li> </ul>
<p>'Verify Certificate' verify-cert [HTTPLocation_ VerifyCertificate]</p>	<p>Enables TLS certificate verification when the connection with the location is based on HTTPS. It verifies the certificate of the incoming connection request from the Upstream Group.</p> <ul style="list-style-type: none"> <li>■ [0] <b>No</b> = (Default) No certificate verification is done.</li> <li>■ [1] <b>Yes</b> = The device verifies the authentication of the certificate received from the HTTPS location. The device authenticates the certificate against the trusted root certificate store associated with the assigned TLS Context (see 'TLS Context' parameter above) and if ok, allows communication with the HTTPS location. If authentication fails, the device denies communication (i.e., handshake fails). The device can also authenticate the certificate by querying with an Online Certificate Status Protocol (OCSP) server whether the certificate has been revoked. This is also configured for the associated TLS Context.</li> </ul> <p><b>Note:</b></p> <ul style="list-style-type: none"> <li>■ The parameter is applicable only if the connection protocol is HTTPS (configured in the 'Upstream Scheme' parameter, above).</li> </ul>

Parameter	Description
	<ul style="list-style-type: none"> <li>The NGINX directive for this parameter is "proxy_ssl_verify".</li> </ul>

## Configuring TCP-UDP Proxy Servers

The TCP/UDP Proxy Servers table lets you configure up to 10 TCP/UDP proxy servers. This table allows you to configure the device as a proxy for other applications that are not based on HTTP. For example, it can be used to intermediate between clients and a DNS server for DNS lookup or between clients and an NTP server for clock synchronization.

The following procedure describes how to configure a TCP-UDP Proxy Server through the Web interface. You can also configure it through ini file [TcpUdpServer] or CLI (`configure network > http-proxy > tcp-udp-server`).

### ➤ To configure a TCP/UDP Proxy Server:

1. Enable the HTTP Proxy application, as described in [Enabling the HTTP Proxy Application](#) on page 323.
2. Open the TCP/UDP Proxy Servers table (**Setup** menu > **IP Network** tab > **HTTP Proxy** folder > **TCP/UDP Proxy Servers**).
3. Click **New**; the following dialog box appears:

4. Configure a TCP/UDP Proxy Server according to the parameters described in the table below.
5. Click **Apply**, and then save your settings to flash memory.

**Table 16-22: TCP/UDP Proxy Servers Table Parameter Descriptions**

Parameter	Description
General	
'Index' [TcpUdpServer_Index]	<p>Defines an index number for the new table row.</p> <p><b>Note:</b></p> <ul style="list-style-type: none"> <li>Each row must be configured with a unique index.</li> </ul>

Parameter	Description
	<ul style="list-style-type: none"> <li>The parameter is mandatory.</li> </ul>
'Name' name [TcpUdpServer_Name]	Defines a descriptive name, which is used when associating the row in other tables.  The valid value is a string of up to 40 characters. By default, no value is defined.  <b>Note:</b> <ul style="list-style-type: none"> <li>Each row must be configured with a unique name.</li> <li>The parameter is mandatory.</li> </ul>
'Additional Directive Set' directive-set [TcpUdpServer_AdditionalDirectiveSet]	Assigns an NGINX Directive Set for the HTTP service. To configure HTTP Directive Sets, see <a href="#">Configuring HTTP Directive Sets</a> on page 341.
Listen Parameters	
'Listening Interface' listen-interface [TcpUdpServer_ListeningInterface]	Assigns a local IP network interface for the listening (source) interface for communication with the TCP-UDP proxy server. To configure IP Interfaces, see <a href="#">Configuring IP Network Interfaces</a> on page 121.  By default, no value is defined.  <b>Note:</b> <ul style="list-style-type: none"> <li>The parameter is mandatory.</li> <li>The NGINX directive for this parameter is "listen ip".</li> </ul>
'TCP Listening Port' tcp-port [TcpUdpServer_TCPListeningPort]	Defines the TCP port of the listening interface.  <b>Note:</b> <ul style="list-style-type: none"> <li>You must configure a TCP and/or UDP port.</li> <li>The NGINX directive for this parameter is "listen ip:port".</li> </ul>
'UDP Listening Port' udp-port [TcpUdpServer_UDPListeningPort]	Defines the TCP port of the listening interface.  <b>Note:</b> <ul style="list-style-type: none"> <li>You must configure a TCP and/or UDP port.</li> <li>The NGINX directive for this parameter is "listen ip:port udp".</li> </ul>
'Listen Side SSL' listen-use-ssl	Enables TLS on the listening side (i.e., listening to incoming connection requests).

Parameter	Description
[TcpUdpServer_ListenUseSSL]	<ul style="list-style-type: none"> <li>■ [0] <b>Disable</b> (default)</li> <li>■ [1] <b>Enable</b></li> </ul> <p><b>Note:</b> The NGINX directive for this parameter is "listen ip:port ssl".</p>
'Listen TLS Context' listen-tls-context [TcpUdpServer_ListenTLSContext]	<p>Assigns a TLS Context (TLS certificate) for the listening side. This is required if you have configured the 'Listen Side SSL' parameter to <b>Enable</b> (see above). To configure TLS Contexts, see <a href="#">Configuring TLS Certificate Contexts</a> on page 154.</p> <p><b>Note:</b> The NGINX directives for this parameter is "ssl_certificate", "ssl_certificate_key", "ssl_ciphers", "ssl_protocols", and "ssl_password_file".</p>
Upstream Parameters	
'Upstream Group' upstream-group [TcpUdpServer_UpstreamGroup]	<p>Assigns a group of servers (Upstream Group) to which to forward connection requests. To configure Upstream Groups, see <a href="#">Configuring Upstream Groups</a> on the next page.</p> <p><b>Note:</b></p> <ul style="list-style-type: none"> <li>■ Only Upstream Groups with TCP/UDP interfaces can be assigned.</li> <li>■ The NGINX directive for this parameter is "proxy_pass upstream".</li> </ul>
'Outbound Interface' outbound-interface [TcpUdpServer_OutboundInterface]	<p>Assigns a local, IP network interface for communicating with the Upstream Group. To configure IP network interfaces, see <a href="#">Configuring IP Network Interfaces</a> on page 121.</p> <p>By default, no value is defined.</p> <p><b>Note:</b></p> <ul style="list-style-type: none"> <li>■ The parameter is mandatory.</li> <li>■ The NGINX directive for this parameter is "proxy_bind".</li> </ul>
'Upstream Side SSL' upstream-use-ssl [TcpUdpServer_UpstreamUseSSL]	<p>Enables TLS for securing connection requests with the Upstream Group.</p> <ul style="list-style-type: none"> <li>■ [0] <b>Disable</b> (default)</li> <li>■ [1] <b>Enable</b></li> </ul> <p><b>Note:</b></p> <ul style="list-style-type: none"> <li>■ If configured to <b>Enable</b>, you must assign a TLS Context</li> </ul>

Parameter	Description
	<p>(see the 'Upstream TLS Context' parameter below).</p> <ul style="list-style-type: none"> <li>■ The NGINX directive for this parameter is "proxy_ssl on".</li> </ul>
<p>'Upstream TLS Context' upstream-tls- context [TcpUdpServer_ UpstreamTLSContext]</p>	<p>Assigns a TLS Context for the TLS connection with the HTTP location. To configure TLS Contexts, see <a href="#">Configuring TLS Certificate Contexts</a> on page 154.</p> <p><b>Note:</b></p> <ul style="list-style-type: none"> <li>■ The parameter is applicable only if the 'Upstream Side SSL' parameter is configured to <b>Enable</b> (see above).</li> <li>■ The NGINX directives for this parameter are "proxy_ssl_certificate", "proxy_ssl_certificate_key", "proxy_ssl_ciphers", "proxy_ssl_protocols", and "proxy_ssl_password_file".</li> </ul>
<p>'Upstream Verify Certificate' upstream-verify- cert [TcpUdpServer_ UpstreamVerifyCertificate]</p>	<p>Enables TLS certificate verification of the Upstream Host on outgoing connection requests to the Upstream Group, when the connection is TLS.</p> <ul style="list-style-type: none"> <li>■ [0] <b>No</b> = (Default) No certificate verification is done.</li> <li>■ [1] <b>Yes</b> = The device verifies the authentication of the certificate received from the host. The device authenticates the certificate against the trusted root certificate store associated with the assigned TLS Context (see 'Upstream TLS Context' parameter above) and if ok, allows communication with the host. If authentication fails, the device denies communication (i.e., handshake fails). The device can also authenticate the certificate by querying with an Online Certificate Status Protocol (OCSP) server whether the certificate has been revoked. This is also configured for the associated TLS Context.</li> </ul> <p><b>Note:</b></p> <ul style="list-style-type: none"> <li>■ The parameter is applicable only if the 'Upstream Side SSL' parameter is configured to <b>Enable</b> (see above).</li> <li>■ The NGINX directive for this parameter is "proxy_ssl_verify".</li> </ul>

## Configuring Upstream Groups

The Upstream Groups table lets you configure up to 10 Upstream Groups. Once configured, you can configure Upstream Hosts for the Upstream Group (see [Configuring Upstream Hosts](#)

on page 339).

An Upstream Group is a set of one or more hosts (*Upstream Host*) that can serve a particular set of data. The HTTP Proxy distributes the requests among the members (hosts) of the Upstream Group according to the specified load balancing mode.

The Upstream Group may be made up of one or more primary hosts and zero or more backup hosts. HTTP requests for the Upstream Group are distributed among all the primary hosts. Backup hosts do not receive requests unless all the primary hosts are down.

The following procedure describes how to configure Upstream Groups through the Web interface. You can also configure it through ini file [UpstreamGroup] or CLI (`configure network > http-proxy > upstream-group`).

➤ **To configure an Upstream Group:**

1. Enable the HTTP Proxy application, as described in [Enabling the HTTP Proxy Application](#) on page 323.
2. Open the Upstream Groups table (**Setup** menu > **IP Network** tab > **HTTP Proxy** folder > **Upstream Groups**).
3. Click **New**; the following dialog box appears:

The screenshot shows a configuration dialog box titled "Upstream Groups". It has a "GENERAL" tab. The fields are as follows:

- Index:** A text input field containing the value "01".
- Name:** An empty text input field.
- Protocol:** A dropdown menu currently showing "HTTP/HTTPS".
- Load Balancing Mode:** A dropdown menu currently showing "Round Robin".

4. Configure an Upstream Group according to the parameters described in the table below.
5. Click **Apply**, and then save your settings to flash memory.

**Table 16-23:Upstream Groups Table Parameter Descriptions**

Parameter	Description
General	
'Index' [UpstreamGroup_ Index]	<p>Defines an index number for the new table row.</p> <p><b>Note:</b></p> <ul style="list-style-type: none"> <li>■ Each row must be configured with a unique index.</li> <li>■ The parameter is mandatory.</li> </ul>
'Name' name	<p>Defines a descriptive name, which is used when associating the row in other tables.</p> <p>The valid value is a string of up to 40 characters. By default, no</p>

Parameter	Description
[UpstreamGroup_Name]	<p>value is defined.</p> <p><b>Note:</b></p> <ul style="list-style-type: none"> <li>■ Each row must be configured with a unique name.</li> <li>■ The NGINX directive for this parameter is "upstream name { ... }".</li> <li>■ The parameter is mandatory.</li> <li>■ The parameter value cannot contain a forward slash (/).</li> </ul>
'Protocol' protocol [UpstreamGroup_Protocol]	<p>Defines the protocol.</p> <ul style="list-style-type: none"> <li>■ [0] <b>HTTP/HTTPS</b> (default)</li> <li>■ [1] <b>TCP/UDP</b></li> </ul> <p><b>Note:</b></p> <ul style="list-style-type: none"> <li>■ To assign the Upstream Group to a TCP/UDP Proxy Server, configure the parameter to TCP/UDP. To configure TCP/UDP Proxy Servers, see <a href="#">Configuring TCP-UDP Proxy Servers</a> on page 333.</li> <li>■ To assign the Upstream Group to an HTTP Proxy Server, configure the parameter to HTTP/HTTPS. To configure HTTP Proxy Servers, see <a href="#">Configuring HTTP Proxy Servers</a> on page 324.</li> <li>■ For NGINX, the parameter determines nesting within the "http" or "stream" context.</li> </ul>
'Load Balancing Mode' load-balancing-mode [UpstreamGroup_LoadBalancingMode]	<p>Defines the load-balancing of traffic method for the hosts belonging to the Upstream Group.</p> <ul style="list-style-type: none"> <li>■ [0] <b>Round Robin</b> = (Default) Traffic requests are balanced across all hosts. Every consecutive request is sent to the next available host.</li> <li>■ [1] <b>IP Hash</b> = All requests from a given client (by IP address) is sent to the same host, regardless of current load.</li> <li>■ [2] <b>Least Connections</b> = New requests are sent to the host with the fewest active connections.</li> </ul> <p><b>Note:</b> The NGINX directive for this parameter is "ip-hash (1)", "least-conn (2)", and "round-robin (0)".</p>



## Configuring Upstream Hosts

The Upstream Hosts table lets you configure up to 50 Upstream Hosts. The Upstream Hosts table is a "child" of the Upstream Group table (see [Configuring Upstream Groups](#) on page 336) and therefore, Upstream Hosts are configured per Upstream Group. Up to 5 Upstream Hosts can be configured per Upstream Group.

The following procedure describes how to configure Upstream Hosts through the Web interface. You can also configure it through ini file [UpstreamHost] or CLI (`configure network > http-proxy > upstream-host`).

### ➤ To configure an Upstream Host:

1. Enable the HTTP Proxy application, as described in [Enabling the HTTP Proxy Application](#) on page 323.
2. Open the Upstream Groups table (**Setup** menu > **IP Network** tab > **HTTP Proxy** folder > **Upstream Groups**).
3. In the table, select the required Upstream Group index row, and then click the **Upstream Hosts** link located below the table; the Upstream Hosts table appears.
4. Click **New**; the following dialog box appears:

The screenshot shows a configuration dialog for 'Upstream Hosts'. It has a title bar with a close button. Below the title bar is a 'GENERAL' tab. The dialog contains the following fields:

- Index:** A text input field containing the value '0'.
- Host:** An empty text input field.
- Port:** An empty text input field.
- Weight:** A text input field containing the value '1'.
- Max Connections:** A text input field containing the value '0'.
- Backup:** A dropdown menu with 'disable' selected.

5. Configure an Upstream Host according to the parameters described in the table below.
6. Click **Apply**, and then save your settings to flash memory.

**Table 16-24:Upstream Hosts Table Parameter Descriptions**

Parameter	Description
'Index' [UpstreamHost_HostIndex]	<p>Defines an index number for the new table row.</p> <p><b>Note:</b></p> <ul style="list-style-type: none"> <li>■ Each row must be configured with a unique index.</li> <li>■ The parameter is mandatory.</li> </ul>

Parameter	Description
'Host' host [UpstreamHost_Host]	<p>Defines the address of the host as an FQDN or IP address (in dotted-decimal notation).</p> <p><b>Note:</b> The NGINX directive for this parameter is "server host:port".</p>
'Port' port [UpstreamHost_Port]	<p>Defines the port number.</p> <p><b>Note:</b></p> <ul style="list-style-type: none"> <li>■ If the Upstream Group to which the host belongs is configured to use the TCP/UDP protocol, then this parameter must be configured.</li> <li>■ The NGINX directive for this parameter is "server ip:port". If not configured, NGINX defaults to 80 for HTTP and 443 for HTTPS.</li> </ul>
'Weight' weight [UpstreamHost_Weight]	<p>Defines the weight for the load balancer. The load balancer distributes the requests among the hosts in the Upstream Group based on the weight of each host. For example, if host A is configured with a weight of 3, host B with a weight of 1, and host C with a weight of 1, then in each cycle, the load balancer will send three requests to host A, one request to host B and one request to host C.</p> <p>The valid range is 1 to 100. The default is 1 (i.e., each host in the Upstream Group has equal weight).</p> <p><b>Note:</b> The NGINX directive for this parameter is "server ip:port weight=n".</p>
'Max Connections' max-connections [UpstreamHost_MaxConnections]	<p>Defines the maximum number of simultaneous active connections to the proxied Upstream Host.</p> <p>The default is 0 (i.e., unlimited).</p> <p><b>Note:</b> The NGINX directive for this parameter is "server ip:port max_conns=n".</p>
'Backup' backup [UpstreamHost_Backup]	<p>Enables the host to serve as a backup host. The backup host does not receive any requests unless all the primary hosts in the Upstream Group are down.</p> <ul style="list-style-type: none"> <li>■ [0] <b>Disable</b> (default)</li> <li>■ [1] <b>Enable</b></li> </ul> <p><b>Note:</b> The NGINX directive for this parameter is "server ip:port backup".</p>

## Configuring HTTP Directive Sets

The HTTP Directive Sets table lets you configure up to 30 HTTP Directive Sets. The table lets you configure additional custom directives to HTTP Proxy server configuration. These directives are reflected in the configuration file generated for the NGINX HTTP Proxy. The directives of each HTTP Directive Set is configured in the HTTP Directives table (see [Configuring HTTP Directives](#) on the next page), which is a "child" of the HTTP Directive Sets table.

Directives are grouped into Directive Sets, which you can then assign to HTTP Proxy Servers (see [Configuring HTTP Proxy Servers](#) on page 324), HTTP Locations (see [Configuring HTTP Locations](#) on page 328), and TCP/UDP Proxy Servers (see [Configuring TCP-UDP Proxy Servers](#) on page 333), using the 'Additional Directive Set' parameter in their respective tables.

For example, to control behavior of specific encoding and communication parameters relating to a particular location, you can configure the following NGINX directives:

```
chunked_transfer_encoding off;
keepalive_timeout 50s;
```



- The device does not validate Directive Sets, which it passes directly to the NGINX configuration file. If the configured directives are not entered using the correct syntax, NGINX rejects the new configuration. For more information, refer to the NGINX documentation at <http://nginx.org/en/docs>. An alphabetical index to all directives can be found at <http://nginx.org/en/docs/dirindex.html>.
- By default, the device is configured with an HTTP Directive Set for rate limiting. This directive ensures that priority is given to network traffic carrying SIP signaling and media over HTTP traffic. It is highly recommended to configure these limitations on the HTTP Proxy. This HTTP Directive Set includes the following directives:
  - ✓ "limit\_conn": Specifies the maximum number of simultaneous client connections (default 100).
  - ✓ "limit\_rate": Specifies the bandwidth limit per connection (bytes per second). This syntax supports a suffix of "k" for kilobytes and "m" for megabytes. The default is 0.

The following procedure describes how to configure HTTP Directive Sets through the Web interface. You can also configure it through ini file [HTTPDirectiveSets] or CLI (`configure network > http-proxy > directive-sets`).

### ➤ To configure an HTTP Directive Set:

1. Enable the HTTP Proxy application, as described in [Enabling the HTTP Proxy Application](#) on page 323.
2. Open the HTTP Directive Sets table (**Setup** menu > **IP Network** tab > **HTTP Proxy** folder > **HTTP Directive Sets**).
3. Click **New**; the following dialog box appears:

The screenshot shows a web interface for configuring HTTP Directive Sets. The window title is "HTTP Directive Sets". Under the "GENERAL" tab, there are three input fields: "Index" with the value "0", "Set Name", and "Description".

4. Configure an HTTP Directive Set according to the parameters described in the table below.
5. Click **Apply**, and then save your settings to flash memory.
6. Configure directives for the HTTP Directive Set (see [Configuring HTTP Directives](#) below).

**Table 16-25: HTTP Directive Sets Table Parameter Descriptions**

Parameter	Description
'Index' [HTTPDirectiveSets_ Index]	Defines an index number for the new table row. <b>Note:</b> <ul style="list-style-type: none"> <li>■ Each row must be configured with a unique index.</li> <li>■ The parameter is mandatory.</li> </ul>
'Set Name' set-name [HTTPDirectiveSets_ SetName]	Defines a descriptive name, which is used when associating the row in other tables. The valid value is a string of up to 40 characters. By default, no value is defined. <b>Note:</b> The parameter value cannot contain a forward slash (/).
'Description' set- description [HTTPDirectiveSets_ Description]	Defines a brief description for the HTTP Directive Set. The valid value is a string of up to 100 characters. By default, no value is defined.

### Configuring HTTP Directives

The HTTP Directives table lets you configure up to 500 HTTP Directives. The table is a "child" of the HTTP Directive Sets table (see [Configuring HTTP Directive Sets](#) on the previous page).

The following procedure describes how to configure HTTP Directives through the Web interface. You can also configure it through ini file [HTTPDirectives] or CLI (`configure network > http-proxy > directives`).

➤ **To configure an HTTP Directive:**

1. Enable the HTTP Proxy application, as described in [Enabling the HTTP Proxy Application](#) on page 323.
2. Open the HTTP Directive Sets table (**Setup** menu > **IP Network** tab > **HTTP Proxy** folder > **HTTP Directive Sets**).
3. In the table, select the required HTTP Directive Set index row, and then click the **HTTP Directives** link located below the table; the HTTP Directives table appears.
4. Click **New**; the following dialog box appears:

The screenshot shows a dialog box titled "HTTP Directives" with a "GENERAL" tab. It contains two input fields: "Index" with the value "01" and "Directive" which is empty.

5. Configure an HTTP Directive according to the parameters described in the table below.
6. Click **Apply**, and then save your settings to flash memory.

**Table 16-26: HTTP Directives Table Parameter Descriptions**

Parameter	Description
'Index' [HTTPOirectives_ RowIndex]	Defines an index number for the new table row. <b>Note:</b> <ul style="list-style-type: none"> <li>■ Each row must be configured with a unique index.</li> <li>■ The parameter is mandatory.</li> </ul>
' Directive' directive [HTTPOirectives_ Directive]	Defines an NGINX directive. <b>Note:</b> <ul style="list-style-type: none"> <li>■ The parameter is mandatory.</li> <li>■ Make sure that you end the directive with a semicolon (;).</li> </ul>

## Configuring an HTTP-based OVOC Service

The OVOC Services table lets you configure a single HTTP-based AudioCodes One Voice Operations Center (OVOC) service. You can configure the device to act as an HTTP Proxy that enables OVOC to manage AudioCodes equipment (such as IP Phones) over HTTP when the equipment is located behind NAT (e.g., in the LAN) and OVOC is located in a public domain (e.g., in the WAN). This setup resolves NAT traversal issues. The IP Phones register with the device to allow communication between the IP Phones and OVOC. Once setup, the OVOC administrator can access the Web-based management interfaces of each IP Phone .

A summary of the steps required to configure an HTTP Proxy for this OVOC service is listed below:

1. Enable the HTTP Proxy application (see [Enabling the HTTP Proxy Application](#)).
2. Configure two local, listening IP network interfaces - one for OVOC and one for the IP Phones (see [Configuring IP Network Interfaces](#) on page 121).
3. Configure the OVOC service in the OVOC Services table (described below). This entails specifying the IP network interfaces as well as the port number within each interface to which the HTTP Proxy must listen to.
4. Configure the device's firewall (Firewall table) to allow incoming traffic from OVOC. For more information, see [Configuring Firewall Rules to Allow Incoming OVOC Traffic](#) on page 178.



- It is recommended **not** to use port 80 as this is the default port used by IP Phones for their Web-based management interface.
- No special configuration is required on the managed equipment.

The following procedure describes how to configure an OVOC service through the Web interface. You can also configure it through ini file [OVOCService] or CLI (`configure network > http-proxy > ovoc-serv`).

#### ➤ To configure an OVOC Service:

1. Enable the HTTP Proxy application, as described in [Enabling the HTTP Proxy Application](#) on page 323.
2. Open the OVOC Services table (**Setup** menu > **IP Network** tab > **HTTP Proxy** folder > **OVOC Services**).
3. Click **New**; the following dialog box appears:

GENERAL		OVOC	
Index	0	OVOC Listening Interface	...
Name		OVOC Listening Port	
DEVICE		OVOC Scheme	HTTP
Device Login Interface	...	OVOC Interface TLS Context	...
Device Login Port		OVOC Interface Verify Certificate	No
Device Scheme	HTTP	OVOC Primary Server	
Device Login TLS Context	...	OVOC Backup Server	
Login Interface Verify Certificate	No		

4. Configure an OVOC Service according to the parameters described in the table below.
5. Click **Apply**, and then save your settings to flash memory.

Table 16-27:OVOC Services Table Parameter Descriptions

Parameter	Description
<b>General</b>	
'Index' [OVOCService_Index]	Defines an index number for the new table row. <b>Note:</b> <ul style="list-style-type: none"> <li>■ Each row must be configured with a unique index.</li> <li>■ The parameter is mandatory.</li> </ul>
'Name' service-name [OVOCService_ServiceName]	Defines a descriptive name, which is used when associating the row in other tables. The valid value is a string of up to 40 characters. By default, no value is defined. <b>Note:</b> <ul style="list-style-type: none"> <li>■ Each row must be configured with a unique name.</li> <li>■ The parameter is mandatory.</li> </ul>
<b>Device</b>	
'Device Login Interface' device-login-interface [OVOCService_DeviceLoginInterface]	Assigns an IP network interface (local, listening HTTP interface:port) for communication with the client. To configure IP Interfaces, see <a href="#">Configuring IP Network Interfaces</a> on page 121. By default, no value is defined. <b>Note:</b> <ul style="list-style-type: none"> <li>■ The parameter is mandatory.</li> <li>■ The NGINX directive for this parameter is "proxy_bind".</li> </ul>
'Device Login Port' device-login-port [OVOCService_DeviceLoginPort]	Defines the login port of the requesting client. <b>Note:</b> The NGINX directive for this parameter is "proxy_bind".
'Device Scheme' device-scheme [OVOCService_DeviceScheme]	Defines the protocol for communication with the requesting client. <ul style="list-style-type: none"> <li>■ [0] HTTP (default)</li> <li>■ [1] HTTPS</li> </ul> <b>Note:</b> If configured to <b>HTTPS</b> , you must assign a TLS

Parameter	Description
	Context (see the 'Device Login TLS Context' parameter, below).
'Device Login TLS Context' device-login-tls-context [OVOCService_LoginInterfaceTLSContext]	<p>Assigns a TLS Context (TLS configuration) for the interface with the requesting client. This is required if you have configured the 'Device Scheme' parameter to <b>HTTPS</b> (see above). To configure TLS Contexts, see <a href="#">Configuring TLS Certificate Contexts</a> on page 154.</p> <p><b>Note:</b> The NGINX directive for this parameter is "proxy_ssl_certificate", "proxy_ssl_certificate_key", "proxy_ssl_ciphers", and "proxy_ssl_protocols".</p>
'Device Login Interface Verify Certificate' device-interface-verify-cert [OVOCService_LoginInterfaceVerifyCert]	<p>Enables the verification of the TLS certificate that is used in the incoming client connection request.</p> <ul style="list-style-type: none"> <li>■ [0] <b>No</b> = (Default) No certificate verification is done.</li> <li>■ [1] <b>Yes</b> = The device verifies the authentication of the certificate received from the client. The device authenticates the certificate against the trusted root certificate store associated with the assigned TLS Context (see 'Device Login TLS Context' parameter above) and if ok, allows communication with the client. If authentication fails, the device denies communication (i.e., handshake fails). The device can also authenticate the certificate by querying with an Online Certificate Status Protocol (OCSP) server whether the certificate has been revoked. This is also configured for the associated TLS Context.</li> </ul> <p><b>Note:</b> The NGINX directive for this parameter is "proxy_ssl_verify".</p>
<b>OVOC</b>	
'OVOC Listening Interface' ovoc-interface [OVOCService_OVOCListeningInterface]	<p>Assigns an IP network interface (local, listening HTTP interface:port) for communication with OVOC. To configure IP Interfaces, see <a href="#">Configuring IP Network Interfaces</a> on page 121.</p> <p>By default, no value is defined.</p> <p><b>Note:</b></p>



Parameter	Description
	<ul style="list-style-type: none"> <li>■ The parameter is mandatory.</li> <li>■ The NGINX directive for this parameter is "proxy_bind".</li> </ul>
<p>'OVOC Listening Port'</p> <p>ovoc-port</p> <p>[OVOCService_OVOCListeningPort]</p>	<p>Defines the listening port for the OVOC interface.</p> <p><b>Note:</b> The NGINX directive for this parameter is "proxy_bind".</p>
<p>'OVOC Scheme'</p> <p>ovoc-scheme</p> <p>[OVOCService_OVOCScheme]</p>	<p>Defines the security scheme for the connection with OVOC.</p> <ul style="list-style-type: none"> <li>■ [0] <b>HTTP</b> (default)</li> <li>■ [1] <b>HTTPS</b></li> </ul> <p><b>Note:</b></p> <ul style="list-style-type: none"> <li>■ If configured to <b>HTTPS</b>, you must assign a TLS Context (see the 'OVOC Interface TLS Context' parameter, below).</li> <li>■ The NGINX directive for this parameter is "proxy_pass scheme://upstream".</li> </ul>
<p>'OVOC Interface TLS Context'</p> <p>ovoc-interface-tls-context</p> <p>[OVOCService_OVOCTLSContext]</p>	<p>Assigns a TLS Context (TLS configuration) for the OVOC listening interface. This is required if you have configured the 'OVOC Scheme' parameter to <b>HTTPS</b> (see above). To configure TLS Contexts, see <a href="#">Configuring TLS Certificate Contexts</a> on page 154.</p> <p><b>Note:</b> The NGINX directive for this parameter is "proxy_ssl_certificate", "proxy_ssl_certificate_key", "proxy_ssl_ciphers", and "proxy_ssl_protocols".</p>
<p>'OVOC Interface Verify Certificate'</p> <p>ovoc-verify-cer</p> <p>[OVOCService_OVOCTLSContext]</p>	<p>Enables the verification of the TLS certificate that is used in the incoming connection request from OVOC.</p> <ul style="list-style-type: none"> <li>■ [0] <b>No</b> = (Default) No certificate verification is done.</li> <li>■ [1] <b>Yes</b> = The device verifies the authentication of the certificate received from OVOC. The device authenticates the certificate against the trusted root certificate store associated with the assigned TLS Context (see 'OVOC Interface TLS</li> </ul>

Parameter	Description
	<p>Context' parameter above) and if ok, allows communication with OVOC. If authentication fails, the device denies communication (i.e., handshake fails). The device can also authenticate the certificate by querying with an Online Certificate Status Protocol (OCSP) server whether the certificate has been revoked. This is also configured for the associated TLS Context.</p> <p><b>Note:</b> The NGINX directive for this parameter is "proxy_ssl_verify".</p>
<p>'OVOC Primary Server' primary-server [OVOCService_PrimaryServer]</p>	<p>Defines the address of the primary OVOC server.</p> <p><b>Note:</b></p> <ul style="list-style-type: none"> <li>■ This parameter is mandatory.</li> <li>■ When you configure this parameter, an Upstream Group is automatically added (see <a href="#">Configuring Upstream Groups</a> on page 336).</li> <li>■ The NGINX directive for this parameter is "upstream ems { addr1, addr2 backup }" and "proxy_pass scheme://ems".</li> </ul>
<p>'OVOC Backup Server' backup-server [OVOCService_BackupServer]</p>	<p>Defines the address of the secondary OVOC server.</p> <p><b>Note:</b></p> <ul style="list-style-type: none"> <li>■ When you configure this parameter, an Upstream Group is automatically added.</li> <li>■ The NGINX directive for this parameter is "upstream ems { addr1, addr2 backup }" and "proxy_pass scheme://ems".</li> </ul>

## Troubleshooting NGINX Configuration

Troubleshooting may be necessary when configuring your HTTP or TCP/UDP proxy services with NGINX directives. Due to the large and complex dictionary of directives supported by NGINX and their complex grammatical structure, the device assists you by validating your configured directives. It does this only once you have applied them (i.e., clicked the **Apply** button) in the HTTP Directives table (see [Configuring HTTP Directives](#) on page 342).

In addition, the device generates the following NGINX configuration files:

- **nginx.conf:** This file contains the currently active configuration, which is valid.

- **temp\_nginx.conf:** This file is generated if you have invalid configuration (directive errors). It is a temporary file and contains your new configuration, which is invalid. It is applied only if the device is restarted.
- **nginx.errors:** This file is generated if you have invalid configuration (directive errors). This file contains all the error messages, indicating the line on which the error exists in the temp\_nginx.conf file.

If you have modified your configuration and errors occur, the device continues running with the previous, valid NGINX configuration, unless the device is restarted, in which case it applies and uses the modified configuration.

In addition, if an NGINX validation error exists during configuration or if the device restarts with an invalid NGINX configuration, the device indicates this by the following:

- Sends an alarm to the Active Alarms table ("NGINX configuration file is not valid")
- Sends the error to Syslog, which is marked with "http\_app"

To send the NGINX files to a remote destination in tar file format (.tar), use the following CLI command:

```
# copy nginx-conf-files to <Protocol>://<Address>/<filename>.tar
```

To view the NGINX files in CLI, use the following command:

```
show network http-proxy conf active|errors|new
```

## Configuring a Public IP Address for NGINX NAT Traversal

When the device is located behind NAT, OVOC can only communicate with the device's embedded NGINX HTTP-based proxy using the device's public static NAT address. However, by default, the device sends OVOC its' private address. The device's address (private or public) appears in the proprietary X-AC-Proxy-URL header in HTTP requests that the device sends to OVOC.

### ➤ To configure a public IP address for HTTP Proxy:

1. Open the General Settings page (**Setup** menu > **IP Network** tab > **HTTP Proxy** folder > **General Settings**).

**HTTP Proxy Global Address**

2. In the 'HTTP Proxy Global Address' [HttpProxyGlobalAddress] field, enter the public IP address.
3. Click **Apply**.

## E9-1-1 Support for Microsoft Teams and Skype for Business

The Enhanced 9-1-1 (E9-1-1) service is becoming the mandatory emergency service required in many countries around the world. The E9-1-1 service, based on its predecessor 911, enables emergency operators to pinpoint the location (granular location) of callers who dial the 9-1-1 emergency telephone number.

Today, most companies implement an IP-based infrastructure providing a VoIP network with fixed and nomadic users, allowing connectivity anywhere with any device. This, together with an often deployed multi-line telephone system (MLTS) poses a challenge for E9-1-1 due to the difficulty in accurately locating the E9-1-1 caller.

This section describes the E9-1-1 solution provided by Microsoft Teams / Skype for Business and AudioCodes' device's ELIN interworking capabilities, which provides the SIP Trunk or ISDN (or CAMA) connectivity to the E9-1-1 emergency service provider. This section also describes the configuration of the device for interoperating between the Teams / Skype for Business environment and the E9-1-1 emergency provider.



- The ELIN feature for E9-1-1 is a license-based feature and is available only if it is included in the License Key installed on the device. For ordering the feature, please contact the sales representative of your purchased device. For installing a new License Key, see [License Key](#).
- The ELIN feature for E9-1-1 is applicable to the SBC application and the Gateway application (digital PSTN interfaces only).

### About E9-1-1 Services

E9-1-1 is a national emergency service for many countries, enabling E9-1-1 operators to automatically identify the geographical location and phone number of a 911 caller. In E9-1-1, the 911 caller is routed to the nearest E9-1-1 operator, termed *public safety answering point* (PSAP) based on the location of the caller. Automatic identification of the caller's location and phone number reduces the time spent on requesting this information from the 911 caller. Therefore, the E9-1-1 service enables the PSAP to quickly dispatch the relevant emergency services (for example, fire department or police) to the caller's location. Even if the call prematurely disconnects, the operator has sufficient information to call back the 911 caller.

The figure below illustrates the routing of an E9-1-1 call to the PSAP:

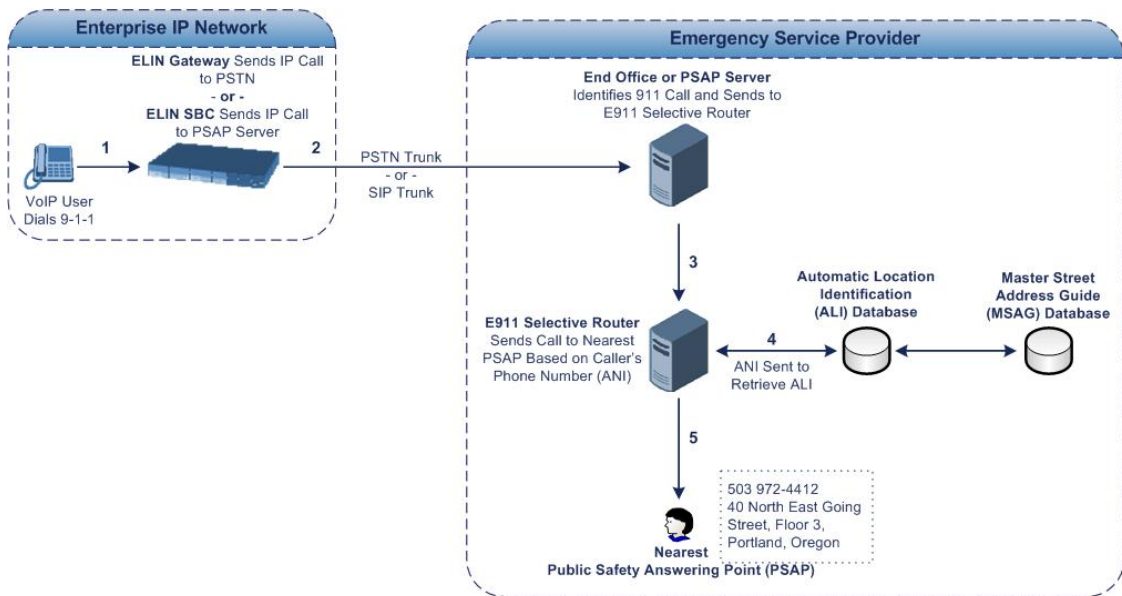

1. The VoIP user dials 9-1-1.
2. The AudioCodes' ELIN device sends the call to the emergency service provider over the PSTN or SIP Trunk (PSAP server).
3. The emergency service provider identifies the call is an emergency call and sends it to an E9-1-1 Selective Router in the Emergency Services provider's network.
4. The E9-1-1 Selective Router determines the geographical location of the caller by requesting this information from an Automatic Location Identification (ALI) database based on the phone number or Automatic Number Identifier (ANI) of the 911 caller. Exact location information is also supplied by the Master Street Address Guide (MSAG) database, which is a companion database to the ALI database. Phone companies and public safety agencies collaborate beforehand to create master maps that match phone numbers, addresses and cross streets to their corresponding PSAP. This MSAG is the official record of valid streets (with exact spelling), street number ranges, and other address elements with which the service providers are required to update their ALI databases.
5. The E9-1-1 Selective Router sends the call to the appropriate PSAP based on the retrieved location information from the ALI.
6. The PSAP operator dispatches the relevant emergency services to the E9-1-1 caller.

## Microsoft Skype for Business and E9-1-1

Microsoft Skype for Business enables Enterprise voice users to access its unified communications platform from virtually anywhere and through many different devices. This, together with a deployed MLTS, poses a challenge for E9-1-1 due to the difficulty in accurately locating the E9-1-1 caller. However, Skype for Business offers an innovative solution to solving Enterprises E9-1-1 location problems.

## Gathering Location Information of Skype for Business Clients for 911 Calls

When a Microsoft Skype for Business client is enabled for E9-1-1, the location data that is stored on the client is sent during an emergency call. This stored location information is acquired automatically from the Microsoft Location Information Server (LIS). The LIS stores the location of each network element in the enterprise. Immediately after the Skype for Business client registration process or when the operating system detects a network connection change, each Skype for Business client submits a request to the LIS for a location. If the LIS is able to resolve a location address for the client request, it returns the address in a location response. Each client then caches this information. When the Skype for Business client dials 9-1-1, this location information is then included as part of the emergency call and used by the emergency service provider to route the call to the correct PSAP.

The gathering of location information in the Skype for Business network is illustrated in the figure below:

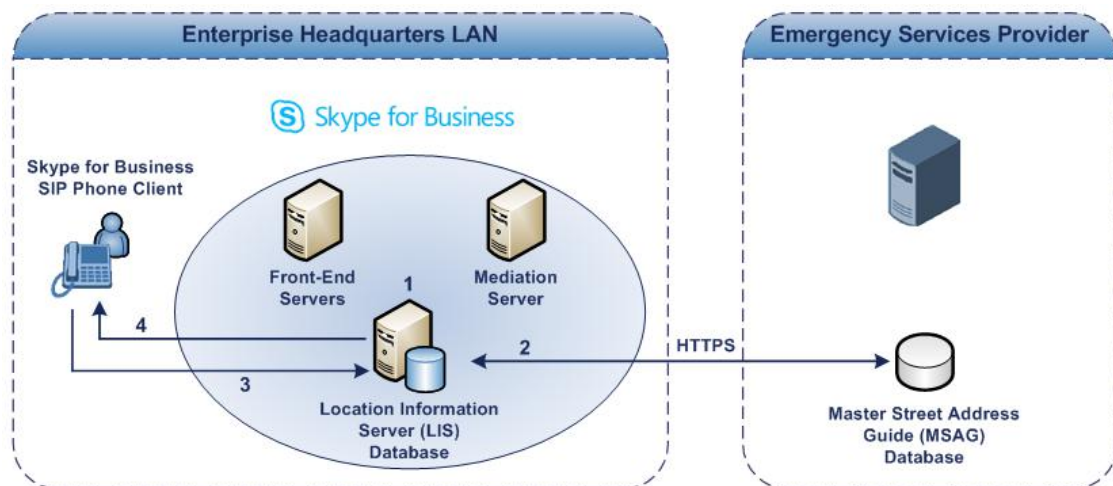

1. The Administrator provisions the LIS database with the location of each network element in the Enterprise. The location is a civic address, which can include contextual in-building and company information. In other words, it associates a specific network entity (for example, a WAP) with a physical location in the Enterprise (for example, Floor 2, Wing A, and the Enterprise's street address). For more information on populating the LIS database, see [Adding ELINs to the Location Information Server](#).
2. The Administrator validates addresses with the emergency service provider's MSAG—a companion database to the ALI database. This ensures that the civic address is valid as an official address (e.g., correct address spelling).
3. The Skype for Business client initiates a location request to the LIS under the following circumstances:
  - Immediately after startup and registering the user with Skype for Business
  - Approximately every four hours after initial registration
  - Whenever a network connection change is detected (such as roaming to a new WAP)

The Skype for Business client includes in its location request the following known network connectivity information:

- Always included:
  - ◆ IPv4 subnet
  - ◆ Media Access Control (MAC) address
- Depends on network connectivity:
  - ◆ Wireless access point (WAP) Basic Service Set Identifier (BSSID)
  - ◆ Link Layer Discovery Protocol-Media Endpoint Discovery (LLDP-MED) chassis ID and port ID

For a Skype for Business client that moves inside the corporate network such as a soft phone on a laptop that connects wirelessly to the corporate network, Skype for Business can determine which subnet the phone belongs to or which WAP / SSID is currently serving the soft-client.

4. The LIS queries the published locations for a location and if a match is found, returns the location information to the client. The matching order is as follows:
  - WAP BSSID
  - LLDP switch / port
  - LLDP switch
  - Subnet
  - MAC address

This logic ensures that for any client that is connected by a wireless connection, a match is first attempted based on the hardware address of its connected access point. The logic is for the match to be based on the most detailed location. The subnet generally provides the least detail. If no match is found in the LIS for WAP BSSID, LLDP switch / port, LLDP switch, or subnet, the LIS proxies the MAC address to an integrated Simple Network Management Protocol (SNMP) scanning application. Using SNMP may benefit some organizations for the following reasons:

- LLDP is not supported by Skype for Business so this provides a mechanism for soft phones to acquire detailed location information.
- Installed Layer-2 switches may not support LLDP.

If there is no match and the LIS cannot determine the location, the user may be prompted to manually enter the location. For example, the client may be located in an undefined subnet, at home, in a coffee shop or anywhere else outside the network. When a user manually provides a location, the location is mapped based on the MAC address of the default gateway of the client's network and stored on the client. When the client returns to any previously stored location, the client is automatically set to that location. A user can also manually select any location stored in the local users table and manage existing entries.

## Adding ELINs to the Location Information Server

As mentioned in the previous section, the administrator needs to populate the Location Information Server (LIS) database with a network wire map, which maps the company's network elements to civic addresses. Once done, it can automatically locate clients within a network. You can add addresses individually to the LIS or in a batch using a comma-separated value (CSV) file containing the column formats for the network elements, as listed below:

- **Wireless access point:**  
`<BSSID>,<Description>,<Location>,<CompanyName>,<HouseNumber>,<HouseNumberSuffix>,<PreDirectional>,<StreetName>,<StreetSuffix>,<PostDirectional>,<City>,<State>,<PostalCode>,<Country>`
- **Subnet:** `<Subnet>,<Description>,<Location>,<CompanyName>,<HouseNumber>,<HouseNumberSuffix>,<PreDirectional>,<StreetName>,<StreetSuffix>,<PostDirectional>,<City>,<State>,<PostalCode>,<Country>`
- **Port:** `<ChassisID>,<PortIDSubType>,<PortID>,<Description>,<Location>,<CompanyName>,<HouseNumber>,<HouseNumberSuffix>,<PreDirectional>,<StreetName>,<StreetSuffix>,<PostDirectional>,<City>,<State>,<PostalCode>,<Country>`
- **Switch:** `<ChassisID>,<Description>,<Location>,<CompanyName>,<HouseNumber>,<HouseNumberSuffix>,<PreDirectional>,<StreetName>,<StreetSuffix>,<PostDirectional>,<City>,<State>,<PostalCode>,<Country>`

For the ELIN number to be included in the SIP INVITE (XML-based PIDF-LO message) sent by the Mediation Server to the ELIN device, the administrator must add the ELIN number to the `<CompanyName>` column (shown in the table above in bold typeface). As the ELIN device supports up to five ELINs per PIDF-LO, the `<CompanyName>` column can be populated with up to this number of ELINs, each separated by a semicolon. The digits of each ELIN can be separated by hyphens (xxx-xxx-xxx) or they can be adjacent (xxxxxxxx). When the ELIN device receives the SIP INVITE message, it extracts the ELINs from the ELIN field in the PIDF-LO (e.g., `<ca:ELIN>1111-222-333; 1234567890 </ca:ELIN>`), which corresponds to the `<CompanyName>` column of the LIS.



For backward compatibility, if the ELIN field doesn't appear in the PIDF-LO, the device extracts the ELINs from the NAM field.

If you do not populate the location database and the Skype for Business location policy, and Location Required is set to **Yes** or **Disclaimer**, the user is prompted to enter a location manually.

## Passing Location Information to the PSTN Emergency Provider

When a Skype for Business client, enabled for E9-1-1 emergency services, dials 9-1-1, the location data and callback information stored on the client is sent with the call through the Mediation Server to a SIP Trunk-based or PSTN-based emergency service provider. The



emergency service provider then routes the call to the nearest and most appropriate PSAP based on the location information contained within the call.

Skype for Business passes the location information of the Skype for Business client in an IETF-standard format - Presence Information Data Format - Location Object (PIDF-LO)—in a SIP INVITE message. However, this content cannot be sent on the SIP Trunk or PSTN since they do not support such a content. To overcome this, Enterprises deploying the device can divide their office space into Emergency Response Locations (ERLs) and assign a dedicated Emergency Location Identification Number (ELIN) to each ERL (or zone). When Skype for Business sends a SIP INVITE message with the PIDF-LO to the device, it can parse the content and translate the calling number to an appropriate ELIN. The device then sends the call to the SIP Trunk or PSTN with the ELIN number as the calling number. The ELIN number is sent to the emergency service provider, which sends it on to the appropriate PSAP according to the ELIN address match in the ALI database lookup.

The ERL defines a specific location at a street address, for example, the floor number of the building at that address. The geographical size of an ERL is according to local or national regulations (for example, less than 7000 square feet per ERL). Typically, you would have an ERL for each floor of the building. The ELIN is used as the phone number for 911 callers within this ERL.

The figure below illustrates the use of ERLs and ELINs, with an E9-1-1 call from floor 2 at the branch office:

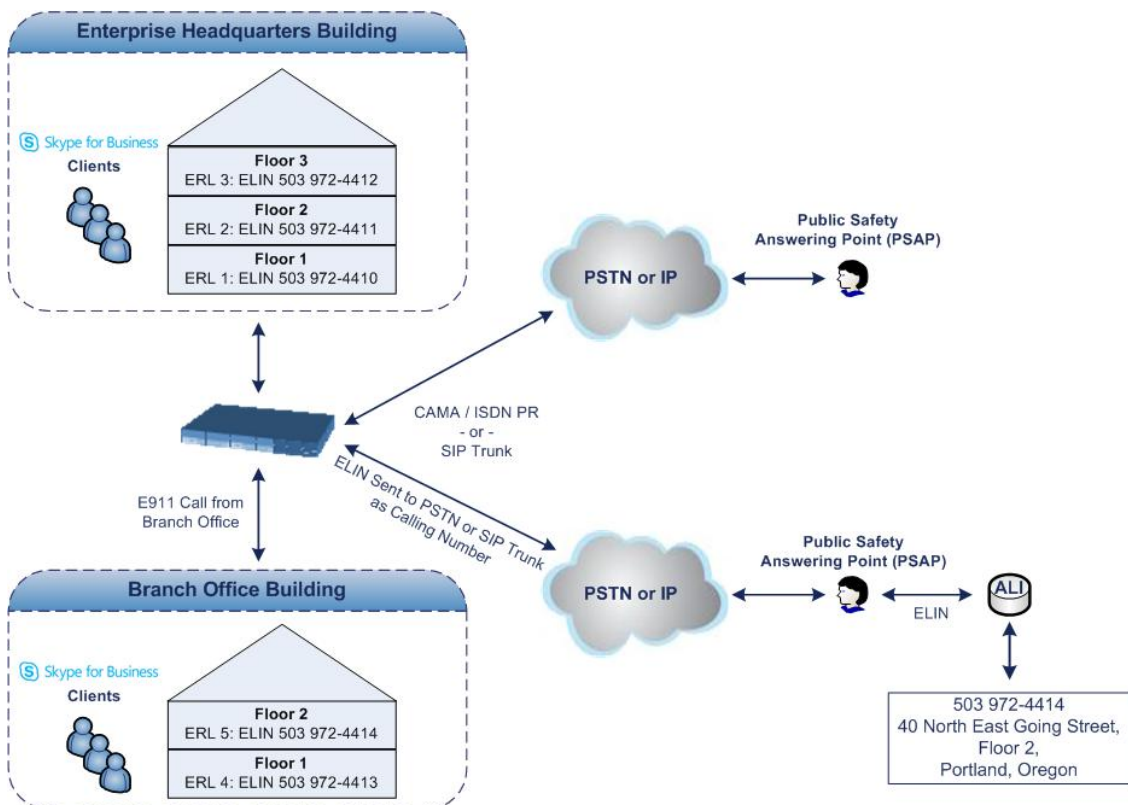

The table below shows an example of designating ERLs to physical areas (floors) in a building and associating each ERL with a unique ELIN.

**Table 16-28: Designating ERLs and Assigning to ELINs**

ERL Number	Physical Area	IP Address	ELIN
1	Floor 1	10.13.124.xxx	503 972-4410
2	Floor 2	10.15.xxx.xxx	503 972-4411
3	Floor 3	10.18.xxx.xxx	503 972-4412

In the table above, a unique IP subnet is associated per ERL. This is useful if you implement different subnets between floors. Therefore, IP phones, for example, on a specific floor are in the same subnet and therefore, use the same ELIN when dialing 9-1-1.

### AudioCodes ELIN Device for Teams / Skype for Business E9-1-1 Calls to PSTN

Microsoft Mediation Server sends the location information of the E9-1-1 caller in the XML-based PIDF-LO body contained in the SIP INVITE message. However, this content cannot be sent on the SIP Trunk or PSTN since they do not support such content. To solve this issue, Skype for Business requires a ELIN SBC or Gateway to send the E9-1-1 call to the SIP Trunk or PSTN. When Skype for Business sends the PIDF-LO to the ELIN device, it parses the content and translates the calling number to an appropriate ELIN. This ensures that the call is routed to an appropriate PSAP based on ELIN-address match lookup in the emergency service provider's ALI database.

The figure below illustrates an AudioCodes ELIN device deployed in the Skype for Business environment for handling E9-1-1 calls between the company and the emergency service provider.

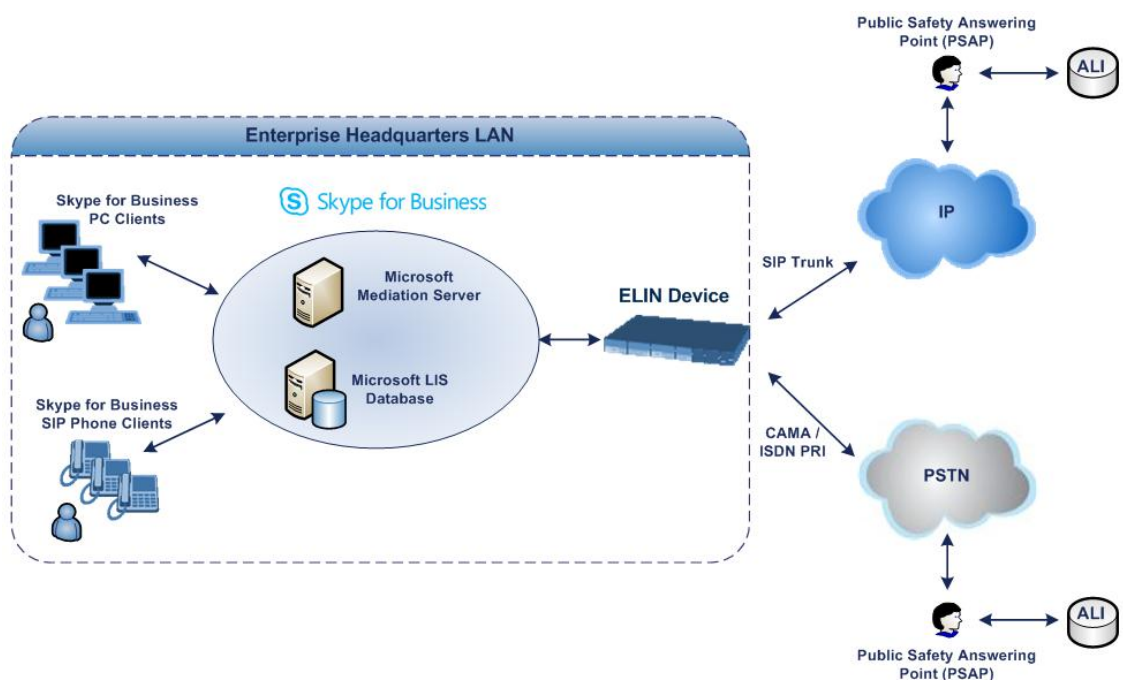

## Detecting and Handling E9-1-1 Calls

The ELIN device identifies E9-1-1 calls and translates their incoming E9-1-1 calling numbers into ELIN numbers, which are sent to the PSAP. The device handles the received E9-1-1 calls as follows:

1. The device identifies E9-1-1 calls if the incoming SIP INVITE message contains a PIDF-LO XML message body. This is indicated in the SIP *Content-Type* header, as shown below:

```
Content-Type: application/pidf+xml
```

2. The device extracts the ELIN number(s) from the ELIN field in the XML message. The ELIN field corresponds to the <CompanyName> column in the Location Information Server (LIS). The device supports up to five ELIN numbers per XML message. The ELINs are separated by a semicolon. The digits of the ELIN number can be separated by hyphens (xxx-xxx-xxx) or they can be adjacent (xxxxxxxx), as shown below:

```
<ca:ELIN>1111-222-333; 1234567890 </ca:ELIN>
```



For backward compatibility, if the ELIN field doesn't appear in the PIDF-LO, the device extracts the ELINs from the NAM field.

3. The device saves the From header value of the SIP INVITE message in its ELIN database table ('Call From' field). The ELIN table is used for PSAP callback, as discussed later in [PSAP Callback for Dropped E9-1-1 Calls](#) on page 360. The ELIN table also stores the following information:

- **ELIN:** ELIN number
- **Time:** Time at which the original E9-1-1 call was terminated with the PSAP
- **Count:** Number of E9-1-1 calls currently using the ELIN

An example of the ELIN database table is shown below:

ELIN	Time	Count	Index	Call From
4257275678	22:11:52	0	2	4258359333
4257275999	22:11:57	0	3	4258359444
4257275615	22:12:03	0	0	4258359555
4257275616	22:11:45	0	1	4258359777

The ELIN table stores this information for a user-defined period (see [Configuring the E9-1-1 Callback Timeout](#)), starting from when the E9-1-1 call, established with the PSAP, terminates. After this time expires, the table entry with its ELIN is disregarded and no

longer used (for PSAP callback). Therefore, table entries of only the most recently terminated E9-1-1 callers are considered in the ELIN table. The maximum entries in the ELIN table is 100.

4. The device uses the ELIN number as the E9-1-1 calling number and sends it in the SIP INVITE or ISDN Setup message (as an ANI / Calling Party Number) to the SIP Trunk or PSTN.

An example of a SIP INVITE message received from an E9-1-1 caller is shown below. The SIP Content-Type header indicating the PPDF-LO and the ELIN field listing the ELINs are shown in **bold** typeface.

```
INVITE sip:911;phone-context=Redmond@192.168.1.12;user=phone SIP/2.0
From: "voip_911_user1"<sip:voip_911_
user1@contoso.com>;epid=1D19090AED;tag=d04d65d924
To: <sip:911;phone-context=Redmond@192.168.1.12;user=phone>
CSeq: 8 INVITE
Call-ID: e6828be1-1cdd-4fb0-bdda-cda7faf46df4
VIA: SIP/2.0/TLS 192.168.0.244:57918;branch=z9hG4bK528b7ad7
CONTACT: <sip:voip_911_
user1@contoso.com;opaque=user:epid:R4bCDaUj51a06PUbkraS0QAA;gruu>;t
ext;audio;video;image
PRIORITY: emergency
CONTENT-TYPE: multipart/mixed; boundary= -----=_NextPart_000_4A6D_
01CAB3D6.7519F890
geolocation: <cid:voip_911_user1@contoso.com>;inserted-by="sip:voip_911_
user1@contoso.com"
```

```
Message-Body:
-----=_NextPart_000_4A6D_01CAB3D6.7519F890
Content-Type: application/sdp ; charset=utf-8
v=0
o=- 0 0 IN IP4 Client
s=session
c=IN IP4 Client
t=0 0
m=audio 30684 RTP/AVP 114 111 112 115 116 4 3 8 0 106 97
c=IN IP4 172.29.105.23
a=rtcp:60423
a=label:Audio
a=rtpmap:3 GSM/8000/1
a=rtpmap:101 telephone-event/8000
a=fmtp:101 0-16
a=rtpmap:0 PCMU/8000
a=rtpmap:8 PCMA/8000
aptime:20-----=_NextPart_000_4A6D_01CAB3D6.7519F890
```

**Content-Type: application/pidf+xml**

Content-ID: &lt;voip\_911\_user1@contoso.com&gt;

&lt;?xml version="1.0" encoding="utf-8"?&gt;

```

<presence xmlns="urn:ietf:params:xml:ns:pidf"
  xmlns:gp="urn:ietf:params:xml:ns:pidf:geopriv10"
  xmlns:bp="urn:ietf:params:xml:ns:pidf:geopriv10:basicPolicy"
  xmlns:ca="urn:ietf:params:xml:ns:pidf:geopriv10:civicAddr"
  xmlns:ms="urn:schema:Rtc.LIS.msftE911PidfExtn.2008" entity="sip:voip_911_
  user1@contoso.com"><tuple id="0"><status><gp:geopriv><gp:location-
  info><ca:civicAddress><ca:country>US</ca:country><ca:A1>WA</ca:A1><ca:A
  3>Redmond</ca:A3><ca:RD>163rd</ca:RD><ca:STS>Ave</ca:STS><ca:POD
  >NE</ca:POD><ca:HNO>3910</ca:HNO><ca:LOC>40/4451</ca:LOC>
  <ca:ELIN>1111-222-333; 1234567890 </ca:ELIN>
  <ca:PC>98052</ca:PC></ca:civicAddress></gp:location-info><gp:usage-
  rules><bp:retransmission-allowed>true</bp:retransmission-allowed></gp:usage-
  rules></gp:geopriv><ms:msftE911PidfExtn><ms:ConferenceUri>sip:+14255550
  199@contoso.com;user=phone</ms:ConferenceUri><ms:ConferenceMode>two
  way</ms:ConferenceMode><LocationPolicyTagID
  xmlns="urn:schema:Rtc.Lis.LocationPolicyTagID.2008">user-
  tagid</LocationPolicyTagID
  ></ms:msftE911PidfExtn></status><timestamp>1991-09-
  22T13:37:31.03</timestamp></tuple></presence>

```

-----=\_NextPart\_000\_4A6D\_01CAB3D6.7519F890--

**Pre-empting Existing Calls for E9-1-1 Calls**

If the ELIN device receives an E9-1-1 call from the IP network and there are unavailable channels (for example, all busy), the device immediately terminates one of the non-E9-1-1 calls (arbitrary) and accepts the E9-1-1 call on the freed-up channel:

- SBC application: Preemption is done only on a call belonging to the same source IP Group from which the E9-1-1 call is received, or the same destination IP Group (i.e., PSAP Server).
- Gateway application: Preemption is done only on a channel belonging to the same Trunk Group for which the E9-1-1 call was initially destined. For example, if an E9-1-1 call is destined for Trunk Group #2 and all the channels belonging to this group are busy, the device terminates one of the calls in this group to free a channel for accepting the E9-1-1 call.

This feature is initiated only if the received SIP INVITE message contains a Priority header set to "emergency", as shown below:

Priority: emergency

### PSAP Callback for Dropped E9-1-1 Calls

As the E9-1-1 service automatically provides all the contact information of the E9-1-1 caller to the PSAP, the PSAP operator can call back the E9-1-1 caller. This is especially useful in cases where the caller disconnects prematurely. However, as the Enterprise sends ELINs to the PSAP for E9-1-1 calls, a callback can only reach the original E9-1-1 caller using the device to translate the ELIN number back into the E9-1-1 caller's extension number.

In the ELIN table of the device, the temporarily stored *From* header value of the SIP INVITE message originally received from the E9-1-1 caller is used for PSAP callback. When the PSAP makes a callback to the E9-1-1 caller, the device translates the called number (i.e., ELIN) received from the PSAP to the corresponding E9-1-1 caller's extension number as matched in the ELIN table.

The handling of PSAP callbacks by the device is as follows:

1. When the device receives a call from the emergency service provider, it searches the ELIN table for an ELIN that corresponds to the received called party number in the incoming message.
2. If a match is found in the ELIN table, it routes the call to the Mediation Sever by sending a SIP INVITE, where the values of the *To* and *Request-URI* are taken from the value of the original *From* header that is stored in the ELIN table (in the **Call From** column).
3. The device updates the 'Time' field in the ELIN table (the 'Count' field is not affected).

The PSAP callback can be done only within a user-defined period (see [Configuring the E9-1-1 Callback Timeout](#)), started from after the original E9-1-1 call, established with the PSAP is terminated. After this time expires, the table entry with its ELIN is disregarded and no longer used (for PSAP callback). Therefore, table entries of only the most recently terminated E9-1-1 callers are considered in the ELIN table. If the PSAP callback is done after this timeout expires, the device is unable to route the call to the E9-1-1 caller and instead, either sends it as a regular call or most likely, rejects it if there are no matching routing rules. However, if another E9-1-1 caller has subsequently been processed with the same ELIN number, the PSAP callback is routed to this new E9-1-1 caller.

In scenarios where the same ELIN number is used by multiple E9-1-1 callers, upon receipt of a PSAP callback, the device sends the call to the most recent E9-1-1 caller. For example, if the ELIN number "4257275678" is being used by three E9-1-1 callers, as shown in the table below, then when a PSAP callback is received, the device sends it to the E9-1-1 caller with phone number "4258359555".

**Table 16-29: Choosing Caller of ELIN**

ELIN	Time	Call From
4257275678	11:00	4258359333

ELIN	Time	Call From
4257275678	11:01	4258359444
4257275678	11:03	<b>4258359555</b>

### Selecting ELIN for Multiple Calls within Same ERL

The device supports the receipt of up to five ELIN numbers in the XML message of each incoming SIP INVITE message. As discussed in the preceding sections, the device sends the ELIN number as the E9-1-1 calling number to the emergency service provider. If the XML message contains more than one ELIN number, the device chooses the ELIN according to the following logic:

- If the first ELIN in the list is not being used by other active calls, it chooses this ELIN.
- If the first ELIN in the list is being used by another active call, the device skips to the next ELIN in the list, and so on until it finds an ELIN that is not being used and sends this ELIN.
- If all the ELINs in the list are in use by active calls, the device selects the ELIN number as follows:
  - a. The ELIN with the lowest count (i.e., lowest number of active calls currently using this ELIN).
  - b. If the count between ELINs is identical, the device selects the ELIN with the greatest amount of time passed since the original E9-1-1 call using this ELIN was terminated with the PSAP. For example, if E9-1-1 caller using ELIN 4257275678 was terminated at **11:01** and E9-1-1 caller using ELIN 4257275670 was terminated at **11:03**, then the device selects ELIN 4257275678.

In this scenario, multiple E9-1-1 calls are sent with the same ELIN.

### Location Based Emergency Routing

The device supports location-based emergency routing (E-911) in Teams / Skype for Business environments. This ensures that E-911 calls from remote branches are routed to emergency providers that are relevant to the geographical area in which the remote branch callers are physically located. To support this, the device enables routing and SIP header / number manipulation of such emergency calls based on the geographical location of the caller. The device manipulates the received destination number (i.e., 911) from the remote branch callers, into a destination number of an emergency provider that is relevant to the geographical area in which the remote branch office is located.

For an example on location-based emergency call routing, see [Configuring Location-Based Emergency Routing](#).



Location-based emergency routing is applicable only to the Gateway application.

## Configuring AudioCodes ELIN Device

This section describes E9-1-1 configuration of the AudioCodes ELIN Gateway deployed in the Microsoft Teams / Skype for Business environment.

### Enabling the E9-1-1 Feature

By default, the ELIN device feature for E9-1-1 emergency call handling in a Microsoft Teams / Skype for Business environment is disabled.

➤ **To enable ELIN feature for the SBC application:**

- For the IP Group through which you want to communicate with the public-safety answering point (PSAP), configure the 'SBC PSAP Mode' parameter to **Enable**. For more information, see [Configuring IP Groups](#).

➤ **To enable ELIN feature for the Gateway application:**

1. Open the Priority & Emergency page (**Setup** menu > **Signaling & Media** tab > **SIP Definitions** folder > **Priority and Emergency**).
2. From the 'E911 Gateway' drop-down list (E911Gateway), select **NG911 Callback Gateway**.

E911 Gateway

NG911 Callback Gateway ▼

3. Click **Apply**.

### Configuring the E9-1-1 Callback Timeout

If the initial established call between the E9-1-1 caller and the PSAP is prematurely terminated, the PSAP can use the ELIN to call back the E9-1-1 caller within a user-defined time interval (in minutes) from when the call was terminated. By default, an ELIN can be used for PSAP callback within 30 minutes after the call terminates. You can change this to any value between 0 and 60. For more information on PSAP callback for dropped E9-1-1 calls, see [PSAP Callback for Dropped E9-1-1 Calls](#) on page 360.

➤ **To configure the E9-1-1 callback timeout**

1. Open the Priority & Emergency page (**Setup** menu > **Signaling & Media** tab > **SIP Definitions** folder > **Priority and Emergency**).
2. In the 'E911 Callback Timeout' field (E911CallbackTimeout), enter the required callback timeout.

E911 Callback Timeout

30

3. Click **Apply**.



### Configuring the SIP Release Cause Code for Failed E9-1-1 Calls

When a Teams / Skype for Business client makes an emergency call, the call is routed through the Microsoft Mediation Server to the ELIN device, which sends it to the PSTN. In some scenarios, the call may not be established due to the destination (for example, busy or not found) or the ELIN device (for example, lack of resources or an internal error). In such a scenario, the Mediation Server requires that the ELIN device "reject" the call with a SIP release cause code 503 "Service Unavailable" (instead of the designated release call). Such a release cause code enables the Mediation Server to issue a failover to another entity (for example, another ELIN device), instead of retrying the call or returning the release call to the user.

To support this requirement, you can configure the ELIN device to send a 503 "Service Unavailable" release cause code instead of SIP 4xx if an emergency call cannot be established.



The feature is applicable only to the Gateway application and for digital interfaces.

➤ **To enable SIP response 503 upon failed E9-1-1:**

1. Open the Advanced Parameters page (**Setup** menu > **Signaling & Media** tab > **Gateway** folder > **Gateway Advanced Parameters**).
2. From the 'Emergency Special Release Cause' drop-down list [EmergencySpecialReleaseCause], select **Enable**.

Emergency Special Release Cause Enable

3. Click **Apply**.

### Configuring SBC IP-to-IP Routing Rule for E9-1-1

To route incoming Teams / Skype for Business E9-1-1 calls to the emergency service provider's PSAP server, you need to configure routing rules in the IP-to-IP Routing table for routing between the emergency callers' IP Group and the PSAP server's IP Group. The only special configuration is to define the emergency number (e.g., 911) in the 'Destination Username Pattern' parameter of the IP Group belonging to the E9-1-1 callers. The following example shows IP-to-IP routing rules for E9-1-1:

INDEX ↕	NAME	ROUTING POLICY	ALTERNATIVE ROUTE OPTIONS	SOURCE IP GROUP	REQUEST TYPE	SOURCE USERNAME PREFIX	DESTINATION USERNAME PREFIX	DESTINATION TYPE	DESTINATION IP GROUP
0	E911 > PSAP	Default_SBCRou	Route Row	LAN IP PBX	All	*	911	IP Group	PSAP Server
1	PSAP > E911	Default_SBCRou	Route Row	PSAP Server	All	*	*	IP Group	LAN IP PBX



This feature is applicable only to the SBC application.

## Configuring Location-Based Emergency Routing

The device identifies the geographical location of emergency callers by their ELIN numbers, which is present in the PIDF-LO XML body of received SIP INVITE messages. Therefore, you need to configure the device to route emergency calls to a destination (i.e., emergency center such as the police) that is appropriate to the caller's ELIN number. As the destination of incoming calls is the emergency number (e.g., 999), the device needs to manipulate the destination number to a number that represents the caller's **local** emergency center (e.g., +4420999 for London police).



Location-based emergency routing is applicable only to the Gateway application.

To add manipulation rules for location-based emergency routing, you need to use the Destination Phone Number Manipulation for IP-to-Tel Calls table. In this table, you need to use the ELIN number (e.g., 5000) as the source prefix, with the "ELIN" string value added in front of it (e.g., ELIN5000) which is used by the device to identify the number as an ELIN number (and **not** used for any other routing processes etc.). For each corresponding ELIN source number prefix entry, you need to configure the manipulation action required on the destination number so that the call is routed to the appropriate destination.

Following is an example of how to configure location-based emergency routing:

### ■ Assumptions:

- Company with offices in different cities -- London and Manchester.
- Each city has its local police department.
- In an emergency, users need to dial 999.
- Company employs Microsoft Skype for Business for communication between employers, and between employers and the external telephone network (PSTN). In other words, all employers are seemingly (virtual) in the same location in respect to the IP network.
- ELIN numbers are used to identify the geographical location of emergency calls dialed by users:
  - ◆ London ELIN is 5000.
  - ◆ Manchester ELIN is 3000.

### ■ Configuration Objectives:

- Emergency calls received from London office users are routed by the device to the London police department (+4420999).
- Emergency calls received from Manchester office users are routed by the device to the Manchester police department (+44161999).

The international code, +44 for England is used for IP routing considerations, but can be omitted depending on your specific deployment.

The above scenario is configured as follows:

1. Enable location-based emergency routing, by loading an ini file to the device with the following parameter setting:
  - a. Open the Gateway Advanced Settings page (**Setup** menu > **Signaling & Media** tab > **Gateway** folder > **Gateway Advanced Settings**).
  - b. From the 'E911 Gateway' drop-down list [E911Gateway], select **Location Based Manipulations**.



2. In the Destination Phone Number Manipulation for IP-to-Tel Calls table (see [Configuring Source/Destination Number Manipulation](#)), add the following two rules for manipulating the destination number of incoming emergency calls, based on ELIN numbers:

INDEX	NAME	SOURCE IP ADDRESS	DESTINATION PREFIX	STRIPPED DIGITS FROM LEFT	STRIPPED DIGITS FROM RIGHT	NUMBER OF DIGITS TO LEAVE	PREFIX TO ADD
0	Emergency London	*	*	0	0	255	+4420
1	Emergency Manchester	*	*	0	0	255	+44161

Index 0 manipulates the destination number for London emergency callers; Index 1 manipulates the destination number for Manchester emergency callers.

### Viewing the ELIN Table

To view the ELIN table:

- CLI:

```
# show voip e911
ELIN      Time   Count Index Call From
-----
4257275678 22:11:52 0 2 4258359333
4257275999 22:11:57 0 3 4258359444
257275615 22:12:03 0 0 4258359555
4257275616 22:11:45 0 1 4258359777
----- Current Time: 22:12:40
```

- Syslog, by invoking the following Web command shell:

```
SIP / GateWay / E911Dump
```

## Microsoft Skype for Business Presence of Third-Party Endpoints

Microsoft presence capability allows Skype for Business users to know the status (e.g., "Available" or "Do Not Disturb") of their contacts. Presence status of contacts is displayed on the user's Skype for Business endpoint. Presence information of Skype for Business endpoints (such as Skype for Business desktop client) is handled solely by the Skype for Business Server, without any intervention of the device. However, when third-party (non-Skype for Business) endpoint devices (e.g., mobile phone or PBX phone) are used by the Skype for Business users, presence status information can only be reported to the Skype for Business Server by the device. For example, if John and Alice are Skype for Business users and John makes or receives a call on a mobile device, Alice is able to see that John is in a call, even though the call is not on a native Skype for Business endpoint. Once the device reports the presence status, the Skype for Business Server sends this status change to the Skype for Business users in the network.



- Currently, the device reports the following presence status:
  - ✓ "On the Phone" - user is busy (in a call or doesn't want to be disturbed)
  - ✓ "Clear" - cancels the "On the Phone" status (returning the user's presence to its previous state)
- The feature supports Skype for Business Server 2015 and Lync Server version 5.0.8308.866 and later.
- The feature is applicable to the SBC application and the Gateway application (Tel-to-IP calls only).

The device notifies the Skype for Business Server of a user's presence status, by using SIP PUBLISH messages. The message transactions between the device and Skype for Business Server is as follows:

1. The device routes a call between two Skype for Business users and when connected, sends a PUBLISH message with the Event header set to "presence", Expires header set to "600", Content-Type header set to "application/pidf+xml", and where the XML body's "activity" is set to "on-the-phone", as shown in the following example for user John Doe:

```
PUBLISH sip:john.doe@sfb.example SIP/2.0
From: <sip:john.doe@sfb.example>;tag=1c537837102
To: <sip:john.doe@sfb.example>
CSeq: 1 PUBLISH
Event: presence
Expires: 600
Content-Type: application/pidf+xml
Content-Length: 489
```

```
<?xml version="1.0" encoding="utf-8"?>
<presence xmlns="urn:ietf:params:xml:ns:pidf"
xmlns:ep="urn:ietf:params:xml:ns:pidf:status:rpidd-status"
xmlns:et="urn:ietf:params:xml:ns:pidf:rpidd-tuple"
```

```

xmlns:ci="urn:ietf:params:xml:ns:pidf:cipid"
entity="sip:john.doe@sfb.example">
<tuple id="0">
<status>
<basic>open</basic>
<ep:activities>
<ep:activity>on-the-phone</ep:activity>
</ep:activities>
</status>
</tuple>
<ci:display-name>John Doe</ci:display-name>
</presence>

```

2. The Skype for Business Server responds to the device with a SIP 200 OK. The message is sent with a SIP-ETag header which identifies the entity (and Expires header set to 600 seconds), as shown in the following example:

```

SIP/2.0 200 OK
From: "John Doe"<sip:john.doe@sfb.example>;tag=1c537837102
To:
<sip:john.doe@sfb.example>;tag=0E4324A4B27040E4A167108D4FAD27E
3
Call-ID: 1284896643279201635736@10.33.221.57
CSeq: 1 PUBLISH
Via: SIP/2.0/TLS 10.33.221.57:5061;alias;...received=10.33.221.57;ms-
received port=48093;ms-received-cid=4900
SIP-ETag: 2545777538-1-1
Expires: 600
Content-Length: 0

```

3. If the call lasts longer than 600 seconds, the device sends another PUBLISH message with the same SIP-ETag value and with an Expires header value of 600 seconds. The Skype for Business Server responds with another 200 OK, but with a new SIP-ETag value (and Expires header set to 600 seconds). This scenario occurs for each 600-second call interval.
4. When the call ends, the device sends a PUBLISH message to cancel the user's online presence status (and the user's previous presence state is restored). The message is sent with a SIP-If-Match header set to the matching entity tag (SIP-ETag) value (i.e., SIP-ETag value of last 200 OK) and Expires header value set to "0", as shown in the following example:

```

PUBLISH sip:john.doe@sfb.example SIP/2.0
From: <sip:john.doe@sfb.example>;tag=1c1654434948
To: <sip:john.doe@sfb.example>
CSeq: 1 PUBLISH

```

```

Contact: <sip:john.doe@10.33.221.57:5061;transport=tls>
Event: presence
Expires: 0
User-Agent: sur1-vg1.ecarecenters.net/v.7.20A.001.080
SIP-If-Match: 2545777538-1-1
Content-Length: 0

```

The following figure shows a basic illustration of the device's integration into Microsoft Skype for Business Presence feature for third-party endpoints.

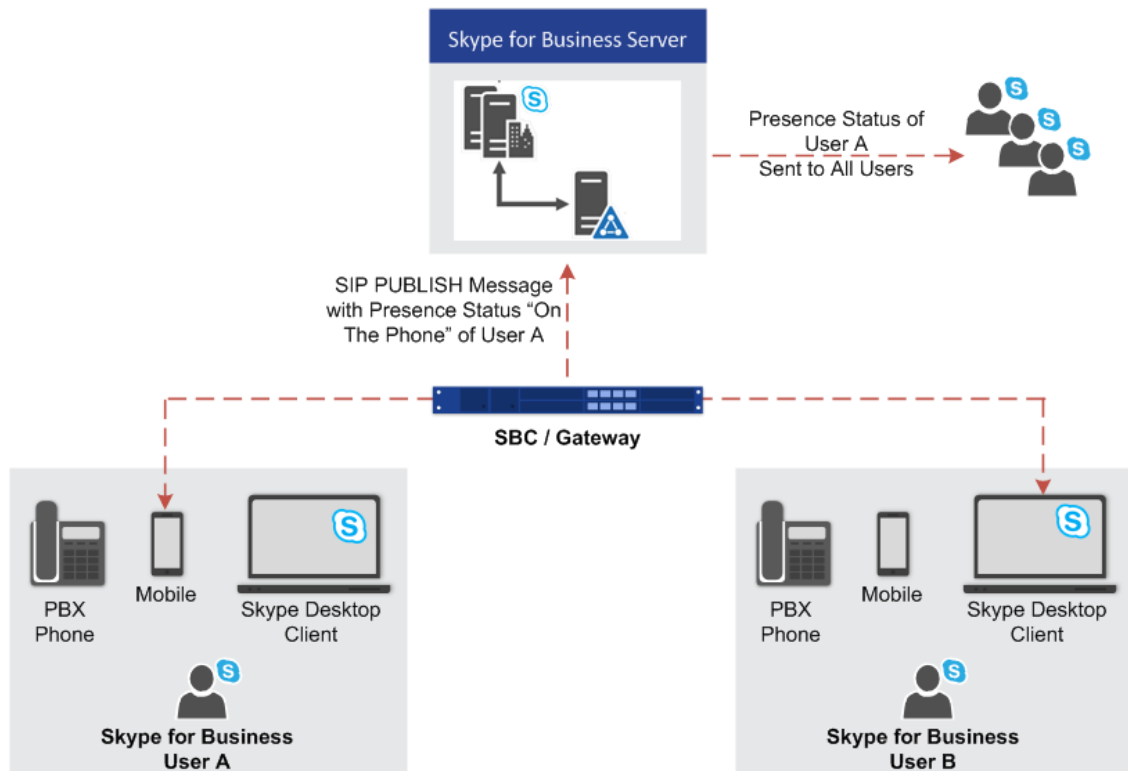

## Configuring Skype for Business Server for Presence

On the Skype for Business Server side, you need to define the device in the Skype for Business Topology as a Trusted Application.



- Detailed configuration of Skype for Business Server is beyond the scope of this document.
- Before performing the below procedure, make sure that you have defined the device in the PSTN Gateway node of the Skype for Business Server Topology (using the Topology Builder).

Using the Skype for Business Server Management Shell, perform the following steps:

### 1. Obtain the Site ID

Run the following cmdlet to retrieve the SiteId property of the site:

```
Get-CsSite
```

## 2. Create a Trusted Application Pool

Run the following cmdlet to create a new pool to host the presence application:

```
New-CsTrustedApplicationPool -Identity <Pool FQDN> -Registrar <Registrar FQDN> -Site <Site Id>
```

where:

- *Identity* is the FQDN of the device, which sends the SIP PUBLISH messages with the presence status to Skype for Business Server
- *Registrar* is the FQDN of the Registrar service for the pool
- *Site* is the Site Id

For example:

```
New-CsTrustedApplicationPool -Identity audcsbcgw.example.com -Registrar skypepool.example.com -Site Portland
```

## 3. Add the Trusted Application (Presence) to the Pool

```
New-CsTrustedApplication -ApplicationId <String> -TrustedApplicationPoolFqdn <String> -Port <Port Number>
```

where:

- *ApplicationId* is the name of the application
- *TrustedApplicationPoolFqdn* is the FQDN of the trusted application pool
- *Port* is the port number on which the application will run (5061)

For example:

```
New-CsTrustedApplication -ApplicationId MSpresence -TrustedApplicationPoolFqdn audcsbcgw.example.com -Port 5061
```

Make sure the port number matches the port number configured on the device.

## 4. Enable and Publish the Skype for Business Server 2015 Topology

Run the following cmdlet to publish and enable your new topology:

```
Enable-CsTopology
```

## Configuring the Device for Skype for Business Presence

The following procedure describes how to configure the device for notifying Skype for Business Server of presence status of Skype for Business users when making and receiving calls using third-party, endpoint devices. To help you understand the configuration, the following lists in chronological order the main processing steps:

1. The device receives an incoming call.
2. The device uses a Call Setup Rule to perform LDAP queries on the Microsoft Active Directory to retrieve Skype for Business usernames (Request URIs) for the corresponding calling (source) and/or called (destination) number. For SBC calls, the Call Setup Rule is associated with the classified source IP Group (in the IP Groups table). For Tel-to-IP Gateway calls, the Call Setup Rule is associated with the destination IP Group (in the Tel-to-IP Routing table).
3. The device routes the call to the required destination, according to the normal routing rules.
4. When the call is connected, the device sends a SIP PUBLISH message to Skype for Business Server, indicating that the users' presence status is now "On-the-Phone".
5. When the call ends, the device sends another SIP PUBLISH message to the Skype for Business Server, clearing the users' "On-the-Phone" status (the presence status changes to what it was before the call was connected).

### ➤ To configure the device for Skype for Business presence:

1. Enable the Microsoft presence feature: open the SIP Definitions General Settings page (**Setup** menu > **Signaling & Media** tab > **SIP Definitions** folder > **SIP Definitions General Settings**), and then from the 'Microsoft Presence Status' drop-down list, select **Enable**:

Microsoft Presence Status

2. Configure a TLS Context (TLS certificate) for secured communication (mutual authentication) between the device and the Skype for Business Server (see [Configuring TLS Certificate Contexts](#)).
3. Configure a Proxy Set to define the address of the Skype for Business Server (see [Configuring Proxy Sets](#)). Make sure you configure the following:
  - 'TLS Context Name': Assign the TLS Context that you configured in Step 2 (above).
  - 'Proxy Address': Configure the address (FQDN or IP address).
  - 'Transport Type': **TLS**
4. Configure an IP Group to represent the Skype for Business Server (see [Configuring IP Groups](#)). Make sure that you assign it with the Proxy Set that you configured in Step 3 (above).



- Assign the IP Group of the Skype for Business Server as the destination (presence gateway) to where the device must send the PUBLISH messages: open the SIP Definitions General Settings page (**Setup** menu > **Signaling & Media** tab > **SIP Definitions** folder > **SIP Definitions General Settings**), and then in the 'Presence Publish IP Group ID' field, enter the IP Group ID of the Skype for Business Server that you configured in Step 4 (above):

**Presence Publish IP Group ID**

-1

- Configure the Skype for Business LDAP server (Active Directory) to query for the Skype for Business users' SIP URIs (see [Configuring LDAP Servers](#)).
- Configure Call Setup Rules to perform LDAP queries in the Microsoft Active Directory for the SIP URI of the caller (source) and called (destination) parties (see [Configuring Call Setup Rules](#)). The device first needs to search the AD for the caller or called number of the third-party endpoint device. For example, to search for a called mobile number, the searched LDAP Attribute would be "mobile" set to the value of the destination number (e.g., 'mobile=+' + param.call.dst.user). If the entry exists, the query searches for the Attribute (e.g., ipPhone) where the SIP URI is defined for the corresponding mobile user. If found, the query returns the Attribute's value (i.e., URI) to the device (instructed using the special 'Condition' string "presence.dst" or "presence.src"). This is the URI that the device uses as the Request-URI in the PUBLISH message that it sends to the Skype for Business Server. The configuration of the example used in this step is shown below:

Parameter	Rule 1	Rule 2
'Request Type'	<b>LDAP</b>	<b>LDAP</b>
'Request Key'	'mobile=+' + param.call.dst.user	'mobile=+' + param.call.src.user
'Attributes To Get'	ipPhone	ipPhone
'Condition'	ldap.attr.ipPhone exists	ldap.attr.ipPhone exists
'Action Subject'	presence.dst	presence.src
'Action Type'	<b>Add</b>	<b>Add</b>
'Action Value'	ldap.attr.ipPhone	ldap.attr.ipPhone

- Configure routing rules to route the calls in the network.
- (For the SBC application only) Configure IP Groups to represent your call party entities, and assign them the group of Call Setup Rules (Set ID) that you configured in Step 7 (above). For configuring IP Groups, see [Configuring IP Groups](#).
- (For the Gateway application only) Assign the group of Call Setup Rules (Set ID) that you configured in Step 7 (above) to your Tel-to-IP Routing rules (see [Configuring Tel-to-IP Routing Rules](#)).

## Microsoft Teams with Local Media Optimization

The device can be configured to support the Local Media Optimization feature when deployed in a Microsoft Teams environment. This feature is intended for complex environments consisting of a central SBC device (i.e., this device that you are configuring), which is referred to by Microsoft as the *Proxy SBC*, integrated in the Teams environment, and multiple remote SBCs or Gateways (referred to by Microsoft as *remote site SBCs*). In this environment, the central SBC determines the optimal path for connecting calls between the Teams clients, based on network connectivity (good or bad) and voice quality. The device path selection is based on supplementary information provided by Microsoft using their proprietary headers that are included in the SIP messages during call setup between Teams clients:

Microsoft SIP Header	Value	Description
X-MS-UserLocation	Internal or External	Indicates if the Teams client is located in the internal or external network with respect to the central SBC. Based on the header value, the device selects the Media Realm, using the IP Group's 'Internal Media Realm' or 'Media Realm' parameters, respectively.
X-MS-MediaPath	sbc1.contoso.com sbc2.contoso.com ...	Indicates the order of remote SBCs that should be used for the media path between the Teams clients. If the first address is the central SBC itself, the media traverses the device (non-direct media).

Configuration of the device for Local Media Optimization is done on the IP Group of the Teams client, using the following IP Group table parameters:

- 'Teams Local Media Optimization Handling': This parameter enables Local Media Optimization and defines how the device handles the Teams call based on the Microsoft proprietary SIP headers.
- 'Internal Media Realm': Assigns a Media Realm which is used if the X-MS-UserLocation header value is "Internal". If the header value is "External" (or not present), the Media Realm assigned by the 'Media Realm' parameter is used.
- 'Teams Local Media Optimization Initial Behavior': This parameter defines how the central SBC device initially sends the received INVITE message with the SDP Offer to Teams.

For more information on the above parameters, see their descriptions in [Configuring IP Groups](#) on page 431.

For detailed technical information on deploying the device in a Microsoft Teams environment with Local Media Optimization, contact your AudioCodes sales representative.



This section is applicable only to the SBC application.

# 17 Quality of Experience

This chapter describes how to configure the Quality of Experience feature.

## Reporting Voice Quality of Experience to OVOC

The device can be configured to report voice (media) Quality of Experience (QoE) to AudioCodes' One Voice Operations Center (OVOC). The reports include real-time metrics of the quality of the actual call experience, which are then processed by OVOC.

OVOC is also a VoIP-quality monitoring and analysis tool. It provides comprehensive details on voice traffic quality, allowing system administrators to quickly identify, fix and prevent issues that could affect the voice calling experience in enterprise and service provider VoIP networks. IT managers and administrators can employ OVOC in their VoIP networks to guarantee effective utilization, smooth performance, reliable QoS levels, and SLA fulfillment.



- For information on OVOC, refer to the *OVOC User's Manual*.
- For configuring the SNMP connection between the device and OVOC, see [Configuring SNMP for OVOC Connectivity](#) on page 88.

## Configuring OVOC for Quality of Experience

The Quality of Experience Settings table lets you configure the address and other connectivity parameters for AudioCodes One Voice Operations Center (OVOC) server to where the device sends Quality of Experience (QoE) voice metric reports. The device can report QoE to a single OVOC server, or to two OVOC servers deployed in a Geographic Redundancy, High-Availability (HA) mode. Geographic Redundancy is when each OVOC server is in a different subnet and has its own IP address. For the device to report QoE to both servers, you need to configure the address of each server (IP address or FQDN). For normal HA mode, when both OVOC servers are in the same subnet, a single OVOC server (global, virtual) address is used for all network components (OVOC clients and managed devices). In such a setup, you need to configure only this address.

You can also configure the device to use a TLS connection with OVOC. Before you can do this, configure a TLS Context (certificate) in the TLS Contexts table (see [Configuring TLS Certificate Contexts](#)). If no TLS Context is specified, the device uses the default TLS Context (ID 0). You can also configure at what stage of the call the device sends the QoE report to OVOC. The report can be sent during the call or only at the end of the call. Reporting at the end of the call may be beneficial when there is network congestion as this reduces bandwidth usage over time.



- If a QoE traffic overflow is experienced between OVOC and the device, the device sends the QoE data only at the end of the call, regardless of your settings.

The following procedure describes how to configure the OVOC server for QoE through the Web interface. You can also configure it through ini file [QOESettings] or CLI (`configure voip > qoe qoe-settings`).

➤ **To configure the OVOC server for QoE:**

1. Open the Quality of Experience Settings table (**Setup** menu > **Signaling & Media** tab > **Media** folder > **Quality of Experience** > **Quality of Experience Settings**).

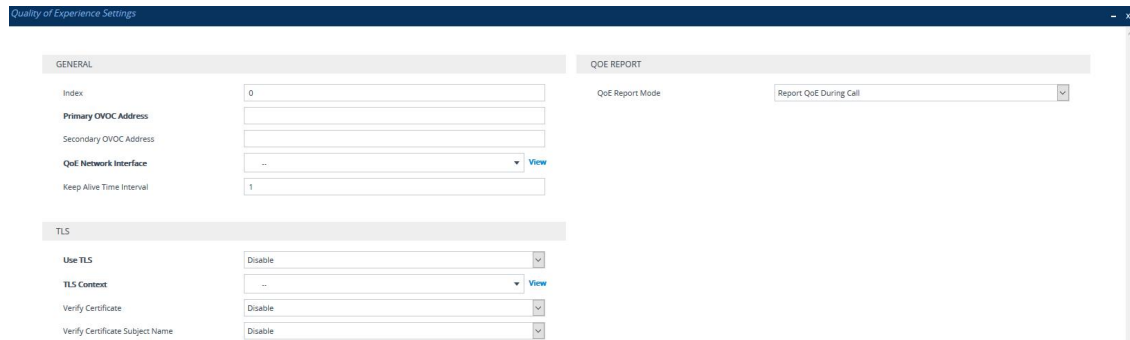

2. Configure the OVOC server according to the parameters described in the table below.
3. Click **Apply**, and then reset the device with a save-to-flash for your settings to take effect.

**Table 17-1: Quality of Experience Settings Parameter Descriptions**

Parameter	Description
<b>General</b>	
'Index' tls [QOESettings_Index]	Defines an index number for the new table row. <b>Note:</b> Each row must be configured with a unique index.
'Primary OVOC Address' server-name [QOESettings_ServerName]	Defines the address of the primary OVOC server to where the QoE reports are sent. The valid value is an IP address in dotted-decimal notation or an FQDN (hostname). <b>Note:</b> ■ If you only configure a primary address (this parameter) without a secondary address (see 'Secondary OVOC Address' parameter below) and the address is an FQDN, the device accepts up to two DNS-resolved IP addresses. The first IP address is used for the primary server and the second IP address for the secondary server. If you configure both this parameter and the 'Secondary OVOC Address' parameter with FQDNs, the device uses only the first DNS-resolved IP address from each

Parameter	Description
	<p>FQDN.</p> <ul style="list-style-type: none"> <li>If you are using a WebSocket tunnel connection between the device and OVOC, then configure the parameter to the IP address mentioned in <a href="#">Configuring WebSocket Tunnel with OVOC</a> on page 90.</li> </ul>
'Secondary OVOC Address' secondary-server-name [QOESettings_SecondaryServerName]	<p>Defines the address of the secondary OVOC server to where the QoE reports are sent. This is applicable only when OVOC is in Geographical Redundancy HA mode. The valid value is an IP address in dotted-decimal notation or an FQDN (hostname).</p> <p><b>Note:</b> See the note for the 'Primary OVOC Address' parameter (above).</p>
'QoE Network Interface' interface [QOESettings_Interface]	<p>Assigns an IP network interface from which the device sends the QoE reports.</p> <p>The default is the OAMP interface (<b>O+M+C</b>).</p> <p>To configure network interfaces, see <a href="#">Configuring IP Network Interfaces</a>.</p>
'Keep Alive Time Interval' keep-alive-time [QOESettings_KeepAliveTime]	<p>Defines the interval (in seconds) between every consecutive keep-alive message that the device sends to the OVOC server. Keep-alive messages can be useful to keep the communication link between the device and OVOC open when there is no other traffic flow between them.</p> <p>The default is 1. A value of 0 disables the keep-alive feature.</p>
TLS	
'Use TLS' tls [QOESettings_EnableTls]	<p>Enables a TLS connection with the OVOC server.</p> <ul style="list-style-type: none"> <li>[0] <b>Disable</b> (default)</li> <li>[1] <b>Enable</b></li> </ul>
'TLS Context' tls-context-name [QOESettings_ContextName]	<p>Assigns a TLS Context (certificate) for the TLS connection with the OVOC server.</p> <p>The default is the default TLS Context (ID 0).</p> <p><b>Note:</b> The parameter is applicable only if the 'Use TLS' parameter is configured to <b>Enable</b>.</p>

Parameter	Description
'Verify Certificate' verify-certificate [QOESettings_VerifyCertificate]	<p>Enables the verification of the TLS certificate that is used in the incoming connection request from the OVOC server.</p> <ul style="list-style-type: none"> <li>■ [0] <b>Disable</b> = (Default) No certificate verification is done.</li> <li>■ [1] <b>Enable</b> = The device verifies the authentication of the certificate received from the OVOC server. The device authenticates the certificate against the trusted root certificate store associated with the assigned TLS Context and if ok, allows communication with OVOC. If authentication fails, the device denies communication (i.e., handshake fails). The device can also authenticate the certificate by querying with an Online Certificate Status Protocol (OCSP) server whether the certificate has been revoked. This is configured for the assigned TLS Context.</li> </ul> <p><b>Note:</b> The parameter is applicable only if the 'Use TLS' parameter is configured to <b>Enable</b>.</p>
'Verify Certificate Subject Name' verify-certificate-subject-name [QOESettings_VerifyCertificateSubjectName]	<p>Enables the verification of the TLS certificate subject name (Common Name / CN or Subject Alternative Name / SAN) that is used in the incoming connection request from the OVOC server.</p> <ul style="list-style-type: none"> <li>■ [0] <b>Disable</b> = (Default) No verification is done.</li> <li>■ [1] <b>Enable</b> = The device verifies the subject name of the certificate received from the OVOC server with the hostname or IP address configured for OVOC (in the 'Primary OVOC Address' and 'Secondary OVOC Address' parameters, above). If authentication fails, the device denies communication (i.e., handshake fails).</li> </ul> <p><b>Note:</b> The parameter is applicable only if the 'Use TLS' parameter is configured to <b>Enable</b>.</p>
QoE Report	
'QoE Report Mode' report-mode [QOESettings_ReportMode]	<p>Defines at what stage of the call the device sends the call's QoE data to the OVOC server.</p> <ul style="list-style-type: none"> <li>■ [0] <b>Report QoE During Call</b> (default)</li> </ul>

Parameter	Description
	<ul style="list-style-type: none"> <li data-bbox="722 282 1118 315">■ [1] Report QoE at End of Call</li> </ul> <p data-bbox="722 342 1366 490"><b>Note:</b> If a QoE traffic overflow between OVOC and the device occurs, the device sends the QoE data only at the end of the call, regardless of the parameter's settings.</p>

## Configuring Clock Synchronization between Device and OVOC

To ensure accurate call quality statistics and analysis by OVOC, you must configure the device and the OVOC server with the same clock source for clock synchronization. In other words, you need to configure them with the same NTP server (same address).

The NTP server can be one of the following:

- OVOC server (also acting as an NTP server)
- Third-party, external NTP server

To configure, the NTP server's address on the device, see [Configuring Automatic Date and Time using SNTP](#).

## Configuring Firewall Rules for OVOC Traffic

To allow incoming traffic from OVOC, you need to configure the device's firewall (Firewall table) with additional "Allow" firewall rules, as described in [Configuring Firewall Rules to Allow Incoming OVOC Traffic](#) on page 178.

## Enabling RTCP XR Reporting to OVOC

For the device to be able to send voice metric reports to AudioCodes OVOC, you need to enable the RTP Control Protocol Extended Reports (RTCP XR) VoIP management protocol. RTCP XR defines a set of voice metrics that contain information for assessing VoIP call quality and diagnosing problems. Enabling RTCP XR means that the device can send RTCP XR messages, containing the call-quality metrics, to OVOC.

For enabling RTCP XR reporting, see [Configuring RTCP XR](#). To configure what to report to OVOC, see [Configuring Quality of Experience Profiles](#).

## Configuring Quality of Experience Profiles

Quality of Experience Profiles enable you to effectively monitor the quality of voice calls traversing the device in your network. Quality of Experience Profiles define severity thresholds for voice metrics monitored by the device, which if crossed can result in various actions (discussed later in the section).



Quality of Experience is configured using two tables with parent-child type relationship. The Quality of Experience Profile table is the parent, which defines the name of the Quality of Experience Profile. The Quality of Experience Color Rules table is the child, which defines severity thresholds per voice metric for the specific Quality of Experience Profile. You can configure up to 256 Quality of Experience Profiles and up to 256 Quality of Experience Color Rules.

Once configured, you can apply the Quality of Experience Profiles to specific calls (network links), by assigning them to any of the following configuration entities:

- IP Groups (see [Configuring IP Groups](#))
- Media Realms (see [Configuring Media Realms](#))
- Remote Media Subnets (see [Configuring Remote Media Subnets](#))

The Quality of Experience Profile allows you to configure thresholds for the following monitored voice metrics:

- **Mean Opinion Score (MOS):** MOS is the average grade on a quality scale, expressed as a single number in the range of 1 to 5, where 1 is the lowest audio quality and 5 the highest audio quality.
- **Delay (or latency):** Time it takes for information to travel from source to destination (round-trip time).
- **Packet Loss:** Lost packets are RTP packets that are not received by the voice endpoint. Packet loss can result in choppy voice transmission.
- **Jitter:** Jitter can result from uneven delays between received voice packets. To space evenly, the device's jitter buffer adds delay. The higher the measurement, the greater the impact of the jitter buffer's delay on audio quality.
- **Residual Echo Return Loss (RERL):** An echo is a reflection of sound arriving at the listener at some time after the sound was initiated (often by the listener). Echo is typically caused by delay.

At any given time during a call, a voice metric can be in one of the following color-coded quality states (as displayed in OVOC):

- **Green:** Indicates good call quality
- **Yellow:** Indicates fair call quality
- **Red:** Indicates poor call quality

When the threshold of a voice metric is crossed, the device changes the alarm severity and corresponding color-coded quality state of the call:

- **Minor Threshold (Yellow):** Lower threshold that indicates changes from Green or Red to Yellow.
- **Major Threshold (Red):** Higher threshold that indicates changes from Green or Yellow to Red.

The device also uses hysteresis to determine whether the threshold has indeed being crossed. Hysteresis defines the amount of fluctuation from the threshold in order for the threshold to be considered as crossed (i.e., change in color state). Hysteresis is used to avoid false reports being sent by the device. Hysteresis is used only for threshold crossings toward a lesser severity (i.e., from Red to Yellow, Red to Green, or Yellow to Green).

The following example is used to explain how the device considers threshold crossings. The example is based on the MOS of a call, where the Major threshold is configured to 2, the Minor threshold to 4 and the hysteresis for both thresholds to 0.1:

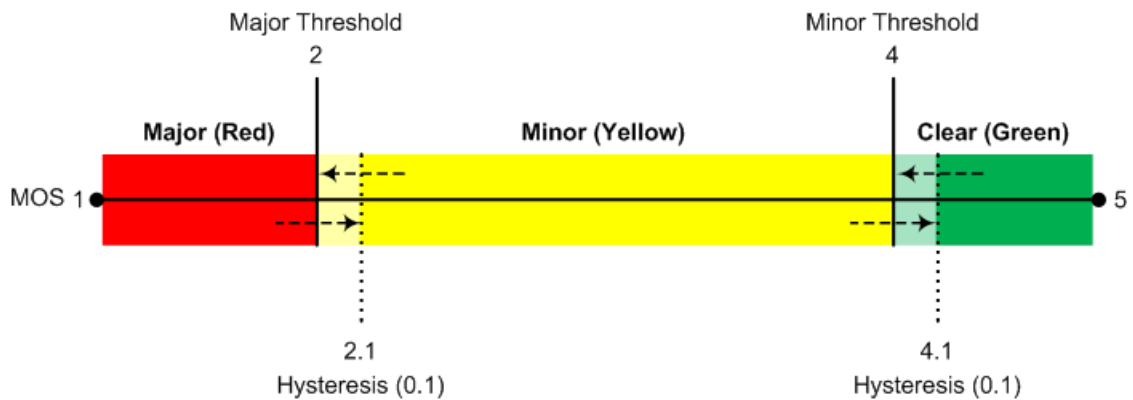

**Table 17-2: Threshold Crossings based on Threshold and Hysteresis**

Threshold Crossing	Calculation	Threshold based on Example
Green to Yellow (Minor alarm)	The change occurs if the measured metric crosses the configured Minor threshold only (i.e., hysteresis is not used).	4
Green to Red (Major alarm)	The change occurs if the measured metric crosses the configured Major threshold only (i.e., hysteresis is not used).	2
Yellow to Red (Major alarm)	The change occurs if the measured metric crosses the configured Major threshold only (i.e., hysteresis is not used).	2
Red to Yellow (Minor alarm)	The change occurs if the measured metric crosses the configured Major threshold with hysteresis configured for the Major threshold.	2.1 (i.e., 2 + 0.1)
Red to Green (alarm cleared)	The change occurs if the measured metric crosses the configured Minor threshold with hysteresis configured for the Minor threshold.	4.1 (i.e., 4 + 0.1)

Threshold Crossing	Calculation	Threshold based on Example
Yellow to Green (alarm cleared)	The change occurs if the measured metric crosses the configured Minor threshold with hysteresis configured for the Minor threshold.	4.1 (i.e., 4 + 0.1)

Each time a voice metric threshold is crossed (i.e., color changes), the device can do the following depending on configuration:

- Report the change in the measured metrics to AudioCodes' OVOC. OVOC displays this call quality status for the associated link (IP Group, Media Realm, or Remote Media Subnet). To configure the OVOC's address, see [Configuring the SEM Server](#).
- Depending on the crossed threshold type, you can configure the device to reject calls to the destination IP Group or use an alternative IP Profile for the IP Group. For more information, see [Configuring Quality of Service Rules](#).
- Alternative routing based on measured metrics. If a call is rejected because of a crossed threshold, the device generates a SIP 806 response. You can configure this SIP response code as a reason for alternative routing (see [Configuring SIP Response Codes for Alternative Routing Reasons](#)).



For your convenience, the device provides pre-configured Quality of Experience Profiles. One of these pre-configured profiles is the default Quality of Experience Profile, which is used if you do not configure a Quality of Experience Profile.

The following procedure describes how to configure Quality of Experience Profiles through the Web interface. You can also configure it through other management platforms:

- **Quality of Experience Profile table:** *ini* file [QoEProfile] or CLI (`configure voip > qoe qoe-profile`)
- **Quality of Experience Color Rules table:** *ini* file [QOECOLORRULES] or CLI (`configure voip > qoe qoe-color-rules`)

➤ **To configure a QoE Profile:**

1. Open the Quality of Experience Profile table (**Setup** menu > **Signaling & Media** tab > **Media** folder > **Quality of Experience** > **Quality of Experience Profile**).
2. Click **New**; the following dialog box appears:

3. Configure a QoE Profile according to the parameters described in the table below.
4. Click **Apply**.

**Table 17-3: Quality of Experience Profile Table Parameter Descriptions**

Parameter	Description
'Index' [QOEProfile_Index]	Defines an index number for the new table row. <b>Note:</b> Each row must be configured with a unique index.
'Profile Name' name [QOEProfile_Name]	Defines a descriptive name, which is used when associating the row in other tables. The valid value is a string of up to 20 characters. <b>Note:</b> The parameter value cannot contain a forward slash (/).
'Sensitivity Level' sensitivity- level [QOEProfile_ SensitivityLevel]	Defines the pre-configured threshold profile to use. <ul style="list-style-type: none"> <li>■ [0] <b>User Defined</b> = Need to define thresholds per monitored parameter in the Quality of Experience Color Rules table.</li> <li>■ [1] <b>Low</b> = Pre-configured low sensitivity thresholds.</li> <li>■ [2] <b>Medium</b> = (Default) Pre-configured medium sensitivity thresholds.</li> <li>■ [3] <b>High</b> = Pre-configured high sensitivity thresholds. Reporting is done for small fluctuations in parameter values.</li> </ul>

5. In the Quality of Experience Profile table, select the row for which you want to configure QoE thresholds, and then click the **Quality of Experience Color Rules** link located below the table; the Quality of Experience Color Rules table appears.
6. Click **New**; the following dialog box appears:

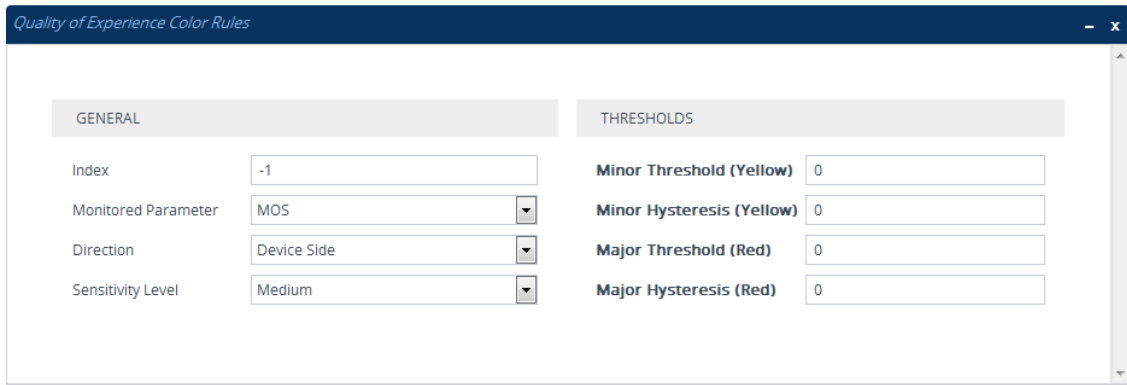

7. Configure a rule according to the parameters described in the table below.
8. Click **New**, and then save your settings to flash memory.

**Table 17-4: Quality of Experience Color Rules Table Parameter Descriptions**

Parameter	Description
<b>General</b>	
'Index' index [QOECOLORRules_ ColorRuleIndex]	Defines an index number for the new table row. <b>Note:</b> Each row must be configured with a unique index.
'Monitored Parameter' monitored- parameter [QOECOLORRules_ monitoredParam]	Defines the parameter to monitor and report. <ul style="list-style-type: none"> <li>■ [0] <b>MOS</b> (default)</li> <li>■ [1] <b>Delay</b></li> <li>■ [2] <b>Packet Loss</b></li> <li>■ [3] <b>Jitter</b></li> <li>■ [4] <b>RERL [Echo]</b></li> </ul>
'Direction' direction [QOECOLORRules_ direction]	Defines the monitoring direction. <ul style="list-style-type: none"> <li>■ [0] <b>Device Side</b> (default)</li> <li>■ [1] <b>Remote Side</b></li> </ul>
'Sensitivity Level' sensitivity- level [QOECOLORRules_ profile]	Defines the sensitivity level of the thresholds. <ul style="list-style-type: none"> <li>■ [0] <b>User Defined</b> = Need to define the thresholds in the parameters described below.</li> <li>■ [1] <b>Low</b> = Pre-configured low sensitivity threshold values. Thus, reporting is done only if changes in parameters' values are significant.</li> </ul>

Parameter	Description
	<ul style="list-style-type: none"> <li>■ [2] <b>Medium</b> = (Default) Pre-configured medium sensitivity threshold values.</li> <li>■ [3] <b>High</b> = Pre-configured high sensitivity threshold values. Thus, reporting is done for small fluctuations in parameter values.</li> </ul>
<b>Thresholds</b>	
<p>'Minor Threshold (Yellow)'</p> <p>minor-threshold-yellow</p> <p>[QOECOLORRULES_MinorThreshold]</p>	<p>Defines the Minor threshold value, which is the lower threshold located between the Yellow and Green states. To consider a threshold crossing:</p> <ul style="list-style-type: none"> <li>■ <b>Increase in severity (i.e., Green to Yellow):</b> Only this value is used.</li> <li>■ <b>Decrease in severity (Red to Green, or Yellow to Green):</b> This value is used with the hysteresis, configured by the 'Minor Hysteresis (Yellow)' parameter (see below).</li> </ul> <p>The valid threshold values are as follows:</p> <ul style="list-style-type: none"> <li>■ MOS values are in multiples of 10. For example, to denote a MOS of 3.2, the value 32 (i.e., 3.2*10) must be entered.</li> <li>■ Delay values are in msec.</li> <li>■ Packet Loss values are in percentage (%).</li> <li>■ Jitter is in msec.</li> <li>■ Echo measures the Residual Echo Return Loss (RERL) in dB.</li> </ul>
<p>'Minor Hysteresis (Yellow)'</p> <p>minor-hysteresis-yellow</p> <p>[QOECOLORRULES_MinorHysteresis]</p>	<p>Defines the amount of fluctuation (hysteresis) from the Minor threshold, configured by the 'Minor Threshold (Yellow)' parameter in order for the threshold to be considered as crossed. The hysteresis is used only to determine threshold crossings to Green (i.e., from Yellow to Green, or Red to Green). In other words, the device considers a threshold crossing to Green only if the measured voice metric crosses the Minor threshold and the hysteresis.</p> <p>For example, if you configure the 'Minor Threshold (Yellow)' parameter to 4 and the 'Minor Hysteresis (Yellow)' parameter to 0.1 (for MOS), the device considers a threshold crossing to Green only if the MOS crosses 4.1 (i.e., 4 + 0.1).</p>
<p>'Major Threshold (Red)'</p> <p>major-</p>	<p>Defines the Major threshold value, which is the upper threshold located between the Yellow and Red states. To</p>

Parameter	Description
threshold-red [QOECOLORRules_ MajorThreshold]	consider a threshold crossing: <ul style="list-style-type: none"> <li>■ <b>Increase in severity (i.e., Yellow to Red):</b> Only this value is used.</li> <li>■ <b>Decrease in severity (Red to Yellow):</b> This value is used with the hysteresis, configured by the 'Major Hysteresis (Red)' parameter (see below).</li> </ul> The valid threshold values are as follows: <ul style="list-style-type: none"> <li>■ MOS values are in multiples of 10. For example, to denote a MOS of 3.2, the value 32 (i.e., 3.2*10) must be entered.</li> <li>■ Delay values are in msec.</li> <li>■ Packet Loss values are in percentage (%).</li> <li>■ Jitter is in msec.</li> <li>■ Echo measures the Residual Echo Return Loss (RERL) in dB.</li> </ul>
'Major Hysteresis (Red)' major- hysteresis-red [QOECOLORRules_ MajorHysteresis]	Defines the amount of fluctuation (hysteresis) from the Major threshold, configured by the 'Major Threshold (Red)' parameter in order for the threshold to be considered as crossed. The hysteresis is used only to determine threshold crossings from Red to Yellow. In other words, the device considers a threshold crossing to Yellow only if the measured voice metric crosses the Major threshold and the hysteresis. <p>For example, if you configure the 'Major Threshold (Red)' parameter to 2 and the 'Major Hysteresis (Red)' parameter to 0.1 (for MOS), the device considers a threshold crossing to Yellow only if the MOS crosses 2.1 (i.e., 2 + 0.1).</p>

## Configuring Bandwidth Profiles

The Bandwidth Profile table lets you configure up to 486 Bandwidth Profiles. A Bandwidth Profile defines bandwidth utilization thresholds for audio and video traffic (incoming and outgoing), which if crossed can result in various actions (discussed later in the section). Bandwidth Profiles enhance the device's monitoring of bandwidth utilization.

Once configured, you can apply Bandwidth Profiles to specific calls, by assigning them to any of the following configuration entities:

- IP Groups (see [Configuring IP Groups](#))
- Media Realms (see [Configuring Media Realms](#))
- Remote Media Subnets (see [Configuring Remote Media Subnets](#))

Each time a configured bandwidth threshold is crossed, the device can do the following, depending on configuration:

- Reject calls destined to the IP Group or use an alternative IP Profile for the IP Group. For more information, see [Configuring Quality of Service Rules](#).
- Use an alternative routing rule for alternative routing. If a call is rejected due to a crossed threshold, the device generates a SIP 806 response. You can configure the SIP response code as a reason for alternative routing (see [Configuring SIP Response Codes for Alternative Routing Reasons](#)).
- Send an SNMP alarm (acMediaRealmBWThresholdAlarm). The device clears the alarm when bandwidth utilization returns to normal (Green).

AudioCodes One Voice Operations Center (OVOC) displays bandwidth utilization using color-coded states:

- **Green:** Indicates bandwidth utilization is within normal range.
- **Yellow:** Indicates bandwidth utilization is encroaching on "total" bandwidth, serving as a warning (or it could also mean that bandwidth utilization has dropped below the red state).
- **Red:** Indicates that bandwidth utilization has exceeded total bandwidth.

Bandwidth Profiles let you configure bandwidth thresholds, which when crossed changes the color-coded state for bandwidth utilization:

- **Green-Yellow (Minor) Threshold:** Lower threshold configured as a percentage of the configured major (total) bandwidth threshold. When bandwidth goes over the threshold, the device considers it a Yellow state (Minor alarm severity); when it goes below the threshold, it considers it a Green state (cleared alarm).
- **Yellow-Red (Major) Threshold:** Upper threshold configured by the major (total) bandwidth threshold. When bandwidth goes over the threshold, the device considers it a Red state (Major alarm severity); when it goes below the threshold, it considers it a Yellow state (Minor alarm severity).

The device also uses hysteresis to determine whether the threshold has indeed been crossed. Hysteresis defines the amount of fluctuation from the threshold in order for the threshold to be considered as crossed (i.e., change in color state). Hysteresis is used to avoid false reports being sent by the device. Hysteresis is used only for threshold crossings toward a lesser severity (i.e., from Red to Yellow, Red to Green, or Yellow to Green). Hysteresis is configured as a percentage of the configured major (total) bandwidth threshold.

The following example is used to explain how the device considers threshold crossings. The example is based on a setup where the Major (total) bandwidth threshold is configured to 64,000 Kbps, the Minor threshold to 50% (of the total) and the hysteresis to 10% (of the total):





➤ **To configure a Bandwidth Profile:**

1. Open the Bandwidth Profile table (**Setup** menu > **Signaling & Media** tab > **Media** folder > **Quality of Experience** > **Bandwidth Profile**).
2. Click **New**; the following dialog box appears:

3. Configure a rule according to the parameters described in the table below.
4. Click **Apply**, and then reset the device with a save to flash memory.

**Table 17-6: Bandwidth Profile Table Parameter Descriptions**

Parameter	Description
<b>General</b>	
'Index' [BWProfile_Index]	Defines an index number for the new table row. <b>Note:</b> Each row must be configured with a unique index.
'Name' name [BWProfile_Name]	Defines a descriptive name, which is used when associating the row in other tables. The valid value is a string of up to 20 characters. <b>Note:</b> The parameter value cannot contain a forward slash (/).
'Egress Audio Bandwidth' egress-audio-bandwidth [BWProfile_EgressAudioBandwidth]	Defines the major (total) threshold for outgoing audio traffic (in Kbps).
'Ingress Audio Bandwidth' ingress-audio-bandwidth	Defines the major (total) threshold for incoming audio traffic (in Kbps).

Parameter	Description
[BWProfile_ IngressAudioBandwidth]	
'Egress Video Bandwidth' egress-video- bandwidth [BWProfile_ EgressVideoBandwidth]	Defines the major (total) threshold for outgoing video traffic (in Kbps).
'Ingress Video Bandwidth' ingress-video- bandwidth [BWProfile_ IngressVideoBandwidth]	Defines the major (total) threshold for incoming video traffic (in Kbps).
'Total Egress Bandwidth' total-egress- bandwidth [BWProfile_ TotalEgressBandwidth]	Defines the major (total) threshold for video and audio outgoing bandwidth (in Kbps).
'Total Ingress Bandwidth' total-ingress- bandwidth [BWProfile_ TotalIngressBandwidth]	Defines the major (total) threshold for video and audio incoming bandwidth (in Kbps).
<b>Thresholds</b>	
'Minor Threshold' minor-threshold [BWProfile_MinorThreshold]	<p>Defines the Minor threshold value, which is the lower threshold located between the Yellow and Green states. The parameter is configured as a percentage of the major (total) bandwidth threshold (configured by the above bandwidth parameters). For example, if you configure the parameter to 50 and the 'Egress Audio Bandwidth' parameter to 64,000, the Minor threshold for outgoing audio bandwidth is 32,000 (i.e., 50% of 64,000).</p> <p>To consider a threshold crossing:</p> <ul style="list-style-type: none"> <li>■ <b>Increase in severity (i.e., Green to Yellow):</b> Only this value is used.</li> <li>■ <b>Decrease in severity (Red to Green, or Yellow to Green):</b> This value is used with the hysteresis,</li> </ul>

Parameter	Description
	<p>configured by the 'Hysteresis' parameter (see below).</p> <p><b>Note:</b> The parameter applies to all your configured bandwidths.</p>
<p>'Hysteresis' hysteresis [BWProfile_Hysteresis]</p>	<p>Defines the amount of fluctuation (hysteresis) from the configured bandwidth threshold in order for the threshold to be considered as crossed (i.e., avoids false reports of threshold crossings). The hysteresis is used only to determine threshold crossings when severity is reduced (i.e., from Red to Yellow, Yellow to Green, or Red to Green). The parameter is configured as a percentage of the Major (total) bandwidth threshold.</p> <p>For example, if you configure the parameter to 10 and the 'Egress Audio Bandwidth' parameter to 64,000, the hysteresis is 6,400 (10% of 64,000) and threshold crossings are considered at the following bandwidths:</p> <ul style="list-style-type: none"> <li>■ Red-to-Yellow (Yellow-Minor alarm severity): 57,600 Kbps [64,000 - (10% x 64,000)]</li> <li>■ Yellow-to-Green (Green-alarm cleared): 25,600 Kbps [32,000 - (10% x 64,000)]</li> </ul>
<p>'Generate Alarm' generate-alarms [BWProfile_GenerateAlarms]</p>	<p>Enables the device to send an SNMP alarm if a bandwidth threshold is crossed.</p> <ul style="list-style-type: none"> <li>■ [0] <b>Disable</b> (default)</li> <li>■ [1] <b>Enable</b></li> </ul>

## Configuring Quality of Service Rules

The Quality of Service Rules table lets you configure up to 510 Quality of Service rules. A Quality of Service rule defines an action to perform when the threshold (major or minor) of a specific performance monitoring call metric is crossed for a specific IP Group. The call metric can be voice quality (i.e., MOS), bandwidth, Answer-seizure ratio (ASR), Network Effectiveness Ratio (NER), or Average Call Duration (ACD).



The section is applicable only to the SBC application.

Depending on the call metric, you can configure the following actions to be performed if the threshold is crossed:

- Reject calls to the IP Group for a user-defined duration.

Rejection of calls can also trigger alternative routing. When the device rejects a call due to an ASR, NER or ACD threshold crossing, it generates the SIP response code 850 (Signaling Limits Exceeded). When the device rejects a call due to Voice Quality and Bandwidth threshold crossing, it generates the SIP response code 806 (Media Limits Exceeded). If you configure these SIP response codes for an Alternative Reasons Set (see [Configuring SIP Response Codes for Alternative Routing Reasons](#)) that is assigned to the IP Group ('SBC Alternative Routing Reasons Set' parameter) and the device rejects a call, it searches in the IP-to-IP Routing table for an alternative routing rule.

When the device rejects calls to an IP Group based on a Quality of Service rule, it raises an SNMP alarm (aclpGroupNoRouteAlarm). The alarm is also raised upon a keep-alive failure with the IP Group. For more information, refer to the *SNMP Reference Guide*.

- Use a different IP Profile for the IP Group or current call. This action can be useful, for example, when poor quality occurs due to packet loss and the device can then switch to an IP Profile configured with a higher RTP redundancy level or lower bit-rate coder.

To learn more about which actions are supported per call metric, see the description of the 'Rule Action' parameter below.

To configure thresholds, see the following sections:

- Voice Quality (MOS) - [Configuring Quality of Experience Profiles](#)
- Bandwidth - [Configuring Bandwidth Profiles](#)
- ASR, ACD and NER - [Configuring Performance Profiles](#)

The following procedure describes how to configure Quality of Service rules through the Web interface. You can also configure it through ini file [QualityOfServiceRules] or CLI (`configure voip > qoe quality-of-service-rules`).

#### ➤ To configure a Quality of Service rule:

1. Open the Quality of Service Rules table (**Setup** menu > **Signaling & Media** tab > **Media** folder > **Quality of Service Rules**).
2. Click **New**; the following dialog box appears:

MATCH		ACTION	
Index	2	Rule Action	Reject Calls
IP Group	--	Calls Reject Duration	5
Rule Metric	Voice Quality	Alternative IP Profile Name	--
Severity	Major		

3. Configure a rule according to the parameters described in the table below.
4. Click **Apply**, and then reset the device with a save-to-flash for your settings to take effect.

**Table 17-7: Quality of Service Rules Table Parameter Descriptions**

Parameter	Description
Match	
'Index' [QualityOfServiceRules_ Index]	Defines an index number for the new table row. <b>Note:</b> Each row must be configured with a unique index.
'IP Group' ip-group-name [QualityOfServiceRules_ IPGroupName]	Assigns an IP Group. The rule applies to all calls belonging to the IP Group.
'Rule Metric' rule-metric [QualityOfServiceRules_ RuleMetric]	Defines the performance monitoring call metric to which the rule applies if the metric's threshold is crossed. <ul style="list-style-type: none"> <li>■ [0] <b>Voice Quality</b> = (Default) The device calculates MOS of calls and if the threshold is crossed (i.e., poor quality), the configured action (see 'Rule Action' parameter below) is done for all <b>new</b> calls and for the <b>entire</b> IP Group.</li> <li>■ [1] <b>Bandwidth</b></li> <li>■ [2] <b>ACD</b></li> <li>■ [3] <b>ASR</b></li> <li>■ [4] <b>NER</b></li> <li>■ [5] <b>Poor InVoice Quality</b> = The device calculates MOS (and TMMBR) of the call and if the threshold is crossed (i.e., poor quality), the device uses a different IP Profile (see 'Rule Action' parameter below) for the <b>current call only</b> (not the entire IP Group).</li> </ul>
'Severity' severity [QualityOfServiceRules_ Severity]	Defines the alarm severity level. When the configured severity occurs, the device performs the action of the rule. <ul style="list-style-type: none"> <li>■ [0] <b>Major</b> (Default)</li> <li>■ [1] <b>Minor</b></li> </ul> <b>Note:</b> If you configure the 'Rule Metric' parameter to <b>ACD</b> , <b>ASR</b> or <b>NER</b> , you must configure the parameter to <b>Major</b> . For all other 'Rule Metric' parameter values, you can configure the parameter to any value.
Action	

Parameter	Description
'Rule Action' rule-action [QualityOfServiceRules_ RuleAction]	<p>Defines the action to be done if the rule is matched.</p> <ul style="list-style-type: none"> <li>■ [0] <b>Reject Calls</b> = (Default) New calls destined to the specified IP Group are rejected for a user-defined duration. To configure the duration, use the 'Calls Reject Duration' parameter (see below).</li> <li>■ [1] <b>Alternative IP Profile</b> = A different IP Profile is used for the IP Group or call (depending on the 'Rule Metric' parameter). To specify the IP Profile, use the 'Alternative IP Profile Name' parameter (see below).</li> </ul> <p><b>Note:</b></p> <ul style="list-style-type: none"> <li>■ If you configure the 'Rule Metric' parameter to <b>ACD, ASR</b> or <b>NER</b>, you must configure the parameter to <b>Reject Calls</b>.</li> <li>■ If you configure the 'Rule Metric' parameter to <b>Voice Quality</b> or <b>Bandwidth</b>:               <ul style="list-style-type: none"> <li>✓ If you configure the 'Severity' parameter to <b>Minor</b>, you must configure the parameter to <b>Alternative IP Profile</b>.</li> <li>✓ If you configure the 'Severity' parameter to <b>Major</b>, you can configure the parameter to any option.</li> </ul> </li> </ul> <p>When configured to <b>Alternative IP Profile</b> and the threshold is crossed, the device changes the IP Profile for the entire IP Group for all new calls.</p> <ul style="list-style-type: none"> <li>■ If you configure the 'Rule Metric' parameter to <b>Poor InVoice Quality</b>, you must configure the parameter to <b>Alternative IP Profile</b>. If the threshold is crossed (i.e., poor call quality), the device changes the IP Profile for the specific call <b>only</b> (during the call).</li> </ul>
'Calls Reject Duration' calls-reject- duration [QualityOfServiceRules_ CallsRejectDuration]	<p>Defines the duration (in minutes) for which the device rejects calls to the IP Group if the rule is matched.</p> <p>The default is 5.</p> <p><b>Note:</b> The parameter is applicable only if the 'Rule Action' parameter is configured to <b>Reject Calls</b>.</p>
'Alternative IP Profile Name' alt-ip-profile- name [QualityOfServiceRules_ AlternativeIPProfileName]	<p>Assigns a different IP Profile to the IP Group or call (depending on the 'Rule Metric' parameter) if the rule is matched.</p> <p>By default, no value is defined.</p> <p><b>Note:</b> The parameter is applicable only if the 'Rule Action' parameter is configured to <b>Alternative IP Profile</b>.</p>

Parameter	Description
AltIPProfileName]	



## 18 Core Entities

This section describes configuration of core SIP entities.

### Configuring Media Realms

The Media Realms table lets you configure a pool of up to 12 SIP media interfaces, termed *Media Realms*. Media Realms lets you divide a Media-type interface (configured in the IP Interfaces table) into several media realms, where each realm is specified by a UDP port range. Media Realms also define the maximum number of permitted media sessions.

Once configured, to apply Media Realms to specific calls, you need to assign them to any of the following configuration entities:

- IP Groups (see [Configuring IP Groups](#))
- SIP Interfaces (see [Configuring SIP Interfaces](#))

You can also apply the device's Quality of Experience feature to Media Realms:

- **Quality of Experience Profile:** Call quality monitoring based on thresholds for voice metrics (e.g., MOS) can be applied per Media Realm. For example, if MOS is considered poor, calls on this Media Realm can be rejected. To configure Quality of Experience Profiles, see [Configuring Quality of Experience Profiles](#).
- **Bandwidth Profile:** Bandwidth utilization thresholds can be applied per Media Realm. For example, if bandwidth thresholds are crossed, the device can reject any new new calls on this Media Realm. To configure Bandwidth Profiles, see [Configuring Bandwidth Profiles](#).

The Media Realms table provides the following "child" tables:

- Remote Media Subnets: Defines remote destination subnets per Media Realm and assigns each subnet a Quality of Experience Profile and Bandwidth Profile. For more information, see [Configuring Remote Media Subnets](#).



- The Media Realm assigned to an IP Group overrides any other Media Realm assigned to any other configuration entity associated with the call.
- If you modify a Media Realm that is currently being used by a call, the device does not perform Quality of Experience for the call.
- If you delete a Media Realm that is currently being used by a call, the device maintains the call until the call parties end the call.
- The device provides a default Media Realm ("DefaultRealm"), which you can modify or delete.

The following procedure describes how to configure Media Realms through the Web interface. You can also configure it through ini file [CpMediaRealm] or CLI (`configure voip > realm`).

➤ **To configure a Media Realm:**

1. Open the Media Realms table (**Setup** menu > **Signaling & Media** tab > **Core Entities** folder > **Media Realms**).
2. Click **New**; the following dialog box appears:

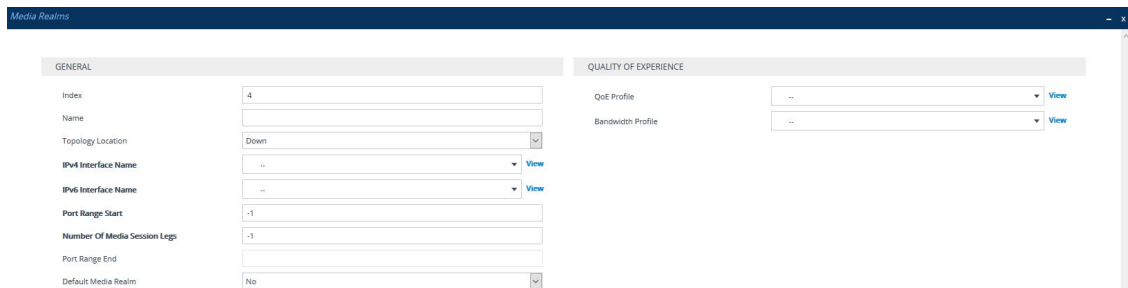

3. Configure the Media Realm according to the parameters described in the table below.
4. Click **Apply**.

**Table 18-1: Media Realms table Parameter Descriptions**

Parameter	Description
<b>General</b>	
'Index' [CpMediaRealm_Index]	Defines an index number for the new table row. <b>Note:</b> Each row must be configured with a unique index.
'Name' name [CpMediaRealm_MediaRealmName]	Defines a descriptive name, which is used when associating the row in other tables. The valid value is a string of up to 39 characters. <b>Note:</b> <ul style="list-style-type: none"> <li>■ The parameter is mandatory.</li> <li>■ Each row must be configured with a unique name.</li> <li>■ The parameter value cannot contain a forward slash (/).</li> </ul>
'Topology Location' topology-location [CpMediaRealm_TopologyLocation]	Defines the display location of the Media Realm in the Topology view. <ul style="list-style-type: none"> <li>■ [0] <b>Down</b> = (Default) The Media Realm element is displayed on the lower border of the view.</li> <li>■ [1] <b>Up</b> = The Media Realm element is displayed on the upper border of the view.</li> </ul>

Parameter	Description
	For more information on the Topology view, see <a href="#">Building and Viewing SIP Entities in Topology View</a> .
'IPv4 Interface Name' ipv4 [CpMediaRealm_IPv4IF]	Assigns an IPv4 interface to the Media Realm. By default, no value is defined. To configure IP network interfaces, see <a href="#">Configuring IP Network Interfaces</a> .
'IPv6 Interface Name' ipv6if [CpMediaRealm_IPv6IF]	Assigns an IPv6 interface to the Media Realm. By default, no value is defined. To configure IP network interfaces, see <a href="#">Configuring IP Network Interfaces</a> .
'UDP Port Range Start' port-range-start [CpMediaRealm_PortRangeStart]	<p>Defines the starting port for the range of media interface UDP ports. By default, no value is defined.</p> <p><b>Note:</b></p> <ul style="list-style-type: none"> <li>■ You must configure <b>all</b> your Media Realms with port ranges or all without; not some with and some without.</li> <li>■ The available UDP port range is according to the [BaseUDPport] parameter. For more information, see <a href="#">Configuring RTP Base UDP Port</a>.</li> <li>■ The base UDP port number, which is configured by the [BaseUDPPort] parameter, must be greater than the highest UDP port configured for a SIP Interface (see <a href="#">Configuring SIP Interfaces</a>). For example, if your highest configured UDP port for a SIP Interface is 6060, you must configure the [BaseUDPPort] parameter to any value greater than 6060.</li> <li>■ The port number <b>must</b> be different from ports configured for SIP traffic (i.e., ports configured for SIP Interfaces) that use the same IP Interface. For example, if the RTP port range is 6000 to 6999, the SIP port can be less than 6000 or greater than 6999.</li> <li>■ Media Realms must not have overlapping port ranges.</li> </ul>

Parameter	Description
'Number of Media' Session Legs <code>session-leg</code> [CpMediaRealm_ MediaSessionLeg]	Defines the number of media sessions for the configured port range.  By default, no value is defined.
'UDP Port Range End' <code>port-range-end</code> [CpMediaRealm_ PortRangeEnd]	(Read-only field) Displays the ending port for the range of media interface UDP ports. The device automatically populates the parameter with a value, calculated by the summation of the 'UDP Port Range Start' parameter and 'Number of Media Session Legs' parameter (multiplied by the port chunk size) minus 1:  $\text{start port} + (\text{sessions} * \text{port spacing}) - 1$ For example, a port starting at 6,000, 5 sessions and 10 port spacing: $6,000 + (5 * 10) - 1 = 6,000 + (50) - 1 = 6,000 + 49 = 6,049$ The device allocates the UDP ports for RTP, RTCP and T.38 traffic per leg in "jumps" (spacing) of 10. For example, if the port range starts at 6000 and the UDP port spacing is 10, the available ports include 6000, 6010, 6020, 6030, and so on (depending on number of media sessions).  For RTCP and T.38 traffic, the port offset from the RTP port used for the voice session is one and two, respectively. For example, if the voice session uses RTP port 6000, the RTCP port and T.38 port for the session is 6001 and 6002, respectively. However, you can configure the device to use the same port for RTP and T.38 packets, by configuring the [T38UseRTPPort] parameter to [1].  For more information on local UDP port range, see <a href="#">Configuring RTP Base UDP Port</a> .
'TCP Port Range Start' <code>tcp-port-range-start</code> [CpMediaRealm_ TCPPortRangeStart]	Defines the starting port of the range of TCP ports for MSRP traffic. The device allocates the ports consecutively to traffic. For example, if the port range starts at 5000 and ends at 5100, the device first allocates port 5000, then 5001, then 5002, and so on. The valid value is 4000 to 32768. The default is 0. For MSRP, the port number is used in the SDP's

Parameter	Description
	<p>'a=path' line. For more information on MSRP, see <a href="#">Configuring Message Session Relay Protocol</a> on page 1030.</p> <p><b>Note:</b></p> <ul style="list-style-type: none"> <li>■ Make sure that you also configure the ending port (see the 'TCP Port Range End' parameter, below).</li> <li>■ Media Realms associated with the same IP Interface must not have overlapping port ranges.</li> <li>■ The parameter is applicable only to the SBC application.</li> </ul>
<p>'TCP Port Range End' tcp-port-range-end [CpMediaRealm_ TCPPortRangeEnd]</p>	<p>Defines the ending port of the range of TCP ports for MSRP traffic. The device allocates the ports consecutively to traffic. For example, if the port range starts at 5000 and ends at 5100, the device first allocates port 5000, then 5001, then 5002, and so on. The valid value is 4000 to 32768. The default is 0. For MSRP, the port number is used in the SDP's 'a=path' line. For more information on MSRP, see <a href="#">Configuring Message Session Relay Protocol</a> on page 1030.</p> <p><b>Note:</b></p> <ul style="list-style-type: none"> <li>■ Make sure that you also configure the starting port (see the 'TCP Port Range Start' parameter, above).</li> <li>■ Media Realms associated with the same IP Interface must not have overlapping ports.</li> <li>■ The port range cannot overlap with TCP ports configured for SIP traffic (i.e., SIP Interfaces) that use the same IP Interface. For example, if the TCP port range is 6000 to 6999, the SIP Interface's TCP port must be less than 6000 or greater than 6999.</li> <li>■ The parameter is applicable only to the SBC application.</li> </ul>
<p>'Default Media Realm' is-default [CpMediaRealm_IsDefault]</p>	<p>Defines the Media Realm as the default Media Realm. The default Media Realm is used for SIP Interfaces and IP Groups for which you have not assigned a</p>

Parameter	Description
	<p>Media Realm.</p> <ul style="list-style-type: none"> <li>■ [0] <b>No</b> (default)</li> <li>■ [1] <b>Yes</b></li> </ul> <p><b>Note:</b></p> <ul style="list-style-type: none"> <li>■ You can configure the parameter to <b>Yes</b> for only <b>one</b> Media Realm; all the other Media Realms must be configured to <b>No</b>.</li> <li>■ If you do not configure the parameter (i.e., the parameter is <b>No</b> for all Media Realms), the device uses the first Media Realm in the table as the default.</li> <li>■ If the table is not configured, the default Media Realm includes all configured media interfaces.</li> </ul>
Quality of Experience	
'QoE Profile' qoe-profile [CpMediaRealm_QoeProfile]	<p>Assigns a QoE Profile to the Media Realm.</p> <p>By default, no value is defined.</p> <p>To configure QoE Profiles, see <a href="#">Configuring Quality of Experience Profiles</a>.</p>
'BW Profile' bw-profile [CpMediaRealm_BWProfile]	<p>Assigns a Bandwidth Profile to the Media Realm.</p> <p>By default, no value is defined.</p> <p>To configure Bandwidth Profiles, see <a href="#">Configuring Bandwidth Profiles</a>.</p>

## Configuring Remote Media Subnets

Remote Media Subnets define destination subnets for media (RTP/SRTP) traffic on a specific Media Realm. Each Remote Media Subnet can be assigned different call quality (Quality of Experience Profile) and bandwidth utilization (Bandwidth Profile) profiles. These profiles are configured in [Configuring Quality of Experience Profiles](#) and [Configuring Bandwidth Profiles](#), respectively. Thus, you can apply these profiles to remote media subnets instead of Media Realms or IP Groups. You can configure up to five Remote Media Subnets per Media Realm.

The figure below illustrates an example for implementing Remote Media Subnets. IP Group #2 represents a SIP Trunk which routes international (USA and India) and local calls. As international calls are typically more prone to higher delay than local calls, different Quality of Experience Profiles are assigned to them. This is done by creating Remote Media Subnets for each of these call destinations and assigning each Remote Media Subnet a different Quality of Experience Profile. A Quality of Experience Profile that defines a packet delay threshold is

assigned to the international calls, which if crossed, a different IP Profile is used that defines higher traffic priority to voice over other traffic. In addition, IP Group #2 has a 10-Mbps bandwidth threshold and a "tighter" bandwidth limitation (e.g., 1 Mbps) is allocated to local calls. If this limit is exceeded, the device rejects new calls to this Remote Media Subnet.

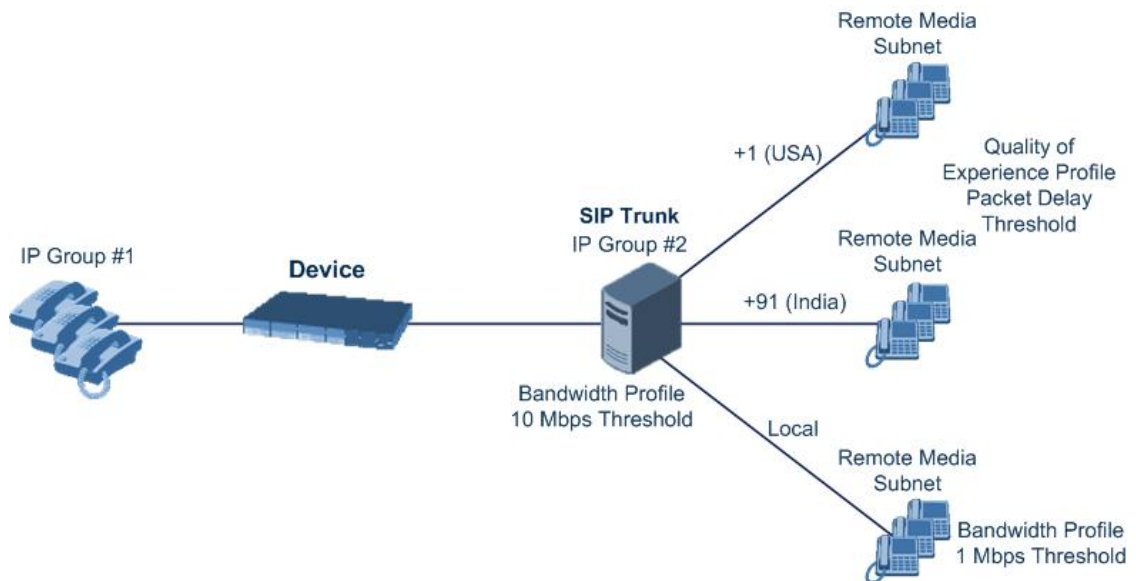

The following procedure describes how to configure Remote Media Subnets through the Web interface. You can also configure it through ini file [RemoteMediaSubnet] or CLI (`configure voip > remote-media-subnet`).

➤ **To configure a Remote Media Subnet:**

1. Open the Media Realms table (see [Configuring Media Realms](#)).
2. Select the Media Realm row for which you want to add Remote Media Subnets, and then click the **Remote Media Subnet** link located below the table; the Remote Media Subnet table appears.
3. Click **New**; the following dialog box appears:

4. Configure the Remote Media Subnet according to the parameters described in the table below.
5. Click **Apply**.

**Table 18-2: Remote Media Subnet Table Parameter Descriptions**

Parameter	Description
'Index' [RemoteMediaSubnet_ RemoteMediaSubnetIndex]	Defines an index number for the new table row. <b>Note:</b> Each row must be configured with a unique index.
'Name' name [RemoteMediaSubnet_ RemoteMediaSubnetName]	Defines a descriptive name, which is used when associating the row in other tables. The valid value is a string of up to 20 characters. <b>Note:</b> Each row must be configured with a unique name.
'Prefix Length' prefix-length [RemoteMediaSubnet_ PrefixLength]	Defines the subnet mask in Classless Inter-Domain Routing (CIDR) notation. For example, 16 denotes 255.255.0.0. The default is 16.
'Address Family' address-family [RemoteMediaSubnet_ AddressFamily]	Defines the IP address protocol. <ul style="list-style-type: none"> <li>■ [2] IPv4 (default)</li> <li>■ [10] IPv6</li> </ul>
'Destination IP' dst-ip-address	Defines the IP address of the destination. The default is 0.0.0.0.



Parameter	Description
[RemoteMediaSubnet_ DstIPAddress]	
'QoE Profile' qoe-profile [RemoteMediaSubnet_ QOEProfileName]	Assigns a Quality of Experience Profile to the Remote Media Subnet.  By default, no value is defined.  To configure QoE Profiles, see <a href="#">Configuring Quality of Experience Profiles</a> .
'BW Profile' bw-profile [RemoteMediaSubnet_ BWProfileName]	Assigns a Bandwidth Profile to the Remote Media Subnet.  By default, no value is defined.  To configure Bandwidth Profiles, see <a href="#">Configuring Bandwidth Profiles</a> .

## Configuring SRDs

The SRDs table lets you configure up to 20 signaling routing domains (SRD). The SRD is a logical representation of an entire SIP-based VoIP network (Layer 5) consisting of groups of SIP users and servers. The SRD is associated with all the configuration entities (e.g., SIP Interfaces and IP Groups) required for routing calls within the network. Typically, only a **single** SRD is required (recommended) for most deployments. Multiple SRDs are only required for multi-tenant deployments, where the physical device is "split" into multiple logical devices. For more information on multi-tenant architecture, see [Multiple SRDs for Multi-tenant Deployments](#).

As the device is shipped with a default SRD ("DefaultSRD" at Index 0), if your deployment requires only one SRD, you can use the default SRD instead of creating a new one. When only one SRD is employed and you create other related configuration entities (e.g., SIP Interfaces), the default SRD is automatically assigned to the new configuration entity. Therefore, when employing a single-SRD configuration topology, there is no need to handle SRD configuration (i.e., transparent).

You can assign SRDs to the following configuration entities:

- SIP Interface (mandatory) - see [Configuring SIP Interfaces](#)
- IP Group (mandatory) - see [Configuring IP Groups](#)
- Proxy Set (mandatory) - see [Configuring Proxy Sets](#)
- (SBC application only) Classification rule - see [Configuring Classification Rules](#)



As mentioned previously, if you use only a single SRD, the device automatically assigns it to the above-listed configuration entities.

As each SIP Interface defines a different Layer-3 network (see [Configuring SIP Interfaces](#) for more information) on which to route or receive calls and as you can assign multiple SIP

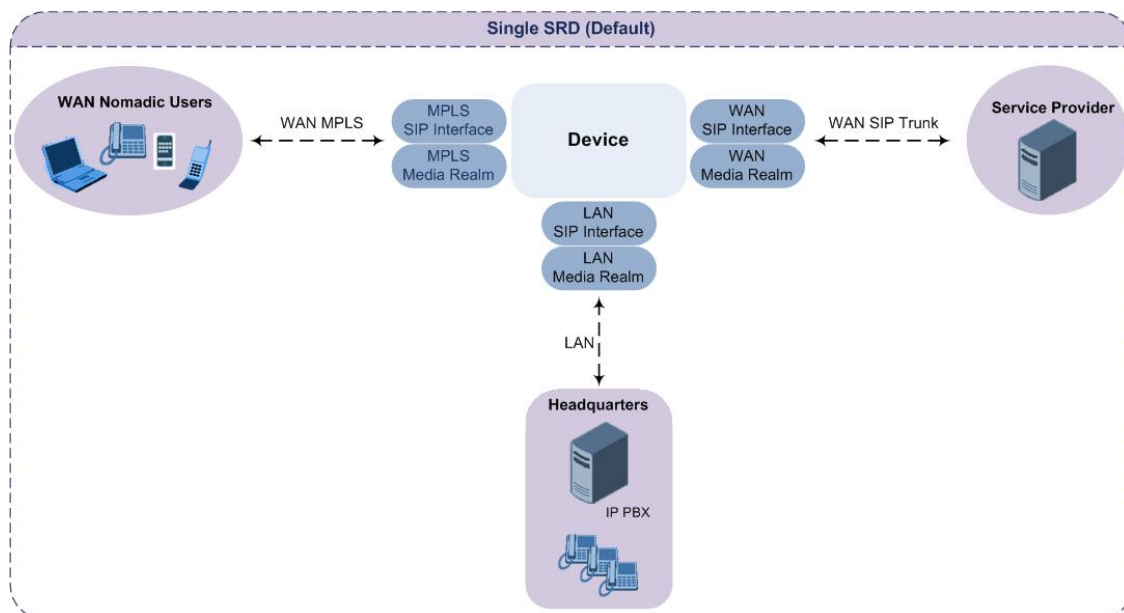
Interfaces to the same SRD, for most deployment scenarios (even for multiple Layer-3 network environments), you only need to employ a single SRD to represent your VoIP network (Layer 5). For example, if your VoIP deployment consists of an corporate IP PBX (LAN), a SIP Trunk (WAN), and far-end users (WAN), you would only need a single SRD. The single SRD would be assigned to three different SIP Interfaces, where each SIP Interface would represent a specific Layer-3 network (IP PBX, SIP Trunk, or far-end users) in your environment. The following figure provides an example of such a deployment:



- It is recommended to use a single-SRD configuration topology, unless you are deploying the device in a multi-tenant environment, in which case multiple SRDs are required.
- Each SIP Interface, Proxy Set, and IP Group can be associated with only one SRD.
- If you have upgraded your device to Version 7.0 and your device was configured with multiple SRDs but not operating in a multi-tenant environment, it is recommended to gradually change your configuration to a single SRD topology.
- If you upgrade the device from an earlier release to Version 7.0, your previous SRD configuration is fully preserved regarding functionality. The same number of SRDs is maintained, but the configuration elements are changed to reflect the configuration topology of Version 7.0. Below are the main changes in configuration topology when upgrading to Version 7.0:
  - ✓ The SIP Interface replaces the associated SRD in several tables (due to support for multiple SIP Interfaces per SRD).
  - ✓ Some fields in the SRDs table were duplicated or moved to the SIP Interfaces table.
  - ✓ Indices used for associating configuration entities in tables are changed to row pointers (using the entity's name).
  - ✓ Some tables are now associated (mandatory) with an SRD (SIP Interface, IP Group, Proxy Set, and Classification).

  Some fields used for associating configuration entities in tables now have a value of **Any** to distinguish between **Any** and **None** (deleted entity or not associated).

The following procedure describes how to configure SRDs through the Web interface. You can also configure it through ini file [SRD] or CLI (`configure voip > srd`).

➤ **To configure an SRD:**

1. Open the SRDs table (**Setup** menu > **Signaling & Media** tab > **Core Entities** folder > **SRDs**).
2. Click **New**; the following dialog box appears:

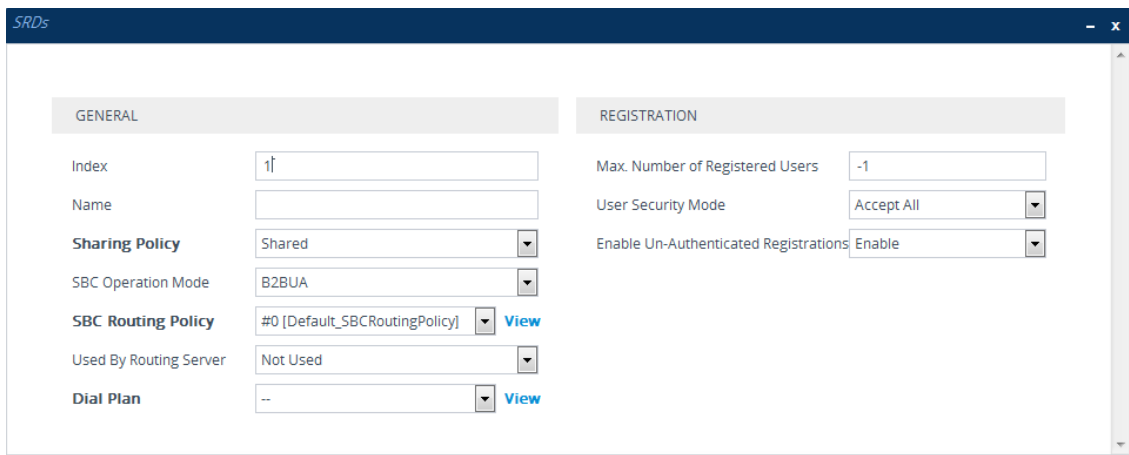

3. Configure an SRD according to the parameters described in the table below.
4. Click **Apply**.

**Table 18-3: SRDs table Parameter Descriptions**

Parameter	Description
General	
'Index' [SRD_Index]	Defines an index for the new table row. <b>Note:</b> Each row must be configured with a unique index.
'Name' name [SRD_Name]	Defines a descriptive name, which is used when associating the row in other tables. The valid value can be a string of up to 40 characters. <b>Note:</b> <ul style="list-style-type: none"> <li>■ The parameter is mandatory.</li> <li>■ Each row must be configured with a unique</li> </ul>

Parameter	Description
	<p>name.</p> <ul style="list-style-type: none"> <li>■ The parameter value cannot contain a forward slash (/).</li> </ul>
<p>'Sharing Policy' type [SRD_SharingPolicy]</p>	<p>Defines the sharing policy of the SRD, which determines whether the SRD shares its SIP resources (SIP Interfaces, Proxy Sets, and IP Groups) with all other SRDs (Shared and Isolated).</p> <ul style="list-style-type: none"> <li>■ [0] <b>Shared</b> = (Default) SRD shares its resources with other SRDs (Isolated and Shared) and calls can thus be routed between the SRD and other SRDs.</li> <li>■ [1] <b>Isolated</b> = SRD does not share its resources with other SRDs and calls cannot be routed between the SRD and other Isolated SRDs. However, calls can be routed between the SRD and other Shared SRDs.</li> </ul> <p>For more information on SRD Sharing Policy, see <a href="#">Multiple SRDs for Multi-tenant Deployments</a>.</p> <p><b>Note:</b> The parameter is applicable only to the SBC application.</p>
<p>'SBC Operation Mode' sbc-operation-mode [SRD_SBCOperationMode]</p>	<p>Defines the device's operational mode for the SRD.</p> <ul style="list-style-type: none"> <li>■ [0] <b>B2BUA</b> = (Default) Device operates as a back-to-back user agent (B2BUA), changing the call identifiers and headers between the inbound and outbound legs.</li> <li>■ [1] <b>Call Stateful Proxy</b> = Device operates as a Stateful Proxy, passing the SIP message transparently between inbound and outbound legs. In other words, the same SIP dialog identifiers (tags, Call-Id and CSeq) occur on both legs (as long as no other configuration disrupts the CSeq compatibility).</li> </ul> <p>For more information on B2BUA and Stateful Proxy modes, see <a href="#">B2BUA and Stateful Proxy Operating Modes</a>.</p>

Parameter	Description
	<p><b>Note:</b></p> <ul style="list-style-type: none"> <li>■ The settings of the parameter also determines the default behavior of related parameters in the IP Profiles table (SBCRemoteRepresentationMode, SBCKeepVIAHeaders, SBCKeepUserAgentHeader, SBCKeepRoutingHeaders, SBCRemoteMultipleEarlyDialogs).</li> <li>■ If the 'SBC Operation Mode' parameter is configured in the IP Groups table, the 'SBC Operation Mode' parameter in the SRDs table is ignored.</li> <li>■ The parameter is applicable only to the SBC application.</li> </ul>
<p>'SBC Routing Policy' sbc-routing-policy-name [SRD_SBCRoutingPolicyName]</p>	<p>Assigns a Routing Policy to the SRD. By default, no value is defined if you have configured multiple Routing Policies. If you have configured only one Routing Policy, the device assigns it to the SRD by default. For more information on Routing Policies, see <a href="#">Configuring SBC Routing Policy Rules</a>.</p> <p><b>Note:</b></p> <ul style="list-style-type: none"> <li>■ If you have assigned a Routing Policy to a Classification rule that is associated with the SRD, the Routing Policy assigned to the SRD is ignored.</li> <li>■ You can assign the same Routing Policy to multiple SRDs.</li> <li>■ The parameter is applicable only to the SBC application.</li> </ul>
<p>'Used By Routing Server' used-by-routing-server [SRD_UsedByRoutingServer]</p>	<p>Enables the SRD to be used by a third-party routing server for call routing decisions.</p> <ul style="list-style-type: none"> <li>■ [0] <b>Not Used</b> (default)</li> <li>■ [1] <b>Used</b></li> </ul> <p>For more information on the third-party routing server feature, see <a href="#">Centralized Third-Party</a></p>

Parameter	Description
	<a href="#">Routing Server</a> .
'Dial Plan' sbc-dial-plan-name [SRD_SBCDialPlanName]	Assigns a Dial Plan to the SRD. The device searches the Dial Plan for a dial plan rule that matches the source number and if not found, for a rule that matches the destination number. If a matching dial plan rule is found, the rule's tag is used in the routing and/or manipulation processes as source and/or destination tags. To configure Dial Plans, see <a href="#">Configuring Dial Plans</a> .
'CAC Profile' cac-profile [SRD_AdmissionProfile]	Assigns a Call Admission Control Profile (CAC rules) to the SRD. By default, no value is defined. To configure CAC Profiles, see <a href="#">Configuring Call Admission Control</a> on page 947.
Registration	
'Max. Number of Registered Users' max-reg-users [SRD_MaxNumOfRegUsers]	Defines the maximum number of users belonging to the SRD that can register with the device. The default is -1, which means that the number of allowed user registrations is unlimited. <b>Note:</b> The parameter is applicable only to the SBC application.
'User Security Mode' block-un-reg-users [SRD_BlockUnRegUsers]	Defines the blocking (reject) policy for incoming SIP dialog-initiating requests (e.g., INVITE messages) from registered and unregistered users belonging to the SRD.  <ul style="list-style-type: none"> <li>■ [0] <b>Accept All</b> = (Default) Accepts requests from registered and unregistered users.</li> <li>■ [1] <b>Accept Registered Users</b> = Accepts requests only from users registered with the device. Requests from users not registered are rejected.</li> <li>■ [2] <b>Accept Registered Users from Same Source</b> = Accepts requests only from registered users whose source address is the same as that registered with the device</li> </ul>

Parameter	Description
	<p>(during the REGISTER message process). All other requests are rejected. If the transport protocol is UDP, the verifies the IP address and port; otherwise, it verifies only the IP address. The verification is performed before any of the device's call handling processes (i.e., Classification, Manipulation and Routing).</p> <p><b>Note:</b></p> <ul style="list-style-type: none"> <li>■ The parameter is applicable only to calls belonging to User-type IP Groups.</li> <li>■ The feature is not applicable to REGISTER requests.</li> <li>■ The option, Accept Registered Users from Same Source [2] does not apply to registration refreshes. These requests are accepted even if the source address is different to that registered with the device.</li> <li>■ When the device rejects a call, it sends a SIP 500 "Server Internal Error" response to the user. In addition, it reports the rejection (Dialog establish failure - Classification failure) using the Intrusion Detection System (IDS) feature (see <a href="#">Configuring IDS Policies</a>), by sending an SNMP trap.</li> <li>■ When the corresponding parameter in the SIP Interfaces table (SIPInterface_ BlockUnRegUsers) is configured to any value other than default [-1] for a SIP Interface that is associated with the SRD, the parameter in the SRDs table is ignored for calls belonging to the SIP Interface.</li> <li>■ The parameter is applicable only to the SBC application.</li> </ul>
<p>'Enable Un-Authenticated Registrations'  enable-un-auth-registrs  [SRD_  EnableUnAuthenticatedRegistrations]</p>	<p>Enables the device to accept REGISTER requests and register them in its registration database from new users that have not been authenticated by a proxy/registrar server (due to proxy down) and thus, re-routed to a User-type</p>

Parameter	Description
	<p>IP Group.</p> <p>In normal operation scenarios in which the proxy server is available, the device forwards the REGISTER request to the proxy and if authenticated by the proxy (i.e., device receives a success response), the device adds the user to its registration database. The routing to the proxy is according to the SBC IP-to-IP Routing table where the destination is the proxy's IP Group. However, when the proxy is unavailable (e.g., due to network connectivity loss), the device can accept REGISTER requests from new users if a matching alternative routing rule exists in the SBC IP-to-IP Routing table where the destination is the user's User-type IP Group (i.e., call survivability scenarios) and if the parameter is enabled.</p> <ul style="list-style-type: none"> <li>■ [0] <b>Disable</b> = The device rejects REGISTER requests from new users that were not authenticated by a proxy server.</li> <li>■ [1] <b>Enable</b> = (Default) The device accepts REGISTER requests from new users even if they were not authenticated by a proxy server, and registers the user in its registration database.</li> </ul> <p><b>Note:</b></p> <ul style="list-style-type: none"> <li>■ Regardless of the parameter, the device always accepts registration refreshes from users that are already registered in its database.</li> <li>■ For a SIP Interface that is associated with the SRD, if the corresponding parameter in the SIP Interfaces table (SIPInterface_EnableUnAuthenticatedRegistrations) is configured to Disable or Enable, the parameter in the SRD is ignored for calls belonging to the SIP Interface.</li> <li>■ The parameter is applicable only to the SBC application.</li> </ul>



## Filtering Tables in Web Interface by SRD

When your configuration includes multiple SRDs, you can filter tables in the Web interface by SRD. The filter is configured in the SRD Filter drop-down list, located on the Web interface's toolbar, as shown below.

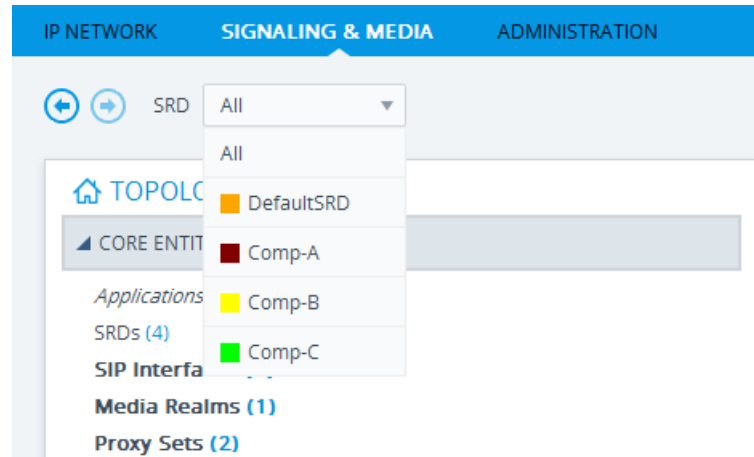

The filter is applied throughout the Web GUI. When you select an SRD for filtering, the Web interface displays only table rows associated with the filtered SRD. When you add a new row to a table, the filtered SRD is automatically selected as the associated SRD. For example, if you filter the Web display by SRD "Comp-A" and you then add a new Proxy Set, the Proxy Set is automatically associated with this SRD (i.e., the 'SRD' parameter is set to "Comp-A"). All other parameters in the dialog box are also automatically set to values associated with the filtered SRD.

The SRD filter also affects display of number of configured rows and invalid rows by status icons on table items in the Navigation tree. The status icons only display information relating to the filtered SRD.

SRD filtering is especially useful in multi-tenant setups where multiple SRDs may be configured. In such a setup, SRD filtering eliminates configuration clutter by "hiding" SRDs that are irrelevant to the current configuration and facilitates configuration by automatically associating the filtered SRD, and other configuration elements associated with the filtered SRD, wherever applicable.

## Multiple SRDs for Multi-tenant Deployments

The device can be deployed in a multi-tenant architecture, serving multiple customers (tenants) from a single, shared physical entity. The device's multi-tenant feature is fully scalable, offering almost "non-bleeding" partition per tenant, whereby users of one tenant can't infringe on the space of users of another tenant. The device provides per tenant configuration, monitoring, reporting, analytics, alarms and interfacing. The device is a real-time multi-tenant system that provides each tenant with optimal real-time performance, as each session received by the device is classified and processed only through the tenant's "orbit".

While some enterprises are large enough to justify a dedicated standalone device, many enterprises require only a fraction of the device's capacity and capabilities. Service providers offering SIP Trunking services can funnel multiple enterprises into a single device and thereby, reap significant cost improvements over a device-per-customer model. Tenant size in a multi-tenant architecture can vary and therefore, the instance CPU, memory and interface allocations should be optimized so as not to waste resources for small-sized tenants on the one hand, and not to allocate too many instances for a single tenant/customer on the other. For example, it would be a waste to allocate a capacity of 100 concurrent sessions to a small tenant for which 10 concurrent sessions suffice.

In a multi-tenant deployment, each tenant is represented by a dedicated SRD. The different Layer-3 networks (e.g., LAN IP-PBX users, WAN SIP Trunk, and WAN far-end users) of the tenant are represented by SIP Interfaces, which are all associated with the tenant's SRD. As related configuration entities (SIP Interfaces, IP Groups, Proxy Sets, Classification rules, and IP-to-IP Routing rules) are associated with the specific SRD, each SRD has its own logically separated configuration tables (although configured in the same tables). Therefore, full logical separation (on the SIP application layer) between tenants is achieved by SRD.

To create a multi-tenant configuration topology that is as non-bleeding as possible, you can configure an SRD (tenant) as *Isolated* and *Shared*:

- **Isolated SRD:** An Isolated SRD has its own dedicated SIP resources (SIP Interfaces, Proxy Sets, and IP Groups). No other SRD can use the SIP resources of an Isolated SRD. Thus, call traffic of an Isolated SRD is kept separate from other SRDs (tenants), preventing any risk of traffic "leakage" with other SRDs.

Isolated SRDs are more relevant when each tenant needs its own separate (dedicated) routing "table" for non-bleeding topology. Separate routing tables are implemented using Routing Policies. In such a non-bleeding topology, routing between Isolated SRDs is not possible. This enables accurate and precise routing per SRD, eliminating any possibility of erroneous call routing between SRDs, restricting routing to each tenant's (SRD's) sphere. Configuring only one Routing Policy that is shared between Isolated SRDs is not best practice for non-bleeding environments, since it allows routing between these SRDs.

- **Shared SRD:** Isolated SRDs have their own dedicated SIP resources (SIP Interfaces, Proxy Sets, and IP Groups). This may not be possible in some deployments. For example, in deployments where all tenants use the same SIP Trunking service, or use the same SIP Interface due to limited SIP interface resources (e.g., multiple IP addresses cannot be allocated and SIP port 5060 must be used). In contrast to Isolated SRDs, a Shared SRD can share its' SIP resources with all other SRDs (Shared and Isolated). This is typically required when tenants need to use common resources. In the SIP Trunk example, the SIP Trunk would be associated with a Shared SRD, enabling all tenants to route calls with the SIP Trunk.

Another configuration entity that can be used for multi-tenant deployments is the Routing Policy. Routing Policies allow each SRD (or tenant) to have its own routing rules, manipulation rules, Least Cost Routing (LCR) rules, and/or LDAP-based routing configuration. However, not all multi-tenant deployments need multiple Routing Policies and typically, their configuration is not required. Isolated SRDs are more relevant only when each tenant requires its own

dedicated Routing Policy to create separate, dedicated routing "tables"; for all other scenarios, SRDs can be Shared. For more information on Routing Policies, see [Configuring SBC Routing Policy Rules](#).

The figure below illustrates a multi-tenant architecture with Isolated SRD tenants ("A" and "B") and a Shared SRD tenant ("Data Center") serving as a SIP Trunk:

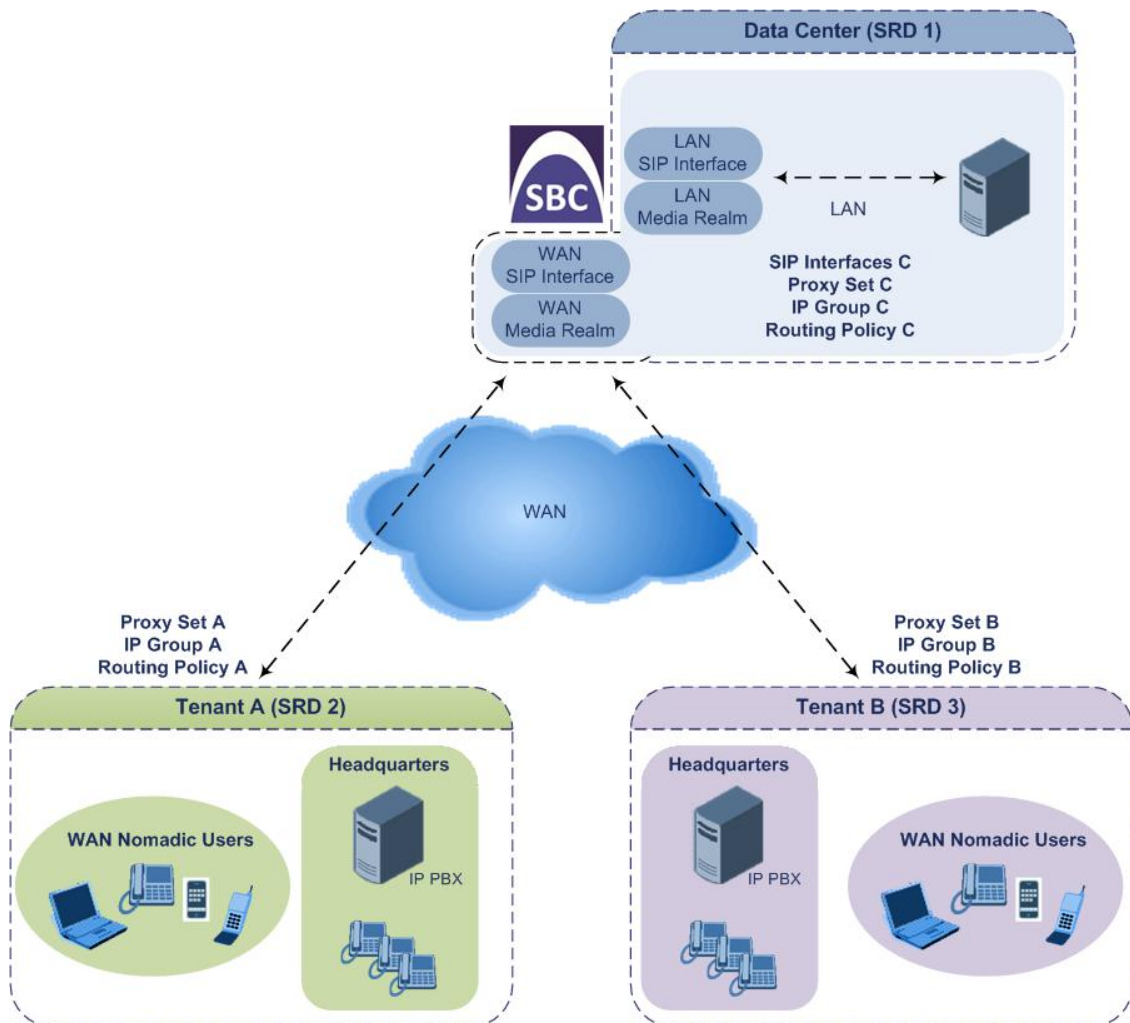

To facilitate multi-tenant configuration through CLI, you can access a specific tenant "view". Once in a specific tenant view, all configuration commands apply only to the currently viewed tenant. Only table rows (indexes) belonging to the viewed tenant can be modified. New table rows are automatically associated with the viewed tenant (i.e., SRD name). The display of tables and show running-configuration commands display only rows relevant to the viewed tenant (and shared tenants). The show commands display only information relevant to the viewed tenant. To support this CLI functionality, use the following commands:

- To access a specific tenant view:

```
#srd-view <SRD name>
```

Once accessed, the tenant's name (i.e., SRD name) forms part of the CLI prompt, for example:

```
# srd-view datacenter
(srd-datacenter)#
```

- To exit the tenant view:

```
# no srd-view
```

## Cloning SRDs

You can clone (duplicate) existing SRDs. This is especially useful when operating in a multi-tenant environment and you need to add new tenants (SRDs). The new tenants can quickly and easily be added by simply cloning one of the existing SRDs. Once cloned, all you need to do is tweak configuration entities associated with the SRD clone.

When an SRD is cloned, the device adds the new SRD clone to the next available index row in the SRDs table. The SRD clone is assigned a unique name in the following syntax format: <unique clone ID>\_<original SRD index>\_CopyOf\_<name, or index if no name, of original SRD>. For example, if you clone SRD "SIP-Trunk" at index 2, the new SRD clone is assigned the name, "36454371\_2\_CopyOf\_SIP-Trunk".

The SRD clone has identical settings as the original SRD. In addition, all configuration entities associated with the original SRD are also cloned and these clones are associated with the SRD clone. The naming convention of these entities is the same as the SRD clone (see above) and all have the same unique clone ID ("36454371" in the example above) as the cloned SRD. These configuration entities include IP Groups, SIP Interfaces, Proxy Sets (without addresses), Classification rules, and Call Admission Control profiles. If the Routing Policy associated with the original SRD is not associated with any other SRD, the Routing Policy is also cloned and its' clone is associated with the SRD clone. All configuration entities associated with the original Routing Policy are also cloned and these clones are associated with the Routing Policy clone. These configuration entities include IP-to-IP Routing rules, Inbound Manipulation rules, and Outbound Manipulation rules.

When any configuration entity is cloned (e.g., an IP-to-IP Routing rule) as a result of a cloned SRD, all fields of the entity's row which "point" to other entities (e.g., SIP Interface, Source IP Group, and Destination IP Group) are replaced by their corresponding clones.



For some cloned entities such as SIP Interfaces, some parameter values may change. This occurs in order to avoid the same parameter having the same value in more than one table row (index), which would result in invalid configuration. For example, a SIP Interface clone will have an empty Network Interface setting. After the clone process finishes, you thus need to update the Network Interface for valid configuration.





### ➤ To clone an SRD:

- Web interface: In the SRDs table, select an SRD to clone, and then click the **Clone** button.
- CLI:

```
(config-voip)# srd clone <SRD index that you want cloned>
```

## Color-Coding of SRDs in Web Interface

To easily identify your configured SRDs, the Web interface displays each SRD in a unique color. The color is automatically and randomly assigned to new SRDs and is displayed in a box alongside the name of the SRD in tables where the SRD is configured or assigned. This is applied throughout the Web interface. The following example shows SRDs assigned with unique color codes.

INDEX ↕	NAME
0	 DefaultSRD (#0)
1	 Comp-A (#1)
2	 Comp-B (#2)
3	 Comp-C (#3)

↑  
|  
|

## Automatic Configuration based on SRD

To facilitate configuration and eliminate possible flaws in configuration due to invalid associations between configuration entities, the Web interface automatically configures configuration entities based on SRD:

- If you delete an SRD (in the SRDs table) that is associated with other configuration entities in other tables, the device automatically deletes the associated table rows. For example, if you delete an SRD that is associated with a Proxy Set, the device automatically deletes the Proxy Set.
- If you associate an SRD with a configuration entity in another table (i.e., other than the SRDs table), the device automatically configures certain parameters of the configuration entity according to the SRD or associated SRD. For example, if you add a rule in the IP-to-IP Routing table and you select a Routing Policy, the 'Source IP Group' and 'Destination IP Group' parameters list only IP Groups that are associated with the SRD to which the Routing Policy is assigned (and IP Groups belonging to a Shared SRD, if exists).
- If your configuration setup includes only a single SRD, the device automatically selects the SRD when adding related configuration entities. For example, when adding an IP Group, the single SRD is automatically selected in the Add Row dialog box.

## Configuring SIP Interfaces

The SIP Interfaces table lets you configure up to 82 SIP Interfaces. A SIP Interface represents a Layer-3 network in your deployment environment, by defining a local, listening port number and type (e.g., UDP), and assigning an IP network interface for SIP signaling traffic. For example, if your deployment consists of an IP PBX in the LAN, a SIP Trunk in the WAN, and

remote far-end users in the WAN, you would need to configure a SIP Interface for each of these SIP entities. You can configure SIP Interfaces for the different types of applications (SBC and Gateway). You can also configure various optional features for the SIP Interface such as assigning it a Media Realm, blocking calls received on the SIP Interface from users not registered with the device, and enabling direct media (media bypass).

Each SIP Interface can be associated with only one SRD. As the SRD configuration entity represents your VoIP deployment SIP network (Layer 5), you need to associate your SIP Interfaces with a specific SRD in order to represent your Layer-3 networks. For most deployments (except multi-tenant deployments), your SRD represents your entire network and thus, only one SRD is required. The device provides a default SRD and in such scenarios where only a single SRD is required, your SIP Interfaces are automatically assigned to the default SRD. Therefore, there is no need to even handle SRD configuration entity.

Once configured, you can apply SIP Interfaces to calls, by assigning them to the following configuration entities in their respective tables:

- (Mandatory) Proxy Set to specify the SIP Interface for communication with the proxy server (i.e., IP Group). For more information, see [Configuring Proxy Sets](#).
- Intrusion Detection System (IDS) for applying the IDS policy to a specific SIP Interface. For more information, see [Configuring IDS Policies](#).
- (SBC application only) IP-to-IP Routing rules for specifying the destination SIP Interface to where you want to route the call. For more information, see [Configuring SBC IP-to-IP Routing Rules](#).
- (SBC application only) Classification rules for specifying the SIP Interface as a matching characteristic of the incoming call. This is especially useful for the single SRD-configuration topology, where each SIP Interface represents a Layer-3 network (SIP entity). Therefore, classification of calls to IP Groups (SIP entities) can be based on SIP Interface.

The SIP Interface can also be used for tag-based classification of incoming SIP dialogs if the SIP Interface is configured with a Call Setup Rule Set ID that determines the source tag. For more information, see [Configuring Classification Based on Tags](#) on page 964.

For more information on classification, see [Configuring Classification Rules](#).

- (Gateway application only) Tel-to-IP Routing rules for specifying the destination SIP Interface to where you want to route Tel-to-IP calls. For more information, see [Configuring Tel-to-IP Routing Rules](#).
- (Gateway application only) IP-to-Trunk Group Routing rules for specifying the SIP Interface as a matching characteristics for the incoming IP call.



The device terminates active calls associated with a SIP Interface if you do one of the following:

- Delete the associated SIP Interface.
- Edit any of the following fields of the associated SIP Interface: 'Application Type', 'UDP Port', 'TCP Port', 'TLS Port' or 'SRD' fields.



- Edit or delete a network interface in the IP Interfaces table that is associated with the SIP Interface.

The following procedure describes how to configure SIP interfaces through the Web interface. You can also configure it through ini file [SIPInterface] or CLI (`configure voip > sip-interface`).

➤ **To configure a SIP Interface:**

1. Open the SIP Interfaces table (**Setup** menu > **Signaling & Media** tab > **Core Entities** folder > **SIP Interfaces**).
2. Click **New**; the following dialog box appears:

3. Configure a SIP Interface according to the parameters described in the table below.
4. Click **Apply**.

**Table 18-4: SIP Interfaces table Parameter Descriptions**

Parameter	Description
'SRD' srd-name [SIPInterface_SRDName]	<p>Assigns an SRD to the SIP Interface.</p> <p>If only one SRD is configured in the SRDs table, the SRD is assigned to the SIP Interface by default. If multiple SRDs are configured in the SRDs table, no value is defined and you must assign an SRD.</p> <p>To configure SRDs, see <a href="#">Configuring SRDs</a>.</p> <p><b>Note:</b></p> <ul style="list-style-type: none"> <li>■ The parameter is mandatory.</li> <li>■ You can assign the same SRD to multiple SIP Interfaces (SBC and Gateway).</li> </ul>

Parameter	Description
General	
'Index' [SIPInterface_Index]	Defines an index for the new table row. <b>Note:</b> Each row must be configured with a unique index.
'Name' interface-name [SIPInterface_InterfaceName]	Defines a descriptive name, which is used when associating the row in other tables. The valid value is a string of up to 40 characters. By default, if you do not configure a name, the device automatically assigns the name "SIPInterface_<row index>" (e.g., "SIPInterface_1" when added to Index 1). <b>Note:</b> The parameter value cannot contain a forward slash (/).
'Topology Location' topology-location [SIPInterface_TopologyLocation]	Defines the display location of the SIP Interface in the Topology view in the Web interface. <ul style="list-style-type: none"><li>■ [0] <b>Down</b> = (Default) The SIP Interface element is displayed on the lower border of the view.</li><li>■ [1] <b>Up</b> = The SIP Interface element is displayed on the upper border of the view.</li></ul> For more information on the Topology view, see <a href="#">Building and Viewing SIP Entities in Topology View</a> .
'Network Interface' network-interface [SIPInterface_NetworkInterface]	Assigns an IP Interface to the SIP Interface. By default, no value is defined. To configure IP Interfaces, see <a href="#">Configuring IP Network Interfaces</a> . <b>Note:</b> <ul style="list-style-type: none"><li>■ The parameter is mandatory.</li><li>■ The 'Application Type' parameter of the assigned IP Interface must at least include "Control".</li></ul>
'Application Type' application-type [SIPInterface_ApplicationType]	Defines the application for which the SIP Interface is used. <ul style="list-style-type: none"><li>■ [0] <b>GW</b> = (Default) Gateway application.</li></ul>



Parameter	Description
'UDP Port' <code>udp-port</code> [SIPInterface_UDPPort]	<p>■ [2] <b>SBC</b> = SBC application.</p> <p>Defines the device's listening and source port for SIP signaling traffic over UDP.</p> <p>The valid range is 1 to 65534. The default is 5060.</p> <p><b>Note:</b></p> <ul style="list-style-type: none"> <li>■ The port number <b>must</b> be different from ports configured for RTP traffic (i.e., ports configured for Media Realms) using the same IP network interface. For example, if the RTP port range is 6000 to 6999, the SIP port can either be less than 6000 or greater than 6999.</li> <li>■ The base UDP port number, which is configured by the [BaseUDPPort] parameter, for RTP traffic must be greater than the highest UDP port configured for a SIP Interface. For example, if your highest configured UDP port for a SIP Interface is 6060, you must configure the [BaseUDPPort] parameter to any value greater than 6060. For more information on base UDP port, see <a href="#">Configuring RTP Base UDP Port</a>.</li> <li>■ Each SIP Interface must have a unique UDP signaling port (i.e., no two SIP Interfaces can share the same port - no port overlapping).</li> </ul>
'TCP Port' <code>tcp-port</code> [SIPInterface_TCPPort]	<p>Defines the device's listening port for SIP signaling traffic over TCP.</p> <p>The valid range is 1 to 65534. The default is 5060.</p> <p><b>Note:</b></p> <ul style="list-style-type: none"> <li>■ Each SIP Interface must have a unique TCP port number (i.e., no two SIP Interfaces can have the same port - no port overlapping).</li> <li>■ For the specific SIP Interface, the TCP port number must be different from the TLS port number (configured by the 'TLS Port' parameter below).</li> <li>■ The port must be different from the TCP port configured for Media Realms that use the same IP Interface.</li> </ul>

Parameter	Description
<p>'TLS Port'</p> <p><code>tls-port</code></p> <p>[SIPInterface_TLSPort]</p>	<p>Defines the device's listening port for SIP signaling traffic over TLS.</p> <p>The valid range is 1 to 65534. The default is 5061.</p> <p><b>Note:</b></p> <ul style="list-style-type: none"> <li>■ Each SIP Interface must have a unique port number (i.e., no two SIP Interfaces can have the same port - no port overlapping).</li> <li>■ For the specific SIP Interface, the TLS port number must be different from the TCP port number (configured by the 'TCP Port' parameter above).</li> <li>■ The port must be different from the TCP port configured for Media Realms that use the same IP Interface.</li> </ul>
<p>'Additional UDP Ports'</p> <p><code>additional-udp-ports</code></p> <p>[SIPInterface_AdditionalUDPPorts]</p>	<p>Defines a port range for the device's local, listening and source ports for SIP signaling traffic over UDP. The parameter can be used for the following features:</p> <ul style="list-style-type: none"> <li>■ Assigning a unique port per registered user (User-type IP Group) on the leg interfacing with the proxy server (Server-type IP Group). For enabling this feature and for more information, see the 'User UDP Port Assignment' parameter in the IP Groups table.</li> <li>■ Assigning a specific local port to each SIP entity (e.g., PBX) communicating with a common SIP entity (e.g., proxy server). This is the port on the leg interfacing with the proxy server. In other words, the SIP Interface associated with the proxy server. For more information, see <a href="#">Configuring Specific UDP Ports using Tag-based Routing</a>.</li> <li>■ Assigning a unique port for each Account registering with the same Serving IP Group (registrar server). For more information, see <a href="#">Configuring Registration Accounts</a> on page 583.</li> </ul>

Parameter	Description
	<p>The valid range is 1,025 to 65535. The range is configured using the syntax x-y, where x is the starting port and y the ending port of the range (e.g., 6000-7000). By default, the parameter is not configured.</p> <p><b>Note:</b></p> <ul style="list-style-type: none"> <li>■ The parameter is applicable only to the SBC application.</li> <li>■ To configure whether the device keeps the configured ports (sockets) open or opens them only when needed, use the SIP Interface's 'Additional UDP Ports Mode' parameter (below).</li> <li>■ The parameter's port range value must not overlap with the UDP port configured by the 'UDP Port' parameter (SIPInterface_UDPPort). For example, if the 'UDP Port' parameter is configured to 5070, you cannot configure the 'Additional UDP Ports' parameter with a range of 5060-6000.</li> <li>■ The parameter's port range value must not overlap with UDP port ranges of Media Realms that are configured on the same network interface. For example, if the RTP port range is 6000-6999, you must configure the 'Additional UDP Ports' parameter to a range that is less than 6000 or greater than 6999.</li> <li>■ The maximum number of ports in the range is limited to the maximum number of licensed registered SBC users as specified in the License Key installed on the device, or the maximum number of IP Groups that can be configured (see <a href="#">Configuring IP Groups</a>) - the higher of the two determines it. For example, if the License Key allows 20 users and the maximum IP Groups that can be configured is 10, then the maximum number of ports is 20.</li> </ul>
'Additional UDP Ports Mode'	Enables the device to open sockets (ports) for

Parameter	Description
<p>additional-udp-ports-mode</p> <p>[AdditionalUDPPortsMode]</p>	<p>signaling only when needed. The parameter applies to the Additional UDP Port feature with dynamic port allocation (see the 'Additional UDP Ports' parameter, above). This allows you to configure the additional UDP port range without having to make sure that the total number of configured ports are within the maximum, as defined by the device's License Key.</p> <ul style="list-style-type: none"> <li>■ [0] <b>Always Open</b> = (Default) The device keeps the ports (sockets) that are configured in the SIP Interface's 'Additional UDP Ports' parameter, open all the time.</li> <li>■ [1] <b>Open When Used</b> = For the ports (sockets) that are configured in the SIP Interface's 'Additional UDP Ports' parameter, the device opens a port only when it is used. A port is needed when the device initiates registration with an external SIP entity for a SIP Account (sent to the Account's Serving IP Group), or forwards a registration request from a user (IP Group) to a proxy (Server-type IP Group). This option is applicable only to dynamic port allocation, where a port is allocated on the outgoing REGISTER message and closed when the registration expires. Ports that are not configured by the SIP Interface's 'Additional UDP Ports' parameter are closed. The option is applicable only when the SIP Interface's 'Additional UDP Ports' parameter is configured and enabled for a Server-type IP Group (IP Group's 'User UDP Port Assignment' parameter) and/or SIP Account (Account's 'UDP Port Assignment' parameter).</li> </ul> <p><b>Note:</b></p> <ul style="list-style-type: none"> <li>■ The parameter is applicable only to the SBC application.</li> <li>■ For static port allocation (i.e., using additional UDP ports feature for assigning a specific local port to each SIP entity), configure the parameter to <b>Always Open</b>.</li> </ul>

Parameter	Description
'Enable TCP Keepalive' tcp-keepalive-enable [SIPInterface_TCPKeepaliveEnable]	Enables the TCP Keep-Alive mechanism with the IP entity on this SIP Interface. TCP keep-alive can be used, for example, to keep a NAT entry open for clients located behind a NAT server, or simply to check that the connection to the IP entity is available. <ul style="list-style-type: none"> <li>■ [0] <b>Disable</b> (default)</li> <li>■ [1] <b>Enable</b></li> </ul> <p><b>Note:</b> To configure TCP keepalive, use the following ini file parameters: TCPKeepAliveTime, TCPKeepAliveInterval, and TCPKeepAliveRetry.</p>
'Used By Routing Server' used-by-routing-server [SIPInterface_UsedByRoutingServer]	Enables the SIP Interface to be used by a third-party routing server for call routing decisions. <ul style="list-style-type: none"> <li>■ [0] <b>Not Used</b> (default)</li> <li>■ [1] <b>Used</b></li> </ul> <p>For more information on the third-party routing server feature, see <a href="#">Centralized Third-Party Routing Server</a>.</p>
'Pre-Parsing Manipulation Set' pre-parsing-man-set [SIPInterface_ PreParsingManSetName]	Assigns a Pre-Parsing Manipulation Set to the SIP Interface. This lets you apply pre-parsing SIP message manipulation rules on any incoming SIP message received on this SIP Interface. <p>By default, no Pre-Parsing Manipulation Set is assigned.</p> <p>To configure Pre-Parsing Manipulation Sets, see <a href="#">Configuring Pre-parsing Manipulation Rules</a>.</p> <p><b>Note:</b></p> <ul style="list-style-type: none"> <li>■ Pre-Parsing Manipulation is done only on incoming calls.</li> <li>■ The device performs Pre-Parsing Manipulation before Pre-Classification Manipulation and Classification.</li> </ul>
'CAC Profile' cac-profile [SIPInterface_AdmissionProfile]	Assigns a Call Admission Control Profile (CAC rules) to the SIP Interface. <p>By default, no value is defined.</p> <p>To configure CAC Profiles, see <a href="#">Configuring Call</a></p>

Parameter	Description
	<a href="#">Admission Control</a> on page 947.
Classification	
<p>'Classification Failure Response Type'</p> <pre>classification_fail_response_type</pre> <p>[SIPInterface_ ClassificationFailureResponseType]</p>	<p>Defines the SIP response code that the device sends if a received SIP request (OPTIONS, REGISTER, or INVITE) fails the SBC Classification process.</p> <p>The valid value can be a SIP response code from 400 through 699, or it can be set to 0 to not send any response at all. The default response code is 500 (Server Internal Error).</p> <p>This feature is important for preventing Denial of Service (DoS) attacks, typically initiated from the WAN. Malicious attackers can use SIP scanners to detect ports used by SIP devices. These scanners scan devices by sending UDP packets containing a SIP request to a range of specified IP addresses, listing those that return a valid SIP response. Once the scanner finds a device that supports SIP, it extracts information from the response and identifies the type of device (IP address and name) and can execute DoS attacks. A way to defend the device against such attacks is to not send a SIP reject response to these unclassified "calls" so that the attacker assumes that no device exists at such an IP address and port.</p> <p><b>Note:</b></p> <ul style="list-style-type: none"> <li>■ The parameter is applicable only if you configure the device to reject unclassified calls, which is done using the 'Unclassified Calls' parameter (see <a href="#">Configuring Classification Rules</a>).</li> <li>■ The parameter is applicable only to the SBC application.</li> </ul>
<p>'Pre Classification Manipulation Set ID'</p> <pre>preclassification-manset</pre> <p>[SIPInterface_ PreClassificationManipulationSet]</p>	<p>Assigns a Message Manipulation Set ID to the SIP Interface. This lets you apply SIP message manipulation rules on incoming SIP initiating-dialog request messages (not in-dialog), received on this SIP Interface, prior to the Classification process.</p>

Parameter	Description
	<p>By default, no Message Manipulation Set ID is defined.</p> <p>To configure Message Manipulation rules, see <a href="#">Configuring SIP Message Manipulation</a>.</p> <p><b>Note:</b></p> <ul style="list-style-type: none"> <li>■ The Message Manipulation Set assigned to a SIP Interface that is associated with an outgoing call, is ignored. Only the Message Manipulation Set assigned to the associated IP Group is applied to the outgoing call.</li> <li>■ If both the SIP Interface and IP Group associated with the incoming call are assigned a Message Manipulation Set, the one assigned to the SIP Interface is applied first.</li> <li>■ If Classification fails or the request is rejected prior to the Classification stage, then manipulation rules according to this parameter are applied to the reject response. In this case, the device adds a Reason header to the reject response. If routing fails, manipulation on the reject response is according to the 'Outbound Message Manipulation Set' parameter of the classified IP Group. When a Reason header is added to the reject response, its value is according to the type of failure: <ul style="list-style-type: none"> <li>✓ Routing failure: "General Routing Failure"</li> <li>✓ Classification failure: "Classification Failure"</li> <li>✓ Pre-Classification rejection due to device overload: "Board In Overload"</li> <li>✓ Pre-Classification rejection due to locked device: "Board Is Locked"</li> <li>✓ Pre-Classification rejection due to too many SIP headers in the request: "Header Overflow"</li> <li>✓ Post-Classification failure of a REGISTER request when the source IP Group</li> </ul> </li> </ul>

Parameter	Description
	<p>doesn't allow registers from the IP Group: "IPGroup Registration Mode Configuration"</p> <ul style="list-style-type: none"> <li>■ The parameter is applicable only to the SBC application.</li> </ul>
<p>'Call Setup Rules Set ID' call-setup-rules-set-id [SIPInterface_CallSetupRulesSetId]</p>	<p>Assigns a Call Setup Rules Set ID to the SIP Interface. The Call Setup Rule is run before the Classification stage.</p> <p>By default, no Call Setup Rules Set ID is defined. To configure Call Setup Rules, see <a href="#">Configuring Call Setup Rules</a> on page 611.</p> <p>Call Setup Rules can be used for Classification of incoming calls to IP Groups based on tags (source), as described in <a href="#">Configuring Classification Based on Tags</a> on page 964.</p> <p><b>Note:</b></p> <ul style="list-style-type: none"> <li>■ Call Setup Rules with HTTP GET operations don't function before the Classification stage. Typically, any asynchronous request is not supported before the routing stage.</li> <li>■ Call Setup Rules can be used to generated source and destination tags. For classification, only source tags are used.</li> <li>■ The parameter is applicable only to the SBC application.</li> </ul>
<b>Media</b>	
<p>'Media Realm' media-realm-name [SIPInterface_MediaRealm]</p>	<p>Assigns a Media Realm to the SIP Interface. By default, no value is defined.</p> <p>To configure Media Realms, see <a href="#">Configuring Media Realms</a>.</p>
<p>'Direct Media' sbc-direct-media [SIPInterface_SBCDirectMedia]</p>	<p>Enables direct media (RTP/SRTP) flow or media bypass (i.e., no Media Anchoring) between endpoints associated with the SIP Interface for SBC calls.</p> <ul style="list-style-type: none"> <li>■ [0] <b>Disable</b> = (Default) Media Anchoring is employed, whereby the media stream</li> </ul>



Parameter	Description
	<p>traverses the device (and each leg uses a different coder or coder parameters).</p> <ul style="list-style-type: none"> <li>■ [1] <b>Enable</b> = Direct Media is enabled (i.e., no Media Anchoring). Media stream flows directly between the endpoints (i.e., doesn't traverse the device).</li> <li>■ [2] <b>Enable when Same NAT</b> = Direct Media is enabled (i.e., no Media Anchoring). Media stream flows directly between the endpoints if they are located behind the same NAT.</li> </ul> <p>For more information on direct media, see <a href="#">Direct Media</a>.</p> <p><b>Note:</b></p> <ul style="list-style-type: none"> <li>■ If the parameter is enabled for direct media and the two endpoints belong to the same SIP Interface, calls cannot be established if the following scenario exists: <ul style="list-style-type: none"> <li>✓ One of the endpoints is defined as a foreign user (for example, “follow me service”)</li> <li>✓ and one endpoint is located on the WAN and the other on the LAN.</li> </ul> </li> </ul> <p>The reason for the above is that in direct media, the device does not interfere in the SIP signaling such as manipulation of IP addresses, which is necessary for calls between LAN and WAN.</p> <ul style="list-style-type: none"> <li>■ To enable direct media for all calls, use the global parameter [SBCDirectMedia]. If enabled, even if the SIP Interface is disabled for direct media, direct media is employed for calls belonging to the SIP Interface.</li> <li>■ If you enable direct media for the SIP Interface, make sure that your Media Realm provides sufficient ports, as media may traverse the device for mid-call services (e.g., call transfer).</li> <li>■ If you have configured a SIP Recording rule</li> </ul>

Parameter	Description
	<p>(see SIP-based Media Recording) for calls associated with this SIP Interface, the device automatically disables direct media for these calls (during their SIP signaling setup). This ensures that the media passes through the device so that it can be recorded and sent to the SRS. However, if you enable direct media using the [SBCDirectMedia] global parameter (i.e., for all calls), direct media is always enforced and calls will not be recorded.</p> <ul style="list-style-type: none"> <li>■ The parameter is applicable only to the SBC application.</li> </ul>
<b>Security</b>	
<p>'TLS Context Name'  <code>tls-context-name</code>  [SIPInterface_TLSContext]</p>	<p>Assigns a TLS Context (TLS configuration) to the SIP Interface.</p> <p>The default TLS Context ("default" at Index 0) is assigned to the SIP Interface by default.</p> <p><b>Note:</b></p> <ul style="list-style-type: none"> <li>■ For incoming calls: The assigned TLS Context is used if no TLS Context is configured for the Proxy Set associated with the call or classification to an IP Group based on Proxy Set fails.</li> <li>■ For outgoing calls: The assigned TLS Context is used if no TLS Context is configured for the Proxy Set associated with the call.</li> <li>■ To configure TLS Contexts, see <a href="#">Configuring TLS Certificates</a> on page 154.</li> </ul>
<p>'TLS Mutual Authentication'  <code>tls-mutual-auth</code>  [SIPInterface_TLSMutualAuthentication]</p>	<p>Enables TLS mutual authentication for the SIP Interface (when the device acts as a server).</p> <ul style="list-style-type: none"> <li>■ [0] <b>Disable</b> = Device does not request the client certificate for TLS connection on the SIP Interface.</li> <li>■ [1] <b>Enable</b> = Device requires receipt and verification of the client certificate to establish the TLS connection on the SIP Interface.</li> </ul> <p>By default, no value is defined and the</p>

Parameter	Description
	[SIPSRequireClientCertificate] global parameter setting is applied.
'Message Policy' message-policy-name [SIPInterface_MessagePolicyName]	Assigns a SIP message policy to the SIP interface. To configure SIP Message Policy rules, see <a href="#">Configuring SIP Message Policy Rules</a> .
'User Security Mode' block-un-reg-users [SIPInterface_BlockUnRegUsers]	<p>Defines the blocking (reject) policy for incoming SIP dialog-initiating requests (e.g., INVITE messages) from registered and unregistered users belonging to the SIP Interface.</p> <ul style="list-style-type: none"> <li>■ [-1] <b>Not Configured</b> = (Default) The corresponding parameter in the SRDs table (SRD_BlockUnRegUsers) of the SRD that is associated with the SIP Interface is applied.</li> <li>■ [0] <b>Accept All</b> = Accepts requests from registered and unregistered users.</li> <li>■ [1] <b>Accept Registered Users</b> = Accepts requests only from users registered with the device. Requests from users not registered are rejected.</li> <li>■ [2] <b>Accept Registered Users from Same Source</b> = Accepts requests only from registered users whose source address is the same as that registered with the device (during the REGISTER message process). All other requests are rejected. If the transport protocol is UDP, the device verifies the IP address and port; otherwise, it verifies only the IP address. The verification is performed before any of the device's call handling processes (i.e., Classification, Manipulation and Routing).</li> </ul> <p><b>Note:</b></p> <ul style="list-style-type: none"> <li>■ The parameter is applicable only to calls belonging to User-type IP Groups.</li> <li>■ The feature is not applicable to REGISTER requests.</li> <li>■ The option, Accept Registered Users from</li> </ul>

Parameter	Description
	<p>Same Source [2] does not apply to registration refreshes. These requests are accepted even if the source address is different to that registered with the device.</p> <ul style="list-style-type: none"> <li>■ When the device rejects a call, it sends a SIP 500 "Server Internal Error" response to the user. In addition, it reports the rejection (Dialog establish failure - Classification failure) using the Intrusion Detection System (IDS) feature (see <a href="#">Configuring IDS Policies</a>), by sending an SNMP trap.</li> <li>■ If you configure the parameter to any value other than default [-1], it overrides the corresponding parameter in the SRDs table (SRD_BlockUnRegUsersInterface) for the SRD associated with the SIP Interface.</li> </ul>
<p>'Enable Un-Authenticated Registrations'  enable-un-auth-registrs  [SIPInterface_ EnableUnAuthenticatedRegistrations]</p>	<p>Enables the device to accept REGISTER requests and register them in its registration database from new users that have not been authenticated by a proxy/registrar server (due to proxy down) and thus, re-routed to a User-type IP Group.</p> <p>In normal operation scenarios in which the proxy server is available, the device forwards the REGISTER request to the proxy and if authenticated by the proxy (i.e., device receives a success response), the device adds the user to its registration database. The routing to the proxy is according to the SBC IP-to-IP Routing table where the destination is the proxy's IP Group. However, when the proxy is unavailable (e.g., due to network connectivity loss), the device can accept REGISTER requests from new users if a matching alternative routing rule exists in the SBC IP-to-IP Routing table where the destination is the user's User-type IP Group (i.e., call survivability scenarios) and if the parameter is enabled.</p> <ul style="list-style-type: none"> <li>■ [-1] <b>Not Configured</b> = (Default) The corresponding parameter in the SRDs table (SRD_EnableUnAuthenticatedRegistrations)</li> </ul>

Parameter	Description
	<p>of the SRD associated with the SIP Interface is applied.</p> <ul style="list-style-type: none"> <li>■ [0] <b>Disable</b> = The device rejects REGISTER requests from new users that were not authenticated by a proxy server.</li> <li>■ [1] <b>Enable</b> = The device accepts REGISTER requests from new users even if they were not authenticated by a proxy server, and registers the user in its registration database.</li> </ul> <p><b>Note:</b></p> <ul style="list-style-type: none"> <li>■ Regardless of the parameter, the device always accepts registration refreshes from users that are already registered in its database.</li> <li>■ If configured to Disable or Enable, the parameter overrides the 'Enable Un-Authenticated Registrations' parameter settings of the SRD (in the SRDs table) that is associated with the SIP Interface.</li> <li>■ The parameter is applicable only to the SBC application.</li> </ul>
<p>'Max. Number of Registered Users'  <code>max-reg-users</code>  [SIPInterface_MaxNumOfRegUsers]</p>	<p>Defines the maximum number of users belonging to the SIP Interface that can register with the device.</p> <p>By default, no value is defined (i.e., the number of allowed user registrations is unlimited).</p> <p><b>Note:</b> The parameter is applicable only to the SBC application.</p>

## Configuring IP Groups

The IP Groups table lets you configure up to 80 IP Groups. An IP Group represents a SIP entity in the network with which the device communicates. This can be a server (e.g., IP PBX or ITSP) or a group of users (e.g., LAN IP phones). For servers, the address of the IP Group is typically defined by associating it with a Proxy Set (see [Configuring Proxy Sets](#)).

You can use IP Groups for the following:

- (SBC Application ) Classification of incoming SIP dialog-initiating requests (e.g., INVITE messages) to IP Groups based on Proxy Set. If the source address of the incoming SIP

dialog is defined for a Proxy Set, the assigns ("bonds") the SIP dialog to the IP Group associated with the Proxy Set. The feature is configured using the IP Groups table's 'Classify by Proxy Set' parameter. For more information and recommended security guidelines, see the parameter's description, later in this section.

- (SBC Application ) Classification of incoming SIP dialog-initiating requests (e.g., INVITE messages) to IP Groups based on source tags of incoming dialog. Tag-based classification occurs only if Classification based on user registration and on Proxy Sets fail. For more information, see [Configuring Classification Based on Tags](#) on page 964.
- (SBC Application) Representing the source and destination of the call in IP-to-IP Routing rules (see [Configuring SBC IP-to-IP Routing Rules](#)).
- SIP dialog registration and authentication (digest user/password) of specific IP Groups (Served IP Group, e.g., corporate IP-PBX) with other IP Groups (Serving IP Group, e.g., ITSP). This is configured in the Accounts table (see [Configuring Registration Accounts](#)).
- (Gateway Application) Call routing rules:
  - Tel-to-IP calls: The IP Group is used as the destination of the outgoing IP call and is used in Tel-to-IP call routing rules (see [Configuring Tel-to-IP Routing Rules](#)).
  - IP-to-Tel calls: The IP Group identifies the source of the IP call and is used in IP-to-Tel call routing rules (see [Configuring IP-to-Tel Routing Rules](#)).
  - Number manipulation: The IP Group can be associated with a number manipulation rule (see [Configuring Number Manipulation Tables](#)).
- Included in routing decisions by a third-party routing server. If deemed necessary for routing, the routing server can even create an IP Group. For more information, see [Centralized Third-Party Routing Server](#).

You can also apply the device's Quality of Experience feature to IP Groups:

- **Quality of Experience Profile:** Call quality monitoring based on thresholds for voice metrics (e.g., MOS) can be applied per IP Group. For example, if MOS is considered poor, calls belonging to this IP Group can be rejected. To configure Quality of Experience Profiles, see [Configuring Quality of Experience Profiles](#).
- **Bandwidth Profile:** Bandwidth utilization thresholds can be applied per IP Group. For example, if bandwidth thresholds are crossed, the device can reject any new calls on this IP Group. To configure Bandwidth Profiles, see [Configuring Bandwidth Profiles](#).



- For the Gateway application, IP Group Index #0 cannot be associated with Proxy Set Index #0.
- For the Gateway application, if no IP Group exists in the IP Groups table, the device rejects all Gateway calls. Even if you are not using IP Groups to route calls, IP Group Index #0 (default) must exist for the device to route calls.
- If you delete an IP Group or modify the 'Type' or 'SRD' parameters, the device immediately terminates currently active calls that are associated with the IP



Group. In addition, all users belonging to the IP Group are removed from the device's users database.

The following procedure describes how to configure IP Groups through the Web interface. You can also configure it through ini file [IPGroup] or CLI (`configure voip > ip-group`).

➤ **To configure an IP Group:**

1. Open the IP Groups table (**Setup** menu > **Signaling & Media** tab > **Core Entities** folder > **IP Groups**).
2. Click **New**; the following dialog box appears:

3. Configure an IP Group according to the parameters described in the table below.
4. Click **Apply**.

**Table 18-5: IP Groups Table Parameter Descriptions**

Parameter	Description
'SRD' srd-name [IPGroup_SRDName]	<p>Assigns an SRD to the IP Group.</p> <p>If only one SRD is configured in the SRDs table, the SRD is assigned by default. If multiple SRDs are configured in the SRDs table, no value is assigned by default and you must assign one.</p> <p>To configure SRDs, see <a href="#">Configuring SRDs</a>.</p> <p><b>Note:</b> The parameter is mandatory.</p>
General	

Parameter	Description
'Index' [IPGroup_Index]	<p>Defines an index for the new table row.</p> <p><b>Note:</b> Each row must be configured with a unique index.</p>
'Name' name [IPGroup_Name]	<p>Defines a descriptive name, which is used when associating the row in other tables.</p> <p>The valid value is a string of up to 40 characters.</p> <p><b>Note:</b></p> <ul style="list-style-type: none"> <li>■ Each row must be configured with a unique name.</li> <li>■ The parameter value cannot contain a forward slash (/).</li> </ul>
'Topology Location' topology-location [IPGroup_TopologyLocation]	<p>Defines the display location of the IP Group in the Topology view of the Web interface.</p> <ul style="list-style-type: none"> <li>■ [0] <b>Down</b> = (Default) The IP Group element is displayed on the lower border of the view.</li> <li>■ [1] <b>Up</b> = The IP Group element is displayed on the upper border of the view.</li> </ul> <p>For more information on the Topology view, see <a href="#">Building and Viewing SIP Entities in Topology View</a>.</p>
'Type' type [IPGroup_Type]	<p>Defines the type of IP Group.</p> <ul style="list-style-type: none"> <li>■ [0] <b>Server</b> = Applicable when the destination address of the IP Group (e.g., ITSP, Proxy, IP-PBX, or Application server) is known. The address is configured by the Proxy Set that is associated with the IP Group.</li> <li>■ [1] <b>User</b> = Represents a group of users such as IP phones and softphones where their location is dynamically obtained by the device when REGISTER requests and responses traverse (or are terminated) by the device. These users are considered remote (far-end).</li> </ul> <p>Typically, this IP Group is configured with a Serving IP Group that represents an IP-PBX, Application or Proxy server that serves this User-type IP Group. Each SIP request sent by a user of this IP Group is proxied to the Serving IP Group. For registrations, the device updates its registration database with the AOR and contacts of the users.</p> <p>Digest authentication using SIP 401/407 responses (if needed) is performed by the Serving IP Group. The device forwards these responses directly to the SIP</p>



Parameter	Description
	<p>users.</p> <p>To route a call to a registered user, a rule must be configured in the Tel-to-IP Routing table or SBC IP-to-IP Routing table. The device searches the dynamic database (by using the Request-URI) for an entry that matches a registered AOR or Contact. Once an entry is found, the IP destination is obtained from this entry and a SIP request is sent to the destination.</p> <p>The device also supports NAT traversal for the SIP clients located behind NAT. In this case, the device must be defined with a global IP address.</p> <p>■ [2] <b>Gateway</b> = (Applicable only to the SBC application) In scenarios where the device receives requests to and from a gateway representing multiple users. This IP Group type is necessary for any of the following scenarios:</p> <ul style="list-style-type: none"> <li>✓ The IP Group cannot be defined as a Server-type since its address is initially unknown and therefore, a Proxy Set cannot be configured for it.</li> <li>✓ The IP Group cannot be defined as a User-type since the SIP Contact header of the incoming REGISTER does not represent a specific user. The Request-URI user part can change and therefore, the device is unable to identify an already registered user and therefore, adds an additional record to the database.</li> </ul> <p>The IP address of the Gateway-type IP Group is obtained dynamically from the host part of the Contact header in the REGISTER request received from the IP Group. Therefore, routing to this IP Group is possible only once a REGISTER request is received (i.e., IP Group is registered with the device). If a REGISTER refresh request arrives, the device updates the new location (i.e., IP address) of the IP Group. If the REGISTER fails, no update is performed. If an UN-REGISTER request arrives, the IP address associated with the IP Group is deleted and therefore, no routing to the IP Group is done.</p> <p>You can view the registration status of the Gateway-type IP Group in the 'GW Group Registered Status' field, and view the IP address of the IP Group in the 'GW Group Registered IP Address' field if it is registered with the</p>

Parameter	Description
	device.
'Proxy Set' proxy-set-name [IPGroup_ProxySetName]	Assigns a Proxy Set to the IP Group. All INVITE messages destined to the IP Group are sent to the IP address configured for the Proxy Set. To configure Proxy Sets, see <a href="#">Configuring Proxy Sets</a> . <b>Note:</b> <ul style="list-style-type: none"> <li>■ For the Gateway application, IP Group ID 0 cannot be associated with Proxy Set ID 0.</li> <li>■ The Proxy Set must be associated with the same SRD as that assigned to the IP Group.</li> <li>■ You can assign the same Proxy Set to multiple IP Groups.</li> <li>■ For the SBC application: Proxy Sets are used for Server-type IP Groups, but may in certain scenarios also be used for User-type IP Groups. For example, this is required in deployments where the device mediates between an IP PBX and a SIP Trunk, and the SIP Trunk requires SIP registration for each user that requires service. In such a scenario, the device must register all the users to the SIP Trunk on behalf of the IP PBX. This is done by using the User Information table, where each user is associated with the source IP Group (i.e., the IP PBX). To configure the User Information table, see <a href="#">SBC User Information for SBC User Database</a>.</li> <li>■ For the Gateway application, Proxy Sets are applicable only to Server-type IP Groups.</li> </ul>
'IP Profile' ip-profile-name [IPGroup_ProfileName]	Assigns an IP Profile to the IP Group. By default, no value is defined. To configure IP Profiles, see <a href="#">Configuring IP Profiles</a> .
'Media Realm' media-realm-name [IPGroup_MediaRealm]	Assigns a Media Realm to the IP Group. The Media Realm determines the UDP port range and maximum sessions on a specific IP interface for media traffic associated with the IP Group. By default, no value is defined. To configure Media Realms, see <a href="#">Configuring Media Realms</a> . <b>Note:</b> If you delete a Media Realm in the Media Realms table that is assigned to the IP Group, the parameter value reverts to undefined.

Parameter	Description
'Internal Media Realm' internal-media-realm-name [IPGroup_InternalMediaRealm]	<p>Assigns an "internal" Media Realm to the IP Group. This is applicable when the device is deployed in a Microsoft Teams environment. The device selects this Media Realm (instead of the Media Realm assigned by the 'Media Realm' parameter above) if the value of the X-MS-UserLocation header in the incoming SIP message is "Internal" and the 'Teams Local Media Optimization Handling' parameter (see below) is configured to any value other than <b>None</b>.</p> <p>The Media Realm determines the UDP port range and maximum sessions on a specific IP interface for media traffic associated with the IP Group.</p> <p>By default, no value is defined.</p> <p>To configure Media Realms, see <a href="#">Configuring Media Realms</a>.</p> <p><b>Note:</b></p> <ul style="list-style-type: none"> <li>■ The parameter is applicable only if you have configured the 'Teams Local Media Optimization Handling' parameter (see below) to any value other than <b>None</b>.</li> <li>■ If you delete a Media Realm in the Media Realms table that is assigned to the IP Group, the parameter value reverts to undefined.</li> <li>■ If you don't configure the parameter, the device uses the Media Realm that you assigned by the 'Media Realm' parameter.</li> </ul>
'Contact User' contact-user [IPGroup_ContactUser]	<p>Defines the user part of the From, To, and Contact headers of SIP REGISTER messages, and the user part of the Contact header of INVITE messages received from this IP Group and forwarded by the device to another IP Group.</p> <p>The valid value is a string of up to 60 characters. By default, no value is defined.</p> <p><b>Note:</b></p> <ul style="list-style-type: none"> <li>■ The parameter is applicable only to Server-type IP Groups.</li> <li>■ The parameter is overridden by the 'Contact User' parameter in the Accounts table (see <a href="#">Configuring Registration Accounts</a>).</li> </ul>
'SIP Group Name' sip-group-name [IPGroup_SIPGroupName]	<p>Defines the hostname (e.g., 194.90.179.0) which the device uses to overwrite the original hostname (host part) of the URI in certain SIP headers. Therefore, the parameter allows</p>

Parameter	Description
	<p>you to implement topology hiding in SIP messages, by concealing the hostname of the communicating UAs from each another.</p> <p>For the SBC application: The affected SIP headers depend on whether the IP Group is the destination or source of the call:</p> <ul style="list-style-type: none"> <li>■ <b>Destination IP Group:</b> The device overwrites the host part of the following SIP headers for messages sent (outgoing) to this IP Group: <ul style="list-style-type: none"> <li>✓ For all requests: Request-URI header (if the destination of the request isn't a registered user or Trunk Group, and the URL in the Request-URI is not GRUU) and P-Called-Party-ID header.</li> <li>✓ For all non-REGISTER requests (e.g., INVITE and SUBSCRIBE): To header and Remote-Party-ID header (only the first Remote-Party-ID header whose type is "called" in the message).</li> <li>✓ For INVITE requests only: If the 'Destination URI Input' parameter is configured for the source IP Group, the header type configured by the 'Destination URI Input' parameter is also modified according to the 'SIP Group Name' parameter of the destination IP Group.</li> </ul> </li> <li>■ <b>Source IP Group:</b> The device overwrites the host part of the following SIP headers for messages received (incoming) from this IP Group. <ul style="list-style-type: none"> <li>✓ For all types of requests: From header.</li> <li>✓ For REGISTER requests: To header.</li> <li>✓ For all non-REGISTER requests (e.g., INVITE and SUBSCRIBE): P-Preferred-Identity (only first P-Preferred-Identity header in message), P-Asserted-Identity (only first P-Asserted-Identity header in message), Remote-Party-ID (only the first Remote-Party-ID header whose type is "calling" in the message).</li> <li>✓ For INVITE requests only: If the 'Source URI Input' parameter is configured for the source IP Group, the header type configured by the 'Source URI Input' parameter is also overwritten according to the 'SIP Group Name' parameter of the source IP Group.</li> </ul> </li> </ul>

Parameter	Description
	<p>The valid value is a string of up to 100 characters. By default, no value is defined.</p> <p><b>Note:</b></p> <ul style="list-style-type: none"> <li>■ For the SBC application: When the IP Group is the source of the call, if you configure the destination IP Group's 'SIP Source Host Name' parameter (see below), the device ignores the 'SIP Group Name' parameter of the source IP Group. (The 'SIP Source Host Name' parameter also defines a URI host part to overwrite the original source host part, but it affects many more source-related SIP headers.)</li> <li>■ When the parameter is configured for the source or destination IP Group, it overrides Inbound Message Manipulation rules (assigned by the 'Inbound Message Manipulation Set' parameter to the source IP Group) that manipulate the host part in the Request-URI, To, and From SIP headers. If you configure the parameter and you want to manipulate the host part in any of these SIP headers, assign your Message Manipulation rules to the destination IP Group using the 'Outbound Message Manipulation Set' parameter.</li> <li>■ For the Gateway application: The parameter is not applicable when the IP Group is the source of the call. When the parameter is configured for the destination IP Group, the device uses the configured value to overwrite the host part in the Request-URI and To headers of INVITE requests, and the Request-URI of REGISTER requests sent (outgoing) to this IP Group.</li> <li>■ For the Gateway application: If the IP Group is of User type, the parameter is used internally as a host name in the Request-URI for Tel-to-IP initiated calls. For example, if an incoming call from the device's trunk is routed to a User-type IP Group, the device first creates the Request-URI (&lt;destination_number&gt;@&lt;SIP Group Name&gt;), and then it searches the registration database for a match.</li> </ul>
'Created By Routing Server' [IPGroup_CreatedByRoutingServer]	<p>(Read-only) Indicates whether the IP Group was created by a third-party routing server:</p> <ul style="list-style-type: none"> <li>■ [0] <b>No</b></li> <li>■ [1] <b>Yes</b></li> </ul>

Parameter	Description
	<p>For more information on the third-party routing server feature, see <a href="#">Centralized Third-Party Routing Server</a>.</p>
<p>'Used By Routing Server' used-by-routing-server [IPGroup_UsedByRoutingServer]</p>	<p>Enables the IP Group to be used by a third-party routing server for call routing decisions.</p> <ul style="list-style-type: none"> <li>■ [0] <b>Not Used</b> (default)</li> <li>■ [1] <b>Used</b></li> </ul> <p>For more information on the third-party routing server feature, see <a href="#">Centralized Third-Party Routing Server</a>.</p>
<p>'Proxy Set Connectivity' show voip proxy sets status [IPGroup_ProxySetConnectivity]</p>	<p>(Read-only field) Displays the connectivity status with Server-type IP Groups. As the Proxy Set defines the address of the IP Group, the connectivity check (keep-alive) by the device is done to this address.</p> <ul style="list-style-type: none"> <li>■ "NA": Functionality is not applicable due to one of the following: <ul style="list-style-type: none"> <li>✓ User-type IP Group.</li> <li>✓ Server-type IP Group, but the keep-alive mechanism of its' associated Proxy Set is disabled.</li> </ul> </li> <li>■ "Not Connected": Keep-alive failure (i.e., no connectivity with the IP Group).</li> <li>■ "Connected": Keep-alive success (i.e., connectivity with the IP Group).</li> </ul> <p>The connectivity status is also displayed in the Topology View page (see <a href="#">Building and Viewing SIP Entities in Topology View</a>).</p> <p><b>Note:</b></p> <ul style="list-style-type: none"> <li>■ The feature is applicable only to Server-type IP Groups.</li> <li>■ To support the feature, you must enable the keep-alive mechanism of the Proxy Set that is associated with the IP Group (see <a href="#">Configuring Proxy Sets</a>).</li> <li>■ If the Proxy Set is configured with multiple proxies (addresses) and at least one of them is "alive", the displayed status is "Connected". To view the connected proxy server, see <a href="#">Viewing Proxy Set Status</a>.</li> <li>■ The "Connected" status also applies to scenarios where the device rejects calls with the IP Group due to low QoE</li> </ul>

Parameter	Description
	(e.g., low MOS), despite connectivity.
SBC General	
<p>'Classify By Proxy Set'  <code>classify-by-proxy-set</code>            [IPGroup_            ClassifyByProxySet]</p>	<p>Enables classification of incoming SIP dialogs (INVITEs) to Server-type IP Groups based on Proxy Set (assigned using the IPGroup_ProxySetName parameter).</p> <ul style="list-style-type: none"> <li>■ [0] <b>Disable</b></li> <li>■ [1] <b>Enable</b> = (Default) The device searches the Proxy Sets table for a Proxy Set that is configured with the same source IP address as that of the incoming INVITE (if host name, then according to the dynamically resolved IP address list). If such a Proxy Set is found, the device classifies the INVITE as belonging to the IP Group associated with the Proxy Set.</li> </ul> <p><b>Note:</b></p> <ul style="list-style-type: none"> <li>■ The parameter is applicable only to Server-type IP Groups.</li> <li>■ For security, it is recommended to classify SIP dialogs based on Proxy Set only if the IP address of the IP Group is unknown. In other words, if the Proxy Set associated with the IP Group is configured with an FQDN. In such cases, the device classifies incoming SIP dialogs to the IP Group based on the DNS-resolved IP address. If the IP address is known, it is recommended to use a Classification rule instead (and disable the Classify by Proxy Set feature), where the rule is configured with not only the IP address, but also with SIP message characteristics to increase the strictness of the classification process (see <a href="#">Configuring Classification Rules</a>).</li> </ul> <p>The reason for preferring classification based on Proxy Set when the IP address is unknown is that IP address forgery (commonly known as IP spoofing) is more difficult than malicious SIP message tampering and therefore, using a Classification rule without an IP address offers a weaker form of security. When classification is based on Proxy Set, the Classification table for the specific IP Group is ignored.</p> <ul style="list-style-type: none"> <li>■ If you have assigned the same Proxy Set to multiple IP</li> </ul>

Parameter	Description
	<p>Groups, disable the parameter and instead, use Classification rules to classify incoming SIP dialogs to these IP Groups. If the parameter is enabled, the device is unable to correctly classify incoming INVITEs to their appropriate IP Groups.</p> <ul style="list-style-type: none"> <li>■ Classification by Proxy Set occurs only if classification based on the device's registration database fails (i.e., the INVITE is not from a registered user).</li> <li>■ The parameter is applicable only to the SBC application.</li> </ul>
<p>'SBC Operation Mode' sbc-operation-mode [IPGroup_SBCOperationMode]</p>	<p>Defines the device's operational mode for the IP Group.</p> <ul style="list-style-type: none"> <li>■ [-1] <b>Not Configured</b> = (Default)</li> <li>■ [0] <b>B2BUA</b> = Device operates as a back-to-back user agent (B2BUA), changing the call identifiers and headers between the inbound and outbound legs.</li> <li>■ [1] <b>Call Stateful Proxy</b> = Device operates as a Stateful Proxy, passing the SIP message transparently between inbound and outbound legs. In other words, the same SIP dialog identifiers (tags, Call-Id and CSeq) occur on both legs (as long as no other configuration disrupts the CSeq compatibleness).</li> </ul> <p>■</p> <p>For more information on B2BUA and Stateful Proxy modes, see <a href="#">B2BUA and Stateful Proxy Operating Modes</a>.</p> <p><b>Note:</b></p> <ul style="list-style-type: none"> <li>■ If configured, the parameter overrides the 'SBC Operation Mode' parameter in the SRDs table.</li> <li>■ The parameter is applicable only to the SBC application.</li> </ul>
<p>'SBC Client Forking Mode' sbc-client-forking-mode [IPGroup_EnableSBCClientForking]</p>	<p>Defines call forking of INVITE messages to up to five separate SIP outgoing legs for User-type IP Groups. This occurs if multiple contacts are registered under the same AOR in the device's registration database.</p> <ul style="list-style-type: none"> <li>■ [0] <b>Sequential</b> = (Default) Sequentially sends the INVITE to each contact. If there is no answer from the first contact, it sends the INVITE to the second contact, and so on until a contact answers. If no contact answers, the call fails or is routed to an alternative destination, if configured.</li> </ul>



Parameter	Description
	<ul style="list-style-type: none"> <li>■ [1] <b>Parallel</b> = Sends the INVITE simultaneously to all contacts. The call is established with the first contact that answers.</li> <li>■ [2] <b>Sequential Available Only</b> = Sequentially sends the INVITE only to available contacts (i.e., not busy). If there is no answer from the first available contact, it sends the INVITE to the second contact, and so on until a contact answers. If no contact answers, the call fails or is routed to an alternative destination, if configured.</li> </ul> <p><b>Note:</b></p> <ul style="list-style-type: none"> <li>■ The device can also fork INVITE messages received for a Request-URI of a specific contact (user) registered in the database to all other users located under the same AOR as the specific contact. This is configured by the [SBCSendInviteToAllContacts] parameter.</li> <li>■ The parameter is applicable only to the SBC application.</li> </ul>
<p>'CAC Profile' cac-profile [IPGroup_ AdmissionProfile]</p>	<p>Assigns a Call Admission Control Profile (CAC rules) to the IP Group.</p> <p>By default, no value is defined.</p> <p>To configure CAC Profiles, see <a href="#">Configuring Call Admission Control</a> on page 947.</p> <p><b>Note:</b> The parameter is applicable only to the SBC application.</p>
<p>'SIP Source Host Name' sip-source-host-name [IPGroup_ SIPSourceHostName]</p>	<p>Defines a hostname, which the device uses to overwrite the hostname of the URI in certain SIP headers. The parameter allows you to implement topology hiding for the source of SIP messages, by concealing the hostname of the source UA.</p> <p>The valid value is a string of up to 100 characters. By default, no value is defined.</p> <p>When the device forwards a SIP message to this IP Group, the configured hostname overwrites the host part in SIP headers (see below) that are concerned with the source of the message:</p> <ul style="list-style-type: none"> <li>■ From, P-Asserted-Identity, P-Preferred-Identity, Referred-By, P-Charge-Info, Remote-Party-ID, P-Associated-URI, Diversion, and History-info headers.</li> <li>■ If you configure the 'SIP Topology Hiding Mode' parameter (see below) to <b>Fallback to IP Addresses</b> and</li> </ul>

Parameter	Description
	<p>the 'Remote REFER Mode' [IpProfile_SBCRemoteReferBehavior] parameter to <b>Regular</b> (default), the host part in the Refer-To header is also overwritten.</p> <ul style="list-style-type: none"> <li>■ For REGISTER requests, the host part in the To header is also overwritten.</li> </ul> <p><b>Note:</b></p> <ul style="list-style-type: none"> <li>■ The parameter is applicable only when the IP Group is the destination of the call (not source).</li> <li>■ This parameter has higher priority than the 'SIP Group Name' parameter (see above) of the source IP Group. When this parameter is configured, the device ignores the value of the 'SIP Group Name' parameter that is configured for the source IP Group.</li> <li>■ The parameter is applicable only to SIP dialog-initiating requests and in-dialog REFER requests.</li> <li>■ The parameter is applicable only to the SBC application.</li> </ul>
<b>Advanced</b>	
<p>'Local Host Name' local-host-name [IPGroup_ContactName]</p>	<p>Defines the host name (string) that the device uses in the SIP message's Via and Contact headers. This is typically used to define an FQDN as the host name. The device uses this string for Via and Contact headers in outgoing INVITE messages sent to a specific IP Group, and the Contact header in SIP 18x and 200 OK responses for incoming INVITE messages received from a specific IP Group. The IP-to-Tel Routing table can be used to identify the source IP Group from where the INVITE message was received.</p> <p>If the parameter is not configured, these headers are populated with the device's dotted-decimal IP address of the network interface on which the message is sent. By default, no value is defined.</p> <p><b>Note:</b> To ensure proper device handling, the parameter should be a valid FQDN.</p>
<p>'Always Use Src Address' always-use-source-addr [IPGroup_</p>	<p>Enables the device to always send SIP requests and responses, within a SIP dialog, to the source IP address received in the previous SIP message packet. This feature is especially useful in scenarios where the IP Group endpoints</p>

Parameter	Description
AlwaysUseSourceAddr]	<p>are located behind a NAT firewall (and the device is unable to identify this using its regular NAT mechanism).</p> <ul style="list-style-type: none"> <li>■ [0] <b>No</b> = (Default) The device sends SIP requests according to the settings of the global parameter, SIPNatDetection.</li> <li>■ [1] <b>Yes</b> = The device sends SIP requests and responses to the source IP address received in the previous SIP message packet.</li> </ul> <p>For more information on NAT traversal, see <a href="#">Remote UA behind NAT</a>.</p>
SBC Advanced	
<p>'Source URI Input' src-uri-input [IPGroup_SourceUriInput]</p>	<p>Defines the SIP header in the incoming INVITE that is used for call matching characteristics based on source URIs.</p> <ul style="list-style-type: none"> <li>■ [-1] <b>Not Configured</b> (default)</li> <li>■ [0] <b>From</b></li> <li>■ [1] <b>To</b></li> <li>■ [2] <b>Request-URI</b></li> <li>■ [3] <b>P-Asserted - First Header</b></li> <li>■ [4] <b>P-Asserted - Second Header</b></li> <li>■ [5] <b>P-Preferred</b></li> <li>■ [6] <b>Route</b></li> <li>■ [7] <b>Diversion</b></li> <li>■ [8] <b>P-Associated-URI</b></li> <li>■ [9] <b>P-Called-Party-ID</b></li> <li>■ [10] <b>Contact</b></li> <li>■ [11] <b>Referred-by</b></li> </ul> <p><b>Note:</b></p> <ul style="list-style-type: none"> <li>■ The parameter is applicable only when classification is done according to the Classification table.</li> <li>■ If the configured SIP header does not exist in the incoming INVITE message, the classification of the message to a source IP Group fails.</li> </ul>

Parameter	Description
	<ul style="list-style-type: none"> <li>■ If the device receives an INVITE as a result of a REFER request or a 3xx response, then the incoming INVITE is routed according to the Request-URI. The device identifies such INVITEs according to a specific prefix in the Request-URI header, configured by the SBCXferPrefix parameter. Therefore, in this scenario, the device ignores the parameter setting.</li> </ul>
'Destination URI Input' dst-uri-input [IPGroup_DestUriInput]	<p>Defines the SIP header in the incoming INVITE to use as a call matching characteristic based on destination URIs. The parameter is used for classification and routing purposes. The device first uses the parameter's settings as a matching characteristic (input) to classify the incoming INVITE to an IP Group (source IP Group) in the Classification table. Once classified, the device uses the parameter for routing the call. For example, if set to To, the URI in the To header of the incoming INVITE is used as a matching characteristic for classifying the call to an IP Group in the Classification table. Once classified, the device uses the URI in the To header as the destination.</p> <ul style="list-style-type: none"> <li>■ [-1] <b>Not Configured</b> (default)</li> <li>■ [0] <b>From</b></li> <li>■ [1] <b>To</b></li> <li>■ [2] <b>Request-URI</b></li> <li>■ [3] <b>P-Asserted - First Header</b></li> <li>■ [4] <b>P-Asserted - Second Header</b></li> <li>■ [5] <b>P-Preferred</b></li> <li>■ [6] <b>Route</b></li> <li>■ [7] <b>Diversion</b></li> <li>■ [8] <b>P-Associated-URI</b></li> <li>■ [9] <b>P-Called-Party-ID</b></li> <li>■ [10] <b>Contact</b></li> <li>■ [11] <b>Referred-By</b></li> </ul> <p><b>Note:</b></p> <ul style="list-style-type: none"> <li>■ The parameter is applicable only when classification is done according to the Classification table.</li> </ul>

Parameter	Description
	<ul style="list-style-type: none"> <li>■ If the configured SIP header does not exist in the incoming INVITE message, the classification of the message to a source IP Group fails.</li> <li>■ If the device receives an INVITE as a result of a REFER request or a 3xx response, the incoming INVITE is routed according to the Request-URI. The device identifies such INVITEs according to a specific prefix in the Request-URI header, configured by the SBCXferPrefix parameter. Therefore, in this scenario, the device ignores the parameter setting.</li> </ul>
'SIP Connect' sip-connect [IPGroup_SIPConnect]	<p>Defines the IP Group as representing multiple registering servers, each of which may use a single registration, yet represent multiple users. In addition, it defines how the device saves registration information for REGISTER messages received from the IP Group, in its registration database. For requests routed to the IP Group's users, the device replaces the Request-URI header with the incoming To header (which contains the remote phone number).</p> <ul style="list-style-type: none"> <li>■ [0] <b>No</b> = (Default) Disables the SIP Connect feature. No extra key based on source IP address is added to the registration database and registration is done by Contact and Address of Record (AoR).</li> <li>■ [1] <b>Yes</b> = Enables the SIP Connect feature. For initial registrations that are received from the IP Group, the device attempts to add two <i>keys</i> representing the user to its registration database:               <ul style="list-style-type: none"> <li>✓ Key 1: The first key contains the incoming REGISTER message's source IP address, port (only if UDP), and SIP Interface ID (e.g., "10.33.3.3:5010#1").</li> <li>✓ Key 2: The second key contains the incoming REGISTER message's URI (user@host) of the Contact header, source IP address, port (only if UDP), and SIP Interface ID (e.g., "user@host.com#10.33.3.3:5010#1").</li> </ul> </li> </ul> <p>If the device receives an initial registration request that has the same IP address and Contact URI, or IP address only, as an existing key (i.e., an existing registration), the device rejects the request.</p> <p>The device classifies incoming non-REGISTER SIP dialog</p>

Parameter	Description
	<p>requests (e.g., INVITEs) from this IP Group, by first using the regular user search method in the registration database by Contact-AoR pair matching. If unsuccessful, the device searches the registration database for a matching Key 2 (i.e., Contact URI, source IP address, and port if the transport type is UDP). If no matching Key 2 exists, the device then searches for a matching Key 1 (i.e., source IP address only and port if the transport type is UDP). If no key is found at all, the device continues with the next Classification stage (e.g., by Proxy Set).</p> <p><b>Note:</b></p> <ul style="list-style-type: none"> <li>■ The parameter is applicable only to User-type IP Groups.</li> <li>■ The parameter is applicable only to the SBC application.</li> </ul>
<p>'SBC PSAP Mode' sbc-psap-mode [IPGroup_SBCPSAPMode]</p>	<p>Enables E9-1-1 emergency call routing in a Microsoft Skype for Business environment.</p> <ul style="list-style-type: none"> <li>■ [0] <b>Disable</b> (default)</li> <li>■ [1] <b>Enable</b></li> </ul> <p>For more information, see <a href="#">E9-1-1 Support for Microsoft Skype for Business</a>.</p>
<p>'Route Using Request URI Port' use-requri-port [IPGroup_SBCRouteUsingRequestURIPort]</p>	<p>Enables the device to use the port indicated in the Request-URI of the incoming message as the destination port when routing the message to the IP Group. The device uses the IP address (and not port) that is configured for the Proxy Set associated with the IP Group. The parameter thus allows the device to route calls to the same server (IP Group), but different port.</p> <ul style="list-style-type: none"> <li>■ [0] <b>Disable</b> = (Default) The port configured for the associated Proxy Set is used as the destination port.</li> <li>■ [1] <b>Enable</b> = The port indicated in the Request-URI of the incoming message is used as the destination port.</li> </ul>
<p>'Media TLS Context' dtls-context [IPGroup_DTLSText]</p>	<p>Assigns a TLS Context (TLS configuration) to the IP Group that is used for secured media sessions (e.g., MSRPS) with the IP Group.</p> <p>The default is the default TLS Context ("default" at Index 0). To configure TLS Contexts, see <a href="#">Configuring TLS Certificates</a> on page 154.</p> <p>For more information on MSRP, see <a href="#">Configuring Message</a></p>

Parameter	Description
	<a href="#">Session Relay Protocol</a> on page 1030.
'Keep Original Call-ID' sbc-keep-call-id [IPGroup_ SBCKeepOriginalCallID]	<p>Enables the device to use the same call identification (SIP Call-ID header value) received in incoming messages for the call identification in outgoing messages. The call identification value is contained in the SIP Call-ID header.</p> <ul style="list-style-type: none"> <li>■ [0] <b>No</b> = (Default) The device creates a new Call-ID value for the outgoing message.</li> <li>■ [1] <b>Yes</b> = The device uses the same Call-ID value received in the incoming message for the Call-ID in the outgoing message.</li> </ul> <p><b>Note:</b> When the device sends an INVITE as a result of a REFER/3xx termination, the device always creates a new Call-ID value and ignores the parameter's settings.</p>
'Dial Plan' sbc-dial-plan-name [IPGroup_ SBCKeepOriginalCallID]	<p>Assigns a Dial Plan to the IP Group. The device searches the Dial Plan for a dial plan rule that matches the prefix of the source number and if not found, for a rule that matches the prefix of the destination number. If a matching Dial Plan rule is found, the rule's tag is used in the routing or manipulation processes as source or destination tags.</p> <p>To configure Dial Plans, see <a href="#">Configuring Dial Plans</a>.</p> <p><b>Note:</b> For IP-to-IP Routing rules that are configured for destination based on tags (i.e., 'Destination Type' parameter configured to Destination Tag), the parameter is applicable only to the source IP Group and the device searches the Dial Plan for a dial plan rule that matches the prefix of the destination number only. For more information on routing based on destination tags, see <a href="#">Using Dial Plan Tags for Routing Destinations</a>.</p>
'Call Setup Rules Set ID' call-setup-rules-set-id [IPGroup_ CallSetupRulesSetId]	<p>Assigns a Call Setup Rule Set ID to the IP Group. The device runs the Call Setup rule immediately before the routing stage (i.e., only after the classification and manipulation stages).</p> <p>By default, no value is assigned.</p> <p>To configure Call Setup Rules, see <a href="#">Configuring Call Setup Rules</a>.</p>
'Tags' tags	<p>Defines a tag, which can be implemented in one of the following manners:</p>

Parameter	Description
[IPGroup_Tags]	<ul style="list-style-type: none"> <li data-bbox="667 286 1391 595">■ <b>Classification based on source tags:</b> If the tag (name=value or value only) is the same tag as that of the incoming SIP dialog (obtained from the Call Setup Rule associated with the SIP Interface on which the dialog is received) and configured in the Classification table, then the incoming dialog is classified to this IP Group. For more information, see <a href="#">Configuring Classification Based on Tags</a> on page 964.</li> <li data-bbox="667 622 1391 891">■ <b>Routing based on destination tags:</b> Assigns a Dial Plan tag which determines whether the incoming SIP dialog is sent to this IP Group. The parameter is used when IP-to-IP Routing rules are configured for destinations-based on tags (i.e., 'Destination Type' parameter configured to <b>Destination Tag</b>). For more information, see <a href="#">Using Dial Plan Tags for Routing Destinations</a>.</li> </ul> <p data-bbox="667 918 1391 1348">The valid value is a string of up to 70 characters. You can configure the parameter with up to five tags, where each tag is separated by a semicolon (;). However, you can configure only up to four tags containing a name and value (e.g., Country=Ireland), and <b>one</b> tag containing a value only (e.g., Ireland). You can also configure multiple tags with the same name (e.g., Country=Ireland;Country=Scotland). The following example configures the maximum number of tags (i.e., four name=value tags and one value-only tag): Country=Ireland;Country=Scotland;Country=RSA;Country=Canada;USA.</p> <p data-bbox="667 1366 1391 1473"><b>Note:</b> For tag-based classification, if multiple IP Groups are configured with the same tag, the device classifies the incoming SIP dialog to the first matching IP Group.</p>
'SBC Alternative Routing Reasons Set' sbc-alt-route-reasons-set [IPGroup_SBCAltRouteReasonsSetName]	<p data-bbox="667 1518 1391 1908">Assigns an Alternative Reasons Set to the IP Group. This defines SIP response codes, which if received by the device from the IP Group, triggers alternative routing. Alternative routing could mean trying to send the SIP message to another online proxy (address) that is configured for the Proxy Set associated with the IP Group, or sending it to an alternative IP-to-IP Routing rule. For configuring Alternative Reasons Sets and for more information on how the device performs alternative routing, see <a href="#">Configuring SIP Response Codes for Alternative Routing Reasons</a> on page 992.</p> <p data-bbox="667 1921 1391 1953">By default, no value is defined.</p>



Parameter	Description
<p>'Teams Local Media Optimization Handling'</p> <p>teams-local-media-optimization-handling</p> <p>[IPGroup_TeamsLocalMediaOptimization]</p>	<p>Enables and defines Local Media Optimization handling when the central SBC device (proxy SBC scenario) is deployed in a Microsoft Teams environment. The handling is based on supplementary information provided by Microsoft proprietary SIP headers, X-MS-UserLocation and X-MS-MediaPath.</p> <ul style="list-style-type: none"> <li>■ [0] <b>None</b> = (Default) The device ignores the Teams headers in the SIP message and uses the "regular" Media Realm assigned by the IP Group's 'Media Realm' parameter for the call.</li> <li>■ [1] <b>Teams Decides</b> = The device's call handling depends on the Teams headers and call direction: <ul style="list-style-type: none"> <li>✓ Teams-to-SBC Call: If the call is a primary route, the device uses the Teams headers (X-MS-UserLocation and X-MS-MediaPath) in the incoming INVITE message. If the X-MS-UserLocation header value is "internal", the device uses the Media Realm assigned by the IP Group's 'Internal Media Realm' parameter. If the X-MS-UserLocation header value is "external", the device uses the Media Realm assigned by the IP Group's 'Media Realm' parameter. Based on the X-MS-MediaPath header, the device determines if it's a direct or non-direct media call. If the X-MS-UserLocation header value is "internal" and the first value of the X-MS-MediaPath header is the same value as configured for the IP Group's 'Local Host Name' parameter, the call traverses the device; otherwise, it bypasses the device (direct media). If the call is a non-primary route (e.g., alternative route, 3xx, or forking), the device only uses the X-MS-UserLocation header in the incoming INVITE message, which it uses to select the appropriate Media Realm (as explained previously for primary routes). For non-primary routes, the media traverses the device (i.e., no direct media).</li> <li>✓ SBC-to-Teams Call: The device forwards the INVITE message with the SDP received from the peer side to Teams according to the configuration of the IP Group's 'Teams Local Media Optimization Initial Behavior' parameter (see below). Based on the</li> </ul> </li> </ul>

Parameter	Description
	<p>Teams headers in the 200 OK response from Teams, the device selects the appropriate Media Realm (as explained previously for Teams-to-SBC calls) and determines if it's a direct or non-direct media call (as explained previously for Teams-to-SBC calls).</p> <ul style="list-style-type: none"> <li>■ [2] <b>SBC Decides</b> = The device only uses the X-MS-UserLocation header in the SIP message, which it uses to select the appropriate Media Realm (as explained previously for the <b>Teams Decides</b> option). When configured to the <b>SBC Decides</b> option, the media traverses the device (i.e., no direct media).</li> </ul> <p><b>Note:</b> For an outgoing INVITE message to Teams, the device sends the call as a non-direct media and uses the Media Realm assigned by the IP Group's 'Media Realm' parameter.</p> <p>For an overview of Microsoft Teams Local Media Optimization feature, see <a href="#">Microsoft Teams with Local Media Optimization</a> on page 372.</p>
<p>'Teams Local Media Optimization Initial Behavior'</p> <p>teams-local-mo-initial-behavior</p> <p>[IPGroup_TeamsLocalMOInitialBehavior]</p>	<p>Defines how the central SBC device (proxy SBC scenario) initially sends the received INVITE message with the SDP Offer to Teams when the device is deployed in a Microsoft Teams environment for its Local Media Optimization feature. The parameter is applicable when the device receives the SDP Offer from a remote site SBC and the 'Teams Local Media Optimization Handling' parameter is configured to <b>Teams Decides</b> or <b>SBC Decides</b>.</p> <ul style="list-style-type: none"> <li>■ [0] <b>Direct Media</b> = (Default) The device sends the SDP Offer as is to Teams, indicating that the call is intended to be a direct media call (i.e., doesn't traverse the device).</li> </ul> <p><b>Note:</b> This option is applicable only when 'Teams Local Media Optimization Handling' parameter is configured to <b>Teams Decides</b>.</p> <ul style="list-style-type: none"> <li>■ [1] <b>Internal</b> = The device sends the SDP Offer using the internal Media Realm (see the IP Group's 'Internal Media Realm' parameter) to Teams, indicating that the call is intended to be a non-direct media call (i.e., media traverses the central SBC device).</li> <li>■ [2] <b>External</b> = The device sends the SDP Offer using the</li> </ul>

Parameter	Description
	<p>external (regular) Media Realm (see the IP Group's 'Media Realm' parameter) to Teams, indicating that the call is intended to be a non-direct media call (i.e., media traverses the central SBC device).</p> <p>For a brief overview of Microsoft Teams Local Media Optimization feature, see <a href="#">Microsoft Teams with Local Media Optimization</a> on page 372.</p>
Quality of Experience	
<p>'QoE Profile' qoe-profile [IPGroup_QOEProfile]</p>	<p>Assigns a Quality of Experience Profile rule. By default, no value is defined. To configure Quality of Experience Profiles, see <a href="#">Configuring Quality of Experience Profiles</a>.</p>
<p>'Bandwidth Profile' bandwidth-profile [IPGroup_BWProfile]</p>	<p>Assigns a Bandwidth Profile rule. By default, no value is defined. To configure Bandwidth Profiles, see <a href="#">Configuring Bandwidth Profiles</a>.</p>
Message Manipulation	
<p>'Inbound Message Manipulation Set' inbound-msg-manipulation-set [IPGroup_InboundManSet]</p>	<p>Assigns a Message Manipulation Set (rule) to the IP Group for SIP message manipulation on the inbound leg. By default, no value is defined. To configure Message Manipulation rules, see <a href="#">Configuring SIP Message Manipulation</a>.</p> <p><b>Note:</b></p> <ul style="list-style-type: none"> <li>■ The parameter is applicable only to the SBC application.</li> <li>■ The IPGroup_SIPGroupName parameter overrides inbound message manipulation rules (assigned to the IPGroup_InboundManSet parameter) that manipulate the host name in Request-URI, To, and/or From SIP headers. If you want to manipulate the host name using message manipulation rules in any of these SIP headers, you must apply your manipulation rule (Manipulation Set ID) to the IP Group as an Outbound Message Manipulation Set (see the [IPGroup_OutboundManSet] parameter), when the IP Group is the destination of the call.</li> </ul>
<p>'Outbound Message</p>	<p>Assigns a Message Manipulation Set (rule) to the IP Group</p>

Parameter	Description
Manipulation Set' outbound-mesg-manipulation-set [IPGroup_OutboundManSet]	for SIP message manipulation on the outbound leg. By default, no value is defined. To configure Message Manipulation rules, see <a href="#">Configuring SIP Message Manipulation</a> . <b>Note:</b> If you assign a Message Manipulation Set ID that includes rules for manipulating the host name in the Request-URI, To, and/or From SIP headers, the parameter overrides the [IPGroup_SIPGroupName] parameter.
'Message Manipulation User-Defined String 1' msg-man-user-defined-string1 [IPGroup_MsgManUserDef1]	Defines a value for the SIP user part that can be used in Message Manipulation rules configured in the Message Manipulations table. The Message Manipulation rule obtains this value from the IP Group, by using the following syntax: <code>param.ipg.&lt;src dst&gt;.user-defined.&lt;0&gt;.</code> The valid value is a string of up to 30 characters. By default, no value is defined. To configure Message Manipulation rules, see <a href="#">Configuring SIP Message Manipulation</a> .
'Message Manipulation User-Defined String 2' msg-man-user-defined-string2 [IPGroup_MsgManUserDef2]	Defines a value for the SIP user part that can be used in Message Manipulation rules configured in the Message Manipulations table. The Message Manipulation rule obtains this value from the IP Group, by using the following syntax: <code>param.ipg.&lt;src dst&gt;.user-defined.&lt;1&gt;.</code> The valid value is a string of up to 30 characters. By default, no value is defined. To configure Message Manipulation rules, see <a href="#">Configuring SIP Message Manipulation</a> .
'Proxy Keep-Alive using IP Group Settings' proxy-keepalive-use-ipg [ProxyKeepAliveUsingIPG]	Enables the device to apply certain IP Group settings to keep-alive SIP OPTIONS messages that are sent by the device to the proxy server. The parameter is applicable only if you have enabled proxy keep-alive for the Proxy Set that is associated with the IP Group (see <a href="#">Configuring Proxy Sets</a> on page 463). <ul style="list-style-type: none"> <li>■ [0] <b>Disable</b> = (Default) The IP Group's settings are not applied to the OPTIONS messages.</li> <li>■ [1] <b>Enable</b> = The following IP Group settings are applied (if configured) to the proxy keep-alive SIP OPTIONS messages:</li> </ul>

Parameter	Description
	<ul style="list-style-type: none"> <li>✓ The IP Group's 'SIP Group Name' parameter (see above) value is used in the OPTIONS messages.</li> <li>✓ The IP Group's 'Outbound Message Manipulation Set' parameter (see above) is applied to the OPTIONS messages (instead of manipulations configured by the [GWOutboundManipulationSet] parameter). You can also use the manipulation syntax "param.ipg.dst" for denoting the IP Group's parameters.</li> <li>✓ When filtering logs (configured in the Logging Filters table), the OPTIONS messages are filtered by IP Group. For more information on log filtering, see <a href="#">Configuring Log Filter Rules</a> on page 1302.</li> </ul> <p><b>Note:</b> When multiple IP Groups are associated with the same Proxy Set, the parameter can be enabled only on <b>one</b> of them.</p>
<b>SBC Registration and Authentication</b>	
<p>'Max. Number of Registered Users'</p> <p>max-num-of-reg-users</p> <p>[IPGroup_MaxNumOfRegUsers]</p>	<p>Defines the maximum number of users in this IP Group that can register with the device.</p> <p>The default is -1, meaning that no limitation exists for registered users.</p> <p><b>Note:</b> The parameter is applicable only to User-type IP Groups.</p>
<p>'Registration Mode'</p> <p>registration-mode</p> <p>[IPGroup_RegistrationMode]</p>	<p>Defines the registration mode for the IP Group.</p> <ul style="list-style-type: none"> <li>■ [0] <b>User Initiates Registration</b> (default)</li> <li>■ [1] <b>SBC Initiates Registration</b> = Used when the device serves as a client (e.g., with an IP PBX). This functions only with the User Information table (see <a href="#">Configuring SBC User Information Table through Web Interface</a> on page 606).</li> <li>■ [2] <b>Registrations not Needed</b> = The device adds users to its database in active state.</li> </ul>
<p>'User Stickiness'</p> <p>sbc-user-stickiness</p> <p>[IPGroup_</p>	<p>Enables user "stickiness" (binding) to a specific registrar server. The registrar server is one of the IP addresses of the Proxy Set associated with this Server-type IP Group. This feature applies to users belonging to a User-type IP Group that are routed to this destination Server-type IP Group.</p>

Parameter	Description
SBCUserStickiness]	<ul style="list-style-type: none"> <li data-bbox="667 286 1382 555">■ [0] <b>Disable</b> = After a successful initial registration of the user to a registrar, whenever the device receives a SIP request or registration refresh from the user, the device sends the request to whichever registrar (IP address of the Proxy Set) is currently active. In the case of proxy load-balancing, there is no certainty to which IP address the request is routed.</li> <li data-bbox="667 584 1382 1010">■ [1] <b>Enable</b> = The device always routes SIP requests (INVITEs, SUBSCRIBEs and REGISTER refreshes) received from the user to the same registrar server to which the last successful REGISTER request for that user was routed. In other words, once initial registration of the user to one of the IP addresses of the Proxy Set associated with this destination Server-type IP Group is successful (i.e., 200 OK), binding occurs to this specific address (registrar) and all future SIP requests from the user are routed (based on matched routing rule) only to this specific registrar.</li> </ul> <p data-bbox="667 1039 740 1068"><b>Note:</b></p> <ul style="list-style-type: none"> <li data-bbox="667 1097 1305 1167">■ The parameter is applicable only to Server-type IP Groups</li> <li data-bbox="667 1196 1366 1305">■ The Proxy Set associated with the Server-type IP Group must be configured with multiple IP addresses (or an FQDN that resolves into multiple IP addresses).</li> <li data-bbox="667 1335 1385 1603">■ This feature is also applicable to IP Group Sets (see <a href="#">Configuring IP Group Sets</a>). If a user is bound to a registrar associated with this Server-type IP Group which also belongs to an IP Group Set, IP Group Set logic of choosing an IP Group is ignored and instead, the device always routes requests from this user to this specific registrar.</li> <li data-bbox="667 1632 1382 1991">■ A user's "stickiness" to a specific registrar ends upon the following scenarios: <ul style="list-style-type: none"> <li data-bbox="715 1727 1091 1756">✓ If you modify the Proxy Set.</li> <li data-bbox="715 1785 1350 1895">✓ If the Proxy Set is configured with an FQDN and a DNS resolution refresh removes the IP address to which the user is bound.</li> <li data-bbox="715 1924 1326 1991">✓ User registration expires or the user initiates an unregister request.</li> </ul> </li> </ul>

Parameter	Description
	<ul style="list-style-type: none"> <li data-bbox="667 286 1394 875">■ The Proxy Set's Hot-Swap feature (for proxy redundancy) is not supported for users that are already bound to a registrar. However, you can achieve proxy "hot-swap" for failed initial (non-bounded) REGISTER requests. If the device receives a failure response for the initial REGISTER request and you have configured this response code for the Alternative Reasons Set associated (by the 'SBC Alternative Routing Reasons Set' parameter below) with the IP Group (see <a href="#">Configuring SIP Response Codes for Alternative Routing Reasons</a>), "hot-swap" to the other IP addresses of the Proxy Set is done until a success response is received from one of the addresses. For failed REGISTER refresh requests from users that are already bound to a registrar, no "hot-swap" occurs for that request; only for subsequent refresh requests.</li> <li data-bbox="667 902 1394 1167">■ When using the User Information table (see <a href="#">SBC User Information for SBC User Database</a>), registrar "stickiness" is supported only when the user initiates the REGISTER request. Therefore, you must configure the 'Registration Mode' parameter of the IP Group (User-type) to which the user belongs, to <b>User Initiates Registration</b>.</li> </ul>
<p data-bbox="312 1211 488 1279">'User UDP Port Assignment'</p> <p data-bbox="312 1294 568 1361">user-udp-port-assignment</p> <p data-bbox="312 1384 616 1451">[IPGroup_UserUDPPortAssignment]</p>	<p data-bbox="671 1211 1394 1480">Enables the device to assign a unique, local UDP port (for SIP signaling) per registered user (User-type IP Group) on the leg interfacing with the proxy server (Server-type IP Group). The port is used for incoming (from the proxy to the user) and outgoing (from the user to the proxy) SIP messages. Therefore, the parameter must be enabled for the IP Group of the proxy server.</p> <ul style="list-style-type: none"> <li data-bbox="667 1507 1362 1659">■ [0] <b>Disable</b> = (Default) The device uses the same local UDP port for all the registered users. This single port is configured for the SIP Interface ('UDP Port' parameter) associated with the Proxy Set of the proxy server.</li> <li data-bbox="667 1686 1378 1879">■ [1] <b>Enable</b> = The device assigns each registered user a unique local port, chosen from a configured UDP port range. The port range is configured for the SIP Interface ('Additional UDP Ports' parameter) associated with the proxy server.</li> </ul> <p data-bbox="711 1906 1394 1973">The device assigns a unique port upon the first REGISTER request received from the user. Subsequent SIP mes-</p>

Parameter	Description
	<p>sages other than REGISTER messages (e.g., INVITE) from the user are sent to the proxy server on this unique local port. The device rejects the SIP request if there is no available unique port for use (due to the number of registered users exceeding the configured port range). The same unique port is also used for registration refreshes. The device de-allocates the port for registration expiry. For SIP requests from the proxy server, the local port on which they are received is irrelevant (unique port or any other port); the device does not use this port to identify the registered user.</p> <p><b>Note:</b></p> <ul style="list-style-type: none"> <li>■ This feature does not apply to SIP requests received from non-registered users. For these users, the device sends all requests to the proxy server on the single port configured for the SIP Interface ('UDP Port' parameter).</li> <li>■ This feature is applicable only if the user initiates registration (i.e., user sends the REGISTER request). In other words, the 'Registration Mode' parameter of the IP Group of the user must be configured to <b>User Initiates Registration</b>.</li> </ul>
<p>'Authentication Mode' authentication- mode [IPGroup_ AuthenticationMode]</p>	<p>Defines the authentication mode.</p> <ul style="list-style-type: none"> <li>■ [0] <b>User Authenticates</b> = (Default) The device does not handle authentication, but simply forwards the authentication messages between the SIP user agents.</li> <li>■ [1] <b>SBC as Client</b> = The device authenticates as a client. It receives the 401/407 response from the proxy requesting for authentication. The device sends the proxy the authorization credentials (i.e., username and password), which is obtained from one of the following (in chronological order): <ul style="list-style-type: none"> <li>a. If an Account exists in the Accounts table (see <a href="#">Configuring Registration Accounts</a>) for the Served IP Group and the Serving IP Group (i.e., the IP Group you are now configuring), the device uses the username and password configured for the Account (only if authenticating a Server-type IP Group). If the Account is not configured with a username and password, the device uses the username and password configured for this IP Group in the IP Groups table</li> </ul> </li> </ul>



Parameter	Description
	<p>(‘Username’ and ‘Password’ parameters).</p> <ul style="list-style-type: none"> <li><b>b.</b> If there is no Account in the Accounts table for the Served IP Group and Serving IP Group (i.e., the IP Group you are now configuring), the device uses the username and password configured for this IP Group in the IP Groups table (‘Username’ and ‘Password’ parameters).</li> <li><b>c.</b> Global username and password parameters (only if authenticating a Server-type IP Group).</li> <li><b>d.</b> User Information file.</li> <li><b>e.</b> Sends a request to users requesting credentials (only if authenticating a User-type IP Group).</li> </ul> <p>■ [2] <b>SBC as Server</b> = The device acts as an Authentication server:</p> <ul style="list-style-type: none"> <li>✓ Authenticates SIP clients. This is applicable only to User-type IP Groups. The device authenticates incoming SIP requests from users belonging to this IP Group. The device authenticates all the users, using the username and password configured in the IP Group’s ‘Username’ and ‘Password’ parameters. However, if a user appears in the User Information table and which is configured with a username and password, then the device authenticates the user with the credentials in the User Information table (see <a href="#">Configuring SBC User Information</a> on page 605). If you have not configured any username and password, and the [SBCServerAuthMode] parameter is configured to [0] (default), the device rejects the incoming SIP request.</li> <li>✓ Authenticates SIP servers. This is applicable only to Server-type IP Groups.</li> </ul>
<p>‘Authentication Method List’                      authentication-method-list                      [IPGroup_MethodList]</p>	<p>Defines SIP methods received from the IP Group that must be challenged by the device when the device acts as an Authentication server. If no methods are configured, the device doesn’t challenge any methods.</p> <p>By default, no value is defined. To define multiple SIP methods, use the backslash (\) to separate each method (e.g., INVITE\REGISTER). To authenticate only setup INVITE requests (and not re-INVITE requests), configure the</p>

Parameter	Description
	<p>parameter to "setup-invite" (without quotation marks).</p> <p><b>Note:</b> The parameter is applicable only if the 'Authentication Mode' parameter is set to <b>SBC as Server</b>.</p>
<p>'SBC Server Authentication Type' sbc-server-auth-type [IPGroup_TypeSBCServerAuthType]</p>	<p>Defines the authentication method when the device, as an Authentication server, authenticates SIP requests from the IP Group.</p> <ul style="list-style-type: none"> <li>■ [-1] <b>According to Global Parameter</b> = (Default) Authentication is according to the settings of the SBCServerAuthMode parameter.</li> <li>■ [0] <b>Authentication is performed locally</b> = The device authenticates incoming SIP requests locally. For more information, see <a href="#">SIP Authentication Server Functionality</a> on page 927.</li> <li>■ [2] <b>According to draft-sterman-aaa-sip-01</b> = The device authenticates incoming SIP requests using a remote RADIUS server, based on Internet Draft "draft-sterman-aaa-sip-01". For more information, see <a href="#">RADIUS-based User Authentication</a> on page 928.</li> <li>■ [3] <b>Authenticate with OAuth authorization</b> = The device authenticates incoming SIP requests according to token-based authentication with an OAuth2 Authorization server. The Authentication server is configured as a Remote Web Service and is assigned to the IP Group using the IP Group's 'OAuth HTTP Service' parameter. For more information, see <a href="#">OAuth2-based User Authentication</a> on page 928.</li> <li>■ [4] <b>ARM Authentication</b> = The device authenticates incoming SIP requests (INVITE or REGISTER) from User-type IP Groups, by first obtaining (REST-based API query) the user's password from a third-party routing server or AudioCodes ARM where the password is stored. Once the password is supplied, the device continues with the regular SIP digest authentication process (challenge) with the user. For more information on the third-party routing server or ARM, see <a href="#">Third-Party Routing Server or AudioCodes Routing Manager</a> on page 311.</li> </ul> <p><b>Note:</b></p> <ul style="list-style-type: none"> <li>■ If you configure the parameter to either <b>Authentication is performed locally</b>, <b>According to draft-sterman-aaa-</b></li> </ul>

Parameter	Description
	<p><b>sip-01, Authenticate with OAuth authorization, or ARM Authentication</b>, you also need to configure the IP Group's 'Authentication Mode' parameter to <b>SBC as Server</b>.</p> <ul style="list-style-type: none"> <li>■ If you configure the parameter to <b>ARM Authentication</b>, you also need to configure the IP Group's 'Authentication Method List' parameter to authenticate INVITE or REGISTER messages.</li> </ul>
<p>'OAuth HTTP Service' oauth-http-service [IPGroup_OAuthHTTPService]</p>	<p>Assigns a Remote Web Service to the IP Group. The Remote Web Service represents the OAuth Authorization server, which the device uses to authenticate incoming SIP requests as a server. The device sends the OAuth token received from the client to the Authorization server for authentication.</p> <p>To configure Remote Web Services, see <a href="#">Configuring Remote Web Services</a> on page 299. For more information on OAuth-based authentication, see <a href="#">OAuth2-based User Authentication</a> on page 928.</p> <p><b>Note:</b> The parameter is applicable only if the IP Group's 'SBC Server Authentication' parameter is configured to <b>Authenticate with OAuth authorization</b>.</p>
<p>'Username' username [IPGroup_Username]</p>	<p>Defines the shared username for authenticating the IP Group.</p> <p>The valid value is a string of up to 60 characters. By default, no username is defined.</p> <p><b>Note:</b> If you configure the 'Authentication Mode' parameter to <b>SBC as Server</b>, you need to specify the SIP request (method) types (e.g., INVITE) that must be challenged by the device, using the IP Group's 'Authentication Method List' parameter.</p>
<p>'Password' password [IPGroup_Password]</p>	<p>Defines the shared password for authenticating the IP Group.</p> <p>The valid value is a string of up to 51 characters. By default, no password is defined.</p> <p><b>Note:</b></p> <ul style="list-style-type: none"> <li>■ If you configure the 'Authentication Mode' parameter to <b>SBC as Server</b>, you can specify the SIP request (method) types (e.g., INVITE) that must be challenged by the device, using the IP Group's 'Authentication Method List' parameter.</li> </ul>

Parameter	Description
	<ul style="list-style-type: none"> <li>■ The password cannot be configured with wide characters.</li> </ul>
<b>Gateway</b>	
'SIP Re-Routing Mode' re-routing-mode [IPGroup_ SIPReRoutingMode]	Defines the routing mode after a call redirection (i.e., a 3xx SIP response is received) or transfer (i.e., a SIP REFER request is received). <ul style="list-style-type: none"> <li>■ [-1] = Not Configured (Default)</li> <li>■ [0] <b>Standard</b> = INVITE messages that are generated as a result of Transfer or Redirect are sent directly to the URI, according to the Refer-To header in the REFER message or Contact header in the 3xx response.</li> <li>■ [1] <b>Proxy</b> = Sends a new INVITE to the Proxy. This is applicable only if a Proxy server is used and the parameter [AlwaysSendtoProxy] is set to [0].</li> <li>■ [2] <b>Routing Table</b> = Uses the Routing table to locate the destination and then sends a new INVITE to this destination.</li> </ul> <p><b>Note:</b></p> <ul style="list-style-type: none"> <li>■ When the parameter is configured to [1] and the INVITE sent to the Proxy fails, the device re-routes the call according to the Standard mode [0].</li> <li>■ When the parameter is configured to [2] and the INVITE fails, the device re-routes the call according to the Standard mode [0]. If DNS resolution fails, the device attempts to route the call to the Proxy. If routing to the Proxy also fails, the Redirect / Transfer request is rejected.</li> <li>■ When the parameter is set to [2], the [XferPrefix] parameter can be used to define different routing rules for redirected calls.</li> <li>■ The parameter is ignored if the parameter [AlwaysSendToProxy] is set to [1].</li> </ul>
'Always Use Route Table' always-use-route-table [IPGroup_]	Defines the Request-URI host name in outgoing INVITE messages. <ul style="list-style-type: none"> <li>■ [0] <b>No</b> (default).</li> </ul>

Parameter	Description
AlwaysUseRouteTable]	<ul style="list-style-type: none"> <li>[1] <b>Yes</b> = The device uses the IP address (or domain name) defined in the Tel-to-IP Routing table (see <a href="#">Configuring Tel-to-IP Routing Rules</a>) as the Request-URI host name in outgoing INVITE messages, instead of the value configured in the 'SIP Group Name' field.</li> </ul> <p><b>Note:</b> The parameter is applicable only to Server-type IP Groups.</p>
GW Group Status	
'GW Group Registered IP Address'	<p>(Read-only field) Displays the IP address of the IP Group entity (gateway) if registered with the device; otherwise, the field is blank.</p> <p><b>Note:</b> The field is applicable only to Gateway-type IP Groups (i.e., the 'Type' parameter is configured to Gateway).</p>
'GW Group Registered Status'	<p>(Read-only field) Displays whether the IP Group entity (gateway) is registered with the device ("Registered" or "Not Registered").</p> <p>Note: The field is applicable only to Gateway-type IP Groups (i.e., the 'Type' parameter is configured to Gateway).</p>

## Configuring Proxy Sets

The Proxy Sets table lets you configure up to 102 Proxy Sets. A Proxy Set defines the address (IP address or FQDN) and transport type (e.g., UDP or TCP) of a SIP server (e.g., SIP proxy and SIP registrar server). The Proxy Set represents the destination of the IP Group configuration entity.



- You can configure each Proxy Set with up to 10 proxy servers (rows) in the Proxy Address table (a "child" of the Proxy Sets table), configured as IP addresses (in dotted-decimal notation) and/or DNS hostnames (FQDN).
- Each Proxy Set supports up to 15 DNS-resolved IP addresses.
- Each Proxy Set supports up to 15 IP addresses, regardless of how the IP address is obtained—DNS resolved or manually configured (dotted-decimal notation).
- For all Proxy Sets together, the device supports up to 500 DNS-resolved IP addresses. If the DNS resolution provides more than this number, it ignores the extra addresses.
- An SRV query sent by the device can return up to 50 hostnames. For each hostname, the subsequent DNS A-record query sent by the device can resolve into up to 50 IP addresses.

Multiple proxy servers enables you to implement proxy load balancing and redundancy. These features are supported by the device's proxy keep-alive feature, which when enabled, sends

keep-alive messages (SIP OPTIONS) to all configured proxy servers to determine their connectivity status (offline or online). You can also configure the device to consider the proxy as offline if specific SIP response codes are received in response to the keep-alive messages. You can configure the number of required consecutive successful keep-alive messages before the device considers a previously offline proxy as online. This mechanism avoids the scenario in which the device falsely detects a proxy as being online when it is actually offline, resulting in call routing failure.

You can assign each Proxy Set a specific TLS Context (TLS configuration), enabling you to use different TLS settings (including certificates) per SIP entity (IP Group).

You can also enable the device to classify incoming SBC SIP dialogs to IP Groups, based on Proxy Set. If the source address of the incoming SIP dialog is the same as the address of a Proxy Set, the device classifies the SIP dialog as belonging to the IP Group that is associated with the Proxy Set.

To use a configured Proxy Set, you need to assign it to an IP Group in the IP Groups table (see [Configuring IP Groups](#)). When the device sends INVITE messages to an IP Group, it sends it to the address configured for the Proxy Set. You can assign the same Proxy Set to multiple IP Groups (belonging to the same SRD).



- It is recommended to classify incoming SIP dialogs to IP Groups based on Classification rules (see [Configuring Classification Rules](#) on page 954) instead of based on Proxy Sets.
- For the Gateway application, you can view the device's connectivity status with proxy servers in the Tel-to-IP Routing table for Tel-to-IP routing rules whose destination is an IP Group that is associated with a Proxy Set. The status is only displayed for Proxy Sets enabled with the Proxy Keep-Alive feature.
- To view the connectivity status of Proxy Sets, see [Viewing Proxy Set Status](#) on page 1194.

The Proxy Set is configured using two tables, one a "child" of the other:

- Proxy Sets table: Defines the attributes of the Proxy Set such as associated SIP Interface and redundancy features - ini file parameter [ProxySet] or CLI command, `configure voip > proxy-set`
- Proxy Set Address table ("child"): Defines the addresses of the Proxy Set - table ini file parameter [ProxyIP] or CLI command, `configure voip > proxy-ip > proxy-set-id`

#### ➤ To configure a Proxy Set:

1. Open the Proxy Sets table (**Setup** menu > **Signaling & Media** tab > **Core Entities** folder > **Proxy Sets**).
2. Click **New**; the following dialog box appears (screenshot has been cropped due to page size):

3. Configure a Proxy Set according to the parameters described in the table below.
4. Click **Apply**.
5. Select the index row of the Proxy Set that you added, and then click the **Proxy Address** link located below the table; the Proxy Address table opens.
6. Click **New**; the following dialog box appears:

7. Configure the address of the Proxy Set according to the parameters described in the table below.
8. Click **Apply**.

**Table 18-6: Proxy Sets Table and Proxy Address Table Parameter Description**

Parameter	Description
'SRD' voip-network	Assigns an SRD to the Proxy Set. <b>Note:</b>

Parameter	Description
<pre>proxy-set &gt; srd-id</pre> <p>[ProxySet_SRDName]</p>	<ul style="list-style-type: none"> <li>■ The parameter is mandatory and must be configured first before you can configure the other parameters in the table.</li> <li>■ To configure SRDs, see <a href="#">Configuring SRDs</a>.</li> </ul>
<b>General</b>	
<p>'Index'</p> <pre>configure voip &gt; voip-network proxy-set</pre> <p>[ProxySet_Index]</p>	<p>Defines an index number for the new table row.</p> <p><b>Note:</b> Each row must be configured with a unique index.</p>
<p>'Name'</p> <pre>proxy-name</pre> <p>[ProxySet_ProxyName]</p>	<p>Defines a descriptive name, which is used when associating the row in other tables.</p> <p>The valid value is a string of up to 40 characters.</p> <p><b>Note:</b></p> <ul style="list-style-type: none"> <li>■ Each row must be configured with a unique name.</li> <li>■ The parameter value cannot contain a forward slash (/).</li> </ul>
<p>'Gateway IPv4 SIP Interface'</p> <pre>gwipv4-sip-int- name</pre> <p>[ProxySet_ GWIPv4SIPInterfaceNa me]</p>	<p>Assigns an IPv4-based SIP Interface for Gateway calls to the Proxy Set.</p> <p><b>Note:</b></p> <ul style="list-style-type: none"> <li>■ At least one SIP Interface must be assigned to the Proxy Set.</li> <li>■ The parameter appears only if you have configured a network interface with an IPv4 address in the IP Interfaces table (see <a href="#">Configuring IP Network Interfaces</a>).</li> <li>■ To configure SIP Interfaces, see <a href="#">Configuring SIP Interfaces</a>.</li> </ul>
<p>'SBC IPv4 SIP Interface'</p> <pre>sbcipv4-sip- int-name</pre> <p>[ProxySet_ SBCIPv4SIPInterfaceNa me]</p>	<p>Assigns an IPv4-based SIP Interface for SBC calls to the Proxy Set.</p> <p><b>Note:</b></p> <ul style="list-style-type: none"> <li>■ At least one SIP Interface must be assigned to the Proxy Set.</li> <li>■ The parameter appears only if you have configured a network interface with an IPv4 address in the IP Interfaces table (see <a href="#">Configuring IP Network Interfaces</a>).</li> <li>■ To configure SIP Interfaces, see <a href="#">Configuring SIP Interfaces</a>.</li> </ul>



Parameter	Description
'Gateway IPv6 SIP Interface' gwipv6-sip-int-name [ProxySet_ GWIPv6SIPInterfaceName]	Assigns an IPv6-based SIP Interface for Gateway calls to the Proxy Set. <b>Note:</b> <ul style="list-style-type: none"> <li>■ At least one SIP Interface must be assigned to the Proxy Set.</li> <li>■ The parameter appears only if you have configured a network interface with an IPv6 address in the IP Interfaces table.</li> </ul>
'SBC IPv6 SIP Interface' sbcipv6-sip-int-name [ProxySet_ SBCIPv6SIPInterfaceName]	Assigns an IPv6-based SIP Interface for SBC calls to the Proxy Set. <b>Note:</b> <ul style="list-style-type: none"> <li>■ At least one SIP Interface must be assigned to the Proxy Set.</li> <li>■ The parameter appears only if you have configured a network interface with an IPv6 address in the IP Interfaces table.</li> </ul>
'TLS Context Name' tls-context-name [ProxySet_ TLSContextName]	Assigns a TLS Context (TLS configuration) to the Proxy Set. By default, no TLS Context is assigned. If you assign a TLS Context, the TLS Context is used as follows: <ul style="list-style-type: none"> <li>■ Incoming calls: If the 'Transport Type' parameter (in this table) is set to <b>TLS</b> and the incoming call is successfully classified to an IP Group based on the Proxy Set, this TLS Context is used. If the 'Transport Type' parameter is set to <b>UDP</b> or classification to this Proxy Set fails, the TLS Context is not used. Instead, the device uses the TLS Context configured for the SIP Interface (see <a href="#">Configuring SIP Interfaces</a>) used for the call; otherwise, the default TLS Context (ID 0) is used.</li> <li>■ Outgoing calls: If the 'Transport Type' parameter is set to <b>TLS</b> and the outgoing call is sent to an IP Group that is associated with this Proxy Set, this TLS Context is used. Instead, the device uses the TLS Context configured for the SIP Interface used for the call; otherwise, the default TLS Context (ID 0) is used. If the 'Transport Type' parameter is set to <b>UDP</b>, the device uses UDP to communicate with the proxy and no TLS Context is used.</li> </ul> To configure TLS Contexts, see <a href="#">Configuring TLS Certificates</a> on page 154.

Parameter	Description
Keep Alive	
<p>'Proxy Keep-Alive'</p> <p>proxy-enable-keep-alive</p> <p>[ProxySet_EnableProxyKeepAlive]</p>	<p>Enables the device's Proxy Keep-Alive feature, which checks connectivity with all the proxy servers of the Proxy Set, by sending keep-alive messages.</p> <ul style="list-style-type: none"> <li>■ [0] <b>Disable</b> (default).</li> <li>■ [1] <b>Using OPTIONS</b> = Enables the Proxy Keep-Alive feature using SIP OPTIONS messages. The device sends an OPTIONS message every user-defined interval, configured by the 'Proxy Keep-Alive Time' parameter (in this table). If the device receives a SIP response code that is configured in the 'Keep-Alive Failure Responses' parameter (in this table), the device considers the proxy as offline. You can also configure if the device uses its IP address, the proxy's IP address, or the device's name in the OPTIONS message, using the [UseGatewayNameForOptions] parameter.</li> <li>■ [2] <b>Using REGISTER</b> = Enables the Proxy Keep-Alive feature using SIP REGISTER messages. The device sends a REGISTER message every user-defined interval, configured by the RegistrationTime parameter (Gateway application) or SBCProxyRegistrationTime parameter (SBC application). Any SIP response from the proxy - success (200 OK) or failure (4xx response) - is considered as if the proxy is "alive". If the proxy does not respond to INVITE messages sent by the device, the proxy is considered as down (offline). The device sends keep-alive REGISTER messages only to one proxy. Only if the proxy fails to respond to the keep-alive, does the device send the next keep-alive REGISTER message to another proxy.</li> <li>■ [3] <b>Using OPTIONS on Active Server</b> = Enables the Proxy Keep-Alive feature using SIP OPTIONS messages (similar to the <b>Using OPTIONS</b> value), except that the proxy servers to which the keep-alive messages are sent depend on the settings of the Proxy Set's 'Redundancy Mode' parameter (see below): <ul style="list-style-type: none"> <li>✓ <b>Parking:</b> The device sends the keep-alive OPTIONS messages only to the currently active proxy server (to which it is connected and using).</li> <li>✓ <b>Homing:</b> The device sends keep-alive OPTIONS messages to the currently active proxy server as well as</li> </ul> </li> </ul>

Parameter	Description
	<p>to all proxy servers with higher priority (according to the 'Proxy Priority' parameter described below) than the active server. Once a higher priority server comes online, the device stops sending the keep-alive OPTIONS messages to the previously active server and connects to the higher priority server. The device now sends keep-alive messages to this newly active server and all other servers with higher priority.</p> <ul style="list-style-type: none"> <li>✓ If the 'Redundancy Mode' parameter is not configured (empty) and the Proxy Set's 'Proxy Load Balancing Method' parameter (see below) is configured to any value other than <b>Disable</b>, the device sends the keep-alive OPTIONS messages to all proxy servers (same behavior as when you configure the 'Proxy Keep-Alive' parameter to <b>Using OPTIONS</b>).</li> </ul> <p><b>Note:</b></p> <ul style="list-style-type: none"> <li>■ Proxy keep-alive using REGISTER messages (<b>Using REGISTER</b>) is applicable only to the Parking redundancy mode ('Redundancy Mode' parameter configured to <b>Parking</b>).</li> <li>■ If you enable this Proxy Keep-Alive feature, the device can operate with multiple proxy servers (addresses) for redundancy and load balancing (see the 'Proxy Load Balancing Method' parameter).</li> <li>■ For Survivability mode for User-type IP Groups, you must enable this Proxy Keep-Alive feature.</li> <li>■ If you enable this Proxy Keep-Alive feature and the proxy uses the TCP/TLS transport type, you can enable CRLF Keep-Alive feature, using the [UsePingPongKeepAlive] parameter.</li> <li>■ If you enable proxy keep-alive using SIP OPTIONS messages (<b>Using OPTIONS</b> or <b>Using OPTIONS on Active Server</b>), you can also enable the device to apply various settings (e.g., SIP message manipulations) of the IP Group that is associated with the Proxy Set , to these SIP messages. For more information, see the 'Proxy Keep-Alive using IP Group Settings' parameter in the IP Groups table.</li> <li>■ If you enable proxy keep-alive using SIP OPTIONS messages (<b>Using OPTIONS</b> or <b>Using OPTIONS on Active Server</b>), you can also configure how long the device waits (in seconds)</li> </ul>

Parameter	Description
	<p>before re-sending a keep-alive OPTIONS message once the device considers the proxy as offline (i.e., after all retransmissions, configured by the 'Failure Detection Retransmissions' have failed). This feature is configured by the [FailedOptionsRetryTime] parameter.</p>
<p>'Proxy Keep-Alive Time' proxy-keep-alive-time [ProxySet_ProxyKeepAliveTime]</p>	<p>Defines the interval (in seconds) between keep-alive messages sent by the device when the Proxy Keep-Alive feature is enabled (see the 'Proxy Keep-Alive' parameter in this table).</p> <p>The valid range is 5 to 2,000,000. The default is 60.</p> <p><b>Note:</b> The parameter is applicable only if the 'Proxy Keep-Alive' parameter is configured to <b>Using OPTIONS</b> or <b>Using OPTIONS on Active Server</b>.</p>
<p>'Keep-Alive Failure Responses' keepalive-fail- resp [ProxySet_KeepAliveFailureResp]</p>	<p>Defines SIP response codes that if any is received in response to a keep-alive message using SIP OPTIONS, the device considers the proxy as down.</p> <p>Up to three response codes can be configured, where each code is separated by a comma (e.g., 407,404). By default, no response code is defined. If no response code is configured, or if response codes received are not those configured, the proxy is considered "alive".</p> <p><b>Note:</b></p> <ul style="list-style-type: none"> <li>■ The SIP 200 response code is not supported for this feature.</li> <li>■ The parameter is applicable only if the 'Proxy Keep-Alive' parameter is configured to <b>Using OPTIONS</b> or <b>Using OPTIONS on Active Server</b>.</li> </ul>
<p>'Success Detection Retries' success-detect- retries [ProxySet_SuccessDetectionRetrie s]</p>	<p>Defines the minimum number of consecutive, successful keep-alive messages that the device sends to an offline proxy, before the device considers the proxy as being online. The interval between the sending of each consecutive successful keep-alive is configured by the 'Success Detection Interval' parameter (see below). For an example of using this parameter, see the 'Success Detection Interval' parameter.</p> <p>The valid range is 1 to 100. The default is 1.</p> <p><b>Note:</b> The parameter is applicable only if the 'Proxy Keep-Alive' parameter is configured to <b>Using OPTIONS</b> or <b>Using OPTIONS on Active Server</b>.</p>
<p>'Success Detection Interval'</p>	<p>Defines the interval (in seconds) between each successful keep-alive retries (as configured by the 'Success Detection Retries'</p>

Parameter	Description
success-detect-int [ProxySet_SuccessDetectionInterval]	<p>parameter) that the device performs for offline proxies. The valid range is 1 to 200. The default is 10.</p> <p>For example, assume that the 'Success Detection Retries' parameter is configured to 3 and the 'Success Detection Interval' parameter to 5 (seconds). When connectivity is lost with the proxy, the device sends keep-alive messages to the proxy. If the device receives a successful response from the proxy, it sends another (1st) keep-alive after 5 seconds, and if successful, sends another (2nd) keep-alive after 5 seconds, and if successful, sends another (3rd) keep-alive after 5 seconds, and if successful, considers connectivity with the proxy as being restored.</p> <p><b>Note:</b> The parameter is applicable only if the 'Proxy Keep-Alive' parameter is configured to <b>Using OPTIONS</b> or <b>Using OPTIONS on Active Server</b>.</p>
'Failure Detection Retransmissions' fail-detect-rtx [ProxySet_FailureDetectionRetransmissions]	<p>Defines the maximum number of UDP retransmissions that the device sends to an offline proxy before the device considers the proxy as offline.</p> <p>The valid range is -1 to 255. The default is -1, which means that the settings of the global parameter [SIPMaxRtx] is applied.</p> <p><b>Note:</b> The parameter is applicable only if the 'Proxy Keep-Alive' parameter is configured to <b>Using OPTIONS</b> or <b>Using OPTIONS on Active Server</b>.</p>
Redundancy	
'Redundancy Mode' proxy-redundancy-mode [ProxySet_ProxyRedundancyMode]	<p>Enables the proxy redundancy mode.</p> <ul style="list-style-type: none"> <li>■ [-1] = Not configured (Default). Proxy redundancy method is according to the settings of the global parameter [ProxyRedundancyMode].</li> <li>■ [0] <b>Parking</b> = If the device operates with a proxy server that has the highest priority and the proxy goes offline, the device attempts to connect and operate with a different proxy that has the highest priority of all currently online proxies. However, once the device starts operating with this new proxy, it remains operating with it even if a previously offline proxy that has higher priority becomes online again.</li> <li>■ [1] <b>Homing</b> = The device always attempts to operate with the proxy that has the highest priority of all currently online proxies. For example, if the device is currently operating</li> </ul>

Parameter	Description
	<p>with proxy server 200.10.1.1 that has priority 4, and then a previously offline proxy 200.10.1.2 that has priority 0 (i.e., a higher priority) becomes online again, the device attempts to connect and operate with proxy 200.10.1.2.</p> <p><b>Note:</b></p> <ul style="list-style-type: none"> <li>■ For proxy redundancy, you also need to enable the proxy keep-alive feature (see the 'Proxy Keep-Alive' parameter, above). The <b>Homing</b> redundancy mode is applicable only to proxy keep-alive using SIP OPTIONS (i.e., 'Proxy Keep-Alive' parameter is configured to <b>Using OPTIONS</b> or <b>Using OPTIONS on Active Server</b>). The <b>Parking</b> redundancy mode is applicable to all proxy keep-alive methods (SIP OPTIONS and SIP REGISTER).</li> <li>■ From Version 7.20A.204, if you configure the parameter to <b>Parking</b> and the proxy keep-alive is done using REGISTER messages, when the proxy goes offline, the device arbitrarily chooses the next proxy to operate with.</li> <li>■ To configure proxy priority, see the 'Proxy Priority' parameter in the Proxy Address table (below).</li> </ul>
<p>'Proxy Hot Swap' is-proxy-hot-swap [ProxySet_ IsProxyHotSwap]</p>	<p>Enables the Proxy Hot-Swap feature, whereby if the device sends a SIP message (INVITE or REGISTER) to the proxy and the message fails, the device re-sends the same message to a redundant proxy configured for the Proxy Set. The redundant proxy is determined by your Proxy Set configuration (i.e., redundancy mode and load balancing).</p> <ul style="list-style-type: none"> <li>■ [0] <b>Disable</b> = (Default) Disables the Proxy Hot-Swap feature. If the SIP message is rejected by the proxy or no response is received for a user-defined number of re-transmissions (configured by the [HotSwapRtx] parameter), the device does not attempt to connect to any other proxy configured for the Proxy Set and the SIP message fails.</li> <li>■ [1] <b>Enable</b> = If the device sends a SIP message (INVITE or REGISTER) to the proxy with which it is currently operating and any of the following occurs, the device re-sends the message to a redundant online proxy: <ul style="list-style-type: none"> <li>✓ No response is received from the proxy each time the device re-sends it. The number of retransmissions is configured by the [HotSwapRtx] parameter. In such a scenario, the device issues itself the SIP response code</li> </ul> </li> </ul>

Parameter	Description
	<p>408 (Request Timeout).</p> <ul style="list-style-type: none"> <li>✓ (SBC Application) The proxy rejects the message with a SIP response code that you have also configured for the Alternative Reasons Set that is assigned to the IP Group ('SBC Alternative Routing Reasons Set' parameter) associated with the Proxy Set (see <a href="#">Configuring SIP Response Codes for Alternative Routing Reasons</a>).</li> <li>✓ (Gateway Application) The proxy rejects the message with a SIP response code that is also configured in the Reasons for Tel-to-IP Alternative Routing table (see <a href="#">Alternative Routing Based on SIP Responses</a>).</li> </ul> <p><b>Note:</b> For the SBC application: You can employ alternative routing with this option. If no response is received from any of the redundant (online) proxies or the proxies reject the message with a SIP response code that you have configured for the Alternative Reasons Set that is assigned to the IP Group ('SBC Alternative Routing Reasons Set' parameter) associated with the Proxy Set, the device searches the IP-to-IP Routing table for an alternative routing rule and if found, sends the message to the rule's destination. For more information on the Proxy Hot Swap feature and alternative routing based on SIP response codes, see <a href="#">Configuring SIP Response Codes for Alternative Routing Reasons</a> on page 992.</p>
<p>'Proxy Load Balancing Method'  <code>proxy-load-balancing-method</code>  [ProxySet_  ProxyLoadBalancingMethod]</p>	<p>Enables load balancing between proxy servers of the Proxy Set.</p> <ul style="list-style-type: none"> <li>■ [0] <b>Disable</b> = (Default) Disables proxy load balancing.</li> <li>■ [1] <b>Round Robin</b> = The device sends outgoing SIP messages to the online proxy servers of the Proxy Set in a round-robin fashion. The order of the round-robin is determined by the listed order of the IP addresses in the Proxy Address table and their priority. You can configure priority of each IP address using the 'Proxy Priority' parameter (see below). For DNS-resolved IP addresses for proxy servers configured with an FQDN (including NAPTR and SRV, if configured), the priority is received from the DNS. For the Gateway application, REGISTER messages are also distributed in a round-robin fashion, unless you have configured a specific IP address of a registrar server (using the RegistrarIP parameter). The IP address list is refreshed every user-defined interval (see the ProxyIPListRefreshTime</li> </ul>

Parameter	Description
	<p>parameter). If a change in the order of the IP address entries in the list occurs, all load statistics are erased and balancing starts over again.</p> <ul style="list-style-type: none"> <li>■ [2] <b>Random Weights</b> = The outgoing requests are not distributed equally among the proxy servers. The distribution is determined by the weight of the proxy servers. You can configure the weight per proxy server, using the 'Proxy Random Weight' parameter in the Proxy Address table (see below). For proxy servers configured with an FQDN, the weight of each DNS-resolved IP address is received from the DNS server (using SRV records). However, if you have configured the weight for the FQDN in the 'Proxy Random Weight' parameter, this parameter's value overrides the weight from the DNS server. The device sends the requests in such a fashion that each proxy receives a percentage of the requests according to its weight.</li> </ul>
<p>'Min. Active Servers for Load Balancing' min-active-serv-lb [ProxySet_MinActiveServersLB]</p>	<p>Defines the minimum number of proxies in the Proxy Set that must be online for the device to consider the Proxy Set as online, when proxy load balancing is used.</p> <p>The valid value is 1 to 15. The default is 1.</p> <p><b>Note:</b> The parameter is applicable only if proxy load balancing is enabled (see the 'Proxy Load Balancing Method' parameter, above).</p>
<b>Advanced</b>	
<p>'Classification Input' classification-input [ProxySet_ClassificationInput]</p>	<p>Defines how the device classifies incoming IP calls to the Proxy Set.</p> <ul style="list-style-type: none"> <li>■ [0] <b>IP Address only</b> = (Default) Classifies calls to the Proxy Set according to IP address only.</li> <li>■ [1] <b>IP Address, Port &amp; Transport Type</b> = Classifies calls to the Proxy Set according to IP address, port, and transport type.</li> </ul> <p><b>Note:</b></p> <ul style="list-style-type: none"> <li>■ The parameter is applicable only to the SBC application.</li> <li>■ The parameter is applicable only if the IP Groups table's parameter 'Classify by Proxy Set' is configured to <b>Enable</b> (see <a href="#">Configuring IP Groups</a>).</li> </ul>



Parameter	Description												
	<p>■ If multiple Proxy Sets are configured with the same IP address and associated with the same SIP Interface, the device may classify the SIP dialog (based on Proxy Set) to an incorrect IP Group. In such a scenario, the device uses the Proxy Set with the lowest Index number (e.g., Proxy Set ID #1 over Proxy Set ID #4). A Syslog warning message is generated in such scenarios. Therefore, it is recommended to configure each Proxy Set with a unique IP address.</p> <p>If multiple Proxy Sets are configured with the same IP address but associated with different SIP Interfaces, then classification based on Proxy Set can be correctly achieved.</p> <p>If multiple Proxy Sets are configured with the same IP address and SIP Interface, but with different ports (e.g., 10.1.1.1:5060 and 10.1.1.1:5070) and the parameter is configured to <b>IP Address, Port &amp; Transport Type</b>, classification to the correct IP Group is achieved. Therefore, when classification is by Proxy Set, pay attention to the configured IP addresses and this parameter. When multiple Proxy Sets are configured with the same IP address, the device selects the matching Proxy Set in the following order:</p> <ul style="list-style-type: none"> <li>✓ Selects the Proxy Set whose IP address, port, and transport type match the source of the incoming SIP request (regardless of the settings of this parameter).</li> <li>✓ If no match is found for above, it selects the Proxy Set whose IP address and transport type match the source of the incoming SIP request (if the parameter is configured to <b>IP Address Only</b>).</li> <li>✓ If no match is found for above, it selects the Proxy Set whose IP address match the source of the incoming SIP request (if the parameter is configured to <b>IP Address Only</b>).</li> </ul> <p>For example:</p> <table border="1" data-bbox="638 1657 1388 1948"> <thead> <tr> <th data-bbox="646 1702 718 1736">Index</th> <th data-bbox="805 1702 1037 1736">Classification Input</th> <th data-bbox="1141 1668 1364 1780">Proxy Address (IP:Port;Transport Type)</th> </tr> </thead> <tbody> <tr> <td data-bbox="646 1803 662 1836">1</td> <td data-bbox="742 1780 1101 1859"><b>IP Address, Port &amp; Transport Type</b></td> <td data-bbox="1125 1803 1388 1836">10.10.10.10:5060;UDP</td> </tr> <tr> <td data-bbox="646 1870 662 1904">2</td> <td data-bbox="742 1870 941 1904"><b>IP Address only</b></td> <td data-bbox="1125 1870 1388 1904">10.10.10.10:5060;UDP</td> </tr> <tr> <td data-bbox="646 1915 662 1948">3</td> <td data-bbox="742 1915 941 1948"><b>IP Address only</b></td> <td data-bbox="1125 1915 1388 1948">10.10.10.10:5070;UDP</td> </tr> </tbody> </table>	Index	Classification Input	Proxy Address (IP:Port;Transport Type)	1	<b>IP Address, Port &amp; Transport Type</b>	10.10.10.10:5060;UDP	2	<b>IP Address only</b>	10.10.10.10:5060;UDP	3	<b>IP Address only</b>	10.10.10.10:5070;UDP
Index	Classification Input	Proxy Address (IP:Port;Transport Type)											
1	<b>IP Address, Port &amp; Transport Type</b>	10.10.10.10:5060;UDP											
2	<b>IP Address only</b>	10.10.10.10:5060;UDP											
3	<b>IP Address only</b>	10.10.10.10:5070;UDP											

Parameter	Description
	<p>4 <b>IP Address only</b> 10.10.10.10:5060;TCP</p> <ul style="list-style-type: none"> <li>✓ <b>Incoming SIP request from 10.10.10.10:5060;UDP:</b> Best match is #1 and #2 (same priority); second best match is #3 (due to transport type); third best match is #4.</li> <li>✓ <b>Incoming SIP request from 10.10.10.10:5080;TLS:</b> Best match is #2, #3 and #4 (same priority).</li> <li>✓ <b>Incoming SIP request from 10.10.10.10:5070;TCP:</b> Best match is #4 (due to transport type); second best match is #2 and #3 (same priority).</li> </ul>
<p>'DNS Resolve Method' dns-resolve-method [ProxySet_DNSResolveMethod]</p>	<p>Defines the DNS query record type for resolving the proxy server's host name (FQDN) into an IP address(es).</p> <ul style="list-style-type: none"> <li>■ [-1] = Not configured. DNS resolution method is according to the settings of the global parameter [ProxyDNSQueryType].</li> <li>■ [0] <b>A-Record</b> = (Default) DNS A-record query is used to resolve DNS to IP addresses.</li> <li>■ [1] <b>SRV</b> = If the proxy address is configured with a domain name without a port (e.g., domain.com), an SRV query is done. The SRV query returns the host names (and their weights). The device then performs DNS A-record queries per host name (according to the received weights). If the configured proxy address contains a domain name with a port (e.g., domain.com:5080), the device performs a regular DNS A-record query.</li> <li>■ [2] <b>NAPTR</b> = NAPTR query is done. If successful, an SRV query is sent according to the information received in the NAPTR response. If the NAPTR query fails, an SRV query is done according to the configured transport type. If the configured proxy address contains a domain name with a port (e.g., domain.com:5080), the device performs a regular DNS A-record query. If the transport type is configured for the proxy address, a NAPTR query is not performed.</li> <li>■ [3] <b>Microsoft Skype for Business</b> = An SRV query is done as required by Microsoft when the device is deployed in a Microsoft Skype for Business environment. The device sends a special SRV query to the DNS server according to the transport protocol configured in the 'Transport Type'</li> </ul>

Parameter	Description
	<p>parameter (described later in this section):</p> <ul style="list-style-type: none"> <li>✓ <b>TLS</b></li> <li>✓ <b>TCP:</b> "_sipinternal_tcp.&lt;domain&gt;" and "_sip_tcp.&lt;domain&gt;".</li> <li>✓ <b>Undefined:</b> "_sipinternaltls_tcp.&lt;domain&gt;", "_sipinternal_tcp.&lt;domain&gt;", "_sip_tls.&lt;domain&gt;" and "_sip_tcp.&lt;domain&gt;".</li> </ul> <p>The SRV query returns the host names (and their weights). The device then performs DNS A-record queries per host name (according to the received weights) to resolve into IP addresses.</p>
<b>Proxy Address Table</b>	
<p>'Index' proxy-ip-index [ProxyIp_ProxyIpIndex]</p>	<p>Defines an index number for the new table row.</p> <p><b>Note:</b> Each row must be configured with a unique index.</p>
<p>'Proxy Address' proxy-address [ProxyIp_IpAddress]</p>	<p>Defines the address of the proxy server (Proxy Set). The address can be defined as an IP address in dotted-decimal notation (e.g., 201.10.8.1) or FQDN. You can also specify the port using the following format:</p> <ul style="list-style-type: none"> <li>■ IPv4 address: &lt;IP address&gt;:&lt;port&gt; (e.g., 201.10.8.1:5060)</li> <li>■ IPv6 address: &lt;[IPV6 address]&gt;:&lt;port&gt; (e.g., [2000::1:200:200:86:14]:5060)</li> </ul> <p><b>Note:</b></p> <ul style="list-style-type: none"> <li>■ When configured with an FQDN, you can configure the periodic rate at which the device performs DNS queries to resolve the FQDN into IP addresses. For more information, see the [ProxyIPListRefreshTime] parameter.</li> <li>■ When configured with an FQDN, you can configure the method (e.g., A-record) for resolving the domain name into an IP address, using the 'DNS Resolve Method' parameter in this table (see above).</li> <li>■ For the SBC application: You can configure the device to use the port indicated in the Request-URI of the incoming message, instead of the port configured for the parameter. To enable this, use the [IPGroup_SBCRouteUsingRequestURIPort] parameter for the IP Group</li> </ul>

Parameter	Description
	<p>that is associated with the Proxy Set (<a href="#">Configuring IP Groups</a>).</p> <ul style="list-style-type: none"> <li>■ If you are configuring the Proxy Sets with IP addresses, it is highly recommended to configure each Proxy Set with a unique IP address. Configuring multiple Proxy Sets with the same IP address can cause problems classifying incoming SIP requests to source IP Groups based on Proxy Set. If you have configured multiple Proxy Sets with the same IP address, the device uses the Proxy Set with lowest Index number. For example, if you have configured Proxy Set ID #1 and Proxy Set ID #4 with the same IP address, the device uses Proxy Set ID #1 to classify the incoming SIP request to an IP Group.</li> </ul> <p>However, configuring multiple Proxy Sets with the same IP address, but with different SIP Interfaces is acceptable for classifying incoming SIP requests to source IP Groups based on Proxy Set.</p> <p>For more information on determining the Proxy Set, see the 'Classification Input' parameter (above) parameter .</p>
<p>'Transport Type' transport-type [ProxyIp_TransportType]</p>	<p>Defines the transport type for communicating with the proxy.</p> <ul style="list-style-type: none"> <li>■ [-1] = (Default) Not configured. The transport type is according to the settings of the global parameter [SIPTransportType].</li> <li>■ [0] <b>UDP</b></li> <li>■ [1] <b>TCP</b></li> <li>■ [2] <b>TLS</b></li> </ul>
<p>'Proxy Priority' priority [ProxyIp_Priority]</p>	<p>Defines the priority of the proxy. When a proxy server goes offline, the device attempts to connect to an online proxy server that has the highest priority.</p> <p>The valid value is 0 to 65535, where 0 is the highest priority and 65535 the lowest. The default is 0.</p> <p><b>Note:</b></p> <ul style="list-style-type: none"> <li>■ You must configure both priority and weight (or none of them). In other words, if you configure this parameter, you must also configure the 'Proxy Random Weight' parameter. If you don't configure this parameter, you must also not configure the 'Proxy Random Weight' parameter.</li> </ul>

Parameter	Description
	<ul style="list-style-type: none"> <li>■ If weight and priority are not configured for any of the proxy servers of the Proxy Set, the order in which the addresses (IP addresses and FQDNs) are listed in the table determine their priority (i.e., top-listed address has the highest priority).</li> <li>■ For FQDNs, weight and priority of DNS-resolved IP addresses are determined by the DNS. However, this parameter's value overrides the priority received from the DNS.</li> <li>■ If you have configured at least one of the proxy servers of the Proxy Set with weight and priority, the device prioritizes all the configured proxy servers according to weight and priority. In this case, proxy servers that are not configured with priority (i.e., 0) are considered as proxy servers with the highest priority.</li> <li>■ The parameter is applicable to load balancing (see the 'Proxy Load Balancing Method' parameter), and homing and parking redundancy (see the 'Redundancy Mode' parameter).</li> </ul>
'Proxy Random Weight' weight [ProxyIp_Weight]	Defines the weight of the proxy. The valid value is 0 to 65535, where 0 is the highest weight and 65535 the lowest. The default is 0. <b>Note:</b> <ul style="list-style-type: none"> <li>■ The parameter is applicable only if you configure the 'Proxy Load Balancing Method' parameter to <b>Random Weights</b>. For more information on weights, see this parameter.</li> <li>■ You must configure both priority and weight (or none of them). In other words, if you configure this parameter, you must also configure the 'Proxy Priority' parameter. If you don't configure this parameter, you must also not configure the 'Proxy Priority' parameter.</li> <li>■ For proxy servers configured with FQDNs, this parameter's value overrides the weight received for DNS-resolved IP addresses from the DNS server.</li> </ul>

## Building and Viewing SIP Entities in Topology View

The Topology view lets you easily build and view your main SIP entities, including trunks and ports (analog and digital), Trunk Groups, IP Groups, SIP Interfaces, and Media Realms. The

Topology view graphically displays these entities and the associations between them, giving you a better understanding of your SIP topology and configuration. The Topology view also lets you configure additional SIP settings that are important to your deployment such as routing and manipulation. You can use the Topology view as an alternative to configuring the entities in their respective Web pages or you can use it in combination.

To access the Topology view, do one of the following:



- Click the Topology View home  icon (**Setup** menu > **Signaling & Media** tab > **Topology View**).
- Click the logo, which is located in the top-left corner of the Web interface.

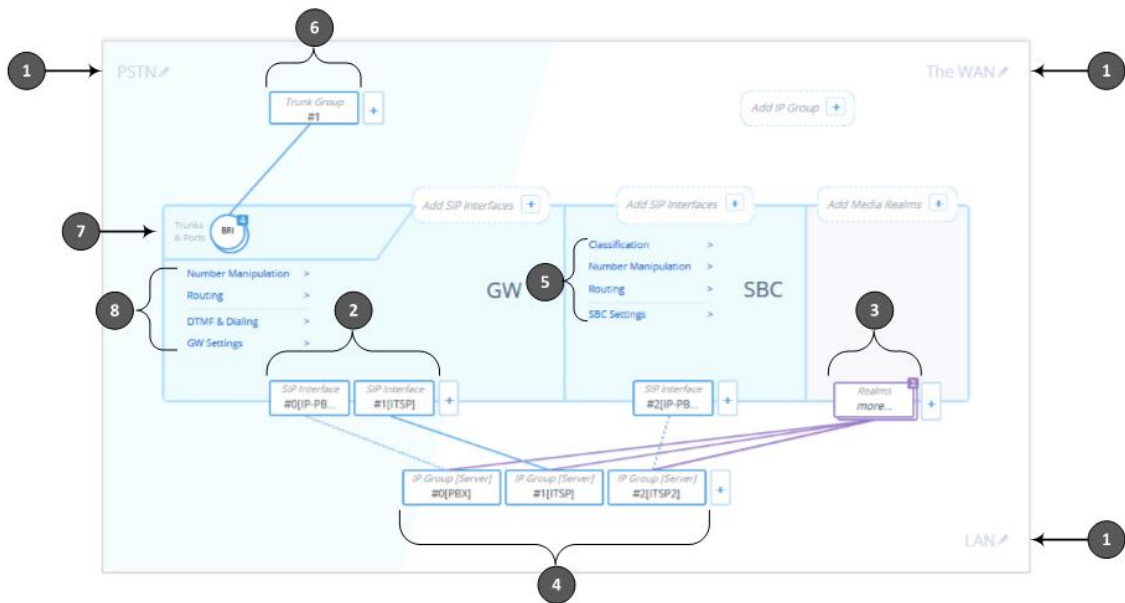

The main areas of the Topology view is shown below and described in the subsequent table.



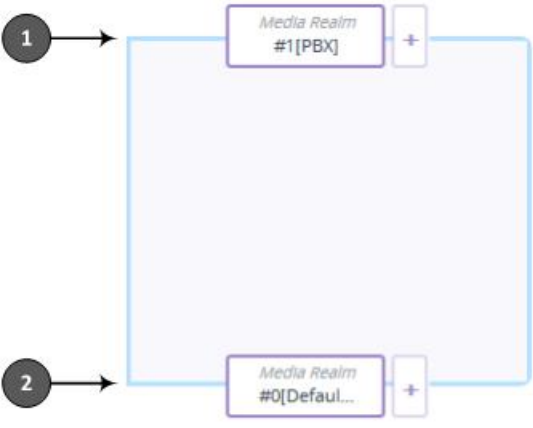

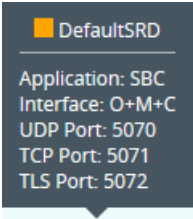
**Table 18-7: Description of Topology View**





Item #	Description
1	<p>Demarcation area of the topology. By default, the Topology view displays the following names to represent the different demarcations of your voice configuration:</p> <ul style="list-style-type: none"> <li>■ "PSTN": Indicates the PSTN side</li> <li>■ "WAN": Indicates the external network side</li> <li>■ "LAN": Indicates the internal network (e.g., inside the company)</li> </ul> <p>To modify a demarcation name, do the following:</p> <ol style="list-style-type: none"> <li>1. Click the demarcation name; the name becomes editable in a text box, as shown in the example below:</li> </ol> <div style="text-align: center; margin-top: 10px;">  </div>

Item #	Description
	<p>2. Type a name as desired, and then click anywhere outside of the text box to apply the name.</p> <p>You can use demarcation to visually separate your voice network to provide a clearer understanding of your topology. This is especially useful for IP Groups, SIP Interfaces, and Media Realms, where you can display them on the top or bottom border of the Topology view (as shown in the figure below for callouts #1 and #2, respectively). For example, on the top border you can position all entities relating to WAN, and on the bottom border all entities relating to LAN.</p>  <p>By default, configuration entities are displayed on the bottom border. To define the position, use the 'Topology Location' parameter when configuring the entity, where <b>Down</b> is the bottom border and <b>Up</b> the top border:</p> <p>Topology Location <input data-bbox="826 1227 1273 1265" type="text" value="Down"/></p>
2	<p>Configured SIP Interfaces. Each SIP Interface is displayed using the following "SIP Interface"-titled icon, which includes the name and row index number:</p>  <p>If you hover your mouse over the icon, a pop-up appears displaying the following basic information (example):</p>  <p>If you click the icon, a drop-down menu appears listing the following commands:</p>

Item #	Description
	<div data-bbox="837 280 986 459" style="border: 1px solid black; padding: 5px; margin-bottom: 10px;"> <p style="text-align: center;">EDIT</p> <hr style="width: 50%; margin: 0 auto;"/> <p style="text-align: center;">SHOW LIST</p> <hr style="width: 50%; margin: 0 auto;"/> <p style="text-align: center;">DELETE</p> </div> <ul style="list-style-type: none"> <li data-bbox="432 495 1294 562">■ <b>Edit:</b> Opens a dialog box in the SIP Interfaces table to modify the SIP Interface.</li> <li data-bbox="432 591 983 624">■ <b>Show List:</b> Opens the SIP Interfaces table.</li> <li data-bbox="432 651 1370 719">■ <b>Delete:</b> Opens the SIP Interfaces table where you are prompted to confirm deletion of the SIP Interface.</li> </ul> <p data-bbox="432 748 911 781">To add a SIP Interface, do the following:</p> <ol style="list-style-type: none"> <li data-bbox="432 804 1398 1039">1. Click the <b>Add SIP Interface</b>  plus icon. The icon appears next to existing SIP Interfaces, or as  when no SIP Interfaces exist on a topology border, or as  when there are no SIP Interfaces at all.  The SIP Interfaces table opens with a new dialog box for adding a SIP Interface to the next available index row.</li> <li data-bbox="432 1162 1390 1274">2. Configure the SIP Interface as desired, and then click <b>Apply</b>; the SIP Interfaces table closes and you are returned to the Topology View, displaying the new SIP Interface.</li> </ol> <p data-bbox="432 1301 1294 1368">For more information on configuring SIP Interfaces, see <a href="#">Configuring SIP Interfaces</a>.</p>
3	<p data-bbox="432 1413 1355 1480">Configured Media Realms. Each Media Realm is displayed using the following "Media Realm"-titled icon, which includes the name and row index number:</p> <div data-bbox="831 1491 992 1554" style="border: 1px solid black; padding: 2px; margin: 10px auto; width: fit-content;"> <p style="text-align: center; font-size: small;">Media Realm #0[Defaul...</p> </div> <p data-bbox="432 1581 1299 1648">If you hover your mouse over the icon, a pop-up appears displaying the following basic information (example):</p> <div data-bbox="775 1659 1046 1850" style="border: 1px solid black; padding: 5px; margin: 10px auto; width: fit-content;"> <div style="background-color: #333; color: white; padding: 5px; text-align: center;"> <p style="font-size: x-small; margin: 0;">Interface: O+M+C Start Port: 6000 Number of Sessions: 5953</p> </div> <div style="border: 1px solid black; padding: 2px; margin-top: 5px; text-align: center; font-size: x-small;"> <p style="margin: 0;">Media Realm #0[Defaul...</p> </div> </div> <p data-bbox="432 1877 1254 1944">If you click the icon, a drop-down menu appears listing the following commands:</p>

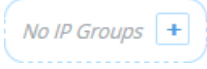
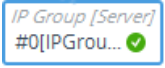

Item #	Description
	<div data-bbox="837 280 986 459" style="border: 1px solid black; padding: 5px; margin-bottom: 10px;"> <p style="text-align: center;">EDIT</p> <hr style="width: 50%; margin: 0 auto;"/> <p style="text-align: center;">SHOW LIST</p> <hr style="width: 50%; margin: 0 auto;"/> <p style="text-align: center;">DELETE</p> </div> <ul style="list-style-type: none"> <li data-bbox="432 495 1337 562">■ <b>Edit:</b> Opens a dialog box in the Media Realms table to modify the Media Realm.</li> <li data-bbox="432 591 986 624">■ <b>Show List:</b> Opens the Media Realms table.</li> <li data-bbox="432 651 1374 719">■ <b>Delete:</b> Opens the Media Realms table where you are prompted to confirm deletion of the Media Realm.</li> </ul> <p data-bbox="432 748 916 781">To add a Media Realm, do the following:</p> <ol data-bbox="432 801 1385 1037" style="list-style-type: none"> <li data-bbox="432 801 1385 1037">1. Click the <b>Add Media Realm</b>  plus icon. The icon appears next to existing Media Realms, or as  when no Media Realms exist on a topology border, or as  when there are no Media Realms at all.</li> </ol> <p data-bbox="477 1066 1337 1133">The Media Realms table opens with a new dialog box for adding a Media Realm to the next available index row.</p> <ol data-bbox="432 1162 1369 1274" style="list-style-type: none"> <li data-bbox="432 1162 1369 1274">2. Configure the Media Realm as desired, and then click <b>Apply</b>; the Media Realms table closes and you are returned to the Topology View, displaying the new Media Realm.</li> </ol> <p data-bbox="432 1303 1337 1370">For more information on configuring Media Realms, see <a href="#">Configuring Media Realms</a>.</p>
4	<p data-bbox="432 1413 1385 1559">Configured IP Groups. Each IP Group is displayed using the following "IP Group [Server]" or "IP Group [User]" titled icon (depending on whether it's a Server- or User-type IP Group respectively), which includes the name and row index number (example of a Server-type):</p> <div data-bbox="826 1570 997 1637" style="border: 1px solid black; padding: 5px; margin: 10px auto; width: fit-content;"> <p style="text-align: center;">IP Group [Server] #0[Defaul...</p> </div> <p data-bbox="432 1659 1297 1727">If you hover your mouse over the icon, a pop-up appears displaying the following basic information (example):</p> <div data-bbox="651 1738 1173 1895" style="display: flex; align-items: center; margin: 10px auto;"> <div data-bbox="655 1783 831 1850" style="border: 1px solid black; padding: 5px; margin-right: 10px;"> <p style="text-align: center;">IP Group [Server] #0[Defaul...</p> </div> <div data-bbox="847 1738 1173 1895" style="background-color: #333; color: white; padding: 10px; border-radius: 5px;"> <div style="display: flex; align-items: center; margin-bottom: 5px;"> <span style="width: 10px; height: 10px; background-color: orange; margin-right: 5px;"></span> <span>DefaultSRD</span> </div> <hr style="border: 0.5px solid white;"/> <p>Type: Server Name: Default_IPG SIP Interface: #0[SIPInterface_0]</p> </div> </div> <p data-bbox="432 1917 1254 1984">If you click the icon, a drop-down menu appears listing the following commands:</p>

Item #	Description
	<div data-bbox="837 280 986 459" style="border: 1px solid black; padding: 5px; margin-bottom: 10px;"> <p style="text-align: center;">EDIT</p> <hr style="width: 50%; margin: 0 auto;"/> <p style="text-align: center;">SHOW LIST</p> <hr style="width: 50%; margin: 0 auto;"/> <p style="text-align: center;">DELETE</p> </div> <ul style="list-style-type: none"> <li>■ <b>Edit:</b> Opens a dialog box in the IP Groups table to modify the IP Group.</li> <li>■ <b>Show List:</b> Opens the IP Groups table.</li> <li>■ <b>Delete:</b> Opens the IP Groups table where you are prompted to confirm deletion of the IP Group.</li> </ul> <p>To add an IP Group, do the following:</p> <ol style="list-style-type: none"> <li>1. Click the <b>Add IP Group</b>  plus icon. The icon appears next to existing IP Groups, or as  when no IP Groups exist on a topology border, or as  when there are no IP Groups at all.</li> </ol> <p>The IP Groups table opens with a new dialog box for adding a IP Group to the next available index row.</p> <ol style="list-style-type: none"> <li>2. Configure the IP Group as desired, and then click <b>Apply</b>; the IP Groups table closes and you are returned to the Topology View, displaying the new IP Group.</li> </ol> <p>For more information on configuring IP Groups, see <a href="#">Configuring IP Groups</a>.</p> <p>IP Group icons also display connectivity status with Server-type IP Groups:</p> <ul style="list-style-type: none"> <li>■  (Green with check mark): Keep-alive is successful and connectivity exists with IP Group.</li> <li>■  (Red with "x"): Keep-alive has failed and there is a loss of connectivity with the IP Group.</li> </ul> <p>The line type connecting between an IP Group and a SIP Interface indicates whether a routing rule has been configured for the IP Group. A solid line indicates that you have configured a routing rule for the IP Group; a dashed line indicates that you have yet to configure a routing rule.</p> <p><b>Note:</b></p> <ul style="list-style-type: none"> <li>■ You can also view connectivity status in the IP Groups table.</li> <li>■ To support the connectivity status feature, you must enable the keep-alive mechanism for the Proxy Set that is associated with the IP Group (see <a href="#">Configuring Proxy Sets</a>).</li> </ul>

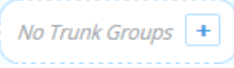
Item #	Description
	<ul style="list-style-type: none"> <li>The green-color state also applies to scenarios where the device rejects calls with the IP Group due to low QoE (e.g., low MOS), despite connectivity.</li> </ul>
5	<p>Links to Web pages relating to commonly required SBC configuration:</p> <ul style="list-style-type: none"> <li>Classification: Opens the Classification table where you can configure Classification rules (see <a href="#">Configuring Classification Rules</a>).</li> <li>Number Manipulation: Opens the Outbound Manipulations table where you can configure manipulation rules on SIP Request-URI user parts (source or destination) or calling names in outbound SIP dialog requests (see <a href="#">Configuring IP-to-IP Outbound Manipulations</a>).</li> <li>Routing: Opens the IP-to-IP Routing table where you can configure IP-to-IP routing rules (see <a href="#">Configuring SBC IP-to-IP Routing Rules</a>).</li> <li>SBC Settings: Opens the SBC General Settings page where you can configure miscellaneous settings.</li> </ul>
6	<p>Configured Trunk Groups. Each Trunk Group is displayed using the following "Trunk Group"-titled icon, which includes the row index number:</p> <div data-bbox="831 1021 991 1077" style="border: 1px solid black; padding: 2px; text-align: center; margin: 10px auto; width: fit-content;"> <i>Trunk Group</i> #1         </div> <p>To edit or delete the Trunk Group, click the icon, and then from the drop-down menu, choose <b>Show List</b> to open the Trunk Group table.</p> <p>To add a Trunk Group, do the following:</p> <ol style="list-style-type: none"> <li>Click the <b>Add Trunk Group</b>  plus icon. The icon appears next to existing Trunk Groups or as  when there are no Trunk Groups. The Trunk Group table opens, allowing you to configure a Trunk Group.</li> <li>Configure the Trunk Group as desired, and then click <b>Apply</b>; the Trunk Group table closes and you are returned to the Topology View, displaying the new Trunk Group and a line connecting it to the associated port, as shown in the example below:</li> </ol> <div data-bbox="461 1621 1362 1924" style="border: 1px solid lightblue; padding: 10px; margin: 10px auto; width: fit-content;"> <p>The diagram shows two Trunk Group icons at the top, labeled "Trunk Group #0" and "Trunk Group #1", each with a plus icon to its right. Below them are two "Trunks &amp; Ports" panels. The left panel shows a port labeled "E1/T1-1" with a line connecting it to "Trunk Group #0". The right panel shows a port labeled "BRI" with a line connecting it to "Trunk Group #1".</p> </div> <p>For more information on configuring Trunk Groups, see <a href="#">Configuring Trunk</a></p>

Item #	Description
	<a href="#">Groups</a> .
7	<p>Displays the device's hardware configuration concerning telephony (Tel/PSTN) trunks and ports. It also displays the number of ports. The ports are displayed as round icons, as shown in Item #6 above.</p> <p>To configure a digital trunk, do the following:</p> <ol style="list-style-type: none"> <li>1. Click the icon, and then from the drop-down menu, choose <b>Trunk Settings</b>; the Trunk Settings page appears.</li> <li>2. Configure the trunk as desired.</li> </ol> <p>For more information on configuring trunk settings, see <a href="#">Configuring Trunk Settings</a>.</p>
8	<p>Links to Web pages relating to commonly required Gateway configuration:</p> <ul style="list-style-type: none"> <li>■ <b>Number Manipulation:</b> Opens the Destination Phone Number Manipulation for IP-to-Tel Calls table where you can configure destination phone number manipulation rules for IP-to-Tel calls (see <a href="#">Configuring Number Manipulation Tables</a>).</li> <li>■ <b>Routing:</b> Opens the IP-to-Tel Routing table where you can configure IP-to-Tel routing rules (see <a href="#">Configuring IP-to-Tel Routing Rules</a>).</li> <li>■ <b>DTMF &amp; Dialing:</b> Opens the DTMF &amp; Dialing page where you can configure DTMF and dialing related settings.</li> <li>■ <b>GW Settings:</b> Opens the Gateway General Settings page where you can configure general gateway related settings.</li> </ul>

## 19 Coders and Profiles

This section describes configuration of coders and SIP profiles.

### Configuring Coder Groups

The Coder Groups table lets you configure up to 11 *Coder Groups*. The Coder Group determines the audio (voice) coders used for calls. Each Coder Group can include up to 10 coders, where the packetization time (ptime), bit rate, payload type, and silence suppression can be configured per coder. The first coder in the Coder Group has the highest priority and is used by the device whenever possible. If the remote side cannot use the first coder, the device attempts to use the next coder in the Coder Group, and so on.

The Coder Groups table provides a pre-defined Coder Group (index 0) that is configured with the G.711 A-law coder. If no other Coder Groups are configured, the default Coder Group (which you can modify) is used for all calls. Alternatively, if you want to use specific coders or coder settings (e.g., packetization time) for different calls (entities), you need to configure a Coder Group for each entity and then assign each Coder Group to a Tel Profile (see [Configuring Tel Profiles](#)) or an IP Profile (see [Configuring IP Profiles](#)) associated with the entity (IP Group). If an IP Group is not associated with a Coder Group, the default Coder Group is used.

You can also use Coder Groups for audio coder transcoding of SBC calls. If two SIP entities need to communicate, but one does not support a coder required by the other, the device can add the required coder to the SDP offer. The added coder is referred to as an extension coder. For more information on extension coders, see [Coder Transcoding](#).

To apply a Coder Group for transcoding to a SIP entity:

1. Configure a Coder Group in the Coder Groups table (see description below).
2. In the IP Profile associated with the SIP entity (see [Configuring IP Profiles](#)):
  - Assign the Coder Group (using the `IpProfile_SBCExtensionCodersGroupName` parameter).
  - Enable the use of the Coder Group for transcoding (by configuring the `IpProfile_SBCAllowedCodersMode` parameter to Restriction or Restriction and Preference).



- For supported audio coders, see [Supported Audio Coders](#).
- Some coders are license-based and are available only if included in the License Key installed on your device. For more information, contact the sales representative of your purchased device.
- Only the packetization time of the first coder listed in the Coder Group is declared in INVITE/200 OK SDP even if multiple coders are configured. The device always uses the packetization time requested by the remote side for sending RTP packets. If not specified, the packetization time is assigned the default value.
- The value of some fields is hard-coded according to common standards (e.g., payload type of G.711 U-law is always 0).



- The G.722 coder provides Packet Loss Concealment (PLC) capabilities, ensuring higher voice quality.
- For more information on V.152 and implementation of T.38 and VBD coders, see [Supporting V.152 Implementation](#).
- The G.729 coder refers to G.729A if silence suppression is disabled, or G.729AB if silence suppression is enabled.

The following procedure describes how to configure the Coder Groups table through the Web interface. You can also configure it through ini file [AudioCodersGroups] and [AudioCoders], or CLI (`configure voip > coders-and-profiles audio-coders-groups`).

➤ **To configure a Coder Group:**

1. Open the Coder Groups table (**Setup** menu > **Signaling & Media** tab > **Coders & Profiles** folder > **Coder Groups**).

Coder Group Name

Coder Name	Packetization Time	Rate	Payload Type	Silence Suppression	Coder Specific
G.711A-law	20	64	8	Disabled	

2. From the 'Coder Group Name' drop-down list, select the desired Coder Group index number and name.
3. Configure the Coder Group according to the parameters described in the table below.
4. Click **Apply**, and then reset the device with a save-to-flash for your settings to take effect.

You can delete a Coder Group, as described in the following procedure.

➤ **To delete a Coder Group:**

1. From the 'Coder Group Name' drop-down list, select the Coder Group that you want to delete.
2. Click **Delete Group**.

**Table 19-1: Coder Groups Table Parameter Descriptions**

Parameter	Description
'Coder Group Name' [AudioCodersGroups_Index] [AudioCodersGroups_Name]	Defines the name and index for the Coder Group. <b>Note:</b> The Coder Group index/name cannot be configured.
[AudioCoders_ AudioCodersIndex]	Index row of the coder per Coder Group <b>Note:</b> The parameter is applicable only to the ini file.
'Coder Name' name [AudioCoders_Name]	Defines the coder type. For coder names, see <a href="#">Supported Audio Coders</a> . <b>Note:</b> Each coder type (e.g., G.729) can be configured only once in the table.
'Packetization Time' p-time [AudioCoders_pTime]	Defines the packetization time (in msec) for the coder. The packetization time determines how many coder payloads are combined into a single RTP packet. For ptime, see <a href="#">Supported Audio Coders</a> .
'Rate' rate [AudioCoders_rate]	Defines the bit rate (in kbps) for the coder. For rates, see <a href="#">Supported Audio Coders</a> .
'Payload Type' payload-type [AudioCoders_PayloadType]	Defines the payload type if the payload type (i.e., format of the RTP payload) for the coder is dynamic. For payload types, see <a href="#">Supported Audio Coders</a> . <b>Note:</b> GSM-FR and MS-GSM coders use Payload Type 3. When using SDP, it is not possible to differentiate between the two. Thus, it is recommended to configure only one of these coders in the table.
'Silence Suppression' silence-suppression [AudioCoders_Sce]	Enables silence suppression for the coder. <ul style="list-style-type: none"> <li>■ [0] <b>Disable</b> (Default)</li> <li>■ [1] <b>Enable</b></li> <li>■ [2] <b>Enable w/o Adaptation</b></li> </ul> <b>Note:</b> <ul style="list-style-type: none"> <li>■ Option [2] Enable w/o Adaptation is applicable only to G.729.</li> <li>■ If you disable silence suppression for G.729, the device includes 'annexb=no' in the SDP of the relevant SIP messages. If you enable silence</li> </ul>

Parameter	Description
	suppression, 'annexb=yes' is included. For the Gateway application, an exception is when the remote gateway is Cisco equipment (IsCiscoSCEMode).
'Coder Specific' coder-specific [AudioCoders_CoderSpecific]	<p>Defines additional settings specific to the coder.</p> <p>Currently, the parameter is applicable only to the AMR coder and is used to configure the payload format type.</p> <ul style="list-style-type: none"> <li>■ [0] 0 = Bandwidth Efficient</li> <li>■ [1] 1 = Octet Aligned (default)</li> </ul> <p>Note: The AMR payload type can be configured globally using the AmrOctetAlignedEnable parameter. However, the Coder Group configuration overrides the global parameter.</p> <p><b>Note:</b> Currently, the parameter is reserved for future use.</p>

## Supported Audio Coders

The table below lists the coders supported by the device.

**Table 19-2: Supported Audio Coders**

Coder Name	Packetization Time (msec) [1] 10, [2] 20, [3] 30, [4] 40, [5] 50, [6] 60, [8] 80, [9] 90, [10] 100, [12] 120	Rate (kbps)	Payload Type	Silence Suppression
<b>G.723.1</b> g723-1 [0]	30 (default), 60, 90, 120, 150	<ul style="list-style-type: none"> <li>■ [7] 5.3 (default)</li> <li>■ [11] 6.3</li> </ul>	4	<ul style="list-style-type: none"> <li>■ [0] Disable (default)</li> <li>■ [1] Enable</li> </ul>
<b>G.711 A-law</b> g711-alaw [1]	10, 20 (default), 30, 40, 50, 60, 80, 100, 120	[90] 64	8	<ul style="list-style-type: none"> <li>■ [0] Disable (default)</li> <li>■ [1] Enable</li> </ul>
<b>G.711 U-law</b>	10, 20 (default),	[90] 64	0	<ul style="list-style-type: none"> <li>■ [0] Disable</li> </ul>



Coder Name	Packetization Time (msec) [1] 10, [2] 20, [3] 30, [4] 40, [5] 50, [6] 60, [8] 80, [9] 90, [10] 100, [12] 120	Rate (kbps)	Payload Type	Silence Suppression
g711-ulaw [2]	30, 40, 50, 60, 80, 100, 120			(default) <input type="checkbox"/> [1] Enable
<b>G.729</b> g729 [3]	10, 20 (default), 30, 40, 50, 60, 80, 100	[19] 8	18	<input type="checkbox"/> [0] Disable (default) <input type="checkbox"/> [1] Enable <input type="checkbox"/> [2] Enable w/o Adaptations
<b>T.38</b> t-38 [4]	N/A	N/A	N/A	N/A (Disabled)
<b>G.726</b> g726 [5]	10, 20 (default), 30, 40, 50, 60, 80, 100, 120	<input type="checkbox"/> [43] 16 <input type="checkbox"/> [57] 24 <input type="checkbox"/> [64] 32 (default) <input type="checkbox"/> [70] 40	Dynamic (default 2)	<input type="checkbox"/> [0] Disable (default) <input type="checkbox"/> [1] Enable
<b>Transparent</b> transparent [7]	10, 20 (default), 40, 60, 80, 100, 120	[90] 64	Dynamic	<input type="checkbox"/> [0] Disable <input type="checkbox"/> [1] Enable
<b>QCELP</b> qcelp [9]	20 (default), 40, 60, 80, 100, 120	[34] 13	12	<input type="checkbox"/> [0] Disable <input type="checkbox"/> [1] Enable
<b>EVRC</b> evrc [12]	20 (default), 40, 60, 80, 100	<input type="checkbox"/> [91] Variable (default)  <input type="checkbox"/> [1] 1/8	Dynamic	<input type="checkbox"/> [0] Disable <input type="checkbox"/> [1] Enable

Coder Name	Packetization Time (msec) [1] 10, [2] 20, [3] 30, [4] 40, [5] 50, [6] 60, [8] 80, [9] 90, [10] 100, [12] 120	Rate (kbps)	Payload Type	Silence Suppression
		<input type="checkbox"/> [94] 1/2 <input type="checkbox"/> [95] Full		
<b>AMR</b> amr [14]	20 (default)	<input type="checkbox"/> [4] 4.75 <input type="checkbox"/> [6] 5.15 <input type="checkbox"/> [9] 5.90 <input type="checkbox"/> [14] 6.70 <input type="checkbox"/> [16] 7.40 <input type="checkbox"/> [18] 7.95 <input type="checkbox"/> [27] 10.2 <input type="checkbox"/> [30] 12.2 (default)	Dynamic	<input type="checkbox"/> [0] Disable <input type="checkbox"/> [1] Enable
<b>GSM FR</b> gsm-fr [16]	20 (default), 40, 60, 80	[34] 13	3	<input type="checkbox"/> [0] Disable <input type="checkbox"/> [1] Enable
<b>MS GSM</b> ms-gsm [17]	40 (default)	[34] 13	3	<input type="checkbox"/> [0] Disable <input type="checkbox"/> [1] Enable
<b>GSM EFR</b> gsm-efr [18]	0, 20 (default), 30, 40, 50, 60, 80, 100	[30] 12.2	Dynamic	<input type="checkbox"/> [0] Disable <input type="checkbox"/> [1] Enable
<b>iLBC</b> ilbc	20 (default), 40, 60, 80, 100, 120	[39] 15 (default)	Dynamic (default 65)	<input type="checkbox"/> [0] Disable <input type="checkbox"/> [1] Enable

Coder Name	Packetization Time (msec) [1] 10, [2] 20, [3] 30, [4] 40, [5] 50, [6] 60, [8] 80, [9] 90, [10] 100, [12] 120	Rate (kbps)	Payload Type	Silence Suppression
[19]	30 (default), 60, 90, 120	[34] 13		
<b>G.722</b> g722 [20]	10 (default), 20, 30, 40, 50, 60, 80, 100, 120	<ul style="list-style-type: none"> <li>■ [90] 64 (default)</li> <li>■ [74] 48</li> <li>■ [80] 56</li> </ul>	<ul style="list-style-type: none"> <li>■ 9 (applicable only to rate 64 kbps)</li> <li>■ 66 (default and applicable only to rate 48 kbps) - payload can be changed</li> <li>■ 67 (default and applicable only to rate 56 kbps) - payload can be changed</li> </ul>	N/A (Disabled)
<b>G.711A-law_VBD</b> g711a-law-vbd [23]	10, 20 (default), 30, 40, 50, 60, 80, 100, 120	[90] 64	8 or Dynamic (default 118)	N/A (Disabled)
<b>G.711U-law_VBD</b> g711u-law-vbd [24]	10, 20 (default), 30, 40, 50, 60, 80, 100, 120	[90] 64	0 or Dynamic (default 110)	N/A (Disabled)
<b>T.38 Over RTP</b>	N/A	N/A	Dynamic	N/A

Coder Name	Packetization Time (msec) [1] 10, [2] 20, [3] 30, [4] 40, [5] 50, [6] 60, [8] 80, [9] 90, [10] 100, [12] 120	Rate (kbps)	Payload Type	Silence Suppression
t-38-over- rtsp [43]			(default 106)	

## Configuring Allowed Audio Coder Groups

The Allowed Audio Coders Groups table lets you configure up to 10 Allowed Audio Coders Groups for SBC calls. For each Allowed Audio Coders Group, you can configure up to 10 audio coders. The coders can include pre-defined coders and user-defined (string) coders for non-standard or unknown coders.

Allowed Audio Coders Groups restrict coders for SIP entities. Only coders listed in the Allowed Audio Coders Group (i.e., allowed coders) that is associated with the SIP entity can be used. If the coders in the SDP offer ('a=rtptime' field) of the incoming SIP message are not listed in the Allowed Audio Coders Group, the device rejects the calls, unless transcoding is configured, whereby "extension" coders are added to the SDP, as described in [Coder Transcoding](#). If the SDP offer contains some coders that are listed in the Allowed Audio Coders Group, the device manipulates the SDP offer by removing the coders that are not listed in the Allowed Audio Coders Group, before routing the SIP message to its destination. Thus, only coders that are common between the coders in the SDP offer and the coders in the Allowed Audio Coders Group are used. For more information on coder restriction, see [Restricting Audio Coders](#).

For example, assume the following:

- The SDP offer in the incoming SIP message contains the G.729, G.711, and G.723 coders.
- The allowed coders configured for the SIP entity include G.711 and G.729.

The device removes the G.723 coder from the SDP offer, re-orders the coder list so that G.711 is listed first, and sends the SIP message containing only the G.711 and G.729 coders in the SDP.

To apply an Allowed Audio Coders Group for restricting coders to a SIP entity:

1. Configure an Allowed Audio Coders Group in the Allowed Audio Coders Groups table (see description below).
2. In the IP Profile associated with the SIP entity (see [Configuring IP Profiles](#)):

- Assign the Allowed Audio Coders Group (using the IpProfile\_SBCAllowedAudioCodersGroupName parameter).
- Enable the use of Allowed Audio Coders Groups (by configuring the IpProfile\_SBCAllowedCodersMode parameter to **Restriction** or **Restriction and Preference**).

The device also re-orders (prioritizes) the coder list in the SDP according to the order of appearance of the coders listed in the Allowed Audio Coders Group. The first listed coder has the highest priority and the last coder has the lowest priority. For more information, see [Prioritizing Coder List in SDP Offer](#).



- The Allowed Audio Coders Groups table is applicable only to the SBC application.
- The Allowed Audio Coders Group for coder restriction takes precedence over the Coder Group for extension coders. In other words, if an extension coder is not listed as an allowed coder, the device does not add the extension coder to the SDP offer.
- To configure "extension" coders for adding to the SDP offer for audio transcoding, use the Coder Groups table (see [Configuring Coder Groups](#)

The following procedure describes how to configure Allowed Audio Coders Groups through the Web interface. You can also configure it through ini file [AllowedAudioCodersGroups] and [AllowedAudioCoders] or CLI (`configure voip > coders- and- profiles allowed- audio- coders- groups ; configure voip > coders- and- profiles allowed- audio- coders < group index/coder index>`).

#### ➤ To configure an Allowed Audio Coders Group:

1. Open the Allowed Audio Coders Groups table (**Setup** menu > **Signaling & Media** tab > **Coders & Profiles** folder > **Allowed Audio Coders Groups**).
2. Click **New**; the following dialog box appears:

3. Configure a name for the Allowed Audio Coders Group according to the parameters described in the table below.
4. Click **Apply**.
5. Select the new row that you configured, and then click the **Allowed Audio Coders** link located below the table; the Allowed Audio Coders table opens.
6. Click **New**; the following dialog box appears:

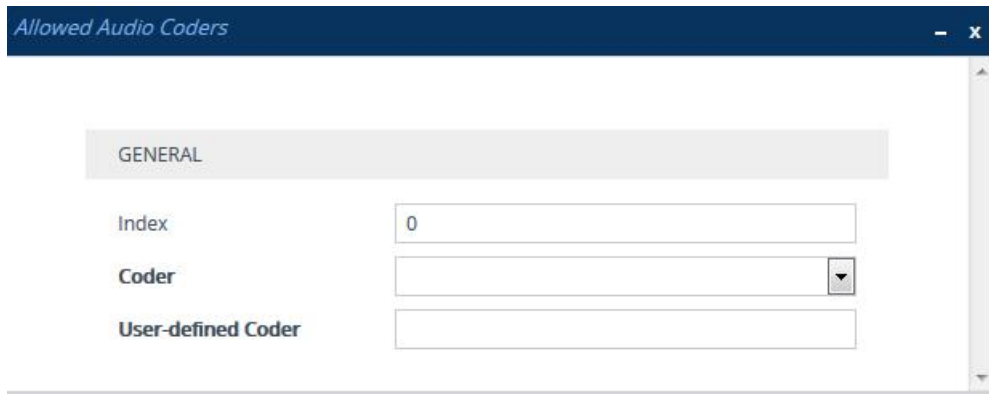

7. Configure coders for the Allowed Audio Coders Group according to the parameters described in the table below.
8. Click **Apply**.

**Table 19-3: Allowed Audio Coders Groups and Allowed Audio Coders Tables Parameter Descriptions**

Parameter	Description
<b>Allowed Audio Coders Groups Table</b>	
'Index' allowed-audio-coders-groups <index> [AllowedAudioCodersGroups_Index]	Defines an index number for the new table row. <b>Note:</b> Each row must be configured with a unique index.
'Name' coders-group-name [AllowedAudioCodersGroups_Name]	Defines a descriptive name, which is used when associating the row in other tables. The valid value is a string of up to 40 characters. <b>Note:</b> <ul style="list-style-type: none"> <li>■ Each row must be configured with a unique name.</li> <li>■ The parameter value cannot contain a forward slash (/).</li> </ul>
<b>Allowed Audio Coders Table</b>	
'Index' allowed-audio-coders <group index/coder index> [AllowedAudioCoders_AllowedAudioCodersIndex]	Defines an index number for the new table row. For a list of supported coders, see <b>Note:</b> Each row must be configured with a unique index.
'Coder'	Defines a coder from the list of coders.

Parameter	Description
coder [AllowedAudioCoders_CoderID]	<b>Note:</b> Each coder can be configured only once per Allowed Audio Coders Group.
'User-defined Coder' user-define-coder [AllowedAudioCoders_ UserDefineCoder]	Defines a user-defined coder. The valid value is a string of up to 24 characters (case-insensitive). For example, "HD.123" (without quotation marks). <b>Note:</b> Each coder can be configured only once per Allowed Audio Coders Group.

## Configuring Allowed Video Coder Groups

The Allowed Video Coders Groups table lets you configure up to four Allowed Video Coders Groups for SBC calls. Each Allowed Video Coders Group can be configured with up to 10 user-defined (string) video coders. An Allowed Video Coders Group defines a list of video coders that can be used when forwarding video streams to a specific SIP entity.

Allowed Video Coders Groups are assigned to SIP entities, using IP Profiles (see [Configuring IP Profiles](#)). The video coders appear in the SDP media type "video" ('m=video' line). Coders that are not listed in the Allowed Video Coders Group are removed from the SDP offer that is sent to the SIP entity. Only coders that are common between the coders in the SDP offer and the coders listed in the Allowed Video Coders Group are used. Thus, Allowed Video Coders Groups enable you to enforce the use of only specified coders. For more information, see [Restricting Audio Coders](#).

The order of appearance of the coders listed in the Allowed Video Coders Group determines the priority (preference) of the coders in the SDP offer. The device arranges the SDP offer's coder list according to their order in the Allowed Video Coders Group. The priority is in descending order, whereby the first coder in the list is given the highest priority and the last coder, the lowest priority. For more information, see [Prioritizing Coder List in SDP Offer](#).



The Allowed Audio Coders Groups table is applicable only to the SBC application.

The following procedure describes how to configure Allowed Video Coders Groups through the Web interface. You can also configure it through ini file [AllowedVideoCodersGroups] and [AllowedVideoCoders] or CLI (`configure voip > coders- and- profiles allowed- video- coders- groups; configure voip > coders- and- profiles allowed- video- coders < group index/coder index>`).

### ➤ To configure an Allowed Video Coders Group:

1. Open the Allowed Video Coders Groups table (**Setup** menu > **Signaling & Media** tab > **Coders & Profiles** folder > **Allowed Video Coders Groups**).
2. Click **New**; the following dialog box appears:

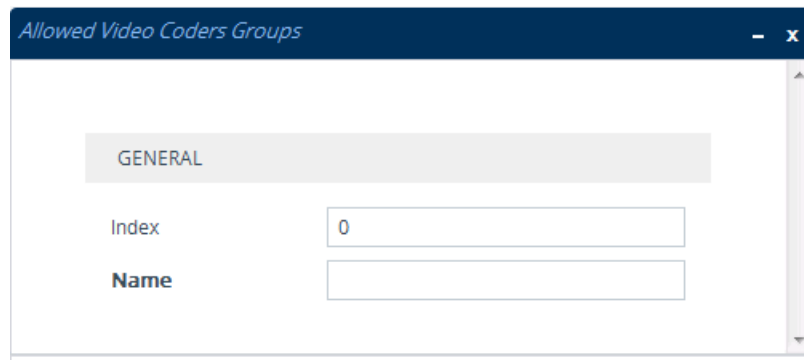

3. Configure a name for the Allowed Video Coders Group according to the parameters described in the table below.
4. Click **Apply**.
5. Select the new row that you configured, and then click the **Allowed Video Coders** link located below the table; the Allowed Video Coders table opens.
6. Click **New**; the following dialog box appears:

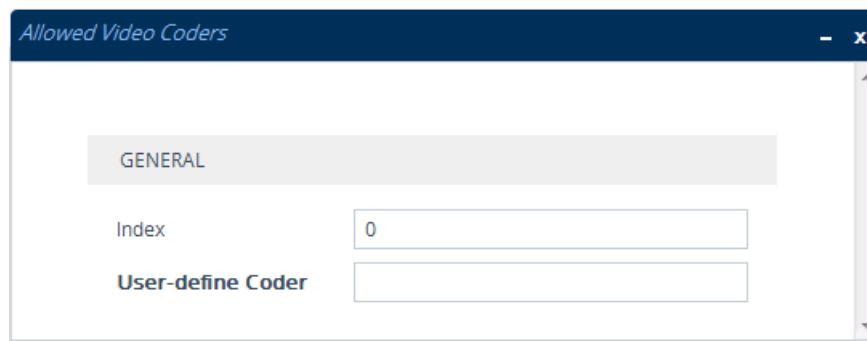

7. Configure coders for the Allowed Video Coders Group according to the parameters described in the table below.
8. Click **Apply**.

**Table 19-4: Allowed Video Coders Groups and Allowed Video Coders Tables Parameter Descriptions**

Parameter	Description
<b>Allowed Video Coders Groups Table</b>	
'Index' allowed-video-coders-groups <index> [AllowedVideoCodersGroups_Index]	Defines an index number for the new table row. <b>Note:</b> Each row must be configured with a unique index.
'Name' coders-group-name [AllowedVideoCodersGroups_	Defines a descriptive name, which is used when associating the row in other tables. The valid value is a string of up to 40 characters.



Parameter	Description
Name]	<p><b>Note:</b></p> <ul style="list-style-type: none"> <li>Each row must be configured with a unique name.</li> <li>The parameter value cannot contain a forward slash (/).</li> </ul>
<b>Allowed Video Coders Table</b>	
<p>'Index'</p> <pre>allowed-video-coders &lt;group index/coder index&gt;</pre> <p>[AllowedVideoCoders_ AllowedVideoCodersIndex]</p>	<p>Defines an index number for the new table row.</p> <p><b>Note:</b> Each row must be configured with a unique index.</p>
<p>'User Define Coder'</p> <pre>user-define-coder</pre> <p>[AllowedVideoCoders_ UserDefineCoder]</p>	<p>Defines a user-defined coder.</p> <p>The valid value is a string of up to 24 characters (case-insensitive). For example, "HD.123" (without quotation marks).</p> <p><b>Note:</b> Each coder can be configured only once per Allowed Video Coders Group.</p>

## Configuring IP Profiles

The IP Profiles table lets you configure up to 40 IP Profiles. An IP Profile is a set of parameters with user-defined settings relating to signaling (e.g., SIP message terminations such as REFER) and media (e.g., coder type). An IP Profile can later be assigned to specific IP calls (inbound and/or outbound). Thus, IP Profiles provide high-level adaptation when the device interworks between different SIP user agents (UA), each of which may require different handling by the device. This can include, for example, transcoding or even transrating (of packetization time). For example, if a specific SIP UA uses the G.711 coder only, you can configure an IP Profile with G.711 for this UA.

To use your IP Profile for specific calls, you need to assign it to any of the following:

- IP Groups - see [Configuring IP Groups](#)
- (Gateway application only) Tel-to-IP routing rules (see [Configuring Tel-to-IP Routing Rules](#))
- (Gateway application only) IP-to-Tel routing rules (see [Configuring IP-to-Tel Routing Rules](#))

For the Gateway application, the device selects the IP Profile as follows:

- If you assign different IP Profiles (not default) to the same specific calls in all of the above-mentioned tables, the device uses the IP Profile that has the highest preference level (as

set in the 'Profile Preference' parameter). If these IP Profiles have the same preference level, the device uses the IP Profile that you assigned in the IP Groups table.

- If you assign different IP Profiles to all of the above-mentioned tables and one table is set to the default IP Profile, the device uses the IP Profile that is not the default.

Many of the parameters in the IP Profiles table have a corresponding "global" parameter. For calls that are not associated with any IP Profile, the settings of the "global" parameters are applied.



You can also use IP Profiles when using a Proxy server (when the AlwaysUseRouteTable parameter is set to 1).

The following procedure describes how to configure IP Profiles through the Web interface. You can also configure it through ini file [IPProfile] or CLI (`configure voip > coders-and-profiles ip-profile`).

➤ **To configure an IP Profile:**

1. Open the IP Profiles table (**Setup** menu > **Signaling & Media** tab > **Coders & Profiles** folder > **IP Profiles**).
2. Click **New**; the following dialog box appears:

3. Configure an IP Profile according to the parameters described in the table below.
4. Click **Apply**.

**Table 19-5: IP Profiles Table Parameter Descriptions**

Parameter	Description
<b>General</b>	
'Index' [IpProfile_Index]	Defines an index number for the new table row. <b>Note:</b> Each row must be configured with a unique index.
'Name' profile-name	Defines a descriptive name, which is used when associating the row in other tables.

Parameter	Description
[IpProfile_ProfileName]	<p>The valid value is a string of up to 40 characters.</p> <p><b>Note:</b> The parameter value cannot contain a forward slash (/).</p>
'Created By Routing Server' [IpProfile_ CreatedByRoutingServer]	<p>(Read-only) Indicates whether the IP Profile was created by a third-party routing server:</p> <ul style="list-style-type: none"> <li>■ [0] <b>No</b></li> <li>■ [1] <b>Yes</b></li> </ul> <p>For more information on the third-party routing server feature, see <a href="#">Centralized Third-Party Routing Server</a>.</p>
<b>Media Security</b>	
'SBC Media Security Mode' sbc-media- security-behaviour  [IpProfile_ SBCMediaSecurityBehaviour]	<p>Defines the handling of RTP/SRTP, and MSRP/MSRPS for the SIP UA associated with the IP Profile.</p> <ul style="list-style-type: none"> <li>■ [0] <b>As is</b> = (Default) No special handling for RTP/SRTP and MSRP/MSRPS is done.</li> <li>■ [1] <b>Secured</b> = SBC legs negotiate only SRTP/MSRPS media lines, and RTP/MSRP media lines are removed from the incoming SDP offer-answer.</li> <li>■ [2] <b>Not Secured</b> = SBC legs negotiate only RTP/MSRP media lines, and SRTP/MSRPS media lines are removed from the incoming offer-answer.</li> <li>■ [3] <b>Both</b> = Each offer-answer is extended (if not already) to two media lines - one RTP/MSRP and the other SRTP/MSRPS.</li> </ul> <p>If two SBC legs (after offer-answer negotiation) use different security types (i.e., one RTP/MSRP and the other SRTP/MSRPS), the device performs RTP-SRTP/MSRP-MSRPS transcoding. For such transcoding, the following prerequisites must be met:</p> <ul style="list-style-type: none"> <li>■ At least one supported SDP "crypto" attribute and parameters.</li> <li>■ The [EnableMediaSecurity] parameter must be configured to [1].</li> </ul> <p>If one of the above prerequisites is not met, then:</p> <ul style="list-style-type: none"> <li>■ any value other than <b>As is</b> is discarded.</li> </ul>

Parameter	Description
	<ul style="list-style-type: none"> <li>■ if the incoming offer is SRTP/MSRPS, forced transcoding, coder transcoding, and DTMF extensions are not applied.</li> </ul> <p><b>Note:</b> For secured MSRP (MSRPS), configure the parameter to <b>Secured</b> or <b>Both</b>. For more information on MSRP, see <a href="#">Configuring Message Session Relay Protocol</a> on page 1030.</p>
<p>'Gateway Media Security Mode'</p> <p>media-security-behaviour</p> <p>[IpProfile_MediaSecurityBehaviour]</p>	<p>Defines the handling of SRTP for the SIP UA associated with the IP Profile.</p> <ul style="list-style-type: none"> <li>■ [-1] <b>Not Configured</b> = Applies the settings of the corresponding global parameter [MediaSecurityBehaviour].</li> <li>■ [0] <b>Preferable</b> = (Default) The device initiates encrypted calls to this SIP UA. However, if negotiation of the cipher suite fails, an unencrypted call is established. The device accepts incoming calls received from the SIP UA that don't include encryption information.</li> <li>■ [1] <b>Mandatory</b> = The device initiates encrypted calls to this SIP UA, but if negotiation of the cipher suite fails, the call is terminated. The device rejects incoming calls received from the SIP UA that don't include encryption information.</li> <li>■ [2] <b>Disable</b> = This SIP UA does not support encrypted calls (i.e., SRTP).</li> <li>■ [3] <b>Preferable - Single Media</b> = The device sends SDP with a single media ('m=') line only (e.g., m=audio 6000 RTP/AVP 4 0 70 96) with RTP/AVP and crypto keys. The SIP UA can respond with SRTP or RTP parameters: <ul style="list-style-type: none"> <li>✓ If the SIP UA does not support SRTP, it uses RTP and ignores the crypto lines.</li> <li>✓ If the device receives an SDP offer with a single media (as shown above) from the SIP UA, it responds with SRTP (RTP/SAVP) if you configure the [EnableMediaSecurity] parameter to [1]. If SRTP is not supported (i.e., [EnableMediaSecurity] is configured to [0]), it responds with RTP.</li> <li>✓ If two 'm=' lines are received in the SDP offer, the device prefers the SAVP (secure audio video profile), regardless of the order in the SDP.</li> </ul> </li> </ul>

Parameter	Description
	<p><b>Note:</b></p> <ul style="list-style-type: none"> <li>■ The parameter is applicable only to the Gateway application.</li> <li>■ The parameter is applicable only if you configure the [EnableMediaSecurity] parameter to [1].</li> <li>■ The corresponding global parameter is [MediaSecurityBehaviour].</li> </ul>
<p>'Symmetric MKI' enable-symmetric- mki [IpProfile_ EnableSymmetricMKI]</p>	<p>Enables symmetric MKI negotiation.</p> <ul style="list-style-type: none"> <li>■ [0] <b>Disable</b> = (Default) The device includes the MKI in its SIP 200 OK response according to the SRTPTxPacketMKISize parameter (if set to 0, it is not included; if set to any other value, it is included with this value).</li> <li>■ [1] <b>Enable</b> = The answer crypto line contains (or excludes) an MKI value according to the selected crypto line in the offer. For example, assume that the device receives an INVITE containing the following two crypto lines in SDP: <pre>a=crypto:2 AES_CM_128_HMAC_SHA1_80 inline:TAaxNnQt8/qLQMnDuG4vxYfWl6K7eBK /ufk04pR4 2^31 1:1 a=crypto:3 AES_CM_128_HMAC_SHA1_80 inline:bnuYZnMxSfUiGitviWJZmzr7OF3AiRO 0l5Vnh0kH 2^31</pre> <p>The first crypto line includes the MKI parameter "1:1". In the 200 OK response, the device selects one of the crypto lines (i.e., '2' or '3'). Typically, it selects the first line that supports the crypto suite. However, for SRTP-to-SRTP in SBC sessions, it can be determined by the remote side on the outgoing leg. If the device selects crypto line '2', it includes the MKI parameter in its answer SDP, for example: <pre>a=crypto:2 AES_CM_128_HMAC_SHA1_80 inline:R1VyA1xV/qwBjkEklU4ksJy13wCtYeZ Lq1/QFuxw 2^31 1:1</pre> <p>If the device selects a crypto line that does not contain the MKI parameter, then the MKI parameter is not included in the crypto line in the SDP answer (even if the SRTPTxPacketMKISize parameter is set to any value</p> </p></li> </ul>

Parameter	Description
	<p>other than 0).</p> <p><b>Note:</b> The corresponding global parameter is EnableSymmetricMKI.</p>
<p>'MKI Size' mki-size [IpProfile_MKISize]</p>	<p>Defines the size (in bytes) of the Master Key Identifier (MKI) in SRTP Tx packets.</p> <p>The valid value is 0 to 4. The default is 0 (i.e., new keys are generated without MKI).</p> <p><b>Note:</b></p> <ul style="list-style-type: none"> <li>■ Gateway application: The device only initiates the MKI size.</li> <li>■ SBC application: The device can forward MKI size as is for SRTP-to-SRTP flows or override the MKI size during negotiation. This can be done on the inbound or outbound leg.</li> <li>■ The corresponding global parameter is SRTPTxPacketMKISize.</li> </ul>
<p>'SBC Enforce MKI Size' sbc-enforce-mki-size [IpProfile_SBCEnforceMKISize]</p>	<p>Enables negotiation of the Master Key Identifier (MKI) length for SRTP-to-SRTP flows between SIP networks (i.e., IP Groups). This includes the capability of modifying the MKI length on the inbound or outbound SBC call leg for the SIP UA associated with the IP Profile.</p> <ul style="list-style-type: none"> <li>■ [0] <b>Don't enforce</b> = (Default) Device forwards the MKI size as is.</li> <li>■ [1] <b>Enforce</b> = Device changes the MKI length according to the settings of the IP Profile parameter, MKISize.</li> </ul>
<p>'Reset SRTP Upon Re-key' reset-srtp-upon-re-key [IpProfile_ResetSRTPStateUponRekey]</p>	<p>Enables synchronization of the SRTP state between the device and a server when a new SRTP key is generated upon a SIP session expire. This feature ensures that the roll-over counter (ROC), one of the parameters used in the SRTP encryption/decryption process of the SRTP packets is synchronized on both sides for transmit and receive packets.</p> <ul style="list-style-type: none"> <li>■ [0] <b>Disable</b> = (Default) ROC is not reset on the device side.</li> <li>■ [1] <b>Enable</b> = If the session expires causing a session refresh through a re-INVITE, the device or server generates a new key and the device resets the ROC</li> </ul>

Parameter	Description
	<p>index (and other SRTP fields) as done by the server, resulting in a synchronized SRTP.</p> <p><b>Note:</b></p> <ul style="list-style-type: none"> <li>■ If this feature is disabled and the server resets the ROC upon a re-key generation, one-way voice may occur.</li> <li>■ The corresponding global parameter is [ResetSRTPStateUponRekey].</li> </ul>
<p>'Generate SRTP Keys Mode' generate-srtp-keys [IpProfile_ GenerateSRTPKeys]</p>	<p>Enables the device to generate a new SRTP key upon receipt of a re-INVITE with the SIP UA associated with the IP Profile.</p> <ul style="list-style-type: none"> <li>■ [0] <b>Only If Required</b> = (Default) The device generates an SRTP key only if necessary.</li> <li>■ [1] <b>Always</b> = The device always generates a new SRTP key.</li> </ul>
<p>'SBC Remove Crypto Lifetime in SDP' sbc-sdp-remove-crypto-lifetime [IpProfile_ SBCRemoveCryptoLifetimeInSDP]</p>	<p>Defines the handling of the lifetime field in the 'a=crypto' attribute of the SDP for the SIP UA associated with the IP Profile. The SDP field defines the lifetime of the master key as measured in maximum number of SRTP or SRTCP packets using the master key.</p> <ul style="list-style-type: none"> <li>■ [0] <b>No</b> = (Default) The device retains the lifetime field (if present) in the SDP.</li> <li>■ [1] <b>Yes</b> = The device removes the lifetime field from the 'a=crypto' attribute.</li> </ul> <p><b>Note:</b> If you configure the parameter to Yes, the following IP Profile parameters must be configured as follows:</p> <ul style="list-style-type: none"> <li>■ IpProfile_EnableSymmetricMKI configured to Enable [1].</li> <li>■ IpProfile_MKISize configured to 0.</li> <li>■ IpProfile_SBCEnforceMKISize configured to Enforce [1].</li> </ul>
<p>'SBC Remove Unknown Crypto' sbc-remove-unknown-crypto [IpProfile_ SBCRemoveUnKnownCrypt</p>	<p>Defines whether the device keeps or removes unknown cryptographic suites (encryption and authentication algorithms) that are present in the SDP 'a=crypto' attribute in the incoming SIP message, before forwarding the message to the SIP UA associated with this IP Profile.</p> <ul style="list-style-type: none"> <li>■ [0] <b>No</b> = (Default) The device keeps all unknown</li> </ul>

Parameter	Description
o]	<p>cryptographic suites that are in the SDP's 'a=crypto' attribute.</p> <ul style="list-style-type: none"> <li>■ [1] <b>Yes</b> = The device removes all unknown cryptographic suites that are in the SDP's 'a=crypto' attribute.</li> </ul> <p><b>Note:</b></p> <ul style="list-style-type: none"> <li>■ The feature is applicable only to SRTP-to-SRTP calls and calls that do not require transcoding.</li> <li>■ The parameter is applicable only to the SBC application.</li> </ul>
<b>SBC Early Media</b>	
'Remote Early Media' sbc-rmt-early-media-supp [IpProfile_ SBCRemoteEarlyMediaSupport]	<p>Defines whether the remote side can accept early media or not.</p> <ul style="list-style-type: none"> <li>■ [0] <b>Not Supported</b> = Early media is not supported.</li> <li>■ [1] <b>Supported</b> = (Default) Early media is supported.</li> </ul>
'Remote Multiple 18x' sbc-rmt-mltple-18x-supp [IpProfile_ SBCRemoteMultiple18xSupport]	<p>Defines whether multiple 18x responses including 180 Ringing, 181 Call is Being Forwarded, 182 Call Queued, and 183 Session Progress are forwarded to the caller, for the SIP UA associated with the IP Profile.</p> <ul style="list-style-type: none"> <li>■ [0] <b>Not Supported</b> = Only the first 18x response is forwarded to the caller.</li> <li>■ [1] <b>Supported</b> = (Default) Multiple 18x responses are forwarded to the caller.</li> </ul>
'Remote Early Media Response Type' sbc-rmt-early-media-resp [IpProfile_ SBCRemoteEarlyMediaResponseType]	<p>Defines the SIP provisional response type - 180 or 183 - for forwarding early media to the caller, for the SIP UA associated with the IP Profile.</p> <ul style="list-style-type: none"> <li>■ [0] <b>Transparent</b> = (Default) All early media response types are supported; the device forwards all responses as is (unchanged).</li> <li>■ [1] <b>180</b> = Early media is sent as 180 response only.</li> <li>■ [2] <b>183</b> = Early media is sent as 183 response only.</li> </ul>
'Remote Multiple Early Dialogs'	<p>Defines the device's handling of To-header tags in call</p>



Parameter	Description
sbc-multi-early-dia [IpProfile_ SBCRemoteMultipleEarlyDia logs]	<p>forking responses (i.e., multiple SDP answers) sent to the SIP UA associated with the IP Profile.</p> <p>When the SIP UA initiates an INVITE that is subsequently forked (for example, by a proxy server) to multiple UAs, the endpoints respond with a SIP 183 containing an SDP answer. Typically, each endpoint's response has a different To-header tag. For example, a call initiated by the SIP UA (100@A) is forked and two endpoints respond with ringing, each with a different tag:</p> <ul style="list-style-type: none"> <li>■ Endpoint "tag 2":           <pre>SIP/2.0 180 Ringing From: &lt;sip:100@A&gt;;tag=tag1 To: sip:200@B;tag=tag2 Call-ID: c2</pre> </li> <li>■ Endpoint "tag 3":           <pre>SIP/2.0 180 Ringing From: &lt;sip:100@A&gt;;tag=tag1 To: sip:200@B;tag=tag3 Call-ID: c2</pre> </li> </ul> <p>In non-standard behavior (when the parameter is configured to Disable), the device forwards all the SDP answers with the same tag. In the example, endpoint "tag 3" is sent with the same tag as endpoint "tag 2" (i.e., To: sip:200@B;tag=tag2).</p> <ul style="list-style-type: none"> <li>■ [-1] <b>According to Operation Mode</b> = (Default) Depends on the setting of the 'Operation Mode' parameter in the IP Group or SRDs table:           <ul style="list-style-type: none"> <li>✓ B2BUA: Device operates as if the parameter is set to Disable [0].</li> <li>✓ Call State-full Proxy: Device operates as if the parameter is set to Enable [1]. In addition, the device preserves the From tags and Call-IDs of the endpoints in the SDP answer sent to the SIP UA.</li> </ul> </li> <li>■ [0] <b>Disable</b> = Device sends the multiple SDP answers with the same To-header tag, to the SIP UA. In other words, this option is relevant if the SIP UA does not support multiple dialogs (and multiple tags). However, non-standard, multiple answer support may still be configured by the SBCRemoteMultipleAnswersMode</li> </ul>

Parameter	Description
	<p>parameter.</p> <ul style="list-style-type: none"> <li>■ [1] <b>Enable</b> = Device sends the multiple SDP answers with different To-header tags, to the SIP UA. In other words, the SIP UA supports standard multiple SDP answers (with different To-header tags). In this case, the SBCRemoteMultipleAnswersMode parameter is ignored.</li> </ul> <p><b>Note:</b> If the parameter and the SBCRemoteMultipleAnswersMode parameter are disabled, multiple SDP answers are not reflected to the SIP UA (i.e., the device sends the same SDP answer in multiple 18x and 200 responses).</p>
<p>'Remote Multiple Answers Mode'</p> <p>sbc-multi-answers</p> <p>[IpProfile_ SBCRemoteMultipleAnswersMode]</p>	<p>Enables interworking multiple SDP answers within the same SIP dialog (non-standard). The parameter enables the device to forward multiple answers to the SIP UA associated with the IP Profile. The parameter is applicable only when the IpProfile_SBCRemoteMultipleEarlyDialogs parameter is disabled.</p> <ul style="list-style-type: none"> <li>■ [0] <b>Disable</b> = (Default) Device always sends the same SDP answer, which is based on the first received answer that it sent to the SIP UA, for all forked responses (even if the 'Forking Handling Mode' parameter is <b>Sequential</b>), and thus, may result in transcoding.</li> <li>■ [1] <b>Enable</b> = If the 'Forking Handling Mode' parameter is configured to <b>Sequential</b>, the device sends multiple SDP answers.</li> </ul>
<p>'Remote Early Media RTP Detection Mode'</p> <p>sbc-rmt-early-media-rtp</p> <p>[IpProfile_ SBCRemoteEarlyMediaRTP]</p>	<p>Defines whether the destination UA sends RTP immediately after it sends a 18x response.</p> <ul style="list-style-type: none"> <li>■ [0] <b>By Signaling</b> = (Default) Remote client sends RTP immediately after it sends 18x response with early media. The device forwards 18x and RTP as is.</li> <li>■ [1] <b>By Media</b> = After sending 18x response, the remote client waits before sending RTP (e.g., Microsoft Skype for Business environment). For the device's handling of this remote UA support, see <a href="#">Interworking SIP Early Media</a>.</li> </ul>
<p>'Remote RFC 3960 Support'</p> <p>sbc-rmt-rfc3960-</p>	<p>Defines whether the destination UA is capable of receiving 18x messages with delayed RTP.</p>

Parameter	Description
supp [IpProfile_ SBCRemoteSupportsRFC39 60]	<ul style="list-style-type: none"> <li>■ [0] <b>Not Supported</b> = (Default) UA does not support receipt of 18x messages with delayed RTP. For the device's handling of this remote UA support, see <a href="#">Interworking SIP Early Media</a>.</li> <li>■ [1] <b>Supported</b> = UA is capable of receiving 18x messages with delayed RTP.</li> </ul>
'Remote Can Play Ringback' sbc-rmt-can-play- ringback [IpProfile_ SBCRemoteCanPlayRingbac k]	Defines whether the destination UA can play a local ringback tone. <ul style="list-style-type: none"> <li>■ [0] <b>No</b> = UA does not support local ringback tone. The device sends 18x with delayed SDP to the UA.</li> <li>■ [1] <b>Yes</b> = (Default) UA supports local ringback tone. For the device's handling of this remote UA support, see <a href="#">Interworking SIP Early Media</a>.</li> </ul>
'Generate RTP' sbc-generate-rtp [IPProfile_SBCGenerateRTP]	Enables the device to generate "silence" RTP packets to the SIP UA until it detects audio RTP packets from the SIP UA. The parameter provides support for interworking with SIP entities that wait for the first incoming packets before sending RTP (e.g., early media used for ringback tone or IVR) during media negotiation. <ul style="list-style-type: none"> <li>■ [0] <b>None</b> = (Default) Silence packets are not generated.</li> <li>■ [1] <b>Until RTP Detected</b> = The device generates silence RTP packets to the SIP UA upon receipt of a SIP response (183 with SDP) from the SIP UA. In other words, these packets serve as the first incoming packets for the SIP UA. The device stops sending silence packets when it receives RTP packets from the peer side (which it then forwards to the SIP UA).</li> </ul> <p><b>Note:</b> To generate silence packets, DSP resources are required (except for calls using the G.711 coder).</p>
SBC Media	
'Mediation Mode' transcoding-mode [IpProfile_ TranscodingMode]	Defines the transcoding mode (media negotiation) for the SIP UA associated with the IP Profile. <ul style="list-style-type: none"> <li>■ [0] <b>RTP Mediation</b> = (Default) Transcoding is done only if required. If not required, many of the media settings (such as gain control) are not applied to the voice stream. The device forwards the RTP packets</li> </ul>

Parameter	Description
	<p>transparently (i.e., RTP-to-RTP) without processing the data; only the RTP headers are re-constructed.</p> <ul style="list-style-type: none"> <li>■ [1] <b>Force Transcoding</b> = Transcoding is always done on the outgoing leg. The device interworks the media for the SIP UA (as both legs have different media capabilities), by implementing DSP transcoding. This enables the device to receive capabilities that are not negotiated between the SIP entities. For example, it can enforce gain control to use voice transcoding even though both legs have negotiated without the device's intervention (such as Extension coders).</li> <li>■ [2] <b>RTP Forwarding</b> = If transcoding is not required and both legs are configured with RTP forwarding, then RTP packets are forwarded transparently without any processing. This mode is needed when the call parties pass invalid RTP packets on the RTP port. If you use this option, you may also need to configure the global parameters 'Forward Unknown RTP Payload Types' to <b>Handle as Valid Packet</b>, and 'Forward Invalid RTP Packets' to <b>Forward Packets</b>.</li> </ul> <p><b>Note:</b></p> <ul style="list-style-type: none"> <li>■ For transcoding, make sure that the device's License Key includes a license for the number of DSP resources ('DSP Channels') and a license for the number of transcoding sessions ('Transcoding Sessions'). For more information on the License Key, see <a href="#">License Key</a> on page 1094.</li> <li>■ Each transcoding session uses two DSP resources.</li> <li>■ When transcoding is required, it is recommended that the device be installed with the MPM(s) module for handling this functionality.</li> <li>■ The corresponding global parameter is [TranscodingMode].</li> </ul>
'Extension Coders Group' sbc-ext-coders- group-name [IpProfile_ SBCExtensionCodersGroup Name]	Assigns a Coder Group for extension coders, which are added to the SDP offer in the outgoing leg for the SIP UA associated with the IP Profile. This is used when transcoding is required between two IP entities (i.e., the SDP answer from one doesn't include any coder included in the offer previously sent by the other).

Parameter	Description
	<p>For more information on extension coders and transcoding, see <a href="#">Coder Transcoding</a>. To configure Coder Groups, see <a href="#">Configuring Coder Groups</a>.</p>
<p>'Allowed Audio Coders' allowed-audio-coders-group-name [IpProfile_ SBCAllowedAudioCodersGroup Name]</p>	<p>Assigns an Allowed Audio Coders Group, which defines audio (voice) coders that can be used for the SIP UA associated with the IP Profile.</p> <p>To configure Allowed Audio Coders Groups, see <a href="#">Configuring Allowed Audio Coder Groups</a>. For a description of the Allowed Coders feature, see <a href="#">Restricting Coders</a>.</p>
<p>'Allowed Coders Mode' sbc-allowed-coders-mode [IpProfile_ SBCAllowedCodersMode]</p>	<p>Defines the mode of the Allowed Coders feature for the SIP UA associated with the IP Profile.</p> <ul style="list-style-type: none"> <li>■ [0] <b>Restriction</b> = In the incoming SDP offer, the device uses only Allowed coders; the rest are removed from the SDP offer (i.e., only coders common between those in the received SDP offer and the Allowed coders are used). If an Extension Coders Group is also assigned (using the 'Extension Coders Group' parameter, above), these coders are added to the SDP offer if they also appear in Allowed coders.</li> <li>■ [1] <b>Preference</b> = The device re-arranges the priority (order) of the coders in the incoming SDP offer according to their order of appearance in the Allowed Audio Coders Group or Allowed Video Coders Group. The coders in the original SDP offer are listed after the Allowed coders.</li> <li>■ [2] <b>Restriction and Preference</b> = Performs both Restriction and Preference.</li> </ul> <p><b>Note:</b></p> <ul style="list-style-type: none"> <li>■ The parameter is applicable only if Allowed coders are assigned to the IP Profile (see the 'Allowed Audio Coders' or 'Allowed Video Coders' parameters).</li> <li>■ For more information on the Allowed Coders feature, see <a href="#">Restricting Coders</a>.</li> </ul>
<p>'Allowed Video Coders' allowed-video-coders-group-name [IpProfile_ SBCAllowedVideoCodersGroup Name]</p>	<p>Assigns an Allowed Video Coders Group. This defines permitted video coders when forwarding video streams to the SIP UA associated with the IP Profile. The video coders are listed in the "video" media type in the SDP (i.e.,</p>

Parameter	Description
SBCAllowedVideoCodersGroup GroupName]	<p>'m=video' line). For this SIP UA, the device uses only video coders that appear in both the SDP offer and the Allowed Video Coders Group.</p> <p>By default, no Allowed Video Coders Group is assigned (i.e., all video coders are allowed).</p> <p>To configure Allowed Video Coders Groups, see <a href="#">Configuring Allowed Video Coder Groups</a>.</p>
'Allowed Media Types' sbc-allowed-media- types [IPProfile_ SBCAllowedMediaTypes]	<p>Defines media types permitted for the SIP UA associated with the IP Profile. The media type appears in the SDP 'm=' line (e.g., 'm=audio'). The device permits only media types that appear in both the SDP offer and this configured list. If no common media types exist between the SDP offer and this list, the device drops the call.</p> <p>The valid value is a string of up to 64 characters. To configure multiple media types, separate the strings with a comma, e.g., " audio, text" (without quotation marks). By default, no media types are configured (i.e., all media types are permitted).</p>
'Direct Media Tag' sbc-dm-tag [IPProfile_ SBCDirectMediaTag]	<p>Defines an identification tag for enabling direct media or media bypass (i.e., no Media Anchoring) of SBC calls for the SIP UA associated with the IP Profile. Direct media occurs between all UAs whose IP Profiles have the same tag value (non-empty value). For example, if you configure the parameter to "direct-rtp" for two IP Profiles "IP-PBX-1" and "IP-PBX-2", the device employs direct media for calls of UAs associated with IP Profile "IP-PBX-1", for calls of UAs associated with IP Profile "IP-PBX-2", and for calls between UAs associated with IP Profile "IP-PBX-1" and IP Profile "IP-PBX-2".</p> <p>The valid value is a string of up to 16 characters. By default, no value is defined.</p> <p>For more information on direct media, see <a href="#">Direct Media</a>.</p> <p><b>Note:</b></p> <ul style="list-style-type: none"> <li>■ If you enable direct media for the IP Profile, make sure that your Media Realm provides enough ports, as media may traverse the device for mid-call services (e.g., call transfer).</li> <li>■ If you have configured a SIP Recording rule (see SIP-based Media Recording) for calls associated with this IP</li> </ul>

Parameter	Description
	<p>Profile, the device automatically disables direct media for these calls (during their SIP signaling setup). This ensures that the media passes through the device so that it can be recorded and sent to the SRS. However, if you enable direct media using the [SBCDirectMedia] global parameter (i.e., for all calls), direct media is always enforced and calls will not be recorded.</p> <ul style="list-style-type: none"> <li>■ The parameter is applicable only to the SBC application.</li> </ul>
<p>'RFC 2833 Mode' sbc-rfc2833- behavior [IpProfile_ SBCRFC2833Behavior]</p>	<p>Defines the handling of RFC 2833 SDP offer-answer negotiation for the SIP UA associated with the IP Profile.</p> <ul style="list-style-type: none"> <li>■ [0] <b>As is</b> = (Default) The device does not intervene in the RFC 2833 negotiation.</li> <li>■ [1] <b>Extend</b> = Each outgoing offer-answer includes RFC 2833 in the offered SDP. The device adds RFC 2833 only if the incoming offer does not include RFC 2833.</li> <li>■ [2] <b>Disallow</b> = The device removes RFC 2833 from the incoming offer.</li> </ul> <p><b>Note:</b> If the device interworks between different DTMF methods and one of the methods is in-band DTMF packets (in RTP), detection and generation of DTMF methods requires DSP resources. However, RFC 2833 to SIP INFO does not require DSP resources.</p>
<p>'RFC 2833 DTMF Payload Type' sbc-2833dtmf- payload [IpProfile_ SBC2833DTMFPayloadType]</p>	<p>Defines the payload type of DTMF digits for the SIP UA associated with the IP Profile. This enables the interworking of the DTMF payload type for RFC 2833 between different SBC call legs. For example, if two entities require different DTMF payload types, the SDP offer received by the device from one UA is forwarded to the destination UA with its payload type replaced with the configured payload type, and vice versa.</p> <p>The value range is 0 to 200. The default is 0 (i.e., the device forwards the received payload type as is).</p>
<p>'Alternative DTMF Method' sbc-alternative- dtmf-method [IpProfile_ SBCAlternativeDTMFMethod]</p>	<p>The device's first priority for DTMF method at each leg is RFC 2833. Thus, if the device successfully negotiates RFC 2833 for the SIP UA associated with the IP Profile, the chosen DTMF method for this leg is RFC 2833. When RFC 2833 negotiation fails, the device uses the DTMF method</p>

Parameter	Description
d]	<p>configured by this parameter for the leg.</p> <ul style="list-style-type: none"> <li>■ [0] <b>As Is</b> = (Default) The device does not attempt to interwork any special DTMF method.</li> <li>■ [1] <b>In Band</b></li> <li>■ [2] <b>INFO - Cisco</b></li> <li>■ [3] <b>INFO - Nortel</b></li> <li>■ [4] <b>INFO - Lucent = INFO, Korea</b></li> </ul> <p><b>Note:</b> If the device interworks between different DTMF methods and one of the methods is in-band DTMF packets (in RTP), detection and generation of DTMF methods requires DSP resources. However, RFC 2833 to SIP INFO does not require DSP resources.</p>
<p>'Send Multiple DTMF Methods'</p> <pre>sbc-send-multiple-dtmf-methods</pre> <p>[IPProfile_ SBCSupportMultipleDTMF Methods]</p>	<p>Enables the device to send DTMF digits out-of-band (not with audio stream) using both the SIP INFO and RFC 2833 methods for the same call on the leg to which this IP Profile is associated. The RFC 2833 method sends out-of-band DTMF digits using the RTP protocol while the SIP INFO method sends the digits using the SIP protocol.</p> <ul style="list-style-type: none"> <li>■ [0] <b>Disable</b> = (Default) The device sends DTMF digits using only one method (either SIP INFO, RFC 2833, or in-band).</li> <li>■ [1] <b>Enable</b> = The device sends DTMF digits using both methods - SIP INFO and RFC 2833.</li> </ul> <p>If you have enabled the parameter, you can also configure the device to stop sending DTMF digits using the SIP INFO method if the device receives a SIP re-INVITE (or UPDATE) from the SIP UA to where the SIP INFO is being sent (and keep sending the DTMF digits using the RFC 2833 method). This is done using the AudioCodes proprietary SIP header X-AC-Action and a Message Manipulation rule (inbound) to instruct the device to switch to a different IP Profile that is configured to disable the sending of DTMF digits using both methods (i.e., 'Send Multiple DTMF Methods' is configured to Disable):</p> <pre>X-AC-Action: 'switch-profile;profile-name=&lt;IP Profile Name&gt;'</pre> <p>If the IP Profile name contains one or more spaces, you must enclose the name in double quotation marks, for</p>



Parameter	Description
	<p>example:</p> <pre>X-AC-Action: 'switch-profile;profile-name="My IP Profile"'</pre> <p>The Message Manipulation rule adds the proprietary header with the value of the new IP Profile to the incoming re-INVITE or UPDATE message and as a result, the device uses the new IP Profile for the SIP UA and stops sending it SIP INFO messages. You can also configure an additional Message Manipulation rule to re-start the sending of the SIP INFO. For example, you can configure two Message Manipulation rules where the sending of both SIP INFO and RFC 2833 depends on the negotiated media port -- the device stops sending SIP INFO if the SDP of the re-INVITE or UPDATE message contains port 7550 and re-starts sending if the port is 8660. The rule that re-starts the SIP INFO switches the IP Profile back to the initial IP Profile that enables the sending of DTMF digits using both methods (i.e., 'Send Multiple DTMF Methods' is configured to Enable). The configured Message Manipulation rules for this example are shown below:</p> <ul style="list-style-type: none"> <li>■ Index 1 <ul style="list-style-type: none"> <li>✓ Message Type: reinvite.request</li> <li>✓ Condition: body.sdp regex (.*)(m=audio 7550 RTP/AVP)(.*)</li> <li>✓ Action Subject: header.X-AC-Action</li> <li>✓ Action Type: Add</li> <li>✓ Action Value: 'switch-profile;profile-name=ITSP-Profile-2'</li> </ul> </li> <li>■ Index 2 <ul style="list-style-type: none"> <li>✓ Message Type: reinvite.request</li> <li>✓ Condition: body.sdp regex (.*)(m=audio 8660 RTP/AVP)(.*)</li> <li>✓ Action Subject: header.X-AC-Action</li> <li>✓ Action Type: Add</li> <li>✓ Action Value: 'switch-profile;profile-name=ITSP-Profile-1'</li> </ul> </li> </ul> <p>The Message Manipulation rules must be assigned to the</p>

Parameter	Description
	<p>SIP UA's IP Group, using the 'Inbound Message Manipulation Set' parameter.</p> <p><b>Note:</b></p> <ul style="list-style-type: none"> <li>■ To send DTMF digits using both methods (i.e., when the parameter is enabled), you need to also configure the following:                             <ul style="list-style-type: none"> <li>✓ Configure the 'Alternative DTMF Method' (IPProfile_SBCAlternativeDTMFMethod) parameter to one of the SIP INFO options (INFO – Cisco, INFO – Nortel, or INFO – Lucent).</li> <li>✓ Enable the sending of DTMF digits using the RFC 2833 method, by configuring the 'RFC 2833 Mode' (IpProfile_SBCRFC2833Behavior) parameter to As Is or Extend.</li> </ul> </li> <li>■ When using the X-AC-Action header to switch IP Profiles, it is recommended that the settings of the switched IP Profile are identical (except for the 'Send Multiple DTMF Methods' parameter) to the initial IP Profile in order to avoid any possible call handling errors.</li> <li>■ The parameter is applicable only to the SBC application.</li> </ul>
<p>'Adapt RFC2833 BW to Voice coder BW'                      sbc-adapt-rfc2833-bw-voice-bw                      [IpProfile_SBCAdaptRFC2833BWToVoiceCoderBW]</p>	<p>Defines the 'telephone-event' type (8000 or 16000) in the SDP that the device sends in the outgoing SIP 200 OK message for DTMF payload negotiation (sampling rate).</p> <ul style="list-style-type: none"> <li>■ [0] <b>Disable</b> = (Default) The device always sends the 'telephone-event' as 8000 in the outgoing SIP 200 OK, even if the SDP of the incoming INVITE contains multiple telephone-event types (e.g., 8000 and 16000).</li> <li>■ [1] <b>Enable</b> = The type of 'telephone-event' that the device sends in the outgoing SIP 200 OK message is according to the coder type (narrowband or wideband). If narrowband, it sends the 'telephone-event' as 8000; if wideband, it sends it as 16000.</li> </ul> <p>An example when the parameter is configured to <b>Enable</b> is shown below, whereby the 'telephone-event' is "16000" in the outgoing message due to the wideband coder:</p> <p><b>SDP in incoming INVITE:</b></p>

Parameter	Description
	<pre>a=rtpmap:97 AMR-WB/16000/1 a=fmtp:97 mode-change-capability=2 a=rtpmap:98 AMR-WB/16000/1 a=fmtp:98 octet- align=1; mode-change-capability=2 a=rtpmap:100 AMR/8000/1 a=fmtp:100 mode-change-capability=2 a=rtpmap:99 telephone-event/16000/1 a=fmtp:99 0-15 a=rtpmap:102 telephone-event/8000/1 a=fmtp:102 0-15</pre> <p><b>SDP in outgoing 200 OK:</b></p> <pre>m=audio 6370 RTP/AVP 97 99 a=rtpmap:99 telephone-event/<b>16000</b>/1 a=fmtp:99 0-15 a=sendrecv a=ptime:20 a=maxptime:120 a=rtpmap:97 AMR-WB/16000 a=fmtp:97 mode-change- capability=2;mode-set=0,1,2,3,4,5,6,7,</pre> <p><b>Note:</b> The parameter is applicable only to the SBC application.</p>
<p>'SDP Ptime Answer' sbc-sdp-ptime-ans [IpProfile_ SBCSDPPtimeAnswer]</p>	<p>Defines the packetization time (ptime) of the coder in RTP packets for the SIP UA associated with the IP Profile. This is useful when implementing transrating.</p> <ul style="list-style-type: none"> <li>■ [0] <b>Remote Answer</b> = (Default) Use ptime according to SDP answer.</li> <li>■ [1] <b>Original Offer</b> = Use ptime according to SDP offer.</li> <li>■ [2] <b>Preferred Value</b> = Use the ptime according to the 'Preferred Ptime' parameter (see below) if it is configured to a non-zero value.</li> </ul> <p><b>Note:</b></p> <ul style="list-style-type: none"> <li>■ Regardless of the settings of this parameter, if a non-zero value is configured for the 'Preferred Ptime' parameter (see below), it is used as the ptime in the SDP offer.</li> </ul>
<p>'Preferred Ptime' sbc-preferred-ptime</p>	<p>Defines the packetization time (ptime) in msec for the SIP UA associated with the IP Profile, in the outgoing SDP offer. If the 'SDP Ptime Answer' parameter (see above) is</p>

Parameter	Description
[IpProfile_ SBCPreferredPTime]	<p>configured to Preferred Value [2] and the 'Preferred Ptime' parameter is configured to a non-zero value, the configured ptime is used (enabling ptime transrating if the other side uses a different ptime).</p> <p>If the 'SDP Ptime Answer' parameter is configured to Remote Answer [0] or Original Offer [1] and the 'Preferred Ptime' parameter is configured to a non-zero value, the configured value is used as the ptime in the SDP offer.</p> <p>The valid range is 0 to 200. The default is 0 (i.e., a preferred ptime is not used).</p>
'Use Silence Suppression' sbc-use-silence- supp [IpProfile_ SBCUseSilenceSupp]	<p>Defines silence suppression support for the SIP UA associated with the IP Profile</p> <ul style="list-style-type: none"> <li>■ [0] <b>Transparent</b> = (Default) Forward as is.</li> <li>■ [1] <b>Add</b> = Enable silence suppression for each relevant coder listed in the SDP.</li> <li>■ [2] <b>Remove</b> = Disable silence suppression for each relevant coder listed in the SDP.</li> </ul> <p><b>Note:</b> This feature requires DSP resources.</p>
'RTP Redundancy Mode' sbc-rtsp-red-behav [IpProfile_ SBCRTPRedundancyBehav or]	<p>Enables interworking RTP redundancy negotiation support between SIP entities in the SDP offer-answer exchange (according to RFC 2198). The parameter defines the device's handling of RTP redundancy for the SIP UA associated with the IP Profile. According to the RTP redundancy SDP offer/answer negotiation, the device uses or discards the RTP redundancy packets. The parameter enables asymmetric RTP redundancy, whereby the device can transmit and receive RTP redundancy packets to and from a specific SIP UA, while transmitting and receiving regular RTP packets (no redundancy) for the other SIP UA involved in the voice path.</p> <p>The device can identify the RTP redundancy payload type in the SDP for indicating that the RTP packet stream includes redundant packets. RTP redundancy is indicated in SDP using the "red" coder type, for example:</p> <pre>a=rtpmap:&lt;payload type&gt; red/8000/1</pre> <p>RTP redundancy is useful when there is packet loss; the missing information may be reconstructed at the receiver side from the redundant packets.</p>

Parameter	Description
	<ul style="list-style-type: none"> <li>■ [0] <b>As Is</b> = (Default) The device does not interfere in the RTP redundancy negotiation and forwards the SDP offer/answer (incoming and outgoing calls) as is without interfering in the RTP redundancy negotiation.</li> <li>■ [1] <b>Enable</b> = The device always adds RTP redundancy capabilities in the outgoing SDP offer sent to the SIP UA. Whether RTP redundancy is implemented depends on the subsequent incoming SDP answer from the SIP UA. The device does not modify the incoming SDP offer received from the SIP UA, but if RTP redundancy is offered, it will support it in the outgoing SDP answer. Select the option if the SIP UA requires RTP redundancy.</li> <li>■ [2] <b>Disable</b> = The device removes the RTP redundancy payload (if present) from the SDP offer/answer for calls received from or sent to the SIP UA. Select the option if the SIP UA does not support RTP redundancy.</li> </ul> <p><b>Note:</b></p> <ul style="list-style-type: none"> <li>■ To enable the device to generate RFC 2198 redundant packets, use the IPProfile_RTPRedundancyDepth parameter.</li> <li>■ To configure the payload type in the SDP offer for RTP redundancy, use the RFC2198PayloadType.</li> </ul>
<p>'RTCP Mode' sbc-rtcp-mode [IPProfile_SBCRTCPMode]</p>	<p>Defines how the device handles RTCP packets during call sessions for the SIP UA associated with the IP Profile. This is useful for interworking RTCP between SIP entities. For example, this may be necessary when incoming RTCP is not compatible with the destination SIP UA's (this IP Profile) RTCP support. In such a scenario, the device can generate the RTCP and send it to the SIP UA.</p> <ul style="list-style-type: none"> <li>■ [0] <b>Transparent</b> = (Default) RTCP is forwarded as is (unless transcoding is done, in which case, the device generates RTCP on both legs).</li> <li>■ [1] <b>Generate Always</b> = Generates RTCP packets during active and inactive (e.g., during call hold) RTP periods (i.e., media is 'a=recvonly' or 'a=inactive' in the INVITE SDP).</li> <li>■ [2] <b>Generate only if RTP Active</b> = Generates RTCP</li> </ul>

Parameter	Description
	<p>packets only during active RTP periods. In other words, the device does not generate RTCP when there is no RTP traffic (such as when a call is on hold).</p> <p><b>Note:</b> The corresponding global parameter is [SBCRTCPMode].</p>
<p>'Jitter Compensation' sbc-jitter-compensation [IpProfile_ SBCJitterCompensation]</p>	<p>Enables the on-demand jitter buffer for SBC calls. The jitter buffer can be used when other functionality such as voice transcoding are not done on the call. The jitter buffer is useful when incoming packets are received at inconsistent intervals (i.e., packet delay variation). The jitter buffer stores the packets and sends them out at a constant rate (according to the coder's settings).</p> <ul style="list-style-type: none"> <li>■ [0] <b>Disable</b> (default)</li> <li>■ [1] <b>Enable</b></li> </ul> <p><b>Note:</b></p> <ul style="list-style-type: none"> <li>■ The jitter buffer parameters, 'Dynamic Jitter Buffer Minimum Delay' (DJBufMinDelay) and 'Dynamic Jitter Buffer Optimization Factor' (DJBufOptFactor) can be used to configure minimum packet delay only when transcoding is employed.</li> <li>■ This feature may require DSP resources. For more information, contact the sales representative of your purchased device.</li> </ul>
<p>'ICE Mode' ice-mode [IPProfile_SBCIceMode]</p>	<p>Enables Interactive Connectivity Establishment (ICE) Lite for the SIP UA associated with the IP Profile. ICE is a methodology for NAT traversal, employing the Session Traversal Utilities for NAT (STUN) and Traversal Using Relays around NAT (TURN) protocols to provide a peer with a public IP address and port that can be used to connect to a remote peer.</p> <p>For example, ICE Lite is required when the device operates in Microsoft Teams Direct Routing (media bypass) environments.</p> <ul style="list-style-type: none"> <li>■ [0] <b>Disable</b> (default)</li> <li>■ [1] <b>Lite</b></li> </ul> <p>For more information on ICE Lite, see <a href="#">ICE Lite</a>.</p>

Parameter	Description
<p>'SDP Handle RTCP'</p> <p>sbc-sdp-handle-rtcp</p> <p>[IpProfile_ SBCSDPHandleRTCPAttribute]</p>	<p>Enables the interworking of the RTCP attribute, 'a=rtcp' (RTCP) in the SDP, for the SIP UA associated with the IP Profile. The RTCP attribute is used to indicate the RTCP port for media when that port is not the next higher port number following the RTP port specified in the media line ('m=').</p> <p>The parameter is useful for SIP entities that either require the attribute or do not support the attribute. For example, Google Chrome and Web RTC do not accept calls without the RTCP attribute in the SDP. In Web RTC, Chrome (SDES) generates the SDP with 'a=rtcp', for example:</p> <pre>m=audio 49170 RTP/AVP 0 a=rtcp:53020 IN IP6 2001:2345:6789:ABCD:EF01:2345:6789:ABCD</pre> <ul style="list-style-type: none"> <li>■ [0] <b>Don't Care</b> = (Default) The device forwards the SDP as is without interfering in the RTCP attribute (regardless if present or not).</li> <li>■ [1] <b>Add</b> = The device adds the 'a=rtcp' attribute to the outgoing SDP offer sent to the SIP UA if the attribute was not present in the original incoming SDP offer.</li> <li>■ [2] <b>Remove</b> = The device removes the 'a=rtcp' attribute, if present in the incoming SDP offer received from the other SIP UA, before sending the outgoing SDP offer to the SIP UA.</li> </ul>
<p>'RTCP Feedback'</p> <p>sbc-rtcp-feedback</p> <p>[IPProfile_ SBCRTCPFeedback]</p>	<p>Enables RTCP-based feedback indication in outgoing SDPs sent to the SIP UA associated with the IP Profile.</p> <p>The parameter supports indication of RTCP-based feedback, according to RFC 5124, during RTP profile negotiation between two communicating SIP entities. RFC 5124 defines an RTP profile (S)AVPF for (secure) real-time communications to provide timely feedback from the receivers to a sender. For more information on RFC 5124, see <a href="http://tools.ietf.org/html/rfc5124">http://tools.ietf.org/html/rfc5124</a>.</p> <p>Some SIP entities may require RTP secure-profile feedback negotiation (AVPF/SAVPF) in the SDP offer/answer exchange, while other SIP entities may not support it. The device indicates whether or not feedback is supported on behalf of the SIP UA. It does this by adding an "F" or removing the "F" from the SDP media line ('m=') for AVP</p>

Parameter	Description
	<p>and SAVP. For example, the following shows "AVP" appended with an "F", indicating that the SIP UA is capable of receiving feedback</p> <pre>m=audio 49170 RTP/SAVPF 0 96</pre> <ul style="list-style-type: none"> <li>■ [0] <b>Feedback Off</b> = (Default) The device does not send the feedback flag ("F") in SDP offers/answers that are sent to the SIP UA. If the SDP 'm=' attribute of an incoming message that is destined to the SIP UA includes the feedback flag, the device removes it before sending the message to the SIP UA.</li> <li>■ [1] <b>Feedback On</b> = The device includes the feedback flag ("F") in the SDP offer sent to the SIP UA. The device includes the feedback flag in the SDP answer sent to the SIP UA only if it was present in the SDP offer received from the other SIP UA.</li> <li>■ [2] <b>As Is</b> = The device does not involve itself in the feedback, but simply forwards any feedback indication as is.</li> </ul> <p><b>Note:</b></p> <ul style="list-style-type: none"> <li>■ As RTCP-based feedback has been defined by the WebRTC standard as mandatory, the support is important for deployments implementing WebRTC. For more information on WebRTC, see WebRTC.</li> </ul>
<p>'SBC Multiple Coders'</p> <pre>configure voip &gt; coders-and- profiles ip- profile &gt; sbc- multiple-coders [IpProfile_ SBCMultipleCoders]</pre>	<p>Enables support of multiple coders in the SDP answer that is received from the peer side for the UA associated with this IP Profile.</p> <ul style="list-style-type: none"> <li>■ [0] <b>Not Supported</b> = (Default) If multiple coders ('m=' line) are present in the SDP answer received from the peer side, the device uses only the first supported coder in the list for the RTP media.</li> <li>■ [1] <b>Supported</b> = If multiple coders ('m=' line) are present in the SDP answer received from the peer side, the device does one of the following, depending on whether DSP resources are required (e.g., for DTMF transcoding): <ul style="list-style-type: none"> <li>✓ DSP resources required: Upon receipt of the SDP answer, the device sends a re-INVITE message with only a single coder (first supported coder in the list)</li> </ul> </li> </ul>



Parameter	Description
	<p>to the UA associated with this IP Profile. In other words, the device “forces” the UAs to negotiate only a single coder for the RTP media.</p> <ul style="list-style-type: none"> <li>✓ DSP resources not required: The device supports multiple coders in the SDP answer, allowing the RTP media to use any one of the listed coders (doesn't send a re-INVITE).</li> </ul> <p><b>Note:</b> The parameter is applicable only to the SBC application.</p>
<b>Quality of Service</b>	
<p>'RTP IP DiffServ' rtp-ip-diffserv [IpProfile_IPDiffServ]</p>	<p>Defines the DiffServ value for Premium Media class of service (CoS) content.</p> <p>The valid range is 0 to 63. The default is 46.</p> <p><b>Note:</b> The corresponding global parameter is [PremiumServiceClassMediaDiffServ].</p>
<p>'Signaling DiffServ' signaling-diffserv [IpProfile_SigIPDiffServ]</p>	<p>Defines the DiffServ value for Premium Control CoS content (Call Control applications).</p> <p>The valid range is 0 to 63. The default is 40.</p> <p><b>Note:</b> The corresponding global parameter is [PremiumServiceClassControlDiffServ].</p>
<p>'Data DiffServ' data-diffserv [IpProfile_DataDiffServ]</p>	<p>Defines the DiffServ value of MSRP traffic in the IP header's DSCP field.</p> <p>The valid range is 0 to 63. The default is 0.</p> <p>For more information on MSRP, see <a href="#">Configuring Message Session Relay Protocol</a> on page 1030.</p> <p><b>Note:</b> The parameter is applicable only to the SBC application.</p>
<b>Jitter Buffer</b>	
<p>'Dynamic Jitter Buffer Minimum Delay' jitter-buffer-minimum-delay [IpProfile_JitterBufMinDelay]</p>	<p>Defines the minimum delay (in msec) of the device's dynamic Jitter Buffer.</p> <p>The valid range is 0 to 150. The default delay is 10.</p> <p>For more information on Jitter Buffer, see <a href="#">Configuring the Dynamic Jitter Buffer</a>.</p> <p><b>Note:</b> The corresponding global parameter is DJBufMinDelay.</p>

Parameter	Description
'Dynamic Jitter Buffer Optimization Factor' jitter-buffer-optimization-factor [IpProfile_JitterBufOptFactor]	<p>Defines the Dynamic Jitter Buffer frame error/delay optimization factor.</p> <p>The valid range is 0 to 12. The default factor is 10.</p> <p>For more information on Jitter Buffer, see <a href="#">Configuring the Dynamic Jitter Buffer</a>.</p> <p><b>Note:</b></p> <ul style="list-style-type: none"> <li>■ For data (fax and modem) calls, set the parameter to 12.</li> <li>■ The corresponding global parameter is DJBufOptFactor.</li> </ul>
'Jitter Buffer Max Delay' jitter-buffer-max-delay [IpProfile_JitterBufMaxDelay]	<p>Defines the maximum delay and length (in msec) of the Jitter Buffer.</p> <p>The valid range is 150 to 2,000. The default is 250.</p>
<b>Voice</b>	
'Echo Canceled' echo-canceller [IpProfile_EnableEchoCanceller]	<p>Enables the device's Echo Cancellation feature (i.e., echo from voice calls is removed).</p> <ul style="list-style-type: none"> <li>■ [0] <b>Disable</b></li> <li>■ [1] <b>Line</b> (default)</li> </ul> <p>For a detailed description of the Echo Cancellation feature, see <a href="#">Configuring Echo Cancellation</a>.</p> <p><b>Note:</b> The corresponding global parameter is EnableEchoCanceller.</p>
'Input Gain' input-gain [IpProfile_InputGain]	<p>Defines the pulse-code modulation (PCM) input gain control (in decibels). For the Gateway application: Defines the level of the received signal for Tel-to-IP calls.</p> <p>The valid range is -32 to 31 dB. The default is 0 dB.</p> <p><b>Note:</b> The corresponding global parameter is InputGain.</p>
'Voice Volume' voice-volume [IpProfile_VoiceVolume]	<p>Defines the voice gain control (in decibels). For the Gateway application: Defines the level of the transmitted signal for IP-to-Tel calls.</p> <p>The valid range is -32 to 31 dB. The default is 0 dB.</p> <p><b>Note:</b> The corresponding global parameter is VoiceVolume.</p>

Parameter	Description
SBC Signaling	
'PRACK Mode' sbc-prack-mode [IpProfile_SbcPrackMode]	<p>Defines the device's handling of SIP PRACK messages for the SIP UA associated with the IP Profile.</p> <ul style="list-style-type: none"> <li>■ [0] <b>Disabled</b> = The device doesn't allow PRACK:               <ul style="list-style-type: none"> <li>✓ For SIP requests (INVITE) and responses (18x), the device removes the '100rel' option from the SIP Supported header (if present). In other words, the device disables PRACK with this SIP UA.</li> <li>✓ If the device receives an INVITE message containing the header and value 'Require: 100rel', it rejects the message (with a SIP 420 response).</li> <li>✓ If the device receives a SIP 18x response containing the RSeq header and the '100rel' option, it sends a CANCEL message to cancel the SIP dialog.</li> </ul> </li> <li>■ [1] <b>Optional</b> = PRACK is optional. If required, the device performs the PRACK process on behalf of the SIP UA.</li> <li>■ [2] <b>Mandatory</b> = PRACK is required for this SIP UA. Calls from UAs that do not support PRACK are rejected. Calls destined to these UAs are also required to support PRACK.</li> <li>■ [3] <b>Transparent</b> = (Default) The device does not intervene with the PRACK process and forwards the request as is.</li> <li>■ [4] <b>Optional With Adaptations</b> = This option may be useful, for example, to prevent PRACK congestion caused by the flooding of the device with 18x messages without body.               <ul style="list-style-type: none"> <li>✓ Outgoing INVITE messages (sent to SIP UA):                   <ul style="list-style-type: none"> <li>- The device adds the header 'Supported: 100rel' to the INVITE message. If the message included the header and value 'Require: 100rel', it removes the '100rel' option.</li> <li>- If the device adds the '100rel' option, it terminates and fully handles PRACK; otherwise, the device forwards the message transparently.</li> </ul> </li> <li>✓ Incoming INVITE messages (from SIP UA):                   <ul style="list-style-type: none"> <li>- If the message doesn't contain the '100rel'</li> </ul> </li> </ul> </li> </ul>

Parameter	Description
	<p>option, the device doesn't handle PRACK.</p> <ul style="list-style-type: none"> <li>- If the message contains the header and value 'Require: 100rel', the device processes PRACK as described for the <b>Mandatory</b> optional value above (and terminates PRACK, if necessary).</li> <li>- If the message contains the header and value 'Supported: 100rel', the device activates PRACK Extensions as follows: <ul style="list-style-type: none"> <li>&gt;&gt; If the device sends an outgoing 18x responses with body (e.g., SDP), the device processes PRACK as described for the <b>Mandatory</b> optional value above (and terminates PRACK, if necessary).</li> <li>&gt;&gt; If the device sends an outgoing 18x responses without body, the device removes the '100rel' option and the RSeq header (if present). If the RSeq header was present, the device sends a terminated PRACK to the incoming leg without Optional With Adaptations outgoing leg involvement.</li> </ul> </li> </ul> <p><b>Note:</b> The parameter is applicable only to the SBC application.</p>
<p>'P-Asserted-Identity Header Mode'</p> <p>sbc-assert-identity</p> <p>[IpProfile_SBCAssertIdentity]</p>	<p>Defines the device's handling of the SIP P-Asserted-Identity header for the SIP UA associated with the IP Profile. This header indicates how the outgoing SIP message asserts identity.</p> <ul style="list-style-type: none"> <li>■ [0] <b>As Is</b> = (Default) P-Asserted Identity header is not affected and the device uses the same P-Asserted-Identity header (if present) in the incoming message for the outgoing message.</li> <li>■ [1] <b>Add</b> = Adds a P-Asserted-Identity header. The header's values are taken from the source URL.</li> <li>■ [2] <b>Remove</b> = Removes the P-Asserted-Identity header.</li> </ul> <p><b>Note:</b></p> <ul style="list-style-type: none"> <li>■ The parameter affects only initial INVITE requests.</li> <li>■ The corresponding global parameter is [SBCAssertIdentity].</li> <li>■ The parameter is applicable only to the SBC application.</li> </ul>

Parameter	Description
'Diversion Header Mode' sbc-diversion-mode  [IpProfile_ SBCDiversionMode]	Defines the device's handling of the SIP Diversion header for the SIP UA associated with the IP Profile. <ul style="list-style-type: none"> <li>■ [0] <b>As Is</b> = (Default) Diversion header is not handled.</li> <li>■ [1] <b>Add</b> = History-Info header is converted to a Diversion header.</li> <li>■ [2] <b>Remove</b> = Removes the Diversion header and the conversion to the History-Info header depends on the SBCHistoryInfoMode parameter.</li> </ul> For more information on interworking of the History-Info and Diversion headers, see <a href="#">Interworking SIP Diversion and History-Info Headers</a> . <p><b>Note:</b></p> <ul style="list-style-type: none"> <li>■ If the Diversion header is used, you can specify the URI type (e.g., "tel:") to use in the header, using the [SBCDiversionUriType] parameter.</li> <li>■ The parameter is applicable only to the SBC application.</li> </ul>
'History-Info Header Mode' sbc-history-info-mode  [IpProfile_ SBCHistoryInfoMode]	Defines the device's handling of the SIP History-Info header for the SIP UA associated with the IP Profile. <ul style="list-style-type: none"> <li>■ [0] <b>As Is</b> = (Default) History-Info header is not handled.</li> <li>■ [1] <b>Add</b> = Diversion header is converted to a History-Info header.</li> <li>■ [2] <b>Remove</b> = History-Info header is removed from the SIP dialog and the conversion to the Diversion header depends on the SBCDiversionMode parameter.</li> </ul> For more information on interworking of the History-Info and Diversion headers, see <a href="#">Interworking SIP Diversion and History-Info Headers</a> . <p><b>Note:</b> The parameter is applicable only to the SBC application.</p>
'Session Expires Mode' sbc-session-expires-mode  [IpProfile_ SBCSessionExpiresMode]	Defines the required session expires mode for the SIP UA associated with the IP Profile. <ul style="list-style-type: none"> <li>■ [0] <b>Transparent</b> = (Default) The device does not interfere with the session expires negotiation.</li> <li>■ [1] <b>Observer</b> = If the SIP Session-Expires header is</li> </ul>

Parameter	Description
	<p>present, the device does not interfere, but maintains an independent timer for each leg to monitor the session. If the session is not refreshed on time, the device disconnects the call.</p> <ul style="list-style-type: none"> <li>■ [2] <b>Not Supported</b> = The device does not allow a session timer with this SIP UA.</li> <li>■ [3] <b>Supported</b> = The device enables the session timer with this SIP UA. If the incoming SIP message does not include any session timers, the device adds the session timer information to the sent message. You can configure the value of the Session-Expires and Min-SE headers, using the [SBCSessionExpires] and [SBCMinSE] parameters, respectively.</li> </ul> <p><b>Note:</b> The parameter is applicable only to the SBC application.</p>
<p>'SIP UPDATE Support' sbc-rmt-update- supp [IpProfile_ SBCRemoteUpdateSupport]</p>	<p>Defines if the SIP UA associated with this IP Profile supports the receipt of SIP UPDATE messages.</p> <ul style="list-style-type: none"> <li>■ [0] <b>Not Supported</b> = The UA doesn't support the receipt of UPDATE messages.</li> <li>■ [1] <b>Supported Only After Connect</b> = The UA supports the receipt of UPDATE messages, but only after the call is connected.</li> <li>■ [2] <b>Supported</b> = (Default) The UA supports the receipt of UPDATE messages during call setup and after call establishment.</li> <li>■ [3] <b>According Remote Allow</b> = For refreshing the timer of currently active SIP sessions, the device sends session refreshes using SIP UPDATE messages only if the SIP Allow header in the last SIP message received from the user contains the value "UPDATE". If the Allow header does not contain the "UPDATE" value (or if the parameter is not configured to this option), the device uses INVITE messages for session refreshes.</li> </ul> <p><b>Note:</b> The parameter is applicable only to the SBC application.</p>
<p>'Remote re-INVITE' sbc-rmt-re-invite-</p>	<p>Defines if the SIP UA associated with this IP Profile supports the receipt of SIP re-INVITE messages.</p>

Parameter	Description
<p>supp</p> <p>[IpProfile_ SBCRemoteReinviteSupport]</p>	<ul style="list-style-type: none"> <li>■ [0] <b>Not Supported</b> = The UA doesn't support the receipt of re-INVITE messages. If the device receives a re-INVITE from another UA that is destined to this UA, the device "terminates" the re-INVITE and sends a SIP response to the UA that sent it, which can be a success or a failure, depending on whether the device can bridge the media between the UAs.</li> <li>■ [1] <b>Supported only with SDP</b> = The UA supports the receipt of re-INVITE messages, but only if they contain an SDP body. If the incoming re-INVITE from another UA doesn't contain SDP, the device creates and adds an SDP body to the re-INVITE that it forwards to the UA.</li> <li>■ [2] <b>Supported</b> = (Default) The UA supports the receipt of re-INVITE messages with or without SDP.</li> </ul> <p><b>Note:</b> The parameter is applicable only to the SBC application.</p>
<p>'Remote Delayed Offer Support'</p> <p>sbc-rmt-delayed-offer</p> <p>[IpProfile_ SBCRemoteDelayedOfferSupport]</p>	<p>Defines if the remote UA supports delayed offer (i.e., initial INVITE requests without an SDP offer).</p> <ul style="list-style-type: none"> <li>■ [0] <b>Not Supported</b></li> <li>■ [1] <b>Supported</b> (default)</li> </ul> <p><b>Note:</b></p> <ul style="list-style-type: none"> <li>■ For the parameter to function, you need to assign extension coders to the IP Profile of the SIP UA that does not support delayed offer (using the IpProfile_SBCExtensionCodersGroupName parameter).</li> <li>■ The parameter is applicable only to the SBC application.</li> </ul>
<p>'MSRP re-INVITE/UPDATE'</p> <p>sbc-msrp-re- invite-update-supp</p> <p>[IpProfile_ SBCMSRPReinviteUpdateSupport]</p>	<p>Defines if the SIP UA (MSRP endpoint) associated with this IP Profile supports the receipt of re-INVITE and UPDATE SIP messages.</p> <ul style="list-style-type: none"> <li>■ [0] <b>Not Supported</b> = The device doesn't send re-INVITE or UPDATE messages to the UA. If the device receives any of these messages from the peer UA, the device "terminates" the messages, and then sends a SIP response to the peer UA on behalf of the UA associated with this IP Profile.</li> <li>■ [1] <b>Supported</b> (default)</li> </ul>

Parameter	Description
	<p>For more information on MSRP, see <a href="#">Configuring Message Session Relay Protocol</a> on page 1030.</p> <p><b>Note:</b> The parameter is applicable only to the SBC application.</p>
<p>'MSRP Offer Setup Role' sbc-msrp-offer-setup-role [IpProfile_ SBCMSRPOfferSetupRole]</p>	<p>Defines the device's preferred MSRP role, which is indicated in the initial SDP offer that it sends to the destination MSRP endpoint ('a=setup' line) associated with this IP Profile. However, this is only a preferred role; the actual role that the device takes on depends on the destination MSRP endpoint's desired role, which is indicated in the SDP answer in its reply to the device:</p> <ul style="list-style-type: none"> <li>■ If 'a=setup:active', the device takes the passive role.</li> <li>■ If 'a=setup:passive', the device takes the active role.</li> <li>■ If 'a=setup' (i.e., empty) or no 'a=setup', the device takes the active role.</li> </ul> <p>The possible values include:</p> <ul style="list-style-type: none"> <li>■ [0] <b>Active</b> = The device prefers the active role and includes 'a=setup:active' in the outgoing SDP offer sent to the endpoint associated with the IP Profile.</li> <li>■ [1] <b>Passive</b> = The device prefers the passive role and includes 'a=setup:passive' in the outgoing SDP offer sent to the endpoint associated with the IP Profile.</li> <li>■ [2] <b>ActPass</b> = (Default) The device has no role preference and includes 'a=setup:actpass' in the outgoing SDP offer sent to the endpoint associated with the IP Profile</li> </ul> <p>For more information on MSRP, see <a href="#">Configuring Message Session Relay Protocol</a> on page 1030.</p> <p><b>Note:</b> The parameter is applicable only to the SBC application.</p>
<p>'MSRP Empty Message Format' sbc-msrp-empty-message-format [IPProfile_ SBCMSRPEmpMsg]</p>	<p>On an active MSRP leg, enables the device to add the Content-Type header to the first empty (i.e., no body) MSRP message that is used to initiate the MSRP connection.</p> <ul style="list-style-type: none"> <li>■ [0] <b>Default</b> = (Default) Sends the empty message with regular headers, according to the RFC for MSRP.</li> </ul>



Parameter	Description
	<ul style="list-style-type: none"> <li>■ [1] <b>With Content Type</b> = Adds the Content-Type header to the empty message (in addition to the regular headers according to the RFC for MSRP).</li> </ul> <p>For more information on MSRP, see <a href="#">Configuring Message Session Relay Protocol</a> on page 1030.</p> <p><b>Note:</b> The parameter is applicable only to the SBC application.</p>
<p>'Remote Representation Mode'</p> <p>sbc-rmt-rprsntation</p> <p>[IpProfile_SBCRemoteRepresentation Mode]</p>	<p>Enables interworking SIP in-dialog, Contact and Record-Route headers between SIP entities. The parameter defines the device's handling of in-dialog, Contact and Record-Route headers for messages sent to the SIP UA associated with the IP Profile.</p> <ul style="list-style-type: none"> <li>■ [-1] <b>According to Operation Mode</b> = (Default) Depends on the setting of the 'Operation Mode' parameter in the IP Groups or SRDs table: <ul style="list-style-type: none"> <li>✓ B2BUA: Device operates as if the parameter is set to Replace Contact [0].</li> <li>✓ Call State-full Proxy: Device operates as if the parameter is set to Add Routing Headers [1].</li> </ul> </li> <li>■ [0] <b>Replace Contact</b> = The URI host part in the Contact header of the received message (from the other side) is replaced with the device's address or with the value of the 'SIP Group Name' parameter (configured in the IP Groups table) in the outgoing message sent to the SIP UA.</li> <li>■ [1] <b>Add Routing Headers</b> = Device adds a Record-Route header for itself to outgoing messages (requests/responses) sent to the SIP UA in dialog-setup transactions. The Contact header remains unchanged.</li> <li>■ [2] <b>Transparent</b> = Device doesn't change the Contact header and doesn't add a Record-Route header for itself. Instead, it relies on its' own inherent mechanism to remain in the route of future requests in the dialog (for example, relying on the way the endpoints are set up or on TLS as the transport type).</li> </ul> <p><b>Note:</b> The parameter is applicable only to the SBC application.</p>

Parameter	Description
<p>'Keep Incoming Via Headers'</p> <p>sbc-keep-via-headers</p> <p>[IpProfile_SBCKeepVIAHeaders]</p>	<p>Enables interworking SIP Via headers between SIP entities. The parameter defines the device's handling of Via headers for messages sent to the SIP UA associated with the IP Profile.</p> <ul style="list-style-type: none"> <li>■ [-1] <b>According to Operation Mode</b> = Depends on the setting of the 'Operation Mode' parameter in the IP Groups table or SRDs table: <ul style="list-style-type: none"> <li>✓ B2BUA: Device operates as if the parameter is set to Disable [0].</li> <li>✓ Call State-full Proxy: Device operates as if the parameter is set to Enable [1].</li> </ul> </li> <li>■ [0] <b>Disable</b> = Device removes all Via headers received in the incoming SIP request from the other leg and adds a Via header identifying only itself, in the outgoing message sent to the SIP UA.</li> <li>■ [1] <b>Enable</b> = Device retains the Via headers received in the incoming SIP request and adds itself as the top-most listed Via header in the outgoing message sent to the SIP UA.</li> </ul> <p><b>Note:</b> The parameter is applicable only to the SBC application.</p>
<p>'Keep Incoming Routing Headers'</p> <p>sbc-keep-routing-headers</p> <p>[IpProfile_SBCKeepRoutingHeaders]</p>	<p>Enables interworking SIP Record-Route headers between SIP entities. The parameter defines the device's handling of Record-Route headers for request/response messages sent to the the SIP UA associated with the IP Profile.</p> <ul style="list-style-type: none"> <li>■ [-1] <b>According to Operation Mode</b> = (Default) Depends on the setting of the 'Operation Mode' in the IP Group or SRDs table: <ul style="list-style-type: none"> <li>✓ B2BUA: Device operates as if the parameter is set to Disable [0].</li> <li>✓ Call State-full Proxy: Device operates as if the parameter is set to Enable [1].</li> </ul> </li> <li>■ [0] <b>Disable</b> = Device removes the Record-Route headers received in requests and responses from the other side, in the outgoing SIP message sent to the SIP UA. The device creates a route set for that side of the dialog based on these headers, but doesn't send them to the SIP UA.</li> </ul>

Parameter	Description
	<ul style="list-style-type: none"> <li>■ [1] <b>Enable</b> = Device retains the incoming Record-Route headers received in requests and non-failure responses from the other side, in the following scenarios:               <ul style="list-style-type: none"> <li>✓ The message is part of a SIP dialog-setup transaction.</li> <li>✓ The messages in the setup and previous transaction didn't include the Record-Route header, and therefore hadn't set the route set.</li> </ul> </li> </ul> <p><b>Note:</b> Record-Routes are kept only for SIP INVITE, UPDATE, SUBSCRIBE and REFER messages.</p> <p><b>Note:</b> The parameter is applicable only to the SBC application.</p>
<p>'Keep User-Agent Header'</p> <p>sbc-keep-user-agent</p> <p>[IpProfile_ SBCKeepUserAgentHeader]</p>	<p>Enables interworking SIP User-Agent headers between SIP entities. The parameter defines the device's handling of User-Agent headers for response/request messages sent to the SIP UA associated with the IP Profile.</p> <ul style="list-style-type: none"> <li>■ [-1] <b>According to Operation Mode</b> = (Default) Depends on the setting of the 'Operation Mode' parameter in the IP Group or SRDs table:               <ul style="list-style-type: none"> <li>✓ B2BUA: Device operates as if this parameter is set to Disable [0].</li> <li>✓ Call State-full Proxy: Device operates as if this parameter is set to Enable [1].</li> </ul> </li> <li>■ [0] <b>Disable</b> = Device removes the User-Agent/Server headers received in the incoming message from the other side, and adds its' own User-Agent header in the outgoing message sent to the SIP UA.</li> <li>■ [1] <b>Enable</b> = Device retains the User-Agent/Server headers received in the incoming message and sends the headers as is in the outgoing message to the SIP UA.</li> </ul> <p><b>Note:</b> The parameter is applicable only to the SBC application.</p>
<p>'Handle X-Detect'</p> <p>sbc-handle-xdetect</p> <p>[IpProfile_ SBCHandleXDetect]</p>	<p>Enables the detection and notification of events (AMD, CPT, and fax), using the X-Detect SIP header.</p> <ul style="list-style-type: none"> <li>■ [0] <b>No</b> (default)</li> </ul>

Parameter	Description
	<ul style="list-style-type: none"> <li>■ [1] <b>Yes</b></li> </ul> <p>For more information, see <a href="#">Event Detection and Notification using X-Detect Header</a>.</p> <p><b>Note:</b> The parameter is applicable only to the SBC application.</p>
<p>'ISUP Body Handling'</p> <p>sbc-isup-body-handling</p> <p>[IpProfile_ SBCISUPBodyHandling]</p>	<p>Defines the handling of ISUP data for interworking SIP and SIP-I endpoints.</p> <ul style="list-style-type: none"> <li>■ [0] <b>Transparent</b> = (Default) ISUP data is passed transparently (as is) between endpoints (SIP-I to SIP-I calls).</li> <li>■ [1] <b>Remove</b> = ISUP body is removed from INVITE messages.</li> <li>■ [2] <b>Create</b> = ISUP body is added to outgoing INVITE messages.</li> <li>■ [3] <b>Create If Not Exists</b> = ISUP body is added to outgoing INVITE messages if it does not exist in the incoming leg. If it exists, unknown fields and messages by the device are passed transparently, while known fields can be manipulated using Message Manipulation rules. For known fields, some values that are "reserved for national use" may be changed to default.</li> </ul> <p>For more information on interworking SIP and SIP-I, see <a href="#">Interworking SIP and SIP-I Endpoints</a>.</p> <p><b>Note:</b> The parameter is applicable only to the SBC application.</p>
<p>'ISUP Variant'</p> <p>sbc-isup-variant</p> <p>[IpProfile_ SBCISUPVariant]</p>	<p>Defines the ISUP variant for interworking SIP and SIP-I endpoints.</p> <ul style="list-style-type: none"> <li>■ [0] <b>itu92</b> = (Default) ITU 92 variant</li> <li>■ [1] <b>Spirou</b> = SPIROU (ISUP France)</li> </ul> <p><b>Note:</b> The parameter is applicable only to the SBC application.</p>
<p>'Max Call Duration'</p> <p>sbc-max-call-duration</p> <p>[IpProfile_ SBCMaxCallDuration]</p>	<p>Defines the maximum duration (in minutes) per SBC call that is associated with the IP Profile. If the duration is reached, the device terminates the call.</p> <p>The valid range is 0 to 35,791, where 0 is unlimited duration. The default is the value configured for the global</p>

Parameter	Description
	<p>parameter [SBCMaxCallDuration].</p> <p><b>Note:</b> The parameter is applicable only to the SBC application.</p>
SBC Registration	
<p>'User Registration Time' sbc-usr-reg-time [IpProfile_ SBCUserRegistrationTime]</p>	<p>Defines the registration time (in seconds) that the device responds to SIP REGISTER requests from users belonging to the SIP UA associated with the IP Profile. The registration time is inserted in the Expires header in the outgoing response sent to the user.</p> <p>The Expires header determines the lifespan of the registration. For example, a value of 3600 means that the registration will timeout in one hour and at that point, the user will not be able to make or receive calls.</p> <p>The valid range is 0 to 2,000,000. The default is 0. If configured to 0, the Expires header's value received in the user's REGISTER request remains unchanged. If no Expires header is received in the REGISTER message and the parameter is set to 0, the Expires header's value is set to 180 seconds, by default.</p> <p><b>Note:</b> The corresponding global parameter is SBCUserRegistrationTime.</p>
<p>'NAT UDP Registration Time' sbc-usr-udp-nat- reg-time [IpProfile_ SBCUserBehindUdpNATRegi- strationTime]</p>	<p>Defines the registration time (in seconds) that the device includes in register responses, in response to SIP REGISTER requests from users belonging to the SIP UA associated with the IP Profile.</p> <p>The parameter applies only to users that are located behind NAT and whose communication type is UDP. The registration time is inserted in the Expires header in the outgoing response sent to the user.</p> <p>The Expires header determines the lifespan of the registration. For example, a value of 3600 means that the registration will timeout in one hour, unless the user sends a refresh REGISTER before the timeout. Upon timeout, the device removes the user's details from the registration database, and the user will not be able to make or receive calls through the device.</p> <p>The valid value is 0 to 2,000,000. If configured to 0, the Expires header's value received in the user's REGISTER request remains unchanged. By default, no value is</p>

Parameter	Description
	<p>defined (-1).</p> <p><b>Note:</b> If the parameter is not configured, the registration time is according to the global parameter SBCUserRegistrationTime or IP Profile parameter IpProfile_SBCUserRegistrationTime.</p>
<p>'NAT TCP Registration Time'</p> <p>sbc-usr-tcp-nat-reg-time</p> <p>[IpProfile_SBCUserBehindTcpNATRegistrationTime]</p>	<p>Defines the registration time (in seconds) that the device includes in register responses, in response to SIP REGISTER requests from users belonging to the SIP UA associated with the IP Profile.</p> <p>The parameter applies only to users that are located behind NAT and whose communication type is TCP. The registration time is inserted in the Expires header in the outgoing response sent to the user.</p> <p>The Expires header determines the lifespan of the registration. For example, a value of 3600 means that the registration will timeout in one hour, unless the user sends a refresh REGISTER before the timeout. Upon timeout, the device removes the user's details from the registration database, and the user will not be able to make or receive calls through the device.</p> <p>The valid value is 0 to 2,000,000. If configured to 0, the Expires header's value received in the user's REGISTER request remains unchanged. By default, no value is defined (-1).</p> <p><b>Note:</b> If the parameter is not configured, the registration time is according to the global parameter SBCUserRegistrationTime or IP Profile parameter IpProfile_SBCUserRegistrationTime.</p>
SBC Forward and Transfer	
<p>'Remote REFER Mode'</p> <p>sbc-rmt-refer-behavior</p> <p>[IpProfile_SBCRemoteReferBehavior]</p>	<p>Defines the device's handling of SIP REFER requests for the SIP UA (transferee - call party that is transferred to the transfer target) associated with the IP Profile.</p> <ul style="list-style-type: none"> <li>■ [0] <b>Regular</b> = (Default) SIP Refer-To header value is unchanged and the device forwards the REFER message as is. However, if you configure the 'Remote Replaces Mode' parameter (see below) to any value other than <b>Keep as is</b>, the device may modify the URI of the Refer-To header to reflect the call identifiers of the leg.</li> </ul>

Parameter	Description
	<ul style="list-style-type: none"> <li data-bbox="683 286 1380 398">■ [1] <b>Database URL</b> = SIP Refer-To header value is changed so that the re-routed INVITE is sent through the device:               <ul style="list-style-type: none"> <li data-bbox="730 427 1380 577">a. Before forwarding the REFER request, the device changes the host part to the device's IP address and adds a special prefix ("T~&amp;R_") to the Contact user part.</li> <li data-bbox="730 600 1316 674">b. The incoming INVITE is identified as a REFER-resultant INVITE according to this special prefix.</li> <li data-bbox="730 696 1396 936">c. The device replaces the host part in the Request-URI with the host from the REFER contact. The special prefix remains in the user part for regular classification, manipulation, and routing. The special prefix can also be used for specific routing rules for REFER-resultant INVITES.</li> <li data-bbox="730 958 1380 1032">d. The special prefix is removed before the resultant INVITE is sent to the destination ((transfer target)).</li> </ul> </li> <li data-bbox="683 1055 1332 1167">■ [2] <b>IP Group Name</b> = Changes the host part in the REFER message to the name configured for the IP Group (in the IP Groups table).</li> <li data-bbox="683 1189 1396 1429">■ [3] <b>Handle Locally</b> = Handles the incoming REFER request itself without forwarding the REFER. The device generates a new INVITE to the alternative destination (transfer target) according to the rules in the IP-to-IP Routing table (the 'Call Trigger' parameter must be set to REFER).</li> <li data-bbox="683 1451 1396 1765">■ [4] <b>Local Host</b> = In the REFER message received from the transferor, the device replaces the Refer-To header value (URL) with the IP address of the device or with the 'Local Host Name' parameter value configured for the IP Group (transferee) to where the device forwards the REFER message. This ensures that the transferee sends the re-routed INVITE back to the device which then sends the call to the transfer target.</li> <li data-bbox="683 1787 1396 1984">■ [5] <b>Keep URI (user@host)</b> = The device forwards the REFER message without changing the URI (user@host) in the SIP Refer-To header. If you configure the 'Remote Replaces Mode' parameter (see below) to any value other than <b>Keep as is</b>, the devicemay modify the</li> </ul>

Parameter	Description
	<p>'replaces' parameter of the Refer-To header to reflect the call identifiers of the leg. This applies to all types of call transfers (e.g., blind and attendant transfer).</p> <p><b>Note:</b></p> <ul style="list-style-type: none"> <li>■ You can override the parameter's settings using Message Manipulation rules configured with the AudioCodes proprietary SIP header, X-AC-Action. For more information, see <a href="#">Using the Proprietary SIP X-AC-Action Header</a> on page 1022.</li> <li>■ The corresponding global parameter is [SBCReferBehavior].</li> <li>■ For MSRP sessions, the <b>Handle Locally</b> option is not applicable. For more information on MSRP sessions, see <a href="#">Configuring Message Session Relay Protocol</a> on page 1030.</li> </ul>
<p>'Remote Replaces Mode' sbc-rmt-replaces-behavior [IpProfile_ SBCRemoteReplacesBehavior]</p>	<p>Enables the device to handle incoming INVITEs containing the Replaces header for the SIP UA (which does not support the header) associated with the IP Profile. The Replaces header is used to replace an existing SIP dialog with a new dialog such as in call transfer or call pickup.</p> <ul style="list-style-type: none"> <li>■ [0] <b>Standard</b> = (Default) The SIP UA supports INVITE messages containing Replaces headers. The device forwards the INVITE message containing the Replaces header to the SIP UA. The device may change the value of the Replaces header to reflect the call identifiers of the leg.</li> <li>■ [1] <b>Handle Locally</b> = The SIP UA does not support INVITE messages containing Replaces headers. The device terminates the received INVITE containing the Replaces header and establishes a new call between the SIP UA and the new call party. It then disconnects the call with the initial call party, by sending it a SIP BYE request.</li> <li>■ [2] <b>Keep as is</b> = The SIP UA supports INVITE messages containing Replaces headers. The device forwards the Replaces header as is in incoming REFER and outgoing INVITE messages from/to the SIP UA (i.e., Replaces header's value is unchanged).</li> </ul>



Parameter	Description
	<p>For example, assume that the device establishes a call between A and B. If B initiates a call transfer to C, the device receives an INVITE with the Replaces header from C. If A supports the Replaces header, the device simply forwards the INVITE as is to A; a new call is established between A and C and the call between A and B is disconnected. However, if A does not support the Replaces header, the device uses this feature to terminate the INVITE with Replaces header and handles the transfer for A. The device does this by connecting A to C, and disconnecting the call between A and B, by sending a SIP BYE request to B. Note that if media transcoding is required, the device sends an INVITE to C on behalf of A with a new SDP offer.</p>
<p>'Play RBT To Transferee'  sbc-play-rbt-to-  xferee  [IpProfile_  SBCPlayRBTTToTransferee]</p>	<p>Enables the device to play a ringback tone to the transferred party (transferee) during a blind call transfer, for the SIP UA associated with the IP Profile (which does not support such a tone generation during call transfer). The ringback tone indicates to the transferee of the ringing of the transfer target (to where the transferee is being transferred).</p> <ul style="list-style-type: none"> <li>■ [0] <b>No</b> (Default)</li> <li>■ [1] <b>Yes</b></li> </ul> <p>Typically, the transferee hears a ringback tone only if the transfer target sends it early media. However, if the transferee is put on-hold before being transferred, no ringback tone is heard.</p> <p>When this feature is enabled, the device generates a ringback tone to the transferee during call transfer in the following scenarios:</p> <ul style="list-style-type: none"> <li>■ Transfer target sends a SIP 180 (Ringing) to the device.</li> <li>■ For non-blind transfer, if the call is transferred while the transfer target is ringing and no early media occurs.</li> <li>■ The 'Remote Early Media RTP Behavior parameter is set to Delayed (used in the Skype for Business environment), and transfer target sends a 183 Session Progress with SDP offer. If early media from the transfer target has already been detected, the transferee receives RTP stream from the transfer target. If it has</li> </ul>

Parameter	Description
	<p>not been detected, the device generates a ringback tone to the transferee and stops the tone generation once RTP has been detected from the transfer target.</p> <p>For any of these scenarios, if the transferee is put on-hold by the transferor, the device retrieves the transferee from hold, sends a re-INVITE if necessary, and then plays the ringback tone.</p> <p><b>Note:</b> For the device to play the ringback tone, it must be loaded with a Prerecorded Tones (PRT) file. For more information, see <a href="#">Prerecorded Tones File</a>.</p>
<p>'Remote 3xx Mode' sbc-rmt-3xx-behavior [IpProfile_ SBCRemote3xxBehavior]</p>	<p>Defines the device's handling of SIP 3xx redirect responses for the SIP UA associated with the IP Profile. By default, the device's handling of SIP 3xx responses is to send the Contact header unchanged. However, some SIP entities may support different versions of the SIP 3xx standard while others may not even support SIP 3xx.</p> <p>When enabled, the device handles SIP redirections between different subnets (e.g., between LAN and WAN sides). This is required when the new address provided by the redirector (Redirect sever) may not be reachable by the far-end user (FEU) located in another subnet. For example, a far-end user (FEU) in the WAN sends a SIP request via the device to a Redirect server in the LAN, and the Redirect server replies with a SIP 3xx response to a PBX in the LAN in the Contact header. If the device sends this response as is (i.e., with the original Contact header), the FEU is unable to reach the new destination.</p> <ul style="list-style-type: none"> <li>■ [0] <b>Transparent</b> = (Default) The device forwards the received SIP 3xx response as is, without changing the Contact header (i.e., transparent handling).</li> <li>■ [1] <b>Database URL</b> = The device changes the Contact header so that the re-route request is sent through the device. The device changes the URI in the Contact header of the received SIP 3xx response to its own URI and adds a special user prefix ("T~&amp;R_"), which is then sent to the FEU. The FEU then sends a new INVITE to the device, which the device then sends to the correct destination.</li> <li>■ [2] <b>Handle Locally</b> = The device handles SIP 3xx responses on behalf of the dialog-initiating UA and</li> </ul>

Parameter	Description
	<p>retries the request (e.g., INVITE) using one or more alternative URIs included in the 3xx response. The device sends the new request to the alternative destination according to the IP-to-IP Routing table (the 'Call Trigger' field must be set to <b>3xx</b>).</p> <ul style="list-style-type: none"> <li>■ [3] <b>IP Group Name</b> = If the 'SIP Group Name' parameter of the IP Group of the dialog-initiating UA is configured with a non-empty value, the device changes the host part of the Contact header in the 3xx response to this value, before forwarding the 3xx response to the dialog-initiating UA.</li> <li>■ [4] <b>Local Host</b> = The device changes the host part of the Contact header in the 3xx response before forwarding the 3xx response to the dialog-initiating UA. If the 'Local Host Name' parameter of the IP Group of the dialog-initiating UA is configured with a non-empty value, the device changes the host part of the Contact header to this value. If the 'Local Host Name' is empty, the device changes the host part to the device's IP address (the same IP address used in the SIP Via and Contact headers of messages sent to the IP Group).</li> </ul> <p><b>Note:</b></p> <ul style="list-style-type: none"> <li>■ When the parameter is changed from <b>Database URL</b> to <b>Transparent</b>, new 3xx Contact headers remain unchanged. However, requests with the special prefix continue using the device's database to locate the new destination.</li> <li>■ Optional values <b>IP Group Name</b> and <b>Local Host</b> are applicable only to 3xx responses received due to INVITE messages.</li> <li>■ Only one database entry is supported for the same host, port, and transport combination. For example, the following URLs cannot be distinguished by the device: <ul style="list-style-type: none"> <li>✓ sip:10.10.10.10:5060;transport=tcp;param=a</li> <li>✓ sip:10.10.10.10:5060;transport=tcp;param=b</li> </ul> </li> <li>■ The database entry expires two hours after the last use.</li> </ul>

Parameter	Description
	<ul style="list-style-type: none"> <li>■ The maximum number of destinations (i.e., database entries) is 50.</li> <li>■ The corresponding global parameter is SBC3xxBehavior.</li> </ul>
<b>SBC Hold</b>	
<p>'Remote Hold Format' remote-hold-Format</p> <p>[IPProfile_ SBCRemoteHoldFormat]</p>	<p>Defines the format of the SDP in the SIP re-INVITE (or UPDATE) for call hold that the device sends to the held party.</p> <ul style="list-style-type: none"> <li>■ [0] <b>Transparent</b> = (Default) Device forwards SDP as is.</li> <li>■ [1] <b>Send Only</b> = Device sends SDP with 'a=sendonly'.</li> <li>■ [2] <b>Send Only Zero Ip</b> = Device sends SDP with 'a=sendonly' and 'c=0.0.0.0'.</li> <li>■ [3] <b>Inactive</b> = Device sends SDP with 'a=inactive'.</li> <li>■ [4] <b>Inactive Zero Ip</b> = Device sends SDP with 'a=inactive' and 'c=0.0.0.0'.</li> <li>■ [5] <b>Not Supported</b> = This option can be used when the remote side does not support call hold. The device terminates call hold requests received on the leg interfacing with the initiator of the call hold, and replies to this initiator with a SIP 200 OK response. However, call retrieve (resume) requests received from the initiator are forwarded to the remote side. The device can play a held tone to the held party if the 'Play Held Tone' parameter is set to <b>Internal</b>.</li> <li>■ [6] <b>Hold and Retrieve Not Supported</b> = This option can be used when the remote side does not support call hold and retrieve (resume). The device terminates call hold and call retrieve requests received on the leg interfacing with the initiator of the call hold/retrieve, and replies to this initiator with a SIP 200 OK response. Therefore, the device does not forward call hold and/or retrieve requests to the remote side.</li> </ul>
<p>'Reliable Held Tone Source' reliable-heldtone-source</p> <p>[IPProfile_ ReliableHoldToneSource]</p>	<p>Enables the device to consider the received call-hold request (re-INVITE/UPDATE) with SDP containing 'a=sendonly', as genuine.</p> <ul style="list-style-type: none"> <li>■ [0] <b>No</b> = (Default) Even if the received SDP contains</li> </ul>

Parameter	Description
	<p>'a=sendonly', the device plays a held tone to the held party. This is useful in cases where the initiator of the call hold does not support the generation of held tones.</p> <ul style="list-style-type: none"> <li>■ [1] <b>Yes</b> = If the received SDP contains 'a=sendonly', the device does not play a held tone to the held party (and assumes that the initiator of the call hold plays the held tone).</li> </ul> <p><b>Note:</b> The device plays a held tone only if the 'Play Held Tone' parameter is set to <b>Internal</b> or <b>External</b>.</p>
<p>'Play Held Tone' play-held-tone [IpProfile_ SBCPlayHeldTone]</p>	<p>Enables the device to play Music-on-Hold (MoH) to call parties that are placed on hold. This is useful if the held party does not support the play of a local hold tone, or for IP entities initiating call hold that do not support the generation of hold tones.</p> <ul style="list-style-type: none"> <li>■ [0] No = (Default) The device does not play any tone to held call parties.</li> <li>■ [1] Internal = Plays the local default hold tone or a tone defined in the PRT file (if installed).</li> </ul> <p><b>Note:</b> If you configure the parameter to <b>Internal</b>, the device plays the tone only if the 'SBC Remote Hold Format' parameter is configured to one of the following: send-only, send only 0.0.0.0, not supported, or transparent (when the incoming SDP is 'sendonly').</p>
SBC Fax	
<p>'Fax Coders Group' sbc-fax-coders- group-name [IpProfile_ SBCFaxCodersGroupName]</p>	<p>Assigns a Coder Group which defines the supported fax coders for fax negotiation for the SIP UA associated with the IP Profile. To configure Coder Groups, see <a href="#">Configuring Coder Groups</a>.</p> <p><b>Note:</b> The parameter is applicable only if you set the IpProfile_SBCFaxBehavior parameter to a value other than [0].</p>
<p>'Fax Mode' sbc-fax-behavior [IpProfile_SBCFaxBehavior]</p>	<p>Enables the device to handle fax offer-answer negotiations for the SIP UA associated with the IP Profile.</p> <ul style="list-style-type: none"> <li>■ [0] <b>As Is</b> = (Default) Device forwards fax transparently, without interference.</li> </ul>

Parameter	Description
	<ul style="list-style-type: none"> <li>■ [1] <b>Handle always</b> = Handle fax according to fax settings in the IP Profile for all offer-answer transactions (including the initial INVITE).</li> <li>■ [2] <b>Handle on re-INVITE</b> = Handle fax according to fax settings in the IP Profile for all re-INVITE offer-answer transactions (except for initial INVITE).</li> </ul> <p><b>Note:</b> The fax settings in the IP Profile include IpProfile_SBCFaxCodersGroupName, IpProfile_SBCFaxOfferMode, and IpProfile_SBCFaxAnswerMode.</p>
<p>'Fax Offer Mode' sbc-fax-offer-mode</p> <p>[IpProfile_SBCFaxOfferMode]</p>	<p>Defines the coders included in the outgoing SDP offer (sent to the called "fax") for the SIP UA associated with the IP Profile.</p> <ul style="list-style-type: none"> <li>■ [0] <b>All coders</b> = (Default) Use only (and all) the coders of the selected Coder Group configured using the SBCFaxCodersGroupID parameter.</li> <li>■ [1] <b>Single coder</b> = Use only one coder. If a coder in the incoming offer (from the calling "fax") matches a coder in the SBCFaxCodersGroupID, the device uses this coder. If no match exists, the device uses the first coder listed in the Coders Group ID (SBCFaxCodersGroupID).</li> </ul> <p><b>Note:</b> The parameter is applicable only if you set the IpProfile_SBCFaxBehavior parameter to a value other than [0].</p>
<p>'Fax Answer Mode' sbc-fax-answer-mode</p> <p>[IpProfile_SBCFaxAnswerMode]</p>	<p>Defines the coders included in the outgoing SDP answer (sent to the calling "fax") for the SIP UA associated with the IP Profile.</p> <ul style="list-style-type: none"> <li>■ [0] <b>All coders</b> = Use matched coders between the incoming offer coders (from the calling "fax") and the coders of the selected Coder Group (configured using the SBCFaxCodersGroupID parameter).</li> <li>■ [1] <b>Single coder</b> = (Default) Use only one coder. If the incoming answer (from the called "fax") includes a coder that matches a coder match between the incoming offer coders (from the calling "fax") and the coders of the selected Coder Group (SBCFaxCodersGroupID, then the device uses this coder. If no match exists, the device uses the first listed coder of the matched coders between the incoming</li> </ul>

Parameter	Description
	<p>offer coders (from the calling "fax") and the coders of the selected Coder Group.</p> <p><b>Note:</b> The parameter is applicable only if you set the IpProfile_SBCFaxBehavior parameter to a value other than [0].</p>
<p>'Remote Renegotiate on Fax Detection'</p> <p>sbc-rmt-renegotiate-on-fax-detect</p> <p>[IPProfile_SBCRemoteRenegotiateOnFaxDetection]</p>	<p>Enables local handling of fax detection and negotiation by the device on behalf of the SIP UA associated with the IP Profile. This applies to faxes sent immediately upon the establishment of a voice channel (i.e., after 200 OK). The device attempts to detect the fax (CNG tone) from the originating SIP UA within a user-defined interval (see the SBCFaxDetectionTimeout parameter) immediately after the voice call is established.</p> <p>Once fax is detected, the device can handle the subsequent fax negotiation by sending re-INVITE messages to both SIP entities. The device also negotiates the fax coders between the two SIP entities. The negotiated coders are according to the list of fax coders assigned to each SIP UA, using the IP Profile parameter 'Fax Coders Group'.</p> <ul style="list-style-type: none"> <li>■ [0] <b>Transparent</b> = (Default) Device does not interfere in the fax transaction and assumes that the SIP UA fully supports fax renegotiation upon fax detection.</li> <li>■ [1] <b>Only on Answer Side</b> = The SIP UA supports fax renegotiation upon fax detection only if it is the terminating (answering) fax, and does not support renegotiation if it is the originating fax.</li> <li>■ [2] <b>No</b> = The SIP UA does not support fax re-negotiation upon fax detection when it is the originating or terminating fax.</li> </ul> <p><b>Note:</b></p> <ul style="list-style-type: none"> <li>■ This feature is applicable only when both SIP entities do not fully support fax detection (receive or send) and negotiation: one SIP UA must be assigned an IP Profile where the parameter is set to [1] or [2], while the peer SIP UA must be assigned an IP Profile where the parameter is set to [2].</li> <li>■ This feature is supported only if at least one of the SIP entities use the G.711 coder.</li> </ul>

Parameter	Description
'Fax Rerouting Mode' sbc-fax-rerouting-mode [IpProfile_ SBCFaxReroutingMode]	<ul style="list-style-type: none"> <li>■ This feature requires DSP resources. If there are insufficient resources, the fax transaction fails.</li> </ul> <p>Enables the rerouting of incoming SBC calls that are identified as fax calls to a new IP destination.</p> <ul style="list-style-type: none"> <li>■ [0] <b>Disable</b> (default)</li> <li>■ [1] <b>Rerouting without delay</b></li> </ul> <p>For more information, see <a href="#">Configuring Rerouting of Calls to Fax Destinations</a>.</p> <p><b>Note:</b> Configure the parameter for the IP leg that is interfacing with the fax termination.</p>
<b>Media</b>	
'Broken Connection Mode' disconnect-on-broken-connection [IpProfile_ DisconnectOnBrokenConnection]	<p>Defines the device's handling of calls when RTP packets (media) are not received within a user-defined timeout. The timeout can be during call setup (configured by the [NoRTPDetectionTimeout] parameter) or mid-call when RTP flow suddenly stops (configured by the [BrokenConnectionEventTimeout] parameter).</p> <ul style="list-style-type: none"> <li>■ [0] <b>Ignore</b> = The call is maintained despite no media and is released when signaling ends the call (i.e., SIP BYE).</li> <li>■ [1] <b>Disconnect</b> = (Default) The device ends the call when the timeout expires.</li> <li>■ [2] <b>Reroute</b> = (SBC application only) The device ends the call and then searches the IP-to-IP Routing table for a matching rule. If found, the device generates a new INVITE to the corresponding destination (i.e., alternative routing). You can configure a routing rule whose matching characteristics is explicitly for calls with broken RTP connections. This is done using the 'Call Trigger' parameter, as described in <a href="#">Configuring SBC IP-to-IP Routing Rules</a>.</li> </ul> <p><b>Note:</b></p> <ul style="list-style-type: none"> <li>■ The device can only detect a broken RTP connection if silence compression is disabled for the RTP session.</li> <li>■ If during a call the source IP address (from where the RTP packets are received by the device) is changed</li> </ul>



Parameter	Description
	<p>without notifying the device, the device rejects these RTP packets. To overcome this, configure the [DisconnectOnBrokenConnection] parameter to [0]. By this configuration, the device doesn't detect RTP packets arriving from the original source IP address and switches (after 300 msec) to the RTP packets arriving from the new source IP address.</p> <ul style="list-style-type: none"> <li>■ The corresponding global parameter is [DisconnectOnBrokenConnection].</li> </ul>
<p>'Media IP Version Preference' media-ip-version-preference [IpProfile_ MediaIPVersionPreference]</p>	<p>Defines the preferred RTP media IP addressing version for outgoing SIP calls (according to RFC 4091 and RFC 4092). The RFCs concern Alternative Network Address Types (ANAT) semantics in the SDP to offer groups of network addresses (IPv4 and IPv6) and the IP address version preference to establish the media stream. The IP address is indicated in the "c=" field (Connection) of the SDP.</p> <ul style="list-style-type: none"> <li>■ [0] <b>Only IPv4</b> = (Default) SDP offer includes only IPv4 media IP addresses.</li> <li>■ [1] <b>Only IPv6</b> = SDP offer includes only IPv6 media IP addresses.</li> <li>■ [2] <b>Prefer IPv4</b> = SDP offer includes IPv4 and IPv6 media IP addresses, but the first (preferred) media is IPv4.</li> <li>■ [3] <b>Prefer IPv6</b> = SDP offer includes IPv4 and IPv6 media IP addresses, but the first (preferred) media is IPv6.</li> </ul> <p>To indicate ANAT support, the device uses the SIP Allow header or to enforce ANAT it uses the Require header: Require: sdp-anat</p> <p>In the outgoing SDP, each 'm=' field is associated with an ANAT group. This is done using the 'a=mid:' and 'a=group:ANAT' fields. Each 'm=' field appears under a unique 'a=mid:' number, for example:</p> <pre>a=mid:1 m=audio 63288 RTP/AVP 0 8 18 101 c=IN IP6 3000::290:8fff:fe40:3e21</pre> <p>The 'a=group:ANAT' field shows the 'm=' fields belonging to it, using the number of the 'a=mid:' field. In addition, the ANAT group with the preferred 'm=' fields appears first. For example, the preferred group includes 'm=' fields under 'a=mid:1' and 'a=mid3':</p>

Parameter	Description
	<p>a=group:ANAT 1 3 a=group:ANAT 2 4</p> <p>If you configure the parameter to a "prefer" option, the outgoing SDP offer contains two medias which are the same except for the "c=" field. The first media is the preferred address type (and this type is also on the session level "c=" field), while the second media has its "c=" field with the other address type. Both medias are grouped by ANAT. For example, if the incoming SDP contains two medias, one secured and the other non-secured, the device sends the outgoing SDP with four medias:</p> <ul style="list-style-type: none"> <li>■ Two secured medias grouped in the first ANAT group, one with IPv4 and the other with IPv6. The first is the preferred type.</li> <li>■ Two non-secured medias grouped in the second ANAT group, one with IPv4 and the other with IPv6. The first is the preferred type.</li> </ul> <p><b>Note:</b></p> <ul style="list-style-type: none"> <li>■ The parameter is applicable only when the device offers an SDP.</li> <li>■ The IP addressing version is determined according to the first SDP "m=" field.</li> <li>■ The feature is applicable to any type of media (e.g., audio and video) that has an IP address.</li> <li>■ The corresponding global parameter is MediaIPVersionPreference.</li> </ul>
'RTP Redundancy Depth' rtp-redundancy-depth [IpProfile_ RTPRedundancyDepth]	<p>Enables the device to generate RFC 2198 redundant packets. This can be used for packet loss where the missing information (audio) can be reconstructed at the receiver's end from the redundant data that arrives in subsequent packets. This is required, for example, in wireless networks where a high percentage (up to 50%) of packet loss can be experienced.</p> <ul style="list-style-type: none"> <li>■ [0] 0 = (Default) Disable.</li> <li>■ [1] 1 = Enable - previous voice payload packet is added to current packet.</li> </ul> <p><b>Note:</b></p>

Parameter	Description
	<ul style="list-style-type: none"> <li>■ When enabled, you can configure the payload type, using the RFC2198PayloadType parameter.</li> <li>■ For the Gateway application, the RTP redundancy dynamic payload type can be included in the SDP, by using the EnableRTPRedundancyNegotiation parameter.</li> <li>■ The corresponding global parameter is RTPRedundancyDepth.</li> </ul>
<p><b>Gateway</b></p> <p><b>Note:</b> These parameters are applicable only to the Gateway application.</p>	
<p>'Early Media' early-media [IpProfile_ EnableEarlyMedia]</p>	<p>Enables the Early Media feature for sending media (e.g., ringing) before the call is established.</p> <ul style="list-style-type: none"> <li>■ [0] <b>Disable</b> (default)</li> <li>■ [1] <b>Enable</b> <ul style="list-style-type: none"> <li>✓ Digital: The device sends a SIP 18x response with SDP, allowing the media stream to be established before the call is answered.</li> <li>✓ Analog: The device sends a SIP 183 Session Progress response with SDP instead of a 180 Ringing, allowing the media stream to be established before the call is answered.</li> </ul> </li> </ul> <p><b>Note:</b></p> <ul style="list-style-type: none"> <li>■ Digital: The inclusion of the SDP in the 18x response depends on the ISDN Progress Indicator (PI). The SDP is sent only if PI is set to 1 or 8 in the received Proceeding, Alerting, or Progress messages. See also the ProgressIndicator2IP parameter, which if set to 1 or 8, the device behaves as if it received the ISDN messages with the PI.</li> <li>✓ CAS: See the ProgressIndicator2IP parameter.</li> <li>✓ ISDN: Sending a 183 response depends on the ISDN PI. It is sent only if PI is set to 1 or 8 in the received Proceeding or Alerting messages. Sending 183 response also depends on the [ReleaseIP2ISDNCallOnProgressWithCause] parameter, which must be set to any value other than 2.</li> </ul>

Parameter	Description
	<ul style="list-style-type: none"> <li>■ See also the IgnoreAlertAfterEarlyMedia parameter. The parameter allows, for example, to interwork Alert with PI to SIP 183 with SDP instead of 180 with SDP.</li> <li>■ You can also configure early SIP 183 response immediately upon the receipt of an INVITE, using the EnableEarly183 parameter.</li> <li>■ Analog: To send a 183 response, you must also set the [ProgressIndicator2IP] parameter to [1]. If set to [0], a 180 Ringing response is sent.</li> <li>■ The corresponding global parameter is [EnableEarlyMedia].</li> </ul>
<p>'Early 183'</p> <p>enable-early-183</p> <p>[IpProfile_EnableEarly183]</p>	<p>Enables the device to send SIP 183 responses with SDP to the IP upon receipt of INVITE messages.</p> <ul style="list-style-type: none"> <li>■ [0] <b>Disable</b> (default)</li> <li>■ [1] <b>Enable</b> = By sending the 183 response, the device opens an RTP channel before receiving the "progress" tone from the ISDN side. The device sends RTP packets immediately upon receipt of an ISDN Progress, Alerting with Progress indicator, or Connect message according to the initial negotiation without sending the 183 response again, thereby saving response time and avoiding early media clipping.</li> </ul> <p><b>Note:</b></p> <ul style="list-style-type: none"> <li>■ The parameter is applicable only to digital interfaces.</li> <li>■ This parameter is applicable only to IP-to-Tel ISDN calls and applies to all calls.</li> <li>■ To enable this feature, set the [EnableEarlyMedia] parameter to [1].</li> <li>■ When the [BChannelNegotiation] parameter is set to Preferred or Any, the [EnableEarly183] parameter is ignored and a SIP 183 is not sent upon receipt of an INVITE. In such a case, you can set the [ProgressIndicator2IP] parameter to [1] (PI = 1) for the device to send a SIP 183 upon receipt of an ISDN Call Proceeding message.</li> <li>■ The corresponding global parameter is [EnableEarly183].</li> </ul>

Parameter	Description
'Early Answer Timeout' early-answer-timeout [IpProfile_ EarlyAnswerTimeout]	Defines the duration (in seconds) that the device waits for an ISDN Connect message from the called party (Tel side), started from when it sends a Setup message. If this timer expires, the call is answered by sending a SIP 200 OK message (to the IP side).  The valid range is 0 to 2400. The default is 0 (i.e., disabled).  <b>Note:</b> <ul style="list-style-type: none"> <li>■ The parameter is applicable only to digital interfaces.</li> <li>■ The corresponding global parameter is EarlyAnswerTimeout.</li> </ul>
'Profile Preference' ip-preference [IpProfile_IpPreference]	Defines the priority of the IP Profile, where 20 is the highest priority and 1 the lowest priority.  <b>Note:</b> <ul style="list-style-type: none"> <li>■ If an IP Profile and a Tel Profile apply to the same call, the coders and other common parameters of the profile with the highest preference are applied to the call. If the preference of the profiles is identical, the Tel Profile parameters are applied.</li> <li>■ If the coder lists of both an IP Profile and a Tel Profile apply to the same call, only the coders common to both are used. The order of the coders is determined by the preference.</li> </ul>
'Coders Group' coders-group [IpProfile_ CodersGroupName]	Assigns a Coder Group, which defines audio coders supported by the SIP UA associated with the IP Profile.  The default value is the default Coder Group ("AudioCodersGroups_0").  To configure Coder Groups, see <a href="#">Configuring Coder Groups</a> .
'Play RB Tone to IP' play-rbt-to-ip [IpProfile_PlayRBTone2IP]	Enables the device to play a ringback tone to the IP side for IP-to-Tel calls.  <ul style="list-style-type: none"> <li>■ [0] <b>Disable</b> (Default)</li> <li>■ [1] <b>Enable</b> = Plays a ringback tone after a SIP 183 session progress response is sent.</li> </ul> <b>Note:</b> <ul style="list-style-type: none"> <li>■ To enable the device to send a 183/180+SDP responses, set the EnableEarlyMedia parameter to 1.</li> </ul>

Parameter	Description
	<ul style="list-style-type: none"> <li>■ If the EnableDigitDelivery parameter is set to 1, the device doesn't play a ringback tone to IP and doesn't send 183 or 180+SDP responses.</li> <li>■ Digital interfaces: If the parameter is enabled and EnableEarlyMedia is set to 1, the device plays a ringback tone according to the following: <ul style="list-style-type: none"> <li>✓ CAS: The device opens a voice channel, sends a 183+SDP response, and then plays a ringback tone to IP.</li> <li>✓ ISDN: If a Progress or an Alerting message with PI (1 or 8) is received from the ISDN, the device opens a voice channel, sends a 183+SDP or 180+SDP response, but doesn't play a ringback tone to IP. If PI (1 or 8) is received from the ISDN, the device assumes that ringback tone is played by the ISDN switch; otherwise, the device plays a ringback tone to IP after receiving an Alerting message from the ISDN. It sends a 180+SDP response, signaling to the calling party to open a voice channel to hear the played ringback tone.</li> </ul> </li> <li>■ The corresponding global parameter is PlayRBTone2IP.</li> </ul>
<p>'Progress Indicator to IP'</p> <p>prog-ind-to-ip</p> <p>[IpProfile_</p> <p>ProgressIndicator2IP]</p>	<p>Defines the Progress Indicator (PI) sent to the IP.</p> <ul style="list-style-type: none"> <li>■ [-1] = (Default) Not configured: <ul style="list-style-type: none"> <li>✓ Analog: Default values are used (1 for FXO interfaces and 0 for FXS interfaces).</li> <li>✓ Digital ISDN: The PI received in ISDN Proceeding, Progress, and Alerting messages is used, as described in the options below.</li> </ul> </li> <li>■ [0] No PI = <ul style="list-style-type: none"> <li>✓ Analog: For IP-to-Tel calls, the device sends a 180 Ringing response to IP after placing a call to a phone (FXS) or PBX (FXO).</li> <li>✓ Digital: For IP-to-Tel calls, the device sends 180 Ringing response to the IP after receiving an ISDN Alerting, or for CAS after placing a call to the PBX/PSTN.</li> </ul> </li> <li>■ [1] PI = 1:</li> </ul>

Parameter	Description
	<ul style="list-style-type: none"> <li>✓ Analog: For IP-to-Tel calls, if the EnableEarlyMedia parameter is set to 1, the device sends a 183 Session Progress message with SDP immediately after a call is placed to the analog line. This is used to cut-through the voice path before the remote party answers the call. This allows the originating party to listen to network call progress tones such as ringback tone or other network announcements.</li> <li>✓ Digital: For IP-to-Tel calls, if the parameter EnableEarlyMedia is set to 1, the device sends 180 Ringing with SDP in response to an ISDN Alerting or it sends a 183 Session Progress message with SDP in response to only the first received ISDN Proceeding or Progress message after a call is placed to PBX/PSTN over the trunk.</li> </ul> <ul style="list-style-type: none"> <li>■ [8] <b>PI = 8: same as PI = 1.</b></li> </ul> <p><b>Note:</b> The corresponding global parameter is ProgressIndicator2IP.</p>
<p>'Hold'</p> <p><code>enable-hold</code></p> <p>[IpProfile_EnableHold]</p>	<p>Analog: Enables the Call Hold feature, which allows users, connected to the device, to place a call on hold (or remove from hold), using the phone's Hook Flash button.</p> <p>Digital: Enables the interworking of the Hold/Retrieve supplementary service from ISDN to SIP .</p> <ul style="list-style-type: none"> <li>■ [0] <b>Disable</b></li> <li>■ [1] <b>Enable</b> (default)</li> </ul> <p><b>Note:</b></p> <ul style="list-style-type: none"> <li>■ Digital interfaces: To interwork the Hold/Retrieve supplementary service from SIP to ISDN (QSIG and Euro ISDN), set the EnableHold2ISDN parameter to 1.</li> <li>■ Analog interfaces: To use the call hold service, the devices at both ends must support this option.</li> <li>■ The corresponding global parameter is EnableHold.</li> </ul>
<p>'Add IE In Setup'</p> <p><code>add-ie-in-setup</code></p> <p>[IpProfile_AddIEInSetup]</p>	<p>Defines an optional Information Element (IE) data (in hex format) which is added to ISDN Setup messages. For example, to add IE '0x20,0x02,0x00,0xe1', enter the value "200200e1".</p>

Parameter	Description
	<p><b>Note:</b></p> <ul style="list-style-type: none"> <li>■ The parameter is applicable only to digital interfaces.</li> <li>■ The IE is sent from the Trunk Group IDs configured by the SendIEonTG parameter.</li> <li>■ You can configure different IE data for Trunk Groups by configuring the parameter for different IP Profiles and then assigning the required IP Profile in the IP-to-Tel Routing table (PSTNPrefix).</li> <li>■ The feature is similar to that of the EnableISDNTunnelingIP2Tel parameter. If both parameters are configured, the EnableISDNTunnelingIP2Tel parameter takes precedence.</li> <li>■ The corresponding global parameter is AddIEinSetup.</li> </ul>
<p>'QSIG Tunneling' enable-qsig-tunneling [IpProfile_ EnableQSIGTunneling]</p>	<p>Enables QSIG tunneling-over-SIP for this SIP UA. This is according to IETF Internet-Draft draft-elwell-sipping-qsig-tunnel-03 and ECMA-355 and ETSI TS 102 345.</p> <ul style="list-style-type: none"> <li>■ [0] <b>Disable</b> (default).</li> <li>■ [1] <b>Enable</b> = Enables QSIG tunneling from QSIG to SIP, and vice versa. All QSIG messages are sent as raw data in corresponding SIP messages using a dedicated message body.</li> </ul> <p><b>Note:</b></p> <ul style="list-style-type: none"> <li>■ The parameter is applicable only to digital interfaces.</li> <li>■ QSIG tunneling must be enabled on originating and terminating devices.</li> <li>■ To enable this function, set the ISDNDuplicateQ931BuffMode parameter to 128 (i.e., duplicate all messages).</li> <li>■ To define the format of encapsulated QSIG messages, use the QSIGTunnelingMode parameter.</li> <li>■ Tunneling according to ECMA-355 is applicable to all ISDN variants (in addition to the QSIG protocol).</li> <li>■ For more information on QSIG tunneling, see <a href="#">QSIG Tunneling</a>.</li> </ul>



Parameter	Description
	<ul style="list-style-type: none"> <li>■ The corresponding global parameter is EnableQSIGTunneling.</li> </ul>
<p>'Copy Destination Number to Redirect Number'</p> <p><code>copy-dst-to-redirect-number</code></p> <p>[IpProfile_CopyDest2RedirectNumber]</p>	<p>Enables the device to copy the called number, received in the SIP INVITE message, to the redirect number in the outgoing Q.931 Setup message, for IP-to-Tel calls. Thus, even if there is no SIP Diversion or History header in the incoming INVITE message, the outgoing Q.931 Setup message will contain a redirect number.</p> <ul style="list-style-type: none"> <li>■ [0] <b>Disable</b> (default).</li> <li>■ [1] <b>After Manipulation</b> = Copies the called number after manipulation. The device first performs IP-to-Tel destination phone number manipulation, and only then copies the manipulated called number to the redirect number sent in the Q.931 Setup message to the Tel. Thus, the called and redirect numbers are the same.</li> <li>■ [2] <b>Before Manipulation</b> = Copies the called number before manipulation. The device first copies the original called number to the SIP Diversion header, and then performs IP-to-Tel destination phone number manipulation. Thus, the called (i.e., SIP To header) and redirect (i.e., SIP Diversion header) numbers are different.</li> </ul> <p><b>Note:</b> The corresponding global parameter is CopyDest2RedirectNumber.</p>
<p>'Number of Calls Limit'</p> <p><code>call-limit</code></p> <p>[IpProfile_CallLimit]</p>	<p>Defines the maximum number of concurrent calls (incoming and outgoing) for the SIP UA associated with the IP Profile. If the number of concurrent calls reaches this limit, the device rejects any new incoming and outgoing calls belonging to this IP Profile.</p> <p>The parameter can also be set to the following:</p> <ul style="list-style-type: none"> <li>■ [-1] <b>-1</b> = (Default) No limitation on calls.</li> <li>■ [0] <b>0</b> = All calls are rejected.</li> </ul>
Gateway DTMF	
<p>'Is DTMF Used'</p> <p>[IpProfile_IsDTMFUsed]</p>	<p>Enables DTMF signaling.</p> <ul style="list-style-type: none"> <li>■ [0] <b>Disable</b> (default)</li> </ul>

Parameter	Description
'First Tx DTMF Option' <code>first-tx-dtmf-option</code> [IpProfile_ FirstTxDtmfOption]	<ul style="list-style-type: none"> <li>■ [1] <b>Enable</b></li> </ul> <p>Defines the first preferred transmit DTMF negotiation method.</p> <ul style="list-style-type: none"> <li>■ [0] <b>Not Supported</b> = No negotiation - DTMF digits are sent according to the parameters [DTMFTransportType] and [RFC2833PayloadType] for transmit and receive.</li> <li>■ [1] <b>INFO (Nortel)</b> = Sends DTMF digits according to IETF Internet-Draft draft-choudhuri-sip-info-digit-00.</li> <li>■ [2] <b>NOTIFY</b> = Sends DTMF digits according to IETF Internet-Draft draft-mahy-sipping-signaled-digits-01.</li> <li>■ [3] <b>INFO (Cisco)</b> = Sends DTMF digits according to the Cisco format.</li> <li>■ [4] <b>RFC 2833</b> = (Default) The device:               <ul style="list-style-type: none"> <li>✓ negotiates RFC 2833 payload type using local and remote SDPs.</li> <li>✓ sends DTMF packets using RFC 2833 payload type according to the payload type in the received SDP.</li> <li>✓ expects to receive RFC 2833 packets with the same payload type as configured by the parameter RFC2833PayloadType.</li> <li>✓ removes DTMF digits in transparent mode (as part of the voice stream).</li> </ul> </li> <li>■ [5] <b>INFO (Korea)</b> = Sends DTMF digits according to the Korea Telecom format.</li> </ul> <p><b>Note:</b></p> <ul style="list-style-type: none"> <li>■ When out-of-band DTMF transfer is used ([1], [2], [3], or [5]), the [DTMFTransportType] parameter is automatically set to 0 (DTMF digits are removed from the RTP stream).</li> <li>■ Digital interfaces: If an ISDN phone user presses digits (e.g., for interactive voice response / IVR applications such as retrieving voice mail messages), ISDN Information messages received by the device for each digit are sent in the voice channel to the IP network as DTMF signals, according to the settings of the</li> </ul>

Parameter	Description
	<p>parameter.</p> <ul style="list-style-type: none"> <li>■ The corresponding global parameter is FirstTxDTMFOption.</li> </ul>
<p>'Second Tx DTMF Option' second-tx-dtmf-option [IpProfile_SecondTxDtmfOption]</p>	<p>Defines the second preferred transmit DTMF negotiation method. For a description, see IpProfile_FirstTxDtmfOption (above).</p> <p><b>Note:</b> The corresponding global parameter is SecondTxDTMFOption.</p>
<p>'Rx DTMF Option' rx-dtmf-option [IpProfile_RxDTMFOption]</p>	<p>Enables the device to declare the RFC 2833 'telephony-event' parameter in the SDP.</p> <ul style="list-style-type: none"> <li>■ [0] <b>Not Supported</b></li> <li>■ [3] <b>Supported</b> (default)</li> </ul> <p>The device is always receptive to RFC 2833 DTMF relay packets. Thus, it is always correct to include the 'telephony-event' parameter by default in the SDP. However, some devices use the absence of the 'telephony-event' in the SDP to decide to send DTMF digits in-band using G.711 coder. If this is the case, set the parameter to 0.</p> <p><b>Note:</b> The corresponding global parameter is RxDTMFOption.</p>
<b>Gateway Fax and Modem</b>	
<p>'Fax Signaling Method' fax-sig-method [IpProfile_IsFaxUsed]</p>	<p>Defines the SIP signaling method for establishing and transmitting a fax session when the device detects a fax.</p> <ul style="list-style-type: none"> <li>■ [0] <b>No Fax</b> = (Default) No fax negotiation using SIP signaling. The fax transport method is according to the FaxTransportMode parameter</li> <li>■ [1] <b>T.38 Relay</b> = Initiates T.38 fax relay.</li> <li>■ [2] <b>G.711 Transport</b> = Initiates fax/modem using the coder G.711 A-law/Mu-law with adaptations (see Note below).</li> <li>■ [3] <b>Fax Fallback</b> = Initiates T.38 fax relay. If the T.38 negotiation fails, the device re-initiates a fax session using the coder G.711 A-law/Mu-law with adaptations (see the Note below).</li> </ul>

Parameter	Description
	<p><b>Note:</b></p> <ul style="list-style-type: none"> <li>■ Fax adaptations (for options 2 and 3): <ul style="list-style-type: none"> <li>✓ Echo Cancellor = On</li> <li>✓ Silence Compression = Off</li> <li>✓ Echo Cancellor Non-Linear Processor Mode = Off</li> <li>✓ Dynamic Jitter Buffer Minimum Delay = 40</li> <li>✓ Dynamic Jitter Buffer Optimization Factor = 13</li> </ul> </li> <li>■ If the device initiates a fax session using G.711 (option 2 or 3), a 'gpmd' attribute is added to the SDP in the following format: <ul style="list-style-type: none"> <li>✓ For A-law: 'a=gpmd:8 vbd=yes;ecan=on'</li> <li>✓ For Mu-law: 'a=gpmd:0 vbd=yes;ecan=on'</li> </ul> </li> <li>■ When the parameter is set to 1, 2, or 3, the parameter FaxTransportMode is ignored.</li> <li>■ When the parameter is set to 0, T.38 might still be used without the control protocol's involvement. To completely disable T.38, set FaxTransportMode to a value other than 1.</li> <li>■ For more information on fax transport methods, see <a href="#">Fax/Modem Transport Modes</a>.</li> <li>■ The corresponding global parameter is IsFaxUsed.</li> </ul>
'CNG Detector Mode' cng-mode [IpProfile_CNGmode]	<p>Enables the detection of the fax calling tone (CNG) and defines the detection method.</p> <ul style="list-style-type: none"> <li>■ [0] <b>Disable</b> = (Default) The originating fax does not detect CNG; the device passes the CNG signal transparently to the remote side.</li> <li>■ [1] <b>Relay</b> = The originating fax detects CNG. The device sends CNG packets to the remote side according to T.38 (if IsFaxUsed is set to 1) and the fax session is started. A SIP Re-INVITE message is not sent and the fax session starts by the terminating fax. This option is useful, for example, when the originating fax is located behind a firewall that blocks incoming T.38 packets on ports that have not yet received T.38 packets from the internal network (i.e., originating fax). To also send a</li> </ul>

Parameter	Description
	<p>Re-INVITE message upon detection of a fax CNG tone in this mode, set the parameter FaxCNGMode to 1.</p> <ul style="list-style-type: none"> <li>■ [2] <b>Event Only</b> = The originating fax detects CNG and a fax session is started by the originating fax, using the Re-INVITE message. Typically, T.38 fax session starts when the preamble signal is detected by the answering fax. Some SIP devices do not support the detection of this fax signal on the answering fax and thus, in these cases, it is possible to configure the device to start the T.38 fax session when the CNG tone is detected by the originating fax. However, this mode is not recommended.</li> </ul> <p><b>Note:</b> The corresponding global parameter is CNGDetectorMode.</p>
<p>'Vxx Modem Transport Type' vxx-transport-type</p> <p>[IpProfile_ VxxTransportType]</p>	<p>Defines the modem transport type.</p> <ul style="list-style-type: none"> <li>■ [-1] = (Not Configured) The settings of the global parameters are used: <ul style="list-style-type: none"> <li>✓ V21ModemTransportType</li> <li>✓ V22ModemTransportType</li> <li>✓ V23ModemTransportType</li> <li>✓ V32ModemTransportType</li> <li>✓ V34ModemTransportType</li> </ul> </li> <li>■ [0] <b>Disable</b> = Transparent.</li> <li>■ [2] <b>Enable Bypass</b> (Default)</li> <li>■ [3] <b>Events Only</b> = Transparent with Events.</li> </ul> <p>For a detailed description of the parameter per modem type, see the relevant global parameter (listed above).</p>
<p>'NSE Mode' nse-mode</p> <p>[IpProfile_NSEMode]</p>	<p>Enables Cisco's compatible fax and modem bypass mode, Named Signaling Event (NSE) packets.</p> <ul style="list-style-type: none"> <li>■ [0] <b>Disable</b> (default)</li> <li>■ [1] <b>Enable</b></li> </ul> <p>In NSE bypass mode, the device starts using G.711 A-Law (default) or G.711Mu-Law, according to the FaxModemBypassCoderType parameter. The payload type</p>

Parameter	Description
	<p>for these G.711 coders is a standard one (8 for G.711 A-Law and 0 for G.711Mu-Law). The parameters defining payload type for the 'old' Bypass mode FaxBypassPayloadType and ModemBypassPayloadType are not used with NSE Bypass. The bypass packet interval is configured according to the FaxModemBypassBasicRtpPacketInterval parameter.</p> <p>The SDP contains the following line:</p> <pre>a=rtpmap:100 X-NSE/8000</pre> <p><b>Note:</b></p> <ul style="list-style-type: none"> <li>■ When enabled, the following conditions must also be met: <ul style="list-style-type: none"> <li>✓ The Cisco gateway must include the following definition: 'modem passthrough nse payload-type 100 codec g711alaw'.</li> <li>✓ Set the Modem transport type to Bypass mode (VxxModemTransportType is set to 2) for all modems.</li> <li>✓ Set the NSEPayloadType parameter to 100.</li> </ul> </li> <li>■ The corresponding global parameter is NSEMode.</li> </ul>
<b>Answer Machine Detection</b>	
<p>'AMD Mode' amd-mode [IpProfile_AmdMode]</p>	<p>Enables the device to disconnect an IP-to-Tel call upon detection of an answering machine on the Tel side.</p> <ul style="list-style-type: none"> <li>■ [0] <b>Don't Disconnect</b> = (Default) Device does not disconnect call upon detection of an answering machine.</li> <li>■ [1] <b>Disconnect on AMD</b> = Device disconnects call upon detection of an answering machine. It disconnects the call only after receipt of an ISDN Connect from the Tel side. In such a scenario, the device sends a SIP BYE message upon AMD.</li> </ul> <p><b>Note:</b></p> <ul style="list-style-type: none"> <li>■ The parameter is applicable only to the Gateway application (digital interfaces).</li> <li>■ When configured to <b>Disconnect on AMD</b>, the feature can only function if you configure the</li> </ul>

Parameter	Description
	<p>[EnableEarlyAMD] parameter to any value other than [1].</p> <ul style="list-style-type: none"> <li>■ This feature does not need the receipt of the SIP X-Detect header in the incoming INVITE to activate the AMD.</li> <li>■ The corresponding global parameter is [AMDmode].</li> </ul>
<p>'AMD Sensitivity Parameter Suite'</p> <p>amd-sensitivity-parameter-suite</p> <p>[IpProfile_AMDSensitivityParameterSuite]</p>	<p>Defines the AMD Parameter Suite to use for the Answering Machine Detection (AMD) feature.</p> <ul style="list-style-type: none"> <li>■ [0] <b>0</b> = (Default) Parameter Suite 0 based on North American English with standard detection sensitivity resolution (8 sensitivity levels, from 0 to 7). This AMD Parameter Suite is provided by the AMD Sensitivity file, which is shipped pre-installed on the device.</li> <li>■ [1] <b>1</b> = Parameter Suite based 1 on North American English with high detection sensitivity resolution (16 sensitivity levels, from 0 to 15). This AMD Parameter Suite is provided by the AMD Sensitivity file, which is shipped pre-installed on the device.</li> <li>■ [2-7] <b>2 to 7</b> = Optional Parameter Suites that you can create based on any language (16 sensitivity levels, from 0 to 15). This requires a customized AMD Sensitivity file that needs to be installed on the device. For more information, contact the sales representative of your purchased device.</li> </ul> <p><b>Note:</b></p> <ul style="list-style-type: none"> <li>■ To configure the detection sensitivity level, use the 'AMD Sensitivity Level' parameter.</li> <li>■ For more information on the AMD feature, see <a href="#">Answering Machine Detection (AMD)</a>.</li> <li>■ The corresponding global parameter is [AMDSensitivityParameterSuite].</li> </ul>
<p>'AMD Sensitivity Level'</p> <p>amd-sensitivity-level</p> <p>[IpProfile_AMDSensitivityLevel]</p>	<p>Defines the AMD detection sensitivity level of the selected AMD Parameter Suite (using the 'AMD Sensitivity Parameter Suite' parameter).</p> <ul style="list-style-type: none"> <li>■ For Parameter Suite 0: The valid range is 0 to 7 (default is 0), where 0 is for best detection of an answering machine and 7 for best detection of a live call.</li> </ul>

Parameter	Description
	<ul style="list-style-type: none"> <li>■ For any Parameter Suite other than 0, the valid range is 0 to 15 (default is 8), where 0 is for best detection of an answering machine and 15 for best detection of a live call.</li> </ul> <p><b>Note:</b> The corresponding global parameter is [AMDSensitivityLevel].</p>
'AMD Max Greeting Time' amd-max-greeting-time [IpProfile_ AMDMaxGreetingTime]	<p>Defines the maximum duration (in 5-msec units) that the device can take to detect a greeting message.</p> <p>The valid range value is 0 to 51132767. The default is 300.</p> <p><b>Note:</b> The corresponding global parameter is [AMDMaxGreetingTime].</p>
'AMD Max Post Silence Greeting Time' amd-max-post-silence-greeting-time [IpProfile_ AMDMaxPostSilenceGreetingTime]	<p>Defines the maximum duration (in 5-msec units) of silence from after the greeting time is over, configured by [AMDMaxGreetingTime], until the device's AMD decision.</p> <p>The valid value is 0 to 511. The default is 400.</p> <p><b>Note:</b> The corresponding global parameter is [AMDMaxPostGreetingSilenceTime].</p>
<b>Local Tones</b>	
'Local Ringback Tone Index' local-ringback-tone-index [IPProfile_ LocalRingbackTone]	<p>Defines the ringback tone that you want to play from the PRT file.</p> <p>To associate a user-defined tone, configure the parameter with the tone's index number (0-79) as appears in the PRT file. By default (value of -1), the device plays a default ringback tone.</p> <p>To play user-defined tones, you need to record your tones and then install them on the device using a loadable Prerecorded Tones (PRT) file, which is created using AudioCodes DConvert utility. When you create the PRT file, each recorded tone file must be added to the PRT file with the tone type "acUserDefineTone&lt;Index&gt;". When you want to specify the ringback tone for this parameter, use the index number. For more information, see <a href="#">Prerecorded Tones File</a>.</p>
'Local Held Tone Index' local-held-tone-	<p>Defines the held tone that you want to play from the PRT file.</p>



Parameter	Description
index [IPProfile_LocalHeldTone]	<p>To associate a user-defined tone, configure the parameter with the tone's index number (0-79) as appears in the PRT file. By default (value of -1), the device plays a default held tone.</p> <p>To play user-defined tones, you need to record your tones and then install them on the device using a loadable Prerecorded Tones (PRT) file, which is created using AudioCodes DConvert utility. When you create the PRT file, each recorded tone file must be added to the PRT file with the tone type "acUserDefineTone&lt;Index&gt;". When you want to specify the held tone for this parameter, use the index number. For more information, see <a href="#">Prerecorded Tones File</a>.</p>

## Configuring Tel Profile

The Tel Profiles table lets you configure up to nine *Tel Profiles*. A Tel Profile is a set of parameters with specific settings which can be assigned to specific calls. The Tel Profiles table includes a wide range of parameters for configuring the Tel Profile. Each of these parameters has a corresponding "global" parameter, which when configured applies to all calls. The main difference, if any, between the Tel Profile parameters and their corresponding global parameters are their default values.

Tel Profiles provide high-level adaptation when the device interworks between different equipment and protocols (at both the Tel and IP sides), each of which may require different handling by the device. For example, if specific channels require the use of the G.711 coder, you can configure a Tel Profile with this coder and assign it to these channels.

To use your Tel Profile for specific calls, you need to assign it to specific channels (trunks or endpoints) in the Trunk Group table (see [Configuring Trunk Groups](#)).

The following procedure describes how to configure Tel Profiles through the Web interface. You can also configure it through ini file [TelProfile] or CLI (`configure voip > coders-and-profiles tel-profile`).

### ➤ To configure a Tel Profile:

1. Open the Tel Profiles table (**Setup** menu > **Signaling & Media** tab > **Coders & Profiles** folder > **Tel Profiles**).
2. Click **New**; the following dialog box appears:

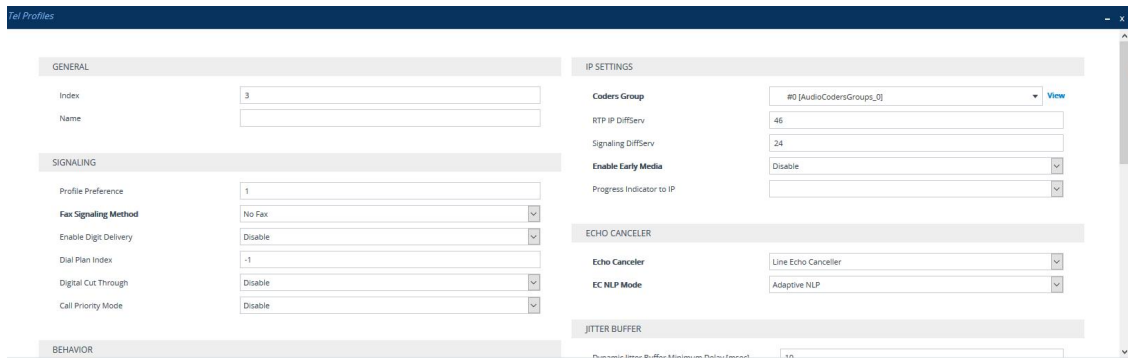

3. Configure a Tel Profile according to the parameters described in the table below. For a description of each parameter, refer to the corresponding "global" parameter.
4. Click **Apply**.

**Table 19-6: Tel Profile Table Parameter Descriptions**

Parameter	Description
<b>General</b>	
'Index' [TelProfile_Index]	Defines an index number for the new table row. <b>Note:</b> Each row must be configured with a unique index.
'Name' profile-name [TelProfile_ProfileName]	Defines a descriptive name, which is used when associating the row in other tables. The valid value is a string of up to 40 characters. <b>Note:</b> The parameter value cannot contain a forward slash (/).
<b>Signaling</b>	
'Profile Preference' tel-preference [TelProfile_TelPreference]	Defines the priority of the Tel Profile, where <b>1</b> is the lowest priority and <b>20</b> the highest priority. <b>Note:</b> <ul style="list-style-type: none"> <li>■ If both the IP Profile and Tel Profile apply to the same call, the coders and common parameters of the Preferred profile are applied to the call.</li> <li>■ If the Preference of the Tel Profile and IP Profile are identical, the Tel Profile parameters are applied.</li> <li>■ If the coder lists of both the IP Profile and Tel Profile apply to the same call, only the coders common to both are used. The order of the coders is determined by the preference.</li> </ul>

Parameter	Description
'Fax Signaling Method' fax-sig-method [TelProfile_IsFaxUsed]	<p>Defines the SIP signaling method for establishing and transmitting a fax session when the device detects a fax.</p> <ul style="list-style-type: none"> <li>■ [0] <b>No Fax</b> = (Default) No fax negotiation using SIP signaling. The fax transport method is according to the FaxTransportMode parameter.</li> <li>■ [1] <b>T.38 Relay</b> = Initiates T.38 fax relay.</li> <li>■ [2] <b>G.711 Transport</b> = Initiates fax/modem using the coder G.711 A-law/Mu-law with adaptations (see Note below).</li> <li>■ [3] <b>Fax Fallback</b> = Initiates T.38 fax relay. If the T.38 negotiation fails, the device re-initiates a fax session using the coder G.711 A-law/Mu-law with adaptations (see the Note below).</li> </ul> <p><b>Note:</b></p> <ul style="list-style-type: none"> <li>■ Fax adaptations (for options 2 and 3):               <ul style="list-style-type: none"> <li>✓ Echo Celler = On</li> <li>✓ Silence Compression = Off</li> <li>✓ Echo Celler Non-Linear Processor Mode = Off</li> <li>✓ Dynamic Jitter Buffer Minimum Delay = 40</li> <li>✓ Dynamic Jitter Buffer Optimization Factor = 13</li> </ul> </li> <li>■ If the device initiates a fax session using G.711 (option 2 or 3), a 'gpmd' attribute is added to the SDP in the following format:               <ul style="list-style-type: none"> <li>✓ For A-law: 'a=gpmd:8 vbd=yes;ecan=on'</li> <li>✓ For Mu-law: 'a=gpmd:0 vbd=yes;ecan=on'</li> </ul> </li> <li>■ When the parameter is set to 1, 2, or 3, the parameter FaxTransportMode is ignored.</li> <li>■ When the parameter is set to 0, T.38 might still be used without the control protocol's involvement. To completely disable T.38, set FaxTransportMode to a value other than 1.</li> <li>■ For more information on fax transport methods, see <a href="#">Fax/Modem Transport Modes</a>.</li> <li>■ The corresponding global parameter is IsFaxUsed.</li> </ul>

Parameter	Description
'Enable Digit Delivery' digit-delivery [TelProfile_EnableDigitDelivery]	<p>Enables the Digit Delivery feature, which sends DTMF digits of the called number to the phone line (device's analog port or digital B-channel) after the call is answered (i.e., line is off-hooked for FXS or seized for FXO) for IP-to-Tel calls.</p> <ul style="list-style-type: none"> <li>■ [0] <b>Disable</b> (default)</li> <li>■ [1] <b>Enable</b></li> </ul> <p>Digital interfaces: If the called number in IP-to-Tel call includes the characters 'w' or 'p', the device places a call with the first part of the called number (before 'w' or 'p') and plays DTMF digits after the call is answered. If the character 'w' is used, the device waits for detection of a dial tone before it starts playing DTMF digits. For example, if the called number is '1007766p100', the device places a call with 1007766 as the destination number, then after the call is answered it waits 1.5 seconds ('p') and plays the rest of the number (100) as DTMF digits. Additional examples: 1664wpp102, 66644ppp503, and 7774w100pp200.</p> <p><b>Note:</b></p> <ul style="list-style-type: none"> <li>■ Analog interfaces: The called number can include characters 'p' (1.5 seconds pause) and 'd' (detection of dial tone). If character 'd' is used, it must be the first 'digit' in the called number. The character 'p' can be used several times. For example (for FXS/FXO interfaces), the called number can be as follows: d1005, dpp699, p9p300. To add the 'd' and 'p' digits, use the usual number manipulation rules.</li> <li>■ Analog interfaces: To use this feature with FXO interfaces, configure the device to operate in one-stage dialing mode.</li> <li>■ Analog interfaces: If the parameter is enabled, it is possible to configure the FXS/FXO interface to wait for dial tone per destination phone number (before or during dialing of destination phone number). Therefore, the parameter <code>IsWaitForDialTone</code> (configurable for the entire device) is ignored.</li> <li>■ Analog interfaces: The FXS interface send SIP 200 OK responses only after the DTMF dialing is complete.</li> </ul>

Parameter	Description
	<ul style="list-style-type: none"> <li>■ The corresponding global parameter is EnableDigitDelivery.</li> </ul>
'Dial Plan Index' dial-plan-index [TelProfile_DialPlanIndex]	DialPlanIndex
'Digital Cut Through' digital-cut-through [TelProfile_DigitalCutThrough]	<p>Enables PSTN CAS channels/endpoints to receive incoming IP calls even if the B-channels are in off-hook state.</p> <ul style="list-style-type: none"> <li>■ [0] <b>Disable</b> (default)</li> <li>■ [1] <b>Enable</b> = When enabled, the feature operates as follows:               <ol style="list-style-type: none"> <li>a. A Tel-to-IP call is established (connected) by the device for a B-channel.</li> <li>b. The device receives a SIP BYE (i.e., IP side ends the call) and plays a reorder tone to the PSTN side for the duration configured by the CutThroughTimeForReOrderTone parameter. The device releases the call towards the IP side (sends a SIP 200 OK).</li> <li>c. The PSTN side, for whatever reason, remains off-hook.</li> <li>d. If a new IP call is received for this B-channel after the reorder tone has ended, the device “cuts through” the channel and connects the call immediately (despite the B-channel being in physical off-hook state) without playing a ring tone. If an IP call is received while the reorder tone is played, the device rejects the call.</li> </ol> </li> </ul> <p><b>Note:</b></p> <ul style="list-style-type: none"> <li>■ If the parameter is disabled and the PSTN side remains in off-hook state after the IP call ends the call, the device releases the call after 60 seconds.</li> <li>■ A special CAS table can be used to report call status events (Active/Idle) to the PSTN side during Cut Through mode (see <a href="#">Configuring CAS State Machines</a>).</li> </ul>

Parameter	Description
	<ul style="list-style-type: none"> <li>■ The corresponding global parameter is DigitalCutThrough.</li> </ul>
<p>'Call Priority Mode' call-priority-mode [TelProfile_CallPriorityMode]</p>	<p>Defines call priority handling.</p> <ul style="list-style-type: none"> <li>■ [0] <b>Disable</b> (default).</li> <li>■ [1] <b>MLPP</b> = Enables MLPP Priority Call handling. MLPP prioritizes call handling whereby the relative importance of various kinds of communications is strictly defined, allowing higher precedence communication at the expense of lower precedence communications. Higher priority calls override less priority calls when, for example, congestion occurs in a network.</li> <li>■ [2] <b>Emergency</b> = Enables Preemption of IP-to-Tel E911 emergency calls. If the device receives an E911 call and there are unavailable channels to receive the call, the device terminates one of the channel calls and sends the E911 call to that channel. The preemption is done only on a channel belonging to the same Trunk Group for which the E911 call was initially destined and if the channel select mode (configured by the ChannelSelectMode parameter) is set to other than <b>By Dest Phone Number</b> (0). The preemption is done only if the incoming IP-to-Tel call is identified as an emergency call. The device identifies emergency calls by one of the following: <ul style="list-style-type: none"> <li>✓ The destination number of the IP call matches one of the numbers configured by the EmergencyNumbers parameter. (For E911, you must configure the parameter to "911".)</li> <li>✓ The incoming SIP INVITE message contains the "emergency" value in the Priority header.</li> </ul> </li> </ul> <p><b>Note:</b></p> <ul style="list-style-type: none"> <li>■ The parameter is applicable to analog and digital interfaces.</li> <li>■ For FXO interfaces, the preemption is done only on existing IP-to-Tel calls. In other words, if all the current FXO channels are busy with calls that were initiated by the FXO (i.e., Tel-to-IP calls), new</li> </ul>

Parameter	Description
	<p>incoming emergency IP-to-Tel calls are rejected.</p> <ul style="list-style-type: none"> <li>■ For more information, see <a href="#">Pre-empting Existing Call for E911 IP-to-Tel Call</a>.</li> <li>■ The corresponding global parameter is CallPriorityMode.</li> </ul>
<b>Behavior</b>	
<p>'Disconnect Call on Detection of Busy Tone' disconnect-on-busy-tone [TelProfile_DisconnectOnBusyTone]</p>	<p>Enables the device to disconnect the call upon detection of a busy or reorder (fast busy) tone.</p> <ul style="list-style-type: none"> <li>■ [0] <b>Disable</b></li> <li>■ [1] <b>Enable</b> (default)</li> </ul> <p><b>Note:</b></p> <ul style="list-style-type: none"> <li>■ The parameter is applicable only to FXO and CAS.</li> <li>■ The corresponding global parameter is DisconnectOnBusyTone.</li> </ul>
<p>'Time For Reorder Tone' time-for-reorder-tone [TelProfile_TimeForReorderTone]</p>	<p>Defines the duration (in seconds) that the device plays a busy or reorder tone before releasing the line.</p> <p>Analog interfaces: Typically, after playing the busy or reorder tone for this duration, the device starts playing an offhook warning tone.</p> <p>The valid range is 0 to 254. The default is 0 seconds for analog interfaces and 10 seconds for digital interfaces. Note that the Web interface denotes the default value as "255".</p> <p><b>Note:</b></p> <ul style="list-style-type: none"> <li>■ The selected busy or reorder tone is according to the SIP release cause code received from IP.</li> <li>■ The parameter is also applicable to CAS.</li> <li>■ The parameter is applicable to ISDN when the PlayBusyTone2ISDN parameter is set to 2.</li> <li>■ The corresponding global parameter is TimeForReorderTone.</li> </ul>
<p>'Enable Voice Mail Delay' enable-voice-mail-delay</p>	<p>Enables and disables voice mail services.</p> <ul style="list-style-type: none"> <li>■ [0] <b>Disable</b></li> </ul>

Parameter	Description
[TelProfile_ EnableVoiceMailDelay]	<ul style="list-style-type: none"> <li>■ [1] <b>Enable</b> (default)</li> </ul> <p>The parameter is useful if you want to disable voice mail services per Trunk Group to eliminate the phenomenon of call delay on Trunks that do not implement voice mail when voice mail is configured using the global parameter, VoiceMailInterface.</p>
'Swap Tel To IP Phone Numbers' swap-teltoip-phone-numbers [TelProfile_ SwapTelToIpPhoneNumbers]	<p>Enables the device to swap the calling and called numbers received from the Tel side (for Tel-to-IP calls). The SIP INVITE message contains the swapped numbers.</p> <ul style="list-style-type: none"> <li>■ [0] <b>Disable</b> (default)</li> <li>■ [1] <b>Enable</b></li> </ul> <p><b>Note:</b> The corresponding global parameter is SwapTEI2IPCalled&amp;CallingNumbers.</p>
'IP-to-Tel Cut-Through Call Mode' ip2tel-cutthrough_call_behavior [TelProfile_ IP2TelCutThroughCallBehavior]	<p>Enables the Cut-Through feature, which allows phones connected to the device's FXS ports to automatically receive IP calls (if there is no other currently active call) even when in off-hook state (and no call is currently active).</p> <ul style="list-style-type: none"> <li>■ [0] <b>Disable</b> = Calls can only be received in on-hook state.</li> <li>■ [1] <b>Cut-Through</b> = (Enabled with tones) Calls can be received in off-hook state. When the IP side ends the call, the device can play a reorder tone to the Tel side for a user-defined duration (configured by the CutThroughTimeForReorderTone parameter). Once the tone stops playing, the FXS phone is ready to automatically answer another incoming IP call in off-hook state. A waiting call is automatically answered by the device when the current call is terminated (and if the EnableCallWaiting parameter is configured to 1).</li> <li>■ [2] <b>Cut-Through and Paging</b> = (Enabled and no tones) Calls can be received in off-hook state, but no tones are played (before or after the call) in off-hook state. The option is useful for paging calls, which provides a one-way voice path from the paging phone to the paged phones (FXS phones).</li> </ul>



Parameter	Description
	<ul style="list-style-type: none"> <li>■ [3] <b>Cut-Through and Streaming</b> = Enabled and allows playing music-on-hold (MoH) that is received from an external media (audio) player. For more information, see <a href="#">Configuring MoH from External Audio Source</a> on page 816.</li> </ul> <p><b>Note:</b></p> <ul style="list-style-type: none"> <li>■ The parameter is applicable only to FXS interfaces.</li> <li>■ The corresponding global parameter is CutThrough. this global parameter currently does not support the <b>CutThrough+Streaming</b> option.</li> </ul>
<b>Voice</b>	
'DTMF Volume' dtmf-volume [TelProfile_DtmfVolume]	Defines the DTMF gain control value (in decibels) to the Tel side. The valid range is -31 to 0 dB. The default is -11 dB. <b>Note:</b> The corresponding global parameter is DTMFVolume.
'Input Gain' input-gain [TelProfile_InputGain]	Defines the pulse-code modulation (PCM) input (received) gain control level (in decibels), which is the level of the received signal for Tel-to-IP calls. The valid range is -32 to 31 dB. The default is 0 dB. <b>Note:</b> The corresponding global parameter is InputGain.
'Voice Volume' voice-volume [TelProfile_VoiceVolume]	Defines the voice gain control (in decibels), which is the level of the transmitted signal for IP-to-Tel calls. The valid range is -32 to 31 dB. The default is 0 dB. <b>Note:</b> The corresponding global parameter is VoiceVolume
'Enable AGC' enable-agc [TelProfile_EnableAGC]	Enables the Automatic Gain Control (AGC) feature. The AGC feature automatically adjusts the level of the received signal to maintain a steady (configurable) volume level. <ul style="list-style-type: none"> <li>■ [0] <b>Disable</b> (default)</li> <li>■ [1] <b>Enable</b></li> </ul> <p><b>Note:</b></p> <ul style="list-style-type: none"> <li>■ For more information on AGC, see <a href="#">Automatic Gain</a></li> </ul>

Parameter	Description
	<p><a href="#">Control (AGC)</a>.</p> <ul style="list-style-type: none"> <li>■ The corresponding global parameter is EnableAGC.</li> </ul>
<b>Analog</b>	
<p>'Enable Polarity Reversal' polarity-rvrsl [TelProfile_ EnableReversePolarity]</p>	<p>Enables the Polarity Reversal feature for call release.</p> <ul style="list-style-type: none"> <li>■ [0] <b>Disable</b> (default)</li> <li>■ [1] <b>Enable</b> = Enables polarity reversal: <ul style="list-style-type: none"> <li>✓ FXS Interfaces: The device changes the line polarity on call answer and then changes it back on call release.</li> <li>✓ FXO Interfaces: The device sends a SIP 200 OK response when polarity reversal signal is detected (applicable only to one-stage dialing) and releases a call when a second polarity reversal signal is detected.</li> </ul> </li> </ul> <p><b>Note:</b></p> <ul style="list-style-type: none"> <li>■ The parameter is applicable to FXS and FXO interfaces.</li> <li>■ The corresponding global parameter is EnableReversalPolarity.</li> </ul>
<p>'Enable Current Disconnect' current-disconnect [TelProfile_ EnableCurrentDisconnect]</p>	<p>Enables call release upon detection of a Current Disconnect signal.</p> <ul style="list-style-type: none"> <li>■ [0] <b>Disable</b> (default)</li> <li>■ [1] <b>Enable</b> = Enables the current disconnect service. <ul style="list-style-type: none"> <li>✓ FXO Interfaces: The device releases a call when a current disconnect signal is detected on its port.</li> <li>✓ FXS Interfaces: The device generates a 'Current Disconnect Pulse' after the call is released from the IP side.</li> </ul> </li> </ul> <p><b>Note:</b></p> <ul style="list-style-type: none"> <li>■ The parameter is applicable to FXS and FXO interfaces.</li> <li>■ The current disconnect duration is configured by the CurrentDisconnectDuration parameter.</li> </ul>

Parameter	Description
	<ul style="list-style-type: none"> <li>■ The current disconnect threshold (FXO only) is configured by the <code>CurrentDisconnectDefaultThreshold</code> parameter.</li> <li>■ The frequency at which the analog line voltage is sampled is configured by the <code>TimeToSampleAnalogLineVoltage</code> parameter.</li> <li>■ The corresponding global parameter is <code>EnableCurrentDisconnect</code>.</li> </ul>
<p>'DID Wink'  <code>enable-did-wink</code>  [<code>TelProfile_EnableDIDWink</code>]</p>	<p>Enables Direct Inward Dialing (DID) using Wink-Start signaling, typically used for signaling between an E-911 switch and the PSAP.</p> <ul style="list-style-type: none"> <li>■ [0] <b>Disable</b> (default)</li> <li>■ [1] <b>Single</b> = The device can be used for connection to EIA/TIA-464B DID Loop Start lines. FXO (detection) and FXS (generation) are supported: <ul style="list-style-type: none"> <li>✓ FXO Interfaces: The device dials DTMF (or MF) digits upon detection of a Wink signal, instead of a dial tone.</li> <li>✓ FXS Interfaces: The device generates a Wink signal upon detection of an off-hook state, instead of playing a dial tone.</li> </ul> <p>For example: (Wink) KP I(I) xxx-xxxx ST (Off Hook)  Where:</p> <ul style="list-style-type: none"> <li>✓ I = one or two information digits</li> <li>✓ x = ANI</li> </ul> <p><b>Note:</b> The FXO interface generates such MF digits when the <code>Enable911PSAP</code> parameter is set to 1.</p> </li> <li>■ [2] <b>Double Wink</b> = Double-wink signaling. This is applicable to FXS interfaces only. The device generates the first Wink upon detection of an off-hook state in the line. The second Wink is generated after a user-defined interval (configured by the <code>TimeBetweenDIDWinks</code> parameter) after which the DTMF/MF digits are collected by the device. Digits that arrive between the first and second Wink are ignored as they contain the same number. For example:</li> </ul>

Parameter	Description
	<p>(Wink) KP 911 ST (Wink) KP I(I) xxx-xxxx ST (Off Hook)</p> <ul style="list-style-type: none"> <li>■ [3] <b>Wink &amp; Polarity =</b> <ul style="list-style-type: none"> <li>✓ FXS Interfaces: The device generates the first Wink after it detects an off-hook state. A polarity change from normal to reversed is generated after a user-defined time (configured by the TimeBetweenDIDWinks parameter). DTMF/MF digits are collected by the device only after this polarity change. Digits that arrive between the first Wink and the polarity change are ignored as they always contain the same number. In this mode, the device does not generate a polarity change to normal if the Tel-to-IP call is answered by an IP party. Polarity reverts to normal when the call is released. For example: (Wink) KP 911 ST (Polarity) KP I(I) xxx-xxxx ST (Off Hook)</li> <li>✓ FXO Interfaces: For IP-to-Tel calls:               <ol style="list-style-type: none"> <li>1) Upon incoming INVITE message, the FXO interface goes off-hook (seizes the line).</li> <li>2) Upon detection of a Wink signal from the Tel side (instead of a dial tone), the device dials the digits, "KP911ST" (denotes *911#).</li> <li>3) The device waits for polarity reversal change from normal to reverse for an interval of 2,000 msec.</li> <li>4) Upon detection of a polarity reversal change, the device dials the DTMF (or MF) digits of the calling party (number that dialed 911) in the format "KP&lt;ANI&gt;ST" (*ANI#), where ANI is the calling number from the INVITE. If no polarity reversal, the FXO goes idle. For example: (Wink) KP911ST (Polarity Change) KP02963700ST Note: The Enable911PSAP parameter must be set to 1.</li> </ol> </li> </ul> </li> </ul> <p><b>Note:</b></p> <ul style="list-style-type: none"> <li>■ For FXS interfaces, the EnableReversalPolarity and PolarityReversalType parameters must be configured to 1.</li> </ul>

Parameter	Description
	<ul style="list-style-type: none"> <li>■ The parameter is applicable to FXS and FXO interfaces.</li> <li>■ The corresponding global parameter is EnableDIDWink.</li> </ul>
<p>'Enable 911 PSAP'</p> <p>enable-911-psap</p> <p>[TelProfile_Enable911PSAP]</p>	<p>Enables the support for the E911 DID protocol, according to the Bellcore GR-350-CORE standard. The protocol defines signaling between E911 Tandem Switches and the PSAP, using analog loop-start lines. The device's FXO interface can be used instead of an E911 switch, connected directly to PSAP DID loop-start lines.</p> <ul style="list-style-type: none"> <li>■ [0] <b>Disable</b> (default)</li> <li>■ [1] <b>Enable</b></li> </ul> <p><b>Note:</b></p> <ul style="list-style-type: none"> <li>■ The parameter is applicable only to FXO interfaces.</li> <li>■ The corresponding global parameter is Enable911PSAP.</li> </ul>
<b>IP Settings</b>	
<p>'Coders Group'</p> <p>coders-group</p> <p>[TelProfile_CodersGroupName]</p>	<p>Assigns a Coder Group, which defines audio (voice) coders that can be used for the endpoints associated with the Tel Profile.</p> <p>To configure Coders Groups, see <a href="#">Configuring Coder Groups</a>.</p>
<p>'RTP IP DiffServ'</p> <p>rtp-ip-diffserv</p> <p>[TelProfile_IPDiffServ]</p>	<p>Defines the DiffServ value for Premium Media class of service (CoS) content.</p> <p>The valid range is 0 to 63. The default is 46.</p> <p><b>Note:</b></p> <ul style="list-style-type: none"> <li>■ For more information on DiffServ, see <a href="#">Configuring Class-of-Service QoS</a>.</li> <li>■ The corresponding global parameter is PremiumServiceClassMediaDiffServ.</li> </ul>
<p>'Signaling DiffServ'</p> <p>signaling-diffserv</p> <p>[TelProfile_SigIPDiffServ]</p>	<p>Defines the DiffServ value for Premium Control CoS content (Call Control applications).</p> <p>The valid range is 0 to 63. The default is 40.</p> <p><b>Note:</b></p>

Parameter	Description
	<ul style="list-style-type: none"> <li>■ For more information on DiffServ, see <a href="#">Configuring Class-of-Service QoS</a>.</li> <li>■ The corresponding global parameter is PremiumServiceClassControlDiffServ.</li> </ul>
<p>'Enable Early Media' early-media [TelProfile_EnableEarlyMedia]</p>	<p>Enables the Early Media feature, which sends media (e.g., ringing) before the call is established.</p> <ul style="list-style-type: none"> <li>■ [0] <b>Disable</b> (default)</li> <li>■ [1] <b>Enable</b> <ul style="list-style-type: none"> <li>✓ Digital: The device sends a SIP 18x response with SDP, allowing the media stream to be established before the call is answered.</li> <li>✓ Analog: The device sends a SIP 183 Session Progress response with SDP instead of a 180 Ringing, allowing the media stream to be established before the call is answered.</li> </ul> </li> </ul> <p><b>Note:</b></p> <ul style="list-style-type: none"> <li>■ Digital: The inclusion of the SDP in the 18x response depends on the ISDN Progress Indicator (PI). The SDP is sent only if PI is set to 1 or 8 in the received Proceeding, Alerting, or Progress messages. See also the ProgressIndicator2IP parameter, which if set to 1 or 8, the device behaves as if it received the ISDN messages with the PI. <ul style="list-style-type: none"> <li>✓ CAS: See the ProgressIndicator2IP parameter.</li> <li>✓ ISDN: Sending a 183 response depends on the ISDN PI. It is sent only if PI is set to 1 or 8 in the received Proceeding or Alerting messages. Sending 183 response also depends on the ReleaseIP2ISDNCallOnProgressWithCause parameter, which must be set to any value other than 2.</li> </ul> </li> <li>■ Digital: See also the IgnoreAlertAfterEarlyMedia parameter. The parameter allows, for example, to interwork Alert with PI to SIP 183 with SDP instead of 180 with SDP.</li> <li>■ Digital: You can also configure early SIP 183 response immediately upon the receipt of an</li> </ul>

Parameter	Description
	<p>INVITE, using the EnableEarly183 parameter.</p> <ul style="list-style-type: none"> <li>■ Analog: To send a 183 response, you must also set the ProgressIndicator2IP parameter to 1. If set to 0, a 180 Ringing response is sent.</li> <li>■ The corresponding global parameter is EnableEarlyMedia.</li> </ul>
<p>'Progress Indicator to IP'  prog-ind-to-ip  [TelProfile_  ProgressIndicator2IP]</p>	<p>Defines the progress indicator (PI) sent to the IP.</p> <ul style="list-style-type: none"> <li>■ [-1] = (Default) Not configured: <ul style="list-style-type: none"> <li>✓ Analog: Default values are used (1 for FXO interfaces and 0 for FXS interfaces).</li> <li>✓ Digital ISDN: The PI received in ISDN Proceeding, Progress, and Alerting messages is used, as described in the options below.</li> </ul> </li> <li>■ [0] <b>No PI</b> = <ul style="list-style-type: none"> <li>✓ Analog: For IP-to-Tel calls, the device sends a 180 Ringing response to IP after placing a call to a phone (FXS) or PBX (FXO).</li> <li>✓ Digital: For IP-to-Tel calls, the device sends 180 Ringing response to the IP after receiving an ISDN Alerting, or for CAS after placing a call to the PBX/PSTN.</li> </ul> </li> <li>■ [1] <b>PI = 1</b> = <ul style="list-style-type: none"> <li>✓ Analog: For IP-to-Tel calls, if the EnableEarlyMedia parameter is set to 1, the device sends a 183 Session Progress message with SDP immediately after a call is placed to a phone/PBX. This is used to cut-through the voice path before the remote party answers the call. This allows the originating party to listen to network call progress tones such as ringback tone or other network announcements.</li> <li>✓ Digital: For IP-to-Tel calls, if the parameter EnableEarlyMedia is set to 1, the device sends 180 Ringing with SDP in response to an ISDN Alerting or it sends a 183 Session Progress message with SDP in response to only the first received ISDN Proceeding or Progress message</li> </ul> </li> </ul>

Parameter	Description
	<p>after a call is placed to PBX/PSTN over the trunk.</p> <ul style="list-style-type: none"> <li>■ [8] <b>PI = 8</b> = Same as <b>PI = 1</b>.</li> </ul> <p><b>Note:</b> The corresponding global parameter is ProgressIndicator2IP.</p>
<b>Echo Canceler</b>	
<p>'Echo Canceler' echo-canceller [TelProfile_EnableEC]</p>	<p>Enables the device's Echo Cancellation feature (i.e., echo from voice calls is removed).</p> <ul style="list-style-type: none"> <li>■ [0] <b>Disable</b></li> <li>■ [1] <b>Line Echo Canceller</b> (default)</li> </ul> <p>For more information on echo cancellation, see <a href="#">Configuring Echo Cancellation</a>.</p> <p><b>Note:</b> The corresponding global parameter is EnableEchoCanceller.</p>
<p>'EC NLP Mode' echo-canceller-nlp-mode [TelProfile_ECnlpMode]</p>	<p>Enables Non-Linear Processing (NLP) mode for echo cancellation.</p> <ul style="list-style-type: none"> <li>■ [0] <b>Adaptive NLP</b> = (Default) NLP adapts according to echo changes</li> <li>■ [1] <b>Disable NLP</b></li> </ul> <p><b>Note:</b> The corresponding global parameter is ECNLPMode.</p>
<b>Jitter Buffer</b>	
<p>'Dynamic Jitter Buffer Minimum Delay' jitter-buffer-minimum-delay [TelProfile_JitterBufMinDelay]</p>	<p>Defines the minimum delay (in msec) of the device's dynamic Jitter Buffer.</p> <p>The valid range is 0 to 150. The default delay is 10.</p> <p>For more information on Jitter Buffer, see <a href="#">Configuring the Dynamic Jitter Buffer</a>.</p> <p><b>Note:</b> The corresponding global parameter is DJBufMinDelay.</p>
<p>'Dynamic Jitter Buffer Maximum Delay' jitter-buffer-maximum-delay [TelProfile_JitterBufMaxDelay]</p>	<p>Defines the maximum delay (in msec) for the device's Dynamic Jitter Buffer.</p> <p>The default is 300.</p>



Parameter	Description
'Dynamic Jitter Buffer Optimization Factor' jitter-buffer-optimization-factor [TelProfile_JitterBufOptFactor]	Defines the Dynamic Jitter Buffer frame error/delay optimization factor. The valid range is 0 to 12. The default factor is 10. For more information on Jitter Buffer, see <a href="#">Configuring the Dynamic Jitter Buffer</a> . <b>Note:</b> <ul style="list-style-type: none"> <li>■ For data (fax and modem) calls, configure the parameter to 12.</li> <li>■ The corresponding global parameter is DJBufOptFactor.</li> </ul>
Analog MWI	
'MWI Analog Lamp' mwi-analog-lamp [TelProfile_MWIANalog]	Enables the visual display of message waiting indications (MWI). <ul style="list-style-type: none"> <li>■ [0] <b>Disable</b> (default).</li> <li>■ [1] <b>Enable</b> = Enables visual MWI by supplying line voltage of approximately 100 VDC to activate the phone's lamp.</li> </ul> <b>Note:</b> <ul style="list-style-type: none"> <li>■ The parameter is applicable only to FXS interfaces.</li> <li>■ The corresponding global parameter is MWIANalogLamp.</li> </ul>
'MWI Display' mwi-display [TelProfile_MWIDisplay]	Enables sending MWI information to the phone display. <ul style="list-style-type: none"> <li>■ [0] <b>Disable</b> = (Default) Does not send MWI information to the phone's display.</li> <li>■ [1] <b>Enable</b> = The device generates an MWI message (determined by the CallerIDType parameter), which is displayed on the MWI display.</li> </ul> <b>Note:</b> <ul style="list-style-type: none"> <li>■ The parameter is applicable only to FXS interfaces.</li> <li>■ The corresponding global parameter is MWIDisplay.</li> </ul>
'MWI Notification Timeout' mwi-ntf-timeout	Defines the maximum duration (timeout) that a

Parameter	Description
[TelProfile_ MWINotificationTimeout]	<p>message MWI is displayed on endpoint equipment (phones LED, screen notification or voice tone). When the timeout expires, the MWI is removed. However, each time a new MWI is sent to the endpoint, the timeout restarts its countdown again. For example, assume the timeout is configured to 10 seconds and the timeout has 2 seconds left until the current MWI is removed. If the endpoint now receives a new MWI, the timeout starts counting once again from 10 seconds, displaying both MWIs until the timeout expires.</p> <p>The valid value range is 0 to 2,000,000 seconds, where 0 means unlimited display (default).</p> <p><b>Note:</b></p> <ul style="list-style-type: none"> <li>■ The parameter is applicable only to FXS interfaces.</li> <li>■ The corresponding global parameter is MWINotificationTimeout.</li> </ul>
Analog FXO	
'Two Stage Dial' is-two-stage-dial [TelProfile_IsTwoStageDial]	<p>Defines the dialing mode for IP-to-Tel (FXO) calls.</p> <ul style="list-style-type: none"> <li>■ [0] <b>No</b> = One-stage dialing. In this mode, the device seizes one of the available lines (according to the ChannelSelectMode parameter), and then dials the destination phone number received in the INVITE message. To specify whether the dialing must start after detection of the dial tone or immediately after seizing the line, use the IsWaitForDialTone parameter.</li> <li>■ [1] <b>Yes</b> = (Default) Two-stage dialing. In this mode, the device seizes one of the PSTN/PBX lines without performing any dialing, connects the remote IP user to the PSTN/PBX and all further signaling (dialing and Call Progress Tones) is performed directly with the PBX without the device's intervention.</li> </ul> <p><b>Note:</b></p> <ul style="list-style-type: none"> <li>■ The parameter is applicable only to FXO interfaces.</li> <li>■ The corresponding global parameter is IsTwoStageDial.</li> </ul>
'FXO Double Answer'	Enables the FXO Double Answer feature, which rejects

Parameter	Description
fxo-double-answer [TelProfile_EnableFXODoubleAnswer]	<p>(disconnects) incoming (FXO) Tel-to-IP collect calls and signals (informs) this call denial to the PSTN.</p> <ul style="list-style-type: none"> <li>■ [0] <b>Disable</b> (default)</li> <li>■ [1] <b>Enable</b></li> </ul> <p><b>Note:</b></p> <ul style="list-style-type: none"> <li>■ The parameter is applicable only to FXO interfaces.</li> <li>■ The corresponding global parameter is EnableFXODoubleAnswer.</li> </ul>
'FXO Ring Timeout' fxo-ring-timeout [TelProfile_FXORingTimeout]	<p>Defines the delay (in msec) before the device generates a SIP INVITE (call) to the IP side upon detection of a RING_START event from the Tel (FXO) side. This occurs instead of waiting for a RING_END event.</p> <p>The feature is useful for telephony services that employ constant ringing (i.e., when no RING_END is sent). For example, Ringdown circuit is a service that sends a constant ringing current over the line, instead of cadence-based 2 seconds on, 4 seconds off. For example, when a telephone goes off-hook, a phone at the other end instantly rings.</p> <p>If a RING_END event is received before the timeout expires, the device does not initiate a call and ignores the detected ring. The device ignores RING_END events detected after the timeout expires.</p> <p>The valid value range is 0 to 50 (msec), in steps of 100-msec. For example, a value of 50 represents 5 sec. The default value is 0 (i.e., standard ring operation - the FXO interface sends an INVITE upon receipt of the RING_END event).</p> <p><b>Note:</b></p> <ul style="list-style-type: none"> <li>■ The parameter is applicable only to FXO interfaces.</li> <li>■ If the parameter is configured for a specific FXO port, Caller ID detection does not occur and the RingBeforeCallerID and FXONumberOfRings parameters do not affect the outgoing INVITE for that FXO port.</li> <li>■ The corresponding global parameter is FXORingTimeout.</li> </ul>

Parameter	Description
'Flash Hook Period' flash-hook-period [TelProfile_FlashHookPeriod]	<p>Defines the hook-flash period (in msec) for Tel and IP sides. For the IP side, it defines the hook-flash period reported to the IP. For the analog side, it defines the following:</p> <ul style="list-style-type: none"> <li>■ FXS interfaces:               <ul style="list-style-type: none"> <li>✓ Maximum hook-flash detection period. A longer signal is considered an off-hook or on-hook event.</li> <li>✓ Hook-flash generation period upon detection of a SIP INFO message containing a hook-flash signal.</li> </ul> </li> <li>■ FXO interfaces: Hook-flash generation period.</li> </ul> <p>The valid range is 25 to 3,000. The default is 700.</p> <p><b>Note:</b></p> <ul style="list-style-type: none"> <li>■ The parameter is applicable to FXS and FXO interfaces</li> <li>■ For FXO interfaces, a constant of 100 msec must be added to the required hook-flash period. For example, to generate a 450 msec hook-flash, configure the parameter to 550.</li> <li>■ The corresponding global parameter is FlashHookPeriod.</li> </ul>

## 20 SIP Definitions

This section describes configuration of various SIP-related functionality.

### Configuring Registration Accounts

The Accounts table lets you configure up to 102 Accounts. An Account defines information for registering and authenticating (digest) Trunk Groups (e.g., PBX) or IP Groups (e.g., IP PBX) with a "serving" IP Group (e.g., ITSP).

The device initiates registration with a "serving" IP Group on behalf of the "served" Trunk Group or IP Group. Therefore, Accounts are typically required when the "served" Trunk Group or IP Group is unable to register or authenticate itself for whatever reason. Registration information includes username, password, host name (AOR), and contact user name (AOR). The device includes this information in the REGISTER message sent to the serving IP Group. Up to 10 Accounts can be configured per "served" Trunk Group or IP Group. A Trunk Group or IP Group can register to more than one IP Group (e.g., multiple ITSPs). This is done by configuring multiple entries in the Accounts table for the same served Trunk Group or IP Group, but with different serving IP Groups, username/password, host name, and contact user values.

Authentication is typically required for INVITE messages sent to the "serving" IP Group. If the device receives a SIP 401 (Unauthorized) in response to a sent INVITE, the device checks for a matching "serving" and "served" entry in the Accounts table. If a matching row exists, the device authenticates the INVITE by providing the corresponding MD5 authentication username and password to the "serving" IP Group.

If the Account is not registered and the device receives a SIP dialog request (e.g., INVITE) from the Served IP Group, the device rejects the dialog and sends the Served IP Group a SIP 400 (Bad Request) response. An Account that is not registered can be due to any of the following reasons:

- You have unregistered the Served IP Group by clicking the **Register** button (discussed later in this section).
- The Serving IP Group has rejected the registration.

However, if the Account is not registered and you have enabled the Registrar Stickiness feature ('Registrar Stickiness' parameter is configured to **Enable**) or dynamic UDP port assignment feature ('UDP Port Assignment' parameter is configured to **Enable**) and the device receives a SIP dialog request (e.g., INVITE) from the Served IP Group, the device rejects the dialog and sends the Served IP Group a SIP 500 (Server Internal Error) response. In this scenario, the Account can be not registered due to any of the reasons listed previously or for the dynamic UDP port assignment feature, there is no available port for the Account (port used for interfacing with the Serving IP Group).



- Gateway application: If no match is found in the Accounts table for incoming or outgoing calls, the username and password is taken from:



- ✓ For FXS interfaces: Authentication table (see [Configuring Authentication per Port](#)[Configuring Authentication](#))
- ✓ 'UserName' and 'Password' parameters on the Proxy & Registration page
- The device uses the username and password configured for the Serving IP Group in the IP Groups table for user registration and authentication, in the scenarios listed below. For this mode of operation, the 'Authentication Mode' parameter in the IP Groups table for the Serving IP Group must be configured to **SBC As Client**:
  - ✓ If there is no Account configured for the Served IP Group and Serving IP Group in the Accounts table.
  - ✓ If there is an Account configured for the Served IP Group and Serving IP Group, but without a username and password.
- See also the following optional, related parameters:
  - ✓ [UseRandomUser] - enables the device to assign a random string to the user part of the SIP Contact header of new Accounts.
  - ✓ [UnregisterOnStartup] - enables the device to unregister and then re-register Accounts upon a device reset.
- Gateway application: If all trunks belonging to the Trunk Group are down, the device un-registers them. If any trunk belonging to the Trunk Group returns to service, the device registers them again. This ensures, for example, that the Proxy does not send SIP INVITE messages to trunks that are out of service.
- Gateway application: If registration with an IP Group fails for all Accounts of a specific Trunk Group that includes all the channels in the Trunk Group, the Trunk Group is set to Out-Of-Service if the [OOSOnRegistrationFail] parameter is set to 1 (see [Proxy & Registration Parameters](#)).

The following procedure describes how to configure Accounts through the Web interface. You can also configure it through ini file [Account] or CLI (`configure voip > sip-definition account`).

### ➤ To configure an Account:

1. Open the Accounts table (**Setup** menu > **Signaling & Media** tab > **SIP Definitions** folder > **Accounts**).
2. Click **New**; the following dialog box appears:

GENERAL	CREDENTIALS
Index	1
Name	
Served Trunk Group	-1
Application Type	GW
Served IP Group	..
Serving IP Group	..
Host Name	
Contact User	
Register	No
Registrar Stickiness	Disable
Registrar Search Mode	Current Working Server
Re-Register on Invite Failure	Disable
	User Name
	Password

3. Configure an account according to the parameters described in the table below.
4. Click **Apply**.

Once you have configured Accounts, you can register or un-register them, as described below:

➤ **To register or un-register an Account:**

1. In the table, select the required Account entry row.
2. From the **Action** drop-down list, choose one of the following commands:
  - **Register** to register the Account.
  - **Un-Register** to un-register the Account.

To view Account registration status, see [Viewing Registration Status](#).

**Table 20-1: Accounts Table Parameter Descriptions**

Parameter	Description
General	
'Index'	Defines an index for the new table row. <b>Note:</b> Each row must be configured with a unique index.
'Name' account-name [Account_AccountName]	Defines an arbitrary name to easily identify the row. The valid value is a string of up to 20 characters. <b>Note:</b> Each row must be configured with a unique name.
'Served Trunk Group' served-trunk-group [Account_ServedTrunkGroup]	Defines the Trunk Group that you want to register and/or authenticate. <ul style="list-style-type: none"> <li>■ For Tel-to-IP calls, the served Trunk Group is the source Trunk Group from where the call originated.</li> <li>■ For IP-to-Tel calls, the served Trunk Group is the Trunk Group to where the call is sent.</li> </ul> <b>Note:</b> The parameter is applicable only to the Gateway application.
'Application Type' application-type [Account_ApplicationType]	Defines the application type: <ul style="list-style-type: none"> <li>■ [0] <b>GW</b> = (Default) Gateway application.</li> <li>■ [2] <b>SBC</b> = SBC application.</li> </ul>
'Served IP Group' served-ip-group-name [Account_ServedIPGroupName]	Defines the IP Group (e.g., IP-PBX) that you want to register and/or authenticate upon its behalf. <b>Note:</b> <ul style="list-style-type: none"> <li>■ The parameter is applicable only to the SBC application.</li> </ul>

Parameter	Description
	<ul style="list-style-type: none"> <li>■ By default, all IP Groups are displayed. However, if you filter the Web display by SRD (using the SRD Filter box), only IP Groups associated with the filtered SRD are displayed.</li> <li>■ The parameter is mandatory.</li> </ul>
<p>'Serving IP Group'</p> <p><code>serving-ip-group-name</code></p> <p>[Account_ServingIPGroupName]</p>	<p>Defines the IP Group (<i>Serving IP Group</i>) to where the device sends the SIP REGISTER requests (if enabled) for registration and authentication (of the Served IP Group).</p> <p>For the Gateway application:</p> <ul style="list-style-type: none"> <li>■ Tel-to-IP calls: The serving IP Group is the destination IP Group configured in the Trunk Group Settings table or Tel-to-IP Routing table (see <a href="#">Configuring Tel-to-IP Routing Rules</a>).</li> <li>■ IP-to-Tel calls: The serving IP Group is the 'Source IP Group ID' configured in the IP-to-Tel Routing table (see <a href="#">Configuring IP-to-Tel Routing Rules</a>).</li> </ul> <p><b>Note:</b></p> <ul style="list-style-type: none"> <li>■ By default, only IP Groups associated with the SRD to which the Served IP Group is associated are displayed, as well as IP Groups of Shared SRDs. However, if you filter the Web display by SRD (using the SRD Filter box), only IP Groups associated with the filtered SRD are displayed, as well as IP Groups of Shared SRDs.</li> <li>■ (Gateway application only) If the Serving IP Group is associated with Proxy Set #0, you must configure the [IsProxyUsed] parameter to [1].</li> <li>■ The parameter is mandatory.</li> </ul>
<p>'Host Name'</p> <p><code>host-name</code></p> <p>[Account_HostName]</p>	<p>Defines the Address of Record (AOR) host name. The host name appears in SIP REGISTER From/To headers as ContactUser@HostName. For a successful registration, the host name is also included in the URI of the INVITE From header.</p> <p>The valid value is a string of up to 49 characters.</p> <p><b>Note:</b> If the parameter is not configured or if registration fails, the 'SIP Group Name' parameter value configured in the IP Groups table is used instead.</p>



Parameter	Description
'Contact User' contact-user [Account_ContactUser]	<p>Defines the AOR username. This appears in REGISTER From/To headers as ContactUser@HostName, and in INVITE/200 OK Contact headers as ContactUser@&lt;device's IP address&gt;.</p> <p>The valid value is a string of up to 60 characters. By default, no value is defined.</p> <p><b>Note:</b></p> <ul style="list-style-type: none"> <li>■ If the parameter is not configured, the 'Contact User' parameter in the IP Groups table is used instead.</li> <li>■ If registration fails, the user part in the INVITE Contact header contains the source party number.</li> </ul>
'Register' register [Account_Register]	<p>Enables registration.</p> <ul style="list-style-type: none"> <li>■ [0] <b>No</b> = (Default) The device only performs authentication (not registration). Authentication is typically done for INVITE messages sent to the "serving" IP Group. If the device receives a SIP 401 (Unauthorized) in response to a sent INVITE, the device checks for a matching "serving" and "served" entry in the table. If a matching row exists, the device authenticates the INVITE by providing the corresponding MD5 authentication username and password to the "serving" IP Group.</li> <li>■ [1] <b>Regular</b> = The device performs regular registration. For more information, see <a href="#">Regular Registration Mode</a>.</li> <li>■ [2] <b>GIN</b> = The device performs registration for legacy PBXs, using Global Identification Number (GIN). For more information, see <a href="#">Single Registration for Multiple Phone Numbers using GIN</a>.</li> </ul> <p><b>Note:</b></p> <ul style="list-style-type: none"> <li>■ Gateway application: To enable registration, you also need to configure the 'Registration Mode' parameter to <b>Per Account</b> in the Trunk Group Settings table (see <a href="#">Configuring Trunk Group Settings</a>).</li> <li>■ Account registration is not affected by the [IsRegisterNeeded] parameter.</li> </ul>

Parameter	Description
<p>'Registrar Stickiness'</p> <p>registrar-stickiness</p> <p>[Account_RegistrarStickiness]</p>	<p>Enables the Registrar Stickiness feature.</p> <ul style="list-style-type: none"> <li data-bbox="715 342 1394 808">■ [0] <b>Disable</b> = (Default) Disables the Registrar Stickiness feature. After a successful initial registration of the Account with a registrar (IP address), whenever the device receives a SIP request or registration refresh, the device sends the request to whichever IP address is the currently working registrar. In other words, there is no binding to a specific IP address in the Proxy Set and at any given time, requests may be sent to a different IP address, whichever is the working one. In the case of proxy load-balancing, there is no certainty as to which IP address in the Proxy Set the request is routed.</li> <li data-bbox="715 842 1394 1384">■ [1] <b>Enable</b> = Enables the Register Stickiness feature. The device always routes SIP requests of a registered Account to the same registrar server to where the last successful REGISTER request was routed. In other words, once initial registration of the Account to one of the IP addresses in the Proxy Set (associated with the Account's Serving IP Group) is successful (i.e., 200 OK), binding ("stickiness") occurs to this specific address (registrar). All future SIP requests (e.g., INVITEs, SUBSCRIBEs and REGISTER refreshes) whose source and destination match the Account are sent to this registrar only. This applies until the registrar is unreachable or registration refresh fails, for whatever reason</li> <li data-bbox="715 1417 1394 1921">■ [2] <b>Enable for Non-REGISTER Requests</b> = Enables the Register Stickiness feature, as described for the <b>Enable</b> option (above), except for refresh REGISTER messages. When the device initiates a refresh REGISTER message for the Account, it restarts the registration process for the Account, sending the message to one of the registrar servers according to the Proxy Set of the Account's Serving IP Group. This option can used, for example, in scenarios where proxy keep-alive is disabled (see the 'Proxy Keep-Alive' parameter in the Proxy Sets table) and restart of registration for refresh REGISTERs is always preferred.</li> </ul> <p><b>Note:</b> The parameter is applicable only if you have</p>

Parameter	Description
	enabled Account registration ('Register' parameter configured to <b>Regular</b> or <b>GIN</b> ).
'Registrar Search Mode' registrar-search-mode [Account_RegistrarSearchMode]	<p>Defines the method for choosing an IP address (registrar) in the Proxy Set (associated with the Serving IP Group) to which the Account initially registers and performs registration refreshes, when the Register Stickiness feature is enabled. Once chosen, the Account is binded to the IP address for subsequent SIP requests.</p> <ul style="list-style-type: none"> <li>■ [0] <b>Current Working Server</b> = (Default) For each initial and refresh registration request, the device routes to the currently working server in the list of IP addresses (configured or DNS-resolved IP addresses) in the Proxy Set. In the case of proxy load-balancing, the chosen IP address is according to the load-balancing mechanism.</li> <li>■ [1] <b>According to IMS Specifications</b> = For the initial registration request, the device performs DNS resolution if the address of the Proxy Set is configured as an FQDN. It then attempts to register to one of the listed DNS-resolved addresses (or configured IP addresses), starting with the first listed address and then going down the list sequentially. If an address results in an unsuccessful registration, the device immediately tries the next address (without waiting any retry timeout). The device goes through the list of addresses until an address results in a successful registration. If registration is unsuccessful for all addresses, the device waits a configured retry time and then goes through the list again. Once initial registration is successful, periodic registration refreshes are performed as usual. In addition to the periodic refreshes, immediate register refreshes are done upon the following triggers according to the IMS specification:             <ul style="list-style-type: none"> <li>✓ The device receives a SIP 408, 480, or 403 response from the Serving IP Group in response to an INVITE.</li> <li>✓ The transaction timeout expires for an INVITE sent to the Serving IP Group.</li> <li>✓ The device receives an INVITE from the Serving</li> </ul> </li> </ul>

Parameter	Description
	<p>IP Group from an IP address other than the address to which it is currently registered. In this case, it also rejects the INVITE with a SIP 480 response.</p> <p>If the device's physical Ethernet link to the proxy goes down, the device re-registers this Account with the proxy when the link comes up again. Re-registration occurs even if proxy keep-alive is disabled.</p> <p><b>Note:</b> The parameter is applicable only if you have enabled the Registrar Stickiness feature (in this table):</p> <ul style="list-style-type: none"> <li>■ 'Register' parameter to <b>Regular</b> or <b>GIN</b>.</li> <li>■ 'Registrar Stickiness' parameter to <b>Enable</b> or <b>Enable for Non-REGISTER Requests</b>.</li> </ul>
<p>'Re-REGISTER on INVITE Failure'</p> <p><code>re-register-on- invite-failure</code></p> <p>[Account_ ReRegisterOnInviteFailure]</p>	<p>Enables the device to re-register an Account upon the receipt of specific SIP response codes (e.g., 403, 408, and 480) for a failed INVITE message sent to the Serving IP Group.</p> <ul style="list-style-type: none"> <li>■ [0] <b>Disable</b> = (Default) If the device receives a SIP response for a failed INVITE message, the device does not re-register the Account.</li> <li>■ [1] <b>Enable</b> = If the device receives a SIP response for a failed INVITE message and the response code is configured in the global parameter, <code>AccountInviteFailureTriggerCodes</code>, the device re-registers the Account according to the settings of the Proxy Set associated with the Account's Serving IP Group. Note that if the Proxy Set's 'Proxy Hot Swap' parameter is configured to <b>Enable</b> and the 'Proxy Keep-Alive' parameter to <b>Using OPTIONS, Using OPTIONS on Active Server, or Using REGISTER</b>, then the registrar at which the INVITE failed is tried last in the list of servers in the Proxy Set.</li> </ul>
<p>'Reg Event Package Subscription'</p> <p><code>reg-event-package- subscription</code></p> <p>[Account_ RegEventPackageSubscription]</p>	<p>Enables the device to subscribe to the registration event package service (as defined in RFC 3680) with the registrar server (Serving IP Group) to which the Account is successfully registered and bound, when the Registrar Stickiness feature is enabled. The service allows the device to receive notifications of the</p>

Parameter	Description
	<p>Accounts registration state change with the registrar. The device subscribes to the service by sending a SUBSCRIBE message containing the Event header with the value "reg" (Event: reg). Whenever a change occurs in the registration binding state, the registrar notifies the device by sending a SIP NOTIFY message.</p> <ul style="list-style-type: none"> <li>■ [0] <b>Disable</b> (default)</li> <li>■ [1] <b>Enable</b></li> </ul> <p><b>Note:</b> The parameter is applicable only if you have enabled the Registrar Stickiness feature (in this table):</p> <ul style="list-style-type: none"> <li>■ 'Registrar' parameter to <b>Regular</b> or <b>GIN</b>.</li> <li>■ 'Registrar Stickiness' parameter to <b>Enable</b>.</li> </ul>
<p>'Register by Served IP Group Status'  reg-by-served-ipg-status  [Account_RegByServedIPG]</p>	<p>Defines the device's handling of Account registration based on the connectivity status of the Served IP Group.</p> <ul style="list-style-type: none"> <li>■ [0] <b>Register Always</b> = (Default) Account registration by the device does not depend on the connectivity status of the Served IP Group. The device sends registration requests to the Serving IP Group even if the Served IP Group is offline.</li> <li>■ [1] <b>Register Only if Online</b> = The device performs Account registration depending on the connectivity status of the Served IP Group. It sends a registration request to the Serving IP Group only if the Served IP Group is online. If the Served IP Group was registered, but then goes offline, the device unregisters it. If it becomes online again, the device re-registers it. This option is applicable only to Accounts where registration is initiated by the device (i.e., the 'Register' parameter is configured to any value other than <b>No</b>).</li> </ul> <p>The Served IP Group's connectivity status is determined by the keep-alive mechanism of its associated Proxy Set (i.e., the 'Proxy Keep-Alive' parameter is configured to <b>Using OPTIONS</b> or <b>Using OPTIONS on Active Server</b>).</p> <p><b>Note:</b> The parameter is applicable only to the SBC application.</p>

Parameter	Description
'UDP Port Assignment' udp-port-assignment [Account_ UDPPortAssignment]	<p>Enables the device to dynamically allocate local SIP UDP ports to Accounts using the same Serving IP Group, where each Account is assigned a unique port on the device's leg interfacing with the Accounts' Serving IP Group.</p> <ul style="list-style-type: none"> <li>■ [0] <b>Disable</b> = (Default) The device uses the same specific UDP port for all registrations done for this Account (traffic between the device and the Serving IP Group). This port is the one configured for the SIP Interface ('UDP Port' parameter - SIPInterface_UDPPort) that is associated with the Proxy Set of the Account's Serving IP Group.</li> <li>■ [1] <b>Enable</b> = The device assigns a unique local port for each Account for which the device initiates registration. The port is taken from a configured UDP port range. The port range is configured for the SIP Interface ('Additional UDP Ports' parameter - SIPInterface_AdditionalUDPPorts) associated with the Proxy Set of the Account's Serving IP Group. Traffic between the Serving IP Group and device is sent from and received on the assigned unique local port. If enabled for other Accounts that are configured with the same Serving IP Group, each Account is allocated a unique UDP port from the port range. For example, if you have configured two Accounts, "PBX-1" and "PBX-2", the device could assign port 6000 to "PBX-1" and 6100 to "PBX-2".</li> </ul> <p><b>Note:</b></p> <ul style="list-style-type: none"> <li>■ The parameter is applicable only to the SBC application.</li> <li>■ If you enable the parameter, you must also enable the device to initiate registration for the Account (i.e., configure the 'Register' parameter to any value other than <b>No</b>).</li> <li>■ If the device fails to allocate a port (e.g., insufficient ports), the device does not send the SIP REGISTER request, but tries again within a period configured by the RegistrationRetryTime and MaxRegistrationBackoffTime parameters.</li> <li>■ If the device receives a SIP request from the Serving</li> </ul>

Parameter	Description
	<p>IP Group for the Account, on a port that was not assigned to the Account, it rejects the request (with a SIP 404 Not Found response).</p> <ul style="list-style-type: none"> <li>■ If the device receives a SIP request from the Served IP Group and the Account has not been allocated a valid port, the device rejects the request (with a SIP 500 Server Internal Error response).</li> <li>■ For more information on configuring the SIP Interface's port range, see <a href="#">Configuring SIP Interfaces</a> on page 415.</li> </ul>
Credentials	
'User Name' <code>user-name</code> [Account_Username]	Defines the digest MD5 Authentication username. The valid value is a string of up to 60 characters. By default, no value is defined.
'Password' <code>password</code> [Account_Password]	Defines the digest MD5 Authentication password. The valid value is a string of up to 50 characters. <b>Note:</b> The password cannot be configured with wide characters.

## Regular Registration Mode

When you configure the registration mode ('Register') in the Accounts table to **Regular**, the device sends REGISTER requests to the Serving IP Group. The host name (in the SIP From/To headers) and contact user (user in From/To and Contact headers) are taken from the configured Accounts table upon successful registration. See the example below:

```
REGISTER sip:xyz SIP/2.0
Via: SIP/2.0/UDP 10.33.37.78;branch=z9hG4bKac1397582418
From: <sip:ContactUser@HostName>;tag=1c1397576231
To: <sip: ContactUser@HostName >
Call-ID: 1397568957261200022256@10.33.37.78
CSeq: 1 REGISTER
Contact: <sip:ContactUser@10.33.37.78>;expires=3600
Expires: 3600
User-Agent: Sip-Gateway/7.20A.260.005
Content-Length: 0
```

## Single Registration for Multiple Phone Numbers using GIN

When you configure the registration mode in the Accounts table to **GIN**, the Global Identifiable Number (GIN) registration method is used, according to RFC 6140. The device performs GIN-based registration of users to a SIP registrar on behalf of a SIP PBX. In effect, the PBX registers with the service provider, just as a directly hosted SIP endpoint would register. However, because a PBX has multiple user agents, it needs to register a contact address on behalf of each of these. Rather than performing a separate registration procedure for each user agents, GIN registration mode does multiple registrations using a single REGISTER transaction.

According to this mechanism, the PBX delivers to the service provider in the Contact header field of a REGISTER request a template from which the service provider can construct contact URIs for each of the AORs assigned to the PBX and thus, can register these contact URIs within its location service. These registered contact URIs can then be used to deliver to the PBX inbound requests targeted at the AORs concerned. The mechanism can be used with AORs comprising SIP URIs based on global E.164 numbers and the service provider's domain name or sub-domain name.

The SIP REGISTER request sent by the device for GIN registration with a SIP server provider contains the Require and Proxy-Require headers. These headers contain the token 'gin'. The Supported header contains the token 'path' and the URI in the Contact header contains the parameter 'bnc' without a user part:

```
Contact: <sip:198.51.100.3;bnc>;
```

The figure below illustrates the GIN registration process:

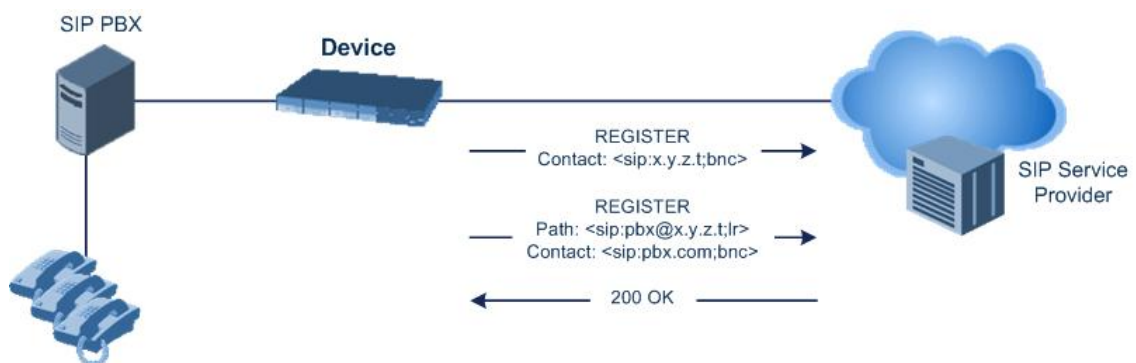

The figure below illustrates an incoming call using GIN:



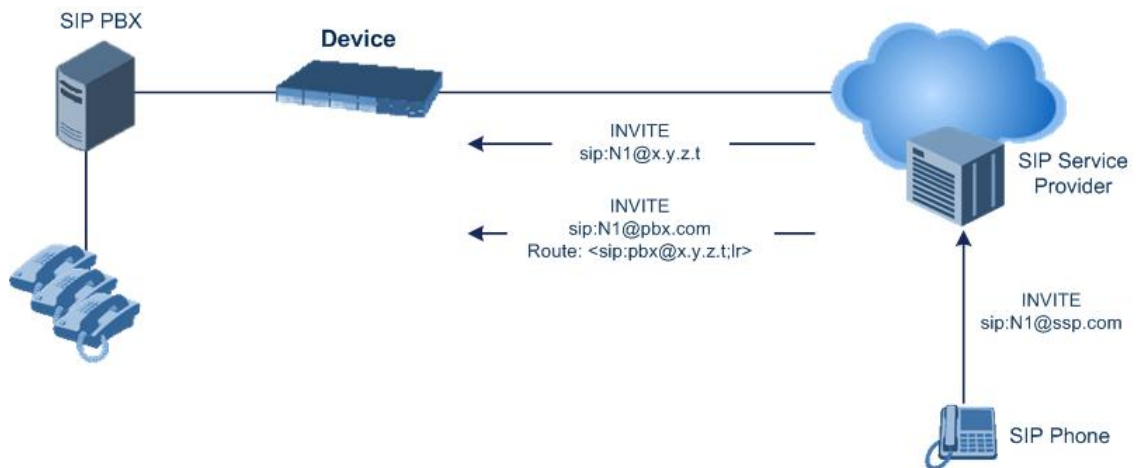

## Registrar Stickiness

You can enable the Registrar Stickiness feature per Account. Registrar Stickiness binds an Account to one of the IP addresses (configured or DNS-resolved) in the Proxy Set associated with the Serving IP Group. Once an Account registers successfully to one of the IP addresses (i.e., SIP registrar server) in the Proxy Set, the device routes all subsequent SIP requests (INVITEs, SUBSCRIBEs and REGISTER refreshes) of the Account to this registrar. This applies until the registrar is unreachable or registration refresh fails, for whatever reason.

To configure the Registrar Stickiness feature, use the following parameters in the Accounts table:

- Registrar Stickiness: Enables the feature.
- Registrar Search Mode: Defines the method for choosing an IP address (registrar) in the Proxy Set to which the Account initially registers and performs registration refreshes. Once chosen, the Account is binded to this registrar.
- Reg Event Package Subscription: Enables the device to subscribe to the registration event package service (as defined in RFC 3680) with the registrar to which the Account is registered and binded. The service allows the device to receive notifications of the Accounts registration state change with the registrar.

## Configuring Proxy and Registration Parameters

The Proxy & Registration page allows you to configure the Proxy server and registration parameters. For a description of the parameters appearing on this page, see [Configuration Parameters Reference](#). To configure Proxy servers (Proxy Sets), see [Configuring Proxy Sets](#).



To view the registration status of endpoints with a SIP Registrar/Proxy server, see [Viewing Registration Status](#).

➤ **To configure the Proxy and registration parameters:**

1. Open the Proxy & Registration page (**Setup** menu > **Signaling & Media** tab > **SIP Definitions** folder > **Proxy & Registration**).
2. Configure the parameters as required.
3. Click **Apply**.

➤ **To register or un-register the device to a Proxy/Registrar:**

- Click the **Register** button to register.
- Click **Un-Register** button to un-register.

Instead of registering the entire device, you can register specific entities as listed below by using the **Register** button located on the page in which these entities are configured:

- FXS endpoints, FXO endpoints, BRI endpoints, Trunk Groups - Trunk Group table (see [Configuring Trunk Groups](#))
- Accounts - Accounts table (see [Configuring Registration Accounts](#))

## SIP Message Authentication Example

The device supports basic and digest (MD5) authentication types, according to SIP RFC 3261. A proxy server might require authentication before forwarding an INVITE message. A Registrar/Proxy server may also require authentication for client registration. A proxy replies to an unauthenticated INVITE with a 407 Proxy Authorization Required response, containing a Proxy-Authenticate header with the form of the challenge. After sending an ACK for the 407, the user agent can then re-send the INVITE with a Proxy-Authorization header containing the credentials.

User agents, Redirect or Registrar servers typically use the SIP 401 Unauthorized response to challenge authentication containing a WWW-Authenticate header, and expect the re-INVITE to contain an Authorization header.

The following example shows the Digest Authentication procedure, including computation of user agent credentials:

1. The REGISTER request is sent to a Registrar/Proxy server for registration:

```
REGISTER sip:10.2.2.222 SIP/2.0
Via: SIP/2.0/UDP 10.1.1.200
From: <sip:122@10.1.1.200>;tag=1c17940
To: <sip:122@10.1.1.200>
Call-ID: 634293194@10.1.1.200

CSeq: 1 REGISTER
Contact: sip:122@10.1.1.200:
Expires:3600
```

2. Upon receipt of this request, the Registrar/Proxy returns a 401 Unauthorized response:

```
SIP/2.0 401 Unauthorized
Via: SIP/2.0/UDP 10.2.1.200
From: <sip:122@10.2.2.222 >;tag=1c17940
To: <sip:122@10.2.2.222 >
Call-ID: 634293194@10.1.1.200
Cseq: 1 REGISTER
Date: Mon, 30 Jul 2012 15:33:54 GMT
Server: Columbia-SIP-Server/1.17
Content-Length: 0
```

```
WWW-Authenticate: Digest realm="AudioCodes.com",
nonce="11432d6bce58ddf02e3b5e1c77c010d2",
stale=FALSE,
algorithm=MD5
```

3. According to the sub-header present in the WWW-Authenticate header, the correct REGISTER request is created.
4. Since the algorithm is MD5:
  - The username is equal to the endpoint phone number "122".
  - The realm return by the proxy is "AudioCodes.com".
  - The password from the *ini* file is "AudioCodes".
  - The equation to be evaluated is "122:AudioCodes.com:AudioCodes". According to the RFC, this part is called A1.
  - The MD5 algorithm is run on this equation and stored for future usage.
  - The result is "a8f17d4b41ab8dab6c95d3c14e34a9e1".
5. The par called A2 needs to be evaluated:
  - The method type is "REGISTER".
  - Using SIP protocol "sip".
  - Proxy IP from *ini* file is "10.2.2.222".
  - The equation to be evaluated is "REGISTER:sip:10.2.2.222".
  - The MD5 algorithm is run on this equation and stored for future usage.
  - The result is "a9a031cfdccb10d91c8e7b4926086f7e".
6. Final stage:
  - A1 result: The nonce from the proxy response is "11432d6bce58ddf02e3b5e1c77c010d2".

- A2 result: The equation to be evaluated is "A1:11432d6bce58dd-f02e3b5e1c77c010d2:A2".
- The MD5 algorithm is run on this equation. The outcome of the calculation is the response needed by the device to register with the Proxy.
- The response is "b9c45d0234a5abf5ddf5c704029b38cf".

At this time, a new REGISTER request is issued with the following response:

```
REGISTER sip:10.2.2.222 SIP/2.0
Via: SIP/2.0/UDP 10.1.1.200
From: <sip: 122@10.1.1.200>;tag=1c23940
To: <sip: 122@10.1.1.200>
Call-ID: 654982194@10.1.1.200
```

```
CSeq: 1 REGISTER
Contact: sip:122@10.1.1.200:
Expires:3600
```

```
Authorization: Digest, username: 122,
realm="AudioCodes.com",
nonce="11432d6bce58ddf02e3b5e1c77c010d2",
uri="10.2.2.222",
response="b9c45d0234a5abf5ddf5c704029b38cf"
```

7. Upon receiving this request and if accepted by the Proxy, the Proxy returns a 200 OK response, completing the registration transaction:

```
SIP/2.0 200 OK
Via: SIP/2.0/UDP 10.1.1.200
From: <sip: 122@10.1.1.200>;tag=1c23940
To: <sip: 122@10.1.1.200>
Call-ID: 654982194@10.1.1.200
Cseq: 1 REGISTER
Date: Thu, 26 Jul 2012 09:34:42 GMT
Server: Columbia-SIP-Server/1.17
Content-Length: 0
```

```
Contact: <sip:122@10.1.1.200>; expires="Thu, 26 Jul 2012 10:34:42 GMT";
action=proxy; q=1.00
```

```
Contact: <122@10.1.1.200:>; expires="Tue, 19 Jan 2038 03:14:07 GMT";
action=proxy; q=0.00
```

Expires: Thu, 26 Jul 2012 10:34:42 GMT

## Configuring User Information

This section describes User Information configuration.

### Enabling the User Information Table

Before you can use the User Information table, you need to enable the User Information functionality.

#### ➤ To enable User Information functionality:

1. Make sure that your device's License Key includes the far-end user license ("Far End Users"), which specifies the maximum number of supported users. To view the License Key, see [Viewing the License Key](#).
2. Open the Proxy & Registration page (**Setup** menu > **Signaling & Media** tab > **SIP Definitions** folder > **Proxy & Registration**).
3. From the 'User-Information Usage' drop-down list [EnableUserInfoUsage], select **Enable**:

User-Information Usage • Enable  

4. Reset the device with a save-to-flash for your settings to take effect; the User Information table now becomes available in the Web interface.

### Gateway User Information for PBX Extensions and "Global" Numbers

The User Information table contains information of Gateway users, which can be used for the following Gateway-related features:

- **Mapping (Manipulating) PBX Extension Numbers with Global Phone Numbers:** maps PBX extension number, connected to the device, with any "global" phone number (alphanumeric) for the IP side. In this context, the "global" phone number serves as a routing identifier for calls in the "IP world" and the PBX extension uses this mapping to emulate the behavior of an IP phone. This feature is especially useful in scenarios where unique or non-consecutive number translation per PBX is needed. This number manipulation feature supports the following call directions:

- **IP-to-Tel Calls:** Maps the called "global" number (in the Request-URI user part) to the PBX extension number. For example, if the device receives an IP call destined for "global" number 638002, it changes this called number to the PBX extension number 402, and then sends the call to the PBX extension on the Tel side.



If you have configured regular IP-to-Tel manipulation rules (see [Configuring Source/Destination Number Manipulation](#)), the device applies these rules before



applying the mapping rules of the User Information table.

- **Tel-to-IP Calls:** Maps the calling (source) PBX extension to the "global" number. For example, if the device receives a Tel call from PBX extension 402, it changes this calling number to 638002, and then sends call to the IP side with this calling number. In addition to the "global" phone number, the display name (caller ID) configured for the PBX user in the User Information table is used in the SIP From header.



If you have configured regular Tel-to-IP manipulation rules (see [Configuring Source/Destination Number Manipulation](#)), the device applies these rules before applying the mapping rules of the User Information table.

- **Registering Users:** The device can register each PBX user configured in the User Information table. For each user, the device sends a SIP REGISTER to an external IP-based Registrar server, using the "global" number in the From/To headers. If authentication is necessary for registration, the device sends the user's username and password, configured in the User Information table, in the SIP MD5 Authorization header.

You can configure up to 1,000 mapping rules in the User Information table. These rules can be configured using any of the following methods:

- Web interface - see [Configuring GW User Info Table through Web Interface](#)
- CLI - see [Configuring GW User Info Table through CLI](#)
- Loadable User Information file - see [Configuring GW User Info Table in Loadable Text File](#)



- This section is applicable only to the Gateway application.
- To enable user registration, configure the following parameters:
  - ✓ 'Enable Registration': **Enable** (or [IsRegisterNeeded] set to 1).
  - ✓ 'Authentication Mode': **Per Endpoint** (or [AuthenticationMode] set to 0).
- For FXS ports, when the device needs to send a new SIP request with the Authorization header (e.g., after receiving a SIP 401 response), it uses the username and password configured in the Authentication table (see [Configuring Authentication per Port](#)). To use the username and password that are configured in the User Information table, configure the 'Password' parameter to any value other than its default value.

## Configuring Gateway User Information Table through Web Interface

You can configure the User Information table through the Web interface. The table allows you to do the following:

- Manually add users (described below).
- Import users from a file: From the **Action** drop-down list, choose **Import**.



- When you import a file, all previously configured entries in the table are deleted and replaced with the users from the imported file.
- For configuring users in a file for import, see [Configuring GW User Info Table in Loadable Text File](#).

- Export the configured users to a .csv file: From the **Action** drop-down list, choose **Export** and save the file to a folder on your computer.
- Register and un-register users:
  - To register a user, select the user, and then from the **Action** drop-down list, choose **Register**.
  - To un-register a user, select the user, and then from the **Action** drop-down list, choose **Un-Register**.



To configure the User Information table, make sure that you have enabled the feature (see [Enabling the User Info Table](#)).

The following procedure describes how to configure and register users in the User Information table through the Web interface.

➤ **To configure the User Information table through the Web interface:**

1. Open the User Information table (**Setup** menu > **Signaling & Media** tab > **Gateway** folder > **User Information**).
2. Click **New**; the following dialog box appears:

The screenshot shows a web interface window titled "User Information". Inside, there is a "GENERAL" tab. Below the tab, there are several input fields: "Index" with the value "0", "PBX Extension", "Global Phone Number", "Display Name", "Username", "Password", and "Status".

3. Configure a user according to the table below.
4. Click **Apply**.

**Table 20-2: User Information Table Parameter Descriptions**

Parameter	Description
'Index'	Defines an index number for the new

Parameter	Description
[GWUserInfoTable_Index]	table row. <b>Note:</b> Each row must be configured with a unique index.
'PBX Extension' [GWUserInfoTable_PBXExtension]	Defines the PBX extension number. The valid value is a string of up to 10 characters. <b>Note:</b> The parameter is mandatory.
'Global Phone Number' [GWUserInfoTable_GlobalPhoneNumber]	Defines the "global" phone number for the IP side. The valid value is a string of up to 20 characters. <b>Note:</b> The parameter is mandatory.
'Display Name' [GWUserInfoTable_DisplayName]	Defines the Caller ID of the PBX extension. The valid value is a string of up to 30 characters.
'Username' [GWUserInfoTable_Username]	Defines the username for registering the user when authentication is necessary. The valid value is a string of up to 60 characters. By default, no value is defined.
'Password' [GWUserInfoTable_Password]	Defines the password for registering the user when authentication is necessary. The valid value is a string of up to 20 characters. <b>Note:</b> The password cannot be configured with wide characters.
'Status'	(Read-only field) Displays the status of the user:  ■ "Registered"  ■ "Not Registered"

### Configuring Gateway User Information Table through CLI

The User Information table can be configured through CLI using the following commands:

- To add or modify a user (example):



```
# configure voip
(config-voip)# sip-definition proxy-and-registration
(sip-def-proxy-and-reg)# user-info gw-user-info <index, e.g., 1>
(gw-user-info-1)# username JohnDee
(gw-user-info-1)# <activate | exit>
```

- To delete a specific user, use the no command:

```
# configure voip
(config-voip)# sip-definition proxy-and-registration
(sip-def-proxy-and-reg)# no user-info gw-user-info <index, e.g., 1>
```

- To import users from a file:

```
# configure voip
(config-voip)# sip-definition proxy-and-registration
(sip-def-proxy-and-reg)# user-info gw-user-info import-csv-from <URL>
```

- To export users to a .csv file:

```
# configure voip
(config-voip)# sip-definition proxy-and-registration
(sip-def-proxy-and-reg)# user-info gw-user-info export-csv-to <URL>
```

- To view all table entries:

```
(sip-def-proxy-and-reg)# user-info gw-user-info display
---- gw-user-info-0 ----
pbx-ext (405)
global-phone-num (405)
display-name (Ext405)
username (user405)
password (0aGzoKfh5ul=)
status (not-resgistered)
```

- To view a specific entry (example):

```
(sip-def-proxy-and-reg)# user-info gw-user-info <index, e.g., 0>
(gw-user-info-0)# display
pbx-ext (405)
global-phone-num (405)
display-name (Ext405)
username (user405)
```

```
password (0aGzoKfh5ul=)
status (not-resgistered)
```

- To search a user by pbx-ext:

```
(sip-def-proxy-and-reg)# user-info find <pbx-ext e.g., 405>
405: Found at index 0 in GW user info table, not registered
```



To configure the User Information table, make sure that you have enabled the feature (see [Enabling the User Info Table](#)).

### Configuring Gateway User Information Table from a Loadable File

You can configure users in a file and then load (import) it to the User Information table. The users must be configured in comma-separated value (CSV) file format. You can create the file using any standard text-based editor such as Notepad, or alternatively a CSV-based program such as Microsoft Excel. The file can have any filename extension (e.g., .csv or .txt).



When you import a file, all previously configured entries in the table are deleted and replaced with the users from the imported file.

When adding users to the file, use the following syntax:

- For text-based editors:

```
PBXExtension,GlobalPhoneNumber,DisplayName,Username>Password
```

For example:

```
PBXExtension,GlobalPhoneNumber,DisplayName,Username>Password
4040,7362400,John,johnd,2798
4041,7362401,Sue,suep,1234
```

- For CSV-based programs:

```
PBXExtension,GlobalPhoneNumber,DisplayName,Username>Password
```

For example:

A	B	C	D	E
PBXExtension	GlobalPhoneNumber	DisplayName	Username	Password
4040	73682400	John	johnd	1234
4041	73682401	Sue	suep	2224

You can load the User Information file using any of the following methods:

- Web interface - User Information table (see [Configuring Gateway User Information Table through Web Interface](#) on page 600)
- CLI - `gateway user-info-table import-csv-from` (see [Configuring Gateway User Information Table through CLI](#) on page 602)
- Automatic Update mechanism - `[GWUserInfoFileUrl]` parameter



For **backward compatibility only**, load the User Information file using the Auxiliary Files page. Configure users with the following syntax:

```
[GW]
```

```
FORMAT PBXExtensionNum,GlobalPhoneNum,DisplayName,UserName,Password
```

For example:

```
[GW]
```

```
FORMAT PBXExtensionNum,GlobalPhoneNum,DisplayName,UserName,Password
```

```
4040,7362400,John,johnd,2798
```

```
4041,7362401,Sue,suep,1234
```

Make sure that the last line in the file ends with a carriage return (i.e., press the Enter key).

When you load the file, the device automatically populates the User Information table with the file's contents and deletes all previous entries in the table.

## Configuring SBC User Information

The User Information table lets you configure up to 800SBC users. You can use the table for the following:

- Registering each user to an external registrar server.
- Authenticating (for any SIP request and as a client) each user if challenged by an external server.
- Authenticating as a server incoming user requests (for SBC security).

If the device registers on behalf of users and the users do not perform registration, any SIP request destined to the user is routed to the Proxy Set associated with the user's IP Group.

The User Information table can be configured using any of the following methods:

- Web interface (see [Configuring SBC User Info Table through Web Interface](#))
- CLI (see [Configuring SBC User Info Table through CLI](#))
- Loadable User Information file (see [Configuring SBC User Info Table in Loadable Text File](#))



- For the SBC User Information feature, the device's License Key must include the license "Far End Users (FEU)", which specifies the maximum number of supported far-end users. If no far-end users are licensed, then this feature cannot be used.
- If you configure the device to authenticate as a server the incoming SIP requests from users of a specific User-type IP Group, the device authenticates the users, using the username and password configured in the IP Group's 'Username' and 'Password' parameters. However, if the user appears in the User Information table and configured with a username and/or password, then the device authenticates the user with the credentials in the table. To enable the device to authenticate as a server, configure the IP Group's 'Authentication Mode' parameter to **SBC as Server**.
- The maximum number of available rows (users) that you can add in the User Information table is according to the number of far-end users ("Far End Users") that is specified in the device's License Key. However, the number of licensed users cannot exceed the maximum rows supported by the device, as stated in the beginning of this section. As an example and for simplicity sake, assume that the supported number of rows is 10 and the number of licensed users is 20. In this scenario, the maximum number of available rows will be 10. If the number of licensed users is 5, the maximum number of available rows will be 5.
- This section is applicable only to the SBC application.

### Configuring SBC User Information Table through Web Interface

You can configure the User Information table for SBC users through the Web interface. The table allows you to do the following:

- Manually add users (described below).
- Import users from a file: From the **Action** drop-down list, choose **Import**.



- When you import a file, all previously configured entries in the table are deleted and replaced with the users from the imported file.
- For configuring users in a file for import, see [Configuring SBC User Information Table from a Loadable File](#) on page 610.

- Export the configured users to a file (.csv file format): From the **Action** drop-down list, choose **Export** and save the file to a folder on your computer.
- Register and un-register users:
  - To register a user: Select the user, and then from the **Action** drop-down list, choose **Register**.
  - To un-register a user: Select the user, and then from the **Action** drop-down list, choose **Un-Register**.



To configure the User Information table, make sure that you have enabled the feature



(see [Enabling the User Info Table](#)).

➤ **To configure User Information table through the Web interface:**

1. Open the User Information table (**Setup** menu > **Signaling & Media** tab > **SBC** folder > **User Information**).
2. Click **New**; the following dialog box appears:

3. Configure a user according to the table below.
4. Click **Apply**.

**Table 20-3: User Information Table Parameter Descriptions**

Parameter	Description
'Index' [SBCUserInfoTable_ Index]	Defines an index number for the new table row. <b>Note:</b> Each row must be configured with a unique index.
'Local User' [SBCUserInfoTable_ LocalUser]	Defines the user and is used as the Request-URI user part for the AOR in the database.  The valid value is a string of up to 60 characters. By default, no value is defined.  <b>Note:</b> The parameter is mandatory.
'Username' [SBCUserInfoTable_ Username]	Defines the username for registering the user when authentication is necessary.  The valid value is a string of up to 60 characters. By default, no value is defined.
'Password' [SBCUserInfoTable_ Password]	Defines the password for registering the user when authentication is necessary.  The valid value is a string of up to 20 characters.  <b>Note:</b> The password cannot be configured with wide characters.

Parameter	Description
'IP Group' [SBCUserInfoTable_ IPGroupName]	<p>Assigns an IP Group to the user. The IP Group is used as the Request-URI source host part for the AOR in the database.</p> <p>To configure IP Groups, see <a href="#">Configuring IP Groups</a>.</p> <p><b>Note:</b></p> <ul style="list-style-type: none"> <li>■ The parameter is mandatory.</li> <li>■ You must assign the user with a User-type IP Group.</li> </ul>
'Status' [SBCUserInfoTable_ Status]	<p>(Read-only field) Displays the status of the user:</p> <ul style="list-style-type: none"> <li>■ "Registered": Valid configuration and the user is registered.</li> <li>■ "Not Registered": Valid configuration but the user has not been registered.</li> <li>■ "N/A": Invalid configuration as the user has not been assigned an IP Group.</li> <li>■ "NA": Invalid configuration as the user has been assigned a Server-type IP Group instead of a User-type IP Group.</li> </ul>

### Configuring SBC User Information Table through CLI

The SBC User Information table can be configured in the CLI using the following commands:

- To add and/or modify a user (example):

```
# configure voip
(config-voip)# sip-definition proxy-and-registration
(sip-def-proxy-and-reg)# user-info sbc-user-info <index, e.g., 1>
(sbc-user-info-1)# username JohnDee
(sbc-user-info-1)# <activate | exit>
```

- To delete a specific user, use the no command:

```
(sip-def-proxy-and-reg)# no user-info sbc-user-info <index, e.g., 1>
```

- To import users from a file:

```
# configure voip
(config-voip)# sip-definition proxy-and-registration
(sip-def-proxy-and-reg)# user-info sbc-user-info import-csv-from <URL>
```

- To export users to a .csv file:

```
# configure voip
(config-voip)# sip-definition proxy-and-registration
(sip-def-proxy-and-reg)# user-info sbc-user-info export-csv-to <URL>
```

- To view all table entries:

```
(sip-def-proxy-and-reg)# user-info sbc-user-info display
---- sbc-user-info-0 ----
local-user (JohnDee)
username (userJohn)
password (s3fn+fn=)
ip-group-id (1)
status (not-resgistered)
```

```
---- sbc-user-info-1 ----
local-user (SuePark)
username (userSue)
password (t6sn+un=)
ip-group-id (1)
status (not-resgistered)
```

- To view a specific entry (example):

```
(sip-def-proxy-and-reg)# user-info sbc-user-info <index, e.g., 0>
(sbc-user-info-0)# display
local-user (JohnDee)
username (userJohn)
password (s3fn+fn=)
ip-group-id (1)
status (not-resgistered)
```

- To search a user by local-user:

```
(sip-def-proxy-and-reg)# user-info find <local-user, e.g., JohnDoe>
JohnDee: Found at index 0 in SBC user info table, not registered
```



To configure the User Information table, make sure that you have enabled the feature as described in [Enabling the User Info Table](#).

## Configuring SBC User Information Table from a Loadable File

You can configure users in a file and then load (import) it to the SBC User Information table. The users must be configured in comma-separated value (CSV) file format. You can create the file using any standard text-based editor such as Notepad, or alternatively a CSV-based program such as Microsoft Excel. The file can have any filename extension (e.g., .csv or .txt).



- When you import a file, all previously configured entries in the table are deleted and replaced with the users from the imported file.
- If a user is configured in the file with an IP Group that does not exist, the user is not assigned an IP Group when you import the file.

When adding users to the file, use the following syntax:

- For text-based editors:

```
LocalUser,UserName,Password,IPGroupName
```

For example:

```
LocalUser,UserName,Password,IPGroupName
John,johnd,2798,ITSP
Sue,suep,1234,IP-PBX
```

- For CSV-based programs:

```
LocalUser,UserName,Password,IPGroupName
```

For example:

	A	B	C	D
1	LocalUser	Username	Password	IPGroupName
2	John	johnd	2798	ITSP
3	Sue	suep	1234	IP-PBX
4				

You can load the User Information file using any of the following methods:

- Web interface - User Information table (see [Configuring SBC User Information Table through Web Interface](#) on page 606)
- CLI - **sbcs user-info-table import-csv-from** (see [Configuring SBC User Information Table through CLI](#) on page 608)
- Automatic Update mechanism - [SBCUserInfoFileUrl] parameter (see [Automatic Update Mechanism](#))





For **backward compatibility** only: When configuring a User Information file to load through the Auxiliary Files page, use the following syntax:

```
[SBC]
```

```
FORMAT LocalUser,UserName>Password,IPGroupID
```

For example:

```
[SBC]
```

```
FORMAT LocalUser,UserName>Password,IPGroupID
```

```
John,johnd,2798,2
```

```
Sue,suep,1234,1
```

## Configuring Call Setup Rules

The Call Setup Rules table lets you configure up to 64 Call Setup rules. Call Setup rules define various sequences that are run upon the receipt of an incoming call (dialog) at call setup, before the device routes the call to its destination. You can configure Call Setup rules for any call direction - IP-to-IP (SBC), Tel-to-IP, or IP-to-Tel calls. Call Setup rules provide you with full flexibility in implementing simple or complex script-like rules that can be used for Lightweight Directory Access Protocol (LDAP) based routing as well as other advanced routing logic requirements such as manipulation. These Call Setup rules are assigned to routing rules.

Below is a summary of functions for which you can employ Call Setup rules:

- LDAP queries: LDAP is used by the device to query Microsoft's Active Directory (AD) server for specific user details for routing, for example, office extension number, mobile number, private number, OCS (Skype for Business) address, and display name. Call Setup rules provides full flexibility in AD-lookup configuration to suit just about any customer deployment requirement:
  - Routing based on query results.
  - Queries based on any AD attribute.
  - Queries based on any attribute value (alphanumeric), including the use of the asterisk (\*) wildcard as well as the source number, destination number, redirect number, and SBC SIP messages. For example, the following Call Setup rule queries the attribute "proxyAddresses" for the record value "WOW:" followed by source number:  
"proxyAddresses=WOW:12345\*"
  - Conditional LDAP queries, for example, where the query is based on two attributes (&(telephoneNumber=4064)(company=ABC)).
  - Conditions for checking LDAP query results.
  - Manipulation of call parameters such as source number, destination number, and redirect number and SBC SIP messages, while using LDAP query results.
  - Multiple LDAP queries.
- Dial Plan queries: For SBC calls, you can use Call Setup rules to query the Dial Plan table (see [Configuring Dial Plans](#)) for a specified key in a specified Dial Plan to obtain the

corresponding Dial Plan tag. Call Setup rules can also change (modify) the name of the obtained tag. The device can then route the call using an IP-to-IP Routing rule (in the IP-to-IP Routing table) that has a matching tag (source or destination). You can also associate a Call Setup rule with an IP Group (in the IP Group table). Once the device classifies the incoming call to a source IP Group, it processes the associated Call Setup rule and then uses the resultant tag to locate a matching IP-to-IP Routing rule. You can also use Call Setup rules for complex routing schemes by using multiple Dial Plan tags. This is typically required when the source or destination of the call needs to be categorized with more than one characteristics. For example, tags can be used to categorize calls by department (source user) within a company, where only certain departments are allowed to place international calls.

- ENUM queries: For SBC calls, you can use Call Setup rules to query an ENUM server and to handle responses from the ENUM server. ENUM translates ordinary telephone numbers (E.164 telephone numbers) into Internet addresses (SIP URIs), using the ENUM's DNS NAPTR records. For example, if the device receives an INVITE message whose destination number is in E.164 format, you can configure a Call Setup rule to query the ENUM server for the corresponding URI address, which is then used in the INVITE's Request-URI.
- HTTP requests (queries): You can use Call Setup rules to query or notify an HTTP/S server, which is configured in the Remote Web Services table ([Configuring Remote Web Services](#) on page 299). If a response is expected from the server, the query is sent as an HTTP GET or HTTP POST request (configurable). If no response is required from the server (i.e., to notify the server of a specific condition), then an HTTP POST for notifications is sent (configurable).
- Manipulation (similar to the Message Manipulations table) of call parameters (such as source number, destination number, and redirect number) and SBC SIP messages.
- Conditions for routing, for example, if the source number equals a specific value, then use the call routing rule.

You configure multiple Call Setup rules and group them using a *Set ID*. This lets you apply multiple Call Setup rules on the same call setup dialog. To use your Call Setup rule(s), you need to assign the Set ID to one of the following, using the 'Call Setup Rules Set ID' field:

- (SBC application) SBC IP-to-IP routing rules (see [Configuring SBC IP-to-IP Routing Rules](#))
- (SBC application) SIP Interface rules (see [Configuring SIP Interfaces](#) on page 415)
- (Gateway application) Tel-to-IP routing rules (see [Configuring Tel-to-IP Routing Rules](#))
- (Gateway application) IP-to-Tel routing rules (see [Configuring IP-to-Tel Routing Rules](#))
- IP Groups (see [Configuring IP Groups](#))

If assigned to an IP Group, the device processes the Call Setup rule for the classified source IP Group immediately before the routing process. If assigned to a routing rule only, the device first locates a matching routing rule for the incoming call, processes the assigned Call Setup Rules Set ID, and then routes the call according to the destination configured for the routing

rule. The device uses the routing rule to route the call depending on the result of the Call Setup Rules Set ID:

- **Rule's condition is met:** The device performs the rule's action, and then runs the next rule in the Set ID until the last rule or until a rule whose 'Action Type' parameter is configured to **Exit**. If this "exit" rule is also configured with a **True** value for the 'Action Value' parameter, the device uses the current routing rule. If this "exit" rule is configured with a **False** value for the 'Action Value' parameter, the device moves to the next routing rule. If the 'Action Type' parameter is not configured to **Exit** and the device has run all the rules in the Set ID, the default of the 'Action Value' parameter of the Set ID is **True** (i.e., use current routing rule).
- **Rule's condition is not met:** The device runs the next rule in the Set ID. When the device reaches the end of the Set ID and no "exit" was performed, the Set ID ends with a "true" result.

You can also configure a Call Setup rule that determines whether the device must discontinue with the Call Setup Rules Set ID and route the call accordingly. This is done using the **Exit** optional value of the 'Action Type' parameter. When used, the 'Action Value' parameter can be configured to one of the following:

- **True:** Indicates that if the condition is met, the device routes the call according to the selected routing rule. Note that if the condition is not met, the device also uses the selected routing rule, unless the next Call Setup rule in the Set ID has an **Exit** option configured to **False** for an empty condition.
- **False:** Indicates that if the condition is met, the device attempts to route the call to the next matching routing rule (if configured). If the condition is not met, the device routes the call according to the selected routing rule.

As the default result of a Call Setup rule is always "true" (**True**), please adhere to the following guidelines when configuring the 'Action Type' field to **Exit**: If, for example, you want to exit the Call Setup Rule Set ID with "true" when LDAP query result is found and "false" when LDAP query result is not found:

- Incorrect: This rule always exits with result as "true":

'Condition': ldap.found exists

'Action Type': **Exit**

'Action Value': **True**

- Correct:

- Single rule:

'Condition': ldap.found !exists

'Action Type': **Exit**

'Action Value': **False**

- Set of rules:

'Condition': ldap.found exists

'Action Type': **Exit**  
 'Action Value': **True**

'Condition': <leave empty>  
 'Action Type': **Exit**  
 'Action Value': **False**



If the source or destination numbers are manipulated by the Call Setup rules, they revert to their original values if the device moves to the next routing rule.

The following procedure describes how to configure Call Setup Rules through the Web interface. You can also configure it through ini file [CallSetupRules] or CLI (`configure voip > message call-setup-rules`).

➤ **To configure a Call Setup rule:**

1. Open the Call Setup Rules table (**Setup** menu > **Signaling & Media** tab > **SIP Definitions** folder > **Call Setup Rules**).
2. Click **New**; the following dialog box appears:

3. Configure a Call Setup rule according to the parameters described in the table below.
4. Click **Apply**, and then save your settings to flash memory.

**Table 20-4: Call Setup Rules Parameter Descriptions**

Parameter	Description
General	
'Index' [CallSetupRules_ Index]	Defines an index number for the new table record. <b>Note:</b> Each rule must be configured with a unique index.
'Name' rules-set- name [CallSetupRules_	Defines an arbitrary name to easily identify the row. The valid value is a string of up to 20 characters. <b>Note:</b> Each row must be configured with a unique name.

Parameter	Description
RulesSetName]	
'Rules Set ID' rules-set-id [CallSetupRules_ RulesSetID]	<p>Defines a Set ID for the rule. You can define the same Set ID for multiple rules to create a group of rules. You can configure up to 32 Set IDs, where each Set ID can include up to 10 rules. The Set ID is used to assign the Call Setup rules to a routing rule in the routing table.</p> <p>The valid value is 0 to 31. The default is 0.</p>
'Request Type' request-type [CallSetupRules_ QueryType]	<p>Defines the type of query.</p> <ul style="list-style-type: none"> <li>■ [0] <b>None</b> (default)</li> <li>■ [1] <b>LDAP</b> = The Call Setup rule performs an LDAP query with an LDAP server. To specify an LDAP server, use the 'Request Target' parameter (see below).</li> <li>■ [2] <b>Dial Plan</b> = The Call Setup rule performs a query with the Dial Plan. To specify a Dial Plan, use the 'Request Target' parameter (see below).</li> <li>■ [3] <b>ENUM</b> = The Call Setup rule performs a query with an ENUM (E.164 Number to URI Mapping) server for retrieving a SIP URI address for an E.164 telephone number. The ENUM server's address is the address configured for the 'Primary DNS' (and optionally, 'Secondary DNS') parameters of the IP Interface (in the IP Interfaces table) that is specified in the 'Request Target' parameter (see below). For a configuration example, see <a href="#">Call Setup Rule Examples</a> on page 620.</li> <li>■ [4] <b>HTTP GET</b> = The Call Setup rule performs an HTTP GET request (query) with an HTTP/S server. To specify an HTTP server, use the 'Request Target' parameter (see below).</li> <li>■ [5] <b>HTTP POST Query</b> = The Call Setup rule sends an HTTP POST request (query) to an HTTP/S server and expects a response from the server. To specify an HTTP server, use the 'Request Target' parameter (see below).</li> <li>■ [6] <b>HTTP POST Notification</b> = The Call Setup rule sends an HTTP POST request to notify an HTTP/S server of a specific condition and does not expect a response from the server. For example, you can configure a rule to notify the server of a 911 emergency call. To specify an HTTP server, use the 'Request Target' parameter (see below).</li> </ul>
'Request Target'	<p>Defines one of the following, depending on the value configured for</p>

Parameter	Description
<p>request-target [CallSetupRules_QueryTarget]</p>	<p>the 'Request Type' parameter (above).</p> <ul style="list-style-type: none"> <li>■ <b>LDAP:</b> Defines an LDAP server (LDAP Server Group) on which to perform an LDAP query for a defined key. To configure LDAP Server Groups, see <a href="#">Configuring LDAP Server Groups</a>.</li> <li>■ <b>Dial Plan:</b> Defines a Dial Plan (name) in which to search for a defined key. To configure Dial Plans, see <a href="#">Configuring Dial Plans</a>.</li> <li>■ <b>ENUM:</b> Specifies the ENUM server on which to perform the ENUM query. The server is specified by IP Interface name (in the IP Interfaces table). The address of the ENUM server is the address of the 'Primary DNS' (and optionally, 'Secondary DNS') parameters that is configured for the specified IP Interface. If you don't specify an IP Interface or the specified IP Interface does not exist in the IP Interfaces table, the device uses the OAMP IP Interface.</li> <li>■ <b>HTTP GET, HTTP POST Query, and HTTP POST Notification:</b> Defines the HTTP server to where the device sends the HTTP request. To configure HTTP servers, see <a href="#">Configuring Remote Web Services</a> on page 299.</li> </ul> <p>To configure the key, use the 'Request Key' parameter (see below).</p>
<p>'Request Key' request-key [CallSetupRules_AttributesToQuery]</p>	<p>Defines the key to query.</p> <ul style="list-style-type: none"> <li>■ For LDAP, the key string is queried on the LDAP server.</li> <li>■ For Dial Plans, the key string is searched for in the specified Dial Plan.</li> <li>■ For ENUM, the key string is queried on the ENUM server.</li> <li>■ For HTTP GET and HTTP POST queries, the key string is queried on the HTTP server.</li> </ul> <p>The valid value is a string of up to 100 characters. Combined strings and values can be configured like in the Message Manipulations table, using the '+' operator. Single quotation marks (') can be used for specifying a constant string (e.g., '12345').</p> <p>You can use the built-in syntax editor to help you configure the field. Click the <b>Editor</b> button located alongside the field to open the Editor, and then simply follow the on-screen instructions.</p> <p>Examples:</p> <ul style="list-style-type: none"> <li>■ To LDAP query the AD attribute "mobile" that has the value of the destination user part of the incoming call:</li> </ul>

Parameter	Description
	<p data-bbox="639 282 1377 376">'mobile=' + param.call.dst.user</p> <ul data-bbox="584 405 1377 472" style="list-style-type: none"> <li data-bbox="584 405 1377 472">■ To LDAP query the AD attribute "telephoneNumber" that has a redirect number:</li> </ul> <p data-bbox="639 499 1377 593">'telephoneNumber=' + param.call.redirect + '*'</p> <ul data-bbox="584 622 1147 645" style="list-style-type: none"> <li data-bbox="584 622 1147 645">■ To query a Dial Plan for the source number:</li> </ul> <p data-bbox="639 672 1377 766">param.call.src.user</p> <ul data-bbox="584 795 1377 862" style="list-style-type: none"> <li data-bbox="584 795 1377 862">■ To query an ENUM server for the URI of the called (destination) number:</li> </ul> <p data-bbox="639 889 1377 983">param.call.dst.user</p> <ul data-bbox="584 1012 1273 1079" style="list-style-type: none"> <li data-bbox="584 1012 1273 1079">■ To send an HTTP POST to notify the HTTP server of call connection status:</li> </ul> <p data-bbox="639 1106 1377 1200">'connectionStatus'</p> <p data-bbox="584 1216 1299 1283"><b>Note:</b> The parameter is applicable only if the 'Request Type' parameter is configured to any value other than <b>None</b>.</p>
'Attributes To Get' attr-to-get [CallSetupRules_ AttributesToGet]	<p data-bbox="584 1328 1362 1395">Defines the Attributes of the queried LDAP record that the device must handle (e.g., retrieve value).</p> <p data-bbox="584 1413 1305 1518">The valid value is a string of up to 100 characters. Up to five attributes can be defined, each separated by a comma (e.g., msRTCSIP-PrivateLine,msRTCSIP-Line,mobile).</p> <p data-bbox="584 1541 655 1563"><b>Note:</b></p> <ul data-bbox="584 1597 1377 1839" style="list-style-type: none"> <li data-bbox="584 1597 1377 1664">■ The parameter is applicable only if you configure the 'Request Type' parameter to <b>LDAP</b>.</li> <li data-bbox="584 1693 1377 1839">■ The device saves the retrieved attributes' values for future use in other rules until the next LDAP query or until the call is connected. Thus, the device does not need to re-query the same attributes.</li> </ul>
'Row Role' row-role	<p data-bbox="584 1888 1394 1955">Determines which condition must be met in order for this rule to be performed.</p>

Parameter	Description
[CallSetupRules_RowRole]	<ul style="list-style-type: none"> <li>■ [0] <b>Use Current Condition</b> = The Condition configured for this rule must be matched in order to perform the configured action (default).</li> <li>■ [1] <b>Use Previous Condition</b> = The Condition configured for the rule located directly above this rule in the Call Setup table must be matched in order to perform the configured action. This option lets you configure multiple actions for the same Condition.</li> </ul>
'Condition' condition [CallSetupRules_Condition]	<p>Defines the condition that must exist for the device to perform the action.</p> <p>The valid value is a string of up to 200 characters (case-insensitive). Regular Expression (regex) can also be used. You can also use the built-in syntax editor to help you configure the field. Click the <b>Editor</b> button located alongside the field to open the Editor, and then simply follow the on-screen instructions.</p> <p>Examples:</p> <ul style="list-style-type: none"> <li>■ LDAP: <ul style="list-style-type: none"> <li>✓ ldap.attr.mobile exists (if Attribute "mobile" exists in AD)</li> <li>✓ param.call.dst.user == ldap.attr.msRTCSIP-PrivateLine (if called number is the same as the number in the Attribute "msRTCSIP-PrivateLine")</li> <li>✓ ldap.found !exists (if LDAP record not found)</li> <li>✓ ldap.err exists (if LDAP error exists)</li> </ul> </li> <li>■ Dial Plan: <ul style="list-style-type: none"> <li>✓ dialplan.found exists (if Dial Plan exists)</li> <li>✓ dialplan.found !exists (if Dial Plan queried key not found)</li> <li>✓ dialplan.result=='uk' (if corresponding tag of the searched key is "uk")</li> </ul> </li> <li>■ ENUM: <ul style="list-style-type: none"> <li>✓ enum.found exists (if ENUM record of E.164 number exists)</li> </ul> </li> <li>■ HTTP GET or HTTP POST: <ul style="list-style-type: none"> <li>● http.response.status == '200' (if the HTTP server responds with a 200 OK)</li> </ul> </li> </ul>
Action	



Parameter	Description
'Action Subject' action- subject [CallSetupRules_ ActionSubject]	<p>Defines the element (e.g., SIP header, SIP parameter, SIP body, or Dial Plan tag) upon which you want to perform the action if the condition, configured in the 'Condition' parameter (see above) is met.</p> <p>The valid value is a string of up to 100 characters (case-insensitive). You can use the built-in syntax editor to help you configure the field. Click the <b>Editor</b> button located alongside the field to open the Editor, and then simply follow the on-screen instructions.</p> <p>Examples:</p> <ul style="list-style-type: none"> <li>■ header.from contains '1234' (SBC application only)</li> <li>■ param.call.dst.user (called number)</li> <li>■ param.call.src.user (calling number)</li> <li>■ param.call.src.name (calling name)</li> <li>■ param.call.redirect (redirect number)</li> <li>■ param.call.src.host (source host)</li> <li>■ param.call.dst.host (destination host)</li> <li>■ srctags (source tag)</li> <li>■ dsttags (destination tag)</li> <li>■ header.content-type (for HTTP POST requests)</li> </ul>
'Action Type' action-type [CallSetupRules_ ActionType]	<p>Defines the type of action to perform.</p> <ul style="list-style-type: none"> <li>■ [-1] <b>None</b> = No action is performed. This option is typically used for HTTP POST requests that are used for notifying the HTTP server (e.g., when the 'Request Type' parameter is configured to <b>HTTP POST Notification</b>). If you configure the parameter to this option and it is the last rule in the table, the device processes the rule and then exits the table. If it is not the last rule, the device processes the rule and then checks the next rule.</li> <li>■ [0] <b>Add</b> = (Default) Adds new message header, parameter or body elements.</li> <li>■ [1] <b>Remove</b> = Removes message header, parameter, or body elements.</li> <li>■ [2] <b>Modify</b> = Sets element to the new value (all element types).</li> <li>■ [3] <b>Add Prefix</b> = Adds value at the beginning of the string (string element only).</li> </ul>

Parameter	Description
	<ul style="list-style-type: none"> <li>■ [4] <b>Add Suffix</b> = Adds value at the end of the string (string element only).</li> <li>■ [5] <b>Remove Suffix</b> = Removes value from the end of the string (string element only).</li> <li>■ [6] <b>Remove Prefix</b> = Removes value from the beginning of the string (string element only).</li> <li>■ [20] <b>Run Rules Set</b> = Performs a different Rule Set ID, specified in the 'Action Value' parameter (see below)</li> <li>■ [21] <b>Exit</b> = Stops the Rule Set ID and returns a result ("true" or "false").</li> </ul>
'Action Value' action-value [CallSetupRules_ ActionValue]	<p>Defines a value that you want to use in the action.</p> <p>The valid value is a string of up to 300 characters (case-insensitive). You can use the built-in syntax editor to help you configure the field. Click the <b>Editor</b> button located alongside the field to open the Editor, and then simply follow the on-screen instructions.</p> <p>Examples:</p> <ul style="list-style-type: none"> <li>■ '+9723976'+ldap.attr.alternateNumber</li> <li>■ '9764000'</li> <li>■ ldap.attr.displayName</li> <li>■ enum.result.url</li> <li>■ srctags</li> <li>■ http.response.body</li> <li>■ application/x-www-form-urlencoded (for HTTP Content-Type header in HTTP requests)</li> <li>■ <b>True</b> (if the 'Action Type' is configured to <b>Exit</b>)</li> <li>■ <b>False</b> (if the 'Action Type' is configured to <b>Exit</b>)</li> </ul>

## Call Setup Rule Examples

Below are configuration examples for using Call Setup Rules.

- **Example 1:** The example configures the device to replace (manipulate) the incoming call's source number with a number retrieved from the AD by an LDAP query. The device queries the AD server for the attribute record, "telephoneNumber" whose value is the same as the received source number (e.g., "telephoneNumber =4064"). If such an Attribute exists, the

device retrieves the number of the attribute record, "alternateNumber" and uses this number as the source number.

- **Call Setup Rules table:**
  - ◆ 'Rules Set ID': **1**
  - ◆ 'Request Type': **LDAP**
  - ◆ 'Request Target': **LDAP-DC-CORP**
  - ◆ 'Request Key': **'telephoneNumber=' + param.call.src.user**
  - ◆ 'Attributes to Get': **alternateNumber**
  - ◆ 'Row Role': **Use Current Condition**
  - ◆ 'Condition': **ldap.attr. alternateNumber exists**
  - ◆ 'Action Subject': **param.call.src.user**
  - ◆ 'Action Type': **Modify**
  - ◆ 'Action Value': **ldap.attr. alternateNumber**
- **IP-to-IP Routing table:** A single routing rule is assigned the Call Setup Rule Set ID.
  - ◆ (Index 1) 'Call Setup Rules Set ID': **1**

■ **Example 2:** The example configures the device to replace (manipulate) the incoming call's calling name (caller ID) with a name retrieved from the AD by an LDAP query. The device queries the AD server for the attribute record, "telephoneNumber" whose value is the same as the received source number (e.g., "telephoneNumber =5098"). If such an attribute is found, the device retrieves the name from the attribute record, "displayName" and uses this as the calling name in the incoming call.

- **Call Setup Rules table:**
  - ◆ 'Rules Set ID': **2**
  - ◆ 'Request Type': **LDAP**
  - ◆ 'Request Target': **LDAP-DC-CORP**
  - ◆ 'Request Key': **'telephoneNumber=' + param.call.src.user**
  - ◆ 'Attributes to Get': **displayName**
  - ◆ 'Row Role': **Use Current Condition**
  - ◆ 'Condition': **ldap.attr. displayName exists**
  - ◆ 'Action Subject': **param.call.src.name**
  - ◆ 'Action Type': **Modify**
  - ◆ 'Action Value': **ldap.attr. displayName**
- **IP-to-IP Routing table:** A single routing rule is assigned the Call Setup Rule Set ID.
  - ◆ (Index 1) 'Call Setup Rules Set ID': **2**

- **Example 3:** The example configures the device to route the incoming call according to whether or not the source number of the incoming call also exists in the AD server. The device queries the AD server for the attribute record, "telephoneNumber" whose value is the same as the received source number (e.g., telephoneNumber=4064"). If such an attribute is found, the device sends the call to Skype for Business; if the query fails, the device sends the call to the PBX.

- **Call Setup Rules table:**

- ◆ 'Rules Set ID': **3**
- ◆ 'Request Type': **LDAP**
- ◆ 'Request Target': **LDAP-DC-CORP**
- ◆ 'Request Key': **'telephoneNumber=' + param.call.src.user**
- ◆ 'Attributes to Get': **telephoneNumber**
- ◆ 'Row Role': **Use Current Condition**
- ◆ 'Condition': **ldap.found !exists**
- ◆ 'Action Subject': **-**
- ◆ 'Action Type': **Exit**
- ◆ 'Action Value': **False**

If the attribute record is found (i.e., condition is not met), the rule ends with a default exit result of true and uses the first routing rule (Skype for Business). If the attribute record does not exist (i.e., condition is met), the rule exits with a "false" result and uses the second routing rule (PBX).

- **IP-to-IP Routing table:** Two routing rules are assigned with the same matching characteristics. Only the main routing rule is assigned a Call Setup Rules Set ID.

- ◆ 'Index': **1**
- ◆ 'Call Setup Rules Set ID': **3**
- ◆ 'Destination IP Group ID': **3** (IP Group for Skype for Business)
- ◆ 'Index': **2**
- ◆ 'Destination IP Group ID': **4** (IP Group of PBX)

- **Example 4:** The example enables routing based on LDAP queries and destination tags. The device queries the LDAP server for the attribute record "telephoneNumber" whose value is the destination number of the incoming call (e.g., "telephoneNumber=4064"). If the attribute-value combination is found, the device retrieves the string value of the attribute record "ofISBCRouting" and creates a destination tag with the name of the retrieved string. The destination tag is then used as a matching characteristics in the IP-to-IP Routing table.

- **Call Setup Rules table:**

- ◆ 'Rules Set ID': **4**
- ◆ 'Request Type': **LDAP**
- ◆ 'Request Target': **LDAP-DC-CORP**
- ◆ 'Request Key': **'telephoneNumber='+param.call.dst.user**
- ◆ 'Attributes to Get': **ofiSBCRouting**
- ◆ 'Row Role': **Use Current Condition**
- ◆ 'Condition': **ldap.found exists**
- ◆ 'Action Subject': **dsttags**
- ◆ 'Action Type': **Modify**
- ◆ 'Action Value': **ldap.attr.ofiSBCrouting**
- **IP Groups table:** 'Call Setup Rules Set ID': 4
- **IP-to-IP Routing table:**
  - ◆ 'Index': 1
  - ◆ 'Destination Tag': dep-sales
  - ◆ 'Destination IP Group': SALES
  - ◆ 'Index': 2
  - ◆ 'Destination Tag': dep-mkt
  - ◆ 'Destination IP Group': MKT
  - ◆ 'Index': 3
  - ◆ 'Destination Tag': dep-rd
  - ◆ 'Destination IP Group': RD

■ **Example 5:** The example configures the device to perform an ENUM query with an ENUM server to retrieve a SIP URI address for the called E.164 telephone number. The device then replaces (manipulates) the incoming call's E.164 destination number in the SIP Request-URI header with the URI retrieved from the ENUM server. The ENUM server's address is the address configured in the 'Primary DNS' parameter for the "ITSP-450" IP Interface in the IP Interfaces table.

- **Call Setup Rules table:**
  - ◆ 'Index': **0**
  - ◆ 'Rules Set ID': **4**
  - ◆ 'Request Type': **ENUM**
  - ◆ 'Request Target': **ITSP-450**
  - ◆ 'Request Key': **param.call.dst.user**

- ◆ 'Condition': **enum.found exists**
- ◆ 'Action Subject': **header.request-uri.url**
- ◆ 'Action Type': **Modify**
- ◆ 'Action Value': **enum.result.url**
- **IP Groups table:**
  - ◆ 'Call Setup Rules Set ID': **4**
- **Example 6:** For an example on HTTP GET operations, see [Configuring an HTTP GET Web Service](#) on page 317.
- **Example 7:** For an example on HTTP POST (notification) operations, see [Configuring HTTP POST Web Service](#) on page 319.

## Configuring Dial Plans

Dial Plans let you categorize incoming calls (source or destination) based on source or destination number. The device categorizes them by searching in the Dial Plan for rules that match these numbers according to prefix, suffix, or whole number. The categorization result in the Dial Plan is a *tag* corresponding to the matched rule. You can then use tags to represent these calls (source or destination) as matching characteristics (source or destination tags) for various configuration entities:

- SBC application:
  - IP-to-IP Routing rules (see [Using Dial Plan Tags for IP-to-IP Routing](#))
  - Outbound Manipulations rules ([Using Dial Plan Tags for Outbound Manipulation](#))
  - Call Setup Rules ([Using Dial Plan Tags for Call Setup Rules](#))
  - Message Manipulation ([Using Dial Plan Tags for Message Manipulation](#))

You can assign a Dial Plan to an IP Group or SRD. After Classification and Inbound Manipulation, the device checks if a Dial Plan is associated with the incoming call. It first checks the source IP Group and if no Dial Plan is assigned, it checks the SRD. If a Dial Plan is assigned to the IP Group or SRD, the device first searches the Dial Plan for a dial plan rule that matches the source number and then it searches the Dial Plan for a rule that matches the destination number. If matching dial plan rules are found, the tags configured for these rules are used in the routing or manipulation processes as source or destination tags.

- Gateway application:
  - IP-to-Tel Routing rules (see [Configuring IP-to-Tel Routing Rules](#) on page 747)
  - Tel-to-IP Routing rules (see [Configuring Tel-to-IP Routing Rules](#) on page 734)



Notes for the SBC application:



- User categorization by Dial Plan is done only after the device's Classification and Inbound Manipulation processes, and before the routing process.
- Once the device successfully categorizes an incoming call by Dial Plan, it not only uses the resultant tag in the immediate routing or manipulation process, but also in subsequent routing and manipulation processes that may occur, for example, due to alternative routing or local handling of call transfer and call forwarding (SIP 3xx\REFER).
- For manipulation, tags are applicable only to outbound manipulation.
- When tags are used in the IP-to-IP Routing table to determine destination IP Groups (i.e., 'Destination Type' parameter configured to **Destination Tag**), the device searches the Dial Plan for a matching **destination** (called) prefix number only.

The figure below shows a conceptual example of routing based on tags, where users categorized as tag "A" are routed to SIP Trunk "X" and those categorized as tag "B" are routed to SIP Trunk "Y":

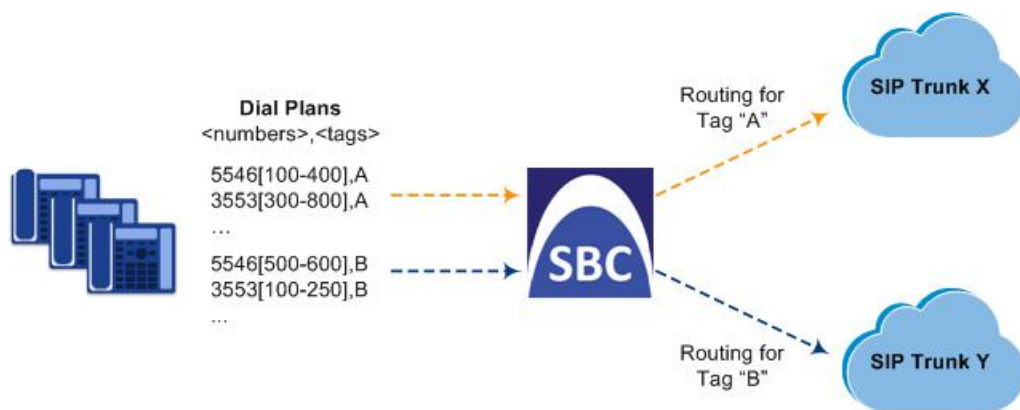

The Dial Plan itself is a set of dial plan rules having the following attributes:

- **Prefix:** The prefix is matched against the source or destination number of the incoming call (e.g., SIP dialog-initiating request for IP calls).
- **Tag:** The tag corresponds to the matched prefix of the source or destination number and is the categorization result.

You can use various syntax notations to configure the prefix numbers in Dial Plan rules. You can configure the prefix as a complete number (all digits) or as a partial number using some digits and various syntax notations (patterns) to allow the device to match a Dial Plan rule for similar source or destination numbers. For more information, see the description of the 'Prefix' parameter (DialPlanRule\_Prefix) described later in this section.

The device employs a "best-match" method instead of a "first-match" method to match the source/destination numbers to prefixes configured in the Dial Plan. The matching order is done digit-by-digit and from left to right. The numbers are first matched to the rule configured with the most constrained (specific) character set. Most constrained implies that the Dial Plan pattern that has the fewest possible matches for a digit is matched first. For example, if one rule contains the "x" wildcard character, which has ten possible matches (i.e., 0-9) and another

rule a specific digit (e.g., 4), the rule with the specific digit is selected as the matching rule. The best match priority is listed below in chronological order:

- Specific character (prefix)
- Number range
- "x" wildcard, which denotes any digit (0-9)
- Suffix, where the longest digits is first matched. For example, ([001-999]) takes precedence over ([01-99]) which takes precedence over ([1-9]).
- . (dot), which denotes any character

For example, the table below shows the best match priority of an incoming call with prefix number "5234":

**Table 20-5: Dial Plan Best Match Priority**

Dial Plan Prefix	Dial Plan Tag	Best Match Priority (Where 1 is Highest)
523x	A	3
523([4]) or [(5234)]	A	4
523[2-6]	A	2
523.	A	5
5234	B	1

The following examples show how the best-matching method is done. Each example has two Dial Plan rules which are shown listed in chronological order as they would be configured in the table.

- For incoming calls with prefix number "5234", the rule with tag B is chosen (more specific for digit "4"):

Prefix	Tag
523x	A
5234	B

- For incoming calls with prefix number "5234", the rule with tag B is chosen (more specific for digit "4"):

Prefix	Tag
523x	A



523[1-9]	B
----------	---

- For incoming calls with prefix number "53211111", the rule with tag B is chosen (more specific for fourth digit):

Prefix	Tag
532[1-9]1111	A
5321	B

- For incoming calls with prefix number "53124", the rule with tag B is chosen (more specific for digit "1"):

Prefix	Tag
53([2-4])	A
531(4)	B

- For incoming calls with prefix number "321444", the rule with tag A is chosen and for incoming calls with prefix number "32144", the rule with tag B is chosen:

Prefix	Tag
321xxx	A
321	B

- For incoming calls with prefix number "5324", the rule with tag B is chosen (prefix is more specific for digit "4"):

Prefix	Tag
532[1-9]	A
532[2-4]	B

- For incoming calls with prefix number "53124", the rule with tag C is chosen (longest suffix - C has three digits, B two digits and A one digit):

Prefix	Tag
53([2-4])	A
53([01-99])	B
53([001-999])	C

- For incoming calls with prefix number "53124", the rule with tag B is chosen (suffix is more specific for digit "4"):

Prefix	Tag
53([2-4])	A
53(4),B	B



The maximum group of numbers (consisting of single numbers or range of numbers, or both) that can be configured for prefixes and suffixes for all the Dial Plan rules can be calculated by multiplying the maximum number of supported Dial Plan rules by six. For example, if the maximum number of Dial Plan rules is 100, then the maximum group of numbers is 600 (6\*100). The following is an example of a Dial Plan rule that is configured with six groups of numbers (each separated by a comma), consisting of ranges and single numbers: [120-125,150,160-164,170,200,210-215]

Dial Plans are configured using two tables with "parent-child" relationship:

- Dial Plan table ("parent" table): Defines the name of the Dial Plan. You can configure up to 10 Dial Plans.
- Dial Plan Rule table ("child" table): Defines the actual dial plans (rules) per Dial Plan. You can configure up to 2,000 of Dial Plan rules in total (where all can be configured for one Dial Plan or configured between different Dial Plans).

The following procedure describes how to configure Dial Plans through the Web interface. You can also configure it through other management platforms:

- **Dial Plan table:** *ini* file [DialPlan] or CLI (`configure voip > sbc dial-plan`)
- **Dial Plan Rule table:** *ini* file (DialPlanRule) or CLI (`configure voip > sbc dial-plan-rule`)

### ➤ To configure Dial Plans:

1. Open the Dial Plan table (**Setup** menu > **Signaling & Media** tab > **SIP Definitions** folder > **Dial Plan**).
2. Click **New**; the following dialog box appears:

3. Configure a Dial Plan name according to the parameters described in the table below.

4. Click **Apply**.

Table 20-6: Dial Plan Table Parameter Descriptions

Parameter	Description
'Index' [DialPlan_ Index]	Defines an index number for the new table row. <b>Note:</b> Each row must be configured with a unique index.
'Name' name [DialPlan_ Name]	Defines a descriptive name, which is used when associating the row in other tables. The valid value is a string of up to 15 characters. <b>Note:</b> <ul style="list-style-type: none"> <li>■ Each row must be configured with a unique name.</li> <li>■ The parameter value cannot contain a forward slash (/).</li> </ul>

5. In the Dial Plan table, select the row for which you want to configure dial plan rules, and then click the **Dial Plan Rule** link located below the table; the Dial Plan Rule table appears.

6. Click **New**; the following dialog box appears:

The screenshot shows a dialog box titled "Dial Plan Rule". It has a dark blue title bar with standard window controls. Below the title bar, there is a tab labeled "GENERAL". Under this tab, there are four labeled input fields: "Index" (containing the number "1"), "Name", "Prefix", and "Tag".

7. Configure a dial plan rule according to the parameters described in the table below.

8. Click **New**, and then save your settings to flash memory.

Table 20-7: Dial Plan Rule Table Parameter Descriptions

Parameter	Description
'Index' index [DialPlanRule_ RuleIndex]	Defines an index number for the new table row. <b>Note:</b> Each row must be configured with a unique index.
'Name'	Defines a descriptive name, which is used when associating

Parameter	Description
name [DialPlanRule_Name]	the row in other tables. The valid value is a string of up to 15 characters.
'Prefix' prefix [DialPlanRule_Prefix]	Defines the prefix number of the source or destination number. The valid value is up to 50 characters. The following syntax can be used: <ul style="list-style-type: none"> <li>■ <b>0-9:</b> Specific digit.</li> <li>■ <b>x:</b> Wildcard denoting any digit from 0 through 9.</li> <li>■ <b>z:</b> Denotes a number from 1 through 9.</li> <li>■ <b>n:</b> Denotes a number from 2 through 9.</li> <li>■ <b>a-z:</b> Lower-case letter.</li> <li>■ <b>A-Z:</b> Upper-case letter.</li> <li>■ <b>*</b>: (Asterisk symbol) If it is the only character in the rule, it denotes any number. To denote the asterisk "*" symbol itself, precede it with the escape "\\" character (see below).</li> <li>■ <b>\:</b> (Backslash escape character) When it prefixes a wildcard character (*, z, n, and x), the character itself is used and not the meta-meaning. For example, "\\x" denotes the character "x", while "x" is the wildcard denoting any digits from 0-9.</li> <li>■ <b>#:</b> (Pound or hash symbol) When used at the end of the prefix it denotes the end of the number. For example, "54324#" represents a 5-digit number that starts with the digits 54324.</li> <li>■ <b>..:</b> (Period) Denotes any letter or digit.</li> <li>■ <b>[n-m], (n-m), or ([n1-m1,n2-m2,a,b,c,n3-m3]):</b>                Represents a mixed notation of single numbers and multiple ranges for prefixes and suffixes. To represent a prefix, the notation is enclosed by square brackets [...]; to represent a suffix, the notation is enclosed by square brackets which are enclosed by parenthesis ([...]).                 For example, to denote numbers 123 through 130, 455, 766, and 780 through 790:               <ul style="list-style-type: none"> <li>✓ Prefix: [123-130,455,766,780-790]</li> </ul> </li> </ul>

Parameter	Description
	<ul style="list-style-type: none"> <li>✓ Suffix: ([123-130,455,766,780-790])</li> </ul> <p><b>Note:</b></p> <ul style="list-style-type: none"> <li>✓ The ranges and the single numbers in the syntax must have the same amount of digits. For example, each number range and single number in the example above consists of three digits.</li> <li>✓ The mixed notation can be configured with up to 19 digits, for example: [1234567891234567890,1234567891234567891]</li> <li>✓ The range (start and end) cannot be greater than 2,147,483,647, as in the following example (which is invalid): [20000000001-40000000001]</li> </ul> <p><b>Note:</b> The Dial Plan prefix is case-sensitive.</p>
<p>'Tag' tag [DialPlanRule_Tag]</p>	<p>Defines a tag(s). The valid value of the tag:</p> <ul style="list-style-type: none"> <li>■ Up to 70 characters (alphanumeric and special characters such as the dollar \$ sign).</li> <li>■ The tag is case-insensitive.</li> <li>■ The tag can be a name value only (e.g., "India") or a name with a value (e.g., "Country=India").</li> <li>■ You can configure multiple tags, where each tag is separated by a semicolon (e.g., "Belgium;Country1=England;Country2=India").</li> <li>■ The value can include dots (.). This can be useful, for example, when you need to configure the tag as an IP address in dotted-decimal notation.</li> </ul> <p><b>Note:</b></p> <ul style="list-style-type: none"> <li>■ The parameter's value cannot include spaces.</li> <li>■ Only one tag name can be configured without a value. For example, "Belgium;England" is an invalid configuration. An example of a valid configuration is "Belgium;Country1=England;Country2=India".</li> <li>■ Tag names with values (i.e., name=value) must be unique. For example, "Country=England;Country=India" is an invalid configuration. An example of a valid configuration is "Country1=England;Country2=India".</li> </ul>

Parameter	Description
	<ul style="list-style-type: none"> <li data-bbox="662 286 1374 434">■ The tag cannot start with a dot (.); it can be used anywhere after the first character. For example, ".Country" is an invalid configuration. Examples of valid configurations are "10.1.1.2" and "Country=USA.NY".</li> <li data-bbox="662 461 1326 528">■ The same tag can be configured in multiple Dial Plan rules.</li> </ul>

## Importing Dial Plans

You can import Dial Plans and Dial Plan Rules from a comma-separated value (CSV) file on your local PC running the Web client.



- For creating Dial Plans in a CSV file for import, see [Creating Dial Plan Files for Import](#).
- The CLI lets you import Dial Plans and Dial Plan rules from a file on a remote server, using the `import-csv-from` command under `(config-voip)# sbc dial-plan`. For more information, refer to the *CLI Reference Guide*.

### ➤ To overwrite all existing Dial Plans with imported Dial Plan:

1. Open the Dial Plan table.
2. From the 'Action' drop-down menu, choose **Import**; the following dialog box appears:

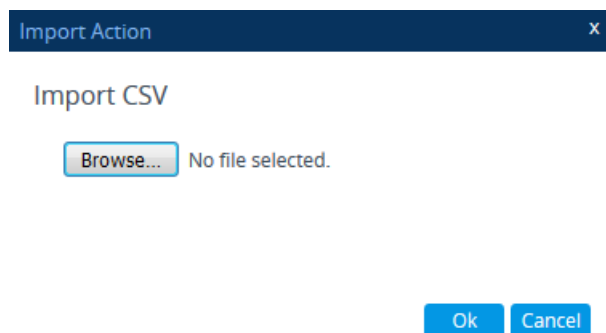

3. Use the **Browse** button to select the Dial Plan file on your PC, and then click **OK**.



- The file import feature only imports rules of Dial Plans that already exist in the Dial Plan table. If a Dial Plan in the file does not exist in the table, the specific Dial Plan is not imported.
- Make sure that the names of the Dial Plans in the imported file are **identical** to the existing Dial Plan names in the Dial Plan table; otherwise, Dial Plans in the file with different names are not imported.



- When importing a file, the rules in the imported file replace all existing rules of the corresponding Dial Plan. For existing Dial Plans in the Dial Plan table that are not listed in the imported file, the device deletes all their rules. For example, if the imported file contains only the Dial Plan "MyDialPlan1" and the device is currently configured with "MyDialPlan1" and "MyDialPlan2", the rules of "MyDialPlan1" in the imported file replace the rules of "MyDialPlan1" on the device, and the rules of "MyDialPlan2" on the device are deleted (the Dial Plan name itself remains).

#### ➤ To import Dial Plan rules for a specific Dial Plan:

1. Open the Dial Plan table.
2. Select the required Dial Plan, and then click the **Dial Plan Rule** link; the Dial Plan Rule table opens, displaying all the rules of the selected Dial Plan.
3. From the 'Action' drop-down menu, choose **Import**; the following dialog box appears:

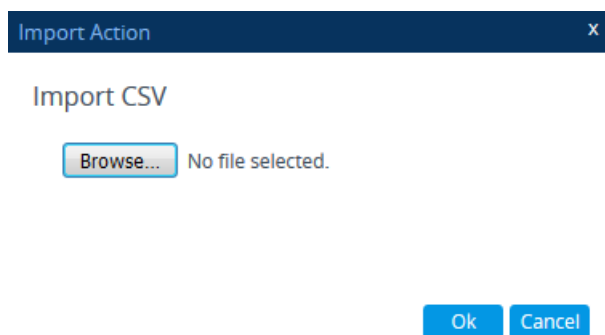

4. Use the **Browse** button to select the Dial Plan file on your PC, and then click **OK**.



The rules in the imported file replace **all** existing rules of the specific Dial Plan.

### Creating Dial Plan Files

You can configure Dial Plans in an external file (\*.csv) and then import them into the device, as described in [Importing and Exporting Dial Plans](#). You can create the file using any text-based editor such as Notepad or Microsoft Excel. The file must be saved with the \*.csv file name extension.

To configure Dial Plans in a file, use the following syntax:

```
DialPlanName,Name,Prefix,Tag
```

Where:

- *DialPlanName*: Name of the Dial Plan.
- *Name*: Name of the dial plan rule belonging to the Dial Plan.

- *Prefix*: Source or destination number prefix.
- *Tag*: Result of the user categorization and can be used as matching characteristics for routing and outbound manipulation

For example:

```
DialPlanName,Name,Prefix,Tag
PLAN1,rule_100,5511361xx,A
PLAN1,rule_101,551136184[4000-9999]#,B
MyDialPlan,My_rule_200,5511361840000#,itsp_1
MyDialPlan,My_rule_201,66666#,itsp_2
```

## Exporting Dial Plans

You can export your configured Dial Plans in comma-separated value (CSV) file format to a folder on the local PC running the Web client.



The CLI lets you export Dial Plans and Dial Plan rules to a remote server, using the `export-csv-to` command under `(config-voip)# sbc dial-plan`. For more information, refer to the *CLI Reference Guide*.

### ➤ To export all configured Dial Plans with their corresponding Dial Plan rules:

1. Open the Dial Plan table.
2. From the 'Action' drop-down menu, choose **Export**; the following dialog box appears:

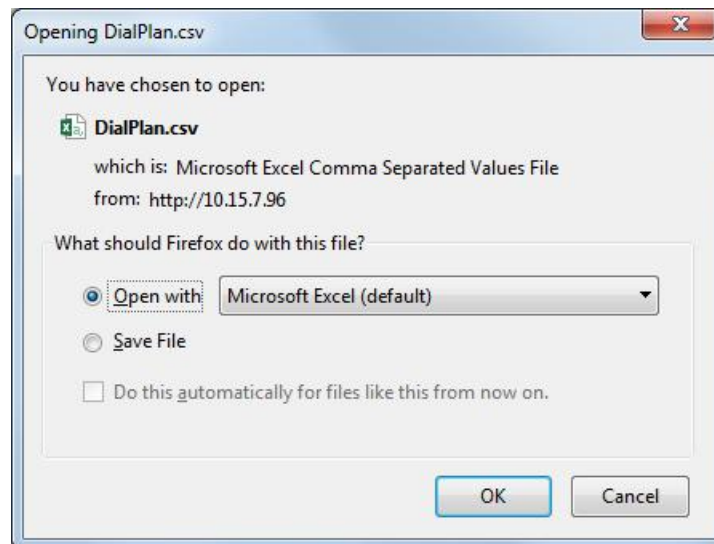

3. Select the **Save File** option, and then click **OK**; the file is saved to the default folder on your PC for downloading files.



➤ **To export Dial Plan rules of a specific Dial Plan:**

1. Open the Dial Plan table.
2. Select the required Dial Plan, and then click the **Dial Plan Rule** link; the Dial Plan Rule table opens, displaying the rules of the selected Dial Plan.
3. From the 'Action' drop-down menu, choose **Export**; a dialog box appears (as shown above).
4. Select the **Save File** option, and then click **OK**; the file is saved to the default folder on your PC for downloading files.

## Using Dial Plan Tags for SBC IP-to-IP Routing

You can use Dial Plan tags with IP-to-IP Routing rules in the IP-to-IP Routing table, where tags can be used for the following:

- Matching routing rules by source and/or destination prefix numbers (see [Using Dial Plan Tags for Matching Routing Rules](#))
- Locating destination IP Group (see [Using Dial Plan Tags for Routing Destinations](#))

## Using Dial Plan Tags for Matching Routing Rules

For deployments requiring hundreds of routing rules (which may exceed the maximum number of rules that can be configured in the IP-to-IP Routing table), you can employ tags to represent the many different calling (source URI user name) and called (destination URI user name) prefix numbers in your routing rules. Tags are typically implemented when you have users of many different called and/or calling numbers that need to be routed to the same destination (e.g., IP Group or IP address). In such a scenario, instead of configuring many routing rules to match all the required prefix numbers, you need only to configure a single routing rule using the tag to represent all the possible prefix numbers.

An example scenario where employing tags could be useful is in deployments where the device needs to service calls in a geographical area that consists of hundreds of local area codes, where each area code is serviced by one of two SIP Trunks in the network. In such a deployment, instead of configuring hundreds of routing rules to represent each local area code, you can simply configure two routing rules where each is assigned a unique tag representing a group of local area codes and the destination IP Group associated with the SIP Trunk servicing them.



- Source and destination tags can be used in the same routing rule.
- The same tag can be used for source and destination tags in the same routing rule.

➤ **To configure IP-to-IP routing based on tags:**

1. In the Dial Plan table, configure a Dial Plan (see [Configuring Dial Plans](#)). For example, the Dial Plan file below defines two tags, "LOC" and "INTL" to represent different called

number prefixes for local and long distance (International) calls:

INDEX ↕	NAME	PREFIX	TAG
0	Local	42520[3-5]	LOC
1	Local	425207	LOC
2	Local	42529	LOC
3	International	425200	INTL
4	International	425100	INTL

- For the IP Group or SRD associated with the calls for which you want to use tag-based routing, assign the Dial Plan that you configured in Step 1.
  - IP Groups table: 'Dial Plan' parameter (IPGroup\_SBCDialPlanName) - see [Configuring IP Groups](#)
  - SRDs table: 'Dial Plan' parameter (SRD\_SBCDialPlanName) - see [Configuring SRDs](#)
- In the IP-to-IP Routing table (see [Configuring SBC IP-to-IP Routing Rules](#)), configure a routing rule with the required destination and whose matching characteristics include the tag(s) that you configured in your Dial Plan in Step 1. The tags are assigned under the **Match** group, using the following parameters:
  - 'Source Tags' parameter (IP2IPRouting\_SrcTags): tag denoting the calling user
  - 'Destination Tags' parameter (IP2IPRouting\_DestTags): tag denoting the called user

### Using Dial Plan Tags for Routing Destinations

You can use Dial Plan tags for determining the destination (IP Group) of an IP-to-IP Routing rule. One of the benefits of using Dial Plan tags is that it can reduce the number of IP-to-IP Routing rules that you would normally need to configure. For example, assume that you need to route calls from IP Group "A" to two different IP Groups, "B" and "C", based on called (destination) prefix number (e.g., 102 and 103). When not using Dial Plan tags, you would need to configure two IP-to-IP Routing rules, where one rule sends calls with prefix number 102 to IP Group "B" and another rule sends calls with prefix number 103 to IP Group "C". However, when using Dial Plan tags, you would need to configure only a single IP-to-IP Routing rule whose destination IP Group is based on a Dial Plan tag.

The following briefly describes the process for using Dial Plan tags in IP-to-IP Routing rules:

- The device searches the Dial Plan Index, associated with the source IP Group of the incoming SIP dialog, for a Dial Plan rule whose 'Prefix' parameter is configured with the same called prefix number as the SIP dialog (e.g., 102). If found, the device inspects the tags in the 'Tag' parameter (e.g., "Country=England;City=London;Essex") configured for that Dial Plan rule.
- The device searches for a matching rule in the IP-to-IP Routing table and if the 'Destination Type' parameter is configured to **Destination Tag**, it checks the tag name configured in the 'Routing Tag Name' parameter and compares it with the tags found in the Dial Plan rule. If the 'Routing Tag Name' parameter is configured as "default", the device selects the first tag name in the Dial Plan rule that is configured without a value, for example, "Essex" (see

Step 1). If the 'Routing Tag Name' parameter is configured with a specific tag name (e.g., "Country"), the device selects the tag name with its value (e.g., "Country=England") in the Dial Plan rule.

3. The device searches the IP Groups table and IP Group Set table for an IP Group whose 'Tags' parameter is configured with the same tag as selected from the Dial Plan rule. If found, the device routes the call to this IP Group.

The following figure displays the device's SIP dialog processing when Dial Plan tags are used to determine the destination IP Group:

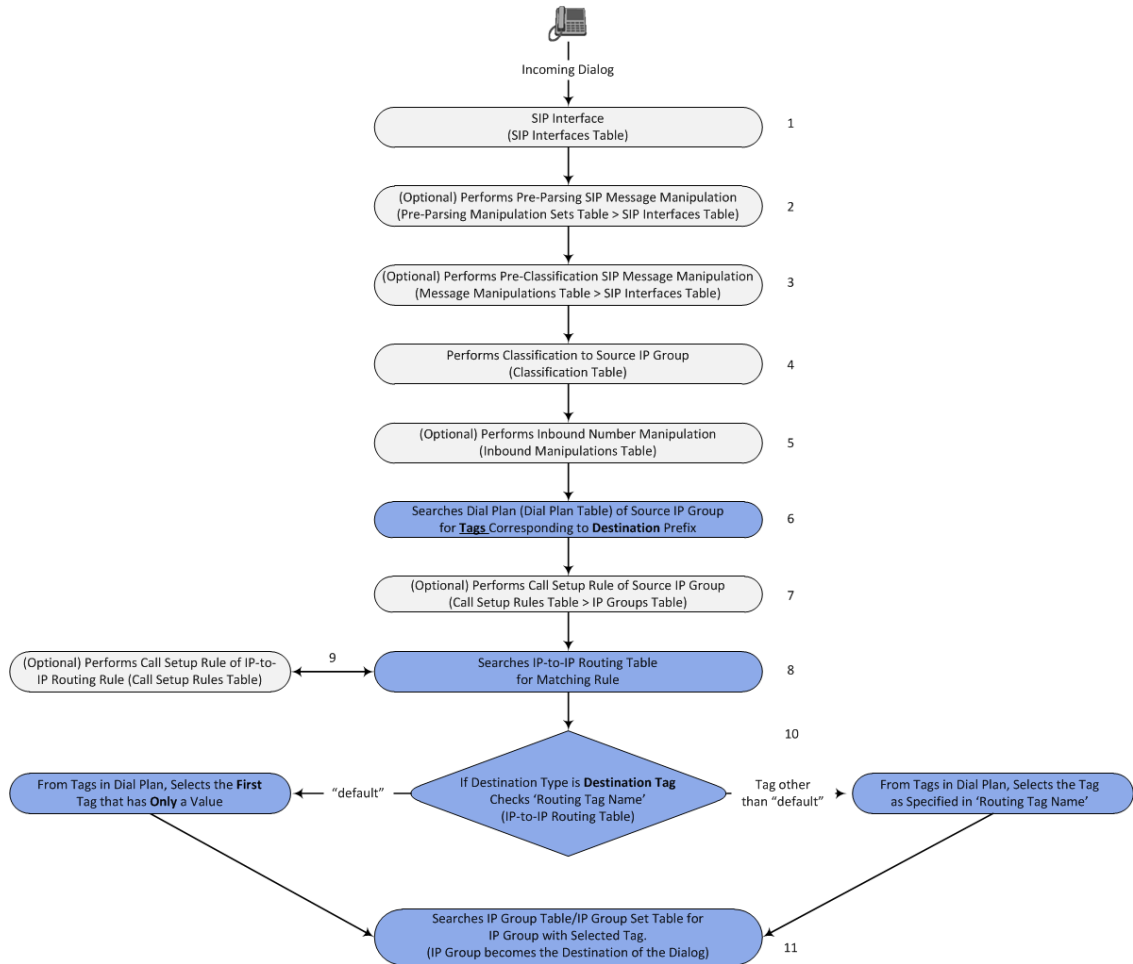

The following procedure describes how to configure routing to destination IP Groups determined by Dial Plan tags. The procedure is based on the following example scenario: Calls from IP Group "HQ" with destination (called) prefix number 102 are sent to IP Group "ENG" while calls with destination prefix number 103 are sent to IP Group "BEL". The destination IP Groups are determined by the Dial Plan tags, where the tag "Country=England" is used to send calls to IP Group "ENG" and the tag "Country=Belgium" is used to send calls to IP Group "BEL".

➤ **To configure routing to destination IP Groups based on Dial Plan tags:**

1. In the Dial Plan table, configure a Dial Plan with Dial Plan rules, where the 'Prefix' parameter is the **destination** (called) prefix number. In our example, we will configure a Dial Plan called "Dial Plan 1" with two Dial Plan rules:

Parameter	Index 0	Index 1
Name	UK	Bel-Neth
Prefix	102	103
Tag	Country=England;City=London	Holland;City=Amsterdam;Country=Belgium

The following displays the configuration in the Web interface of the Dial Plan rule for Index 0:

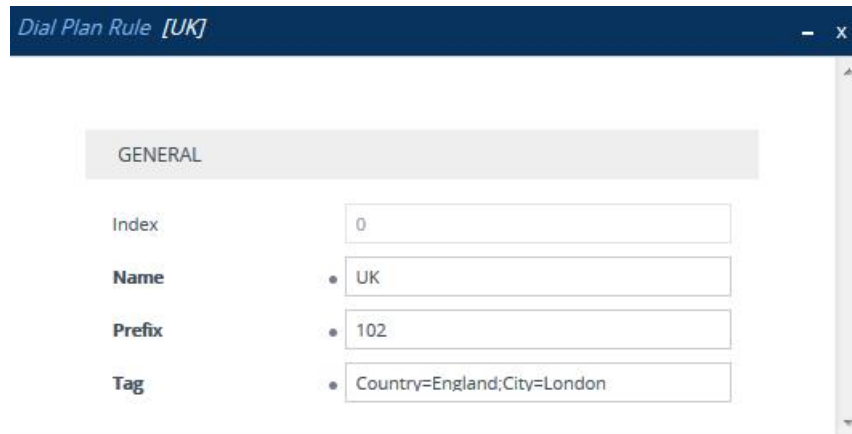

- In the IP Groups table, configure your IP Groups. Make sure that you assign the source IP Group with the Dial Plan that you configured in Step 1 and that you configure each destination IP Group with one of the required Dial Plan tags. If the tag has a value, include it as well. In our example, we will configure three IP Groups:

Parameter	Index 0	Index 1	Index 2
Name	HQ	ENG	BEL
Dial Plan	Dial Plan 1	-	-
Tags	-	Country=England	Country=Belgium

- In the IP-to-IP Routing table, configure a routing rule where the 'Destination Type' parameter is configured to **Destination Tag** and the 'Routing Tag Name' to one of your Dial Plan tags. In our example, the tag "Country" is used:

Parameter	Index 0
Name	Europe
Source IP Group	HQ
Destination Type	Destination Tag
Routing Tag Name	Country



- Please adhere to the following regarding the 'Tag' parameter in the Dial Plan Rule table:
  - ✓ Only one tag name **without** a value can be configured. In the above example, "Holland" is the tag name without a value. If an additional tag name is configured, for example, "Holland;France", the setting is invalid.
  - ✓ Tag names with values (i.e., name=value) must be unique within a Dial Plan rule. In the above example, "Country=England" is a tag name with value. Configuring the parameter with "Country=England;Country=Scotland" is invalid. A valid configuration would be "Country=England;Country1=Scotland".
- Configure the 'Routing Tag Name' parameter with only the name of the tag (i.e., without the value, if exists). For example, instead of "Country=England", configure it as "Country" only.
- If the same Dial Plan tag is configured for an IP Group in the IP Groups table and an IP Group Set in the IP Group Set table, the IP Group Set takes precedence and the device sends the SIP dialog to the IP Group(s) belonging to the IP Group Set.

### Dial Plan Backward Compatibility



This section is for backward compatibility **only**. It is recommended to migrate your Dial Plan configuration to the latest Dial Plan feature (see [Using Dial Plan Tags for IP-to-IP Routing](#)).

Configure prefix tags in the Dial Plan file using the following syntax:

```
[ PLAN<index> ]
<prefix number>,0,<prefix tag>
```

where:

- *Index* is the Dial Plan index
- *prefix number* is the called or calling number prefix (ranges can be defined in brackets)
- *prefix tag* is the user-defined prefix tag of up to nine characters, representing the prefix number

Each prefix tag type - called or calling - must be configured in a dedicated Dial Plan index number. For example, Dial Plan 1 can be for called prefix tags and Dial Plan 2 for calling prefix tags.

The example Dial Plan file below defines the prefix tags "LOCL" and "INTL" to represent different called number prefixes for local and long distance calls:

```
[ PLAN1 ]
42520[3-5],0,LOCL
425207,0,LOCL
42529,0,LOCL
```

```
425200,0,INTL
425100,0,INTL
....
```



- Called and calling prefix tags can be used in the same routing rule.
- When using prefix tags, you need to configure manipulation rules to remove the tags before the device sends the calls to their destinations.

The following procedure describes how to configure IP-to-IP routing using prefix tags.

➤ **To configure IP-to-IP routing using prefix tags:**

1. Configure a Dial Plan file with prefix tags, and then load the file to the device.
2. Add the prefix tags to the numbers of specific incoming calls using Inbound Manipulation rules:
  - a. Open the Inbound Manipulations table (see [Configuring IP-to-IP Inbound Manipulations](#)), and then click **New**.
  - b. Configure matching characteristics for the incoming call (e.g., set 'Source IP Group' to "1").
  - c. From the 'Manipulated Item' drop-down list, select **Source** to add the tag to the calling URI user part, or **Destination** to add the tag to the called URI user part.
  - d. Configure the Dial Plan index for which you configured your prefix tag, in the 'Prefix to Add' or 'Suffix to Add' fields, using the following syntax: \$DialPlan<x>, where x is the Dial Plan index (0 to 7). For example, if the called number is 4252000555, the device manipulates it to LOCL4252000555.
3. Add an SBC IP-to-IP routing rule using the prefix tag to represent the different source or destination URI user parts:
  - a. Open the IP-to-IP Routing table (see [Configuring SBC IP-to-IP Routing Rules](#)), and then click **New**.
  - b. Configure the prefix tag in the 'Source Username Pattern' or 'Destination Username Pattern' fields (e.g., "LOCL", without the quotation marks).
  - c. Continue configuring the rule as required.
4. Configure a manipulation rule to remove the prefix tags before the device sends the message to the destination:
  - a. Open the Outbound Manipulations table (see [Configuring IP-to-IP Outbound Manipulations](#)), and then click **New**.
  - b. Configure matching characteristics for the incoming call (e.g., set 'Source IP Group' to "1"), including calls with the prefix tag (in the 'Source Username Pattern' or 'Destination Username Pattern' fields, enter the prefix tag to remove).

- c. Configure the 'Remove from Left' or 'Remove from Right' fields (depending on whether you added the tag at the beginning or end of the URI user part, respectively), enter the number of characters making up the tag.

## Using Dial Plan Tags for SBC Outbound Manipulation

You can use Dial Plan tags to denote source and/or destination URI user names in Outbound Manipulation rules in the Outbound Manipulations table.

### ➤ To configure Outbound Manipulation based on tags:

1. In the Dial Plan table, configure a Dial Plan (see [Configuring Dial Plans](#)).
2. In the IP Group or SRD associated with the calls for which you want to use tag-based routing, assign the Dial Plan that you configured in Step 1.
  - IP Groups table: 'Dial Plan' parameter (IPGroup\_SBCDialPlanName) - see [Configuring IP Groups](#)
  - SRDs table: 'Dial Plan' parameter (SRD\_SBCDialPlanName) - see [Configuring SRDs](#)
3. In the Outbound Manipulations table (see [Configuring IP-to-IP Outbound Manipulations](#)), configure a rule with the required manipulation and whose matching characteristics include the tag(s) that you configured in your Dial Plan in Step 1. The tags are assigned using the following parameters:
  - 'Source Tags' parameter (IPOutboundManipulation\_SrcTags): tag denoting the calling users
  - 'Destination Tags' parameter (IPOutboundManipulation\_DestTags): tag denoting the called users

## Using Dial Plan Tags for Call Setup Rules

You can use Dial Plan tags in Call Setup rules, configured in the Call Setup Rules table (see [Configuring Call Setup Rules](#)). The Call Setup rule can be assigned to an IP Group and is processed by the device for the classified source IP Group immediately before the routing process (i.e., Classification > Manipulation > Dial Plan table > Call Setup rules > Routing). The result of the Call Setup rule (i.e., source and/or destination tag) can be used as the matching characteristics for locating a suitable IP-to-IP Routing rule in the IP-to-IP Routing table.

You can configure Call Setup rules to query the Dial Plan table for a specified key (prefix) in a specified Dial Plan to obtain the corresponding tag. The Call Setup rule can then perform many different manipulations (based on Message Manipulation syntax), including modifying the name of the tag. The tags can be used only in the 'Condition', 'Action Subject' and 'Action Value' fields.

## Using Dial Plans for IP-to-Tel or Tel-to-IP Call Routing

For deployments requiring hundreds of routing rules (which may exceed the maximum number of rules that can be configured in the routing tables), you can employ Dial Plan tags to

represent the many different calling (source) and called (destination) prefix numbers as matching input characteristics in your IP-to-Tel and Tel-to-IP routing rules. Tags are typically implemented when you have users of many different called and/or calling numbers that need to be routed to the same destination. In such a scenario, instead of configuring many routing rules to match all the required prefix numbers, you need only to configure a single routing rule using the tag to represent all the possible prefix numbers.

An example scenario where employing tags could be useful is in deployments where the device needs to service calls in a geographical area that consists of many local area codes, where the area codes are serviced by different SIP Trunks (for Tel-to-IP) and Trunk Groups (for IP-to-Tel). Another example includes routing local calls and International calls using different SIP Trunks. In such a scenario, instead of configuring hundreds of routing rules to represent each local area code and the International dialing code, you can simply configure two routing rules where one is assigned a unique tag representing the local area codes and the other is assigned a tag representing International calls.



- Source and destination tags can be used in the same routing rule.
- The same tag can be used for source and destination tags in the same routing rule.

The procedure below describes how to configure tag-based routing for Gateway calls based on the following example setup:

- Tel-to-IP routing: Local calls whose destination tag is "NYPSP0" are routed to IP Group "SP-0" and calls whose destination tag is "NYPSP1" are routed to IP Group "SP-1".
- IP-to-Tel routing: Local calls whose destination tag is "NYPSP0" are routed to Trunk Group 1 and calls whose destination tag is "NYPSP1" are routed to Trunk Group 2.

➤ **To configure tag-based routing for IP-to-Tel and Tel-to-IP calls:**

1. Open the Dial Plan table (see [Configuring Dial Plans](#)), and then configure your Dial Plan rules, for example:

Dial Plan Name	Dial Plan Rule			Comment
	Name	Prefix	Tag	
TEL2IP	Local1	21[2-4]	NYPSP0	Denotes local area codes with prefixes 212, 213, and 214
	Local2	332	NYPSP0	Denotes local area code with prefix 332
	Local3	34[7,9]	NYPSP1	Denotes local area codes with prefixes 347 and 349
	Local4	9 [17,29]	NYPSP1	Denotes local area codes with prefixes 917 and 929



Dial Plan Name	Dial Plan Rule			Comment
IP2TEL	Local1	21[2-4]	NYPSP0	See above
	Local2	332	NYPSP0	See above
	Local3	34[7,9]	NYPSP1	See above
	Local4	9 [17,29]	NYPSP1	See above

- Open the Routing Settings page (**Setup** menu > **Signaling & Media** tab > **Gateway** folder > **Routing** > **Routing Settings**), and then specify the Dial Plan names that you want to use for each routing table:
  - In the 'IP-to-Tel Dial Plan Name' parameter, enter the name of the Dial Plan (e.g., "IP2TEL") that you want to use for IP-to-Tel routing rules.
  - In the 'Tel-to-IP Dial Plan Name' parameter, enter the name of the Dial Plan (e.g., "TEL2IP") that you want to use for Tel-to-IP routing rules.

IP-to-Tel DialPlan Name

• IP2TEL

Tel-to-IP DialPlan Name

• TEL2IP



Dial Plan names are case-sensitive.

- Open the Tel-to-IP Routing table (see [Configuring Tel-to-IP Routing Rules](#) on page 734), and then configure a routing rule with the required destination and whose matching characteristics include the tag(s) that you configured in your Dial Plan for Tel-to-IP routing. The tags are assigned using the 'Source Tag' and 'Destination Tag' parameters. In our example, configure two routing rules:
  - Routing rule 1:
    - 'Destination Tag': **NYPSP0**
    - 'Destination IP Group': **SP-0**
  - Routing rule 2:
    - 'Destination Tag': **NYPSP1**
    - 'Destination IP Group': **SP-1**
- Open the IP-to-Tel Routing table (see [Configuring IP-to-Tel Routing Rules](#) on page 747), and then configure a routing rule with the required destination and whose matching characteristics include the tag(s) that you configured in your Dial Plan for IP-to-Tel routing.

The tags are assigned using the 'Source Tag' and 'Destination Tag' parameters. In our example, configure two routing rules:

- Routing rule 1:
  - ◆ 'Destination Tag': **NYPSP0**
  - ◆ 'Destination Type': **Trunk Group**
  - ◆ 'Trunk Group ID': **1**
- Routing rule 2:
  - ◆ 'Destination Tag': **NYPSP1**
  - ◆ 'Destination Type': **Trunk Group**
  - ◆ 'Trunk Group ID': **2**

## Using Dial Plan Tags for Message Manipulation

You can use Dial Plan tags (*srctags* and *dsttags*) in Message Manipulation rules, configured in the Message Manipulations table (see [Configuring SIP Message Manipulation](#)). The tags can be used only in the 'Condition' and 'Action Value' fields. For example, you can configure a rule that adds the SIP header "City" with the value "ny" (i.e., City: ny) to all outgoing SIP INVITE messages associated with the source tag "ny":

The screenshot shows the 'Message Manipulations' configuration window with the following settings:

GENERAL		ACTION	
Index	0	Action Subject	header.City
Name	New Header for Tag ny	Action Type	Add
Manipulation Set ID	0	Action Value	srctags
Row Role	Use Current Condition		
MATCH			
Message Type	invite.request		
Condition	srctags=='ny'		



Dial Plan tags cannot be modified using Message Manipulation rules.

## Configuring Push Notification Servers

The Push Notification Servers table lets you configure up to five Push Notification Servers. The device uses this table to determine which Push Notification Server to send push notification

requests for a specific user. The device searches the table for a row that is configured with the user's 'pn-provider' parameter value and if located, sends the push notification request to the Push Notification Server, using the address of the associated Remote Web Service.

The Push Notification Service uses Push Notification Servers to send push notifications to "wake" end-user equipment (typically, mobile platforms) that have gone to "sleep" (e.g., to save resources such as battery life) so that they can receive traffic. The device can handle calls (and registration) for such SIP user agents (UAs), by interoperating with these third-party, Push Notification Servers (over HTTP, using RESTful APIs). For more information on Push Notification Service, see [Configuring Push Notification Service](#) on page 1050.

Before you can configure a Push Notification Server in this table, you need to configure a Remote Web Service (HTTP-based server) to represent the Push Notification Server. The Remote Web Service defines the actual address (and other required parameters) of the server. You must configure the Remote Web Service with the 'Type' parameter set to **General**. To configure Remote Web Services, see [Configuring Remote Web Services](#) on page 299.



The Push Notification Service is applicable only to the SBC application.

The following procedure describes how to configure Push Notification Servers through the Web interface. You can also configure it through ini file [PushNotificationServers] or CLI (configure voip > sip-definition push-notification-servers).

#### ➤ To configure Push Notification Server:

1. Open the Push Notification Servers table (**Setup** menu > **Signaling & Media** tab > **SIP Definitions** folder > **Push Notification Servers**).
2. Click **New**; the following dialog box appears:

3. Configure a Push Notification Server according to the parameters described in the table below.
4. Click **Apply**.

**Table 20-8: Push Notification Servers Table Parameter Descriptions**

Parameter	Description
'Index'	Defines an index number for the new table row.

Parameter	Description
[PushNotificationServers_Index]	<b>Note:</b> Each row must be configured with a unique index.
'Provider' provider [PushNotificationServers_Provider]	<p>Defines the type of the Push Notification Service. The type of the service provider is indicated in the SIP Contact header's 'pn-provider' parameter of the REGISTER message that is sent by the user to the device. For example, Android-based mobile phone platforms typically use Firebase Cloud Messaging (FCM) for its Push Notification Service. The value of the 'pn-provider' parameter for this service type is "fcm". Therefore, you would need to configure the 'Provider' parameter to "cfm" (without quotation marks).</p> <p>The valid value is a string of up to 10 characters. By default, no value is defined. To denote any provider, use the asterisk (*) wildcard character.</p> <p><b>Note:</b></p> <ul style="list-style-type: none"> <li>■ You can configure this parameter to the * wildcard character for only one table row.</li> <li>■ The parameter is mandatory.</li> </ul>
'Remote Web Service' remote-http-service [PushNotificationServers_RemoteHTTPService]	<p>Assigns a Remote Web Service, which defines the URL address (and other related parameters) of the HTTP-based Push Notification Server.</p> <p>To configure Remote Web Services, see <a href="#">Configuring Remote Web Services</a> on page 299.</p> <p><b>Note:</b> The parameter is mandatory.</p>
'Protocol' protocol [PushNotificationServers_Protocol]	<p>Defines the protocol for exchanging information between the device and the Push Notification Server.</p> <ul style="list-style-type: none"> <li>■ [0] AC-Proprietary = (Default) The device exchanges information with the server using the JavaScript Object Notation (JSON) format.</li> </ul>

## 21 SIP Message Manipulation

This section describes SIP message manipulation.

### Configuring SIP Message Manipulation

The Message Manipulations table lets you configure up to 200 Message Manipulation rules. A Message Manipulation rule defines a manipulation sequence for SIP messages. SIP message manipulation enables the normalization of SIP messaging fields between communicating network segments. For example, it allows service providers to design their own policies on the SIP messaging fields that must be present before a SIP call enters their network. Similarly, enterprises and small businesses may have policies for the information that can enter or leave their networks for policy or security reasons from a service provider. SIP message manipulations can also be implemented to resolve incompatibilities between SIP devices inside the enterprise network.

Each Message Manipulation rule is configured with a Manipulation Set ID. You can create groups (sets) of Message Manipulation rules by assigning each of the relevant Message Manipulation rules to the same Manipulation Set ID. The Manipulation Set ID is then used to assign the rules to specific calls:

- SBC application: Message manipulation rules can be applied pre- or post-classification:
  - Pre-classification Process: Message manipulation can be done on incoming SIP dialog-initiating messages (e.g., INVITE) prior to the classification process. You configure this by assigning the Manipulation Set ID to the SIP Interface on which the call is received (see [Configuring SIP Interfaces](#)).
  - Post-classification Process: Message manipulation can be done on inbound and/or outbound SIP messages after the call has been successfully classified. Manipulation occurs only after the routing process - inbound message manipulation is done first, then outbound number manipulation (see [Configuring IP-to-IP Outbound Manipulations](#)), and then outbound message manipulation. For viewing the call processing flow, see [Call Processing of SIP Dialog Requests](#). You configure this by assigning the Manipulation Set ID to the relevant IP Group in the IP Groups table (see [Configuring IP Groups](#)).
- Gateway application: Message Manipulation rules are applied to calls as follows:
  - Manipulating Inbound SIP INVITE Messages: Message manipulation can be applied only to all inbound calls (not specific calls). This is done by assigning a Manipulation Set ID to the "global" ini file parameter, GWInboundManipulationSet.
  - Manipulating Outbound SIP INVITE Messages: Message manipulation can be done for specific calls, by assigning a Manipulation Set ID to an IP Group in the IP Groups table, using the 'Outbound Message Manipulation Set' parameter. Message manipulation can be applied to all outbound calls (except for IP Groups that have been assigned a Manipulation Set ID). This is done by assigning a Manipulation Set ID to the "global" ini file parameter, GWOutboundManipulationSet.

- SIP requests initiated by the device (Gateway and SBC applications): You can apply Message Manipulation rules to SIP requests that are initiated by the device, for example, SIP REGISTERS for certain entities (e.g., Accounts) and keep-alive by SIP OPTIONS. If the destination of the request is an IP Group, then the device uses the Inbound and Outbound Manipulation Sets that are assigned to the IP Group. If there is no IP Group for the destination or the IP Group is not assigned an Inbound or Outbound Manipulation Set, then the global parameters GWInboundManipulationSet or GWOutboundManipulationSet are used. The GWInboundManipulationSet parameter defines the Message Manipulation Set that is applied to incoming responses for requests that the device initiated. The GWOutboundManipulationSet parameter defines the Message Manipulation Set that is applied to outgoing requests that the device initiates.

The device also supports a built-in SIP message normalization feature that can be enabled per Message Manipulation rule. The normalization feature removes unknown SIP message elements before forwarding the message. These elements can include SIP headers, SIP header parameters, and SDP body fields.

The SIP message manipulation feature supports the following:

- Manipulation on SIP message type (Method, Request/Response, and Response type)
- Addition of new SIP headers
- Removal of SIP headers ("black list")
- Modification of SIP header components such as values, header values (e.g., URI value of the P-Asserted-Identity header can be copied to the From header), call's parameter values
- Deletion of SIP body (e.g., if a message body is not supported at the destination network this body is removed)
- Translating one SIP response code to another
- Topology hiding (generally present in SIP headers such as Via, Record Route, Route and Service-Route).
- Configurable identity hiding (information related to identity of subscribers, for example, P-Asserted-Identity, Referred-By, Identity and Identity-Info)
- Multiple manipulation rules on the same SIP message
- Apply conditions per rule - the condition can be on parts of the message or call's parameters
- Multiple manipulation rules using the same condition. The following figure shows a configuration example where Rules #1 and #2 ('Row Rule' configured to **Use Previous Condition**) use the same condition as configured for Rule #0 ('Row Rule' configured to **Use Current Condition**). For more information, see the description of the 'Row Rule' parameter in this section.

INDEX	NAME	MANIPULATION SET ID	MESSAGE TYPE	CONDITION	ACTION SUBJECT	ACTION TYPE	ACTION VALUE	ROW ROLE
0	To Header Urgent	1	Invite.Request	Header:Request-URI:URI	Header.To	Modify	Header.To + ";urgent=1"	Use Current Condition
1	Add Emergency	1			Header.Priority	Add	'emergency'	Use Previous Condition
2	User-Agent	1			Header.User-Agent	Modify	'trunk-a'	Use Previous Condition

The following figure illustrates an example of a SIP message that is manipulated by the device as follows:

1. Removes the "Unknown\_header: unknown\_value" in the incoming message.
2. Changes the P-Asserted-Identity header value to "sip:200@10.33.216.1" in the outgoing message.

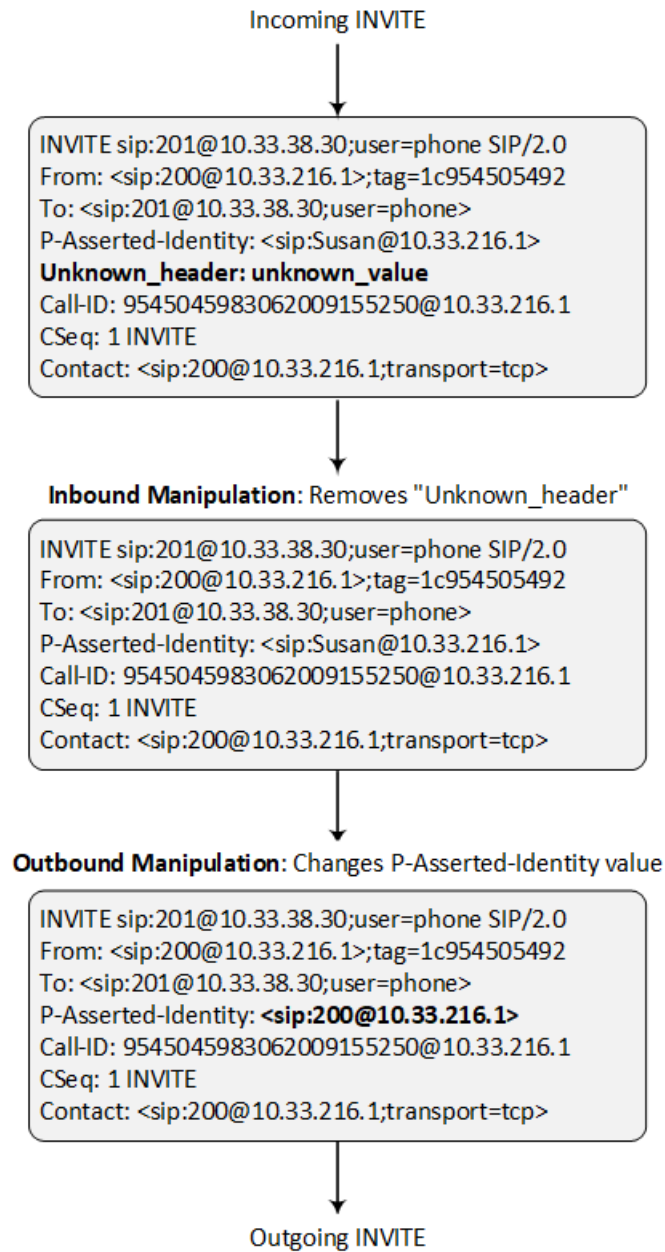

This manipulation example is done by configuring two Message Manipulation rules, where Rule #1 is assigned to the source IP Group and Rule #2 to the destination IP Group.

Parameter	Rule 1	Rule 2
Message Type	Invite.request	Invite.request

Parameter	Rule 1	Rule 2
Condition	Header.Unkown_header !contains 'unknown_value'	Header.P-Asserted-Identity.URL.User == 'Susan'
Action Subject	Header.Unkown_header	Header.P-Asserted-Identity
Action Type	Remove	Modify
Action Value		'<sip:200@212.3.216.1>'



- For a detailed description of the syntax used for configuring Message Manipulation rules, refer to the *Syntax for SIP Message Manipulation Reference Guide*.
- For the SBC application: Inbound message manipulation is done only after the Classification, inbound and outbound number manipulation, and routing processes.
- Each message can be manipulated twice - on the source leg and on the destination leg (i.e., source and destination IP Groups).
- Unknown SIP parts can only be added or removed.
- SIP manipulations do not allow you to remove or add mandatory SIP headers. They can only be modified and only on requests that initiate new dialogs. Mandatory SIP headers include To, From, Via, CSeq, Call-Id, and Max-Forwards.
- The SIP Group Name (IPGroup\_SIPGroupName) parameter overrides inbound message manipulation rules that manipulate the host name in Request-URI, To, and/or From SIP headers. If you configure a SIP Group Name for the IP Group (see [Configuring IP Groups](#)) and you want to manipulate the host name in these SIP headers, you must apply your manipulation rule (Manipulation Set ID) to the IP Group as an Outbound Message Manipulation Set (IPGroup\_OutboundManSet), when the IP Group is the destination of the call. If you apply the Manipulation Set as an Inbound Message Manipulation Set (IPGroup\_InboundManSet), when the IP Group is the source of the call, the manipulation rule will be overridden by the SIP Group Name.

The following procedure describes how to configure Message Manipulation rules through the Web interface. You can also configure it through ini file [MessageManipulations] or CLI (configure voip > message message-manipulations).

➤ **To configure SIP message manipulation rules:**

1. Open the Message Manipulations table (**Setup** menu > **Signaling & Media** tab > **Message Manipulation** folder > **Message Manipulations**).
2. Click **New**; the following dialog box appears:



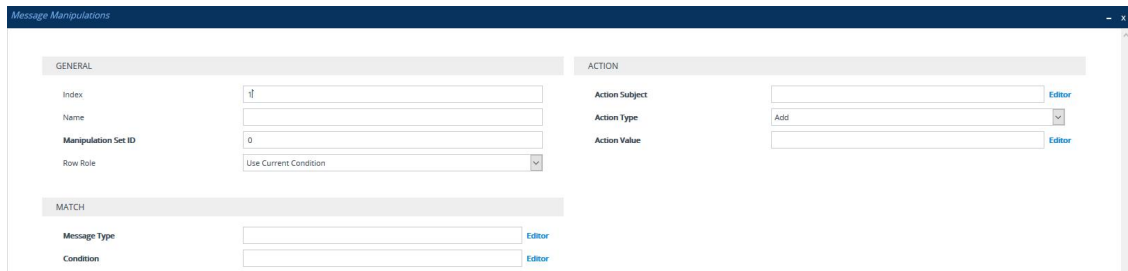

3. Configure a Message Manipulation rule according to the parameters described in the table below.

4. Click **Apply**.

An example of configured message manipulation rules are shown in the figure below:

INDEX ↕	NAME	MANIPULATION SET ID	MESSAGE TYPE	CONDITION	ACTION SUBJECT	ACTION TYPE	ACTION VALUE
0	ITSP A	0	invite.response.200		header.to.url.user	Add Suffix	'.com'
1		0	invite.response.200		header.from.url.user	Modify	header.p-asserted-id.url.user
2		0	invite.request		header.from.url.user	Modify	'200'
3		2	invite.request	header.from.url.user==Unknown	header.from.url.user	Modify	param.ipg.src.user
4		2	invite.request		header.priority	Remove	

- **Index 0:** Adds the suffix ".com" to the host part of the To header.
- **Index 1:** Changes the user part of the From header to the user part of the P-Asserted-ID.
- **Index 2:** Changes the user part of the SIP From header to "200".
- **Index 3:** If the user part of the From header equals "unknown", then it is changed according to the srcIPGroup call's parameter.
- **Index 4:** Removes the Priority header from an incoming INVITE message.

**Table 21-1: Message Manipulations Parameter Descriptions**

Parameter	Description
General	
'Index' [MessageManipulations_Index]	Defines an index number for the new table row. <b>Note:</b> Each row must be configured with a unique index.
'Name' manipulation-name [MessageManipulations_ManipulationName]	Defines a descriptive name, which is used when associating the row in other tables. The valid value is a string of up to 40 characters.
'Manipulation Set ID' manipulation-set-id [MessageManipulations_ManSetID]	Defines a Manipulation Set ID for the rule. You can define the same Manipulation Set ID for multiple rules to create a group of rules. The Manipulation Set ID is used to assign the

Parameter	Description
	<p>manipulation rules to an IP Group (in the IP Groups table) for inbound and/or outbound messages.</p> <p>The valid value is 0 to 19. The default is 0.</p>
<p>'Row Role' row-role [MessageManipulations_RowRole]</p>	<p>Determines which message manipulation condition (configured by the 'Condition' parameter) to use for the rule.</p> <ul style="list-style-type: none"> <li>■ [0] <b>Use Current Condition</b> = (Default) The condition configured in the table row of the rule is used.</li> <li>■ [1] <b>Use Previous Condition</b> = The condition configured in the first table row above the rule that is configured to <b>Use Current Condition</b> is used. For example, if Index 3 is configured to <b>Use Current Condition</b> and Index 4 and 5 are configured to <b>Use Previous Condition</b>, Index 4 and 5 use the condition configured for Index 3. A configuration example is shown in the beginning of this section. The option allows you to use the same condition for multiple manipulation rules.</li> </ul> <p><b>Note:</b></p> <ul style="list-style-type: none"> <li>■ When configured to <b>Use Previous Condition</b>, the 'Message Type' and 'Condition' parameters are not applicable and if configured are ignored.</li> <li>■ When multiple manipulation rules apply to the same header, the next rule applies to the resultant string of the previous rule.</li> </ul>
Match	
<p>'Message Type' message-type [MessageManipulations_MessageType]</p>	<p>Defines the SIP message type that you want to manipulate.</p> <p>The valid value is a string (case-insensitive) denoting the SIP message. You can use the built-in syntax editor to help you configure the field. Click the <b>Editor</b> button located alongside the field to open the Editor, and then simply follow</p>

Parameter	Description
	<p>the on-screen instructions.</p> <p>For example:</p> <ul style="list-style-type: none"> <li>■ Empty = rule applies to all messages</li> <li>■ Invite = rule applies to all INVITE requests and responses</li> <li>■ Invite.Request = rule applies to INVITE requests</li> <li>■ Invite.Response = rule applies to INVITE responses</li> <li>■ subscribe.response.2xx = rule applies to SUBSCRIBE confirmation responses</li> </ul> <p><b>Note:</b> Currently, SIP 100 Trying messages cannot be manipulated.</p>
<p>'Condition' condition [MessageManipulations_Condition]</p>	<p>Defines the condition that must exist for the rule to be applied.</p> <p>The valid value is a string (case-insensitive). You can use the built-in syntax editor to help you configure the field. Click the <b>Editor</b> button located alongside the field to open the Editor, and then simply follow the on-screen instructions.</p> <p>For example:</p> <ul style="list-style-type: none"> <li>■ header.from.url.user== '100' (indicates that the user part of the From header must have the value "100")</li> <li>■ header.contact.param.expires &gt; '3600'</li> <li>■ header.to.url.host contains 'domain'</li> <li>■ param.call.dst.user != '100'</li> </ul>
Action	
<p>'Action Subject' action-subject [MessageManipulations_ActionSubject]</p>	<p>Defines the SIP header upon which the manipulation is performed.</p> <p>The valid value is a string (case-insensitive). You can use the built-in syntax editor to help you configure the field. Click the <b>Editor</b> button located alongside the field to open the Editor,</p>

Parameter	Description
	and then simply follow the on-screen instructions.
'Action Type' action-type [MessageManipulations_ActionType]	Defines the type of manipulation. <ul style="list-style-type: none"> <li>■ [0] <b>Add</b> = (Default) Adds new header/param/body (header or parameter elements).</li> <li>■ [1] <b>Remove</b> = Removes header/param/body (header or parameter elements).</li> <li>■ [2] <b>Modify</b> = Sets element to the new value (all element types).</li> <li>■ [3] <b>Add Prefix</b> = Adds value at the beginning of the string (string element only).</li> <li>■ [4] <b>Add Suffix</b> = Adds value at the end of the string (string element only).</li> <li>■ [5] <b>Remove Suffix</b> = Removes value from the end of the string (string element only).</li> <li>■ [6] <b>Remove Prefix</b> = Removes value from the beginning of the string (string element only).</li> <li>■ [7] <b>Normalize</b> = Removes unknown SIP message elements before forwarding the message.</li> </ul>
'Action Value' action-value [MessageManipulations_ActionValue]	Defines a value that you want to use in the manipulation. The default value is a string (case-insensitive) in the following syntax: <ul style="list-style-type: none"> <li>■ string/&lt;message-element&gt;/&lt;call-param&gt; +</li> <li>■ string/&lt;message-element&gt;/&lt;call-param&gt;</li> </ul> For example: <ul style="list-style-type: none"> <li>■ 'itsp.com'</li> <li>■ header.from.url.user</li> <li>■ param.call.dst.user</li> <li>■ param.call.dst.host + '.com'</li> <li>■ param.call.src.user + '&lt;' + header.from.url.user + '@' + header.p-</li> </ul>

Parameter	Description
	<p>asserted-id.url.host + '&gt;'</p> <ul style="list-style-type: none"> <li>■ Func.To-Upper(Param.Call.Src.Host)</li> </ul> <p>You can use the built-in syntax editor to help you configure the field. Click the <b>Editor</b> button located alongside the field to open the Editor, and then simply follow the on-screen instructions.</p> <p><b>Note:</b> Only single quotation marks must be used.</p>

## Configuring Message Condition Rules

The Message Conditions table lets you configure up to 82 Message Condition rules. A Message Condition defines special conditions (requisites) for incoming SIP messages. These rules can be used as additional matching criteria for the following:

- Classification rules in the Classification table (see [Configuring Classification Rules](#))
- IP-to-IP routing rules in the IP-to-IP Routing table (see [Configuring SBC IP-to-IP Routing Rules](#))
- Outbound Manipulation rules in the Outbound Manipulations table (see [Configuring IP-to-IP Outbound Manipulations](#))

Message Condition rules are configured using the same syntax as that used for Conditions when configuring Message Manipulation rules in the Message Manipulations table (see [Configuring SIP Message Manipulation](#)). You can configure simple Message Condition rules, for example, "header.to.host contains company", meaning SIP messages whose To header has a host part containing the string "company". You can configure complex rules using the "AND" or "OR" Boolean operands and also use regular expressions (regex), for example:

- "body.sdp regex pcmu" can be used to enable routing based on the offered codec (G.711 Mu) in the incoming SDP message.
- "body.sdp regex (AVP[0-9| |\s]\*\s8[\s| |\n])" can be used to enable routing based on payload type 8 in the incoming SDP message.



For a description on SIP message manipulation syntax, refer to the *Syntax for SIP Message Manipulation Reference Guide*.

The following procedure describes how to configure Message Condition rules through the Web interface. You can also configure it through ini file [ConditionTable] or CLI (`configure voip > sbc routing condition-table`).

➤ **To configure a Message Condition rule:**

1. Open the Message Conditions table (**Setup** menu > **Signaling & Media** tab > **Message Manipulation** folder > **Message Conditions**).
2. Click **New**; the following dialog box appears:

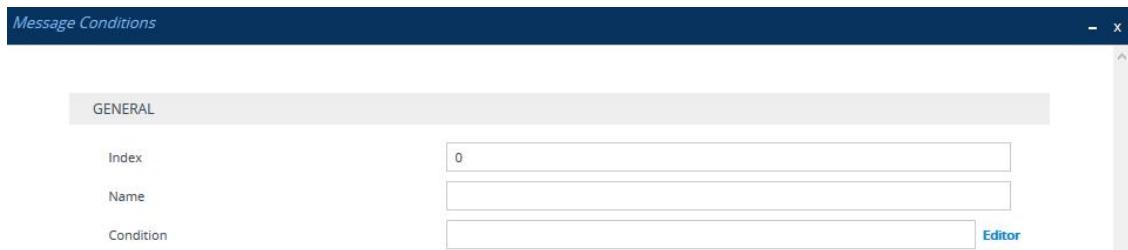

3. Configure a Message Condition rule according to the parameters described in the table below.
4. Click **Apply**.

An example of configured Message Condition rules is shown in the figure below:

INDEX ↕	NAME	CONDITION
0	IP Group user	param.ipg.src.type==user
1	Contains SIP Via Header	header.via.exists
2	"101" user part in From header	header.from.url.user=="101"

- **Index 0:** Incoming SIP dialog that is classified as belonging to a User-type IP Group.
- **Index 1:** Incoming SIP dialog that contains a SIP Via header.
- **Index 2:** Incoming SIP dialog with "101" as the user part in the SIP From header.

**Table 21-2: Message Conditions Table Parameter Descriptions**

Parameter	Description
'Index' [ConditionTable_ Index]	Defines an index number for the new table row. <b>Note:</b> Each row must be configured with a unique index.
'Name' name [ConditionTable_ Name]	Defines a descriptive name, which is used when associating the row in other tables. The valid value is a string of up to 59 characters. <b>Note:</b> The parameter value cannot contain a forward slash (/).
'Condition' condition [ConditionTable_ Condition]	Defines the condition of the SIP message. The valid value is a string. You can use the built-in syntax editor to help you configure the field. Click the <b>Editor</b> button located alongside the field to open the Editor, and then simply follow the on-screen instructions.

Parameter	Description
	<b>Note:</b> User and host parts must be enclosed by a single quotation mark ('...').

## Configuring SIP Message Policy Rules

The Message Policies table lets you configure up to 20 SIP Message Policy rules. SIP Message Policy rules are used to block (blacklist) unwanted incoming SIP messages or permit (whitelist) receipt of desired SIP messages. You can configure legal and illegal characteristics of SIP messages. This feature is helpful against VoIP fuzzing (also known as robustness testing), which sends different types of packets to its "victims" for finding bugs and vulnerabilities. For example, the attacker might try sending a SIP message containing either an oversized parameter or too many occurrences of a parameter.

You can also enable the Message Policy to protect the device against incoming SIP messages with malicious signature patterns, which identify specific scanning tools used by attackers to search for SIP servers in a network. To configure Malicious Signatures, see [Configuring Malicious Signatures](#).

Each Message Policy rule can be configured with the following:

- Maximum message length
- Maximum header length
- Maximum message body length
- Maximum number of headers
- Maximum number of bodies
- Option to send 400 "Bad Request" response if message request is rejected
- Blacklist and whitelist for defined methods (e.g., INVITE)
- Blacklist and whitelist for defined bodies
- Malicious Signatures

The Message Policies table provides a default Message Policy called "Malicious Signature DB Protection" (Index 0), which is based only on Malicious Signatures and discards SIP messages identified with any of the signature patterns configured in the Malicious Signature table.

To apply a SIP Message Policy rule to calls, you need to assign it to the SIP Interface associated with the relevant IP Group (see [Configuring SIP Interfaces](#)).

The following procedure describes how to configure Message Policy rules through the Web interface. You can also configure it through ini file [MessagePolicy] or CLI (`configure voip > message message-policy`).

➤ **To configure SIP Message Policy rules:**

1. Open the Message Policies table (**Setup** menu > **Signaling & Media** tab > **Message Manipulation** folder > **Message Policies**).
2. Click **New**; the following dialog box appears:

3. Configure a Message Policy rule according to the parameters described in the table below.
4. Click **Apply**.

**Table 21-3: Message Policies Table Parameter Descriptions**

Parameter	Description
<b>General</b>	
'Index' [MessagePolicy_Index]	Defines an index number for the new table row. <b>Note:</b> Each row must be configured with a unique index.
'Name' name [MessagePolicy_Name]	Defines a descriptive name, which is used when associating the row in other tables. The valid value is a string of up to 40 characters. <b>Note:</b> <ul style="list-style-type: none"> <li>■ Each row must be configured with a unique name.</li> <li>■ The parameter value cannot contain a forward slash (/).</li> </ul>
<b>Limits</b>	
'Max Message Length'	Defines the maximum SIP message length.



Parameter	Description
max-message-length [MessagePolicy_MaxMessageLength]	The valid value is up to 32,768 characters. The default is 32,768.
'Max Header Length' max-header-length [MessagePolicy_MaxHeaderLength]	Defines the maximum SIP header length. The valid value is up to 512 characters. The default is 512.
'Max Body Length' max-body-length [MessagePolicy_MaxBodyLength]	Defines the maximum SIP message body length. This is the value of the Content-Length header. The valid value is up to 1,024 characters. The default is 1,024.
'Max Num Headers' max-num-headers [MessagePolicy_MaxNumHeaders]	Defines the maximum number of SIP headers. The valid value is any number up to 32. The default is 32. <b>Note:</b> The device supports up to 20 SIP Record-Route headers that can be received in a SIP INVITE request or a 200 OK response. If it receives more than this, it responds with a SIP 513 'Message Too Large' response.
'Max Num Bodies' max-num-bodies [MessagePolicy_MaxNumBodies]	Defines the maximum number of bodies (e.g., SDP) in the SIP message. The valid value is any number up to 8. The default is 8.
Policies	
'Send Rejection' send-rejection [MessagePolicy_SendRejection]	Defines whether the device sends a SIP response if it rejects a message request due to the Message Policy. The default response code is SIP 400 "Bad Request". To configure a different response code, use the MessagePolicyRejectResponseType parameter.  <ul style="list-style-type: none"> <li>■ [0] <b>Policy Reject</b> = (Default) The device discards the message and sends a SIP response to reject the request.</li> <li>■ [1] <b>Policy Drop</b> = The device discards the message without sending any response.</li> </ul>
SIP Method Blacklist-Whitelist Policy	

Parameter	Description
'Method List' method-list [MessagePolicy_ MethodList]	Defines SIP methods (e.g., INVITE\BYE) to blacklist or whitelist.  Multiple methods are separated by a backslash (\). The method values are case-insensitive.
'Method List Type' method-list-type [MessagePolicy_ MethodListType]	Defines the policy (blacklist or whitelist) for the SIP methods specified in the 'Method List' parameter (above). <ul style="list-style-type: none"> <li>■ [0] <b>Policy Blacklist</b> = The specified methods are rejected.</li> <li>■ [1] <b>Policy Whitelist</b> = (Default) Only the specified methods are allowed; the others are rejected.</li> </ul>
<b>SIP Body Blacklist-Whitelist Policy</b>	
'Body List' body-list [MessagePolicy_ BodyList]	Defines the SIP body type (i.e., value of the Content-Type header) to blacklist or whitelist. For example, application/sdp.  The values of the parameter are case-sensitive.
'Body List Type' body-list-type [MessagePolicy_ BodyListType]	Defines the policy (blacklist or whitelist) for the SIP body specified in the 'Body List' parameter (above). <ul style="list-style-type: none"> <li>■ [0] <b>Policy Blacklist</b> =The specified SIP body is rejected.</li> <li>■ [1] <b>Policy Whitelist</b> = (Default) Only the specified SIP body is allowed; the others are rejected.</li> </ul>
<b>Malicious Signature</b>	
'Malicious Signature Database' signature-db-enable [MessagePolicy_ UseMaliciousSignatureDB]	Enables the use of the Malicious Signature database (signature-based detection). <ul style="list-style-type: none"> <li>■ [0] <b>Disable</b> (default)</li> <li>■ [1] <b>Enable</b></li> </ul> <p>To configure Malicious Signatures, see <a href="#">Configuring Malicious Signatures</a>.</p> <p><b>Note:</b> The parameter is applicable only to the SBC application.</p>

## Configuring Pre-Parsing Manipulation Rules

The Pre-Parsing Manipulation Set table lets you configure up to 10 Pre-Parsing Manipulation Sets. Pre-Parsing Manipulation allows you to manipulate incoming SIP messages (dialog-initiating and in-dialog) before they are parsed (as an object) by the device. In other words,

messages can be manipulated in their original format (plain text) as received from the network. Pre-Parsing Manipulation may be useful, for example, to overcome parser strictness or to “allow” possible parsing errors.

To use a configured Pre-Parsing Manipulation Set, you need to assign it to a SIP Interface (see [Configuring SIP Interfaces](#)). The device performs Pre-Parsing Manipulation before Pre-Classification Manipulation and Classification.

Pre-Parsing Manipulation rules are defined by the SIP message element to manipulate (for example, INVITE), the pattern based on regular expression (regex) to search for (match) in the incoming message, and the regex pattern to replace the matched pattern.



For a detailed description of supported regex syntax, refer to the *Syntax for SIP Message Manipulation Reference Guide*

Pre-Parsing Manipulation is configured using two tables with "parent-child" relationship:

- Pre-Parsing Manipulation Sets table ("parent"): Defines a descriptive name for the Pre-Parsing Manipulation Set.
- Pre-Parsing Manipulation Rules table ("child"): Defines the actual manipulation rule. You can configure up to 10 rules per Pre-Parsing Manipulation Set.

The following procedure describes how to configure Pre-Parsing Manipulation Sets through the Web interface. You can also configure it through other management platforms:

- **Pre-Parsing Manipulation Sets table:** *ini* file [PreParsingManipulationSets] or CLI (configure voip > message pre-parsing-manip-sets)
- **Pre-Parsing Manipulation Rules table:** *ini* file [PreParsingManipulationRules] or CLI (configure voip > message pre-parsing-manip-rules)

#### ➤ To configure Pre-Parsing Manipulation Sets:

1. Open the Pre-Parsing Manipulation Sets table (**Setup** menu > **Signaling & Media** tab > **Message Manipulation** folder > **Pre-Parsing Manipulation Sets**).
2. Click **New**; the following dialog box appears:

3. Configure a Pre-Parsing Manipulation Set name according to the parameters described in the table below.
4. Click **Apply**.

**Table 21-4: Pre-Parsing Manipulation Set Table Parameter Descriptions**

Parameter	Description
'Index' [PreParsingManipulationSets_ Index]	Defines an index number for the new table row. <b>Note:</b> Each row must be configured with a unique index.
'Name' name [PreParsingManipulationSets_ Name]	Defines a descriptive name, which is used when associating the row in other tables. The valid value is a string of up to 40 characters. <b>Note:</b> <ul style="list-style-type: none"> <li>■ Each row must be configured with a unique name.</li> <li>■ The parameter value cannot contain a forward slash (/).</li> </ul>

5. In the Pre-Parsing Manipulation Sets table, select the row, and then click the **Pre-Parsing Manipulation Rules** link located below the table; the Pre-Parsing Manipulation Rules table appears.
6. Click **New**; the following dialog box appears:

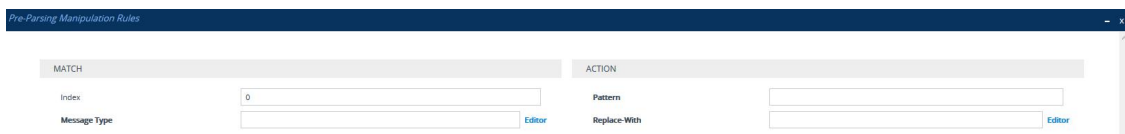

7. Configure a rule according to the parameters described in the table below.
8. Click **New**, and then save your settings to flash memory.

**Table 21-5: Pre-Parsing Manipulation Rules Table Parameter Descriptions**

Parameter	Description
Match	
'Index' [PreParsingManipulationRules_ RuleIndex]	Defines an index number for the new table row. <b>Note:</b> Each row must be configured with a unique index.
'Message Type' message-type [PreParsingManipulationRules_	Defines the SIP message type to which you want to apply the rule. The following syntax is supported:

Parameter	Description
MessageType]	<ul style="list-style-type: none"> <li>■ To apply the rule to any message type, leave the field empty or configure it to <b>any</b>.</li> <li>■ SIP requests:               <ul style="list-style-type: none"> <li>✓ <b>any.request:</b> The rule is applied to any request.</li> <li>✓ <b>&lt;SIP Method&gt;.request:</b> The rule is applied to the specified SIP Method (e.g., invite.request).</li> </ul> </li> <li>■ SIP responses:               <ul style="list-style-type: none"> <li>✓ <b>any.response:</b> The rule is applied to any response.</li> <li>✓ <b>response.&lt;response code&gt;:</b> The rule is applied to messages with the specified response (e.g., response.200 for SIP 200 or response.1xx for any provisional response).</li> </ul> </li> </ul> <p>You can use the built-in syntax editor to help you configure the field. Click the <b>Editor</b> button located alongside the field to open the Editor, and then simply follow the on-screen instructions.</p>
Action	
'Pattern' pattern [PreParsingManipulationRules_ Pattern]	Defines a pattern, based on regex, to search for (match) in the incoming message.  For more information on regex, refer to the <i>Syntax for SIP Message Manipulation Reference Guide</i> .
'Replace-With' replace-with [PreParsingManipulationRules_ ReplaceWith]	Defines a pattern, based on regex, to replace the matched pattern (defined above). You can use the built-in syntax editor to help you configure the field. Click the <b>Editor</b> button located alongside the field to open the Editor, and then simply follow the on-screen instructions.  For more information on regex, refer to the <i>Syntax for SIP Message Manipulation Reference Guide</i> .

# Part V

## Gateway Application

## 22 Introduction

This section describes configuration of the Gateway application. The Gateway application refers to IP-to-Tel and Tel-to-IP call routing. The term *Tel* refers to:

■ Analog:

- FXS equipment such as a fax machine or plain old telephone service (POTS)
- FXO equipment such as a PBX

■ Digital: PSTN

IP-to-Tel refers to calls received by the device from the IP network and then sent to the PSTN or an analog endpoint connected directly or indirectly to the device. Tel-to-IP refers to calls received by the device from an analog endpoint connected directly or indirectly to the device or the PSTN and then sent to the IP network.



- FXO (Foreign Exchange Office) is the interface replacing the analog telephone and connects to a Public Switched Telephone Network (PSTN) line from the Central Office (CO) or to a Private Branch Exchange (PBX). The FXO is designed to receive line voltage and ringing current, supplied from the CO or the PBX (just like an analog telephone). An FXO VoIP device interfaces between the CO/PBX line and the Internet.
- FXS (Foreign Exchange Station) is the interface replacing the Exchange (i.e., the CO or the PBX) and connects to analog telephones, dial-up modems, and fax machines. The FXS is designed to supply line voltage and ringing current to these telephone devices. An FXS VoIP device interfaces between the analog telephone devices and the Internet.

### Call Processing Summary

The device processes Gateway calls as shown below:

■ IP-to-Tel Call:

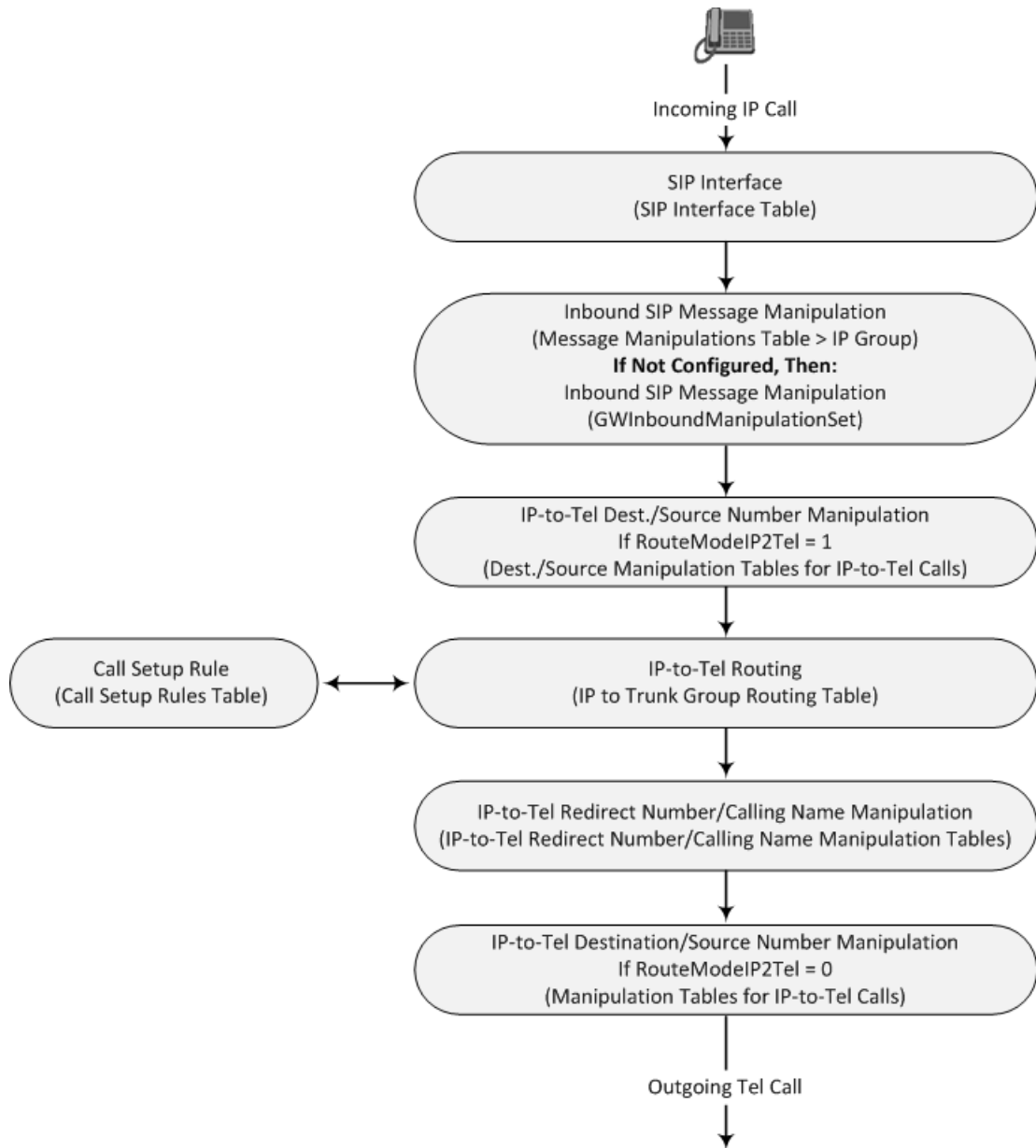

■ Tel-to-IP Call:



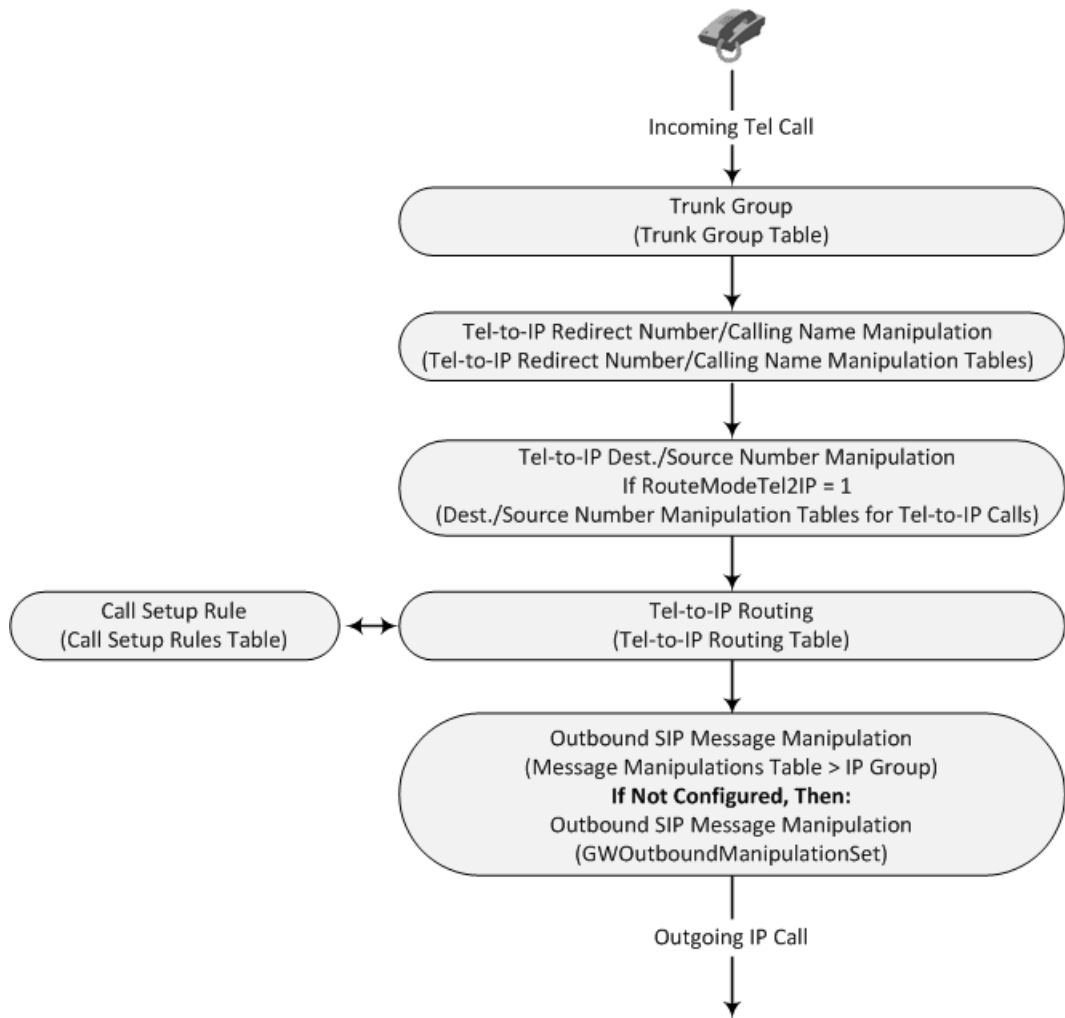

## 23 Digital PSTN

This section describes the configuration of the device's Gateway application for its' digital interfaces (PSTN).

### Configuring Trunk Settings

The Trunk Settings page allows you to configure the device's PSTN trunks. This includes selecting the PSTN protocol and configuring related parameters. This page also lets you perform the following maintenance procedures:

- **Taking a Trunk Out of Service:** Some parameters can be configured when the trunk is in service, while others require you to take the trunk out of service. To take a trunk out of service, click the **Stop Trunk** button. Once a trunk is "stopped", all current calls are dropped and no new calls can be made on the trunk.
- **Deactivating an E1/T1 Trunk:** To deactivate a trunk, click the **Deactivate** button. Deactivation temporarily disconnects (logically) the trunk from the PSTN network. Upon trunk deactivation, the device generates an AIS alarm on the trunk to the far-end. As a result, an RAI alarm signal may be received by the device. A subsequent trunk activation, done by clicking the **Activate** button, reconnects the trunk to the PSTN network and clears the AIS alarm. Trunk deactivation is typically used for maintenance such as checking the trunk's physical integrity.
- **Creating a Loopback Line:** You can create (and remove) remote loopback for DS1 lines. This is done by clicking the **Create Loopback** button. To remove the loopback, click the **Remove Loopback** button.



- The parameters displayed on the Trunk Settings page depends on the protocol type (configured by the 'Protocol Type' parameter).
- When modifying an existing (configured) trunk through the Web interface, some parameters require you to first stop the trunk. The Web interface displays the values of these parameters as grayed out. To configure these parameters, stop the trunk by clicking the **Stop Trunk** button, modify the parameter values, and then click the **Apply Trunk Settings** (or **Apply to All Trunks**) button. For all other parameters, simply modify their parameter values, and then click **Submit**.
- To delete a configured trunk, configure the 'Protocol Type' parameter to **NONE**.
- You cannot configure trunks that you have deactivated.
- You cannot activate or deactivate a stopped trunk.
- If the trunk can't be stopped because it provides the device's clock (assuming the device is synchronized with the trunk clock), assign a different trunk to provide the device's clock or enable 'TDM Bus PSTN Auto Clock' in the TDM Bus Settings page (see [TDM and Timing](#)).
- If you configure the 'Protocol Type' parameter to **NONE** (i.e., no protocol type is selected) and no other trunks have been configured, after selecting a PRI protocol type, you must reset the device.
- BRI trunks can operate with E1 or T1 trunks.



- All PRI trunks of the device must be of the same line type (either E1 or T1). However, different variants of the same line type can be configured on different trunks. For example, E1 Euro ISDN and E1 CAS (subject to the constraints in the device's Release Note).
- The ISDN BRI North American variants (NI-2, DMS-100, and 5ESS) are partially supported by the device. Please contact the sales representative of your purchased device before implementing this protocol.
- If the protocol type is CAS, you can assign or modify a dial plan (in the 'Dial Plan' field) and perform this without stopping the trunk.
- When configuring through ini file, if you want to configure a parameter for a specific trunk, append the parameter name with an underscore (\_) followed by the trunk ID (i.e., ProtocolType\_x, where x denotes the trunk ID). When using this format, the first trunk (ID 1) is denoted with a 0, trunk ID 2 with a 1, trunk ID 3 with a 2, and so on.
- For a description of all the trunk parameters, see [PSTN Parameters](#).

The following procedure describes how to configure trunks through the Web interface. You can also configure trunks through ini file parameters or CLI (`configure voip > interface`).

#### ➤ To configure a new trunk:

1. Open the Trunk Settings page (**Setup** menu > **Signaling & Media** tab > **Gateway** folder > **Trunks & Groups** > **Trunks**).

Trunk Settings



GENERAL		ADVANCED SETTINGS	
Module ID	1	PSTN Alert Timeout	-1
Trunk ID	1	Out-Of-Service Behavior	Not Configured
Trunk Configuration State	Not Configured	Remove Calling Name	Use Global Paramete
Protocol Type	NONE	Play Ringback Tone to Trunk	Not Configured
		Call Rerouting Mode	None
		Trunk Name	

On the top of the page, a bar with Trunk number icons displays the status of each trunk according to the following color codes:

- **Grey:** Disabled
- **Green:** Active
- **Yellow:** RAI alarm (also appears when you deactivate a Trunk by clicking the **Deactivate** button)
- **Red:** LOS/LOF alarm
- **Blue:** AIS alarm

- **Orange:** D-channel alarm (ISDN only)
2. Select the trunk that you want to configure, by clicking the desired Trunk number icon. The bar initially displays the first eight trunk number icons (i.e., trunks 1 through 8), if they exist. To scroll through the trunk number icons (i.e., view the next/last or previous/first group of eight trunks), see the figure below. If the scroll bar displays all available trunks, the scroll bar buttons are unavailable.

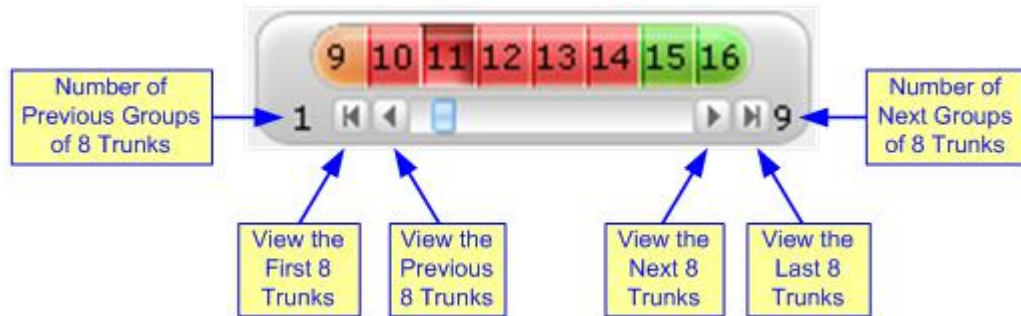

3. To configure a new trunk:
  - a. Configure the trunk parameters as required (see following table for parameter descriptions).
  - b. Click the **Apply Trunk Settings** button.
4. To modify an existing trunk configuration:
  - If you only need to modify parameters that don't require the trunk to be stopped (see previous note), simply modify their values, and then click **Submit**.
  - If you need to modify parameters that require the trunk to be stopped (see previous note), click the **Stop Trunk** button, modify their values, and then click the **Apply Trunk Settings** button to apply the changes to the selected trunk (or click **Apply to All Trunks** to apply the changes to all trunks); the **Stop Trunk** button replaces **Apply Trunk Settings** and the 'Trunk Configuration State' displays "Active".
5. Reset the device with a save-to-flash for your settings to take effect.

**Table 23-1: Trunk Settings Table Parameter Descriptions**

Parameter	Description
General	
'Module ID'	Displays the module number to which the trunk belongs.
'Trunk ID'	Displays the selected trunk ID number.
'Trunk Configuration State'	Displays the status of the trunk: <ul style="list-style-type: none"> <li>■ "Not Configured": The trunk is not configured.</li> <li>■ "Active": The trunk is configured and currently active.</li> </ul>

Parameter	Description
	<ul style="list-style-type: none"> <li>■ "Inactive": The trunk is configured and currently is stopped (inactive).</li> </ul>
<p>'Protocol Type'</p> <pre>configure voip &gt; interface e1- t1 bri &gt; protocol</pre> <p>[ProtocolType]</p>	<p>Defines the PSTN protocol for the trunk.</p> <ul style="list-style-type: none"> <li>■ [0] <b>NONE</b></li> <li>■ [1] <b>E1 EURO ISDN</b> = ISDN PRI Pan-European (CTR4) protocol</li> <li>■ [2] <b>T1 CAS</b> = Common T1 robbed bits protocols including E&amp;M wink start, E&amp;M immediate start, E&amp;M delay dial/start and loop-start and ground start.</li> <li>■ [3] <b>T1 RAW CAS</b></li> <li>■ [4] <b>T1 TRANSPARENT</b> = Transparent protocol, where no signaling is provided by the device. Timeslots 1 to 24 of all trunks are mapped to DSP channels.</li> <li>■ [5] <b>E1 TRANSPARENT 31</b> = Transparent protocol, where no signaling is provided by the device. Timeslots 1 to 31 of each trunk are mapped to DSP channels.</li> <li>■ [6] <b>E1 TRANSPARENT 30</b> = Transparent protocol, where no signaling is provided by the device. Timeslots 1 to 31, excluding time slot 16 of all trunks are mapped to DSP channels.</li> <li>■ [7] <b>E1 MFCR2</b> = Common E1 MFC/R2 CAS protocols (including line signaling and compelled register signaling).</li> <li>■ [8] <b>E1 CAS</b> = Common E1 CAS protocols (including line signaling and MF/DTMF address transfer).</li> <li>■ [9] <b>E1 RAW CAS</b></li> <li>■ [10] <b>T1 NI2 ISDN</b> = National ISDN 2 PRI protocol</li> <li>■ [11] <b>T1 4ESS ISDN</b> = ISDN PRI protocol for the Lucent™/AT&amp;T™ 4ESS switch.</li> <li>■ [12] <b>T1 5ESS 9 ISDN</b> = ISDN PRI protocol for the Lucent™/AT&amp;T™ 5ESS-9 switch.</li> <li>■ [13] <b>T1 5ESS 10 ISDN</b> = ISDN PRI protocol for the Lucent™/AT&amp;T™ 5ESS-10 switch.</li> <li>■ [14] <b>T1 DMS100 ISDN</b> = ISDN PRI protocol for the Nortel™ DMS switch.</li> <li>■ [15] <b>J1 TRANSPARENT</b></li> </ul>

Parameter	Description
	<ul style="list-style-type: none"> <li data-bbox="659 286 1362 353">■ [16] <b>T1 NTT ISDN</b> = ISDN PRI protocol for the Japan - Nippon Telegraph Telephone (known also as INS 1500).</li> <li data-bbox="659 383 1278 450">■ [17] <b>E1 AUSTEL ISDN</b> = ISDN PRI protocol for the Australian Telecom.</li> <li data-bbox="659 479 1358 546">■ [18] <b>E1 HKT ISDN</b> = ISDN PRI (E1) protocol for the Hong Kong - HKT.</li> <li data-bbox="659 575 1283 642">■ [19] <b>E1 KOR ISDN</b> = ISDN PRI protocol for Korean Operator (similar to ETSI).</li> <li data-bbox="659 672 1358 739">■ [20] <b>T1 HKT ISDN</b> = ISDN PRI (T1) protocol for the Hong Kong - HKT.</li> <li data-bbox="659 768 1161 801">■ [21] <b>E1 QSIG</b> = ECMA 143 QSIG over E1</li> <li data-bbox="659 831 1390 898">■ [22] <b>E1 TNZ</b> = ISDN PRI protocol for Telecom New Zealand (similar to ETSI)</li> <li data-bbox="659 927 1161 960">■ [23] <b>T1 QSIG</b> = ECMA 143 QSIG over T1</li> <li data-bbox="659 990 1294 1023">■ [30] <b>E1 FRENCH VN6 ISDN</b> = France Telecom VN6</li> <li data-bbox="659 1052 1294 1086">■ [31] <b>E1 FRENCH VN3 ISDN</b> = France Telecom VN3</li> <li data-bbox="659 1115 1362 1149">■ [34] <b>T1 EURO ISDN</b> = ISDN PRI protocol for Euro over T1</li> <li data-bbox="659 1178 1362 1245">■ [35] <b>T1 DMS100 Meridian ISDN</b> = ISDN PRI protocol for the Nortel™ DMS Meridian switch</li> <li data-bbox="659 1274 1270 1308">■ [36] <b>T1 NI1 ISDN</b> = National ISDN 1 PRI protocol</li> <li data-bbox="659 1337 1362 1370">■ [40] <b>E1 NI2 ISDN</b> = National ISDN 2 PRI protocol over E1</li> <li data-bbox="659 1400 1198 1433">■ [50] <b>BRI EURO ISDN</b> = Euro ISDN over BRI</li> <li data-bbox="659 1462 916 1496">■ [51] <b>BRI NI2 ISDN</b></li> <li data-bbox="659 1525 983 1559">■ [52] <b>BRI DMS 100 ISDN</b></li> <li data-bbox="659 1588 967 1621">■ [53] <b>BRI 5ESS 10 ISDN</b></li> <li data-bbox="659 1650 1059 1684">■ [54] <b>BRI QSIG</b> = QSIG over BRI</li> <li data-bbox="659 1713 1038 1747">■ [55] <b>BRI VN6</b> = VN6 over BRI</li> <li data-bbox="659 1776 1299 1809">■ [56] <b>BRI NTT</b> = BRI ISDN Japan (Nippon Telegraph)</li> <li data-bbox="659 1839 852 1872">■ [57] <b>BRI IUA</b></li> </ul> <p data-bbox="659 1901 735 1935"><b>Note:</b></p> <ul style="list-style-type: none"> <li data-bbox="659 1964 1378 2031">■ If you are modifying the parameter for an existing (configured) trunk through the Web interface, you must</li> </ul>

Parameter	Description
	<p>first stop the trunk.</p> <ul style="list-style-type: none"> <li>■ All PRI trunks must be configured as the same line type (either E1 or T1). The device can support different variants of CAS and PRI protocols on different E1/T1 spans (no more than four simultaneous PRI variants).</li> <li>■ BRI trunks can operate together with E1 or T1 trunks.</li> <li>■ The ISDN BRI North American variants (NI-2, DMS-100, and 5ESS) are partially supported by the device. Please contact the sales representative of your purchased device before implementing this protocol.</li> </ul>
<b>Configuration</b>	
<p>'Clock Master'</p> <pre>configure voip &gt; interface e1-t1 &gt; clock- masterclock- master [ClockMaster]</pre>	<p>Determines the Tx clock source of the E1/T1 line.</p> <ul style="list-style-type: none"> <li>■ [0] <b>Recovered</b> = (Default) Generate the clock according to the Rx of the E1/T1 line.</li> <li>■ [1] <b>Generated</b> = Generate the clock according to the internal TDM bus.</li> </ul> <p><b>Note:</b></p> <ul style="list-style-type: none"> <li>■ If you are modifying the parameter for an existing (configured) trunk through the Web interface, you must first stop the trunk.</li> <li>■ The source of the internal TDM bus clock is determined by the parameter TDMBusClockSource.</li> <li>■ The parameter is applicable only to E1/T1 interfaces.</li> </ul>
<p>'Auto Clock Trunk Priority'</p> <pre>configure voip &gt; interface e1- t1 bri &gt; clock- priority clock- priority [AutoClockTrunkPriority]</pre>	<p>Defines the trunk priority for auto-clock fallback (per trunk parameter).</p> <p>The valid range is 0 to 100, where 0 (default) is the highest priority and 100 indicates that the device does not perform a fallback to the trunk (typically, used to mark untrusted source of clock).</p> <p><b>Note:</b></p> <ul style="list-style-type: none"> <li>■ If you are modifying the parameter for an existing (configured) trunk through the Web interface, you must first stop the trunk.</li> <li>■ Fallback is enabled when the TDMBusPSTNAutoClockEnable parameter is set to 1.</li> </ul>

Parameter	Description
<p>'Line Code'</p> <pre>configure voip &gt; interface e1-t1 &gt; line-code</pre> <p>[LineCode]</p>	<p>Selects B8ZS or AMI for T1 spans, and HDB3 or AMI for E1 spans.</p> <ul style="list-style-type: none"> <li>■ [0] <b>B8ZS</b> = (Default) B8ZS line code (for T1 trunks only).</li> <li>■ [1] <b>AMI</b> = AMI line code.</li> <li>■ [2] <b>HDB3</b> = HDB3 line code (for E1 trunks only).</li> </ul> <p><b>Note:</b></p> <ul style="list-style-type: none"> <li>■ If you are modifying the parameter for an existing (configured) trunk through the Web interface, you must first stop the trunk.</li> <li>■ The parameter is not configurable for BRI interfaces; the device automatically uses the Modified Alternate Mark Invert (MAMI) line code.</li> </ul>
<p>'Line Build Out Loss'</p> <pre>configure voip &gt; interface e1-t1 &gt; line-build-out-loss</pre> <p>[LineBuildOut.Loss]</p>	<p>Defines the line build out loss for the selected T1 trunk.</p> <ul style="list-style-type: none"> <li>■ [0] <b>0 dB</b> (default)</li> <li>■ [1] <b>-7.5 dB</b></li> <li>■ [2] <b>-15 dB</b></li> <li>■ [3] <b>-22.5 dB</b></li> </ul> <p><b>Note:</b></p> <ul style="list-style-type: none"> <li>■ If you are modifying the parameter for an existing (configured) trunk through the Web interface, you must first stop the trunk.</li> <li>■ The parameter is applicable only to T1 trunks.</li> </ul>
<p>'Trace Level'</p> <pre>configure voip &gt; interface e1- t1 bri &gt; trace- level</pre> <p>[TraceLevel]</p>	<p>Defines the trace level:</p> <ul style="list-style-type: none"> <li>■ [0] <b>No Trace</b> (default)</li> <li>■ [1] <b>Full ISDN Trace</b></li> <li>■ [2] <b>Layer 3 ISDN Trace</b></li> <li>■ [3] <b>Only ISDN Q.931 Messages Trace</b></li> <li>■ [4] <b>Layer 3 ISDN No Duplication Trace</b></li> </ul>
<p>'Framing Method'</p> <pre>configure voip &gt; interface e1-t1 &gt; framing</pre>	<p>Determines the physical framing method for the trunk.</p> <ul style="list-style-type: none"> <li>■ [0] <b>Extended Super Frame</b> = (Default) Depends on protocol type:</li> </ul>



Parameter	Description
[FramingMethod]	<ul style="list-style-type: none"> <li>✓ E1: E1 CRC4 MultiFrame Format extended G.706B (same as c)</li> <li>✓ T1: T1 Extended Super Frame with CRC6 (same as D)</li> <li>■ [1] <b>Super Frame</b> = T1 SuperFrame Format (as B).</li> <li>■ [a] <b>E1 FRAMING DDF</b> = E1 DoubleFrame Format - CRC4 is forced to off</li> <li>■ [b] <b>E1 FRAMING MFF CRC4</b> = E1 CRC4 MultiFrame Format - CRC4 is always on</li> <li>■ [c] <b>E1 FRAMING MFF CRC4 EXT</b> = E1 CRC4 MultiFrame Format extended G.706B - auto negotiation is on. If the negotiation fails, it changes automatically to CRC4 off (ddf)</li> <li>■ [A] <b>T1 FRAMING F4</b> = T1 4-Frame multiframe.</li> <li>■ [B] <b>T1 FRAMING F12</b> = T1 12-Frame multiframe (D4).</li> <li>■ [C] <b>T1 FRAMING ESF</b> = T1 Extended SuperFrame without CRC6</li> <li>■ [D] <b>T1 FRAMING ESF CRC6</b> = T1 Extended SuperFrame with CRC6</li> <li>■ [E] <b>T1 FRAMING F72</b> = T1 72-Frame multiframe (SLC96)</li> <li>■ [F] <b>T1 FRAMING ESF CRC6 J2</b> = J1 Extended SuperFrame with CRC6 (Japan)</li> </ul> <p><b>Note:</b></p> <ul style="list-style-type: none"> <li>■ If you are modifying the parameter for an existing (configured) trunk through the Web interface, you must first stop the trunk.</li> <li>■ The parameter is not configurable for BRI interfaces; the device automatically sets the BRI framing method. If the TerminationSide parameter is set to USER_TERMINATION_SIDE (0), ClockMaster is automatically set to 0.; if the TerminationSide parameter is set to NETWORK_TERMINATION_SIDE (1), ClockMaster is automatically set to 1.</li> </ul>
<b>ISDN/BRI Configuration</b>	
'ISDN Termination Side' configure voip >	Determines the ISDN termination side.

Parameter	Description
<pre>interface e1- t1 bri &gt; isdn- termination-side [TerminationSide]</pre>	<ul style="list-style-type: none"> <li>■ [0] <b>User side</b> = (Default) ISDN User Termination Equipment (TE) side.</li> <li>■ [1] <b>Network side</b> = ISDN Network Termination (NT) side.</li> </ul> <p><b>Note:</b></p> <ul style="list-style-type: none"> <li>■ If you are modifying the parameter for an existing (configured) trunk through the Web interface, you must first stop the trunk.</li> <li>■ Select <b>User side</b> when the PSTN or PBX side is configured as <b>Network side</b> and vice versa. If you don't know the device's ISDN termination side, select <b>User side</b>. If the D-channel alarm is indicated, choose <b>Network side</b>.</li> <li>■ The BRI module supports the ITU-T I.430 standard, which defines the ISDN-BRI layer 1 specification. The BRI and PRI ports are configured similarly, using the parameter. When an NT port is active, it drives a 38-V line and sends an INFO1 signal (as defined in ITU-T I.430 Table 4) on the data line to synchronize to a TE port that might be connected to it. To stop the voltage and the INFO1 signal on the line, stop the trunk by clicking <b>Stop Trunk</b>.</li> </ul>
<p>'BRI Layer2 Mode'</p> <pre>configure voip &gt; interface bri &gt; isdn-layer2-mode [BriLayer2Mode]</pre>	<p>Defines Point-to-Point (P2P) or Point-to-Multipoint (P2MP) mode for BRI ports.</p> <ul style="list-style-type: none"> <li>■ [0] <b>Point to Point</b> (default)</li> <li>■ [1] <b>Point to Multipoint</b></li> </ul> <p><b>Note:</b> The parameter is applicable only to BRI interfaces.</p>
<p>'Q.931 Layer Response Behavior'</p> <pre>configure voip &gt; interface e1- t1 bri &gt; isdn- bits-ns-behavior [ISDNIBehavior]</pre>	<p>Defines (by bit-field) several behavior options that influence the behavior of the Q.931 protocol.</p> <ul style="list-style-type: none"> <li>■ [0] = Disable (default).</li> <li>■ [1] <b>NO STATUS ON UNKNOWN IE</b> = Q.931 Status message isn't sent if Q.931 received message contains an unknown/unrecognized IE. By default, the Status message is sent.</li> </ul> <p><b>Note:</b> This value is applicable only to ISDN variants in which sending of Status message is optional.</p> <ul style="list-style-type: none"> <li>■ [2] <b>NO STATUS ON INV OP IE</b> = Q.931 Status message isn't sent if an optional IE with invalid content is received. By default, the Status message is sent.</li> </ul>

Parameter	Description
	<p><b>Note:</b> This option is applicable only to ISDN variants in which sending of Status message is optional.</p> <ul style="list-style-type: none"> <li>■ [4] <b>ACCEPT UNKNOWN FAC IE</b> = Accepts unknown/unrecognized Facility IE. Otherwise, the Q.931 message that contains the unknown Facility IE is rejected (default). <b>Note:</b> This option is applicable only to ISDN variants where a complete ASN1 decoding is performed on Facility IE.</li> <li>■ [128] <b>SEND USER CONNECT ACK</b> = The Connect ACK message is sent in response to received Q.931 Connect; otherwise, the Connect ACK is not sent. <b>Note:</b> This option is applicable only to Euro ISDN User side outgoing calls.</li> <li>■ [512] <b>EXPLICIT INTERFACE ID</b> = Enables configuration of T1 NFAS Interface ID (refer to the parameter ISDNNFASInterfaceID_x). <b>Note:</b> This value is applicable only to 4/5ESS, DMS, NI-2 and HKT variants.</li> <li>■ [2048] <b>ALWAYS EXPLICIT</b> = Always set the Channel Identification IE to explicit Interface ID, even if the B-channel is on the same trunk as the D-channel. <b>Note:</b> This value is applicable only to 4/5ESS, DMS and NI-2 variants.</li> <li>■ [32768] <b>ACCEPT MU LAW</b> =Mu-Law is also accepted in ETSI.</li> <li>■ [65536] <b>EXPLICIT PRES SCREENING</b> = The calling party number (octet 3a) is always present even when presentation and screening are at their default. <b>Note:</b> This option is applicable only to ETSI, NI-2, and 5ESS.</li> <li>■ [131072] <b>STATUS INCOMPATIBLE STATE</b> = Clears the call on receipt of Q.931 Status with incompatible state. Otherwise, no action is taken (default).</li> <li>■ [262144] <b>STATUS ERROR CAUSE</b> = Clear call on receipt of Status according to cause value.</li> <li>■ [524288] <b>ACCEPT A LAW</b> =A-Law is also accepted in 5ESS.</li> <li>■ [2097152] <b>RESTART INDICATION</b> = Upon receipt of a</li> </ul>

Parameter	Description
	<p>Restart message, acEV_PSTN_RESTART_CONFIRM is generated.</p> <ul style="list-style-type: none"> <li>■ [4194304] <b>FORCED RESTART</b> = On data link (re)initialization, send RESTART if there is no call.</li> <li>■ [67108864] <b>NS ACCEPT ANY CAUSE</b> = Accept any Q.850 Cause IE from ISDN. <b>Note:</b> This option is applicable only to Euro ISDN.</li> <li>■ [134217728] <b>NS BRI_DL_ALWAYS_UP (0x08000000)</b> = By default, the BRI D-channel goes down if there are no active calls. If this option is configured, the BRI D-channel is always up and synchronized.</li> <li>■ [536870912] = Alcatel coding for redirect number and display name is accepted by the device. <b>Note:</b> This option is applicable only to QSIG (and relevant for specific Alcatel PBXs such as OXE).</li> <li>■ [1073741824] <b>QSI ENCODE INTEGER</b> = If this bit is set, INTEGER ASN.1 type is used in operator coding (compliant to new ECMA standards); otherwise, OBJECT IDENTIFIER ASN.1 type is used. <b>Note:</b> This option is applicable only to QSIG.</li> <li>■ [2147483648] <b>5ESS National Mode For Bch Maintenance</b> = Use the National mode of AT&amp;T 5ESS for B-channel maintenance. <b>Note:</b> <ul style="list-style-type: none"> <li>■ If you are modifying the parameter for an existing (configured) trunk through the Web interface, you must first stop the trunk.</li> <li>■ To configure the device to support several ISDNBehavior features, enter a summation of the individual feature values. For example, to support both [512] and [2048] features, set the parameter ISDNBehavior is set to 2560 (i.e., 512 + 2048).</li> <li>■ When configuring through the Web interface, to select the options click the arrow button and then for each required option select 1 to enable.</li> <li>■ For BRI terminal endpoint identifier (TEI) configuration, instead of using the ISDNBehavior parameter, use the following parameters: BriTEIConfigP2P_x,</li> </ul> </li> </ul>

Parameter	Description
<p>'Outgoing Calls Behavior'</p> <pre>configure voip &gt; interface e1-t1 bri &gt; isdn-bits- outgoing-calls- behavior</pre> <p>[ISDNOutCallsBehavior]</p>	<p>BriTEIConfigP2MP_x, BriTEIAssignTrigger_x, and BriTEIRemoveTrigger_x.</p> <p>Defines (by bit-field) several options that influence the behavior of the ISDN Stack outgoing calls. To select options, click the arrow button, and then for each required option, select 1 to enable. The default is 0 (i.e., disable).</p> <ul style="list-style-type: none"> <li>■ [2] <b>USER SENDING COMPLETE</b> =The default behavior of the device (when this bit is not set) is to automatically generate the Sending-Complete IE in the Setup message. This behavior is used when overlap dialing is not needed. When overlap dialing is needed, set this bit and the behavior is changed to suit the scenario, i.e., Sending-Complete IE is added when required in the Setup message for Enblock mode or in the last Digit with Overlap mode.</li> <li>■ [16] <b>USE MU LAW</b> = The device sends G.711-m-Law in outgoing voice calls. When disabled, the device sends G.711-A-Law in outgoing voice calls. <b>Note:</b> This option is applicable only to the Korean variant.</li> <li>■ [128] <b>DIAL WITH KEYPAD</b> = The device uses the Keypad IE to store the called number digits instead of the CALLED_NB IE. <b>Note:</b> This option is applicable only to the Korean variant (Korean network). This is useful for Korean switches that don't accept the CALLED_NB IE.</li> <li>■ [256] <b>STORE CHAN ID IN SETUP</b> = The device forces the sending of a Channel-Id IE in an outgoing Setup message even if it's not required by the standard (i.e., optional) and no Channel-Id has been specified in the establishment request. This is useful for improving required compatibility with switches. On BRI lines, the Channel-Id IE indicates 'any channel'. On PRI lines it indicates an unused channel ID, preferred only.</li> <li>■ [512] <b>USE A LAW</b> = The device sends G.711 A-Law in outgoing voice calls. When disabled, the device sends the default G.711-Law in outgoing voice calls. <b>Note:</b> The option is applicable only to the E10 variant (T1 ISDN).</li> <li>■ [1024] = Numbering plan/type for T1 IP-to-Tel calling</li> </ul>

Parameter	Description
	<p>numbers are defined according to the manipulation tables or according to the RPID header (default). Otherwise, the plan/type for T1 calls are set according to the length of the calling number.</p> <p>Note: The option is applicable only to T1 ISDN.</p> <ul style="list-style-type: none"> <li>■ [2048] = The device accepts any IA5 character in the called_nb and calling_nb strings and sends any IA5 character in the called_nb, and is not restricted to extended digits only (i.e., 0-9, *,#).</li> <li>■ [16384] <b>DLCI REVERSED OPTION</b> = Behavior bit used in the IUA interface groups to indicate that the reversed format of the DLCI field must be used.</li> </ul> <p><b>Note:</b></p> <ul style="list-style-type: none"> <li>■ If you are modifying the parameter for an existing (configured) trunk through the Web interface, you must first stop the trunk.</li> <li>■ When using the <i>ini</i> file to configure the device to support several ISDNOutCallsBehavior features, add the individual feature values. For example, to support both [2] and [16] features, set ISDNOutCallsBehavior = 18 (i.e., 2 + 16).</li> </ul>
<p>'Incoming Calls Behavior'</p> <pre>configure voip &gt; interface e1- t1 bri &gt; isdn- bits-incoming- calls-behavior [ISDNInCallsBehavior]</pre>	<p>Defines (by bit-field) several options that influence how the ISDN Stack INCOMING calls behave.</p> <ul style="list-style-type: none"> <li>■ [32] <b>DATA CONN RS</b> = The device automatically sends a Q.931 Connect (answer) message on incoming Tel calls (Q.931 Setup).</li> <li>■ [64] <b>VOICE CONN RS</b> = The device sends a Connect (answer) message on incoming Tel calls.</li> <li>■ [2048] <b>CHAN ID IN FIRST RS</b> = The device sends Channel ID in the first response to an incoming Q.931 Call Setup message. If not set, the Channel ID is sent only if the device requires changing the proposed Channel ID.</li> <li>■ [4096] <b>USER SETUP ACK</b> = (Default) The Setup Ack message is sent by the SIP Gateway application layer and not automatically by the PSTN stack.</li> <li>■ [8192] <b>CHAN ID IN CALL PROC</b> = The device sends Channel ID in a Q.931 Call Proceeding message.</li> </ul>

Parameter	Description
	<ul style="list-style-type: none"> <li data-bbox="659 286 1390 555">■ [65536] <b>PROGR IND IN SETUP ACK</b> = (Default) The device includes Progress Indicator (PI=8) in Setup Ack message if an empty called number is received in an incoming Setup message. This option is applicable to the overlap dialing mode. The device also plays a dial tone (for TimeForDialTone) until the next called number digits are received.</li> <li data-bbox="659 584 1342 734">■ [2147483648] <b>USER SCREEN INDICATOR</b> = When the device receives two Calling Number IE's in the Setup message, the device, by default, uses only one of the numbers according to the following:               <ul style="list-style-type: none"> <li data-bbox="707 763 1342 831">✓ Network provided, Network provided: first calling number is used</li> <li data-bbox="707 860 1294 927">✓ Network provided, User provided: first calling number is used</li> <li data-bbox="707 956 1337 1023">✓ User provided, Network provided: second calling number is used</li> <li data-bbox="707 1052 1374 1120">✓ User provided, user provided: first calling number is used</li> </ul> <p data-bbox="707 1149 1342 1216">When this bit is configured, the device behaves as follows:</p> <ul style="list-style-type: none"> <li data-bbox="707 1245 1342 1312">✓ Network provided, Network provided: first calling number is used</li> <li data-bbox="707 1341 1337 1408">✓ Network provided, User provided: second calling number is used</li> <li data-bbox="707 1438 1294 1505">✓ User provided, Network provided: first calling number is used</li> <li data-bbox="707 1534 1374 1601">✓ User provided, user provided: first calling number is used</li> </ul> <p data-bbox="659 1637 735 1671"><b>Note:</b></p> <ul style="list-style-type: none"> <li data-bbox="659 1700 1374 1812">■ If you are modifying the parameter for an existing (configured) trunk through the Web interface, you must first stop the trunk.</li> <li data-bbox="659 1841 1374 1991">■ In the Web interface, the parameter displays the summation of the enabled optional bit values, in hex format. For example, the default value is 0x11000 (69632 in decimal), which is the summation of the two bit</li> </ul> </li> </ul>

Parameter	Description
	<p>options, USER SETUP ACK (0x01000 or 4096 in decimal) and PROGR IND IN SETUP ACK (0x10000 or 65536 in decimal) that are enabled by default (i.e., 4096 + 65536 = 69632).</p> <ul style="list-style-type: none"> <li>■ When using the <i>ini</i> file to configure the device to support several ISDNInCallsBehavior features, enter a summation of the individual feature values. For example, to support both [2048] and [65536] features, set ISDNInCallsBehavior = 67584 (i.e., 2048 + 65536).</li> </ul>
<p>'General Call Control Behavior'</p> <pre>configure voip &gt; interface e1- t1 bri &gt; isdn- bits-cc-behavior [ISDNGeneralCCBehavior]</pre>	<p>Defines (by bit-field) several general CC behavior options. To select the options, click the arrow button, and then for each required option, select 1 to enable. The default is 0 (i.e., disable).</p> <ul style="list-style-type: none"> <li>■ [2] = Data calls with interworking indication use 64 kbps B-channels (physical only).</li> <li>■ [8] <b>REVERSE CHAN ALLOC ALGO</b> = Channel ID allocation algorithm.</li> <li>■ [16] = The device clears down the call if it receives a NOTIFY message specifying 'User-Suspended'. A NOTIFY (User-Suspended) message is used by some networks (e.g., in Italy or Denmark) to indicate that the remote user has cleared the call, especially in the case of a long distance voice call.</li> <li>■ [32] <b>CHAN ID 16 ALLOWED</b> = Applies only to ETSI E1 lines (30B+D). Enables handling the differences between the newer QSIG standard (ETS 300-172) and other ETSI-based standards (ETS 300-102 and ETS 300-403) in the conversion of B-channel ID values into timeslot values: <ul style="list-style-type: none"> <li>✓ In 'regular ETSI' standards, the timeslot is identical to the B-channel ID value, and the range for both is 1 to 15 and 17 to 31. The D-channel is identified as channel-id #16 and carried into the timeslot #16.</li> <li>✓ In newer QSIG standards, the channel-id range is 1 to 30, but the timeslot range is still 1 to 15 and 17 to 31. The D-channel is not identified as channel-id #16, but is still carried into the timeslot #16.</li> </ul> When this bit is set, the channel ID #16 is considered as a valid B-channel ID, but timeslot values are converted to reflect the range 1 to 15 and 17 to 31. </li> </ul>



Parameter	Description
	<p>This is the new QSIG mode of operation. When this bit is not set (default), the channel_id #16 is not allowed, as for all ETSI-like standards.</p> <ul style="list-style-type: none"> <li>■ [64] <b>USE T1 PRI</b> = PRI interface type is forced to T1.</li> <li>■ [128] <b>USE E1 PRI</b> = PRI interface type is forced to E1.</li> <li>■ [256] <b>START WITH B CHAN OOS</b> = B-channels start in the Out-Of-Service state (OOS).</li> <li>■ [512] <b>CHAN ALLOC LOWEST</b> = CC allocates B-channels starting from the lowest available B-channel id.</li> <li>■ [1024] <b>CHAN ALLOC HIGHEST</b> = CC allocates B-channels starting from the highest available B-channel id.</li> <li>■ [16384] <b>CC_TRANSPARENT_UUI</b> = The UUI-protocol implementation of CC is disabled allowing the application to freely send UUI elements in any primitive, regardless of the UUI-protocol requirements (UUI Implicit Service 1). This allows more flexible application control on the UUI. When this bit is not set (default behavior), CC implements the UUI-protocol as specified in the ETS 300-403 standards for Implicit Service 1.</li> <li>■ [65536] <b>GTD5 TBCT</b> = CC implements the VERIZON-GTD-5 Switch variant of the TBCT Supplementary Service, as specified in FSD 01-02-40AG Feature Specification Document from Verizon. Otherwise, TBCT is implemented as specified in GR-2865-CORE specification (default behavior).</li> </ul> <p><b>Note:</b></p> <ul style="list-style-type: none"> <li>■ If you are modifying the parameter for an existing (configured) trunk through the Web interface, you must first stop the trunk.</li> <li>■ When using the <i>ini</i> file to configure the device to support several ISDNGeneralCCBehavior features, add the individual feature values. For example, to support both [16] and [32] features, set ISDNGeneralCCBehavior = 48 (i.e., 16 + 32).</li> </ul>
<p>'ISDN NS Behaviour 2'            configure voip &gt;            interface e1-</p>	<p>Defines (by bit-field) several options that influence the behavior of the Q.931 protocol.</p> <ul style="list-style-type: none"> <li>■ [8] <b>NS BEHAVIOUR2 ANY UUI</b> = Any User to User</li> </ul>

Parameter	Description
<pre>t1 bri &gt; isdn- bits-ns- extension- behavior [ISDNNSBehaviour2]</pre>	<p>Information Element (UUIE) is accepted for any protocol discriminator. This is useful for interoperability with non-standard switches.</p> <ul style="list-style-type: none"> <li>■ [16] <b>NS BEHAVIOUR2 DISPLAY</b> = The Display IE is accepted even if it is not defined in the QSIG ISDN protocol standard. This is applicable only when configuration is QSI.</li> <li>■ [64] <b>NS BEHAVIOUR2 FAC REJECT</b> = When this bit is set, the device answers with a Facility IE message with the Reject component on receipt of Facility IE with unknown/invalid Invoke component. This bit is implemented in QSIG and ETSI variants.</li> </ul>
<pre>'NFAS Group Number' configure voip &gt; interface e1-t1 &gt; isdn-nfas-group- number [NFASGroupNumber]</pre>	<p>Defines the ISDN Non-Facility Associated Signaling (NFAS) group number (NFAS member), per trunk.</p> <ul style="list-style-type: none"> <li>■ [0] 0 = (Default) Non-NFAS trunk.</li> <li>■ [1-12] 1 to 12 = NFAS group number.</li> </ul> <p>Trunks that belong to the same NFAS group have the same number. With NFAS, you can use a single D-channel to control multiple PRI interfaces.</p> <p><b>Note:</b></p> <ul style="list-style-type: none"> <li>■ If you are modifying the parameter for an existing (configured) trunk through the Web interface, you must first stop the trunk.</li> <li>■ For the parameter to take effect, a device reset is required.</li> <li>■ The parameter is applicable only to T1 ISDN protocols.</li> <li>■ For more information on NFAS, see <a href="#">ISDN Non-Facility Associated Signaling (NFAS)</a>.</li> </ul>
<pre>'NFAS Interface ID' configure voip &gt; interface e1-t1 &gt; isdn-nfas- interface-id [ISDNNFASInterfaceID]</pre>	<p>Defines a different Interface ID per T1 trunk. The valid range is 0 to 100. The default interface ID equals the trunk's ID.</p> <p><b>Note:</b></p> <ul style="list-style-type: none"> <li>■ If you are modifying the parameter for an existing (configured) trunk through the Web interface, you must first stop the trunk.</li> <li>■ To set the NFAS interface ID, configure ISDNIBehavior_x</li> </ul>

Parameter	Description
	<p>to include '512' feature per T1 trunk.</p> <ul style="list-style-type: none"> <li>■ The parameter is applicable only to T1 ISDN protocols.</li> <li>■ For more information on NFAS, see <a href="#">ISDN Non-Facility Associated Signaling (NFAS)</a>.</li> </ul>
<p>'D-channel Configuration'</p> <pre>configure voip &gt; interface e1-t1 &gt; isdn-nfas- dchannel-type [DChConfig]</pre>	<p>Defines primary, backup (optional), and B-channels only, per trunk.</p> <ul style="list-style-type: none"> <li>■ [0] <b>PRIMARY</b>= (Default) Primary Trunk - contains a D-channel that is used for signaling.</li> <li>■ [1] <b>BACKUP</b> = Backup Trunk - contains a backup D-channel that is used if the primary D-channel fails.</li> <li>■ [2] <b>NFAS</b> = NFAS Trunk - contains only 24 B-channels, without a signaling D-channel.</li> </ul> <p><b>Note:</b></p> <ul style="list-style-type: none"> <li>■ If you are modifying the parameter for an existing (configured) trunk through the Web interface, you must first stop the trunk.</li> <li>■ The parameter is applicable only to T1 ISDN protocols.</li> <li>■ For more information on NFAS, see <a href="#">ISDN Non-Facility Associated Signaling (NFAS)</a>.</li> </ul>
<b>CAS Configuration</b>	
<p>'Dial Plan'</p> <pre>configure voip &gt; interface e1-t1 &gt; cas-dial-plan- name [CASTrunkDialPlanName_ x]</pre>	<p>Defines the CAS Dial Plan name per trunk.</p> <p>The range is up to 11 characters.</p> <p>For example, the below configures E1_MFCR2 trunk with a single protocol (Trunk 5):</p> <pre>ProtocolType_5 = 7 CASFileName_0='R2_Korea_CP_ANI.dat' CASTableIndex_5 = 0 DialPlanFileName = 'DialPlan_USA.dat' CASTrunkDialPlanName_5 = 'AT_T'</pre>
<p>'CAS Table per Trunk'</p> <pre>configure voip &gt; interface e1-t1 &gt; cas-table-index [CASTableIndex_x]</pre>	<p>Defines the CAS protocol per trunk from a list of CAS protocols defined by the parameter CASFileName_x.</p> <p>For example, the below configuration specifies Trunks 0 and 1 to use the E&amp;M Winkstart CAS (E_M_WinkTable.dat) protocol, and Trunks 2 and 3 to use the E&amp;M Immediate Start CAS (E_M_ImmediateTable.dat) protocol:</p>

Parameter	Description
	<pre>CASFileName_0 = 'E_M_WinkTable.dat' CASFileName_1 = 'E_M_ImmediateTable.dat' CASTableIndex_0 = 0 CASTableIndex_1 = 0 CASTableIndex_2 = 1 CASTableIndex_3 = 1</pre> <p><b>Note:</b> You can define CAS tables per B-channel using the parameter CASChannelIndex.</p>
<p>'CAS Table per Channel'</p> <pre>configure voip &gt; interface e1-t1 &gt; cas-channel-index</pre> <p>[CASChannelIndex]</p>	<p>Defines the loaded CAS protocol table index per B-channel pertaining to a CAS trunk. The parameter is assigned a string value and can be set in one of the following two formats:</p> <ul style="list-style-type: none"> <li> <p><b>CAS table per channel:</b> Each channel is separated by a comma and the value entered denotes the CAS table index used for that channel. The syntax is &lt;CAS index&gt;,&lt;CAS index&gt; (e.g., "1,2,1,2..."). For this format, 31 indices must be defined for E1 trunks (including dummy for B-channel 16), or 24 indices for T1 trunks. Below is an example for configuring a T1 CAS trunk (Trunk 5) with several CAS variants:</p> <pre>ProtocolType_5 = 7 CASFILENAME_0='E_M_FGBWinkTable.dat' CASFILENAME_1='E_M_FGDWinkTable.dat' CASFILENAME_2='E_M_WinkTable.txt' CasChannelIndex_5 = '0,0,0,1,1,1,2,2,2,0,0,0,1,1,1,0,1,2,0,2,1,2,2,2' CASDelimitersPaddingUsage_5 = 1</pre> </li> <li> <p><b>CAS table per channel group:</b> Each channel group is separated by a colon and each channel is separated by a comma. The syntax is &lt;x-y channel range&gt;:&lt;CAS table index&gt;, (e.g., "1-10:1,11-31:3"). Every B-channel (including 16 for E1) must belong to a channel group. Below is an example for configuring an E1 CAS trunk (Trunk 5) with several CAS variants:</p> <pre>ProtocolType_5 = 8 CASFILENAME_2='E1_R2D' CASFILENAME_7= E_M_ImmediateTable_A-Bit.txt' CasChannelIndex_5 = '1-10:2,11-20:7,21-31:2'</pre> </li> </ul>

Parameter	Description
	<p><b>Note:</b></p> <ul style="list-style-type: none"> <li>■ To configure the parameter, the trunk must first be stopped.</li> <li>■ Only one of these formats can be implemented; not both.</li> <li>■ When the parameter is not configured, a single CAS table for the entire trunk is used, configured by the parameter CASTableIndex.</li> </ul>
<b>Advanced Settings</b>	
<p>'PSTN Alert Timeout'</p> <pre>configure voip &gt; interface e1- t1 bri &gt; pstn- alrt-timeout [TrunkPSTNAlertTimeout]</pre>	<p>Defines the Alert Timeout (ISDN T301 timer) in seconds for outgoing calls to PSTN, per trunk. This timer is used between the time that an ISDN Setup message is sent to the Tel side (IP-to-Tel call establishment) and a Connect message is received. If Alerting is received, the timer is restarted. The range is 1 to 600. The default is 180.</p>
<p>'Local ISDN Ringback Tone Source'</p> <pre>configure voip &gt; interface e1- t1 bri &gt; local- isdn-rbt-src [LocalISDNRBSource]</pre>	<p>Determines whether the ringback tone is played to the ISDN by the PBX/PSTN or by the device, per trunk.</p> <ul style="list-style-type: none"> <li>■ [0] <b>PBX</b> = (Default) PBX/PSTN plays the ringback tone.</li> <li>■ [1] <b>Gateway</b> = The device plays the ringback tone.</li> </ul> <p><b>Note:</b> The parameter is used together with the [PlayRBTone2Trunk] parameter.</p>
<p>'Set PI in Rx Disconnect Message'</p> <pre>configure voip &gt; interface e1- t1 bri &gt; pi-in- rx-disc-msg [PIForDisconnectMsg]</pre>	<p>Defines the device's behavior per trunk when a Disconnect message is received from the ISDN before a Connect message is received.</p> <ul style="list-style-type: none"> <li>■ [-1] <b>Not Configured</b> = (Default) Sends a 183 SIP response according to the received progress indicator (PI) in the ISDN Disconnect message. If PI = 1 or 8, the device sends a 183 response, enabling the PSTN to play a voice announcement to the IP side. If there isn't a PI in the Disconnect message, the call is released.</li> <li>■ [0] <b>No PI</b> = Doesn't send a 183 response to IP. The call is released.</li> <li>■ [1] <b>PI = 1</b> = Sends a 183 response to IP.</li> <li>■ [8] <b>PI = 8</b> = Sends a 183 response to IP.</li> </ul>

Parameter	Description
<p>'ISDN Transfer Capabilities'</p> <pre>configure voip &gt; interface e1- t1 bri &gt; isdn- xfer-cab</pre> <p>[ISDNTransferCapability]</p>	<p>Defines the IP-to-ISDN Transfer Capability of the Bearer Capability IE in ISDN Setup messages, per trunk (where the x in the ini file parameter name denotes the trunk number and where 0 is Trunk 1).</p> <ul style="list-style-type: none"> <li>■ [-1] <b>Not Configured</b></li> <li>■ [0] <b>Audio 3.1</b> (default)</li> <li>■ [1] <b>Speech</b></li> <li>■ [2] <b>Data</b></li> <li>■ [3] <b>Audio 7</b></li> </ul> <p><b>Note:</b> If the parameter is not configured or set to -1, Audio 3.1 capability is used.</p>
<p>'Progress Indicator to ISDN'</p> <pre>configure voip &gt; interface e1- t1 bri &gt; pi-to- isdn</pre> <p>[ProgressIndicator2ISDN]</p>	<p>Defines the Progress Indicator (PI) in ISDN messages per trunk sent to the PSTN.</p> <ul style="list-style-type: none"> <li>■ [-1] <b>Not Configured</b> = (Default) The PI in ISDN messages is set according to the [PlayRBTone2Tel] parameter.</li> <li>■ [0] <b>No PI</b> = PI is not sent to ISDN.</li> <li>■ [1] <b>PI = 1</b> = The PI value is sent to PSTN in Q.931/Proceeding and Alerting messages. Typically, the PSTN/PBX cuts through the audio channel without playing local ringback tone, enabling the originating party to hear remote Call Progress Tones or network announcements.</li> <li>■ [2] <b>PI = 2</b> = The PI value is sent to PSTN in Q.931/Proceeding and Alerting messages. The destination address is non-ISDN.</li> <li>■ [8] <b>PI = 8</b> = The PI value is sent to PSTN in Q.931/Proceeding and Alerting messages. Typically, the PSTN/PBX cuts through the audio channel without playing local ringback tone, enabling the originating party to hear remote Call Progress Tones or network announcements.</li> </ul>
<p>'Select Receiving of Overlap Receiving'</p> <pre>configure voip &gt; interface e1- t1 bri &gt; ovrlp-</pre>	<p>Determines the receiving (Rx) type of ISDN overlap dialing for Tel-to-IP calls, per trunk.</p> <ul style="list-style-type: none"> <li>■ [0] <b>None</b> = (Default) Disabled.</li> <li>■ [1] <b>Local receiving</b> = ISDN Overlap Dialing - the complete</li> </ul>

Parameter	Description
rcving-type [ISDNRxOverlap]	<p>number is sent in the INVITE Request-URI user part. The device receives ISDN called number that is sent in the 'Overlap' mode. The ISDN Setup message is sent to IP only after the number (including the Sending Complete IE) is fully received (via Setup and/or subsequent Info Q.931 messages). In other words, the device waits until it has received all the ISDN signaling messages containing parts of the called number, and only then it sends a SIP INVITE with the entire called number in the Request-URI.</p> <ul style="list-style-type: none"> <li>■ [2] <b>Through SIP</b> = Interworking of ISDN Overlap Dialing to SIP according to RFC 3578. The device sends the first received digits from the ISDN Setup message to the IP side in the initial INVITE message. For each subsequently received ISDN Info Q.931 message, the device sends the collected digits to the IP side in re-INVITE messages.</li> <li>■ [3] <b>Through SIP INFO</b> = Interworking of ISDN Overlap Dialing to SIP according to RFC 3578. The device sends the first received digits from the ISDN Setup message to the IP side in the initial INVITE message. For each subsequently received ISDN Info Q.931 message, the device sends the collected digits to the IP side in INFO messages.</li> </ul> <p><b>Note:</b></p> <ul style="list-style-type: none"> <li>■ When configured to <b>Through SIP</b> or <b>Through SIP INFO</b>, you can define the minimum number of overlap digits to collect before sending the first SIP message for routing the call, using the <code>MinOverlapDigitsForRouting</code> parameter.</li> <li>■ When configured to <b>Through SIP</b> or <b>Through SIP INFO</b>, even if SIP 4xx responses are received during this ISDN overlap receiving, the device does not release the call.</li> <li>■ The <code>MaxDigits</code> parameter can be used to limit the length of the collected number for ISDN overlap dialing (if Sending Complete is not received).</li> <li>■ If a digit map pattern is defined (using the <code>DigitMapping</code> or <code>DialPlanIndex</code> parameters), the device collects digits until a match is found (e.g., for closed numbering schemes) or until a timer expires (e.g., for open numbering schemes). If a match is found (or the timer expires), the digit collection process is terminated even if</li> </ul>

Parameter	Description
	<p>Sending Complete is not received.</p> <ul style="list-style-type: none"> <li>■ For enabling ISDN overlap dialing for IP-to-Tel calls, use the ISDNTxOverlap parameter.</li> <li>■ For more information on ISDN overlap dialing, see <a href="#">ISDN Overlap Dialing</a>.</li> </ul>
<p>'B-Channel Negotiation'</p> <pre>configure voip &gt; interface e1-t1 &gt; b-channel-nego- for-trunk</pre> <p>[BChannelNegotiationForTrunk]</p>	<p>Determines the ISDN B-channel negotiation mode, per trunk.</p> <ul style="list-style-type: none"> <li>■ [-1] <b>Not Configured</b> = (Default) Use per device configuration of the BChannelNegotiation parameter.</li> <li>■ [0] <b>Preferred</b></li> <li>■ [1] <b>Exclusive</b></li> <li>■ [2] <b>Any</b></li> </ul> <p><b>Note:</b> The option <b>Any</b> is applicable only if TerminationSide is set to 0 (i.e., User side).</p>
<p>'Digital Out-Of-Service Behavior'</p> <pre>configure voip &gt; interface e1-t1 &gt; dig-oos-behavior</pre> <p>[DigitalOOSBehaviorForTrunk_x]</p>	<p>Defines the method for setting digital trunks to out-of-service state. The parameter is defined per trunk. The parameter is applicable to the Busy Out feature (see the [EnableBusyOut] parameter) and the Lock/Unlock per Trunk Group feature performed in the Trunk Group Settings table of the Web interface.</p> <ul style="list-style-type: none"> <li>■ [-1] <b>Not Configured</b> = (Default) Use the settings of the [DigitalOOSBehavior] parameter ("global" parameter that applies to all trunks).</li> <li>■ [0] <b>Default</b> = <ul style="list-style-type: none"> <li>✓ ISDN: Sends ISDN Service messages to indicate out-of-service or in-service state for ISDN variants that support Service messages. For ISDN variants that do not support Service messages, the device sends an Alarm Indication Signal (AIS) alarm.</li> <li>✓ CAS: Sends an Alarm Indication Signal (AIS) alarm.</li> </ul> </li> <li>■ [1] <b>Service</b> = (Applicable only to T1 ISDN variants that support this method)Sends ISDN Service messages indicating out-of-service or in-service state. <ul style="list-style-type: none"> <li>✓ Graceful out-of-service disabled: The device rejects new incoming calls and immediately takes all channels (idle and busy) out-of-service, by sending</li> </ul> </li> </ul>



Parameter	Description
	<p>Service messages on the B-channels. The device disconnects busy channels before it sends out-of-service Service messages on them.</p> <ul style="list-style-type: none"> <li>✓ Graceful out-of-service enabled: The device rejects new incoming calls. If at least one busy channel exists during the graceful period, the device immediately takes all idle channels out-of-service and sends out-of-service Service messages to the other B-channels as soon as they become idle. When graceful period ends, the device disconnects all non-idle channels and then sends out-of-service Service messages to them.</li> </ul> <p>When connectivity is restored for the Busy Out feature or the Trunk Group is unlocked, the device brings all the trunks back into service by sending in-service Service messages to all their B-channels.</p> <ul style="list-style-type: none"> <li>■ [2] <b>D-Channel</b> = (Applicable only to ISDN and fully configured trunks) Takes the D-channel down or brings it up. <ul style="list-style-type: none"> <li>✓ Graceful out-of-service disabled: The device rejects new incoming calls and immediately takes the D-channel down.</li> <li>✓ Graceful out-of-service enabled: The device rejects new incoming calls. Only when all channels are idle (when graceful period ends or when all channels become idle before graceful period ends, whichever occurs first), does the device take the D-channel down.</li> </ul> <p>When connectivity is restored for the Busy Out feature or the Trunk Group is unlocked, the device brings the D-channels up again.</p> <p><b>Note:</b> For partially configured trunks (only some channels configured), this option only rejects new calls for the trunk; the D-channel remains up.</p> </li> <li>■ [3] <b>Alarm</b> = Sends or clears a PSTN Alarm Indication Signal (AIS) alarm. <ul style="list-style-type: none"> <li>✓ Graceful out-of-service disabled: The device rejects new incoming calls and immediately sends an AIS alarm.</li> </ul> </li> </ul>

Parameter	Description
	<ul style="list-style-type: none"> <li>✓ Graceful out-of-service enabled: The device rejects new incoming calls and only when all channels are idle (when graceful period ends or when all channels become idle before graceful period ends, whichever occurs first), does the device send an alarm on the trunk.</li> </ul> <p>When connectivity is restored for the Busy Out feature or the Trunk Group is unlocked, the device clears the alarm.</p> <p><b>Note:</b> For partially configured trunks (only some channels configured), this option only rejects new calls for the trunk; no alarm is sent.</p> <ul style="list-style-type: none"> <li>■ [4] <b>Block</b> = (Applicable only to CAS) Blocks the B-channels.</li> </ul> <ul style="list-style-type: none"> <li>✓ Graceful out-of-service disabled: The device rejects new incoming calls and immediately blocks all channels (idle and busy). The device disconnects busy channels before blocking them.</li> <li>✓ Graceful out-of-service enabled: The device rejects new incoming calls. If at least one busy channel exists during the graceful period, the device immediately blocks all idle channels, and blocks the other B-channels as soon as they become idle. When graceful period ends, the device disconnects all non-idle channels and then blocks them.</li> </ul> <p>When connectivity is restored for the Busy Out feature or the Trunk Group is unlocked, the device unblocks all the B-channels.</p> <ul style="list-style-type: none"> <li>■ [5] <b>Service and D-Channel</b> = (Applicable only to T1 ISDN variants that support this method) Sends ISDN Service messages to indicate out-of-service or in-service state and takes the D-channel down or brings it up.</li> </ul> <ul style="list-style-type: none"> <li>✓ Graceful out-of-service disabled:             <ul style="list-style-type: none"> <li>- Fully configured trunk (all channels): The device rejects new incoming calls, disconnects busy channels, and takes the D-channel down.</li> <li>- Partially configured trunk (only some channels configured): The device rejects new incoming calls, disconnects busy channels, and sends out-of-service Service messages to all the configured channels (D-channel remains up).</li> </ul> </li> </ul>

Parameter	Description
	<p>✓ Graceful out-of-service enabled: The device rejects new incoming calls and does the following:</p> <ul style="list-style-type: none"> <li>- Fully configured trunk (all channels): <ul style="list-style-type: none"> <li>&gt; If all channels are idle when the graceful period begins, the device immediately takes the channels out-of-service without sending out-of-service Service messages and instead, only takes the D-channel down.</li> <li>&gt; If at least one channel is busy during the graceful period, the device immediately takes all idle channels out-of-service and sends out-of-service Service messages to these B-channels. Thus, the PSTN/PBX side can detect that these calls are in out-of-service state and does not send new calls to these out-of-service channels, eliminating the scenario of loss of calls due to rejection.</li> <li>&gt; If a channel is released (call ends) during the graceful period and there are still other busy channels, the device sends an out-of-service Service message to the idle channel.</li> <li>&gt; When the last channel is released in the trunk (or Trunk Group), the device takes all the channels out-of-service (locks the Trunk Group) without sending an out-of-service Service message; instead, it only takes the D-channel down. The device disconnects busy channels before it takes the D-channel down. When connectivity is restored for the Busy Out feature or the Trunk Group is unlocked, the device brings the D-channel up again without sending any Service messages to the B-channels.</li> </ul> </li> <li>- Partially configured trunk (only some channels configured): Same as above, but the D-channel remains up and out-of-service Service message is sent to remaining busy channels.</li> </ul> <p><b>Note:</b></p> <ul style="list-style-type: none"> <li>■ The parameter is applicable only to digital interfaces.</li> <li>■ When configuring out-of-service behavior per trunk (see [DigitalOOSBehaviorForTrunk_x]), you must stop the trunk (<b>Stop Trunk</b> button in the Trunk Settings page), configure the parameter, and then restart the trunk (<b>Apply Trunk Settings</b> button in the Trunk Settings page)</li> </ul>

Parameter	Description
	<p>for the settings to take effect.</p> <ul style="list-style-type: none"> <li>■ To define out-of-service behavior for all trunks (globally), see the [DigitalOOSBehavior] parameter.</li> <li>■ For locking and unlocking Trunk Groups in the Trunk Group Settings table, see <a href="#">Configuring Trunk Group Settings</a>.</li> <li>■ For a description of the Busy Out feature and for enabling the feature, see the [EnableBusyOut] parameter.</li> <li>■ To configure the graceful out-of-service period, see the [GracefulBusyOutTimeout] parameter.</li> <li>■ If the ISDN variant does not support the configured out-of-service option of the parameter, the device sets the parameter to Default [0].</li> <li>■ The x in the ini file parameter name denotes the trunk number, where 0 is Trunk 1.</li> </ul>
<p>'Digital Out-Of-Service Behavior'  <code>dig-oos-behavior</code>            [DigitalOOSBehavior]</p>	<p>Defines the method for setting all digital trunks to out-of-service state. To configure the out-of-service method per trunk, see the [DigitalOOSBehaviorForTrunk_x] parameter.</p> <ul style="list-style-type: none"> <li>■ [0] <b>Default</b> = (Default) For a detailed description, see option [0] of the [DigitalOOSBehaviorForTrunk_x] parameter (per trunk setting).</li> <li>■ [1] <b>Service</b> = Sends an ISDN Service message indicating out-of-service state (or in-service). For a detailed description, see option [1] of the [DigitalOOSBehaviorForTrunk_x] parameter (per trunk setting).</li> <li>■ [2] <b>D-Channel</b> = Takes the D-Channel down or brings it up. For a detailed description, see option [2] of the [DigitalOOSBehaviorForTrunk_x] parameter (per trunk setting).</li> <li>■ [3] <b>Alarm</b> = Sends or clears a PSTN Alarm Indication Signal (AIS) alarm. For a detailed description, see option [3] of the [DigitalOOSBehaviorForTrunk_x] parameter (per trunk setting).</li> <li>■ [4] <b>Block</b> = Blocks the trunk. For a detailed description, see option [4] of the [DigitalOOSBehaviorForTrunk_x] parameter (per trunk setting).</li> </ul>

Parameter	Description
	<ul style="list-style-type: none"> <li>■ [5] <b>Service and D-Channel</b> = Sends ISDN Service messages to indicate out-of-service or in-service state and takes the D-channel down or brings it up. For a detailed description, see option [5] of the [DigitalOOSBehaviorForTrunk_x] parameter (per trunk setting).</li> </ul> <p><b>Note:</b></p> <ul style="list-style-type: none"> <li>■ The parameter is applicable only to digital interfaces.</li> <li>■ When using the parameter to configure out-of-service behavior for all trunks, you must reset the device for the settings to take effect.</li> <li>■ If the ISDN variant does not support the configured out-of-service option of the parameter, the device sets the parameter to Default [0].</li> </ul>
<p>'Remove Calling Name'</p> <pre>configure voip &gt; interface bri &gt; rmv-calling-name [RemoveCallingNameForTrunk_x]</pre>	<p>Enables the device to remove the Calling Name for SIP-to-ISDN calls, per trunk.</p> <ul style="list-style-type: none"> <li>■ [-1] <b>Use Global Parameter</b> = (Default) Settings of the global parameter [RemoveCallingName] are used.</li> <li>■ [0] <b>Disable</b> = Does not remove Calling Name.</li> <li>■ [1] <b>Enable</b> = Remove Calling Name.</li> </ul>
<p>'Play Ringback Tone to Trunk'</p> <pre>configure voip &gt; interface e1- t1 bri &gt; play- rbt-to-trk [PlayRBTone2Trunk_x]</pre>	<p>Determines the playing method of the ringback tone to the trunk side, per trunk.</p> <ul style="list-style-type: none"> <li>■ [-1] <b>Not configured</b> = (Default) The settings of the PlayRBTone2Tel parameter is used.</li> <li>■ [0] <b>Don't Play</b> = When the device is configured for ISDN or CAS , it doesn't play a ringback tone. No Progress Indicator (PI) is sent to the ISDN unless the [ProgressIndicator2ISDN_x] parameter is configured differently.</li> <li>■ [1] <b>Play on Local</b> = When the device is configured for CAS, it plays a local ringback tone to the PSTN upon receipt of a SIP 180 Ringing response (with or without SDP). Note that the receipt of a SIP 183 response does not cause the device configured for CAS to play a ringback tone (unless the SIP183Behaviour parameter is set to 1).</li> </ul>

Parameter	Description
	<p>When the device is configured for ISDN, it operates according to the LocalISDNRBSource parameter, as follows:</p> <ul style="list-style-type: none"> <li>✓ If the device receives a SIP 180 Ringing response (with or without SDP) and the LocalISDNRBSource parameter is set to 1, it plays a ringback tone and sends an ISDN Alert with PI = 8 (unless the [ProgressIndicator2ISDN_x] parameter is configured differently).</li> <li>✓ If the LocalISDNRBSource parameter is set to 0, the device doesn't play a ringback tone and an Alert message without PI is sent to the ISDN. In this case, the PBX / PSTN plays the ringback tone to the originating terminal. Note that the receipt of a 183 response does not cause the device to play a ringback tone; the device sends a Progress message (unless SIP183Behaviour is set to 1). If the SIP183Behaviour parameter is set to 1, the 183 response is handled the same way as a 180 Ringing response.</li> </ul> <p>■ [2] <b>Prefer IP</b> = Plays according to 'Early Media'. If a SIP 180 response is received and the voice channel is already open (due to a previous 183 early media response or due to an SDP in the current 180 response), the device configured for ISDN or CAS doesn't play the ringback tone; PI = 8 is sent in an ISDN Alert message (unless the [ProgressIndicator2ISDN_x] parameter is configured differently).</p> <p>If a 180 response is received, but the 'early media' voice channel is not opened, the device configured for CAS plays a ringback tone to the PSTN. If a 180 response is received, but the 'early media' voice channel is not opened, the device configured for ISDN operates according to the LocalISDNRBSource parameter:</p> <ul style="list-style-type: none"> <li>✓ If LocalISDNRBSource is set to 1, the device plays a ringback tone and sends an ISDN Alert with PI = 8 to the ISDN (unless the [ProgressIndicator2ISDN_x] parameter is configured differently).</li> <li>✓ If LocalISDNRBSource is set to 0, the device doesn't play a ringback tone. No PI is sent in the ISDN Alert</li> </ul>

Parameter	Description
	<p>message (unless the [ProgressIndicator2ISDN_x] parameter is configured differently). In this case, the PBX / PSTN plays a ringback tone to the originating terminal. Note that the receipt of a 183 response results in an ISDN Progress message (unless SIP183Behaviour is set to 1). If SIP183Behaviour is set to 1 (183 is handled the same way as a 180 with SDP), the device sends an Alert message with PI = 8 without playing a ringback tone.</p> <ul style="list-style-type: none"> <li>■ [3] <b>Play Local Until Remote Media Arrive</b> = Plays tone according to received media. The behaviour is similar to option [2]. If a SIP 180 response is received and the voice channel is already open (due to a previous 183 early media response or due to an SDP in the current 180 response), the device plays a local ringback tone if there are no prior received RTP packets. The device stops playing the local ringback tone as soon as it starts receiving RTP packets. At this stage, if the device receives additional 18x responses, it does not resume playing the local ringback tone. Note that for ISDN trunks, this option is applicable only if LocalISDNRBSsource is set to 1.</li> </ul>
<p>'Call Rerouting Mode'  <code>configure voip &gt;</code>  <code>interface e1-</code>  <code>t1 bri &gt; call-re-</code>  <code>rte-mode</code>  [CallReroutingMode]</p>	<p>Determines whether ISDN call rerouting (call forward) is performed by the PSTN instead of by the SIP side. This call forwarding is based on Call Deflection for Euro ISDN (ETS-300-207-1) and QSIG (ETSI TS 102 393).</p> <ul style="list-style-type: none"> <li>■ [0] <b>None</b> (default)</li> <li>■ [1] <b>ISDN Rerouting Enabled</b> = Enables ISDN call rerouting. When the device sends the INVITE message to the remote SIP entity and receives a SIP 302 response with a Contact header containing a URI host name that is the same as the device's IP address, the device sends a Facility message with a Call Rerouting invoke method to the ISDN and waits for the PSTN side to disconnect the call.</li> </ul> <p><b>Note:</b> When the parameter is enabled, ensure that you configure in the IP-to-Tel Routing table (PSTNPrefix <i>ini</i> file parameter) a rule to route the redirected call (using the user part from the 302 Contact header) to the same Trunk Group from where the incoming Tel-to-IP call was received.</p>

Parameter	Description
'ISDN Duplicate Q931 BuffMode' [ISDNDuplicateQ931BuffMode]	Determines the activation/deactivation of delivering raw Q.931 messages. <ul style="list-style-type: none"> <li>■ [0] 0 = (Default) ISDN messages aren't duplicated.</li> <li>■ [128] 1 = All ISDN messages are duplicated.</li> </ul>
'Trunk Name' config-voip > interface <e1 t1 bri> name [DigitalPortInfo_x]	Defines a descriptive name for a trunk. This can be used to help you easily identify the trunk.  The valid value is a string of up to 40 characters. The following special characters can be used (without quotation marks): <ul style="list-style-type: none"> <li>■ " " (space)</li> <li>■ "." (period)</li> <li>■ "=" (equal sign)</li> <li>■ "-" (hyphen)</li> <li>■ "_" (underscore)</li> <li>■ "#" (pound sign)</li> </ul> By default, the value is undefined.

## TDM and Timing

This section describes the configuration of the TDM and clock timing parameters.

### TDM Bus Clock Settings

In a traditional TDM service network such as PSTN, both ends of the TDM connection must be synchronized. If synchronization is not achieved, voice frames are either dropped (to prevent a buffer overflow condition) or inserted (to prevent an underflow condition). In both cases, connection quality and reliability is affected.

- PSTN line clock (see [Recovering Clock from PSTN Line](#))
- Internal clock (see [Configuring Internal Clock as Clock Source](#))



When the device is used in a 'non-span' configuration, the internal device clock must be used (as explained above).



## Recovering Clock from PSTN Line Interface

This section provides a brief description for configuring synchronization based on recovering clock from the PSTN line interface. For a full description of the clock parameters, see [PSTN Parameters](#).

### ➤ To configure synchronization based on clock from PSTN line:

1. Open the TDM Bus Settings page (**Setup** menu > **Signaling & Media** tab > **Gateway** folder > **TDM Bus Settings**).

GENERAL	
TDM Bus Clock Source	Internal <input type="button" value="v"/> ⚡
TDM Bus PSTN Auto FallBack Clock	Disable <input type="button" value="v"/> ⚡
<b>TDM Bus PSTN Auto Clock Reverting</b>	Disable <input type="button" value="v"/> ⚡
TDM Bus Local Reference	1

- a. From the 'TDM Bus Clock Source' drop-down list (TDMBusClockSource), select **Network** to recover the clock from the line interface.
- b. In the 'TDM Bus Local Reference' field (TDMBusLocalReference), enter the trunk from which the clock is derived.



- The E1/T1 trunk should recover the clock from the remote side (see below description of the 'Clock Master' parameter).
- The BRI trunk should be configured as an ISDN user-side.

- c. Enable automatic switchover to the next available "slave" trunk if the device detects that the local-reference trunk is no longer capable of supplying the clock to the system:
  - i. From the 'TDM Bus PSTN Auto FallBack Clock' drop-down list (TDMBusPSTNAutoClockEnable), select **Enable**.
  - ii. From the 'TDM Bus PSTN Auto Clock Reverting' drop-down list (TDMBusPSTNAutoClockRevertingEnable), select **Enable** to enable the device to switch back to a previous trunk that returns to service if it has higher switchover priority.
  - iii. In the Trunk Settings page (see [Configuring Trunk Settings](#)), configure the priority level of the trunk for taking over as a local-reference trunk, using the 'Auto Clock Trunk Priority' parameter (AutoClockTrunkPriority). A value of 100 means that it never uses the trunk as local reference.

2. (E1/T1 Trunks Only) Configure the PSTN trunk to recover/derive clock from/to the remote side of the PSTN trunk (i.e. clock slave or clock master): In the Trunk Settings page, configure the 'Clock Master' parameter (ClockMaster) to one of the following:
  - Recovered - to recover clock (i.e. slave)
  - Generated - to transmit clock (i.e. master)

### Configuring Internal Clock as Clock Source

You can configure the device to use its internal clock source. The internal clock source is a stratum 4E-compliant clock source. When the device has no line interfaces, the device should be configured in this mode.

#### ➤ To configure internal clock as clock source:

1. Set the clock source to be from the device's internal oscillator. In the TDM Bus Settings page, set the 'TDM Bus Clock Source' parameter (TDMBusClockSource) to **Internal**.
2. (E1/T1 Trunks Only) Set the line to drive the clock on all trunks: In the Trunk Settings page, set the 'Clock Master' parameter (ClockMaster) to Generated (for all trunks).

### Configuring CAS State Machines

The CAS State Machine table lets you modify various timers and other basic parameters to define the initialization of the CAS state machine without changing the state machine itself (no compilation is required). The change doesn't affect the state machine itself, but rather the configuration.

The CAS table used can be chosen in two ways (using the parameter CasChannelIndex):

- Single CAS table per trunk
- Different CAS table per group of B-channels in a trunk



- CAS is applicable only to ISDN PRI interfaces.

#### ➤ To modify the CAS state machine parameters:

1. Open the CAS State Machine page (**Setup** menu > **Signaling & Media** tab > **Gateway** folder > **Trunks & Groups** > **CAS State Machines**).

CAS State Machine

CAS Table Name	Generate Digit On Time	Generate Inter Digit Time	DTMF Max Detection Time	DTMF Min Detection Time	Max Incoming Address Digits	Max Incoming ANI Digits	Collect ANI	Digit Signaling System	Related Trunks
Earth_Calling.dat	-1	-1	-1	-1	-1	-1	Default ▼	Default ▼	

2. Ensure that the trunk is inactive. The trunk number displayed in the 'Related Trunks' field must be green. If it is red, indicating that the trunk is active, click the trunk number to

open the Trunk Settings page (see [Configuring Trunk Settings](#)), select the required Trunk number icon, and then click **Stop Trunk**.

3. In the CAS State Machine table, modify the required parameters according to the table below.
4. Once you have completed the configuration, activate the trunk if required in the Trunk Settings page, by clicking the trunk number in the 'Related Trunks' field, and in the Trunk Settings page, select the required Trunk number icon, and then click **Apply Trunk Settings**.
5. Click **Apply**, and then reset the device.



- The CAS state machine can only be configured using the Web-based management tool.
- Don't modify the default values unless you fully understand the implications of the changes and know the default values. Every change affects the configuration of the state machine parameters and the call process related to the trunk you are using with this state machine.
- You can modify CAS state machine parameters only if the following conditions are met:
  - ✓ Trunks are inactive (stopped), i.e., the 'Related Trunks' field displays the trunk number in green.
  - ✓ State machine is not in use or is in reset, or when it is not related to any trunk. If it is related to a trunk, you must delete the trunk or de-activate (*Stop*) the trunk.
- Field values displaying "-1" indicate CAS default values. In other words, CAS state machine values are used.
- The modification of the CAS state machine occurs at the CAS application initialization only for non-default values (-1).
- For more information on the CAS Protocol table, refer to the *CAS Protocol Table Configuration Note*.

**Table 23-2: CAS State Machine Parameters Description**

Parameter	Description
'Generate Digit On Time' [CasStateMachineGenerateDigitOnTime]	Generates digit on-time (in msec). The value must be a positive value. The default is -1 (use value from CAS state machine).
'Generate Inter Digit Time' [CasStateMachineGenerateInterDigitTime]	Generates digit off-time (in msec). The value must be a positive value. The default is -1 (use value from CAS state machine).
'DTMF Max Detection Time' [CasStateMachineDTMFMaxOnDetectionTime]	Detects digit maximum on time (according to DSP detection information)

Parameter	Description
	<p>event) in msec units.</p> <p>The value must be a positive value. The default is -1 (use value from CAS state machine).</p>
<p>'DTMF Min Detection Time' [CasStateMachineDTMFMinOnDetectionTime]</p>	<p>Detects digit minimum on time (according to DSP detection information event) in msec units. The digit time length must be longer than this value to receive a detection. Any number may be used, but the value must be less than CasStateMachineDTMFMaxOnDetectionTime.</p> <p>The value must be a positive value. The default is -1 (use value from CAS state machine).</p>
<p>'MAX Incoming Address Digits' [CasStateMachineMaxNumOfIncomingAddressesDigits]</p>	<p>Defines the limitation for the maximum address digits that need to be collected. After reaching this number of digits, the collection of address digits is stopped. The value must be an integer. The default is -1 (use value from CAS state machine).</p>
<p>'MAX Incoming ANI Digits' [CasStateMachineMaxNumOfIncomingANIDigits]</p>	<p>Defines the limitation for the maximum ANI digits that need to be collected. After reaching this number of digits, the collection of ANI digits is stopped. The value must be an integer. The default is -1 (use value from CAS state machine).</p>
<p>'Collect ANI' [CasStateMachineCollectANI]</p>	<p>In some cases, when the state machine handles the ANI collection (not related to MFCR2), you can control the state machine to collect ANI or discard ANI.</p> <ul style="list-style-type: none"> <li>■ [0] <b>No</b> = Don't collect ANI.</li> <li>■ [1] <b>Yes</b> = Collect ANI.</li> <li>■ [-1] <b>Default</b> = Default value - use value from CAS state machine.</li> </ul>

Parameter	Description
'Digit Signaling System' [CasStateMachineDigitSignalingSystem]	<p>Defines which Signaling System to use in both directions (detection\generation).</p> <ul style="list-style-type: none"> <li>■ [0] <b>DTMF</b> = Uses DTMF signaling.</li> <li>■ [1] <b>MF</b> = (Default) Uses MF signaling.</li> <li>■ [-1] <b>Default</b> = Default value - use value from CAS state machine.</li> </ul>

## Configuring Digital Gateway Parameters

The Digital Gateway Parameters page allows you to configure miscellaneous digital parameters. For a description of these parameters, see [Configuration Parameters Reference](#).

### ➤ To configure the digital gateway parameters:

1. Open the Digital Gateway Settings page (**Setup** menu > **Signaling & Media** tab > **Gateway** folder > **Digital Gateway** > **Digital Gateway Settings**).

GENERAL		CALLER & CALLEE	
B-channel Negotiation	Exclusive	Remove CLI when Restricted	No
MFC R2 Category	1	Remove Calling Name	Disable
Add IE in SETUP		Use EndPoint Number As Calling Number Tel2IP	Disable
ISDN Transfer on Connect	Alert	Use EndPoint Number As Calling Number IP2Tel	Disable
Trunk Groups to Send IE		ISDN SubAddress Format	ASCII
Trunk Status Reporting Mode to Proxy	Disable	Enable Calling Party Category	Disable
TDM Over IP Min Calls	0	Calling Party Category Mode	None
ISDN Facility Trace	Disable		
REDIRECT NUMBER		SCREENING INDICATOR	
Swap Redirect and Called Numbers	No	Send Screening Indicator to IP	Not Configured
		Send Screening Indicator to ISDN	Not Configured

2. Configure the parameters as required.
3. Click **Apply**.

## Tunneling Applications

This section discusses the device's support for VoIP tunneling applications.

### TDM Tunneling

The device's TDM Tunneling feature allows you to tunnel groups of digital trunk spans or timeslots (B-channels) over the IP network. TDM Tunneling utilizes the device's internal routing

(without Proxy control) capabilities to receive voice and data streams from TDM spans or individual timeslots, convert them into packets, and then transmit them over the IP network (using point-to-point or point-to-multipoint device distributions). A device opposite it (or several devices when point-to-multipoint distribution is used) converts the IP packets back into TDM traffic. Each timeslot can be targeted to any other timeslot within a trunk in the opposite device.



TDM tunneling is applicable only to PRI (not BRI).

When TDM Tunneling is enabled (the parameter `EnableTDMoverIP` is set to '1') on the originating device, the originating device automatically initiates SIP calls from all enabled B-channels belonging to the spans that are configured with the protocol type 'Transparent' (for ISDN trunks) or 'Raw CAS' (for CAS trunks). The called number of each call is the internal phone number of the B-channel from where the call originates. The IP-to-Tel Routing table is used to define the destination IP address of the terminating device. The terminating device automatically answers these calls if the protocol type is set to 'Transparent' (`ProtocolType = 5`) or 'Raw CAS' (`ProtocolType = 3` for T1 and `9` for E1) and the parameter `ChannelSelectMode` is set to 0 (By Dest Phone Number).



It's possible to configure both devices to also operate in symmetric mode. To do so, set `EnableTDMOverIP` to 1 and configure the Tel-to-IP Routing table in both devices. In this mode, each device (after it's reset) initiates calls to the second device. The first call for each B-channel is answered by the second device.

The device continuously monitors the established connections. If for some reason, one or more calls are released, the device automatically re-establishes these 'broken' connections. When a failure in a physical trunk or in the IP network occurs, the device re-establishes the tunneling connections when the network is restored.



It's recommended to use the keep-alive mechanism for each connection, by activating the 'session expires' timeout and using Re-INVITE messages.

The device supports the configuration (`TDMoIPInitiateInviteTime` and `TDMoIPInviteRetryTime` parameters) of the following timers for the TDM-over-IP tunneling application:

- Time between successive INVITEs sent from the same trunk.
- Time between call release and the new INVITE that is sent on the same channel. The call can be released if the device receives a 4xx or 5xx response.

By using Profiles (see [Configuring Tel Profiles](#)), you can configure the TDM Tunneling feature to choose different settings based on a timeslot or groups of timeslots. For example, you can use low-bit-rate vocoders to transport voice and 'Transparent' coder to transport data (e.g., for D-channel). You can also use Profiles to assign ToS (for DiffServ) per source - a timeslot carrying data or signaling is assigned a higher priority value than a timeslot carrying voice.

For tunneling CAS trunks, set the protocol type to 'Raw CAS' (ProtocolType = 3 / 9) and enable RFC 2833 CAS relay mode ('CAS Transport Type' parameter is set to 'CAS RFC2833 Relay').



For TDM over IP, the parameter CallerIDTransportType must be set to '0' (disabled), i.e., transparent.

Below is an example of *ini* files for two devices implementing TDM Tunneling for four E1 spans. Note that in this example both devices are dedicated to TDM tunneling.

#### ■ Terminating Side:

```
EnableTDMOverIP = 1
```

```
;E1_TRANSPARENT_31
ProtocolType_0 = 5
ProtocolType_1 = 5
ProtocolType_2 = 5
ProtocolType_3 = 5
```

```
[PREFIX]
FORMAT PREFIX_Index = PREFIX_RouteName, PREFIX_
DestinationPrefix, PREFIX_DestAddress, PREFIX_SourcePrefix, PREFIX_
ProfileName, PREFIX_MeteringCode, PREFIX_DestPort, PREFIX_
DestIPGroupName, PREFIX_TransportType, PREFIX_SrcTrunkGroupID,
PREFIX_DestSIPInterfaceName, PREFIX_CostGroup, PREFIX_
ForkingGroup, PREFIX_CallSetupRulesSetId, PREFIX_ConnectivityStatus;
Prefix 1 = TunnelA, *, 10.8.24.12;
[PREFIX]
```

```
;IP address of the device in the opposite
;location
```

```
;Channel selection by Phone number.
ChannelSelectMode = 0
```

```
;Profiles can be used do define different coders per B-channels ;such as
Transparent
```

```
;coder for B-channels (timeslot 16) that carries PRI ;signaling.
```

```
[TrunkGroup]
FORMAT TrunkGroup_Index = TrunkGroup_TrunkGroupNum, TrunkGroup_
FirstTrunkId, TrunkGroup_LastTrunkId, TrunkGroup_FirstBChannel,
```

```

TrunkGroup_LastBChannel, TrunkGroup_FirstPhoneNumber, TrunkGroup_
ProfileName, TrunkGroup_Module;
TrunkGroup 1 = 0,0,0,1,31,1000,1;
TrunkGroup 1 = 0,1,1,1,31,2000,1;
TrunkGroup 1 = 0,2,2,1,31,3000,1;
TrunkGroup 1 = 0,3,3,1,31,4000,1;
TrunkGroup 1 = 0,0,0,16,16,7000,2;
TrunkGroup 1 = 0,1,1,16,16,7001,2;
TrunkGroup 1 = 0,2,2,16,16,7002,2;
TrunkGroup 1 = 0,3,3,16,16,7003,2;
[/TrunkGroup]

```

```

[AudioCodersGroups]
FORMAT AudioCodersGroups_Index = AudioCodersGroups_Name;
AudioCodersGroups 0 = "AudioCodersGroups_0";
AudioCodersGroups 1 = "AudioCodersGroups_1";
[\\AudioCodersGroups]

```

```

[AudioCoders]
AudioCoders 0 = "AudioCodersGroups_0", 0, 0, 3, 7, -1, 0, "";
AudioCoders 1 = "AudioCodersGroups_1", 0, 7, 2, 90, 56, 0, "";

```

```

[TelProfile]
FORMAT TelProfile_Index = TelProfile_ProfileName, TelProfile_
TelPreference, TelProfile_CodersGroupName, TelProfile_IsFaxUsed,
TelProfile_JitterBufMinDelay, TelProfile_JitterBufOptFactor, TelProfile_
IPDiffServ, TelProfile_SigIPDiffServ, TelProfile_DtmfVolume, TelProfile_
InputGain, TelProfile_VoiceVolume, TelProfile_EnableReversePolarity,
TelProfile_EnableCurrentDisconnect, TelProfile_EnableDigitDelivery,
TelProfile_EnableEC, TelProfile_MWIAAnalog, TelProfile_MWIDisplay,
TelProfile_FlashHookPeriod, TelProfile_EnableEarlyMedia, TelProfile_
ProgressIndicator2IP;
TelProfile 1 = voice,$$,1,$$,,$$,,$$,,$$,,$$,,$$;
TelProfile 2 = data,$$,2,$$,,$$,,$$,,$$,,$$,,$$;
[\\TelProfile]

```

#### ■ Originating Side:

```

;E1_TRANSPARENT_31
ProtocolType_0 = 5
ProtocolType_1 = 5
ProtocolType_2 = 5
ProtocolType_3 = 5

```



```
;Channel selection by Phone number.
ChannelSelectMode = 0
```

```
[TrunkGroup]
FORMAT TrunkGroup_Index = TrunkGroup_TrunkGroupNum, TrunkGroup_
FirstTrunkId, TrunkGroup_LastTrunkId, TrunkGroup_FirstBChannel,
TrunkGroup_LastBChannel, TrunkGroup_FirstPhoneNumber, TrunkGroup_
ProfileName, TrunkGroup_Module;
TrunkGroup 0 = 0,0,0,1,31,1000,1;
TrunkGroup 0 = 0,1,1,1,31,2000,1;
TrunkGroup 0 = 0,2,2,1,31,3000,1;
TrunkGroup 0 = 0,3,1,31,4000,1;
TrunkGroup 0 = 0,0,0,16,16,7000,2;
TrunkGroup 0 = 0,1,1,16,16,7001,2;
TrunkGroup 0 = 0,2,2,16,16,7002,2;
TrunkGroup 0 = 0,3,3,16,16,7003,2;
[\TrunkGroup]
```

```
[ CodersGroup0 ]
FORMAT CodersGroup0_Index = CodersGroup0_Name, CodersGroup0_
pTime, CodersGroup0_rate, CodersGroup0_PayloadType, CodersGroup0_
Sce, CodersGroup0_CoderSpecific;
CodersGroup0 0 = g7231;
CodersGroup0 1 = Transparent;
[\CodersGroup0 ]
```

```
[TelProfile]
FORMAT TelProfile_Index = TelProfile_ProfileName, TelProfile_
TelPreference, TelProfile_CodersGroupName, TelProfile_IsFaxUsed,
TelProfile_JitterBufMinDelay, TelProfile_JitterBufOptFactor, TelProfile_
IPDiffServ, TelProfile_SigIPDiffServ, TelProfile_DtmfVolume, TelProfile_
InputGain, TelProfile_VoiceVolume, TelProfile_EnableReversePolarity,
TelProfile_EnableCurrentDisconnect, TelProfile_EnableDigitDelivery,
TelProfile_EnableEC, TelProfile_MWIAAnalog, TelProfile_MWIDisplay,
TelProfile_FlashHookPeriod, TelProfile_EnableEarlyMedia, TelProfile_
ProgressIndicator2IP;
TelProfile_1 = voice,$$,1,$$,,$$,,$$,,$$,,$$,,$$
TelProfile_2 = data,$$,2,$$,,$$,,$$,,$$,,$$,,$$
[\TelProfile]
```

## DSP Pattern Detector

For TDM tunneling applications, you can use the DSP pattern detector feature to initiate the echo canceller at call start. The device can be configured to support detection of a specific one-byte idle data pattern transmitted over digital E1/T1 timeslots. The device can be configured to detect up to four different one-byte data patterns. When the defined idle data pattern is detected, the channel resets its echo canceller.

### ➤ To configure DSP pattern detector:

1. On the DSP Settings page (**Setup** menu > **Signaling & Media** tab > **Media** folder > **DSP Settings**), do the following:
  - a. From the 'IPMedia Detectors' drop-down list [EnableDSPIPMDetectors], select **Enable**.

IPMedia Detectors

Enable

- b. From the 'Enable Pattern Detector' drop-down list [EnablePatternDetector], select **Enable**.
2. Configure the number (e.g., 5) of consecutive patterns to trigger the pattern detection event, using the ini file parameter [PDThreshold].
3. Configure the patterns that can be detected by the Pattern Detector, using the ini file parameter [PDPattern]. For example:

PDPattern = 84, 85, 212, 213 ; for idle patterns 54, 55, D4 and D5

## Configuring Private Wire Interworking

You can configure the device to interwork in a private wire system, where one side is IP (SIP) based and the other side is legacy, digital PSTN (E1/T1 CAS) based.



The feature is applicable only to IP-to-Tel calls.

Private wire is a generic term used to describe static point-to-point voice connections between two locations. Private Wires are typically used by a number of communities such as military, railways, emergency services, and financial services. Historically, private wire services were achieved by running direct private connections (telephone cables) between offices in the same building. In private wire services, dialing is unnecessary and there is a direct, "always on" and immediate connection.

Trading turret systems are also part of private wire services. A trading turret or dealer board is a specialized telephony key system that is generally used by financial traders on their trading desk. Trading turrets enable users to prioritize incoming call activity from customers or counter-parties and make calls to these same people instantaneously by pushing a single button to access dedicated point-to-point telephone lines (commonly called Ringdown

circuits). No dialing is necessary; the user simply picks up the handset or pushes a button and a dedicated line is seized. Thus, many turrets have multiple handsets and multi-channel speaker units, allowing immediate connection with multiple parties (e.g., 30 channels). These channels remain constantly open throughout the trading day.

Today, private wire services are evolving from digital TDM architectures to IP-based architectures. The device can be used for interworking between these two architectures, where you have the PSTN switch (PBX) using the E1/T1 CAS protocol on one side, and a SIP-based private wire (turret system) trunk on the other side. The device converts the CAS channels into a SIP call with a called and calling number and if required, passes the ABCD bit state changes through SIP messages, and vice versa. The following diagram shows an example of private-wire interworking by the device:

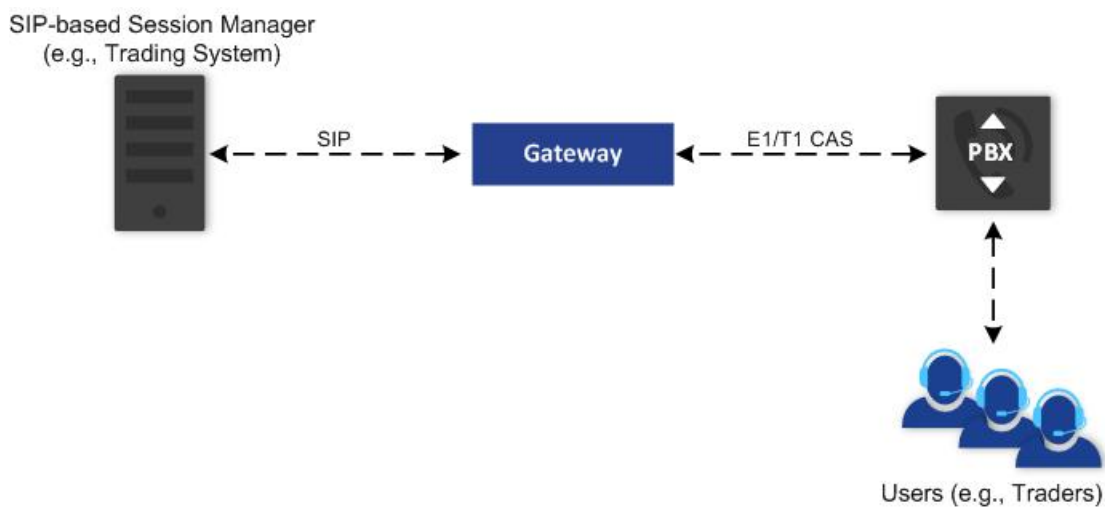

SIP-based private wire calls are established as any other INVITE dialog, but with the addition of the following headers:

- SIP Supported header with the value "pw-info-package" (i.e., Supported: pw-info-package).
- SIP Recv-Info header with the value "pw-info-package" and with the parameter "pw-type=" with a value denoting the private wire state, which can be:

- Ring Down state:

```
Recv-Info: pw-info-package;pw-type=ringdown
```

- Hook Switch:

```
Recv-Info: pw-info-package;pw-type=hookswitch
```

- TOS:

```
Recv-Info: pw-info-package;pw-type=tos
```

The following is an example of an INVITE message for a private wire call:

```
INVITE sip:109701@10.221.108.249:5060;transport=tcp SIP/2.0
Via:SIP/2.0/TCP10.221.109.4:5060;oc-
node=101;branch=z9hG4bKqkYGTNi7Husc11Jlmw6d9g;rport
From: <sip:uas@10.221.109.4>;tag=ENvIDQ
To: <sip:109701@10.221.108.249:5060;transport=tcp>
Call-ID: WHuqvQgdIZB27ewgrhJRYw
CSeq: 835392 INVITE
Contact: <sip:10.221.109.4:5060;transport=tcp;oc-node=101>
Max-Forwards: 70
Content-Type: application/sdp
Content-Length: 635
Supported: pw-info-package
Recv-Info: pw-info-package;pw-type=ringdown
```

Once a SIP-based private wire is established, the private wire user may wish to signal any of the following private wire events to the far-end private wire user, at any time during the "always-on" call:

- **Hook Switch (On Hook and Off Hook states):** This event signals a change in the state of an electronic hook switch. An example is when the user connects a wireless headset to the phone.
- **Ring Down (Ring and No Ring states):** This event signals a ring or no ring state. An example is when the user lifts the handset or pushes a button on the phone to alert the far-end user, which instantly sends ringing to the far end (even though they are already connected). This is also known as Automatic Ring Down (ARD) or Manual Ring Down (MRD).
- **TOS (transmission only service):** If neither Ring Down or Hook Switch modes are specified in the INVITE, TOS is assumed. In this case, the device ignores all CAS signaling, replies with 200 OK and opens a media channel.

These special private wire events are signaled during a call using the SIP INFO message in association with the INFO package (per IETF draft). The INFO package is the INFO message's body, which is in XML schema. The root element of the XML is "<pwsignal>", which contains two child elements:

- "<ringDown>" - requests a local Ring Down alert
- "<hookSwitch>" - requests a Hook Switch alert:
  - ◆ "onHook" - signals that the endpoint is not in use
  - ◆ "offHook" - signals that the endpoint is in use

The following is an example of the XML for private wire signaling in the SIP INFO message:

```
<?xml version="1.0" encoding="UTF-8"?>
<xsd:schema targetNamespace="urn:bt-trs:params:xml:ns:private-wire:0"
  xmlns="urn:bt-trs:params:xml:ns:private-wire:0"
  xmlns:xsd="http://www.w3.org/2001/XMLSchema"
  elementFormDefault="qualified"
  version="0.1">
```

```
<xsd:annotation>
  <xsd:documentation xml:lang="en">Version 0.1 Draft XML schema
    for Private Wire Signalling in SIP INFO body
  </xsd:documentation>
</xsd:annotation>
```

```
<!-- pwSignal -->
<xsd:complexType name="pwSignallingType">
  <xsd:sequence>
    <xsd:choice>
      <xsd:element ref="ringDown" />
      <xsd:element ref="hookSwitch" />
      <xsd:any namespace="##other" minOccurs="0"
        maxOccurs="unbounded" processContents="lax" />
    </xsd:choice>
  </xsd:sequence>
  <xsd:anyAttribute namespace="##other" processContents="lax" />
</xsd:complexType>
<xsd:element name="pwSignal" type="pwSignallingType"/>
```

```
<!-- ringDown -->
<xsd:complexType name="ringDownType">
  <xsd:sequence>
    <xsd:any namespace="##other" minOccurs="0"
      maxOccurs="unbounded" processContents="lax" />
  </xsd:sequence>
  <xsd:attribute name="signal" type="ringDownSignalType" use="required"/>
  <xsd:anyAttribute namespace="##other" processContents="lax" />
</xsd:complexType>
<xsd:element name="ringDown" type="ringDownType"/>
```

```
<!-- hookSwitch -->
<xsd:complexType name="hookSwitchType">
  <xsd:sequence>
    <xsd:any namespace="##other" minOccurs="0"
      maxOccurs="unbounded" processContents="lax" />
```

```

</xsd:sequence>
<xsd:attribute name="signal" type="hookSwitchSignalType" use="required"/>
<xsd:anyAttribute namespace="##other" processContents="lax" />
</xsd:complexType>
<xsd:element name="hookSwitch" type="hookSwitchType"/>

```

```

<!-- DATATYPES-->
<xsd:simpleType name="ringDownSignalType">
  <xsd:restriction base="xsd:token">
    <xsd:enumeration value="ring"/>
  </xsd:restriction>
</xsd:simpleType>

```

```

<xsd:simpleType name="hookSwitchSignalType">
  <xsd:restriction base="xsd:token">
    <xsd:enumeration value="onHook"/>
    <xsd:enumeration value="offHook"/>
  </xsd:restriction>
</xsd:simpleType>

```

```

</xsd:schema>

```

The following is an example of the message flow for the interworking private wire Ring Down state between the private wire trunk and the E1/T1 CAS trunk:

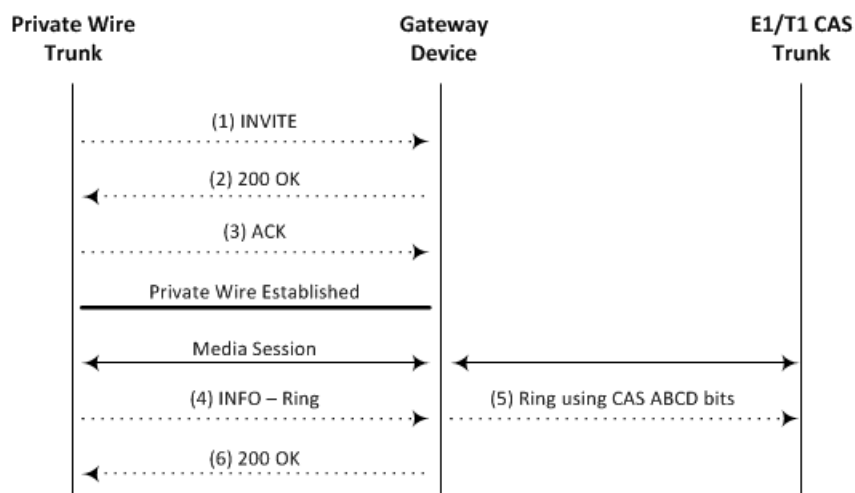

The following is an example of the message flow for interworking private wire Hook Switch states between the private wire trunk and the E1/T1 CAS trunk:

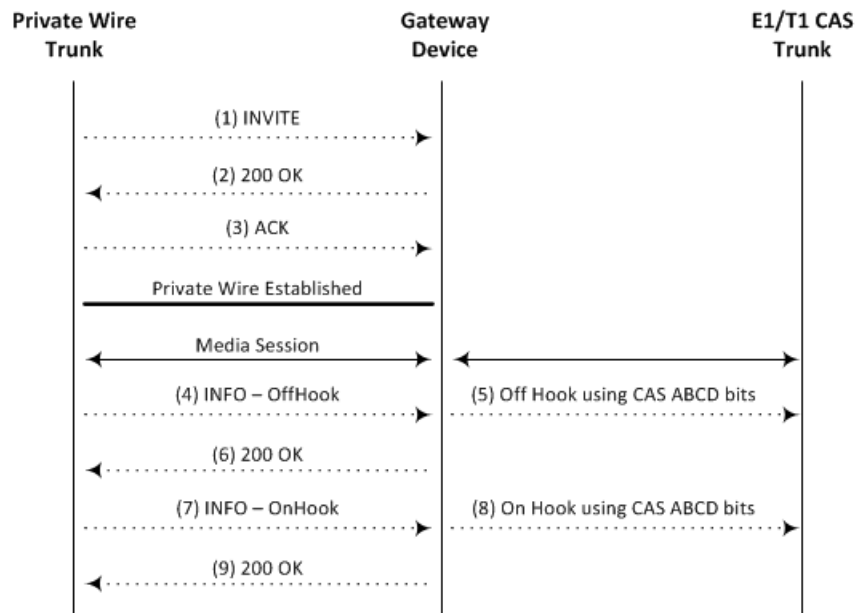

➤ To configure private wire interworking:

1. Enable TDM tunneling for private wire services, by doing one of the following:
  - **Globally:** Open the Digital Gateway Parameters page (**Setup** menu > **Signaling & Media** tab > **Gateway** folder > **Digital Gateway** > **Digital Gateway Parameters**), and then from the 'TDM Tunneling' drop-down list, select **Private Wire**:

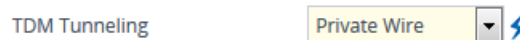

- **Per Trunk:** Configure the ini file parameter EnableTDMOverIPforTrunk.
2. Configure the ini file parameter EnableReansweringInfo to 1.
  3. Load a CAS table file that supports your private wire service. For loading files to the device, see [Loading Auxiliary Files](#).
  4. In the Trunk Settings page (see [Configuring Trunk Settings](#)), configure your E1 or T1 CAS Trunk. Make sure that you select the CAS table file that you loaded in the previous step, in the 'CAS Table per Trunk' field:



5. In the Trunk Group table (see [Configuring Trunk Groups](#)), configure the Trunk Group ID for the E1/T1 CAS Trunk, as shown in the following example:

Group Index	Module	From Trunk	To Trunk	Channels	Phone Number	Trunk Group ID	Tel Profile Name
1	Module 1 PRI	1	1	1-30	4000	1	None

6. In the Trunk Group Settings table (see [Configuring <trnkgrpsettable<product>>](#)), configure the method for selecting channels for the E1/T1 CAS Trunk to **By Dest Phone Number**, as shown in the following example:

INDEX	NAME	TRUNK GROUP ID	CHANNEL SELECT MODE
0	PW	1	By Dest Phone Number

- In the IP-to-Tel Routing table (see [Configuring IP-to-Tel Routing Rules](#)), configure IP-to-Tel Routing rules.

## QSIG Tunneling

The device supports QSIG tunneling over SIP, according to IETF Internet-Draft draft-elwell-sipping-qsig-tunnel-03 ("Tunnelling of QSIG over SIP") and ECMA-355/ISO/IEC 22535. This is applicable to all ISDN variants. QSIG tunneling can be applied to all calls or to specific calls using IP Profiles.



TDM tunneling is applicable only to PRI and BRI.

QSIG tunneling sends all QSIG messages as raw data in corresponding SIP messages using a dedicated message body. This is used, for example, to enable two QSIG subscribers connected to the same or different QSIG PBX to communicate with each other over an IP network. Tunneling is supported in both directions (Tel-to-IP and IP-to-Tel).

The term tunneling means that messages are transferred 'as is' to the remote side without being converted (QSIG > SIP > QSIG). The advantage of tunneling over QSIG-to-SIP interworking is that by using interworking, QSIG functionality can only be partially achieved. When tunneling is used, all QSIG capabilities are supported and the tunneling medium (the SIP network) does not need to process these messages.

QSIG messages are transferred in SIP messages in a separate Multipurpose Internet Mail Extensions (MIME) body. Therefore, if a message contains more than one body (e.g., SDP and QSIG), multipart MIME must be used. The Content-Type of the QSIG tunneled message is 'application/QSIG'. The device also adds a Content-Disposition header in the following format:

Content-Disposition: signal; handling=required.

QSIG tunneling is done as follows:

- Call setup (originating device):** The QSIG Setup request is encapsulated in the SIP INVITE message without being altered. After the SIP INVITE request is sent, the device does not encapsulate the subsequent QSIG message until a SIP 200 OK response is received. If the originating device receives a 4xx, 5xx, or 6xx response, it disconnects the QSIG call with a 'no route to destination' cause.
- Call setup (terminating device):** After the terminating device receives a SIP INVITE request with a 'Content-Type: application/QSIG', it sends the encapsulated QSIG Setup message to the Tel side and sends a 200 OK response (no 1xx response is sent) to IP. The 200 OK response includes an encapsulated QSIG Call Proceeding message (without waiting for a Call Proceeding message from the Tel side). If tunneling is disabled and the incoming INVITE includes a QSIG body, a 415 response is sent.



- **Mid-call communication:** After the SIP connection is established, all QSIG messages are encapsulated in SIP INFO messages.
- **Call tear-down:** The SIP connection is terminated once the QSIG call is complete. The Release Complete message is encapsulated in the SIP BYE message that terminates the session.

➤ **To enable QSIG tunneling:**

1. Open the Digital Gateway Settings page (**Setup** menu > **Signaling & Media** tab > **Gateway** folder > **Digital Gateway** > **Digital Gateway Settings**), and then from the 'Enable QSIG Tunneling' drop-down list (EnableQSIGTunneling), select **Enable** on the originating and terminating devices.
2. Configure the QSIGTunnelingMode parameter for defining the format of encapsulated QSIG message data in the SIP message MIME body (0 for ASCII presentation; 1 for binary encoding).
3. Configure the ISDNDuplicateQ931BuffMode parameter to 128 to duplicate all messages.
4. Configure the ISDNInCallsBehavior parameter to 4096.
5. Configure the ISDNRxOverlap parameter to 0 for tunneling of QSIG overlap-dialed digits (see below for description).

The configuration of the ISDNInCallsBehavior and ISDNRxOverlap parameters allows tunneling of QSIG overlap-dialed digits (Tel to IP). In this configuration, the device **delays** the sending of the QSIG Setup Ack message upon receipt of the QSIG Setup message. Instead, the device sends the Setup Ack message to QSIG only when it receives the SIP INFO message with Setup Ack encapsulated in its MIME body. The PBX sends QSIG Information messages (to complete the Called Party Number) only after it receives the Setup Ack. The device relays these Information messages encapsulated in SIP INFO messages to the remote party.

## ISDN Non-Facility Associated Signaling (NFAS)

In regular T1 ISDN trunks, a single 64 kbps channel carries signaling for the other 23 B-channels of that particular T1 trunk. This channel is called the D-channel and usually resides on timeslot # 24. ISDN Non-Facility Associated Signaling (NFAS) enables the use of a single D-channel to control multiple PRI interfaces.



NFAS is applicable only to T1 trunks.

With NFAS it is possible to define a group of T1 trunks, called an *NFAS group*, in which a single D-channel carries ISDN signaling messages for the entire group. The NFAS group's B-channels are used to carry traffic such as voice or data. The NFAS mechanism also enables definition of a backup D-channel on a different T1 trunk, to be used if the primary D-channel fails.

The device supports up to 12 NFAS groups. Each group can comprise up to 10 T1 trunks and each group must contain different T1 trunks. Each T1 trunk is called an "NFAS member". The

T1 trunk whose D-channel is used for signaling is called the "Primary NFAS Trunk". The T1 trunk whose D-channel is used for backup signaling is called the "Backup NFAS Trunk". The primary and backup trunks each carry 23 B-channels while all other NFAS trunks each carry 24 B-channels.

The NFAS group is identified by an NFAS GroupID number (possible values are 1 to 12). To assign a number of T1 trunks to the same NFAS group, use the `NFASGroupNumber_x = groupID` (where x is the physical trunk ID (0 to the maximum number of trunks) or the Web interface (see [Configuring Trunk Settings](#)).

The parameter `DchConfig_x = Trunk_type` defines the type of NFAS trunk. `Trunk_type` is set to 0 for the primary trunk, to 1 for the backup trunk, and to 2 for an ordinary NFAS trunk. 'x' denotes the physical trunk ID (0 to the maximum number of trunks). You can also use the Web interface (see [Configuring Trunk Settings](#)).

For example, to assign the first four T1 trunks to NFAS group #1, in which trunk #0 is the primary trunk and trunk #1 is the backup trunk, use the following configuration:

```
NFASGroupNumber_0 = 1
NFASGroupNumber_1 = 1
NFASGroupNumber_2 = 1
NFASGroupNumber_3 = 1
DchConfig_0 = 0      ;Primary T1 trunk
DchConfig_1 = 1      ;Backup T1 trunk
DchConfig_2 = 2      ;24 B-channel NFAS trunk
DchConfig_3 = 2      ;24 B-channel NFAS trunk
```

The NFAS parameters are described in [PSTN Parameters](#).

## NFAS Interface ID

Several ISDN switches require an additional configuration parameter per T1 trunk that is called 'Interface Identifier'. In NFAS T1 trunks, the Interface Identifier is sent explicitly in Q.931 Setup / Channel Identification IE for all NFAS trunks, except for the B-channels of the Primary trunk (see note below).

The Interface ID can be defined per member (T1 trunk) of the NFAS group, and must be coordinated with the configuration of the Switch. The default value of the Interface ID is identical to the number of the physical T1 trunk (0 for the first trunk, 1 for the second T1 trunk, and so on, up to the maximum number of trunks).

To define an explicit Interface ID for a T1 trunk (that is different from the default), use the following parameters:

- `ISDNIBehavior_x = 512` (x = 0 to the maximum number of trunks identifying the device's physical trunk)
- `ISDNNFASInterfaceID_x = ID` (x = 0 to 255)



- Usually the Interface Identifier is included in the Q.931 Setup/Channel Identification IE only on T1 trunks that doesn't contain the D-channel. Calls initiated on B-channels of the Primary T1 trunk, by default, don't contain the Interface Identifier. Setting the parameter `ISDNIBehavior_x` to 2048' forces the inclusion of the Channel Identifier parameter also for the Primary trunk.
- The parameter `ISDNNFASInterfaceID_x = ID` can define the 'Interface ID' for any Primary T1 trunk, even if the T1 trunk is not a part of an NFAS group. However, to include the Interface Identifier in Q.931 Setup/Channel Identification IE configure `ISDNIBehavior_x = 2048` in the *ini* file.

## Working with DMS-100 Switches

The DMS-100 switch requires the following NFAS Interface ID definitions:

- `InterfaceID #0` for the Primary trunk
- `InterfaceID #1` for the Backup trunk
- `InterfaceID #2` for a 24 B-channel T1 trunk
- `InterfaceID #3` for a 24 B-channel T1 trunk, and so on for subsequent T1 trunks

For example, if four T1 trunks on a device are configured as a single NFAS group with Primary and Backup T1 trunks that is used with a DMS-100 switch, the following parameters should be used:

```
NFASGroupNumber_0 = 1
NFASGroupNumber_1 = 1
NFASGroupNumber_2 = 1
NFASGroupNumber_3 = 1
DchConfig_0 = 0 ;Primary T1 trunk
DchConfig_1 = 1 ;Backup T1 trunk
DchConfig_2 = 2 ;B-Channel NFAS trunk
DchConfig_3 = 2 ;B-channel NFAS trunk
```

If there is no NFAS Backup trunk, the following configuration should be used:

```
ISDNNFASInterfaceID_0 = 0
ISDNNFASInterfaceID_1 = 2
ISDNNFASInterfaceID_2 = 3
ISDNNFASInterfaceID_3 = 4
ISDNIBehavior = 512 ;The parameter should be added because of
;ISDNNFASInterfaceID configuration above
NFASGroupNumber_0 = 1
NFASGroupNumber_1 = 1
NFASGroupNumber_2 = 1
NFASGroupNumber_3 = 1
DchConfig_0 = 0 ;Primary T1 trunk
```

```
DchConfig_1 = 2 ;B-Channel NFAS trunk
DchConfig_2 = 2 ;B-Channel NFAS trunk
DchConfig_3 = 2 ;B-channel NFAS trunk
```

## Creating an NFAS-Related Trunk Configuration

The procedures for creating and deleting an NFAS group must be performed in the correct order, as described below.

### ➤ To create an NFAS Group:

1. If there's a backup ('secondary') trunk for this group, it must be configured first.
2. Configure the primary trunk before configuring any NFAS ('slave') trunk.
3. Configure NFAS ('slave') trunks.

### ➤ To stop / delete an NFAS Group:

1. Stop or delete (by setting ProtocolType to 0, i.e., 'None') all NFAS ('slave') trunks.
2. Stop or delete (by setting ProtocolType to 0, i.e., 'None') the backup trunk if a backup trunk exists.
3. Stop or delete (by setting ProtocolType to 0, i.e., 'None') the primary trunk.



- All trunks in the group must be configured with the same values for trunk parameters TerminationSide, ProtocolType, FramingMethod, and LineCode.
- After stopping or deleting the backup trunk, delete the group and then reconfigure it.

## Performing Manual D-Channel Switchover in NFAS Group

If an NFAS group is configured with two D-channels (Primary and Backup), you can do a manual switchover between these D-channels.

### ➤ To manually switchover from active to standby D-channel:

1. Open the NFAS Group & D-Channel Status page (**Monitor** menu > **PSTN Status** tab > **NFAS Group & D-Channel Status**).
2. Select the required NFAS group, and then click the **Switch Activity** button.



- The **Switch Activity** button is unavailable (i.e., grayed out) if a switchover cannot be done due to, for example, alarms or unsuitable states.
- This feature is applicable only to T1 ISDN protocols supporting NFAS, and only if the NFAS group is configured with two D-channels.

## ISDN Overlap Dialing

Overlap dialing is a dialing scheme used by several ISDN variants to send and/or receive called number digits one after the other (or several at a time). This is in contrast to en-bloc dialing in which a complete number is sent in one message.

The device supports the following ISDN overlap dialing methods:

- Collects ISDN called party number digits and then sends the SIP INVITE to the IP side with the complete destination number (see [Collecting ISDN Digits and Sending Complete Number in SIP](#))
- Interworks ISDN overlap dialing with SIP, according to RFC 3578 (see [Interworking ISDN Overlap Dialing with SIP According to RFC 3578](#))



ISDN overlap dialing is applicable to PRI and BRI.

### Collecting ISDN Digits and Sending Complete Number in SIP

The device can support an overlap dialing mode whereby the device collects the called party number digits from ISDN Q.931 Information messages or DTMF signals, and then sends a SIP INVITE message to the IP side containing the complete destination number.

ISDN overlap dialing for incoming ISDN calls can be configured for the entire device or per ISDN trunk. This is configured using the global parameter, [ISDNRxOverlap] or the [ISDNRxOverlap\_x] parameter (where x denotes the trunk number), respectively.

By default (see the [ISDNINCallsBehavior] parameter), the device plays a dial tone to the ISDN user side when it receives an empty called number from the ISDN. In this scenario, the device includes the Progress Indicator in the SetupAck ISDN message that it sends to the ISDN side.

The device can also mute in-band DTMF detection until it receives the complete destination number from the ISDN. This is configured by the [MuteDTMFInOverlap] parameter. The Information digits can be sent in-band in the voice stream, or out-of-band using Q.931 Information messages. If Q.931 Information messages are used, the DTMF in-band detector must be disabled. Note that when at least one digit is received in the ISDN Setup message, the device stops playing a dial tone.

The device stops collecting digits (from the ISDN) upon the following scenarios:

- The device receives a Sending Complete IE in the ISDN Setup or Information messages, indicating no more digits.
- The timeout between received digits expires (configured by the [TimeBetweenDigits] parameter).
- The maximum number of received digits has been reached (configured by the [MaxDigits] parameter).
- A match is found with the defined digit map (configured by the [DigitMapping] parameter).

Relevant parameters (described in [PSTN Parameters](#)):

- [ISDNRxOverlap\_x = 1] (can be configured per trunk)
- [TimeBetweenDigits]
- [MaxDigits]
- [MuteDTMFInOverlap]
- [DigitMapping]

To configure ISDN overlap dialing using the Web interface, see [Configuring Trunk Settings](#).

## Interworking ISDN Overlap Dialing with SIP According to RFC 3578

With overlap dialing disabled, the device expects to receive the digits all at once (enbloc) or with very little delay between digits and then sends the complete number in a single message. Overlap signaling sends portions of the number in separate messages as it collects the digits from the sender. The interval between receiving the digits (*time between digits*) is relatively long. However, overlap dialing allows the device to begin call setup (routing) even before all digits have been collected. For example, if the dialed (destination) number is "3312418", the device first receives the digits "331" and then routes the call based on these digits. It then delivers the remaining 4 digits "2418" in overlap mode. The device supports the interworking of ISDN overlap dialing to SIP and vice versa, according to RFC 3578.

- **Interworking ISDN overlap dialing to SIP (Tel to IP):** The device sends the first digits (e.g., "331") received from the ISDN Setup message to the IP side in the initial SIP INVITE message. Each time it receives additional (collected) digits, which are received from subsequent Q.931 Information messages, it sends them to the IP side in SIP re-INVITE or SIP INFO messages. You can use the following parameters to configure overlap dialing for Tel-to-IP calls:
  - ISDNRxOverlap: Enables Tel-to-IP overlap dialing and defines how the device sends the collected digits to the IP side - in SIP re-INVITE [2] or INFO messages [3].
  - MinOverlapDigitsForRouting: Defines the minimum number of overlap digits to collect from the Tel side before the device can send the first SIP message (INVITE) for routing the call to the IP side.
  - MaxDigits: Defines the maximum number of collected digits that can be received from the Tel side (if ISDN Sending Complete IE is not received). When the number of collected digits reaches the maximum, the device uses these digits for the called destination number.
  - TimeBetweenDigits: Defines the maximum time (in seconds) that the device waits between digits received from the Tel side. When the time expires, the device uses the collected digits to dial the called destination number.
  - MuteDTMFInOverlap: Enables the device to ignore in-band DTMF digits received during overlap dialing.



If the device receives SIP 4xx responses during the overlap dialing (while collecting digits), it does not release the call.

- **Interworking SIP to ISDN overlap dialing (IP to Tel):** The device sends the first digits (e.g., "331") received from the initial SIP INVITE message to the Tel side in an ISDN Setup message. Each time it receives additional (collected) digits for the same dialog, which are received from subsequent SIP re-INVITE messages or SIP INFO messages, it sends them to the Tel side in SIP Q.931 Information messages. For each subsequent re-INVITE or SIP INFO message received, the device sends a SIP 484 "Address Incomplete" response to the IP side to maintain the current dialog session and to receive additional digits from subsequent re-INVITE or INFO messages. You can use the following parameters to configure overlap dialing for IP-to-Tel calls:

- **ISDNTxOverlap:** Enables IP-to-Tel overlap dialing and defines how the device receives the collected digits from the IP side - in SIP re-INVITE [1] or INFO messages [2].
- **TimeBetweenDigits:** Defines the maximum time (in seconds) that the device waits between digits received from the IP side. When the time expires, the device uses the collected digits to dial the called destination number.



For IP-to-Tel overlap dialing, to send ISDN Setup messages without including the Sending Complete IE, you must configure the ISDNOutCallsBehavior parameter to USER SENDING COMPLETE [2].

For more information on the above mentioned parameters, see [PSTN Parameters](#). To configure ISDN overlap dialing using the Web interface, see [Configuring Trunk Settings](#).

## Redirect Number and Calling Name (Display)

The following tables define the device's redirect number and calling name (Display) support for various ISDN variants according to NT (Network Termination) / TE (Termination Equipment) interface direction:

**Table 23-3: Calling Name (Display)**

NT/TE Interface	DMS-100	NI-2	4/5ESS	Euro ISDN	QSIG
NT-to-TE	Yes	Yes	Yes	Yes	Yes
TE-to-NT	Yes	Yes	Yes	No	Yes

**Table 23-4: Redirect Number**

NT/TE Interface	DMS-100	NI-2	4/5ESS	Euro ISDN	QSIG
NT-to-TE	Yes	Yes	Yes	Yes	Yes

NT/TE Interface	DMS-100	NI-2	4/5ESS	Euro ISDN	QSIG
TE-to-NT	Yes	Yes	Yes	Yes*	Yes

\* When using ETSI DivertingLegInformation2 in a Facility IE (not Redirecting Number IE).



## 24 Trunk Groups

This section describes Trunk Group configuration.

### Configuring Trunk Groups

The Trunk Group table lets you configure up to 240 Trunk Groups. A Trunk Group is a logical group of physical trunks and channels. A Trunk Group can include multiple trunks and a range of channels. To enable and activate the channels, you need to configure the Trunk Group and assign it telephone numbers. Channels that are not configured in this table are disabled.

Once you have configured your Trunk Group, you can use it for call routing. To configure IP-to-Tel routing rules, see [Configuring IP-to-Tel Routing Rules](#). To configure Tel-to-IP routing rules, see [Configuring Tel-to-IP Routing Rules](#).

The following procedure describes how to configure Trunk Groups through the Web interface. You can also configure it through ini file [TrunkGroup\_x] or CLI (`configure voip > gateway trunk-group`).

➤ **To configure a Trunk Group:**

1. Open the Trunk Group table (**Setup** menu > **Signaling & Media** tab > **Gateway** folder > **Trunks & Groups** > **Trunk Groups**).

Add Phone Context As Prefix Disable ▾  
Trunk Group Index 1-12 ▾

GROUP INDEX	MODULE	FROM TRUNK	TO TRUNK	CHANNELS	PHONE NUMBER	TRUNK GROUP ID	TEL PROFILE NAME
1	<input type="text"/>	<input type="text"/>	<input type="text"/>	<input type="text"/>	<input type="text"/>	<input type="text"/>	None ▾
2	<input type="text"/>	<input type="text"/>	<input type="text"/>	<input type="text"/>	<input type="text"/>	<input type="text"/>	None ▾
3	<input type="text"/>	<input type="text"/>	<input type="text"/>	<input type="text"/>	<input type="text"/>	<input type="text"/>	None ▾
4	<input type="text"/>	<input type="text"/>	<input type="text"/>	<input type="text"/>	<input type="text"/>	<input type="text"/>	None ▾
5	<input type="text"/>	<input type="text"/>	<input type="text"/>	<input type="text"/>	<input type="text"/>	<input type="text"/>	None ▾
6	<input type="text"/>	<input type="text"/>	<input type="text"/>	<input type="text"/>	<input type="text"/>	<input type="text"/>	None ▾
7	<input type="text"/>	<input type="text"/>	<input type="text"/>	<input type="text"/>	<input type="text"/>	<input type="text"/>	None ▾
8	<input type="text"/>	<input type="text"/>	<input type="text"/>	<input type="text"/>	<input type="text"/>	<input type="text"/>	None ▾
9	<input type="text"/>	<input type="text"/>	<input type="text"/>	<input type="text"/>	<input type="text"/>	<input type="text"/>	None ▾
10	<input type="text"/>	<input type="text"/>	<input type="text"/>	<input type="text"/>	<input type="text"/>	<input type="text"/>	None ▾
11	<input type="text"/>	<input type="text"/>	<input type="text"/>	<input type="text"/>	<input type="text"/>	<input type="text"/>	None ▾
12	<input type="text"/>	<input type="text"/>	<input type="text"/>	<input type="text"/>	<input type="text"/>	<input type="text"/>	None ▾

Register Un-Register

2. Configure a Trunk Group according to the parameters described in the table below.
3. Click **Apply**.

You can also register all your Trunk Groups. The registration method per Trunk Group is configured by the 'Registration Mode' parameter in the Trunk Group Settings page (see [Configuring Trunk Group Settings](#)).

- To register Trunk Groups, click the **Register** button.
- To unregister Trunk Groups, click the **Unregister** button.

**Table 24-1: Trunk Group Table Parameter Descriptions**

Parameter	Description
'Module' module [TrunkGroup_Module]	Defines the telephony interface module for which you want to define the Trunk Group.
'From Trunk' first-trunk-id [TrunkGroup_FirstTrunkId]	Defines the starting physical Trunk number in the Trunk Group. The number of listed Trunks depends on the device's hardware configuration. <b>Note:</b> The parameter is applicable only to digital interfaces.
'To Trunk' last-trunk-id [TrunkGroup_LastTrunkId]	Defines the ending physical Trunk number in the Trunk Group. The number of listed Trunks depends on the device's hardware configuration. <b>Note:</b> The parameter is applicable only to digital interfaces.
'Channels' first-b-channel [TrunkGroup_FirstBChannel] last-b-channel [TrunkGroup_LastBChannel]	<ul style="list-style-type: none"> <li>■ Analog: Defines the ports (channels) on the module.</li> <li>■ Digital: Defines the Trunk's B-channels .</li> </ul> <p>To enable channels, enter the channel numbers. You can enter a range of channels by using the syntax <i>n-m</i>, where <i>n</i> represents the lower channel number and <i>m</i> the higher channel number. For example, "1-4" (without quotation marks) specifies channels 1 through 4. For digital interfaces, to represent all the Trunk's B-channels, enter a single asterisk (*).</p> <p><b>Note:</b> For digital interface, the number of defined channels must not exceed the maximum number of the Trunk's B-channels.</p>
'Phone Number' first-phone-number [TrunkGroup_FirstPhoneNumber]	Defines the telephone number(s) of the channels. The valid value can be up to 50 characters. For a range of channels, enter only the first telephone number. Subsequent channels are assigned the next consecutive telephone number. For example, if you enter 400 for channels 1 to 4,

Parameter	Description
	<p>then channel 1 is assigned phone number 400, channel 2 is assigned phone number 401, and so on. These numbers are also used for channel allocation for IP-to-Tel calls if the Trunk Group's 'Channel Select Mode' parameter is set to <b>By Dest Phone Number</b>.</p> <p><b>Note:</b></p> <ul style="list-style-type: none"> <li>■ If this field includes alphabetical characters and the phone number is defined for a range of channels (e.g., 1-4), then the phone number must end with a number (e.g., 'user1').</li> <li>■ This field is optional. The logical numbers defined in this field are used when an incoming Tel call doesn't contain the calling number or called number (the latter being determined by the ReplaceEmptyDstWithPortNumber parameter). These numbers are used to replace them.</li> <li>■ This field is ignored if routing of IP-to-Tel calls is done according to the Supplementary Services table, where multiple line extension numbers are configured per port (see <a href="#">Configuring Multi-Line Extensions and Supplementary Services</a>). For this routing method, the 'Channel Select Mode' must be set to <b>Select Trunk By Supplementary Services Table</b> in the Trunk Group Settings table (see <a href="#">Configuring Trunk Group Settings</a>).</li> </ul>
<p>'Trunk Group ID' trunk-group-id [TrunkGroup_TrunkGroupNum]</p>	<p>Defines the Trunk Group ID for the specified channels. The same Trunk Group ID can be assigned to more than one group of channels. If an IP-to-Tel call is assigned to a Trunk Group, the IP call is routed to the channel(s) pertaining to that Trunk Group ID. The valid value can be 0 to 119.</p>
<p>'Tel Profile Name' tel-profile-id [TrunkGroup_ProfileName]</p>	<p>Assigns a Tel Profile to the Trunk Group. To configure Tel Profiles, see <a href="#">Configuring Tel Profiles</a>.</p>

## Configuring Trunk Group Settings

The Trunk Group Settings table lets you configure various settings per Trunk Group ID, which is assigned to a Trunk Group in [Configuring Trunk Groups](#). The main configuration includes the

following:

- Channel select method, which defines how the device allocates incoming IP-to-Tel calls to the channels of a Trunk Group.
- Registration method for registering Trunk Groups to remote IP servers (*Serving IP Group*).

The Trunk Group Settings table also provides an **Action** drop-down button with commands that let you perform various actions per configured Trunk Group:

- **Lock / Unlock:** Locks (blocks) a Trunk Group in order to take its member trunks out-of-service. For more information, see [Locking and Unlocking Trunk Groups](#).
- **Register / Un-Register:** Initiates a registration request for the Trunk Group with a Serving IP Group. For more information, see the description of the 'Registration Mode' parameter of the Trunk Group Settings table in this section.

The following procedure describes how to configure settings for Trunk Groups through the Web interface. You can also configure it through ini file [TrunkGroupSettings] or CLI (configure voip > gateway trunk-group-setting).

➤ **To configure Trunk Group settings per Trunk Group ID:**

1. Open the Trunk Group Settings table (**Setup** menu > **Signaling & Media** tab > **Gateway** folder > **Trunks & Groups** > **Trunk Group Settings**).
2. Click **New**; the following dialog box appears:

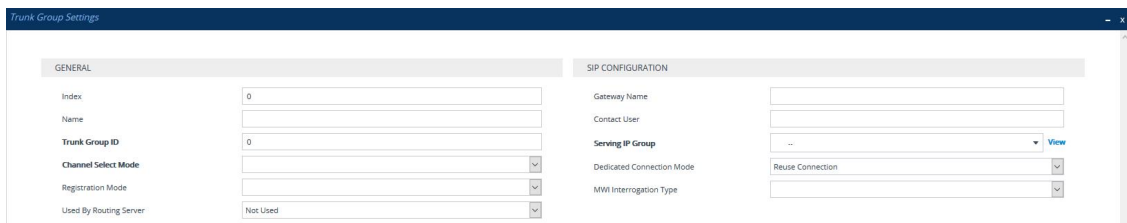

3. Configure settings for a Trunk Group ID according to the parameters described in the table below.
4. Click **Apply**.

**Table 24-2: Trunk Group Settings Table Parameter Descriptions**

Parameter	Description
General	
'Index' [TrunkGroupSettings_ Index]	Defines an index number for the new table row. Up to 241 rows can be configured. <b>Note:</b> Each row must be configured with a unique index.
'Name' trunk-group-	Defines a descriptive name, which is used when associating the row in other tables.

Parameter	Description
name [TrunkGroupSettings_ TrunkGroupName]	<p>The valid value can be a string of up to 40 characters. By default, no name is configured.</p> <p>The name also represents the Trunk Group in the SIP 'tgrp' parameter in outgoing INVITE messages (according to RFC 4904) if the UseSIPtgrp or UseBroadsoftDTG parameter is enabled. For example, if you configure the parameter to "ITSP-ABC":</p> <pre> sip:+16305550100;tgrp=<b>ITSP-ABC</b>;trunk-context=+1-630@isp.example.net;user=phone </pre> <p>If the parameter is not configured, the Trunk Group number is used in the 'tgrp' parameter, for example:</p> <pre> sip:+16305550100;tgrp=<b>TG-1</b>;trunk-context=+1-630@isp.example.net;user=phone </pre> <p><b>Note:</b> Each row must be configured with a unique name.</p>
'Trunk Group ID' trunk-group-id [TrunkGroupSettings_ TrunkGroupId]	Defines the Trunk Group ID.
'Channel Select Mode' channel-select-mode [TrunkGroupSettings_ ChannelSelectMode]	<p>Defines the method by which IP-to-Tel calls are assigned to the channels of the Trunk Group.</p> <ul style="list-style-type: none"> <li>■ [0] <b>By Dest Phone Number</b> = The channel is selected according to the called (destination) number. If the number is not located, the call is released. If the channel is unavailable (e.g., busy), the call is put on call waiting (if call waiting is enabled and no other call is on call waiting); otherwise, the call is released.</li> <li>■ [1] <b>Channel Cyclic Ascending</b> = The next available channel in the Trunk Group, in ascending cyclic order is selected. After the device reaches the highest channel number in the Trunk Group, it selects the lowest channel number in the Trunk Group, and then starts ascending again.</li> <li>■ [2] <b>Always Ascending</b> = The lowest available channel in the Trunk Group is selected, and if unavailable, the next higher channel is selected.</li> <li>■ [3] <b>Cyclic Descending</b> = The next available channel in descending cyclic order is selected. The next lower channel number in the Trunk Group is always selected. When the device reaches the lowest channel number in the Trunk</li> </ul>

Parameter	Description
	<p>Group, it selects the highest channel number in the Trunk Group, and then starts descending again.</p> <ul style="list-style-type: none"> <li>■ [4] <b>Always Descending</b> = The highest available channel in the Trunk Group is selected, and if unavailable, the next lower channel is selected.</li> <li>■ [5] <b>Dest Number &amp; Cyclic Ascending</b> = The channel is selected according to the called number. If the called number isn't found, the next available channel in ascending cyclic order is selected.</li> </ul> <p><b>Note:</b> If the called number is located, but the port associated with the number is busy, the call is released.</p> <ul style="list-style-type: none"> <li>■ [6] <b>By Source Phone Number</b> = The channel is selected according to the calling number.</li> <li>■ [7] <b>Trunk Cyclic Ascending</b> = The channel from the first channel of the next trunk (adjacent to the trunk from which the previous channel was selected) is selected.</li> </ul> <p><b>Note:</b> This option is applicable only to digital interfaces.</p> <ul style="list-style-type: none"> <li>■ [8] <b>Trunk &amp; Channel Cyclic Ascending</b> = The device implements the Trunk Cyclic Ascending and Cyclic Ascending methods to select the channel. This method selects the next physical trunk in the Trunk Group, and then selects the B-channel of this trunk according to the Cyclic Ascending method (i.e., selects the channel after the last allocated channel).</li> </ul> <p>For example, if the Trunk Group includes two physical trunks, 0 and 1:</p> <ul style="list-style-type: none"> <li>✓ For the first incoming call, the first channel of Trunk 0 is selected.</li> <li>✓ For the second incoming call, the first channel of Trunk 1 is selected.</li> <li>✓ For the third incoming call, the second channel of Trunk 0 is selected.</li> </ul> <p><b>Note:</b> This option is applicable only to digital interfaces.</p> <ul style="list-style-type: none"> <li>■ [9] <b>Ring to Hunt Group</b> = The device allocates IP-to-Tel calls to all the FXS ports (channels) in the Trunk Group (i.e., a ringing group). When a call is received for the Trunk Group, all telephones connected to the FXS ports belonging to the</li> </ul>

Parameter	Description
	<p>Trunk Group start ringing. The call is eventually received by whichever telephone first answers the call (after which the other phones stop ringing).</p> <p><b>Note:</b> This option is applicable only to FXS interfaces.</p> <ul style="list-style-type: none"> <li>■ [10] <b>Select Trunk by Supp-Serv Table</b> = The BRI port/module is selected according to the settings in the Supplementary Services table (see <a href="#">Configuring Multi-Line Extensions and Supplementary Services</a>), allowing the routing of IP-to-Tel calls to specific BRI endpoints according to extension number.</li> </ul> <p><b>Note:</b> This option is applicable only to FXS and BRI interfaces.</p> <ul style="list-style-type: none"> <li>■ [11] <b>By Dest Number &amp; Ascending</b> = The device allocates channels to incoming IP-to-Tel calls as follows: <ul style="list-style-type: none"> <li>a. The device attempts to route the call to the channel that is associated with the destination (called) number. If located, the call is sent to that channel.</li> <li>b. If the number is not located or the channel is unavailable (e.g., busy), the device searches in ascending order for the next available channel in the Trunk Group. If located, the call is sent to that channel.</li> <li>c. If all channels are unavailable, the call is released.</li> </ul> </li> </ul> <p><b>Note:</b> If the parameter is not configured, the Trunk Group's channel select method is according to the global parameter [ChannelSelectMode].</p>
'Registration Mode' registration-mode [TrunkGroupSettings_RegistrationMode]	<p>Defines the registration method of the Trunk Group.</p> <ul style="list-style-type: none"> <li>■ [0] <b>Per Endpoint</b> = Each channel in the Trunk Group registers individually. The registrations are sent to the 'Serving IP Group ID' if configured in the table; otherwise, it is sent to the default Proxy, and if no default Proxy, then to the Registrar IP.</li> <li>■ [1] <b>Per Gateway</b> = (Default) Single registration for the entire device. This is applicable only if a default Proxy or Registrar IP is configured and Registration is enabled (i.e., parameter [IsRegisterUsed] is set to 1). In this mode, the SIP URI user part in the From, To, and Contact headers is set to the value of the global registration parameter,</li> </ul>

Parameter	Description
	<p>[GWRegistrationName] or username if [GWRegistrationName] is not configured.</p> <ul style="list-style-type: none"> <li>■ [4] <b>Don't Register</b> = No registrations are sent by endpoints pertaining to the Trunk Group. For example, if the device is configured globally to register all its endpoints (using the parameter [ChannelSelectMode]), you can exclude some endpoints from being registered by assigning them to a Trunk Group and configuring the Trunk Group registration mode to <b>Don't Register</b>.</li> <li>■ [5] <b>Per Account</b> = Registrations are sent (or not) to an IP Group according to the settings in the Accounts table (see <a href="#">Configuring Registration Accounts</a>).</li> </ul> <p>An example is shown below of a REGISTER message for registering endpoint "101" using the registration Per Endpoint mode:</p> <pre>REGISTER sip:SipGroupName SIP/2.0 Via: SIP/2.0/UDP 10.33.37.78;branch=z9hG4bKac862428454 From: &lt;sip:101@GatewayName&gt;;tag=1c862422082 To: &lt;sip:101@GatewayName&gt; Call-ID: 9907977062512000232825@10.33.37.78 CSeq: 3 REGISTER Contact: &lt;sip:101@10.33.37.78&gt;;expires=3600 Expires: 3600 User-Agent: Sip-Gateway/7.20A.260.005 Content-Length: 0</pre> <p>The "SipGroupName" in the Request-URI is configured in the IP Groups table (see <a href="#">Configuring IP Groups</a>).</p> <p><b>Note:</b></p> <ul style="list-style-type: none"> <li>■ If the parameter is not configured, registration is done according to the global registration parameter [ChannelSelectMode].</li> <li>■ To enable Trunk Group registration, configure the global parameter [IsRegisterNeeded] to 1. This is unnecessary for <b>Per Account</b> registration mode.</li> <li>■ If the device is configured globally to register Per Endpoint and an channel group includes four channels to register Per</li> </ul>



Parameter	Description
	Gateway, the device registers all channels except the first four channels. The group of these four channels sends a single registration request.
'Used By Routing Server' used-by-routing-server [TrunkGroupSettings_UsedByRoutingServer]	<p>Enables the use of the Trunk Group by a routing server for routing decisions.</p> <ul style="list-style-type: none"> <li>■ [0] <b>Not Used</b> (default)</li> <li>■ [1] <b>Used</b></li> </ul> <p>For more information, see <a href="#">Centralized Third-Party Routing Server</a>.</p>
SIP Configuration	
'Gateway Name' gateway-name [TrunkGroupSettings_GatewayName]	<p>Defines the host name of the SIP From header in INVITE messages, and the From and To headers in REGISTER requests. By default, no value is defined.</p> <p><b>Note:</b> If the parameter is not configured, the global parameter [SIPGatewayName] is used.</p>
'Contact User' contact-user [TrunkGroupSettings_ContactUser]	<p>Defines the user part for the SIP Contact URI in INVITE messages, and the From, To, and Contact headers in REGISTER requests.</p> <p>The valid value is a string of up to 60 characters. By default, no value is defined.</p> <p><b>Note:</b></p> <ul style="list-style-type: none"> <li>■ The parameter is applicable only if the 'Registration Mode' parameter is configured to <b>Per Account</b> and registration based on the Accounts table is successful.</li> <li>■ If registration fails, the user part in the INVITE Contact header is set to the source party number.</li> <li>■ The 'Contact User' parameter in the Accounts table overrides this parameter (see <a href="#">Configuring Registration Accounts</a>).</li> </ul>
'Serving IP Group' serving-ip-group [TrunkGroupSettings_ServingIPGroupName]	<p>Assigns an IP Group to where the device sends INVITE messages for calls received from the Trunk Group. The actual destination to where the INVITE messages are sent is according to the Proxy Set associated with the IP Group. The Request-URI host name in the INVITE and REGISTER messages (except for <b>Per Account</b> registration mode) is set to the value of the 'SIP Group Name' parameter configured in the IP Groups table (see</p>

Parameter	Description
	<p><a href="#">Configuring IP Groups</a> on page 431).</p> <p><b>Note:</b></p> <ul style="list-style-type: none"> <li>■ If the parameter is not configured, the INVITE messages are sent to the default Proxy or according to the Tel-to-IP Routing table (see <a href="#">Configuring Tel-to-IP Routing Rules</a>).</li> <li>■ If the PreferRouteTable parameter is set to 1 (see <a href="#">Configuring Proxy and Registration Parameters</a>), the routing rules in the Tel-to-IP Routing table take precedence over the selected Serving IP Group ID.</li> </ul>
<p>'MWI Interrogation Type'</p> <p>mwi-interrogation-type</p> <p>[TrunkGroupSettings_MWIIterrogationType]</p>	<p>Defines message waiting indication (MWI) QSIG-to-IP interworking for interrogating MWI supplementary services.</p> <ul style="list-style-type: none"> <li>■ [255] <b>Not configured</b>.</li> <li>■ [0] <b>None</b> = Disables the feature.</li> <li>■ [1] <b>Use Activate Only</b> = MWI Interrogation messages are not sent and only "passively" responds to MWI Activate requests from the PBX.</li> <li>■ [2] <b>Result Not Used</b> = MWI Interrogation messages are sent, but the result is not used. Instead, the device waits for MWI Activate requests from the PBX.</li> <li>■ [3] <b>Use Result</b> = MWI Interrogation messages are sent, its results are used, and the MWI Activate requests are used. MWI Activate requests are interworked to SIP NOTIFY MWI messages. The SIP NOTIFY messages are sent to the IP Group defined by the NotificationIPGroupID parameter.</li> </ul> <p><b>Note:</b></p> <ul style="list-style-type: none"> <li>■ The parameter is applicable only to digital interfaces.</li> <li>■ The parameter appears in the table only if the VoiceMailInterface parameter is set to 3 (QSIG) (see <a href="#">Configuring Voice Mail</a>).</li> </ul>
<b>Status</b>	
<p>'Admin State'</p>	<p>(Read-only) Displays the administrators state:</p> <ul style="list-style-type: none"> <li>■ "Locked": The Lock command has been chosen from the Action drop-down button.</li> <li>■ "Unlocked": The Unlock command has been chosen from the Action drop-down button.</li> </ul>

Parameter	Description
'Status'	<p>(Read-only) Displays the current status of the trunks/channels in the Trunk Group:</p> <ul style="list-style-type: none"><li data-bbox="635 383 1382 533">■ "In Service": Indicates that all channels in the Trunk Group are in service, for example, when the Trunk Group is unlocked or Busy Out state cleared (see the [EnableBusyOut] parameter for more information).</li><li data-bbox="635 562 1390 674">■ "Going Out Of Service": Appears as soon as you choose the Lock command and indicates that the device is starting to lock the Trunk Group and take channels out of service.</li><li data-bbox="635 703 1382 927">■ "Going Out Of Service (&lt;duration remaining of graceful period&gt; sec / &lt;number of calls still active&gt; calls)": Appears when the device is locking the Trunk Group and indicates the number of busy channels and the time remaining until the graceful period ends, after which the device locks the channels regardless of whether the call has ended or not.</li><li data-bbox="635 956 1350 1106">■ "Out Of Service": All fully configured trunks in the Trunk Group are out of service, for example, when the Trunk Group is locked or in Busy Out state (see the [EnableBusyOut] parameter).</li></ul>

## 25 Routing

This section describes the configuration of call routing for the Gateway application.

### Configuring Tel-to-IP Routing Rules

The Tel-to-IP Routing table lets you configure up to 180 Tel-to-IP routing rules. Tel-to-IP routing rules are used to route calls from the Tel side to an IP destination.

Configuration of Tel-to-IP routing rules includes two areas:

- **Match:** Defines the characteristics of the incoming Tel call (e.g., Trunk Group on which the call is received). You can configure routing rules with one or more of the following incoming Tel characteristics:
  - Source Trunk Group (from where the call is received)
  - Source (calling) and destination (called) telephone number prefix and suffix
  - Source and destination Dial Plan tags
- **Action:** Defines the action that is done if the incoming call matches the characteristics of the rule (i.e., routes the call to the specified IP destination). You can configure the IP destination to one of the following:
  - IP address or FQDN.
  - E.164 Telephone Number Mapping (ENUM service).
  - Lightweight Directory Access Protocol (LDAP). For more information, see [LDAP-based Management and SIP Services](#) and [AD-based Routing for Microsoft Skype for Business](#).
  - IP Group. When an IP Group is selected, the device sends the call to the IP address configured for the Proxy Set that is associated with the IP Group (configured in [Configuring IP Groups](#)). The SRD associated with the IP Group determines the:
    - ◆ SIP Interface (SIP port and control network interface) - important when using multiple SIP control VLANs
    - ◆ Media Realm (port and network interface for media / RTP voice)
    - ◆ SRD-related features on which the call is routed

If you configure the routing rule to send the call to any destination other than an IP Group (e.g., an IP address), you need to select a SIP Interface for the call. If no SIP Interface is selected, the device uses the SIP Interface associated with the default SRD (Index 0). If you have deleted this SRD or SIP Interface, for whatever reason, the device drops the call. The SIP Interface determines many attributes for the destination:

- Device's logical SIP port and network interface through which the call signaling is sent
- Device's logical RTP port and network interface through which the media is sent (Media Realm)

- Other features that can be configured for the SIP Interface
- SRD. As one of the attributes of a SIP Interface is an SRD and as you can configure multiple SIP Interfaces per SRD, the specific SIP Interface not only determines the above-mentioned attributes, but also the SRD for routing the call.

The device searches the table from **top to bottom** for the **first** rule that matches the characteristics of the incoming call. If it finds a matching rule, it sends the call to the IP destination configured for that rule. If it doesn't find a matching rule, it rejects the call.

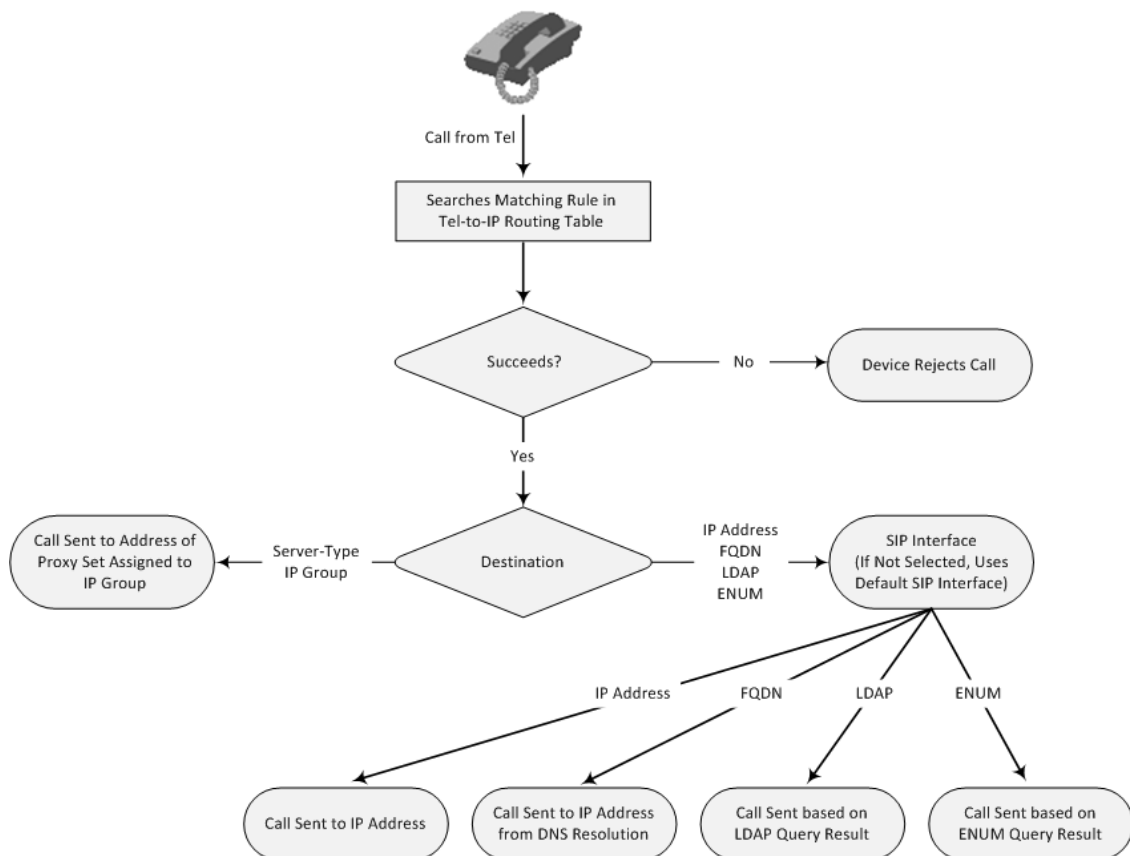

In addition to normal Tel-to-IP routing, you can configure the following features:

- **Least Cost Routing (LCR):** If the LCR feature is enabled, the device searches the routing table for matching routing rules and then selects the one with the lowest call cost. The call cost of the routing rule is done by assigning it a Cost Group. To configure Cost Groups, see [Least Cost Routing](#). If two routing rules have identical costs, the rule appearing higher up in the table (i.e., first-matched rule) is used. If a selected route is unavailable, the device uses the next least-cost routing rule. However, even if a matched rule is not assigned a Cost Group, the device can select it as the preferred route over other matched routing rules with Cost Groups, according to the optional, default LCR settings configured by the Routing Policy (see [Configuring a Gateway Routing Policy Rule](#)).
- **Call Forking:** If the Tel-to-IP Call Forking feature is enabled, the device can send a Tel call to multiple IP destinations. An incoming Tel call with multiple matched routing rules (e.g., all with the same source prefix numbers) can be sent (forked) to multiple IP destinations if all

these rules are configured with a Forking Group. The call is established with the first IP destination that answers the call.

- **Call Restriction:** Calls whose matching routing rule is configured with the destination IP address of 0.0.0.0 are rejected.
- **Always Use Routing Table:** Even if a proxy server is used, the SIP Request-URI host name in the outgoing INVITE message is obtained from this table. Using this feature, you can assign a different SIP URI host name for different called and/or calling numbers. This feature is enabled using the AlwaysUseRouteTable parameter.
- **IP Profiles:** IP Profiles can be assigned to destination addresses (also when a proxy is used).
- **Alternative Routing (when a proxy isn't used):** An alternative IP destination (alternative routing rule) can be configured for specific calls ("main" routing rule). When the "main" route fails (e.g., busy), the device can send the call to the alternative route. You must configure the alternative routing rules in table rows (indices) that are located anywhere **below** the "main" routing rule. For example, if you configure a "main" routing rule in Index 4, the alternative routing rule can be configured in Index 6. In addition, you must configure the alternative routing rules with identical matching characteristics (e.g., destination prefix number) as the "main" routing rule, but assigned with different destination IP addresses. Instead of an IP address, you can use an FQDN to resolve into two IP addresses. For more information on alternative routing, see [Alternative Routing for Tel-to-IP Calls](#).
- **Advice of Charge (AOC):** AOC is a pre-billing feature that tasks the rating engine with calculating the cost of using a service (Tel-to-IP call) and relaying that information to the customer. AOC, which is configured in the Charge Codes table, can be applied per Tel-to-IP routing rule.



- Instead of using the table for Tel-to-IP routing, you can employ a third-party Routing server to handle the routing decisions. For more information, see [Centralized Third-Party Routing Server](#).
- You can configure up to three alternative routing rules per "main" routing rule in the Tel-to-IP Routing table.
- By default, the device applies telephone number manipulation (if configured) only after processing the routing rule. You can change this and apply number manipulation before processing the routing rule (see the RouteModeTel2IP parameter).
- By default, if the device receives a REFER message, it forwards the message to the destination specified in the message. Alternatively, if you want the device to search again for a matching routing rule in the Tel-to-IP Routing table and to then forward the REFER message to the destination of the matched rule, you need to configure the [SIPReRoutingMode] parameter to [2].
- When using a proxy server, it is unnecessary to configure routing rules in the Tel-to-IP Routing table unless you require one of the following:
  - ✓ Alternative routing (fallback) when communication with the proxy server fails.



- ✓ IP security, whereby the device routes only received calls whose source IP addresses are configured in the table. Enable IP security using the SecureCallsFromIP parameter.
- ✓ Filter Calls to IP feature. The device checks the table before a call is routed to the proxy server. However, if the number is not allowed (i.e., the number is not specified in the table or a Call Restriction routing rule is configured), the call is rejected.
- ✓ Obtain different SIP URI host names (per called number).
- ✓ Assign IP Profiles to calls.
- ✓ For the table to take precedence over a proxy server for routing calls, you need to configure the PreferRouteTable parameter to 1. The device checks the 'Destination IP Address' field in the table for a match with the outgoing call; a proxy is used only if a match is not found.

The following procedure describes how to configure Tel-to-IP routing rules through the Web interface. You can also configure it through ini file [Prefix] or CLI (`configure voip > gateway routing tel2ip-routing`).

➤ **To configure Tel-to-IP routing rules:**

1. Open the Tel-to-IP Routing table (**Setup** menu > **Signaling & Media** tab > **Gateway** folder > **Routing** > **Tel** > **IP Routing**).
2. Click **New**; the following dialog box appears:

3. Configure a routing rule according to the parameters described in the table below.
4. Click **Apply**.

The following table shows configuration examples of Tel-to-IP routing rules:

**Table 25-1: Example of Tel-to-IP Routing Rules**

Parameter	Rule 1	Rule 2	Rule 3	Rule 4	Rule 5	Rule 6	Rule 7	Rule 8
<b>Matching Characteristics of Incoming Call</b>								

Parameter	Rule 1	Rule 2	Rule 3	Rule 4	Rule 5	Rule 6	Rule 7	Rule 8
'Source Trunk Group ID'	-	-	-	4	-	*	*	*
'Source Phone Pattern'	100	100	*	*	*	*	*	*
'Destination Phone Pattern'	10	10	20	[5,7-9]	00	100	100	100
<b>Action</b>								
'Destination IP Group'	-	-	ITS P-ZA	-	-	-	-	-
'Destination IP Address'	10.33.45.63	10.33.45.50		itsp.com	0.0.0.0	10.33.45.68	10.33.45.67	domain.com
'IP Profile'	ABC	ABC	-	-	-	-	-	-
'Forking Group'	-	-	-	-	-	1	2	1
'Cost Group ID'	Weekend-Low	Weekend_High	-	-	-	-	-	-

Below are descriptions of each rule:

- **Rules 1 and 2 (Least Cost Routing):** For both rules, the called (destination) phone number prefix is 10, the caller's (source) phone number prefix is 100, and the call is assigned IP Profile "ABC". However, Rule 1 is assigned a cheaper Cost Group than Rule 2, and therefore, the call is sent to the destination IP address (10.33.45.63) associated with Rule 1.
- **Rule 3 (IP Group destination):** For all callers (\*), if the called phone number prefix is 20, the call is sent to IP Group "ITSP-ZA".



- **Rule 4 (domain name destination):** For called phone number prefixes 5, 7, 8, or 9, and the caller belongs to Trunk Group ID 4, the call is sent to the domain "itsp.com".
- **Rule 5 (block):** For all callers (\*), if the called phone number prefix is 00, the call is rejected (IP address 0.0.0.0).
- **Rule 6, 7, and 8 (Forking Group):** For all callers (\*), if the called phone number prefix is 100, the call is sent to Rule 7 and 9 (belonging to Forking Group "1"). If their destinations are unavailable and alternative routing is enabled, the call is sent to Rule 8 (Forking Group "2").

**Table 25-2: Tel-to-IP Routing Table Parameter Descriptions**

Parameter	Description
General	
'Index' [PREFIX_Index]	Defines an index number for the new table row. <b>Note:</b> Each row must be configured with a unique index.
'Name' route-name [PREFIX_RouteName]	Defines a descriptive name, which is used when associating the row in other tables. The valid value is a string of up to 40 characters. By default, no value is defined. <b>Note:</b> Each row must be configured with a unique name.
'Connectivity Status'	(Read-only field) Displays the connectivity status of the routing rule's destination. The destination can be an IP address or an IP Group, as configured in the 'Destination IP Address' and 'Destination IP Group' fields respectively. For IP Groups, the status indicates the connectivity with the SIP proxy server's address configured for the Proxy Set that is associated with the IP Group. For the status to be displayed, the Proxy Keep-Alive feature, which monitors the connectivity with proxy servers per Proxy Set, must be enabled for the Proxy Set (see <a href="#">Configuring Proxy Sets</a> ). If a Proxy Set is configured with multiple proxies for redundancy, the status may change according to the proxy server with which the device attempts to verify connectivity. For example, if there is no response from the first configured proxy address, the status displays "No Connectivity". However, if there is a response from the next proxy server in the list, the status changes to "OK". If there is connectivity with the destination, the field displays "OK" and the device uses the routing rule if required. The routing rule is not used if any of the following is displayed:

Parameter	Description
	<ul style="list-style-type: none"> <li>■ "n/a" = IP Group is unavailable.</li> <li>■ "No Connectivity" = No connection with the destination (no response to the SIP OPTIONS).</li> <li>■ "QoS Low" = Poor Quality of Service (QoS) of the destination.</li> <li>■ "DNS Error" = No DNS resolution. This status is applicable only when a domain name is used (instead of an IP address).</li> <li>■ "Not Available" = Destination is unreachable due to networking issues.</li> </ul>
<b>Match</b>	
'Source Trunk Group ID' <code>src-trunk-group-id</code> [PREFIX_SrcTrunkGroupID]	Defines the Trunk Group from where the call is received. To denote any Trunk Group, use the asterisk (*) symbol. By default, no Trunk Group is defined (-1).
'Source Phone Pattern' <code>src-phone-pattern</code> [PREFIX_SourcePrefix]	Defines the prefix and/or suffix of the calling (source) telephone number. You can use special notations for denoting the prefix. For example, [100-199](100,101,105) denotes a number that starts with 100 to 199 and ends with 100, 101 or 105. To denote any prefix, use the asterisk (*) symbol (default) or to denote calls without a calling number, use the \$ sign. For a description of available notations, see <a href="#">Dialing Plan Notation for Routing and Manipulation Tables</a> .  The number can include up to 50 digits.
'Source Tags' <code>src-tags</code> [PREFIX_SrcTags]	Assigns a Dial Plan tag to denote a group of users by calling (source) number prefixes and/or suffixes.  The valid value is a string of up to 20 characters. The tag is case insensitive.  To configure Dial Plan tags, see <a href="#">Configuring Dial Plans</a> .  <b>Note:</b> <ul style="list-style-type: none"> <li>■ The tag must belong to the Dial Plan that is assigned for Tel-to-IP routing. To do this, use the 'Tel-to-IP Dial Plan Name' (Tel2IPDialPlanName) parameter.</li> <li>■ The device uses the tag before or after manipulation, depending on the 'Tel To IP Routing Mode' (RouteModeTel2IP) parameter. If configured to <b>Route</b></li> </ul>

Parameter	Description
	<p><b>calls before manipulation</b>, the tag is used before manipulation. If configured to <b>Route calls after manipulation</b>, the tag is used after manipulation.</p>
<p>'Destination Phone Pattern' dst-phone-pattern [PREFIX_DestinationPrefix]</p>	<p>Defines the called (destination) telephone number. You can use special patterns (notations) to denote the number. For example, if you want to match this rule to user parts whose last four digits (i.e., suffix) are 4 followed by any three digits (e.g., 4008), then configure this parameter to "(4xxx)". As another example, the pattern "[100-199](100,101,105)" denotes a number that starts with 100 to 199 and ends with 100, 101 or 105. To denote any number, use the asterisk (*) symbol (default). To denote calls without a called number, use the dollar (\$) sign. For available patterns, see <a href="#">Dialing Plan Notation for Routing and Manipulation Tables</a>.</p> <p>The number can include up to 50 digits.</p> <p><b>Note:</b></p> <ul style="list-style-type: none"> <li>■ For LDAP-based routing, enter the LDAP query keyword as the prefix number to denote the IP domain: <ul style="list-style-type: none"> <li>✓ "PRIVATE" = Private number</li> <li>✓ "OCS" = Skype for Business / OCS client number</li> <li>✓ "PBX" = PBX / IP PBX number</li> <li>✓ "MOBILE" = Mobile number</li> <li>✓ "LDAP_ERR" = LDAP query failure</li> </ul> </li> </ul> <p>For more information, see <a href="#">AD-based Routing for Microsoft Skype for Business</a>.</p> <ul style="list-style-type: none"> <li>■ If you want to configure re-routing of ISDN Tel-to-IP calls to fax destinations, enter the value string "FAX" (case-sensitive) as the destination phone prefix. For more information, see the [FaxReroutingMode] parameter.</li> </ul>
<p>'Destination Tags' dest-tags [Prefix_DestTags]</p>	<p>Assigns a Dial Plan tag to denote a group of users by called (destination) number prefixes and/or suffixes. The valid value is a string of up to 20 characters. The tag is case insensitive.</p> <p>To configure Dial Plan tags, see <a href="#">Configuring Dial Plans</a>.</p>

Parameter	Description
	<p><b>Note:</b></p> <ul style="list-style-type: none"> <li>■ The tag must belong to the Dial Plan that is assigned for IP-to-Tel routing. To do this, use the 'Tel-to-IP Dial Plan Name' (Tel2IPDialPlanName) parameter.</li> <li>■ The device uses the tag before or after manipulation, depending on the 'Tel To IP Routing Mode' (RouteModeTel2IP) parameter. If configured to <b>Route calls before manipulation</b>, the tag is used before manipulation. If configured to <b>Route calls after manipulation</b>, the tag is used after manipulation.</li> </ul>
<b>Action</b>	
<p>'Destination IP Group' dst-ip-group-id [PREFIX_DestIPGroupName]</p>	<p>Assigns an IP Group to where you want to route the call. The SIP INVITE message is sent to the IP address configured for the Proxy Set that is associated with the IP Group.</p> <p><b>Note:</b></p> <ul style="list-style-type: none"> <li>■ If you select an IP Group, you do not need to configure a destination IP address. However, if both parameters are configured in the table, the INVITE message is sent only to the IP Group.</li> <li>■ If the destination is a User-type IP Group, the device searches for a match of the Request-URI in the received INVITE to an AOR registration record in the device's database. The INVITE is then sent to the IP address of the registered contact.</li> <li>■ If the AlwaysUseRouteTable parameter is set to 1 (see <a href="#">Configuring IP Groups</a>), the Request-URI host name in the INVITE message is set to the value configured for the 'Destination IP Address' parameter (in this table); otherwise, if no IP address is defined, it is set to the value of the 'SIP Group Name' parameter (configured in the IP Groups table).</li> <li>■ The parameter is used as the 'Serving IP Group' in the Accounts table for acquiring authentication username/password for this call (see <a href="#">Configuring Registration Accounts</a>).</li> <li>■ To configure Proxy Sets, see <a href="#">Configuring Proxy Sets</a>.</li> </ul>

Parameter	Description
'SIP Interface' dest-sip-interface-name [PREFIX_ DestSIPInterfaceName]	Assigns a SIP Interface to the routing rule. The call is sent to its' destination through this SIP interface. To configure SIP Interfaces, see <a href="#">Configuring SIP Interfaces</a> . <b>Note:</b> If a SIP Interface is not assigned, the device uses the SIP Interface associated with the default SRD (Index 0). If, for whatever reason, you have deleted the default SRD and there are no SRDs, the call is rejected.
'Destination IP Address' dst-ip-address [PREFIX_DestAddress]	Defines the IP address (in dotted-decimal notation or FQDN) to where the call is sent. If an FQDN is used (e.g., domain.com), DNS resolution is done according to the DNSQueryType parameter. For ENUM-based routing, enter the string "ENUM". The device sends an ENUM query containing the destination phone number to an external DNS server (configured in the IP Interfaces table. The ENUM reply includes a SIP URI which is used as the Request-URI in the subsequent outgoing INVITE and for routing (if a proxy is not used). To configure the type of ENUM service (e.g., e164.arpa), see the EnumService parameter. For LDAP-based routing, enter the string "LDAP" to denote the IP address of the LDAP server. For more information, see <a href="#">Active Directory-based Routing for Microsoft Skype for Business</a> . <b>Note:</b> <ul style="list-style-type: none"> <li>■ The parameter is ignored if you have configured a destination IP Group in the 'Destination IP Group' field (in this table).</li> <li>■ To reject calls, enter the IP address 0.0.0.0. For example, if you want to prohibit international calls, then in the 'Destination Phone Prefix' field, enter 00 and in the 'Destination IP Address' field, enter 0.0.0.0.</li> <li>■ For routing calls between phones connected to the device (i.e., local routing), enter the device's IP address. If the device's IP address is unknown (e.g., when DHCP is used), enter IP address 127.0.0.1.</li> <li>■ When using domain names, enter the DNS server's IP address or alternatively, configure these names in the Internal DNS table (see <a href="#">Configuring the Internal DNS Table</a>).</li> </ul>

Parameter	Description
'IP Profile' ip-profile-id [PREFIX_ProfileName]	Assigns an IP Profile to the routing rule in the outgoing direction. The IP Profile allows you to assign various configuration attributes (e.g., voice coder) per routing rule. To configure IP Profiles, see <a href="#">Configuring IP Profiles</a> . If you do not configure the parameter, the device uses the following IP Profile: <ul style="list-style-type: none"> <li>■ If an IP Group is configured for the destination ('Destination IP Group' parameter), the device uses the IP Profile associated with the IP Group.</li> <li>■ If no IP Group is configured, the device uses IP Profile 0</li> </ul>
'Destination Port' dst-port [PREFIX_DestPort]	Defines the destination port to where you want to route the call.
'Transport Type' transport-type [PREFIX_TransportType]	Defines the transport layer type used for routing the call. <ul style="list-style-type: none"> <li>■ [-1] = (Default) Not configured and the transport type is according to the settings of the global parameter, SIPTransportType.</li> <li>■ [0] <b>UDP</b></li> <li>■ [1] <b>TCP</b></li> <li>■ [2] <b>TLS</b></li> </ul>
<b>Advanced</b>	
'Call Setup Rules Set ID' call-setup-rules-set-id [PREFIX_CallSetupRulesSetId]	Assigns a Call Setup Rule Set ID to the routing rule. The device performs the Call Setup rules of this Set ID if the incoming call matches the characteristics of the routing rule. The device routes the call to the destination according to the routing rule's configured action only after it has performed the Call Setup rules. By default, no value is defined. To configure Call Setup rules, see <a href="#">Configuring Call Setup Rules</a> .
'Forking Group' forking-group [PREFIX_ForkingGroup]	Defines a Forking Group number for the routing rule. This enables forking of incoming Tel calls to multiple IP destinations. The device sends simultaneous INVITE messages and handles multiple SIP dialogs until one of the calls is answered. When one of the calls is answered,

Parameter	Description
	<p>the other calls are dropped.</p> <p>Each Forking Group can contain up to 10 members. In other words, up to 10 routing rules can be configured with the same Forking Group number.</p> <p>By default, no value is defined.</p> <p>If all matched routing rules belong to the same Forking Group number, the device sends an INVITE to all the destinations belonging to this group. If matched routing rules belong to different Forking Groups, the device sends the call to the Forking Group of the first matched routing rule. If the call cannot be established with any of the destinations associated with the Forking Group and alternative routing is enabled, the device forks the call to the Forking Group of the next matched routing rules, as long as the Forking Group is defined with a <b>higher</b> number than the previous Forking Group. For example:</p> <ul style="list-style-type: none"> <li>■ Table index entries 1 and 2 are defined with Forking Group "1", and index entries 3 and 4 with Forking Group "2": The device first sends the call according to index entries 1 and 2, and if unavailable and alternative routing is enabled, sends the call according to index entries 3 and 4.</li> <li>■ Table index entry 1 is defined with Forking Group "2", and index entries 2, 3, and 4 with Forking Group "1": The device sends the call according to index entry 1 only and ignores the other index entries even if the destination is unavailable and alternative routing is enabled. This is because the subsequent index entries are defined with a Forking Group number that is lower than that of index entry 1.</li> <li>■ Table index entry 1 is defined with Forking Group "1", index entry 2 with Forking Group "2", and index entries 3 and 4 with Forking Group "1": The device first sends the call according to index entries 1, 3, and 4 (all belonging to Forking Group "1"), and if the destination is unavailable and alternative routing is enabled, the device sends the call according to index entry 2.</li> <li>■ Table index entry 1 is defined with Forking Group "1", index entry 2 with Forking Group "3", index entry 3 with Forking Group "2", and index entry 4 with Forking</li> </ul>

Parameter	Description
	<p>Group "1": The device first sends the call according to index entries 1 and 4 (all belonging to Forking Group "1"), and if the destination is unavailable and alternative routing is enabled, the device sends the call according to index entry 2 (Forking Group "3"). Even if index entry 2 is unavailable and alternative routing is enabled, the device ignores index entry 3 because it belongs to a Forking Group that is lower than index entry 2.</p> <p><b>Note:</b></p> <ul style="list-style-type: none"> <li>■ To enable Tel-to-IP call forking, set the 'Tel2IP Call Forking Mode' (<i>Tel2IPCallForkingMode</i>) parameter to <b>Enable</b>.</li> <li>■ You can configure the device to immediately send the INVITE message to the first member of the Forking Group (as in normal operation) and then only after a user-defined interval, send the INVITE messages simultaneously to the other members. If the device receives a SIP 4xx or 5xx in response to the first INVITE, it immediately sends INVITEs to all the other members, regardless of the interval. To configure this feature, see the <i>ForkingDelayTimeForInvite</i> ini file parameter.</li> <li>■ You can implement Forking Groups when the destination is an LDAP server or a domain name using DNS. In such scenarios, the INVITE is sent to all the queried LDAP or resolved IP addresses, respectively. You can also use LDAP routing rules with standard routing rules for Forking Groups.</li> <li>■ When the <i>UseDifferentRTPportAfterHold</i> parameter is enabled, every forked call is sent with a different RTP port. Thus, ensure that the device has sufficient available RTP ports for these forked calls.</li> </ul>
'Cost Group' <i>cost-group-id</i> [PREFIX_CostGroup]	<p>Assigns a Cost Group to the routing rule for determining the cost of the call (i.e., Least Cost Routing or LCR). By default, no value is defined.</p> <p>To configure Cost Groups, see <a href="#">Configuring Cost Groups</a>.</p> <p><b>Note:</b> To implement LCR and its Cost Groups, you must enable LCR</p>



Parameter	Description
	<ul style="list-style-type: none"> <li data-bbox="695 286 1385 434">■ To implement LCR and its Cost Groups, the Routing Policy must be enabled for LCR (see <a href="#">Configuring a Gateway Routing Policy Rule</a>). If LCR is disabled, the device ignores the parameter.</li> <li data-bbox="695 465 1385 891">■ The Routing Policy also determines whether matched routing rules that are <b>not</b> assigned Cost Groups are considered as a higher or lower cost route compared to matching routing rules that are assigned Cost Groups. For example, if the 'Default Call Cost' parameter in the Routing Policy is configured to <b>Lowest Cost</b>, even if the device locates matching routing rules that are assigned Cost Groups, the first-matched routing rule without an assigned Cost Group is considered as the lowest cost route and thus, chosen as the preferred route.</li> </ul>
'Charge Code' charge-code [PREFIX_MeteringCode]	Assigns a Charge Code to the routing rule for generating metering pulses (Advice of Charge). By default, no value is defined. To configure Charge Codes, see <a href="#">Configuring Charge Codes</a> . <b>Note:</b> The parameter is applicable only to FXS, Euro ISDN PRI, Euro ISDN BRI.

## Configuring IP-to-Tel Routing Rules

The IP-to-Tel Routing table lets you configure up to 120 IP-to-Tel routing rules. IP-to-Tel routing rules route incoming IP calls to Trunk Groups. The specific channel pertaining to the Trunk Group to which the call is routed is determined according to the Trunk Group's channel selection mode. The channel selection mode can be configured per Trunk Group (see [Configuring Trunk Group Settings](#)) or for all Trunk Groups, using the global parameter ChannelSelectMode.

Configuration of IP-to-Tel routing rules includes two areas:

- **Match:** Defines the characteristics of the incoming IP call (e.g., source IP address from which the call is received).
- **Action:** Defines the action that is done if the incoming call matches the characteristics of the rule (i.e., routes the call to the specified Tel/Trunk Group destination).

The device searches the table from **top to bottom** for the **first** rule that matches the characteristics of the incoming call. If it finds a matching rule, it sends the call to the Tel destination configured for that rule. If it doesn't find a matching rule, it rejects the call.

If an IP-to-Tel call cannot be routed to the Trunk Group, the device can route it to an alternative destination:

- **Routing to an Alternative Trunk Group:** If the device sends the IP call to the Tel destination and a subsequent call release reason (cause) code (e.g., 17 for User Busy) is received from the Tel side, and you have configured this release reason code in the Reasons for IP-to-Tel Alternative Routing table, the device re-routes the call to an alternative Trunk Group if an alternative routing rule has been configured in the table. Alternative routing rules must be configured in table rows (indices) located anywhere below the "main" routing rule. For example, if you configure a "main" routing rule in Index 4, the alternative routing rule can be configured in Index 6. In addition, you must configure alternative routing rules with identical matching characteristics (e.g., destination prefix number) to the "main" routing rule, but assigned with different destinations (Trunk Groups). For more information on IP-to-Tel alternative routing and for configuring call release reasons for alternative routing, see [Alternative Routing to Trunk upon Q.931 Call Release Cause Code](#).
- **Routing to an IP Destination (i.e., Call Redirection):** The device can re-route the IP-to-Tel call to an alternative IP destination, using SIP 3xx responses. For more information, see [Alternative Routing to IP Destinations upon Busy Trunk](#).
- **Routing to an Alternative Physical FXO Port or Trunk within Same Trunk Group:** The device can re-route an IP-to-Tel call to a different physical FXO port or trunk if the destined FXO port or trunk within the same Trunk Group is out of service (e.g., physically disconnected). When the physical FXO port or trunk is disconnected, the device sends the SNMP trap, GWAPP\_TRAP\_BUSYOUT\_LINK notifying of the out-of-service state for the specific FXO line or trunk number. When the FXO port or physical trunk is physically reconnected, this trap is sent notifying of the back-to-service state.



- Instead of using the table for IP-to-Tel routing, you can employ a third-party Routing server to handle the routing decisions. For more information, see [Centralized Third-Party Routing Server](#).
- You can configure up to three alternative routing rules per "main" routing rule in the table.
- If your deployment includes calls of many different called (source) and/or calling (destination) numbers that need to be routed to the same destination, you can employ user-defined prefix tags to represent these numbers. Thus, instead of configuring many routing rules, you need to configure only one routing rule using the prefix tag as the source and destination number matching characteristics, and a destination for the calls. For more information on prefix tags, see [Dial Plan Prefix Tags for IP-to-Tel Routing](#).
- By default, the device applies destination telephone number manipulation (if configured) only after processing the routing rule. You can change this and apply number manipulation before processing the routing rule (see the RouteModelP2Tel parameter). To configure number manipulation, see [Configuring Source/Destination Number Manipulation](#).

The following procedure describes how to configure IP-to-Tel routing rules through the Web interface. You can also configure it through ini file [PSTNPrefix] or CLI (configure voip > gateway routing ip2tel-routing).

➤ **To configure IP-to-Tel routing rules:**

1. Open the IP-to-Tel Routing table (**Setup** menu > **Signaling & Media** tab > **Gateway** folder > **Routing** > **IP** > **Tel Routing**).
2. Click **New**; the following dialog box appears:

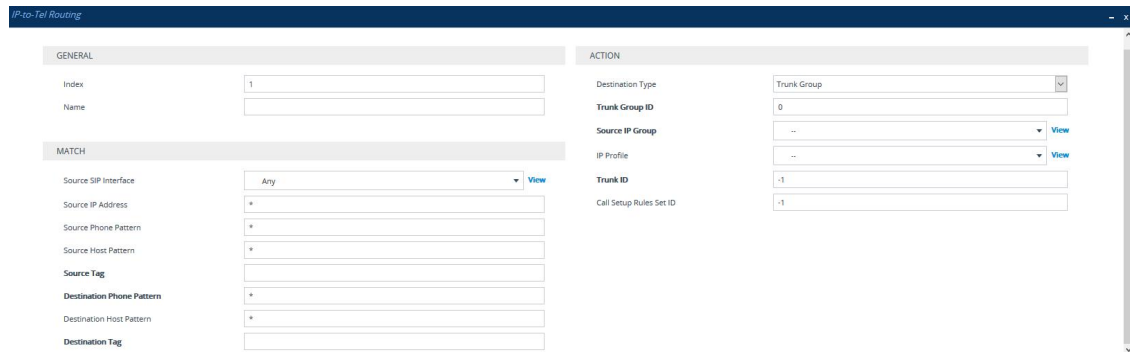

3. Configure a routing rule according to the parameters described in the table below.
4. Click **Apply**.

The following table shows configuration examples of Tel-to-IP routing rules:

**Table 25-3: Example of IP-to-Tel Routing Rules**

Parameter	Rule 1	Rule 2	Rule 3
'Source Host Pattern'	-	-	abcd.domain
'Destination Phone Pattern'	1x	[501-502]	-
'Source Phone Pattern'	-	101	-
'Trunk Group ID'	3	2	4
'IP Profile'	ITSP-A	ITSP-B	-

Below provides descriptions of each rule:

- **Rule 1:** If the incoming IP call destination phone prefix is between 10 and 19, the call is assigned settings configured for IP Profile "ITSP-A" and routed to Trunk Group ID 3.
- **Rule 2:** If the incoming IP call destination phone prefix is between 501 and 502 and source phone prefix is 101, the call is assigned settings configured for IP Profile "ITSP-B" and routed to Trunk Group ID 2.
- **Rule 3:** If the incoming IP call has a From URI host prefix as abcd.com, the call is routed to Trunk Group ID 4.

Table 25-4: IP-to-Tel Routing Table Parameter Description

Parameter	Description
General	
'Index' [PstnPrefix_Index]	Defines an index number for the new table row. <b>Note:</b> Each row must be configured with a unique index.
'Name' route-name [PstnPrefix_RouteName]	Defines a descriptive name, which is used when associating the row in other tables. The valid value is a string of up to 40 characters. By default, no value is defined. <b>Note:</b> Each row must be configured with a unique name.
Match	
'Source SIP Interface' src-sip-interface-name [PstnPrefix_SrcSIPInterfaceName]	Defines the SIP Interface on which the incoming IP call is received. The default is Any (i.e., any SIP Interface). To configure SIP Interfaces, see <a href="#">Configuring SIP Interfaces</a> . <b>Note:</b> If the incoming INVITE is received on the specified SIP Interface and the SIP Interface associated with the specified IP Group in the 'Source IP Group' parameter (in this table) is different, the incoming SIP call is rejected. If the 'Source IP Group' parameter is not defined, the SIP Interface associated with the default SRD (Index 0) is used. If there is no valid source IP Group, the call is rejected.
'Source IP Address' src-ip-address [PstnPrefix_SourceAddress]	Defines the source IP address of the incoming IP call. The IP address must be configured in dotted-decimal notation (e.g., 10.8.8.5); not as an FQDN. The default is the asterisk (*) symbol, meaning any IP address. <b>Note:</b> <ul style="list-style-type: none"> <li>■ The source IP address is obtained from the Contact header in the INVITE message.</li> <li>■ You can configure from where the source IP address is obtained, using the SourceIPAddressInput parameter.</li> <li>■ The source IP address can include the following wildcards: <ul style="list-style-type: none"> <li>✓ "x": denotes single digits. For example, 10.8.8.xx represents all the addresses between 10.8.8.10 and 10.8.8.99.</li> <li>✓ "*": denotes any number between 0 and 255. For</li> </ul> </li> </ul>

Parameter	Description
	<p>example, 10.8.8.* represents all addresses between 10.8.8.0 and 10.8.8.255.</p>
<p>'Source Phone Pattern' src-phone-pattern [PstnPrefix_SourcePrefix]</p>	<p>Defines the calling (source) telephone number.</p> <p>The valid value can be up to 49 digits. You can use special patterns to denote the number. For example, "[100-199] (100,101,105)" denotes a number that starts with 100 to 199 and ends with 100, 101 or 105. To denote any number, use the asterisk (*) symbol (default). To denote calls without a calling number, use the dollar (\$) sign. For available patterns, see <a href="#">Dialing Plan Notation for Routing and Manipulation Tables</a>.</p> <p><b>Note:</b> If the SIP P-Asserted-Identity header is present in the incoming INVITE message, the value of the parameter is compared to the P-Asserted-Identity URI host name (and not the From header).</p>
<p>'Source Host Pattern' src-host-pattern [PstnPrefix_SrcHostPrefix]</p>	<p>Defines the URI host part in the From header of the incoming INVITE message.</p> <p>You can use special patterns (notations) to denote the host part. For example, if you want to match this rule to host parts that end (suffix) in ".com", then configure this parameter to "(.com)". To denote any host part, use the asterisk (*) symbol. For available patterns, see <a href="#">Dialing Plan Notation for Routing and Manipulation Tables</a>.</p> <p>By default, no value is defined.</p> <p><b>Note:</b> If the P-Asserted-Identity header is present in the incoming INVITE message, the value of the parameter is compared to the P-Asserted-Identity URI host name (and not the From header).</p>
<p>'Source Tags' src-tags [PstnPrefix_SrcTags]</p>	<p>Assigns a Dial Plan tag to denote a group of source URI user names.</p> <p>The valid value is a string of up to 20 characters. The tag is case insensitive.</p> <p>To configure Dial Plan tags, see <a href="#">Configuring Dial Plans</a>.</p> <p><b>Note:</b></p> <ul style="list-style-type: none"> <li>■ The tag must belong to the Dial Plan that is assigned for IP-to-Tel routing. To do this, use the 'IP-to-Tel Dial Plan Name' (IP2TelDialPlanName) parameter.</li> <li>■ The device uses the tag before or after manipulation, depending on the 'IP-to-Tel Routing Mode' (RouteModeIP2Tel) parameter. If configured to <b>Route calls</b></li> </ul>

Parameter	Description
	<p><b>before manipulation</b>, the tag is used before manipulation. If configured to <b>Route calls after manipulation</b>, the tag is used after manipulation.</p>
<p>'Destination Phone Pattern' dst-host-pattern [PstnPrefix_DestPrefix]</p>	<p>Defines the called (destined) telephone number.</p> <p>You can use special patterns (notations) to denote the number. For example, "[100-199](100,101,105)" denotes a number that starts with 100 to 199 and ends with 100, 101 or 105. To denote any prefix, use the asterisk (*) symbol (default). To denote calls without a called number, use the dollar (\$) sign. For available patterns, see <a href="#">Dialing Plan Notation for Routing and Manipulation Tables</a>.</p> <p>The value can include up to 49 digits.</p>
<p>'Destination Host Pattern' dst-phone-pattern [PstnPrefix_DestHostPrefix]</p>	<p>Defines the Request-URI host name of the incoming INVITE message.</p> <p>You can use special patterns (notations) to denote the host part. For example, if you want to match this rule to host parts that end (suffix) in ".com", then configure this parameter to "(.com)". To denote any host part, use the asterisk (*) symbol. For available patterns, see <a href="#">Dialing Plan Notation for Routing and Manipulation Tables</a>.</p> <p>By default, no value is defined.</p>
<p>'Destination Tags' dest-tags [PstnPrefix_DestTags]</p>	<p>Assigns a prefix tag to denote destination URI user names corresponding to the tag configured in the associated Dial Plan.</p> <p>The valid value is a string of up to 20 characters. The tag is case insensitive.</p> <p>To configure Dial Plan tags, see <a href="#">Configuring Dial Plans</a>.</p> <p><b>Note:</b></p> <ul style="list-style-type: none"> <li>■ The tag must belong to the Dial Plan that is assigned for IP-to-Tel routing. To do this, use the 'IP-to-Tel Dial Plan Name' (IP2TelDialPlanName) parameter.</li> <li>■ The device uses the tag before or after manipulation, depending on the 'IP-to-Tel Routing Mode' (RouteModeIP2Tel) parameter. If configured to <b>Route calls before manipulation</b>, the tag is used before manipulation. If configured to <b>Route calls after manipulation</b>, the tag is used after manipulation.</li> </ul>
Action	

Parameter	Description
'Destination Type' dst-type [PstnPrefix_ DestType]	Defines the type of Tel destination.  <ul style="list-style-type: none"> <li>■ [0] <b>Trunk Group</b> (default)</li> <li>■ [1] <b>Trunk</b></li> </ul>
'Trunk Group ID' trunk-group-id [PstnPrefix_ TrunkGroupId]	Defines the Trunk Group ID to where the incoming SIP call is sent.  <b>Note:</b> This parameter is applicable only if you configure the 'Destination Type' parameter (see above) to <b>Trunk Group</b> .
'Trunk ID' trunk-id [PstnPrefix_ TrunkId]	Defines the Trunk to where the incoming SIP call is sent.  <b>Note:</b> <ul style="list-style-type: none"> <li>■ If both 'Trunk Group ID' and 'Trunk ID' parameters are configured in the table, the routing is done according to the 'Trunk Group ID' parameter.</li> <li>■ To configure the method for selecting the trunk's channel to which the IP call is sent, see the global parameter, ChannelSelectMode.</li> </ul>
'Source IP Group' src-ip-group-id [PstnPrefix_ SrcIPGroupName]	Assigns an IP Group from where the SIP message (INVITE) is received.  By default, no value is defined.  To configure IP Groups, see <a href="#">Configuring IP Groups</a> .  The IP Group can be used as the 'Serving IP Group' in the Accounts table for obtaining authentication username/password for the call. To configure registration accounts, see <a href="#">Configuring Registration Accounts</a> .
'IP Profile' ip-profile-id [PstnPrefix_ ProfileName]	Assigns an IP Profile to the call.  To configure IP Profiles, see <a href="#">Configuring IP Profiles</a> .
'Call Setup Rules Set' ID call-setup-rules-set-id [PstnPrefix_ CallSetupRulesSetId]	Assigns a Call Setup Rule Set ID to the routing rule. The device performs the Call Setup rules of this Set ID if the incoming call matches the characteristics of the routing rule. The device routes the call to the destination according to the routing rule's configured action, only after it has performed the Call Setup rules.  To configure Call Setup rules, see <a href="#">Configuring Call Setup Rules</a> .

## Configuring a Gateway Routing Policy Rule

The Routing Policies table lets you edit the default Routing Policy rule. The Routing Policy is used for Gateway call routing and defines the following:

- LDAP server (LDAP Server Group) for LDAP-based call routing (LDAP or Call Setup Rules queries). LDAP-based routing is applicable to Tel-to-IP routing ([Configuring Tel-to-IP Routing Rules](#)) and IP-to-Tel routing ([Configuring IP-to-Tel Routing Rules](#)).
- Enables Least Cost Routing (LCR), and defines default call cost (highest or lowest) and average call duration for Tel-to-IP routing rules that are not assigned LCR Cost Groups. The default call cost determines whether matched routing rules that are not assigned a Cost Group are considered as a higher or lower cost route compared to other matching routing rules that are assigned Cost Groups. If you disable LCR, the device ignores the Cost Groups assigned to Tel-to-IP routing rules in the Tel-to-IP Routing table. LCR is applicable only to Tel-to-IP routing.

The following procedure describes how to configure Routing Policy rules through the Web interface. You can also configure it through ini file [GwRoutingPolicy] or CLI (`configure voip > gateway routing gw-routing-policy`).

### ➤ To edit the Routing Policy rule:

1. Open the Routing Policies table (**Setup** menu > **Signaling & Media** tab > **Gateway** folder > **Routing** > **Routing Policies**).
2. Click **New**; the following dialog box appears:

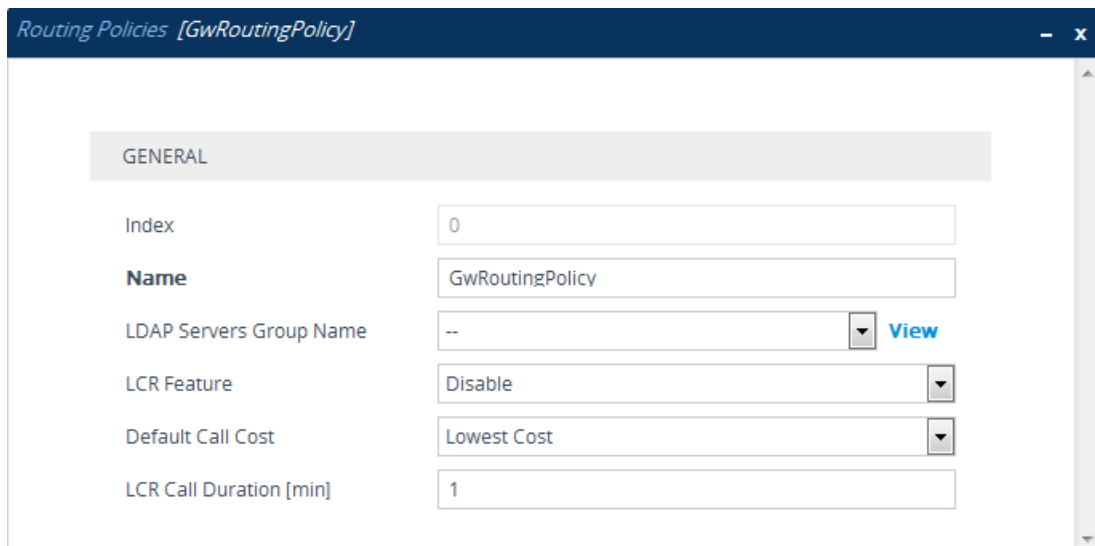

GENERAL	
Index	0
<b>Name</b>	GwRoutingPolicy
LDAP Servers Group Name	-- <a href="#">View</a>
LCR Feature	Disable
Default Call Cost	Lowest Cost
LCR Call Duration [min]	1

3. Configure the Routing Policy rule according to the parameters described in the table below.
4. Click **Apply**.



**Table 25-5: Routing Policies Table Parameter Descriptions**

Parameter	Description
'Index' [GwRoutingPolicy_Index]	(Read-only) Displays the index number of the table row.
'Name' name [GWRoutingPolicy_Name]	Defines a descriptive name, which is used when associating the row in other tables. The valid value is a string of up to 40 characters. The default value is "GwRoutingPolicy".
'LDAP Servers Group Name' ldap-srv-group-name [GWRoutingPolicy_LdapServersGroupName]	Assigns an LDAP Server Group to the Routing Policy. IP-to-Tel and Tel-to-IP routing rules that require LDAP-based routing (or Call Setup Rules) use the LDAP server(s) assigned to the LDAP Server Group. By default, no value is defined. For more information on LDAP Server Groups, see <a href="#">Configuring LDAP Server Groups</a> .
'LCR Feature' lcr-enable [GWRoutingPolicy_LCREnable]	Enables the Least Cost Routing (LCR) feature for the Routing Policy.  <ul style="list-style-type: none"> <li>■ [0] <b>Disable</b> (default)</li> <li>■ [1] <b>Enable</b></li> </ul> For more information on LCR, see <a href="#">Least Cost Routing</a> . <b>Note:</b> LCR is applicable only to Tel-to-IP routing.
'Default Call Cost' lcr-default-cost [GWRoutingPolicy_LCRDefaultCost]	Defines whether routing rules in the Tel-to-IP Routing table that are not assigned a Cost Group are considered a higher cost or lower cost route compared to other matched routing rules that are assigned Cost Groups.  <ul style="list-style-type: none"> <li>■ [0] <b>Lowest Cost</b> = (Default) The device considers a matched routing rule that is not assigned a Cost Group as the lowest cost route. Therefore, it uses the routing rule.</li> <li>■ [1] <b>Highest Cost</b> = The device considers a matched routing rule that is not assigned a Cost Group as the highest cost route. Therefore, it is only used if the other matched routing rules that are assigned Cost Groups are unavailable.</li> </ul>
'LCR Call Duration' lcr-call-length [GWRoutingPolicy_	Defines the average call duration (in minutes) and is used to calculate the variable portion of the call cost. This is useful, for example, when the average call duration spans over multiple

Parameter	Description
LCRAverageCallLength]	<p>time bands. The LCR is calculated as follows:  <math>\text{cost} = \text{call connect cost} + (\text{minute cost} * \text{average call duration})</math>            The valid value is 0-65533. The default is 1.            For example, assume the following Cost Groups:</p> <ul style="list-style-type: none"> <li>■ "Weekend A": call connection cost is 1 and charge per minute is 6. Therefore, a call of 1 minute cost 7 units.</li> <li>■ "Weekend B": call connection cost is 6 and charge per minute is 1. Therefore, a call of 1 minute cost 7 units.</li> </ul> <p>Therefore, for calls under one minute, "Weekend A" carries the lower cost. However, if the average call duration is more than one minute, "Weekend B" carries the lower cost.</p>

## Alternative Routing for Tel-to-IP Calls

The device supports various alternative Tel-to-IP call routing methods, as described in this section.

### IP Destinations Connectivity Feature

The device can be configured to check the integrity of the connectivity to IP destinations of Tel-to-IP routing rules in the Tel-to-IP Routing table. The IP Connectivity feature can be used for the Alternative Routing feature, whereby the device attempts to re-route calls from unavailable Tel-to-IP routing destinations to available ones (see [Alternative Routing Based on IP Connectivity](#)).

The device supports the following methods for checking the connectivity of IP destinations:

- **Network Connectivity:** The device checks the network connectivity of the IP destination configured by the 'Alt Routing Tel to IP Connectivity Method' parameter:
  - **SIP OPTIONS:** The device sends "keep-alive" SIP OPTIONS messages to the IP destination. If the device receives a SIP 200 OK in response, it considers the destination as available. If the destination does not respond to the OPTIONS message, then it is considered unavailable. You can configure the time interval for sending these OPTIONS messages, using the 'Alt Routing Tel to IP Keep Alive Time' parameter.

These parameters are configured in the Routing Settings page (**Setup** menu > **Signaling & Media** tab > **Gateway** folder > **Routing** > **Routing Settings**), as shown below:

Alt Routing Tel to IP Connectivity Method •

Alt Routing Tel to IP Keep Alive Time

- **Quality of Service (QoS):** You can enable the device to check the QoS of IP destinations. The device measures the QoS according to RTCP statistics of previously established calls

with the IP destination. The RTCP includes packet delay (in milliseconds) and packet loss (in percentage). If these measured statistics exceed a user-defined threshold, the destination is considered unavailable. Note that if call statistics is not received within two minutes, the QoS data is reset. These thresholds are configured using the following parameters:

- 'Max Allowed Packet Loss for Alt Routing' (IPConnQoSMaxAllowedPL): defines the threshold value for packet loss after which the IP destination is considered unavailable.
- 'Max Allowed Delay for Alt Routing' (IPConnQoSMaxAllowedDelay): defines the threshold value for packet delay after which the IP destination is considered unavailable

These parameters are configured in the Routing Settings page (**Setup** menu > **Signaling & Media** tab > **Gateway** folder > **Routing** > **Routing Settings**), as shown below:

Max Allowed Packet Loss for Alt Routing [%]	<input type="text" value="20"/>
Max Allowed Delay for Alt Routing [msec]	<input type="text" value="250"/>

- **DNS Resolution:** When a host name (FQDN) is used (instead of an IP address) for the IP destination, it is resolved into an IP address by a DNS server. The device checks network connectivity and QoS of the resolved IP address. If the DNS host name is unresolved, the device considers the connectivity of the IP destination as unavailable.

You can view the connectivity status of IP destinations in the following Web interface pages:

- **Tel-to-IP Routing table:** The connectivity status of the IP destination per routing rule is displayed in the 'Status' column. For more information, see [Configuring Tel-to-IP Routing Rules](#).
- **IP Connectivity:** This page displays a more informative connectivity status of the IP destinations used in Tel-to-IP routing rules in the Tel-to-IP Routing table. For viewing this page, see [Viewing IP Connectivity](#).

## Alternative Routing Based on IP Connectivity

You can configure the device to route Tel-to-IP calls to an alternative IP destination when the connectivity state of an IP destination is unavailable. The alternative routing rules are configured in the Tel-to-IP Routing table. These rules must be configured anywhere below the "main" routing rule and with identical matching characteristics (e.g., destination prefix number) to the "main" routing rule. The device uses the first alternative route that is available. For more information on configuring alternative Tel-to-IP routing rules in the Tel-to-IP Routing table, see [Configuring Tel-to-IP Routing Rules](#).



- Alternative routing based on IP connectivity is applicable only when a proxy server is **not** used.
- You can also enable the Busy Out feature, whereby the device can take specified actions if all IP destinations of matching routing rules in the Tel-to-IP Routing table



do not respond to connectivity checks. For more information, see the [EnableBusyOut] parameter.

- If you enable the [AltRoutingTel2IPEnable] parameter, the Busy Out feature does not function with the Proxy Set keep-alive mechanism (see [Alternative Routing Based on SIP Responses](#)). To use the Busy Out feature with the Proxy Set keep-alive mechanism (for IP Groups), disable the [AltRoutingTel2IPEnable] parameter.

The device searches for an alternative routing rule (IP destination) when any of the following connectivity states are detected with the IP destination of the "main" routing rule:

- No response received from SIP OPTIONS messages. This depends on the chosen method for checking IP connectivity.
- Poor QoS according to the configured thresholds for packet loss and delay.
- No response from a DNS-resolved IP address, where the domain name (FQDN) is configured for the IP destination. If the device sends the INVITE message to the first IP address and receives no response, the device makes a user-defined number of attempts (configured by the [HotSwapRtx] parameter) to send it again (re-transmit). If there is still no response after all the attempts, it sends it to the next DNS-resolved IP address, and so on. For example, if you configure the parameter to "3" (without quotation marks) and the device receives no response from the first IP address, it attempts up to three times to send the INVITE to the first IP address and if unsuccessful, it attempts to send the call to the next DNS-resolved IP address, and so on.
- No response for in-dialog request from a DNS-resolved IP address, where the domain name is received in the Contact header of an incoming setup or target refresh SIP message (e.g., 200 OK). If no response is received from the first IP address, the device tries to send it again for up to a user-defined number of attempts (configured by the [HotSwapRtx] parameter). If there is still no response, it attempts to send the SIP request to the next DNS-resolved IP address, and so on.

The connectivity status of the IP destination is displayed in the 'Status' column of the Tel-to-IP Routing table per routing rule. If it displays a status other than "ok", the device considers the IP destination as unavailable and attempts to re-route the call to an alternative destination. For more information on the IP connectivity methods and on viewing IP connectivity status, see [IP Destinations Connectivity Feature](#).

The table below shows an example of alternative routing where the device uses an available alternative routing rule in the Tel-to-IP Routing table to re-route the initial Tel-to-IP call.

**Table 25-6: Alternative Routing based on IP Connectivity Example**

	Destination Phone Prefix	IP Destination	IP Connectivity Status	Rule Used?
<b>Main Route</b>	40	10.33.45.68	"No Connectivity"	No
<b>Alternative</b>	40	10.33.45.70	"QoS Low"	No

	Destination Phone Prefix	IP Destination	IP Connectivity Status	Rule Used?
<b>Route #1</b>				
<b>Alternative Route #2</b>	40	10.33.45.72	"ok"	Yes

The following procedure describes how to configure alternative Tel-to-IP routing based on IP connectivity.

➤ **To configure alternative Tel-to-IP routing based on IP connectivity:**

1. In the Tel-to-IP Routing table (see [Configuring Tel-to-IP Routing Rules](#)), add alternative Tel-to-IP routing rules for specific calls.
2. Open the Routing Settings page (**Setup** menu > **Signaling & Media** tab > **Gateway** folder > **Routing** > **Routing Settings**):

ALTERNATIVE ROUTE

Enable Alt Routing Tel to IP	Enable <input type="button" value="v"/>
Alt Routing Tel to IP Mode	Connectivity <input type="button" value="v"/>
Alt Routing Tel to IP Connectivity Method	SIP OPTIONS <input type="button" value="v"/>
Alt Routing Tel to IP Keep Alive Time	<input type="text" value="60"/>
Alternative Routing Tone Duration [ms]	<input type="text" value="0"/>

3. Under the Alternative Route group, do the following:
  - a. From the 'Enable Alt Routing Tel to IP' [AltRoutingTel2IPEnable] drop-down list, select **Enable** to enable alternative Tel-to-IP routing based on IP connectivity.
  - b. From the 'Alt Routing Tel to IP Mode' drop-down list [AltRoutingTel2IPMode], configure the IP connectivity reason for triggering alternative routing.
    - ◆ Connectivity: Alternative routing is performed if SIP OPTIONS message to the initial destination fails
    - ◆ QoS: Alternative routing is performed if poor QoS is detected. QoS is quantified according to delay and packet loss calculated according to previous calls.
    - ◆ Both (above)
  - c. (For Analog Interfaces Only) In the 'Alternative Routing Tone Duration' field, configure the duration for which the device plays a tone to the Tel endpoint (for analog interfaces) whenever an alternative route is used.
  - d. Enable the connectivity feature (see [IP Destinations Connectivity Feature](#)).

## Alternative Routing Based on SIP Responses

The device can perform alternative routing based on the received SIP response code (i.e., 4xx, 5xx, 6xx, or 8xx). If you have configured the response code in the Reasons for Tel-to-IP Alternative Routing table, the device attempts to re-route the call to an alternative destination, if configured. You can configure up to 10 SIP response codes in the Reasons for Tel-to-IP Alternative Routing table.

Typically, the device performs alternative routing when there is no response at all to an INVITE message. This is done after a user-defined number of INVITE re-transmissions, configured by the [SIPMaxRtx] parameter. In such a scenario, the device issues itself the SIP response code 408 (Request Timeout). You can also configure the device to perform alternative routing for the following proprietary response codes that are issued by the device itself:

- **805 IP Profile Call Limit:** The device generates this response code when Call Admission Control (CAC) limits are exceeded for an IP Group. The CAC rules are configured in the IP Profiles table (see [Configuring IP Profiles](#)). When this occurs, the device sends a SIP 480 (Temporarily Unavailable) response to the SIP user agent (UA).
- **806 Media Limits Exceeded:** The device generates Release Cause Code 806 when the call is terminated due to crossed thresholds of QoE metrics such as MOS, packet delay, and packet loss (configured in the Quality of Experience Profile table - see [Configuring Quality of Experience Profiles](#) on page 378) and/or media bandwidth (configured in the Bandwidth profile table - see [Configuring Bandwidth Profiles](#) on page 385). When this occurs, the device sends a SIP 480 (Temporarily Unavailable) response to the SIP entity. When the threshold is crossed, the device maintains the existing call and applies alternative routing only to subsequent calls. To configure alternative routing based on Release Cause 806, do the following :
  - a. Assign an IP Group with a QoE and/or Bandwidth profile that rejects calls if the threshold is crossed.
  - b. Configure Release Cause Code 806 in the Reasons for Tel-to-IP Alternative Routing table.
  - c. Configure an alternative routing rule.

The device always routes at least two calls to the destination that has crossed the threshold, so that it can continue measuring QoE / bandwidth. When the threshold drops below the configured QoE / bandwidth threshold (i.e., good QoE), the device stops using the alternative routing rule and starts routing the calls using the initial routing rule.



- You can also enable the Busy Out feature, whereby the device can take specified actions if all Proxy Sets of associated destination IP Groups of matching routing rules in the Tel-to-IP Routing table do not respond to connectivity checks. For more information, see the [EnableBusyOut] parameter.
- If you enable the [AltRoutingTel2IPEnable] parameter for the IP Connectivity feature (see [Alternative Routing Based on IP Connectivity](#)), the Busy Out feature



does not function with the Proxy Set keep-alive mechanism (see below). To use the Busy Out feature with the Proxy Set keep-alive mechanism (for IP Groups), disable the [AltRoutingTel2IPEnable] parameter.

- The device also plays a tone to the endpoint whenever an alternative route is used. This tone is played for a user-defined time, configured by the [AltRoutingToneDuration] parameter

Depending on configuration, alternative routing is done using one of the following configuration entities:

- **Tel-to-IP Routing Rules:** Alternative routing rules can be configured for a specific routing rule in the Tel-to-IP Routing table. If the destination of the "main" routing rule is unavailable, the device searches the table for the next matching rule (e.g., destination phone number), and if available attempts to re-route the call to the IP destination configured for this alternative routing rule. For more information on configuring alternative Tel-to-IP routing rules, see [Configuring Tel-to-IP Routing Rules](#). The table below shows an example of alternative routing where the device uses the first available alternative routing rule to re-route the initial, unsuccessful Tel-to-IP call destination.

**Table 25-7: Alternative Routing based on SIP Response Code Example**

	Destination Phone Prefix	IP Destination	SIP Response	Rule Used?
<b>Main Route</b>	40	10.33.45.68	408 Request Timeout	No
<b>Alternative Route #1</b>	40	10.33.45.70	486 Busy Here	No
<b>Alternative Route #2</b>	40	10.33.45.72	200 OK	Yes

- **Proxy Sets:** Proxy Sets are used for Server-type IP Groups (e.g., an IP PBX or proxy), which define the address (IP address or FQDN) of the server (see 'Configuring Proxy Sets' on page 415). As you can configure multiple proxy servers per Proxy Set, the device supports proxy redundancy, which works together with the alternative routing feature. If the destination of a routing rule in the Tel-to-IP Routing table is a Server-type IP Group, the device routes the call to the IP destination configured for the Proxy Set associated with the IP Group. If the IP destination of the Proxy Set is offline, the device attempts to re-route the call to another online proxy destination with the highest priority. To enable the Proxy Redundancy feature for a Proxy Set, configure the [IsProxyHotSwap] parameter to [1] and the [EnableProxyKeepAlive] parameter to [1]. For more information on proxy redundancy, see [Configuring Proxy Sets](#).



The device assumes that all the proxy servers belonging to the Proxy Set are



synchronized with regards to registered users. Thus, when the device locates an available proxy using the Hot Swap feature, it does not re-register the users; new registration (refresh) is done as normal.

The following procedure describes how to configure alternative Tel-to-IP routing based on SIP response codes through the Web. You can also configure it through ini file [AltRouteCauseTel2Ip] or CLI (`configure voip > gateway routing alt-route-cause-tel2ip`).

➤ **To configure alternative Tel-to-IP routing based on SIP response codes:**

1. Configure SIP response codes (call failure reasons) that invoke alternative Tel-to-IP routing:
  - a. Open the Reasons for Tel-to-IP Alternative Routing table (**Setup** menu > **Signaling & Media** tab > **Gateway** folder > **Routing** > **Alternative Routing Reasons** > **Reasons for Tel > IP**).
  - b. Click **New**; the following dialog box appears:

- c. Configure a SIP response code for alternative routing according to the parameters described in the table below.
  - d. Click **Apply**.

**Table 25-8: Reasons for Tel-to-IP Alternative Routing Table Parameter Descriptions**

Parameter	Description
'Index' [AltRouteCauseTel2Ip_ Index]	Defines an index number for the new table row. <b>Note:</b> Each row must be configured with a unique index.
'Release Cause' rel-cause [AltRouteCauseTel2Ip_ ReleaseCause]	Defines a SIP response code that if received, the device attempts to route the call to an alternative destination (if configured).

2. Enable alternative routing based on SIP responses:



- a. Open the Proxy & Registration page (**Setup** menu > **Signaling & Media** tab > **SIP Definitions** folder > **Proxy & Registration**).
- b. From the 'Redundant Routing Mode' drop-down list, select one of the following:
  - **Routing Table:** Tel-to-IP Routing table is used for alternative routing.
  - **Proxy:** Proxy Set redundancy feature is used for alternative routing.

Redundant Routing Mode Routing Table ▼

3. If you are using the Tel-to-IP Routing table, configure alternative routing rules with identical call matching characteristics, but different IP destinations. If you are using the Proxy Set, configure redundant proxies.

### Alternative Routing upon SIP 3xx with Multiple Contacts

You can configure how the device handles received SIP 3xx responses that contain multiple alternative contacts. The 3xx response indicates that the original destination is unavailable (e.g., 301 Moved Permanently – user cannot be found) and that the call can be redirected to alternative destinations specified in the SIP Contact headers.

Configured by the '3xx Use Alt Route Reasons' parameter, the device can handle the receipt of 3xx responses using one of the following methods:

- The device tries each contact sequentially, listed in the Contact headers, until a successful destination is found. If a contact responds with a SIP 486 or 600, the device does not try to redirect the call to the next contact and drops the call.
- The device tries each contact sequentially, listed in the Contact headers. If a SIP 6xx Global Failure response is received during this process (e.g., 600 Busy Everywhere), the device does not try to redirect the call to the next contact and drops the call.
- The device redirects the call to the first contact listed in the Contact header. If the contact responds with a SIP response that is configured in the Reasons for Tel-to-IP Alternative Routing table (see [Alternative Routing Based on SIP Responses](#)), the device tries to redirect the call to the next contact, and so on. If a contact responds with a response that is not configured in the table, the device does not try to redirect the call to the next contact and drops the call.

#### ➤ To configure handling of SIP 3xx responses with multiple contacts:

1. Open the Gateway Advanced Settings page (**Setup** menu > **Signaling & Media** tab > **Gateway** folder > **Gateway Advanced Settings**).
2. From the '3xx Use Alt Route Reasons' drop-down list, select the required handling.

3xx Use Alt Route Reasons No ▼

3. Click **Apply**.



If a SIP 401 or 407 response is received from a contact, the device does not try to redirect the call to the next contact. Instead, the device continues with the regular authentication process, as indicated by these response types.

## PSTN Fallback

The PSTN Fallback feature enables the device to re-route a Tel-to-IP call to the legacy PSTN using one of its trunks if the IP destination is unavailable. For example, if poor voice quality is detected over the IP network, the device attempts to re-route the call to the PSTN.

The following procedure describes how to configure alternative Tel-to-IP routing to the PSTN.

### ➤ To configure alternative Tel-to-IP routing to the PSTN:

1. In the Tel-to-IP Routing table (see [Configuring Tel-to-IP Routing Rules](#)), configure an alternative routing rule with the same call matching characteristics (e.g., phone number destination) as the "main" routing rule, but where the destination is the IP address of the device itself.
2. In the IP-to-Tel Routing table (see [Configuring IP-to-Tel Routing Rules](#)), configure an IP-to-Tel routing rule to route calls received from the device (i.e., its IP address) to a specific Trunk Group connected to the PSTN. This configuration is necessary as the re-routed call is now considered an IP-to-Tel call.



The PSTN Fallback feature is applicable only to digital interfaces.

## Alternative Routing for IP-to-Tel Calls

This section describes configuration for alternative IP-to-Tel call routing.

### Alternative Routing to Trunk upon Q.931 Call Release Cause Code

You can configure up to 10 ISDN Q.931 release cause codes. If the device receives a configured release cause code from the Tel side, it routes the IP-to-Tel call to an alternative Trunk Group, if configured.

Alternative IP-to-Tel routing rules are configured in the IP-to-Tel Routing table. These rules must be configured anywhere below the "main" routing rule and with identical matching characteristics (e.g., destination prefix number) to the "main" routing rule. The device uses the first alternative route that is available. For more information on configuring alternative IP-to-Tel routing rules in the IP-to-Tel Routing table, see [Configuring IP-to-Tel Routing Rules](#).

A release cause code indicates that the IP-to-Tel call has been rejected or disconnected on the Tel side. The release cause codes are configured in the Reasons for IP-to-Tel Alternative Routing table. For example, you can configure alternative IP-to-Tel routing for scenarios where the

initial Tel destination is busy and a Q.931 Cause Code No. 17 is received (or for other call releases that issue the default Cause Code No. 3).

You can configure a default release cause code that the device issues itself upon the following scenarios:

- The device initiates a call release whose cause is unknown.
- No free channels (i.e., busy) in the Trunk Group.
- No appropriate routing rule located in the IP-to-Tel Routing table.
- Phone number is not located in the IP-to-Tel Routing table.

The default release code is Cause Code No. 3 (No Route to Destination). You can change the default code as follows:

➤ **To change the default Q.931 release code:**

1. Open the Gateway Advanced Settings page (**Setup** menu > **Signaling & Media** tab > **Gateway** folder > **Gateway Advanced Settings**).
2. In the 'Default Release Cause' field, enter the release cause code:

Default Release Cause

3. Click **Apply**.



- If a Trunk is disconnected or not synchronized, the device issues itself the internal Cause Code No. 27. This cause code is mapped (by default) to SIP 502.
- The default release cause is described in the Q.931 notation and translated to corresponding SIP 40x or 50x values (e.g., Cause Code No. 3 to SIP 404, and Cause Code No. 34 to SIP 503).
- For analog interfaces: For information on mapping PSTN release causes to SIP responses, see [PSTN Release Cause to SIP Response Mapping](#).
- For mapping SIP-to-Q.931 and Q.931-to-SIP release causes, see [Configuring Release Cause Mapping](#).

The following procedure describes how to configure alternative routing reasons for IP-to-Tel calls through the Web interface. You can also configure it through ini file [AltRouteCauseIP2Tel] or CLI (`configure voip > gateway routing alt-route-cause-ip2tel`).

➤ **To configure alternative Trunk Group routing based on Q.931 cause codes:**

1. Open the Proxy & Registration page (**Setup** menu > **Signaling & Media** tab > **SIP Definitions** folder > **Proxy & Registration**).
2. From the 'Redundant Routing Mode' drop-down list, select **Routing Table** so that the device uses the IP-to-Tel Routing table for alternative routing:

Redundant Routing Mode

3. Open the IP-to-Tel Routing table, and then configure alternative routing rules with the same call matching characteristics as the "main" routing rule, but with different Trunk Group destinations.
4. Configure Q.931 cause codes that invoke alternative IP-to-Tel routing:
  - a. Open the Reasons for IP-to-Tel Alternative Routing table (**Setup** menu > **Signaling & Media** tab > **Gateway** folder > **Routing** > **Alternative Routing Reasons** > **Reasons for IP > Tel**).
  - b. Click **New**; the following dialog box appears:

- c. Configure a Q.931 release cause code for alternative routing according to the parameters described in the table below.
- d. Click **Apply**.

**Table 25-9: Reasons for IP-to-Tel Alternative Routing Table Parameter Descriptions**

Parameter	Description
'Index' [AltRouteCauseIP2Tel_ Index]	Defines an index number for the new table row. <b>Note:</b> Each row must be configured with a unique index.
'Release Cause' rel-cause [AltRouteCauseIP2Tel_ ReleaseCause]	Defines a Q.931 release code that if received, the device attempts to route the call to an alternative destination (if configured).

### Alternative Routing to an IP Destination upon a Busy Trunk

The Forward on Busy Trunk Destination table lets you configure alternative routing rules for forwarding (i.e., call redirection) IP-to-Tel calls to an alternative IP destination (instead of the Tel destination) using SIP 3xx responses. The alternative routing is triggered upon the following:

- Digital interfaces: Trunk Group has no free channels (i.e., "busy").

- Analog interfaces: Unavailable FXS / FXO Trunk Group. This feature can be used, for example, to forward calls to another FXS / FXO endpoint.

This feature is configured per Trunk Group. The alternative destination can be defined as a host name or as a SIP Request-URI user name and host part (i.e., user@host). For example, the below configuration forwards IP-to-Tel calls to destination user "112" at host IP address 10.13.4.12, port 5060, using transport protocol TCP, if Trunk Group ID 2 is unavailable:

```
ForwardOnBusyTrunkDest 1 = 2, 112@10.13.4.12:5060;transport=tcp;
```

When configured with user@host, the original destination number is replaced by the user part.

The device forwards calls using this table **only** if no alternative IP-to-Tel routing rule has been configured in the IP-to-Tel Routing table or alternative routing fails and the following reason(s) in the SIP Diversion header of 3xx messages exists:

- Digital interfaces: "out-of-service" - all trunks are unavailable/disconnected
- "unavailable":
  - Digital interfaces: All trunks are busy or unavailable
  - Analog interfaces: All FXS / FXO lines pertaining to a Trunk Group are busy or unavailable

The following procedure describes how to configure Forward on Busy Trunks through the Web interface. You can also configure it through ini file [ForwardOnBusyTrunkDest] or CLI (configure voip > gateway routing fwd-on-busy-trk-dst).

#### ➤ To configure a Forward on Busy Trunk Destination rule:

1. Open the Forward on Busy Trunk Destination table (**Setup** menu > **Signaling & Media** tab > **Gateway** folder > **Routing** > **Forward on Busy Trunk Destination**).
2. Click **New**; the following dialog box appears:

GENERAL	
Index	0
Trunk Group ID	1
Forward Destination	10.13.5.67

The figure above displays a configuration that forwards IP-to-Tel calls destined for Trunk Group ID 1 to destination IP address 10.13.5.67 if conditions mentioned earlier exist.

3. Configure a rule according to the parameters described in the table below.

4. Click **Apply**, and then reset the device with a save-to-flash for your settings to take effect.

**Table 25-10: Forward on Busy Trunk Destination Parameter Descriptions**

Parameter	Description
'Index' [ForwardOnBusyTrunkDest_ Index]	Defines an index number for the new table row. <b>Note:</b> Each row must be configured with a unique index.
'Trunk Group ID' trunk-group-id [ForwardOnBusyTrunkDest_ TrunkGroupId]	Defines the Trunk Group ID to where the IP call is destined.
'Forward Destination' forward-dst [ForwardOnBusyTrunkDest_ ForwardDestination]	Defines the alternative IP destination for the call used if the Trunk Group is busy or unavailable. The valid value can be an IP address in dotted-decimal notation, an FQDN, or a SIP Request-URI user name and host part (i.e., user@host). The following syntax can also be used: host:port;transport=xxx (i.e., IP address, port and transport type). <b>Note:</b> <ul style="list-style-type: none"> <li>■ If you do not specify a port, the device uses UDP port 5060.</li> <li>■ When configured with a user@host, the original destination number is replaced by the user part.</li> </ul>

## Alternative Routing upon ISDN Disconnect

You can configure when the device sends a call to an alternative route if it receives an ISDN Q.931 Disconnect message with a Progress Indicator (PI) IE from the Tel side for IP-to-Tel calls. The Disconnect message indicates that the call cannot be established due to, for example, a busy state on the Tel side.



The feature is applicable only to digital interfaces.

You can configure the following modes of operation:

- **Disable:** The device does not immediately disconnect the call. Instead, it waits for any subsequent media from the Tel side (e.g., "this number is currently busy") and forwards it to the IP side (SIP 183 for early media). Only when it receives a Q.931 Release message, does the device disconnect the call (sends a SIP BYE message to the IP side). If you have configured an alternative route, the device sends the IP call to the alternative route.

- **Enable:** The device immediately sends the IP call to an alternative route, if you have configured one. If no alternative route has been configured and the Disconnect message is received with PI, the device forwards the subsequent early media to the IP side. The device disconnects the IP call only upon receipt of the subsequent Release message.

➤ **To configure alternative routing upon receipt of ISDN Disconnect:**

1. Open the Digital Gateway Parameters page (**Setup** menu > **Signaling & Media** tab > **Gateway** folder > **Digital Gateway** > **Digital Gateway Settings**).
2. From the 'Disconnect Call With PI If Alt' drop-down list (DisconnectCallwithPIifAlt), select the required option:

Disconnect Call With PI If Alt

Disable

3. Click **Apply**.

### Alternative Routing from FXO to IP

You can enable the device to automatically switch the destination of an FXS call from FXO (PSTN) to IP (SIP Trunk) when the PSTN disconnects the FXS subscriber. When a PSTN disconnects a subscriber, the device automatically (or manually through TR-104), recognizes the signal of the call placed by the subscriber and then re-routes the call to a SIP Trunk. This is configured by the [TR104FXOSwitchover] parameter.



For more information on this application, please contact the sales representative of your purchased device.

## 26 Manipulation

This section describes configuration of various manipulation processes for the Gateway application.

### Configuring Redirect Reasons

You can manipulate call redirect (diversion) reasons between IP (SIP) and Tel (ISDN). The SIP Diversion header contains the information on the redirection of the call, including the reason (e.g., 'reason=user-busy'). The ISDN provides the Redirect Number and the Reason for Redirection. You can configure the following redirect manipulations:

- Redirect Number screening indicator (e.g., User Failed) in ISDN Setup messages for IP-to-Tel calls. Configuration is done using the [SetIp2TelRedirectScreeningInd] parameter.
- IP-to-Tel redirect reason for IP-to-Tel calls in the ISDN message if redirect information is received from the IP side. Configuration is done using the [SetIp2TelRedirectReason] parameter.
- Tel-to-IP redirect reason in SIP messages for Tel-to-IP calls if redirect information is received from the Tel side. Configuration is done using the [SetTel2IpRedirectReason] parameter.



The section is applicable only to digital interfaces.

#### ➤ To configure redirect reason manipulation:

1. Open the Manipulations Settings page (**Setup** menu > **Signaling & Media** tab > **Gateway** folder > **Manipulation** > **Manipulations Settings**).

Set IP-to-Tel Redirect Reason	Not Configured ▼
Redirect Number IP to Tel	Not Configured ▼
Set Tel-to-IP Redirect Reason	Not Configured ▼

2. Configure the parameters as required, and then click **Apply**.

### Configuring Source-Destination Number Manipulation Rules

The number manipulation tables let you configure rules for manipulating source and destination telephone numbers for IP-to-Tel and Tel-to-IP calls. Number manipulation include the following tables:

#### ■ Tel-to-IP calls:

- Source Phone Number Manipulation for Tel-to-IP Calls (up to 120 entries)
- Destination Phone Number Manipulation for Tel-to-IP Calls (up to 120 entries)

#### ■ IP-to-Tel calls:



- Source Phone Number Manipulation for IP-to-Tel Calls (up to 120 entries)
- Destination Phone Number Manipulation for IP-to-Tel Calls (up to 120 entries)

Configuration of number manipulation rules includes two areas:

- **Match:** Defines the matching characteristics of the incoming call (e.g., prefix of destination number).
- **Action:** Defines the action that is done if the incoming call matches the characteristics of the rule (e.g., removes a user-defined number of digits from the left of the number).

The device searches the table from **top to bottom** for the **first** rule that matches the characteristics of the incoming call. If it finds a matching rule, it applies the manipulation configured for that rule. In other words, a rule at the top of the table takes precedence over a rule defined lower down in the table. Therefore, define more specific rules above more generic rules. For example, if you configure the source prefix number as "551" for rule index 1 and "55" for rule index 2, the device uses rule index 1 for numbers that start with 551 and uses rule index 2 for numbers that start with 550, 552, 553, and so on until 559. However, if you configure the source prefix number as "55" for rule index 1 and "551" for rule index 2, the device applies rule index 1 to all numbers that start with 55, including numbers that start with 551. If the device doesn't find a matching rule, no manipulation is done on the call.

You can perform a second "round" (additional) of source and destination number manipulations for IP-to-Tel calls on an already manipulated number. The initial and additional number manipulation rules are both configured in the number manipulation tables for IP-to-Tel calls. The additional manipulation is performed on the initially manipulated number. Thus, for complex number manipulation schemes, you only need to configure relatively few manipulation rules in these tables (that would otherwise require many rules). To enable this additional manipulation, use the following parameters:

- Source number manipulation - PerformAdditionalIP2TELSourceManipulation
- Destination number manipulation - PerformAdditionalIP2TELDestinationManipulation

Telephone number manipulation can be useful, for example, for the following:

- Stripping or adding dialing plan digits from or to the number, respectively. For example, a user may need to first dial 9 before dialing the phone number to indicate an external line. This number 9 can then be removed by number manipulation before the call is setup.
- Allowing or blocking Caller ID information according to destination or source prefixes. For more information on Caller ID for analog interfaces, see [Configuring Caller Display Information](#).
- For digital interfaces only: Assigning Numbering Plan Indicator (NPI) and Type of Numbering (TON) to IP-to-Tel calls. The device can use a single global setting for NPI/TON classification or it can use the setting in the manipulation tables on a call-by-call basis.



- Number manipulation can be performed before or after a routing decision is made. For example, you can route a call to a specific Trunk Group according to its original



number, and then you can remove or add a prefix to that number before it is routed. To determine when number manipulation is performed, use the 'IP to Tel Routing Mode' parameter (RouteModelIP2Tel) and 'Tel to IP Routing Mode' parameter (RouteModeTel2IP).

- The device manipulates the number in the following order: 1) strips digits from the left of the number, 2) strips digits from the right of the number, 3) retains the defined number of digits, 4) adds the defined prefix, and then 5) adds the defined suffix.

The following procedure describes how to configure number manipulation rules through the Web interface. You can also configure this using the following management tools:

- **Destination Phone Number Manipulation for IP-to-Tel Calls table:** ini file [NumberMapIP2Tel] or CLI (configure voip > gateway manipulation dst-number-map-ip2tel)
- **Destination Phone Number Manipulation for Tel-to-IP Calls table:** ini file [NumberMapTel2IP] or CLI (configure voip > gateway manipulation dst-number-map-tel2ip)
- **Source Phone Number Manipulation for IP-to-Tel Calls table:** ini file [SourceNumberMapIP2Tel] or CLI (configure voip > gateway manipulation src-number-map-ip2tel)
- **Source Phone Number Manipulation for Tel-to-IP Calls table:** ini file [SourceNumberMapTel2IP] or CLI (configure voip > gateway manipulation src-number-map-tel2ip)

➤ **To configure a number manipulation rule:**

1. Open the required Phone Number Manipulation table (**Setup** menu > **Signaling & Media** tab > **Gateway** folder > **Manipulation** > **Dest Number IP->Tel**, **Dest Number Tel->IP**, **Source Number IP->Tel**, or **Source Number Tel->IP**).
2. Click **New**; the following dialog box appears:

3. Configure a number manipulation rule according to the parameters described in the table below.
4. Click **Apply**.

The table below shows configuration examples of Tel-to-IP source phone number manipulation rules configured in the Source Phone Number Manipulation for Tel-to-IP Calls table:

**Table 26-1: Configuration Examples of Source Phone Number Manipulation for Tel-to-IP Calls**

Parameter	Rule 1	Rule 2	Rule 3	Rule 4	Rule 5
<b>Destination Phone Pattern</b>	03		*	*	[6,7,8]
<b>Source Phone Pattern</b>	201	1001	123451001#	[30-40]x	2001
<b>Stripped Digits From Left</b>	-	4	-	-	5
<b>Stripped Digits From Right</b>	-	-	-	1	-
<b>Prefix to Add</b>	971	5	-	2	3
<b>Suffix to Add</b>	-	23	8	-	-
<b>Number of Digits to Leave</b>	-	-	4	-	-
<b>Presentation</b>	Allowed	Restricted	-	-	-

Below is a description of each rule:

- **Rule 1:** When the destination number has the prefix 03 (e.g., 035000), source number prefix 201 (e.g., 20155), and from source IP Group ID 2, the source number is changed to, for example, 97120155.
- **Rule 2:** When the source number has prefix 1001 (e.g., 1001876), it is changed to 587623.
- **Rule 3:** When the source number has prefix 123451001 (e.g., 1234510012001), it is changed to 20018.
- **Rule 4:** When the source number has prefix from 30 to 40 and a digit (e.g., 3122), it is changed to 2312.
- **Rule 5:** When the destination number has the prefix 6, 7, or 8 (e.g., 85262146), source number prefix 2001, it is changed to 3146.

**Table 26-2: Phone Number Manipulation Tables Parameter Descriptions**

Parameter	Description
General	
'Index'	Defines an index number for the new table row.

Parameter	Description
[_Index]	<b>Note:</b> Each row must be configured with a unique index.
'Name' manipulation-name [_ManipulationName]	Defines a descriptive name, which is used when associating the row in other tables.  The valid value is a string of up to 40 characters. By default, no value is defined.  <b>Note:</b> Each row must be configured with a unique name.
<b>Match</b>	
'Source IP Address' src-ip-address [_SourceAddress]	Defines the source IP address of the caller. This is obtained from the Contact header in the INVITE message.  The default is the asterisk (*) wildcard (i.e., any address).  <b>Note:</b> <ul style="list-style-type: none"> <li>■ The parameter is applicable only to the Destination Phone Number Manipulation for IP-to-Tel Calls table and Source Phone Number Manipulation for IP-to-Tel Calls table.</li> <li>■ The source IP address can include the 'x' wildcard to represent single digits. For example, 10.8.8.xx represents all IP addresses between 10.8.8.10 to 10.8.8.99.</li> <li>■ The source IP address can include the asterisk (*) wildcard to represent any number between 0 and 255. For example, 10.8.8.* represents all IP addresses between 10.8.8.0 and 10.8.8.255.</li> </ul>
'Destination IP Group' dst-ip-group-name  [_DestIPGroupID]	Defines the IP Group to where the call is sent.  The default is Any (i.e., any IP Group).  <b>Note:</b> The parameter is applicable only to the Destination Phone Number Manipulation for Tel-to-IP Calls table.
'Source Trunk Group' src-trunk-group-id  [_SrcTrunkGroupID]	Defines the source Trunk Group ID for Tel-to-IP calls.  The default is -1 (i.e., any Trunk Group).  <b>Note:</b> The parameter is applicable only to the number manipulation tables for Tel-to-IP calls.
'Source Phone Pattern' src-pattern [_SourcePrefix]	Defines the source (calling) telephone number.  You can use special patterns (notations) to denote the number. For example, "[100-199](100,101,105)" denotes a number that starts with 100 to 199 and ends with 100, 101 or 105. You can use the dollar (\$) sign to denote calls without a

Parameter	Description
	<p>calling number. For available patterns, see <a href="#">Dialing Plan Notation for Routing and Manipulation Tables</a>.</p> <p>The default is the asterisk (*) symbol, meaning any source number.</p>
<p>'Source Host Pattern' src-host-pattern [_SrcHost]</p>	<p>Defines the URI host part of the incoming SIP INVITE message in the From header.</p> <p>You can use special patterns (notations) to denote the host part. For example, if you want to match this rule to host parts that end (suffix) in ".com", then configure this parameter to "(.com)". For available patterns, see <a href="#">Dialing Plan Notation for Routing and Manipulation Tables</a>.</p> <p>The default is the asterisk (*) symbol, meaning any source host part.</p> <p><b>Note:</b></p> <ul style="list-style-type: none"> <li>■ The parameter is applicable only to the Destination Phone Number Manipulation for IP-to-Tel Calls table and Source Phone Number Manipulation for IP-to-Tel Calls table.</li> <li>■ If the P-Asserted-Identity header is present in the incoming INVITE message, then the value of the parameter is compared to the P-Asserted-Identity URI host name (instead of the From header).</li> </ul>
<p>'Destination Phone Pattern' dst-pattern [_DestinationPrefix]</p>	<p>Defines the destination (called) telephone number.</p> <p>You can use special patterns (notations) to denote the number. For example, "[100-199](100,101,105)" denotes a number that starts with 100 to 199 and ends with 100, 101 or 105. You can also use the dollar (\$) sign to denote calls without a called number. For available patterns, see <a href="#">Dialing Plan Notation for Routing and Manipulation Tables</a>.</p> <p>The default is the asterisk (*) symbol, meaning any destination number.</p>
<p>'Destination Host Pattern' dst-host-pattern [_DestHost]</p>	<p>Defines the Request-URI host part of the incoming SIP INVITE message.</p> <p>You can use special patterns (notations) to denote the host part. For example, if you want to match this rule to host parts that end (suffix) in ".com", then configure this parameter to "(.com)". For available patterns, see <a href="#">Dialing Plan Notation for Routing and Manipulation Tables</a>.</p>

Parameter	Description
	<p>The default is the asterisk (*) symbol, meaning any destination host part.</p> <p><b>Note:</b> The parameter is applicable only to the Destination Phone Number Manipulation for IP-to-Tel Calls table and Source Phone Number Manipulation for IP-to-Tel Calls table.</p>
'Source IP Group' src-ip-group-id [_SrcIPGroupID]	<p>Defines the IP Group from where the IP call originated. The default is Any (i.e., any IP Group).</p> <p><b>Note:</b> The parameter is applicable only to the Destination Phone Number Manipulation for IP-to-Tel Calls table and Source Phone Number Manipulation for IP-to-Tel Calls table.</p>
Action	
'Stripped Digits From Left' remove-from-left [_RemoveFromLeft]	<p>Defines the number of digits to remove from the left of the telephone number prefix. For example, if you enter 3 and the phone number is 5551234, the new phone number is 1234.</p>
'Stripped Digits From Right' remove-from-right [RemoveFromRight]	<p>Defines the number of digits to remove from the right of the telephone number prefix. For example, if you enter 3 and the phone number is 5551234, the new phone number is 5551.</p>
'Number of Digits to Leave' num-of-digits-to-leave [LeaveFromRight]	<p>Defines the number of digits that you want to keep from the right of the phone number. For example, if you enter 4 and the phone number is 00165751234, then the new number is 1234.</p>
'Prefix to Add' prefix-to-add [Prefix2Add]	<p>Defines the number or string that you want added to the front of the telephone number. For example, if you enter 9 and the phone number is 1234, the new number is 91234.</p>
'Suffix to Add' suffix-to-add [Suffix2Add]	<p>Defines the number or string that you want added to the end of the telephone number. For example, if you enter 00 and the phone number is 1234, the new number is 123400.</p>
'TON' ton [NumberType]	<p>Defines the Type of Number (TON).</p> <ul style="list-style-type: none"> <li>■ [0] <b>Unknown</b> (default)</li> <li>■ [1] <b>International-Level2 Regional</b></li> </ul>

Parameter	Description
	<ul style="list-style-type: none"> <li>■ [2] <b>National-Level1 Regional</b></li> <li>■ [3] <b>Network-PSTN Specific</b></li> <li>■ [4] <b>Subscriber-Level0 Regional</b></li> <li>■ [6] <b>Abbreviated</b></li> </ul> <p>The applicable values depend on the NPI value:</p> <ul style="list-style-type: none"> <li>■ If you select <b>Unknown</b> for NPI, you can select <b>Unknown</b>.</li> <li>■ If you select <b>Private</b> for NPI, you can set TON to one of the following:                             <ul style="list-style-type: none"> <li>✓ <b>Unknown</b></li> <li>✓ <b>International-Level2 Regional</b></li> <li>✓ <b>National-Level1 Regional</b></li> <li>✓ <b>PISN Specific</b></li> <li>✓ <b>Subscriber-Level0 Regional</b></li> </ul> </li> <li>■ If you select <b>E.164 Public</b> for NPI, you can set TON to one of the following:                             <ul style="list-style-type: none"> <li>✓ <b>Unknown</b></li> <li>✓ <b>International-Level2 Regional</b></li> <li>✓ <b>National-Level1 Regional</b></li> <li>✓ <b>Network-PSTN Specific</b></li> <li>✓ <b>Subscriber-Level0 Regional</b></li> <li>✓ <b>Abbreviated</b></li> </ul> </li> </ul> <p><b>Note:</b></p> <ul style="list-style-type: none"> <li>■ The parameter is applicable only to digital interfaces.</li> <li>■ TON can be used in the SIP Remote-Party-ID header by using the EnableRPIHeader and AddTON2RPI parameters.</li> <li>■ For more information on available NPI/TON values, see <a href="#">Numbering Plans and Type of Number</a>.</li> </ul>
<p>'NPI' npi [NumberPlan]</p>	<p>Defines the Numbering Plan Indicator (NPI).</p> <ul style="list-style-type: none"> <li>■ [-1] = Not configured and the value received from PSTN/IP is used.</li> </ul>

Parameter	Description
	<ul style="list-style-type: none"> <li>■ [0] <b>Unknown</b> (default)</li> <li>■ [1] <b>E.164 Public</b></li> <li>■ [9] <b>Private</b></li> </ul> <p><b>Note:</b></p> <ul style="list-style-type: none"> <li>■ The parameter is applicable only to digital interfaces.</li> <li>■ NPI can be used in the SIP Remote-Party-ID header by using the EnableRPIHeader and AddTON2RPI parameters.</li> <li>■ For more information on available NPI/TON values, see <a href="#">Numbering Plans and Type of Number</a>.</li> </ul>
<p>'Presentation' is-presentation-restricted [IsPresentationRestricted]</p>	<p>Enables caller ID.</p> <ul style="list-style-type: none"> <li>■ <b>Not Configured</b> = Privacy is determined according to the Caller ID table (see <a href="#">Configuring Caller Display Information</a>). This option is applicable only to analog interfaces.</li> <li>■ [0] <b>Allowed</b> = Sends Caller ID information when a call is made using these destination/source prefixes.</li> <li>■ [1] <b>Restricted</b> = Restricts Caller ID information for these prefixes.</li> </ul> <p><b>Note:</b></p> <ul style="list-style-type: none"> <li>■ The parameter is applicable only to the Source Phone Number Manipulation for IP-to-Tel Calls table and Source Phone Number Manipulation for Tel-to-IP Calls table.</li> <li>■ If you configure the parameter to <b>Restricted</b> and the 'Asserted Identity Mode' (AssertedIdMode) parameter to <b>Add P-Asserted-Identity</b>, the From header in the INVITE message includes the following:</li> </ul> <pre>From: 'anonymous' &lt;sip:anonymous@anonymous.invalid&gt; and 'privacy: id' header</pre>

## Manipulating Number Prefix

The device supports a notation for adding a prefix where part of the prefix is first extracted from a user-defined location in the original destination or source number. The notation is



entered in the 'Prefix to Add' field in the Number Manipulation tables (see [Configuring Source/Destination Number Manipulation](#)):  $x[n,l]y\dots$

where,

- $x$  = any number of characters/digits to add at the beginning of the number (i.e. first digits in the prefix).
- $[n,l]$  = defines the location in the original destination or source number where the digits  $y$  are added:
  - $n$  = location (number of digits counted from the left of the number) of a specific string in the original destination or source number.
  - $l$  = number of digits that this string includes.
- $y$  = prefix to add at the specified location.

For example, assume that you want to manipulate an incoming IP call with destination number "+5492028888888" (i.e., area code "202" and phone number "8888888") to the number "0202158888888". To perform such manipulation, the following configuration is required in the Number Manipulation table:

1. The following notation is used in the 'Prefix to Add' field:

0[5,3]15

where,

- 0 is the number to add at the beginning of the original destination number.
  - [5,3] denotes a string that is located after (and including) the fifth character (i.e., the first '2' in the example) of the original destination number, and its length being three digits (i.e., the area code 202, in the example).
  - 15 is the number to add immediately after the string denoted by [5,3] - in other words, 15 is added after (i.e. to the right of) the digits 202.
2. The first seven digits from the left are removed from the original number, by entering "7" in the 'Stripped Digits From Left' field.

**Table 26-3: Example of Configured Rule for Manipulating Prefix using Special Notation**

Parameter	Rule 1
Destination Phone Pattern	+5492028888888
Source Phone Pattern	*
Source IP Address	*
Stripped Digits from Left	7
Prefix to Add	0[5,3]15

In this configuration example, the following manipulation process occurs:

1. The prefix is calculated as 020215.
2. The first seven digits from the left are removed from the original number, thereby changing the number to 8888888.
3. The prefix that was previously calculated is then added.

## SIP Calling Name Manipulations

The calling name manipulation tables let you configure up to 120 manipulation rules for manipulating the calling name (i.e., caller ID) in SIP messages for IP-to-Tel and Tel-to-IP calls. Manipulation includes modifying or removing the calling name. For example, assume that an incoming SIP INVITE message includes the following header:

```
P-Asserted-Identity: "company:john" sip:6666@78.97.79.104
```

Using the Calling Name Manipulation for IP-to-Tel Calls table, "company" can be changed to "worker" in the outgoing INVITE, as shown below:

```
P-Asserted-Identity: "worker:john" sip:996666@10.13.83.10
```

The calling name manipulation tables include the following:

- Calling Name Manipulation for IP-to-Tel Calls table
- Calling Name Manipulation for Tel-to-IP Calls table

Configuration of calling name manipulation rules includes two areas:

- **Match:** Defines the matching characteristics of an incoming call (e.g., prefix of destination number).
- **Action:** Defines the action that is done if the incoming call matches the characteristics of the rule (e.g., removes a user-defined number of digits from the left of the calling name).

The device searches the table from **top to bottom** for the **first** rule that matches the characteristics of the incoming call. If it finds a matching rule, it applies the manipulation configured for that rule.



To use the Calling Name Manipulation for Tel-to-IP Calls table for retrieving the calling name (display name) from an Active Directory using LDAP queries, see [Querying the AD for Calling Name](#).

The following procedure describes how to configure calling name manipulation rules through the Web interface. You can also configure these rules using the the following management tools:

- Calling Name Manipulation for Tel-to-IP Calls table: *ini* file [CallingNameMapTel2Ip] or CLI (configure voip > gateway manipulation calling-name-map-tel2ip)
- Calling Name Manipulation for IP-to-Tel Calls table: *ini* file [CallingNameMapIp2Tel] or CLI (configure voip > gateway manipulation calling-name-map-ip2tel)

➤ **To configure calling name manipulation rules:**

1. Open the required calling name manipulations table (**Setup** menu > **Signaling & Media** tab > **Gateway** folder > **Manipulation** > **Calling Name IP->Tel** or **Calling Name Tel->IP**).
2. Click **New**; the following dialog box appears:

3. Configure a manipulation rule according to the parameters described in the table below.
4. Click **Apply**.

**Table 26-4: Calling Name Manipulation Tables Parameter Descriptions**

Parameter	Description
<b>General</b>	
'Index' [_Index]	Defines an index number for the new table row. <b>Note:</b> Each row must be configured with a unique index.
'Name' manipulation-name [_ManipulationName]	Defines a descriptive name, which is used when associating the row in other tables. The valid value is a string of up to 40 characters. <b>Note:</b> Each row must be configured with a unique name.
<b>Match</b>	
'Destination Phone Pattern' dst-pattern [_DestinationPrefix]	Defines the destination (called) telephone number. You can use special patterns (notations) to denote the number. For example, "[100-199](100,101,105)" denotes a number that starts with 100 to 199 and ends with 100, 101 or 105. You can use the dollar (\$) sign to denote calls without a

Parameter	Description
	<p>called number. For available notations, see <a href="#">Dialing Plan Notation for Routing and Manipulation Tables</a>.</p> <p>The default value is the asterisk (*) symbol, meaning any destination number.</p>
<p>'Source Phone Pattern' src-pattern [_SourcePrefix]</p>	<p>Defines the source (calling) telephone number.</p> <p>You can use special patterns (notations) to denote the number. For example, "[100-199](100,101,105)" denotes a number that starts with 100 to 199 and ends with 100, 101 or 105. You can also use the dollar (\$) sign to denote calls without a calling number. For available patterns, see <a href="#">Dialing Plan Notation for Routing and Manipulation Tables</a>.</p> <p>The default value is the asterisk (*) symbol, meaning any source number.</p>
<p>'Calling Name Pattern' calling-name-pattern [_CallingNamePrefix]</p>	<p>Defines the caller name (i.e., caller ID).</p> <p>You can use special patterns (notations) to denote the calling name. For example, to denote calls without a calling name, use the dollar (\$) sign. For available patterns, see <a href="#">Dialing Plan Notation for Routing and Manipulation Tables</a>.</p> <p>The default value is the asterisk (*) symbol, meaning any calling name.</p>
<p>'Source Trunk Group ID' src-trunk-group-id [_SrcTrunkGroupID]</p>	<p>Defines the source Trunk Group ID from where the Tel-to-IP call was received.</p> <p>The default value is -1, which denotes any Trunk Group.</p> <p><b>Note:</b> The parameter is applicable only to the Calling Name Manipulation for Tel-to-IP Calls table.</p>
<p>'Source IP Address' src-ip-address [_SourceAddress]</p>	<p>Defines the source IP address of the caller for IP-to-Tel calls. The source IP address appears in the SIP Contact header in the INVITE message.</p> <p>The default value is the asterisk (*) symbol (i.e., any IP address). The source IP address can include the following wildcards:</p> <ul style="list-style-type: none"> <li>■ "x" wildcard: represents single digits. For example, 10.8.8.xx represents all IP addresses between 10.8.8.10 to 10.8.8.99.</li> <li>■ "*" (asterisk) wildcard: represents any number between 0 and 255. For example, 10.8.8.* represents all IP addresses between 10.8.8.0 and 10.8.8.255.</li> </ul>

Parameter	Description
	<p><b>Note:</b> The parameter is applicable only to the Calling Name Manipulation for IP-to-Tel Calls table.</p>
<p>'Source Host Pattern' src-host-pattern [_SrcHost]</p>	<p>Defines the URI host part of the incoming SIP INVITE message in the From header.</p> <p>You can use special patterns (notations) to denote the host part. For example, if you want to match this rule to host parts that end (suffix) in ".com", then configure this parameter to "(.com)". For available patterns, see <a href="#">Dialing Plan Notation for Routing and Manipulation Tables</a>.</p> <p>The default value is the asterisk (*) symbol, meaning any source host part.</p> <p><b>Note:</b></p> <ul style="list-style-type: none"> <li>■ The parameter is applicable only to the Calling Name Manipulation for IP-to-Tel Calls table.</li> <li>■ If the P-Asserted-Identity header is present in the incoming INVITE message, the value of the parameter is compared to the P-Asserted-Identity URI host name (instead of the From header).</li> </ul>
<p>'Destination Host Pattern' dst-host-pattern [_DestHost]</p>	<p>Defines the Request-URI host part of the incoming SIP INVITE message.</p> <p>You can use special patterns (notations) to denote the host part. For example, if you want to match this rule to host parts that end (suffix) in ".com", then configure this parameter to "(.com)". For available patterns, see <a href="#">Dialing Plan Notation for Routing and Manipulation Tables</a>.</p> <p>The default value is the asterisk (*) symbol, meaning any destination host part.</p> <p><b>Note:</b> The parameter is applicable only to the Calling Name Manipulation for IP-to-Tel Calls table.</p>
Action	
<p>'Stripped Characters From Left' remove-from-left [_RemoveFromLeft]</p>	<p>Defines the number of characters to remove from the left of the calling name.</p> <p>For example, if you enter 3 and the calling name is "company:john", the new calling name is "pany:john".</p>
<p>'Stripped Characters From Right' remove-from-right</p>	<p>Defines the number of characters to remove from the right of the calling name.</p> <p>For example, if you enter 3 and the calling name is</p>

Parameter	Description
[RemoveFromRight]	"company:name", the new name is "company:n".
'Number of Characters to Leave' num-of-digits-to-leave [LeaveFromRight]	Defines the number of characters that you want to keep from the right of the calling name. For example, if you enter 4 and the calling name is "company:name", the new name is "name".
'Prefix to Add' prefix-to-add [_Prefix2Add]	Defines the number or string to add at the front of the calling name. For example, if you enter ITSP and the calling name is "company:name", the new name is ITSPcompany:john".
'Suffix to Add' suffix-to-add [_Suffix2Add]	Defines the number or string to add at the end of the calling name. For example, if you enter 00 and calling name is "company:name", the new name is "company:name00".

## Configuring Redirect Number Manipulation

Each redirect number manipulation table lets you configure up to 20 rules for manipulating the redirect number received in SIP messages. The redirect number manipulation tables include:

- **Redirect Number IP-to-Tel table:** (Applicable only to ISDN) Defines IP-to-Tel redirect number manipulation. You can manipulate the value of the received SIP Diversion, Resource-Priority, or History-Info headers, which is then added to the Redirecting Number Information Element (IE) in the ISDN Setup message sent to the Tel side. This also includes the reason for the call redirection.
- **Redirect Number Tel-to-IP table:** Defines Tel-to-IP redirect number manipulation. You can manipulate the prefix of the redirect number received from the Tel side, in the outgoing SIP Diversion, Resource-Priority, or History-Info headers sent to the IP side.

Configuration of redirect number manipulation rules includes two areas:

- **Match:** Defines the matching characteristics of an incoming call (e.g., prefix of redirect number).
- **Action:** Defines the action that is done if the incoming call matches the characteristics of the rule (e.g., removes a user-defined number of digits from the left of the redirect number).

The device searches the table from **top to bottom** for the **first** rule that matches the characteristics of the incoming call. If it finds a matching rule, it applies the manipulation configured for that rule.



- If the device copies the received destination number to the outgoing SIP redirect number (enabled by the CopyDest2RedirectNumber parameter), no redirect number Tel-to-IP manipulation is done.
- The manipulation rules are done in the following order: 'Stripped Digits From Left', 'Stripped Digits From Right', 'Number of Digits to Leave', 'Prefix to Add', and then 'Suffix to Add'.
- The device uses the 'Redirect Prefix' parameter before it manipulates the prefix.

The following procedure describes how to configure redirect number manipulation rules through the Web interface. You can also configure these rules using the following management tools:

- Redirect Number IP-to-Tel table: ini file [RedirectNumberMapIp2Tel] or CLI (`configure voip > gateway manipulation redirect-number-map-ip2tel`)
- Redirect Number Tel-to-IP table: ini file [RedirectNumberMapTel2Ip] or CLI (`configure voip > gateway manipulation redirect-number-map-tel2ip`)

➤ **To configure a redirect number manipulation rule:**

1. Open the required redirect number manipulation table (**Setup** menu > **Signaling & Media** tab > **Gateway** folder > **Manipulation** > **Redirect Number Tel > IP** or **Redirect Number IP > Tel**).
2. Click **New**; the following dialog box appears (e.g., Redirect Number Tel-to-IP table):

3. Configure a manipulation rule according to the parameters described in the table below.
4. Click **Apply**.

**Table 26-5: Redirect Number Manipulation Tables Parameter Description**

Parameter	Description
<b>General</b>	
'Index' [_Index]	Defines an index number for the new table row. <b>Note:</b> Each row must be configured with a unique index.
'Name' manipulation- name	Defines a descriptive name, which is used when associating the row in other tables. The valid value is a string of up to 40 characters.

Parameter	Description
[_ManipulationName]	
<b>Match</b>	
'Destination Phone Pattern' dst-pattern [_DestinationPrefix]	<p>Defines the destination (called) telephone number.</p> <p>You can use special patterns (notations) to denote the number. For example, if you want to match this rule to a number whose last four digits (i.e., suffix) are 4 followed by any three digits (e.g., 4008), then configure this parameter to "(4xxx)". For available patterns, see <a href="#">Patterns for Denoting Phone Numbers and SIP URIs</a> on page 1369.</p> <p>The default value is the asterisk (*) symbol, meaning any destination number.</p> <p>Digital interfaces: For manipulating the diverting and redirected numbers for call diversion, you can use the strings "DN" and "RN" to denote the destination prefix of these numbers. For more information, see <a href="#">Manipulating Redirected and Diverted Numbers for Call Diversion</a>.</p>
'Redirect Phone Pattern' redirect-pattern [_RedirectPrefix]	<p>Defines the redirect telephone number.</p> <p>You can use special patterns (notations) to denote the number. For example, if you want to match this rule to a number whose last four digits (i.e., suffix) are 4 followed by any three digits (e.g., 4008), then configure this parameter to "(4xxx)". For available patterns, see <a href="#">Patterns for Denoting Phone Numbers and SIP URIs</a> on page 1369.</p> <p>The default value is the asterisk (*) symbol, meaning any redirect number.</p>
'Source Trunk Group ID' src-trunk-group-id [_SrcTrunkGroupID]	<p>Defines the Trunk Group from where the Tel call is received.</p> <p>To denote any Trunk Group, leave this field empty. The value -1 indicates that this field is ignored in the rule.</p> <p><b>Note:</b> The parameter is applicable only to the Redirect Number Tel-to-IP table.</p>
'Source IP Address' src-ip-address [_SourceAddress]	<p>Defines the IP address of the caller. The IP address appears in the SIP Contact header of the incoming INVITE message.</p> <p>The default value is the asterisk (*) symbol (i.e., any IP address). The value can include the following wildcards:</p> <ul style="list-style-type: none"> <li>■ "x": represents single digits, for example, 10.8.8.xx denotes all addresses between 10.8.8.10 and 10.8.8.99.</li> <li>■ "*": represents any number between 0 and 255, for</li> </ul>



Parameter	Description
	<p>example, 10.8.8.* denotes all addresses between 10.8.8.0 and 10.8.8.255.</p> <p><b>Note:</b> The parameter is applicable only to the Redirect Number IP-to-Tel table.</p>
<p>'Source Host Pattern' src-host-pattern [_SrcHost]</p>	<p>Defines the URI host part of the caller. The host name appears in the SIP From header of the incoming SIP INVITE message.</p> <p>You can use special patterns (notations) to denote the host part. For example, if you want to match this rule to host parts that end (suffix) in ".com", then configure this parameter to "(.com)". For available patterns, see <a href="#">Patterns for Denoting Phone Numbers and SIP URIs</a> on page 1369.</p> <p>The default value is the asterisk (*) symbol, meaning any source host part.</p> <p><b>Note:</b></p> <ul style="list-style-type: none"> <li>■ The parameter is applicable only to the Redirect Number IP-to-Tel table.</li> <li>■ If the P-Asserted-Identity header is present in the incoming INVITE message, the value of the parameter is compared to the P-Asserted-Identity URI host name (instead of to the From header).</li> </ul>
<p>'Destination Host Pattern' dst-host-pattern [_DestHost]</p>	<p>Defines the Request-URI host part, which appears in the incoming SIP INVITE message.</p> <p>You can use special patterns (notations) to denote the host part. For example, if you want to match this rule to host parts that end (suffix) in ".com", then configure this parameter to "(.com)". For available patterns, see <a href="#">Patterns for Denoting Phone Numbers and SIP URIs</a> on page 1369.</p> <p>The default value is the asterisk (*) symbol, meaning any destination host part.</p> <p><b>Note:</b> The parameter is applicable only to the Redirect Number IP-to-Tel table.</p>
<b>Action</b>	
<p>'Stripped Digits From Left' remove-from-left [_RemoveFromLeft]</p>	<p>Defines the number of digits to remove from the left of the redirect number prefix.</p> <p>For example, if you enter 3 and the redirect number is 5551234, the new number is 1234.</p>

Parameter	Description
'Stripped Digits From Right' remove-from-right [_RemoveFromRight]	Defines the number of digits to remove from the right of the redirect number prefix.  For example, if you enter 3 and the redirect number is 5551234, the new number is 5551.
'Number of Digits to Leave' num-of-digits-to-leave [_LeaveFromRight]	Defines the number of digits that you want to retain from the right of the redirect number.
'Prefix to Add' prefix-to-add [_Prefix2Add]	Defines the number or string that you want added to the front of the redirect number.  For example, if you enter 9 and the redirect number is 1234, the new number is 91234.
'Suffix to Add' suffix-to-add [_Suffix2Add]	Defines the number or string that you want added to the end of the redirect number.  For example, if you enter 00 and the redirect number is 1234, the new number is 123400.
'TON' ton [_NumberType]	Defines the Type of Number (TON). <ul style="list-style-type: none"> <li>■ [-1] = (Default) Not configured</li> <li>■ [0] <b>Unknown</b> (default)</li> <li>■ [1] <b>International-Level2 Regional</b></li> <li>■ [2] <b>National-Level1 Regional</b></li> <li>■ [3] <b>Network-PSTN Specific</b></li> <li>■ [4] <b>Subscriber-Level0 Regional</b></li> <li>■ [6] <b>Abbreviated</b></li> </ul> The applicable values depend on the NPI value: <ul style="list-style-type: none"> <li>■ If NPI is set to <b>Unknown</b>, you can set TON to Unknown.</li> <li>■ If NPI is set to Private, you can set TON to one of the following:               <ul style="list-style-type: none"> <li>✓ <b>Unknown</b></li> <li>✓ <b>International-Level2 Regional</b></li> <li>✓ <b>National-Level1 Regional</b></li> </ul> </li> </ul>

Parameter	Description
	<ul style="list-style-type: none"> <li>✓ <b>Network-PSTN Specific</b></li> <li>✓ <b>Subscriber-Level0 Regional</b></li> </ul> <p>■ If NPI is set to <b>E.164 Public</b>, you can set TON to one of the following:</p> <ul style="list-style-type: none"> <li>✓ <b>Unknown</b></li> <li>✓ <b>International-Level2 Regional</b></li> <li>✓ <b>National-Level1 Regional</b></li> <li>✓ <b>Network-PSTN Specific</b></li> <li>✓ <b>Subscriber-Level0 Regional</b></li> <li>✓ <b>Abbreviated</b></li> </ul> <p>For more information on available NPI/TON values, see <a href="#">Numbering Plans and Type of Number</a>.</p> <p><b>Note:</b> The parameter is applicable only to digital interfaces.</p>
<p>'NPI' npi [_NumberPlan]</p>	<p>Defines the Numbering Plan Indicator (NPI).</p> <ul style="list-style-type: none"> <li>■ [-1] <b>Not Configured</b> = (Default) Value received from PSTN/IP is used</li> <li>■ [0] <b>Unknown</b></li> <li>■ [1] <b>E.164 Public</b></li> <li>■ [9] <b>Private</b></li> </ul> <p>For more information on available NPI/TON values, see <a href="#">Numbering Plans and Type of Number</a>.</p> <p><b>Note:</b> The parameter is applicable only to digital interfaces.</p>
<p>'Presentation' is-presentation-restricted [IsPresentationRestricted]</p>	<p>Enables caller ID.</p> <ul style="list-style-type: none"> <li>■ <b>Not Configured</b> = Privacy is determined according to the Caller ID table (see <a href="#">Configuring Caller Display Information</a>). This option is applicable only to analog interfaces.</li> <li>■ [0] <b>Allowed</b> = Sends Caller ID information when a call is made using these destination / source prefixes.</li> <li>■ [1] <b>Restricted</b> = Restricts Caller ID information for these prefixes.</li> </ul> <p><b>Note:</b> If you configure the parameter to <b>Restricted</b> and the 'AssertedIdMode' parameter to <b>Add P-Asserted-Identity</b>, the From header in the INVITE message includes the following:</p>

Parameter	Description
	From: 'anonymous' <sip:anonymous@anonymous.invalid> and 'privacy: id' header.

## Manipulating Redirected and Diverted Numbers for Call Diversion

You can configure manipulation rules to manipulate the Diverted-to and Diverting numbers received in the incoming Call Redirection Facility message for call diversion, which is interworked to outgoing SIP 302 responses.



This feature is applicable only to the Gateway application - Euro ISDN and QSIG variants in the IP-to-Tel call direction.

The incoming redirection Facility message includes, among other parameters, the Diverted-to number and Diverting number. The Diverted-to number (i.e., new destination) is mapped to the user part in the Contact header of the SIP 302 response. The Diverting number is mapped to the user part in the Diversion header of the SIP 302 response. These two numbers can be manipulated by entering the following special strings in the 'Destination Phone Pattern' field of the Redirect Number Tel-to-IP table:

- "RN" - used in the rule to manipulate the Redirected number (i.e., originally called number or Diverting number).
- "DN" - used in the rule to manipulate the Diverted-to number (i.e., the new called number or destination). This manipulation is done on the user part in the Contact header of the SIP 302 response.

For example, assume the following required manipulation:

- Manipulate Redirected number 6001 (originally called number) to 6005
- Manipulate Diverted-to number 8002 (the new called number or destination) to 8005

The configuration in the Redirect Number Tel-to-IP table is as follows:

**Table 26-6: Redirect Number Configuration Example**

Parameter	Rule 1	Rule 2
Destination Phone Pattern	RN	DN
Redirect Phone Pattern	6	8
Stripped Digits From Right	1	1

Parameter	Rule 1	Rule 2
Suffix to Add	5	5
Number of Digits to Leave	5	-

After the above manipulation is done, the device sends the following outgoing SIP 302 response:

```
SIP/2.0 302 Moved Temporarily
Via: SIP/2.0/TLS 10.33.45.68;branch=z9hG4bKac54132643;alias
From: "MP118 1" <sip:8001@10.33.45.68>;tag=1c54119560
To: <sip:6001@10.33.45.69;user=phone>;tag=1c664560944
Call-ID: 541189832710201115142@10.33.45.68
CSeq: 1 INVITE
Contact: <sip:8005@10.33.45.68;user=phone>
Supported: em,timer,replaces,path,early-session,resource-priority
Allow:
REGISTER,OPTIONS,INVITE,ACK,CANCEL,BYE,NOTIFY,PRACK,REFER,INFO,SUBSCRIBE,UPDATE
Diversion: <tel:6005>;reason=unknown;counter=1
Server: Sip-Gateway/7.20A.260.005
Reason: SIP ;cause=302 ;text="302 Moved Temporarily"
Content-Length: 0
```

## Mapping NPI/TON to SIP Phone-Context

The Phone Contexts table lets you configure up to 20 rules for mapping the Numbering Plan Indication (NPI) and Type of Number (TON) to the SIP 'phone-context' parameter, and vice versa. The 'phone-context' parameter appears in the standard SIP headers where a phone number is used (i.e., Request-URI, To, From, and Diversion). When a call is received from the Tel side, the device searches the table for a matching rule (i.e., same NPI and TON values). If a matching rule is found, the device uses the rule's corresponding 'phone-context' value in the outgoing SIP INVITE message. The same mapping occurs when an INVITE with a 'phone-context' parameter is received.

For example, for a Tel-to-IP call with NPI/TON set as E164 National (values 1/2), the device can send the following SIP INVITE URI:

```
sip:12365432;phone-context= na.e.164.nt.com
```

For an IP-to-Tel call, if the incoming INVITE contains this 'phone-context' (e.g. "phone-context=na.e.164.nt.com"), the NPI/TON of the called number in the outgoing Setup message is changed to E164 National.

The following procedure describes how to configure NPI/TON-SIP phone-context mapping rules through the Web interface. You can also configure it through ini file [PhoneContext] or CLI (configure voip > gateway manipulation phone-context-table).

➤ **To configure NPI/TON-SIP phone-context mapping rules:**

1. Open the Phone Contexts table (**Setup** menu > **Signaling & Media** tab > **Gateway** folder > **Manipulation** > **Phone Contexts**).
2. Click **New**; the following dialog box appears:

3. Configure a mapping rule according to the parameters described in the table below.
4. Click **Apply**.



- You can configure multiple rows with the same NPI/TON or same SIP 'phone-context'. In such a configuration, a Tel-to-IP call uses the first matching rule in the table.
- To add the incoming SIP 'phone-context' parameter as a prefix to the outgoing ISDN Setup message (for digital interfaces) with called and calling numbers, from the 'Add Phone Context As Prefix' drop-down list (AddPhoneContextAsPrefix), select **Enable**.

**Table 26-7: Phone Contexts table Parameter Description**

Parameter	Description
'Index' [PhoneContext_ Index]	Defines an index number for the new table row. <b>Note:</b> Each row must be configured with a unique index.
'NPI' npi [PhoneContext_ Npi]	Defines the Number Plan Indicator (NPI). <ul style="list-style-type: none"> <li>■ [0] <b>Unknown</b> (default)</li> <li>■ [1] <b>E.164 Public</b></li> <li>■ [9] <b>Private</b></li> </ul>

Parameter	Description
	For a detailed list of the available NPI/TON values, see <a href="#">Numbering Plans and Type of Number</a> .
'TON' ton [PhoneContext_Ton]	<p>Defines the Type of Number (TON).</p> <ul style="list-style-type: none"> <li>■ [0] <b>Unknown</b></li> <li>■ [1] <b>International-Level2 Regional</b></li> <li>■ [2] <b>National-Level1 Regional</b></li> <li>■ [3] <b>Network-PSTN Specific</b></li> <li>■ [4] <b>Subscriber-Level0 Regional</b></li> <li>■ [6] <b>Abbreviated</b></li> </ul> <p>The applicable values depend on the NPI value:</p> <ul style="list-style-type: none"> <li>■ If you select <b>Unknown</b> as NPI, you can select <b>Unknown</b>.</li> <li>■ If you select <b>Private</b> as NPI, you can select one of the following: <ul style="list-style-type: none"> <li>✓ [0] <b>Unknown</b></li> <li>✓ [1] <b>International-Level2 Regional</b></li> <li>✓ [2] <b>National-Level1 Regional</b></li> <li>✓ [3] <b>Network-PSTN Specific</b></li> <li>✓ [4] <b>Subscriber-Level0 Regional</b></li> </ul> </li> <li>■ If you select <b>E.164 Public</b> as NPI, you can select one of the following: <ul style="list-style-type: none"> <li>✓ [0] <b>Unknown</b></li> <li>✓ [1] <b>International-Level2 Regional</b></li> <li>✓ [2] <b>National-Level1 Regional</b></li> <li>✓ [3] <b>Network-PSTN Specific</b></li> <li>✓ [4] <b>Subscriber-Level0 Regional</b></li> <li>✓ [6] <b>Abbreviated</b></li> </ul> </li> </ul>
'SIP Phone-Context' context [PhoneContext_Context]	Defines the SIP 'phone-context' URI parameter.

## Configuring Release Cause Mapping

When a call is disconnected, the reason for the disconnection (or call failure) is sent by the side (IP or Tel) on which the call disconnection occurred. From the IP side, a SIP response is sent (e.g., 406); from the Tel side, an ISDN cause code is sent (e.g., 6). You can configure ISDN-SIP release cause mapping rules, as discussed in this section.



The feature is applicable only to digital interfaces.

### SIP-to-ISDN Release Cause Mapping

This section shows SIP-to-ISDN release cause mapping.

#### Configuring SIP-to-ISDN Release Cause Mapping

The Release Cause Mapping from SIP to ISDN table lets you configure up to 12 SIP response code to ISDN ITU-T Q.850 release cause code (call failure) mapping rules. The table lets you override the default SIP-to-ISDN release cause mappings, listed in [Fixed Mapping of SIP Response to ISDN Release Reason](#). When the device receives a SIP response from the IP side, it searches the table for a matching SIP response. If found, the device sends the corresponding Q.850 Release Cause to the PSTN. If the SIP response is not configured in the table, the default, fixed SIP-to-ISDN release reason mapping is used.



For Tel-to-IP calls, you can also map less commonly used SIP responses to a single, default ISDN release cause code, using the `DefaultCauseMapISDN2IP` parameter. The parameter defines a default ISDN cause code that is always used, except when the following Release Causes are received: Normal Call Clearing (16), User Busy (17), No User Responding (18) or No Answer from User (19).

The following procedure describes how to configure SIP-to-ISDN release cause mapping through the Web interface. You can also configure it through ini file [`CauseMapSIP2ISDN`] or CLI (`configure voip > gateway manipulation cause-map-sip2isdn`).

#### ➤ To configure a SIP-to-ISDN release cause mapping rule:

1. Open the Release Cause Mapping from SIP to ISDN table (**Setup** menu > **Signaling & Media** tab > **Gateway** folder > **Manipulation** > **Release Cause SIP > ISDN**).
2. Click **New**; the following dialog box appears:





3. Configure a mapping rule according to the parameters described in the table below.
4. Click **Apply**.

**Table 26-8: Release Cause Mapping from SIP to ISDN Table Parameter Descriptions**

Parameter	Description
'Index' [CauseMapSip2Isdn_ Index]	Defines an index number for the new table row. <b>Note:</b> Each row must be configured with a unique index.
'SIP Response' sip-response [CauseMapSip2Isdn_ SipResponse]	Defines the SIP response code. For example, you can enter "406" (without quotation marks) to represent the SIP 406 Not Acceptable response.
'Q.850 Causes' q850-causes [CauseMapSip2Isdn_ IsdnReleaseCause]	Defines the ISDN Q.850 cause code. For example, you can enter "6" (without quotation marks) to represent Cause Code 6 Channel Unacceptable.

### Fixed Mapping of SIP Response to ISDN Release Reason

The following table shows the mapping of SIP response to ISDN release reason.

**Table 26-9: Mapping of SIP Response to ISDN Release Reason**

SIP Response	Description	ISDN Release Reason	Description
400*	Bad request	31	Normal, unspecified
401	Unauthorized	21	Call rejected
402	Payment required	21	Call rejected

SIP Response	Description	ISDN Release Reason	Description
403	Forbidden	21	Call rejected
404	Not found	1	Unallocated number
405	Method not allowed	63	Service/option unavailable
406	Not acceptable	79	Service/option not implemented
407	Proxy authentication required	21	Call rejected
408	Request timeout	102	Recovery on timer expiry
409	Conflict	41	Temporary failure
410	Gone	22	Number changed w/o diagnostic
411	Length required	127	Interworking
413	Request entity too long	127	Interworking
414	Request URI too long	127	Interworking
415	Unsupported media type	79	Service/option not implemented
417	Unknown Resource Priority	127	Interworking
420	Bad extension	127	Interworking
480	Temporarily unavailable	18	No user responding
481*	Call leg/transaction doesn't exist	127	Interworking
482*	Loop detected	127	Interworking
483	Too many hops	127	Interworking
484	Address incomplete	28	Invalid number format

SIP Response	Description	ISDN Release Reason	Description
485	Ambiguous	1	Unallocated number
486	Busy here	17	User busy
488	Not acceptable here	31	Normal, unspecified
489	Bad Event	31	Normal, unspecified
491	Request Pending	31	Normal, unspecified
500	Server internal error	41	Temporary failure
501	Not implemented	38	Network out of order
502	Bad gateway	38	Network out of order
503	Service unavailable	41	Temporary failure
504	Server timeout	102	Recovery on timer expiry
505*	Version not supported	127	Interworking
600	Busy everywhere	17	User busy
603	Decline	21	Call rejected
604	Does not exist anywhere	1	Unallocated number
606*	Not acceptable	38	Network out of order

\* Messages and responses were created because the 'ISUP to SIP Mapping' draft does not specify their cause code mapping.

### SIP-to-ISDN Disconnect Release Cause Code Mapping

For trunks configured for the Japanese NTT ISDN PRI (T1) variant, you can configure the device to send an ISDN Disconnect message if it receives from the IP network a SIP 183 response with SDP that contains a specific cause value (SIP status code) in the Reason header, in response to an INVITE message. The device translates this cause code in the Release Cause field of the outgoing Disconnect message. After the device sends the Disconnect message, it can send early media (e.g., an announcement) received from the IP side to the ISDN. If after sending the Disconnect message the device receives a SIP failure response (e.g., 4xx) or a 200 OK from the IP side, it sends a Release message to the ISDN. However, you can configure the device to send the Release after a user-defined timeout, activated from when the Disconnect is sent, if no SIP message is received. The timeout is configured using the [ISDNJapanNttTimerT305] parameter.

If the device receives a SIP failure response or 200 OK before the timeout expires, it sends the Release instead of waiting for the timeout to expire.

The above described behavior is configured using SIP Message Manipulation rules.



- This feature is applicable only to digital interfaces (T1 NTT protocol variant), and applies only to Tel-to-IP calls.
- For normal Disconnect scenarios (not due to SIP 183 with specific cause), you must configure the timer to 30 seconds, using the [TimeToWaitForPstnReleaseAck] parameter.

➤ **To configure the ISDN Disconnect feature:**

1. Open the Message Manipulations table (see [Configuring SIP Message Manipulation](#) on page 647), and then configure the following SIP Message Manipulation rules:
  - Index #0:
    - ◆ 'Name': Clean var with cause
    - ◆ 'Manipulation Set ID': 0
    - ◆ 'Message Type': Invite.Request
    - ◆ 'Action Subject': Var.Call.Dst.0
    - ◆ 'Action Type': Modify
    - ◆ 'Action Value': '0'
  - Index #1 (specifies the cause value in the SIP Reason header of the 18x response):
    - ◆ 'Name': Disconnect on 183 with cause
    - ◆ 'Manipulation Set ID': 1
    - ◆ 'Message Type': invite.response.18x
    - ◆ 'Condition': header.Reason.Reason.Cause == '1' or header.Reason.Reason.Cause == '22' or header.Reason.Reason.Cause == '31'
    - ◆ 'Action Subject': Var.Call.dst.0
    - ◆ 'Action Type': Modify
    - ◆ 'Action Value': header.Reason.Reason.Cause
  - Index #2 (adds X-AC-Action header):
    - ◆ 'Name': Add X\_Action header
    - ◆ 'Manipulation Set ID': 1
    - ◆ 'Action Subject': Header.X-AC-Action
    - ◆ 'Action Type': Add
    - ◆ 'Action Value': 'SendPSTNDisconnect;Q850Cause='+var.Call.Dst.0

- Index #3 (if SIP 410 response, translate to 102 cause in ISDN message):
  - ◆ 'Name': Add reason if not exist
  - ◆ 'Manipulation Set ID': 1
  - ◆ 'Message Type': invite.response.410
  - ◆ 'Condition': Var.Call.Dst.0 != '0' and header.Reason !exists
  - ◆ 'Action Subject': header.Reason
  - ◆ 'Action Type': Add
  - ◆ 'Action Value': 'Q.850 ;cause=102 ; text="recovery of timer expiry"'
- Index #4:
  - ◆ 'Name': Translate 3xx to 500
  - ◆ 'Manipulation Set ID': 1
  - ◆ 'Message Type': invite.response.3xx
  - ◆ 'Condition': Var.Call.Dst.0 != '0'
  - ◆ 'Action Subject': Header.Request-URI.MethodType
  - ◆ 'Action Type': Modify
  - ◆ 'Action Value': '500'
- Index #5:
  - ◆ 'Name': Add reason if not exist
  - ◆ 'Manipulation Set ID': 1
  - ◆ 'Condition': header.Reason !exists
  - ◆ 'Action Subject': Header.Reason
  - ◆ 'Action Type': Add
  - ◆ 'Action Value': 'Q.850 ;cause=31 ; text="normal, unspecified"'



The cause codes in the above Message Manipulation rules are used only as examples; you can define different cause codes according to your requirements.

2. Assign Manipulation Set #1 to inbound calls, by configuring the [GWInboundManipulationSet] parameter to [1].
3. Assign Manipulation Set #0 to outbound calls, by configuring the [GWOutboundManipulationSet] parameter to [0].
4. (Optional) Configure how long the device must wait before sending an ISDN Release message if no SIP message is received, using the [ISDNJapanNttTimerT305] parameter. An explanation on this feature is described at the beginning of the section.



For Step 4, make sure that the [IPAlertTimeout] parameter value is greater than the [ISDNJapanNttTimerT305] parameter. If not, the device will use the timeout configured by the [IPAlertTimeout] parameter.

## ISDN-to-SIP Release Cause Mapping

This section shows ISDN-to-SIP release cause mapping.

### Configuring ISDN-to-SIP Release Cause Mapping

The Release Cause Mapping from ISDN to SIP table lets you configure up to 12 ISDN ITU-T Q.850 release cause code (call failure) to SIP response code mapping rules. The table lets you override the default ISDN-to-SIP release cause mappings, listed in [Fixed Mapping of ISDN Release Reason to SIP Response](#). When the device receives an ISDN cause code from the PSTN side, it searches the table for a matching ISDN cause code. If found, the device sends the corresponding SIP response to the IP. If the ISDN cause code is not configured in the table, the default, fixed ISDN-to-SIP release reason mapping is used.



You can change the originally received ISDN cause code to any other ISDN cause code, using the Release Cause ISDN to ISDN table (see [Configuring ISDN-to-ISDN Release Cause Mapping](#)). If the originally received ISDN cause code appears in both the Release Cause ISDN to ISDN table and the Release Cause Mapping ISDN to SIP table, the mapping rule in the Release Cause Mapping ISDN to SIP table is ignored. The device only uses a mapping rule that matches the new ISDN cause code.

The following procedure describes how to configure ISDN-to-SIP release cause mapping through the Web interface. You can also configure it through ini file [CauseMapISDN2SIP] or CLI (`configure voip > gateway manipulation cause-map-isdn2sip`).

#### ➤ To configure a ISDN-to-SIP release cause mapping rule:

1. Open the Release Cause Mapping from ISDN to SIP table (**Setup** menu > **Signaling & Media** tab > **Gateway** folder > **Manipulation** > **Release Cause ISDN > SIP**).
2. Click **New**; the following dialog box appears:

GENERAL	
Index	0
Q.850 Causes	-1
SIP Response	-1

3. Configure a mapping rule according to the parameters described in the table below.

4. Click **Apply**.**Table 26-10:Release Cause Mapping from ISDN to SIP Table Parameter Descriptions**

Parameter	Description
'Index' [CauseMapIsdn2Sip_ Index]	Defines an index number for the new table row. <b>Note:</b> Each row must be configured with a unique index.
'Q.850 Causes' q850-causes [CauseMapIsdn2Sip_ IsdnReleaseCause]	Defines the ISDN Q.850 cause code. For example, you can enter "6" (without quotation marks) to represent Cause Code 6 Channel Unacceptable.
'SIP Response' sip-response [CauseMapIsdn2Sip_ SipResponse]	Defines the SIP response code. For example, you can enter "406" (without quotation marks) to represent the SIP 406 Not Acceptable response.

**Fixed Mapping of ISDN Release Reason to SIP Response**

The following table shows the mapping of ISDN release reason to SIP response.

**Table 26-11:Mapping of ISDN Release Reason to SIP Response**

ISDN Release Reason	Description	SIP Response	Description
1	Unallocated number	404	Not found
2	No route to network	404	Not found
3	No route to destination	404	Not found
4	Send Special Information Tone	400	Bad Request
5	Misdialed Trunk Prefix	400	Bad Request
6	Channel unacceptable	406*	Not acceptable
7	Call awarded and being delivered in an established channel	500	Server internal error
8	Preemption	480	Temporarily unavailable

ISDN Release Reason	Description	SIP Response	Description
9	Preemption - Circuit Reserved for Reuse	488	Not Acceptable Here
16	Normal call clearing	.*	BYE
17	User busy	486	Busy here
18	No user responding	408	Request timeout
19	No answer from the user	480	Temporarily unavailable
21	Call rejected	403	Forbidden
22	Number changed w/o diagnostic	410	Gone
23	Redirection	400	Bad Request
25	Exchange Routing Error	400	Bad Request
26	Non-selected user clearing	404	Not found
27	Destination out of order	502	Bad gateway
28	Address incomplete	484	Address incomplete
29	Facility rejected	501	Not implemented
30	Response to status enquiry	501*	Not implemented
31	Normal unspecified	480	Temporarily unavailable
32	Circuit Congestion	500	Server internal error
33	User Congestion	500	Server internal error



ISDN Release Reason	Description	SIP Response	Description
34	No circuit available	503	Service unavailable
38	Network out of order	503	Service unavailable
39	Permanent Frame Mode Connection Out-of-Service	503	Service unavailable
40	Permanent Frame Mode Connection Operational	503	Service unavailable
41	Temporary failure	503	Service unavailable
42	Switching equipment congestion	503	Service unavailable
43	Access information discarded	502*	Bad gateway
44	Requested channel not available	503*	Service unavailable
46	Precedence Call Blocked	488	Not Acceptable Here
47	Resource unavailable	503	Service unavailable
49	QoS unavailable	503*	Service unavailable
50	Facility not subscribed	503*	Service unavailable
53	Outgoing Calls Barred within CUG	488	Not Acceptable Here
55	Incoming calls barred within CUG	403	Forbidden
57	Bearer capability not authorized	403	Forbidden

ISDN Release Reason	Description	SIP Response	Description
58	Bearer capability not presently available	503	Service unavailable
62	Inconsistency In Outgoing Information Element	503	Service unavailable
63	Service/option not available	503*	Service unavailable
65	Bearer capability not implemented	501	Not implemented
66	Channel type not implemented	480*	Temporarily unavailable
69	Requested facility not implemented	503*	Service unavailable
70	Only restricted digital information bearer capability is available	503*	Service unavailable
79	Service or option not implemented	501	Not implemented
81	Invalid call reference value	502*	Bad gateway
82	Identified channel does not exist	502*	Bad gateway
83	Suspended call exists, but this call identity does not	503*	Service unavailable
84	Call identity in use	503*	Service unavailable
85	No call suspended	503*	Service unavailable
86	Call having the requested call identity has been cleared	408*	Request timeout
87	User not member of CUG	503	Service unavailable
88	Incompatible destination	503	Service

ISDN Release Reason	Description	SIP Response	Description
			unavailable
90	Non-Existent CUG	503	Service unavailable
91	Invalid transit network selection	502*	Bad gateway
95	Invalid message	503	Service unavailable
96	Mandatory information element is missing	409*	Conflict
97	Message type non-existent or not implemented	480*	Temporarily not available
98	Message not compatible with call state or message type non-existent or not implemented	409*	Conflict
99	Information element non-existent or not implemented	480*	Not found
100	Invalid information elements contents	501*	Not implemented
101	Message not compatible with call state	503*	Service unavailable
102	Recovery of timer expiry	408	Request timeout
103	Parameter Non-Existent Or Not Implemented - Passed On	400	Bad Request
110	Message With Unrecognized Parameter Discarded	400	Bad Request
111	Protocol error	500	Server internal error
112	Unknown Error	400	Bad Request
127	Interworking unspecified	500	Server internal error

\* Messages and responses were created because the 'ISUP to SIP Mapping' draft doesn't specify their cause code mapping.

## Configuring ISDN-to-ISDN Release Cause Mapping

The Release Cause ISDN to ISDN table lets you configure up to 10 ISDN ITU-T Q.850 release cause code (call failure) to ISDN ITU-T Q.850 release cause code mapping rules. In other words, it lets you change the originally received ISDN cause code to a different ISDN cause code. For example, the PSTN may indicate disconnected calls (hang up) by sending cause code 127. However, you can change the cause code to 16, which is a more typical cause code for such call scenarios. When the device receives an ISDN cause code from the PSTN side, it searches the table for a matching ISDN cause code. If found, the device changes the cause code to the corresponding ISDN cause code. If the ISDN cause code is not configured in the table, the originally received ISDN cause code is used. If the new ISDN cause code also appears in the Release Cause Mapping ISDN to SIP table (see [Configuring ISDN-to-SIP Release Cause Mapping](#)), the device maps it to the corresponding SIP response code, which it sends to the IP side.



If the originally received ISDN cause code is configured in both the Release Cause ISDN to ISDN table and the Release Cause Mapping ISDN to SIP table, the mapping rule with the originally received code in the Release Cause Mapping ISDN to SIP table is ignored; the device uses only the mapping rule in the Release Cause Mapping ISDN to SIP table that matches the new ISDN cause code. For example, if you configure a mapping rule in the Release Cause ISDN to ISDN table to change a received 127 code to 16, the device searches for a rule in the Release Cause Mapping ISDN to SIP table for an ISDN code of 16 (ignoring any entry with code 127).

The following procedure describes how to configure ISDN-to-ISDN release cause mapping through the Web interface. You can also configure it through ini file [CauseMapIsdn2Isdn] or CLI (`configure voip > gateway manipulation cause-map-isdn2isdn`).

### ➤ To configure a ISDN-to-ISDN release cause mapping rule:

1. Open the Release Cause Mapping from ISDN to ISDN table (**Setup** menu > **Signaling & Media** tab > **Gateway** folder > **Manipulation** > **Release Cause ISDN** > **ISDN**).
2. Click **New**; the following dialog box appears:

GENERAL	
Index	0
Orig Q.850 Cause	1
Map Q.850 Cause	1

3. Configure a mapping rule according to the parameters described in the table below.
4. Click **Apply**.

**Table 26-12:Release Cause Mapping ISDN to ISDN Table Parameter Descriptions**

Parameter	Description
'Index' [CauseMapIsdn2Isdn_ Index]	Defines an index number for the new table row. <b>Note:</b> Each row must be configured with a unique index.
'Orig. Q.850 Causes' orig-q850-cause [CauseMapIsdn2Isdn_ OrigIsdnReleaseCause]	Defines the originally received ISDN Q.850 cause code. For example, you can enter "127" (without quotation marks) to represent cause code 127 Interworking, Unspecified. The valid value (cause code) is 1 to 127.
'Map Q.850 Causes' map-q850-cause [CauseMapIsdn2Isdn_ MapIsdnReleaseCause]	Defines the ISDN Q.850 cause code to which you want to change the originally received cause code. For example, you can enter "16" (without quotation marks) to represent cause code 16 Normal Call Clearing. The valid value (cause code) is 1 to 127.

## SIP Reason Header for Release Cause

The device supports the SIP Reason header according to RFC 3326. The Reason header describes the disconnection cause of a call:

- **Sending Reason header:** If a call is disconnected from the Tel side (ISDN), the Reason header contains the value of the received Q.850 cause in the appropriate message (BYE/CANCEL/final failure response) and sent to the IP side. If the call is disconnected because of a SIP reason, the Reason header is set to the appropriate SIP response.
- **Receiving Reason header:** If a call is disconnected from the IP side and the SIP message includes the Reason header, it is sent to the Tel side according to the following logic:
  - If the Reason header includes a Q.850 cause, it is sent as is.
  - If the Reason header includes a SIP response:
    - ◆ If the message is a final response, the response status code is translated to Q.850 format and passed to ISDN.
    - ◆ If the message isn't a final response, it is translated to a Q.850 cause.
  - When the Reason header is received twice (i.e., SIP Reason and Q.850), the Q.850 takes precedence over the SIP reason and is sent to the Tel side.

## Mapping PSTN Release Cause to SIP Response for Analog Interfaces

The device's FXO interface interoperates between the SIP network and the PSTN/PBX. This interoperability includes the mapping of PSTN/PBX Call Progress tones to SIP 4xx or 5xx responses for IP-to-Tel calls. The converse is also true - for Tel-to-IP calls, the SIP 4xx or 5xx responses are mapped to tones played to the PSTN/PBX.

When establishing an IP-to-Tel call, the following rules are applied:

- If the remote party (PSTN/PBX) is busy and the FXO device detects a busy tone, it sends a SIP 486 Busy response to IP. If it detects a reorder tone, it sends a SIP 404 Not Found (no route to destination) to IP. In both cases the call is released. Note that if the 'Disconnect Call on Busy Tone Detection' parameter is set to **Disable**, the FXO device ignores the detection of busy and reorder tones and does not release the call.
- For all other FXS/FXO release types such as:
  - no free channels in the Trunk Group,
  - an appropriate call routing rule to a Trunk Group doesn't exist, or
  - the phone number isn't found

the device sends a SIP response to the IP according to the 'Default Release Cause' parameter. The parameter defines Q.931 release causes. Its default value is **3**, which is mapped to the SIP 404 response. By changing its value to **34**, the SIP 503 response is sent. Other causes can be used as well.

## Numbering Plans and Type of Number

The IP-to-Tel destination or source number manipulation tables allow you to classify numbers by their Numbering Plan Indication (NPI) and Type of Number (TON). The device supports all NPI/TON classifications used in the ETSI ISDN variant, as shown in the table below:

**Table 26-13:NPI/TON Values for ETSI ISDN Variant**

NPI	TON	Description
Unknown [0]	Unknown [0]	A valid classification, but one that has no information about the numbering plan.
E.164 Public [1]	Unknown [0]	A public number in E.164 format, but no information on what kind of E.164 number.
	International-Level2 Regional [1]	A public number in complete international E.164 format, e.g., 16135551234.

NPI	TON	Description
	National-Level1 Regional [2]	A public number in complete national E.164 format, e.g., 6135551234.
	Network-PSTN Specific [3]	The type of number "network specific number" is used to indicate administration / service number specific to the serving network, e.g., used to access an operator.
	Subscriber-Level0 Regional [4]	A public number in complete E.164 format representing a local subscriber, e.g., 5551234.
	Abbreviated [6]	The support of this code is network dependent. The number provided in this information element presents a shorthand representation of the complete number in the specified numbering plan as supported by the network.
Private [9]	Unknown [0]	A private number, but with no further information about the numbering plan.
	International-Level2 Regional [1]	-
	National-Level1 Regional [2]	A private number with a location, e.g., 3932200.
	PISN Specific [3]	-
	Subscriber-Level0 Regional [4]	A private local extension number, e.g., 2200.

For NI-2 and DMS-100 ISDN variants, the valid combinations of TON and NPI for calling and called numbers include (Plan/Type):

- 0/0 - Unknown/Unknown
- 1/1 - International number in ISDN/Telephony numbering plan
- 1/2 - National number in ISDN/Telephony numbering plan
- 1/4 - Subscriber (local) number in ISDN/Telephony numbering plan
- 9/4 - Subscriber (local) number in Private numbering plan

## 27 Configuring DTMF and Dialing

This section describes configuration of dual-tone multi-frequency (DTMF) and dialing for the Gateway application.

### Dialing Plan Features

This section describes various dialing plan features.

#### Digit Mapping

The device collects digits until a match is found in the user-defined digit pattern (e.g., for closed numbering schemes). The device stops collecting digits and starts sending the digits (collected number) upon any of the following scenarios:

- Maximum number of digits is received. You can define (using the MaxDigits parameter) the maximum number of collected destination (dialed) number digits that can be received from the Tel side by the device. When the number of collected digits reaches the maximum (or a digit map pattern is matched), the device uses these digits for the called destination number.
- Inter-digit timeout expires (e.g., for open numbering schemes). This is defined using the TimeBetweenDigits parameter. This is the time that the device waits between each received digit. When this inter-digit timeout expires, the device uses the collected digits to dial the called destination number.
- (Analog Interfaces) The phone's pound (#) key is pressed.
- Digit string (i.e., dialed number) matches one of the patterns defined in the digit map.

Digit map (pattern) rules are defined using the DigitMapping parameter. The digit map pattern can contain up to 52 options (rules), each separated by a vertical bar ("|"). The maximum length of the entire digit pattern is 152 characters. The available notations are described in the table below:

**Table 27-1: Digit Map Pattern Notations**

Notation	Description
[n-m]	Range of numbers (not letters).
.	(single dot) Repeat digits until next notation (e.g., T).
x	Any single digit. <b>Note:</b> This notation does not apply to some scenarios when using the star (*) or hash (#) key. For example, the key sequence of ** must be presented in the dial plan as *x.s (instead of xx).



Notation	Description
T	Dial timeout (configured by the TimeBetweenDigits parameter).
S	Short timer (configured by the TimeBetweenDigits parameter; default is two seconds) that can be used when a specific rule is defined after a more general rule. For example, if the digit map is 99 998, then the digit collection is terminated after the first two 9 digits are received. Therefore, the second rule of 998 can never be matched. But when the digit map is 99s 998, then after dialing the first two 9 digits, the device waits another two seconds within which the caller can enter the digit 8.

Below is an example of a digit map pattern containing eight rules:

```
DigitMapping = 11xS|00[1-7]xxx|8xxxxxxx|#xxxxxxx|*xx|91xxxxxxxxxx|9011x|xx.T
```

In the example, the rule "00[1-7]xxx" denotes dialed numbers that begin with 00, and then any digit from 1 through 7, followed by three digits (of any number). Once the device receives these digits, it does not wait for additional digits, but starts sending the collected digits (dialed number) immediately.

(For Digital Interfaces) Digit map pattern rules are used for Tel-to-IP ISDN overlap dialing (by setting the ISDNRxOverlap parameter to 1) to reduce the dialing period (for digital interface). For more information on digit maps for ISDN overlapping, see [ISDN Overlap Dialing](#).



- If you want the device to accept/dial any number, ensure that the digit map contains the rule "xx.T"; otherwise, dialed numbers not defined in the digit map are rejected.
- If you are using an external Dial Plan file for dialing plans (see [Dialing Plans for Digit Collection](#)), the device first attempts to locate a matching digit pattern in the Dial Plan file, and if not found it searches for a matching digit pattern in the Digit Map (configured by the DigitMapping parameter).
- It may be useful to configure both Dial Plan file and Digit Maps. For example, the Digit Map can be used for complex digit patterns (which are not supported by the Dial Plan) and the Dial Plan can be used for long lists of relatively simple digit patterns. In addition, as timeout between digits is not supported by the Dial Plan, the Digit Map can be used to define digit patterns (MaxDigits parameter) that are shorter than those defined in the Dial Plan, or left at default. For example, "xx.T" Digit Map instructs the device to use the Dial Plan and if no matching digit pattern, it waits for two more digits and then after a timeout (TimeBetweenDigits parameter), it sends the collected digits. Therefore, this ensures that calls are not rejected as a result of their digit pattern not been completed in the Dial Plan.

## Dial Plan Rules

You can configure dialing plans by using Dial Plan rules or loading a Dial Plan file. For more information, see [Configuring Dial Plans](#) on page 624.

## Interworking Keypad DTMFs for SIP-to-ISDN Calls

The device can interwork DTMF tones received from the IP to the PSTN, using the ISDN Keypad Facility information element (IE) in Q.931 INFORMATION messages.



The feature is applicable only to the Euro ISDN variant (User side).

If the device receives from the IP side an INVITE message whose called party number (To header) contains the asterisk (\*) or pound (#) character, or a SIP NOTIFY or SIP INFO message that contains these characters (e.g., 123#456), the device sends the character and the digits positioned to its right, as Keypad IE in the INFORMATION message. The device sends only the digits positioned before the character to the PSTN (in SETUP message) as the called party number. For example, if the device receives the below INVITE, it sends "123" to the PSTN as the called party number and #456 as Keypad IE in the INFORMATION message:

```
INVITE sip:%7B54443994-BDFF-413C-AE4F-
D039B0FFB134%7D@192.168.100.214:5064;transport=tcp;rinstance=9f25c445
2eff4acb SIP/2.0
To: sip:123#456@192.168.100.214;user=phone;x-type=unknown;x-
plan=unknown;x-pres=allowed
```

The destination number can be manipulated when this feature is enabled. Note that if manipulation before routing is required, the \* and # characters should not be used, as the device will handle them according to the above keypad protocol. For example, a manipulation rule should not be configured to add #456 to the destination number. If manipulation after routing is required, the destination number to be manipulated will not include the keypad part. For example, if you configure a manipulation rule to add the suffix 888 and the received INVITE contains the number 123#456, only 123 is manipulated and the number dialed toward the PSTN is 123888; #456 is sent as keypad.

To enable this feature, use the ISDNKeypadMode parameter.

## Configuring Hook Flash

The following procedure describes how to configure various hook-flash features.

### ➤ To configure hook-flash features:

1. Configure the digit pattern used by the Tel side to indicate a hook-flash event:
  - a. Open the Supplementary Services Settings page (**Setup** menu > **Signaling & Media** tab > **Gateway** folder > **DTMF & Supplementary** > **Supplementary Services Settings**).
  - b. In the 'Hook-Flash Code' (HookFlashCode) field, enter the digit pattern.

Hook-Flash Code

- c. Click **Apply**.
2. Configure the hook-flash transport type:
    - a. Open the DTMF & Dialing page (**Setup** menu > **Signaling & Media** tab > **Gateway** folder > **DTMF & Supplementary** > **DTMF & Dialing**).
    - b. From the the 'Hook-Flash Option' (HookFlashOption) drop-down list, select the required transport type.

Hook-Flash Option Not Supported ▼

- c. Click **Apply**.
3. To configure the period by the device for detecting hook-flash initiated by analog interfaces:
    - a. Open the Analog Settings page (**Setup** menu > **Signaling & Media** tab > **Gateway** folder > **Analog Gateway** > **Analog Settings**).
    - b. Configure the following:
      - ◆ 'Min. Hook-Flash Detection Period' (MinFlashHookTime): Defines the minimum time (in msec) for detection of a hook-flash event from an FXS interface. Detection is guaranteed for hook-flash periods of at least 60 msec (when configuring the period to 25). The device ignores hook-flash signals lasting a shorter period of time.
      - ◆ 'Max. Flash-Hook Detection Period' (FlashHookPeriod): Defines the maximum hook-flash period (in msec) for Tel and IP sides for FXS and FXO interfaces. For more information, see the Telprofile\_FlashHookPeriod parameter in [Configuring Tel Profiles](#).

Min. Hook-Flash Detection Period [msec]	300
Max. Hook-Flash Detection Period [msec]	700

- c. Click **Apply**.

## 28 Configuring Supplementary Services

This section describes the Gateway application's SIP supplementary services that can enhance your telephone service.



- All call participants must support the specific supplementary service that is used.
- When working with certain application servers (such as BroadSoft's BroadWorks) in client server mode (the application server controls all supplementary services and keypad features by itself), the device's supplementary services must be disabled.

### Call Hold and Retrieve

**For analog interfaces:** Initiating call hold and retrieve:

- Active calls can be put on-hold by pressing the phone's hook-flash button.
- The party that initiates the hold is called the *holding* party; the other party is called the *held* party.
- After a successful Hold, the holding party hears a dial tone (HELD\_TONE defined in the device's Call Progress Tones file).
- Call retrieve can be performed only by the holding party while the call is held and active.
- The holding party performs the retrieve by pressing the telephone's hook-flash button.
- After a successful retrieve, the voice is connected again.
- Hold is performed by sending a re-INVITE message with IP address 0.0.0.0 or a=sendonly in the SDP, according to the HoldFormat parameter.

**For digital interfaces:** Call hold and retrieve:

- The party that initiates the hold is called the *holding* party; the other party is called the *held* party.
- After a successful Hold, the holding party hears a dial tone (HELD\_TONE defined in the device's Call Progress Tones file).
- After a successful retrieve, the voice is connected again.
- The hold and retrieve functionalities are implemented by re-INVITE messages. The IP address 0.0.0.0 as the connection IP address or the string 'a=inactive' in the received re-INVITE SDP cause the device to enter Hold state and to play the held tone (configured in the device) to the PBX/PSTN. If the string 'a=sendonly' is received in the SDP message, the device stops sending RTP packets, but continues to listen to the incoming RTP packets. Usually, the remote party plays, in this scenario, Music on Hold (MOH) and the device forwards the MOH to the held party.

**For analog interfaces:** Receiving Hold/Retrieve:

- When an active call receives a re-INVITE message with IP address 0.0.0.0 or 'inactive' string in SDP, the device stops sending RTP and plays a local held tone.
- When an active call receives a re-INVITE message with the 'sendonly' string in SDP, the device stops sending RTP and listens to the remote party. In this mode, it is expected that music on-hold (or any other hold tone) is played (over IP) by the remote party.

You can also configure the device to keep a call on-hold for a user-defined time after which the call is disconnected, using the HeldTimeout parameter.

The device also supports "double call hold" for FXS interfaces where the called party, which has been placed on-hold by the calling party, can then place the calling party on hold as well and make a call to another destination. The flowchart below provides an example of this type of call hold:

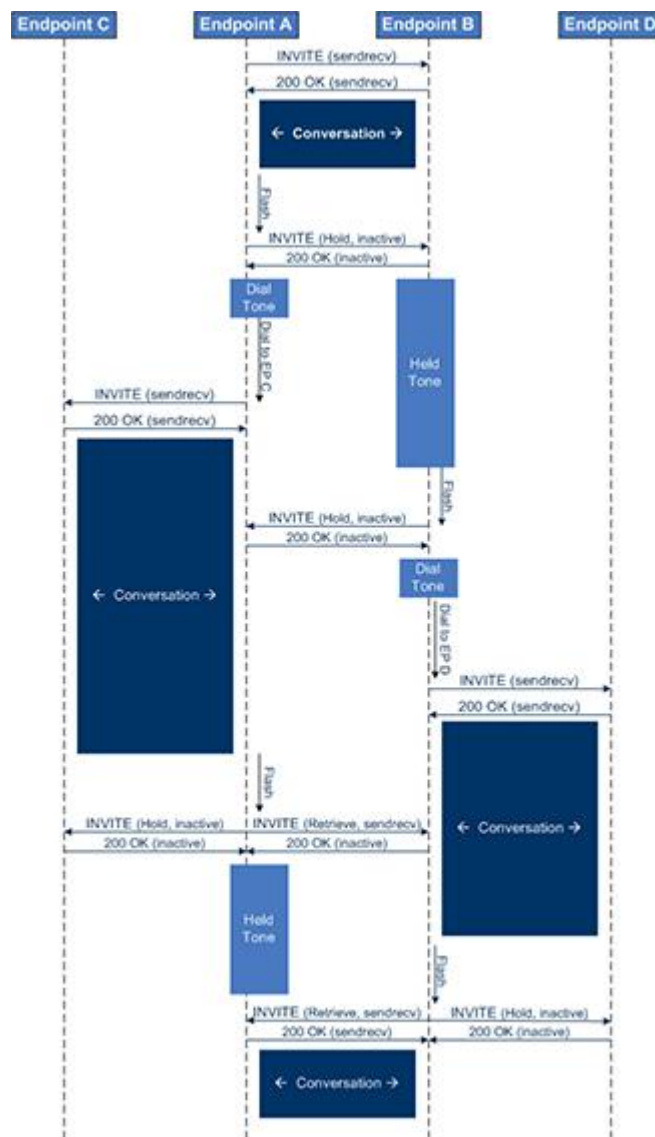

The flowchart above describes the following "double" call-hold scenario for analog interfaces:

1. A calls B and establishes a voice path.
2. A places B on hold; A hears a dial tone and B hears a held tone.

3. A calls C and establishes a voice path.
4. B places A on hold; B hears a dial tone.
5. B calls D and establishes a voice path.
6. A ends call with C; A hears a held tone.
7. B ends call with D.
8. B retrieves call with A.



For analog interfaces:

- If a party that is placed on hold (e.g., B in the above example) is called by another party (e.g., D), then the on-hold party receives a call waiting tone instead of the held tone.
- While in a Double Hold state, placing the phone on-hook disconnects both calls (i.e. call transfer is not performed).
- You can enable the device to handle incoming re-INVITE messages with 'a=sendonly' in the SDP, in the same way as if 'a=inactive' is received in the SDP. This is configured using the [SIPHoldBehavior] parameter. When enabled, the device plays a held tone to the Tel phone and responds with a 200 OK containing 'a=recvonly' in the SDP.

## Configuring MoH from External Audio Source

The device's Gateway application (FXS interfaces) can play Music on Hold (MoH) audio originating from an external, third-party media (audio) player, to call parties that are placed on hold. Implementing an external media source offers flexibility in the type of audio that you want played as MoH (e.g., radio, adverts, or music). If you are not using an external media source, the device plays its' local default hold tone or a hold tone from an installed PRT file (depending on your configuration). The device can forward this audio stream to any external IP-based system (for example, a softswitch, media gateway or SBC) or use it for SBC calls that it processes (applicable only to the SBC application). Thus, the device functions like an IP media server (audio streamer), except that the actual source of the media is from an external player.

The external media source is connected to the device's FXS port through a telephone adapter (for FXS emulation). The FXS port is always in off-hook state, continuously receiving media streams from the external media source. When the device receives a SIP INVITE for this port (IP-to-Tel call), it responds with a SIP 200 OK and forwards the audio stream to the sender of the INVITE.

Up to two FXS ports can be used for this feature, where each port can play media to up to 20 concurrent call sessions. In addition, each FXS port can play a specific media for MoH. For example, one port can play music while the other port can play advertising messages.

The following figure provides an example of this feature where each FXS port receives different audio from the external audio player, which the device forwards as music-on-hold to an external call processing system. The device determines which audio to play based on the phone number (destination) of the held call party.

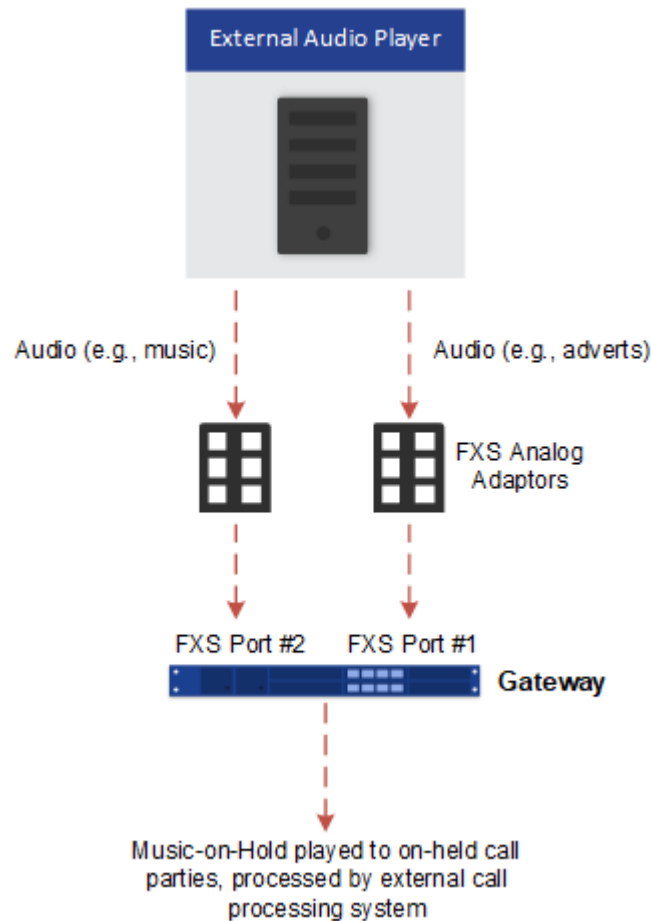

➤ **To configure MoH from external audio streamer:**

1. Connect the external media player to one of the device's FXS ports through an FXS emulator (analog telephone adapter).
2. Open the Tel Profiles table (see [Configuring Tel Profile](#) on page 563), and then configure a Tel Profile with the following:
  - 'IP-to-Tel Cut-Through Call Mode' parameter configured to **CutThrough+Streaming**:

IP-to-Tel Cut-Through Call Mode

- 'Coders Group' parameter assigned to the required Coder Group (configured with one coder).
3. Open the Trunk Group table (see [Configuring Trunk Groups](#) on page 723), and then configure a Trunk Group for the FXS port to which the external media player is connected. Specify the phone number and Trunk Group ID, and assign it the Tel Profile that you configured in the previous step.

Group Index	Module	From Trunk	To Trunk	Channels	Phone Number	Trunk Group ID	Tel Profile Name
1	Module 2 FXS	1	1	1	4444	1	MoH

- Open the Trunk Group Settings table (see [Configuring Trunk Group Settings](#) on page 725), and then for the Trunk Group that you configured in the previous step, configure the 'Channel Select Mode' parameter to **By Dest Phone Number**.

INDEX ↕	NAME	TRUNK GROUP ID	CHANNEL SELECT MODE
0	MoH	1	By Dest Phone Number

- Open the IP-to-Tel Routing table (see [Configuring IP-to-Tel Routing Rules](#) on page 747), and then configure a routing rule to route INVITE messages from the remote IP call entity to which you want to play MoH, to the FXS port. Configure the rule as follows:
  - 'Destination Type': **Trunk Group**
  - 'Trunk Group ID': **1** (as configured in Step 3 above)
  - Configure a specific matching characteristics, for example, 'Source Host Pattern': **mypizza.com**
- Open the Supplementary Services Settings page (**Setup** menu > **Signaling & Media** tab > **Gateway** folder > **DTMF & Supplementary** > **Supplementary Services Settings**), and then in the 'Maximum simultaneous streaming calls' field (MaxStreamingCalls), enter the maximum number of concurrent calls that the FXS port can service for playing MoH.
- Click **Apply**, and then reset the device with a burn-to-flash for your settings to take effect.

You can forcibly stop or start audio streaming on the FXS port(s) through CLI:

- To start audio streaming:

```
admin streaming start <FXS Channel>|all
```

- To stop audio streaming:

```
admin streaming stop <FXS Channel>|all
```



- The feature is applicable only to the Gateway application (FXS interfaces). However, you can also use this feature for playing MoH to SBC calls. For this scenario, you need to configure a routing rule between the SBC application (IP-to-IP Routing rule with 'Destination Type' parameter configured to **Gateway**) and the Gateway application (IP-to-Tel Routing table, as described above).
- You must configure the 'Maximum simultaneous streaming calls' parameter to a value greater than 0.
- Each FXS port that is used for this audio streaming service must be configured with its own dedicated Tel Profile, Trunk Group, and IP-to-Tel Routing rule.
- Only one coder can be configured for the port. If the device receives an INVITE/re-INVITE with a coder that is different to the one configured for the Tel Profile, the device rejects it.





- If the external audio streamer is disconnected or powered off, the FXS port changes to on-hook state and the device stops playing MoH to call parties that are currently on hold (by sending a SIP BYE).
- If the port goes on-hook or the number of concurrent sessions exceed the configured maximum, the device rejects all streaming sessions with a SIP BYE response.
- If your streaming service is working and you want to modify its configuration, after you have modified configuration you need to restart the service.

## Call Pickup

The Call Pickup feature allows any FXS user (endpoint) to pick up (answer) an incoming call (ringing) of another FXS user within the same Trunk Group ID. Call pickup is done by pressing (dialing) a user-defined sequence of phone keys (e.g., "#77"). When the FXS user presses this call-pickup key sequence and the phone of another FXS user is ringing, the incoming call is automatically forwarded to the FXS user attempting to pick up the call. For example, assume that three FXS phones are connected to the device and configured with the following:

- Phone numbers: 100, 200 and 300
- Trunk Group ID: #1
- Call-pickup key sequence: "#77"

If there is an incoming call for FXS user whose phone number is 100, FXS user whose phone number is 300 can pick up the call by dialing "#77".



- The Call Pickup feature is supported only for FXS endpoints within the same Trunk Group ID.
- For the Call Pickup feature, the channel select mode ('Channel Select Mode') of the FXS endpoints' Trunk Group must be configured to **By Dest Phone Number** (see [Configuring Trunk Group Settings](#) on page 725).
- If more than one FXS phone is ringing and an FXS user dials the call-pickup key sequence, the first phone number configured in the Trunk Group table is picked up. In our example (above), if FXS endpoints 100 and 200 are ringing and FXS endpoint 300 dials the call-pickup key sequence, the incoming call for FXS endpoint 100 is picked up (forwarded to FXS endpoint 300).

### ➤ To configure the call-pickup key sequence:

1. Open the Keypad Features page (**Setup** menu > **Signaling & Media** tab > **Analog Gateway** folder > **Keypad Features**).
2. In the 'Call Pickup Key' field (KeyCallPickup), enter the sequence of phone keys for call pickup.

Call Pickup Key

3. Click **Apply**.

## BRI Suspend and Resume

The device supports call suspend and resume services initiated by ISDN BRI phones connected to the device. During an ongoing call, the BRI phone user can suspend the call by typically pressing the phone's "P" button or a sequence of keys (depending on the phone), and then on-hooking the handset. To resume the call, the phone user typically presses the same keys or button and then off-hooks the phone. During the suspended state, the device plays a howler tone to the remote party. This service is also supported when instead of pressing the call park button(s), the phone cable is disconnected (suspending the call) and then reconnected again (resuming the call). If the phone user does not resume the call within a user-defined interval (configured by the HeldTimeout parameter), the device releases the call.



Only one call can be suspended per trunk. If another suspend request is received from a BRI phone while there is already a suspended call (even if done by another BRI phone connected to the same trunk), the device rejects this suspend request.

## Consultation Feature

The device's Consultation feature allows you to place a call on hold and then make a second call to another party.

- After placing a call on hold (by pressing hook-flash), the holding party hears a dial tone and can initiate a new call, which is called a Consultation call.
- While hearing a dial tone or when dialing to the new destination (before dialing is complete), the user can retrieve the held call by pressing hook-flash.
- The held call can't be retrieved while ringback tone is heard.
- After the Consultation call is connected, the user can toggle between the held and active call by pressing the hook-flash key.



Consultation calls are applicable only to FXS interfaces.

## Call Transfer

This section describes configuration of call transfer for the Gateway application.

### Consultation Call Transfer

The device supports Consultation Call Transfer. For analog interfaces: It supports Consultation Call Transfer using the SIP REFER message and the Replaces header.

The common method to perform consultation transfer is described in the following example, which assumes three call parties:

- A = transferring party

- B = transferred party
- C = transferred to party
- 1. A Calls B.
- 2. B answers.
- 3. A presses the hook-flash button and places B on-hold (party B hears a hold tone).
- 4. A dials C.
- 5. After A completes dialing C, A on-hooks the phone to transfer the call so that the call is established between B and C.

The transfer can be initiated at any of the following stages of the call between A and C:

- Immediately after A completes dialing C (transfer at call setup)
- While A hears a ringback (transfer from alert)
- While A speaks to C (transfer from active)



For FXS interfaces: The device can also handle call transfers using SIP INVITE and re-INVITE messages, instead of REFER messages. This is useful when communicating with SIP UAs that do not support the receipt of REFER messages. This feature is applicable to FXS interfaces. To enable this support, use the `EnableCallTransferUsingReinvites` parameter.

**For BRI interfaces:** The device also supports attended (consultation) call transfer for BRI phones (user side) connected to the device and using the Euro ISDN protocol. BRI call transfer is according to ETSI TS 183 036, Section G.2 (Explicit Communication Transfer – ECT). Call transfer is enabled using the `EnableTransfer` and `EnableHoldtoISDN` parameters.

➤ **To configure call transfer for connected BRI phones:**

1. Open the Supplementary Services Settings page (Setup menu > Signaling & Media tab > Gateway folder > DTMF & Supplementary > Supplementary Services Settings).
2. From the 'Enable Hold to ISDN' drop-down list (`EnableHoldtoISDN`), select Enable.
3. From the 'Enable Transfer' drop-down list (`EnableTransfer`), select Enable.
4. Click Apply.

The Explicit Call Transfer (ECT, according to ETS-300-367, 368, 369) supplementary service is supported for BRI and PRI trunks. This service provides the served user who has two calls to ask the network to connect these two calls together and release its connection to both parties. The two calls can be incoming or outgoing calls. This service is similar to NI-2 Two B-Channel Transfer (TBCT) Supplementary Service. The main difference is that in ECT one of the calls must be in HELD state. The ECT standard defines two methods - Implicit and Explicit. In implicit method, the two calls must be on the same trunk. BRI uses the implicit mechanism. PRI uses the explicit mechanism.

## Consultation Transfer for QSIG Path Replacement

The device can interwork consultation call transfer requests for ISDN QSIG-to-IP calls. When the device receives a request for a consultation call transfer from the PBX, the device sends a SIP REFER message with a Replaces header to the SIP UA to transfer it to another SIP UA. Once the two SIP UA parties are successfully connected, the device requests the PBX to disconnect the ISDN call, thereby freeing resources on the PBX.

For example, assume legacy PBX user "A" has two established calls connected through the device – one with remote SIP UA "B" and the other with SIP UA "C". In this scenario, user "A" initiates a consultation call transfer to connect "B" with "C". The device receives the consultation call transfer request from the PBX and then connects "B" with "C", by sending "B" a REFER message with a Replaces header (i.e., replace caller "A" with "C"). Upon receipt of a SIP NOTIFY 200 message in response to the REFER, the device sends a Q.931 Disconnect messages to the PBX, notifying the PBX that it can disconnect the ISDN calls (of user "A").

This feature is enabled by the QSIGPathReplacementMode parameter.



The feature is applicable only to digital interfaces.

## Blind Call Transfer

Blind call transfer is done (using SIP REFER messages) after a call is established between call parties A and B, and party A decides to immediately transfer the call to C without first speaking to C. The result of the transfer is a call between B and C (similar to consultation transfer, but skipping the consultation stage).

### For digital interfaces:

You can also use the ManipulateIP2PSTNReferTo parameter to manipulate the destination number according to the number received in the SIP Refer-To header. This is applicable to all types of blind transfers to the PSTN (e.g., TBCT, ECT, RLT, QSIG, FXO, and CAS). During blind transfer, the device initiates a new call to the PSTN and the destination number of this call can be manipulated if the parameter is enabled. The following is an example of such a blind transfer:

1. IP phone A calls PSTN phone B, and the call is established.
2. A performs a blind transfer to PSTN phone C. It does this as follows:
  - a. A sends a SIP REFER message (with the phone number of C in the Refer-To header) to the device.
  - b. The device sends a Q.931 Setup message to C. This feature enables manipulating the called party number in this outgoing Setup message.

The manipulation is done as follows:

1. If you configure a value for the xferPrefix parameter, the value (string) is added as a prefix to the number in the Refer-To header.

2. This called party number is then manipulated using the Destination Phone Number Manipulation for IP-to-Tel Calls table.
3. The source number of the transferred call is taken from the original call, according to its initial direction:
  - Tel-to-IP call: source number of the original call.
  - IP-to-Tel call: destination number of the original call.
  - If the UseReferredByForCallingNumber parameter is set to 1, the source number is taken from the SIP Referred-By header if included in the received SIP REFER message.

This source number can also be used as the value for the 'Source Phone Pattern' field in the Destination Phone Number Manipulation for IP-to-Tel Calls table. The local IP address is used as the value for the 'Source IP Address' field.



Manipulation using the ManipulateIP2PSTNReferTo parameter does not affect IP-to-Trunk Group routing rules.

## Call Forward

### For digital interfaces:

The device supports Call Deflection (ETS-300-207-1) for Euro ISDN and QSIG (ETSI TS 102 393) for Network and User sides, which provides IP-ISDN interworking of call forwarding (call diversion) when the device receives a SIP 302 response.

Call forward performed by the SIP side: Upon receipt of a Facility message with Call Rerouting IE from the PSTN, the device initiates a SIP transfer process by sending a SIP 302 (including the Call Rerouting destination number) to the IP in response to the remote SIP entity's INVITE message. The device then responds with a Disconnect message to the PSTN side.

Call forward performed by the PSTN side: When the device sends the INVITE message to the remote SIP entity and receives a SIP 302 response, the device sends a Facility message with the same IE mentioned above to the PSTN, and waits for the PSTN side to disconnect the call. This is configured using the CallReroutingMode.

### For analog interfaces:

The following methods of call forwarding are supported:

- Immediate: incoming call is forwarded immediately and unconditionally.
- Busy: incoming call is forwarded if the endpoint is busy.
- No Reply: incoming call is forwarded if it isn't answered for a specified time.
- On Busy or No Reply: incoming call is forwarded if the port is busy or when calls are not answered after a specified time.
- Do Not Disturb: immediately reject incoming calls. Upon receiving a call for a Do Not Disturb, the 603 Decline SIP response code is sent.

Three forms of forwarding parties are available:

- Served party: party configured to forward the call (FXS device). To configure this type of forwarding party and per endpoint, see [Configuring Call Forward](#).
- Originating party: party that initiates the first call (FXS or FXO).
- Diverted party: new destination of the forwarded call (FXS or FXO).



- When call forward is initiated, the device sends a SIP 302 response with a contact that contains the phone number from the Call Forward table (see [Configuring Call Forward](#) on page 879) and its corresponding IP address from the routing table (or when a proxy is used, the proxy's IP address).
- For receiving call forward, the device handles SIP 3xx responses for redirecting calls with a new contact.

## Enabling Call Forwarding

The following procedure describes how to enable call forwarding.

### ➤ To enable call forwarding:

1. Open the Supplementary Services Settings page (**Setup** menu > **Signaling & Media** tab > **Gateway** folder > **DTMF & Supplementary** > **Supplementary Services Settings**).

Enable Call Forward

Enable

2. From the 'Enable Call Forward' drop-down list (EnableForward), select **Enable**.
3. Click **Apply**.

To configure call forwarding per analog interface port, see [Configuring Call Forward](#).

## Call Forward Reminder Ring

The device supports the Call Forward Reminder Ring feature for FXS interfaces whereby the device's FXS endpoint emits a short ring burst when a third-party Application server (e.g., softswitch) forwards an incoming call to another destination. The ring is emitted only when the endpoint is in on-hook state.



The feature is applicable only to FXS interfaces.

The feature is useful in that it notifies the endpoint user that a call forwarding service is currently being performed. The device generates a call forward reminder ring burst to the endpoint upon receipt of a SIP NOTIFY message containing a "reminder ring" xml body. The NOTIFY message is sent by the Application server to the device each time the server forwards an incoming call. The service is cancelled when the device sends an UNSUBSCRIBE request or when the subscription time expires.

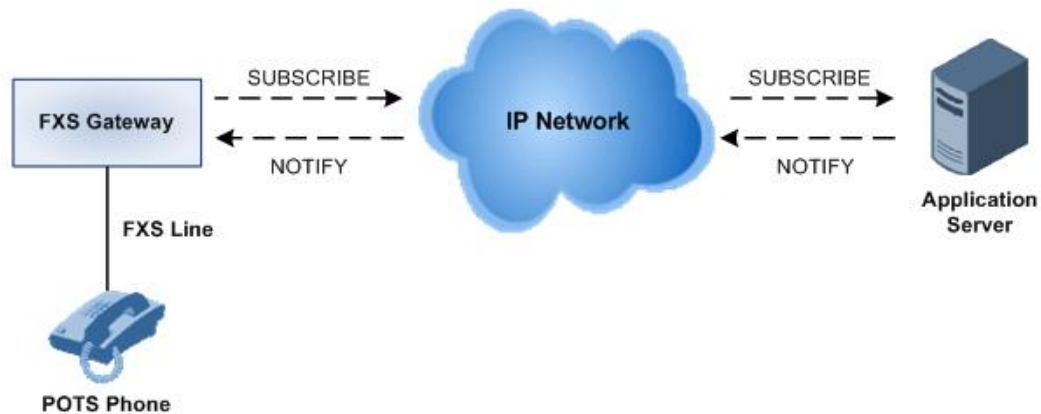

The following procedure describes how to configure the feature.

➤ **To configure the call forward reminder ring feature:**

1. Open the Supplementary Services Settings page (**Setup** menu > **Signaling & Media** tab > **Gateway** folder > **DTMF & Supplementary** > **Supplementary Services Settings**).

Enable NRT Subscription	<input type="text" value="Disable"/>
AS Subscribe IPGroupID	<input type="text" value="-1"/>
NRT Subscribe Retry Time	<input type="text" value="120"/>
Call Forward Ring Tone ID	<input checked="" type="radio"/> <input type="text" value="3"/>

2. In the 'Enable NRT Subscription' field (EnableNRTSubscription), select **Enable** to enable endpoint subscription to ring reminder event notification.
3. In the 'AS Subscribe IP Group ID' field (ASSubscribeIPGroupID), enter the IP Group ID of the Application server providing the services.
4. In the 'NRT Subscribe Retry Time' field (NRTSubscribeRetryTime), enter the retry period (in seconds) for dialog subscription to the Application server if a previous request fails.
5. Configure the reminder ring tone:
  - a. Configure a tone for the reminder ring in the Call Progress Tone (CPT) file (see [Call Progress Tones File](#)).
  - b. In the 'Call Forward Ring Tone ID' field (CallForwardRingToneID), enter the ID number of the tone that you defined in the previous step.
6. Click **Apply**.

### Call Forward Reminder (Off-Hook) Special Dial Tone

The device plays a special dial tone (stutter dial tone - Tone Type #15) to a specific FXS endpoint when the phone is off-hooked and when a third-party Application server (e.g., a softswitch) is used to forward calls intended for the endpoint to another destination. This is useful in that it reminds the FXS user of this service. The feature does not involve device subscription (SIP SUBSCRIBE) to the Application server.



The feature is applicable only to FXS interfaces.

Activation/deactivation of the service is notified by the server. An unsolicited SIP NOTIFY request is sent from the Application server to the device when the Call Forward service is activated or de-activated. Depending on this NOTIFY request, the device plays either the standard dial tone or the special dial tone for Call Forward.

For playing the special dial tone, the received SIP NOTIFY message must contain the following headers:

- **From and To:** contain the same information, indicating the specific endpoint
- **Event:** "ua-profile"
- **Content-Type:** "application/simservs+xml"
- Message body is the XML body and contains the "dial-tone-pattern" set to "special-condition-tone", which is the special tone indication:

```
<ss:dial-tone-pattern>special-condition-tone</ss:dial-tone-pattern>
```

To cancel the special dial tone and playing the regular dial tone, the received SIP NOTIFY message must contain the following headers:

- **From and To:** contain the same information, indicating the specific endpoint
- **Event:** ua-profile
- **Content-Type:** "application/simservs+xml"
- Message body is the XML body containing the "dial-tone-pattern" set to "standard-condition-tone", which is the regular dial tone indication:

```
<ss:dial-tone-pattern>standard-condition-tone</ss:dial-tone-pattern>
```

Therefore, the special dial tone is valid until another SIP NOTIFY is received that instructs otherwise (as described above).



If the MWI service is active, the MWI dial tone overrides this special Call Forward dial tone.

## Call Forward Reminder Dial Tone (Off-Hook) upon Spanish SIP Alert-Info

The device plays a special dial tone to FXS phones in off-hook state that are activated with the call forwarding service. The special dial tone is used as a result of the device receiving a SIP



NOTIFY message from a third-party softswitch providing the call forwarding service with the following SIP Alert-Info header:

```
Alert-Info: <http://127.0.0.1/Tono-Espec-Invitacion>;lpi-aviso=Desvio-Inmediato
```

This special tone is a stutter dial tone (Tone Type = 15), as defined in the CPT file (see [Call Progress Tones File](#)).

The FXS phone user, connected to the device, activates the call forwarding service by dialing a special number (e.g., \*21\*xxxx) and as a result, the device sends a regular SIP INVITE message to the softswitch. The softswitch later notifies of the activation of the forwarding service by sending an unsolicited NOTIFY message with the Alert-Info header, as mentioned above. When the call forwarding service is de-activated, for example, by dialing #21# and sending an INVITE with this number, the softswitch sends another SIP NOTIFY message with the following Alert-Info header:

```
Alert-Info: <http://127.0.0.1/Tono-Normal-Invitacion>; Aviso = Desvió-Inmediato
```

From this point on, the device plays a normal dial tone to the FXS phone when it goes off-hook.



The feature is applicable only to FXS interfaces.

## Remote Handling of BRI Call Forwarding

The device supports call forwarding (CF) services initiated by ISDN Basic BRI phones connected to it. Upon receipt of an ISDN Facility message for call forward from the BRI phone, the device sends a SIP INVITE to the softswitch with a user-defined code (see procedure below) in the SIP To header, indicating the call forward reason.



The feature is applicable only to BRI interfaces.

*call forward service* can be one of the following:

- “cfu-activate”: Call Forwarding Unconditional activated
- “cfu-deactivate”: Call Forwarding Unconditional deactivated
- “cfb-activate”: Call Forward on Busy activated
- “cfb-deactivate”: Call Forward on Busy deactivated
- “cfnr-activate”: Call Forward on No Reply activated
- “cfnr-deactivate”: Call Forward on No Reply deactivated

For example:

```
INVITE sip:400@10.33.2.48;user=phone;facility=cfu-activate SIP/2.0
```

To enable the feature, configure the UseFacilityInRequest ini file parameter to 1.

➤ **To configure the digit codes for call forwarding services by BRI phones:**

1. Open the Supplementary Services Settings page (**Setup** menu > **Signaling & Media** tab > **Gateway** folder > **DTMF & Supplementary** > **Supplementary Services Settings**).

BRI TO SIP SUPPLEMENTARY SERVICES CODES	
Call Forward Unconditional code	<input type="text"/>
Call Forward Unconditional Deactivation	<input type="text"/>
Call Forward on Busy Code	<input type="text"/>
Call Forward on Busy Deactivation	<input type="text"/>
Call Forward on No Reply Code	<input type="text"/>
Call Forward on No Reply Deactivation	<input type="text"/>

2. Under the BRI To SIP Supplementary Codes group, configure the reason codes for call forward:
  - 'Call Forward Unconditional code' (SuppServCodeCFU)
  - 'Call Forward Unconditional Deactivation' (SuppServCodeCFUDeact)
  - 'Call Forward on Busy Code' (SuppServCodeCFB)
  - 'Call Forward on Busy Deactivation' (SuppServCodeCFBDeact)
  - 'Call Forward on No Reply Code' (SuppServCodeCFNR)
  - 'Call Forward on No Reply Deactivation' (SuppServCodeCFNRDeact)
3. Click **Apply**.



The call forward codes must be configured according to the settings of the softswitch (i.e., the softswitch must recognize them).

Below is an example of an INVITE message sent by the device indicating an unconditional call forward (“\*72”) to extension number 100. The code is configured by the SuppServCodeCFU parameter.

```
INVITE sip:*72100@10.33.8.53;user=phone SIP/2.0
Via: SIP/2.0/UDP
10.33.2.5:5060;branch=z9hG4bKWDSUKUHWFEQXSVUUVJGM
From: <sip:400@10.33.2.5;user=phone>;tag=DUOROSXSOYJLNBFRQTG
To: <sip:*72100@10.33.8.53;user=phone>
Call-ID: GMNOVQRRXUUCYCQSF AHS@10.33.2.5
```

```
CSeq: 1 INVITE
Contact: <sip:400@10.33.2.5:5060>
Supported: em,100rel,timer,replaces
Allow:
REGISTER,OPTIONS,INVITE,ACK,CANCEL,BYE,NOTIFY,PRACK,REFER,INFO,SUBSCRIBE
User-Agent: Sip Message Generator V1.0.0.5
User-to-User: 31323334;pd=4
Content-Type: application/sdp
Content-Length: 155
```

## Local Handling of BRI Call Forwarding

You can configure the device to handle BRI call forwarding per BRI extension line, using the Supplementary Services table.



The feature is applicable only to BRI interfaces.

Upon receipt of an ISDN Facility message from the BRI phone user, the device retrieves and stores the user's call forwarding information. This includes whether the user has activated or de-activated call forwarding as well as the type of call forwarding service (Call Forward Busy, Call Forward No Reply, and Call Forward Unconditional). When the device receives a call (INVITE message) for a user whose phone number is configured in the 'Local Phone Number' field of the Supplementary Services table and call forwarding has been activated by the user, the device replies to the calling party with a SIP 302 (Moved Temporarily) response containing the configured call forwarding number corresponding to the call forwarding type. The call forwarding type and original called number (user's phone number) is sent in the SIP Diversion header, for example:

```
Diversion: <sip:401>;reason=unconditional;counter=1
```

The call forwarding number is sent in the SIP Contact header, for example:

```
Contact: sip:567@10.33.77.17;user=phone
```

When call forwarding is activated and the user off-hooks the phone, the device plays the stutter dial tone (Tone Type #15) as a reminder to the user that call forwarding is activated.

### ➤ To configure BRI call forwarding:

1. Open the Supplementary Services table (see [Configuring Multi-Line Extensions and Supplementary Services](#)), and then configure BRI line extensions with the required call forwarding parameters:

User Password	<input type="text" value="•"/>
CFB Phone Number	<input type="text"/>
CFNR Phone Number	<input type="text"/>
CFU Phone Number	<input type="text"/>
No Reply Time	<input type="text" value="30"/>

For more information, see [Configuring Multi-Line Extensions and Supplementary Services](#).

2. Enable BRI call forwarding, by using the following ini file parameter setting:

```
BRICallForwardHandling=1
```

3. Open the Trunk Group table ([Configuring Trunk Groups](#)), and then configure a Trunk Group (e.g., 1) for the BRI ports.
4. Open the Trunk Group Settings table (see [Configuring <trnkgpsettable<product>>](#)), and then for the Trunk Group ID to which the BRI ports belong, set the 'Channel Select Mode' parameter to **Select Trunk by Supp-Serv Table**:

Trunk Group ID	<input type="text" value="1"/>
Channel Select Mode	<input type="text" value="Select Trunk by Supp-Serv Table"/>

5. Open the Trunk Settings page (see [Configuring Trunk Settings](#)), and then make sure that you configure the BRI ports with the following settings:
  - 'Protocol Type': **BRI EURO ISDN**
  - 'ISDN Termination Side': **Network Side**
  - 'BRI Layer2 Mode': **Point to Multipoint**

GENERAL	
Module ID	2
Trunk ID	1
Trunk Configuration State	<b>Inactive</b>
Protocol Type	<input type="text" value="BRI EURO ISDN"/>

BRI CONFIGURATION	
Auto Clock Trunk Priority	<input type="text" value="0"/>
Trace Level	<input type="text" value="No Trace"/>
ISDN Termination Side	<input type="text" value="Network side"/>
BRI Layer2 Mode	<input type="text" value="Point To Multipoint"/>

## Enabling Call Waiting

The Call Waiting feature enables busy FXS endpoints connected to the device to accept an additional (second) call. If an incoming IP call is designated to a busy port, the called FXS endpoint hears a call waiting tone (several configurable short beeps) and can view the Caller ID of the incoming call (for Bellcore and ETSI Caller IDs). The calling party hears a call waiting ringback tone. The called party can accept the new call using hook-flash and can toggle between the two calls. To indicate call waiting, the device sends a SIP 182 (Call Queued) response. The device identifies call waiting when a 182 (Call Queued) response is received.



- The feature is applicable only to FXS and FXO interfaces. FXS interfaces support the calling and called sides. FXO interfaces support only the calling side.
- You can enable call waiting per port in the Call Waiting table (see [Configuring Call Waiting](#)). For ports that are not configured in the table, call waiting is according to the global parameter, as described in the procedure below.

### ➤ To enable and configure call waiting:

1. Open the Supplementary Services Settings page (**Setup** menu > **Signaling & Media** tab > **Gateway** folder > **DTMF & Supplementary** > **Supplementary Services Settings**).

Enable Call Waiting	Enable ▾
Number of Call Waiting Indications	2
Time Between Call Waiting Indications	10
Time Before Waiting Indications	0

2. From the 'Enable Call Waiting' drop-down list (EnableCallWaiting), select **Enable**.
3. Configure call waiting indication and call waiting ringback tones in the Call Progress Tones file (see [Call Progress Tones File](#)). You can configure up to four call waiting indication tones (see the FirstCallWaitingToneID parameter). To configure call waiting tones per FXS port(s) based on source or destination number, see [Configuring FXS Distinctive Ringing and Call Waiting Tones per Source/Destination Number](#).
4. In the 'Number of Call Waiting Indications' field (NumberOfWaitingIndications), enter the number of call waiting indications that can be played to the endpoint.
5. In the 'Time Between Call Waiting Indications' field (TimeBetweenWaitingIndications), enter the time (in seconds) between consecutive call waiting indications.
6. In the 'Time Before Waiting Indications' field (TimeBeforeWaitingIndication), enter the delay interval before a call waiting indication tone is played to the busy endpoint. This enables the caller to hang up before disturbing the called party with call waiting indications.
7. In the 'Waiting Beep Duration' field (WaitingBeepDuration), enter the duration (in msec) that the call waiting indication is played to the endpoint.

8. From the 'Enable Hold' drop-down list (EnableHold), select **Enable** to enable call hold.

## Message Waiting Indication

The device supports Message Waiting Indication (MWI) according to IETF RFC 3842. The device also supports subscribing to an MWI server (using SIP SUBSCRIBE messages).

For FXS interfaces: The device can accept a SIP MWI NOTIFY message that indicates waiting messages or cleared messages. Users are informed of these messages by a stutter dial tone. You can define the stutter and confirmation tones in the CPT file. If the MWI display is configured, the number of waiting messages is also displayed. If the MWI lamp is configured, the phone's lamp (on a phone that is equipped with an MWI lamp) is lit. The device can subscribe to the MWI server per port (usually used on FXS) or per device (used on FXO).



For more information on configuring IP-based voice mail, refer to the *IP Voice Mail CPE Configuration Guide*.

To configure MWI, use the following parameters:

- EnableMWI
- MWIServerIP, or MWISubscribeIPGroupID and ProxySet
- MWIAnalogLamp (FXS interfaces only)
- MWIDisplay (FXS interfaces only)
- StutterToneDuration (FXS interfaces only)
- EnableMWISubscription
- MWIExpirationTime
- SubscribeRetryTime
- SubscriptionMode
- CallerIDType - determines the standard for detection of MWI signals (FXS interfaces only)
- ETSIVMWITypeOneStandard (FXS interfaces only)
- BellcoreVMWITypeOneStandard (FXS interfaces only)
- VoiceMailInterface
- EnableVMURI

The device supports the following PSTN-based (digital) MWI features:

- ISDN BRI: The device supports MWI for its BRI phones, using the Euro ISDN BRI variant. When this feature is activated and a voice mail message is recorded to the mail box of a BRI extension, the softswitch sends a notification to the device. In turn, the device notifies the BRI extension and a red light flashes on the BRI extension's phone. Once the voice message is retrieved, the MWI light on the BRI phone turns off. This is configured by

setting the VoiceMailInterface parameter to 8 (“ETSI”) and enabled by the EnableMWI parameter.

- Euro-ISDN MWI: The device supports Euro-ISDN MWI for IP-to-Tel calls. The device interworks SIP MWI NOTIFY messages to Euro-ISDN Facility information element (IE) MWI messages. This is configured by setting the VoiceMailInterface parameter to 8.
- ISDN PRI NI-2: The device support the interworking of the SIP MWI NOTIFY messages to ISDN PRI NI-2 Message Waiting Notification (MWN), sent in the ISDN Facility IE message. This is applicable when the device is connected to a PBX through an ISDN PRI trunk configured to NI-2. This is configured by setting the VoiceMailInterface parameter to [9].
- QSIG MWI: The device supports the interworking of QSIG MWI to IP (in addition to interworking of SIP MWI NOTIFY to QSIG Facility MWI messages). This provides interworking between an ISDN PBX with voice mail capabilities and a softswitch, which requires information on the number of messages waiting for a specific user. This support is configured using the TrunkGroupSettings\_MWIIterrogationType parameter (in the Trunk Group Settings table), which determines the device's handling of MWI Interrogation messages. The process for sending the MWI status upon request from a softswitch is as follows:
  - a. The softswitch sends a SIP SUBSCRIBE message to the device.
  - b. The device responds by sending an empty SIP NOTIFY to the softswitch, and then sending an ISDN Setup message with Facility IE containing an MWI Interrogation request to the PBX.
  - c. The PBX responds by sending to the device an ISDN Connect message containing Facility IE with an MWI Interrogation result, which includes the number of voice messages waiting for the specific user.
  - d. The device sends another SIP NOTIFY to the softswitch, containing this MWI information.
  - e. The SIP NOTIFY messages are sent to the IP Group defined by the NotificationIPGroupID parameter.

When a change in the status occurs (e.g., a new voice message is waiting or the user has retrieved a message from the voice mail), the PBX initiates an ISDN Setup message with Facility IE containing an MWI Activate request, which includes the new number of voice messages waiting for the user. The device forwards this information to the softswitch by sending a SIP NOTIFY.

Depending on PBX support, the MWIIterrogationType parameter can be configured to handle these MWI Interrogation messages in different ways. For example, some PBXs support only the MWI Activate request (and not MWI Interrogation request). Some support both these requests. Therefore, the device can be configured to disable this feature or enable it with one of the following support:

- Responds to MWI Activate requests from the PBX by sending SIP NOTIFY MWI messages (i.e., does not send MWI Interrogation messages).

- Send MWI Interrogation message, but don't use its result. Instead, wait for MWI Activate requests from the PBX.
- Send MWI Interrogation message, use its result, and use the MWI Activate requests.

## Caller ID

This section describes the device's Caller ID support.



The feature is applicable only to analog interfaces.

### Enabling Caller ID Generation and Detection on Tel Side

The device's Caller ID support depends on the type of analog interface:

- FXS interfaces: The device sends (generates) the Caller ID signal to the device's FXS port.
- FXO interfaces: The device detects the Caller ID signal from the FXO port.



You can enable Caller ID generation (FXS interfaces) and detection (FXO interfaces) per port in the Caller ID Permissions table (see [Configuring Caller ID Permissions](#)). For ports that are not configured in the table, Caller ID is according to the global parameter, as described in the procedure below.

The following procedure describes how to enable Caller ID for all analog ports.

#### ➤ To enable Caller ID:

1. Open the Supplementary Services Settings page (**Setup** menu > **Signaling & Media** tab > **Gateway** folder > **DTMF & Supplementary** > **Supplementary Services Settings**).
2. From the 'Enable Caller ID' drop-down list (EnableCallerID), select **Enable**.

Enable Caller ID

Enable

3. Click **Apply**.

Additional Caller ID parameters includes the following:

- **CallerIDType**: Defines the Caller ID standard. The configured standard Caller ID must match the standard used on the PBX or phone.
- **BellcoreCallerIDTypeOneSubStandard**: Defines the Bellcore Caller ID sub-standard.
- **ETSICallerIDTypeOneSubStandard**: Defines the ETSI FSK Caller ID sub-standard.
- **EnableCallerIDTypeTwo**: Enables generation of Caller ID type 2 when the phone is off-hooked (used for call waiting).



- **RingsBeforeCallerID:** (FXO interfaces only) Defines the number of rings before the device starts detection of Caller ID. By default, the device detects Caller ID between the first and second rings.
- **AnalogCallerIDTimingMode:** (FXS interfaces only) Defines the time period when a Caller ID signal is generated. By default, Caller ID is generated between the first two rings.
- **PolarityReversalType:** (FXS interfaces only) Defines reversal polarity and/or wink signals for Caller ID signals. It is recommended to configure the parameter to 1 (Hard).
- **UseSourceNumberAsDisplayName and UseDisplayNameAsSourceNumber:** Defines Caller ID interworking.

## Debugging a Caller ID Detection on FXO

The following procedure describes how to debug caller ID detection on FXO interfaces.

### ➤ To debug a Caller ID detection on an FXO interface:

1. Verify that the parameter `EnableCallerID` is set to 1.
2. Verify that the caller ID standard (and substandard) of the device matches the standard of the PBX (using the parameters `CallerIDType`, `BellcoreCallerIDTypeOneSubStandard`, and `ETSICallerIDTypeOneSubStandard`).
3. Define the number of rings before the device starts the detection of caller ID (using the parameter `RingsBeforeCallerID`).
4. Verify that the correct FXO coefficient type is configured (see the `CountryCoefficients` parameter in [Configuring FXS/FXO Coefficient Types](#)), as the device is unable to recognize caller ID signals that are distorted.
5. Connect a phone to the analog line of the PBX (instead of to the device's FXO interface) and verify that it displays the caller ID.

If the above does not solve the problem, you need to record the caller ID signal (and send it to AudioCodes), as described below.

### ➤ To record the caller ID signal using the debug recording mechanism:

1. Access the FAE page (by appending "FAE" to the device's IP address in the Web browser's URL, for example, `http://10.13.4.13/FAE`).
2. Press the **Cmd Shell** link.
3. Enter the following commands:

```
dr
```

```
ait <IP address of PC to collect the debug traces sent from the device>
```

```
AddChannelIdTrace ALL-WITH-PCM <port number, which starts from 0>
```

```
Start
```

4. Make a call to the FXO.
5. To stop the DR recording, at the CLI prompt, type **STOP**.

## Caller ID on IP Side

Caller ID for analog interfaces is provided by the SIP From header containing the caller's name and "number", for example:

```
From: "John" <SIP:101@10.33.2.2>;tag=35dfsgasd45dg
```

If Caller ID is restricted (received from Tel or configured in the device), the From header is set to:

```
From: "anonymous" <anonymous@anonymous.invalid>; tag=35dfsgasd45dg
```

The P-Asserted (or P-Preferred) headers are used to present the originating party's caller ID even when the caller ID is restricted. These headers are used together with the Privacy header.

- If Caller ID is restricted:
  - The From header is set to "anonymous" <anonymous@anonymous.invalid>
  - The 'Privacy: id' header is included
  - The P-Asserted-Identity (or P-Preferred-Identity) header shows the caller ID
- If Caller ID is allowed:
  - The From header shows the caller ID
  - The 'Privacy: none' header is included
  - The P-Asserted-Identity (or P-Preferred-Identity) header shows the caller ID

The caller ID (and presentation) can also be displayed in the Calling Remote-Party-ID header.

The Caller Display Information table (see [Configuring Caller Display Information](#) on page 877) is used for the following:

- **FXS interfaces:** To define the caller ID (per port) that is sent to IP.
- **FXO interfaces:** To define the caller ID (per port) that is sent to IP if caller ID isn't detected on the Tel side, or when EnableCallerID = 0.
- **FXS and FXO interfaces:** To determine the presentation of the caller ID (allowed or restricted).

- **To maintain backward compatibility:** When the strings 'Private' or 'Anonymous' are set in the Caller ID/Name field, the caller ID is restricted and the value in the Presentation field is ignored.

The value of the 'Presentation' parameter in the Caller Display Information table can be overridden by configuring the 'Presentation' parameter in the Source Phone Number Manipulation for Tel- to- IP Calls table (see [Configuring Source-Destination Number Manipulation Rules](#) on page 770). Therefore, this table can be used to configure the presentation for specific calls according to source / destination prefixes.

The caller ID can be restricted/allowed (per port) using keypad features [KeyCLIR] and [KeyCLIRDeact] (FXS only).

The [AssertedIdMode] parameter configures the header that is used (in the generated INVITE request) to deliver the caller ID (P-Asserted-Identity or P-Preferred-Identity). Use the parameter [UseTelURIForAssertedID] to configure the format of the URI in these headers (sip: or tel:).

The parameter [EnableRPIheader] enables Remote-Party-ID (RPI) headers for calling and called numbers for Tel-to-IP calls.



This section is applicable only to analog interfaces.

## Three-Way Conferencing

The device supports three-way conference calls. Three-way conferencing occurs when an endpoint connected to the FXS or BRI port initiates a call and invites two remote IP-based participants. The device also supports multiple, concurrent three-way conference calls.



The feature is applicable only to FXS and BRI interfaces.

The device supports the following three-way conference modes:

- **Conference Managed by External AudioCodes Conferencing (Media) Server:** The conference-initiating INVITE sent by the device uses the ConferenceID concatenated with a unique identifier as the Request-URI. This same Request-URI is set as the Refer-To header value in the REFER messages that are sent to the two remote parties. To enable this mode, configure the [3WayConferenceMode] parameter to [0] (default.)

To join a conference, the Request-URI includes the Conference ID string preceded by the number of the participants in the conference and terminated by a unique number. INVITE messages with the same URI join the same conference. For example:

```
INVITE sip:4conf1234@10.1.10.10
```

- **Conference Managed by External, Third-party Conferencing Server: Two optional modes of operation:**

- The conference-initiating INVITE sent by the device uses only the ConferenceID as the Request-URI. The Conferencing server sets the Contact header of the 200 OK response to the actual unique identifier (Conference URI) to be used by the participants. The device includes this Conference URI in the SIP Refer-To header value in the REFER messages sent by the device to the remote parties. The remote parties join the conference by sending INVITE messages to the Conferencing server using this conference URI. To enable this mode, configure the [3WayConferenceMode] parameter to [1].
- The conference-initiating INVITE sent by the device uses only the ConferenceID as the Request-URI. The Conferencing server sets the Contact header of the 200 OK response to the actual unique identifier (Conference URI) to be used by the participants. The Conference URI is included in the URI of the REFER with a Replaces header sent by the device to the Conferencing server. The Conferencing server then sends an INVITE with a Replaces header to the remote participants. To enable this mode, configure the [3WayConferenceMode] parameter to [3].

When the device is used for Gateway and SBC applications, it can also support conference calls initiated by third-party network entities (e.g., Skype for Business) that use the same Conference server. To support these conference calls, you can do one of the following:

- ◆ Configure the third-party network entity with a Conference ID that is different from the Conference ID configured for the device.
- ◆ Configure the device with an Inbound Manipulation rule that is applied to calls received from the third-party network entity so that the device considers conference calls as regular calls and forwards them to the Conference server without getting involved in the conferencing setup.

To join a conference, the Request-URI includes the Conference ID string preceded by the number of the participants in the conference and terminated by a unique number. INVITE messages with the same URI join the same conference. For example:

```
INVITE sip:4conf1234@10.1.10.10
```



Three-way conferencing using an external conference server is applicable only to FXS interfaces.

- **Local, On-board Conferencing:** The conference is established on the device without the need for an external Conferencing server. The device supports up to five simultaneous, on-board, three-way conference calls. This feature supports local mixing and transcoding of the three-way conferencing legs on the device and multiple codec conference calls. You can configure the maximum number of simultaneous, on-board conferences, using the [MaxInBoardConferenceCalls] parameter.

The device uses resources from DSPs for on-board conferencing calls. However, if there are no available resources from the device's pool of DSPs, the device obtains resources from

idle FXS ports to establish the conference call. You can specify ports that you don't want to be used as a resource for conference calls that are initiated by other ports, using the [3WayConfNoneAllocateablePorts] parameter.

Each on-board three-way conference uses two DSP channels. As one channel is already provided by the FXS port interface to which the calling party (initiator of the three-way conference) is connected, the device obtains an additional DSP channel from another FXS port interface that is idle. However, if your device is installed with an MPM module(s), it obtains the DSP channel from the module. If the device is not installed with any MPM modules and all FXS ports are busy, the three-way conference call cannot be made. To enable this mode, configure the [3WayConferenceMode] parameter to [2].





- Three-way conferencing is applicable only to FXS and BRI interfaces.
- If the device houses three MPMs or more, no other telephony interface module can be installed in the device.
- Instead of using the flash-hook button to establish a three-way conference call, you can dial a user-defined hook-flash code (e.g., "\*1"), configured by the HookFlashCode parameter.
- Three-way conferencing support for the BRI phones connected to the device complies with ETS 300 185.

The following example demonstrates three-way conferencing using the device's local, on-board conferencing feature. In the example, telephone "A" connected to the device establishes a three-way conference call with two remote IP phones, "B" and "C":

1. A establishes a regular call with B.
2. A places B on hold, by pressing the telephone's flash-hook button and the number "1" key.
3. A hears a dial tone and then makes a call to C.
4. C answers the call.
5. A establishes a three-way conference call with B and C, by pressing the flash-hook button and the number "3" key.

➤ **To configure three-way conferencing:**

1. Open the Supplementary Services Settings page (**Setup** menu > **Signaling & Media** tab > **Gateway** folder > **DTMF & Supplementary** > **Supplementary Services Settings**).

CONFERENCE	
Enable 3-Way Conference	Disable 
Establish Conference Code	!
Conference ID	conf
3-Way Conference Mode	AudioCodes Media Server 
Max. 3-Way Conference	2 
Non Allocatable Ports	0

2. From the 'Enable 3-Way Conference' drop-down list (Enable3WayConference), select **Enable**.
3. From the '3-Way Conference Mode' drop-down list (3WayConferenceMode), select the three-way conference mode (e.g, **On Board**).
4. For On Board mode:
  - In the 'Max. 3-Way Conference' field (MaxInBoardConferenceCalls), enter the maximum number of simultaneous, on-board three-way conference calls.
  - In the 'Non Allocatable Ports' field (3WayConfNoneAllocateablePorts), enter the FXS ports that you don't want to use to obtain resources for conference calls when there are unavailable DSP resources.
5. In the 'Conference ID' field (ConferenceID), enter the Conference Identification string.
6. The valid value is a string of up to 16 characters. The default is "conf".
7. Configure one of the following for how the device recognizes a three-way conference request:
  - In the 'Establish Conference Code' field (ConferenceCode), enter the DTMF digit pattern (e.g., hook flash) that upon detection generates the conference call.
  - From the 'Flash Keys Sequence Style' drop-down list (FlashKeysSequenceStyle), select **Sequence 1** or **Sequence 2** to use the flash + 3 key-combination to create the three way conference call.
8. Click **Apply** and then reset the device with a save-to-flash for your settings to take effect.

## Emergency E911 Phone Number Services

This section describes the device's support for emergency phone number services.

The device supports the North American emergency telephone number system known as Enhanced 911 (E911), according to the TR-TSY-000350 and Bellcore's GR-350-Jun2003 standards. The E911 emergency system automatically associates a physical address with the calling party's telephone number, and routes the call to the most appropriate (closest) Public Safety Answering Point (PSAP), allowing the PSAP to quickly dispatch emergency response (e.g., police) to the caller's location.

Typically, the dialed emergency number is routed to the appropriate PSAP by the telephone company's switch, known as a 911 Selective Router (or E911 tandem switch). If the PSAP receives calls from the telephone company on old-style digital trunks, they are specially formatted Multi-Frequency (MF) trunks that pass only the calling party's number (known as Automatic Number Identification - ANI). Once the PSAP receives the call, it searches for the physical address that is associated with the calling party's telephone number (in the Automatic Location Identification database - ALI).

## FXS Device Emulating PSAP using DID Loop-Start Lines

The device's FXS interface can be configured to emulate PSAP (using DID loop start lines), according to the Telcordia GR-350-CORE specification.

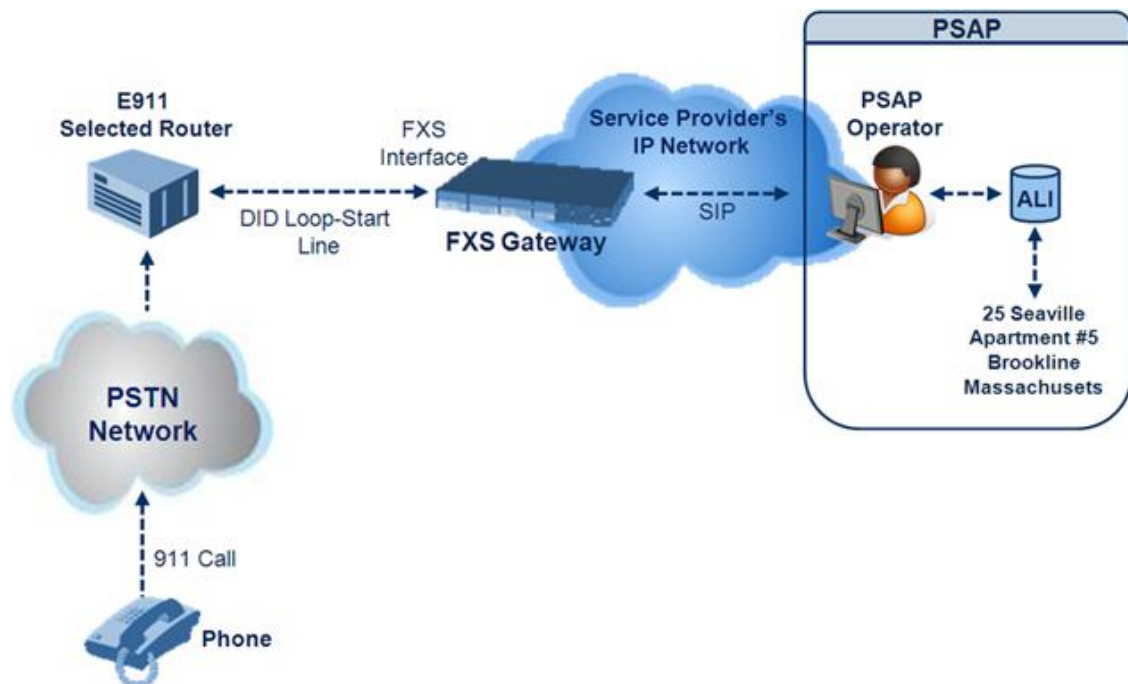

The call flow of an E911 call to the PSAP is as follows:

1. The E911 tandem switch seizes the line.
2. The FXS device detects the line seize, and then generates a wink signal (nominal 250 msec). The wink can be delayed by configuring the parameter [DelayBeforeDIDWink] to 200 (for 200 msec or a higher value).
3. The switch detects the wink and then sends the MF Spill digits with ANI and (optional) Pseudo-ANI (P ANI).
4. The FXS device collects the MF digits, and then sends a SIP INVITE message to the PSAP with all collected MF digits in the SIP From header as one string.
5. The FXS device generates a mid-call wink signal (two subsequent polarity reversals) toward the E911 tandem switch upon either detection of an RFC 2833 "hookflash" telephony event, or if a SIP INFO message with a "hooflash" body is received from the PSAP (see the example below). The duration of this "flashhook" wink signal is configured using the

parameter [FlashHookPeriod] (usually 500 msec). Usually the wink signal is followed by DTMF digits sent by PSAP to perform call transfer. Another way to perform the call transfer is to use SIP REFER messages, as described below.

6. The FXS device supports call transfer initiated by the PSAP. If it receives a SIP REFER message with the Refer-To URI host part containing an IP address that is equal to the device's IP address, the FXS device generates a 500-msec wink signal (double polarity reversals), and then (after a user-defined interval configured by the parameter [WaitForDialTime]), plays DTMF digits according to the transfer number received in the SIP Refer-To header URI userpart.
7. When the call is answered by the PSAP operator, the PSAP sends a SIP 200 OK to the FXS device, and the FXS device then generates a polarity reversal signal to the E911 switch.
8. After the call is disconnected by the PSAP, the PSAP sends a SIP BYE to the FXS device, and the FXS device reverses the polarity of the line toward the tandem switch.

The following parameters need to be configured:

- [EnableDIDWink = 1]
- [EnableReversalPolarity = 1]
- [PolarityReversalType = 1]
- [FlashHookPeriod = 500] - for 500 msec "hookflash" mid-call Wink
- [WinkTime = 250] - for 250 msec signalling Wink generated by the FXS device after it detects the line seizure
- [EnableTransfer = 1] - for call transfer
- [LineTransferMode = 1] - for call transfer
- [WaitforDialTime = 1000] - for call transfer
- [SwapTEI2IPCalled&CallingNumbers = 1]
- [DTMFDetectorEnable = 0]
- [MFR1DetectorEnable = 1]
- [DelayBeforeDIDWink = 200] - for 200 msec and can be configured in the range from 0 (default) to 1000



Modification of the WinkTime parameter requires a device reset.

The outgoing SIP INVITE message contains the following headers:

```
INVITE sip:Line@DomainName
From: <sip:*81977820#@sipgw>;tag=1c143
To: <sip:Line@DomainName>
```

Where:



- *Line* = as configured in the Endpoint Phone Number Table
- *SipGtw* = configured by the [SIPGatewayName] parameter
- *From* header/user part = calling party number as received from the MF spill

The ANI and the pseudo-ANI numbers are sent to the PSAP either in the From and/or P-AssertedID SIP header.

Typically, the MF spills are sent from the E911 tandem switch to the PSAP, as shown in the table below:

**Table 28-1: Dialed MF Digits Sent to PSAP**

Digits of Calling Number	Dialed MF Digits
8 digits "nnnnnnnn" (ANI)	"KPnnnnnnnnST"
12 digits "nnnnnnnnnnnn" (ANI)	"KPnnnnnnnnnnnnSTP"
12 digits ANI and 10 digits PANI	"KPnnnnnnnnnnnnSTKPmmmmmmmmmmST"
two digits "nn"	"KPnnSTP"

The MF KP, ST, and STP digits are mapped as follows:

- \* for KP
- # for ST
- B for STP

For example, if ANI and PANI are received, the SIP INVITE contains the following From header:

```
From: <sip:*nnnnnnnnnnnn#*mmmmmmmmmm#@10.2.3.4>;tag=1c14
```



It is possible to remove the \* and # characters, using the device's number manipulation rules.

If the device receives the SIP INFO message below, it then generates a "hookflash" mid-call Wink signal:

```
INFO sip:4505656002@192.168.13.40:5060 SIP/2.0
Via: SIP/2.0/UDP 192.168.13.2:5060
From: port1vega1 <sip:06@192.168.13.2:5060>
To: <sip:4505656002@192.168.13.40:5060>;tag=132878796-1040067870294
Call-ID: 0010-0016-D69A7DA8-1@192.168.13.2
CSeq:2 INFO
Content-Type: application/broadsoft
```

Content-Length: 17  
event flashhook

## FXO Device Interworking SIP E911 Calls from Service Provider's IP Network to PSAP DID Lines

The device's FXO interface can interwork SIP emergency E911 calls from the Service Provider's IP network to the analog PSAP DID lines. The standards that define this interface include TR-TSY-000350 or Bellcore's GR-350-Jun2003. This protocol defines signaling between the E911 tandem switch (E911 Selective Router) and the PSAP, using analog loop-start lines. The FXO device can be implemented instead of an E911 switch, by connecting directly to the PSAP DID loop-start lines.



When an IP phone subscriber dials 911, the device receives the SIP INVITE message and makes a call to the PSAP as follows:

1. The FXO device seizes the line.
2. PSAP sends a Wink signal (250 msec) to the device.
3. Upon receipt of the Wink signal, the device dials MF digits after a user-defined time (WaitForDialTime) containing the caller's ID (ANI) obtained from the SIP headers From or P-Asserted-Identity.
4. When the PSAP operator answers the call, the PSAP sends a polarity reversal to the device, and the device then sends a SIP 200 OK to the IP side.

5. After the PSAP operator disconnects the call, the PSAP reverses the polarity of the line, causing the device to send a SIP BYE to the IP side.
6. If, during active call state, the device receives a Wink signal (typically of 500 msec) from the PSAP, the device generates a SIP INFO message that includes a "hookflash" body, or sends RFC 2833 hookflash Telephony event (according to the HookFlashOption parameter).
7. Following the "hookflash" Wink signal, the PSAP sends DTMF digits. These digits are detected by the device and forwarded to the IP, using RFC 2833 telephony events (or inband, depending on the device's configuration). Typically, this Wink signal followed by the DTMF digits initiates a call transfer.

For supporting the E911 service, used the following configuration parameter settings:

- Enable911PSAP = 1 (also forces the EnableDIDWink and EnableReversalPolarity)
- HookFlashOption = 1 (generates the SIP INFO hookflash message) or 4 for RFC 2833 telephony event
- WinkTime = 700 (defines detection window of 50 to 750 msec for detection of both winks - 250 msec wink sent by the PSAP for starting the device's dialing; 500 msec wink during the call)
- IsTwoStageDial = 0
- EnableHold = 0
- EnableTransfer = 0
  - Use RFC 2833 DTMF relay:
    - ◆ RxDTMFOption = 3
    - ◆ FirstTxDTMFOption = 4
    - ◆ RFC2833PayloadType = 101
- TimeToSampleAnalogLineVoltage = 100
- WaitForDialTime = 1000 (default is 1 sec)
- SetDefaultLinePolarityState = 0 (you need to verify that the RJ-11 two-wire cable is connected without crossing, Tip to Tip, Ring to Ring. Typically, the Tip line is positive compared to the Ring line.)



If the two-wire cable is crossed, the SetDefaultLinePolarityState parameter must be set to 1.

The device expects to receive the ANI number in the From and/or P-Asserted-Identity SIP header. If the pseudo-ANI number exists, it should be sent as the display name in these headers.

**Table 28-2: Dialed Number by Device Depending on Calling Number**

Digits of Calling Number (ANI)	Digits of Displayed Number	Number Dialed MF Digits
8 "nnnnnnnnn"	-	MF dialed "KPnnnnnnnnST"
12 "nnnnnnnnnnn n"	None	"KPnnnnnnnnnnnnSTP"
12 "nnnnnnnnnnn n"	10 "mmmmmmmm m" (pANI)	"KPnnnnnnnnnnnnSTKPmmmmmmmmmmS T"
2 "nn"	None	"KPnnSTP"
1 "n"	-	MF dialed "KPnST"  For example:

Table notes:

- For all other cases, a SIP 484 response is sent.
- KP is for .
- ST is for #.
- STP is for B.

The MF duration of all digits, except for the KP digit is 60 msec. The MF duration of the KP digit is 120 msec. The gap duration is 60 msec between any two MF digits.



- Manipulation rules can be configured for the calling (ANI) and called number (but not on the "display" string), for example, to strip 00 from the ANI "00INXXYYYY".
- The called number, received as userpart of the Request URI ("301" in the example below), can be used to route incoming SIP calls to FXO specific ports, using the TrunkGroup and PSTNPrefix parameters.
- When the PSAP party off-hooks and then immediately on-hooks (i.e., the device detects wink), the device releases the call sending SIP response "403 Forbidden" and the release reason 21 (i.e., call rejected) "Reason: Q.850 ;cause=21" is sent. Using the cause mapping parameter, it is possible to change the 403 to any other SIP reason, for example, to 603.
- Sometimes a wink signal sent immediately after the FXO device seizes the line is not detected. To overcome this problem, configure the parameter TimeToSampleAnalogLineVoltage to 100 (instead of 1000 msec, which is the default value). The wink is then detected only after this timeout + 50 msec (minimum 150 msec).

Below are two examples for a) INVITE messages and b) INFO messages generated by hook-flash.

- **Example A:** INVITE message with ANI = 333333444444 and pseudo-ANI = 0123456789:

```
INVITE sip:301@10.33.37.79;user=phone SIP/2.0
Via: SIP/2.0/UDP 10.33.37.78;branch=z9hG4bKac771627168
Max-Forwards: 70
From: "0123456789" <sip:333333444444@example.com>;tag=1c771623824
To: <sip:301@10.33.37.79;user=phone>
Call-ID: 77162335841200014153@10.33.37.78
CSeq: 1 INVITE
Contact: <sip:101@10.33.37.78>
Supported: em,100rel,timer,replaces,path
Allow:
REGISTER,OPTIONS,INVITE,ACK,CANCEL,BYE,NOTIFY,PRACK,REFER,INFO,SUBSCRIBE,UPDATE
User-Agent: AudioCodes-Sip-Gateway-FXO/7.20A.260.005
Privacy: none
P-Asserted-Identity: "0123456789" <sip:333333444444@example.com>
Content-Type: application/sdp
Content-Length: 253
```

```
v=0
o=AudioCodesGW 771609035 771608915 IN IP4 10.33.37.78
s=Phone-Call
c=IN IP4 10.33.37.78
t=0 0
m=audio 4000 RTP/AVP 8 0 101
a=rtpmap:8 pcma/8000
a=rtpmap:0 pcmu/8000
a=rtpmap:101 telephone-event/8000
a=fmtp:101 0-15
a=ptime:20
a=sendrecv
```

- **Example B:** The detection of a Wink signal generates the following SIP INFO message:

```
INFO sip:4505656002@192.168.13.40:5060 SIP/2.0
Via: SIP/2.0/UDP 192.168.13.2:5060
From: port1vega1 <sip:06@192.168.13.2:5060>
To: <sip:4505656002@192.168.13.40:5060>;tag=132878796-1040067870294
Call-ID: 0010-0016-D69A7DA8-1@192.168.13.2
CSeq:2 INFO
```

Content-Type: application/broadsoft  
 Content-Length: 17  
 event flashhook

## Pre-empting Existing Calls for E911 IP-to-Tel Calls

If the device receives an emergency call (E911) from the IP network destined to the Tel and there are unavailable channels (e.g., all busy), the device terminates one of the current calls (arbitrary) and then sends the emergency call to that channel. The preemption is done only on a channel belonging to the same Trunk Group for which the emergency call was initially destined and if the 'Channel Select Mode' parameter (ChannelSelectMode) is configured with a value other than **By Dest Phone Number** (0). Call preemption is done only if the incoming IP-to-Tel call is identified as an emergency call.

### ➤ To configure call preemption for emergency calls:

#### 1. Enable call preemption for emergency calls:

- **For all calls:** Open the Priority & Emergency page (**Setup** menu > **Signaling & Media** tab > **SIP Definitions** folder > **Priority and Emergency**), and then from the 'Call Priority Mode' drop-down list (CallPriorityMode), select **Emergency**:

Call Priority Mode

- **For specific calls:** Open the Tel Profiles table (see [Configuring Tel Profiles](#)), and then for the required Tel Profile, configure the 'Call Priority Mode' drop-down list (TelProfile\_CallPriorityMode) to **Emergency**.
2. (Optional) Configure emergency telephone numbers (e.g., 911). Open the Priority & Emergency page (**Setup** menu > **Signaling & Media** tab > **SIP Definitions** folder > **Priority and Emergency**), and then in the 'Emergency Number' fields (EmergencyNumbers), configure the emergency numbers:

Emergency Number 1	<input type="text" value="911"/>
Emergency Number 2	<input type="text"/>
Emergency Number 3	<input type="text"/>
Emergency Number 4	<input type="text"/>

The device identifies the IP-to-Tel call as an emergency call if the destination number matches one of these configured emergency numbers. For E911, you must configure the parameter to "911".



- The feature is applicable to the following interfaces:
  - ✓ FXO
  - ✓ ISDN



#### ✓ CAS

- The device also identifies emergency calls if the Priority header of the incoming SIP INVITE message contains the “emergency” value.
- For Trunk Groups configured with call preemption, all must be configured to MLPP [1] or all configured to Emergency [2]. In other words, you cannot set some trunks to [1] and some to [2].
- If you are using a Tel Profile, you must configure the 'Call Priority Mode' parameter in the Tel Profile table and on the Priority & Emergency page with the same value; otherwise, the Tel Profile parameter is not applied.
- If you configure call preemption using the global parameter and a new Tel Profile is subsequently added, the TelProfile\_CallPriorityMode parameter automatically acquires the same setting as well.
- For FXO interfaces, the preemption is done only on existing IP-to-Tel calls. In other words, if all the current FXO channels are busy with calls that were answered by the FXO device (i.e., Tel-to-IP calls), new incoming emergency IP-to-Tel calls are rejected.

## Multilevel Precedence and Preemption

The device supports Multilevel Precedence and Preemption (MLPP) service. MLPP is a call priority scheme, which does the following:

- Assigns a precedence level (priority level) to specific phone calls or messages.
- Allows higher priority calls (*precedence call*) and messages to preempt lower priority calls and messages (i.e., terminates existing lower priority calls) that are recognized within a user-defined domain (*MLPP domain ID*). The domain specifies the collection of devices and resources that are associated with an MLPP subscriber. When an MLPP subscriber that belongs to a particular domain places a precedence call to another MLPP subscriber that belongs to the same domain, MLPP service can preempt the existing call that the called MLPP subscriber is on for a higher-precedence call. MLPP service availability does not apply across different domains.

MLPP is typically used in the military where, for example, high-ranking personnel can preempt active calls during network stress scenarios such as a national emergency or degraded network situations.

MLPP can be enabled for all calls, using the global parameter, CallPriorityMode, or for specific calls using the Tel Profile parameter, CallPriorityMode.



- For digital interfaces, MLPP is applicable only to PRI and BRI interfaces.
- The device provides MLPP interworking between SIP and ISDN (both directions).
- For Trunk Groups configured with call preemption, all must be configured to MLPP [1] or all configured to Emergency [2]. In other words, you cannot set some trunks to [1] and some to [2].
- The global parameter must be set to the same value as that of the Tel Profile parameter; otherwise, the Tel Profile parameter is not applied.



- If you configure call preemption using the global parameter and a new Tel Profile is subsequently added, the TelProfile\_CallPriorityMode parameter automatically acquires the same setting as well.
- If required, you can exclude the "resource-priority" tag from the SIP Require header in INVITE messages for Tel-to-IP calls when MLPP priority call handling is used. This is configured using the RPRRequired parameter.
- For a complete list of the MLPP parameters, see [MLPP and Emergency Call Parameters](#).

The Resource Priority value in the Resource-Priority SIP header can be any one of those listed in the table below.

For digital interfaces: A default MLPP call Precedence Level (configured by the SIPDefaultCallPriority parameter) is used if the incoming SIP INVITE or ISDN Setup message contains an invalid priority or Precedence Level value respectively.

For each MLPP call priority level, the Multiple Differentiated Services Code Points (DSCP) can be set to a value from 0 to 63.

**Table 28-3: MLPP Call Priority Levels (Precedence) and DSCP Configuration Parameters**

MLPP Precedence Level	Precedence Level in Resource-Priority SIP Header	DSCP Configuration Parameter
0 (lowest)	routine	MLPPRoutineRTPDSCP
2	priority	MLPPPRIORITYRTPDSCP
4	immediate	MLPPImmediateRTPDSCP
6	flash	MLPPFlashRTPDSCP
8	flash-override	MLPPFlashOverRTPDSCP
9 (highest)	flash-override-override	MLPPFlashOverOverRTPDSCP

**For digital interfaces:**

The device automatically interworks the network identity digits (NI) in the ISDN Q.931 Precedence Information Element (IE) to the network domain subfield of the INVITE's Resource-Priority header, and vice versa. The SIP Resource-Priority header contains two fields, namespace and priority. The namespace is subdivided into two subfields, network-domain and precedence-domain. Below is an example of a Resource-Priority header whose network-domain subfield is "uc", r-priority field is "priority" (2), and precedence-domain subfield is "000000":

```
Resource-Priority: uc-000000.2
```



The MLPP Q.931 Setup message contains the Precedence IE. The NI digits are presented by four nibbles found in octets 5 and 6. The device checks the NI digits according to the translation table of the Department of Defense (DoD) Unified Capabilities (UC) Requirements (UCR 2008, Changes 3) document, as shown below:

**Table 28-4: NI Digits in ISDN Precedence**

Level IE	Network Domain in SIP Resource-Priority Header
0000	uc
0001	cuc
0002	dod
0003	nato



- If the received ISDN message contains NI digits that are not listed in the translation table, the device sets the network-domain to "uc" in the outgoing SIP message.
- If the received SIP message contains a network-domain value that is not listed in the translation table, the device sets the NI digits to "0000" in the outgoing ISDN message.
- If the received ISDN message does not contain a Precedence IE, you can configure the namespace value - dsn (default), dod, drsn, uc, or cuc - in the SIP Resource-Priority header of the outgoing INVITE message. This is done using the MLPPDefaultNamespace parameter. You can also configure up to 32 user-defined namespaces, using the table ini file parameter, ResourcePriorityNetworkDomains. Once defined, you need to set the MLPPDefaultNamespace parameter value to the desired table row index.

By default, the device maps the received Resource-Priority field of the SIP Resource-Priority header to the outgoing ISDN Precedence Level (priority level) field as follows:

- If the network-domain field in the Resource-Priority header is "uc", then the device sets the Precedence Level field in the ISDN Precedence Level IE according to Table 5.3.2.12-4 (Mapping of RPH r-priority Field to ISDN Precedence Level Value):

**Table 28-5: Mapping of SIP Resource-Priority Header to ISDN Precedence Level for MLPP**

MLPP Precedence Level	ISDN Precedence Level	SIP Resource-Priority Header Field
Routine	4	0
Priority	3	2
Immediate	2	4

MLPP Precedence Level	ISDN Precedence Level	SIP Resource-Priority Header Field
Flash	1	6
Flash Override	0	8

- If the network-domain field in the Resource-Priority header is any value other than "uc", then the device sets the Precedence Level field to "0 1 0 0" (i.e., "routine").

This can be modified using the `EnableIp2TelInterworkingtable` field of the ini file parameter, `ResourcePriorityNetworkDomains`.

### MLPP Preemption Events in SIP Reason Header

The device sends the SIP Reason header (as defined in RFC 4411) to indicate the reason and type of a preemption event. The device sends a SIP BYE or CANCEL request, or SIP 480, 486, 488 response (as appropriate) with a Reason header whose Reason-params can include one of the following preemption cause classes:

- Reason: preemption ;cause=1 ;text="UA Preemption"
- Reason: preemption ;cause=2 ;text="Reserved Resources Preempted"
- Reason: preemption ;cause=3 ;text="Generic Preemption"
- Reason: preemption ;cause=4 ;text="Non-IP Preemption"

This Reason cause code indicates that the session preemption has occurred in a non-IP portion of the infrastructure. The device sends this code in the following scenarios:

- The device performs a network preemption of a busy call (when a high priority call is received), the device sends a SIP BYE or CANCEL request with this Reason cause code.
- The device performs a preemption of a B-channel for a Tel-to-IP outbound call request from the softswitch for which it has not received an answer response (e.g., Connect), and the following sequence of events occurs:
  - i. The device sends a Q.931 DISCONNECT over the ISDN MLPP to the partner switch to preempt the remote end instrument.
  - ii. The device sends a 488 (Not Acceptable Here) response with this Reason cause code.
- Reason: preemption; cause=5; text="Network Preemption"

This Reason cause code indicates preempted events in the network. Within the Defense Switched Network (DSN) network, the following SIP request messages and response codes for specific call scenarios have been identified for signaling this preemption cause:

- SIP:BYE - If an active call is being preempted by another call
- CANCEL - If an outgoing call is being preempted by another call

- 480 (Temporarily Unavailable), 486 (User Busy), 488 (Not Acceptable Here) - Due to incoming calls being preempted by another call.

The device receives SIP requests with preemption reason cause=5 in the following cases:

- The softswitch performs a network preemption of an active call - the following sequence of events occurs:
  - i. The softswitch sends the device a SIP BYE request with this Reason cause code.
  - ii. The device initiates the release procedures for the B-channel associated with the call request and maps the preemption cause to ISDN Cause = #8 'Preemption'. This value indicates that the call is being preempted. For ISDN, it also indicates that the B-channel is not reserved for reuse.
  - iii. The device sends a SIP 200 OK in response to the received BYE, before the SIP end instrument can proceed with the higher precedence call.
- The softswitch performs a network preemption of an outbound call request for the device that has not received a SIP 2xx response - the following sequence of events occur:
  - i. The softswitch sends the device a SIP 488 (Not Acceptable Here) response code with this Reason cause code. The device initiates the release procedures for the B-channel associated with the call request and maps the preemption cause to ISDN Cause = #8 'Preemption'.
  - ii. The device deactivates any user signaling (e.g., ringback tone) and when the call is terminated, it sends a SIP ACK message to the softswitch.

## Precedence Ring Tone

**For analog interfaces:** You can assign a ring tone that is defined in the CPT file to be played when a precedence call is received from the IP side. This is configured by the PrecedenceRingingType parameter. Emergency Telecommunications Services (ETS) calls (e.g., E911) can be configured with a higher priority than any MLPP call (default), using the E911MLPPBehavior parameter.

**For digital interfaces:** You can configure the duration for which the device plays a preemption tone to the Tel and IP sides if a call is preempted, using the PreemptionToneDuration parameter.

## Denial of Collect Calls

You can configure the device to reject (disconnect) incoming Tel-to-IP collect calls and to signal this denial to the PSTN. This capability is required, for example, in the Brazilian telecommunication system to deny collect calls. When the feature is enabled upon rejecting the incoming call, the device sends a sequence of signals to the PSTN. This consists of an off-hook, an on-hook after one second, and then an off-hook after two seconds. In other words, this is in effect, a double-answer sequence.

This feature can be enabled for all calls, using the EnableFXODoubleAnswer "global" parameter, or it can be enabled for specific calls, by enabling this feature in a Tel Profile.



- The feature is applicable only to FXO interfaces.
- If automatic dialing is also configured for an FXO port enabled with Denial of Collect Calls, the FXO line does not answer the incoming call (ringing) until a SIP 200 OK is received from the remote destination. When a 200 OK is received, a double answer is sent from the FXO line.
- Ensure that the PSTN side is configured to identify this double-answer signal.

## Configuring Multi-Line Extensions and Supplementary Services

The Supplementary Services table lets you configure up to 100 supplementary services for endpoints connected to the device.



The feature is applicable only to FXS and BRI interfaces.

You can use the table for the following functionality:

- Configuring multiple phone line extension numbers per port, supporting point-to-multipoint configuration of several phone numbers per channel.
- Registration of each line extension (endpoint), using a user-defined user ID and password, to a third-party softswitch for authentication and/or billing. For each line extension, the device sends a SIP REGISTER to the softswitch, using the global number in the From/To headers. If authentication is necessary for registration, the device sends the endpoint's user ID and password in the SIP MD5 Authorization header. For viewing registration status, see [Viewing Registration Status](#).
- Caller ID name per line extension, which is displayed to the called party (if enabled).
- Enabling receipt by the line extension of caller ID from incoming calls.
- BRI call forwarding services for point-to-multipoint configurations (according to ETSI 300 207-1) - Call Forward Busy (CFB), Call Forward No Reply (CFNR), and Call Forward Unconditional (CFU).
- Routing IP-to-Tel calls (including voice and fax) to specific endpoints based on called line extension number (*local* number). To enable this functionality, in the Trunk Group Settings table, set the 'Channel Select Mode' field to **Select Trunk by Supplementary Services Table** for the Trunk Group to which the port belongs (see [Configuring Trunk Group Settings](#)).
- Mapping local numbers (line extension number) with global phone numbers (E.164). The endpoint can be configured with two numbers – *local* and *global*. The local number represents the endpoint's line extension number (e.g., PBX extension number); the global number represents the corresponding E.164 number used for the IP side in the SIP message:

- IP-to-Tel calls: Maps the called global number in the user part of the SIP Request-URI in the incoming SIP message to the local number sent to the Tel side. For example, the device receives an incoming IP call with a destination (called) that is a global number 638002 and then sends the call to the Tel side with the destination number manipulated to the corresponding local number of 402.
- Tel-to-IP Calls: Maps the calling (source) local number of the Tel side to the global number sent to the IP side (in the From and To headers of the outgoing SIP message). For example, if the device receives a Tel call from line extension local number 402, it changes this calling number to 638002 and then sends the call to the IP side with this calling number. This functionality in effect, validates the calling number.



- If you have configured regular Tel-to-IP or IP-to-Tel manipulation rules (see [Configuring Source/Destination Number Manipulation](#)), the device applies them before applying the local-global mapping rules configured in the table.
- To allow the end user to hear a dial tone when picking up the BRI phone, it is recommended to set the Progress Indicator in the Setup Ack bit (0x10000=65536). Therefore, the recommended value is  $0x10000 + 0 \times 1000 = 65536 + 4096 = 69632$  (i.e., set the ISDNInCallsBehavior parameter to 69632).

The following procedure describes how to configure the Supplementary Services table through the Web interface. You can also configure it through ini file [ISDNSuppServ] or CLI (configure voip > gateway digital isdn-supp-serv).

➤ **To configure endpoint supplementary services:**

1. Open the Supplementary Services table (**Setup** menu > **Signaling & Media** tab > **Gateway** folder > **DTMF & Supplementary** > **Supplementary Services**).
2. Click **New**; the following dialog box appears:

GENERAL		CALLER ID	
Index	1	Caller ID Enabled	<input type="checkbox"/>
Global Phone Number		Caller ID Name	
Local Phone Number		Presentation	
Module	0		
Port	0		
User ID			
User Password			
CFB Phone Number			
CFNR Phone Number			
CFU Phone Number			
No Reply Time	30		

3. Configure a supplementary service according to the parameters described in the table below.
4. Click **Apply**.

The figure below displays an example of multiple-line extensions configured in the Supplementary Services table:

INDEX ↕	GLOBAL PHONE NUMBER	LOCAL PHONE NUMBER	MODULE	PORT	USER ID	USER PASSWORD	CALLER ID NAME	PRESENTATION	CALLER ID ENABLED
0	+15032638002	402	1	1	JoeV	*	Joe	Allowed	Enabled
1	+15032638003	403	1	1	SueK	*	Sue	Allowed	Enabled
2	+15032638004	404	1	2	LeeM	*	Lee	Allowed	Enabled
3	+15032638005	405	1	2	MikeD	*	Mike	Allowed	Enabled

You can also register and un-register an endpoint configured in the table:

➤ **To register or un-register an endpoint:**

1. In the Trunk Group Settings table (see [Configuring Trunk Group Settings](#)), configure the registration method using the 'Registration Mode' parameter.
2. In the Supplementary Services table, select the required endpoint.
3. From the 'Action' drop-down list, select **Register**. To unregister the endpoint, select **Un-Register**.

**Table 28-6: Supplementary Services Table Parameter Description**

Parameter	Description
General	
'Index' [ISDNSuppServ_Index]	Defines an index number for the new table row. <b>Note:</b> Each row must be configured with a unique index.
'Global Phone Number' phone-number [ISDNSuppServ_PhoneNumber]	Defines a global telephone extension number for the endpoint. The global number is used for the following functionality: <ul style="list-style-type: none"> <li>■ Endpoint registration</li> <li>■ IP-to-Tel routing</li> <li>■ Mapping between local and global (E.164) numbers between Tel and IP sides respectively</li> </ul>
'Local Phone Number' local-phone-number [ISDNSuppServ_LocalPhoneNumber]	Defines a local telephone extension number for the endpoint (e.g., the PBX extension number). The local number is used for the following functionality: <ul style="list-style-type: none"> <li>■ Validation of source (calling) number for Tel-to-IP calls</li> <li>■ Mapping between local and global (E.164) numbers</li> </ul>

Parameter	Description
	between Tel and IP sides respectively
'Module' module [ISDNSuppServ_Module]	Defines the device's module number to which the endpoint is connected.
'Port' port [ISDNSuppServ_Port]	Defines the port number on the module to which the endpoint is connected.
'User ID' user-id [ISDNSuppServ_UserId]	Defines the User ID for registering the endpoint to a third-party softswitch for authentication and/or billing. The valid value is a string of up to 60 characters. By default, no value is defined.
'User Password' user-password [ISDNSuppServ_UserPassword]	Defines the user password for registering the endpoint to a third-party softswitch for authentication and/or billing. <b>Note:</b> <ul style="list-style-type: none"> <li>■ For security, the password is displayed as an asterisk (*).</li> <li>■ The password cannot be configured with wide characters.</li> </ul>
'CFB Phone Number' cfb-to_phone-number [ISDNSuppServ_CFB2PhoneNumber]	Defines the phone number for BRI Call Forward Busy (CFB) services. If the BRI extension is currently in use, the device forwards the call to this number. <b>Note:</b> <ul style="list-style-type: none"> <li>■ The parameter is applicable only to BRI interfaces.</li> <li>■ To enable BRI call forwarding services, see the BRICallForwardHandling parameter.</li> <li>■ For more information on configuring local handling of BRI call forwarding, see <a href="#">Local Handling of BRI Call Forwarding</a>.</li> </ul>
'CFNR Phone Number' cfnr-to_phone-number [ISDNSuppServ_CFNR2PhoneNumber]	Defines the phone number for BRI Call Forward No Reply (CFNR) services. If the BRI extension does not answer the call within a user-defined timeout (see the 'No Reply Time' parameter below), the device forwards the call to this number. <b>Note:</b> <ul style="list-style-type: none"> <li>■ The parameter is applicable only to BRI interfaces.</li> <li>■ To enable BRI call forwarding services, see the BRICallForwardHandling parameter.</li> </ul>

Parameter	Description
	<ul style="list-style-type: none"> <li>■ For more information on configuring local handling of BRI call forwarding, see <a href="#">Local Handling of BRI Call Forwarding</a>.</li> </ul>
'CFU Phone Number' <code>cfu-to_phone-number</code> [ISDNSuppServ_ CFU2PhoneNumber]	Defines the phone number for BRI Call Forward Unconditional (CFU) services. The device always forwards the call to this number. <b>Note:</b> <ul style="list-style-type: none"> <li>■ The parameter is applicable only to BRI interfaces.</li> <li>■ To enable BRI call forwarding services, see the BRICallForwardHandling parameter.</li> <li>■ For more information on configuring local handling of BRI call forwarding, see <a href="#">Local Handling of BRI Call Forwarding</a>.</li> </ul>
'No Reply Time' <code>no-reply-time</code> [ISDNSuppServ_ NoReplyTime]	Defines the timeout (in seconds) that if the BRI extension does not answer before it expires, the device forwards the call to the phone number as defined by the 'CFNR Phone Number' parameter (see above). The default is 30. <b>Note:</b> <ul style="list-style-type: none"> <li>■ The parameter is applicable only to BRI interfaces.</li> <li>■ To enable BRI call forwarding services, see the BRICallForwardHandling parameter.</li> <li>■ For more information on configuring local handling of BRI call forwarding, see <a href="#">Local Handling of BRI Call Forwarding</a>.</li> </ul>
Caller ID	
'Caller ID Enabled' <code>caller-id-enable</code> [ISDNSuppServ_ IsCallerIDEnabled]	Enables the receipt of Caller ID. <ul style="list-style-type: none"> <li>■ [0] <b>Disabled</b> = The device does not send Caller ID information to the endpoint.</li> <li>■ [1] <b>Enabled</b> = The device sends Caller ID information to the endpoint.</li> </ul>
'Caller ID Name' <code>caller-id-number</code> [ISDNSuppServ_ CallerID]	Defines the caller ID name of the endpoint (sent to the IP side). The valid value is a string of up to 18 characters.
'Presentation' <code>presentation-restricted</code>	Determines whether the endpoint sends its Caller ID information to the IP when a call is made.



Parameter	Description
[ISDNSuppServ_ IsPresentationRestricted]	<ul style="list-style-type: none"> <li>■ [0] <b>Allowed</b> = The device sends the string defined in the 'Caller ID' field when this endpoint makes a Tel-to-IP call.</li> <li>■ [1] <b>Restricted</b> = The string defined in the 'Caller ID' field is not sent.</li> </ul>

## Detecting Collect Calls

The device detects collect calls (reverse charge calls) using any of the following information elements (IE) in the received Q.931 ISDN Setup message for Tel-to-IP calls:

- Reverse Charging Indication IE
- Facility IE

When the device detects a collect call, it adds a proprietary header (*X-Siemens-Call-Type: collect call*) to the outgoing SIP INVITE message.

No special configuration is required for the feature.



The feature is applicable only to the Euro ISDN protocol variant.

## Advice of Charge Services for Euro ISDN

Advice of charge (AOC) is a pre-billing function that tasks the rating engine with calculating the cost of using a service and relaying that information back to the customer (caller). This allows users to obtain call charging information periodically during the call (AOC-D) or at the end of the call (AOC-E).

AOC messages are sent in the EURO ISDN Facility Information Element (IE) message. The device interworks these ISDN messages with SIP by converting the AOC messages into SIP INFO (during call) and BYE messages (end of call) using the AudioCodes proprietary SIP AOC header, and vice versa. The device supports both currency (monetary units) and pulse (non-monetary units) AOC messages.

This feature can typically be implemented in the hotel industry, where external calls made by guests can be billed accurately. In such a setup, the device is connected on one side to a PBX through an ISDN line (Euro ISDN), and on the other side to a SIP trunk provided by an ITSP. When a call is made by a guest, the device first sends an AOC-D Facility message to the PBX indicating the connection charge unit, and then sends subsequent AOC-D messages every user-defined interval to indicate the charge unit during the call. When the call ends, the device sends an AOC-E Facility message to the PBX indicating the total number of charged units.



The feature is applicable only to Euro ISDN PRI and BRI.

The device supports various AOC methods:

- **Tel-to-IP Direction:** The device converts the AOC messages received in the EURO ISDN Facility IE messages into SIP INFO and BYE messages using the proprietary SIP AOC header.
- **Device Generation of AOC to Tel:** The device generates the metering tones according to user-defined amounts, intervals, currency type, and multiplier. For more information, see [Configuring Charge Codes](#).
- **IP-to-Tel Direction:**
  - SIP-to-Tel interworking: The device uses the AOC header from the IP side and sends to Tel in EURO ISDN Facility IE messages. Below shows the SIP AOC header:

```
AOC: charged; <parameters>
```

Where parameters can be:

- ◆ state="active" or "terminated"
- ◆ charging-info="currency" or "pulse"

If "currency", the following parameters are available:

- ◆ currency=<string>
- ◆ currency-type="iso4217-a" or <string>
- ◆ amount=<number>
- ◆ multiplier=("0.001", "0.01", "0.1", "1", "10", "100", "1000")

If "pulse", the following parameter is available:

- ◆ recorded-units=<number>

The device can also receive AOC data in the SIP INFO message containing an 'application/vnd.etsi.aoc+xml' body. For example:

```
INFO sip:103@10.10.12.188:5060 SIP/2.0
Via: SIP/2.0/UDP 10.10.12.159:5061;branch=z9hG4bK-1-18439@10.10.12.159;rport
From: "2110017: Bob" <sip:4988@10.10.12.188>;tag=1
To: <sip:103@10.10.12.188;user=phone>;tag=pmvsivy1ju
Call-ID: 1-18439@10.10.12.159
CSeq: 3 INFO
Max-Forwards: 70
Contact: <sip:4988@10.10.12.159:5061;line=qhpks806>;reg-id=1
Content-Type: application/vnd.etsi.aoc+xml
Content-Length: 405

<?xml version="1.0" encoding="UTF-8"?>
<aoc xmlns="http://uri.etsi.org/ngn/params/xml/simservs/aoc">
```

```

<aoc-d>
  <charging-info>subtotal</charging-info>
  <recorded-charges>
    <recorded-currency-units>
      <currency-id>EUR</currency-id>
      <currency-amount>0.1</currency-amount>
    </recorded-currency-units>
  </recorded-charges>
  <billing-id>normal-charging</billing-id>
</aoc-d>
</aoc>

```

In such a case, you should use message manipulation rules on the SIP INFO message to convert the advice of charge data in the XML to the AOC SIP header with the relevant format (parameters) as discussed above:

Parameter	Value	
'Index'	1	2
'Name'	Add AOC header	Remove XML body
'Manipulation Set ID'	0	0
'Row Rule'	<b>Use Current Condition</b>	<b>Use Previous Condition</b>
'Message Type'	Any	
'Condition'	body.application/vnd.etsi.aoc+xml   REGEX (<currency-amount>)(\d+) (</currency-amount>)	body.application/vnd.etsi.aoc+xml   exists
'Action Subject'	Header.AOC	body.application/vnd.etsi.aoc+xml 
'Action Type'	<b>Add</b>	<b>Remove</b>
'Action Value'	'charged;charging-info=pulse;recorded-units='+\$2	

- TELES proprietary method
- Cirpack proprietary methods

For more information on the proprietary methods, see the `PayPhoneMeteringMode` parameter in [Metering Tone Parameters](#).

➤ **To configure AOC:**

1. Make sure that the PSTN protocol for the trunk line is configured to Euro ISDN and network side.
2. Make sure that the date and time of the device is correct. For accuracy, it is recommended to use an NTP server to obtain the date and time. For more information, see [Date and Time](#).
3. Configure the required AOC method:

- **Device Generation of AOC to Tel:**

- i. Open the Supplementary Services page (**Setup** menu > **Signaling & Media** tab > **Gateway** folder > **DTMF & Supplementary** > **Supplementary Services Settings**), and then configure the 'Generate Metering Tones' parameter (PayPhoneMeteringMode) to **Charge Code Table**.

Generate Metering Tones Charge Code Table ▼

- ii. In the Charge Codes table, configure Charge Codes (see [Configuring Charge Codes](#)).
- iii. In the Tel-to-IP Routing table, assign the Charge Code index to the relevant Tel-to-IP routing rule (see [Configuring Tel-to-IP Routing Rules](#)).

- **AOC in Tel-to-IP Direction:** Open the Supplementary Services Settings page, and then configure the 'AoC Support' parameter to **Enable** to send AOC to IP.

AoC Support Enable ▼

- **AOC in IP-to-Tel Direction:** Open the Supplementary Services page, and then configure the 'Generate Metering Tones' parameter (PayPhoneMeteringMode) to one of the following: **SIP Interval Provided**, **SIP RAW Data Provided**, **SIP RAW Data Incremental Provided**, or **SIP-to-Tel Interworking**.

## Configuring Charge Codes

The Charge Codes table lets you configure metering tones:

- Analog interfaces: Metering tones that the device generates to the Tel side on its FXS interfaces.
- Digital interfaces: Advice of Charge (AOC) services for Euro ISDN trunks (see [Advice of Charge Services for Euro ISDN](#)).

You can configure up to 25 different Charge Codes, where each table row represents a Charge Code. Each Charge Code can include up to four different time periods in a day (24 hours). The device selects the time period by comparing the device's current time to the end time of each time period of the selected Charge Code. The device generates the number of pulses (units) upon call connection (answer), and from that point on, it generates a pulse (unit) for each

interval. If a call starts at a certain time period and crosses to the next period, the information of the next time period is used. For Advice of Charge services (digital interfaces only), you can also configure the currency type in the sent AOC messages as well as a multiplier that is applied to the charged units.

To assign Charge Codes to Tel-to-IP calls, use the Tel-to-IP Routing table.



- The Charge Codes table is applicable only to the following interfaces:
  - ✓ FXS
  - ✓ Euro ISDN PRI
  - ✓ Euro ISDN BRI
- Analog interfaces: To enable generation of metering tones, see [Configuring Metering Tones](#).

The following procedure describes how to configure Charge Codes through the Web interface. You can also configure it through ini file [ChargeCode] or CLI (`configure voip > gateway dtmf-suppl-service charge-code`).

#### ➤ To configure a Charge Code:

1. Open the Charge Codes table (**Setup** menu > **Signaling & Media** tab > **Gateway** folder > **Routing** > **Charge Codes**).
2. Click **New**; the following dialog box appears:

GENERAL	
Index	0
Name	
End Time 1	
Interval 1	
Amount On Answer 1	
End Time 2	
Interval 2	
Amount On Answer 2	
End Time 3	
Interval 3	
Amount On Answer 3	
End Time 4	

3. Configure a Charge Code according to the parameters described in the table below.
4. Click **Apply**.

**Table 28-7: Charge Codes Table Parameter Descriptions**

Parameter	Description
'Index' [ChargeCode_ Index]	Defines an index number for the new table row. <b>Note:</b> Each row must be configured with a unique index.
'Name' charge-code- name [ChargeCode_ ChargeCodeName]	Defines a descriptive name, which is used when associating the row in other tables. The valid value is a string of up to 40 characters. <b>Note:</b> <ul style="list-style-type: none"> <li>■ Each row must be configured with a unique name.</li> <li>■ The parameter value cannot contain a forward slash (/).</li> </ul>
'End Time (1 - 4)' end-time-<1- 4> [ChargeCode_ EndTime<1-4>]	Defines the time at which this charging code ends. The valid value is a time in 24-hour format ( <i>hh</i> ). For example, to denote 4 AM, configure the parameter to "04" (without quotation marks). <b>Note:</b> <ul style="list-style-type: none"> <li>■ The first time period always starts at midnight (00).</li> <li>■ It is mandatory that the last time period of each rule end at midnight (00). This prevents undefined time frames in a day.</li> </ul>
'Interval (1 - 4)' interval-<1- 4> [ChargeCode_ PulseInterval<1-4>]	Defines the interval (in tenths of a second) for charging the call. The first interval starts from when the call is answered (connected). <ul style="list-style-type: none"> <li>■ FXS interfaces: Defines the interval between every generated pulse.</li> <li>■ Digital (Euro ISDN) interfaces: Defines the interval between every sent AOC-D message, which is included in the ISDN Facility information element (IE) message.</li> </ul> <p>For example, if you configure the parameter to 20, the device sends a charge every 2 seconds (i.e., 20 x 0.1). If the call duration is 10 seconds, the total call charge amount (excluding the connection charge, which is configured by the 'Amount On Answer' parameter) is 5. In other words, 10 seconds divided by 2-second intervals is 5, and then 5 multiplied by the default interval charge of 1 is 5.</p> <b>Note:</b> <ul style="list-style-type: none"> <li>■ By default, the charged amount sent per interval is <b>one</b> pulse (unit). However, for digital interfaces, you can configure this charge, using the ISDNAoCAmountPerInterval parameter.</li> </ul>

Parameter	Description
	<ul style="list-style-type: none"> <li>■ Digital interfaces: If you configure the 'Multiplier of Amount' parameter (see below), then the actual interval charge is multiplied by the 'Multiplier of Amount' parameter value. For example, if the interval charge is 1 (default) and you configure the 'Multiplier of Amount' parameter to 0.1, then the interval charge is 0.1 (i.e., 1 x 0.1).</li> <li>■ Digital interfaces: You can configure the interval for sending the AOC messages, using the ISDNAoCMinIntervalGeneration global parameter. This does not affect the interval charge. If this global parameter value is less than the 'Interval' parameter, the global parameter is ignored. For example, if you configure the 'Interval' parameter to 20 (i.e., 2 seconds) and the ISDNAoCMinIntervalGeneration parameter to 40 (i.e., 4 seconds), the device sends AOC messages every 0.4 seconds, but charges the call every 2 seconds.</li> </ul>
<p>'Amount On Answer (1 - 4)'  <code>amount-on-answer-&lt;1-4&gt;</code>  <code>[ChargeCode_PulsesOnAnswer&lt;1-4&gt;]</code></p>	<p>Defines the one-time call charge upon call connection (call answer).</p> <ul style="list-style-type: none"> <li>■ FXS interfaces: Defines the number of charging pulses that the device generates to the Tel side when the call is answered.</li> <li>■ Digital (Euro ISDN) interfaces: Defines the number of charging units or amount that the device generates when the call is answered, which it sends as the first AOC-D message in the ISDN Facility information element (IE) message.</li> </ul> <p><b>Note:</b></p> <ul style="list-style-type: none"> <li>■ Digital interfaces: If you configure the 'Currency' parameter (see below), the charge is sent with this currency (e.g., 5 USD).</li> <li>■ Digital interfaces: If you configure the 'Multiplier of Amount' parameter (see below), then the actual charge is the value of the 'Amount On Answer' parameter multiplied by the 'Multiplier of Amount' parameter value. For example, if you configure the 'Amount On Answer' parameter to 50 and the 'Multiplier of Amount' parameter to 0.1, then the charge sent is 5 (i.e., 50 x 0.1).</li> </ul>
<p>'Currency'  <code>currency</code>  <code>[ChargeCode_Currency]</code></p>	<p>Defines the currency of the charge.</p> <p>The valid value is a string of up to 10 characters. For example, "USD" (without quotation marks). By default, no value is defined. The device includes the currency in AOC messages in IA5 format.</p> <p><b>Note:</b></p> <ul style="list-style-type: none"> <li>■ The parameter is applicable only to the Euro ISDN protocol</li> </ul>

Parameter	Description
	<p>(Advice of Charge supplementary services).</p> <ul style="list-style-type: none"> <li>The parameter is applicable only to Tel-to-IP calls.</li> </ul>
'Multiplier of Amount' multiplier [ChargeCode_Multiplier]	<p>Defines the multiplier of the call connection charge (configured by the 'Amount On Answer' parameter) and the interval charge.</p> <ul style="list-style-type: none"> <li>[0] <b>0.001</b></li> <li>[1] <b>0.01</b> (default)</li> <li>[2] <b>0.1</b></li> <li>[3] <b>1</b></li> <li>[4] <b>10</b></li> <li>[5] <b>100</b></li> <li>[6] <b>1000</b></li> </ul> <p>For example, if you configure the parameter to <b>0.1</b> and the 'Amount On Answer' parameter to 50, the sent call connection charge is 5 (i.e., 50 x 0.1). In addition, if the interval charge is 1 (default), the charge for every interval is 0.1 (i.e., 1 x 0.1).</p> <p><b>Note:</b></p> <ul style="list-style-type: none"> <li>The parameter is applicable only to the Euro ISDN protocol (Advice of Charge supplementary services).</li> <li>The parameter is applicable only to Tel-to-IP calls.</li> </ul>

## Configuring Voice Mail

The Voice Mail Settings page lets you configure voice mail.



- For more information on voice mail, refer to the *IP-based Voice Mail Configuration Note*.
- For a detailed description of the voice mail parameters, see [Voice Mail Parameters](#).
- Voice mail is applicable only to FXO, CAS, QSIG, Euro ISDN, and NI2 interfaces.

### ➤ To configure voice mail:

1. Open the Voice Mail Settings page (**Setup** menu > **Signaling & Media** tab > **Gateway** folder > **Voice Mail Settings**).



GENERAL		DIGIT PATTERNS	
Line Transfer Mode	<input type="text" value="None"/>	Forward on Busy Digit Pattern (Internal)	<input type="text"/>
Voice Mail Interface	<input type="text" value="NONE"/>	Forward on No Answer Digit Pattern (Internal)	<input type="text"/>
<b>MESSAGE WAITING INDICATOR (MWI)</b>		Forward on Do Not Disturb Digit Pattern (Internal)	<input type="text"/>
MWI Off Digit Pattern	<input type="text"/>	Forward on No Reason Digit Pattern (Internal)	<input type="text"/>
MWI On Digit Pattern	<input type="text"/>	Forward on Busy Digit Pattern (External)	<input type="text"/>
MWI Suffix Pattern	<input type="text"/>	Forward on No Answer Digit Pattern (External)	<input type="text"/>
MWI Source Number	<input type="text"/>	Forward on Do Not Disturb Digit Pattern (External)	<input type="text"/>
<b>SMDI</b>		Forward on No Reason Digit Pattern (External)	<input type="text"/>
Enable SMDI	<input type="text" value="Disable"/>	Internal Call Digit Pattern	<input type="text"/>
SMDI Timeout [msec]	<input type="text" value="2000"/>	External Call Digit Pattern	<input type="text"/>
		Disconnect Call Digit Pattern	<input type="text"/>
		Digit To Ignore Digit Pattern	<input type="text"/>

2. Under the General group, configure the following:
  - 'Line Transfer Mode' (LineTransferMode): Defines the call transfer method used by the device.
  - 'Voice Mail Interface' (VoiceMailInterface): Enables the device's Voice Mail feature and defines the communication method between the device and PBX.
3. Under the Message Waiting Indicator group, configure the digit codes used by the device for relaying message waiting indication information to the PBX:
  - 'MWI Off Digit Pattern' (MWIOffCode): Defines the digit code indicating no messages waiting for a specific extension.
  - 'MWI On Digit Pattern' (MWIONCode): Defines the digit code indicating messages waiting for a specific extension.
  - 'MWI Suffix Pattern' (MWISuffixCode): Defines the digit code used as a suffix for 'MWI On Digit Pattern' and 'MWI Off Digit Pattern'.
  - 'MWI Source Number' (MWISourceNumber): Defines the calling party's phone number in the Q.931 MWI Setup message to PSTN.
4. Under the SMDI group, configure Simplified Message Desk Interface (SMDI):
  - 'Enable SMDI' (SMDI): Enables SMDI interface on the device.
  - 'SMDI Timeout' (SMDITimeOut): Defines the time (in msec) that the device waits for an SMDI Call Status message before or after a Setup message is received.
5. Under the Digit Patterns group, configure the digit patterns used by the PBX to indicate various services:

- 'Forward on Busy Digit Pattern Internal' (DigitPatternForwardOnBusy): Defines the digit pattern to indicate 'call forward on busy' when the original call is received from an internal extension.
- 'Forward on No Answer Digit Pattern Internal' (DigitPatternForwardOnNoAnswer): Defines the digit pattern to indicate 'call forward on no answer' when the original call is received from an internal extension.
- 'Forward on Do Not Disturb Digit Pattern Internal' (DigitPatternForwardOnDND): Defines the digit pattern to indicate 'call forward on do not disturb' when the original call is received from an internal extension.
- 'Forward on No Reason Digit Pattern Internal' (DigitPatternForwardNoReason): Defines the digit pattern to indicate 'call forward with no reason' when the original call is received from an internal extension.
- 'Forward on Busy Digit Pattern External' (DigitPatternForwardOnBusyExt): Defines the digit pattern to indicate 'call forward on busy' when the original call is received from an external line.
- 'Forward on No Answer Digit Pattern External' (DigitPatternForwardOnNoAnswerExt): Defines the digit pattern to indicate 'call forward on no answer' when the original call is received from an external line.
- 'Forward on Do Not Disturb Digit Pattern External' (DigitPatternForwardOnDNDExt): Defines the digit pattern to indicate 'call forward on do not disturb' when the original call is received from an external line.
- 'Forward on No Reason Digit Pattern External' (DigitPatternForwardNoReasonExt): Defines the digit pattern to indicate 'call forward with no reason' when the original call is received from an external line.
- 'Internal Call Digit Pattern' (DigitPatternInternalCall): Defines the digit pattern to indicate an internal call.
- 'External Call Digit Pattern' (DigitPatternExternalCall): Defines the digit pattern to indicate an external call.
- 'Disconnect Call Digit Pattern' (TelDisconnectCode): Defines a digit pattern that when received from the Tel side indicates the device to disconnect the call.
- 'Digit To Ignore Digit Pattern' (DigitPatternDigitToIgnore): Defines a digit pattern that if received as Src (S) or Redirect (R) numbers is ignored and not added to that number.

6. Click **Apply**.

## Converting Accented Characters from IP to Tel

The Char Conversion table lets you configure up to 40 Character Conversion rules. A Character Conversion rule maps (converts) accented characters (Unicode / UTF-8) received from the IP side into simple ASCII characters (ISO-8859) for sending to the Tel side. Typically, the device receives the caller ID and calling name in Unicode characters (in the SIP INVITE message).

Unicode characters consist of two bytes, while ASCII characters consist of one byte. Accented characters are used in various languages such as German. An example of such a character is the umlaut (or diaeresis), which consists of two dots placed over a letter, as in ä. The importance of this conversion feature is that it allows Tel entities that do not support accented characters, to receive ASCII characters. For example, the device can convert the Unicode character ä into the ASCII character "ae".



The table works in conjunction with the ISO8859CharacterSet parameter. When the parameter is set to [0] (Latin only), it converts accented characters into ASCII (e.g., ä to "a"). However, the table can be used to overwrite these "basic" conversions and customize them (e.g., ä to "ae" instead of the default "a").

The following procedure describes how to configure Character Conversion rules through the Web interface. You can also configure it through ini file [CharConversion] or CLI (`configure voip > gateway dtmf-suppl-service dtmf-and-dialing > char-conversion`).

➤ **To configure a Character Conversion rule:**

1. Open the Char Conversion table (**Setup** menu > **Signaling & Media** tab > **Gateway** folder > **DTMF & Supplementary** > **Char Conversion**).
2. Click **New**; the following dialog box appears:

GENERAL	
Index	0
Character Name	a with Diaeresis
First Byte	195
Second Byte	164
Converted Output	ae

The figure above shows a configuration example where ä is converted to ae.

3. Configure a Character Conversion rule according to the parameters described in the table below.
4. Click **Apply**.

**Table 28-8: Char Conversion Table Parameter Descriptions**

Parameter	Description
'Index' [CharConversion_ Index]	Defines an index number for the new table row. <b>Note:</b> Each row must be configured with a unique index.
'Character Name' char-name [CharConversion_ CharName]	Defines a descriptive name, which is used when associating the row in other tables. The valid value is a string of up to 40 characters. <b>Note:</b> Each row must be configured with a unique name.
'First Byte' first-byte [CharConversion_ FirstByte]	Defines the first byte of the Unicode character (e.g., 195). The default is 194.
'Second Byte' second-byte [CharConversion_ SecondByte]	Defines the second byte of the Unicode character (e.g., 164). The default is 128.
'Converted Output' converted- output [CharConversion_ ConvertedOutput]	Defines the ASCII character (e.g., "ae") to which the Unicode character must be converted. The valid value is a string of up to four characters. The valid value is up to four ASCII characters. This can include any ASCII character - alphanumerical (e.g., a, A, 6) and/or symbols (e.g., !, ?, _, &).

## 29 Analog Gateway

This section describes configuration of analog settings for the Gateway application.

### Configuring Keypad Features

The Keypad Features page lets you configure key sequences that can be pressed on the keypad of the phones that are connected to the device's FXS ports, for the following features:

- Activating and deactivating call forwarding
- Activating and deactivating caller ID restriction
- Activating and deactivating hotline for automatic dialing
- Activating and deactivating call waiting
- Activating and deactivating rejection of anonymous calls
- Activating and deactivating call pickup
- Configuring phone numbers



- This section is applicable only to FXS interfaces.
- The method used by the device to collect dialed numbers is identical to the method used during a regular call (i.e., max digits, interdigit timeout, digit map, etc.).
- The activation of each feature remains in effect until it is deactivated (i.e., not deactivated after a call).

The following procedure describes how to configure some of the keypad features through the Web interface. For a description of all the keypad parameters, see [Telephone Keypad Sequence Parameters](#).

➤ **To configure key sequences:**

1. Open the Keypad Features page (**Setup** menu > **Signaling & Media** tab > **Gateway** folder > **Analog Gateway** > **Keypad Features**).

<b>FORWARD</b>		<b>HOTLINE</b>	
Forward Unconditional	<input type="text"/>	Hot-line Activate	<input type="text"/>
Forward No Answer	<input type="text"/>	Hot-line Deactivate	<input type="text"/>
Forward On Busy	<input type="text"/>	<b>CALL WAITING</b>	
Forward On Busy or No Answer	<input type="text"/>	Call Waiting Activate	<input type="text"/>
Do Not Disturb	<input type="text"/>	Call Waiting Deactivate	<input type="text"/>
Forward Deactivate	<input type="text"/>	<b>REJECT ANONYMOUS CALL</b>	
<b>CALLER ID RESTRICTION</b>		Reject Anonymous Call Activate	<input type="text"/>
Restricted Caller ID Activate	<input type="text"/>	Reject Anonymous Call Deactivate	<input type="text"/>
Restricted Caller ID Deactivate	<input type="text"/>		

2. Configure the key sequence for each required call feature.
3. Click **Apply**.

## Configuring Metering Tones

The FXS interfaces can generate 12/16 KHz metering pulses toward the Tel side (e.g., for connection to a pay phone or private meter). Tariff pulse rate is according to the device's Charge Codes table. This capability enables users to define different tariffs according to the source/destination numbers and the time-of-day. The tariff rate includes the time interval between the generated pulses and the number of pulses generated on answer.



- The Metering Tones page is applicable only to FXS interfaces.
- Charge Code rules can be assigned to routing rules in the Tel-to-IP Routing table (see [Configuring Tel-to-IP Routing Rules](#)). When a new call is established, the Tel-to-IP Routing table is searched for the destination IP address. Once a route is located, the Charge Code (configured for that route) is used to associate the route with an entry in the Charge Codes table.

### ➤ To configure metering tone type:

1. Open the Analog Settings page (**Setup** menu > **Signaling & Media** tab > **Gateway** folder > **Analog Gateway** > **Analog Settings**).

Analog TTX Voltage Level	0.5V	<input type="button" value="⌵"/>	<input type="button" value="⚡"/>
Analog Metering Type	• 16 kHz sinusoidal bursts	<input type="button" value="⌵"/>	<input type="button" value="⚡"/>

2. From the 'Analog Metering Type' drop-down list (MeteringType), select the metering pulse generated toward the Tel side.

3. In the 'Analog TTX Voltage Level' field (AnalogTTXVoltageLevel), configure the metering signal/pulse voltage level.
4. Click **Apply**, and then reset the device with a save-to-flash for your settings to take effect.

## Configuring FXO Settings

The FXO Settings page lets you configure the device's specific FXO parameters. For a description of these parameters, see [Configuration Parameters Reference](#).



The FXO Settings page is applicable only to FXO interfaces.

### ➤ To configure the FXO parameters:

1. Open the FXO Settings page (**Setup** menu > **Signaling & Media** tab > **Gateway** folder > **Analog Gateway** > **FXO Settings**).

GENERAL	ADVANCED
<b>Dialing Mode</b>	Disconnect Call on Busy Tone Detection (CAS)
<input type="text" value="Two Stages"/>	<input type="text" value="Enable"/>
<b>Waiting for Dial Tone</b>	Disconnect On Dial Tone
<input type="text" value="No"/>	<input type="text" value="Disable"/>
Time to Wait before Dialing [msec]	Guard Time Between Calls
<input type="text" value="1000"/>	<input type="text" value="1"/>
Ring Detection Timeout [sec]	FXO Double Answer
<input type="text" value="8"/>	<input type="text" value="Disable"/>
Reorder Tone Duration [sec]	FXO AutoDial Play BusyTone
<input type="text" value="255"/>	<input type="text" value="Disable"/>
Rings before Detecting Caller ID	
<input type="text" value="1"/>	
Send Metering Message to IP	
<input type="text" value="No"/>	

2. Configure the parameters as required.
3. Click **Apply**.

## Configuring Authentication

The Authentication table lets you configure an authentication username and password per analog port.



- The feature is applicable only to the Gateway application - FXS and FXO interfaces.
- If authentication is configured for the entire device, configuration in the table is ignored.
- If the username or password is not configured in the table, the port's phone number (configured in the Trunk Group table) and global password (configured by the global parameter, Password) are used instead for authentication of the port.
- After you click **Apply**, the password is displayed as an asterisk (\*).

The following procedure describes how to configure authentication per port through the Web interface. You can also configure it through ini file [Authentication] or CLI (`configure voip > gateway analog authentication`).

➤ **To configure authentication credentials per port:**

1. Configure the device to authenticate per endpoint. You can configure this globally for all endpoints or for endpoints belonging to a specific Trunk Group:

- For all endpoints: Open the Proxy & Registration page (**Setup** menu > **Signaling & Media** tab > **SIP Definitions** folder > **Proxy & Registration**), and then configure the 'Authentication Mode' [AuthenticationMode] parameter to **Per Endpoint**:



- Endpoints per Trunk Group: Open the Trunk Group Settings table (see [Configuring Trunk Group Settings](#)), and then for the required Trunk Group ID, configure the 'Registration Mode' parameter to **Per Endpoint** (TrunkGroupSettings\_RegistrationMode).

2. Open the Authentication table (**Setup** menu > **Signaling & Media** tab > **Gateway** folder > **Analog Gateway** > **Authentication**).

3. Select the row corresponding to the port that you want to configure, and then click **Edit**; the following dialog box appears:

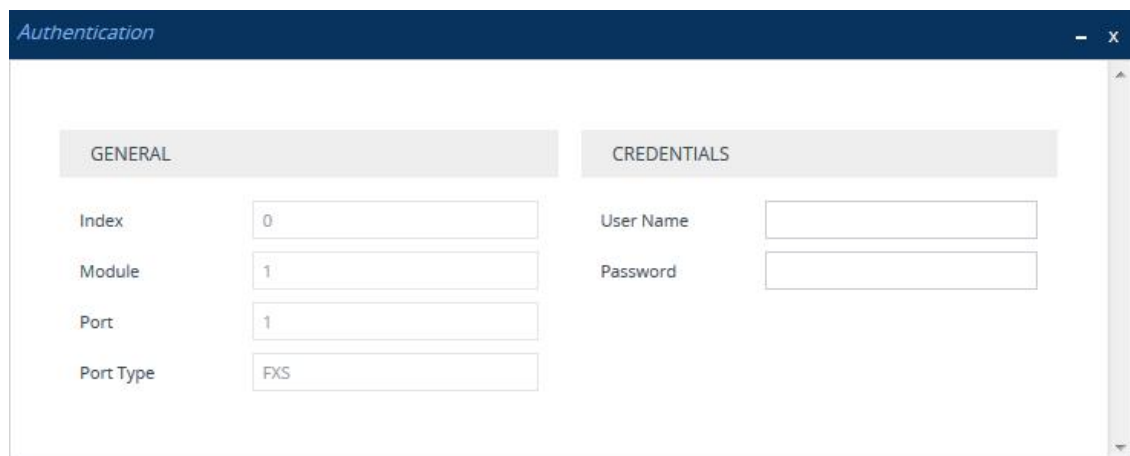

4. Configure the authentication username and password per port according to the parameters described in the table below.

5. Click **Apply**.

**Table 29-1: Authentication Table Parameter Descriptions**

Parameter	Description
<b>General</b>	
'Index'	(Read-only) Displays the index number of the table row.



Parameter	Description
[Authentication_Index]	
'Module' port-type [Authentication_Module]	(Read-only) Displays the module number on which the port is located.
'Port' port [Authentication_Port]	(Read-only) Displays the port number.
'Port Type' [Authentication_PortType]	(Read-only) Displays the port type (FXS or FXO).
<b>Credentials</b>	
'User Name' user-name [Authentication_UserId]	Defines the username for authenticating the port. The valid value is a string of up to 60 characters. By default, no value is defined.
'Password' password [Authentication_UserPassword]	Defines the password for authenticating the port. <b>Note:</b> The password cannot be configured with wide characters.

## Configuring Automatic Dialing

The Automatic Dialing table lets you configure telephone numbers that are automatically dialed when analog ports go off-hook. The dialing can be done immediately upon off-hook or after a user-defined interval after off-hook, referred to as *Hotline* dialing. For example, you can configure Hotline automatic dialing where if Port #1 remains off-hooked for over 15 seconds, the device automatically dials 911.



The feature is applicable only to FXS and FXO interfaces.

The following procedure describes how to configure automatic dialing upon off-hook through the Web interface. You can also configure it through ini file [TargetOfChannel] or CLI (configure voip > gateway analog automatic-dialing).

➤ **To configure automatic dialing per port:**

1. Open the Automatic Dialing table (**Setup** menu > **Signaling & Media** tab > **Gateway** folder > **Analog Gateway** > **Automatic Dialing**).
2. Select the row corresponding to the port that you want to configure, and then click **Edit**; the following dialog box appears:

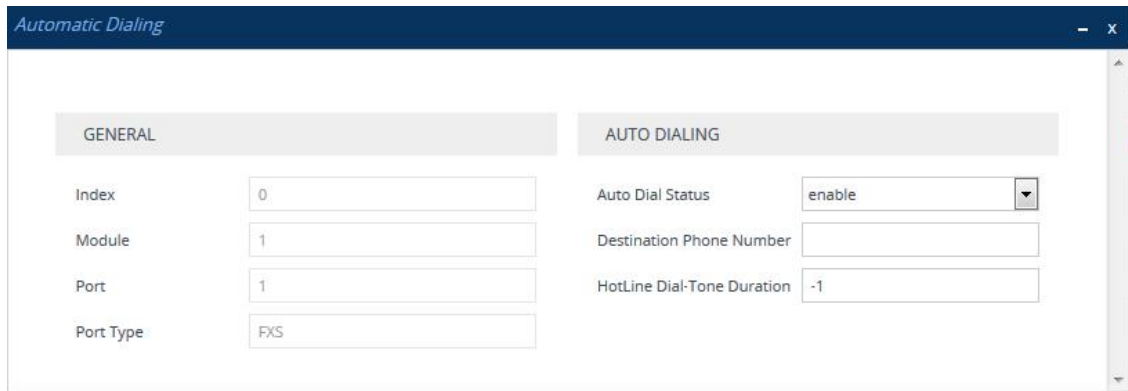

3. Configure automatic dialing per port according to the parameters described in the table below.
4. Click **Apply**.

**Table 29-2: Automatic Dialing Table Parameter Descriptions**

Parameter	Description
'Index' [TargetOfChannel_ Index]	(Read-only) Displays the index number of the table row.
'Module' [TargetOfChannel_ Module]	(Read-only) Displays the module number on which the port is located.
'Port' port [TargetOfChannel_ Port]	(Read-only) Displays the port number.
'Port Type' [TargetOfChannel_ PortType]	(Read-only) Displays the port type (FXS or FXO).
'Destination Phone Number' dst-number	Defines the destination telephone number to automatically dial.

Parameter	Description
[TargetOfChannel_Destination]	
'Auto Dial Status' auto-dial-status [TargetOfChannel_Type]	<p>Enables automatic dialing.</p> <ul style="list-style-type: none"> <li>■ [0] <b>Disable</b> = Automatic dialing for the specific port is disabled.</li> <li>■ [1] <b>Enable</b> = (Default) Automatic dialing is enabled and the phone number configured in the 'Destination Phone Number' field is automatically dialed if the following occurs: <ul style="list-style-type: none"> <li>✓ FXS interfaces: The phone is off-hooked</li> <li>✓ FXO interfaces: A ring signal (from a PBX/PSTN switch) is detected on the FXO line. The device initiates a call to the destination without seizing the FXO line. The line is seized only after the SIP call is answered.</li> </ul> </li> <li>■ [2] <b>Hotline</b> = Automatic dialing is done after an interval configured by the 'Hotline Dial Tone Duration' parameter: <ul style="list-style-type: none"> <li>✓ FXS interfaces: When the phone is off-hooked and no digit is dialed within a user-defined time, the configured destination number is automatically dialed.</li> <li>✓ FXO interfaces: If a ring signal is detected, the device seizes the FXO line, plays a dial tone, and then waits for DTMF digits. If no digits are detected within a user-defined time, the configured destination number is automatically dialed by sending a SIP INVITE message with this number.</li> </ul> </li> </ul>
'Hotline Dial Tone Duration' hotline-dial-tone-duration [TargetOfChannel_HotLineToneDuration]	<p>Defines the duration (in seconds) after which the destination phone number is automatically dialed. This is applicable only if the port has been configured for Hotline (i.e., 'Auto Dial Status' is set to <b>Hotline</b>).</p> <p>The valid value is 0 to 60. The default is 16.</p> <p><b>Note:</b> You can configure this Hotline interval for all ports, using the global parameter [HotLineToneDuration].</p>

## Configuring Caller Display Information

The Caller Display Information table lets you configure caller identification strings (Caller ID) per analog port. The table also lets you enable the device to send Caller ID to the IP side for Tel-to-IP calls. The device sends the configured caller ID in the From header of the outgoing SIP INVITE

message. For more information on Caller ID restriction according to destination/source prefixes, see [Configuring Source/Destination Number Manipulation](#).



- The feature is applicable to FXS and FXO interfaces.
- If an FXS port receives 'private' or 'anonymous' strings in the SIP From header, the calling name or number is not sent to the Caller ID display.
- If the device detects Caller ID on an FXO line (EnableCallerID = 1), it uses this Caller ID instead of the Caller ID configured in the Caller Display Information table.

The following procedure describes how to configure caller ID through the Web interface. You can also configure it through ini file [CallerDisplayInfo] or CLI (`configure voip > gateway analog caller-display-info`).

➤ **To configure caller ID:**

1. Open the Caller Display Information table (**Setup** menu > **Signaling & Media** tab > **Gateway** folder > **Analog Gateway** > **Caller Display Information**).
2. Select the row corresponding to the port that you want to configure, and then click **Edit**; the following dialog box appears:

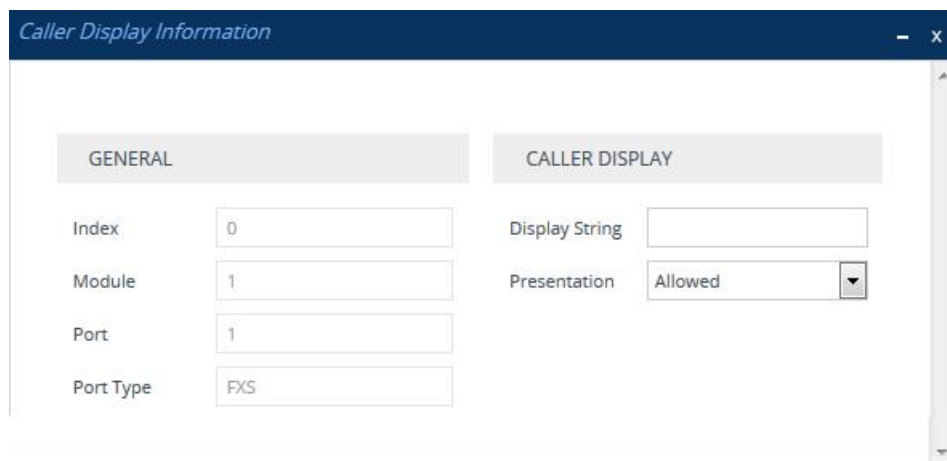

3. Configure caller ID per port according to the parameters described in the table below.
4. Click **Apply**.

**Table 29-3: Caller Display Information Table Parameter Descriptions**

Parameter	Description
<b>General</b>	
'Index' [CallerDisplayInfo_ Index]	(Read-only) Displays the index number of the table row.
'Module'	(Read-only) Displays the module number on which the port is

Parameter	Description
[CallerDisplayInfo_ Module]	located.
'Port' [CallerDisplayInfo_ Port]	(Read-only) Displays the port number.
'Port Type' [CallerDisplayInfo_ PortType]	(Read-only) Displays the port type (FXS or FXO).
<b>Caller Display</b>	
'Display String' display-string [CallerDisplayInfo_ DisplayString]	<p>Defines the Caller ID string.</p> <p>The valid value is a string of up to 18 characters.</p> <p><b>Note:</b> If you configure the parameter to "Private" or "Anonymous" (without quotation marks), Caller ID is restricted and the settings of the 'Presentation' parameter is ignored.</p>
'Presentation' presentation [CallerDisplayInfo_ IsCidRestricted]	<p>Enables the sending of the caller ID string.</p> <ul style="list-style-type: none"> <li>■ [0] <b>Allowed</b> = The caller ID string is sent when a Tel-to-IP call is made.</li> <li>■ [1] <b>Restricted</b> = The caller ID string is not sent. The Caller ID is sent to the remote side using only the SIP P-Asserted-Identity or P-Preferred-Identity headers, according to the AssertedIdMode parameter.</li> </ul> <p><b>Note:</b> The parameter is overridden by the 'Presentation' parameter in the Source Number Manipulation table (see <a href="#">Configuring Source/Destination Number Manipulation</a>).</p>

## Configuring Call Forward

The Call Forward table lets you configure call forwarding per analog port for IP-to-Tel calls. Call forwarding redirects calls, using a SIP 302 response, initially destined to a specific port to a different port on the device or to an IP destination. You can configure the reason upon which the call is forwarded:

- Immediate: incoming call is forwarded immediately and unconditionally.
- Busy: incoming call is forwarded if the endpoint is busy.
- No Reply: incoming call is forwarded if it isn't answered for a specified time.

- On Busy or No Reply: incoming call is forwarded if the port is busy or when calls are not answered after a specified time.
- Do Not Disturb: immediately reject incoming calls. Upon receiving a call for a Do Not Disturb, the SIP 603 (Decline) response code is sent.

 • The feature is applicable only to FXS and FXO interfaces.  
 • To enable call forwarding, see [Enabling Call Forwarding](#).

The following procedure describes how to configure call forwarding per port through the Web interface. You can also configure it through ini file [FwdInfo] or CLI (`configure voip > gateway analog call-forward`).

➤ **To configure call forwarding per port:**

1. Open the Call Forward table (**Setup** menu > **Signaling & Media** tab > **Gateway** folder > **Analog Gateway** > **Call Forward**).
2. Select the row corresponding to the port that you want to configure, and then click **Edit**; the following dialog box appears:

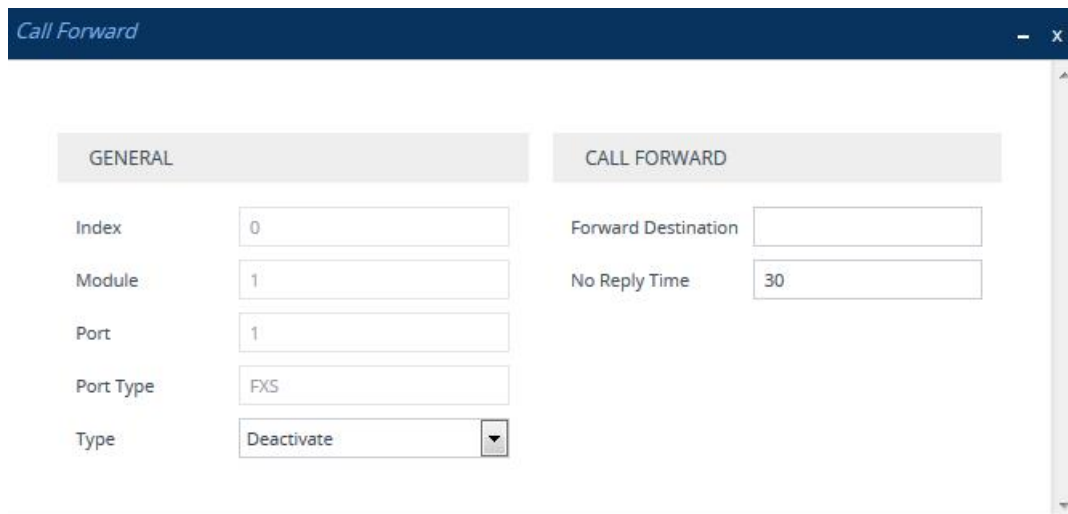

3. Configure call forwarding per port according to the parameters described in the table below.
4. Click **Apply**.

**Table 29-4: Call Forward Table Parameter Descriptions**

Parameter	Description
<b>General</b>	
'Index' [FwdInfo_Index]	(Read-only) Displays the index number of the table row.

Parameter	Description
'Module' [FwdInfo_ Module]	(Read-only) Displays the module number on which the port is located.
'Port' [FwdInfo_Port]	(Read-only) Displays the port number.
'Port Type' [FwdInfo_ PortType]	(Read-only) Displays the port type (FXS or FXO).
'Type' type [FwdInfo_Type]	<p>Defines the condition upon which the call is forwarded.</p> <ul style="list-style-type: none"> <li>■ [0] <b>Deactivate</b> = (Default) Don't forward incoming calls.</li> <li>■ [1] <b>On Busy</b> = Forward incoming calls when the port is busy.</li> <li>■ [2] <b>Unconditional</b> = Always forward incoming calls.</li> <li>■ [3] <b>No Answer</b> = Forward incoming calls that are not answered within the time specified in the 'No Reply Time' field.</li> <li>■ [4] <b>On Busy or No Answer</b> = Forward incoming calls when the port is busy or when calls are not answered within the time specified in the 'No Reply Time' field.</li> <li>■ [5] <b>Don't Disturb</b> = Immediately reject incoming calls.</li> </ul>
<b>Call Forward</b>	
'Forward Destination' destination [FwdInfo_ Destination]	<p>Defines the telephone number or URI (&lt;number&gt;@&lt;IP address&gt;) to where the call is forwarded.</p> <p><b>Note:</b> If the parameter is configured with only a telephone number and a Proxy isn't used, this forwarded-to phone number must be specified in the Tel-to-IP Routing table (see <a href="#">Configuring Tel-to-IP Routing Rules</a>).</p>
'No Reply Time' no-reply-time [FwdInfo_ NoReplyTime]	<p>If you have set the 'Type' parameter for this port to <b>No Answer</b> or <b>On Busy or No Answer</b>, then configure the number of seconds the device waits before forwarding the call to the specified phone number.</p> <p><b>Note:</b> If you deactivate an active call forwarding rule (i.e., 'Type' parameter changed to <b>Deactivate</b>), the configured value in the 'No Reply Time' parameter is maintained and the value in the 'Forward Destination' parameter is deleted.</p>

## Configuring Caller ID Permissions

The Caller ID Permissions table lets you enable Caller ID generation per port for FXS interfaces and detection for FXO interfaces.



- The feature is applicable only to FXS and FXO interfaces.
- For ports that are not configured in the table, Caller ID is according to the global parameter, as described in [Enabling Caller ID Generation and Detection on Tel Side](#).

The following procedure describes how to configure Caller ID permissions through the Web interface. You can also configure it through ini file [EnableCallerID] or CLI (`configure voip > gateway analog enable-caller-id`).

➤ **To configure Caller ID permissions per port:**

1. Open the Caller ID Permissions table (**Setup** menu > **Signaling & Media** tab > **Gateway** folder > **Analog Gateway** > **Caller ID Permissions**).
2. Select the row corresponding to the port that you want to configure, and then click **Edit**; the following dialog box appears:

3. Configure a Caller ID permission per port according to the parameters described in the table below.
4. Click **Apply**.

**Table 29-5: Caller ID Permissions Table Parameter Descriptions**

Parameter	Description
General	
'Index' [EnableCallerId_Index]	Defines an index number for the new table row. <b>Note:</b> Each row must be configured with a unique index.



Parameter	Description
'Module' [EnableCallerId_Module]	(Read-only) Displays the module number on which the port is located.
'Port' [EnableCallerId_Port]	(Read-only) Displays the port number.
'Port Type' [EnableCallerId_PortType]	(Read-only) Displays the port type (e.g., FXS).
Caller ID	
'Caller ID' caller-id [EnableCallerId_IsEnabled]	Enables Caller ID generation (FXS) or detection (FXO) for the port.  <input type="checkbox"/> 0] <b>Disable</b> <input type="checkbox"/> [1] <b>Enable</b>

## Configuring Call Waiting

The Call Waiting table lets you enable call waiting per FXS port. When call waiting is enabled for a port and the device receives a call for the port, if the port is busy (i.e., currently in another call):

1. The device responds to the caller with a SIP 182 response (instead of a 486 busy).
2. The device plays a call waiting indication signal to the busy port.
3. When the device detects a hook-flash from the port, the device switches to the waiting call.
4. The device plays a call waiting ringback tone to the calling party after a 182 response is received.



- The feature is applicable only to FXS interfaces.
- For ports that are not configured in the table, call waiting is according to the global parameter, as described in [Enabling Call Waiting](#).
- In the installed CPT file, you must include the "Call Waiting Ringback" (#17) tone (heard by the calling party) and "Call Waiting" (#9) tone (heard by the called party, for FXS interfaces only). For more information, see [Call Progress Tones File](#).
- For call waiting support, you must enable call hold for the calling and called parties, as described in [Enabling Call Waiting](#).
- For additional call waiting configuration, see [Enabling Call Waiting](#).

The following procedure describes how to configure call waiting per port through the Web interface. You can also configure it through ini file [CallWaitingPerPort] or CLI (`configure voip > gateway analog call-waiting`).

➤ **To enable call waiting per port:**

1. Open the Call Waiting table (**Setup** menu > **Signaling & Media** tab > **Gateway** folder > **Analog Gateway** > **Call Waiting**).
2. Select the row corresponding to the port that you want to configure, and then click **Edit**; the following dialog box appears:

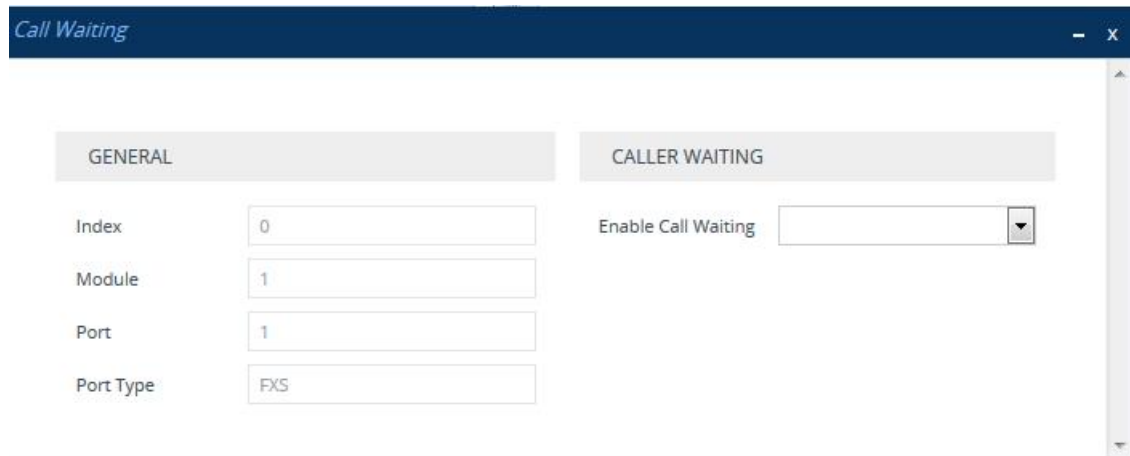

3. Configure call waiting per port according to the parameters described in the table below.
4. Click **Apply**.

**Table 29-6: Call Waiting Table Parameter Descriptions**

Parameter	Description
General	
'Index' [CallWaitingPerPort_Index]	Defines an index number for the new table row. <b>Note:</b> Each row must be configured with a unique index.
'Module' [CallWaitingPerPort_Module]	(Read-only) Displays the module number on which the port is located.
'Port' [CallWaitingPerPort_Port]	(Read-only) Displays the port number.
'Port Type' [CallWaitingPerPort_PortType]	(Read-only) Displays the port type (e.g., FXS).

Parameter	Description
Caller Waiting	
'Enable Call Waiting' enable-call-waiting [CallWaitingPerPort_Enabled]	Enables call waiting for the port.  <ul style="list-style-type: none"> <li>■ [0] <b>Disable</b></li> <li>■ [1] <b>Enable</b></li> </ul>

## Rejecting Anonymous Calls

The device can reject anonymous calls received from the IP and destined to an FXS port. To configure the functionality, use the ini file parameter, `RejectAnonymousCallPerPort`. If configured for a specific port and the port receives an anonymous call, the device rejects the call and responds with a SIP 433 (Anonymity Disallowed) response. For a description of the parameter see [Caller ID Parameters](#).



The feature is applicable only to FXS interfaces.

## Configuring FXS Distinctive Ringing and Call Waiting Tones per Source/Destination Number

The Tone Index table lets you configure up to 50 rules, which define distinctive ringing tones and call waiting tones per calling (source) and called (destination) number (or prefix) for IP-to-Tel calls. You can configure the feature per FXS port or for a range of FXS ports. Therefore, different tones can be played per FXS port, depending on the source or destination number of the received call. You can also configure multiple entries with different source or destination prefixes and tones for the same FXS port.

Typically, the played ring tone or call waiting tone is indicated in the SIP Alert-Info header of the received INVITE message. However, if the header is not present, the feature is used and the tone played is according to the settings in this table.



- The feature is applicable only to FXS interfaces.
- To enable call waiting, see [Configuring Call Waiting](#).

The following procedure describes how to configure tones per FXS port through the Web interface. You can also configure it through ini file [`ToneIndex`] or CLI (`configure voip > gateway analog tone-index`).

➤ **To configure distinctive ringing and call waiting tones per FXS port:**

1. Open the Tone Index table (**Setup** menu > **Signaling & Media** tab > **Gateway** folder > **Analog Gateway** > **Tone Index**).
2. Click **New**; the following dialog box appears:

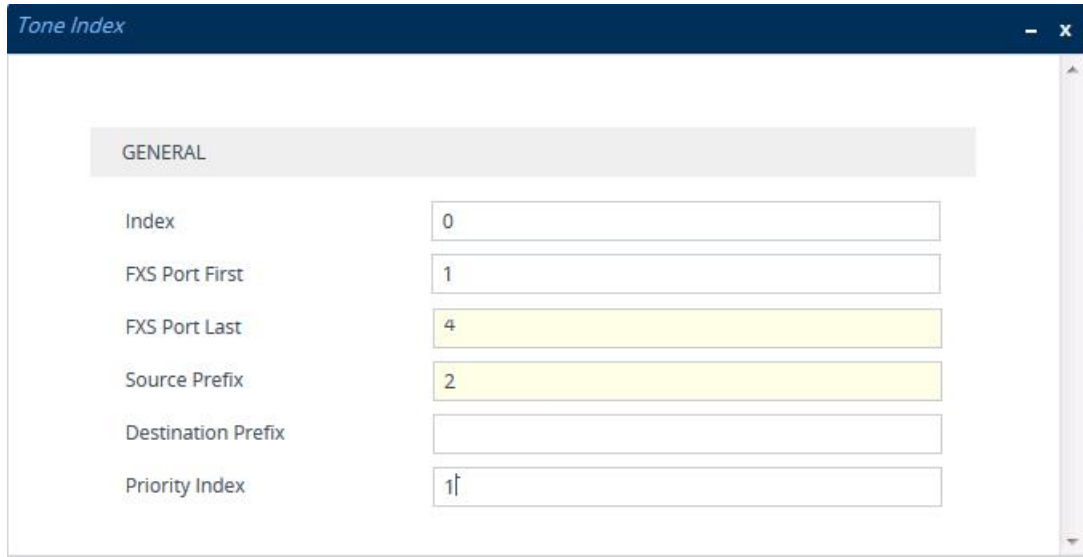

The figure above shows a configuration example for using distinctive ringing and call waiting tones of Index #9 ('Priority Index' 1) in the CPT file for FXS endpoints 1 through 4 when a call is received from a calling (source) number with prefix 2.

3. Configure distinctive ringing and call waiting tones per port according to the parameters described in the table below.
4. Click **Apply**.

**Table 29-7: Tone index Table Parameter Description**

Parameter	Description
'Index'	Defines the table index entry.
'FXS Port First' fxs-port-first [ToneIndex_ FXSPort_First]	Defines the first port in the FXS port range.
'FXS Port Last' fxs-port-last [ToneIndex_ FXSPort_Last]	Defines the last port in the FXS port range.

Parameter	Description
'Source Prefix' src-pattern [ToneIndex_ SourcePrefix]	Defines the prefix of the calling number.
'Destination Prefix' dst-pattern [ToneIndex_ DestinationPrefix]	Defines the prefix of the called number.
'Priority Index' priority [ToneIndex_ PriorityIndex]	<p>Defines the index of the distinctive ringing and call waiting tones.</p> <p>The call waiting tone index is equal to the value of the 'Priority Index' parameter plus the value of the FirstCallWaitingToneID parameter (which defines the index of the first call waiting tone in the CPT file). For example, if you want to use the call waiting tone in the CPT file that is defined at Index #9, you need to configure the 'Priority Index' parameter to "1" and the FirstCallWaitingToneID parameter to "8". The summation of these values is 9 (1 + 8).</p> <p>The default is 0.</p> <p>To configure the CPT file, see <a href="#">Call Progress Tones File</a>.</p>

## Analog Coefficient Types

The device can use the following analog Coefficient types:

### ■ FXS:

- USA line type: 600 ohm AC impedance and 40 V RMS ringing voltage for ringer equivalence number (REN) of 3
- European standard (TBR21)

### ■ FXO:

- REN: 0.5
- USA line type: 600 ohm AC impedance
- European standard (TBR21)

The Coefficient types increase return loss and trans-hybrid loss performance for two telephony line type interfaces (US or European). The adaptation is performed by modifying the telephony interface characteristics. This means, for example, that changing impedance matching or hybrid balance doesn't require hardware modifications, so that a single device is able to meet requirements for different markets. The digital design of the filters and gain stages also

ensures high reliability, no drifts (over temperature or time) and simple variations between different line types.

The FXS Coefficient types provide best termination and transmission quality adaptation for two FXS line type interfaces. The parameter affects the following AC and DC interface parameters:

- DC (battery) feed characteristics
- AC impedance matching
- Transmit gain
- Receive gain
- Hybrid balance
- Frequency response in transmit and receive direction
- Hook thresholds
- Ringing generation and detection parameters

➤ **To select the Coefficient types:**

1. Open the Analog Settings page (**Setup** menu > **Signaling & Media** tab > **Gateway** folder > **Analog Gateway** > **Analog Settings**).

COEFFICIENT

FXS Coefficient Type	<input style="width: 90%; border: 1px solid #ccc;" type="text" value="USA"/> <span style="float: right; border-left: 1px solid #ccc; border-top: 1px solid #ccc; border-bottom: 1px solid #ccc; padding: 0 5px;">▼</span> <span style="font-size: 0.8em; color: #00aaff; margin-left: 5px;">⚡</span>
FXO Coefficient Type	<input style="width: 90%; border: 1px solid #ccc;" type="text" value="USA"/> <span style="float: right; border-left: 1px solid #ccc; border-top: 1px solid #ccc; border-bottom: 1px solid #ccc; padding: 0 5px;">▼</span> <span style="font-size: 0.8em; color: #00aaff; margin-left: 5px;">⚡</span>

2. From the 'FXS Coefficient Type' drop-down list (FXSCountryCoefficients), select the required FXS Coefficient type.
3. From the 'FXO Coefficient Type' drop-down list (CountryCoefficients), select the required FXO Coefficient type.
4. Click **Apply**, and then reset the device with a save-to-flash for your settings to take effect.

## FXO Operating Modes

This section provides a description of the device's FXO operating modes:

- For IP-to-Tel calls (see [FXO Operations for IP-to-Tel Calls](#))
- For Tel-to-IP calls (see [FXO Operations for Tel-to-IP Calls](#))
- Call termination on FXO devices (see [Call Termination on FXO Devices](#))

### FXO Operations for IP-to-Tel Calls

The FXO device provides the following operating modes for IP-to-Tel calls:

- One-stage dialing (see [One-Stage Dialing](#))
  - Waiting for dial tone (see [Two-Stage Dialing](#))
  - Time to wait before dialing
  - Answer supervision
- Two-stage dialing (see [Two-Stage Dialing](#))
- Dialing time: DID wink (see [DID Wink](#))

### One-Stage Dialing

One-stage dialing is when the FXO device receives an IP-to-Tel call, off-hooks the PBX line connected to the telephone, and then immediately dials the destination telephone number. In other words, the IP caller doesn't dial the PSTN number upon hearing a dial tone.

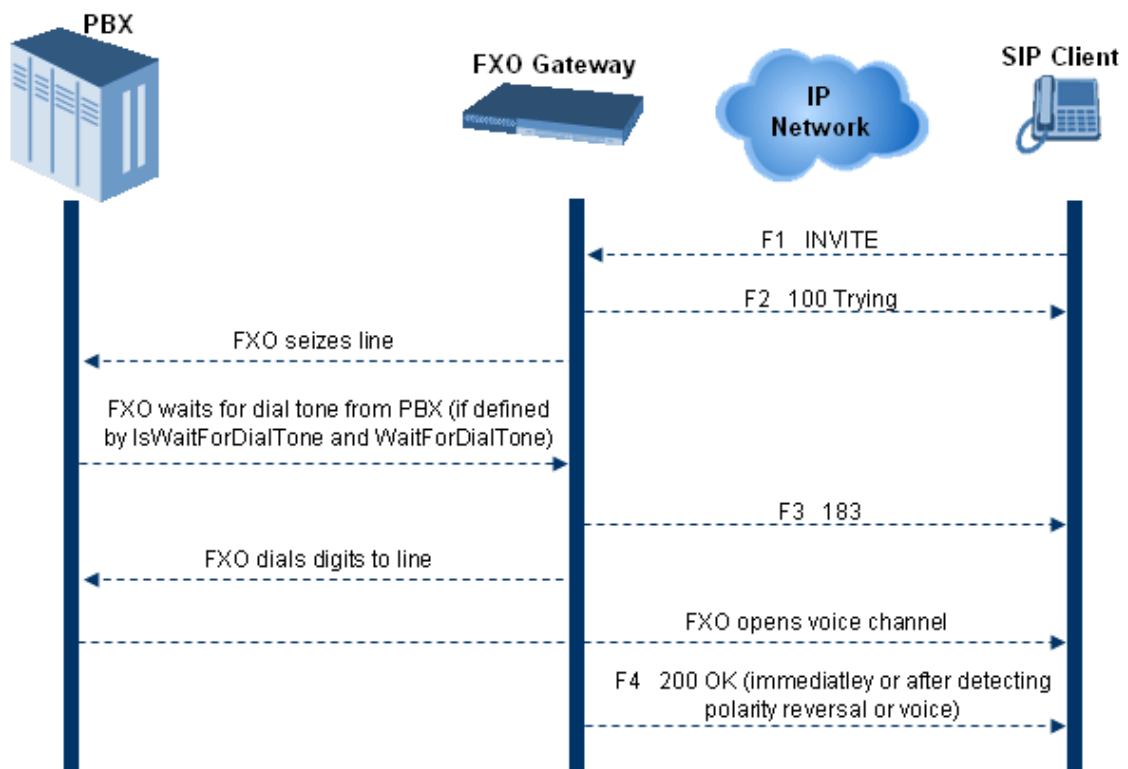

One-stage dialing incorporates the following FXO functionality:

- **Waiting for Dial Tone:** Enables the device to dial the digits to the Tel side only after detecting a dial tone from the PBX line. The *ini* file parameter `IsWaitForDialTone` is used to configure this operation.
- **Time to Wait Before Dialing:** Defines the time (in msec) between seizing the FXO line and starting to dial the digits. The *ini* file parameter `WaitForDialTime` is used to configure this operation.



The *ini* file parameter `IsWaitForDialTone` must be disabled for this mode.

- **Answer Supervision:** The Answer Supervision feature enables the FXO device to determine when a call is connected, by using one of the following methods:
  - **Polarity Reversal:** the device sends a 200 OK in response to an INVITE only when it detects a polarity reversal.
  - **Voice Detection:** the device sends a 200 OK in response to an INVITE only when it detects the start of speech (fax or modem answer tone) from the Tel side. Note that the IPM detectors must be enabled.

### Two-Stage Dialing

Two-stage dialing is when the IP caller is required to dial twice. The caller initially dials to the FXO device and only after receiving a dial tone from the PBX (via the FXO device), dials the destination telephone number.

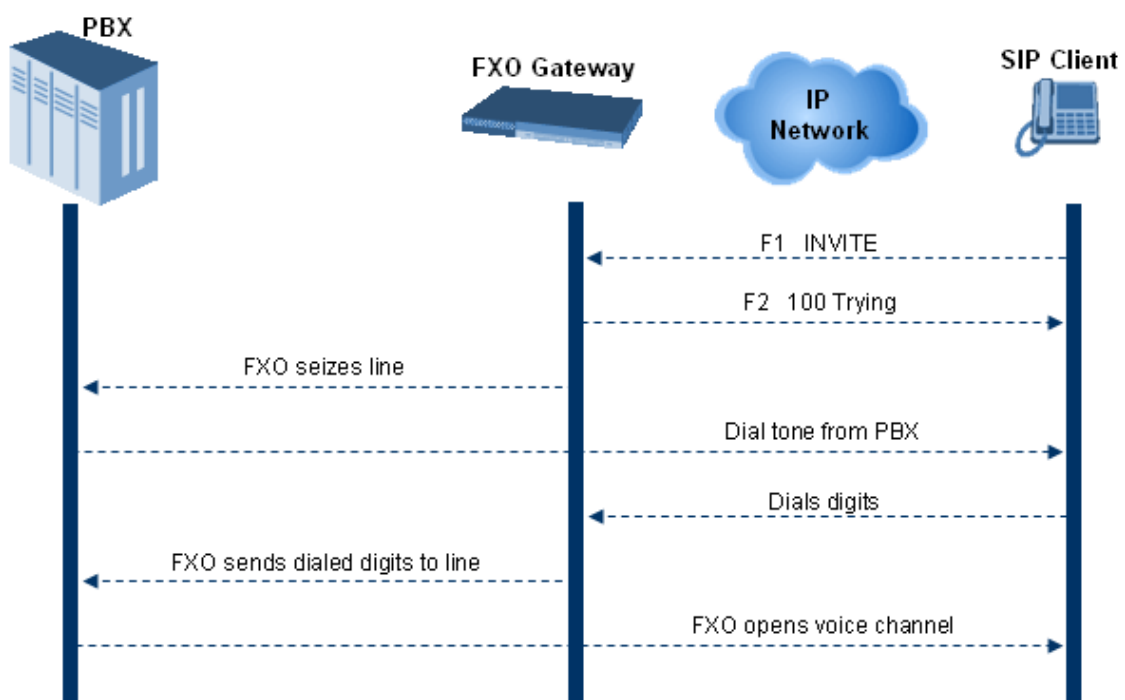

Two-stage dialing implements the Dialing Time feature. Dialing Time allows you to define the time that each digit can be separately dialed. By default, the overall dialing time per digit is 200 msec. The longer the telephone number, the greater the dialing time.

The relevant parameters for configuring Dialing Time include the following:

- **DTMFDigitLength (100 msec):** time for generating DTMF tones to the PSTN (PBX) side
- **DTMFInterDigitInterval (100 msec):** time between generated DTMF digits to PSTN (PBX) side

### DID Wink

The device's FXO ports support Direct Inward Dialing (DID). DID is a service offered by telephone companies that enables callers to dial directly to an extension on a PBX without the



assistance of an operator or automated call attendant. This service makes use of DID trunks, which forward only the last three to five digits of a phone number to the PBX. If, for example, a company has a PBX with extensions 555-1000 to 555-1999, and a caller dials 555-1234, the local central office (CO) would forward, for example, only 234 to the PBX. The PBX would then ring extension 234.

DID wink enables the originating end to seize the line by going off-hook. It waits for acknowledgment from the other end before sending digits. This serves as an integrity check that identifies a malfunctioning trunk and allows the network to send a re-order tone to the calling party.

The "start dial" signal is a wink from the PBX to the FXO device. The FXO then sends the last four to five DTMF digits of the called number. The PBX uses these digits to complete the routing directly to an internal station (telephone or equivalent).



- DID Wink can be used for connection to EIA/TIA-464B DID Loop Start lines.
- DID service for FXS interfaces is also supported.

## FXO Operations for Tel-to-IP Calls

The FXO device provides the following FXO operating modes for Tel-to-IP calls:

- Automatic Dialing (see [Automatic Dialing](#))
- Collecting Digits Mode (see [Collecting Digits Mode](#))
- FXO Supplementary Services (see [FXO Supplementary Services](#))
  - Hold/Transfer Toward the Tel side
  - Hold/Transfer Toward the IP side
  - Blind Transfer to the Tel side

### Automatic Dialing

The SIP call flow diagram below illustrates Automatic Dialing:

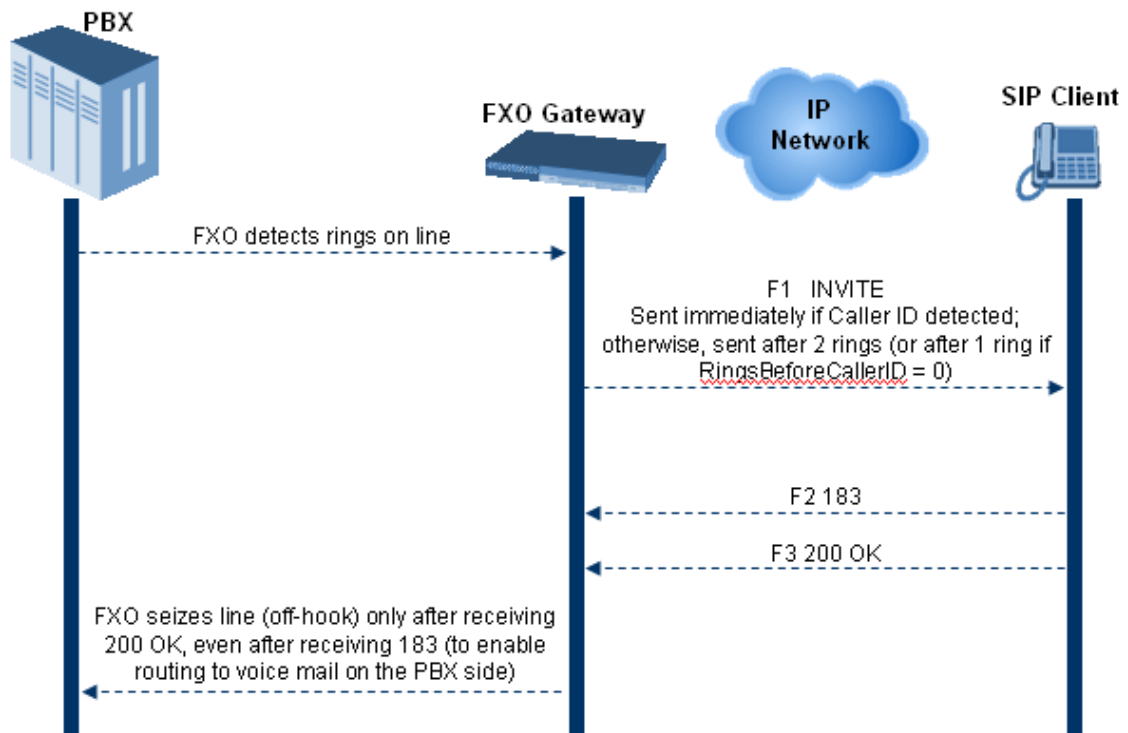

To configure Automatic dialing, see [Configuring Automatic Dialing](#).

### Collecting Digits Mode

When automatic dialing is not configured, the device collects the digits. The SIP call flow diagram below illustrates the Collecting Digits Mode.

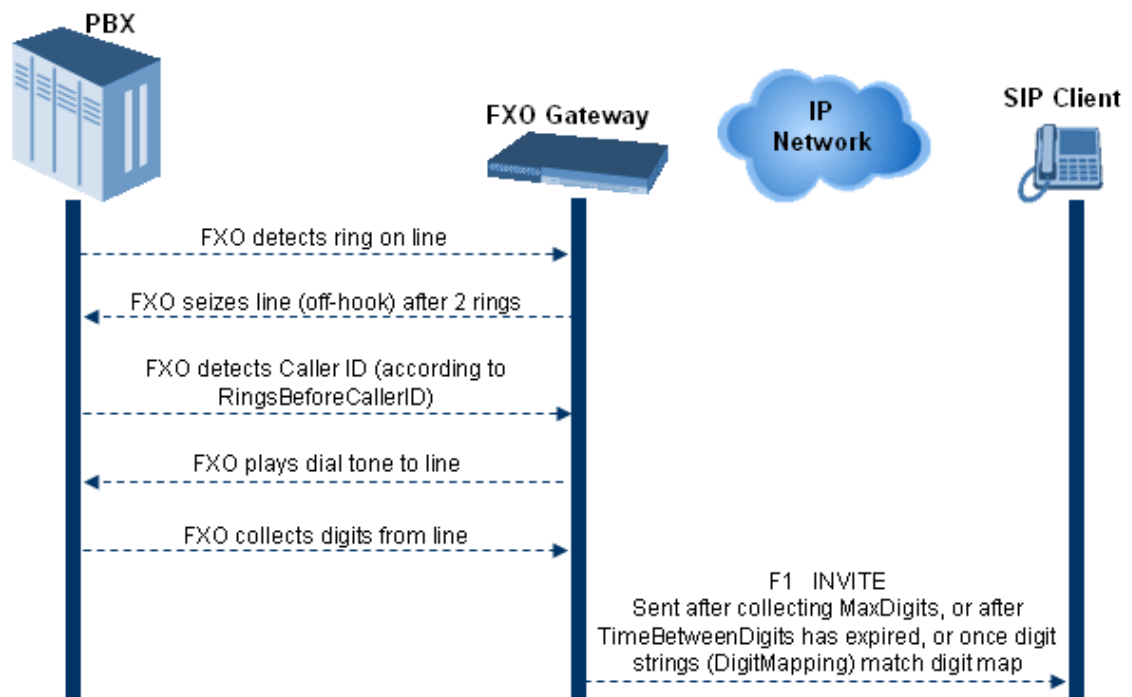

## FXO Supplementary Services

The FXO supplementary services include the following:

- **Hold / Transfer toward the Tel side:** The *ini* file parameter `LineTransferMode` must be set to 0 (default). If the FXO receives a hook-flash from the IP side (using out-of-band or RFC 2833), the device sends the hook-flash to the Tel side by performing one of the following:

- Performing a hook flash (i.e., on-hook and off-hook)
- Sending a hook-flash code (defined by the *ini* file parameter `HookFlashCode`)

The PBX may generate a dial tone that is sent to the IP, and the IP side may dial digits of a new destination.

- **Blind Transfer to the Tel side:** A blind transfer is one in which the transferring phone connects the caller to a destination line before ringback begins. The *ini* file parameter `LineTransferMode` must be set to 1.

The blind transfer call process is as follows:

- FXO receives a REFER request from the IP side
  - FXO sends a hook-flash to the PBX, dials the digits (that are received in the Refer-To header), and then drops the line (on-hook). Note that the time between flash to dial is according to the `WaitForDialTime` parameter.
  - PBX performs the transfer internally
- **Hold / Transfer toward the IP side:** The FXO device doesn't initiate hold / transfer as a response to input from the Tel side. If the FXO receives a REFER request (with or without replaces), it generates a new INVITE according to the Refer-To header.

## Call Termination on FXO Devices

This section describes the device's call termination capabilities for its FXO interfaces:

- Calls terminated by a PBX (see [Call Termination by PBX](#))
- Calls terminated before call establishment (see [Call Termination before Call Establishment](#))
- Ring detection timeout (see [Ring Detection Timeout](#))

### Calls Termination by PBX

The FXO device supports various methods for identifying when a call has been terminated by the PBX.

The PBX doesn't disconnect calls, but instead signals to the device that the call has been disconnected using one of the following methods:

- **Detection of polarity reversal/current disconnect:** The call is immediately disconnected after polarity reversal or current disconnect is detected on the Tel side (assuming the PBX/CO generates this signal). This is the recommended method.

Relevant parameters: [EnableReversalPolarity], [EnableCurrentDisconnect], [CurrentDisconnectDuration], [CurrentDisconnectDefaultThreshold], and [TimeToSampleAnalogLineVoltage].

- **Detection of Reorder, Busy, Dial, and Special Information Tone (SIT) tones:** The call is immediately disconnected after a Reorder, Busy, Dial, or SIT tone is detected on the Tel side (assuming the PBX / CO generates this tone). This method requires the correct tone frequencies and cadence to be defined in the Call Progress Tones file. If these frequencies are unknown, define them in the CPT file. The tone produced by the PBX / CO must be recorded and its frequencies analyzed. This method is slightly less reliable than the previous one.

Relevant parameters: [DisconnectOnBusyTone] and [DisconnectOnDialTone].

- **Detection of silence:** The call is disconnected after silence is detected on both call directions for a specific (configurable) amount of time. The call is not disconnected immediately. Thus, use this method only as a backup option.

Relevant parameters: [EnableSilenceDisconnect] and [FarEndDisconnectSilencePeriod].

- **Special DTMF code:** A digit pattern that when received from the Tel side, indicates to the device to disconnect the call.

Relevant parameter: [TelDisconnectCode].

- **Interruption of RTP stream:** Relevant parameters: [BrokenConnectionEventTimeout] and [DisconnectOnBrokenConnection].



This method operates correctly only if silence suppression is not used.

- **Protocol-based termination of the call from the IP side**



Note: The implemented disconnect method must be supported by the CO or PBX.

## Call Termination before Call Establishment

The device supports the following call termination methods before a call is established:

- **Call termination upon receipt of SIP error response (in Automatic Dialing mode):** By default, when the FXO device operates in Automatic Dialing mode, there is no method to inform the PBX if a Tel-to-IP call has failed (SIP error response - 4xx, 5xx or 6xx - is received). The reason is that the FXO device does not seize the line until a SIP 200 OK response is received. Use the FXOAutoDialPlayBusyTone parameter to allow the device to play a busy / reorder tone to the PSTN line if a SIP error response is received. The FXO device seizes the line (off-hook) for the duration defined by the TimeForReorderTone parameter. After playing the tone, the line is released (on-hook).
- **Call termination after caller (PBX) on-hooks phone (Ring Detection Timeout feature):** This method operates in one of the following manners:

- **Automatic Dialing is enabled:** if the remote IP party doesn't answer the call and the ringing signal (from the PBX) stops for a user-defined time (configured by the parameter FXOBetweenRingTime), the FXO device releases the IP call.
- **No automatic dialing and Caller ID is enabled:** the device seizes the line after detection of the second ring signal (allowing detection of caller ID sent between the first and the second rings). If the second ring signal is not received within this timeout, the device doesn't initiate a call to IP.

### Ring Detection Timeout

The operation of Ring Detection Timeout depends on the following:

- **Automatic dialing is disabled and Caller ID is enabled:** if the second ring signal is not received for a user-defined time (using the parameter FXOBetweenRingTime), the FXO device doesn't initiate a call to the IP.
- **Automatic dialing is enabled:** if the remote party doesn't answer the call and the ringing signal stops for a user-defined time (using the parameter FXOBetweenRingTime), the FXO device releases the IP call.

Ring Detection Timeout supports full ring cycle of ring on and ring off (from ring start to ring start).

### Remote PBX Extension between FXO and FXS Devices

Remote PBX extension offers a company the capability of extending the "power" of its local PBX by allowing remote phones (remote offices) to connect to the company's PBX over the IP network (instead of via PSTN). This is as if the remote office is located in the head office (where the PBX is installed). PBX extensions are connected through FXO ports to the IP network, instead of being connected to individual telephone stations. At the remote office, FXS units connect analog phones to the same IP network. To produce full transparency, each FXO port is mapped to an FXS port (i.e., one-to-one mapping). This allows individual extensions to be extended to remote locations. To call a remote office worker, a PBX user or a PSTN caller simply dials the PBX extension that is mapped to the remote FXS port.

This section provides an example on how to implement a remote telephone extension through the IP network, using FXO and FXS interfaces. In this configuration, the FXO device routes calls received from the PBX to the 'Remote PBX Extension' connected to the FXS device. The routing is transparent as if the telephone connected to the FXS device is directly connected to the PBX.

The following is required:

- FXO interfaces with ports connected directly to the PBX lines (shown in the figure below)
- FXS interfaces for the 'remote PBX extension'
- Analog phones (POTS)
- PBX (one or more PBX loop start lines)
- LAN network

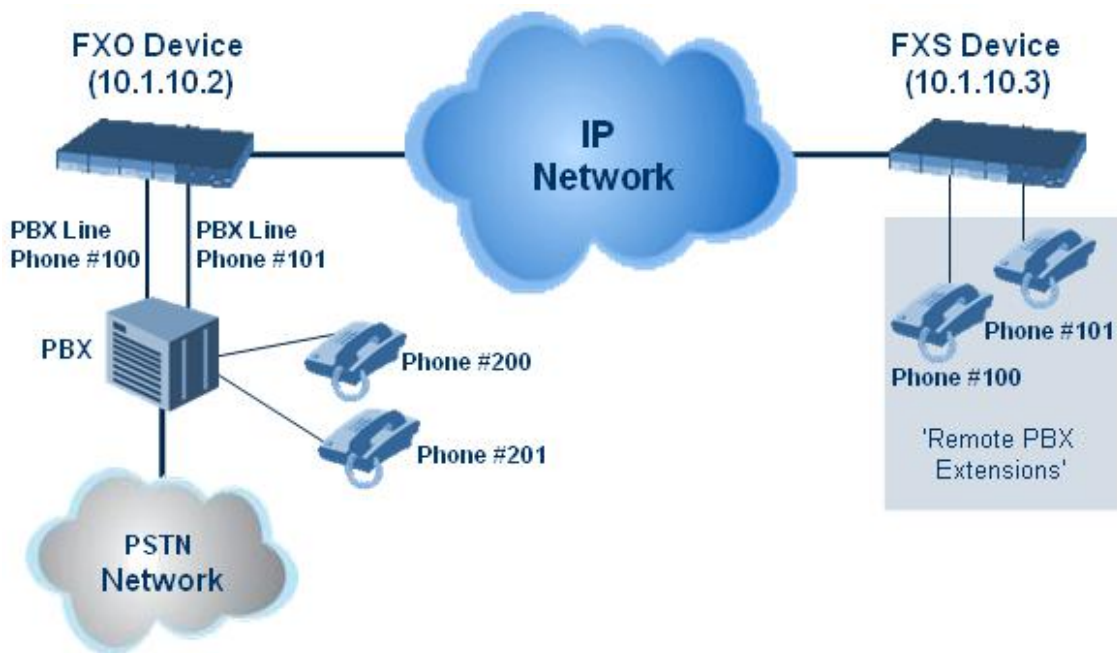

### Dialing from Remote Extension (Phone at FXS)

The following procedure describes how to dial from the 'remote PBX extension' (i.e., phone connected to the FXS interface).

➤ **To make a call from the FXS interface:**

1. Off-hook the phone and wait for the dial tone from the PBX. This is as if the phone is connected directly to the PBX. The FXS and FXO interfaces establish a voice path connection from the phone to the PBX immediately after the phone is off-hooked.
2. Dial the destination number (e.g., phone number 201). The DTMF digits are sent over IP directly to the PBX. All the audible tones are generated from the PBX (such as ringback, busy, or fast busy tones). One-to-one mapping occurs between the FXS ports and PBX lines.
3. The call disconnects when the phone connected to the FXS goes on-hook.

### Dialing from PBX Line or PSTN

The following procedure describes how to dial from a PBX line (i.e., from a telephone directly connected to the PBX) or from the PSTN to the 'remote PBX extension' (i.e., telephone connected to the FXS interface).

➤ **To dial from a telephone directly connected to the PBX or from the PSTN:**

- Dial the PBX subscriber number (e.g., phone number 101) in the same way as if the user's phone was connected directly to the PBX. As soon as the PBX rings the FXO device, the ring signal is 'sent' to the phone connected to the FXS device. Once the phone connected to the FXS device is off-hooked, the FXO device seizes the PBX line and the voice path is established between the phone and PBX.

There is one-to-one mapping between PBX lines and FXS device ports. Each PBX line is routed to the same phone (connected to the FXS device). The call disconnects when the phone connected to the FXS device is on-hooked.

### Message Waiting Indication for Remote Extensions

The device supports the relaying of Message Waiting Indications (MWI) for remote extensions (and voice mail applications). Instead of subscribing to an MWI server to receive notifications of pending messages, the FXO device receives subscriptions from the remote FXS device and notifies the appropriate extension when messages (and the number of messages) are pending.

The FXO device detects an MWI message from the Tel (PBX) side using any one of the following methods:

- 100 VDC (sent by the PBX to activate the phone's lamp)
- Stutter dial tone from the PBX
- MWI display signal (according to the parameter CallerIDType)

Upon detection of an MWI message, the FXO device sends a SIP NOTIFY message to the IP side. When receiving this NOTIFY message, the remote FXS device generates an MWI signal toward its Tel side.

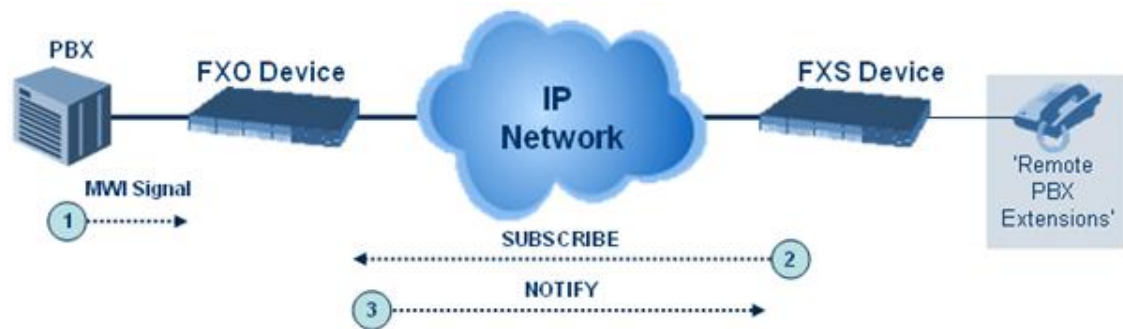

### Call Waiting for Remote Extensions

When the FXO device detects a Call Waiting indication (FSK data of the Caller Id - CallerIDType2) from the PBX, it sends a proprietary INFO message, which includes the caller identification to the FXS device. Once the FXS device receives this INFO message, it plays a call waiting tone and sends the caller ID to the relevant port for display. The remote extension connected to the FXS device can toggle between calls using the Hook Flash button.



## FXS Gateway Configuration

The following procedure describes how to configure the FXS interface (at the 'remote PBX extension').

➤ **To configure the FXS interface:**

1. In the Trunk Group table (see [Configuring Trunk Groups](#)), assign the phone numbers 100 to 104 to the device's FXS ports.

Group Index	Module	From Trunk	To Trunk	Channels	Phone Number	Trunk Group ID	Tel Profile Name
1	Module 5 FXS			1-4	100		None

2. In the Automatic Dialing table (see [Configuring Automatic Dialing](#)), configure automatic dialing for the FXS ports to dial the FXO endpoints, as shown in the figure below. For example, when the phone connected to FXS Port #1 off-hooks, the device automatically dials the number "200".

INDEX	MODULE	PORT	PORT TYPE	AUTO DIAL STATUS	DESTINATION PHONE NUMBER
0	2	1	FXS	enable	200
1	2	2	FXS	enable	201
2	2	3	FXS	enable	202
3	2	4	FXS	enable	203

3. In the Tel-to-IP Routing table (see [Configuring Tel-to-IP Routing Rules](#)), enter 20 for the destination phone prefix and 10.1.10.2 for the IP address of the FXO device.

INDEX	NAME	SOURCE TRUNK GROUP ID	SOURCE PHONE PREFIX	DESTINATION PHONE PREFIX	DESTINATION IP GROUP	SIP INTERFACE	DESTINATION IP ADDRESS	FORKING GROUP	CONNECTIVITY STATUS
0	FXS Routing	-1	*	20	--	--	10.1.10.2	-1	Not Available



For the transfer to function in remote PBX extensions, Hold must be disabled at the FXS device (i.e., Enable Hold = 0) and hook-flash must be transferred from the FXS to the FXO (HookFlashOption = 4).

## FXO Gateway Configuration

The following procedure describes how to configure the FXO interface (to which the PBX is directly connected).

➤ **To configure the FXO interface:**

1. In the Trunk Group table page (see [Configuring Trunk Groups](#)), assign the phone numbers 200 to 204 to the device's FXO endpoints.

Group Index	Module	From Trunk	To Trunk	Channels	Phone Number	Trunk Group ID	Tel Profile Name
1	Module 3 FXO			1-4	200		None



- In the Automatic Dialing table, enter the phone numbers of the FXS device in the 'Destination Phone Number' fields. When a ringing signal is detected at Port #1, the FXO device automatically dials the number "100".

INDEX ↕	MODULE	PORT	PORT TYPE	AUTO DIAL STATUS	DESTINATION PHONE NUMBER
0	2	1	FXO	enable	100
1	2	2	FXO	enable	101
2	2	3	FXO	enable	102
3	2	4	FXO	enable	103

- In the Tel-to-IP Routing table, enter 10 in the 'Destination Phone Prefix' field, and the IP address of the FXS device (10.1.10.3) in the field 'IP Address'.

INDEX ↕	NAME	SOURCE TRUNK GROUP ID	SOURCE PHONE PREFIX	DESTINATION PHONE PREFIX	DESTINATION IP GROUP	SIP INTERFACE	DESTINATION IP ADDRESS	FORKING GROUP	CONNECTIVITY STATUS
0		-1	*	10	--	--	10.1.10.3	-1	Not Available

- In the FXO Settings page (see [Configuring FXO Parameters](#)), set the parameter 'Dialing Mode' to **Two Stages** (IsTwoStageDial = 1).

# Part VI

## Session Border Controller Application

## 30 SBC Overview

This section provides an overview of the device's SBC application.



- For guidelines on how to deploy your SBC device, refer to the *SBC Design Guide* document.
- The SBC feature is available only if the device is installed with a License Key that includes this feature. For installing a License Key, see [License Key](#).
- For the maximum number of supported SBC sessions, and SBC users that can be registered in the device's registration database, see [Technical Specifications](#).

### Feature List

The SBC application supports the following main features:

- NAT traversal: The device supports NAT traversal, allowing, for example, communication with ITSPs with globally unique IP addresses and with far-end users located behind NAT on the WAN. The device supports this by:
  - Continually registering far-end users with its users registration database.
  - Maintaining remote NAT binding state by frequent registrations and thereby, off-loading far-end registrations from the LAN IP PBX.
  - Using Symmetric RTP (RFC 4961) to overcome bearer NAT traversal.
- VoIP firewall and security for signaling and media:
  - SIP signaling:
    - ◆ Deep and stateful inspection of all SIP signaling packets.
    - ◆ SIP dialog initiations may be rejected based on values of incoming SIP INVITE message and other Layer-3 characteristics.
    - ◆ Packets not belonging to an authorized SIP dialog are discarded.
  - RTP:
    - ◆ Deep packet inspection of all RTP packets.
    - ◆ Late rogue detection - if a SIP session was gracefully terminated and someone tries to "ride on it" with rogue traffic from the already terminated RTP and SIP context, the VoIP Firewall prevents this from occurring.
    - ◆ Disconnects call (after user-defined time) if RTP connection is broken.
    - ◆ Black/White lists for both Layer-3 firewall and SIP classification.
- Stateful Proxy Operation Mode: The device can act as a Stateful Proxy by enabling SIP messages to traverse it transparently (with minimal interference) between the inbound and outbound legs.

- **B2BUA and Topology Hiding:** The device intrinsically supports topology hiding, limiting the amount of topology information displayed to external parties. For example, IP addresses of ITSPs' equipment (e.g. proxies, gateways, and application servers) can be hidden from outside parties. The device's topology hiding is provided by implementing back-to-back user agent (B2BUA) leg routing:
  - Strips all incoming SIP Via header fields and creates a new Via value for the outgoing message.
  - Each leg has its own Route/Record Route set.
  - User-defined manipulation of SIP To, From, and Request-URI host names.
  - Generates a new SIP Call-ID header value (different between legs).
  - Changes the SIP Contact header and sets it to the device's address.
  - Layer-3 topology hiding by modifying source IP address in the SIP IP header.
- **SIP normalization:** The device supports SIP normalization, whereby the SBC application can overcome interoperability problems between SIP user agents. This is achieved by the following:
  - Manipulation of SIP URI user and host parts.
  - Connection to ITSP SIP trunks on behalf of an IP-PBX - the device can register and utilize user and password to authenticate for the IP-PBX.
- **Survivability:**
  - Routing calls to alternative routes such as the PSTN.
  - Routing calls between user agents in the local network using a dynamic database (built according to registrations of SIP user agents).
- **Routing:**
  - IP-to-IP routing translations of SIP, UDP, TCP, TLS (when extensive transcoding is not required).
  - Load balancing and redundancy of SIP servers.
  - Routing according to Request-URI\Specific IP address\Proxy\FQDN.
  - Alternative routing.
  - Routing between different Layer-3 networks (e.g., LAN and WAN).
- Load balancing\redundancy of SIP servers.
- ITSP accounts.
- SIP URI user and host name manipulations.
- Coder transcoding.

## B2BUA and Stateful Proxy Operating Modes

The device can operate in one or both of the following SBC modes:

- **Back-to-Back User Agent (B2BUA):** Maintains independent sessions toward the endpoints, processing an incoming request as a user agent server (UAS) on the inbound leg, and processing the outgoing request as a user agent client (UAC) on the outbound leg. SIP messages are modified regarding headers between the legs and all the device's interworking features may be applied.
- **Stateful Proxy Server:** SIP messages traverse the device transparently (with minimal interference) between the inbound and outbound legs, for connecting SIP endpoints.

By default, the device's B2BUA mode changes SIP dialog identifiers and topology data in SIP messages traversing through it:

- Call identifiers: Replaces the From-header tag and Call-ID header so that they are different for each leg (inbound and outbound).
- Routing headers:
  - Removes all Via headers in incoming requests and sends the outgoing message with its own Via header.
  - Doesn't forward any Record-Route headers from the inbound to outbound leg, and vice versa.
  - Replaces the address of the Contact header in the incoming message with its own address in the outgoing message.
- Replaces the User-Agent/ Server header value in the outgoing message, and replaces the original value with itself in the incoming message.

In contrast, when the device operates in Stateful Proxy mode, the device by default forwards SIP messages transparently (unchanged) between SIP endpoints (from inbound to outbound legs). The device retains the SIP dialog identifiers and topology headers received in the incoming message and sends them as is in the outgoing message. The device handles the above mentioned headers transparently (i.e., they remain unchanged) or according to configuration (enabling partial transparency), and only adds itself as the top-most Via header and optionally, to the Record-Route list. To configure the handling of these headers for partial transparency, use the following IP Profile parameters (see [Configuring IP Profiles](#)):

- IpProfile\_SBCRemoteRepresentationMode: Contact and Record-Route headers
- IpProfile\_SBCKeepVIAHeaders: Via headers
- IpProfile\_SBCKeepUserAgentHeader: User-Agent headers
- IpProfile\_SBCKeepRoutingHeaders: Record-Route headers
- IpProfile\_SBCRemoteMultipleEarlyDialogs: To-header tags

Thus, the Stateful Proxy mode provides full SIP transparency (no topology hiding) or asymmetric topology hiding. Below is an example of a SIP dialog-initiating request when

operating in Stateful Proxy mode for full transparency, showing all the incoming SIP headers retained in the outgoing INVITE message.

Incoming INVITE	Outgoing INVITE
<pre> INVITE sip:bob@domain.com SIP/2.0 To: Bob &lt;sip:bob@domain.com&gt; From: Alice &lt;sip:alice@caller.com&gt;;tag=100 Call-ID: callid1@caller.com Contact: &lt;sip:alice@pc1.caller.com&gt; Via: SIP/2.0/UDP pc2.com;branch=branch2 Via: SIP/2.0/UDP pc1.com;branch=branch1 Record-Route: &lt;pc2.com;lr&gt; Record-Route: &lt;pc1.com;lr&gt; CSeq: 666 INVITE User-Agent: IPPv3.1 Max-Forwards: 70 Content-Type: application/sdp Content-Length: 142  v=0 ... </pre>	<pre> INVITE sip:bob@domain.com SIP/2.0 To: Bob &lt;sip:bob@domain.com&gt; From: Alice &lt;sip:alice@caller.com&gt;;tag=100 Call-ID: callid1@caller.com Contact: &lt;sip:alice@pc1.caller.com&gt; Via: SIP/2.0/UDP Proxy-IP;branch=branch3 Via: SIP/2.0/UDP pc2.com;branch=branch2 Via: SIP/2.0/UDP pc1.com;branch=branch1 Record-Route: &lt;Proxy-IP;lr&gt; Record-Route: &lt;pc2.com;lr&gt; Record-Route: &lt;pc1.com;lr&gt; CSeq: 666 INVITE User-Agent: IPPv3.1 Max-Forwards: 70 Content-Type: application/sdp Content-Length: 142  v=0 ... </pre>

Some of the reasons for implementing Stateful Proxy mode include:

- B2BUA typically hides certain SIP headers for topology hiding. In specific setups, some SIP servers require the inclusion of these headers to know the history of the SIP request. In such setups, the requirement may be asymmetric topology hiding, whereby SIP traffic toward the SIP server must expose these headers whereas SIP traffic toward the users must not expose these headers.
- B2BUA changes the call identifiers between the inbound and outbound SBC legs and therefore, call parties may indicate call identifiers that are not relayed to the other leg. Some SIP functionalities are achieved by conveying the SIP call identifiers either in SIP specific headers (e.g., Replaces) or in the message bodies (e.g. Dialog Info in an XML body).
- In some setups, the SIP client authenticates using a hash that is performed on one or more of the headers that B2BUA changes (removes). Therefore, implementing B2BUA would cause authentication to fail.
- For facilitating debugging procedures, some administrators require that the value in the Call-ID header remains unchanged between the inbound and outbound SBC legs. As B2BUA changes the Call-ID header, such debugging requirements would fail.

The operating mode can be configured per the following configuration entities:

- SRDs in the SRDs table (see [Configuring SRDs](#))
- IP Groups in the IP Groups table (see [Configuring IP Groups](#))

If the operation mode is configured in both tables, the operation mode of the IP Group is applied. Once configured, the device uses default settings in the IP Profiles table for handling the SIP headers, as mentioned previously. However, you can change the default settings to enable partial transparency.



- The To-header tag remains the same for inbound and outbound legs of the dialog, regardless of operation mode.
- If the Operation Mode of the SRD\IP Group of one leg of the dialog is set to 'Call Stateful Proxy', the device also operates in this mode on the other leg with regards to the dialog identifiers (Call-ID header, tags, CSeq header).
- It is recommended to implement the B2BUA mode, unless one of the reasons mentioned previously is required. B2BUA supports all the device's feature-rich offerings, while Stateful Proxy may offer only limited support. The following features are not supported when in Stateful Proxy mode:
  - ✓ Alternative routing
  - ✓ Call forking
  - ✓ Terminating REFER/3xx
- If Stateful Proxy mode is enabled and any one of the unsupported features is enabled, the device disables the Stateful Proxy mode and operates in B2BUA mode.
- You can configure the device to operate in both B2BUA and Stateful Proxy modes for the same users. This is typically implemented when users need to communicate with different SIP entities (IP Groups). For example, B2BUA mode for calls destined to a SIP Trunk and Stateful Proxy mode for calls destined to an IP PBX. The configuration is done using IP Groups and SRDs.
- If Stateful Proxy mode is used only due to the debugging benefits, it is recommended to configure the device to only forward the Call-ID header unchanged

## Call Processing of SIP Dialog Requests

The device processes incoming SIP dialog requests (SIP methods) such as INVITE, SUBSCRIBE, OPTIONS, REFER, INFO, UNSOLICITED NOTIFY, MESSAGE, and REGISTER. The process is summarized in the following figure and subsequently described:

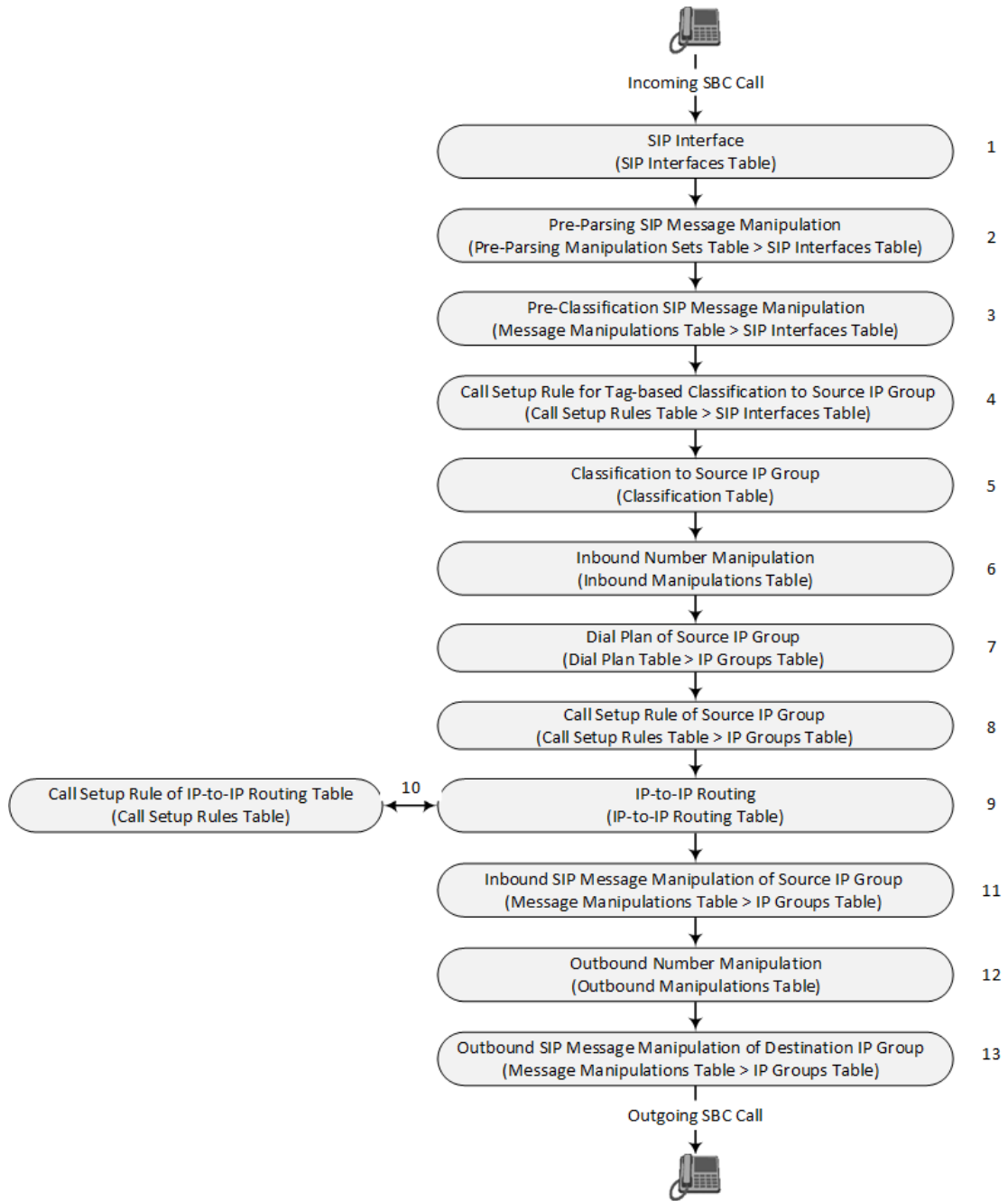

The first stage of the SIP dialog-initiating process is **determining source and destination URLs**. The SIP protocol has more than one URL in a dialog-initiating request that may represent the source and destination URLs. The device obtains the source and destination URLs from certain SIP headers. Once the URLs are determined, the user and host parts of the URLs can be used as matching rule characteristics for classification, message manipulation, and call routing.

■ **All SIP requests (e.g., INVITE) except REGISTER:**

- Source URL: Obtained from the From header. If the From header contains the value 'Anonymous', the source URL is obtained from the P-Preferred-Identity header. If the P-Preferred-Identity header does not exist, the source URL is obtained from the P-Asserted-Identity header.
- Destination URL: Obtained from the Request-URI.



### ■ REGISTER dialogs:

- Source URL: Obtained from the To header.
- Destination URL: Obtained from the Request-URI.



You can specify the SIP header from where you want the device to obtain the source URL in the incoming dialog request. This is configured in the IP Groups table using the 'Source URI Input' parameter (see [Configuring IP Groups](#)).

The next stages of the SIP dialog-initiating process is as follows:

- 1. Determining the SIP Interface:** The device checks the SIP Interface on which the SIP dialog is received. The SIP Interface defines the local SIP "listening" port and IP network interface. For more information, see [Configuring SIP Interfaces](#).
- 2. Applying Pre-parsing SIP Message Manipulation:** If configured, the device can apply SIP message manipulation to the incoming SIP message before it is parsed by the device. This type of manipulation is called Pre-Parsing Manipulation, which is configured in the Pre-Parsing Manipulation Sets table (see [Configuring Pre-Parsing Manipulation Rules](#) on page 660) and is assigned to the SIP Interface.
- 3. Applying Pre-classification SIP Message Manipulation:** If configured, the device can apply SIP message manipulation to the incoming SIP message before it is classified to a source IP Group. This manipulation is configured in the SIP Message Manipulations table (see [Configuring SIP Message Manipulation](#)) and is assigned to the SIP Interface.
- 4. Classifying to a Source IP Group using Tags:** If configured, the device can classify the incoming SIP message to a source IP Group, based on a source tag that is determined by running a Call Setup Rule. The Call Setup Rule is configured in the Call Setup Rules table (see [Configuring Call Setup Rules](#) on page 611) and is assigned to the SIP Interface. For more information on tag-based classification, see [Configuring Classification Based on Tags](#) on page 964.
- 5. Classifying to a Source IP Group:** Classification identifies the incoming SIP dialog request as belonging to a specific IP Group (i.e., from where the SIP dialog request originated). The classification process is based on the SRD to which the dialog belongs (the SRD is determined according to the SIP Interface). For more information, see [Configuring Classification Rules](#).
- 6. Applying Inbound Manipulation:** Depending on configuration, the device can apply an Inbound Manipulation rule to the incoming dialog. This manipulates the user part of the SIP URI for source (e.g., in the SIP From header) and destination (e.g., in the Request-URI line). The manipulation rule is associated with the incoming dialog, by configuring the rule with incoming matching characteristics such as source IP Group and destination host name. The manipulation rules are also assigned a Routing Policy, which in turn, is assigned to IP-to-IP routing rules. As most deployments require only one Routing Policy, the default Routing Policy is automatically assigned to manipulation and routing rules. For more information, see [Configuring IP-to-IP Inbound Manipulations](#).

- 7. Applying a Dial Plan to Determine Tag:** If configured, the device can run a Dial Plan rule based on the source (or destination) number of the incoming SIP message to determine its' tag. The tag can later be used in the routing and manipulation stages. Dial Plan rules are configured in the Dial Plan table (see [Configuring Dial Plans](#) on page 624) and assigned to the IP Group.
- 8. Applying Call Setup Rules for Various Functions:** If configured, the device can run Call Setup Rules to apply various functions to the call, for example, querying an LDAP server. The Call Setup Rule is configured in the Call Setup Rules table (see [Configuring Call Setup Rules](#) on page 611) and is assigned to the IP Group.
- 9. SBC IP-to-IP Routing:** The device searches the IP-to-IP Routing table for a routing rule that matches the characteristics of the incoming call. If found, the device routes the call to the configured destination which can be, for example, an IP Group, the Request-URI if the user is registered with the device, and a specified IP address. For more information, see [Configuring SBC IP-to-IP Routing Rules](#).
- 10. Applying Call Setup Rules for Various Functions:** If configured, the device can run Call Setup Rules to apply various functions to the call. The Call Setup Rule is configured in the Call Setup Rules table (see [Configuring Call Setup Rules](#) on page 611) and is assigned to the IP-to-IP Routing table.
- 11. Applying Inbound SIP Message Manipulation:** Depending on configuration, the device can apply a SIP message manipulation rule (assigned to the IP Group) on the incoming dialog. For more information, see Stage 3.
- 12. Applying Outbound Manipulation:** Depending on configuration, the device can apply an Outbound Manipulation rule to the outbound dialog. This manipulates the user part of the Request-URI for source (e.g., in the SIP From header) or destination (e.g., in the SIP To header) or calling name in the outbound SIP dialog. The manipulation rule is associated with the dialog, by configuring the rule with incoming matching characteristics such as source IP Group and destination host name. The manipulation rules are also assigned a Routing Policy, which in turn, is assigned to IP-to-IP routing rules. As most deployments require only one Routing Policy, the default Routing Policy is automatically assigned to manipulation rules and routing rules. For more information, see [Configuring IP-to-IP Outbound Manipulations](#).
- 13. Applying Outbound SIP Message Manipulation:** Depending on configuration, the device can apply a SIP message manipulation rule (assigned to the IP Group) on the outbound dialog. For more information, see Stage 3.
- 14.** The call is sent to the configured destination.

## User Registration

The device provides a registration database for registering users. Only users belonging to a User-type IP Group can register with the device. User-type IP Groups represent a group of SIP user agents that share the following characteristics:

- Perform registrations and share the same serving proxy\registrar

- Same SIP and media behavior
- Same IP Profile
- Same SIP handling configuration
- Same Call Admission Control (CAC)

Typically, the device is configured as the user's outbound proxy, routing requests (using the IP-to-IP Routing table) from the user's User-type IP Group to the serving proxy, and vice versa. Survivability can be achieved using the alternative routing feature.

The device forwards registration requests (REGISTER messages) from a Server-type IP Group, but does not save the registration binding in its' registration database.

## Initial Registration Request Processing

A summary of the device's handling of registration requests (REGISTER messages) is as follows:

- The URL in the SIP To header of the REGISTER message constitutes the primary Address of Record (AOR) for registration (according to SIP standards). If the To header's URL includes the "user=phone" parameter, then only the user part of the URL constitutes the AOR. If the To header's URL does not include the "user=phone" parameter, then both the user part and host part of the URL constitutes the AOR.
- The device can save other AORs in its registration database as well. When the device searches for a user in its' registration database, any of the user's AORs can result in a match.
- The device's Classification process for initial REGISTER messages is slightly different than for other SIP messages. Unlike other requests, initial REGISTER requests can't be classified according to the registration database.
- If registration succeeds (replied with 200 OK by the destination server), the device adds a record to its' registration database, which identifies the specific contact of the specific user (AOR). The device uses this record to route subsequent SIP requests to the specific user (in normal or survivability modes).
- The records in the device's registration database include the Contact header. The device adds every REGISTER request to the registration database before manipulation, allowing correct user identification in the Classification process for the next received request.
- You can configure Call Admission Control (CAC) rules for incoming and outgoing REGISTER messages. For example, you can limit REGISTER requests from a specific IP Group or SRD. Note that this applies only to concurrent REGISTER dialogs and not concurrent registrations in the device's registration database.

The device provides a dynamic registration database that it updates according to registration requests traversing it. Each database entry for a user represents a binding between an AOR (obtained from the SIP To header), optional additional AORs, and one or more contacts (obtained from the SIP Contact headers). Database bindings are added upon successful

registration responses from the proxy server (SIP 200 OK). The device removes database bindings in the following cases:

- Successful de-registration responses (REGISTER with Expires header that equals zero).
- Registration failure responses.
- Timeout of the Expires header value (in scenarios where the UA did not send a refresh registration request).



- The same contact cannot belong to more than one AOR.
- Contacts with identical URIs and different ports and transport types are not supported (same key is created).
- Multiple contacts in a single REGISTER message is not supported.
- One database is shared between all User-type IP Groups.

## Classification and Routing of Registered Users

The device can classify incoming SIP dialog requests (e.g., INVITE) from registered users to an IP Group, by searching for the sender's details in the registration database. The device uses the AOR from the From header and the URL in the Contact header of the request to locate a matching registration binding. The found registration binding contains information regarding the registered user, including the IP Group to which it belongs. (Upon initial registration, the Classification table is used to classify the user to a User-type IP Group and this information is then added with the user in the registration database.)

The destination of a dialog request can be a registered user and the device thus uses its registration database to route the call. This can be achieved by various ways such as configuring a rule in the IP-to-IP Routing table where the destination is a User-type IP Group or any matching user registered in the database ('Destination Type' is configured to **All Users**). The device searches the registration database for a user that matches the incoming Request-URI (listed in chronological order):

- Unique Contact generated by the device and sent in the initial registration request to the serving proxy.
- AOR. The AOR is originally obtained from the incoming REGISTER request and must either match both user part and host part (user@host) of the Request-URI, or only user part.
- Contact. The Contact is originally obtained from the incoming REGISTER request.

If registrations are destined to the database (using the above rules), the device does not attempt to find a database match, but instead replies with a SIP 200 OK (used for Survivability). Once a match is found, the request is routed either to the contact received in the initial registration or (if the device identifies that the user agent is behind a NAT) to the source IP address of the initial registration.

You can configure (using the [SBCDBRoutingSearchMode] parameter) for which part of the destination Request-URI in the INVITE message the device must search in the registration database:

- Only by entire Request-URI (user@host), for example, "4709@joe.company.com".
- By entire Request-URI, but if not found, by the user part of the Request-URI, for example, "4709".

When an incoming INVITE is received for routing to a user and the user is located in the registration database, the device sends the call to the user's corresponding contact address specified in the database.



If the Request-URI contains the "tel:" URI or "user=phone" parameter, the device searches only for the user part.

You can also configure (using the [SBCURIComparisonExcludedParams] parameter) which URI parameters are excluded when the device compares the URIs of two incoming dialog-initiating SIP requests (e.g., INVITES) to determine if they were sent from a user that is registered in the device's registration database. For example, you can configure the parameter to exclude ports from the comparison. For more information, see the description of the [SBCURIComparisonExcludedParams] parameter.

## General Registration Request Processing

The device's general handling of registration requests (REGISTER messages) for unregistered users is as follows:

- The device routes REGISTER requests according to the IP-to-IP Routing table. If the destination is a User-type IP Group, the device does not forward the registration; instead, it accepts (replies with a SIP 200 OK response) or rejects (replies with a SIP 4xx) the request according to the user's IP Group configuration.
- Alternative routing can be configured for REGISTER requests, in the IP-to-IP Routing table.
- By default, the Expires header has the same value in incoming and outgoing REGISTER messages. However, you can modify the Expires value using the following parameters: SBCUserRegistrationTime, SBCProxyRegistrationTime, SBCRandomizeExpires, and SBCSurvivabilityRegistrationTime. You can also modify the Expires value of REGISTER requests received from users located behind NAT, using the IP Profile parameters IpProfile\_SBCUserBehindUdpNATRegistrationTime and IpProfile\_SBCUserBehindTcpNATRegistrationTime.
- By default, the Contact header in outgoing REGISTER message is different than the Contact header in the incoming REGISTER. The user part of the Contact is populated with a unique contact generated by the device and associated with the specific registration. The IP address in the host part is changed to the address of the device. Alternatively, the original user can be retained in the Contact header and used in the outgoing REGISTER request (using the SBCKeepContactUserinRegister parameter).

## Registration Refreshes

Registration refreshes are incoming REGISTER requests from users that are registered in the device's registration database. The device sends these refreshes to the serving proxy only if

the serving proxy's Expires time is about to expire; otherwise, the device responds with a 200 OK to the user without routing the REGISTER. Each such refresh also refreshes the internal timer set on the device for this specific registration.

The device automatically notifies SIP proxy / registrar servers of users that are registered in its registration database and whose registration timeout has expired. When a user's registration timer expires, the device removes the user's record from the database and sends an un-register notification (REGISTER message with the Expires header set to 0) to the proxy/registrar. This occurs only if a REGISTER message is sent to an IP Group destination type (in the IP-to-IP Routing table).

You can also apply a graceful period to unregistered requests, using the 'User Registration Grace Time' parameter ([SBCUserRegistrationGraceTime]):

- You can configure the device to add extra time (grace period) to the expiration timer of registered users in the database. If you configure this grace period, the device keeps the user in the database (and does not send an unregister to the registrar server), allowing the user to send a "late" re-registration to the device. The device removes the user from the database only when this additional time expires.
- The graceful period is also used before removing a user from the registration database when the device receives a successful unregister response (200 OK) from the registrar/proxy server. This is useful in scenarios, for example, in which users (SIP user agents) such as IP Phones erroneously send unregister requests. Instead of immediately removing the user from the registration database upon receipt of a successful unregister response, the device waits until it receives a successful unregister response from the registrar server, waits the user-defined graceful time and if no register refresh request is received from the user agent, removes the contact (or AOR) from the database.

The device keeps registered users in its' registration database even if connectivity with the proxy is lost (i.e., proxy does not respond to users' registration refresh requests). The device removes users from the database only when their registration expiry time is reached (with the additional grace period, if configured).

## Registration Restriction Control

The device provides flexibility in controlling user registrations:

- **Limiting Number of Registrations:** You can limit the number of users that can register with the device per IP Group, SIP Interface, and/or SRD, in the IP Group, SIP Interface and SRDs tables respectively. By default, no limitation exists.
- **Blocking Incoming Calls from Unregistered Users:** You can block incoming calls (INVITE requests) from unregistered users belonging to User-type IP Groups. By default, calls from unregistered users are not blocked. This is configured per SIP Interface or SRD. When the call is rejected, the device sends a SIP 500 (Server Internal Error) response to the remote end.

## Deleting Registered Users

You can remove registered users from the device's registration database through CLI:

- To delete a specific registered user:

```
# clear voip register db sbc user <AOR of user - user part or user@host>
```

For example:

```
# clear voip register db sbc user John@10.33.2.22
# clear voip register db sbc user John
```

- To delete all registered users belonging to a specific IP Group:

```
# clear voip register db sbc ip-group <ID or name>
```

## Media Handling

Media behavior includes anything related to the establishment, management and termination of media sessions within the SIP protocol. Media sessions are created using the SIP offer-answer mechanism. If successful, the result is a bi-directional media (RTP) flow (e.g. audio, fax, modem, DTMF). Each offer-answer may create multiple media sessions of different types (e.g. audio and fax). In a SIP dialog, multiple offer-answer transactions may occur and each may change the media session characteristics (e.g. IP address, port, coders, media types, and RTP mode). The media capabilities exchanged in an offer-answer transaction include the following:

- Media types (e.g., audio, secure audio, video, fax, and text)
- IP addresses and ports of the media flow
- Media flow mode (send receive, receive only, send only, inactive)
- Media coders (coders and their characteristics used in each media flow)
- Other (standard or proprietary) media and session characteristics

Typically, the device does not change the negotiated media capabilities (mainly performed by the remote user agents). However, it does examine and may take an active role in the SDP offer-answer mechanism. This is done mainly to anchor the media to the device (default) and also to change the negotiated media type, if configured. Some of the media handling features, which are described later in this section, include the following:

- Media anchoring (default)
- Direct media
- Audio coders restrictions
- Audio coders transcoding

- RTP-SRTP transcoding
- DTMF translations
- Fax translations and detection
- Early media and ringback tone handling
- Call hold translations and held tone generation
- NAT traversal
- RTP broken connections
- Media firewall
  - RTP pin holes - only RTP packets related to a successful offer-answer negotiation traverse the device: When the device initializes, there are no RTP pin holes opened. This means that each RTP\RTCP packets destined to the device are discarded. Once an offer-answer transaction ends successfully, an RTP pin hole is opened and RTP\RTCP flows between the two remote user agents. Once a pin hole is opened, the payload type and RTP header version is validated for each packet. RTP pin holes close if one of the associated SIP dialogs is closed (may also be due to broken connection).
  - Late rogue detection - once a dialog is disconnected, the related pin holes also disconnect.
  - Deep Packet inspection of the RTP that flows through the opened pin holes.

## Media Anchoring

By default, the device anchors the media (RTP) traffic. In other words, the media between SIP endpoints traverses the device. You can change this default mode by enabling direct media between SIP endpoints. Media anchoring may be required, for example, to resolve NAT problems, enforce media security policies, perform media transcoding, and media monitoring.

To enforce RTP traffic to flow through the device, the device modifies all IP address fields in the SDP:

- Origin: IP address, session and version id
- Session connection attribute ('c=' field)
- Media connection attribute ('c=' field)
- Media port number
- RTCP media attribute IP address and port

The device uses different local ports (e.g., for RTP, RTCP and fax) for each leg (inbound and outbound). The local ports are allocated from the Media Realm associated with each leg. The Media Realm assigned to the leg's IP Group (in the IP Groups table) is used. If not assigned to the IP Group, the Media Realm assigned to the leg's SIP Interface (in the SIP Interfaces table) is used. The following figure provides an example of SDP handling for a call between a LAN IP Phone 10.2.2.6 and a remote IP Phone 212.179.1.13 on the WAN.



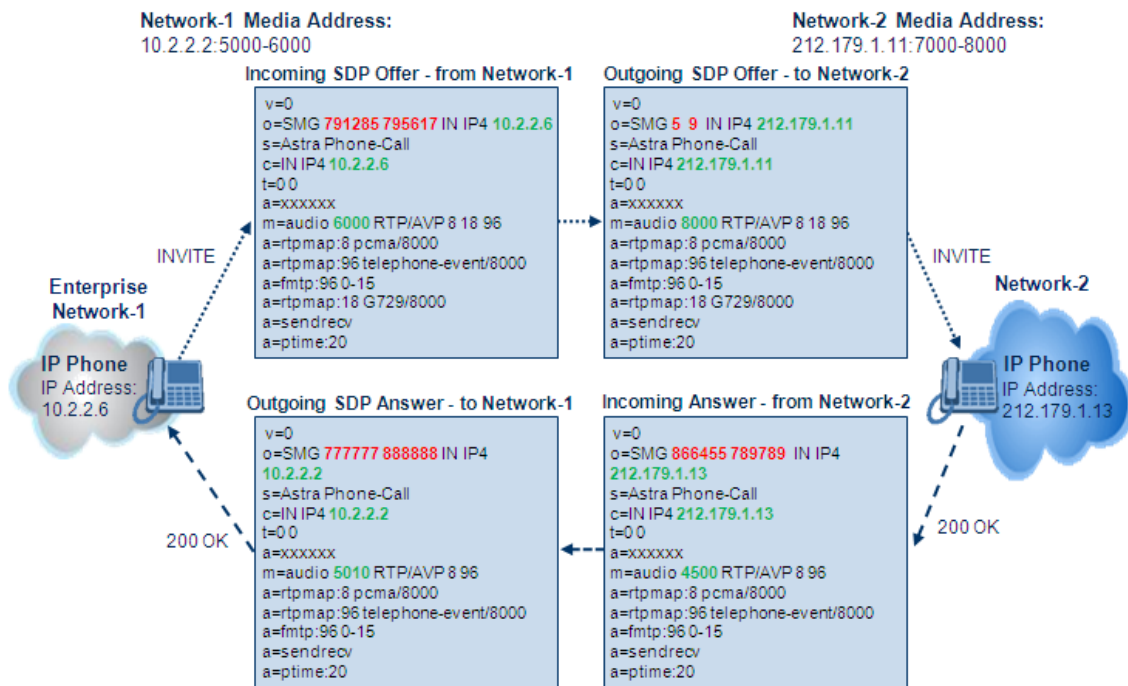

## Direct Media Calls

You can configure the device to allow the media (RTP/SRTP) session to flow directly between the SIP endpoints without traversing the device. This is referred to as No Media Anchoring (also known as Anti-Tromboning or Direct Media). SIP signaling continues to traverse the device with minimal intermediation and involvement to enable certain SBC capabilities such as routing. By default, the device employs media anchoring, whereby the media session traverses the device, as described in [Media Anchoring](#).

Direct media offers the following benefits:

- Saves network bandwidth
- Reduces the device's CPU usage (as there is no media handling)
- Avoids interference in SDP negotiation and header manipulation on RTP/SRTP

Direct media is typically implemented for calls between users located in the same LAN or domain, and where NAT traversal is not required and other media handling features such as media transcoding is not required. The following figure provides an example of direct media between LAN IP phones, while SIP signaling continues to traverse the device between LAN IP phones and the hosted WAN IP-PBX.

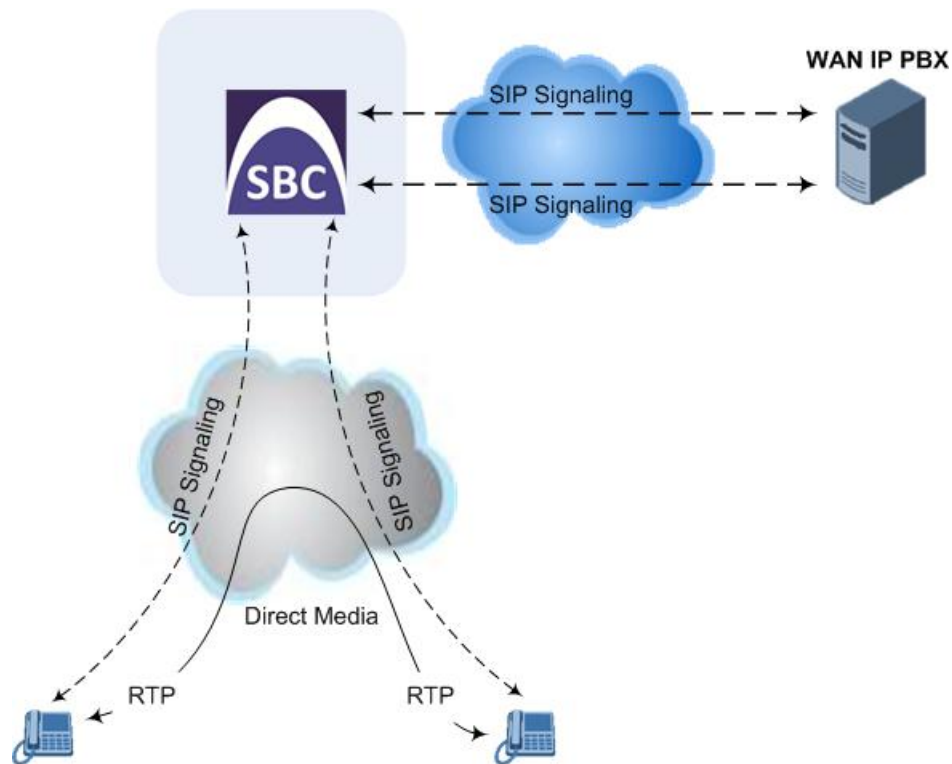

➤ **To enable direct media:**

- **For all calls:** Use the global parameter [SBCDirectMedia], which **overrides** all other direct media configuration.
- **For specific calls:**
  - SIP Interface: You can enable direct media per SIP Interface (in the SIP Interfaces table), whereby calls (source and destination) associated with **this same** SIP Interface are handled as direct media calls. The SIP Interface can also enable direct media for users located behind the same NAT. For more information, see [Configuring SIP Interfaces](#).
  - Direct Media Tag: You can enable direct media between users that are configured with the same Direct Media tag value. The tag is configured using the IP Profiles table's IProfile\_SBCDirectMediaTag parameter (see [Configuring IP Profiles](#)).

The device employs direct media between endpoints under the following configuration conditions (listed in chronological order):

1. Direct media is enabled by the global parameter [SBCDirectMedia].
2. IP Groups of the endpoints are associated with IP Profiles whose 'Direct Media Tag' parameter has the same value (non-empty value).
3. IP Groups of the endpoints have the 'SBC Operation Mode' parameter set to **Microsoft Server** (direct media is required in the Skype for Business environment). For more information, see [Configuring IP Groups](#).

4. IP Groups of the endpoints use the same SIP Interface and the SIP Interface's 'SBC Direct Media' parameter is set to **Enable** (SIPInterface\_SBCDirectMedia = 1).
5. IP Groups of the endpoints use the same SIP Interface and the SIP Interface's 'SBC Direct Media' parameter is set to Enable When Single NAT (SIPInterface\_SBCDirectMedia = 2), and the endpoints are located behind the same NAT.



- **Direct Media configured for all calls (i.e., using the [SBCDirectMedia] parameter):** The device doesn't open voice channels and doesn't allocate media ports for these calls, because the media always bypasses the device.
- **Direct Media configured for specific calls (i.e., using the IP Profile's 'Direct Media Tag' parameter or SIP Interface's 'Direct Media' parameter):** The device always allocates ports for these calls, because these ports may be required at some stage during the call if it changes to a **non-direct media** call for mid-call services such as early media, call forwarding, call transfer, or playing on-hold tones. Therefore, make sure that you have allocated sufficient media ports (Media Realm) for these calls.
- The following features are not supported for Direct Media calls:
  - ✓ Manipulation of SDP data (offer-answer transaction) such as ports, IP address, coders
  - ✓ Forced transcoding
  - ✓ Extension Coders
  - ✓ Extension of RFC 2833 / out-of-band DTMF / in-band DTMF
  - ✓ Extension of SRTP/RTP
  - ✓ All restriction features (Allowed Coders, restrict SRTP/RTP, and restrict RFC 2833)
  - ✓ All media-related parameters in the IP Profiles table are not applicable to Direct Media calls
- The device doesn't fully support call transfer (SIP REFER) terminations for direct media calls. One of the SIP User Agents (UA) in the call must support re-INVITE messages without SDP for the device to synchronize the media.
- For two users belonging to the same SIP Interface that is enabled for direct media and one of the users is defined as a foreign user (example, "follow me service") located in the WAN while the other is located in the LAN: calls between these two users cannot be established until direct media is disabled for the SIP Interface. The reason for this is that the device does not interfere in the SIP signaling. In other words, parameters such as IP addresses are not manipulated for calls between LAN and WAN (although required).
- If you have configured a SIP Recording rule (see SIP-based Media Recording) for calls that have also been configured for direct media, using a SIP Interface ('Direct Media' parameter) or an IP Profile ('Direct Media Tag' parameter), the device automatically disables direct media for these calls (during their SIP signaling setup). This ensures that the media passes through the device so that it can be recorded and sent to the SRS. However, if you enable direct media using the [SBCDirectMedia] parameter (i.e., for all calls), direct media is always enforced and calls will not be recorded.

## Restricting Audio Coders

You can configure a list of permitted (allowed) voice coders that can be used for a specific SIP entity (leg). In other words, you can enforce the use of specific coders. If the SDP offer in the incoming SIP message does not contain any coder that is configured as an allowed coder, the device rejects the calls (unless transcoding is implemented whereby Extension coders are added to the SDP, as described in [Coder Transcoding](#)). If the SDP offer contains some coders that are configured as allowed coders, the device manipulates the SDP offer by removing the coders that are not configured as allowed coders, before routing the SIP message to its destination. The device also re-orders (prioritizes) the coder list in the SDP according to the listed order of configured allowed coders.

For example, assume the following:

- The SDP offer in the incoming SIP message contains the G.729, G.711, and G.723 coders.
- The allowed coders configured for the SIP entity include G.711 and G.729.

The device removes the G.723 coder from the SDP offer, re-orders the coder list so that G.711 is listed first, and sends the SIP message containing only the G.711 and G.729 coders in the SDP.

The allowed coders are configured in the Allowed Audio Coders Groups table. For more information, see [Configuring Allowed Audio Coder Groups](#).



If you assign the SIP entity an Allowed Audio Coders Group for coder restriction and a Coders Group for extension coders (i.e., voice transcoding), the allowed coders take precedence over the extension coders. In other words, if an extension coder is not listed as an allowed coder, the device does not add the extension coder to the SDP offer.

## Coder Transcoding

By default, the device forwards media packets transparently (i.e., no media negotiation) between the SIP endpoints. However, when there are no common coders between two SIP entities that need to establish voice communication (i.e., the SDP answer from one SIP entity doesn't include any coder included in the SDP offer previously sent by the other), you can configure the device to perform audio coder transcoding between the inbound and outbound legs in order to enable media flow between them.

Transcoding may also be performed in scenarios where the same coder has been chosen between the legs, but where coder transrating is required. For example, the coders may use different coder settings such as rate and packetization time (G.729 at 20 ms to G.729 at 30 ms).

The coders that the device adds to the SDP offer on the outbound leg is referred to as *extension coders*. The extension coders are configured using Coder Groups (see [Configuring Coder Groups](#)), which you need to then assign to the IP Profile associated with the SIP entity.

The figure below illustrates transcoding between two SIP entities (IP Groups) where one uses G.711 (LAN IP phone) and the other G.729 (WAN IP phone). The initial SDP offer received on the inbound leg from the LAN IP phone includes coder G.711 as the supported coder. In the outgoing SDP offer on the outbound leg to the WAN IP phone, the device adds extension coder G.729 to the SDP, which is supported by the WAN IP phone. The subsequent incoming SDP answer from the WAN IP phone includes the G.729 coder as the chosen coder. Since this coder was not included in the original incoming SDP offer from the LAN IP phone, the device performs G.729-G.711 transcoding between the inbound and outbound legs.

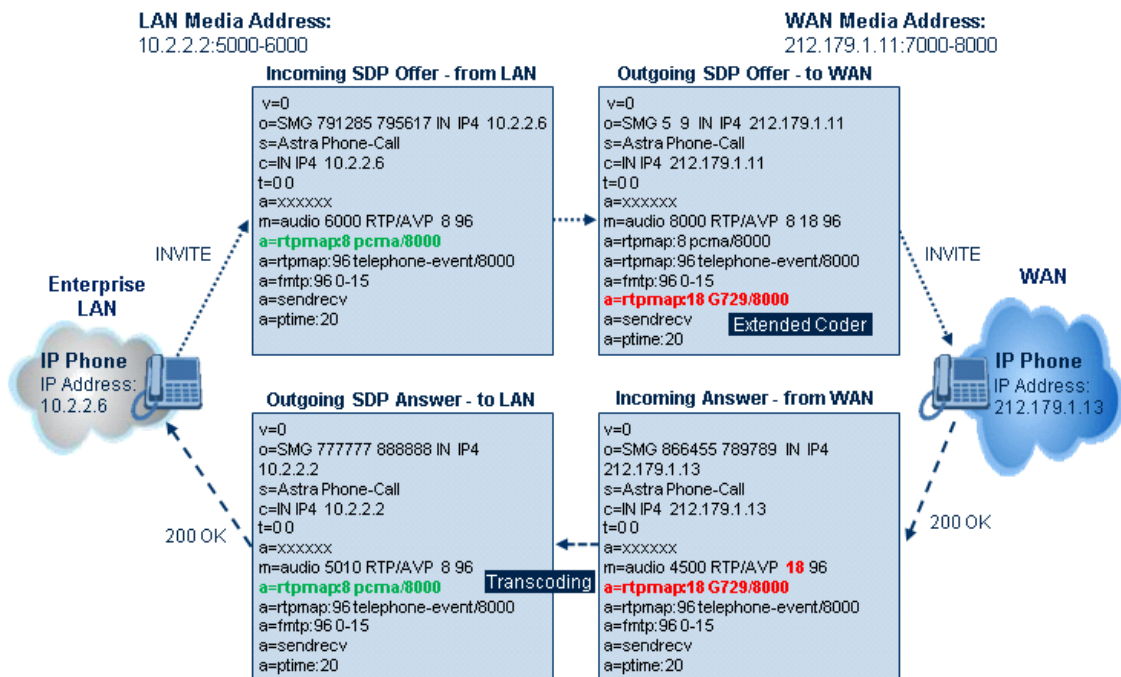

- If you assign a SIP entity an Allowed Audio Coders Group for coder restriction (allowed coders) and a Coders Group for extension coders, the allowed coders take precedence over the extension coders. In other words, if an extension coder is not listed as an allowed coder, the device does not add the extension coder to the SDP offer.
- If none of the coders in the incoming SDP offer on the inbound leg appear in the associated Allowed Audio Coders Group for coder restriction, the device rejects the call (sends a SIP 488 to the SIP entity that initiated the SDP offer).
- If none of the coders (including extension coders) in the outgoing SDP offer on the outbound leg appear in the associated Allowed Audio Coders Group for coder restriction, the device rejects the call (sends a SIP 488 to the SIP entity that initiated the SDP offer).
- For coder transcoding, the following prerequisites must be met (otherwise, the extension coders are not added to the SDP offer):
  - ✓ The device must support at least one of the coders listed in the incoming SDP offer.
  - ✓ The device must have available DSPs for both legs (inbound and outbound).
  - ✓ The incoming SDP offer must have at least one media line that is audio ('m=audio').



- The device adds the extension coders below the coder list received in the original SDP offer. This increases the chance of media flow without requiring transcoding.
- The device does not add extension coders that also appear in the original SDP offer.
- You can view the number of currently active transcoding sessions, using the CLI command `show voip calls statistics sbc media`.

As an example for using allowed and extension coders, assume the following:

#### ■ Inbound leg:

- Incoming SDP offer includes the G.729, G.711, and G.723 coders.

```
m=audio 6050 RTP/AVP 18 0 8 4 96
a=rtpmap:18 G729/8000
a=rtpmap:0 PCMU/8000
a=rtpmap:8 PCMA/8000
a=rtpmap:4 G723/8000
a=fmtp:4 annexa=no
a=rtpmap:96 telephone-event/8000
a=fmtp:96 0-15
a=ptime:20
a=sendrecv
```

The SDP "m=audio 6010 RTP/AVP 18 0 8 4 96" line shows the coder priority, where "18" (G.729) is highest and "4" (G.723) is lowest.

- Allowed Audio Coders Group for coder restriction includes the G.711 and G.729 coders (listed in order of appearance).

#### ■ Outbound leg:

- Allowed Audio Coders Group for coder restriction includes the G.723, G.726, and G.729 coders (listed in order of appearance).
- Allowed Audio Coders Group for coder extension (transcoding) includes the G.726 coder.

1. On the inbound leg for the incoming SDP offer: The device allows and keeps the coders in the SDP that also appear in the Allowed Audio Coders Group for coder restriction (i.e., G.711 and G.729). It changes the order of listed coders in the SDP so that G.711 is listed first. The device removes the coders (i.e., G.723) from the SDP that do not appear in the Allowed Audio Coders Group for coder restriction.

```
m=audio 6050 RTP/AVP 0 8 18 96
a=rtpmap:0 PCMU/8000
a=rtpmap:8 PCMA/8000
a=rtpmap:18 G729/8000
a=fmtp:4 annexa=no
```

```
a=rtpmap:96 telephone-event/8000
a=fmtp:96 0-15
a=ptime:20
a=sendrecv
```

2. On the outbound leg for the outgoing SDP offer: The SDP offer now includes only the G.711 and G.729 coders due to the coder restriction process on the incoming SDP offer (see Step 1).
  - a. The device adds the extension coder to the SDP offer and therefore, the SDP offer now includes the G.711, G.729 and G.726 coders.

```
m=audio 6050 RTP/AVP 0 8 18 96 96
a=rtpmap:0 PCMU/8000
a=rtpmap:8 PCMA/8000
a=rtpmap:18 G729/8000
a=rtpmap:96 G726-32/8000
a=fmtp:4 annexa=no
a=rtpmap:96 telephone-event/8000
a=fmtp:96 0-15
a=ptime:20
a=sendrecv
```

- b. The device applies coder restriction to the SDP offer. As the Allowed Audio Coders Group for coder restriction includes the G.723, G.726, and G.729 coders, the device allows and keeps the G.729 and G.726, but removes the G.711 coder as it does not appear in the Allowed Audio Coders Group for coder restriction.

```
m=audio 6050 RTP/AVP 18 96 96
a=rtpmap:18 G729/8000
a=rtpmap:96 G726-32/8000
a=fmtp:4 annexa=no
a=rtpmap:96 telephone-event/8000
a=fmtp:96 0-15
a=ptime:20
a=sendrecv
```

3. The device includes only the G.729 and G.726 coders in the SDP offer that it sends from the outgoing leg to the outbound SIP entity. The G.729 is listed first as the Allowed Audio Coders Group for coder restriction takes precedence over the extension coder.

➤ **To configure coder transcoding:**

1. In the Coder Groups table, configure a Coders Group for extension coders. For more information, see [Configuring Coder Groups](#).

2. In the IP Profiles table, configure the IP Profile associated with the SIP entity:
  - a. Assign the Coders Group to the IP Profile, using the 'Extension Coders Group' parameter (SBCExtensionCodersGroupName).
  - b. Enable extension coders by configuring the 'Allowed Coders Mode' parameter to **Restriction** or **Restriction and Preference**.



- For transcoding, make sure that the device's License Key includes a license for the number of DSP resources ('DSP Channels') and a license for the number of transcoding sessions ('Transcoding Sessions'). For more information on the License Key, see [License Key](#) on page 1094.
- Each transcoding session uses two DSP resources.
- You can configure the transcoding mode globally, using the [TranscodingMode] parameter, or for specific calls, using the IP Profiles table parameter [IpProfile\_TranscodingMode].
- It is recommended to use the MPM(s) when transcoding is required.

## Transcoding Mode

By default, the device performs transcoding only when necessary. This refers to all types of transcoding (interworking) that require the use of the device's DSP resources, for example, voice coder transcoding, DTMF negotiations, and fax negotiations. Transcoding is required, for example, when two SIP entities use different coders. In such a scenario, the device can be configured to use a different coder for each leg (inbound and outbound), using IP Profiles. If the SIP entities use the same coder, the device does not perform transcoding.

Alternatively, you can configure the device to always perform transcoding, regardless of whether it is required or not. This is referred to as *forced* transcoding. For example, if the SIP entities use the same coder, the device performs transcoding of the same coder (e.g., G.711 and G.711) between the two legs.

To configure the transcoding mode, use the global parameter [TranscodingMode] or the IP Profile parameter [IpProfile\_TranscodingMode] parameter.



- If the transcoding mode is configured to **Force Transcoding** (i.e., always perform transcoding) for an IP Profile associated with a specific SIP entity, the device also applies forced transcoding for the SIP entity communicating with this SIP entity, regardless of its IP Profile settings.

## Prioritizing Coder List in SDP Offer

In addition to restricting the use of coders using Allowed Audio Coders Groups (see [Configuring Allowed Audio Coder Groups](#)), you can also prioritize the coders listed in the SDP offer. This feature is referred to as *Coder Preference* and applies to both SBC legs:

- **Incoming SDP offer:** The device arranges the coder list in the incoming SDP offer according to the order of appearance of the Allowed Audio Coders Group that is



associated with the incoming dialog. The coders listed higher up in the group take preference over ones listed lower down. To configure this, configure the 'Allowed Coders Mode' parameter (IpProfile\_SBCAllowedCodersMode) in the associated IP Profile to **Preference** or **Restriction and Preference**. If you configure the parameter to to **Preference**, the coders in the SDP offer that also appear in the Allowed Audio Coders Group are listed first in the SDP offer, and the coders in the SDP offer that do not appear in the Allowed Audio Coders Group are listed after the Allowed coders in the SDP offer. Therefore, this setting does not restrict coder use to Allowed coders, but uses (prefers) the Allowed coders whenever possible.

- **Outgoing SDP offer:** If only Allowed coders are used, the device arranges the coders in the SDP offer as described above. However, if Extension coders are also used, the coder list is arranged according to the SBCPreferencesMode parameter. Depending on the parameter's settings, the Extension coders are added after the Allowed coders according to their order in the Allowed Audio Coders Group, or the Allowed and Extension coders are arranged according to their position in the Allowed Audio Coders Group.

## Allocating DSPs on SDP Offer or Answer

By default, the device allocates DSP resources for a call at the SDP Offer stage. If DSP resources are available at this stage, the device reserves DSPs for the call just in case call setup succeeds with the SDP Answer and DSPs are required (e.g., for transcoding). If there are no free DSP resources at the SDP Offer stage, no DSP resources are allocated for the call, at any stage of the SDP Offer-Answer exchange, and if DSPs are required (based on the SDP Answer), the device rejects the call.

However, this default behavior may cause call failure for a call requiring DSPs even when the device has sufficient DSP resources. For example, assume the device is licensed for 10 concurrent transcoding calls and is currently handling the establishment of 10 calls where only half require transcoding (DSPs). For all these calls, the device allocates DSPs during the SDP Offer stage (even if some of these calls may not require DSPs, based on the SDP Answer). If during this time the device starts processing an 11<sup>th</sup> call that requires transcoding (DSPs), since it has already allocated all of its DSP resources, it doesn't allocate any DSPs to this call and as a result, the device rejects the call.

To avoid such scenarios, you can configure the device to allocate DSPs only at the SDP Answer stage (SIP 200 OK or 180), when it can determine if DSPs are required or not for the call. If DSPs are required and DSP resources are available, the device allocates DSPs. If DSPs are required but there are no available DSPs, the device rejects the call.

### ➤ To disable reserving DSPs on SDP Offer:

1. Open the Media Settings page (**Setup** menu > **Signaling & Media** tab > **Media** folder > **Media Settings**).
2. From the 'Reserve DSP on SDP Offer' drop-down list, select **Disable**.

Reserve DSP on SDP Offer

Disable 

### 3. Click **Apply**.

## SRTP-RTP and SRTP-SRTP Transcoding

The device supports transcoding between SRTP and RTP. The device can also enforce specific SBC legs to use SRTP and/or RTP. The device's handling of SRTP/RTP is configured using the IP Profile parameter [SBCMediaSecurityBehaviour], which provides the following options:

- SBC passes the media as is, regardless of whether it's RTP or SRTP (default).
- SBC legs negotiate only SRTP media lines (m=); RTP media lines are removed from the incoming SDP offer-answer.
- SBC legs negotiate only RTP media lines; SRTP media lines are removed from the incoming offer-answer.
- Each SDP offer-answer is extended (if not already) to two media lines for RTP and SRTP.

If after SDP offer-answer negotiation, an SBC leg uses RTP while the other uses SRTP, the device performs RTP- SRTP transcoding. To translate between RTP and SRTP, the following prerequisites must be met:

- At least one supported SDP "crypto" attribute.
- SRTP must be enabled - [EnableMediaSecurity] parameter configured to [1].

Transcoding where both legs are configured for SRTP is typically required to trans-encrypt and trans-decrypt. This is relevant when the MKI and Symmetric MKI parameters are enabled. In other words, both sides need to both encrypt and decrypt the outgoing and incoming SRTP packets, respectively.



DSP resources are not required for RTP-SRTP transcoding.

## Multiple RTP Media Streams per Call Session

The device's SBC application supports multiple RTP media streams per SBC call session. It supports the negotiation of up to five media streams ('m=' line) in the SDP offer/answer model per session. The media can include a combination of any of the following types:

- Audio, indicated in the SDP as 'm=audio'
- Video, indicated in the SDP as 'm=video'
- Text, indicated in the SDP as 'm=text'
- Fax, indicated in the SDP as 'm=image'
- Binary Floor Control Protocol (BFCP), indicated in the SDP as 'm=application <port> UDP/BFCP'

Therefore, the device supports transcoding of various attributes in the SDP offer-answer (e.g., codec, port, and packetization time) per media type. If the device is unable to perform transcoding (e.g., does not support the coder), it relays the SBC dialog transparently.

## Interworking Miscellaneous Media Handling

This section describes various interworking features relating to media handling.

### Interworking DTMF Methods

The device supports interworking between various DTMF methods such as RFC 2833, In-Band DTMF's, and SIP INFO (Cisco\Nortel\Korea). By default, the device allows the remote user agents to negotiate (in case of RFC 2833) and passes DTMF without intervention. However, if two user agents (UA) support different DTMF methods, the device can interwork these different DTMF methods at each leg.

This DTMF interworking feature is enabled using IP Profiles (*ini* file parameter IPProfile):

- SBCRFC2833Behavior - affects the RFC 2833 SDP offer-answer negotiation:
  - [0]: (default) the device does not intervene in the RFC 2833 negotiation.
  - [1]: each outgoing offer-answer includes RFC 2833 in the offered SDP (the device adds RFC 2833 only if the incoming offer does not include RFC 2833).
  - [2]: the device removes RFC 2833 from the incoming offer.
- SBCAlternativeDTMFMethod – the device's first priority for DTMF method at each leg is RFC 2833. Therefore, if a specific leg negotiates RFC 2833 successfully, then the chosen DTMF method for this leg is RFC 2833. For legs where RFC 2833 is not negotiated successfully, the device uses the parameter to determine the DTMF method for the leg.

The chosen DTMF method determines (for each leg) which DTMF method is used for sending DTMF's. If the device interworks between different DTMF methods and one of the methods is In-band\RFC 2833, detection and generation of DTMF methods requires DSP resources.

### Interworking RTP Redundancy

The device supports interworking of RTP redundancy (according to RFC 2198) between SIP entities. Employing IP Profiles, you can configure RTP redundancy handling per SIP entity:

- Generate RFC 2198 redundant packets (IpProfile\_RTPRedundancyDepth parameter).
- Determine RTP redundancy support in the RTP redundancy negotiation in SDP offer/answer (IpProfile\_SBCRTPRedundancyBehavior parameter). If not supported, the device discards RTP redundancy packets (if present) received from or sent to the SIP entity.

For more information, see the above parameters in [Configuring IP Profiles](#).

### Interworking RTCP Attribute in SDP

The device supports interworking the RTCP attribute 'a=rtcp' in the SDP between SIP entities. Employing IP Profiles, you can configure RTCP attribute handling (add, remove or transparent) per SIP entity, using the IpProfile\_SBCSDPHandlerRTCPAttribute parameter (see [Configuring IP Profiles](#)).

## Interworking Crypto Lifetime Field

The device supports interworking the lifetime field in the 'a=crypto' attribute of the SDP, between SIP entities. Employing IP Profiles, you can configure the lifetime field handling (remove or retain) per SIP entity, using the `IpProfile_SBCRemoveCryptoLifetimeInSDP` parameter (see [Configuring IP Profiles](#)).

## Interworking ICE Lite for NAT Traversal

The device supports interworking ICE for NAT traversal, between SIP entities. Employing IP Profiles, you can enable ICE Lite per SIP entity, using the `[IPProfile_SBCIceMode]` parameter (see [Configuring IP Profiles](#)).

## Fax Negotiation and Transcoding

The device can allow fax transmissions to traverse transparently without transcoding or it can handle the fax as follows:

- Allow interoperability between different fax machines, supporting fax transcoding if required.
- Restrict usage of specific fax coders to save bandwidth, enhance performance, or comply with supported coders. These coders include G.711 (A-Law or Mu-Law), VBD (G.711 A-Law or G.711 Mu-Law), and T38.

Fax configuration is done in the Coder Groups table and IP Profiles table. The Coder Groups table defines the supported coders, which is assigned to the IP Profile associated with the SIP entity. The IP Profiles table also defines the negotiation method used between the incoming and outgoing fax legs, using the following fax-related parameters:

- `IPProfile_SBCFaxBehavior`: defines the offer negotiation method - pass fax transparently, negotiate fax according to fax settings in IP Profile, or enforce remote UA to first establish a voice channel before fax negotiation.
- `IPProfile_SBCFaxCodersGroupName`: defines the supported fax coders (from the Coder Groups table).
- `IPProfile_SBCFaxOfferMode`: determines the fax coders sent in the outgoing SDP offer.
- `IPProfile_SBCFaxAnswerMode`: determines the fax coders sent in the outgoing SDP answer.
- `IPProfile_SBCRemoteRenegotiateOnFaxDetection`: You can also configure the device to detect for faxes (CNG tone) immediately after the establishment of a voice channel (i.e., after 200 OK) and within a user-defined interval. If detected, it can then handle the subsequent fax renegotiation by sending re-INVITE messages to both SIP entities (originating and terminating faxes). For more information, see the parameter in [Configuring IP Profiles](#).



The voice-related coder configuration (Allowed and Extension coders) is independent of



the fax-related coder configuration, with the exception of the G.711 coder. If the G.711 coder is restricted by the Allowed Audio Coders Groups table, it is not used for fax processing even if it is listed in the Coder Groups table for faxes. However, support for G.711 coders for voice is not dependent upon which fax coders are listed in the Coder Groups table.

## SBC Authentication

The device can authenticate SIP servers and SBC users (clients). The different authentication methods are described in the subsequent subsections.

### SIP Authentication Server Functionality

The device can function as an Authentication server for authenticating received SIP message requests, based on HTTP authentication Digest with MD5. Alternatively, such requests can be authenticated by an external, third-party server.

When functioning as an Authentication server, the device can authenticate the following SIP entities:

- **SIP servers:** This is applicable to Server-type IP Groups. This provides protection from rogue SIP servers, preventing unauthorized usage of device resources and functionality. To authenticate remote servers, the device challenges the server with a user-defined username and password that is shared with the remote server. When the device receives an INVITE request from the remote server, it challenges the server by replying with a SIP 401 Unauthorized response containing the WWW-Authenticate header. The remote server then re-sends the INVITE containing an Authorization header with authentication information based on this username-password combination to confirm its identity. The device uses the username and password to authenticate the message prior to processing it.
- **SIP clients:** These are clients belonging to a User-type IP Group. This support prevents unauthorized usage of the device's resources by rogue SIP clients. When the device receives an INVITE or REGISTER request from a client (e.g., SIP phone) for SIP message authorization, the device processes the authorization as follows:
  - a. The device challenges the received SIP message only if it is configured as a SIP method (e.g., INVITE) for authorization. This is configured in the IP Groups table, using the 'Authentication Method List' parameter.
  - b. If the message is received without a SIP Authorization header, the device "challenges" the client by sending a SIP 401 or 407 response. The client then resends the request with an Authorization header (containing the user name and password).
  - c. The device validates the SIP message according to the AuthNonceDuration, AuthChallengeMethod and AuthQOP parameters.

- ◆ If validation fails, the device rejects the message and sends a 403 (Forbidden) response to the client.
- ◆ If validation succeeds, the device verifies client identification. It checks that the username and password received from the client is the same username and password in the device's User Information table / database (see [SBC User Information for SBC User Database](#)). If the client is not successfully authenticated after three attempts, the device sends a SIP 403 (Forbidden) response to the client. If the user is successfully identified, the device accepts the SIP message request.

The device's Authentication server functionality is configured per IP Group, using the 'Authentication Mode' parameter in the IP Groups table (see [Configuring IP Groups](#)).

## RADIUS-based User Authentication

The device can authenticate SIP clients (users) using a remote RADIUS server. The device supports the RADIUS extension for digest authentication of SIP clients, according to draft-sterman-aaa-sip-01. Based on this standard, the device generates the nonce (in contrast to RFC 5090, where it is done by the RADIUS server).

RADIUS based on draft-sterman-aaa-sip-01 operates as follows:

1. The device receives a SIP request without an Authorization header from the SIP client.
2. The device generates the nonce and sends it to the client in a SIP 407 (Proxy Authentication Required) response.
3. The SIP client sends the SIP request with the Authorization header to the device.
4. The device sends an Access-Request message to the RADIUS server.
5. The RADIUS server verifies the client's credentials and sends an Access-Accept (or Access-Reject) response to the device.
6. The device accepts the SIP client's request (sends a SIP 200 OK or forwards the authenticated request) or rejects it (sends another SIP 407 to the SIP client).

To configure this feature, set the SBCServerAuthMode ini file parameter to 2.

## OAuth2-based User Authentication

The device supports the OAuth 2.0 authentication protocol (RFC 7662 and Internet Draft "draft-ietf-sipcore-sip-authn-02"), allowing it to authenticate any specified incoming SIP request (e.g., REGISTER and INVITE) with a third-party OAuth Authorization server over HTTP/S.



OAuth-based authentication is applicable only to the SBC application.

OAuth authorization consists of the following main stages:



```
N5a9XgvPfltYuf0En9bKriezYLcQoUlvDZ4Oq7bK5C4aWkTUu6eMgkqIC50f
Cb3oyiYzLbbMmZ06JA
```

```
Contact: <sip:lnumvv6i@9rihbeck4vat.invalid;transport=ws>;+sip.ice;reg-
id=1;+sip.instance="<urn:uuid:1007ed30-98a3-492e-966f
67b6f6eb99c5>";expires=600
Expires: 600
Allow:
INVITE,ACK,CANCEL,BYE,UPDATE,MESSAGE,OPTIONS,REFER,INFO
Supported: path,gruu,outbound
User-Agent: Example WebRTC phone
Content-Length: 0
```

3. The device authenticates the SIP request, by sending (HTTP POST) an HTTP Introspection request with the user's Access Token to the OAuth Authorization server, as shown in the following example:

```
POST /auth/realms/demo/protocol/openid-connect/token/introspect HTTP/1.1
Host: authorizationhost.com
Content-Type: application/x-www-form-urlencoded
Content-Length:...
Authorization: Basic
dGVzdEludHJvc3BIY3Q6NTliZDA4NGUtMTJiNi00N2I5LWJmNz
token=<Access Token from Bearer in SIP Authorization header>
```

4. The OAuth Authorization server checks (*introspects*) if the token is currently active (or if it has expired or revoked). Upon a successful introspection, the OAuth Authorization server sends to the device a 200 OK response containing a JSON body ("application/ json").
5. The device checks the following attributes in the received JSON body:
  - "active": A "true" value indicates a valid token and the device allows the user access to its resources and continues with the regular handling and processing of the SIP request (e.g., registers user or processes the call). A "false" value indicates an invalid token and the device responds to the SIP request with a 401 (Unauthorized) response containing the header 'WWW-Authenticate: Bearer error="invalid-token"', indicating authentication failure.
  - "username": (Optional attribute) When it exists, the device compares it to the AOR of the SIP message. For REGISTER requests, the AOR is taken from the To header; for all other requests, the AOR is taken from the From header. If the username includes a "@" character, the entire AOR is compared; otherwise, only the user-part of the AOR is compared. If comparison fails, the device responds to the SIP request with a 401 (Unauthorized) response containing the header 'WWW-Authenticate: Bearer error="invalid\_request"', indicating authentication failure.



**Figure 30-1: General Stages of OAuth-based Authentication**

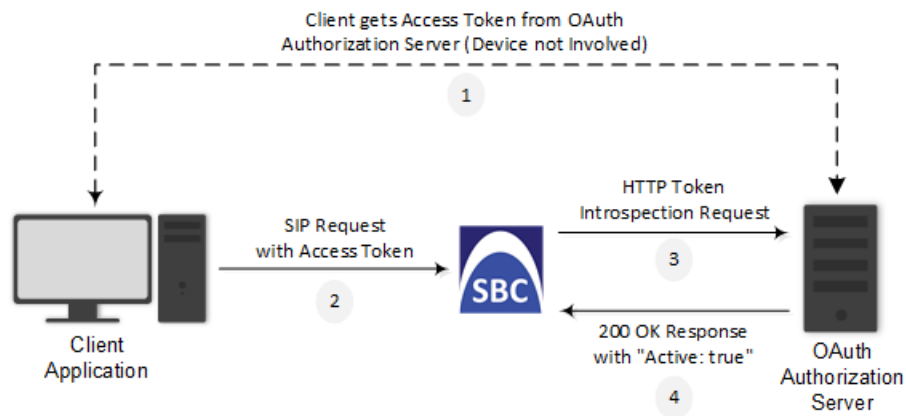

The main configuration required for OAuth-based authentication, includes the following:

- Configuring a Remote Web Service to represent the OAuth Authentication server
- Configuring the source IP Group (client) to authenticate by an OAuth Authorization server

The following provides a step-by-step example of configuring OAuth authentication.

➤ **To configure OAuth-based authentication:**

1. Open the Remote Web Services table (see [Configuring Remote Web Services](#) on page 299), and then configure a Remote Web Service to represent the OAuth Authentication server:

Parameter	Value	Comment
'Name'	"OAuth-Server"	Any descriptive name.
'Type'	<b>General</b>	-
'Path'	"auth/realms/demo/protocol/openid-connect/token/introspect"	Relative URL for the introspection service on the server.
'Username'	"device234"	Username that the device uses for authenticating the HTTP POST introspection request which it sends to the OAuth server.
'Password'	"12abMt"	Password that the device uses for authenticating the HTTP POST introspection request which it sends to the OAuth server.

Parameter	Value	Comment
		<b>Note:</b> The password cannot be configured with wide characters.

2. Select the Remote Web Service that you configured in Step 1, click the **HTTP Remote Hosts** link located below the table, and then configure an HTTP Remote Host:

Parameter	Value	Comment
'Address'	"oauth.example.com"	Address of the Authentication server.
'Port'	"443"	Port number of the Authentication server.
'Transport Type'	<b>HTTPS</b>	Secured HTTP.

3. Configure OAuth-based authentication for the source IP Group (client that the device needs to authenticate):

Parameter	Value	Comment
'Authentication Mode'	<b>SBC as Server</b>	The device authenticates as a server.
'Authentication Method List'	"register/setup- invite"	The SIP methods that the device needs to authenticate.
'SBC Server Authentication Type'	<b>Authenticate with OAuth Server</b>	The device authenticates the SIP requests with an OAuth Authentication server.
'OAuth HTTP Service'	<b>OAuth-Server</b>	Assigns the Remote Web Service that you configured (in Step 1) for the OAuth Authentication server.

## Interworking SIP Signaling

The device supports interworking of SIP signaling messages to ensure interoperability between communicating SIP UAs or entities. This is critical in network environments where the UAs on opposing SBC legs have different SIP signaling support. For example, some UAs may support different versions of a SIP method while others may not even support a specific SIP method. The configuration method for assigning specific SIP message handling modes to UAs, includes configuring an IP Profile with the required interworking mode, and then assigning the IP Profile to the relevant IP Group.

This section describes some of the device's support for handling SIP methods to ensure interoperability.

## Interworking SIP 3xx Redirect Responses

The device supports interworking of SIP 3xx redirect responses. By default, the device's handling of SIP 3xx responses is to send the Contact header unchanged. However, some SIP UAs may support different versions of the SIP 3xx standard while others may not even support SIP 3xx.

The handling of SIP 3xx can be configured for all calls, using the global parameter `SBC3xxBehavior`. To configure different SIP 3xx handling options for different UAs (i.e., per IP Group), use the IP Profiles table parameter, 'SBC Remote 3xx Mode'.

## Resultant INVITE Traversing Device

The device can handle SIP 3xx responses so that the new INVITE message sent as a result of the 3xx traverses the device. The reasons for enforcing resultant INVITEs to traverse the device may vary:

- The user that receives the 3xx is unable to route to the 3xx contact (i.e., the user is on the LAN and the new contact is on the WAN). In such a scenario, the device enables the user to reach the WAN contact and overcome NAT problems.
- Enforce certain SBC policies (e.g., call admission control, header manipulation, and transcoding) on the resultant INVITE.

The device enforces this by modifying each Contact in the 3xx response as follows:

- Changes the host part to the device's IP address – this change causes the remote user agent to send the INVITE to the device.
- Adds a special prefix ("T~&R\_") to the Contact user part – to identify the new INVITE as a 3xx resultant INVITE.

The SBC handling for the 3xx resultant INVITE is as follows:

1. The incoming INVITE is identified as a 3xx resultant INVITE according to the special prefix.
2. The device automatically replaces the SBC host part (in the Request-URI) with the host from the 3xx Contact.
3. The prefix ("T~&R\_") remains in the user part for the classification, manipulation, and routing mechanisms.
4. The classification, manipulation, and routing processes are done exactly like any other INVITE handling. The special prefix can be used for specific routing rules for 3xx resultant INVITEs.
5. The prefix is removed before the resultant INVITE is sent to the destination.

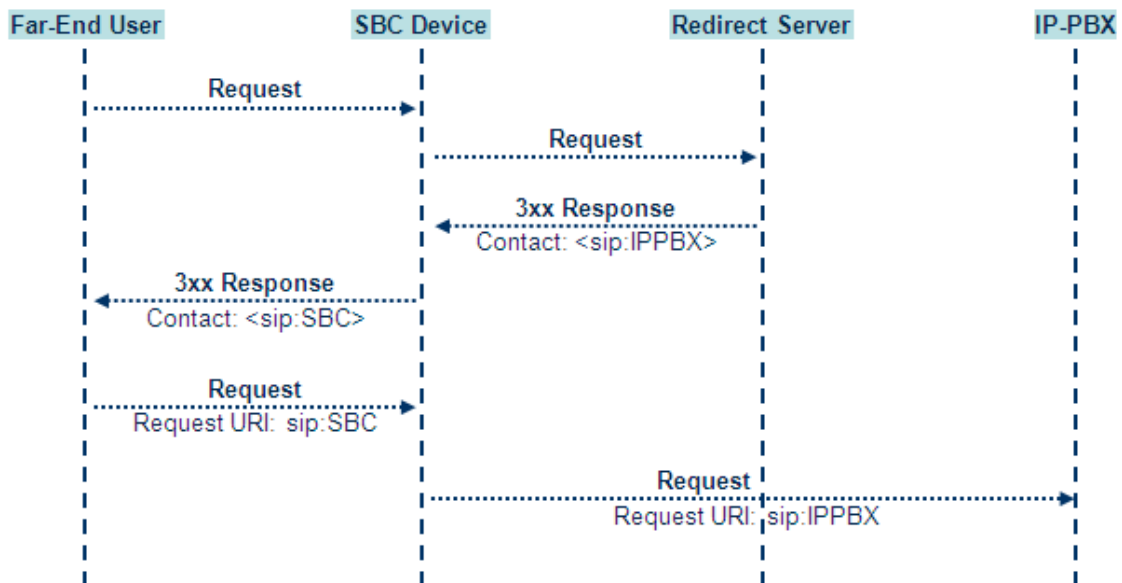

The process of this feature is described using an example:

1. The device receives the Redirect server's SIP 3xx response (e.g., Contact: < sip:User-@IPPBX:5060;transport=tcp;param=a>;q=0.5).
2. The device replaces the Contact header value with the special prefix and database key value as user part, and with the device's URL as host part (e.g., Contact: < sip:Prefix\_Key\_User@SBC:5070;transport=udp>;q=0.5).
3. The device sends this manipulated SIP 3xx response to the Far-End User (FEU).
4. The FEU sends a new request with the Request-URI set to the value of the received 3xx response's Contact header (e.g., RequestURI: sip:Prefix\_Key\_User@SBC:5070;transport=udp).
5. Upon receipt of the new request from the FEU, the device replaces the Request-URI with the new destination address (e.g., RequestURI: sip:Prefix\_User-@IPPBX:5070;transport=tcp;param=a).
6. The device removes the user prefix from the Request-URI, and then sends this Request-URI to the new destination (e.g., RequestURI: sip:User-@IPPBX:5070;transport=tcp;param=a).

### Local Handling of SIP 3xx

The device can handle SIP 3xx responses on behalf of the dialog-initiating UA and retry the request (e.g., INVITE) using one or more alternative URIs included in the 3xx response. The new request includes SIP headers from the initial request such as Diversion, History-Info, P-Asserted-Id, and Priority. The source and destination URIs can be manipulated using the regular manipulation mechanism.

The device sends the new request to the alternative destination according to the IP-to-IP Routing table rules. (where the 'Call Trigger' field is set to **3xx**). It is also possible to specify the

IP Group that sent the 3xx request as matching criteria for the re-routing rule in this table ('ReRoute IP Group ID' field).

## Interworking SIP Diversion and History-Info Headers

This device can be configured to interwork between the SIP Diversion and History-Info headers. This is important, for example, to networks that support the Diversion header but not the History-Info header, or vice versa. Therefore, mapping between these headers is crucial for preserving the information in the SIP dialog regarding how and why (e.g., call redirection) the call arrived at a certain SIP UA. If the Diversion header is used, you can specify the URI type (e.g., "tel:") to use in the header, using the SBCDiversionUriType parameter.

This feature is configured in the IP Profiles table using the following parameters:

- 'Diversion Header Mode' (IPProfile\_SBCDiversionMode) - defines the device's handling of the Diversion header
- 'History-Info Header Mode' (IPProfile\_SBCHistoryInfoMode) - defines the device's handling of the History-Info header

The handling of the SIP Diversion and History-Info headers is described in the table below:

**Table 30-1: Handling of SIP Diversion and History-Info Headers**

Parameter Value	SIP Header Present in incoming SIP Message		Device Action	IP Header Present in outgoing SIP Message	
	Diversion	History-Info		Diversion	History-Info
'Diversion Header Mode' = <b>Add</b> 'History-Info Header Mode' = <b>Add</b>	Not present	Present	Diversion added from History-Info	Present	Present
'Diversion Header Mode' = <b>Add</b> 'History-Info Header Mode' = <b>Add</b>	Present	Not present	History-Info added from Diversion	Present	Present
'Diversion Header Mode' = <b>Add</b>	Present	Present	Diversion replaced and added from History-Info History-Info replaced and added from	Present	Present

Parameter Value	SIP Header Present in incoming SIP Message		Device Action	IP Header Present in outgoing SIP Message	
'History-Info Header Mode' = <b>Add</b>			Diversion		
'Diversion Header Mode' = * 'History-Info Header Mode' = *	Not present	Not present	As no headers are present on incoming message, nothing is added	Not present	Not present
'Diversion Header Mode' = <b>Add</b> 'History-Info Header Mode' = <b>As Is</b>	Not present	Present	Diversion added from History-Info	Present	Present
'Diversion Header Mode' = <b>As Is</b> 'History-Info Header Mode' = <b>Add</b>	Present	Not present	History-Info added from Diversion	Present	Present
'Diversion Header Mode' = <b>Add</b> 'History-Info Header Mode' = <b>Remove</b>	Not present	Present	Diversion added from History-Info History-Info removed	Present	Not present
'Diversion Header Mode' = <b>Remove</b> 'History-Info Header Mode' = <b>Add</b>	Present	Not present	History-Info added from Diversion Diversion removed	Not present	Present
'Diversion Header Mode'	Present	Present	Both removed	Not present	Not present

Parameter Value	SIP Header Present in incoming SIP Message		Device Action	IP Header Present in outgoing SIP Message	
= Remove 'History-Info Header Mode' = Remove					

## Interworking SIP REFER Messages

The device supports interworking of SIP REFER messages. SIP UAs may support different versions of the REFER standard while others may not even support REFER.

This feature supports the following:

- Attended, unattended, and semi-attended call transfers
- Sending INVITE, REFER-notifications, BYE, PRACK and Session Timer on behalf of peer PBXs
- Advanced routing rules for the new, initiated INVITE
- Forwarding early media after REFER while attempting to avoid transcoding (by sending session update)
- Interoperate with environments where different SIP UAs lack basic SIP functionality such as re-INVITE, UPDATE, PRACK, Delayed Offer, re-INVITE without SDP
- Session updates after connect to avoid transcoding

The handling of REFER can be configured for all calls, using the global parameter [SBCReferBehavior]. To configure different REFER handling options for different UAs (i.e., IP Groups), use the IP Profiles table parameter, 'Remote REFER Mode'.

- Local handling of REFER: This option is used for UAs that do not support REFER. Upon receipt of a REFER request, instead of forwarding it to the IP Group, the device handles it locally. It generates a new INVITE to the alternative destination according to the rules in the IP-to-IP Routing table (where the 'Call Trigger' field is set to **REFER**). It is also possible to specify the IP Group that sent the REFER request, as matching criteria for the re-routing rule in this table ('ReRoute IP Group ID' field).
- Transparent handling: The device forwards the REFER with the Refer-To header unchanged.
- Re-routing through SBC: The device changes the Refer-To header so that the re-routed INVITE is sent through the SBC application.
- IP Group Name: The device sets the host part in the REFER message to the name configured for the IP Group in the IP Groups table.

## Interworking SIP PRACK Messages

The device supports interworking of SIP Provisional Response ACKnowledgement (PRACK) messages (18x). While some UAs may not support PRACK (RFC 3262) others may require it. The device can be configured to resolve this interoperable issue and enable sessions between such endpoints. SIP PRACK handling is configured using the IP Profile parameter, 'SBC Prack Mode':

- **Optional:** PRACK is optional for these UAs. If required, the device performs the PRACK process on behalf of the destination UA.
- **Mandatory:** PRACK is required for these UAs. Calls from UAs that do not support PRACK are rejected. Calls destined to these UAs are also required to support PRACK.
- **Transparent (default):** The device does not intervene with the PRACK process and forwards the request as is.

## Interworking SIP Session Timer

The device supports interworking of the SIP signaling keep-alive mechanism. The SIP standard provides a signaling keep-alive mechanism using re-INVITE and UPDATE messages. In certain setups, keep-alive may be required by some SIP UAs while for others it may not be supported. The device can resolve this mismatch by performing the keep-alive process on behalf of SIP UAs that do not support it.

To configure the handling of session expires, use the IP Profile parameter, 'SBC Session Expires Mode'.

## Interworking SIP Early Media

The device supports early media. Early media is when the media flow starts before the SIP call is established (i.e., before the 200 OK response). This occurs when the first SDP offer-answer transaction completes. The offer-answer options can be included in the following SIP messages:

- Offer in first INVITE, answer on 180, and no or same answer in the 200 OK
- Offer in first INVITE, answer on 180, and a different answer in the 200 OK (not standard)
- INVITE without SDP, offer in 180, and answer in PRACK
- PRACK and UPDATE transactions can also be used for initiating subsequent offer-answer transactions before the INVITE 200 OK response.
- In a SIP dialog life time, media characteristics after originally determined by the first offer-answer transaction can be changed by using subsequent offer-answer transactions. These transactions may be carried either in UPDATE or re-INVITE transactions. The media handling is similar to the original offer-answer handling. If the offer is rejected by the remote party, no media changes occur (e.g., INVITE without SDP, then 200 OK and ACK, offer-answer within an offer-answer, and Hold re-INVITE with IP address of 0.0.0.0 - IP address is unchanged).



The device supports various interworking modes for early media between SIP UAs (i.e., IP Groups):

- **Early Media Enabling:** The device supports the interworking of early media between SIP UAs that support early media and those that do not support receipt of early media. Early media can arrive in provisional responses to an INVITE request. The device forwards the request of early media for IP Groups that support this capability; otherwise, the device terminates it. Provisional responses whose SDP are suppressed are changed to a SIP 180 response. This feature is also supported for delayed offers. This is configured using the IP Profile parameter, 'SBC Remote Early Media Support'. The device refers to the parameter also for features that require early media such as playing ringback tone.
- **Early Media Response Type:** The device supports the interworking of different SIP provisional response types between UAs for forwarding the early media to the caller. This can support all early media response types (default), SIP 180 only, or SIP 183 only, and is configured by the IP Profile parameter, 'SBC Remote Early Media Response Type'.
- **Multiple 18x:** The device supports the interworking of different support for multiple 18x responses (including 180 Ringing, 181 Call is Being Forwarded, 182 Call Queued, and 183 Session Progress) that are forwarded to the caller. The UA can be configured as supporting only receipt of the first 18x response (i.e., the device forwards only this response to the caller), or receipt of multiple 18x responses (default). This is configured by the IP Profile parameter, 'SBC Remote Multiple 18x Support'.
- **Early Media RTP:** The device supports the interworking with remote clients that send 18x responses with early media and whose subsequent RTP is delayed, and with remote clients that do not support this and require RTP to immediately follow the 18x response. Some clients do not support 18x with early media, while others require 18x with early media (i.e., they cannot play ringback tone locally). These various interworking capabilities are configured by the IP Profile parameters, 'Remote Early Media RTP Detection Mode', 'SBC Remote Supports RFC 3960', and 'SBC Remote Can Play Ringback'. See the flowcharts below for the device's handling of such scenarios:

**Figure 30-2: SBC Early Media RTP 18x without SDP**

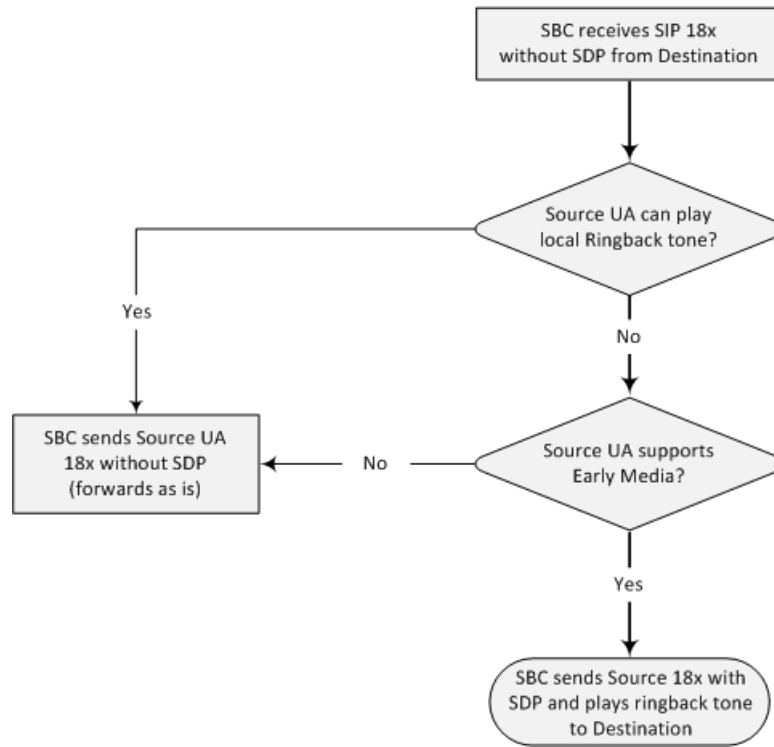
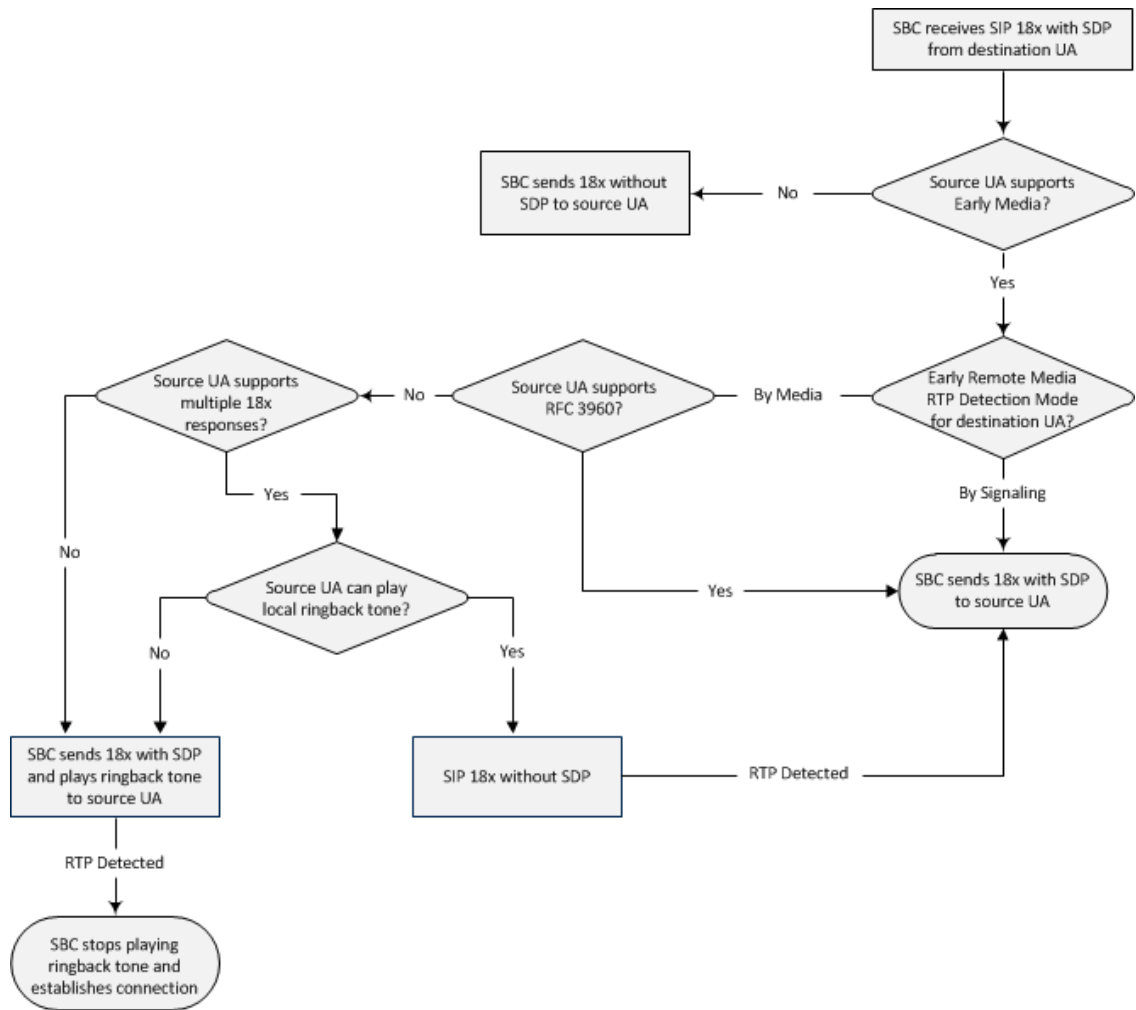

Figure 30-3: SBC Early Media RTP 18x with SDP



## Interworking SIP re-INVITE Messages

The device supports interworking of SIP re-INVITE messages. This enables communication between endpoints that generate re-INVITE requests and those that do not support the receipt of re-INVITES. The device does not forward re-INVITE requests to IP Groups that do not support it. Instead, it sends a SIP response to the re-INVITE request, which can either be a success or a failure, depending on whether the device can bridge the media between the endpoints. The device can also handle re-INVITES with or without an SDP body, enabling communication between endpoints that do not support re-INVITE requests without SDP, and those that require SDP. The device generates an SDP offer and adds it to the incoming re-INVITE request if it does not contain an SDP and only then forwards it to the destination endpoint. This interworking support is configured by the IP Profile parameter, 'SBC Remote Reinvite Support'.

## Interworking SIP UPDATE Messages

The device supports interworking of the SIP UPDATED message. This enables communication between UAs that generate UPDATE requests and those that do not support the receipt of

UPDATE requests. The device does not forward UPDATE requests to IP Groups that do not support it. Instead, it sends a SIP response to the UPDATE request which can either be a success or a failure, depending on whether the device can bridge the media between the endpoints. The handling of UPDATE messages is configured by the IP Profile parameter 'SIP UPDATE Support'.

## Interworking SIP re-INVITE to UPDATE

The device enables communication between endpoints (IP Groups) that do not support re-INVITE requests but support the UPDATE method, and vice versa. The device translates the re-INVITE request to the UPDATE request, and vice versa. Note that if a re-INVITE request arrives without SDP, the device generates the SDP and adds it to the outgoing UPDATE request. To enable this feature, each IP Group needs to be configured with its unique capabilities by associating it with a relevant IP Profile. For example, an IP Group that supports UPDATE requests but not re-INVITES would be configured as follows:

- SBCRemoteUpdateSupport = 2 (Supported)
- SBCRemoteReinviteSupport = 0 (Not Supported)

If a re-INVITE request needs to be forwarded to this IP Group, it is translated to an UPDATE request.

## Interworking Delayed Offer

The device supports interworking of INVITE messages with and without SDP between SIP entities. The device enables sessions between endpoints (IP Groups) that send INVITES without SDP (i.e., delayed media) and those that do not support the receipt of INVITES without SDP. The device creates an SDP and adds it to INVITES that arrive without SDP. Delayed offer is also supported when early media is present.

Employing IP Profiles, you can configure this interworking feature per SIP entity, using the 'SBC Remote Delayed Offer Support' parameter (see [Configuring IP Profiles](#)).



- The above mentioned intervention in the SDP offer-answer process may require transcoding.
- For SIP entities that do not support delayed offer, you must assign extension coders to its IP Profile (using the 'Extension Coders' parameter).

## Interworking Call Hold

The device supports the interworking of call hold / retrieve requests between SIP entities supporting different call hold capabilities:

- Interworking SDP call hold formats. This is configured by the IP Profile parameter, 'SBC Remote Hold Format'.
- Interworking the play of the held tone for IP entities that cannot play held tones locally. This is configured by the IP Profile parameter, 'Play Held Tone'.

- Interworking generation of held tone where the device generates the tone to the held party instead of the call hold initiator. This is configured by the IP Profile parameter, 'SBC Reliable Held Tone Source'.

To configure IP Profiles, see [Configuring IP Profiles](#).

## Interworking SIP Via Headers

The device supports the interworking of SIP Via headers between SIP entities. For the outgoing message sent to a SIP entity, the device can remove or retain all the Via headers received in the incoming SIP request from the other side. Employing IP Profiles, you can configure this interworking feature per SIP entity, using the IpProfile\_SBCKeepVIAHeaders parameter (see [Configuring IP Profiles](#)).

## Interworking SIP User-Agent Headers

The device supports the interworking of SIP User-Agent headers between SIP entities. For the outgoing message sent to a SIP entity, the device can remove or retain all the User-Agent headers received in the incoming SIP request/response from the other side. Employing IP Profiles, you can configure this interworking feature per SIP entity, using the IpProfile\_SBCKeepUserAgentHeader parameter (see [Configuring IP Profiles](#)).

## Interworking SIP Record-Route Headers

The device supports the interworking of SIP Record-Route headers between IP entities. For the outgoing message sent to a SIP entity, the device can remove or retain all the Record-Route headers received in the incoming SIP request/response from the other side. Employing IP Profiles, you can configure this interworking feature per SIP entity, using the IpProfile\_SBCKeepRoutingHeaders parameter (see [Configuring IP Profiles](#)).

## Interworking SIP To-Header Tags in Multiple SDP Answers

The device supports the interworking of SIP To-header tags in call forking responses (i.e., multiple SDP answers) between IP entities. The device can either use the same To-header tag value for all SDP answers sent to the SIP entity, or send each SDP answer with its original tag. Employing IP Profiles, you can configure this interworking feature per SIP entity, using the IpProfile\_SBCRemoteMultipleEarlyDialogs parameter (see [Configuring IP Profiles](#)).

## Interworking In-dialog SIP Contact and Record-Route Headers

The device supports the interworking of in-dialog, SIP Contact and Record-Route headers between SIP entities. Employing IP Profiles, you can configure this interworking feature per SIP entity, using the IpProfile\_SBCRemoteRepresentationMode parameter (see [Configuring IP Profiles](#)).

## 31 Utilizing Gateway Channel Resources for SBC

The device can utilize resources of non-configured Gateway channels (analog and digital) for SBC sessions, regardless of whether the device is licensed for SBC functionality. This feature, in essence, allows "call" resources to be migrated from the Gateway application to the SBC application, allowing you to migrate your Gateway deployment to an all IP-based voice network with only a simple configuration change. One of the main advantages of the feature is that if you purchased the device for deploying it initially as a Gateway for PSTN calls, you can at any stage easily use the device for SBC calls without having to purchase an SBC license.

A Gateway channel is considered "not configured" if it is not associated with any Trunk Group (see [Configuring Trunk Groups](#)). If all Gateway channels are configured, resources from these channels cannot be used for SBC sessions. If the resources of a currently active SBC call is obtained from a Gateway channel and you configure all Gateway channels during the call, the device maintains the SBC call until it is terminated by the call parties, but obtaining resources from Gateway channels for new SBC calls will not be made possible.

For every non-configured Gateway channel, one SBC session can be processed. For example:

A License Key licensing 1 E1 and 4 FXS and 1 BRI can support up to 37 SBC sessions (31 channels for E1 + 4 channels for FXS + 2 channels for 1 BRI port) if all the Gateway channels are not configured. If the License Key also provides a license for 5 SBC sessions, up to 42 SBC sessions (31 channels for E1 + 4 channels for FXS + 2 channels for 1 BRI port + 5 sessions for SBC) can be supported.

The number of SBC sessions that can be derived from using resources from Gateway channels that are not configured is displayed in the Web interface's License Key page (see [Viewing the License Key](#)), in the 'TDM-to-SBC Sessions' field.



- To support the feature, the License Key installed on your device must include the "TDM-to-SBC" feature key; otherwise, to purchase the feature, contact the sales representative of your purchased device to upgrade your License Key.
- The maximum number of SBC sessions that can be supported is according to the device's maximum SBC capacity (see [Channel Capacity](#)).

## 32 Configuring General SBC Settings

This section describes configuration of various SBC features.

### Interworking Dialog Information in SIP NOTIFY Messages

You can enable the device to interwork dialog information (XML body) received in SIP NOTIFY messages from a remote (WAN) application server. The NOTIFY message is sent by application servers to notify a SIP client, subscribed to a service and located behind the device (LAN), of the status of another SIP client in the LAN. For example, user B can subscribe to an application server for call pick-up service, whereby if user A's phone rings, the application server notifies user B. User B can then press a pre-configured key sequence to answer the call.

The NOTIFY message contains the XML body with call identifiers (call-id and tags). However, as the application server is located in the external network WAN and the SIP clients behind the device, the call dialog information sent by the application server reflects only the dialog between the device and itself; not that of the involved SIP clients. This is due to, for example, the device's topology hiding (e.g., IP address) of its LAN elements. The device resolves this by replacing the call identifiers received from the application server with the correct call identifiers (e.g., user A and user B). Thus, users subscribed to the service can receive relevant NOTIFY messages from the device and use the service.

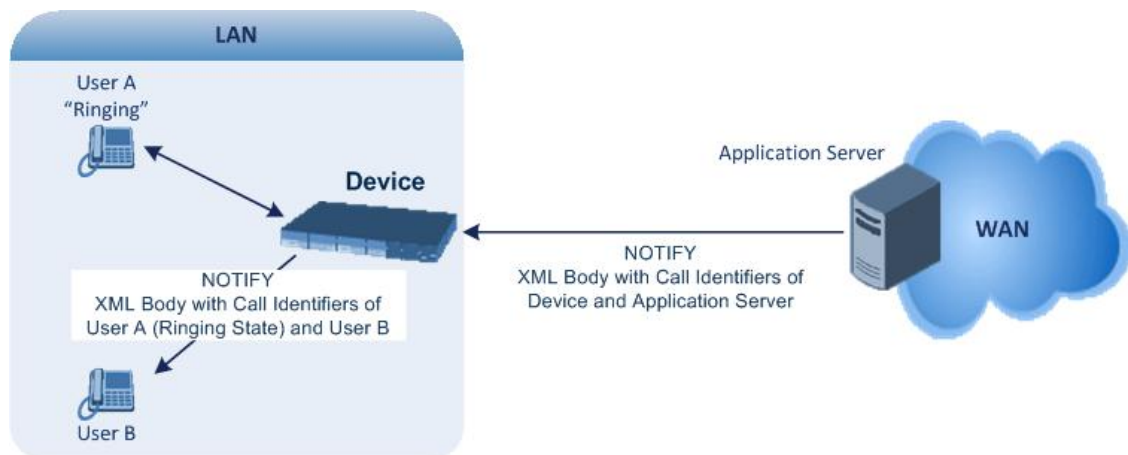

#### ➤ To enable the feature:

- Configure the 'SBC Dialog-Info Interworking' (EnableSBCDialogInfoInterworking) parameter to **Enable**.

When the feature is disabled, the device forwards the NOTIFY message as is, without modifying its XML body.

Below is an example of an XML body where the call-id, tags, and URIs have been replaced by the device:

```
<?xml version="1.0"?>
<dialog-info xmlns="urn:ietf:params:xml:ns:dialog-info"
```

```
version="10" state="partial"
entity="sip:alice@example.com">
<dialog id="zxcvbnm3" call-id="67402270@10.132.10.150"
local-tag="1c137249965"
remote-tag="CCDORRTDRKIKWFVBRWYM" direction="initiator">
<state event="replaced">terminated</state>
</dialog>
<dialog id="sfhjsjk12" call-id="67402270@10.132.10.150"
local-tag="1c137249965"
remote-tag="CCDORRTDRKIKWFVBRWYM" direction="receiver">
<state reason="replaced">confirmed</state>
<replaces
call-id="67402270@10.132.10.150"
local-tag="1c137249965"
remote-tag="CCDORRTDRKIKWFVBRWYM"/>
<referred-by>
sip:bob-is-not-here@vm.example.net
</referred-by>
<local>
<identity display="Jason Forster">
sip:jforsters@home.net
</identity>
<target uri="sip:alice@pc33.example.com">
<param pname="+sip.rendering" pval="yes"/>
</target>
</local>
<remote>
<identity display="Cathy Jones">
sip:cjones@example.net
</identity>
<target uri="sip:line3@host3.example.net">
<param pname="actor" pval="attendant"/>
<param pname="automaton" pval="false"/>
</target>
</remote>
</dialog>
</dialog-info>
```



## 33 Configuring Call Admission Control

You can implement Call Admission Control (CAC) to regulate the volume of voice traffic handled by the device.

CAC configuration is done using two tables with parent-child type relationship:

- Call Admission Control Profile table: This is the parent table, which defines a name for the CAC profile.
- Call Admission Control Rule table: This is the child table, which defines the actual CAC rules for the profile.

You can configure up to 102 CAC profiles and up to 102 CAC rules. In addition, a CAC profile can be configured with up to 8 CAC rules.

Once you have configured a CAC profile with CAC rules, you need to assign it to any of the following SIP configuration entities (using the 'CAC Profile' parameter):

- IP Group (see [Configuring IP Groups](#) on page 431)
- SIP Interface (see [Configuring SIP Interfaces](#) on page 415)
- SRD (see [Configuring SRDs](#) on page 403)

CAC rules define the maximum number of allowed concurrent calls (SIP dialog-initiating requests) for the assigned SIP entity (listed above) and per registered user belonging to the SIP entity. This can also include the maximum number of allowed concurrent SIP dialogs per second (*rate*). The CAC rule can be defined for a specific SIP message type (e.g., only INVITES) as well as for a specific call direction (e.g., only outbound calls).

The CAC feature supports SIP-dialog rate control using the token-bucket mechanism. Token bucket is a control mechanism that determines the rate of SIP dialog processing based on the presence of tokens in the bucket. Tokens in the bucket are removed ("cached in") for the ability to process each dialog. If there are no tokens, the device rejects the dialog request with a SIP 480 (Temporarily Unavailable). Configuration of the token-bucket mechanism involves the following:

- Configuring the number of tokens that are added to the bucket per second. This is referred to as *rate*. To process (allow) a SIP dialog, the device needs a token from the bucket.
- Configuring the maximum number of tokens that the bucket can hold and thus, the maximum number of tokens that can be used for processing SIP dialogs that are received at one time. This is referred to as *burst*.

For example, assume that the rate is configured to 1 and the burst to 4:

- One token is added to the bucket every second.
- The maximum number of tokens that the bucket can hold is four.

- If SIP dialogs have never been received by the device, the bucket is filled to its maximum, which is four tokens (i.e., burst), regardless of the number of seconds that have passed.
- If four SIP dialogs are received at the same time (i.e., burst), the device uses the four tokens to process the dialogs. The bucket is now left with no tokens at that given moment, but after a second, a new token is added to the bucket (due to the rate). If there are no calls for the next three seconds, the bucket fills up again to four tokens (and no more).
- If the bucket contains four tokens (i.e., full) and five SIP dialogs are received at the same time, the device uses the four tokens to process four of the dialogs and rejects one.
- If the bucket has one token and SIP dialogs are then received every second, the device uses the token to process the first dialog, adds a token to the bucket after a second and processes the second dialog, and so on.

Your CAC rule can also define a guaranteed number of concurrent calls (reserved capacity) for the assigned SIP entity (see above) . Reserved capacity is especially useful when the device operates with multiple entities. For example, if the total call capacity supported by the device is 200, a scenario may arise where a SIP entity may reach 200 call sessions, leaving no available call resources for the other SIP entities. If the reserved call capacity of a SIP entity is threatened by a new call for a different SIP entity, the device rejects the call to safeguard the reserved capacity.

Requests that reach the user-defined call limit (maximum concurrent calls or call rate) are sent to an alternative route, if configured (in the IP-to-IP Routing table). If no alternative routing rule exists, the device rejects the SIP request with a SIP 480 "Temporarily Unavailable" response.



- The device applies the CAC rule for the incoming leg immediately after the Classification process. If the call/request is rejected at this stage, no routing is performed. The enforcement for the outgoing leg is performed within each alternative route iteration. This is accessed from two places - during initial classification/routing and during alternative routing.
- CAC does not apply to Test Calls.

The following procedure describes how to configure CAC profiles through the Web interface. You can also configure them through other management interfaces:

- Call Admission Control Profile table: ini file [SBCAdmissionProfile] or CLI (`configure voip > sbc cac-profile`)
- Call Admission Control Rule table: ini file [SBCAdmissionRule] or CLI (`configure voip > sbc cac-rule`)

#### ➤ To configure a CAC profile:

1. Open the Call Admission Control Profile table (**Setup** menu > **Signaling & Media** tab > **SBC** folder > **Call Admission Control Profile**).
2. Click **New**; the following dialog box appears:

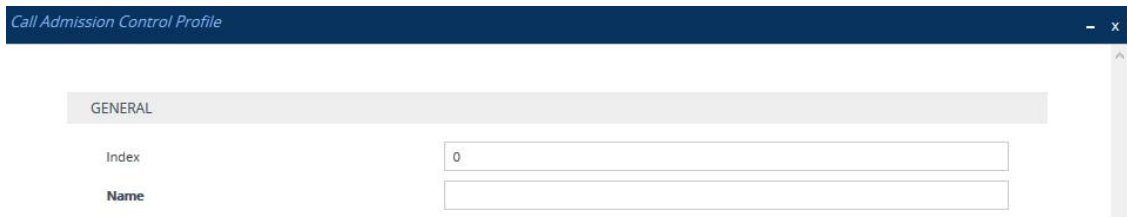

3. Configure a CAC profile according to the parameters described in the table below.
4. Click **Apply**.

**Table 33-1: Call Admission Control Profile Table Parameter Description**

Parameter	Description
'Index' [SBCAdmissionProfile_ Index]	Defines an index number for the new table row. <b>Note:</b> Each row must be configured with a unique index.
'Name' name [SBCAdmissionProfile_ Name]	Defines a descriptive name, which is used when associating the row in other tables. The valid value is a string of up to 40 characters. By default, no value is defined. <b>Note:</b> The parameter value cannot contain a forward slash (/).

5. In the Call Admission Control Profile table, select the required row, and then click the **Call Admission Control Rule** link located below the table; the Call Admission Control Rule table appears.
6. Click **New**; the following dialog box appears:

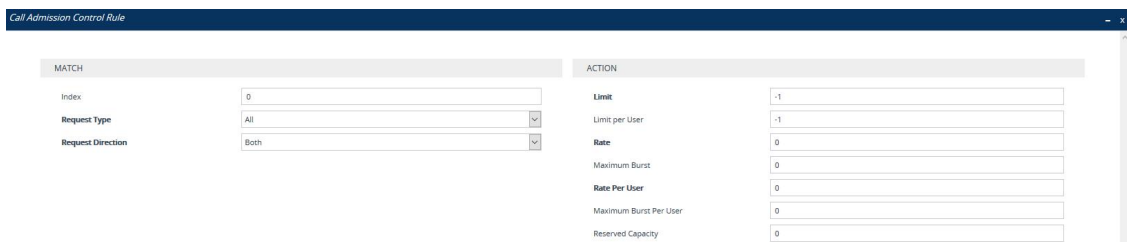

7. Configure a CAC rule according to the parameters described in the table below.
8. Click **Apply**.

**Table 33-2: Call Admission Control Rule Table Parameter Description**

Parameter	Description
Match	
'Index' sbc-admission-rule- <Index>/<Index>	Defines an index number for the new table row. <b>Note:</b> Each row must be configured with a unique index.

Parameter	Description
[SBCAdmissionRule_ RuleIndex]	
'Request Type' request-type [SBCAdmissionRule_ RequestType]	<p>Defines the type of SIP dialog-initiating request to which you want to apply the rule (not to subsequent requests, which can be of different type and direction).</p> <ul style="list-style-type: none"> <li>■ [0] <b>All</b> (default)</li> <li>■ [1] <b>INVITE</b></li> <li>■ [2] <b>SUBSCRIBE</b></li> <li>■ [3] <b>Other</b> = All SIP request types except INVITEs and SUBSCRIBEs (e.g., REGISTER).</li> </ul>
'Request Direction' request-direction [SBCAdmissionRule_ RequestDirection]	<p>Defines the call direction of the SIP request to which the rule applies.</p> <ul style="list-style-type: none"> <li>■ [0] <b>Both</b> = (Default) Rule applies to inbound and outbound SIP dialogs.</li> <li>■ [1] <b>Inbound</b> = Rule applies only to inbound SIP dialogs.</li> <li>■ [2] <b>Outbound</b> = Rule applies only to outbound SIP dialogs.</li> </ul>
Action	
'Limit' limit [SBCAdmissionRule_ Limit]	<p>Defines the maximum allowed number of concurrent SIP dialogs. You can also use the following special values:</p> <ul style="list-style-type: none"> <li>■ [-1] <b>-1</b> = (Default) Unlimited.</li> <li>■ [0] <b>0</b> = Block all the SIP dialog types specified in the 'Request Type' parameter (above).</li> </ul>
'Limit per User' limit-per-user [SBCAdmissionRule_ LimitPerUser]	<p>Defines the maximum allowed number of concurrent SIP dialogs per user.</p> <p>You can also use the following special values:</p> <ul style="list-style-type: none"> <li>■ [-1] <b>-1</b> = (Default) Unlimited.</li> <li>■ [0] <b>0</b> = Block all the SIP dialog types specified in the 'Request Type' parameter (above).</li> </ul>
'Rate' rate [SBCAdmissionRule_ Rate]	<p>Defines the number of tokens added to the token "bucket" per second, where a token "buys" a SIP dialog.</p> <p>For example, if you configure the parameter to 1, one</p>

Parameter	Description
	<p>token is added to the bucket every second. If there are no calls for five seconds, the bucket would have accumulated 5 tokens.</p> <p>The default is 0 (i.e., unlimited rate).</p> <p><b>Note:</b> If you configure this parameter, you must also configure the 'Maximum Burst' parameter to a non-zero value.</p>
<p>'Maximum Burst'  <code>max-burst</code>  [SBCAdmissionRule_  MaxBurst]</p>	<p>Defines the maximum number of SIP dialogs that can be processed at any given time. In other words, it defines the maximum number of tokens that the "bucket" can hold.</p> <p>The device only accepts a SIP dialog if a token exists in the "bucket". Once the SIP dialog is accepted, a token is removed from the "bucket".</p> <p>If a SIP dialog is received by the device and the token "bucket" is empty, the device rejects the SIP dialog. Alternatively, if the "bucket" is full, for example, 100 tokens, and 101 SIP dialogs arrive (before another token is added to the "bucket", i.e., faster than that configured in the 'Rate' parameter), the device accepts the first 100 SIP dialogs and rejects the last one.</p> <p>The device sends a SIP 480 "Temporarily Unavailable" response when it rejects requests. Dropped requests are not counted in the "bucket".</p> <p>The default is 0 (i.e., unlimited SIP dialogs).</p> <p><b>Note:</b></p> <ul style="list-style-type: none"> <li>■ The parameter functions together with the 'Rate' parameter (see above).</li> <li>■ The parameter's value cannot be greater than 10 times (x) the value of the 'Rate' parameter. For example, if you configured the 'Rate' parameter to 2, you can configure the 'Maximum Burst' parameter to any value less than or equal to 20 (i.e., 10 x 2).</li> <li>■ The token bucket feature is per SIP request type and SIP request direction.</li> </ul>
<p>'Rate Per User'  <code>rate-per-user</code>  [SBCAdmissionRule_  RatePerUser]</p>	<p>Defines the maximum allowed number of concurrent SIP dialogs per registered user that can be handled per second.</p> <p>The default is 0 (i.e., unlimited rate).</p>

Parameter	Description
	<p><b>Note:</b> If you configure this parameter, you must also configure the 'Maximum Burst per User' parameter to a non-zero value (see below).</p>
<p>'Maximum Burst Per User' max-burst-per-user [SBCAdmissionRule_ MaxBurstPerUser]</p>	<p>Defines the maximum number of tokens (SIP dialogs) per user that the bucket can hold (see the 'Maximum Burst' parameter for a detailed description). The default is 0 (i.e., unlimited SIP dialogs). <b>Note:</b> The parameter functions together with the 'Rate Per User' parameter (see above).</p>
<p>'Reserved Capacity' reservation [SBCAdmissionRule_ Reservation]</p>	<p>Defines the guaranteed (minimum) call capacity. The default is 0 (i.e., no reserved capacity). If you configure reserved call capacity for an SRD and each of its associated IP Groups, the SRD's reserved call capacity must be greater or equal to the summation of the reserved call capacity of all these IP Groups. In other words, the SRD serves as the "parent" reserved call capacity. If the SRD's reserved call capacity is greater, the extra call capacity can be used as a shared pool between the IP Groups for unreserved calls when they exceed their reserved capacity. For example, assume that the reserved capacity for an SRD and its associated IP Groups are as follows:</p> <ul style="list-style-type: none"> <li>■ SRD reserved call capacity: 40</li> <li>■ IP Group ID 1 reserved call capacity: 10</li> <li>■ IP Group ID 2 reserved call capacity: 20</li> </ul> <p>In this setup, the SRD offers a shared pool for unreserved call capacity of 10 [i.e., 40 – (10 + 20)]. If IP Group ID 1 needs to handle 15 calls, it is guaranteed 10 calls and the remaining 5 is provided from the SRD's shared pool. If the SDR's shared pool is currently empty and resources for new calls are required, the quota is taken from the device's total capacity, if available. For example, if IP Group ID 1 needs to handle 21 calls, it's guaranteed 10, the SRD's shared pool provides another 10, and the last call is provided from the device's total call capacity support (e.g., of 200).</p> <p><b>Note:</b></p> <ul style="list-style-type: none"> <li>■ Reserved call capacity is applicable only to IP Groups</li> </ul>

Parameter	Description
	<p>and SRDs.</p> <ul style="list-style-type: none"><li data-bbox="715 342 1350 416">■ Reserved call capacity is applicable only to INVITE and SUBSCRIBE messages.</li><li data-bbox="715 443 1394 555">■ Reserved call capacity must be less than the maximum capacity (limit) configured for the CAC rule (see the 'Limit' parameter).</li><li data-bbox="715 580 1394 692">■ The total reserved call capacity configured for all CAC rules must be within the device's total call capacity support.</li></ul>

## 34 Routing SBC

This section describes configuration of call routing for the SBC application.

### Configuring Classification Rules

The Classification table lets you configure up to 102 Classification rules. A Classification rule classifies incoming SIP dialog-initiating requests (e.g., INVITE messages) to a "source" IP Group. The source IP Group is the SIP entity that sent the SIP dialog request. Once classified, the device uses the IP Group to process the call (manipulation and routing).

You can also use the Classification table for employing SIP-level access control for successfully classified calls, by configuring Classification rules with whitelist and blacklist settings. If a Classification rule is configured as a whitelist ("Allow"), the device accepts the SIP dialog and processes the call. If the Classification rule is configured as a blacklist ("Deny"), the device rejects the SIP dialog.

Configuration of Classification rules includes two areas:

- **Match:** Defines the matching characteristics of the incoming IP call (e.g, source SIP Interface and IP address). Classification is primarily based on the SIP Interface (as the matching characteristics) on which the incoming dialog is received. As Classification rules must first be assigned with an SRD, the SIP Interface is one that belongs to the SRD. Therefore, Classification rules are configured per SRD, where multiple SIP Interfaces can be used as matching characteristics. However, as multiple SRDs are relevant only for multi-tenant deployments, for most deployments only a single SRD is required. As the device provides a default SRD ("Default\_SRD"), when only one SRD is required, the device automatically assigns it to the Classification rule.
- **Action:** Defines the action that is done if the incoming call matches the characteristics of the rule (i.e., classifies the call to the specified IP Group).

The device searches the table from **top to bottom** for the **first** rule that matches the characteristics of the incoming call. If it finds a matching rule, it classifies the call to the IP Group configured for that rule. If you are using source tags to classify incoming calls to IP Groups, then once the device locates a matching rule (including a match for the source tag), the device searches the IP Groups table for an IP Group with the matching tag. For more information on classification based on tags, see [Configuring Classification Based on Tags](#) on page 964.



Configure stricter classification rules higher up in the table than less strict rules to ensure incoming dialogs are classified to the desired IP Group. *Strict* refers to the number of matching characteristics configured for the rule. For example, a rule configured with source host name and destination host name as matching characteristics is stricter than a rule configured with only source host name. If the rule configured with only source host name appears higher up in the table, the device ("erroneously") uses the rule to classify incoming dialogs matching this source host





name (even if they also match the rule appearing lower down in the table configured with the destination host name as well).

If the device doesn't find a matching rule (i.e., classification fails), the device rejects or allows the call depending on the following configuration:

➤ **To configure the action for unclassified calls:**

1. Open the SBC General Settings (**Setup** menu > **Signaling & Media** tab > **SBC** folder > **SBC General Settings**).
2. From the 'Unclassified Calls' drop-down list, select **Reject** to reject unclassified calls or **Allow** to accept unclassified calls:

Unclassified Calls

Reject ▼

3. Click **Apply**.

If you configure the parameter to **Allow**, the incoming SIP dialog is assigned to an IP Group as follows:

1. The device determines on which SIP listening port (e.g., 5061) the incoming SIP dialog request was received and the SIP Interface configured with this port (in the SIP Interfaces table).
2. The device determines the SRD associated with this SIP Interface (in the SIP Interfaces table) and then classifies the SIP dialog to the first IP Group in the IP Groups table that is associated with the SRD. For example, if IP Groups 3 and 4 belong to the same SRD, the device classifies the call to IP Group 3.

The Classification table is used to classify incoming SIP dialog requests **only if** the following classification stages **fail**:

1. **Classification Stage 1 - Based on User Registration Database:** The device searches its users registration database to check whether the incoming SIP dialog arrived from a registered user. The device searches the database for a user that matches the address-of-record (AOR) and Contact of the incoming SIP message:
  - Compares the SIP Contact header to the contact value in the database.
  - Compares the URL in the SIP P-Asserted-Identity/From header to the registered AOR in the database.

If the device finds a matching registered user, it classifies the user to the IP Group associated with the user in the database. If this classification stage fails, the device proceeds to classification based on Proxy Set.

2. **Classification Stage 2 - Based on Proxy Set:** If the database search fails, the device performs classification based on Proxy Set. This classification is applicable only to Server-type IP Groups and is done only if classification based on Proxy Set is enabled (see the 'Classify By Proxy Set' parameter in the IP Groups table in [Configuring IP Groups](#)). The

device checks whether the incoming INVITE's IP address (if host name, then according to the dynamically resolved IP address list) is configured for a Proxy Set (in the Proxy Sets table). If such a Proxy Set exists, the device classifies the INVITE to the IP Group that is associated with the Proxy Set. The Proxy Set is assigned to the IP Group in the IP Groups table.

If more than one Proxy Set is configured with the same IP address and associated with the same SIP Interface, the device may classify and route the SIP dialog to an incorrect IP Group. In such a scenario, a warning is generated in the Syslog message. However, if some Proxy Sets are configured with the same IP address but different ports (e.g., 10.1.1.1:5060 and 10.1.1.1:5070) and the 'Classification Input' parameter is configured to **IP Address, Port & Transport Type**, classification (based on IP address and port combination) to the correct IP Group is achieved. Therefore, when classification is by Proxy Set, pay attention to the configured IP addresses and the 'Classification Input' parameter of your Proxy Sets. When more than one Proxy Set is configured with the same IP address, the device selects the matching Proxy Set in the following precedence order:

- a. Selects the Proxy Set whose IP address, port, and transport type match the source of the incoming dialog.
- b. If no match is found for a), it selects the Proxy Set whose IP address and transport type match the source of the incoming dialog (if the 'Classification Input' parameter is configured to **IP Address Only**).
- c. If no match is found for b), it selects the Proxy Set whose IP address match the source of the incoming dialog (if the 'Classification Input' parameter is configured to **IP Address Only**).

If classification based on Proxy Set fails (or classification based on Proxy Set is disabled), the device proceeds to classification based on the Classification table.



- For security, it is recommended to classify SIP dialogs based on Proxy Set only if the IP address of the Server-type IP Group is **unknown**. In other words, if the Proxy Set associated with the IP Group is configured with an FQDN. In such cases, the device classifies incoming SIP dialogs to the IP Group based on the DNS-resolved IP address. If the IP address is known, it is recommended to use a Classification rule instead (and disable the Classify by Proxy Set feature), where the rule is configured with not only the **IP address, but also with SIP message characteristics** to increase the strictness of the classification process. The reason for preferring classification based on Proxy Set when the IP address is unknown is that IP address forgery (commonly known as IP spoofing) is more difficult than malicious SIP message tampering and therefore, using a Classification rule without an IP address offers a weaker form of security. When classification is based on Proxy Set, the Classification table for the specific IP Group is ignored.
- If multiple IP Groups are associated with the same Proxy Set, use Classification rules to classify the incoming dialogs to the IP Groups (do **not** use the Classify by Proxy Set feature).



- The device saves incoming SIP REGISTER messages in its registration database. If the REGISTER message is received from a User-type IP Group, the device sends the message to the configured destination.

The flowchart below illustrates the classification process:

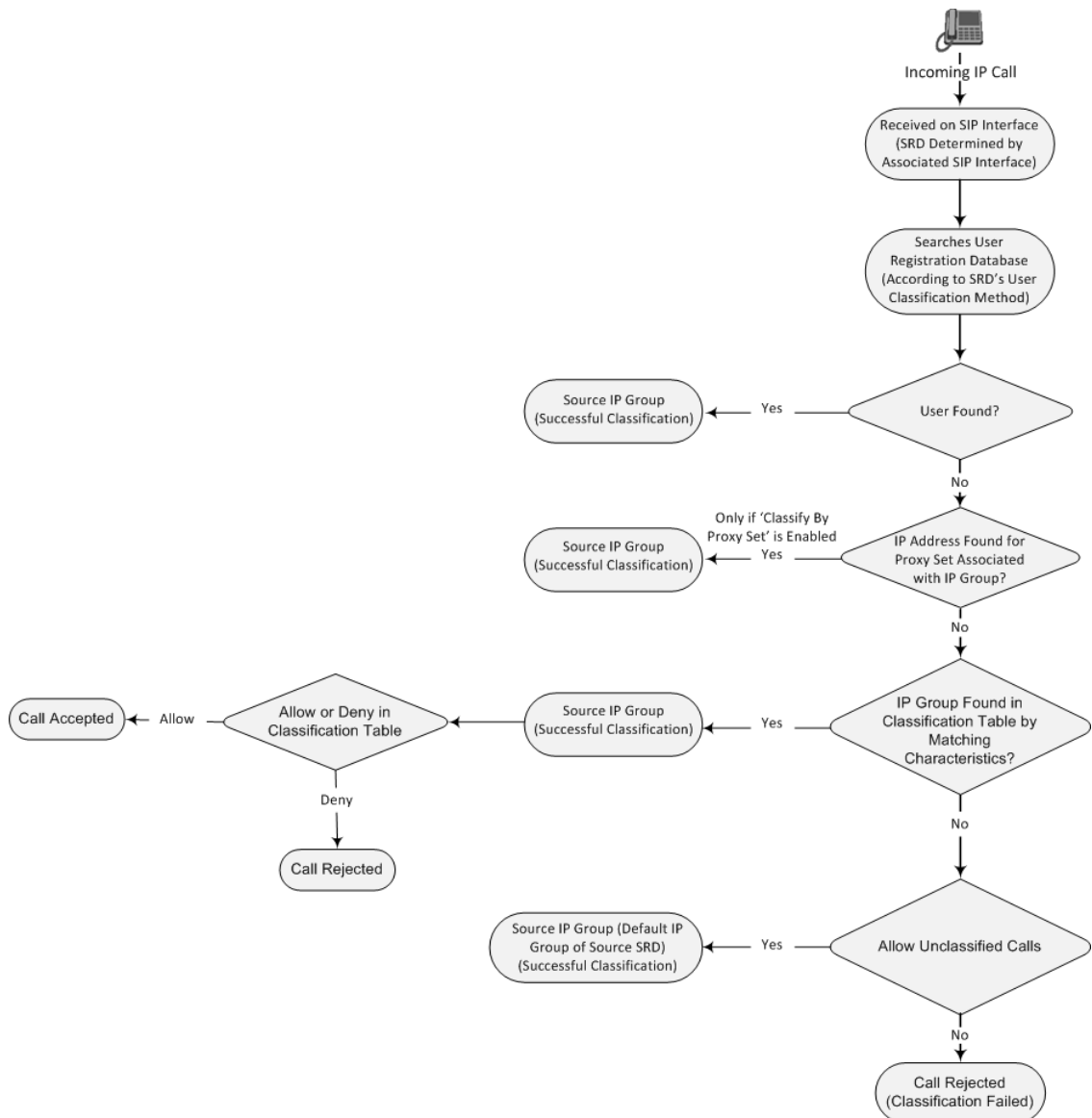

The following procedure describes how to configure Classification rules through the Web interface. You can also configure it through ini file [Classification] or CLI (`configure voip > sbc classification`).

➤ **To configure a Classification rule:**

- Open the Classification table (**Setup** menu > **Signaling & Media** tab > **SBC** folder > **Classification Table**).
- Click **New**; the following dialog box appears:

3. Configure the Classification rule according to the parameters described in the table below.
4. Click **Apply**.

**Table 34-1: Classification Table Parameter Descriptions**

Parameter	Description
'SRD' srd-name [Classification_SRDName]	<p>Assigns an SRD to the rule as a matching characteristic for the incoming SIP dialog.</p> <p>If only one SRD is configured in the SRDs table, the SRD is assigned to the rule by default. If multiple SRDs are configured in the SRDs table, no value is assigned.</p> <p>To configure SRDs, see <a href="#">Configuring SRDs</a>.</p> <p><b>Note:</b> The parameter is mandatory.</p>
<b>Match</b>	
'Index' [Classification_Index]	<p>Defines an index number for the new table row.</p> <p><b>Note:</b> Each row must be configured with a unique index.</p>
'Name' classification-name [Classification_ClassificationName]	<p>Defines a descriptive name, which is used when associating the row in other tables.</p> <p>The valid value is a string of up to 40 characters. By default, no name is defined.</p> <p><b>Note:</b> Each row must be configured with a unique name.</p>
'Source SIP Interface' src-sip-interface-name [Classification_SrcSIPInterfaceName]	<p>Assigns a SIP Interface to the rule as a matching characteristic for the incoming SIP dialog.</p> <p>The default is <b>Any</b> (i.e., all SIP Interfaces belonging to the SRD assigned to the rule).</p> <p><b>Note:</b> The SIP Interface must belong to the SRD assigned to the rule (see the 'SRD' parameter in the table).</p>
'Source IP Address' src-ip-address [Classification_SrcAddress]	<p>Defines a source IP address as a matching characteristic for the incoming SIP dialog.</p> <p>The valid value is an IP address in dotted-decimal</p>

Parameter	Description
	<p>notation. In addition, the following wildcards can be used:</p> <ul style="list-style-type: none"> <li>■ "x" wildcard: represents single digits. For example, 10.8.8.xx represents all addresses between 10.8.8.10 and 10.8.8.99.</li> <li>■ Asterisk (*) wildcard: represents any number between 0 and 255. For example, 10.8.8.* represents all addresses between 10.8.8.0 and 10.8.8.255.</li> </ul> <p>By default, no value is defined (i.e., any source IP address is accepted).</p> <p><b>Note:</b></p> <ul style="list-style-type: none"> <li>■ The parameter is applicable only to Server-type IP Groups.</li> <li>■ If the IP address is unknown (i.e., configured for the associated Proxy Set as an FQDN), it is recommended to classify incoming dialogs based on Proxy Set (instead of using a Classification rule). For more information on classification by Proxy Set or by Classification rule, see the note bulletin in the beginning of this section.</li> </ul>
'Source Transport Type' src-transport-type  [Classification_ SrcTransportType]	<p>Defines the source transport type as a matching characteristic for the incoming SIP dialog.</p> <ul style="list-style-type: none"> <li>■ [-1] <b>Any</b> = (Default) All transport types</li> <li>■ [0] <b>UDP</b></li> <li>■ [1] <b>TCP</b></li> <li>■ [2] <b>TLS</b></li> <li>■ [3] <b>SCTP</b></li> </ul>
'Source Port' src-port  [Classification_SrcPort]	<p>Defines the source port number as a matching characteristic for the incoming SIP dialog.</p> <p>By default, no value is defined.</p>
'Source Username Pattern' src-user-name- pattern  [Classification_ SrcUsernamePrefix]	<p>Defines the source URI user part as a matching characteristic for the incoming SIP dialog. The URI is typically located in the SIP From header. However, you can configure the SIP header from where the device obtains the source URI, in the IP Groups table ('Source URI Input' parameter). For more information on how the device</p>

Parameter	Description
	<p>obtains the URI, see <a href="#">SIP Dialog Initiation Process</a>.</p> <p>You can use special patterns (notations) to denote the user part. For example, if you want to match this rule to user parts whose last four digits (i.e., suffix) are 4 followed by any three digits (e.g., 4008), then configure this parameter to "(4xxx)", without the quotation marks. For available patterns, see <a href="#">Dialing Plan Notation for Routing and Manipulation</a>.</p> <p>The valid value is a string of up to 60 characters. The default is the asterisk (*) symbol, meaning any source user part.</p> <p><b>Note:</b> For REGISTER requests, the source URI is obtained from the To header.</p>
<p>'Source Host' src-host [Classification_SrcHost]</p>	<p>Defines the prefix of the source URI host name as a matching characteristic for the incoming SIP dialog.</p> <p>The URI is typically located in the SIP From header. However, you can configure the SIP header from where the device obtains the source URI, in the IP Groups table ('Source URI Input' parameter). For more information on how the device obtains this URI, see <a href="#">Call Processing of SIP Dialog Requests</a>.</p> <p>The default is the asterisk (*) symbol, which represents any source host prefix.</p> <p><b>Note:</b> For REGISTER requests, the source URI is obtained from the To header.</p>
<p>'Destination Username Pattern' dst-user-name-pattern [Classification_DestUsernamePrefix]</p>	<p>Defines the destination Request-URI user part as a matching characteristic for the incoming SIP dialog.</p> <p>You can use special patterns (notations) to denote the user part. For example, if you want to match this rule to user parts whose last four digits (i.e., suffix) are 4 followed by any three digits (e.g., 4008), then configure this parameter to "(4xxx)", without the quotation marks. For available patterns, see <a href="#">Dialing Plan Notation for Routing and Manipulation</a>.</p> <p>The valid value is a string of up to 60 characters. The default is the asterisk (*) symbol, meaning any destination user part.</p>
<p>'Destination Host' dst-host</p>	<p>Defines the prefix of the destination Request-URI host name as a matching characteristic for the incoming SIP</p>

Parameter	Description
[Classification_DestHost]	<p>dialog.</p> <p>The default is the asterisk (*) symbol, which represents any destination host prefix.</p>
'Message Condition' message-condition-name [Classification_MessageConditionName]	<p>Assigns a Message Condition rule to the Classification rule as a matching characteristic for the incoming SIP dialog.</p> <p>By default, no value is defined.</p> <p>To configure Message Condition rules, see <a href="#">Configuring Message Condition Rules</a>.</p>
Action	
'Action Type' action-type [Classification_ActionType]	<p>Defines a whitelist or blacklist for the matched incoming SIP dialog.</p> <ul style="list-style-type: none"> <li>■ [0] <b>Deny</b> = Blocks incoming SIP dialogs that match the characteristics of the rule (blacklist).</li> <li>■ [1] <b>Allow</b> = (Default) Allows incoming SIP dialogs that match the characteristics of the rule (whitelist) and assigns it to the associated IP Group.</li> </ul>
'Destination Routing Policy' dest-routing-policy [Classification_DestRoutingPolicy]	<p>Assigns a Routing Policy to the matched incoming SIP dialog.</p> <p>The assigned Routing Policy overrides the Routing Policy assigned to the SRD (in the SRDs table). The option to assign Routing Policies to Classification rules is useful in deployments requiring different routing and manipulation rules for specific calls pertaining to the <b>same</b> SRD. In such scenarios, you need to configure multiple Classification rules for the same SRD, where for some rules no Routing Policy is assigned (i.e., the SRD's assigned Routing Policy is used) while for others a different Routing Policy is specified to override the SRD's assigned Routing Policy.</p> <p>By default, no value is defined.</p> <p>To configure Routing Policies, see <a href="#">Configuring SBC Routing Policy Rules</a>.</p>
'IP Group Selection' ip-group-selection [Classification_IPGroupSelection]	<p>Defines how the incoming SIP dialog is classified to an IP Group.</p> <ul style="list-style-type: none"> <li>■ [0] <b>Source IP Group</b> = (Default) The SIP dialog is classified to the IP Group that is specified in the 'Source IP Group' parameter (see below).</li> </ul>

Parameter	Description
	<ul style="list-style-type: none"> <li>■ [1] <b>Tagged IP Group</b> = The SIP dialog is classified to an IP Group based on source tag, which is specified in the 'IP Group Tag Name' parameter (see below). For more information on Classification of incoming SIP dialogs to IP Groups using tags, see <a href="#">Configuring Classification Based on Tags</a> on page 964.</li> </ul>
'Source IP Group' src-ip-group-name [Classification_ SrcIPGroupName]	Assigns an IP Group to the matched incoming SIP dialog. By default, no value is defined. To configure IP Groups, see <a href="#">Configuring IP Groups</a> . <b>Note:</b> <ul style="list-style-type: none"> <li>■ The parameter is applicable only if you configure the 'IP Group Selection' parameter to <b>Source IP Group</b>.</li> <li>■ The IP Group must be associated with the assigned SRD (see the 'SRD' parameter in the table).</li> </ul>
'IP Group Tag Name' ip-group-tag-name [Classification_ IpGroupName]	Defines the source tag of the incoming SIP dialog. The tag is used for classifying the SIP dialog to an IP Group. The tag is obtained from the Call Setup Rule that is associated with the SIP Interface on which the dialog is received. The valid value is a string of up to 70 characters. The default value is "default" (without quotation marks), which must be used when the resultant tag from the Call Setup Rule is only a value (e.g., "Ireland"). If the resultant tag is a name=value (e.g., "Country=Ireland"), then configure the parameter with the <b>name</b> only (e.g., "Country"). Only <b>one</b> tag name can be configured. For more information on Classification of incoming SIP dialogs to IP Groups using tags, see <a href="#">Configuring Classification Based on Tags</a> on page 964. <b>Note:</b> The parameter is applicable only if you configure the 'IP Group Selection' parameter to <b>Tagged IP Group</b> .
'IP Profile' ip-profile-id [Classification_ IpProfileName]	Assigns an IP Profile to the matched incoming SIP dialog. The assigned IP Profile overrides the IP Profile assigned to the IP Group (in the IP Groups table) to which the SIP dialog is classified. Therefore, assigning an IP Profile during classification allows you to assign different IP Profiles to specific users (calls) that belong to the same IP Group (User or Server type). For example, you can configure two Classification rules to



Parameter	Description
	<p>classify incoming calls to the same IP Group. However, one Classification rule is a regular rule that doesn't specify any IP Profile (IP Profile assigned to IP Group is used), while the second rule is configured with an additional matching characteristic for the source hostname prefix (e.g., "abcd.com") and with an additional action that assigns a different IP Profile.</p> <p>By default, no value is defined.</p> <p><b>Note:</b> For User-type IP Groups, if a user is already registered with the device (from a previous, initial classification process), the device classifies subsequent INVITE requests from the user according to the device's users database instead of the Classification table. In such a scenario, the same IP Profile that was previously assigned to the user by the Classification table is also used (in other words, the device's users database stores the associated IP Profile).</p>

### Classification Based on URI of Selected Header Example

The following example describes how to configure classification of incoming calls to IP Groups, based on source URI in a specific SIP header. The example assumes the following incoming INVITE message:

```

INVITE sip:8000@10.33.4.226 SIP/2.0
Via: SIP/2.0/UDP 10.33.4.226;branch=z9hG4bKVEBTAHSUYRTEXEDEGJY
From: <sip:100@10.33.4.226>;tag=YSQQKXXREVPYPTNFMWG
To: <sip:8000@10.33.4.226>
Call-ID: FKPNOYRNKROIMEGBSSKS@10.33.4.226
CSeq: 1 INVITE
Contact: <sip:100@10.33.4.226>
Route: <sip:2000@10.10.10.10>,<sip:300@10.10.10.30>
Supported: em,100rel,timer,replaces
P-Called-Party-ID: <sip:1111@10.33.38.1>
User-Agent: Sip Message Generator V1.0.0.5
Content-Length: 0

```

1. In the Classification table, add the following classification rules:

Index	Source Username Pattern	Destination Username Pattern	Destination Host	Source IP Group
0	333	-	-	1
1	1111	2000	10.10.10.10	2

- In the IP Groups table, add the following IP Groups:

Index	Source URI Input	Destination URI Input
1	-	-
2	P-Called-Party-ID	Route

In the example, a match exists only for Classification Rule #1. This is because the source (1111) and destination (2000) username prefixes match those in the INVITE's P-Called-Party-ID header (i.e., "< sip:1111@10.33.38.1>") and Route header (i.e., "< sip:2000@10.10.10.10.10>"), respectively. These SIP headers were determined in IP Group 2.

## Configuring Classification Based on Tags

You can classify incoming SIP dialogs to IP Groups, using tags (source tags) that are obtained from Call Setup Rules associated with the SIP Interfaces on which dialogs are received. Using tags can significantly reduce the number of required Classification rules. In some scenarios, a single Classification rule may suffice.

Classification based on tags includes the following stages:

- The device determines the tag of the incoming SIP dialog by running a Call Setup Rule that is associated with the SIP Interface on which the dialog is received. The Call Setup Rule can be based on any query (request) type (e.g., LDAP, Dial Plan or HTTP). You can configure the Call Setup Rule to generate a tag with a name and value (e.g., "Country=Ireland") or only a value (e.g., "Ireland").
- The device searches the Classification table for a matching rule based on the SIP Interface (and optionally, any other existing matching properties) as well as the tag. The tag can be a name (e.g., "Country"), or "default" if the tag only has a value (e.g., "Ireland").
- The device searches the IP Groups table for an IP Group that is configured with the tag from the Call Setup Rule (name=value or value only) and if found, classifies the dialog to that IP Group.



- Classification based on tags is done only if classification based on user registration and Proxy Set fail.
- The IP Group Set table is not used for classification (i.e., ignores tags).

The following procedure describes how to configure incoming SIP dialog classification based on tags. The procedure is based on an example that uses Dial Plan tags to classify calls to three different IP Groups:

- Calls with source number (user) 410 are classified to IP Group-1
- Calls with source number (user) 420 are classified to IP Group-2
- Calls with source number (user) 430 are classified to IP Group-3

Instead of using Dial Plan tags, you can use any other request type (e.g., LDAP) in Call Setup Rules to determine the source tags.

➤ **To configure Classification based on tags:**

1. Open the Dial Plan table (see [Configuring Dial Plans](#) on page 624), and then configure Dial Plan tags. In our example, the following Dial Plan rules are configured for Dial Plan "ITSP":

Name	Prefix	Tag
Rule1	410	Country=Ireland
Rule2	420	Country=Scotland
Rule3	430	Country=England

2. Open the Call Setup Rules table (see [Configuring Call Setup Rules](#) on page 611), and then configure Call Setup Rules for obtaining source tags of incoming SIP dialogs. In our example, the following Call Setup Rule is configured:

General	
'Rules Set ID'	<b>1</b>
'Request Type'	<b>Dial Plan</b>
'Request Target'	<b>ITSP</b>
'Request Key'	<b>Param.Call.Src.User</b>
'Condition '	<b>DialPlan.Found exists</b>
Action	
'Action Subject'	<b>SrcTags</b>
'Action Type'	<b>Modify</b>
'Action Value'	<b>DialPlan.Result</b>

3. Open the SIP Interfaces table (see [Configuring SIP Interfaces](#) on page 415), and then configure a SIP Interface with the 'Call Setup Rules Set ID' parameter set to the 'Rules Set ID' value of your Call Setup Rules. In our example, the SIP Interface is named "SIPIfx-Tags" and the parameter is configured to 1.
4. Open the Classification table, and then configure a rule with the following:

Match	
'Source SIP Interface'	SIPIfx-Tags (or select <b>Any</b> )
Action	
'IP Group Selection'	<b>Tagged IP Group</b>
'IP Group Tag Name'	<b>Country</b> <b>Note:</b> Enter the tag's name only. If the tag only has a value, then enter "default" (without quotation marks).

5. Open the IP Groups table (see [Configuring IP Groups](#) on page 431), and then configure IP Groups with the 'Tags' parameter set to the appropriate tag. If the source tag has a name and value, then configure the parameter as name=value (e.g., "Country=Ireland"). If it only has a value, then configure it with the value. In our example, the following IP Groups are configured:

Name	Tags
IPGroup-1	Country=Ireland
IPGroup-2	Country=Scotland
IPGroup-3	Country=England

## Configuring SBC IP-to-IP Routing

The IP-to-IP Routing table lets you configure up to 615 SBC IP-to-IP routing rules.

Configuration of IP-to-IP routing rules includes two areas:

- **Match:** Defines the characteristics of the incoming SIP dialog message (e.g., IP Group from which the message is received).
- **Action:** Defines the action that is done if the incoming call matches the characteristics of the rule (i.e., routes the call to the specified destination).

The device searches the table from **top to bottom** for the **first** rule that matches the characteristics of the incoming call. If it finds a matching rule, it sends the call to the destination configured for that rule. If it doesn't find a matching rule, it rejects the call.



Configure stricter rules higher up in the table than less strict rules to ensure the desired rule is used to route the call. *Strict* refers to the number of matching characteristics configured for the rule. For example, a rule configured with source host name and source IP Group as matching characteristics is stricter than a rule configured with only source host name. If the rule configured with only source host name appears higher up in the table, the device ("erroneously") uses the rule to route calls matching this source host name (even if they also match the rule appearing lower down in the table configured with the source IP Group as well).

The IP-to-IP Routing table lets you route incoming SIP dialog messages (e.g., INVITE) to any of the following IP destinations:

- According to registered user Contact listed in the device's registration database (only for User-type IP Groups).
- IP Group - the destination is the address configured for the Proxy Set associated with the IP Group.
- IP Group Set - the destination can be based on multiple IP Groups for load balancing, where each call may be sent to a different IP Group within the IP Group Set depending on the IP Group Set's definition.
- Routing tag - the device sends the call to an IP Group (or IP Group Set) based on a destination Dial Plan tag that corresponds to the destination (called) prefix number.
- IP address in dotted-decimal notation or FQDN. Routing to a host name can be resolved using NAPTR/SRV/A-Record.
- Request-URI of incoming SIP dialog-initiating requests.
- Any registered user in the registration database. If the Request-URI of the incoming INVITE exists in the database, the call is sent to the corresponding contact address specified in the database.
- According to result of an ENUM query.
- Hunt Group - used for call survivability of call centers (see [Configuring Call Survivability for Call Centers](#)).
- According to result of LDAP query (for more information on LDAP-based routing, see [Routing Based on LDAP Active Directory Queries](#)).
- Third-party routing server, which determines the destination (next hop) of the call (IP Group). The IP Group represents the next device in the routing path to the final destination. For more information, see [Centralized Third-Party Routing Server](#).
- Tel destination (Gateway application). The rule redirects the call to the IP-to-Tel Routing table where the device searches for a matching IP-to-Tel routing rule. This feature can also

be done for alternative routing. If an IP-to-IP routing rule fails and it is configured with a "Gateway" routing rule as an alternative route, the device uses the IP-to-Tel Routing table to send the call to the Tel. The device identifies (internally) calls re-directed for alternative Gateway routing, by appending a user-defined string to the prefix destination Request-URI user part (by default, "acgateway-<prefix destination>", for example, acgateway-200). The device removes this prefix before sending it to the Tel side. To configure this prefix string, use the GWDirectRoutePrefix ini file parameter.

- Back to the sender of the incoming message, where the reply can be a SIP response code or a 3xx redirection response (with an optional Contact field to where the sender must re-send the message).

The following figure summarizes the destination types:



To configure and apply an IP-to-IP Routing rule, the rule must be associated with a Routing Policy. The Routing Policy associates the routing rule with an SRD(s). Therefore, the Routing Policy lets you configure routing rules for calls belonging to specific SRD(s). However, as multiple Routing Policies are relevant only for multi-tenant deployments (if needed), for most deployments, only a single Routing Policy is required. As the device provides a default Routing Policy ("Default\_SBCRoutingPolicy"), when only one Routing Policy is required, the device automatically assigns the default Routing Policy to the routing rule. If you are implementing LDAP-based routing (with or without Call Setup Rules) and/or Least Cost Routing (LCR), you need to configure these settings for the Routing Policy (regardless of the number of Routing

Policies employed). For more information on Routing Policies, see [Configuring SBC Routing Policy Rules](#).

The IP-to-IP Routing table also provides the following features:

■ **Alternative Routing:** In addition to the alternative routing/load balancing provided by the Proxy Set associated with the destination IP Group, the table allows the configuration of alternative routes where if a route fails, the next adjacent (below) rule in the table that is configured to **Alt Route Ignore/Consider Inputs** are used. The alternative routing rules can be set to enforce the input matching criteria or to ignore any matching criteria. Alternative routing occurs upon one of the following conditions:

- A request sent by the device is responded with one of the following:
  - ◆ SIP response code (e.g., 4xx, 5xx, and 6xx) that is also configured for an Alternative Reasons Set (see [Configuring SIP Response Codes for Alternative Routing Reasons](#)) assigned to the IP Group ('SBC Alternative Routing Reasons Set' parameter).
  - ◆ SIP 408 Timeout or no response (after timeout).
- The DNS resolution includes IP addresses that the device has yet to try (for the current call).

Messages are re-routed with the same SIP Call-ID and CSeq header fields (increased by 1).



If the Proxy Set (see [Configuring Proxy Sets](#)) associated with the destination of the call is configured with multiple IP addresses, the device first attempts to route the call to one of these IP addresses, starting with the first listed address. Only when the call cannot be routed to any of the Proxy Set's IP addresses does the device search the IP-to-IP Routing table for an alternative routing rule for the call.

■ **Load Balancing:** You can implement load balancing of calls, belonging to the same source, between a set of destination IP Groups known as an *IP Group Set*. The IP Group Set can include up to five IP Groups (Server-type and/or Gateway-type only) and the chosen IP Group depends on the configured load-balancing policy (e.g., Round Robin). To configure the feature, you need to first configure an IP Group Set (see [Configuring IP Group Sets](#)), and then assign it to a routing rule with 'Destination Type' configured to **IP Group Set**.

■ **Re-routing SIP Requests:** This table enables you to configure "re-routing" rules of requests (e.g., INVITEs) that the device sends upon receipt of SIP 3xx responses or REFER messages. These rules are configured for destinations that do not support receipt of 3xx or REFER and where the device handles the requests locally (instead of forwarding the 3xx or REFER to the destination).

■ **Least Cost Routing (LCR):** If the LCR feature is enabled, the device searches the routing table for matching routing rules and then selects the one with the lowest call cost. The call cost of the routing rule is done by assigning it a Cost Group. To configure Cost Groups, see [Least Cost Routing](#). If two routing rules have identical costs, then the rule appearing higher up in the table (i.e., first-matched rule) is used. If a selected route is unavailable, the

device uses the next least-cost routing rule. However, even if a matched rule is not assigned a Cost Group, the device can select it as the preferred route over other matched routing rules that are assigned Cost Groups, according to the default LCR settings configured for the assigned Routing Policy (see [Configuring SBC Routing Policy Rules](#)).

- **Call Forking:** The IP-to-IP Routing table can be configured to route an incoming IP call to multiple destinations (call forking). The incoming call can be routed to multiple destinations of any type such as an IP Group or IP address. The device forks the call by sending simultaneous INVITE messages to all the specified destinations. It handles the multiple SIP dialogs until one of the calls is answered and then terminates the other SIP dialogs.

Call forking is configured by creating a Forking group. A Forking group consists of a main routing rule ('Alternative Route Options' set to **Route Row**) whose 'Group Policy' is set to **Forking**, and one or more associated routing rules ('Alternative Route Options' set to **Group Member Ignore Inputs** or **Group Member Consider Inputs**). The group members must be configured in contiguous table rows to the main routing rule. If an incoming call matches the input characteristics of the main routing rule, the device routes the call to its destination and all those of the group members.

An alternative routing rule can also be configured for the Forking group. The alternative route is used if the call fails for the Forking group (i.e., main route and all its group members). The alternative routing rule must be configured in the table row immediately below the last member of the Forking group. The 'Alternative Route Options' of this alternative route must be set to **Alt Route Ignore Inputs** or **Alt Route Consider Inputs**. The alternative route can also be configured with its own forking group members, where if the device uses the alternative route, the call is also sent to its group members. In this case, instead of setting the alternative route's 'Group Policy' to **None**, you must set it to **Forking**. The group members of the alternative route must be configured in the rows immediately below it.

The LCR feature can also be employed with call forking. The device calculates a maximum call cost for each Forking group and routes the call to the Forking group with the lowest cost. Thus, even if the call can successfully be routed to the main routing rule, a different routing rule can be chosen (even an alternative route, if configured) based on LCR. If routing to one Forking group fails, the device tries to route the call to the Forking group with the next lowest cost (main or alternative route), and so on. The prerequisite for this functionality is that the incoming call must successfully match the input characteristics of the main routing rule.

- **Dial Plan Tags Representing Source / Destination Numbers:** If your deployment includes calls of many different called (source URI user name) and/or calling (destination URI user name) numbers that need to be routed to the same destination, you can employ user-defined tags to represent these numbers. Thus, instead of configuring many routing rules, you can configure only one routing rule using the tag as the source and destination number matching characteristics, and a destination for the calls. For more information, see [Using Dial Plan Tags for Matching Routing Rules](#).



- **Dial Plan Tags for Determining Destination IP Group:** Instead of configuring multiple routing rules, you can configure a single routing rule with a specific "destination" Dial Plan tag. The device uses the tag to determine the destination IP Group. For more information, see [Using Dial Plan Tags for Routing Destinations](#).
- **Fax Rerouting:** You can configure the device to reroute incoming calls that it identifies as fax calls to a new IP destination. For more information, see [Configuring Rerouting of Calls to Fax Destinations](#).

 **Call forking is not applicable to LDAP-based routing.**

The following procedure describes how to configure IP-to-IP routing rules through the Web interface. You can also configure it through ini file [IP2IPRouting] or CLI (`configure voip > sbc routing ip2ip-routing`).

➤ **To configure an IP-to-IP routing rule:**

1. Open the IP-to-IP Routing table (**Setup** menu > **Signaling & Media** tab > **SBC** folder > **Routing** > **IP-to-IP Routing**).
2. Click **New**; the following dialog box appears:

3. Configure an IP-to-IP routing rule according to the parameters described in the table below.
4. Click **Apply**.

**Table 34-2: IP-to-IP Routing Table Parameter Descriptions**

Parameter	Description
'Routing Policy' sbc-routing-policy-name [IP2IPRouting_RoutingPolicyName]	Assigns a Routing Policy to the rule. The Routing Policy associates the rule with an SRD(s). The Routing Policy also defines default LCR settings as well as the LDAP servers used if the routing rule is based on LDAP routing (and Call Setup Rules).  If only one Routing Policy is configured in the Routing Policies table, the Routing Policy is automatically assigned. If multiple Routing Policies are configured, no value is assigned.

Parameter	Description
	<p>To configure Routing Policies, see <a href="#">Configuring SBC Routing Policy Rules</a>.</p> <p><b>Note:</b> The parameter is mandatory.</p>
General	
'Index' [IP2IPRouting_Index]	<p>Defines an index number for the new table row.</p> <p><b>Note:</b> Each row must be configured with a unique index.</p>
'Name' route-name [IP2IPRouting_RouteName]	<p>Defines a descriptive name, which is used when associating the row in other tables.</p> <p>The valid value is a string of up to 40 characters. By default, no value is defined.</p>
'Alternative Route Options' alt-route-options [IP2IPRouting_AltRouteOptions]	<p>Determines whether this routing rule is the main routing rule or an alternative routing rule (to the rule defined directly above it in the table).</p> <ul style="list-style-type: none"> <li>■ [0] <b>Route Row</b> = (Default) Main routing rule - the device first attempts to route the call to this route if the incoming SIP dialog's input characteristics matches this rule.</li> <li>■ [1] <b>Alternative Route Ignore Inputs</b> = If the call cannot be routed to the main route (Route Row), the call is routed to this alternative route regardless of the incoming SIP dialog's input characteristics.</li> <li>■ [2] <b>Alternative Route Consider Inputs</b> = If the call cannot be routed to the main route (Route Row), the call is routed to this alternative route only if the incoming SIP dialog matches this routing rule's input characteristics.</li> <li>■ [3] <b>Group Member Ignore Inputs</b> = This routing rule is a member of the Forking routing rule. The incoming call is also forked to the destination of this routing rule. The matching input characteristics of the routing rule are ignored.</li> <li>■ [4] <b>Group Member Consider Inputs</b> = This routing rule is a member of the Forking routing rule. The incoming call is also forked to the destination of this routing rule only if the incoming call matches this rule's input characteristics.</li> </ul> <p><b>Note:</b></p> <ul style="list-style-type: none"> <li>■ The alternative routing entry ([1] or [2]) must be defined in the next consecutive table entry index to the Route Row entry (i.e., directly below it). For example, if Index 4 is configured as</li> </ul>

Parameter	Description
	<p>a Route Row, Index 5 must be configured as the alternative route.</p> <ul style="list-style-type: none"> <li>■ The Forking Group members must be configured in a table row that is immediately below the main Forking routing rule, or below an alternative routing rule for the main rule, if configured.</li> <li>■ For IP-to-IP alternative routing, configure alternative routing based on the receipt of specific SIP responses (see <a href="#">Configuring SIP Response Codes for Alternative Routing Reasons</a>). However, if no response, ICMP, or a SIP 408 response is received, the device attempts to use the alternative route even if you haven't configured any SIP responses for alternative routing.</li> <li>■ Multiple alternative route entries can be configured (e.g., Index 1 is the main route - Route Row - and indices 2 through 4 are configured as alternative routes).</li> </ul>
<b>Match</b>	
<p>'Source IP Group' src-ip-group-name [IP2IPRouting_SrcIPGroupName]</p>	<p>Defines the IP Group from where the IP call is received (i.e., the IP Group that sent the SIP dialog). Typically, the IP Group of an incoming SIP dialog is determined (or classified) using the Classification table (see <a href="#">Configuring Classification Rules</a>). The default is <b>Any</b> (i.e., any IP Group).</p> <p><b>Note:</b> The selectable IP Group for the parameter depends on the assigned Routing Policy (in the 'Routing Policy' parameter in this table). For more information, see <a href="#">Configuring SBC Routing Policy Rules</a>.</p>
<p>'Request Type' request-type [IP2IPRouting_RequestType]</p>	<p>Defines the SIP dialog request type (SIP Method) of the incoming SIP dialog.</p> <ul style="list-style-type: none"> <li>■ [0] <b>All</b> (default)</li> <li>■ [1] <b>INVITE</b></li> <li>■ [2] <b>REGISTER</b></li> <li>■ [3] <b>SUBSCRIBE</b></li> <li>■ [4] <b>INVITE and REGISTER</b></li> <li>■ [5] <b>INVITE and SUBSCRIBE</b></li> <li>■ [6] <b>OPTIONS</b></li> </ul>

Parameter	Description
	<p><b>Note:</b></p> <ul style="list-style-type: none"> <li>■ For User-type IP Groups, if you also need to send REGISTER messages received from this IP Group, then it is highly recommended that the configured destination of the routing rule is a Server-type IP Group and <b>not</b> an IP address (configured by the 'Destination Type' parameter). If you need to send non-REGISTER messages (e.g., INVITE) to a destination that is configured as an IP address, then you need to configure two IP-to-IP Routing rules for this User-type IP Group, one for routing REGISTER messages and one for routing non-REGISTER messages.</li> <li>■ If the device receives a REFER message, it searches again for a matching routing rule in the IP-to-IP Routing table and then forwards the message to the destination configured of the matched rule.</li> </ul>
<p>'Source Username Pattern'</p> <p><code>src-user-name-pattern</code></p> <p>[IP2IPRouting_SrcUsernamePrefix]</p>	<p>Defines the user part of the incoming SIP dialog's source URI (usually the From URI).</p> <p>You can use special patterns (notations) to denote the user part. For example, if you want to match this rule to user parts whose last four digits (i.e., suffix) are 4 followed by any three digits (e.g., 4008), then configure this parameter to "(4xxx)". To denote calls without a user part in the URI, use the dollar (\$) sign. For available patterns, see <a href="#">Dialing Plan Notation for Routing and Manipulation</a>.</p> <p>The valid value is a string of up to 60 characters. The default is the asterisk (*) symbol (i.e., any user part).</p> <p>If this rule is not required, leave this field empty.</p> <p><b>Note:</b> If you need to route calls of many different source URI user names to the same destination, you can use tags (see 'Source Tags' parameter below) instead of this parameter.</p>
<p>'Source Host'</p> <p><code>src-host</code></p> <p>[IP2IPRouting_SrcHost]</p>	<p>Defines the host part of the incoming SIP dialog's source URI (usually the From URI).</p> <p>The default is the asterisk (*) symbol (i.e., any host name). If this rule is not required, leave this field empty.</p>
<p>'Source Tags'</p> <p><code>src-tags</code></p> <p>[IP2IPRouting_SrcTags]</p>	<p>Assigns a tag to denote source URI user names corresponding to the tag configured in the associated Dial Plan.</p> <p>The valid value is a string of up to 70 characters. By default, no value is defined. You can configure the parameter with up to five tags, where each tag is separated by a semicolon (;). However,</p>

Parameter	Description
	<p>you can configure only up to four tags containing a name and value (e.g., Country=Ireland), and <b>one</b> tag containing a value only (e.g., Ireland). If you are configuring multiple tags in the name=value format, the names of each tag must be unique (e.g., <b>Country</b>=Ireland;<b>Land</b>=Scotland). The following example configures the maximum number of tags (i.e., four name=value tags and one value-only tag):</p> <p>Country=Ireland;Country2=Scotland;Country3=RSA;Country4=Canada;USA.</p> <p>To configure tags, see <a href="#">Configuring Dial Plans</a>.</p> <p><b>Note:</b></p> <ul style="list-style-type: none"> <li>■ The tag is case insensitive.</li> <li>■ Make sure that you assign the Dial Plan in which you have configured the tag, to the related IP Group or SRD.</li> <li>■ Instead of using tags and configuring the parameter, you can use the 'Source Username Pattern' parameter to specify a specific URI source user or all source users.</li> </ul>
<p>'Destination Username Pattern'</p> <p>dst-user-name-pattern</p> <p>[IP2IPRouting_DestUsernamePrefix]</p>	<p>Defines the incoming SIP dialog's destination URI (usually the Request URI) user part.</p> <p>You can use special patterns (notations) to denote the user part. For example, if you want to match this rule to user parts whose last four digits (i.e., suffix) are 4 followed by any three digits (e.g., 4008), then configure this parameter to "(4xxx)". To denote calls without a user part in the URI, use the dollar (\$) sign. For available patterns, see <a href="#">Dialing Plan Notation for Routing and Manipulation</a>.</p> <p>The valid value is a string of up to 60 characters. The default is the asterisk (*) symbol (i.e., any user part). If this rule is not required, leave this field empty.</p> <p><b>Note:</b> If you need to route calls of many different destination URI user names to the same destination, you can use tags (see 'Source Tags' parameter below) instead of this parameter.</p>
<p>'Destination Host'</p> <p>dst-host</p> <p>[IP2IPRouting_DestHost]</p>	<p>Defines the host part of the incoming SIP dialog's destination URI (usually the Request-URI).</p> <p>The default is the asterisk (*) symbol (i.e., any destination host). If this rule is not required, leave this field empty.</p>
<p>'Destination Tags'</p> <p>dest-tags</p> <p>[IP2IPRouting_</p>	<p>Assigns a prefix tag to denote destination URI user names corresponding to the tag configured in the associated Dial Plan.</p>

Parameter	Description
DestTags]	<p>The valid value is a string of up to 70 characters. By default, no value is defined. You can configure the parameter with up to five tags, where each tag is separated by a semicolon (;). However, you can configure only up to four tags containing a name and value (e.g., Country=Ireland), and <b>one</b> tag containing a value only (e.g., Ireland). If you are configuring multiple tags in the name=value format, the names of each tag must be unique (e.g., <b>Country=Ireland;Land=Scotland</b>). The following example configures the maximum number of tags (i.e., four name=value tags and one value-only tag):</p> <p>Country=Ireland;Country2=Scotland;Country3=RSA;Country4=Canada;USA.</p> <p>To configure prefix tags, see <a href="#">Configuring Dial Plans</a>.</p> <p><b>Note:</b></p> <ul style="list-style-type: none"> <li>■ The tag is case insensitive.</li> <li>■ Make sure that you assign the Dial Plan in which you have configured the prefix tag, to the related IP Group or SRD.</li> <li>■ Instead of using tags and configuring the parameter, you can use the 'Destination Username Pattern' parameter to specify a specific URI destination user or all destinations users.</li> </ul>
'Message Condition' message- condition- name [IP2IPRouting_ MessageConditionN ame]	<p>Assigns a SIP Message Condition rule to the IP-to-IP Routing rule. To configure Message Condition rules, see <a href="#">Configuring Message Condition Rules</a>.</p>
'Call Trigger' trigger [IP2IPRouting_ Trigger]	<p>Defines the reason (i.e., trigger) for re-routing (i.e., alternative routing) the SIP request.</p> <ul style="list-style-type: none"> <li>■ [0] <b>Any</b> = (Default) This routing rule is used for all scenarios (re-routes and non-re-routes).</li> <li>■ [1] <b>3xx</b> = Re-routes the request if it was triggered as a result of a SIP 3xx response.</li> <li>■ [2] <b>REFER</b> = Re-routes the INVITE if it was triggered as a result of a REFER request.</li> <li>■ [3] <b>3xx or REFER</b> = Applies to options [1] and [2].</li> <li>■ [4] <b>Initial only</b> = This routing rule is used for regular requests</li> </ul>

Parameter	Description
	<p>that the device forwards to the destination. This rule is not used for re-routing of requests triggered by the receipt of REFER or 3xx.</p> <ul style="list-style-type: none"> <li>■ [5] <b>Broken Connection</b> = If the device detects a broken RTP connection during the call and the Broken RTP Connection feature is enabled (IpProfile_DisconnectOnBrokenConnection parameter is configured to [2]), you can use this option as an explicit matching characteristics to route the call to an alternative destination. Therefore, for alternative routing upon broken RTP detection, position the routing rule configured with this option above the regular routing rule associated with the call. Such a configuration setup ensures that the device uses this alternative routing rule only when RTP broken connection is detected.</li> <li>■ [6] <b>Fax Rerouting</b> = Reroutes the INVITE to a fax destination (different IP Group) if it is identified as a fax call. For more information, see <a href="#">Configuring Rerouting of Calls to Fax Destinations</a>.</li> </ul>
<p>'ReRoute IP Group' re-route-ip-group-id [IP2IPRouting_ReRouteIPGroupName]</p>	<p>Defines the IP Group that initiated (sent) the SIP redirect response (e.g., 3xx) or REFER message. This parameter is typically used for rerouting requests (e.g., INVITEs) when interworking is required for SIP 3xx redirect responses or REFER messages. For more information, see <a href="#">Interworking SIP 3xx Redirect Responses</a> and <a href="#">Interworking SIP REFER Messages</a>, respectively. The parameter functions together with the 'Call Trigger' parameter (in the table). The default is <b>Any</b> (i.e., any IP Group).</p> <p><b>Note:</b> The selectable IP Group for the parameter depends on the assigned Routing Policy (in the 'Routing Policy' parameter in this table). For more information, see <a href="#">Configuring SBC Routing Policy Rules</a>.</p>
<b>Action</b>	
<p>'Destination Type' dst-type [IP2IPRouting_DestType]</p>	<p>Determines the destination type to which the outgoing SIP dialog is sent.</p> <ul style="list-style-type: none"> <li>■ [0] <b>IP Group</b> = (Default) The SIP dialog is sent to the IP Group as defined in the 'Destination IP Group' (IP2IPRouting_DestIPGroupName) parameter. For more information on the actual address, see the 'Destination IP Group' parameter.</li> <li>■ [1] <b>Dest Address</b> = The SIP dialog is sent to the address</li> </ul>

Parameter	Description
	<p>configured in the following parameters: 'Destination Address', 'Destination Port' and 'Destination Transport Type'.</p> <ul style="list-style-type: none"> <li>■ [2] <b>Request URI</b> = The SIP dialog is sent to the address indicated in the incoming Request-URI. If the parameters 'Destination Port' and 'Destination Transport Type' are configured, the incoming Request-URI parameters are overridden and these parameters take precedence.</li> <li>■ [3] <b>ENUM</b> = An ENUM query is sent to include the destination address. If the parameters 'Destination Port' and 'Destination Transport Type' are configured, the incoming Request-URI parameters are overridden and these parameters take precedence.</li> <li>■ [4] <b>Hunt Group</b> = Used for call center survivability. For more information, see <a href="#">Configuring Call Survivability for Call Centers</a>.</li> <li>■ [5] <b>Dial Plan</b> = (<b>For Backward Compatibility Only - see Note below</b>) The IP destination is determined by a Dial Plan index of the loaded Dial Plan file. The syntax of the Dial Plan index in the Dial Plan file is as follows: &lt;destination / called prefix number&gt;,0,&lt;IP destination&gt;</li> </ul> <p>Note that the second parameter "0" is ignored. An example of a configured Dial Plan (# 6) in the Dial Plan file is shown below:</p> <div style="background-color: #f0f0f0; padding: 10px; border: 1px solid #ccc;"> <pre>[ PLAN6 ] 200,0,10.33.8.52 ; called prefix 200 is routed to destination 10.33.8.52 201,0,10.33.8.52 300,0,itsp.com ; called prefix 300 is routed to destination itsp.com</pre> </div> <p>Once the Dial Plan is defined, you need to assign it (0 to 7) to the routing rule as the destination in the 'Destination Address' parameter, where "0" denotes [PLAN1], "1" denotes [PLAN2], and so on.</p> <ul style="list-style-type: none"> <li>■ [7] <b>LDAP</b> = LDAP-based routing. Make sure that the Routing Policy assigned to the routing rule is configured with the LDAP Server Group for defining the LDAP server(s) to query.</li> <li>■ [8] <b>Gateway</b> = The device routes the SBC call to the Tel side (Gateway call) using an IP-to-Tel routing rule in the IP-to-Tel Routing table (see <a href="#">Configuring IP-to-Tel Routing Rules</a>). The IP-to-Tel routing rule must be configured with the same call</li> </ul>



Parameter	Description
	<p>matching characteristics as this SBC IP-to-IP routing rule. This option is also used for alternative routing of an IP-to-IP route to the PSTN. In such a case, the IP-to-Tel routing rule must also be configured with the same call matching characteristics as this SBC IP-to-IP routing rule.</p> <p><b>Note:</b></p> <ul style="list-style-type: none"> <li>✓ If you configure the parameter to <b>Gateway</b> for a rule that is used for alternative routing (i.e., 'Alternative Route Options' parameter is configured to any value other than <b>Route Row</b>), the device uses two DSP session resources. One session resource is for the new Gateway route and one for the initial SBC session used for the incoming leg.</li> <li>✓ When the device uses this rule that is configured to <b>Gateway</b> and the 'Alternative Route Options' parameter is configured to <b>Route Row</b>, it ignores all other matching rules listed below this rule in the IP-to-IP Routing table.</li> </ul> <ul style="list-style-type: none"> <li>■ [9] <b>Routing Server</b> = Device sends a request to a third-party routing server for an appropriate destination (next hop) for the matching call.</li> <li>■ [10] <b>All Users</b> = Device checks whether the Request-URI (i.e., destination user) in the incoming INVITE is registered in its' users' database, and if yes, it sends the INVITE to the address of the corresponding contact specified in the database. If the Request-URI is not registered, the call is rejected.</li> <li>■ [11] <b>IP Group Set</b> = The device employs load balancing and routes the call to one of the IP Groups in the IP Group Set assigned using the 'IP Group Set' parameter (below).</li> <li>■ [12] <b>Destination Tag</b> = The device routes the call to an IP Group determined by Dial Plan tags. The tag is specified in the 'Routing Tag Name' parameter (below). For more information on using tags to determine destination IP Group, see <a href="#">Using Dial Plan Tags for Routing Destinations</a>.</li> <li>■ [13] <b>Internal</b> = Instead of sending the incoming SIP dialog to another destination, the device replies to the sender of the dialog with a SIP response code or a redirection response, configured by the 'Internal Action' (IP2IPRouting_ InternalAction) parameter in this table (see below).</li> </ul> <p><b>Note:</b></p>

Parameter	Description
	<ul style="list-style-type: none"> <li>■ Use the <b>Dial Plan</b> option only for backward compatibility purposes; otherwise, use prefix tags as described in <a href="#">Configuring Dial Plans</a>.</li> <li>■ If you configure the parameter to <b>Dest Address, Request URI, ENUM, Dial Plan</b> or <b>LDAP</b>, you must specify a destination IP Group using the 'Destination IP Group' parameter, even though these calls are <b>not</b> sent to the specified IP Group (i.e., its associated Proxy Set). This allows you to associate other configuration entities (such as an IP Profile) that are assigned to the IP Group, with the destination of these calls. If you do not specify a destination IP Group, the device uses its own logic in choosing a destination IP Group (and thus its associated configuration entities) for the routing rule.</li> <li>■ You can configure up to 20 IP-to-IP Routing rules whose 'Destination Type' is <b>Internal</b>.</li> </ul>
'Destination IP Group' dst-ip-group-name [IP2IPRouting_DestIPGroupName]	<p>Defines the IP Group to where you want to route the call. The actual destination of the SIP dialog message depends on the IP Group type (as defined in the 'Type' parameter):</p> <ul style="list-style-type: none"> <li>■ Server-type IP Group: The SIP dialog is sent to the IP address configured for the Proxy Set that is associated with the IP Group.</li> <li>■ User-type IP Group: The device checks if the SIP dialog is from a registered user, by searching for a match between the Request-URI of the received SIP dialog and an AOR registration record in the device's database. If found, the device sends the SIP dialog to the IP address specified in the database for the registered contact.</li> </ul> <p>By default, no value is defined.</p> <p><b>Note:</b></p> <ul style="list-style-type: none"> <li>■ The parameter is applicable only if the 'Destination Type' parameter is configured to <b>IP Group</b>. However, you also need to specify this parameter if the 'Destination Type' parameter is configured to <b>Dest Address, Request URI, ENUM, Dial Plan</b> or <b>LDAP</b> (even though these calls are <b>not</b> sent to the specified IP Group). For these cases, it allows you to associate other configuration entities (such as an IP Profile) that are assigned to the IP Group, with the destination of these calls.</li> <li>■ The selectable IP Group for the parameter depends on the assigned Routing Policy (in the 'Routing Policy' parameter in</li> </ul>

Parameter	Description
'Destination SIP Interface' dest-sip-interface-name [IP2IPRouting_DestSIPInterfaceName]	<p>this table). For more information, see <a href="#">Configuring SBC Routing Policy Rules</a>.</p> <p>Defines the destination SIP Interface to where the call is sent. By default, no value is defined.</p> <p>To configure SIP Interfaces, see <a href="#">Configuring SIP Interfaces</a>.</p> <p><b>Note:</b></p> <ul style="list-style-type: none"> <li>■ The parameter is applicable <b>only</b> if the 'Destination Type' parameter is configured to any value other than <b>IP Group</b>. If the 'Destination Type' parameter is configured to <b>IP Group</b>, the following SIP Interface is used:               <ul style="list-style-type: none"> <li>✓ Server-type IP Groups: SIP Interface that is assigned to the Proxy Set associated with the IP Group.</li> <li>✓ User-type IP Groups: SIP Interface is determined during user registration with the device.</li> </ul> </li> <li>■ For multi-tenancy, if the assigned Routing Policy is not shared (i.e., the Routing Policy is associated with an Isolated SRD), the SIP Interface must be one that is associated with the Routing Policy or with a shared Routing Policy (i.e., the Routing Policy is associated with one or more Shared SRDs). If the Routing Policy is shared, the SIP Interface can be one that is associated with any SRD or Routing Policy (but it's recommended that it belong to the same SRD/Routing Policy or to shared SRD/Routing Policy to avoid "bleeding").</li> </ul>
'Destination Address' dst-address [IP2IPRouting_DestAddress]	<p>Defines the destination address to where the call is sent. The valid value is an IP address in dotted-decimal notation or an FQDN (domain name, e.g., domain.com).</p> <p>If ENUM-based routing is used (i.e., the 'Destination Type' parameter is set to <b>ENUM</b>) the parameter configures the address of the ENUM service, for example, e164.arpa, e164.customer.net or NREnum.net. The device sends the ENUM query containing the destination phone number to an external DNS server, configured in the IP Interfaces table. The ENUM reply includes a SIP URI (user@host) which is used as the destination Request-URI in this routing table.</p> <p>The valid value is a string of up to 50 characters (IP address or FQDN). By default, no value is defined.</p> <p><b>Note:</b></p> <ul style="list-style-type: none"> <li>■ The parameter is applicable only if the 'Destination Type'</li> </ul>

Parameter	Description
	<p>parameter is configured to <b>Dest Address</b> [1] or <b>ENUM</b> [3]; otherwise, the parameter is ignored.</p> <ul style="list-style-type: none"> <li>■ When using domain names, enter the DNS server's IP address or alternatively, define these names in the Internal DNS table (see <a href="#">Configuring the Internal SRV Table</a>).</li> <li>■ To terminate SIP OPTIONS messages at the device (i.e., to handle them locally), set the parameter to "internal".</li> </ul>
'Destination Port' dst-port [IP2IPRouting_ DestPort]	Defines the destination port to where the call is sent.
'Destination Transport Type' dst-transport-type [IP2IPRouting_ DestTransportType]	<p>Defines the transport layer type for sending the call.</p> <ul style="list-style-type: none"> <li>■ [-1] = (Default) Not configured. The transport type is determined by the [SIPTransportType] global parameter.</li> <li>■ [0] <b>UDP</b></li> <li>■ [1] <b>TCP</b></li> <li>■ [2] <b>TLS</b></li> <li>■ [3] <b>SCTP</b></li> </ul>
'IP Group Set' ipgroupset-name [IP2IPRouting_ IPGroupSetName]	<p>Assigns an IP Group Set to the routing rule. The device routes the call to one of the IP Groups in the IP Group Set according to the load-balancing policy configured for the IP Group Set. For more information, see <a href="#">Configuring IP Group Sets</a>.</p> <p><b>Note:</b> The parameter is applicable only if you configure the 'Destination Type' parameter to <b>IP Group Set</b> (above).</p>
'Call Setup Rules Set ID' call-setup-rules-set-id [IP2IPRouting_ CallSetupRulesSetId]	<p>Assigns a Call Setup Rule Set ID to the routing rule. The device performs the Call Setup rules of this Set ID if the incoming call matches the characteristics of this routing rule. The device routes the call to the destination according to the routing rule's configured action, only after it has performed the Call Setup rules. To configure Call Setup rules, see <a href="#">Configuring Call Setup Rules</a>.</p>
'Group Policy' group-policy [IP2IPRouting_ GroupPolicy]	<p>Defines whether the routing rule includes call forking.</p> <ul style="list-style-type: none"> <li>■ [0] <b>None</b> = (Default) Call uses only this route (even if Forking Group members are configured in the rows below it).</li> <li>■ [1] <b>Forking</b> = Call uses this route and the routes of Forking</li> </ul>

Parameter	Description
	<p>Group members, if configured (in the rows below it).</p> <p><b>Note:</b> Each Forking Group can contain up to 20 members. In other words, up to 20 routing rules can be configured for the same Forking Group.</p>
<p>'Cost Group' cost-group [IP2IPRouting_ CostGroup]</p>	<p>Assigns a Cost Group to the routing rule for determining the cost of the call.</p> <p>By default, no value is defined.</p> <p>To configure Cost Groups, see <a href="#">Configuring Cost Groups</a>.</p> <p><b>Note:</b></p> <ul style="list-style-type: none"> <li>■ To implement LCR and its Cost Groups, you must enable LCR for the Routing Policy assigned to the routing rule (see <a href="#">Configuring SBC Routing Policy Rules</a>). If LCR is disabled, the device ignores the parameter.</li> <li>■ The Routing Policy also determines whether matched routing rules that are <b>not</b> assigned Cost Groups are considered as a higher or lower cost route compared to matching routing rules that are assigned Cost Groups. For example, if the 'Default Call Cost' parameter in the Routing Policy is configured to <b>Lowest Cost</b>, even if the device locates matching routing rules that are assigned Cost Groups, the first-matched routing rule without an assigned Cost Group is considered as the lowest cost route and thus, chosen as the preferred route.</li> </ul>
<p>'Routing Tag Name' routing-tag-name [IP2IPRouting_ RoutingTagName]</p>	<p>Defines the destination Dial Plan tag, which is used to determine the destination IP Group.</p> <p>The valid value is a string of up to 70 characters. Only <b>one</b> tag can be configured. Only the tag <b>name</b> must be configured (not the value, if exists). For example, if the tag is configured in the Dial Plan rule as "Country=England", configure the parameter to "Country" only. The tag is case insensitive.</p> <p>The default value is "default", meaning that the device uses the first tag name in the Dial Plan rule that is configured without a value. For example, if the Dial Plan rule is configured with tags "Country=England;City=London;Essex", the default tag is "Essex".</p> <p>For more information on using tags to determine destination IP Group, see <a href="#">Using Dial Plan Tags for Routing Destinations</a>.</p> <p><b>Note:</b> The parameter is applicable only if the 'Destination Type' parameter is configured to <b>Destination Tag</b> (see above).</p>
<p>'Internal Action'</p>	<p>Defines a SIP response code (e.g., 200 OK) or a redirection</p>

Parameter	Description
<p><code>internal-action</code> [IP2IPRouting_InternalAction]</p>	<p>response (with an optional Contact field indicating to where the sender must re-send the message) that the device sends to the sender of the incoming SIP dialog (instead of sending the call to another destination). The parameter is applicable only when the 'Destination Type' parameter in this table is configured to <b>Internal</b> (see above).</p> <p>The valid value syntax (case-insensitive) is:</p> <ul style="list-style-type: none"> <li>■ For SIP response codes:           <pre>reply(response='&lt;code&gt;')</pre> <p>The following example sends a SIP 200:</p> <pre>reply(response='200')</pre> </li> <li>■ For redirection responses:           <pre>redirect(response='&lt;code&gt;',contact='sip:'+....)</pre> <pre>redirect(contact='...',response='&lt;code&gt;')</pre> <pre>redirect(contact='sip:user@host')</pre> <p>Examples:</p> <ul style="list-style-type: none"> <li>✓ The device responds to the dialog with a SIP 300 redirect response that includes a contact value:               <pre>redirect(response='300',contact='sip:102@host')</pre> </li> <li>✓ The device redirects the call from the sender to a SIP Recording Server (SRS):               <pre>redirect (response='302',contact='sip:'+header.to.url.user+'@si precording.com')</pre> </li> </ul> </li> </ul> <p>You can use the built-in syntax editor to help you configure the field. Click the <b>Editor</b> button located alongside the field to open the Editor, and then simply follow the on-screen instructions.</p> <p><b>Note:</b></p>

Parameter	Description
	<ul style="list-style-type: none"> <li>■ The parameter can be used for normal and alternative routing.</li> <li>■ The response code for redirect messages can only be 3xx.</li> </ul>

## Configuring Rerouting of Calls to Fax Destinations

You can configure the device to reroute incoming SBC calls identified as fax calls to a new IP destination. The device identifies a fax call if it detects, within a user-defined interval, a calling (CNG) tone on the originator side (incoming IP leg). If the device detects a fax call, it terminates the call and reroutes it using a new INVITE to the new fax destination (new IP Group). If the initial INVITE that was used to establish the voice call was already sent, the device sends a CANCEL (if not connected yet) or a BYE (if already connected) to release the call (with the internal disconnect reason `RELEASE_BECAUSE_FAX_REROUTING`, translated to Q.850 reason `GWAPP_NORMAL_UNSPECIFIED 31`).



- You must configure the originating fax to use the G.711 coder.
- If the remote side replies with T.38 or G.711 VBD, fax rerouting is not done.
- If both fax rerouting and fax re-INVITE are configured, only fax rerouting is done.

The following provides a basic example on how to configure fax rerouting.

### ➤ To configure fax rerouting:

1. Open the Fax/Modem/CID Settings page (**Setup** menu > **Signaling & Media** tab > **Media** folder > **Fax/Modem/CID Settings**).
  - a. In the 'Fax Detection Timeout' field [`SBCFaxDetectionTimeout`], enter the duration (in seconds) for which the device attempts to detect fax (CNG tone):

Fax Detection Timeout [sec]

10

- b. From the 'CNG Detector Mode' drop-down list [`CNGDetectorMode`], select **Event Only**.
2. Load an ini file to the device through the Auxiliary Files page (see [Loading Auxiliary Files through Web Interface](#) on page 1082) with the following parameter setting, which enables in-band network detection related to fax:

```
EnableFaxModemInbandNetworkDetection = 1
```

3. In the IP Groups table (see [Configuring IP Groups](#)), configure the following IP Groups:
  - IP Group #0 "HQ": This is the source IP Group, sending voice calls and fax calls.
  - IP Group #1 "Voice": This is the destination for voice calls sent from IP Group #0.

- IP Group #2 "Fax": This is the destination for fax calls sent from IP Group #0.
4. For the fax destination (IP Group #2), do the following:
    - a. In the Coder Groups table (see [Configuring Coder Groups](#)), configure a Coder Group with T.38 to enable fax transmission over IP.
    - b. In the IP Profiles table (see [Configuring IP Profiles](#)), configure an IP Profile:
      - i. From the 'Fax Coders Group' drop-down list, select the Coder Group that you configured above.
      - ii. From the 'Fax Mode' drop-down list, select **Handle always**.
    - c. In the IP Groups table, edit IP Group #2, and then from the 'IP Profile' drop-down list, select the IP Profile that you configured above.
  5. For the voice destination (IP Group #1), do the following:
    - a. In the IP Profiles table, configure an IP Profile - from the 'Fax Rerouting Mode' drop-down list, select **Rerouting without delay**:

Fax Rerouting Mode  Rerouting without delay

- b. In the IP Groups table, edit IP Group #1, and then from the 'IP Profile' drop-down list, select the IP Profile that you configured above.
6. In the IP-to-IP Routing table (see [Configuring SBC IP-to-IP Routing Rules](#)), configure the following adjacent rows of IP-to-IP Routing rules:
  - IP-to-IP Routing Rule #0 to route voice calls from IP Group #0 to IP Group #1:

Match	
Source IP Group	HQ (IP Group #0)
Call Trigger	Initial Only
ReRoute IP Group	Voice (IP Group #1)
Action	
Destination Type	IP Group
Destination IP Group	Voice (IP Group #1)

- IP-to-IP Routing Rule #1 to route fax calls from IP Group #0 to IP Group #2:

Match	
Source IP Group	HQ (IP Group #0)



Call Trigger	<b>Fax Rerouting</b>
<b>Action</b>	
Destination Type	<b>IP Group</b>
Destination IP Group	<b>Fax (IP Group #2)</b>

## Configuring Specific UDP Ports using Tag-based Routing

You can configure the device to use a specific local UDP port for each SIP entity (e.g., PBX) communicating with a common proxy server (e.g., ITSP). The figure below illustrates an example scenario of such an implementation, whereby the device uses a specific local UDP port (e.g., 6001, 6002, and 6003) for each IP PBX, on the leg interfacng with the proxy server:

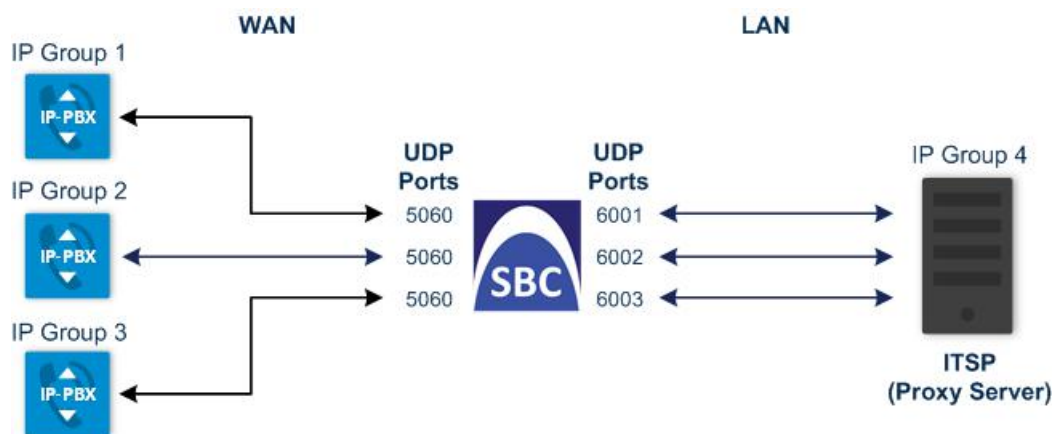

For each IP PBX, the device sends SIP messages to the proxy server using the specific local, UDP port on the leg interfacng with the proxy server. For SIP messages received from the proxy server, the device routes the messages to the appropriate IP PBX according to the local UDP port on which the message was received. On the leg interfacng with the IP PBXs, the device uses the same local UDP port (e.g., 5060) for all IP PBXs (send and receive).

To configure this feature, you need to configure the SIP Interface of the proxy server with a special UDP port range, and use tag-based routing with Call Setup Rules to specify the exact UDP port you want assigned to each SIP entity (IP PBX), from the SIP Interface port range. The following procedure describes how to configure the device to use a specific local UDP port per SIP entity on the leg interfacng with a proxy server that is common to all the SIP entities. To facilitate understanding, the procedure is based on the previous example.

### ➤ To configure specific UDP ports for SIP entities communicating with common proxy server:

1. Open the SIP Interfaces table (see [Configuring SIP Interfaces](#)), and then configure the following SIP Interfaces:
  - SIP Interface for leg interfacng with IP PBXs (local UDP port 5060 is used):

General	
Index	<b>1</b>
Name	<b>PBX</b>
Network Interface	<b>WAN</b>
UDP Port	<b>5060</b>

- SIP Interface for leg interfacing with proxy server (specific local UDP ports are later taken from this port range):

General	
Index	<b>2</b>
Name	<b>ITSP</b>
Network Interface	<b>LAN</b>
UDP Port	<b>5060</b>
Additional UDP Ports	<b>6000-7000</b>



For guidelines on configuring the 'Additional UDP Ports' parameter (SIPInterface\_AdditionalUDPPorts), see [Configuring SIP Interfaces](#).

2. Open the IP Groups table (see [Configuring IP Groups](#)), and then configure the following IP Groups:
  - IP Group for the first IP PBX ("Type" and "Port" tags are later used to identify the IP PBX and assign it a local UDP port 6001 on the leg interfacing with the proxy server):

General	
Index	<b>1</b>
Name	<b>PBX-1</b>
Type	<b>Server</b>
<b>SBC Advanced</b>	
Call Setup Rules Set ID	<b>1</b>
Tags	<b>Type=PBX;Port=6001</b>

- IP Group for the second IP PBX ("Type" and "Port" tags are later used to identify the IP PBX and assign it a local UDP port 6002 on the leg interfacing with the proxy server):

General	
Index	2
Name	PBX-2
Type	Server
SBC Advanced	
Call Setup Rules Set ID	1
Tags	Type=PBX;Port=6002

- IP Group for the third IP PBX ("Type" and "Port" tags are later used to identify the IP PBX and assign it a local UDP port 6003 on the leg interfacing with the proxy server):

General	
Index	3
Name	PBX-3
Type	Server
SBC Advanced	
Call Setup Rules Set ID	1
Tags	Type=PBX;Port=6003

- IP Group for the proxy server ("Type" tag is later used to identify proxy server):

General	
Index	4
Name	ITSP
Type	Server
SBC Advanced	
Call Setup Rules Set ID	1
Tags	Type=ITSP

3. Open the Call Setup Rules table (see [Configuring Call Setup Rules](#)), and then configure the following Call Setup rules:
  - Uses the value of the "Type" tag name, configured in the IP Group's 'Tags' parameter, as the source tag:

General	
Index	<b>1</b>
Rule Set ID	<b>1</b>
Action	
Action Subject	<b>srctags.Type</b>
Action Type	<b>Modify</b>
Action Value	<b>param.ipg.src.tags.Type</b>

- If the source tag name "Type" equals "PBX" (i.e., SIP message from an IP Group belonging to one of the IP PBXs), then use the value of the "Port" tag name, configured in the 'Tags' parameter of the classified IP Group, as the local UDP port on the leg interfacing with the proxy server for messages sent to the proxy server:

General	
Index	<b>2</b>
Rule Set ID	<b>1</b>
Condition	<b>srctags.Type=='PBX'</b>
Action	
Action Subject	<b>message.outgoing.local-port</b>
Action Type	<b>Modify</b>
Action Value	<b>param.ipg.src.tags.Port</b>

- If the source tag name "Type" equals "ITSP" (i.e., SIP message from the ITSP), then use the value (port number) of the local port on which the incoming message from the proxy server is received by the device, as the value of the destination tag name "Port". In other words, the value could either be "6001", "6002", or "6003". This value is then used by the IP-to-IP Routing table to determine to which IP PBX to send the message. For example, if the destination tag value is "6001", the device identifies the destination as "PBX-1":

General	
Index	<b>3</b>
Rule Set ID	<b>1</b>
Condition	<b>srctags.Type=='ITSP'</b>
Action	
Action Subject	<b>dsttags.Port</b>
Action Type	<b>Modify</b>
Action Value	<b>message.incoming.local-port</b>

4. Open the IP-to-IP Routing table (see [Configuring SBC IP-to-IP Routing Rules](#)), and then configure the following IP-to-IP Routing rules:
- Routes calls from the IP PBXs (identified by the source tag name-value "Type=PBX") to the ITSP (identified as an IP Group):

General	
Index	<b>1</b>
Name	<b>PBX-to-ITSP</b>
Match	
Source Tag	<b>Type=PBX</b>
Action	
Destination Type	<b>IP Group</b>
Destination IP Group	<b>ITSP</b>

- Routes calls from the ITSP (identified by the source tag name-value "Type=ITSP") to the IP PBXs (identified by the specific port assigned to the IP PBX by the value of the destination tag name "Port"):

General	
Index	<b>2</b>
Name	<b>ITSP-to-PBX</b>

General	
<b>Match</b>	
Source Tag	Type=ITSP
<b>Action</b>	
Destination Type	Destination Tag
Routing Tag Name	Port

## Configuring a Routing Response Timeout

If you have routing rules in the IP-to-IP Routing table that need to query external servers (e.g., an LDAP server or ENUM server) on whose responses the device uses to determine where to route the SBC calls, you can configure a timeout for the responses. If the timeout expires before the device receives a response from the server, the device sends a routing failure message (SIP 500) to the caller, or uses an alternative routing rule (if configured).

### ➤ To configure a timeout for routing query responses:

1. Open the SBC General Settings page (**Setup** menu > **Signaling & Media** tab > **SBC** folder > **SBC General Settings**).
2. In the 'Routing Timeout' (SbcRoutingTimeout) field, enter the maximum duration (in seconds) that the device is prepared to wait for a response from external servers.

Routing Timeout [sec]

3. Click **Apply**.

## Configuring SIP Response Codes for Alternative Routing Reasons

The Alternative Reasons Set table lets you configure groups of SIP response codes for SBC call release (termination) reasons that trigger alternative routing. This feature works together with the Proxy Hot Swap feature, which is configured in the Proxy Sets table.

Alternative routing based on SIP responses is configured using two tables with "parent-child" relationship:

- **Alternative Reasons Set table ("parent"):** Defines the name of the Alternative Reasons Set. You can configure up to 10 Alternative Reasons Sets.
- **Alternative Reasons Rules table ("child"):** Defines SIP response codes per Alternative Reasons Set. You can configure up to 200 Alternative Reasons Rules in total, where each Alternative Reasons Set can include up to 20 Alternative Reasons Rules.

To apply your configured alternative routing reason rules, you need to assign the Alternative Reasons Set for which you configured the rules, to the relevant IP Group in the IP Groups table, using the 'SBC Alternative Routing Reasons Set' parameter.

In addition to configuring the response codes described in this section, you need to configure the following:

- A Proxy Set with one or more addresses (proxy servers) and whose 'Proxy Hot Swap' parameter is configured to **Enable** (see [Configuring Proxy Sets](#)).
- An IP-to-IP Routing rule 1) whose 'Destination IP Group' parameter is a Server-type IP Group that is associated with the above Proxy Set (see [Configuring SBC IP-to-IP Routing Rules](#)) and 2) that is assigned the relevant Alternative Reasons Set (using the 'SBC Alternative Routing Reasons Set' parameter).
- An alternative IP-to-IP Routing rule for the above rule.

Alternative routing based on SIP response codes operates as follows:

1. The device sends (outgoing) a SIP dialog-initiating message (e.g., INVITE, OPTIONS, and SUBSCRIBE) to one of the online proxy servers (addresses) configured for the Proxy Set that is associated with the destination IP Group of the matched IP-to-IP Routing rule.
2. If there is no response to the sent SIP message, or a "reject" (release) response is received (e.g., SIP 406) that is also configured for the Alternative Reasons Set assigned to the destination IP Group, the device tries to route the SIP message again (re-transmission) to the same proxy for a user-defined number of times, configured by the [HotSwapRtx] parameter. If still unsuccessful, the device tries to send the message to a different online proxy of the Proxy Set and if unsuccessful, it tries another online proxy, and so on. The order of attempted online proxies is according to the Proxy Set's configuration.

The following can then occur depending on received response codes or no responses:

- If any attempted proxy sends a response code that you have not configured for the assigned Alternative Reasons Set, the routing of the SIP message fails and the device **does not** make any further attempts to route the message.
- If the device has tried all the online proxies of the Proxy Set and no response has been received or responses have been received that you have also configured for the assigned Alternative Reasons Set, the device searches the IP-to-IP Routing table for a matching alternative routing rule and if found, sends the SIP message to the destination configured for that alternative routing rule (repeating steps 1 through 2 above, if needed).

You can also configure alternative routing for the following proprietary response codes (if configured in the table) that are issued by the device itself:

- **806 Media Limits Exceeded:** The device generates the response code when the call is terminated due to crossed user-defined thresholds of QoE metrics such as MOS, packet delay, and packet loss (see [Configuring Quality of Experience Profiles](#)) and/or media bandwidth (see [Configuring Bandwidth Profiles](#)). When this occurs, the device sends a SIP 480 (Temporarily Unavailable) response to the SIP entity (IP Group). This is configured by 1)

assigning an IP Group a QoS and/or Bandwidth profile that rejects calls if the threshold is crossed, 2) configuring 806 for an Alternative Reasons Set that is assigned to the IP Group and 3) configuring an alternative routing rule.

The device also generates the response code when it rejects a call based on Quality of Service rules due to crossed Voice Quality and Bandwidth thresholds (see [Configuring Quality of Service Rules](#)). If the response code is configured in the table and the device rejects a call due to threshold crossing, it searches in the IP-to-IP Routing table for an alternative routing rule.

- **850 Signalling Limits Exceeded:** The device generates the response code when it rejects a call based on Quality of Service rules due to crossed ASR, NER or ACD thresholds (see [Configuring Quality of Service Rules](#)). If the response code is configured for an Alternative Reasons Set that is assigned to the IP Group and the device rejects a call due to threshold crossing, it searches in the IP-to-IP Routing table for an alternative routing rule.



- This section is applicable only to the SBC application.
- The device issues itself the SIP response code 408 when no response is received from a sent SIP message.
- If the device receives a SIP 408 response, an ICMP message, or no response, it still does alternative routing even if you have not configured this code for an Alternative Reasons Set.
- SIP requests belonging to an SRD or IP Group that have reached the call limit (maximum concurrent calls and/or call rate), configured in the Call Admission table, are sent to an alternative route (if configured in the IP-to-IP Routing table for the SRD or IP Group). If no alternative routing rule is found, the device automatically rejects the SIP request with a SIP 480 (Temporarily Unavailable) response.
- If due to an INVITE message the device receives from the proxy a SIP 18x response (e.g., 180 or 183) followed by any failure response (e.g., 400 Not Found), the device does not do alternative routing, but instead terminates the call. This occurs even if the failure response is configured in the associated Alternative Reasons Set.

The following procedure describes how to configure Alternative Reasons sets through the Web interface. You can also configure it through other management platforms:

- Alternative Reasons Set table: ini file [SBCAltRoutingReasonsSet] or CLI (`configure voip > sbc routing alt-route-reasons-set`)
- Alternative Reasons Rules table: ini file [SBCAltRoutingReasonsList] or CLI (`configure voip > sbc routing alt-route-reasons-set < alt-route-reasons-rules`)

➤ **To configure SIP reason codes for alternative IP routing:**

1. Open the Alternative Reasons Set table (**Setup** menu > **Signaling & Media** tab > **SBC** folder > **Routing** > **Alternative Reasons Set**).
2. Click **New**; the following dialog box appears:



3. Configure an Alternative Reasons Set according to the parameters described in the table below.
4. Click **Apply**.

**Table 34-3: Alternative Reasons Set Table Parameter Descriptions**

Parameter	Description
'Index' [SBCAltRoutingReasonsSet_Index]	Defines an index number for the new table row. <b>Note:</b> Each row must be configured with a unique index.
'Name' name [SBCAltRoutingReasonsSet_Name]	Defines an arbitrary name to easily identify the row. The valid value is a string of up to 40 characters. <b>Note:</b> Each row must be configured with a unique name.
'Description' description [SBCAltRoutingReasonsSet_Description]	Defines a description for the Alternative Reasons Set. The valid value is a string of up to 99 characters. By default, no value is defined.

5. Select the index row of the Alternative Reasons Set that you added, and then click the **Alternative Reasons Rules** link located at the bottom of the page; the Alternative Reasons Rules table opens.
6. Click **New**; the following dialog box appears:

7. Configure Alternative Reasons rules according to the parameters described in the table below.

8. Click **Apply**.**Table 34-4: Alternative Reasons Rules Table Parameter Descriptions**

Parameter	Description
'Index' alt-route-reasons- rules [SBCAltRoutingReasonsList_ SBCAltRouteIndex]	Defines an index number for the new table row. <b>Note:</b> Each row must be configured with a unique index.
'Release Cause Code' rel-cause-code [SBCAltRoutingReasonsList_ ReleaseCauseCode]	Defines a SIP response code that triggers the device's alternative routing mechanism. [4] <b>4xx</b> ; [5] <b>5xx</b> ; [6] <b>6xx</b> ; [400] <b>400 Bad Request</b> ; [402] <b>402 Payment Required</b> ; [403] <b>403 Forbidden</b> ; [404] <b>404 Not Found</b> ; [405] <b>405 Method Not Allowed</b> ; [406] <b>406 Not Acceptable</b> ; [408] <b>408 Request Timeout</b> (Default); [409] <b>409 Conflict</b> ; [410] <b>410 Gone</b> ; [413] <b>413 Request Too Large</b> ; [414] <b>414 Request URI Too Long</b> ; [415] <b>415 Unsupported Media</b> ; [420] <b>420 Bad Extension</b> ; [421] <b>421 Extension Required</b> ; [423] <b>423 Session Interval Too Small</b> ; [480] <b>480 Unavailable</b> ; [481] <b>481 Transaction Not Exist</b> ; [482] <b>482 Loop Detected</b> ; [483] <b>483 Too Many Hops</b> ; [484] <b>484 Address Incomplete</b> ; [485] <b>485 Ambiguous</b> ; [486] <b>486 Busy</b> ; [487] <b>487 Request Terminated</b> ; [488] <b>488 Not Acceptable Here</b> ; [491] <b>491 Request Pending</b> ; [493] <b>493 Undecipherable</b> ; [500] <b>500 Internal Error</b> ; [501] <b>501 Not Implemented</b> ; [502] <b>502 Bad Gateway</b> ; [503] <b>503 Service Unavailable</b> ; [504] <b>504 Server Timeout</b> ; [505] <b>505 Version Not Supported</b> ; [513] <b>513 Message Too Large</b> ; [600] <b>600 Busy Everywhere</b> ; [603] <b>603 Decline</b> ; [604] <b>604 Does Not Exist Anywhere</b> ; [606] <b>606 Not Acceptable</b> ; [806] <b>806 Media Limits Exceeded</b> ; [850] <b>850 Signalling Limits Exceeded</b> .

## Configuring SBC Routing Policy Rules

The Routing Policies table lets you configure up to 41 Routing Policy rules. A Routing Policy determines the routing and manipulation (inbound and outbound) rules per SRD in a multiple SRD configuration topology. The Routing Policy also configures the following:

- Enables Least Cost Routing (LCR), and configures default call cost (highest or lowest) and average call duration for routing rules that are not assigned LCR Cost Groups. The default call cost determines whether matched routing rules that are not assigned Cost Groups are considered as a higher or lower cost route compared to other matching routing rules that

are assigned Cost Groups. If you disable LCR, the device ignores the Cost Groups assigned to the routing rules in the IP-to-IP Routing table.

- Assigns LDAP servers (LDAP Server Group) for LDAP-based routing. IP-to-IP routing rules configured for LDAP or CSR (Call Setup Rules) queries use the LDAP server(s) that is assigned to the routing rule's associated Routing Policy. You can configure a Routing Policy per SRD or alternatively, configure a single Routing Policy that is shared between all SRDs.

The implementation of Routing Policies is intended for the following deployments **only**:

- Deployments requiring LCR and/or LDAP-based routing.
- Multi-tenant deployments that require multiple, logical routing tables where each tenant has its own dedicated ("separated") routing (and manipulation) table. In such scenarios, each SRD (tenant) is configured as an Isolated SRD and assigned its own unique Routing Policy, implementing an almost isolated, non-bleeding routing configuration topology.

For all other deployment scenarios, the Routing Policy is irrelevant and the handling of the configuration entity is not required as a default Routing Policy ("Default\_SBCRoutingPolicy" at Index 0) is provided. When only one Routing Policy is required, the device automatically associates the default Routing Policy with newly added configuration entities that can be associated with the Routing Policy (as mentioned later in this section, except for Classification rules). This facilitates configuration, eliminating the need to handle the Routing Policy configuration entity (except if you need to enable LCR and/or assign an LDAP server to the Routing Policy). In such a setup, where only one Routing Policy is used, single routing and manipulation tables are employed for all SRDs.



If possible, it is recommended to use only **one** Routing Policy for all SRDs (tenants), unless deployment requires otherwise (i.e., a dedicated Routing Policy per SRD).

Once configured, you need to associate the Routing Policy with an SRD(s) in the SRDs table. To determine the routing and manipulation rules for the SRD, you need to assign the Routing Policy to routing and manipulation rules. The figure below shows the configuration entities to which Routing Policies can be assigned:

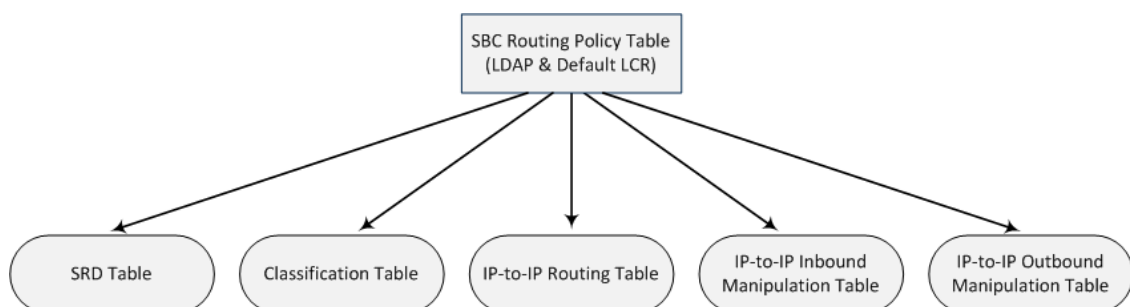

Typically, assigning a Routing Policy to a Classification rule is not required, as when an incoming call is classified it uses the Routing Policy associated with the SRD to which it belongs. However, if a Routing Policy is assigned to a Classification rule, it overrides the Routing Policy assigned to the SRD. The option to assign Routing Policies to Classification rules is useful in deployments requiring different routing and manipulation rules for specific calls pertaining to

the **same** SRD. In such scenarios, you need to configure multiple Classification rules for the same SRD, where for some rules no Routing Policy is assigned (i.e., the SRD's assigned Routing Policy is used) while for others a different Routing Policy is specified to override the SRD's assigned Routing Policy.

In multi-tenant environments employing multiple SRDs and Routing Policies, the IP Groups that can be used in routing rules (in the IP-to-IP Routing table) are as follows:

- If the Routing Policy is assigned to only one SRD and the SRD is an Isolated SRD, the routing rules of the Routing Policy can be configured with IP Groups belonging to the Isolated SRD and IP Groups belonging to all Shared SRDs.
- If the Routing Policy is assigned to a Shared SRD, the routing rules of the Routing Policy can be configured with any IP Group (i.e., belonging to Shared and Isolated SRDs). In effect, the Routing Policy can include routing rules for call routing between Isolated SRDs.
- If the Routing Policy is assigned to multiple SRDs (Shared and/or Isolated), the routing rules of the Routing Policy can be configured with IP Groups belonging to all Shared SRDs as well as IP Groups belonging to Isolated SRDs that are assigned the Routing Policy.

To facilitate the configuration of routing rules in the IP-to-IP Routing table through the Web interface, only the permitted IP Groups (according to the above) are displayed as optional values.

The general flow for processing the call for multi-tenant deployments and Routing Policies is as follows:

1. Using the Classification table, the device classifies the incoming call to an IP Group, based on the SIP Interface on which the call is received. Based on the SIP Interface, the device associates the call to the SRD that is assigned to the SIP Interface.
2. Once the call has been successfully classified to an IP Group, the Routing Policy assigned to the associated SRD is used. However, if a Routing Policy is configured in the Classification table, it overrides the Routing Policy assigned to the SRD.
3. The regular manipulation (inbound and outbound) and routing processes are done according to the associated Routing Policy.



- The Classification table is used only if classification by registered user in the device's users registration database or by Proxy Set fails.
- If the device receives incoming calls (e.g., INVITE) from users that have already been classified and registered in the device's registration database, the device ignores the Classification table and uses the Routing Policy that was determined for the user during the initial classification process.

The following procedure describes how to configure Routing Policies rules through the Web interface. You can also configure it through ini file [SBCRoutingPolicy] or CLI (`configure voip > sbc routing sbc-routing-policy`).

➤ **To configure a Routing Policy rule:**

1. Open the Routing Policies table (**Setup** menu > **Signaling & Media** tab > **SBC** folder > **Routing** > **Routing Policies**).
2. Click **New**; the following dialog box appears:

3. Configure the Routing Policy rule according to the parameters described in the table below.
4. Click **Apply**.

**Table 34-5: Routing Policies table Parameter Descriptions**

Parameter	Description
General	
'Index'	Defines an index number for the new table row. <b>Note:</b> Each row must be configured with a unique index.
'Name' name [SBCRoutingPolicy_ Name]	Defines a descriptive name, which is used when associating the row in other tables. The valid value is a string of up to 40 characters. By default, no name is defined. If you don't configure a name, the device automatically assigns a name in the following format: "SBCRoutingPolicy_<Index>", for example, "SBCRoutingPolicy_2". <b>Note:</b> ■ Each row must be configured with a unique name.

Parameter	Description
	<ul style="list-style-type: none"> <li>■ The parameter value cannot contain a forward slash (/).</li> </ul>
'LDAP Servers Group Name' ldap-srv-group-name [SBCRoutingPolicy_ LdapServersGroupName]	Assigns an LDAP Server Group to the Routing Policy. Routing rules in the IP-to-IP Routing table that are associated with the Routing Policy and that are configured with LDAP and/or Call Setup Rules, use the LDAP server(s) configured for this LDAP Server Group. By default, no value is defined. For more information on LDAP Server Groups, see <a href="#">Configuring LDAP Server Groups</a> . <b>Note:</b> The default Routing Policy is assigned the default LDAP Server Group ("DefaultCTRLServersGroup").
Least Cost Routing	
'LCR Feature' lcr-enable [SBCRoutingPolicy_ LCREnable]	Enables the Least Cost Routing (LCR) feature for the Routing Policy. <ul style="list-style-type: none"> <li>■ [0] <b>Disable</b> (default)</li> <li>■ [1] <b>Enable</b></li> </ul> For more information on LCR, see <a href="#">Least Cost Routing</a> .
'Default Call Cost' lcr-default-cost [SBCRoutingPolicy_ LCRDefaultCost]	Defines whether routing rules in the IP-to-IP Routing table that are not assigned a Cost Group are considered a higher cost or lower cost route compared to other matched routing rules that are assigned Cost Groups. <ul style="list-style-type: none"> <li>■ [0] <b>Lowest Cost</b> = (Default) The device considers a matched routing rule (belonging to the Routing Policy) that is not assigned a Cost Group as the lowest cost route. Therefore, it uses the routing rule.</li> <li>■ [1] <b>Highest Cost</b> = The device considers a matched routing rule (belonging to the Routing Policy) that is not assigned a Cost Group as the highest cost route. Therefore, it is only used if the other matched routing rules that are assigned Cost Groups are unavailable.</li> </ul> <b>Note:</b> If multiple matched routing rules without an assigned Cost Group exist, the device selects the first matched rule in the table.
'LCR Call Duration' lcr-call-length	Defines the average call duration (in minutes) and is used to calculate the variable portion of the call cost. This is useful, for example, when the average call duration spans over

Parameter	Description
[SBCRoutingPolicy_LCRAverageCallLength]	<p>multiple time bands. The LCR is calculated as follows: cost = call connect cost + (minute cost * average call duration). The valid value is 0-65533. The default is 1. For example, assume the following Cost Groups:</p> <ul style="list-style-type: none"> <li>■ "Weekend A": call connection cost is 1 and charge per minute is 6. Therefore, a call of 1 minute cost 7 units.</li> <li>■ "Weekend B": call connection cost is 6 and charge per minute is 1. Therefore, a call of 1 minute cost 7 units.</li> </ul> <p>Therefore, for calls under one minute, "Weekend A" carries the lower cost. However, if the average call duration is more than one minute, "Weekend B" carries the lower cost.</p>

## Configuring IP Group Sets

The IP Group Set table lets you configure up to 51 IP Group Sets. An IP Group Set is a group of IP Groups used for load balancing of calls, belonging to the same source, to a call destination (i.e., IP Group). Each IP Group Set can include up to five IP Groups (Server-type and Gateway-type only). The chosen destination IP Group for each call depends on the configured load-balancing policy, which can be Round Robin, Random Weights, or Homing (for more information, see the table's description, later in this section).

Alternative routing within the IP Group Set is also supported. If a chosen destination IP Group responds with a reject response that is configured for an Alternative Reasons Set (see [Configuring SIP Response Codes for Alternative Routing Reasons](#)) that is assigned to the IP Group ('SBC Alternative Routing Reasons Set' parameter), or doesn't respond at all (i.e., keep-alive with its' associated Proxy Set fails), the device attempts to send the call to another IP Group in the IP Group Set (according to the load-balancing policy). For enabling Proxy Set keep-alive, see [Configuring Proxy Sets](#).

An example of round-robin load-balancing and alternative routing: The first call is sent to IP Group #1 in the IP Group Set, the second call to IP Group #2, and the third call to IP Group #3. If the call sent to IP Group #1 is rejected, the device employs alternative routing and sends it to IP Group #4.

Once you have configured your IP Group Set, to implement call load-balancing by IP Groups, do one of the following:

- In the IP-to-IP Routing table, configure the routing rule's 'Destination Type' parameter to **IP Group Set**, and then assign it the IP Group Set in the 'IP Group Set' parameter.
- If you are routing to IP Groups based on Dial Plan tags:
  - In the IP Group Set table (see below), specify the tag name.

- In the IP-to-IP Routing table, configure the routing rule's 'Destination Type' parameter to **Destination Tag**, and then specify the tag name in the 'Routing Tag Name' parameter.

For more information on IP-to-IP Routing rules, see [Configuring SBC IP-to-IP Routing Rules](#). For more information on routing based on destination Dial Plan tags, see [Using Dial Plan Tags for Routing Destinations](#).

IP Group Sets are configured using two tables with parent-child type relationship:

- **Parent table:** IP Group Set table, which defines the name and load-balancing policy of the IP Group Set.
- **Child table:** IP Group Set Member table, which assigns IP Groups to IP Group Sets. You can assign up to five IP Groups per IP Group Set.

The following procedure describes how to configure IP Group Sets through the Web interface. You can also configure it through other management platforms:

- **IP Group Set Table:** *ini* file [IPGroupSet] or CLI (`configure voip > sbc routing ip-group-set`)
- **IP Group Set Member Table:** *ini* file [IPGroupSetMember] or CLI (`configure voip > sbc routing ip-group-set-member`)

➤ **To configure an IP Group Set:**

1. Open the IP Group Set table (**Setup** menu > **Signaling & Media** tab > **SBC** folder > **Routing** > **IP Group Set**).
2. Click **New**; the following dialog box appears:

The screenshot shows a web-based configuration dialog for an IP Group Set. The dialog is titled "IP Group Set" and has a "GENERAL" tab selected. The configuration fields are as follows:

Field	Value
Index	0
Name	
Policy	Round-Robin
Tags	

3. Configure the IP Group Set according to the parameters described in the table below.
4. Click **Apply**.

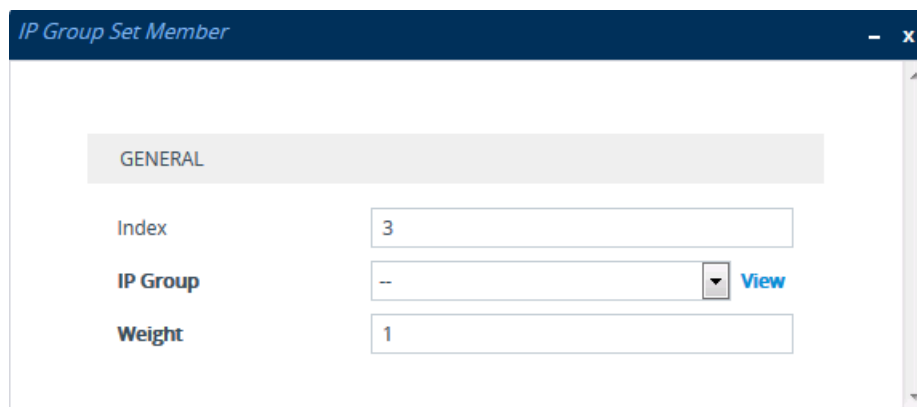

**Table 34-6: IP Group Set Table Parameter Descriptions**

Parameter	Description
'Index' [IPGroupSet_ Index]	<p>Defines an index number for the new table row.</p> <p><b>Note:</b> Each row must be configured with a unique index.</p>
'Name' name [IPGroupSet_ Name]	<p>Defines a descriptive name, which is used when associating the row in other tables.</p> <p><b>Note:</b></p> <ul style="list-style-type: none"> <li>■ Each row must be configured with a unique name.</li> <li>■ The parameter value cannot contain a forward slash (/).</li> </ul>
'Policy' policy [IPGroupSet_ Policy]	<p>Defines the load-balancing policy.</p> <ul style="list-style-type: none"> <li>■ [0] <b>Round-Robin</b> = (Default) The device selects the next consecutive, available IP Group for each call. The device selects the first IP Group in the table (i.e., lowest index) for the first call and the next consecutive IP Groups for the next calls. For example, first call to IP Group at Index 0, second call to IP Group at Index 2, third call to IP Group at Index 3, and so on. If an IP Group is offline, the device selects the next consecutive IP Group. Once the last IP Group in the IP Group Set list is selected for a call, the device goes to the beginning of the list and sends the next call to the first IP Group, and so on.</li> <li>■ [1] <b>Random Weight</b> = The device selects IP Groups at random and their weights determine their probability of getting chosen over others. The higher the weight, the more chance of the IP Group being chosen.</li> <li>■ [2] <b>Homing</b> = The device always attempts to send all calls to the first IP Group in the table (i.e., lowest index). If unavailable, it sends the calls to the next consecutive, available IP Group. However, if the first IP Group comes online again, the device selects it.</li> </ul> <p><b>Note:</b> For the <b>Random Weight</b> optional value, use the 'Weight' parameter in the IP Group Set Member table (below) to configure weight value per IP Group.</p>
'Tags' tags [IPGroupSet_ Tags]	<p>Assigns a Dial Plan tag that is used to determine whether the incoming SIP dialog is sent to IP Groups belonging to this IP Group Set. The parameter is used when IP-to-IP Routing rules are configured for destination based on tags (i.e., 'Destination Type' parameter configured to Destination Tag). For more information on routing based on destination tags, see <a href="#">Using Dial Plan Tags for Routing Destinations</a>.</p>

Parameter	Description
	<p>The valid value is a string of up to 70 characters. By default, no value is defined. You can configure the parameter with up to five tags, where each tag is separated by a semicolon (;). However, you can configure only up to four tags containing a name and value (e.g., Country=Ireland), and <b>one</b> tag containing a value only (e.g., Ireland). You can also configure multiple tags with the same name (e.g., Country=Ireland;Country=Scotland). The following example configures the maximum number of tags (i.e., four name=value tags and one value-only tag): Country=Ireland;Country=Scotland;Country=RSA;Country=Canada;USA.</p> <p><b>Note:</b> If the IP Groups belonging to the IP Group Set are also configured with Dial Plan tags, the Dial Plan tag configured for the parameter takes precedence. If the same Dial Plan tag is also configured for other IP Groups in the IP Groups table, the IP Group Set takes precedence and the device sends the SIP dialog to the IP Group(s) belonging to the IP Group Set.</p>

5. Select the IP Group Set row for which you want to assign IP Groups, and then click the **IP Group Set Member** link located below the table; the IP Group Set Member table appears.
6. Click **New**; the following dialog box appears:



7. Configure IP Group Set members according to the parameters described in the table below.
8. Click **Apply**, and then save your settings to flash memory.

**Table 34-7: IP Group Set Member Table Parameter Descriptions**

Parameter	Description
'Index' index [IPGroupSetMember_	<p>Defines an index number for the new table row.</p> <p><b>Note:</b> Each row must be configured with a unique index.</p>

Parameter	Description
IPGroupSetMemberIndex]	
'IP Group' ip-group-name [IPGroupSetMember_ IPGroupName]	Assigns an IP Group to the IP Group Set. To configure IP Groups, see <a href="#">Configuring IP Groups</a> . <b>Note:</b> The IP Group can only be a Server-type or Gateway-type.
'Weight' weight [IPGroupSetMember_ Weight]	Defines the weight of the IP Group. The higher the weight, the more chance of the IP Group being selected as the destination of the call. The valid value is 1 to 9. The default is 1. <b>Note:</b> The parameter is applicable only if you configure the 'Policy' parameter to <b>Random Weight</b> .

## 35 SBC Manipulations

This section describes the configuration of the manipulation rules for the SBC application.



For additional manipulation features, see the following:

- [Configuring SIP Message Policy Rules](#)
- [Configuring SIP Message Manipulation](#)

The device supports SIP URI user part (source and destination) manipulations for inbound and outbound routing. These manipulations can be applied to a source IP group, source and destination host and user prefixes, and/or user-defined SIP request (e.g., INVITE, OPTIONS, SUBSCRIBE, and/or REGISTER). Since outbound manipulations are performed after routing, the outbound manipulation rule matching can also be done by destination IP Group. Manipulated destination user and host are performed on the following SIP headers: Request-URI, To, and Remote-Party-ID (if exists). Manipulated source user and host are performed on the following SIP headers: From, P-Asserted (if exists), P-Preferred (if exists), and Remote-Party-ID (if exists).

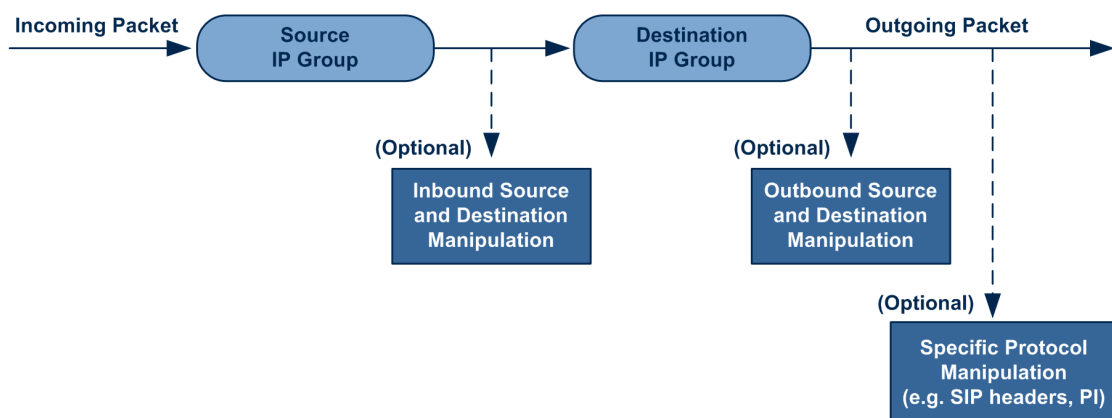

You can also restrict source user identity in outgoing SIP dialogs in the Outbound Manipulation table (using the column PrivacyRestrictionMode). The device identifies an incoming user as restricted if one of the following exists:

- From header user is 'anonymous'.
- P-Asserted-Identity and Privacy headers contain the value 'id'.

All restriction logic is done after the user number has been manipulated.

Host name (source and destination) manipulations are simply host name substitutions with the names defined for the source and destination IP Groups respectively (if any, in the IP Groups table).

Below is an example of a call flow and consequent SIP URI manipulations:

- **Incoming INVITE from LAN:**

```
INVITE sip:1000@10.2.2.3;user=phone;x=y;z=a SIP/2.0
Via: SIP/2.0/UDP 10.2.2.6;branch=z9hGLLLLLan
From: <sip:7000@10.2.2.6;user=phone;x=y;z=a>;tag=OILAN;paramer1=abe
To: <sip:1000@10.2.2.3;user=phone>
Call-ID: USELLLLAN@10.2.2.3
CSeq: 1 INVITE
Contact: <sip:7000@10.2.2.3>
Supported: em,100rel,timer,replaces
Allow: REGISTER,OPTIONS,INVITE,ACK,CANCEL,BYE,NOTIFY,PRACK
User-Agent: Sip Message Generator V1.0.0.5
Content-Type: application/sdp
Content-Length: 155
```

```
v=0
o=SMG 791285 795617 IN IP4 10.2.2.6
s=Phone-Call
c=IN IP4 10.2.2.6
t=0 0
m=audio 6000 RTP/AVP 8
a=rtpmap:8 pcma/8000
a=sendrecv
a=ptime:20
```

#### ■ Outgoing INVITE to WAN:

```
INVITE sip: 9721000@ITSP;user=phone;x=y;z=a SIP/2.0
Via: SIP/2.0/UDP 212.179.1.12;branch=z9hGWwan
From: <sip:97000@IP_
PBX;user=phone;x=y;z=a>;tag=OWan;paramer1=abe
To: <sip: 9721000@ ITSP;user=phone>
Call-ID: USEVWWAN@212.179.1.12
CSeq: 38 INVITE
Contact: <sip:7000@212.179.1.12>
Supported: em,100rel,timer,replaces
Allow:
REGISTER,OPTIONS,INVITE,ACK,CANCEL,BYE,NOTIFY,PRACK,REFER
User-Agent: Sip Message Generator V1.0.0.5
Content-Type: application/sdp
Content-Length: 155
```

```
v=0
o=SMG 5 9 IN IP4 212.179.1.11
s=Phone-Call
```

```
c=IN IP4 212.179.1.11
t=0 0
m=audio 8000 RTP/AVP 8
a=rtpmap:8 pcma/8000
a=sendrecv
a=ptime:20
```

The SIP message manipulations in the example above (contributing to typical topology hiding) are as follows:

- Inbound source SIP URI user name from "7000" to "97000":

```
From:<sip:7000@10.2.2.6;user=phone;x=y;z=a>;tag=OILAN;paramer1=abe
```

to

```
From: <sip:97000@IP_
PBX;user=phone;x=y;z=a>;tag=OWan;paramer1=abe
```

- Source IP Group name (i.e., SIP URI host name) from "10.2.2.6" to "IP\_PBX":

```
From:<sip:7000@10.2.2.6;user=phone;x=y;z=a>;tag=OILAN;paramer1=abe
```

to

```
From: <sip:97000@IP_
PBX;user=phone;x=y;z=a>;tag=OWan;paramer1=abe
```

- Inbound destination SIP URI user name from "1000" to 9721000":

```
INVITE sip:1000@10.2.2.3;user=phone;x=y;z=a SIP/2.0
```

```
To: <sip:1000@10.2.2.3;user=phone>
```

to

```
INVITE sip:9721000@ITSP;user=phone;x=y;z=a SIP/2.0
```

```
To: <sip:9721000@ITSP;user=phone>
```

- Destination IP Group name (SIP URI host name) from "10.2.2.3" to "ITSP":

```
INVITE sip:1000@10.2.2.3;user=phone;x=y;z=a SIP/2.0
```

```
To: <sip:1000@10.2.2.3;user=phone>
```

to

```
INVITE sip:9721000@ITSP;user=phone;x=y;z=a SIP/2.0
```

```
To: <sip:9721000@ITSP;user=phone>
```

## Configuring IP-to-IP Inbound Manipulations

The Inbound Manipulations table lets you configure up to 205 IP-to-IP Inbound Manipulation rules. An Inbound Manipulation rule defines a manipulation sequence for the source or destination SIP URI user part of inbound SIP dialog requests. You can apply these manipulations to different SIP dialog message types (e.g., INVITE or REGISTER) and SIP headers as follows:

- Manipulated destination URI user part are done on the following SIP headers: Request-URI, To, and Remote-Party-ID (if exists)
- Manipulated source URI user part are done on the following SIP headers: From, P-Asserted-Identity (if exists), P-Preferred-Identity (if exists), and Remote-Party-ID (if exists)

Configuration of Inbound Manipulation rules includes two areas:

- **Match:** Defines the matching characteristics of an incoming SIP dialog (e.g., source host name).
- **Action:** Defines the action that is done if the incoming call matches the characteristics of the rule. In other words, the device manipulates the source or destination SIP URI user part of the SIP dialog (e.g., removes a user-defined number of characters from the left of the SIP URI user part).



Configure stricter classification rules higher up in the table than less strict rules to ensure the desired rule is used to manipulate the incoming dialog. *Strict* refers to the number of matching characteristics configured for the rule. For example, a rule configured with source host name and source IP Group as matching characteristics is stricter than a rule configured with only source host name. If the rule configured with only source host name appears higher up in the table, the device ("erroneously") uses the rule to manipulate incoming dialogs matching this source host name (even if they also match the rule appearing lower down in the table configured with the source IP Group as well).

To configure and apply an Inbound Manipulation rule, the rule must be associated with a Routing Policy. The Routing Policy associates the rule with an SRD(s). Therefore, the Routing Policy lets you configure manipulation rules for calls belonging to specific SRD(s). However, as multiple Routing Policies are relevant only for multi-tenant deployments (if needed), for most deployments, only a single Routing Policy is required. As the device provides a default Routing

Policy ("Default\_SBCRoutingPolicy"), when only one Routing Policy is required, the device automatically assigns the default Routing Policy to the routing rule. If you are implementing LDAP-based routing (with or without Call Setup Rules) and/or Least Cost Routing (LCR), you need to configure these settings for the Routing Policy (regardless of the number of Routing Policies employed). For more information on Routing Policies, see [Configuring SBC Routing Policy Rules](#).

 The IP Groups table can be used to configure a host name that overwrites the received host name. This manipulation can be done for source and destination IP Groups (see [Configuring IP Groups](#)).

The following procedure describes how to configure Inbound Manipulation rules through the Web interface. You can also configure it through ini file [IPInboundManipulation] or CLI (configure voip > sbc manipulation ip-inbound-manipulation).

➤ **To configure an Inbound Manipulation rule:**

1. Open the Inbound Manipulations table (**Setup** menu > **Signaling & Media** tab > **SBC** folder > **Manipulation** > **Inbound Manipulations**).
2. Click **New**; the following dialog box appears:

3. Configure the Inbound Manipulation rule according to the parameters described in the table below.
4. Click **Apply**.

**Table 35-1: Inbound Manipulations Table Parameter Descriptions**

<p>'Routing Policy' routing-policy-name [IPInboundManipulation_RoutingPolicyName]</p>	<p>Assigns an Routing Policy to the rule. The Routing Policy associates the rule with an SRD(s). The Routing Policy also defines default LCR settings as well as the LDAP servers if the routing rule is based on LDAP routing (and Call Setup Rules). If only one Routing Policy is configured in the Routing Policies table, the Routing Policy is automatically assigned. If multiple Routing Policies are configured, no value is assigned.</p>
---	---



	<p>To configure Routing Policies, see <a href="#">Configuring SBC Routing Policy Rules</a>.</p> <p><b>Note:</b> The parameter is mandatory.</p>
General	
'Index' [IPInboundManipulation_ Index]	<p>Defines an index number for the new table record.</p> <p><b>Note:</b> Each table row must be configured with a unique index.</p>
'Name' manipulation-name [IPInboundManipulation_ ManipulationName]	<p>Defines an arbitrary name to easily identify the manipulation rule.</p> <p>The valid value is a string of up to 40 characters. By default, no value is defined.</p>
'Additional Manipulation' is-additional-manipulation [IPInboundManipulation_ IsAdditionalManipulation]	<p>Determines whether additional SIP URI user part manipulation is done for the table entry rule listed directly above it.</p> <ul style="list-style-type: none"> <li>■ [0] <b>No</b> = (Default) Regular manipulation rule (not done in addition to the rule above it).</li> <li>■ [1] <b>Yes</b> = If the above row entry rule matched the call, consider this row entry as a match as well and perform the manipulation specified by this rule.</li> </ul> <p><b>Note:</b> Additional manipulation can only be done on a different SIP URI, source or destination, to the rule configured in the row above as configured by the 'Manipulated URI' parameter (see below).</p>
'Manipulation Purpose' purpose [IPInboundManipulation_ ManipulationPurpose]	<p>Defines the purpose of the manipulation.</p> <ul style="list-style-type: none"> <li>■ [0] <b>Normal</b> = (Default) Inbound manipulations affect the routing input and source and/or destination number.</li> <li>■ [1] <b>Routing input only</b> = Inbound manipulations affect the routing input only, retaining the original source and destination number.</li> <li>■ [2] <b>Shared Line</b> = Used for the Shared-Line Appearance feature. This manipulation is for registration requests to change the destination number of the secondary extension numbers to the primary extension. For more information, see <a href="#">Configuring BroadSoft's Shared Phone Line Call Appearance for Survivability</a>.</li> </ul>

Match	
<p>'Request Type' request-type [IPInboundManipulation_ RequestType]</p>	<p>Defines the SIP request type to which the manipulation rule is applied.</p> <ul style="list-style-type: none"> <li>■ [0] <b>All</b> = (Default) All SIP messages.</li> <li>■ [1] <b>INVITE</b> = All SIP messages except REGISTER and SUBSCRIBE.</li> <li>■ [2] <b>REGISTER</b> = Only REGISTER messages.</li> <li>■ [3] <b>SUBSCRIBE</b> = Only SUBSCRIBE messages.</li> <li>■ [4] <b>INVITE and REGISTER</b> = All SIP messages except SUBSCRIBE.</li> <li>■ [5] <b>INVITE and SUBSCRIBE</b> = All SIP messages except REGISTER.</li> </ul>
<p>'Source IP Group' src-ip-group-name [IPInboundManipulation_ SrcIpGroupName]</p>	<p>Defines the IP Group from where the incoming INVITE is received.</p> <p>The default is <b>Any</b> (i.e., any IP Group).</p>
<p>'Source Username Pattern' src-user-name-pattern [IPInboundManipulation_ SrcUsernamePrefix]</p>	<p>Defines the source SIP URI user name (usually in the From header).</p> <p>The default is the asterisk (*) symbol (i.e., any source user name). You can use special pattern notations to denote the user part. For available notations, see <a href="#">Dialing Plan Notation for Routing and Manipulation</a>.</p>
<p>'Source Host' src-host [IPInboundManipulation_ SrcHost]</p>	<p>Defines the source SIP URI host name - full name (usually in the From header).</p> <p>The default is the asterisk (*) symbol (i.e., any host name).</p>
<p>'Destination Username Pattern' dst-user-name-pattern [IPInboundManipulation_ DestUsernamePrefix]</p>	<p>Defines the destination SIP URI user name, typically located in the Request-URI and To headers.</p> <p>The default is the asterisk (*) symbol (i.e., any destination user name). You can use special pattern notations to denote the user part. For available notations, see <a href="#">Dialing Plan Notation for Routing and Manipulation</a>.</p>
<p>'Destination Host' dst-host</p>	<p>Defines the destination SIP URI host name - full name, typically located in the Request URI and To headers.</p>

[IPInboundManipulation_DestHost]	The default is the asterisk (*) symbol (i.e., any destination host name).
Operation Rule - Action	
'Manipulated Item' manipulated-uri [IPInboundManipulation_ManipulatedURI]	<p>Determines whether the source or destination SIP URI user part is manipulated.</p> <ul style="list-style-type: none"> <li>■ [0] <b>Source</b> = (Default) Manipulation is done on the source SIP URI user part.</li> <li>■ [1] <b>Destination</b> = Manipulation is done on the destination SIP URI user part.</li> </ul>
'Remove From Left' remove-from-left [IPInboundManipulation_RemoveFromLeft]	Defines the number of digits to remove from the left of the user name prefix. For example, if you enter 3 and the user name is "john", the new user name is "n".
'Remove From Right' remove-from-right [IPInboundManipulation_RemoveFromRight]	<p>Defines the number of digits to remove from the right of the user name prefix. For example, if you enter 3 and the user name is "john", the new user name is "j".</p> <p><b>Note:</b> If both 'Remove From Right' and 'Leave From Right' parameters are configured, the 'Remove From Right' setting is applied first.</p>
'Leave From Right' leave-from-right [IPInboundManipulation_LeaveFromRight]	<p>Defines the number of characters that you want retained from the right of the user name.</p> <p><b>Note:</b> If both 'Remove From Right' and 'Leave From Right' parameters are configured, the 'Remove From Right' setting is applied first.</p>
'Prefix to Add' prefix-to-add [IPInboundManipulation_Prefix2Add]	Defines the number or string that you want added to the front of the user name. For example, if you enter 'user' and the user name is "john", the new user name is "userjohn".
'Suffix to Add' suffix-to-add [IPInboundManipulation_Suffix2Add]	Defines the number or string that you want added to the end of the user name. For example, if you enter '01' and the user name is "john", the new user name is "john01".

## Configuring IP-to-IP Outbound Manipulations

The Outbound Manipulations table lets you configure up to 205 IP-to-IP Outbound Manipulation rules. An Outbound Manipulation rule defines a manipulation action for the SIP Request-URI user part (source or destination) or calling name of outbound SIP dialog requests. Outbound Manipulation rules can be applied to any SIP request type (e.g., INVITE). Manipulated destination URI user part are done on the following SIP headers: Request URI, To, and Remote-Party-ID (if exists). Manipulated source URI user part are done on the following SIP headers: From, P-Asserted (if exists), P-Preferred (if exists), and Remote-Party-ID (if exists).

Configuration of Outbound Manipulation rules includes two areas:

- **Match:** Defines the matching characteristics of an incoming SIP dialog (e.g., source host name). As the device performs outbound manipulations only after the routing process, destination IP Groups can also be used as matching characteristics.
- **Action:** Defines the action that is done if the incoming call matches the characteristics of the rule. In other words, the device manipulates the source or destination SIP URI user part or calling name of the SIP dialog (e.g., removes a user-defined number of characters from the left of the SIP URI user part).



- Configure stricter classification rules higher up in the table than less strict rules to ensure the desired rule is used to manipulate the outbound dialog. *Strict* refers to the number of matching characteristics configured for the rule. For example, a rule configured with source host name and source IP Group as matching characteristics is stricter than a rule configured with only source host name. If the rule configured with only source host name appears higher up in the table, the device ("erroneously") uses the rule to manipulate outbound dialogs matching this source host name (even if they also match the rule appearing lower down in the table configured with the source IP Group as well).
- SIP URI host name (source and destination) manipulations can also be configured in the IP Groups table (see [Configuring IP Groups](#)). These manipulations are simply host name substitutions with the names configured for the source and destination IP Groups, respectively.

The following procedure describes how to configure Outbound Manipulations rules through the Web interface. You can also configure it through ini file [IPOutboundManipulation] or CLI (`configure voip > sbc manipulation ip-outbound-manipulation`).

### ➤ To configure Outbound Manipulation rules:

1. Open the Outbound Manipulations table (**Setup** menu > **Signaling & Media** tab > **SBC** folder > **Manipulation** > **Outbound Manipulations**).
2. Click **New**; the following dialog box appears:

3. Configure an Outbound Manipulation rule according to the parameters described in the table below.
4. Click **Apply**.

**Table 35-2: Outbound Manipulations Table Parameter Description**

Parameter	Description
'Routing Policy' routing-policy-name [IPOutboundManipulation_RoutingPolicyName]	<p>Assigns a Routing Policy to the rule. The Routing Policy associates the rule with an SRD(s). The Routing Policy also defines default LCR settings as well as the LDAP servers if the routing rule is based on LDAP routing (and Call Setup Rules). If only one Routing Policy is configured in the Routing Policies table, the Routing Policy is automatically assigned. If multiple Routing Policies are configured, no value is assigned.</p> <p>To configure Routing Policies, see <a href="#">Configuring SBC Routing Policy Rules</a>.</p> <p><b>Note:</b> The parameter is mandatory.</p>
<b>General</b>	
'Index' [IPOutboundManipulation_Index]	<p>Defines an index number for the new table row.</p> <p><b>Note:</b> Each row must be configured with a unique index.</p>
'Name' manipulation-name [IPOutboundManipulation_ManipulationName]	<p>Defines a descriptive name, which is used when associating the row in other tables.</p> <p>The valid value is a string of up to 40 characters. By default, no value is defined.</p>
'Additional Manipulation' is-additional-manipulation	<p>Determines whether additional manipulation is done for the table entry rule listed directly above it.</p> <ul style="list-style-type: none"> <li>■ [0] <b>No</b> = (Default) Regular manipulation rule - not done in addition to the rule above it.</li> </ul>

Parameter	Description
[IPOutboundManipulation_IsAdditionalManipulation]	<ul style="list-style-type: none"> <li>■ [1] <b>Yes</b> = If the previous table row entry rule matched the call, consider this row entry as a match as well and perform the manipulation specified by this rule.</li> </ul> <p><b>Note:</b> Additional manipulation can only be done on a different item (source URI, destination URI, or calling name) to the rule configured in the row above (configured by the 'Manipulated URI' parameter).</p>
'Call Trigger' trigger [IPOutboundManipulation_Trigger]	<p>Defines the reason (i.e., trigger) for the re-routing of the SIP request.</p> <ul style="list-style-type: none"> <li>■ [0] <b>Any</b> = (Default) Re-routed for all scenarios (re-routes and non-re-routes).</li> <li>■ [1] <b>3xx</b> = Re-routed if it triggered as a result of a SIP 3xx response.</li> <li>■ [2] <b>REFER</b> = Re-routed if it triggered as a result of a REFER request.</li> <li>■ [3] <b>3xx or REFER</b> = Applies to options [1] and [2].</li> <li>■ [4] <b>Initial only</b> = Regular requests that the device forwards to a destination. In other words, re-routing of requests triggered by the receipt of REFER or 3xx does not apply.</li> </ul>
Match	
'Request Type' request-type [IPOutboundManipulation_RequestType]	<p>Defines the SIP request type to which the manipulation rule is applied.</p> <ul style="list-style-type: none"> <li>■ [0] <b>All</b> = (Default) all SIP messages.</li> <li>■ [1] <b>INVITE</b> = All SIP messages except REGISTER and SUBSCRIBE.</li> <li>■ [2] <b>REGISTER</b> = Only SIP REGISTER messages.</li> <li>■ [3] <b>SUBSCRIBE</b> = Only SIP SUBSCRIBE messages.</li> <li>■ [4] <b>INVITE and REGISTER</b> = All SIP messages except SUBSCRIBE.</li> <li>■ [5] <b>INVITE and SUBSCRIBE</b> = All SIP messages except REGISTER.</li> </ul>
'Source IP Group' src-ip-group-name	<p>Defines the IP Group from where the INVITE is received.</p> <p>The default value is <b>Any</b> (i.e., any IP Group).</p>

Parameter	Description
[IPOutboundManipulation_SrcIPGroupName]	
'Destination IP Group' dst-ip-group-name [IPOutboundManipulation_DestIPGroupName]	Defines the IP Group to where the INVITE is to be sent. The default value is <b>Any</b> (i.e., any IP Group).
'Source Username Pattern' src-user-name-pattern [IPOutboundManipulation_SrcUsernamePrefix]	Defines the source SIP URI user name (typically used in the SIP From header). You can use special patterns (notations) to denote the user part. For example, if you want to match this rule to user parts whose last four digits (i.e., suffix) are 4 followed by any three digits (e.g., 4008), then configure this parameter to "(4xxx)". For available patterns, see <a href="#">Dialing Plan Notation for Routing and Manipulation</a> . The valid value is a string of up to 60 characters. The default value is the asterisk (*) symbol, meaning any source user part. <b>Note:</b> If you need to manipulate calls of many different source URI user parts, you can use tags (see 'Source Tags' parameter below) instead of this parameter.
'Source Host' src-host [IPOutboundManipulation_SrcHost]	Defines the source SIP URI host name - full name, typically in the From header. The default value is the asterisk (*) symbol (i.e., any source host name).
'Source Tags' src-tags [IPOutboundManipulation_SrcTags]	Assigns a prefix tag to denote source URI user names corresponding to the tag configured in the associated Dial Plan. The valid value is a string of up to 70 characters. The tag is case insensitive. By default, no value is defined. You can configure the parameter with up to five tags, where each tag is separated by a semicolon (;). However, you can configure only up to four tags containing a name and value (e.g., Country=Ireland), and <b>one</b> tag containing a value only (e.g., Ireland). If you are configuring multiple tags in the name=value format, the names of each tag must be unique (e.g., <b>Country</b> =Ireland; <b>Land</b> =Scotland). The following example configures the maximum number of tags (i.e., four name=value tags and one value-only tag):

Parameter	Description
	<p>Country=Ireland;Country2=Scotland;Country3=RSA;Country4=Canada;USA.</p> <p>To configure prefix tags, see <a href="#">Configuring Dial Plans</a>.</p> <p><b>Note:</b></p> <ul style="list-style-type: none"> <li>■ Make sure that you assign the Dial Plan in which you have configured the prefix tag, to the related IP Group or SRD.</li> <li>■ Instead of using tags and configuring the parameter, you can use the 'Source Username Pattern' parameter to specify a specific URI source user or all source users.</li> </ul>
<p>'Destination Username Pattern'</p> <p><code>dst-user-name-pattern</code></p> <p>[IPOutboundManipulation_ DestUsernamePrefix]</p>	<p>Defines the destination SIP URI user part (typically located in the Request-URI and To headers).</p> <p>You can use special patterns (notations) to denote the user part. For example, if you want to match this rule to user parts whose last four digits (i.e., suffix) are 4 followed by any three digits (e.g., 4008), then configure this parameter to "(4xxx)". For available patterns, see <a href="#">Dialing Plan Notation for Routing and Manipulation</a>.</p> <p>The valid value is a string of up to 60 characters. The default value is the asterisk (*) symbol, meaning any destination user part.</p> <p><b>Note:</b> If you need to manipulate calls of many different destination URI user names, you can use tags (see 'Destination Tags' parameter below) instead of this parameter.</p>
<p>'Destination Host'</p> <p><code>dst-host</code></p> <p>[IPOutboundManipulation_ DestHost]</p>	<p>Defines the destination SIP URI host name - full name, typically located in the Request-URI and To headers.</p> <p>The default value is the asterisk (*) symbol (i.e., any destination host name).</p>
<p>'Destination Tags'</p> <p><code>dst-tags</code></p> <p>[IPOutboundManipulation_ DestTags]</p>	<p>Assigns a prefix tag to denote destination URI user names corresponding to the tag configured in the associated Dial Plan.</p> <p>The valid value is a string of up to 70 characters. The tag is case insensitive. By default, no value is defined. You can configure the parameter with up to five tags, where each tag is separated by a semicolon (;). However, you can configure only up to four tags containing a name and value (e.g., Country=Ireland), and <b>one</b> tag containing a value only (e.g., Ireland). If you are configuring multiple tags in the name=value format, the names of each tag must be unique (e.g., <b>Country</b>=Ireland;<b>Land</b>=Scotland). The following example</p>



Parameter	Description
	<p>configures the maximum number of tags (i.e., four name=value tags and one value-only tag): Country=Ireland;Country2=Scotland;Country3=RSA;Country4=Canada;USA.</p> <p>To configure prefix tags, see <a href="#">Configuring Dial Plans</a>.</p> <p><b>Note:</b></p> <ul style="list-style-type: none"> <li>■ Make sure that you assign the Dial Plan in which you have configured the prefix tag, to the related IP Group or SRD.</li> <li>■ Instead of using tags and configuring the parameter, you can use the 'Destination Username Pattern' parameter to specify a specific URI destination user or all destinations users.</li> </ul>
<p>'Calling Name Pattern' calling-name-pattern [IPOutboundManipulation_CallingNamePrefix]</p>	<p>Defines the calling name (caller ID). The calling name appears in the SIP From header.</p> <p>The valid value is a string of up to 37 characters. By default, no calling name is defined. You can use special patterns (notations) to denote the calling name. For available patterns, see <a href="#">Dialing Plan Notation for Routing and Manipulation</a>.</p>
<p>'Message Condition' message-condition-name [IPOutboundManipulation_MessageConditionName]</p>	<p>Assigns a Message Condition rule as a matching characteristic. Message Condition rules define required SIP message formats.</p> <p>To configure Message Condition rules, see <a href="#">Configuring Message Condition Rules</a>.</p>
<p>'ReRoute IP Group' re-route-ip-group-name [IPOutboundManipulation_ReRouteIPGroupName]</p>	<p>Defines the IP Group that initiated (sent) the SIP redirect response (e.g., 3xx) or REFER message. The parameter is typically used for re-routing requests (e.g., INVITEs) when interworking is required for SIP 3xx redirect responses or REFER messages.</p> <p>The default is <b>Any</b> (i.e., any IP Group).</p> <p><b>Note:</b></p> <ul style="list-style-type: none"> <li>■ The parameter functions together with the 'Call Trigger' parameter (see below).</li> <li>■ For more information on interworking of SIP 3xx redirect responses or REFER messages, see <a href="#">Interworking SIP 3xx Redirect Responses</a> and <a href="#">Interworking SIP REFER Messages</a>,</li> </ul>

Parameter	Description
	respectively.
Action	
'Manipulated Item' manipulated-uri  [IPOutboundManipulation_ IsAdditionalManipulation]	Defines the element in the SIP message that you want manipulated.  <ul style="list-style-type: none"> <li>■ [0] <b>Source URI</b> = (Default) Manipulates the source SIP Request-URI user part.</li> <li>■ [1] <b>Destination URI</b> = Manipulates the destination SIP Request-URI user part.</li> <li>■ [2] <b>Calling Name</b> = Manipulates the calling name in the SIP message.</li> </ul>
'Remove From Left' remove-from-left  [IPOutboundManipulation_ RemoveFromLeft]	Defines the number of digits to remove from the left of the manipulated item prefix. For example, if you enter 3 and the user name is "john", the new user name is "n".
'Remove From Right' remove-from-right  [IPOutboundManipulation_ RemoveFromRight]	Defines the number of digits to remove from the right of the manipulated item prefix. For example, if you enter 3 and the user name is "john", the new user name is "j".
'Leave From Right' leave-from-right  [IPOutboundManipulation_ LeaveFromRight]	Defines the number of digits to keep from the right of the manipulated item.
'Prefix to Add' prefix-to-add [IPOutboundManipulation_ Prefix2Add]	Defines the number or string to add in the front of the manipulated item. For example, if you enter 'user' and the user name is "john", the new user name is "userjohn".  If you set the 'Manipulated Item' parameter to <b>Source URI</b> or <b>Destination URI</b> , you can configure the parameter to a string of up to 49 characters. If you set the 'Manipulated Item' parameter to <b>Calling Name</b> , you can configure the parameter to a string of up to 36 characters.

Parameter	Description
'Suffix to Add' suffix-to-add [IPOutboundManipulation_Suffix2Add]	Defines the number or string to add at the end of the manipulated item. For example, if you enter '01' and the user name is "john", the new user name is "john01".  If you set the 'Manipulated Item' parameter to <b>Source URI</b> or <b>Destination URI</b> , you can configure the parameter to a string of up to 49 characters. If you set the 'Manipulated Item' parameter to <b>Calling Name</b> , you can configure the parameter to a string of up to 36 characters.
'Privacy Restriction Mode' privacy-restriction-mode [IPOutboundManipulation_PrivacyRestrictionMode]	Defines user privacy handling (i.e., restricting source user identity in outgoing SIP dialogs). <ul style="list-style-type: none"> <li>■ [0] <b>Transparent</b> = (Default) No intervention in SIP privacy.</li> <li>■ [1] <b>Don't change privacy</b> = The user identity remains the same as in the incoming SIP dialog. If a restricted number exists, the restricted presentation is normalized as follows:               <ul style="list-style-type: none"> <li>✓ From URL header: "anonymous@anonymous.invalid"</li> <li>✓ If a P-Asserted-Identity header exists (either in the incoming SIP dialog or added by the device), a Privacy header is added with the value "id".</li> </ul> </li> <li>■ [2] <b>Restrict</b> = The user identity is restricted. The restriction is as follows:               <ul style="list-style-type: none"> <li>✓ From URL header: "anonymous@anonymous.invalid"</li> <li>✓ If a P-Asserted-Identity header exists (either in the incoming SIP dialog or added by the device), a Privacy header is added with the value "id".</li> </ul> </li> <li>■ [3] <b>Remove Restriction</b> = The device attempts to reveal the user identity by setting user values in the From header and removing the privacy "id" value if the Privacy header exists. If the From header user is "anonymous", the value is taken from the P-Preferred-Identity, P-Asserted-Identity, or Remote-Party-ID header (if exists).</li> </ul> <p><b>Note:</b></p> <ul style="list-style-type: none"> <li>■ Restriction is done only after user number manipulation, if any.</li> <li>■ The device identifies an incoming user as restricted if one of the following exists:               <ul style="list-style-type: none"> <li>✓ From header user is "anonymous".</li> </ul> </li> </ul>

Parameter	Description
	<ul style="list-style-type: none"> <li>✓ P-Asserted-Identity and Privacy headers contain the value "id".</li> </ul>

## Using the Proprietary SIP X-AC-Action Header

You can use AudioCodes proprietary SIP header, X-AC-Action in Message Manipulation rules to trigger certain actions. These actions can be used to support, for example, interworking of SIP-I and SIP endpoints for the ISUP SPIROU variant (see [Enabling Interworking of SIP and SIP-I Endpoints](#)).

The following actions are supported by the X-AC-Action header:

- **To disconnect a call (optionally, after a user-defined time):**

```
X-AC-Action: 'disconnect'
```

```
X-AC-Action: 'disconnect;delay=<time in ms>'
```

- **To resume a previously suspended call:**

```
X-AC-Action: 'abort-disconnect'
```

- **To automatically reply to a message without forwarding the response to the other side:**

```
X-AC-Action: 'reply'
```

- **To automatically reply to a message with a specific SIP response without forwarding the response to the other side:**

```
X-AC-Action: 'reply;response=<response code, e.g., 200>'
```

- **To override the device's handling of SIP REFER messages for SBC calls, which is configured by the 'Remote REFER Mode' [IpProfile\_SBCRemoteReferBehavior] parameter.** The X-AC-Action header can be added to the incoming SIP REFER request using Message Manipulation rules. This is useful if you don't want the settings of this parameter to apply to all calls that are associated with the IP Profile. For example, if you configure the 'Remote REFER Mode' parameter to **Handle Locally**, all incoming SIP REFER requests associated with the IP Profile are terminated at the device. However, you can configure a Message Manipulation rule with the proprietary header to override this parameter setting and allow the device to forward the REFER requests as is for calls with a specific URI, for

example. You can configure Message Manipulation rules to add this X-AC-Action header for REFER handling, with one of the following values:

- To allow the device to forward the REFER as is, regardless of the 'Remote REFER Mode' parameter settings:

```
X-AC-Action: 'use-config;refer-behavior=regular'
```

- To allow the device to handle (terminate) the REFER request regardless of the 'Remote REFER Mode' parameter settings:

```
X-AC-Action: 'use-config;refer-behavior= handle-locally'
```

■ **To switch to a different IP Profile for the call (re-INVITE only), as defined in the IP Group:**

```
X-AC-Action: 'switch-profile;profile-name=<IP Profile Name>'
```

```
X-AC-Action: 'switch-profile;profile-name=<IP Profile Name>;reason=<PoorInVoiceQuality or PoorInVoiceQualityFailure>'
```

If the IP Profile name contains one or more spaces (e.g., "ITSP NET"), enclose the name in double quotation marks, for example:

```
X-AC-Action: 'switch-profile;profile-name="ITSP NET"'
```

For example, to use the X-AC-Action header to switch IP Profiles from "ITSP-Profile-1" to "ITSP-Profile-2" during a call for an IP Group (e.g., IP PBX) if the negotiated media port changes to 7550, perform the following configuration:

1. In the IP Profiles table, configure two IP Profiles ("ITSP-Profile-1" and "ITSP-Profile-2").
2. In the IP Groups table, assign the main IP Profile ("ITSP-Profile-1") to the IP Group using the 'IP Profile' parameter.
3. In the Message Manipulations table (see [Configuring SIP Message Manipulation](#)), configure the following manipulation rule:
  - Manipulation Set ID: **1**
  - Message Type: **reinvite.request**
  - Condition: **body.sdp regex (.\*)(m=audio 7550 RTP/AVP)(.\*)**
  - Action Subject: **header.X-AC-Action**
  - Action Type: **Add**
  - Action Value: **'switch-profile;profile-name=ITSP-Profile-2'**

4. In the IP Groups table, assign the Message Manipulation rule to the IP Group, using the 'Inbound Message Manipulation Set' parameter.

In the above example, if the device receives from the IP Group a re-INVITE message whose media port value is 7550, the device adds the SIP header "X-AC-Action: switch-profile;profile-name=ITSP-Profile-2" to the incoming re-INVITE message. As a result of receiving this manipulated message, the device starts using IP Profile "ITSP-Profile-2" instead of "ITSP-Profile-1", for the IP Group.

## 36 Configuring Malicious Signatures

The Malicious Signature table lets you configure up to 30 Malicious Signature patterns. Malicious Signatures are signature patterns that identify SIP user agents (UA) who perform malicious attacks on SIP servers by SIP scanning. Malicious Signatures allow you to protect SBC calls handled by the device from such malicious activities, thereby increasing your SIP security. The Malicious Signature patterns identify specific scanning tools used by attackers to search for SIP servers in the network. The feature identifies and protects against SIP (Layer 5) threats by examining new inbound SIP dialog messages. Once the device identifies an attack based on the configured malicious signature pattern, it marks the SIP message as invalid and discards it or alternatively, rejects it with a SIP response (by default, 400), configured in the Message Policies table. Protection applies only to new dialogs (e.g., INVITE and REGISTER messages) and unauthenticated dialogs.

Malicious signatures can also be used with the Intrusion Detection System (IDS) feature (see [Configuring IDS Policies](#)). You can configure an IDS Policy that is activated if the device detects a malicious signature (when the 'Reason' parameter is configured to **Dialog establishment failure**).

Malicious signature patterns are typically based on the value of SIP User-Agent headers, which attackers use as their identification string (e.g., "User-Agent: VaxSIPUserAgent"). However, you can configure signature patterns based on any SIP header. To configure signature patterns, use the same syntax as that used for configuring Conditions in the Message Manipulations table (see [Configuring SIP Message Manipulation](#)). Below are configured signature patterns based on the User-Agent header:

- Malicious signature for the VaxSIPUserAgent malicious UA:

```
header.user-agent prefix 'VaxSIPUserAgent'
```

- Malicious signature for the scanning tool "sip-scan":

```
header.user-agent prefix 'sip-scan'
```

By default, the table provides preconfigured malicious signatures of known, common attackers.



- Malicious Signatures do not apply to the following:
  - ✓ Calls from IP Groups where Classification is by Proxy Set.
  - ✓ In-dialog SIP sessions (e.g., refresh REGISTER requests and re-INVITEs).
  - ✓ Calls from users that are registered with the device.
- If you delete all the entries in the table, when you next reset the device, the table is populated again with all the default signatures.

You can export / import Malicious Signatures in CSV file format to / from a remote server through HTTP, HTTPS, or TFTP. To do this, use the following CLI commands:

```
(config-voip)# sbc malicious-signature-database <export-csv-to | import-csv-from>
<URL>
```

To apply malicious signatures to calls, you need to enable the use of malicious signatures for a Message Policy and then assign the Message Policy to the SIP Interface associated with the calls (i.e., IP Group). To configure Message Policies, see [Configuring SIP Message Policy Rules](#).

The following procedure describes how to configure Malicious Signatures through the Web interface. You can also configure it through ini file [MaliciousSignatureDB] or CLI (configure voip > sbc malicious-signature-database).

➤ **To configure a Malicious Signature:**

1. Open the Malicious Signature table (**Setup** menu > **Signaling & Media** tab > **SBC** folder > **Malicious Signature**).
2. Click **New**; the following dialog box appears:



3. Configure a Malicious Signature according to the parameters described in the table below.
4. Click **Apply**.

**Table 36-1: Malicious Signature Table Parameter Descriptions**

Parameter	Description
'Index' [ConditionTable_Index]	Defines an index number for the new table row. <b>Note:</b> Each row must be configured with a unique index.
'Name' name [MaliciousSignatureDB_Name]	Defines a descriptive name, which is used when associating the row in other tables. The valid value is a string of up to 30 characters. <b>Note:</b> Each row must be configured with a unique name.
'Pattern' pattern [MaliciousSignatureDB_Pattern]	Defines the signature pattern. The valid value is a string of up to 60 characters. You can use the built-in syntax editor to help you configure the field. Click the <b>Editor</b> button located alongside the field to open the



Parameter	Description
	Editor, and then simply follow the on-screen instructions. <b>Note:</b> The parameter is mandatory.

## 37 Advanced SBC Features

This section describes configuration of advanced SBC features.

### Configuring Call Preemption for SBC Emergency Calls

The device supports emergency call preemption for SBC calls by prioritizing emergency calls over regular calls. If the device receives an incoming emergency call when there are unavailable resources to process the call, the device preempts one of the regular calls to free up resources for sending the emergency call to its' destination (i.e., emergency service provider), instead of rejecting it. The device may preempt more than one active call in order to provide sufficient resources for processing the emergency call. Available resources depends on the number of INVITE messages currently processed by the device.

If the device preempts a call, it disconnects the call as follows:

- If the call is being setup (not yet established), it sends a SIP 488 response to the incoming leg and a SIP CANCEL message to the outgoing leg.
- If the call is already established, it sends a SIP BYE message to each leg. The device includes in the SIP BYE message, the Reason header describing the cause as "preemption".

Once the device terminates the regular call, it immediately sends the INVITE message of the emergency call to its' destination without waiting for any response from the remote sides (e.g., 200 OK after BYE). If the device is unable to preempt a call for the emergency call, it rejects the emergency call with a SIP 503 "Emergency Call Failed" (instead of "Service Unavailable") response.

For the device to identify incoming calls as emergency calls, you need to configure a Message Condition rule in the Message Conditions table. Below are examples of Message Condition rules for identifying emergency calls:

**Table 37-1: Examples of Message Condition Rules for Emergency Calls**

Index	Name	Condition
0	Emergency1 - RP header	header.resource-priority contains 'emergency'
1	Emergency2 - RP header	header.resource-priority contains 'esnet'
2	Emergency1 - user with providers address	header.to.url.user=='911'
3	Emergency2 - user with providers address	header.to.url.user=='100'   header.to.url.user=='101'  header.to.url.user=='102'
4	Emergency3 - user with	header.request.uri contains 'urn:service:sos'

Index	Name	Condition
	providers address	

- Indices 0 and 1: SIP Resource-Priority header contains a string indicating an emergency call.
- Indices 2 to 4: Destination user-part contains the emergency provider's address.

The device applies the Message Condition rule only after call classification (but, before inbound manipulation).



The device does not preempt established emergency calls.

### ➤ To configure SBC emergency call preemption:

1. In the Message Conditions table (see [Configuring Message Condition Rules](#)), configure a Message Condition rule to identify incoming emergency calls. See above for examples.
2. Open the SBC General Settings page (**Setup** menu > **Signaling & Media** tab > **SIP Definitions** folder > **Priority and Emergency**), and then scroll down to the Call Priority and Preemption group:

CALL PRIORITY AND PREEMPTION	
Preemption Mode	Enable
Emergency Message Condition	1
Emergency RTP DiffServ	46
Emergency Signaling DiffServ	40

3. From the 'Preemption Mode' drop-down list (SBCPreemptionMode), select **Enable** to enable call preemption.
4. In the 'Emergency Message Condition' field, enter the row index of the Message Condition rule that you configured in Step 1.
5. (Optional) Assign DiffServ levels (markings) to packets belonging to emergency calls:
  - In the 'Emergency RTP DiffServ' field (SBCEmergencyRTPDiffServ), enter the QoS level for RTP packets.
  - In the 'Emergency Signaling DiffServ' field (SBCEmergencySignalingDiffServ), enter the QoS level for SIP signaling packets.
6. Click **Apply**.

## Configuring Message Session Relay Protocol

The device supports Message Session Relay Protocol (MSRP), which is a text-based protocol for exchanging a series of related instant messages (IM) across an IP network (TCP or TLS only) in the context of a session. The protocol can also be used to transfer large files or images, or share remote desktops or whiteboards. MSRP is typically required for Next Generation 911 (NG911) services, allowing 911 callers to not only access 911 services through voice calls, but also through text messages with Public Safety Answering Points (PSAPs). The device's MSRP support is in accordance with RFC 4975 (The Message Session Relay Protocol (MSRP)) and RFC 6135 (An Alternative Connection Model for the Message Session Relay Protocol (MSRP)). The device also supports secure MSRP sessions (MSRPS), using TLS certificates (TLS Context).

The device establishes MSRP sessions using the SDP offer/answer negotiation model over SIP. The MSRP session starts with a SIP INVITE and ends with a SIP BYE message. As a B2BUA, the device interoperates between the MSRP endpoints, terminating the incoming MSRP message on the inbound leg and then generating a new MSRP message on the outbound leg. Before sending the INVITE, the device manipulates the SDP body (e.g., 'a=path', 'c=', 'm=', 'a=setup' and 'a=fingerprint' lines). The device can perform optional message manipulation and other translations such as resolving NAT traversal when the endpoints or device are located behind NAT.

An example of an SDP body with the fields for MSRP negotiation in the INVITE message is shown below:

```
INVITE sip:alice@atlanta.example.com SIP/2.0
To: <sip:bob@biloxi.example.com>
From: <sip:alice@atlanta.example.com>;tag=786
Call-ID: 3413an89KU
Content-Type: application/sdp

c=IN IP4 atlanta.example.com
m=message 7654 TCP/MSRP *
a=accept-types:text/plain
a=path:msrp://atlanta.example.com:7654/jshA7weztas;tcp
a=setup:active
```

Where,

- 'c=' line ignores IP address and port
- 'm=' line indicates an MSRP message
- 'a=accept-types:' line lists allowed content types
- 'a=path:msrp:' line indicates the URI to where the messages are to be sent
- 'a=setup' line indicates the MSRP role (active UA initiates connection; passive UA listens on port)

If secured MSRP (MSRPS) is required (i.e., incoming SDP contains 'm=' line with 'TCP/TLS/MSRP' value, 'a=path' with 'msrps', and 'a=fingerprint'), during MSRP session establishment, the device enforces the validity of the fingerprint from the TLS handshake (public key) with the fingerprint in the received SDP. When the device establishes a secured MSRP session, the offered fingerprint is obtained from the TLS Context, which is assigned to the IP Profile of the endpoint.

The device handles MSRP sessions as follows:

1. When the device receives an INVITE message with the MSRP offer, it initiates an SDP offer to the destination endpoint on the outgoing leg. Before sending the INVITE message, the device does the following:
  - Chooses an unused MSRP listening port (SDP 'm=' line) from the TCP media port range configured for the associated Media Realm.
  - Uses the IP address (SDP 'c=' line) of the associated IP Interface (SIP Interface).
  - Sets the 'a=setup' line to the configured preferred MSRP role of the device.
2. When the device receives the MSRP answer from the destination endpoint, it sends an SDP answer to the dialog-initiating endpoint. Before sending the INVITE message, the device does the following:
  - If the device has chosen a TCP server role, it selects an unused listening port from the TCP media port range which is capable of accepting TCP connections. This port number is included in the media line of the SDP.
  - The device includes the IP address of the associated IP Interface in the 'c=' line of the SDP.
  - Sets the 'a=setup' line to the device's negotiated role.

Once SDP negotiation between the UAs is complete and the MSRP session is being established, the device initiates a TCP/TLS connection (or waits to be initiated) on each leg, depending on SDP negotiation. Once a TCP/TLS connection is established, the endpoints can start sending MSRP messages using MSRP SEND requests, as shown in the following example:

```
MSRP a786hjs2 SEND
To-Path: msrp://biloxi.example.com:12763/kjhd37s2s20w2a;tcp
From-Path: msrp://atlanta.example.com:7654/jshA7weztas;tcp
Message-ID: 87652491
Byte-Range: 1-25/25
Content-Type: text/plain

Hey Bob, are you there?
-----a786hjs2$
```

The MSRP payload or content (i.e. the actual message) follows the Content-Type header. Finally, the SEND request is closed with an end-line of seven hyphens, the Transaction ID, and one of the following symbols:

- **\$**: The request contains the final part of the message (end).
- **+**: The request does not contain the final part of the message (\$), but is only part of a series of messages.
- **#**: The sender is aborting an incomplete message and intends to send no further chunks in that message (message should be discarded).

An example of a basic MSRP flow is shown below:

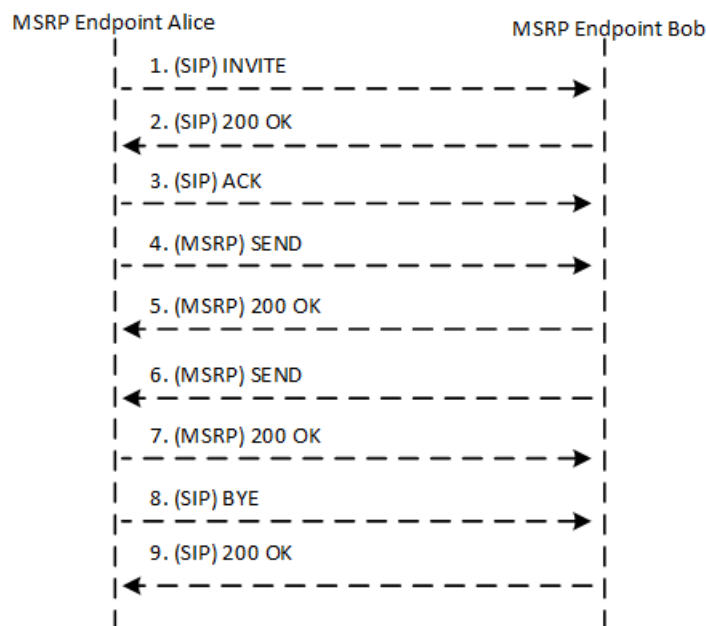

- MSRP is not supported with other media types (i.e., voice) in the same SDP session.
- The Call Admission Control (CAC) mechanism handles MSRP sessions as regular media sessions (i.e., they are not calculated and monitored separately from regular media calls).
- CDRs generated by the device for MSRP calls include the value "msrp" in the Media List CDR field.
- MSRP is applicable only to the SBC application.

The following procedure provides the basic steps for configuring MSRP.

#### ➤ To configure MSRP:

1. Open the IP Profiles table (see [Configuring IP Profiles](#) on page 499), and then configure the MSRP endpoint's IP Profile with the following (in addition to other IP Profile settings that may require):

- From the 'SBC Media Security Mode' drop-down list, select the transport protocol for the outgoing leg - **Secured** or **Both** for MSRPS (example below); **Not Secured** for MSRP.

**SBC Media Security Mode**

- From the 'MSRP Offer Setup Role' drop-down list, select the MSRP role mode in SDP negotiations ('a=setup' line). The device's role is according to the response: If 'a=setup passive', it's the "active" role; if 'a=setup active', it's the "passive" role. If no 'a=setup' in the response, it's the "active" role.

**MSRP Offer Setup Role**

- In the 'Data DiffServ' field, configure the DiffServ value of MSRP traffic ('m=message').

**Data DiffServ**

- From the 'MSRP re-INVITE/UPDATE' drop-down list, select if the destination MSRP endpoint supports the receipt of re-INVITE requests and UPDATE messages.

**MSRP re-INVITE/UPDATE**

- From the 'MSRP Empty Message Format' drop-down list, select if the device must add a Content-Type header to empty MSRP messages that are used to initiate the connection.

**MSRP Empty Message Format**

- Open the Media Realms table (see [Configuring Media Realms](#) on page 395), and then configure the MSRP endpoint's Media Realm with MSRP ports in the 'TCP Port Range Start' and 'TCP Port Range End' fields. The port number is used in the SDP's 'a=path' line.

**TCP Port Range Start**

**TCP Port Range End**

- Open the IP Groups table (see [Configuring IP Groups](#) on page 431), and then for secured MSRP (MSRPS), assign a TLS Context (certificate) to the endpoint's IP Group, using the 'Media TLS Context' parameter.

**Media TLS Context**

- For NAT traversal of MSRP sessions when the device is located behind NAT, use the NAT Translation table (see [Configuring NAT Translation per IP Interface](#) on page 136). The target IP address:port (public) is used in the SDP's 'a=path' line.

## Emergency Call Routing using LDAP to Obtain ELIN

The device can route emergency calls (e.g., 911) for INVITE messages that are received without an ELIN number. This is in contrast to when the device is deployed in a Microsoft Teams / Skype for Business environment, whereby the received INVITE messages contain ELIN numbers. For a detailed explanation on ELIN numbers and handling of emergency calls by emergency server providers, see [E9-1-1 Support for Microsoft Teams and Skype for Business](#) on page 350.

To obtain an ELIN number for emergency calls received without ELINs, you can configure the device to query an LDAP server for the 911 caller's ELIN number. The device adds the resultant ELIN number and a Content-Type header for the PIDF XML message body to the outgoing INVITE message, for example:

```
Content-Type: application/pidf+xml
<ELIN>1234567890</ELIN>
```

### ➤ To enable emergency call routing using LDAP to obtain ELIN:

1. Configure a Call Setup rule in the Call Setup Rules table (see [Configuring Call Setup Rules](#)). The following example shows a Call Setup rule that queries an Active Directory (AD) server for the attribute "telephoneNumber" whose value is the E9-1-1 caller's number (source), and then retrieves the user's ELIN number from the attribute "numberELIN":

The screenshot shows the configuration for a Call Setup Rule named "ELIN from LDAP". The interface is divided into two main sections: GENERAL and ACTION.

**GENERAL Section:**

- Index: 1
- Name: ELIN from LDAP
- Rules Set ID: 1
- Request Type: LDAP
- Request Target: (empty)
- Request Key: \*telephoneNumber\*Param.Call.Src.User
- Attributes To Get: numberELIN
- Row Role: Use Current Condition
- Condition: LDAP.Attr.numberELIN exists

**ACTION Section:**

- Action Subject: Body:application/pidf+xml
- Action Type: Add
- Action Value: <ELIN>\*ldap.attr.numberELIN\*</ELIN>

2. Enable the E9-1-1 feature, by configuring the 'PSAP Mode' parameter to **PSAP Server** in the IP Groups table for the IP Group of the PSAP server (see [Enabling the E9-1-1 Feature](#)).
3. Configure routing rules in the IP-to-IP Routing table for routing between the emergency callers' IP Group and the PSAP server's IP Group. The only special configuration required for the routing rule from emergency callers to the PSAP server:
  - Configure the emergency number (e.g., 911) in the 'Destination Username Pattern' field.
  - Assign the Call Setup rule that you configured for obtaining the ELIN number from the AD (see Step 1) in the 'Call Setup Rules Set ID' field (see [Configuring SBC IP-to-IP Routing Rule for E9-1-1](#)).



## Configuring Dual Registration for SIP Entity

Some SIP entities (e.g., IP Phones) are setup to register with two registrar/proxy servers (primary and secondary). The reason for this is to provide call redundancy for the SIP entity in case one of the proxy servers fail. When the SIP entity registers with the proxy servers, it sends two identical REGISTER messages - one to the primary proxy and one to the secondary proxy. When the device is located between the SIP entity and the two proxy servers, it needs to differentiate between these two REGISTER messages even though they are identical. This is crucial to ensure that the device forwards the two registrations to the proxy servers and that the device performs correct call routing between the SIP entity and the two proxy servers.

To differentiate between these REGISTER messages, a unique SIP Interface needs to be used for each REGISTER message. Each REGISTER message is registered in the registration database using a unique "ac-int=<value>" string identifying the SIP Interface for the Contact user. In addition, for SIP requests (e.g., INVITE) from the proxy servers, the device needs to search its registration database for the contact user so that it can forward it to the user. In normal registration, the host part of the Request-URI contains the IP address of the device and therefore, there is no way of knowing which registered user the INVITE is intended for. To overcome this issue, you can configure the device to use a special string with a unique value, "ac-feu=<value>" for each registration, allowing the device to differentiate between two registrations from the same user (identical REGISTER requests). Each REGISTER message is registered in the registration database using the unique "ac-feu=" string identifier for the Contact user.

A summary of how the device registers the two REGISTER messages in its registration database is as follows:

1. The addresses of the proxy servers that are configured on the SIP entity (IP Phone) must be the device's IP address with a different SIP local port for each one, for example:
  - Primary Proxy Server: 172.17.0.1.20:5060
  - Secondary Proxy Server: 172.17.0.1:5080
2. When the device receives two identical REGISTER messages from the SIP entity, it differentiates them by the SIP port on which they are received. The port allows the device to associate them with a SIP Interface (5060 for "Interface-1" and 5080 for "Interface-2").
3. The device performs SIP message manipulation (Pre-classification Manipulation) on the REGISTER messages to add a special parameter ("ac-int=<value>") to the Contact header to identify the SIP Interface on which each message is received. For example:

- REGISTER for Primary Proxy received on SIP Interface "Interface-1":

```
REGISTER
To: <sip:100@audc.com>
Contact: <sip:100@172.17.100.20;ac-int=1>
```

- REGISTER for Secondary Proxy received on SIP Interface "Interface-2":

```
REGISTER
To: <sip:100@audc.com>
Contact: <sip:100@172.17.100.20;ac-int=2>
```

4. The device adds to the Contact header a special string with a unique value, "ac-feu=<value>" for each registration (e.g., "Contact: <sip:100@172.17.100.20;ac-int=1;ac-feu=x>").
5. The device saves the two contacts (100@172.17.100.20;ac-int=1;ac-feu=x and 100@172.17.100.20;ac-int=2;ac-feu=y) under the **same AOR** (100@audc.com) in its user registration database.

The SIP call flow for dual registration is shown below:

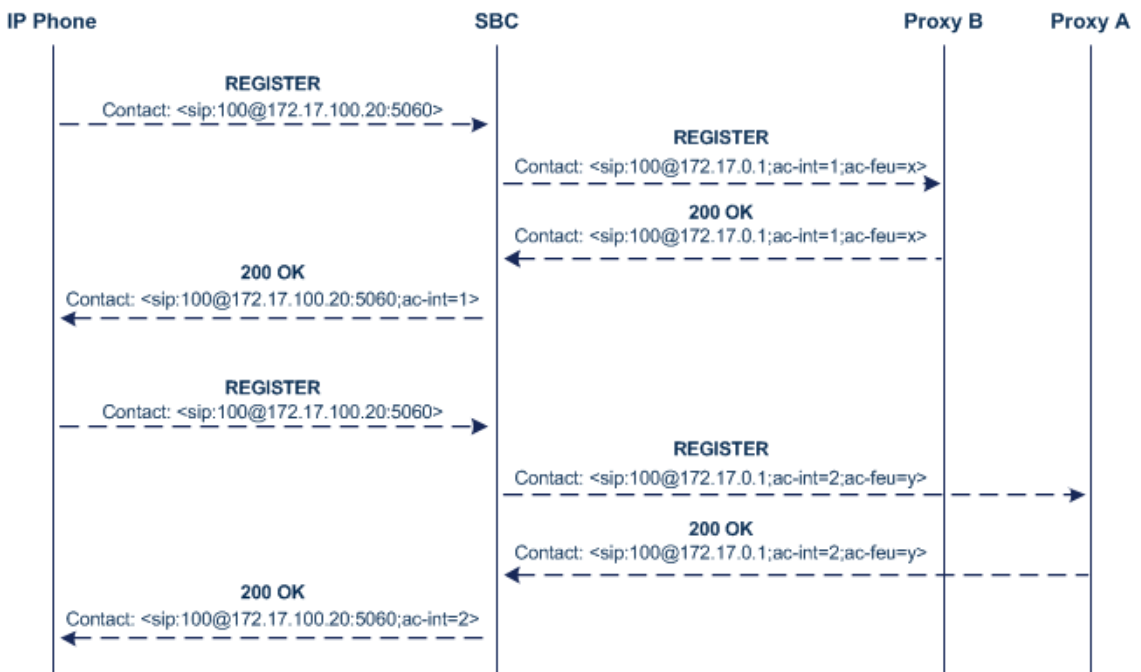

The basic SIP call flow for INVITEs to and from the registered user is shown below:

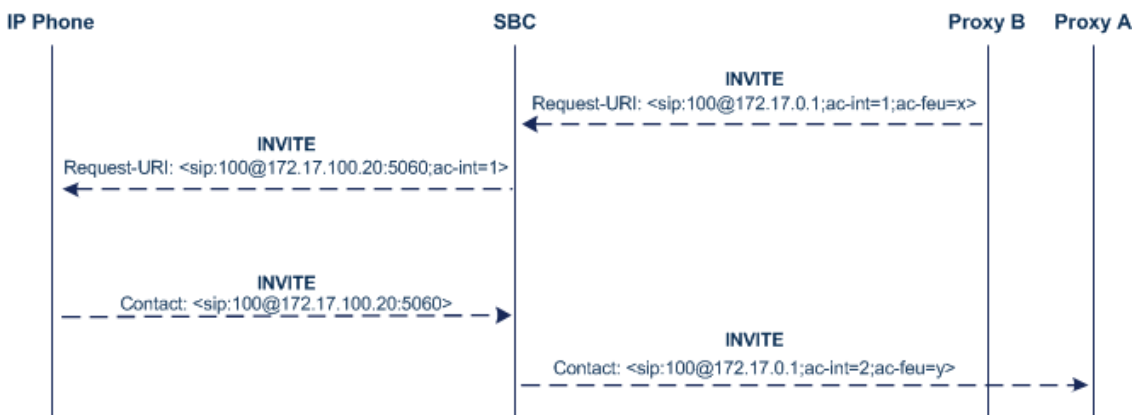

➤ **To configure support for dual registration:**

1. On the SIP entity (IP Phone), configure the primary and secondary proxy server addresses as the IP address of the device and where each address has a different SIP port number.
2. Open the SBC General Settings page (**Setup** menu > **Signaling & Media** tab > **SBC** folder > **SBC General Settings**), and then from the 'Keep Original User in Register' drop-down list, select **Keep user; add unique identifier as URI parameter**.
3. In the Message Manipulations table, configure the following rules:
  - Index 0:
    - ◆ Manipulation Set ID: **1**
    - ◆ Action Subject: **header.contact.url.ac-int**
    - ◆ Action Type: **Modify**
    - ◆ Action Value: **'1'**
  - Index 1:
    - ◆ Manipulation Set ID: **2**
    - ◆ Action Subject: **header.contact.url.ac-int**
    - ◆ Action Type: **Modify**
    - ◆ Action Value: **'2'**
4. In the SIP Interfaces table, configure the following SIP Interfaces:
  - Index 0 (SIP Interface for IP Phone A):
    - ◆ Name: **Interface-1**
    - ◆ UDP Port: **5060**
    - ◆ Pre-classification Manipulation Set ID: **1**
  - Index 1 (SIP Interface for IP Phone B):
    - ◆ Name: **Interface-2**
    - ◆ UDP Port: **5080**
    - ◆ Pre-classification Manipulation Set ID: **2**
5. In the Proxy Sets table, configure a Proxy Set for each proxy server (primary and secondary):
  - Index 0:
    - ◆ Proxy Name: **Primary**
    - ◆ SBC IPv4 SIP Interface: **Interface-1**
    - ◆ Proxy Address: **200.10.10.1**
  - Index 1:

- ◆ Proxy Name: **Secondary**
  - ◆ SBC IPv4 SIP Interface: **Interface-2**
  - ◆ Proxy Address: **200.10.10.2**
6. In the IP Groups table, configure the following IP Groups:
- Index 0:
    - ◆ Type: **Server**
    - ◆ Name: **Primary-Proxy**
    - ◆ Proxy Set: **Primary**
    - ◆ Classify By Proxy Set: **Enable**
  - Index 1:
    - ◆ Type: **Server**
    - ◆ Name: **Sec-Proxy**
    - ◆ Proxy Set: **Secondary**
    - ◆ Classify By Proxy Set: **Enable**
  - Index 2:
    - ◆ Type: **User**
    - ◆ Name: **IP-Phone-A**
  - Index 3:
    - ◆ Type: **User**
    - ◆ Name: **IP-Phone-B**
7. In the Classification table, configure rules to classify calls from the IP Phones based on SIP Interface:
- Index 0:
    - ◆ Source SIP Interface: **Interface-1**
    - ◆ Source IP Group: **IP-Phone-A**
  - Index 1:
    - ◆ Source SIP Interface: **Interface-2**
    - ◆ Source IP Group: **IP-Phone-B**
8. In the IP-to-IP Routing table, configure the routing rules:
- Index 0:
    - ◆ Source IP Group: **IP-Phone-A**
    - ◆ Destination IP Group: **Primary-Proxy**

- Index 1:
  - ◆ Source IP Group: **Primary-Proxy**
  - ◆ Destination IP Group: **IP-Phone-A**
- Index 2:
  - ◆ Source IP Group: **IP-Phone-B**
  - ◆ Destination IP Group: **Sec-Proxy**
- Index 3:
  - ◆ Source IP Group: **Sec-Proxy**
  - ◆ Destination IP Group: **IP-Phone-B**

## Handling Registered AORs with Same Contact URIs

The device can handle registration and call routing in cases where user registration includes AORs with the same Contact header URIs, as shown in the example below. Such a scenario typically occurs when two SIP endpoints reside in separate private networks and both are assigned the same local IP address.

### ■ User 1 Registration:

```
REGISTER sip:300@10.33.4.140;user=phone SIP/2.0
```

```
Via: SIP/2.0/UDP 10.33.2.40;branch=OTGHREPCXDIBIWECOPJK
```

```
From:  
<sip:300@domain1;user=phone>;tag=ULYEYCGXHXMBPSOCXVWH
```

```
To: <sip:300@domain1;user=phone>
```

```
Call-ID: XDRXGAAWNVTBFHBMQCKE@10.33.2.38
```

```
CSeq: 1 REGISTER
```

```
Contact: <sip:300@10.33.2.40>
```

### ■ User 2 Registration:

```
REGISTER sip:300@10.33.4.140;user=phone SIP/2.0
```

```
Via: SIP/2.0/UDP 10.33.2.40;branch=YHDWUJRMMOEIJRXVYKHD
```

```
From: <sip:300@domain2;user=phone>;tag=CVYTCHLIVMPBCGNGRTUA
```

```
To: <sip:300@domain2;user=phone>
```

```
Call-ID: INRNGFCHFHETRQAQNAIT@10.33.2.38
```

```
CSeq: 1 REGISTER
```

```
Contact: <sip:300@10.33.2.40>
```

For two such user registrations as shown in the example above, the device adds two AORs ("300@domain1" and "300@domain2") to its registration database, where each AOR is assigned the same Contact URI ("300@10.33.2.40"). To route a call to the correct user, the device needs to search the database for the full URI (user@host parts). To enable this support, perform the following configuration steps:

➤ **To enable handling of multiple AORs with identical Contact URIs:**

1. Open the Proxy & Registration page (**Setup** menu > **Signaling & Media** tab > **SIP Definitions** folder > **Proxy & Registration**).
2. From the 'DB Routing Search Mode' drop-down list (SBCDBRoutingSearchMode), select **Dest URI dependant**, and then click **Apply**.

## Enabling Interworking of SIP and SIP-I Endpoints

The device can interwork between SIP and SIP-I endpoints for SBC calls. SIP-I endpoints are entities that are connected to the SS7 PSTN network, referred to as the ISDN User Part (ISUP) domain. The device supports the SIP-I Application-layer signaling protocol, which is the standard for encapsulating a complete copy of the SS7 ISUP message in SIP messages, according to ITU-T Q.1912.5, Interworking between Session Initiation Protocol (SIP) and Bearer Independent Call Control protocol or ISDN User Part. In other words, SIP-I is SIP encapsulated with ISUP and the interworking is between SIP signaling and ISUP signaling. This allows you to deploy the device in a SIP environment where part of the call path involves the PSTN.

The SIP-I sends calls, originating from the SS7 network, to the SIP network by adding ISUP messaging in the SIP INVITE message body. The device can receive such a message from the SIP-I and remove the ISUP information before forwarding the call to the SIP endpoint. In the other direction, the device can receive a SIP INVITE message that has no ISUP information and before forwarding it to the SIP-I endpoint, create a SIP-I message by adding ISUP information in the SIP body. For SIP-I to SIP-I calls, the device can pass ISUP data transparently between the endpoints.

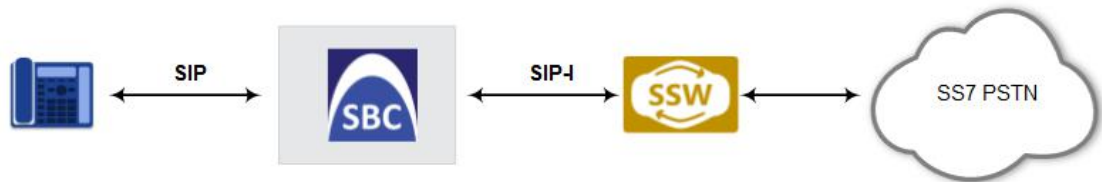

For the interworking process, the device maps between ISUP data (including cause codes) and SIP headers. For example, the E.164 number in the Request-URI of the outgoing SIP INVITE is mapped to the Called Party Number parameter of the IAM message, and the From header of the outgoing INVITE is mapped to the Calling Party Number parameter of the IAM message.

The ISUP data is included in SIP messages using the Multipurpose Internet Mail Extensions (MIME) body part, for example (some headers have been removed for simplicity):

```
INVITE sip:1774567@172.20.1.177;user=phone SIP/2.0
Via: SIP/2.0/UDP 172.20.73.230:5060;branch=z9hG4bK.il
```

...

```
Accept: application/sdp, application/isup, applicatio
Content-Type: multipart/mixed; boundary=unique-bounda
MIME-Version: 1.0
Content-Length: 350
```

...

```
Content-Type: application/isup; version=FTSSURI; base
Content-Disposition: signal; handling=required
01 00 40 01 0a 02 02 08 06 83 10 71 47 65 07 08
01 00 00
--unique-boundary-1--
```

```
D6 SIP-T ISUP/IAM (Initial address message)
(--) len:-- >> Nature of connection indicators
Oct 1 : ---0---- Echo ctrl = Half echo not included
----00-- Cont. check = Not required
-----00 Satellite = No circuit
(--) len:-- >> Forward call indicators
Oct 1 : 01----- ISUP pref. = Not req. all the way
--0----- ISUP indic. = Not used all the way
---0---- End-end inf = Not available
----0--- Interwork. = Not encountered
-----00- Method. ind = No method available
```

```
-----0 Call indic. = as National call  
Oct 2 : -----00- SCCP method = No indication
```

ISUP data, received in the MIME body of the incoming SIP message is parsed according to the ISUP variant (SPIROU itu or ansi), indicated in the SIP Content-Type header. The device supports the following ISUP variants (configured by the 'ISUP Variant' parameter in the IP Profile table):

- French (France) specification, SPIROU (Système Pour l'Interconnexion des Réseaux OUverts), which regulates Telecommunication equipment that interconnect with networks in France. For SPIROU, the device sets the value of the SIP Content-Type header to "version=spirou; base=itu-t92+".
- ITU-92, where the device sets the value of the SIP Content-Type header to "version=itu-t92+; base=itu-t92+".

To configure interworking of SIP and SIP-I endpoints, using the 'ISUP Body Handling' parameter (IpProfile\_SBCISUPBodyHandling) in the IP Profile table (see [Configuring IP Profiles](#)).

You can manipulate ISUP data, by configuring manipulation rules for the SIP Content-Type and Content-Disposition header values, in the Message Manipulations table (see [Configuring SIP Message Manipulation](#)). For a complete description of the ISUP manipulation syntax, refer to the *Syntax for SIP Message Manipulation Reference Guide*. In addition, you can use the AudioCodes proprietary SIP header X-AC-Action in Message Manipulation rules to support the various call actions (e.g., SIP-I SUS and RES messages) for the ISUP SPIROU variant. For more information, see [Using the Proprietary SIP X-AC-Action Header](#).

## Call Forking

This section describes various Call Forking features supported by the device.

### Initiating SIP Call Forking

The SBC device supports call forking of an incoming call to multiple SBC users (destinations). Call forking is supported by the device's capability of registering multiple SIP client user phone contacts (mobile and fixed-line extensions) under the same Address of Record (AOR) in its registration database. This feature can be implemented in the following example scenarios:

- An enterprise Help Desk, where incoming customer calls are simultaneously sent to multiple customer service agent extensions.
- An employee's phone devices, where the incoming call is simultaneously sent to multiple devices (e.g., to the employee's office phone and mobile SIP phone).
- An enterprise reception desk, where an incoming call is simultaneously sent to multiple receptionists.

The device supports various modes of call forking. For example, in Parallel call forking mode, the device sends the INVITE message simultaneously to all the users registered under the



same AOR, resulting in the ringing of all extensions; the first extension to pick up the call receives the call, and all other extensions stop ringing. The Call Forking feature is configured by creating a User-type IP Group and configuring the IP Groups table's parameter, 'SBC Client Forking Mode' (see [Configuring IP Groups](#)).

The device can also fork INVITE messages received for a Request-URI of a specific contact (user), belonging to the destination IP Group User-type, registered in the database to all other users located under the same AOR as the specific contact. This is configured by the [SBCSendInviteToAllContacts] parameter.

## Configuring SIP Forking Initiated by SIP Proxy

The device can handle the receipt of multiple SIP 18x responses as a result of SIP forking initiated by a proxy server. This occurs when the device forwards an INVITE, received from a user agent (UA), to a proxy server and the proxy server then forks the INVITE request to multiple UAs. Several UAs may answer and the device may therefore, receive several replies (responses) for the single INVITE request. Each response has a different 'tag' value in the SIP To header.

During call setup, forked SIP responses may result in a single SDP offer with two or more SDP answers. The device "hides" all the forked responses from the INVITE-initiating UA, except the first received response ("active" UA) and it forwards only subsequent requests and responses from this active UA to the INVITE-initiating UA. All requests/responses from the other UAs are handled by the device; SDP offers from these UAs are answered with an "inactive" media.

The device supports two forking modes:

- **Latch On First:** The device forwards only the first received 18x response to the INVITE-initiating UA and disregards subsequently received 18x forking responses (with or without SDP).
- **Sequential:** The device forwards all 18x responses to the INVITE-initiating UA, sequentially (one after another). If 18x arrives with an offer only, only the first offer is forwarded to the INVITE-initiating UA.

### ➤ To configure the call forking mode:

1. Open the SBC General Settings page (**Setup** menu > **Signaling & Media** tab > **SBC** folder > **SBC General Settings**).
2. From the 'Forking Handling Mode' [SBCForkingHandlingMode] drop-down list, select the required mode:

Forking Handling Mode  ▼

3. Click **Apply**.

The device also supports media synchronization for call forking. If the active UA is the first one to send the final response (e.g., 200 OK), the call is established and all other final responses are acknowledged and a BYE is sent if needed. If another UA sends the first final response, it is

possible that the SDP answer that was forwarded to the INVITE-initiating UA is irrelevant and thus, media synchronization is needed between the two UAs. Media synchronization is done by sending a re-INVITE request immediately after the call is established. The re-INVITE is sent without an SDP offer to the INVITE-initiating UA. This causes the INVITE-initiating UA to send an offer which the device forwards to the UA that confirmed the call. Media synchronization is enabled by the EnableSBCMediaSync parameter.

## Configuring Call Forking-based IP-to-IP Routing Rules

You can configure call forking routing rules in the IP-to-IP Routing table. This is done by configuring multiple routing rules under a forking group. These rules send an incoming IP call to multiple destinations of any type (e.g., IP Group or IP address). The device forks the call by sending simultaneous INVITE messages to all the specified destinations. It handles the multiple SIP dialogs until one of the calls is answered and then terminates the other SIP dialogs. For more information, see [Configuring SBC IP-to-IP Routing Rules](#).

## Call Survivability

This section describes various call survivability features supported by the SBC device.

### Enabling Auto-Provisioning of Subscriber-Specific Information of BroadWorks Server for Survivability

This feature enables SBC user registration for interoperability with BroadSoft BroadWorks server to provide call survivability in case of connectivity failure with the BroadWorks server, for example, due to a WAN failure. The feature enables local users to dial a local extension (or any other configured alias) that identifies another local user, in survivability mode.

In normal operation, when subscribers (such as IP phones) register with the BroadWorks server through the device, the device includes the SIP Allow-Events header in the sent REGISTER message. In response, the BroadWorks server sends the device a SIP 200 OK containing an XML body with subscriber information such as extension number, phone number, and URIs (aliases), as shown in the example below:

```
<?xml version="1.0" encoding="utf-8"?>
<BroadsoftDocument version="1.0" content="subscriberData">
  <phoneNumbers>
    <phoneNumber>2403645317</phoneNumber>
    <phoneNumber>4482541321</phoneNumber>
  </phoneNumbers>
  <aliases>
    <alias>sip:bob@broadsoft.com</alias>
    <alias>sip:rhughes@broadsoft.com</alias>
  </aliases>
  <extensions>
    <extension>5317</extension>
    <extension>1321</extension>
  </extensions>
</BroadsoftDocument>
```

```
</extensions>
</BroadSoftDocument>
```

The device forwards the 200 OK to the subscriber (without the XML body). The call flow is shown below:



The device saves the users in its registration database with their phone numbers and extensions, enabling future routing to these destinations during survivability mode when communication with the BroadWorks server is lost. When in survivability mode, the device routes the call to the Contact associated with the dialed phone number or extension number in the registration database.

➤ **To enable the BroadWorks survivability feature:**

1. Open the SBC General Settings page (**Setup** menu > **Signaling & Media** tab > **SBC** folder > **SBC General Settings**).
2. From the 'BroadWorks Survivability Feature' drop-down list (SBCExtensionsProvisioningMode), select **Enable**:

BroadWorks Survivability Feature •

3. Click **Apply**.

## Configuring BroadSoft's Shared Phone Line Call Appearance for Survivability

The device can provide redundancy for BroadSoft's Shared Call Appearance feature. When the BroadSoft application server switch (AS) fails or does not respond, or when the network connection between the device and the BroadSoft AS is down, the device manages the Shared Call Appearance feature for the SIP clients.

The feature is supported by configuring a primary extension and associating it with secondary extensions (i.e., *shared lines*) so that incoming calls to the primary extension also ring at the secondary extensions. The call is established with the first extension to answer the call and consequently, the ringing at the other extensions stop. For example, assume primary extension number 600 is shared with secondary extensions 601 and 602. In the case of an incoming call to 600, all three phone extensions ring simultaneously, using the device's call forking feature as described in [Configuring SIP Forking Initiated by SIP Proxy](#). Note that incoming calls specific to extensions 601 or 602 ring only at these specific extensions.

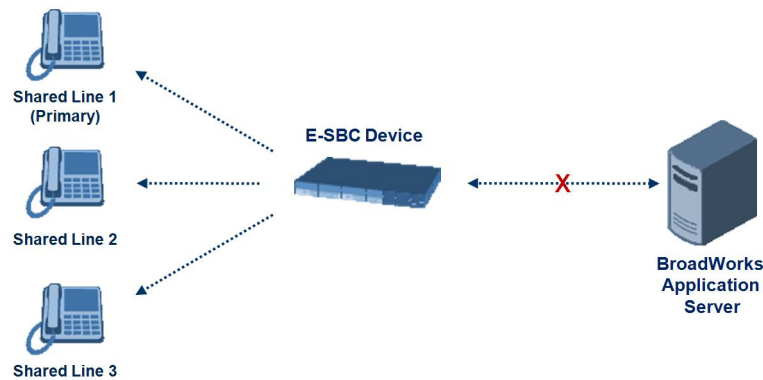

To configure this capability, you need to configure a shared-line, inbound manipulation rule for registration requests to change the destination number of the secondary extension numbers (e.g. 601 and 602) to the primary extension (e.g., 600). Call forking must also be enabled. The following procedure describes the main configuration required.



- The device enables outgoing calls from all equipment that share the same line simultaneously (usually only one simultaneous call is allowed per a specific shared line).
- You can configure whether REGISTER messages from secondary lines are terminated on the device or forwarded transparently (as is), using the `SBCSharedLineRegMode` parameter.
- The LED indicator of a shared line may display the wrong current state.

#### ➤ To configure BroadSoft's Shared Line feature:

1. In the IP Groups table (see [Configuring IP Groups](#)), add a Server-type IP Group for the BroadWorks server.
2. In the IP Groups table, add a User-type IP Group for the IP phone users and set the 'SBC Client Forking Mode' parameter to **Parallel** so that the device forks incoming calls to all contacts under the same AOR registered in the device's registration database.
3. In the IP-to-IP Routing table (see [Configuring SBC IP-to-IP Routing Rules](#)), add a rule for routing calls between the above configured IP Groups.
4. In the Inbound Manipulations table (see [Configuring IP-to-IP Inbound Manipulations](#)), add a manipulation rule for the secondary extensions (e.g., 601 and 602) so that they also register to the device's database under the primary extension contact (e.g., 600):
  - 'Manipulation Purpose': **Shared Line**
  - Match:
    - ◆ 'Request Type': **REGISTER**
    - ◆ 'Source IP Group': IP Group that you created for the users (e.g., 2)
    - ◆ 'Source Username Pattern': Represents the secondary extensions, e.g., 601 and 602
  - Action:

- ◆ 'Manipulated URI': **Source** (manipulates the source URI)
- ◆ 'Remove From Right': 1 (removes the last digit of the extensions, e.g., 601 is changed to 60)
- ◆ 'Suffix to Add': 0 (adds 0 to the end of the manipulated number, e.g., 60 is changed to 600)

### Configuring Call Survivability for Call Centers

The device supports call survivability for call centers. When a communication failure (e.g., in the network) occurs with the remote voice application server responsible for handling the call center application (such as IVR), the device routes the incoming calls received from the customer (i.e., from the TDM gateway) to the call center agents.

In normal operation, the device registers the agents in its users registration database. Calls received from the TDM gateway are forwarded by the device to the application server, which processes the calls and sends them to specific call center agents, through the device. Upon a failure with the application server, the device routes the calls from the TDM Gateway to the agents. The device routes the call to the first available user it finds. If the call is not answered by the user, the device routes it to the next available user. The SBC can handle a sequence of up to five users, after which the session is timed out and the call is dropped.

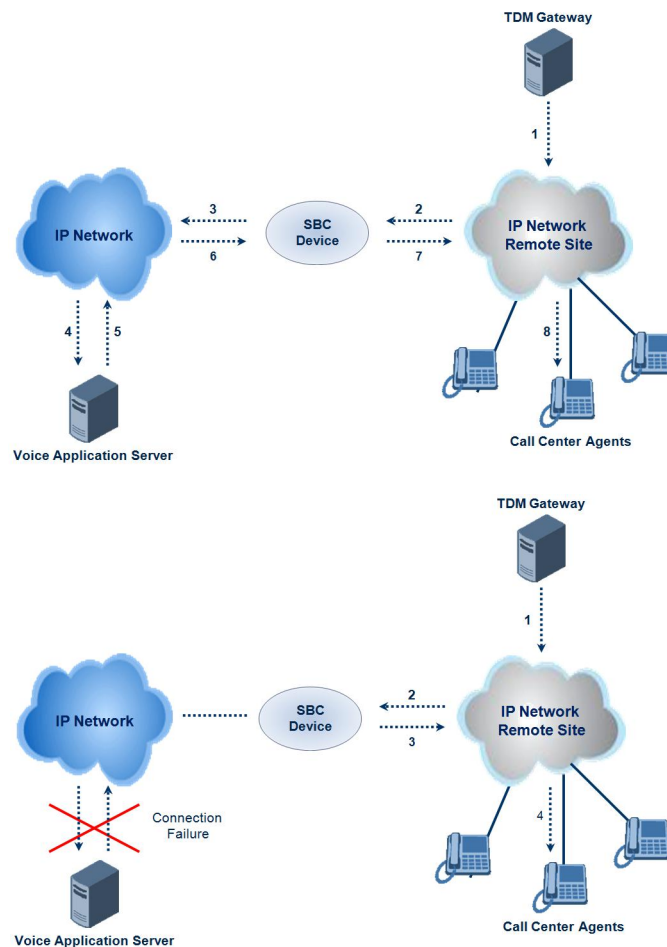

➤ **To configure call survivability for a call center application:**

1. In the IP Groups table (see [Configuring IP Groups](#)), add IP Groups for the following entities:
  - TDM Gateway (Server-type IP Group). This entity forwards the customer calls through the device to the Application server.
  - Application server (Server-type IP Group). This entity processes the call and sends the call through the device to the specific call center agent located on a different network (remote).
  - Call center agents (User-type IP Group). You can configure multiple IP Groups to represent different groups of call center agents, for example, agents and managers.
2. In the Classification table (see [Configuring Classification Rules](#)), add rules to classify incoming calls that are received from the entities listed in Step 1, to IP Groups.
3. In the SBC IP-to-IP Routing table (see [Configuring SBC IP-to-IP Routing Rules](#)), add the following IP-to-IP routing rules:
  - For normal operation:
    - ◆ Routing from TDM Gateway to Application server.
    - ◆ Routing from Application server to call center agents.
  - For call survivability mode: Routing from TDM Gateway to call center agents. This configuration is unique due to the following settings:
    - ◆ The 'Source IP Group' field is set to the IP Group of the TDM Gateway.
    - ◆ The 'Destination Type' field is set to **Hunt Group**, which is specifically used for call center survivability.
    - ◆ The 'Destination IP Group' field is set to the IP Group of the call center agents.

The figure below displays a routing rule example, assuming IP Group #1 represents the TDM Gateway and IP Group #3 represents the call center agents:

**IP-to-IP Routing**

**GENERAL**

Index: 3

Name: TDM GW > Call Center

Alternative Route Options: Route Row

**MATCH**

Source IP Group: #1 [TDM Gateway] View

Request Type: All

Source Username Prefix: \*

Source Host: \*

Source Tags:

Destination Username Prefix: \*

Destination Host: \*

**ACTION**

Destination Type: Hunt Group

Destination IP Group: #3 [Call Center] View

Destination SIP Interface: -- View

Destination Address:

Destination Port: 0

Destination Transport Type:

Call Setup Rules Set ID: -1

Group Policy: None

Cost Group: -- View

## Enabling Survivability Display on Aastra IP Phones

If the SBC device is deployed in a network with Aastra IP phones and connectivity with the WAN fails, the device provides call survivability by enabling communication between IP phone users within the LAN enterprise. In such a scenario, the device can be configured to notify the IP phones that it is currently operating in Survivability mode. When this occurs, the Aastra IP phones display the message, "Stand Alone Mode" on their LCD screens.

If you enable the feature and the device is in Survivability mode, it responds to SIP REGISTER messages from the IP phones with a SIP 200 OK containing the following XML body:

```
Content-Type: application/xml
<?xml version="1.0" encoding="utf-8"?>
<LMIDocument version="1.0">
<LocalModeStatus>
  <LocalModeActive>true</LocalModeActive>
  <LocalModeDisplay>StandAlone Mode</LocalModeDisplay>
</LocalModeStatus>
</LMIDocument>
```

### ➤ To enable survivability display on Aastra phones:

1. Load an ini file to the device that includes the following parameter setting:

```
SBCEnableSurvivabilityNotice = 1
```

## Alternative Routing on Detection of Failed SIP Response

The device can detect failure of a sent SIP response (e.g., TCP timeout, and UDP ICMP). In such a scenario, the device re-sends the response to an alternative destination. This support is in addition to alternative routing if the device detects failed SIP requests.

For example, assume the device sends a SIP 200 OK in response to a received INVITE request. If the device does not receive a SIP ACK in response to this, it sends a new 200 OK to the next alternative destination. This new destination can be the next given IP address resolved from a DNS from the Contact or Record-Route header in the request related to the response.

## Configuring Push Notification Service

The device supports the Push Notification Service per IETF draft "[Push Notification with the Session Initiation Protocol \(SIP\)](#)". This service is used to wake end-user equipment (typically, mobile platforms) and operating systems that have gone to "sleep" (to save resources such as battery life) so that they can receive traffic. Typically, each operating system uses a dedicated Push Notification Service. For example, Apple iOS devices use the Apple Push Notification service (APNs) while Android devices use the Firebase Cloud Messaging (FCM) service. Without using a Push Notification Service to wake SIP User Agents (UAs), UAs wouldn't be able to send binding-refresh SIP REGISTER requests, receive SIP requests (e.g., INVITE), or send periodic keep-alive messages for maintaining connectivity with SIP servers. The device communicates with third-party, HTTP-based Push Notification Servers over HTTP, using RESTful APIs for exchanging information (currently, only JSON format is supported).



The Push Notification Service feature is applicable only to the SBC application.

SIP users wanting to receive push notifications must specify the following parameters in the Contact header of the SIP REGISTER request that it sends to the device for registration:

- 'pn-provider': Specifies the type of Push Notification Service.
- 'pn-prid': Specifies the unique identifier (Push Resource ID / PRID) that the Push Notification Service uses to identify the user.
- 'pn-param': (Optional) Specifies additional implementation-specific data required by the Push Notification Service.

Below shows an example of a REGISTER message containing the Push Notification parameters (in bold):

```
REGISTER sip:alice@example.com SIP/2.0
Via: SIP/2.0/TCP alicemobile.example.com:5060;branch=z9hG4bKnashds7
Max-Forwards: 70
To: Alice <sip:alice@example.com>
From: Alice <sip:alice@example.com>;tag=456248
Call-ID: 843817637684230@998sdasdh09
```



```

CSeq: 1826 REGISTER
Contact: <sip:alice@alicemobile.example.com;
pn-provider=acme;
pn-param=acme-param;
pn-prid=ZTY4ZDJMzODE1NmUgKi0K>
Expires: 7200
Content-Length: 0

```

The device handles registrations from users requiring Push Notification Service, as follows:

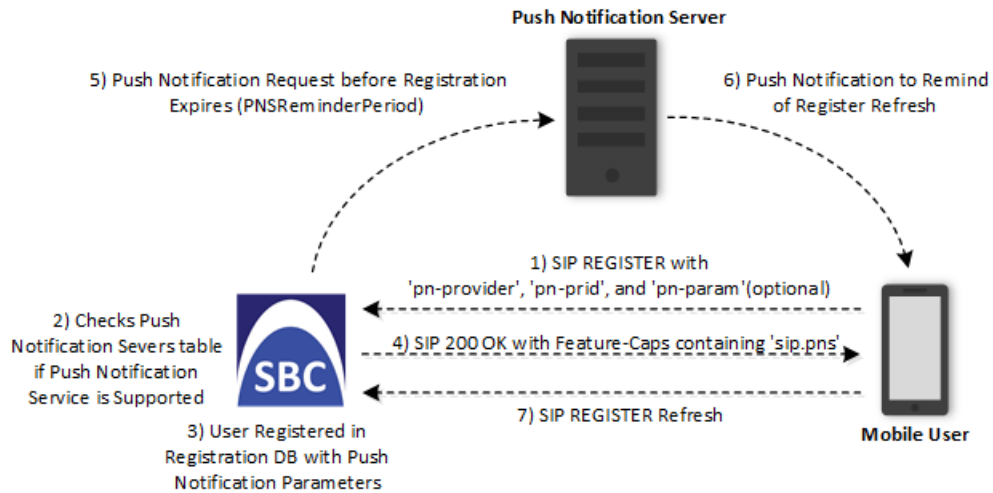

1. The user sends a REGISTER request to the device that contains the Push Notification parameters in the Contact header, as mentioned previously.
2. The device searches its Push Notification Servers table for a row whose 'Provider' parameter has the \* wildcard character value, or the same value as the 'pn-provider' parameter in the REGISTER request.
3. Regardless of the search, the device adds the user in its registration database with the Push Notification parameters (mentioned previously).
4. If a matching row in the Push Notification Servers table is located, the device sends a SIP 200 OK response containing the Feature-Caps header with the 'sip.pns=' feature-capability indicator, identifying the type of Push Notification Service as specified in the 'pn-provider' parameter (e.g., Feature-Caps: \*;+sip.pns="acme";+sip.pnsreg="121"). If no matching row in the table is located (i.e., Push Notification Service is not supported), the device sends a 200 OK response, but without the Feature-Caps header.
5. (6 and 7) At a user-defined time (using the [PNSReminderPeriod] parameter) before the user's registration expires, the device sends a push notification request containing the user's PRID to the Push Notification Server to trigger it into sending a push notification to the user to remind it to send a refresh REGISTER message to the device.

If the user sends the device a refresh REGISTER request without the Push Notification parameters, the device considers the user as no longer using Push Notification Service. In this

scenario, the device stops sending push notification requests to the Push Notification Server for the user.

Once a user is registered with the device, the device can route calls to it. The following figure shows how the device processes an incoming dialog-initiating SIP request (e.g., INVITE) whose destination is a mobile user that uses Push Notification Service:

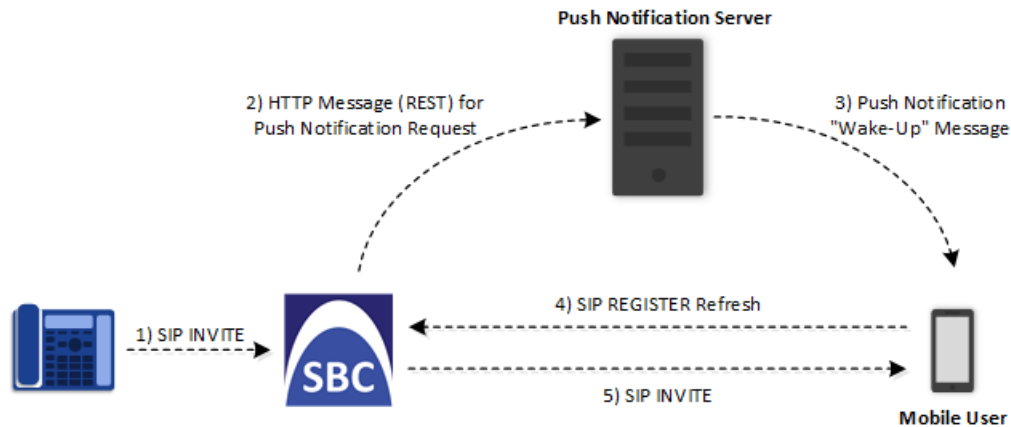

- The device receives an incoming call (SIP INVITE message) for the mobile user, which according to the device's registration database (i.e., user's registration includes Push Notification parameters), uses a Push Notification Service.
- The device sends a push notification request containing the user's PRID (over HTTP) to the Push Notification Server. The device uses the Push Notification Servers table to determine which Push Notification Server to send this push notification request. The device searches the table for a row that is configured with the value of the user's 'pn-provider' parameter (table's 'Provider' parameter) and if located, sends the push notification request to the address of the associated Remote Web Service.
- The Push Notification Server sends a push notification to the user to "wake" it up.
- The user sends a refresh SIP REGISTER message to the device, which indicates that the user is "awake" and ready to receive the call.
- The device sends the INVITE message to the user, using its regular routing logic.



- If the push notification request that is sent to the Push Notification Server fails, the device rejects the INVITE message with a SIP 480 response.
- If the device doesn't receive a refresh REGISTER message within a user-defined time (configured by the [PNSRegisterTimeout] parameter), the device rejects the INVITE with a SIP 480 response.
- When the device receives an incoming INVITE message for a user who is registered for push notification, but the corresponding row in the Push Notification Servers table has been deleted, the device immediately forwards the INVITE message to the user (as though the user had not requested push notification service).

➤ **To configure Push Notification Service:**

1. Configure a Remote Web Service (see [Configuring Remote Web Services](#) on page 299) to represent the HTTP-based Push Notification Server (address and other required parameters). You must configure the Remote Web Service with the 'Type' parameter set to **General**.
2. Configure the Push Notification service in the Push Notification Servers table (see [Configuring Push Notification Servers](#) on page 644). This table configures the Push Notification Service type, the Remote Web Service that you configured in Step 1, and the information-exchange protocol (currently, only JSON) used between the device and the server. Therefore, the device uses this table to determine which Push Notification Server to send push notification requests for a specific user. The device searches the table for a row that is configured with the value of the user's 'pn-provider' parameter (table's 'Provider' parameter) and if located, sends the push notification request to the Push Notification Server using the address of the associated Remote Web Service.
3. Configure the time (in seconds) before the user's registration on the device expires, when the device sends a push notification request (over HTTP) to the Push Notification Server to trigger it into sending a push notification to the user to remind it to send a refresh REGISTER message to the device. This is configured by the [PNSReminderPeriod] parameter or CLI command `configure voip > sbc settings > pns-reminder-period`.
4. Configure the time (in seconds) that the device must wait for a refresh REGISTER message from the user after the device sends a push notification request to the Push Notification Server for the user, when the device receives an incoming SIP dialog-initiating request (e.g., INVITE) that it must send to the user. This is configured by the [PNSRegisterTimeout] parameter or CLI command `configure voip > sbc settings > pns-register-timeout`.

## Limiting SBC Call Duration

You can configure the maximum allowed call duration (in minutes) per SBC call. If an established call reaches this user-defined limit, the device terminates the call. The feature ensures that calls are properly terminated, allowing available resources for new calls. The following procedure describes how to configure the feature for all calls (globally). To configure the feature per specific calls, use IP Profiles (IpProfile\_SBCMaxCallDuration).

➤ **To configure maximum call duration:**

1. Open the SBC General Settings page (**Setup** menu > **Signaling & Media** tab > **SBC** folder > **SBC General Settings**).
2. In the 'Max Call Duration' field (SBCMaxCallDuration), enter the maximum call duration per SBC call:

Max Call Duration [min]

3. Click **Apply**.

# Part VII

## Cloud Resilience Package

## 38 CRP Overview

The device's Cloud Resilience Package (CRP) application enhances cloud-based or hosted communications environments by ensuring survivability, high voice quality and security at enterprise branch offices and cloud service customer premises. CRP is designed to be deployed at customer sites and branches of:

- Cloud-based and hosted communications
- Cloud-based or hosted contact-center services
- Distributed PBX or unified communications deployments

The CRP application is based on the functionality of the SBC application, providing branch offices with call routing and survivability support. CRP is implemented in a network topology where the device is located at the branch office, routing calls between the branch users, and/or between the branch users and other users located elsewhere (at headquarters or other branch offices), through a hosted server (IP PBX) located at the Enterprise's headquarters. The device maintains call continuity even if a failure occurs in communication with the hosted IP PBX. It does this by using its Call Survivability feature, enabling the branch users to call one another or make external calls through the device's PSTN gateway interface (if configured).



- The CRP application is available only if the device is installed with a License Key that includes this feature. For installing a License Key, see [License Key](#).
- For the maximum number of supported CRP sessions and CRP users than can be registered in the device's registration database, see [Technical Specifications](#).

For cloud providers, CRP ensures uninterrupted communications in the event of lost connection with the cloud providers' control systems. For distributed enterprises and contact centers, CRP is an essential solution for enterprises deploying geographically distributed communications solutions or distributed call centers with many branch offices. CRP ensures the delivery of internal and external calls even when the connection with the centralized control servers is lost.

**Table 38-1: Key Features**

Survivability	Quality of Experience/Service	Security
<ul style="list-style-type: none"> <li>■ PSTN fallback</li> <li>■ WAN redundancy</li> <li>■ Local mode</li> <li>■ High availability</li> <li>■ Emergency calling (E911)</li> <li>■ Basic call routing between registering users</li> </ul>	<ul style="list-style-type: none"> <li>■ QoE monitoring</li> <li>■ Call Admission Control</li> <li>■ SLA fulfillment</li> <li>■ SIP mediation</li> </ul>	<ul style="list-style-type: none"> <li>■ Layer 3 to 7 protection</li> <li>■ Media encryption</li> <li>■ Call control</li> </ul>

Survivability	Quality of Experience/Service	Security
<p>and device, or any other route to responding server</p> <ul style="list-style-type: none"> <li>■ Short number dialog (short numbers are learned dynamically in the registration process)</li> <li>■ Survivability indication to IP phone</li> <li>■ Call hold and retrieve</li> <li>■ Call transfer (if IP phone initiates REFER)</li> <li>■ Basic Shared Line Appearance (excluding correct busy line indications)</li> <li>■ Call waiting (if supported by IP phone)</li> </ul>	<ul style="list-style-type: none"> <li>■ Media transcoding</li> <li>■ Test call agent</li> </ul>	<p>encryption</p> <ul style="list-style-type: none"> <li>■ NAT traversal</li> <li>■ Topology hiding</li> </ul>

One of the main advantages of CRP is that it enables quick-and-easy configuration. This is accomplished by its pre-configured routing entities, whereby only minimal configuration is required. For example, defining IP addresses to get the device up and running and deployed in the network.

## 39 CRP Configuration

This section describes configuration specific to the CRP application.

As CRP has similar functionality to the SBC application, for configuration that is common to the SBC, which is not covered in this section, see the following SBC sections:

- [Configuring Admission Control](#)
- [Configuring Allowed Audio Coder Groups](#)
- [Configuring Classification Rules](#)
- [Configuring Message Condition Rules](#)
- [Configuring SBC IP-to-IP Routing Rules](#)
- [Configuring SIP Response Codes for Alternative Routing Reasons](#)
- [Configuring IP-to-IP Inbound Manipulations](#)
- [Configuring IP-to-IP Outbound Manipulations](#)



- The main difference in the common configuration between the CRP and SBC applications is the navigation menu paths to opening these Web configuration pages. Wherever "SBC" appears in the menu path, for the CRP application it appears as "CRP".
- If you installed a License Key with the CRP feature and you later want to stop (disable) working with CRP, you need to purchase (from your AudioCodes sales representative) a new License Key without CRP and install it, and then delete all CRP-related configuration (described in this section) or reset the device to factory default settings.

### Configuring Call Survivability Mode

The CRP can be configured to operate in one of the following call survivability modes:

- **Normal (Default):** The CRP interworks between the branch users and the IP PBX located at headquarters. The CRP forwards all requests (such as for registration) from the branch users to the IP PBX, and routes the calls based on the IP-to-IP routing rules. If communication with the IP PBX fails (i.e., Emergency mode), it still allows calls between the branch users themselves. If this fails, it routes the calls to the PSTN (if employed).



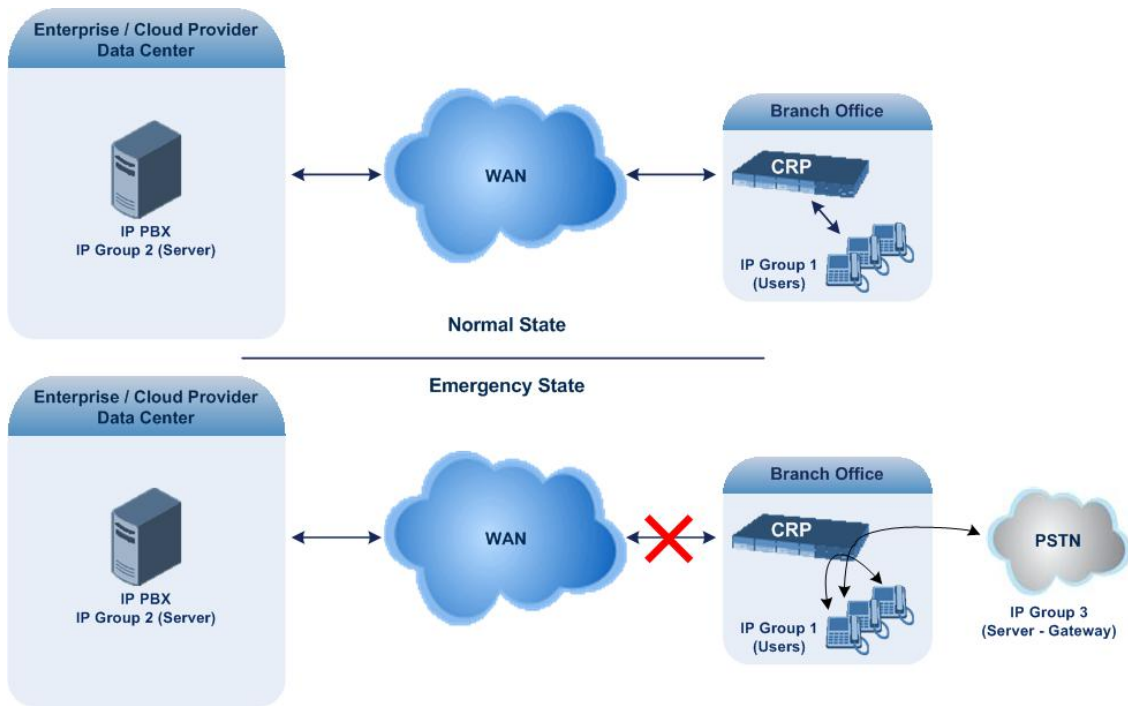

- **Auto Answer to Registrations:** This mode is the same as the Normal mode, except that the CRP registers the branch users in its registration database instead of forwarding them to the IP PBX.



SIP REGISTER and OPTIONS requests are terminated at the CRP.

- **Always Emergency:** The CRP routes the calls between the branch users themselves as if connectivity failure has occurred with the IP PBX. The CRP also registers the branch users in its registration database.

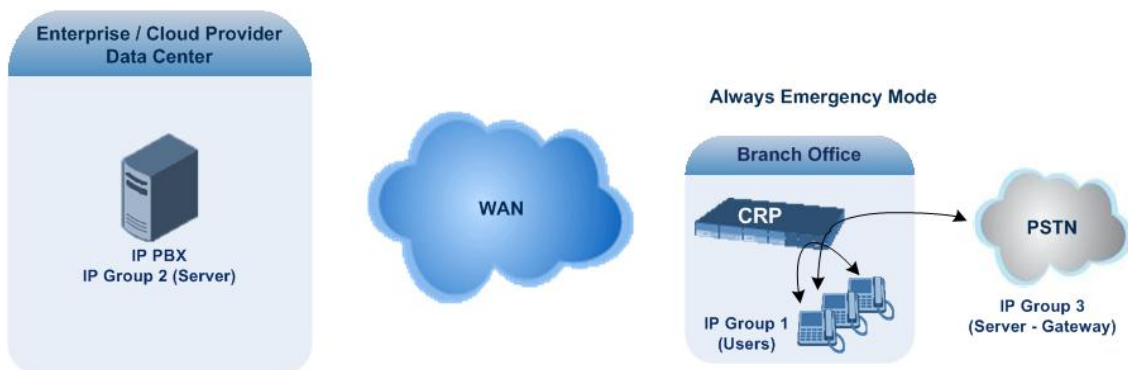

➤ **To configure the Call Survivability mode:**

1. Open the SBC General Settings page (**Setup** menu > **Signaling & Media** tab > **SBC** folder > **SBC General Settings**).
2. From the 'CRP Survivability Mode' drop-down list, select the required mode.
3. Click **Apply**.

## Pre-Configured IP Groups

For CRP, the device is pre-configured with the following IP Groups in the IP Groups table:

**Table 39-1: Pre-configured IP Groups in the IP Groups Table**

Index	Name	Type	Description
1	"CRP Users"	User	LAN users (e.g., IP phones) at the branch office
2	"CRP Proxy"	Server	Server (e.g., hosted IP PBX at the Enterprise's headquarters)
3	"CRP Gateway"	Server	Device's interface with the PSTN

These IP Groups are used in the IP-to-IP routing rules to indicate the source and destination of the call (see [Pre-Configured IP-to-IP Routing Rules](#)).



- These IP Groups cannot be deleted and additional IP Groups cannot be configured. The IP Groups can be edited, except for the fields listed above, which are read-only.
- For accessing the IP Groups table and for a description of its parameters, see [Configuring IP Groups](#).

## Pre-Configured IP-to-IP Routing Rules

For the CRP application, the IP-to-IP Routing table is pre-configured with IP-to-IP routing rules. These rules depend on the configured Call Survivability mode, as described in [Configuring Call Survivability Mode](#).



- The IP-to-IP Routing table is read-only.
- For accessing the IP-to-IP Routing table and for a description of its parameters, see [Configuring SBC IP-to-IP Routing Rules](#).

### Normal Mode

The pre-configured IP-to-IP routing rules for the Normal CRP call survivability mode are shown in the table below:

**Table 39-2: Pre-Configured IP-to-IP Routing Rules for CRP Normal Mode**

Index	Source IP Group / Emergency	Request Type	Destination Type	Destination IP Group	Destination Address	Alternative Route Options
1	Any	OPTIONS	Dest Address	-	Internal	Route Row
3	#1 [CRP Users]	All	IP Group	#2 [CRP Proxy]	-	Route Row
4	#1 [CRP Users]	All	IP Group	#1 [CRP Users]	-	Alternative Route Ignore Inputs
5	#1 [CRP Users]	All	IP Group	#3 [CRP Gateway]	-	Alternative Route Ignore Inputs
6	#2 [CRP Proxy]	All	IP Group	#1 [CRP Users]	-	Route Row
7*	#2 [CRP Proxy]	All	IP Group	#3 [CRP Gateway]	-	Route Row
8	#3 [CRP Gateway]	All	IP Group	#2 [CRP Proxy]	-	Route Row
9	#3 [CRP Gateway]	All	IP Group	#1 [CRP Users]	-	Alternative Route Ignore Inputs



The routing rule at Index 7 appears only if the CRPGatewayFallback parameter is enabled (see [Configuring PSTN Fallback](#)). This routing rule is used if the device can't find a matching destination user for IP Group 1 (User-type IP Group) in its registration database. If the CRPGatewayFallback parameter is disabled and no matching user is found, the device rejects the call.

## Emergency Mode

The pre-configured IP-to-IP routing rules for the Emergency CRP call survivability mode are shown in the table below:

**Table 39-3: Pre-Configured IP-to-IP Routing Rules for Emergency Mode**

Mode	Index	Source IP Group / Emergency	Request Type	Destination Type	Destination IP Group ID	Destination Address	Alternative Route Options
Always Emergency	1	Any	OPTIONS	Dest Address	-	Internal	Route Row
	4	#1 [CRP Users]	All	IP Group	#1 [CRP Users]		Route Row
	5	#1 [CRP Users]	All	IP Group	#3 [CRP Gateway]		Route Row
	9	#3 [CRP Gateway]	All	IP Group	#1 [CRP Users]		Route Row



The routing rule at Index 5 appears only if the CRPGatewayFallback parameter is enabled (1).

## Auto Answer to Registrations

The pre-configured IP-to-IP routing rules for the Auto Answer to Registrations CRP call survivability mode are shown in the table below:

**Table 39-4: Pre-Configured IP-to-IP Routing Rule for Auto Answer to Registrations Mode**

Mode	Index	Source IP Group	Request Type	Destination Type	Destination IP Group	Destination Address	Alternative Route Options
Auto Answer to Registrations	1	Any	OPTIONS	Dest Address	-	Internal	Route Row

Mode	Index	Source IP Group	Request Type	Destination Type	Destination IP Group	Destination Address	Alternative Route Options
	2	Any	REGISTER	IP Group	Any	-	Route Row
	3	#1 [CRP Users]	All	IP Group	#2 [CRP Proxy]	-	Route Row
	4	#1 [CRP Users]	All	IP Group	#1 [CRP Users]	-	Alternative Route Ignore Inputs
	5	#1 [CRP Users]	All	IP Group	#3 [CRP Gateway]	-	Alternative Route Ignore Inputs
	6	#2 [CRP Proxy]	All	IP Group	#1 [CRP Users]	-	Route Row
	7*	#2 [CRP Proxy]	All	IP Group	#3 [CRP Gateway]	-	Route Row
	8	#3 [CRP Gateway]	All	IP Group	#2 [CRP Proxy]	-	Route Row
	9	#3 [CRP Gateway]	All	IP Group	#1 [CRP Users]	-	Alternative Route Ignore Inputs



- The destination for the routing rule at Index 2 is the source IP Group (i.e., from where the REGISTER message is received).
- Routing rule at Index 7 appears only if the CRPGatewayFallback parameter is enabled (see [Configuring PSTN Fallback](#)).

## Configuring PSTN Fallback

You can enable the CRP to route emergency calls (or PSTN-intended calls) such as "911" from the Proxy server (IP Group #2 "CRP Proxy") to the PSTN (IP Group #3 "CRP Gateway"). In

addition, for calls from the Proxy server to Users (IP Group #1 "CRP Users"), the device searches for a matching user in its Users Registration database and if not located, it sends the call to the PSTN (IP Group #3 "CRP Gateway") as an alternative route.

➤ **To enable CRP Gateway fallback:**

1. Open the SBC General Settings page (**Setup** menu > **Signaling & Media** tab > **SBC** folder > **SBC General Settings**).
2. From the 'CRP Gateway Fallback' drop-down list, select **Enable**.
3. Click **Apply**; the alternative routing rule is added to row index #7 ("CRP Proxy" to "CRP Gateway" routing) in the IP-to-IP Routing table.



- Enabling this feature (this routing rule) may expose the device to a security "hole", allowing calls from the WAN to be routed to the Gateway. Thus, configure this feature with caution and only if necessary.
- This PSTN routing rule is not an alternative routing rule. In other words, if a match for a user is located in the database, this PSTN rule will never be used regardless of the state of the user endpoint (e.g., busy).

# Part VIII

## Maintenance

## 40 Basic Maintenance

This section describes basic maintenance.

### Resetting the Device

You can reset the device through the device's management tools. Device reset may be required for maintenance purposes. Certain parameters require a device reset for their settings to take effect. These parameters are displayed in the Web interface with the lightning ⚡ symbol. In addition, whenever you make any configuration change that requires a reset, the **Reset** button on the Web interface's toolbar is displayed with a red border, as shown below:

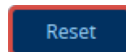

The Web interface also provides you with the following options when resetting the device:

- Save current configuration to the device's flash memory (non-volatile) prior to reset
- Reset the device only after a user-defined time (*Graceful Reset*) to allow current calls to end (calls are terminated after this interval)

To reset the device (and save configuration to flash) through CLI, use the following command:

```
# reset now
```

#### ➤ To reset the device through Web interface:

1. Open the Maintenance Actions page:
  - Toolbar: Click the **Reset** button.
  - Navigation tree: **Setup** menu > **Administration** tab > **Maintenance** folder > **Maintenance Actions**.

RESET DEVICE	
Reset Device	<b>RESET</b>
Save To Flash	Yes <input type="button" value="v"/>
Graceful Reset	Yes <input type="button" value="v"/>
Graceful Timeout [sec]	0

2. From the 'Save To Flash' drop-down list, select one of the following:
  - **Yes:** Current configuration is saved (*burned*) to flash memory prior to reset (default).
  - **No:** The device resets without saving the current configuration to flash. All configuration done after the last configuration save will be discarded (lost) after reset.



3. From the 'Graceful Reset' drop-down list, select one of the following:
  - **Yes:** The device reset only after a user-defined time, configured in the 'Graceful Timeout' field (see next step). During this interval, no new traffic is accepted. If no traffic exists and the time has not yet expired, the device resets immediately.
  - **No:** The device resets immediately, regardless of traffic. Any existing traffic is immediately terminated.
4. In the 'Graceful Timeout' field (available only if you have configured the 'Graceful Reset' field to **Yes**), enter the time (in seconds) after which the device resets. Note that if no traffic exists and the time has not yet expired, the device resets.
5. Click the **Reset** button; a confirmation message box appears, requesting you to confirm.
6. Click **OK** to confirm device reset; if you configured the 'Graceful Reset' field to **Yes** (in Step 3), the reset is delayed and a screen appears displaying the number of remaining calls and time. When the device begins to reset, a message appears to notify you.

## Remotely Resetting Device using SIP NOTIFY

The device can be remotely reset upon the receipt of a SIP NOTIFY message that contains an Event header set to 'check-sync;reboot=true' (proprietary to AudioCodes), as shown in the example below:

```
NOTIFY sip:<user>@<dsthost> SIP/2.0
To: sip:<user>@<dsthost>
From: sip:sipsak@<srchost>
CSeq: 10 NOTIFY
Call-ID: 1234@<srchost>
Event: check-sync;reboot=true
```

### ➤ To enable remote reset upon receipt of SIP NOTIFY:

1. Open the SIP Definitions General Settings page (**Setup** menu > **Signaling & Media** tab > **SIP Definitions** folder > **SIP Definitions General Settings**).
2. From the 'Remote Management by SIP Notify' (EnableSIPRemoteReset) drop-down list, select **Enable**:

Remote Management by SIP Notify      •  ▼

3. Click **Apply**.

## Locking and Unlocking the Device

You can lock the device so that it stops processing calls. This may be useful, for example, when you want to upload new software files to the device and you don't want any traffic to interfere with the process. Locking the device may be done gracefully, whereby the device stops

accepting new calls, but allows existing calls to continue for up to a user-defined duration before terminating them.

➤ **To lock the device:**

1. Open the Maintenance Actions page:
  - Toolbar: Click the **Reset** button.
  - Navigation tree: **Setup** menu > **Administration** tab > **Maintenance** folder > **Maintenance Actions**.

LOCK / UNLOCK	
Lock	<input type="button" value="LOCK"/>
Graceful Option	<input type="text" value="Yes"/>
Disconnect Client Connections	<input checked="" type="radio"/> <input type="text" value="Enable"/>
Lock Timeout [sec]	<input type="text" value="180"/>
Gateway Operational State	UNLOCKED

2. From the 'Graceful Option' drop-down list, select one of the following options:
  - **Yes:** The device locks only after a user-defined duration, configured in the 'Lock Timeout' field (see next step). During this interval, no new traffic is accepted, allowing only existing calls to continue until the timeout expires. If at any time during this timeout there are no active calls, the device locks. If there are still active calls when the timeout expires, the device terminates them and locks.
  - **No:** The device locks immediately, terminating all existing traffic.

**Note:** These options are available only if the current status of the device is in "UNLOCKED" state.
3. If you configured 'Graceful Option' to **Yes** (see previous step), then in the 'Lock Timeout' field, enter the time (in seconds) after which the device locks.
4. If you also want the device to terminate (close) existing TLS/TCP client connections and reject new incoming TLS/TCP client connections during the locked state, then from the 'Disconnect Client Connections' drop-down list, select **Enable**. If disabled (default), existing client connections will remain and incoming TLS/TCP client connections will be accepted during the locked state.
5. Click the **LOCK** button; a confirmation message box appears requesting you to confirm device lock.
6. Click **OK** to confirm;

- If you configured 'Graceful Option' to **Yes**, a lock icon is displayed and a window appears displaying the number of remaining calls and time. To cancel the lock, click the **Cancel Graceful Lock** button.

#### Graceful reset initiated.

**Device will be reset when all active calls are terminated, or when shutdown timer expires.**

Remaining Active Calls  Remaining Time [sec]

Click button to cancel the Graceful Lock

- If you configured 'Graceful Option' to **No**, the lock process begins immediately.

The 'Gateway Operational State' read-only field displays "LOCKED" and the device does not process any calls.

#### ➤ To unlock the device:

- Click the **UNLOCK** button; the device unlocks immediately and accepts new incoming calls. The 'Gateway Operational State' read-only field displays "UNLOCKED".

## Saving Configuration

When you configure parameters and tables in the Web interface and then click the **Apply** button on the pages in which the configurations are done, changes are saved to the device's *volatile* memory (RAM). These changes revert to their previous settings if the device subsequently resets (hardware or software) or powers down. Therefore, to ensure that your configuration changes are retained, you must save them to the device's non-volatile memory (i.e., flash memory).

To save your settings to flash, click the **Save** button located on the toolbar. To remind you to save your settings to flash, the **Save** button is displayed with a red border, as shown below:

To save configuration to flash through CLI, use the following command:

```
# write
```



Saving configuration to flash may disrupt current traffic on the device. To avoid this, disable all new traffic before saving, by performing a graceful lock (see [Locking and Unlocking the Device](#)).

## 41 Replacing Modules

To replace the device's modules, you must use the Web interface in combination with physical removal and insertion of the modules. Therefore, when you replace a module, you first need to 'software-remove' it, extract it physically from the chassis, insert a new module, and then 'software-insert' it using the Web interface.



- You must replace a module with the same type of module and in the same module slot number. For example, a module with two digital spans in Slot 1 must be replaced with a module with two digital spans in Slot 1.
- When the device is housed with only one module, removal of the module causes a device reset.
- Before inserting a module into a previously empty slot, you must power down the device.

### ➤ To replace a module:

#### 1. Remove the module:

- Open the Monitor home page (**Monitor** menu > ).
- Click the title of the module that you want to replace; the **Remove Module** button appears:

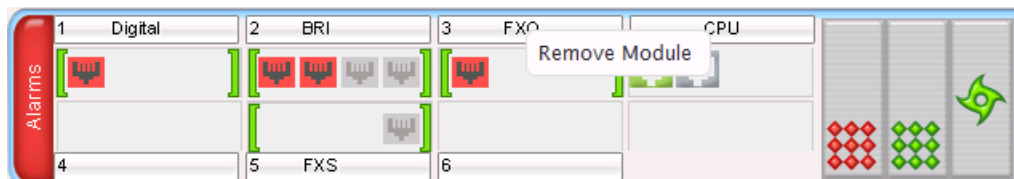

- Click the **Remove Module** button; a message box appears requesting you to confirm module removal.
- Click **OK**; after a few seconds, the module is software-removed, the module's port status icons turn gray and the name of the module is suffixed with the word "Reserved":

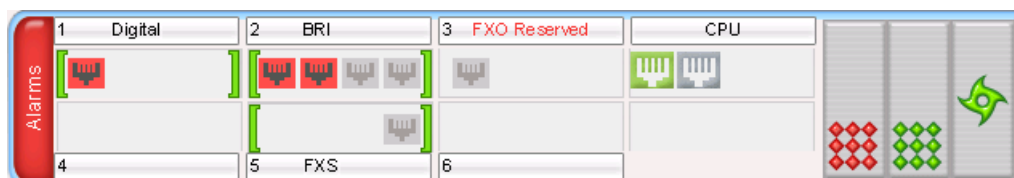

- Physically remove the module from the chassis.
- #### 2. Insert the new module:
- Physically insert the new module into the same chassis slot in which the previous module was housed (refer to the *Hardware Installation Manual*).

- b. On the Monitor home page, click the title of the module ("**<module type> Reserved**") that you are replacing; the **Insert Module** button appears:

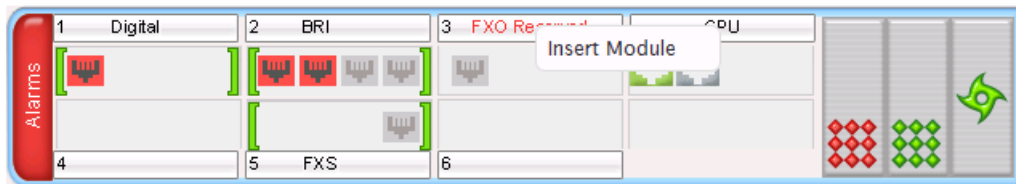

- c. Click the **Insert Module** button; a message appears informing you that this may take a few seconds. When the message disappears, the module is inserted, indicated by the disappearance of the word 'Reserved' from the module's name.

## 42 Channel Maintenance

This chapter describes channel-related maintenance.

### Resetting an Analog Channel

You can reset an analog (FXO or FXS) channel by disconnecting the current call (if exists). This is sometimes useful, for example, when the device (FXO) is connected to a PBX and communication between the two cannot be disconnected (e.g., when using reverse polarity).

➤ **To reset an analog channel through the Web interface:**

1. Open the Monitor home page (**Monitor** menu > ).
2. Click the required **FXS** or **FXO** port icon; a shortcut menu appears.

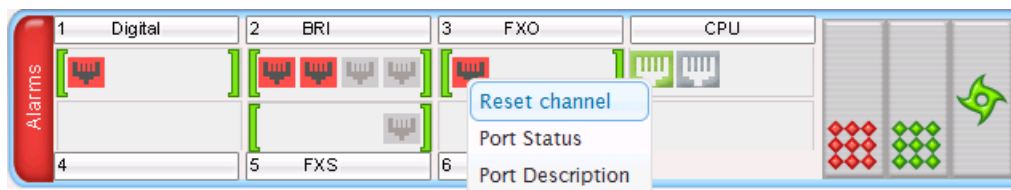

3. From the shortcut menu, choose **Reset Channel**; a message appears informing you when the channel has reset.
4. Click the required port icon.
5. Click the **Reset Port** button; a message appears informing you that the port has successfully reset.

### Restarting a B-Channel

You can restart a specific B-channel belonging to an ISDN or CAS trunk, using the SNMP MIB variable, `acTrunkISDNCommonRestartBChannel`. This may be useful, for example, for troubleshooting specific voice channels.



- If a voice call is currently in progress on the B-channel, it is disconnected when the B-channel is restarted.
- B-channel restart can only be done if the D-channel of the trunk to which it belongs is synchronized (Layer 2).
- B-channel restart does not affect the B-channel's configuration.

### Locking and Unlocking Trunk Groups

You can lock a Trunk Group to take its trunks (and their channels) out of service. When you initiate a lock, the device rejects all new incoming calls for the Trunk Group and immediately

terminates active calls (busy channels), eventually taking the entire Trunk Group out of service.

For digital interfaces: You can lock a Trunk Group “gracefully”, whereby the device rejects new incoming calls, but terminates busy channels only after a user-defined graceful period if they are still busy by the end of the period. When configured to 0, graceful lock is disabled.

For analog interfaces: For Tel-to-IP calls, the device plays a fast busy tone when the phone is off-hooked on the Tel side. For IP-to-Tel calls, the device rejects the incoming INVITE message.

When you lock a Trunk Group, the method for taking channels out-of-service is determined by the following parameters:

- Digital interfaces: DigitalOOSBehaviorForTrunk parameter per trunk or DigitalOOSBehavior parameter for all trunks.
- FXS interfaces: FXSOOSBehavior parameter

If you have configured registration for the Trunk Group (see the 'Registration Mode' parameter in the Trunk Group Settings table) and you subsequently lock the Trunk Group, it stops performing registration requests (un-registers) with the Serving IP Group with which you have configured it to register. When you unlock such a Trunk Group, it starts performing registration requests (re-registers) with the Serving IP Group once its trunks return to service.

#### ➤ To lock or unlock a Trunk Group:

1. (Digital Interfaces Only) Configure a graceful lock:
  - a. Open the Gateway Advanced Settings page (Setup menu > Signaling & Media tab > Gateway folder > Gateway Advanced Settings).
  - b. In the 'Graceful Busy Out Timeout' (GracefulBusyOutTimeout) field, enter the period after which the Trunk Group is locked:

Graceful Busy Out Timeout [sec]

- c. Click **Apply**.
2. Lock the Trunk Group:
  - a. Open the Trunk Group Settings table (see [Configuring Trunk Group Settings](#)).
  - b. Select the row of the Trunk Group that you want to lock or unlock.
  - c. Click the **Action** button located on the table's toolbar, and then from the drop-down list, choose one of the following:
    - ◆ **Lock:** Locks the Trunk Group.
    - ◆ **Un-Lock:** Unlocks a locked Trunk Group.

The Trunk Group Settings table provides the following read-only fields related to locking and unlocking of a Trunk Group:

- 'Admin State': Displays the administrators state - "Locked" or "Unlocked"

- 'Status': Displays the current status of the channels in the Trunk Group:
  - "In Service": Indicates that all channels in the Trunk Group are in service, for example, when the Trunk Group is unlocked or Busy Out state cleared (see the EnableBusyOut parameter for more information).
  - "Going Out Of Service": Appears as soon as you choose the **Lock** button and indicates that the device is starting to lock the Trunk Group and take channels out of service.
  - "Going Out Of Service (<duration remaining of graceful period> sec / <number of calls still active> calls)": Appears when the device is locking the Trunk Group and indicates the number of busy channels and the time remaining until the graceful period ends, after which the device locks the channels regardless of whether the call has ended or not.
  - "Out Of Service": All fully configured trunks in the Trunk Group are out of service, for example, when the Trunk Group is locked or in Busy Out state (see the EnableBusyOut parameter).



- If the device is reset, a locked Trunk Group remains locked. If the device is reset while graceful lock is in progress, the Trunk Group is forced to lock immediately after the device finishes its reset.

## Disconnecting Active Calls

You can forcibly disconnect all active calls, or disconnect specific calls based on Session ID.

### ➤ To disconnect calls through CLI:

- Disconnect all active calls:

```
# clear voip calls
```

- Disconnect active calls belonging to a specified Session ID:

```
# clear voip calls <Session ID>
```

## Remotely Disconnecting Calls using SIP NOTIFY

The device can be triggered to disconnect all current calls upon the receipt of a SIP NOTIFY message containing an Event header with the value 'soft-sync' (proprietary to AudioCodes), as shown in the example below:

```
NOTIFY sip:<user>@<dsthost> SIP/2.0  
To: sip:<user>@<dsthost>  
From: sip:sipsak@<srchost>
```



```
CSeq: 10 NOTIFY
Call-ID: 1234@<srchost>
Event: soft-sync
```

➤ **To enable remote call disconnect upon receipt of SIP NOTIFY:**

1. Open the SIP Definitions General Settings page (**Setup** menu > **Signaling & Media** tab > **SIP Definitions** folder > **SIP Definitions General Settings**).
2. From the 'Remote Management by SIP Notify' (EnableSIPRemoteReset) drop-down list, select **Enable**:

Remote Management by SIP Notify    • Enable

3. Click **Apply**.

## Configuring Names for Telephony Ports

You can configure an arbitrary name or a brief description for each telephony port displayed on the Home page. This description is displayed as a tooltip when you hover your mouse over the port.



Only alphanumerical characters can be used in the port description.

➤ **To add a port description:**

1. Open the Monitor home page (see [Viewing Device Status on Monitor Page](#)).
2. Click the required port icon; a shortcut menu appears.

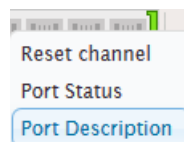

3. From the shortcut menu, choose **Port Description**; the following dialog box appears:

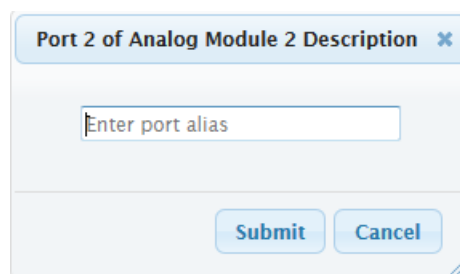

4. Type a brief description for the port, and then click **Submit**.

## 43 Upgrading the Device's Software

You can use the Web interface's Software Upgrade Wizard to easily upgrade the device's software version (.cmp file). You can also use the wizard to load an *ini* file and Auxiliary files (e.g., CPT file). However, you can only use the wizard if you at least load a .cmp file. Once loaded, you can select other file types to load.



- You can obtain the latest software version files from AudioCodes website (registered users only) at <https://www.audiocodes.com/library/firmware>.
- When you start the wizard, the rest of the Web interface is unavailable. After the files are successfully installed with a device reset, access to the full Web interface is restored.
- If you upgraded your firmware (.cmp file) and the "SW version mismatch" message appears in the Syslog or Web interface, your License Key does not support the new .cmp file version. If this occurs, contact AudioCodes support team for assistance.
- Instead of manually upgrading the device, you can use the device's Automatic Update feature for automatic provisioning (see [Automatic Provisioning](#)).

The following procedure describes how to load files using the Web interface's Software Upgrade Wizard.

Alternatively, you can load files using the CLI:

- cmp file:

```
copy firmware from <URL>
```

- ini or Auxiliary file:

```
copy <ini file or auxiliary file> from <URL>
```

- CLI Script file:

```
copy cli-script from <URL>
```

If you load the firmware file through CLI, when you initiate the copy command a message is displayed in the console showing the load progress. If other management users are connected to the device through CLI, the message also appears in their CLI sessions, preventing them from performing further actions on the device and disrupting the upload process. For more information, refer to the CLI Reference Guide.

### ➤ To upgrade the device using the Software Upgrade wizard:

1. Make sure that you have installed a License Key that is compatible with the software version to be installed (see [License Key](#)).

- It is recommended to enable the Graceful Lock feature (see [Locking and Unlocking the Device](#)). The wizard resets the device at the end of the upgrade process, thereby causing current calls to be untimely terminated. To minimize traffic disruption, the Graceful Lock feature prevents the establishment of new calls.
- It is recommended to backup the device's configuration to your computer. If an upgrade failure occurs, you can restore your configuration by uploading the backup file to the device. For more information, see [Configuration File](#).
- Open the Software Upgrade wizard:
  - Toolbar:** From the **Actions** drop-down menu, choose **Software Upgrade**.
  - Navigation tree:** **Setup** menu > **Administration** tab > **Maintenance** folder > **Software Upgrade**.

Software Upgrade

Start Software Upgrade

- Click **Start Software Upgrade**; the wizard starts, prompting you to load a .cmp file:

Load a **CMP** file from your computer to the device.

No file selected.

**Warning:** Once you load the CMP file, you must complete the upgrade process.



- At this stage, you can quit the Software Upgrade wizard without having to reset the device, by clicking **Cancel**. However, if you continue with the wizard and start loading the .cmp file, the upgrade process must be completed with a device reset.

- Click **Browse**, and then navigate to and select the .cmp file.
- Click **Load File**; the device begins to install the .cmp file and a progress bar displays the status of the loading process:

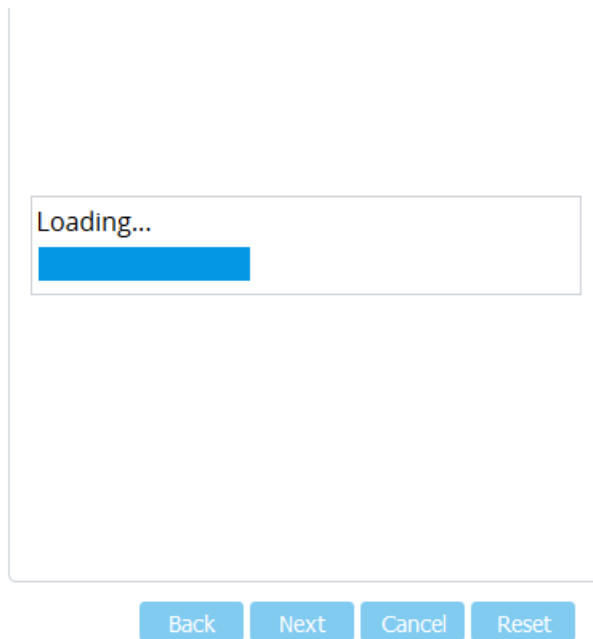

When the file is loaded, a message is displayed to inform you that the file was successfully loaded.

8. To load additional files, use the **Next** and **Back** buttons to navigate through the wizard to the desired file-load wizard page; otherwise, skip to the next step to load the .cmp file only.

The wizard page for loading an *ini* file lets you do one of the following:

- **Load a new ini file:**
  - i. Click **Browse**, and then navigate to and select the new ini file.
  - ii. Click **Load File**; the device loads the *ini* file.
- **Restore configuration to factory defaults:** Clear the 'Use existing configuration' check box.
- **Retain the existing configuration (default):** Select the 'Use existing configuration' check box.

Load an *ini* file from your computer to the device.

No file selected.

Use existing configuration

Warning: 1. If you choose to load an ini file, parameters that are omitted from the file, revert to default settings. Therefore, make sure that the ini file contains all required configuration (e.g. IP networking parameters).  
2. The device restores to factory default settings if you clear the Use Existing Configuration check box and don't select a file to load.



If you use the wizard to load an *ini* file, parameters excluded from the *ini* file are assigned default values (according to the .cmp file) and thereby, overwrite values previously configured for these parameters.

9. Click **Reset**; a progress bar is displayed, indicating the progress of saving the files to flash and device reset.

Burn and reset in progress...



Device reset may take a few minutes (even up to 30 minutes), depending on .cmp file version.

After the device finishes the installation process and resets, the wizard displays the End Process page, showing the installed .cmp software version and any other files that you may have also installed. For example:

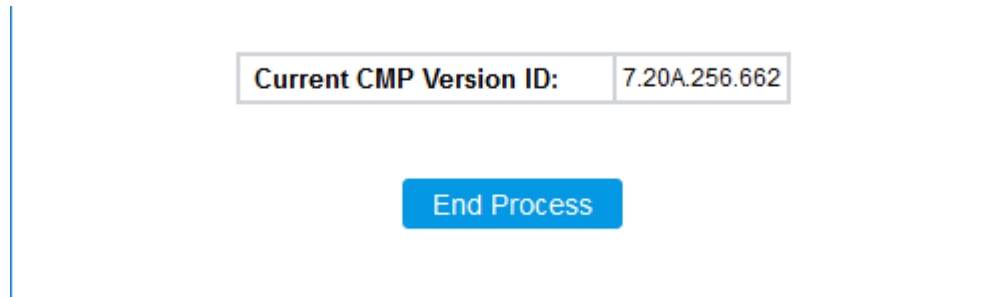

10. Click **End Process** ; the Web Login screen appears, prompting you to log into the device.
11. Log in with your username and password; a message box appears informing you that the device's software has been upgraded (new .cmp file).
12. Click **OK** to close the message box.

## 44 Loading Auxiliary Files

You can load Auxiliary files to the device using any of the following methods:

- Web interface - see [Loading Auxiliary Files through Web Interface](#)
- CLI - see [Loading Auxiliary Files through CLI](#)
- One Voice Operations Center (OVOC) – refer to the *OVOC User's Manual*



- You can also automatically load Auxiliary files from a remote server, using the device's Automatic Update mechanism (see [Automatic Update Mechanism](#)).
- Saving Auxiliary files to flash memory may disrupt current traffic on the device. To avoid this, stop all traffic on the device by performing a graceful lock (see [Locking and Unlocking the Device](#)).

The following table lists the different types of Auxiliary files.

**Table 44-1: Auxiliary Files**

File	Description
INI	Configures the device. The Web interface enables practically full device provisioning. However, some features may only be configured by ini file or you may wish to configure your device through ini file. For more information, see <a href="#">INI File-Based Management</a> .
CAS	Contains CAS Protocol definitions for CAS-terminated trunks (for various types of CAS signaling). You can use the supplied files or construct your own files. Up to eight different CAS files can be installed on the device. For more information, see <a href="#">CAS Files</a> .
Voice Prompts	Voice announcement file containing a set of Voice Prompts (VP) that are played by the device during operation. For more information, see <a href="#">Voice Prompts File</a> .
Call Progress Tones	Region-specific, telephone exchange-dependent file that contains the Call Progress Tones (CPT) levels and frequencies for the device. The default CPT file is U.S.A. For more information, see <a href="#">Call Progress Tones File</a> .
Prerecorded Tones	The Prerecorded Tones (PRT) file enhances the device's capabilities of playing a wide range of telephone exchange tones that cannot be defined in the CPT file. For more information, see <a href="#">Prerecorded Tones File</a> .
Dial Plan	Provides dialing plans.  <b>Note:</b> Load a Dial Plan file using the Auxiliary Files page only for <b>backward compatibility</b> ; otherwise, import Dial Plan files using the Dial Plan table (see <a href="#">Configuring Dial Plans</a> on page 624).

File	Description
User Info	Loads a User Information file. <b>Note:</b> Load a User Information file using the Auxiliary Files page only for <b>backward compatibility</b> ; otherwise, load the file or configure users in the User Information table for SBC users (see <a href="#">Configuring SBC User Information Table through Web Interface</a> on page 606) and for Gateway users (see <a href="#">Configuring Gateway User Information Table through Web Interface</a> on page 600).
AMD Sensitivity	Answer Machine Detector (AMD) Sensitivity file containing the AMD Sensitivity suites. For more information, see <a href="#">AMD Sensitivity File</a> .
SBC Wizard Template Package	Contains the vendor-interoperability configuration templates for the SBC Configuration Wizard. For more information, see <a href="#">SBC Configuration Wizard</a> .

## Loading Auxiliary Files through Web Interface

The following procedure describes how to load Auxiliary files through the Web interface.



- When loading an ini file through the Auxiliary Files page, only parameter settings specified in the ini file are applied to the device; all other parameters remain at their current settings.
- If you load an ini file containing Auxiliary file(s), the Auxiliary files specified in the file overwrite the Auxiliary files currently installed on the device.
- For the User Information file, **only** use the Auxiliary Files page for **backward compatibility**. If backward compatibility is not needed, load the file or configure users in the User Information table for SBC users (see [Configuring SBC User Information Table through Web Interface](#) on page 606) and for Gateway users (see [Configuring Gateway User Information Table through Web Interface](#) on page 600).

### ➤ To load Auxiliary files through Web interface:

1. Open the Auxiliary Files page:
  - Toolbar: From the **Actions** drop-down menu, choose **Auxiliary Files**.
  - Navigation tree: **Setup** menu > **Administration** tab > **Maintenance** folder > **Auxiliary Files**.



<b>INI file (incremental)</b>	<input type="button" value="Browse..."/> No file selected.	<input type="button" value="Load File"/>
 <b>Call Progress Tones file</b>	<input type="button" value="Browse..."/> No file selected.	<input type="button" value="Load File"/>
<b>Prerecorded Tones file</b>	<input type="button" value="Browse..."/> No file selected.	<input type="button" value="Load File"/>
<b>Dial Plan file</b>	<input type="button" value="Browse..."/> No file selected.	<input type="button" value="Load File"/>
<b>User Info file</b>	<input type="button" value="Browse..."/> No file selected.	<input type="button" value="Load File"/>
<b>AMD Sensitivity file</b>	<input type="button" value="Browse..."/> No file selected.	<input type="button" value="Load File"/>
<b>SBC Wizard Template package file</b>	<input type="button" value="Browse..."/> No file selected.	<input type="button" value="Load File"/>

2. Click the **Browse** button corresponding to the Auxiliary file type that you want to load, navigate to the folder in which the file is located, and then click **Open**; the name of the file appears next to the **Browse** button.
3. Click the corresponding **Load File** button.
4. Repeat steps 2 through 3 for each file you want to load.
5. If you have loaded a Call Progress Tones file, reset the device with a save-to-flash for your settings to take effect. For all other Auxiliary files, a device reset is not required and you can click the **Save** button instead.

## Loading Auxiliary Files through CLI

You can load Auxiliary files from remote servers through CLI:

### ■ Single Auxiliary file:

```
# copy <file> from <URL of remote server>
```

For example:

```
# copy call_progress_tones from http://192.169.11.11:80/cpt_us.dat
```

- **Multiple (batch) Auxiliary files:** The Auxiliary files must be contained in a TAR (Tape ARchive) file (.tar). The TAR file can contain any number and type of Auxiliary files (e.g., Dial Plan file and CPT file).

```
# copy aux-package from | to <URL of remote server with TAR file name>
```

For example:

```
# copy aux-package from http://192.169.11.11:80/aux_files.tar
```

For more information on CLI, refer to the *CLI Reference Guide*.

## Deleting Auxiliary Files

You can delete loaded Auxiliary files through the Web interface, as described below.

### ➤ To delete a loaded Auxiliary file:

1. Open the Device Information page (see [Viewing Device Information](#)); the loaded files are listed under the Loaded Files group:

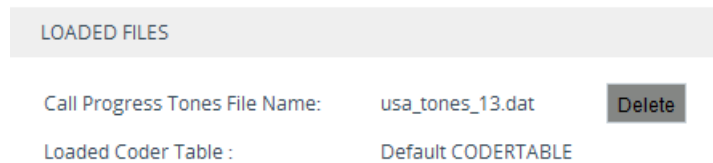

2. Click the **Delete** button corresponding to the file that you want deleted; a confirmation message box appears.
3. Click **OK** to confirm.
4. Reset the device with a save-to-flash for your settings to take effect.

## Call Progress Tones File

The Call Progress Tones (CPT) and Distinctive Ringing (analog interfaces only) Auxiliary file contains definitions of the CPT (levels and frequencies) that are detected and generated by the device.

The CPT for analog interfaces is comprised of two sections:

- The first section contains the definitions of the Call Progress Tones (levels and frequencies) that are detected/generated by the device.

- The second section contains the characteristics of the Distinctive Ringing signals that are generated by the device (see [Distinctive Ringing](#)).

You can use one of the supplied Auxiliary files (.dat file format) or create your own file. To create your own file, it's recommended to modify the supplied *usa\_tone.ini* file (in any standard text editor) to suit your specific requirements and then convert the modified *ini* file into binary *dat* file format, using AudioCodes DConvert utility. For more information, refer to the *DConvert Utility User's Guide*.



The CPT file can only be loaded in .dat file format.

You can create up to 32 different Call Progress Tones, each with frequency and format attributes. The frequency attribute can be single or dual-frequency (in the range of 300 to 1980 Hz) or an Amplitude Modulated (AM). Up to 64 different frequencies are supported. Only eight AM tones, in the range of 1 to 128 kHz, can be configured (the detection range is limited to 1 to 50 kHz). Note that when a tone is composed of a single frequency, the second frequency field must be set to zero.

The format attribute can be one of the following:

- **Continuous:** A steady non-interrupted sound (e.g., a dial tone). Only the 'First Signal On time' should be specified. All other on and off periods must be set to zero. In this case, the parameter specifies the detection period. For example, if it equals 300, the tone is detected after 3 seconds (300 x 10 msec). The minimum detection time is 100 msec.
- **Cadence:** A repeating sequence of on and off sounds. Up to four different sets of on/off periods can be specified.
- **Burst:** A single sound followed by silence. Only the 'First Signal On time' and 'First Signal Off time' should be specified. All other on and off periods must be set to zero. The burst tone is detected after the off time is completed.

You can specify several tones of the same type. These additional tones are used only for tone detection. Generation of a specific tone conforms to the first definition of the specific tone. For example, you can define an additional dial tone by appending the second dial tone's definition lines to the first tone definition in the *ini* file. The device reports dial tone detection if either of the two tones is detected.

The Call Progress Tones section of the *ini* file comprises the following segments:

- **[NUMBER OF CALL PROGRESS TONES]:** Contains the following key:  
'Number of Call Progress Tones' defining the number of Call Progress Tones that are defined in the file.
- **[CALL PROGRESS TONE #X]:** containing the Xth tone definition, starting from 0 and not exceeding the number of Call Progress Tones less 1 defined in the first section (e.g., if 10 tones, then it is 0 to 9), using the following keys:
  - **Tone Type:** Call Progress Tone types:
    - ◆ **[1]** Dial Tone

- ◆ [2] Ringback Tone
- ◆ [3] Busy Tone
- ◆ [4] Congestion Tone
- ◆ [6] Warning Tone
- ◆ [7] Reorder Tone
- ◆ [8] Confirmation Tone (analog interfaces)
- ◆ [9] Call Waiting Tone - heard by called party (analog interfaces)
- ◆ [15] Stutter Dial Tone (analog interfaces)
- ◆ [16] Off Hook Warning Tone (analog interfaces)
- ◆ [17] Call Waiting Ringback Tone (heard by the calling party)
- ◆ [18] Comfort Tone
- ◆ [23] Hold Tone
- ◆ [46] Beep Tone
- **Tone Modulation Type:** Amplitude Modulated (1) or regular (0)
- **Tone Form:** The tone's format can be one of the following:
  - ◆ Continuous (1)
  - ◆ Cadence (2)
  - ◆ Burst (3)
- **Low Freq [Hz]:** Frequency (in Hz) of the lower tone component in case of dual frequency tone, or the frequency of the tone in case of single tone. This is not relevant to AM tones.
- **High Freq [Hz]:** Frequency (in Hz) of the higher tone component in case of dual frequency tone, or zero (0) in case of single tone (not relevant to AM tones).
- **Low Freq Level [-dBm]:** Generation level 0 dBm to -31 dBm in dBm (not relevant to AM tones).
- **High Freq Level:** Generation level of 0 to -31 dBm. The value should be set to 32 in the case of a single tone (not relevant to AM tones).
- **First Signal On Time [10 msec]:** 'Signal On' period (in 10 msec units) for the first cadence on-off cycle. For continuous tones, the parameter defines the detection period. For burst tones, it defines the tone's duration.
- **First Signal Off Time [10 msec]:** 'Signal Off' period (in 10 msec units) for the first cadence on-off cycle (for cadence tones). For burst tones, the parameter defines the off time required after the burst tone ends and the tone detection is reported. For continuous tones, the parameter is ignored.

- **Second Signal On Time [10 msec]:** 'Signal On' period (in 10 msec units) for the second cadence on-off cycle. Can be omitted if there isn't a second cadence.
- **Second Signal Off Time [10 msec]:** 'Signal Off' period (in 10 msec units) for the second cadence on-off cycle. Can be omitted if there isn't a second cadence.
- **Third Signal On Time [10 msec]:** 'Signal On' period (in 10 msec units) for the third cadence on-off cycle. Can be omitted if there isn't a third cadence.
- **Third Signal Off Time [10 msec]:** 'Signal Off' period (in 10 msec units) for the third cadence on-off cycle. Can be omitted if there isn't a third cadence.
- **Fourth Signal On Time [10 msec]:** 'Signal On' period (in 10 msec units) for the fourth cadence on-off cycle. Can be omitted if there isn't a fourth cadence.
- **Fourth Signal Off Time [10 msec]:** 'Signal Off' period (in 10 msec units) for the fourth cadence on-off cycle. Can be omitted if there isn't a fourth cadence.
- **Carrier Freq [Hz]:** Frequency of the carrier signal for AM tones.
- **Modulation Freq [Hz]:** Frequency of the modulated signal for AM tones (valid range from 1 to 128 Hz).
- **Signal Level [-dBm]:** Level of the tone for AM tones.
- **AM Factor [steps of 0.02]:** Amplitude modulation factor (valid range from 1 to 50). Recommended values from 10 to 25.



- When the same frequency is used for a continuous tone and a cadence tone, the 'Signal On Time' parameter of the continuous tone must have a value that is greater than the 'Signal On Time' parameter of the cadence tone. Otherwise, the continuous tone is detected instead of the cadence tone.
- The tones frequency must differ by at least 40 Hz between defined tones.

Below shows an example of a configured dial tone to 440 Hz only:

```
[NUMBER OF CALL PROGRESS TONES]
Number of Call Progress Tones=1
#Dial Tone
[CALL PROGRESS TONE #0]
Tone Type=1
Tone Form =1 (continuous)
Low Freq [Hz]=440
High Freq [Hz]=0
Low Freq Level [-dBm]=10 (-10 dBm)
High Freq Level [-dBm]=32 (use 32 only if a single tone is required)
First Signal On Time [10msec]=300; the dial tone is detected after 3 sec
First Signal Off Time [10msec]=0
Second Signal On Time [10msec]=0
Second Signal Off Time [10msec]=0
```

## Distinctive Ringing

Distinctive Ringing is applicable only to FXS interfaces. Using the Distinctive Ringing section of the Call Progress Tones Auxiliary file, you can create up to 16 Distinctive Ringing patterns. Each ringing pattern configures the ringing tone frequency and up to four ringing cadences. The same ringing frequency is used for all the ringing pattern cadences. The ringing frequency can be configured in the range of 10 to 200 Hz with a 5 Hz resolution.



The feature is applicable only to FXS interfaces.

Each of the ringing pattern cadences is specified by the following parameters:

- **Burst Ring On Time:** Configures the cadence to be a burst cadence in the entire ringing pattern. The burst relates to On time and the Off time of the same cadence. It must appear between 'First/Second/Third/Fourth' string and the 'Ring On/Off Time' This cadence rings once during the ringing pattern. Otherwise, the cadence is interpreted as cyclic: it repeats for every ringing cycle.
- **Ring On Time:** Specifies the duration of the ringing signal.
- **Ring Off Time:** Specifies the silence period of the cadence.

The Distinctive Ringing section of the *ini* file format contains the following strings:

- **[NUMBER OF DISTINCTIVE RINGING PATTERNS]:** Contains the following key:
  - 'Number of Distinctive Ringing Patterns' defining the number of Distinctive Ringing signals that are defined in the file.
- **[Ringing Pattern #X]:** Contains the Xth ringing pattern definition (starting from 0 and not exceeding the number of Distinctive Ringing patterns defined in the first section minus 1) using the following keys:
  - **Ring Type:** Must be equal to the Ringing Pattern number.
  - **Freq [Hz]:** Frequency in hertz of the ringing tone.
  - **First (Burst) Ring On Time [10 msec]:** 'Ring On' period (in 10 msec units) for the first cadence on-off cycle.
  - **First (Burst) Ring Off Time [10 msec]:** 'Ring Off' period (in 10 msec units) for the first cadence on-off cycle.
  - **Second (Burst) Ring On Time [10 msec]:** 'Ring On' period (in 10 msec units) for the second cadence on-off cycle.
  - **Second (Burst) Ring Off Time [10 msec]:** 'Ring Off' period (in 10 msec units) for the second cadence on-off cycle.
  - **Third (Burst) Ring On Time [10 msec]:** 'Ring On' period (in 10 msec units) for the third cadence on-off cycle.

- **Third (Burst) Ring Off Time [10 msec]:** 'Ring Off' period (in 10 msec units) for the third cadence on-off cycle.
- **Fourth (Burst) Ring On Time [10 msec]:** 'Ring Off' period (in 10 msec units) for the fourth cadence on-off cycle.
- **Fourth (Burst) Ring Off Time [10 msec]:** 'Ring Off' period (in 10 msec units) for the fourth cadence on-off cycle.



In SIP, the Distinctive Ringing pattern is selected according to the Alert-Info header in the INVITE message. For example:

```
Alert-Info:<Bellcore-dr2>
```

```
--or--
```

```
Alert-Info:<http://.../Bellcore-dr2>
```

"dr2" defines ringing pattern #2.

If the Alert-Info header is not present, the default ringing tone #0 is played.

An example of a **ringing burst** definition is shown below:

```
#Three ringing bursts followed by repeated ringing of 1 sec on and 3 sec off.
[NUMBER OF DISTINCTIVE RINGING PATTERNS]
Number of Ringing Patterns=1
```

```
[Ringing Pattern #0]
Ring Type=0
Freq [Hz]=25
First Burst Ring On Time [10msec]=30
First Burst Ring Off Time [10msec]=30
Second Burst Ring On Time [10msec]=30
Second Burst Ring Off Time [10msec]=30
Third Burst Ring On Time [10msec]=30
Third Burst Ring Off Time [10msec]=30
Fourth Ring On Time [10msec]=100
Fourth Ring Off Time [10msec]=300
```

An example of **various ringing signals** definition is shown below:

```
[NUMBER OF DISTINCTIVE RINGING PATTERNS]
Number of Ringing Patterns=3
```

```
#Regular North American Ringing Pattern
[Ringing Pattern #0]
Ring Type=0
Freq [Hz]=20
```

```
First Ring On Time [10msec]=200
First Ring Off Time [10msec]=400
```

```
#GR-506-CORE Ringing Pattern 1
[Ringing Pattern #1]
Ring Type=1
Freq [Hz]=20
First Ring On Time [10msec]=200
First Ring Off Time [10msec]=400
```

```
#GR-506-CORE Ringing Pattern 2
[Ringing Pattern #2]
Ring Type=2
Freq [Hz]=20
First Ring On Time [10msec]=80
First Ring Off Time [10msec]=40
Second Ring On Time [10msec]=80
Second Ring Off Time [10msec]=400
```

## Prerecorded Tones File

The Prerecorded Tone (PRT) file contains up to 80 (and maximum of 10 minutes) user-defined prerecorded tones that can be played by the device. For example, it can be used to play a held tone (music on hold) to a call party that has been put on hold or a ringback tone to a calling party. The PRT file overcomes the limitations of the CPT file (such as limited number of predefined tones and limited number of frequency integrations in a single tone). The PRT file also lets you play different held and ringback tones for different groups of users. To do this, configure an IP Profile with the required ringback tone (IPProfile\_LocalRingbackTone) and/or held tone (IPProfile\_LocalHeldTone) from the PRT file, and then associate the IP Profile with the required IP Group.

You can define a PRT file for SBC calls with multiple tones of the same tone type, but with different coders. If one of the tones is defined with the same coder as used in the current call, the device always selects it to eliminate the need for using DSP resources. If the coder of the tone is the same as that of the call, DSPs are not required. If they are different, DSPs are required.



- The PRT file only generates (plays) tones; detection of tones is according to the CPT file.
- The PRT file can be up to 4 megabytes in size.
- If the PRT file contains a tone that also exists in the CPT file, the tone in the PRT file is played instead (i.e., overrides the tone in the CPT file).
- Playing tones from the PRT file is applicable to Gateway and SBC calls.





- If the coder defined for the tone in the PRT file is the same as that used by the current call, then DSPs are not required for playing the tone. If the coders are different, DSPs are required.
- The device requires DSPs for local generation of tones.
- The PRT file supports only the ringback tone and hold tone for SBC calls.

The tones can be recorded using a standard third-party, recording utility (such as Adobe Audition). Once recorded, you need to combine the recorded files into a single and loadable PRT file (.dat), using the latest version of AudioCodes DConvert utility. In DConvert, each recording must be added to the PRT file with the tone type "acUserDefineTone<Index>". When you want to specify the tone (ringback or held tone) to play for a specific IP Profile (IPProfile\_LocalRingbackTone and IPProfile\_LocalHeldTone parameters), you need to use this index number. For more information on the DConvert utility, refer to the [DConvert Utility User's Guide](#). Once you have created the PRT .dat file, you need to load it to the device (flash memory), using the Web interface (see [Loading Auxiliary Files](#)) or CLI.

You must record the tones (raw data files) with the following properties:

- Coders: G.711 A-law, G.711  $\mu$ -law, or G.729
- Rate: 8 kHz
- Resolution: 8-bit
- Channels: mono

The PRT file can include prerecorded audio tones of different coders (e.g., some with G.711 and some with G.729). The prerecorded tones are played repeatedly. This allows you to record only part of the tone and then play the tone for the full duration. For example, if a tone has a cadence of 2 seconds on and 4 seconds off, the recorded file should contain only these 6 seconds. The device repeatedly plays this cadence for the configured duration. Similarly, a continuous tone can be played by repeating only part of it.

The following figure shows an example of the creation of the PRT file containing multiple user-defined tones ("acUserDefineTone<Index>") through the DConvert utility:

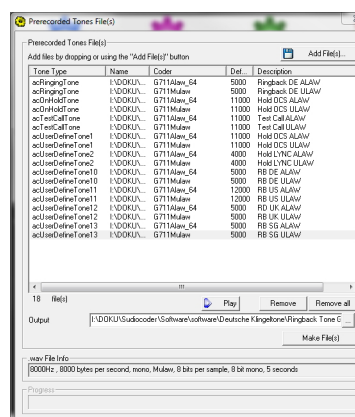

## Voice Prompts File

The Voice Prompts (VP) file contains a set of voice prompts (or announcements) and/or .wav files that can be played by the device. The voice announcements are prepared offline using standard, third-party recording utilities and then combined into a single file using AudioCodes DConvert utility. The VP file can then be loaded to the device using the Web interface.

The raw data files must be recorded with the following characteristics:

- **Coders:** Linear G.711 A-law or G.711  $\mu$ -law
- **Rate:** 8000 kHz
- **Resolution:** 8-bit
- **Channels:** mono

When the list of recorded files is converted to a single *voiceprompts.dat* file, every Voice Prompt is tagged with an ID number, starting with '1'. This ID is later used by the device to play the correct announcement. Up to 1,000 Voice Prompts can be defined. If the size of the combined VP file is less than 1 MB, it can be permanently stored on flash memory. Larger files (up to 10 MB) are stored in RAM and should be loaded again after the device is reset.

The device can be provided with a professionally recorded English (U.S.) VP file.

### ➤ To generate and load the VP file:

1. Prepare one or more voice files using standard utilities.
2. Use the DConvert utility to generate the *voiceprompts.dat* file from the pre-recorded voice messages. For more information, refer to *DConvert Utility User's Guide*.
3. Load the *voiceprompts.dat* file to the device using the Web interface (see [Loading Auxiliary Files](#)).

## CAS Files

The CAS Auxiliary files contain the CAS Protocol definitions that are used for CAS-terminated trunks. You can use the supplied files or construct your own files. Up to eight files can be loaded to the device. Different files can be assigned to different trunks (CASTableIndex\_x) and different CAS tables can be assigned to different B-channels (CASChannelIndex).

To load CAS files see [Loading Auxiliary Files](#).



All CAS files loaded together must belong to the same trunk type (i.e., either E1 or T1)

## AMD Sensitivity File

The device is shipped with a default, pre-installed *AMD Sensitivity* file for its Answering Machine Detection (AMD) feature. This file includes the detection algorithms for detecting whether a human or answering machine has answered the call, and is based on North American English. In most cases, the detection algorithms in this file suffice even when your deployment is in a region where a language other than English is spoken. However, if you wish to replace the default file with a different AMD Sensitivity file containing customized detection algorithms, please contact the sales representative of your purchased device for more information.

The AMD Sensitivity file is created in .xml format and then converted to a binary .dat file that can be installed on the device. The XML-to-binary format conversion can be done using AudioCodes DConvert utility. For more information on using this utility, refer to *DConvert Utility User's Guide*.

Only one AMD Sensitivity file can be installed on the device. To install a new AMD Sensitivity file, use one of the following methods:

- Web interface: Auxiliary Files page - see [Loading Auxiliary Files](#).
- TFTP during initialization: Configure the [AMDSensitivityFileName] parameter, and then copy the AMD Sensitivity file to the TFTP directory.
- Automatic Update feature: Configure the [AMDSensitivityFileUrl] parameter through ini file. For more information, see [Automatic Update Mechanism](#).

For more information on the AMD feature, see [Answering Machine Detection \(AMD\)](#).

## User Info File



For loading User Info (User Information) files, use the Auxiliary Files page for **backward compatibility only**. If backward compatibility is not needed, load the file or configure users in the User Information table for SBC users (see [Configuring SBC User Information Table through Web Interface](#) on page 606) and for Gateway users (see [Configuring Gateway User Information Table through Web Interface](#) on page 600). For file syntax when loading a User Information file using the Auxiliary Files page, see the note bulletins in these sections.

## 45 License Key

The License Key determines the features (e.g., Test Call and voice coders) and various capacity figures (e.g., number of Test Calls and SBC call sessions) that you have ordered for your device.

The local License Key, which is installed on the device through ini file (locally or through the Automatic Update mechanism), contains all the licenses for the ordered features and capacity. However, for the SBC capacity licenses, which includes SBC sessions, transcoding sessions, and registered far-end users, you can use AudioCodes OVOC management tool to provide and manage them. OVOC provides various SBC capacity licensing modes, as described in [OVOC-Managed SBC Capacity Licenses](#) on page 1101.



- The availability of certain Web pages in the Web interface depends on the licensed features in the License Key.

### Viewing the License Key

The License Key is displayed on the License Key page, showing all the device's licensed features and capacity.

#### ➤ To view License Key through Web interface:

- Open the License Key page:
  - **Toolbar:** From the **Actions** drop-down menu, choose **License Key**.
  - **Navigation tree:** **Setup** menu > **Administration** tab > **License** folder > **License Key**.



- Ordered features are always licensed by the **local** License Key. In other words, even if you are using OVOC to manage the device's SBC capacity licenses, all the other features and capacity figures are licensed by the local License Key.
- If you save the device's ini configuration file to a folder on your computer, the local License Key is also included (see [Downloading and Loading ini Configuration File](#) on page 1114).

In addition to displaying the licensed features and capacity, the License Key page also displays general information on a bar at the top of the page, as shown in the example below:

Product Key	NA	Floating License	5967925	72	Not connected
	OVOC Product Key	Mode	Serial Number	Device Type	License Server Status

**Table 45-1: Description of General information on License Key Page**

Field	Description
<b>Product Key</b>	Displays the device's Product Key. For more information, see <a href="#">Viewing the Device's Product Key</a> .

Field	Description
<b>OVOC Product Key</b>	<p>Displays the Product Key of OVOC that is providing and managing the SBC capacity licenses for the device.</p> <p><b>Note:</b> The field only appears when the device uses OVOC to manage its SBC capacity licenses, as described in <a href="#">OVOC-Managed SBC Capacity Licenses</a> on page 1101.</p>
<b>Mode</b>	<p>Displays the type of license used for the device's SBC capacity licenses:</p> <ul style="list-style-type: none"> <li>■ "Local License Key": The SBC capacity licenses are only based on the local License Key.</li> <li>■ "License Pool": The SBC capacity licenses are obtained remotely from the Fixed License Pool, which is managed by OVOC. For more information, see <a href="#">Fixed License Pool Model</a> on page 1101.</li> <li>■ "Floating License": The SBC capacity licenses are obtained remotely from the Floating License, which is managed by OVOC. For more information, see <a href="#">Floating License Model</a> on page 1104.</li> <li>■ "Flex License": The SBC capacity licenses are obtained remotely from the Flex License, which is managed by OVOC. For more information, see <a href="#">Flex License Model</a> on page 1106.</li> </ul>
<b>Serial Number</b>	<p>Displays the device's serial number.</p>
<b>Device Type</b>	<p>Displays AudioCodes internal model identification number of the device.</p>
<b>License Server Status</b>	<p>Displays the connectivity status between the device and OVOC when the device uses OVOC to manage its SBC capacity licenses (Fixed License, Floating License, or Flex License):</p> <ul style="list-style-type: none"> <li>■ "Connected": This indicates that the device is connected to OVOC.</li> <li>■ "Disconnected": This indicates that the device was connected to OVOC, but has lost connection with OVOC due to network problems (HTTPS TCP connection).</li> <li>■ "Not Connected": This indicates that the device has not connected to OVOC.</li> </ul>

Field	Description
	<b>Note:</b> The field only appears when the device uses OVOC to manage its SBC capacity licenses, as described in <a href="#">OVOC-Managed SBC Capacity Licenses</a> on page 1101.

## Local License Key

The local License Key contains all the licenses for your ordered features and capacity. This License Key is installed locally on the device.



- When you install a new License Key, it overwrites the previously installed License Key. Therefore, features that were licensed by the previous License Key and not included in the new License Key will no longer be available.
- The local License Key is unique to the device (based on Serial Number) and cannot be installed on other devices.
- To use OVOC to manage the SBC capacity licenses (SBC sessions, and registered users), see [OVOC-Managed SBC Capacity Licenses](#) on page 1101.
- You can also install the local License Key remotely using the device's Automatic Update mechanism (see [Automatic Provisioning](#) on page 1119).

## Installing License Key through Web Interface

You can install the local License Key through the Web interface using one of the following methods:

- Installing a License Key file (see [Installing a License Key File](#) on page 1099)
- Installing a License Key string (see [Installing a License Key String](#) on the next page)

When you initially load the License Key before installing it, the License Key page uses color-coded icons to indicate the changes between the currently installed License Key and the new License Key that you loaded. The following table describes these color codes:

**Table 45-2: Color-Coded Icons for Newly Loaded License Key**

Icon	Color	Description
	Green	Indicates new features added by the new License Key.
	Orange	Indicates the capacity change of an existing feature. Move your mouse over the icon to view a pop-up describing the capacity change, as shown in the following example for SIPRec Sessions:

Icon	Color	Description
		<div style="border: 1px solid #ccc; padding: 5px; margin-bottom: 5px;"> <p>VOIP FEATURES</p> <p>Voice Quality Monitoring <span style="float: right;">🔗</span></p> <p>RTCP-XR <span style="float: right;">🔗</span></p> <p>Media Enhancement <span style="float: right;">🔗</span></p> <p>SIPRec Sessions <span style="float: right;">10</span></p> </div> <p>Value changed from 6 to 10</p>
●	Red	Indicates features of the currently installed License Key that are not included in the new License Key and are no longer available.

 After you install the License Key (device reset with a save-to-flash), the icons are no longer displayed and the License Key page displays only features and capacity that are licensed by the new License Key.

### Installing a License Key String

You can install the License Key as a string in encrypted format through the Web interface.

 The License Key installation process includes a device reset and therefore, is traffic-affecting. To minimize disruption of current calls, it is recommended to perform this procedure during periods of low traffic.

➤ **To install a License Key string through Web interface:**

1. Open the License Key page (see [Viewing the License Key](#) on page 1094).
2. Back up the currently installed License Key as a precaution. If the new License Key does not comply with your requirements, you can re-load the backed-up License Key to restore the device's original capabilities. For backing up the License Key, see [Backing up Local License Key](#) on page 1101.
3. Copy the License Key string (from the License Key file or email) to your clipboard. Make sure that you copy **only** the encrypted string (and not the serial number or any other part of the string), as shown in the example below:

```
[LicenseKeys]
S/N5967925=r4Rqr5to27458ANud3hr6x402R5c0lcbgNfuhcsiP8ealNefjQ9ay0c405bcindhbgM8f9G1iP8ealNe8OcpdHic4055c019bg
Mfehcsjjgealp4820ba28e4055c0lcbgMfehcsiP8ealtestNefjQba20c4055c0lcbgMfeggkqN8ealNefjQba20c4057ciV9bgMD4hcsiP8
eal17pmkba3Ui4055c0lcbgMfehcsiJgcaRVcf3Maai4d4050dZCMkDFPNhgrh3c19BZanBUba24d4idhcypfQwk62y00
```

4. Click **Load String**; the Load License Key String dialog box appears.
5. In the text box, paste your License Key string, as shown in the following example:

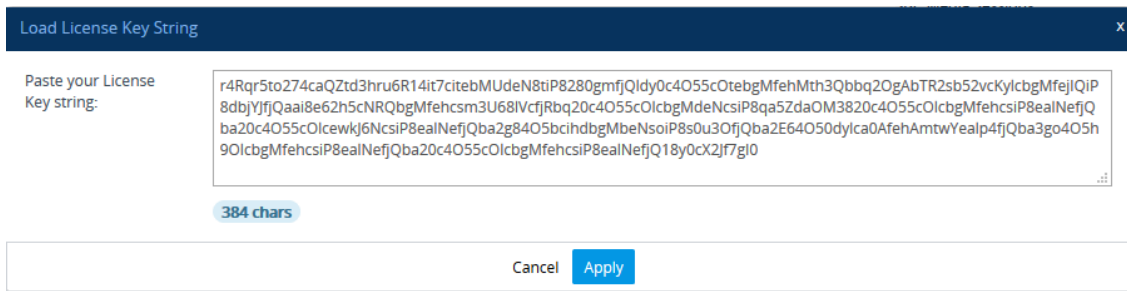

- Click **Apply**; the dialog box closes and the "String Uploaded!" message is briefly displayed at the bottom of the page when the License Key is successfully loaded to the device. The License Key page uses color-coded icons to indicate the changes between the currently installed License Key and the newly loaded License Key. For more information, see [Installing License Key through Web Interface](#).
- Click **Apply New License Key**; the following message box appears:

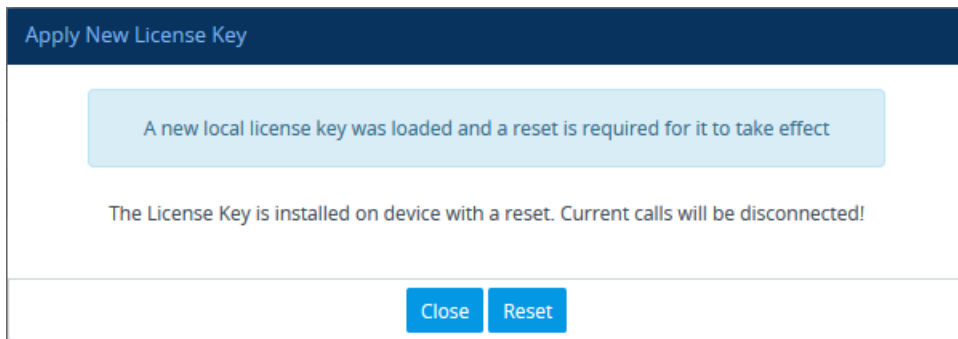

- Click **Reset**; the device saves the file to flash memory with a device reset, displaying the following progress message box:

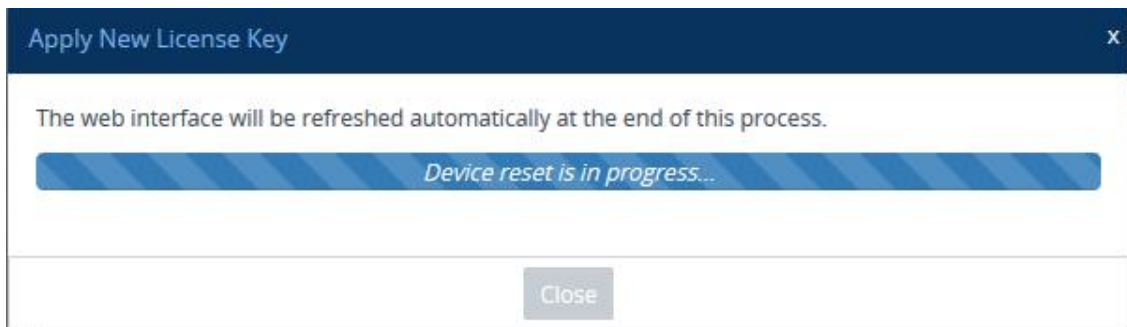

When installation completes, the following message box appears:

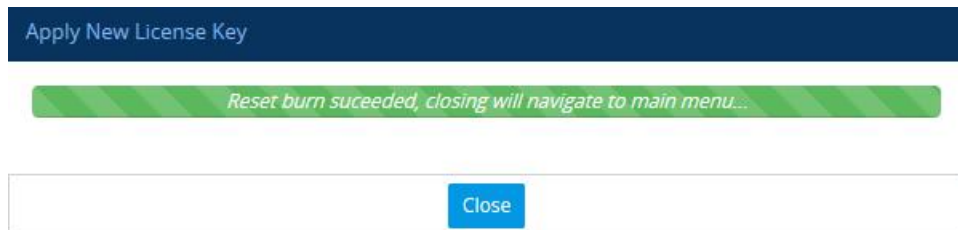

- Click **Close** to close the message box; you are logged out of the Web interface and prompted to log in again. The features and capabilities displayed on the License Key page now reflect the newly installed License Key.



## Installing a License Key File

You can install the License Key as a file through the Web interface.

### Installing on Standalone Devices

You can install the License Key as a file through the Web interface.



The License Key installation process includes a device reset and is therefore, traffic-affecting. To minimize disruption of current calls, it is recommended to perform this procedure during periods of low traffic.

#### ➤ To install License Key file through Web interface:

1. Place the purchased License Key file in a folder on the computer from where you are logged into the device.
2. Open the License Key page (see [Viewing the License Key](#) on page 1094).
3. Back up the currently installed License Key as a precaution. If the new License Key does not comply with your requirements, you can re-load the backed-up License Key to restore the device's original capabilities. For backing up the License Key, see [Backing up Local License Key](#) on page 1101.
4. Click the **Load File** button to select the License Key file on your computer; the **Apply New License Key** button appears. The License Key page uses color-coded icons to indicate the changes between the currently installed License Key and the newly loaded License Key (see [Installing License Key through Web Interface](#) on page 1096).



If want to cancel installation, reset the device without a save to flash. For more information, see [Resetting the Device](#).

5. Click **Apply New License Key**; the following message box appears:

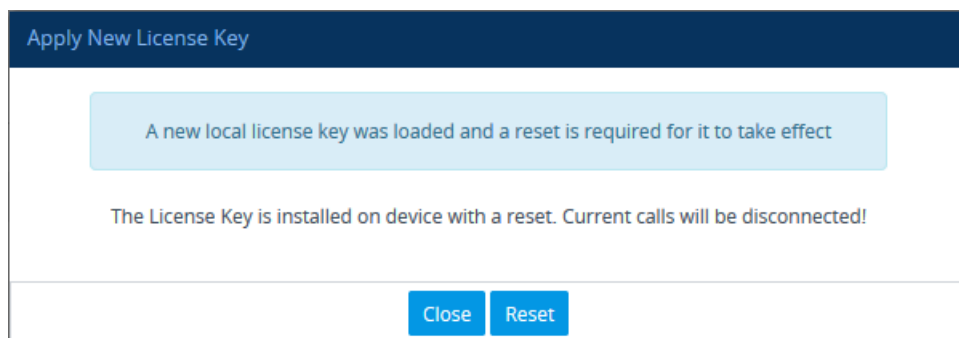

6. Click **Reset**; the device saves the file to flash memory with a reset and the following progress message box appears:

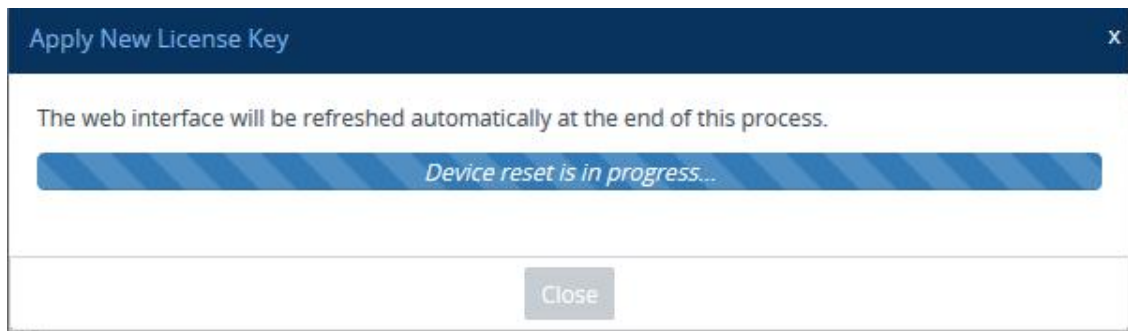

When installation completes, the following message box appears:

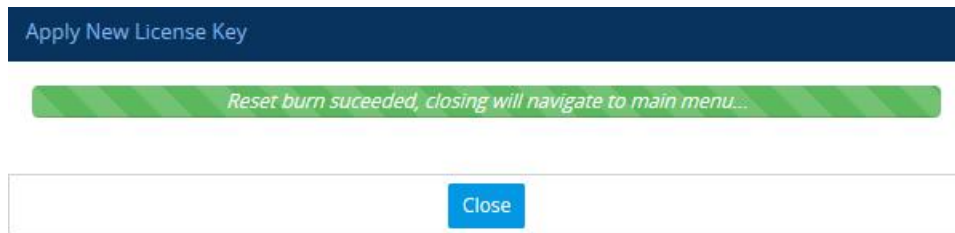

7. Click **Close** to close the message box; you are logged out of the Web interface and prompted to log in again. The features and capabilities displayed on the License Key page now reflect the newly installed License Key.

## Installing License Key String through CLI

To install the License Key string through CLI, use the following command:

```
(config-system)# feature-key <"License Key string enclosed in double quotation marks">
```

To view the installed License Key, use the following command:

```
show system feature-key
```

## Verifying Installed License Key

To verify that the new License Key has been installed:

1. On the License Key page, check that the listed features and capabilities of the new License Key match those that you ordered.
2. Access the Syslog server and check that the following message appears:
 

```
"S/N<serial number> Key Was Updated. The Board Needs to be Reloaded with ini file\n"
```



 If the Syslog server indicates that the License Key was unsuccessfully loaded (i.e., the "SN\_" line is blank), do the following preliminary troubleshooting procedures:
  - a. Open the License Key file and check that the "S/N" line appears. If it does not appear, contact your AudioCodes sales representative.

- b. Verify that you have loaded the correct file. Open the file and ensure that the first line displays "[LicenseKeys]".
- c. Verify that the content of the file has not been altered.

## Backing up Local License Key

You can back up the installed local License Key. This may be useful, for example, if you have installed a new License Key and you want to revert to the previous License Key.

### ➤ To back up local License Key:

1. Open the License Key page (see [Viewing the License Key](#) on page 1094).
2. Click one of the following buttons:
  -  : Saves the License Key as a file to a folder on your computer. By default, the device saves the License Key as a .txt file type with the name license.txt.
  -  : Copies the License Key as a string to your computer's clipboard. You can then paste the string into, for example, an e-mail message or a text-based program such as Notepad.

## OVOC-Managed SBC Capacity Licenses

The device's licenses for SBC capacity -- SBC sessions and user registrations -- can be provided by and managed remotely by OVOC.

OVOC offers the following SBC capacity licensing models:

- Fixed License Pool (see [Fixed License Pool Model](#) below)
- Floating License ([Floating License Model](#) on page 1104)
- Flex License ([Flex License Model](#) on page 1106)

### Fixed License Pool Model

The device can receive SBC capacity licenses from a centralized pool of SBC licenses that is located on and managed by AudioCodes OVOC management tool. The license pool is purchased for OVOC as one bulk license and is used to provide SBC licenses to multiple devices. The OVOC user manually allocates a specific number of SBC licenses per license type (see list below) from the pool to each device in the network. Whenever required, the OVOC user can increase or decrease the number of allocated SBC licenses according to the device's capacity demands. The allocation of licenses to the devices cannot exceed the purchased Fixed License pool.

The Fixed License pool includes the following SBC capacity license types:

- SBC Sessions (maximum number of concurrent SBC call sessions - media and signaling)

- Far End Users (maximum number of SIP endpoints or users that can be registered with the device)



- The Fixed License does not involve any configuration on the device; it is enabled and managed entirely by OVOC. For more information on the OVOC License Pool, refer to the *OVOC User's Manual*.
- The Fixed License does not affect transcoding session capacity. By default, transcoding session capacity is at maximum (as supported by the device).

As an example of how the Fixed License pool allocates licenses, assume that the pool contains a maximum of 20 SBC far-end user (registration) licenses and it needs to service three devices (A, B and C). It can allocate 10 to A, 8 to B, and 2 to C. In this example, because all the far-end user licenses in the pool have been allocated, it cannot allocate any more far-end user licenses to the devices. However, if it de-allocates 5 licenses from A, for example, it can allocate these additional licenses to B and/or C.

As another example, assume that an OVOC tenant is allocated 500 SBC Session licenses to service 4 devices (A, B, and C), where each device has a capacity of 250 SBC sessions. If A and B are operating at maximum capacity (i.e. aggregated number of active SBC call sessions is 500), and C requires 50 SBC sessions, then C is taken out-of-service until the number of active calls on A and B combined drops to 450 sessions. When this occurs, the 50 free licenses can be allocated by the pool to C. If over a period of time, call traffic on A and B is showing a downward trend, the OVOC user can reallocate extra licenses to C.

The device periodically (and after a device reset) checks with OVOC for any SBC capacity license updates. OVOC identifies the device by serial number and sends licenses to the device according to OVOC configuration. If the device's local License Key already includes SBC capacity licenses, the SBC licenses allocated by OVOC are added to it (but up to the device's maximum supported capacity capabilities). When the device applies the licenses received from OVOC, the License Key page displays "License Pool" in the 'Mode' field (see [Viewing the License Key](#) on page 1094) and displays the allocated SBC licenses under the **SBC Capacity** group, as shown in the example below:

SBC CAPACITY			
	<u>Remote</u>	<u>Local</u>	<u>Actual</u>
SBC Sessions	5	10	15
SBC Signaling Sessions	2	5	7
SBC Media Sessions		5	5
Far End Users (FEU)	2	22	24
Transcoding Sessions	2	20	22

- 'Remote': This column displays the number of SBC licenses per license type received from the OVOC Fixed License pool.
- 'Local': This column displays the number of SBC licenses per license type from the locally installed License Key.

- 'Actual': This column displays the total SBC licenses per license type, which is the summation of the remote and local licenses.



For the SBC licenses allocated by OVOC to take effect, the device **must** be reset with a save to flash. The reset can be initiated by the OVOC user or locally on the device by you. The total licenses (displayed in the "Actual" column) is only updated once the device completes this reset.

Communication between the device and OVOC is through HTTPS (port 443) and SNMP. If a firewall exists in the network, make sure that ports for these applications are opened. If the device loses connectivity with OVOC for a long duration, it discards the allocated SBC licenses and resets with its initial SBC licenses according to the local License Key. This mechanism prevents misuse of SBC licenses allocated by the OVOC license pool. Connectivity status with OVOC is displayed in the 'License Server Status' field on the License Key page (see [Viewing the License Key](#) on page 1094).

The device sends the following SNMP alarms to indicate various conditions relating to the allocation of SBC licenses by the OVOC Fixed License pool:

- `acLicensePoolInfraAlarm` (OID 1.3.6.1.4.1.5003.9.10.1.21.2.0.106): Sent if the device loses connection with OVOC, for example.
- `acLicensePoolApplicationAlarm` (OID 1.3.6.1.4.1.5003.9.10.1.21.2.0.107): Sent when the device receives new SBC licenses from the Fixed License pool.
- `acLicensePoolOverAllocationAlarm` (OID 1.3.6.1.4.1.5003.9.10.1.21.2.0.125): Sent when the device receives new SBC licenses from the Fixed License pool, which has caused the device to exceed its maximum supported capacity.

For more information on these alarms, refer to the device's *SNMP Reference Guide*.



- The Fixed License only provides SBC capacity licenses (listed in the beginning of this section). Therefore, your device must still be installed with a local License Key to enable other ordered license-based features (e.g., Test Calls) and capacity.
- The allocation and de-allocation of SBC licenses to standalone devices by the OVOC Fixed License pool is service affecting because it requires a device reset.
- If the device is restored to factory defaults, the SBC licenses allocated by the OVOC Fixed License pool are removed and only the SBC licenses from the locally installed License Key are applied instead.
- If the device is allocated SBC licenses by the OVOC Fixed Licenses pool that exceeds the maximum number of sessions that the device can support, the device sets the number of sessions to its maximum supported capacity.
- The Fixed License pool cannot operate with the other OVOC-managed license modes (e.g., Floating License). Therefore, before using the Fixed License, make sure that the other license modes are disabled on the device and OVOC.

## Floating License Model

The Floating License is a network-wide SBC capacity-related license pool, which is managed by AudioCodes OVOC and the cloud-based License Manager, and shared dynamically among multiple devices. The Floating License is a pay-as-you-grow service, eliminating the need to manually purchase additional SBC licenses each time your capacity requirements increase. You initially purchase a Floating License based on your estimated SBC capacity requirements. If you later experience business growth and your devices use more SBC licenses than specified by the Floating License, you are billed for these additional licenses. In other words, the Floating License pool capacity can be exceeded.

The Floating License pool includes the following SBC capacity license types:

- SBC sessions (maximum number of concurrent SBC call sessions - media and signaling)
- User registrations (maximum number of SIP endpoints that can be registered with the device)

As an example of how the Floating License pool operates, assume that an OVOC tenant is allocated 500 SBC Session licenses and the tenant has deployed three devices (A, B, and C), where each device has a maximum capacity of 250 SBC sessions. If A and B are operating at maximum capacity (i.e. the aggregated number of active SBC call sessions is 500), and then C requires 50 SBC sessions, even though the initially purchased Floating License pool capacity has been reached (500), C is allowed to process these 50 new call sessions. When you are next billed, you are charged for these extra 50 SBC session licenses.

For providing the Floating License service, OVOC and the Cloud License Manager need to be set up accordingly (refer to the *OVOC User's Manual*). The Floating License service also needs to be enabled on these devices. Once these devices connect to OVOC, they are "open" to use any number of licenses in the Floating License pool. However, capacity is limited by the device's inherent maximum capacity support and by an optional user-defined limit called *Allocation Profile* (discussed later in this section), which specifies a capacity that is less than the device's inherent capacity per SBC license type.

Connection between the devices and OVOC is established over SNMP. Functionality of the Floating License service is managed over TCP/HTTPS REST. For more information, see the *One Voice Operations Center IOM Manual* and the *OVOC Security Guidelines*. Connectivity status with OVOC is displayed in the 'License Server Status' field on the License Key page (see [Viewing the License Key](#) on page 1094). If the device loses connectivity with OVOC, it continues using the licenses that it received before the disconnection for a specific grace period, and then once this period expires, it stops accepting new calls.

The devices report their SBC license consumption per license type to OVOC at fixed intervals (typically, every five minutes). OVOC accumulates these reports and sends them to AudioCodes Cloud License Manager every 12 hours with all the SBC licenses usage in the last 12 hours. OVOC uses REST APIs over HTTPS to report to the Cloud License Manager. AudioCodes personnel analyze these license consumption reports in the Cloud License Manager on a monthly basis to check if capacity specified by your Floating License was exceeded. If it was exceeded, AudioCodes sends you a report detailing the excess licenses and requests that you

purchase additional SBC licenses for your Floating License. To view the Floating License reports of SBC license consumption that the device sends OVOC, see [Viewing Floating or Flex License Reports](#) on page 1112.

When the device uses the Floating License, the License Key page (see [Viewing the License Key](#) on page 1094) displays "Floating License" in the 'Mode' field and display the SBC capacity licenses received from the Floating License under the **SBC Capacity** group, as shown in the example below:

SBC CAPACITY			
	<u>Local</u>	<u>Floating</u>	<u>Actual</u>
Far End Users	<del>5</del>	0	0
SBC Media Sessions		250	250
SBC Signaling Sessions		250	250
Transcoding Sessions		0	0
SBC Sessions	<del>2</del>		

- 'Local': This column displays the number of SBC licenses per license type from the locally installed License Key. These licenses are not used by the device and the figures are displayed crossed out (strikethrough).
- 'Floating': This column displays the number of SBC licenses per license type received from the OVOC Floating License pool.
- 'Actual': (see the 'Floating' column).

The device sends the following SNMP alarms to indicate various conditions relating to the allocation of SBC licenses by the OVOC Floating License pool:

- acFloatingLicenseAlarm: Sent if you have configured an Allocation Profile that exceeds the device's maximum supported capacity.
- acCloudLicenseManagerAlarm: Sent upon various conditions such as loss of connectivity between the device and OVOC.

For more information on these alarms, refer to the device's *SNMP Reference Guide*.



- The Floating License only provides SBC capacity licenses (listed previously). Therefore, your device must still be installed with a local License Key to enable the other ordered license-based features (e.g., Test Calls) and capacity.
- The Floating License does not affect transcoding session capacity. By default, transcoding session capacity is at maximum (as supported by the device).
- For configuring the Floating License on OVOC, refer to the *OVOC User's Manual*.
- The Floating License cannot operate with other OVOC-managed SBC capacity license modes (e.g., Fixed License). Therefore, before enabling the Floating License, make sure that the other license modes are disabled on OVOC.
- The Floating License ignores OVR, TDM2SBC, and LAD capacity licenses in the local License Key.

## Flex License Model

The Flex License model is a network-wide SBC capacity-related license, managed by AudioCodes OVOC, which is dynamically shared among multiple devices. The Flex License is ordered as a single license, which provides a pool of SBC licenses that cannot be exceeded. The Flex License pool includes the following SBC capacity license types:

- SBC Sessions (maximum number of concurrent SBC call sessions - media and signaling)
- Far End Users (maximum number of SIP endpoints or users that can be registered with the device)

The Flex License model is similar to the Floating License model (as described in [Floating License Model](#) on page 1104), but provides some important advantages:

- The Flex License is solely managed by OVOC; it doesn't employ a cloud-based license manager like the Floating License. This reduces the exposure of OVOC to security risks from its connectivity with the public cloud.
- The Flex License gracefully enforces license capacity of the pool; the Floating License allows devices to exceed pool capacity, resulting in you being billed at the end of the month for unexpected license usages.

The Flex License is managed by AudioCodes OVOC, which defines the devices using the Flex License. Once connected to OVOC, each device can handle calls using the licenses of the different license types in the Flex License pool, as long as the pool has available (unused) licenses. However, the device's capacity is limited by its inherent maximum capacity support and by an optional user-defined limit called *Allocation Profile* (discussed later in this section), which specifies a capacity that is less than the device's inherent capacity per SBC license type.

The devices periodically (typically, every five minutes) report their current SBC license consumption (usage) per SBC license type to OVOC. OVOC uses these reports to calculate the total number of currently used licenses from the pool and therefore, determines the remaining licenses in the pool per license type. To view the license usage reports that the device sends to OVOC, see [Viewing Floating or Flex License Reports](#) on page 1112.

Each device in OVOC is configured with a priority level (Low, Normal, or Critical). When all the licenses of a specific license type in the Flex License pool are being used (or even exceeded) by the devices, OVOC uses this priority level to determine which of the devices to initially "take out" of service. OVOC first notifies a certain percentage of devices of this "over-license" status, instructing them to **reject all new calls** that require this specific license type. This percentage of devices starts from those with Low priority level, then Normal priority level, and lastly Critical priority level.

For example, assume there are 100 devices in the network, 10 configured with Low priority, 20 with Normal priority, and 70 with Critical priority, and OVOC notifies 20% of them of an "over-license" state for a specific license type. In this example, OVOC takes out of service the 10 devices with Low priority and 10 devices with Normal priority (i.e., total of 20, which is 20% of 100). This selective process allows devices with higher priority to continue providing call service, while attempting to restore licenses to the Flex License pool due to the rejection of



new calls by the selected devices. During this period, the devices send their usage reports more frequently to OVOC, providing OVOC with a more up-to-date status of license usages in the network. If licenses become available for the specific license type in the pool, OVOC allows the selected devices to start accepting new calls ("ok" status). However, if after a certain period there are still unavailable licenses for the specific license type in the pool, OVOC notifies all devices (including those with Critical priority level) of this "over-license" status, and instructs **all of them to reject new calls**. To view the device's current license utilization (in percentage) per license type of the OVOC Flex License pool and the status ("ok" and "overlicense") of each license type, see [Viewing Flex License Utilization and Status](#) on page 1110.

Connection between the devices and OVOC is established over SNMP and functionality of the Flex License service is managed over TCP/HTTPS REST. If the device loses connectivity with OVOC, the device continues handling calls for a graceful period. If connectivity is not restored when this period expires, the device is blocked from handling new calls. When the device succeeds in connecting again with OVOC, it continues using the Flex License pool as normal.

When the device uses the Flex License, the License Key page (see [Viewing the License Key](#) on page 1094) displays "Flex License" in the 'Mode' field and displays the SBC capacity licenses received from the Flex License pool per license type under the **SBC Capacity** group, as shown in the following example:

SBC CAPACITY			
	<u>Local</u>	<u>Flex</u>	<u>Actual</u>
Far End Users	<del>240</del>	10	200
SBC Media Sessions		9	20
SBC Signaling Sessions		12	60
Transcoding Sessions		5	120
SBC Sessions	<del>240</del>		

- 'Local': This column displays the number of SBC licenses per license type from the locally installed License Key. These licenses are not used by the device and the figures are displayed crossed out (strikethrough).
- 'Flex': This column displays the maximum number of SBC licenses per license type in the OVOC Flex License pool.
- 'Actual': (This column can be ignored.)



After a device reset, the figures in the 'Flex' column appear only after the device receives its first report from OVOC on the Flex License pool capacity. This typically takes about five minutes.

The device sends the following SNMP alarms to indicate various conditions relating to the OVOC Flex License pool:

- **acFloatingLicenseAlarm**: Sent if you have configured an Allocation Profile that exceeds the device's resource capability.

- **acCloudLicenseManagerAlarm:** Sent upon various conditions such as loss of connectivity between device and OVOC.

For more information on these alarms, refer to the device's *SNMP Reference Guide*.



- The Flex License does not affect transcoding session capacity. By default, transcoding session capacity is at maximum (as supported by the device).
- For configuring the Flex License on OVOC, refer to the *OVOC User's Manual*, which can be downloaded from AudioCodes [website](#).
- The Fixed License only provides SBC capacity licenses (listed in the beginning of this section). Therefore, your device must still be installed with a local License Key to enable other ordered license-based features (e.g., Test Call) and capacity.
- The Flex License cannot operate with the other OVOC-managed license modes (e.g., Fixed License and Floating License). Therefore, before enabling the Flex License, make sure that the other license modes are disabled on OVOC.
- The Flex License ignores OVR, TDM2SBC, and LAD capacity licenses in the local License Key.

## Enabling Floating or Flex License

Before you can use the Floating or Flex license, you need to enable this feature.



Prior to enabling the Floating or Flex License, make sure that the following OVOC-related prerequisites have been fulfilled:

- The Floating or Flex License has been purchased from AudioCodes with the required SBC license capacities and installed on OVOC.
- The devices for which you want to use the Floating or Flex License have been configured on OVOC.
- For Floating License, OVOC has been configured for communication with AudioCodes Cloud License Manager.
- For Flex License, the devices have been configured with priority levels on OVOC.

For more information on configuring and managing the Floating or Flex License on OVOC, refer to the *OVOC User's Manual*, which can be downloaded from AudioCodes [website](#).

### ➤ To enable the Floating or Flex License:

1. Open the Floating License page (**Setup** menu > **Administration** tab > **License** folder > **Floating License**).
2. From the 'Floating License' drop-down list, select **Enable**.

**Figure 45-1: Enabling the Floating or Flex License**

GENERAL	
Floating License	Enable 
Connection with OVOC	Connected 
OVOC IP Address	10.8.6.250
OVOC Product Key	F83FBC1BFBCF

- Reset the device with a burn-to-flash for your settings to take effect. After the device resets, it connects with OVOC and OVOC-related information is displayed in the read-only fields:
  - '**Connection with OVOC**': Displays the device's connectivity status with OVOC:
    - "Connected": The device is connected to OVOC.
    - "Disconnected" The device has disconnected from OVOC due to problems with the network (HTTPS TCP connection).
    - "Not Connected": The device is not connected to OVOC.
  - '**OVOC IP Address**': Displays the IP address of OVOC.
  - '**OVOC Product Key**': Displays the Product Key of OVOC that is providing the Floating or Flex License.



Once you enable the Floating or Flex License, OVOC initiates a connection with the device. In other words, you don't configure the address of OVOC. The device connects with OVOC over SNMP and an SNMP manager is automatically added to the SNMP Trap Destinations table for this connection (see [Configuring SNMP Trap Destinations with IP Addresses](#) on page 80).

The status of the Floating License or Flex License is also displayed on the top bar of the License Key page, as shown below (e.g., Flex License mode):

Product Key	E25B13DE2205 OVOC Product Key	Flex License Mode	2576900 Serial Number	72 Device Type	Connected License Server Status
-------------	----------------------------------	----------------------	--------------------------	-------------------	------------------------------------

- '**OVOC Product Key**': Product Key of the OVOC tool providing the Floating License or Flex License
- '**Mode**': Indicates the license type:
  - "Floating License": Floating License mode
  - "Flex License": Flex License mode
- '**License Server Status**': Connectivity status with OVOC (for more information, see [Viewing the License Key](#) on page 1094)

## Viewing Flex License Utilization and Status

You can view the device's current license utilization (in percentage) per license type of the OVOC Flex License pool.

You can also view the status of total license utilization per license type of the pool by **all** devices. If total utilization is within the pool's capacity, the "ok" status is displayed. If utilization has reached (or exceeded) the pool's capacity, the "overlicense" status is displayed. When the status is "overlicense", OVOC first attempts to return licenses to the pool by instructing certain devices (based on their priority level) to block new calls. If this doesn't help after a graceful period, OVOC instructs all devices to block new calls until licenses return to the pool. For more information, see [Flex License Model](#) on page 1106.



- The **Flex Pool** group (below) appears only if you have enabled the Floating License or Flex License feature (see [Floating License Model](#) on page 1104).
- The Flex License does not affect transcoding session capacity. By default, transcoding session capacity is at maximum (as supported by the device).

### ➤ To view Flex License utilization and status:

1. Open the Floating License page (**Setup** menu > **Administration** tab > **License** folder > **Floating License**).
2. Scroll down to the **Flex Pool** group:

FLEX POOL		
	Utilization	Status
SBC Media Sessions	66.67%	ok
SBC Signaling Sessions	50.00%	ok
Far End Users	<1%	ok
Transcoding Sessions	120.00%	overlicense

- 'Utilization': Displays the percentage (%) of the license capacity per license type in the OVOC Flex License pool that the device is currently using. Utilization of less than 1% is displayed as "<1%".
- 'Status': Displays the utilization status of the OVOC Flex License pool by all devices:
  - ◆ "ok": Utilization is within the pool capacity.
  - ◆ "overlicense": Utilization has reached or exceeded the Flex License pool capacity.

## Configuring Floating or Flex License Allocation Profiles

The Floating or Flex License allows you to configure *Allocation Profiles*, which specify license capacity per license type that you want allocated to the device by OVOC. For example, you may want to limit the device to only 20 Far End Users, even though OVOC could allocate up to 100 Far End Users.

You can choose a default Allocation Profile (**SIP Trunking** or **Registered Users**) that has a pre-defined capacity suited for these applications, or you can configure a customized Allocation Profile. In addition, once you have chosen an Application Profile and reset the device to apply it, you can easily reduce (*limit*) the pre-defined capacity or customized capacity when needed, without resetting the device.



You can only configure Allocation Profiles once you have enabled the Floating or Flex License (see [Enabling Floating or Flex License](#) on page 1108).

➤ **To configure Allocation Profiles:**

1. Open the Floating License page (**Setup** menu > **Administration** tab > **License** folder > **Floating License**).
2. From the 'Allocation Profile' drop-down list, select an SBC license Allocation Profile:
  - **SIP Trunking:** Provides default capacity (cannot be modified) in the 'Allocation' field per license type and is suited for SIP Trunking applications (i.e., where user registration is typically not required). You can later reduce the capacity using the 'Limit' field after you reset the device, as described in Step 4.
  - **Registered Users:** Provides default capacity (cannot be modified) in the 'Allocation' field per license type and is suited for applications where user registration is required. You can later reduce the capacity using the 'Limit' field after you reset the device, as described in Step 4.
  - **Custom:** Allows you to configure a customized Allocation Profile. In the 'Allocation' field corresponding to each SBC license type, configure the desired capacity.

**Figure 45-2: Configuring Allocation Profile (e.g., Custom)**

Allocation Profile	Custom	⌵ ⚡
	Allocation ⚡	Limit
Far End Users	1600	⌵
SBC Media Sessions	400	⌵
SBC Signaling Sessions	400	⌵
Transcoding Sessions	60	⌵

Range: 0-400



When configuring a customized Allocation Profile (i.e., 'Allocation Profile' configured to **Custom**):

- To view the device's maximum supported capacity per license type, hover your mouse over the corresponding 'Allocation' field and a pop-up appears displaying the capacity.
- The 'Transcoding Sessions' license type capacity cannot be modified in the 'Allocation' field. However, you can reduce the license using its corresponding 'Limit' field, as described below.
- The Floating or Flex Licenses don't affect transcoding session capacity. By default, transcoding session capacity is at maximum (as supported by the device).

3. Reset the device with a burn-to-flash for your settings to take effect.
4. You can now reduce each SBC license type capacity whenever needed **without** resetting the device:
  - a. Select the check box corresponding to the license type you want reduced.
  - b. In the corresponding 'Limit' field, enter a new capacity. The value can be equal to or less than the value in the 'Allocation' field.
  - c. Click **Apply**.

The figure below shows an example of using the 'Limit' field to reduce the allocation of SBC Media Sessions to 40 and the SBC Signaling Sessions to 80 for the **SIP Trunking** Allocation Profile:

**Figure 45-3: Configuring Limits for Allocation Profile**

ALLOCATION			
Allocation Profile	SIP Trunking		
	Allocation	Limit	
SBC Media Sessions	250	40	<input checked="" type="checkbox"/>
SBC Signaling Sessions	250	80	<input checked="" type="checkbox"/>
Far End Users	0		<input type="checkbox"/>
Transcoding Sessions	15		<input type="checkbox"/>

## Viewing Floating or Flex License Reports

You can view the SBC resource consumption (signaling sessions, media sessions, transcoding sessions, and far-end user registrations) reports of the Floating License or Flex License that the device periodically sends to OVOC.



- The Floating License Reports page is available only if you have enabled the Floating License or Flex License feature (see [Floating License Model](#) on page 1104).
- The Floating License does not affect transcoding session capacity. By default, transcoding session capacity is at maximum (as supported by the device).

➤ **To view the Floating License or Flex License Report through Web interface:**

- Open the Floating License Reports page (**Setup** menu > **Administration** tab > **License** folder > **Floating License Reports**).

REPORT DATE ↕	SIGNALING SESSIONS	MEDIA SESSIONS	TRANSCODING SESSIONS	FAR END USERS
2018-09-04 15:16:12	0	0	0	0
2018-09-04 15:15:11	0	0	0	0
2018-09-04 15:14:10	0	0	0	0
2018-09-04 15:13:10	0	0	0	0
2018-09-04 15:12:08	0	0	0	0
2018-09-04 15:11:08	0	0	0	0
2018-09-04 15:10:07	0	0	0	0
2018-09-04 15:09:06	0	0	0	0
2018-09-04 15:08:06	0	0	0	0
2018-09-04 15:07:04	0	0	0	0
2018-09-04 15:06:04	2111	2109	0	0
2018-09-04 15:05:03	2032	2029	0	0
2018-09-04 15:04:02	2009	2008	0	0
2018-09-04 15:03:01	2012	2010	0	0
2018-09-04 15:02:00	2009	2007	0	0

## Viewing the Device's Product Key

The Product Key identifies a specific purchase of your device installation for the purpose of subsequent communication with AudioCodes (e.g., for support and software upgrades). The Product Key is your chassis' serial number--"S/N(Product Key)"--which also appears on the product label affixed to the chassis.

The Product Key is included in the License Key. You can view the Product Key on the following Web pages:

- License Key page (see [Viewing the License Key](#) on page 1094). The Product Key is displayed in the read-only 'Product Key' field, as shown in the example below:

### License Key

QEE3C2A64FF016Y5

Product Key

- Device Information page (see [Viewing Device Information](#) on page 1163).

If your License Key was purchased in an earlier version, the 'Product Key' field may appear empty.

## 46 Configuration File

This section describes how to save the device's configuration to a file and how to load a configuration file to the device.

### Downloading and Loading ini Configuration File

You can save (download) the device's configuration as an ini file to a folder on your computer or load (upload) an ini file to the device. Saving an ini file can serve as a backup of your configuration and if needed, you can later load the file to the device to restore your previous configuration settings.



- The saved (downloaded) ini file includes only the following:
  - ✓ Configuration tables that contain row entries (default and non-default).
  - ✓ Standalone parameters whose values you changed from default. However, it also includes parameters whose values you changed from non-default back to default without subsequently resetting the device. If you changed from non-default back to default but subsequently reset the device, then they'll not be included.
  - ✓ All SNMP performance monitoring MIBs whose threshold values (low or high) you changed from default. (To apply these same threshold values to other devices, load the ini file to the devices.)
  - ✓ The device's License Key.
- When loading an ini file, parameters not included in the file **are restored to default settings**. If you want to keep the device's current configuration settings and also apply the settings specified in the ini file, load the file through the Auxiliary Files page (see [Loading Auxiliary Files through Web Interface](#)).
- When loading an ini file, the device needs to reset for the parameter settings to take effect.

#### ➤ To save or load an ini file through the Web interface:

1. Open the Configuration File page:
  - **Toolbar:** From the **Actions** drop-down menu, choose **Configuration File**
  - **Navigation tree:** Setup menu > Administration tab > Maintenance folder > Configuration File

The relevant buttons for saving and loading an ini file are located under the INI File group:

#### INI FILE

Save **INI** file to the PC.

Load **INI** file to the device.

No file selected.



2. To save the ini file: Click the **Save INI File** button, and then save the file to a folder on your computer.
3. To load an ini file:
  - a. Click the **Browse** button, and then browse to and select the file on your computer.
  - b. Click the **Load INI File** button; the following message box appears, informing you that the device will reset after the file is loaded.

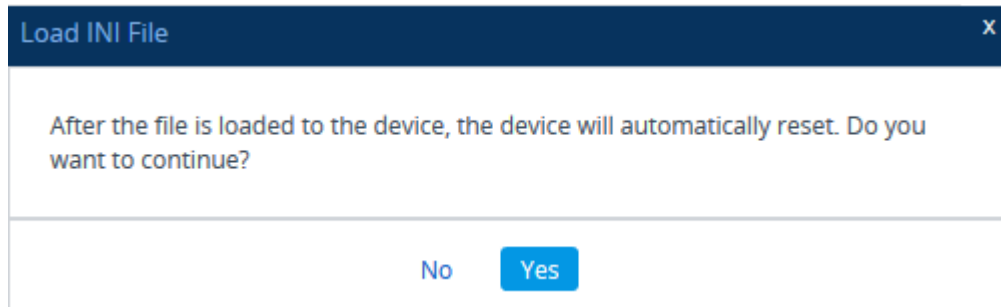

- c. Click **Yes** to continue (or **No** to cancel the file load). If you click **Yes**, the device loads the file and then resets with a save to flash for the settings to take effect.

## Saving and Loading CLI Script Files

You can save and load the device's configuration as a CLI Script file. Saving a CLI Script file can serve as a backup of your configuration and if needed, you can later load the file to the device to restore your previous configuration settings. You can also load a CLI Startup Script file.



- When loading a CLI Script file, the device resets only if it contains the **reload now** command (on the last line). For more information on this command, refer to the *CLI Reference Guide*.
- When loading a CLI Startup Script file, the device needs to reset twice for its settings to take effect.
- The saved file includes only parameters whose values you have modified.
- To save the CLI Script file to a remote server (TFTP or HTTP/S): `# write-and-backup to <URL with file name>`

### ➤ To save or load a CLI Script file through Web interface:

1. Open the Configuration File page:
  - **Toolbar:** From the **Actions** drop-down menu, choose **Configuration File**
  - **Navigation tree:** **Setup** menu > **Administration** tab > **Maintenance** folder > **Configuration File**
2. To save the CLI Script file, under the CLI Script group: Click the **Save CLI Script File** button, and then save the file to a folder on your computer.

Save **CLI Script** file to the PC

Save CLI Script File

3. To load a CLI Script file, under the CLI Script group, do the following:

Load **CLI Script** file to the device.



- a. Click the **Browse** button, and then browse to and select the file on your computer.
  - b. Click the **Load CLI Script File** button; the device loads the file and then resets with a save to flash.
4. To load a CLI Startup Script file, under the CLI Script group, do the following:

Load **CLI Startup Script** to the device.



- a. Click the **Browse** button, and then browse to and select the file on your computer.
- b. Click the **Load CLI Startup Script** button; the following message box appears, informing you that the device will reset after the file is loaded.

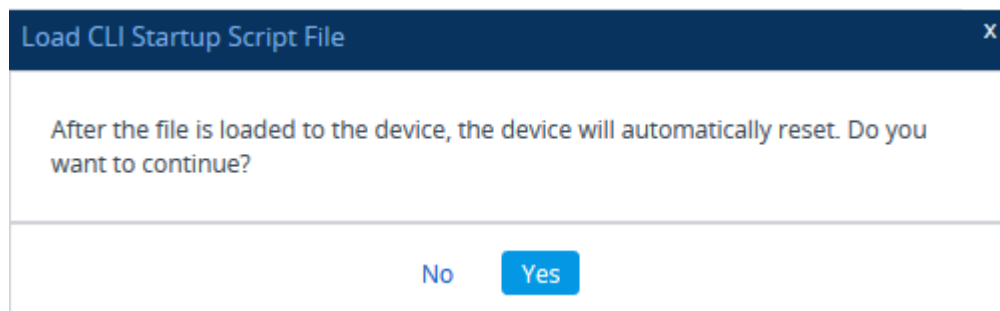

- c. Click **Yes** to continue (or **No** to cancel the file load). If you click **Yes**, the device loads the file and then resets with a save to flash for the settings to take effect..

## Saving and Loading a Configuration Package File

You can save and load a bundle of files used by the device in one single packaged file. The packaged file is a TAR (Tape ARchive) file (.tar), compressed with gzip. The feature can be used for backing up full configuration and then later restoring it to the device in case of device configuration failure (for whatever reason), or for loading the backed-up configuration package file to other devices requiring similar configuration.

The configuration package file can include the following files:

- ini.ini (ini configuration file)
- LOGO.dat (image file used as the logo in the Web interface)
- FAVICON.dat (favicon file used for Web browsers)
- CPT.dat (Call Progress Tone file) - present only if a CPT file was previously loaded to the device

- PRT.dat (Pre-recorded Tone file) - present only if a PRT file was previously loaded to the device
- AMD.dat (Answer Machine Detection file) - present only if a CPT file was previously loaded to the device
- SBC\_Wizard.dat (SBC Configuration Wizard template file)
- CAS\_<ID>.dat (CAS file) - present only if a CAS file was previously loaded to the device
- DPLN.dat (Dial Plan file) - only for backward compatibility of previous versions that supported a Dial Plan file; for current versions, the Dial Plan is included in the ini file
- Certificate files (<ctx\_id>.crt, <ctx\_id>.root, <ctx\_id>.pkey)
- DialPlanRule.csv (Dial Plan file) - present only if the device was configured with Dial Plan rules



- When loading a Configuration Package file, the device needs to reset for the settings to take effect.
- For the certificate files, only the root certificate file (.root) can be saved.
- When loading a Configuration Package file, the filenames must be as listed above.
- By default, the Configuration Package file is saved with the filename "ConfBackupPkg<Serial Number>.tar.gz".

You can save and load a Configuration Package file using the following methods:

■ **CLI:**

```
# copy configuration-pkg from|to <URL>
```

- **Auto-Update Feature:** To load the Configuration Package file through the Auto-Update mechanism, use the ConfPackageURL ini file parameter.
- **SFTP:** The Configuration Package file (configuration-package.tar.gz) can also be downloaded (Get) from the device through SFTP. The file is located in the */configuration* directory. Your SFTP client needs to authenticate itself with the SFTP server (i.e., the device) and access is granted only to users with Security Administrator level.
- **Web interface:**
  - a. Open the Configuration File page:
    - ◆ **Toolbar:** From the **Actions** drop-down menu, choose **Configuration File**
    - ◆ **Navigation tree:** Setup menu > Administration tab > Maintenance folder > Configuration File

**CONFIGURATION PACKAGE**Save **Configuration Package** to the PC.

Save Configuration Package

Load **Configuration Package** to the device.

Browse...

No file selected.

Load Configuration Package

- b. To save the Configuration Package file: Click the **Save Configuration Package** button, and then save the file to a folder on your computer.
- c. To load a Configuration Package file:
  - i. Click the **Browse** button, and then browse to and select the file on your computer.
  - ii. Click the **Load Configuration Package** button; the following message box appears, informing you that the device will reset after the file is loaded.

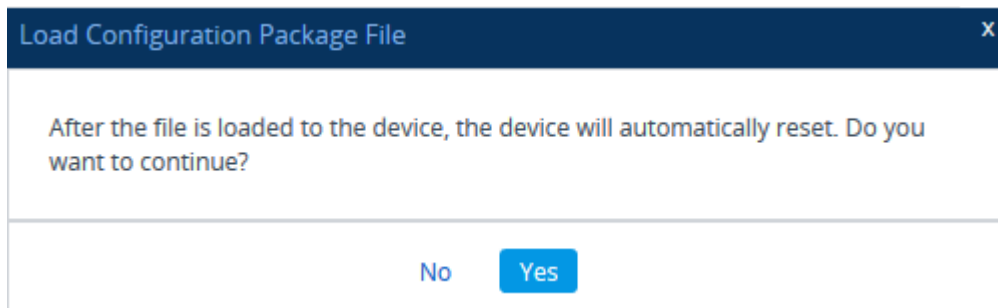

- iii. Click **Yes** to continue (or **No** to cancel the file load). If you click **Yes**, the device loads the file and then resets with a save to flash for the settings to take effect.

## 47 Automatic Provisioning

This chapter describes automatic provisioning of the device.

### Automatic Configuration Methods

The device supports the following automatic provisioning methods:

- DHCP (Option 66, Option 67, Option 160)
- HTTP/S
- TFTP
- FTP
- SNMP (AudioCodes OVOC)

### DHCP-based Provisioning

A third-party DHCP server can be configured to automatically provide each device, acting as a DHCP client, with a temporary IP address so that individual MAC addresses are not required. The DHCP server can provide additional networking parameters such as subnet mask, default gateway, primary and secondary DNS server, and two SIP server addresses. These network parameters have a time limit, after which the device must 'renew' its lease from the DHCP server.

The device can use a host name in the DHCP request. The host name is set to `acl_nnnnn`, where `nnnnn`



- When using DHCP to acquire an IP address, VLANs and other advanced configuration options are disabled.
- For additional DHCP parameters, see [DHCP Parameters](#).

#### ➤ To enable the device as a DHCP client:

1. Open the Network Settings page (**Setup** menu > **IP Network** tab > **Advanced** folder > **Network Settings**).
2. From the 'Enable DHCP' drop-down list, select **Enable**.

DHCP

Enable DHCP Enable ▼

3. Click **Apply**.
4. To activate the DHCP process, reset the device.

The following shows an example of a configuration file for a Linux DHCP server (dhcpd.conf). The devices are allocated temporary IP addresses in the range 10.31.4.53 to 10.31.4.75. TFTP is assumed to be on the same computer as the DHCP server (alternatively, the "next-server" directive may be used).

```
ddns-update-style ad-hoc;
default-lease-time 60;
max-lease-time 60;
```

```
class "gateways" {
    match if(substring(hardware, 1, 3) = 00:90:8f);
}
subnet 10.31.0.0 netmask 255.255.0.0 {
    pool {
        allow members of "AudioCodes";
        range 10.31.4.53 10.31.4.75;
        filename "SIP_F6.60A.217.003.cmp-fb;device.ini";
        option routers      10.31.0.1;
        option subnet-mask  255.255.0.0;
    }
}
```



- If the DHCP server denies the use of the device's current IP address and specifies a different IP address (according to RFC 1541), the device must change its networking parameters. If this occurs while calls are in progress, they are not automatically rerouted to the new network address. Therefore, administrators are advised to configure DHCP servers to allow renewal of IP addresses.
- If the device's network cable is disconnected and then reconnected, a DHCP renewal is performed (to verify that the device is still connected to the same network). The device also includes its product name in the DHCP Option 60 Vendor Class Identifier. The DHCP server can use this product name to assign an IP address accordingly.
- After power-up, the device performs two distinct DHCP sequences. Only in the second sequence is DHCP Option 60 included. If the device is software reset (e.g., from the Web interface or SNMP), only a single DHCP sequence containing Option 60 is sent.

### Provisioning from HTTP Server using DHCP Option 67

You can provision the device through HTTP using DHCP Option 67. In this setup, DHCP Option 67 informs the device of the URL address of the HTTP server from where it can download the configuration file. This provisioning method is possible only if the DHCP server allows configuration of DHCP Option values for different equipment in the network.

Upon device startup, the device sends a DHCP request. The DHCP response received from the DHCP server contains networking (e.g., IP address and DNS server) information. In addition, the response includes DHCP Option 67, which specifies the URL address of the HTTP server where the device's configuration file is located. The device then automatically downloads the configuration file from this HTTP server.

Below is an example of a configuration file (dhcpd.conf) of a Linux-based DHCP server, showing the required format of Option 67:

```
ddns-update-style ad-hoc;
default-lease-time 3600;
max-lease-time 3600;
```

```
class "AudioCodes" {
    match if(substring(hardware, 1, 3) = 00:90:8f);
}
subnet 10.31.0.0 netmask 255.255.0.0 {
    pool {
        allow members of "AudioCodes";
        range 10.31.4.53 10.31.4.75;
        option routers      10.31.0.1;
        option subnet-mask  255.255.0.0;
        option domain-name-servers 10.1.0.11;
        option bootfile-name  "INI=http://www.corp.com/master.ini";
        option dhcp-parameter-request-list 1,3,6,51,67;
    }
}
```



- The value of Option 67 must include the URL address, using the following syntax: "INI=<URL with ini file name>"
- This method is NAT-safe.

➤ **To configure the device for automatic provisioning through HTTP/S using DHCP Option 67:**

1. Enable DHCP client functionality, by configuring the following ini file parameter:

```
DHCPEnable = 1
```

2. Enable the device to include DHCP Option 67 in DHCP Option 55 (Parameter Request List) when requesting HTTP provisioning parameters from a DHCP server, using the following ini file parameter:

```
DHCPRequestTFTPParams = 1
```

3. Reset the device with a save-to-flash for your settings to take effect.

### Provisioning from TFTP Server using DHCP Option 66

Provisioning the device from a third-party TFTP server is suitable when the network in which the device is deployed includes a provisioning TFTP server for all network equipment, without the capability of distinguishing between AudioCodes and non-AudioCodes devices.

Upon startup, the device checks for DHCP Option 66 in the DHCP response received from the DHCP server. If Option 66 contains a valid IP address (or FQDN) of the TFTP provisioning server, the device attempts to download through TFTP, a configuration file whose filename contains the device's MAC address (e.g., 00908f0130aa.ini).

This method loads the configuration file to the device as a one-time action. The download is repeated only if the device is manually restored to factory defaults (by pressing the hardware reset button while the Ethernet cable is not connected) and DHCP is enabled (see note below).

#### ➤ To configure the device for automatic provisioning through TFTP using DHCP Option 66:

1. Enable DHCP client functionality, by configuring the following ini file parameter:

```
DHCPEnable = 1
```

2. Enable the device to include DHCP Option 66 in DHCP Option 55 (Parameter Request List) when requesting TFTP provisioning parameters from a DHCP server, using the following ini file parameter:

```
DHCPRequestTFTPParams = 1
```

3. Reset the device with a save-to-flash for your settings to take effect.



- Access to the core network through TFTP is not NAT-safe.
- The TFTP data block size (packets) when downloading a file from a TFTP server for the Automatic Update mechanism can be configured using the AUPDTftpBlockSize parameter.

### Provisioning the Device using DHCP Option 160

You can provision the device using DHCP Option 160. DHCP Option 160 provides the device with the URL address of the provisioning server from where it can download its software (.cmp) and configuration (.ini) files. The URL can also include the names of the required files to download and their folder location on the server.



If you enable DHCP client functionality with DHCP Option 160, upon a device reset or power up, the device (as a DHCP client) sends a DHCP request to the DHCP server to obtain networking information (e.g., the device's IP address) and the URL address of the provisioning server.

The following syntax is supported for defining the URL and configuration/firmware filenames in DHCP Option 160 (on the DHCP server):

- <protocol>://<server IP address or hostname>
- <protocol>://<server IP address or hostname>/<software filename>
- <protocol>://<server IP address or hostname>/;<configuration filename>
- <protocol>://<server IP address or hostname>/<software filename>;<configuration filename>

The protocol can be HTTP, HTTPS, FTP, or TFTP. As shown above, the URL can include both the software and configuration filenames. In this case, they must be separated by a semicolon (;) and without spaces.

If the URL does not specify a configuration filename or the file does not exist on the provisioning server, the device requests from the server a "default" configuration file whose name includes the device's product name and MAC address (<Product><MAC>.ini, for example, "M800B00908f5b1035.ini"). If this "default" file also does not exist on the server, the device attempts to retrieve another "default" configuration file whose name includes only the device's product name (<Product>.ini, for example, "M800B.ini"). The device makes up to three attempts to download the configuration file if a failure occurs (i.e., file not exist or any other failure reason). This applies to each of the configuration files, as mentioned previously.

If the URL specifies a software file, the device makes only one attempt to download the file (even if a failure occurs). If the URL does not specify a software file, the device does not make any attempt to download a software file.

Once the device downloads the file(s), it undergoes a reset to apply the configuration and/or software. In addition, once the file(s) has been downloaded, the device ignores all future DHCP Option 160 messages. Only if the device is restored to factory defaults will it process Option 160 again (and download any required files).

➤ **To enable provisioning using DHCP Option 160:**

1. Make sure that the DHCP server is configured with the appropriate information (including the URL address of the provisioning server for Option 160).
2. Make sure that the required configuration and/or software files are located on the provisioning server.
3. Enable DHCP client functionality, as described in [DHCP-based Provisioning](#) on page 1119
4. Enable the device to include DHCP Option 160 in the DHCP Parameter Request List field of the DHCP request packet that is sent to the DHCP server. Do this by loading an ini file to the device with the following parameter setting:

```
DhcpOption160Support = 1
```

1. Reset the device with a save-to-flash for your settings to take effect.

## HTTP-based Provisioning

An HTTP or HTTPS server can be located in the network in which the device is deployed, storing configuration and software files for the device to download. This does not require additional servers and is NAT-safe.

For example, assume the core network HTTPS server is `https://www.corp.com`. A master configuration ini file can be stored on the server, for example, `https://www.corp.com/gateways/master.ini`. This file could point to additional ini files, Auxiliary files (e.g., call progress tones), and software files (cmp), all on the same HTTP server or different HTTP servers in the network.

The main advantage of this method is that the device can be configured to periodically check the HTTP server for file updates. HTTP(S) is not sensitive to NAT devices, enabling configuration whenever needed without on-site intervention. For additional security, the URL may contain a different port, and username and password.

The only configuration required is to preconfigure the device(s) with the URL of the initial (master) ini file. This can be done using one of the following methods:

- DHCP, as described in [DHCP-based Provisioning](#) or via TFTP at a staging warehouse. The URL is configured using the `IniFileURL` parameter.
- Private labeling (preconfigured during the manufacturing process).
- Using DHCP Option 67 (see [Provisioning from HTTP Server using DHCP Option 67](#)).
- Manually on-site, using the RS-232 port or Web interface.

When the device is deployed at the customer site, local DHCP server provides the devices with IP addressing and DNS server information. From the URL provided in the DHCP response, the device can then contact the HTTP server at the core network and automatically download its configuration. The URL can be a simple file name or contain the device's MAC or IP address, e.g.:

- `http://corp.com/config-<MAC>.ini` - which becomes, for example, `http://corp.com/config-00908f030012.ini`
- `http://corp.com/<IP>/config.ini` - which becomes, for example, `http://corp.com/192.168.0.7/config.ini`

For more information on HTTP-based provisioning, see [HTTP/S-Based Provisioning using the Automatic Update Feature](#).

## FTP-based Provisioning

The Automatic Update feature provides limited support for FTP/FTPS connectivity. Periodic polling for updates is not possible since these protocols do not support conditional fetching (i.e., updating files only if they are changed on the server).

The only difference between FTP-based provisioning and those described in [HTTP-based Provisioning](#) and [Provisioning from HTTP Server using DHCP Option 67](#) is that the protocol in the URL is "ftp" (instead of "http").

## Provisioning through OVOC

AudioCodes One Voice Operations Center (OVOC) server functions as a core-network provisioning server. The device's SNMP Manager should be configured with the IP address of the OVOC server, using one of the methods detailed in the previous sections. As soon as a registered device contacts OVOC through SNMP, OVOC handles all required configuration automatically, upgrading software as needed. This alternative method doesn't require additional servers at the customer premises, and is NAT-safe.

## HTTP/S-Based Provisioning using the Automatic Update Feature

The Automatic Update feature can be used for automatic provisioning of the device through HTTP/S. Automatic provisioning is useful for large-scale deployment of devices. In some cases, the devices are shipped to the end customer directly from the manufacturer. In other cases, they may pass through a staging warehouse. Configuration may occur at the staging warehouse or at the end-customer premises.

The device may be preconfigured during the manufacturing process (commonly known as private labeling). Typically, a two-stage configuration process is implemented whereby initial configuration includes only basic configuration, while the final configuration is done only when the device is deployed in the live network.



If you use the `IniFileURL` parameter for the Automatic Update feature, do not use the Web interface to configure the device. If you do configure the device through the Web interface and save (burn) the new settings to the device's flash memory, the `IniFileURL` parameter is automatically set to 0 and Automatic Updates is consequently disabled. To enable Automatic Updates again, you need to re-load the ini file (using the Web interface or BootP) with the correct `IniFileURL` settings. As a safeguard to an unintended save-to-flash when resetting the device, if the device is configured for Automatic Updates, the 'Burn To FLASH' field under the Reset Configuration group in the Web interface's Maintenance Actions page is automatically set to No by default.



- For a description of all the Automatic Update parameters, see [Automatic Update Parameters](#) or refer to the *CLI Reference Guide*.



- For additional security, use HTTPS or FTPS. The device supports HTTPS (RFC 2818) and FTPS using the AUTH TLS method <draft-murray-auth-ftp-ssl-16>.

## Files Provisioned by Automatic Update

You can use the Automatic Update feature to update the device with any of the following files:

- Software file (*.cmp*)
- License Key file
- Auxiliary files (e.g., Dial Plan file, CAS file, SBC User Information file, and Call Progress Tones file)
- TLS security files (trusted root certificate file, TLS certificate file, and private key)
- Web GUI file (favicon file)
- Configuration file:
  - **ini File:** Contains only ini file parameters and configures all the device's functionality.
  - **CLI Script File:** Contains only CLI commands and configures all the device's functionalities (except commands such as show, debug or copy). The file updates the device's configuration only according to the configuration settings in the file. The device's existing configuration settings (not included in the file) are retained. The device does not undergo a reset and therefore, this file typically contains configuration settings that do not require a device reset. If a reset is required, for example, to apply certain settings, you must include the following CLI command (root level) at the end of the file:

```
# reload if-needed
```

To configure the URL of the server where the file is located, use the `CliScriptURL` ini file parameter or CLI command, `configure system > automatic-update > cli-script <URL>`.

- **Startup Script File:** Contains only CLI commands and configures all the device's functionality (except commands such as show, debug or copy). The file updates the device's configuration according to the configuration settings in the file and sets all other parameters that are not included in the file to factory defaults. The file causes two device resets to apply the settings. Therefore, the file typically contains the Automatic Update settings and other configuration settings that require a device reset. The URL of the server where this file is located is configured by the `CLIScriptURL` ini file parameter or CLI command, `configure system > automatic-update > startup-script <URL>`.



- You can use any filename extension for the CLI script files.

## File Location for Automatic Update

The files for updating the device can be stored on any standard Web (HTTP/S), TFTP, FTP, or NFS server. The files can be loaded periodically to the device using HTTP/S, TFTP, FTP, or NFS. This mechanism can be used even when the device is installed behind NAT and firewalls. The Automatic Update feature is done per file and configured by specifying the file name and URL address of the provisioning server where the file is located. If the device needs to authenticate itself with the server, you can use the same parameters to configure the authentication username and password (for more information, see [Access Authentication with HTTP Server](#) on page 1132). For a description of the parameters for configuring the URLs of the servers of the files, see [Automatic Update Parameters](#).

Below are examples for configuring the file names and their URLs for Automatic Update:

### ■ ini File:

```
IniFileURL = 'http://www.corp.com/configuration.ini'
CptFileURL = 'http://www.corp.com/call_progress.dat'
AutoCmpFileUrl = 'http://www.corp.com/SIP_F7.20A.008.cmp'
FeatureKeyURL = 'https://www.company.com/License_Key.txt'
```

### ■ CLI:

```
# configure system
(config-system)# automatic update
(automatic-update)# cli-script https://company.com/cli/<MAC>
(automatic-update)# startup-script https://company.com/startup/<MAC>
(automatic-update)# ini-file http://www.company.com/configuration.ini
(automatic-update)# call-progress-tones http://www.company.com/call_
progress.dat
(automatic-update)# feature-key http://www.company.com/License_Key.txt
(automatic-update)# auto-firmware http://www.company.com/SIP_
F7.20A.008.cmp
```



- For configuration files, the file name in the URL can automatically contain the device's MAC address for enabling the device to download a file unique to the device. For more information, see [MAC Address Placeholder in Configuration File Name](#).
- When using the [IniFileURL] parameter, parameters not included in the file are restored to default settings. If you want to keep the settings of such parameters, use the [IncrementalIniFileURL] parameter.

## MAC Address Placeholder in Configuration File Name

You can configure the file name of the configuration file in the URL to automatically include the MAC address of the device. As described in [File Location for Automatic Update](#)

```
IniFileURL = 'https://www.company.com/config_<MAC>.ini'
(automatic-update)# cli-script https://company.com/files/cli_script_<MAC>.txt
(automatic-update)# startup-script https://company.com/files/startup_<MAC>.txt
```

The device automatically replaces the string with its hardware MAC address, resulting in a file name request that contains the device's MAC address, for example, config\_00908F033512.ini or startup\_00908F033512.txt. Therefore, you can configure all the devices with the same URL and file name.



If you write the MAC address placeholder string in lowercase (i.e., "<mac>"), the device adds the MAC address in lowercase to the file name (e.g., config\_<mac>.ini results in config\_00908f053736e); if in uppercase (i.e., "<MAC>"), the device adds the MAC address in uppercase to the file name (e.g., config\_<MAC>.ini results in config\_00908F053736E).

## File Template for Automatic Provisioning

To facilitate automatic provisioning setup, you can use a single template to define the files to download during automatic provisioning. The template uses special keywords to denote the different file types to download and in the URL address of the provisioning server it uses a placeholder for the file names which is replaced by hardcoded file names and extensions according to file type, as described in more detail below.



- Unlike the parameters that define specific URLs for Auxiliary files (e.g., CptFileURL), the file template feature always retains the URLs after each automatic update process. Therefore, with the file template the device always attempts to download the files upon each automatic update process.
- If you configure a parameter used to define a URL for a specific file (e.g., CptFileURL), the settings of the TemplateUrl parameter is ignored for the specific file type (e.g., CPT file).
- Additional placeholders can be used in the file name in the URL, for example, <MAC> for MAC address (see [MAC Address Placeholder in Configuration File Name](#)).

### ➤ To use a file template for automatic provisioning:

1. Define the file **types** to download by the file template, using the AupdFilesList parameter. Use the keywords listed in the table below to specify each file type. For example, to specify ini, License Key, and CPT files:
  - ini File:

```
AupdFilesList = 'ini', 'fk', 'cpt'
```

- CLI:

```
# configure system
(config-system)# automatic update
(automatic-update)# template-files-list ini,fk,cpt
```

2. Define the URL address of the provisioning server on which the files (specified in Step 1) are located for download, using the TemplateUrl parameter. When you configure the URL, you must include the file type placeholder, "<FILE>", which represents the file name. For each file type specified in Step 1, the device sends an HTTP request to the server, where the placeholder in the URL is replaced with the filename and extension, as listed in the below table. For example, if you configure the AupdFilesList parameter as in Step 1 and the TemplateUrl parameter to:

- ini File:

```
TemplateUrl = 'http://10.8.8.20/Site1_<FILE>'
```

- CLI:

```
# configure system
(config-system)# automatic update
(automatic-update)# template-url http://10.8.8.20/Site1_<FILE>
```

The device sends HTTP requests to the following URLs:

- [http://10.8.8.20/Site1\\_device.ini](http://10.8.8.20/Site1_device.ini)
  - [http://10.8.8.20/Site1\\_fk.ini](http://10.8.8.20/Site1_fk.ini)
  - [http://10.8.8.20/Site1\\_cpt.data](http://10.8.8.20/Site1_cpt.data)
3. Place the files to download on the provisioning server. Make sure that their file names and extensions are based on the hardcoded string values specific to the file type for the <FILE> placeholder (e.g., "Site1\_device.ini" for the ini file), as shown in the table below.

**Table 47-1: File Template Keywords and Placeholder Values per File Type**

File Type	Keywords for Template File	Value Replacing <FILE> Placeholder
ini file	ini	device.ini
CLI Script file	cli	cliScript.txt

File Type	Keywords for Template File	Value Replacing <FILE> Placeholder
CLI Startup Script file	clis	cliStartupScript.txt
CMP file based on timestamp	acmp	autoFirmware.cmp
Voice Prompts (VP) file	vp	vp.dat
User Information file	usrinf	userInfo.txt
CMP file	cmp	firmware.cmp
License Key file	fk	fk.ini
Call Progress Tone (CPT) file	cpt	cpt.dat
Prerecorded Tones (PRT) file	prt	prt.dat
CAS file	cas	cas.dat
Dial Plan file	dpln	dialPlan.dat
Answering Machine Detection (AMD) file	amd	amd.dat
TLS Private Key file	sslp	pkey.pem pkey<ID>.pem (for multi-certificate system)
TLS Root Certificate file	sslr	root.pem root<ID>.pem (for multi-certificate system)
TLS Certificate file	sslc	cert.pem cert<ID>.pem (for multi-certificate system)

## Triggers for Automatic Update

The Automatic Update feature can be triggered by the following:

- Upon device startup (reset or power up). To disable this trigger, run the following CLI command:

```
(config-system)# automatic-update
(automatic-update)# run-on-reboot off
```



- Periodically:
  - Specified time of day (e.g., 18:00), configured by the ini file parameter [AutoUpdatePredefinedTime] or CLI command `configure system > automatic-update > predefined-time`. You can configure (using the [AutoUpdatePredefinedRandomTime] parameter) an interval from the specified time in which the automatic update is randomly triggered. This is useful for reducing load on the provisioning server when you have deployed multiple devices that are implementing the Automatic Update feature. For example, if you configure [AutoUpdatePredefinedTime] to 18:00 and [AutoUpdatePredefinedRandomTime] to 300 seconds (i.e., 5 min.), the automatic update process is randomly triggered anywhere between 18:00 and 18:05.
  - Interval between Automatic Updates (e.g., every 60 minutes), configured by the ini file parameter [AutoUpdateFrequency] or CLI command `configure system > automatic-update > update-frequency`.
- Centralized provisioning server request:
  - Upon receipt of an SNMP request from the provisioning server.
  - Upon receipt of a special SIP NOTIFY message from the provisioning server. The NOTIFY message includes an Event header with the AudioCodes proprietary value, "check-sync;reboot=false", as shown in the example below:

```
NOTIFY sip:<user>@<dsthost> SIP/2.0
To: sip:<user>@<dsthost>
From: sip:sipsak@<srchost>
CSeq: 10 NOTIFY
Call-ID: 1234@<srchost>
Event: check-sync;reboot=false
```

#### To enable the feature:

- i. Open the SIP Definitions General Settings page (**Setup** menu > **Signaling & Media** tab > **SIP Definitions** folder > **SIP Definitions General Settings**).
- ii. From the 'Remote Management by SIP Notify' (EnableSIPRemoteReset) drop-down list, select **Enable**:

Remote Management by SIP Notify      •

- iii. Click **Apply**.

To enable through CLI: `configure voip > sip-definition advanced-settings > sip-remote-reset`.

## Applying Downloaded ini File after Graceful Timeout

If you use the Automatic Update feature for updating the device's configuration from an ini file, you can configure the device to gracefully lock itself before applying the settings of the ini

file. When the Automatic Update feature is triggered (for example, by a device reset) and the device downloads the ini file from the remote provisioning server, the graceful timeout begins. During this period, the device does not accept any new calls, allowing only existing calls to continue until the timeout expires. If all existing calls end before the timeout expires, the device applies the configuration of the downloaded ini file. If there are still existing calls when the timeout expires, the device terminates the calls, and then applies the configuration of the downloaded ini file.

➤ **To configure graceful timeout for automatic update of ini file:**

1. In the ini file used for enabling and configuring the device for Automatic Update, include the following parameters with the other parameters (such as IniFileURL) relating to Automatic Update setup:

```
...
AupdGracefulShutdown=1
AdminStateLockControl=<Graceful Timeout>
...
```

2. Load the ini file to the device.

## Access Authentication with HTTP Server

You can configure the device to authenticate itself with the HTTP/S server storing the files that you want to download for the Automatic Update mechanism. The device authenticates itself by providing the HTTP/S server with its authentication username and password. The credentials are used for both Digest access authentication (MD5 cryptographic hashing) and the non-secured Basic access authentication method.

When configuring the URL of the server with the name of the file that you want downloaded, you can also include the username and password in the format "username:password" (without quotation marks), as shown in the example below for the software file (.cmp):

- ini file:

```
AutoCmpFileUrl = 'https://JoeD:1234@10.1.1.1/mysw.cmp'
```

- CLI:

```
# configure system
(config-system)# automatic update
(automatic-update)# auto-firmware https://JoeD:1234@10.1.1.1/mysw.cmp
```

If you have not included the username and password in the parameters used for configuring the URL of the server with the name of the file that you want downloaded, the device uses the

username and password that you configured for the ini file parameter [AUPDUserPassword] or CLI command `configure system > automatic-update > credentials`.



The password cannot be configured with wide characters (for example, Chinese characters).

## Querying Provisioning Server for Updated Files

Each time the Automatic Update feature is triggered, for each file and its configured URL the device does the following:

1. If you have configured the device to authenticate itself to the HTTP/S server for secure access, the device sends the access authentication username and password to the HTTP/S server (for more information, see [Access Authentication with HTTP Server](#)). If authentication succeeds, Step 2 occurs.
2. The device establishes an HTTP/S connection with the URL host (provisioning server). If the connection is HTTPS, the device verifies the certificate of the provisioning server, and presents its own certificate if requested by the server.
3. The device queries the provisioning server for the requested file by sending an HTTP Get request. This request contains the HTTP User-Agent Header, which identifies the device to the provisioning server. By default, the header includes the device's model name, MAC address, and currently installed software and configuration versions. Based on its own dynamic applications for logic decision making, the provisioning server uses this information to check if it has relevant files available for the device and determines which files must be downloaded (working in conjunction with the HTTP If-Modified-Since header, described further on in this section).

You can configure the information sent in the User-Agent header, using the [AupdHttpUserAgent] parameter or CLI command, `configure system > http-user-agent`. The information can include any user-defined string or the following supported string variable tags (case-sensitive):

- **<NAME>**: product name, according to the installed License Key
- **<MAC>**: device's MAC address
- **<VER>**: software version currently installed on the device, e.g., "7.00.200.001"
- **<CONF>**: configuration version, as configured by the ini file parameter, [INIFileVersion] or CLI command, `configuration-version`

The device automatically populates these tag variables with actual values in the sent header. By default, the device sends the following in the User-Agent header:

```
User-Agent: Mozilla/4.0 (compatible; AudioCodes;  
<NAME>;<VER>;<MAC>;<CONF>)
```

For example, if you configure [AupdHttpUserAgent] to "MyWorld-<NAME>;<VER> (<MAC>)", the device sends the following User-Agent header:

```
User-Agent: MyWorld-Mediant;7.00.200.001(00908F1DD0D3)
```



If you configure the [AupdHttpUserAgent] parameter with the <CONF> variable tag, you must reset the device with a save-to-flash for your settings to take effect.

4. If the provisioning server has relevant files available for the device, the following occurs, depending on file type and configuration:
  - **File Download upon each Automatic Update process:** This is applicable to software (.cmp) and configuration files. In the sent HTTP Get request, the device uses the HTTP If-Modified-Since header to determine whether to download these files. The header contains the date and time (timestamp) of when the device last downloaded the file from the specific URL. This date and time is regardless of whether the file was installed or not on the device. An example of an If-Modified-Since header is shown below:

```
If-Modified-Since: Mon, 1 January 2014 19:43:31 GMT
```

If the file on the provisioning server was unchanged (not modified) since the date and time specified in the header, the server replies with an HTTP 304 response and the file is not downloaded. If the file was modified, the provisioning server sends an HTTP 200 OK response with the file in the body of the HTTP response. The device downloads the file and compares the version of the file with the currently installed version on its flash memory. If the downloaded file is of a later version, the device installs it after the device resets (which is only done after the device completes all file downloads); otherwise, the device does not reset and does not install the file.

To enable the automatic software (.cmp) file download method based on this timestamp method, use the [AutoCmpFileUrl] parameter or CLI command `configure system > automatic-update > auto-firmware <URL>`. The device uses the same configured URL to download the .cmp file for each subsequent Automatic Update process.

You can also enable the device to run a CRC on the downloaded configuration file to determine whether the file has changed in comparison to the previously downloaded file. Depending on the CRC result, the device can install or discard the downloaded file. For more information, see [Cyclic Redundancy Check on Downloaded Configuration Files](#).



- When this method is used, there is typically no need for the provisioning server to check the device's current firmware version using the HTTP-User-Agent header.
- The Automatic Update feature assumes that the Web server conforms to the HTTP standard. If the Web server ignores the If-Modified-Since header or doesn't provide the current date and time during the HTTP 200 OK response, the device



may reset itself repeatedly. To overcome this problem, modify the update frequency, using the [AutoUpdateFrequency] parameter or CLI command `configure system > automatic update > update-frequency`.

- **One-time File Download:** This is applicable to software (.cmp) and Auxiliary (e.g., License Key, CPT and Dial Plan) files. The device downloads these files only **once**, regardless of how many times the device may repeat the Automatic Update process. Once they are downloaded, the device discards their configured URLs. To update these files again, you need to configure their URL addresses and filenames again. Below is an example of how to configure URLs for some of these files:

#### Auxiliary Files:

- ◆ ini:

```
CptFileURL = 'https://www.company.com/call_progress.dat'
FeatureKeyURL = 'https://www.company.com/License_Key.txt'
```

- ◆ CLI:

```
(config-system)# automatic-update
(automatic-update)# call-progress-tones
http://www.company.com/call_progress.dat
(automatic-update)# tls-root-cert https://company.com/root.pem
```

#### Software (.cmp) File:

- ◆ ini:

```
CmpFileUrl = 'https://www.company.com/device/7.20A.260.005.cmp'
```

- ◆ CLI:

```
(config-system)# automatic-update
(automatic-update)# firmware
https://www.company.com/device/7.20A.260.005.cmp
```



- For one-time file download, the HTTP Get request sent by the device does not include the If-Modified-Since header. Instead, the HTTP-User-Agent header can be used in the HTTP Get request to determine whether firmware update is required.
- When downloading TLS certificate files, it is recommended to use HTTPS with mutual authentication for secure transfer of the TLS Private Key.

5. If the device receives an HTTP 301/302/303 redirect response from the provisioning server, it establishes a connection with the new server at the redirect URL and re-sends the HTTP Get request.

## File Download Sequence

Whenever the Automatic Update feature is triggered (see [Triggers for Automatic Update](#)), the device attempts to download the files (if available) from the configured URLs in the following order:

1. ini file
2. CLI Script file
3. CLI Startup Script file
4. Periodic software file (.cmp) download
5. One-time software file (.cmp) download
6. Auxiliary file(s)

The following files automatically instruct the device to reset:

- CLI Startup Script file
- Periodic software file (.cmp)
- One-time software file (.cmp)

When multiple files requiring a reset are downloaded, the device resets only **after** it has downloaded and installed **all** the files. However, you can explicitly instruct the device to immediately reset for the following files:

- ini file: Use the `ResetNow` in file parameter
- CLI Script file: Use the `reload if-needed` CLI command



If you use the `[ResetNow]` parameter in an ini file for periodic automatic provisioning with non-HTTP (e.g., TFTP) and without CRC, the device resets after every file download. Therefore, use the parameter with caution and only if necessary for your deployment requirements.



- For ini file downloads, by default, parameters not included in the file are set to defaults. To retain the current settings of these parameters, set the `SetDefaultOnINIFileProcess` parameter to 0.
- If you have configured one-time software file (.cmp) download (configured by the `[CmpFileURL]` parameter or CLI command `configure system > automatic-update > firmware`), the device will only apply the file if one-time software updates are enabled. This is disabled by default to prevent unintentional software upgrades. To enable one-time software upgrades, set the



[AutoUpdateCmpFile] parameter to [1] or CLI command, `configure system > automatic-update > update-firmware on`.

- If you need to update the device's software and configuration, it is recommended to first update the software. This is because the current ("old") software (before the upgrade) may not be compatible with the new configuration. However, if both files are available for download on the provisioning server(s), the device first downloads and applies the new configuration, and only then does it download and install the new software. Therefore, this is a very important issue to take into consideration.
- If more than one file needs to be updated:
  - ✓ CLI Script and cmp: The device downloads and applies the CLI Script file on the currently ("old") installed software version. It then downloads and installs the cmp file with a reset. Therefore, the CLI Script file **MUST** have configuration compatible with the "old" software version.
  - ✓ CLI Startup Script and cmp: The device downloads both files, resets, applies the new cmp, and then applies the configuration from the Startup Script file on the new software version.
  - ✓ CLI Script and Startup Script: The device downloads and applies both files; but the Startup Script file overwrites all the configuration of the CLI Script file

## Cyclic Redundancy Check on Downloaded Configuration Files

You can enable the device to perform cyclic redundancy checks (CRC) on downloaded configuration files during the Automatic Update process. The CRC checks whether the content (raw data) of the downloaded file is different to the content of the previously downloaded file from the previous Automatic Update process. The device compares the CRC check value (code) result with the check value of the previously downloaded file. If the check values are identical, it indicates that the file has no new configuration settings, and the device discards the file. If the check values are different, it indicates that the downloaded file is different (i.e., includes updates), and the device installs the downloaded file and applies the new configuration settings.

CRC is useful, for example, when the service provider replaces a file, on the provisioning server, with another file whose contents are the same. When the device sends an HTTP Get request during the Automatic Update process, the provisioning server sends the new file to the device. This occurs as the timestamp between the previously downloaded file and this new file is different (determined by the HTTP If-Modified-Since header in the Get request). Therefore, the CRC feature can be used to prevent the device from installing such files.

For enabling CRC, use the ini file parameter `AUPDCheckIfIniChanged` or CLI command, `configure system > automatic-update > crc-check regular`. By default, CRC is disabled. For more information on the parameter, see [Automatic Update Parameters](#).

## Automatic Update Configuration Examples

This section provides a few examples on configuring the Automatic Update feature.

## Automatic Update for Single Device

This simple example describes how to configure the Automatic Update feature for updating a single device. In this example, the device queries the provisioning server for software, configuration and Auxiliary files every 24 hours.

### ➤ To set up Automatic Provisioning for single device (example):

1. Set up an HTTP Web server (e.g., <http://www.company.com>) and place all the required configuration files on this server.
2. Configure the device with the IP address of the DNS server for resolving the domain name (e.g., <http://www.company.com>) that is used in the URL of the provisioning server. You configure this in the IP Interfaces table:

- ini File:

```
[ InterfaceTable ]
FORMAT InterfaceTable_Index = InterfaceTable_ApplicationTypes,
InterfaceTable_InterfaceMode, InterfaceTable_IPAddress,
InterfaceTable_PrefixLength, InterfaceTable_Gateway, InterfaceTable_
VlanID, InterfaceTable_InterfaceName, InterfaceTable_
PrimaryDNSServerIPAddress, InterfaceTable_
SecondaryDNSServerIPAddress, InterfaceTable_
UnderlyingDevice;InterfaceTable 0 = 6, 10, 10.15.7.95, 16, 10.15.0.1, 1,
"Voice", 80.179.52.100, 0.0.0.0, "vlan 1";
[ \InterfaceTable ]
```

- CLI:

```
# configure network
(config-network)# interface network-if 0
(network-if-0)# primary-dns 80.179.52.100
```

3. Configure the device with the following Automatic Update settings:
  - a. Automatic Update is done every 24 hours (1440 minutes):

- ◆ ini File:

```
AutoUpdateFrequency = 1440
```

- ◆ CLI:



```
# configure system
(config-system)# automatic update
(automatic-update)# update-frequency 1440
```

**b.** Automatic Update of software file (.cmp):

◆ ini File:

```
AutoCmpFileUrl = 'https://www.company.com/sw.cmp'
```

◆ CLI:

```
# configure system
(config-system)# automatic update
(automatic-update)# auto-firmware
'http://www.company.com/sw.cmp'
```

**c.** Automatic Update of Call Progress Tone file:

◆ ini File:

```
CptFileURL = 'https://www.company.com/call_progress.dat'
```

◆ CLI:

```
# configure system
(config-system)# automatic update
(automatic-update)# call-progress-tones
'http://www.company.com/call_progress.dat'
```

**d.** Automatic Update of ini configuration file:

◆ ini File:

```
IniFileURL = 'https://www.company.com/config.ini'
```

◆ CLI:

```
# configure system
(config-system)# automatic update
(automatic-update)# ini-file 'http://www.company.com/config.ini'
```

**e.** Enable Cyclical Redundancy Check (CRC) on downloaded ini file:

◆ ini File:

```
AUPDCheckIfIniChanged = 1
```

◆ CLI:

```
# configure system
(config-system)# automatic update
(automatic-update)# crc-check regular
```

4. Power down and then power up the device.

### Automatic Update from Remote Servers

This example describes how to configure the Automatic Update feature where files are stored and downloaded from different file server types. The example scenario includes the following:

- NFS server (Version 2) at 10.13.2.10 for storing the CPT file.
- FTPS server at ftpserver.corp.com for storing the License Key file. The login credentials to the server are username "root" and password "wheel".
- HTTP server at www.company.com for storing the configuration file.
- DNS server at 80.179.52.100 for resolving the domain names of the provisioning servers (FTPS and HTTP).

➤ **To set up Automatic Provisioning for files stored on different server types (example):**

1. CPT file:
  - a. Set up an NFS server and copy the CPT file to the directory /usr/shared/public on the NFS server.
  - b. Configure the device with the NFS server:

```
[NFSServers]
FORMAT NFSServers_Index = NFSServers_HostOrIP, NFSServers_
RootPath, NFSServers_NfsVersion, NFSServers_AuthType,
NFSServers_UID, NFSServers_GID, NFSServers_VlanType;
NFSServers 0 = "10.31.2.10", "/usr/share/public", 2, 1, 0, 1, 1;
[NFSServers]
```

- c. Configure the device with the URL path of the CPT file:

◆ ini File:

```
CptFileURL = 'file://10.31.2.10/usr/share/public/usa_tones.dat'
```

2. License Key file:

- a. Set up an FTPS server and copy the License Key file to the server.
- b. Configure the device with the URL path of the License Key file:

- ◆ ini File:

```
FeatureKeyURL = 'ftps://root:wheel@ftpsserver.corp.com/license_
key.txt'
```

- ◆ CLI:

```
# configure system
(config-system)# automatic update
(automatic-update)# feature-key
'ftps://root:wheel@ftpsserver.corp.com/license_key.txt'
```

### 3. Software (.cmp) and ini files:

- a. Set up an HTTP Web server and copy the .cmp and configuration files to the server.
- b. Configure the device with the URL paths of the .cmp and ini files:

- ◆ ini File:

```
AutoCmpFileUrl = 'http://www.company.com/device/sw.cmp'
IniFileURL = 'http://www.company.com/device/inifile.ini'
```

- ◆ CLI:

```
# configure system
(config-system)# automatic update
(automatic-update)# auto-firmware 'http://www.company.com/sw.cmp'
(automatic-update)# startup-script https://company.com/files/startup_script.txt
```

4. Configure the device with the IP address of the DNS server for resolving the domain names of the FTPS and HTTP servers:

```
[ InterfaceTable ]
FORMAT InterfaceTable_Index = InterfaceTable_ApplicationTypes,
InterfaceTable_InterfaceMode, InterfaceTable_IPAddress, InterfaceTable_
PrefixLength, InterfaceTable_Gateway, InterfaceTable_VlanID,
InterfaceTable_InterfaceName, InterfaceTable_
PrimaryDNSServerIPAddress, InterfaceTable_
SecondaryDNSServerIPAddress, InterfaceTable_UnderlyingDevice;
InterfaceTable 0 = 6, 10, 10.15.7.95, 16, 10.15.0.1, 1, "Voice", 80.179.52.100,
0.0.0.0, "vlan 1";
[ \InterfaceTable ]
```

5. Configure the device to perform the Automatic Update process daily at 03:00 (3 a.m):

- ini File:

```
AutoUpdatePredefinedTime = '03:00'
```

- CLI:

```
# configure system
(config-system)# automatic update
(automatic-update)# predefined-time 03:00
```

### Automatic Update for Mass Deployment

This example describes how to configure the Automatic Update feature for updating multiple devices (i.e., mass deployment) using an HTTP provisioning server. In this example, all the devices are configured to download the same "master" configuration file. This file serves as the configuration template and instructs the devices which files to download and how often to perform the Automatic Update process. In addition, the master file also instructs each device to download an ini configuration file whose file name contains the MAC address of the device.

The example scenario is as follows:

- All devices download a "master" configuration file that contains the following:
  - Common configuration shared by all device's.
  - [MAC Address Placeholder in Configuration File Name.](#)
- Device queries the provisioning server daily at 24:00 (midnight) for software, configuration and Auxiliary files.
- HTTP-based provisioning server at www.company.com for storing the files.
- DNS server at 80.179.52.100 for resolving the domain name of the provisioning server.

#### ➤ To set up automatic provisioning for mass provisioning (example):

1. Create a "master" configuration file template named "master\_configuration.ini" or "master\_startup.txt" with the following settings:

- Common configuration for all devices:

- ◆ ini file:

```
AutoUpdatePredefinedTime = '24:00'
CptFileURL = 'https://www.company.com/call_progress.dat'
AutoCmpFileUrl = 'https://www.company.com/sw.cmp'
```

- ◆ CLI:

```
# configure system
(config-system)# automatic update
(automatic-update)# update-frequency 24:00
(automatic-update)# call-progress-tones
https://www.company.com/call_progress.dat
(automatic-update)# auto-firmware
https://www.company.com/sw.cmp
```

- Configuration per device based on MAC address:

- ◆ ini file:

```
IniFileURL = 'http://www.company.com/config_<MAC>.ini'
```

- ◆ CLI:

```
# configure system
(config-system)# automatic update
(automatic-update)# cli-script https://company.com/files/cli_script_
<MAC>.txt
(automatic-update)# ini-file http://www.company.com/config_
<MAC>.ini
```

2. Copy the master configuration file that you created in Step 1 as well as the CPT and .cmp files to the HTTP-based provisioning server.
3. Configure **each** device with the following:
  - a. URL of the master configuration file:

- ◆ ini File:

```
IniFileURL = 'http://www.company.com/master_configuration.ini'
```

- ◆ CLI:

```
# configure system
(config-system)# automatic update
(automatic-update)# ini-file http://www.company.com/master_
configuration.ini
(automatic-update)# cli-script https://company.com/files/master_
startup.txt
```



## 48 SBC Configuration Wizard

The SBC Configuration Wizard provides you with a quick-and-easy method for initial configuration of your device. The SBC Configuration Wizard guides you through a sequence of pages, assisting you in defining your device. Once the wizard is complete, your device is sufficiently configured to successfully process and route calls in your deployment.

The SBC Configuration Wizard is based on partially and fully tested interoperability setups between the device and a wide range of vendors, including SIP trunking providers, IP PBXs, and contact centers. Once you have selected the involved vendors and defined basic settings in the SBC Configuration Wizard, it then generates a configuration file based on the matching interoperability configuration template. Alternatively, instead of basing your configuration on specific vendors, you can use the SBC Configuration Wizard to generate a configuration file based on a generic template for commonly used setups. In such cases, you may later need to manually fine-tune your configuration to suit your setup needs.

The SBC Configuration Wizard can automatically load the generated configuration (with a reset) to the device, or you can simply save the generated configuration file to a folder on your PC and then load the file to the device at a later stage.

The generated configuration is a good starting point to enable the successful establishment of basic calls. For complete device configuration, you may need to manually configure additional functionality. For example, you may need to configure security settings (e.g., firewalls and IDS) to ensure that the device is protected from malicious activity and DoS attacks.

For AudioCodes' full interoperability list, visit AudioCodes website at <https://www.audiocodes.com/partners/sbc-interoperability-list>.



- When the device is configured for WebSocket tunneling with OVOC (see [Configuring WebSocket Tunnel with OVOC](#) on page 90), the SBC Configuration Wizard is not supported (and not accessible from the Web interface).
- When the SBC Configuration Wizard applies the configuration template to the device, all parameters configured by the SBC Configuration Wizard overwrite the device's existing configuration of those parameter. Parameters not configured by the SBC Configuration Wizard are restored to factory defaults, except basic device settings such as management users (Web and CLI). Some of these basic settings also appear in the SBC Configuration Wizard and their fields are automatically populated with their current settings; if you do modify them in the SBC Configuration Wizard, their new settings are used.
- On some wizard pages, the availability of certain fields depends on the selected application.

### Starting the SBC Configuration Wizard

The following procedure describes how to start the SBC Configuration Wizard. Throughout the wizard, you can get help on the current wizard page, by clicking the  icon, located on the top-right of the page.

➤ **To start the SBC Configuration Wizard:**

1. Access the SBC Configuration Wizard's Welcome page:
  - **Toolbar:** Click **Actions**, and then from the drop-down list, choose **Configuration Wizard**.
  - **Navigation Tree:** **Setup** menu > **Administration** tab > **Maintenance** folder > **Configuration Wizard**.

2. If desired, the SBC Configuration Wizard allows you to share usage statistics with AudioCodes to help us improve our software. To agree, select the 'Report Usage Statistics' check box, and then fill in the subsequent mandatory fields; otherwise, clear the 'Report Usage Statistics' check box.
3. The version of the template pack currently installed on the device is displayed in the 'Template Pack Version' field. The template pack contains the interoperability configuration templates available on the SBC Configuration Wizard. If the template pack is the latest, "Template pack is up to date" is displayed below the field. If the template pack is not the latest version, you can update it by clicking the **Update from Remote Server** button (see below note). Alternatively, if you have received a template pack file from the sales representative of your purchased device, you can install it on the device using the Auxiliary Files page (see [Loading Auxiliary Files](#)). If you click the version number, the Template Pack Version History window appears, displaying the updates for the current and previous versions.



The device checks with AudioCodes server if it has the latest template pack only if it has Internet connectivity. Therefore, the **Update from Remote Server** button is displayed only if the device has connectivity to the Internet and has subsequently found that the template pack is not the latest.

4. Click **Next**; the General Setup page appears (see [General Setup Page](#)).



## General Setup Page

The General Setup wizard page defines the network topology of the device, which includes the application (e.g., SIP trunk) and the involved third-party vendors, configuration template based on the selected vendor interoperability, and physical network (ports). The wizard displays an illustration of the basic architecture according to your chosen setup.

Choose application type and configuration ?

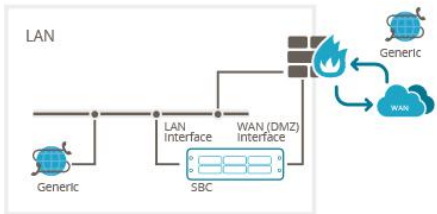
PRE-DEFINED TEMPLATES	ARCHITECTURE DIAGRAM
<p>Application</p> <p><input checked="" type="radio"/> SIP Trunk (IP-PBX with ITSP)</p> <p><input type="radio"/> SIP Normalization (two IP-PBX's)</p> <p><input type="radio"/> Hosted IP-PBX (IP-PBX with Users)</p> <p><input type="radio"/> Remote users (IP-PBX with remote Users)</p> <p>IP-PBX: <span style="border: 1px solid #ccc; padding: 2px;">Generic IP-PBX</span></p> <p>SIP-Trunk: <span style="border: 1px solid #ccc; padding: 2px;">Generic SIP Trunk</span></p> <p>Override template: <input type="checkbox"/></p> <p>Network setup: <span style="border: 1px solid #ccc; padding: 2px;">Two ports: LAN &amp; WAN</span></p>	

### ➤ To define the general setup:

1. Select one of the following 'Application' options:
  - **SIP Trunk (IP-PBX with SIP Trunk):** The device connects the Enterprise IP PBX with the Internet Telephony Service Provider (ITSP) or SIP Trunk Provider. The IP PBX resides on the Enterprise LAN, while the ITSP resides on the WAN. Only calls between the IP PBX and ITSP traverse the device. Calls between Enterprise phones, users and certain SIP messages (REGISTER, SUBSCRIBE and NOTIFY) are managed locally by the IP PBX and do not traverse the device.
  - **SIP Normalization (two IP-PBX's):** The device performs SIP "normalization" of traffic between two IP PBXs. The first IP PBX resides on the Enterprise LAN (co-located with the device) and the second IP PBX resides on the WAN (or at another branch site). Only calls between the IP PBXs traverse the device. Calls between the phones and users of the same IP PBX, and certain SIP messages (REGISTER, SUBSCRIBE and NOTIFY) are managed locally by each IP PBX and do not traverse the device.
  - **Hosted IP-PBX (IP-PBX with Users):** The device connects phones (users) with the "hosted" IP PBX. The users reside on the Enterprise LAN (co-located with the device) and the IP PBX resides on the WAN (or at the datacenter). All traffic between users and IP PBX traverse the device, including SIP REGISTER, SUBSCRIBE and NOTIFY messages.
  - **Remote Users (IP-PBX with Remote Users):** The device connects remote phones (users) with the "local" IP PBX (additional IP PBX servers can be configured). The IP PBX resides on the Enterprise LAN (co-located with the device) and the remote users reside on the WAN (or at the datacenter). All traffic between users and IP PBX traverse the device, including SIP REGISTER, SUBSCRIBE and NOTIFY messages.

2. If you selected the **SIP Trunk** application in Step 1, do the following:
  - a. From the 'IP-PBX' drop-down list, select the IP PBX model. If the model is not listed, select **Generic IP-PBX**.
  - b. From the 'SIP-Trunk' drop-down list, select the SIP trunk provider. If the provider is not listed, select **Generic SIP Trunk**.
  - c. To generate a configuration template based on the individual properties of the selected IP PBX and SIP Trunk, instead of using the existing template for the specific combination, select the 'Override template' check box.
3. If you selected any application except **SIP Trunk** in Step 1, from the 'Template' drop-down list, select the interoperability configuration template.
4. From the 'Network Setup' drop-down list, select the physical network topology:
  - **Two ports: LAN and WAN:** The device connects to the network through two separate physical network links (interfaces). The first interface ("LAN") is connected to the Enterprise LAN (typically, a switch) and has a private IP address. The second interface ("WAN") is connected to the DMZ port of the Enterprise router and has a public (globally routable) IP address. Each link may be accompanied with a backup link for Ethernet link redundancy.
  - **One port: LAN:** The device connects to the Enterprise LAN (typically, a switch) through a single physical network link (interface). The interface ("LAN") has a private IP address. You must enable port forwarding on the Enterprise router to forward all VoIP traffic from the ITSP (located on the WAN) to the device. The exact port forwarding configuration is shown on the Conclusion page and consists of the device's address, SIP port (e.g. 5060) and a media port range (e.g. 6000-6999).
  - **One port: WAN:** The device connects to the DMZ port of the Enterprise router through a single physical network link (interface). The interface ("WAN") has a public (globally routable) IP address. You must enable port forwarding on the Enterprise router to forward all VoIP traffic from the device to the IP PBX (located on the LAN). The exact port forwarding configuration is shown on the Conclusion page and consists of the IP PBX address, SIP port (e.g. 5060) and a media port range (e.g. 6000-6999).
  - **One port: LAN only:** The device connects to the Enterprise LAN (typically, a switch) through a single physical network link (interface). All SIP entities (IP PBX and users) connect to the same LAN. Note that this option is applicable to all applications (see Step 1), except **SIP Trunk**.
5. Click **Next**; the System page appears (see [System Page](#)).

## System Page

The System wizard page configures the device's basic system settings, including management interface protocol, date and time, and syslog.

### Configure system parameters ?

<div style="background-color: #f0f0f0; padding: 2px; margin-bottom: 5px;">MANAGEMENT</div> <p>Web Interface <input style="width: 80%;" type="text" value="HTTP"/></p> <p>CLI Interface <input style="width: 80%;" type="text" value="Telnet"/></p> <p>Enable Syslog <input type="checkbox"/></p> <p>Syslog IP <input style="width: 80%;" type="text" value="0.0.0.0"/></p>	<div style="background-color: #f0f0f0; padding: 2px; margin-bottom: 5px;">LOCAL DNS TABLE</div> <p>Enable <input type="checkbox"/></p>
<div style="background-color: #f0f0f0; padding: 2px; margin-bottom: 5px;">TIME AND DATE</div> <p>Time Zone <input style="width: 80%;" type="text" value="GMT"/></p> <p>Primary NTP Server <input style="width: 80%;" type="text" value="10.1.1.11"/></p> <p>Secondary NTP Server <input style="width: 80%;" type="text" value="0.0.0.0 or domain.com"/></p>	

➤ **To configure system settings:**

1. Configure the protocol for accessing the management interfaces:
  - 'Web Interface': Select the type of Web interface protocol (**HTTP** or **HTTPS**).
  - 'CLI Interface': Select the type of CLI protocol (**Disabled**, **Telnet**, **SSH**).
2. (Optional) Enable Syslog by selecting the 'Enable Syslog' check box, and then in the 'Syslog IP' field, configuring the Syslog server's IP address. Note that if you enable Syslog, the device generates verbose logs (debug level 5), which adversely affects performance. For more information on Syslog, see [Configuring Syslog](#).
3. Configure the time and date:
  - 'Time Zone': Select the GMT time zone in which the device is located.
  - 'Primary NTP Server' and 'Secondary NTP Server': Configure the IP address (or hostname) of the primary (and optionally, secondary) NTP server in your network. The NTP server synchronizes the time of the device. This is mandatory when the IP PBX or ITSP uses a TLS connection, as correct time is required for certificate validation.

For more information on configuring date and time, see [Date and Time](#).

4. (Optional) Configure a local DNS table, which allows the device to resolve domain names (hostnames) using a locally defined address resolution table. This may be needed when your setup lacks a DNS server and the IP PBX or ITSP require the use of hostnames instead of IP addresses. Select the 'Apply local DNS' check box, and then configure the following parameters:
  - 'Domain Name': Domain name to resolve into an IP address.
  - 'First IP address': IP address of the domain name.

- 'Secondary IP address': Second IP address of the domain name (optional).

For more information on configuring the device's DNS table, see [Configuring the Internal DNS Table](#).

5. Click **Next**; the Interfaces page appears (see [Interfaces Page](#)).

## Interfaces Page

The Interfaces wizard page configures the device's LAN and WAN settings.

The screenshot shows the 'Configure interfaces' wizard page. It is organized into three main sections: LAN INTERFACE, WAN INTERFACE, and MANAGEMENT INTERFACE. Each section contains several configuration fields. The LAN and WAN sections have identical fields: Physical Port (a dropdown menu), VLAN Tagging (a checkbox), VLAN ID (a dropdown menu), IP Address, Subnet Mask, Default Gateway, Primary DNS, and Secondary DNS. The WAN IP Address and Subnet Mask fields are highlighted with a pink border. The MANAGEMENT INTERFACE section has a single field: OAM Interface (a dropdown menu).

### ➤ To configure LAN and WAN interface settings:

1. From the 'Physical Port' drop-down list, select the Ethernet Group containing the required physical Ethernet port for connecting the device to the 1) Enterprise LAN (typically, a switch) or 2) DMZ port of the Enterprise router for WAN. You may configure two physical ports for Ethernet link redundancy.
2. Select the **VLAN Tagging** check box, and then in the 'VLAN ID' field, configure the VLAN ID for the interface. For untagged traffic, clear the check box.
3. In the 'IP Address' field, configure the device's IP address on the interface.
  - For LAN interfaces: The IP address must be part of the Enterprise LAN and therefore, is typically a private IP address. The address is used for communicating with the IP PBX and/or users that reside on the LAN, as well as for management (OAMP) traffic.
  - For WAN interfaces: The IP address must be a public (globally routable) address and is used for communicating with the ITSP and/or IP PBX that resides on the WAN. If the WAN is the only interface, it is also used for management (OAMP) traffic.
4. In the 'Subnet Mask' field, configure the subnet mask of the interface.
5. In the 'Default Gateway' field, configure the default gateway of the interface.

6. If the device is connected through an Enterprise router that performs NAT, then in the 'NAT Public IP' address, configure the public IP address (of the Enterprise router) used by the device to communicate with the ITSP (for the **SIP Trunk** application) or IP PBX (for the **Hosted IP-PBX** application).
7. In the 'Primary DNS Server' (and optionally, 'Secondary DNS Server') field, configure your primary (and optionally, secondary) DNS server in the network. This is mandatory if you use a hostname (FQDN) for ITSP (WAN only) and IP PBX addresses.
8. From the 'OAM Interface' drop-down list, select the device's interface for management traffic:
  - **LAN:** Management traffic is carried over the regular LAN interface, as defined above.
  - **WAN:** Management traffic is carried over the WAN interface, as defined above.
  - **Additional:** Configure a different interface for management traffic.
9. Click **Next**; the IP-PBX page appears (see [IP-PBX Page](#)).

## IP-PBX Page

The IP-PBX wizard page configures the IP PBX settings.

IP-PBX configuration ?

NETWORK INTERFACE

Network Type

<p>IP-PBX</p> <p>Address <input type="text" value="10.15.9.11"/></p> <p>Backup Address <input type="text" value="0.0.0.0 or domain.com"/></p> <p>SIP Domain <input type="text" value="0.0.0.0 or domain.com"/></p> <p>Keep Alive <input type="checkbox"/></p>	<p>SIP INTERFACE</p> <p>Transport Type <input type="text" value="UDP"/></p> <p>Destination Port <input type="text" value="5060"/></p> <p>Listening Port <input type="text" value="5060"/></p>
---	---

MEDIA PORTS (REALM)

Media Protocol

Base Port

Number Of Sessions



- The following fields are read-only:
  - ✓ 'Network Type': Displays the IP network interface for communicating with the IP PBX.
  - ✓ 'NAT Public IP': Displays the public IP address (of the Enterprise router) for communicating with the IP PBX. The field is applicable only when the device is connected to a router that performs NAT.



- Depending on the application type that you selected on the General Setup page ([General Setup Page](#) on page 1147), the wizard may provide additional IP-PBX pages ("IP-PBX2" and "IP-PBX3") for configuring additional servers.

➤ **To configure IP PBX settings:**

1. Under the IP-PBX group, configure the following:
  - 'Address': Configure the IP address (or hostname) of the IP PBX. Note that for the **One port: WAN** network topology, when the device is assigned a public IP address, you must use the public IP address (of the Enterprise router) instead of the private address of the IP PBX, and configure the Enterprise router to forward VoIP traffic from the device to the IP PBX.
  - 'Backup Address': (Optional) Configure the backup IP address (or hostname) of the IP PBX.
  - 'SIP Domain': Configure the SIP domain name used for communication with the IP PBX. The domain name is used in the following SIP message headers:
    - ◆ Outbound calls: Request-URI and To headers
    - ◆ Inbound calls: From header
  - 'Keep Alive': Enable the periodic keep-alive check for multiple IP PBX addresses.
2. Under the Media Ports (Realm) group, configure the media protocol type and ports used by the device for communicating with the IP PBX:
  - 'Media Protocol': Configure the media protocol type (**RTP** or **SRTP**).
  - 'Base Port' Configure the first media port in the port range.
  - 'Number Of Sessions': Configure the number of required media sessions. For more information on media port ranges and number of sessions, see [Configuring RTP Base UDP Port](#).
3. Under the SIP Interface group, configure SIP ports and transport type for communicating with the IP PBX:
  - 'Transport Type': Configure the SIP transport type.
  - 'Destination Port': Configure the SIP port used by the IP PBX.
  - 'Listening Port': Configure the SIP port used by the device when communicating with the IP PBX.
4. Click **Next**; the SIP Trunk page appears ([SIP Trunk Page](#)).

## SIP Trunk Page

The SIP Trunk wizard page configures the SIP Trunk settings.

### SIP Trunk configuration ?

<div style="background-color: #f0f0f0; padding: 2px; margin-bottom: 5px;">NETWORK INTERFACE</div> <p>Network Type <input type="text" value="WAN"/></p>	<div style="background-color: #f0f0f0; padding: 2px; margin-bottom: 5px;">NAT</div> <p>NAT Public IP <input type="text"/></p>
<div style="background-color: #f0f0f0; padding: 2px; margin-bottom: 5px;">SIP TRUNK</div> <p>Address <input type="text" value="213.148.136.2"/></p> <p>Backup Address <input type="text" value="0.0.0.0 or domain.com"/></p> <p>SIP Domain <input type="text" value="0.0.0.0 or domain.com"/></p> <p>Keep Alive <input type="checkbox"/></p>	<div style="background-color: #f0f0f0; padding: 2px; margin-bottom: 5px;">SIP INTERFACE</div> <p>Transport Type <input type="text" value="UDP"/></p> <p>Destination Port <input type="text" value="5060"/></p> <p>Listening Port <input type="text" value="5060"/></p>
<div style="background-color: #f0f0f0; padding: 2px; margin-bottom: 5px;">SIP ACCOUNT</div> <p>Account Type <input type="text" value="None"/></p> <p>Trunk Main Line <input type="text"/></p> <p>Username <input type="text" value="user name value"/></p> <p>Password <input type="text"/></p>	<div style="background-color: #f0f0f0; padding: 2px; margin-bottom: 5px;">MEDIA PORTS (REALM)</div> <p>Media Protocol <input type="text" value="RTP"/></p> <p>Base Port <input type="text" value="7000"/></p> <p>Number Of Sessions <input type="text" value="100"/></p>

The following fields are read-only:

- 'Network Type': Displays the IP network interface for communicating with the SIP Trunk.
- 'NAT Public IP': Displays the public IP address (of the Enterprise router) for communicating with the SIP Trunk. The field is applicable only when the device is connected to a router that performs NAT. Note that the Enterprise router must be configured to "port forward" all VoIP traffic from the SIP Trunk (located on the WAN) to the device. The exact port forwarding configuration is displayed on the Conclusion page and consists of the device's address, SIP listening port (e.g. 5060) and a range of media ports defined below (e.g. 6000-6999).

➤ **To configure SIP Trunk settings:**

1. Under the SIP Trunk group, configure the following:
  - 'Address': Configures the IP address or hostname of the SIP Trunk.
  - 'Backup Address': (Optional) Configures the backup IP address or hostname of the SIP Trunk.
  - 'SIP Domain': Configures the SIP domain name for communicating with the SIP Trunk. The domain name is used in the following SIP message headers:
    - ◆ Outbound calls: Request-URI and To headers
    - ◆ Inbound calls: From header

- 'Keep Alive': Enables the periodic keep-alive check of multiple SIP Trunk addresses.
2. Under the SIP Interface group, configure the SIP ports and transport type for communicating with the SIP Trunk:
    - 'Transport Type': Configure the SIP transport type.
    - 'Destination Port': Configure the SIP port used by the SIP Trunk.
    - 'Listening Port': Configure the SIP port used by the device for communicating with the SIP Trunk. Note that for the **One port: WAN** network topology, the device must use different Listening Ports when communicating with the IP PBX and SIP Trunk.
  3. Under the Media Ports (Realm) group, configure the media protocol type and ports used by the device for communicating with the IP PBX:
    - 'Media Protocol': Configure the media protocol type.
    - 'Base Port': Configure the first media port.
    - 'Number Of Sessions': Configure the number of required media sessions. For more information on media port ranges and number of sessions, see [Configuring RTP Base UDP Port](#).
  4. Under the SIP Account group, configure the device's registration with the SIP Trunk:
    - 'Account Type': Configure whether the device must perform registration or authentication with the SIP Trunk (**None, Registration or Authentication**).
    - 'Trunk Main Line': Configure the "leading number" assigned by the SIP Trunk. Many SIP Trunks use the same value for Trunk Main Line and Username parameters.
    - 'Username': Configure the SIP authentication username (as provided by the SIP Trunk provider).
    - 'Password': Configure the SIP authentication password (as provided by the SIP Trunk provider).



The password cannot be configured with wide characters.

5. Click **Next**; the Number Manipulation page appears (see [Number Manipulation Page](#)).

## Number Manipulation Page

The Number Manipulation wizard page configures caller (source) and callee (destination) number manipulation for outbound and inbound calls, and allows you to use AudioCodes Routing Manager (ARM) to determine the routing.



### Number Manipulation configuration ?

<div style="background-color: #f0f0f0; padding: 2px; margin-bottom: 5px;">OUTBOUND CALLS (IP-PBX → IP-PBX2)</div> <p>Destination Number Manipulation <input checked="" type="checkbox"/></p> <p>Prefix <input type="text" value="+972"/></p> <p>Remove <input type="text" value="4"/></p> <p>Add <input type="text" value="0"/></p> <p>Source Number Manipulation <input type="checkbox"/></p>	<div style="background-color: #f0f0f0; padding: 2px; margin-bottom: 5px;">INBOUND CALLS (IP-PBX2 → IP-PBX)</div> <p>Destination Number Manipulation <input checked="" type="checkbox"/></p> <p>Prefix <input type="text" value="0"/></p> <p>Remove <input type="text" value="1"/></p> <p>Add <input type="text" value="+972"/></p> <p>Source Number Manipulation <input type="checkbox"/></p>
<div style="background-color: #f0f0f0; padding: 2px; margin-bottom: 5px;">ADVANCED ROUTING MANAGER</div> <p>Use ARM for call routing <input checked="" type="checkbox"/></p> <p>Host <input type="text" value="10.4.5.100"/></p> <p>Username <input type="text" value="Admin"/></p> <p>Password <input type="password" value="•••••"/></p>	

➤ **To configure number manipulation:**

1. Configure number manipulation:

- a. Under the Outbound Calls and/or Inbound Calls groups, select the required manipulation check box:
  - ◆ Destination Number Manipulation: Manipulates the destination number.
  - ◆ Source Number Manipulation: Manipulates the source number.
- b. In the 'Prefix' field, configure the prefix (digits at the beginning of the number) to which you want to apply manipulation. If configured to "\*" (asterisk), manipulation is applied to all numbers.
- c. In the 'Remove' field, configure the number of digits to be removed from the beginning of the number. If configured to "0", no digits are removed.
- d. In the 'Add' field, configure a new prefix to be added to the beginning of the number. If not configured, no prefix is added.

The example below changes the number "+15033311432" to "03311432":

- Prefix: "+1503"
  - Remove: "4"
  - Add: "0"
2. To enable routing by ARM, select the 'Use ARM for call routing' check box, and then configure the following fields:
    - 'Host': IP address or FQDN of the ARM server.
    - 'Username': Username for communication with ARM.

- 'Password': Password for communication with ARM.
3. Click **Next**; Remote Users (FEU) page appears (see [Remote Users Page](#)).

## Remote Users or Users Page

The Remote Users or Users wizard page configures remote users settings.



- This page is applicable only to IP PBXs that support such configuration.
- The parameters displayed on the page depends on the application type and template that you selected on the General Setup wizard page (see [General Setup Page](#) on page 1147).

### Remote Users configuration

?

REMOTE USERS

Enable remote users

NETWORK INTERFACE

Network Type

MEDIA PORTS (REALM)

Media Protocol

Base Port

Number Of Sessions

SIP INTERFACE

Transport Type

Listening Port

### ➤ To configure remote users:

1. Select the 'Enable remote users' check box.
2. Under the SIP Interface group, configure the SIP interface for the remote users:
  - 'Transport Type': Configure the SIP transport type.
  - 'Listening Port': Configure the SIP port used by the device for communicating with remote users. For **One Port: LAN** and **One Port: WAN** network topologies, you must configure different listening ports for communication with the IP PBX and remote users.
3. Under the Media Ports (Realm) group, configure the media protocol type and ports used by the device for communicating with the remote users:
  - 'Media Protocol': Configure the media protocol type (RTP or SRTP).
  - 'Base Port': Configure the first media port.

- 'Number Of Sessions': Configure the number of required media sessions. For more information on media port ranges and number of sessions, see [Configuring RTP Base UDP Port](#).
4. Click **Next**; the Summary page appears (see [Summary Page](#)).

## Summary Page

The Summary wizard page displays a summary of your configuration.

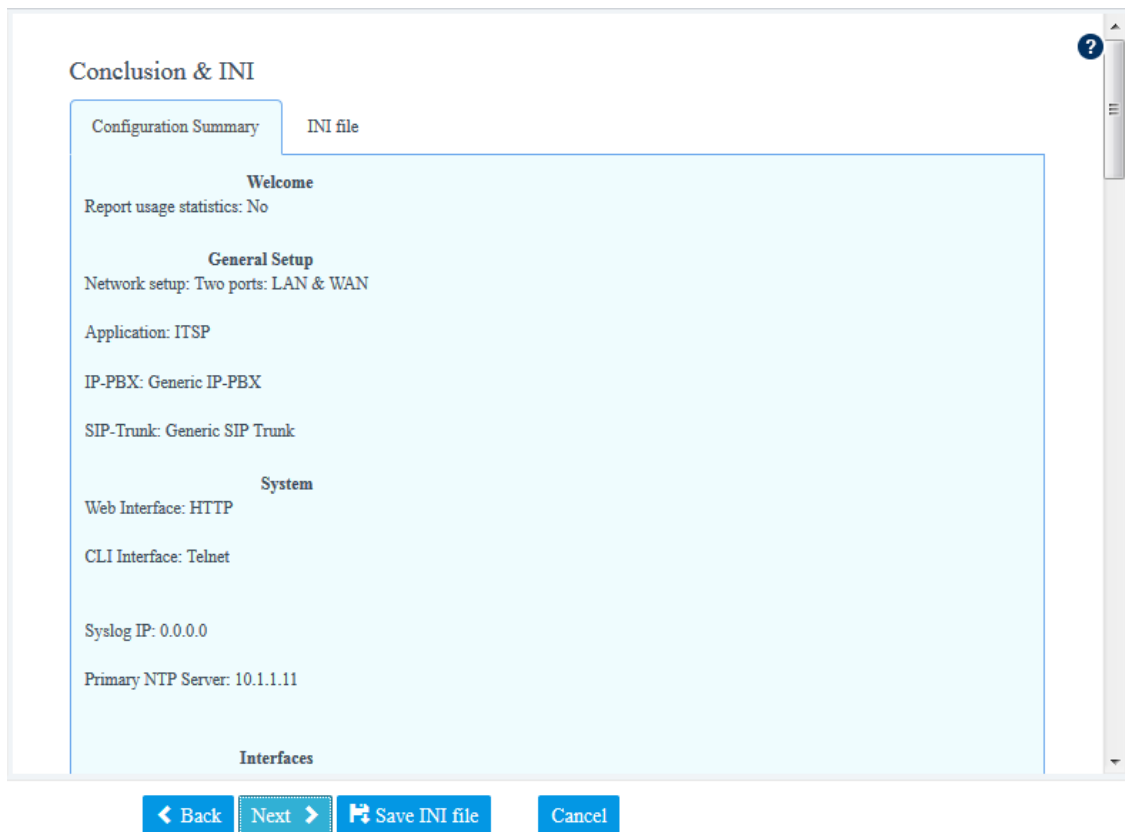

### ➤ To review your configuration:

1. Review the configuration:
  - To view the configuration in ini-file format, click the **INI File** tab.
  - To view the configuration in normal format, click the **Configuration Summary** tab.
2. To save the configuration as an ini file to a folder on your PC, click the **Save INI file** button. You can later load the file to the device (see [Loading an ini File to the Device](#)).
3. Click **Next**; the Congratulations page appears (see [Congratulations Page](#)).

## Congratulations Page

The Congratulations wizard page is the last wizard page and allows you to complete configuration.

## Congratulations!

You have successfully completed the SBC Configuration wizard.

Click "Apply & Reset" button to activate the new configuration. Note that device will be restarted and it may take up to 4 minutes before it completes activation.

The generated configuration file is a good "starting point" that enables successful establishment of basic calls.

For complete device configuration you may need to configure additional functionality.

For example, you may need to add security configuration (e.g. Firewalls, IDS) to ensure that SBC is protected from malicious user activity and DoS attacks.

Refer to the User Manual for more information.

**WARNING:** Applying this configuration will overwrite all of the existing device configuration.

**Apply & Reset**

➤ **To complete the SBC Configuration Wizard:**

- Click **Apply & Reset** to apply configuration to the device or click **Save INI File** to save configuration as an ini file on your PC.

## 49 Restoring Factory Defaults

This section describes how to restore the device's configuration to factory defaults.

### Restoring Factory Defaults through CLI

You can restore the device to factory defaults through CLI. You can restore all configuration to factory defaults or you can restore all configuration to factory defaults except the current network settings. Preserving network settings allows you to remotely connect to the device using its current OAMP IP address even after the device has been restored to default settings.

➤ **To restore factory defaults through CLI:**

1. Access the CLI:
  - a. Connect the RS-232 serial port of the device to the communication port on your computer. For serial cabling, refer to the Hardware Installation Manual.
  - b. Establish serial communication with the device using a serial communication program (such as HyperTerminal™) with the following communication port settings:
    - ◆ Baud Rate: 115,200 bps
    - ◆ Data Bits: 8
    - ◆ Parity: None
    - ◆ Stop Bits: 1
    - ◆ Flow Control: None
2. At the CLI prompt, type the username (default is "Admin" - case sensitive), and then press Enter:

```
# Username: Admin
```

3. At the prompt, type the password (default is "Admin" - case sensitive), and then press Enter:

```
# Password: Admin
```

4. At the prompt, type the following, and then press Enter:

```
# enable
```

5. At the prompt, type the password again, and then press Enter:

```
# Password: Admin
```

6. At the prompt, type one of the following commands, and then press Enter:

- To restore all configuration to factory defaults:

```
# write factory
```

- To restore configuration to factory defaults except current network settings:

```
# write factory keep-network-and-users-configuration
```

## Restoring Factory Defaults through Web Interface

You can restore the device to factory defaults through the Web interface.



When restoring the device to factory defaults, you can preserve basic IP network settings (configured in the IP Interfaces table - see [Configuring IP Network Interfaces](#)), as described below. This ensures that connectivity to the device (through the OAMP interface) is maintained after factory defaults have been applied.

### ➤ To restore factory defaults through Web interface:

1. Open the Configuration File page:
  - **Toolbar:** From the **Actions** drop-down menu, choose **Configuration File**.
  - **Navigation tree:** **Setup** menu > **Administration** tab > **Maintenance** folder > **Configuration File**.

RESTORE THE DEFAULT CONFIGURATION OF THE DEVICE

Restore Factory Defaults

Preserve basic connectivity.

2. To keep your current IP network settings (e.g., OAMP), select the **Preserve basic connectivity** check box. To overwrite all your IP network settings with the default IP network interface, clear this check box.
3. Click the **Restore Defaults** button; a message appears requesting you to confirm.
4. Click **OK** to confirm or **Cancel** to return to the page.
5. Once the device is restored to factory defaults, reset the device for the settings to take effect.

## Restoring Defaults using Hardware Reset Button

You can restore the device to factory defaults by pressing the device's hardware reset pinhole button.

➤ **To restore default settings using the hardware reset pinhole button:**

- With a paper clip or any other similar pointed object, press and hold down the device's reset pinhole button for at least 15 seconds (but no more than 25 seconds).

For the exact location of the reset pinhole button on the device, refer to the *Hardware Installation Manual*.

## Restoring Defaults through ini File

You can restore the device to factory defaults as described below.

➤ **To restore the device to factory defaults:**

1. Create an **empty** text-based file and save it in a folder on your PC with the filename extension `.ini`.
2. Load the file to the device using the Configuration File page (see [Configuration File](#)).



The only settings that are not restored to default are the management (OAMP) LAN IP address and the Web interface's login username and password.

# **Part IX**

## **Status, Performance Monitoring and Reporting**



## 50 System Status

This section describes how to view system status.

### Viewing Device Information

You can view hardware and software information about the device on the Device Information page.

➤ **To view device information:**

- Open the Device Information page (**Monitor** menu > **Monitor** tab > **Summary** folder > **Device Information**).

GENERAL SETTINGS		LOADED FILES	
MAC Address:	00908f5b1035	Call Progress Tones File Name: usa_tones_13.dat	Delete
Serial Number:	5967925		
Product Key:			
Board Type:	72		
Device Up Time:	0d:0h:43m:41.26s		
Device Administrative State:	Unlocked		
Device Operational State:	Enabled		
Flash Size [Mbytes]:	64		
RAM Size [Mbytes]:	512		
CPU Speed [MHz]:	500		

VERSIONS	
Version ID:	7.20A.240.418
DSP Type:	1
DSP Software Version:	71011
DSP Software Name:	5014AE3_R
Flash Version:	720

**Table 50-1: Device Information Description**

Parameter	Description
<b>General Settings</b>	
MAC Address	Media access control (MAC) address.
Serial Number	Serial number of the CPU. This serial number also appears on the product label that is affixed to the chassis.
Product Key	Product Key, which identifies the specific device purchase (and used for communication with AudioCodes, for example, for support and

Parameter	Description
	software upgrades). The Product Key also appears on the product label that is affixed to the chassis. For more information, see <a href="#">Viewing the Device's Product Key</a> .
<b>Board Type</b>	Numerical identification of the product (device).
<b>Device Up Time</b>	Duration that the device has been up and running since the last reset (uptime). The duration is displayed in the following format: <i>dd:hh:mm:ss.ss</i> . For example, "1d:21h:40m:21s:75.22" means that the device has been running for one day and 21 hours, 40 minutes and 21.22 seconds.
<b>Device Administrative State</b>	Administrative status ("Unlocked" or "Locked"), as performed in <a href="#">Locking and Unlocking the Device</a> .
<b>Device Operational State</b>	Operational status: <ul style="list-style-type: none"> <li>■ "Disabled"</li> <li>■ "Enabled"</li> <li>■ "Error"</li> <li>■ "Unknown"</li> </ul>
<b>Flash Size [Mbytes]</b>	Size of the non-volatile storage memory (flash), measured in megabytes.
<b>RAM Size [Mbytes]</b>	Size of the random access memory (RAM), measured in megabytes.
<b>CPU Speed [MHz]</b>	Clock speed of the CPU, measured in megahertz (MHz).
<b>Versions</b>	
<b>Version ID</b>	Software version number.
<b>DSP Type</b>	Type of DSP.
<b>DSP Software Version</b>	DSP software version.
<b>DSP Software Name</b>	DSP software name.

Parameter	Description
<b>Flash Version</b>	Flash memory version number.
<b>Loaded Files:</b> Displays installed Auxiliary files. You can also delete a file, by clicking the corresponding <b>Delete</b> button, as described in <a href="#">Deleting Auxiliary Files</a> .	

## Viewing Device Status on Monitor Page

The Web interface's Monitor page provides basic status and information on the device. The page is useful in that it allows you to easily obtain an overview of the device's operating status at a glance.

### ➤ To view device status and information on the Monitor home page:

- On the Menu bar, click **Monitor** or if you are already in the Monitor menu's Navigation tree, click  **Monitor**.

The Monitor page displays the following groups of information:

#### ■ Device Information:

- **Address:** IP address of the device's OAMP interface
- **Firmware:** Software version currently running on the device
- **Type:** Name of the device
- **S/N:** Serial number of the device.

#### ■ SBC Call Statistics:

- **Active Calls:** Total number of SBC calls. The corresponding SNMP performance monitoring MIB is PM\_gwINVITEDialogs.
- **Average Success Rate (ASR):** Number of successfully answered calls out of the total number of attempted calls. The corresponding SNMP performance monitoring MIB is PM\_gwSBCASR.
- **Average Call Duration (ACD):** Average call duration in seconds of established calls. The value is refreshed every 15 minutes and therefore, this value reflects the average duration of all established calls made within a 15 minute period. The corresponding SNMP performance monitoring MIB is PM\_gwSBCACD.
- **Calls per Sec:** Total number of new calls per second (CPS).
- **Transactions per Sec:** Total number of new SIP transactions per second (out-of-dialog transactions such as INVITE and REGISTER, or in-dialog transactions such as UPDATE and BYE). The corresponding SNMP performance monitoring MIB is PM\_gwActiveSIPTransactionsPerSecond. The counter is applicable to SBC and Gateway calls.
- **Registered Users:** Number of users registered with the device. The corresponding SNMP performance monitoring MIB is acPMSBCRegisteredUsersTable.

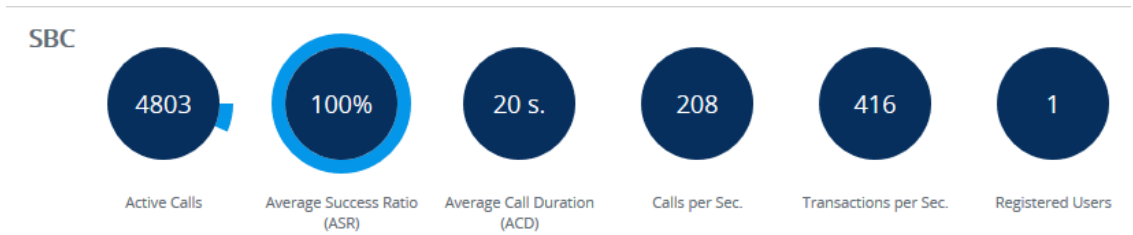

■ **Graphical Display of device:** Shows color-coded status icons, as shown in the figure below and described in the subsequent table:



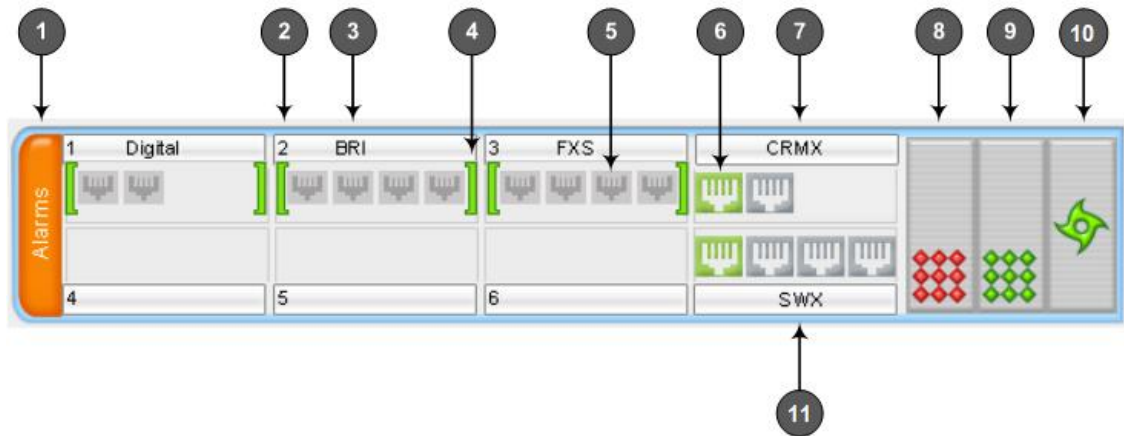







**Figure 50-1: Graphical Display of Device on Monitor Page - Mediant 1000B Gateway and E-SBC**













 • The figure above is used only as an example as the graphical display of your device in the Web interface reflects your specific ordered hardware configuration.

**Table 50-2: Description of Graphical Display of Device on Monitor Page**

Item #1	Description
1	<p><b>Alarms:</b> Displays the highest severity of an active alarm raised (if any) by the device:</p> <ul style="list-style-type: none"> <li>Green = no alarms</li> <li>Red = Critical alarm</li> <li>Orange = Major alarm</li> <li>Yellow = Minor alarm</li> </ul> <p>To view active alarms, click <b>Alarms</b> to open the Active Alarms page (see <a href="#">Viewing Active Alarms</a>).</p>
2	Module slot number.
3	Module interface type.
4	Module status icon:

Item #1	Description
	<ul style="list-style-type: none"> <li>■  (green): Module has been inserted or is correctly configured</li> <li>■  (gray): Module was removed and "Reserved" is displayed</li> <li>■  (red): Module failure and "Failure" is displayed</li> </ul>
5	<p>Port analog channel status icon:</p> <ul style="list-style-type: none"> <li>■  (gray): <ul style="list-style-type: none"> <li>✓ <b>FXS</b> (one of the following): <p>The port is physically connected to an FXS analog device (e.g., telephone), which is in idle state (i.e., on-hook position).</p> <p>-or-</p> <p>The port is not physically connected.</p> </li> <li>✓ <b>FXO</b>: The port is physically connected to an FXO analog device (e.g., PBX), which is in idle state (i.e., on-hook position).</li> </ul> </li> <li>■  (green): The FXS or FXO port is physically connected to an analog device, which is in off-hook state with an established call (i.e., active RTP stream).</li> <li>■  (red): <ul style="list-style-type: none"> <li>✓ <b>FXS</b>: n/a</li> <li>✓ <b>FXO</b>: <p>The port is not physically connected.</p> <p>-or-</p> <p>If the port is physically connected to an FXS analog device, it is out-of-service due to Serial Peripheral Interface (SPI) failure.</p> </li> </ul> </li> <li>■  (blue): The FXS or FXO port is physically connected to an analog device which is in off-hook state, but no established call.</li> </ul> <p>Port trunk status icon:</p> <ul style="list-style-type: none"> <li>■  (gray): The trunk is not configured (i.e., not in use or disabled).</li> <li>■  (green): The trunk is synchronized.</li> <li>■  (yellow): The trunk has a Remote Alarm Indication (RAI), also known as the Yellow Alarm.</li> </ul>

Item #1	Description
	<ul style="list-style-type: none"> <li>■  (red): The trunk has a loss due to LOS (Loss of Signal) or LOF (Loss of Frame).</li> <li>■  (blue): The trunk has an Alarm Indication Signal (AIS), also known as the Blue Alarm.</li> <li>■  (orange): The trunk has a D-channel alarm.</li> <li>■  (dark orange): The trunk has an NFAS alarm.</li> </ul> <p>If you click a port, a shortcut menu appears with commands allowing you to do the following:</p> <ul style="list-style-type: none"> <li>■ <b>Reset Channel:</b> (Analog ports only) Resets the analog port. For more information, see <a href="#">Resetting an Analog Channel</a>.</li> <li>■ <b>Port Status:</b> Displays trunk status (see <a href="#">Viewing Trunk and Channel Status</a>) and analog port status (see <a href="#">Viewing Port Information</a>).</li> <li>■ <b>Port Description:</b> Let's you define a name for the port (see <a href="#">Configuring Name for Telephony Ports</a>).</li> </ul>
6	<p>Gigabit Ethernet port status icons:</p> <ul style="list-style-type: none"> <li>■  (green): Ethernet link is working.</li> <li>■  (gray): Ethernet link is not configured.</li> </ul> <p>To view detailed port information, click the port icon. For more information, see <a href="#">Viewing Ethernet Port Information</a>.</p>
7	CRMX module.
8	<p>Power Supply Unit 1 status icon:</p> <ul style="list-style-type: none"> <li>■  (green): Power supply is operating</li> <li>■  (red): Power supply failure or no power supply unit installed</li> </ul>
9	Power Supply Unit 2 status icon. For more information, see the description above.
10	<p>Fan tray unit status icon:</p> <ul style="list-style-type: none"> <li>■  (green): Normal operation of Fan tray.</li> </ul>

Item #1	Description
	<ul style="list-style-type: none"> <li>■  (red): Fan tray failure.</li> </ul>
11	SWX LAN expansion module, providing 4 Ethernet ports operating in port-pair group redundancy.

## Viewing Voice Port Information

You can view detailed information per voice port. The information is grouped under the following tabs:

- SIP: Displays SIP-related information such as endpoint status (e.g., idle) and phone number
- Basic: Displays information such as call duration and analog information such as line voltage, hook status (off or on), and polarity reversal.
- RTP/RTCP: Displays RTP/RTCP-related information such as packet loss and network jitter.
- Voice Settings: Displays voice-related configuration such as silence suppression.

### ➤ To view information on an analog port:

1. Open the Monitor home page (see [Viewing Device Status on Monitor Page](#)).
2. On the graphical display of the device, click a port; a shortcut menu appears.
3. From the shortcut menu, choose **Port Status**.
  - For digital ports: The Trunks & Channel Status page appears (see [Viewing Trunk and Channel Status](#)). Click a channel; the following page appears with the Basic tab selected:
  - For analog ports: The following page appears with the **Basic** tab selected:

		SIP	Basic	RTP/RTCP	Voice Settings
Endpoint Status:		IDLE			
Assigned Phone Number:		200			
Hunt Group:		default (0)			
MWI Information:		--			
Call ID:		--	--		
Call Originator:		--	--		
Source Tel Number:		--	--		
Destination Tel Number:		--	--		
Redirect Calling Number:		--	--		
Remote Signaling IP:		--	--		
Remote RTP (IP:Port):		--	--		
Call Establishment Duration:		--	--		
Call Duration:		--	--		
Call State:		--	--		
Fax State:		--	--		
Coder + PTime:		--	--		
Call Type:		--	--		
Call Establishment Method:		--	--		
DTMF Selected Method for Tx/Rx:		--	--		

- To view additional channel information, click the required tab - **SIP**, **RTP/RTCP**, and **Voice Settings**.

**Table 50-3: Port Status Description**

Field	Description
<b>SIP</b>	
Endpoint Status	Status of endpoint: <ul style="list-style-type: none"> <li>■ "IDLE": No call</li> <li>■ "ACTIVE": Active call</li> </ul>
Assigned Phone Number	Phone number of the port.
Hunt Group	Trunk Group to which the port is assigned. To configure Trunk Groups, see <a href="#">Configuring Trunk Groups</a> .
MWI Information	Indicates if the phone has a voice-mail message (Message Waiting Indicator): <ul style="list-style-type: none"> <li>■ "yes": Endpoint has a voice-mail message.</li> <li>■ "...": No voice mail for the endpoint.</li> </ul> <p><b>Note:</b> The field is applicable only to FXS interfaces.</p>



Field	Description
Call ID	Call ID number of the call (SIP Call-ID header).
Call Originator	Caller: <ul style="list-style-type: none"> <li>■ "TEL": Call made from Tel side (i.e., the port)</li> <li>■ "IP": Call made from IP side</li> </ul>
Source Tel Number	Telephone number of the caller.
Destination Tel Number	Telephone number of the called party.
Redirect Calling Number	Telephone number of the redirected number.
Remote Signaling IP	IP address used for SIP on the IP side.
Remote RTP (IP:Port)	IP address and port used for RTP on the IP side.
Call Establishment Duration	Length of time (in seconds) it took to establish the call.
Call Duration	Call duration (in seconds) from when call was established.
Call State	Current state of the call: <ul style="list-style-type: none"> <li>■ "IDLE": No call.</li> <li>■ "SETUP": Signaling to setup call (SIP INVITE).</li> <li>■ "ALERT": Ringing at remote end (SIP 180 Ringing).</li> <li>■ "RINGBACK": Ringback played to port.</li> <li>■ "SESSION": Call has been answered and is established.</li> <li>■ "RELEASE": Call has been terminated (SIP 200 OK).</li> </ul>
Fax State	Currently, not in use.
Coder + PTime	Coder and packetization time used for the call.
Call Type	Type of call: <ul style="list-style-type: none"> <li>■ "Voice": Voice call</li> </ul>

Field	Description
	<ul style="list-style-type: none"> <li>■ "Fax": Fax call</li> </ul>
Call Establishment Method	Mode of call: <ul style="list-style-type: none"> <li>■ "Normal": No early media during SIP session establishment (before call accepted).</li> <li>■ "EarlyMedia": Media sent (e.g., announcements) before call accepted by called party.</li> </ul>
DTMF Selected Method for Tx/Rx	DTMF Transport method used for the call. For configuring the transport method, see <a href="#">Configuring DTMF Transport Types</a> .
<b>Basic</b>	
Channel Identifier:	Channel identifier number.
Status	Status of port: <ul style="list-style-type: none"> <li>■ "Inactive": No call</li> <li>■ "Active": Active call</li> </ul>
Call ID	See above.
Endpoint ID	ID of endpoint: <ul style="list-style-type: none"> <li>■ "Not Available"</li> </ul>
Call Duration	Call duration (in seconds) from when call was established.
Call Type	Type of call: <ul style="list-style-type: none"> <li>■ "Voice": Voice call</li> <li>■ "Fax": Fax call</li> </ul>
Call Destination	IP address of called party.
Coder	Coder type used for the call.
Last Current Disconnect Duration	Duration of the disconnect signal. <b>Note:</b> The parameter is applicable only to analog interfaces.
Line Current	Line current (in mA). <b>Note:</b> The parameter is applicable only to analog interfaces.
Line Voltage	Line voltage (in V).

Field	Description
	<b>Note:</b> The parameter is applicable only to analog interfaces.
Hook	Status of phone: <ul style="list-style-type: none"> <li>■ "0": On hook</li> <li>■ "1": Off hook</li> </ul> <b>Note:</b> The parameter is applicable only to analog interfaces.
Ring	Status of ringing: <ul style="list-style-type: none"> <li>■ "0": Off</li> <li>■ "1": On</li> </ul> <b>Note:</b> The parameter is applicable only to analog interfaces.
Line Connected	Line status: <ul style="list-style-type: none"> <li>■ "0": Disconnected</li> <li>■ "1": Connected</li> </ul> <b>Note:</b> The parameter is applicable only to analog interfaces.
Polarity state	Port polarity: <ul style="list-style-type: none"> <li>■ "0": Normal</li> <li>■ "1": Reversed</li> <li>■ "2": N/A</li> </ul> <b>Note:</b> The parameter is applicable only to analog interfaces.
Line polarity	Line polarity: <ul style="list-style-type: none"> <li>■ "0": Positive</li> <li>■ "1": Negative</li> </ul> <b>Note:</b> The parameter is applicable only to analog interfaces.
Message Waiting Indication	MWI status: <ul style="list-style-type: none"> <li>■ "0": Off</li> <li>■ "1": On</li> </ul> <b>Note:</b> The parameter is applicable only to analog interfaces.
<b>RTP/RTCP</b>	

Field	Description
Channel Identifier	Channel identifier number.
RTP Direction	Direction of RTP: "Tx & Rx": both directions (transmit and receive)
Local UDP Port	Local UDP port on the device.
Remote IP Addr	IP address of the remote IP side.
Remote UDP Port	Port of the remote IP side.
Rx Octet Count	Total number of received packets.
Tx Octet Count	Total number of transmitted packets.
Network Jitter	Network jitter (in msec).
Roundtrip Delay	Round-trip delay time (in msec).
Packet Loss	Packet loss (in %).
Remote RTCP CName	RTP Control Protocol (RTCP) Canonical Name (CNAME) - persistent transport-level identifier for an RTP endpoint.
Channel Identifier	Channel ID.
<b>Voice Settings</b>	
Coder	Displays the coder used for the call.
Frame Duration	Frame duration (in msec).
Echo Canceller	Indicates whether the echo canceller is enabled or disabled.
Silence Suppression	Indicates whether silence suppression is enabled or disabled.
Input Gain	Displays the volume gain (in dB).
Voice Volume	Displays the voice volume gain (in dB).
DTMF Transport Type	Displays the DTMF transport type.
Enabled Detectors	Displays enabled detectors (e.g., AMD).

Field	Description
Fax Transport Type	Displays the fax transport type.

## 51 Viewing Carrier-Grade Alarms

This section describes how to view SNMP alarms raised by the device.

### Viewing Active Alarms

You can view current (active) alarms in the Web interface that have been raised by the device. If an alarm is cleared, it is moved into the History Alarms table (see [Viewing History Alarms](#)). The alarms are displayed from newest to oldest. In other words, the most recently raised alarm is shown first in the list. The table is automatically refreshed every 60 seconds.



- The alarms in the table are deleted upon a device reset.
- To configure the maximum number of active alarms that can be displayed in the table, see the ini file parameter, ActiveAlarmTableMaxSize.
- The alarm bell icon, located on the top-right of the Web interface's window, displays the number of currently active alarms raised by the device and the highest severity (color coded - see below) of these alarms.
- For more information on SNMP alarms, refer to the *SNMP Reference Guide* document.

#### ➤ To view active alarms:

1. Open the Active Alarms table:
  - Navigation tree: **Monitor** menu > **Monitor** tab > **Summary** folder > **Active Alarms**.
  - Monitor home page: Click the "Alarms" area on the graphical display of the device (see [Viewing Device Status on Monitor Page](#)).
  - Alarm bell  icon (located in the top-right area of the Web interface)

SEQUENTIAL #	SEVERITY	SOURCE	DESCRIPTION	TIME
13	Minor	Board#1/HTTPProxyService#0	HTTP Proxy Upstream Host 10.1.1.1:45(Host #0 in Upstream Group #0) is OF	04/01/2010, 00:12:23
12	Major	Board#1/HTTPProxyService#0	NGINX Configuration file is not valid. Nginx configuration file is Not Valid	04/01/2010, 00:12:11
5	Major	Board#1/ProxyConnection#1	Proxy Set Alarm Proxy Set 1 (IP-PBX): Proxy lost. looking for another proxy	01/01/2010, 00:00:53
4	Minor	Board#1/EthernetLink#4	Ethernet link alarm. LAN port number 4 is down.	01/01/2010, 00:00:51
3	Minor	Board#1/EthernetLink#3	Ethernet link alarm. LAN port number 3 is down.	01/01/2010, 00:00:51
2	Minor	Board#1/EthernetLink#2	Ethernet link alarm. LAN port number 2 is down.	01/01/2010, 00:00:51
1	Major	Board#1/ProxyConnection#2	Proxy Set Alarm Proxy Set 2 (ITSP-2): Proxy lost. looking for another proxy	01/01/2010, 00:00:50

**Table 51-1: Active Alarms Table Description**

Field	Description
<b>Sequential #</b>	The number of the alarm. Alarms are numbered sequentially as they are raised by the device. The numbering resets to 1 after a device reset (i.e., the first alarm raised after a reset is assigned the number #1).
<b>Severity</b>	Severity level of the alarm:

Field	Description
	<ul style="list-style-type: none"> <li>■ ● Critical (red)</li> <li>■ ● Major (orange)</li> <li>■ ● Minor (yellow)</li> </ul>
<b>Source</b>	Component of the device from which the alarm was raised.
<b>Description</b>	Brief description of the alarm.
<b>Date</b>	Date (DD/MM/YYYY) and time (HH:MM:SS) the alarm was raised.

## Viewing History Alarms

You can view all SNMP alarms, in the Web interface's Alarms History table, that have been raised (active alarms) as well as cleared (resolved). One of the benefits of this is that you can view alarms that may have been raised and then cleared on a continuous basis. For example, such an alarm may be raised due to an Ethernet cable that is not securely attached to the device's Ethernet port, causing the Ethernet link to be sometimes up and sometimes down. This alarm would not be listed in the Active Alarms table due to it being cleared.

The alarms in the table are displayed from newest to oldest. In other words, the most recently raised alarm is shown first in the list. The table displays both the cleared alarm and the alarm for which it was cleared adjacent to one another, as shown in the figure below for alarms #8 and #9.

To configure the maximum number of alarms that can be displayed in the table, use the AlarmHistoryTableMaxSize ini file parameter. If the maximum is reached and a new alarm is added to the table, the oldest alarm is removed from the table to accommodate the new alarm.







- The alarms in the table are deleted upon a device reset.
- For more information on SNMP alarms, refer to the *SNMP Reference Guide* document.

### ➤ To view history alarms:

- Open the Alarms History table (**Monitor** menu > **Monitor** tab > **Summary** folder > **Alarms History**).

SEQUENTIAL #	SEVERITY	SOURCE	DESCRIPTION	TIME
13	Minor	Board#1/HTTPProxyService#0	HTTP Proxy Upstream Host 10.1.1.1:45(Host #0 in Upstream Group #0) is OF	04/01/2010, 00:12:23
12	Major	Board#1/HTTPProxyService#0	NGINX Configuration file is not valid. Nginx configuration file is Not Valid	04/01/2010, 00:12:11
11	Cleared	Board#1/HTTPProxyService#0	HTTP Proxy Upstream Host 10.1.1.1:77(Host #0 in Upstream Group #0) is ONL	02/01/2010, 23:45:15
10	Cleared	Board#1/HTTPProxyService#0	Nginx configuration file is Valid	02/01/2010, 23:45:14
9	Major	Board#1/HTTPProxyService#0	NGINX Configuration file is not valid. Nginx configuration file is Not Valid	02/01/2010, 23:26:57
8	Cleared	Board#1/HTTPProxyService#0	Nginx configuration file is Valid	02/01/2010, 02:59:36
7	Major	Board#1/HTTPProxyService#0	NGINX Configuration file is not valid. Nginx configuration file is Not Valid	02/01/2010, 02:46:21
6	Minor	Board#1/HTTPProxyService#0	HTTP Proxy Upstream Host 10.1.1.1:77(Host #0 in Upstream Group #0) is OFF	02/01/2010, 00:46:24
5	Major	Board#1/ProxyConnection#1	Proxy Set Alarm Proxy Set 1 (IP-PBX): Proxy lost. looking for another proxy	01/01/2010, 00:00:53
4	Minor	Board#1/EthernetLink#4	Ethernet link alarm. LAN port number 4 is down.	01/01/2010, 00:00:51

Table 51-2: Alarms History Table Description

Field	Description
<b>Sequential #</b>	The number of the alarm. The alarms are numbered sequentially as they are raised by the device. The numbering resets to 1 immediately after a device reset (i.e., the first alarm raised after a reset is assigned the number #1).
<b>Severity</b>	Severity level of the alarm:  Critical (red)  Major (orange)  Minor (yellow)  Cleared (green)
<b>Source</b>	Component of the device from which the alarm was raised.
<b>Description</b>	Brief description of the alarm.
<b>Date</b>	Date (DD/MM/YYYY) and time (HH:MM:SS) the alarm was raised.

➤ **To delete all the alarms in the table:**

1. Click the **Delete History Table** button; a confirmation message box appears.
2. Click **OK** to confirm.



## 52 Viewing Management User Activity Logs

If you have enabled the reporting of management user activities performed in the device's management interfaces (see [Configuring Reporting of Management User Activities](#)), you can view the logged activities in the Web interface, as described in the procedure below.

➤ **To view management user activity logs:**

- Open the Activity Log table (**Monitor** menu > **Monitor** tab > **Summary** folder > **Activity Log**).

ID ↕	TIME	DESCRIPTION	USER	INTERFACE	CLIENT
7	11/29/2010, 11:44:45	CLI: 'enable'	Admin	Telnet	10.13.2.3
6	11/29/2010, 11:44:43	User login succeeded	Admin	Telnet	10.13.2.3
5	11/29/2010, 11:40:38	System configuration has be	Admin	WEB	10.13.2.3
4	11/29/2010, 11:40:27	WEB: Successful login at 10	Admin	WEB	10.13.2.3
3	11/29/2010, 11:40:24	WEB: User logout	Admin	WEB	10.13.2.3
2	11/29/2010, 11:40:16	SRTP Tunneling Authenticati	Admin	WEB	10.13.2.3
1	11/29/2010, 11:39:58	System configuration has be	Admin	WEB	10.13.2.3

**Table 52-1: Activity Log Table Description**

Parameter	Description
Time	Date (mm/dd/yyyy) and time (hh:mm:ss) that the activity was performed.
Description	Description of the activity.
User	Username of the user account that performed the activity.
Interface	Protocol used for connecting to the management interface (e.g., Telnet, SSH, Web, or HTTP).
Client	IP address of the client PC from where the user accessed the management interface.

## 53 Viewing Performance Monitoring

This section describes how to view performance monitoring in the device's Web interface.

### Viewing Call Success and Failure Ratio

You can view success and failure ratio of SIP dialogs in the Web interface's Success/Failure Ratio page. You can filter the display by SRD or IP Group, and by call direction and type of SIP dialog (e.g., INVITEs only). The information is displayed in the following pie charts:

- **Dialog Success Ratio:** Displays the SIP call and subscribe (SUBSCRIBE) dialog success-failed ratio.
- **Dialog Failed Attempts:** Displays failed SIP dialog attempts. This includes the number of calls and subscribes which were successfully and abnormally terminated.
- **Dialog Termination Ratio:** Displays SIP dialog termination by reason (e.g., due to no answer).

#### ➤ To view success and failed call ratio:

1. Open the Success/Failure Ratio page (**Monitor** menu > **Monitor** tab > **Performance Monitoring** folder > **Success / Failure Ratio**).

#### Success/Failure Ratio

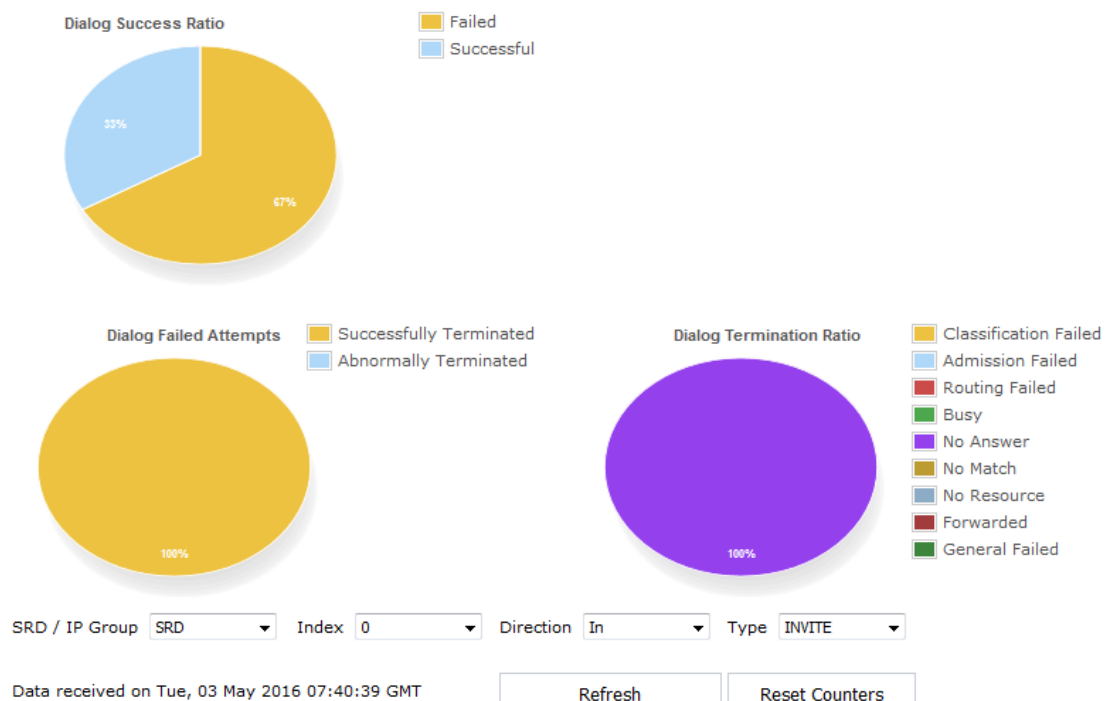

2. From the 'SRD / IP Group' drop-down list, select whether you want to view statistic for an SRD or IP Group.
3. From the 'Index' drop-down list, select the SRD or IP Group index.

4. From the 'Direction' drop-down list, select the call direction:
  - **In:** incoming calls
  - **Out:** outgoing calls
  - **Both:** incoming and outgoing calls
5. From the 'Type' drop-down list, select the SIP message type:
  - **INVITE:** INVITE
  - **SUBSCRIBE:** SUBSCRIBE
  - **Other:** all SIP messages

If there is no data for the charts, the chart appears gray and "No Data" is displayed to the right of the chart.

➤ **To refresh the charts:**

- Click **Refresh**.

➤ **To reset the counters:**

- Click **Reset Counters**.

## Viewing Average Call Duration

You can view the number of established calls over a 15-minute interval and the average call duration (ACD) in the Web interface's Average Call Duration page. You can filter display by a specific SRD or IP Group. The page displays the following two graphs:

- **Upper graph:** Displays the number of established calls (INVITEs) in a 15-minute interval. The x-axis indicates the time (hh:mm:ss) of the call and the y-axis the number of calls. The graph is refreshed every 15 minutes.
- **Lower graph:** Displays the ACD. The x-axis indicates the time (hh:mm:ss) and the y-axis the average call duration. The ACD is refreshed every 15 minutes and therefore, this value reflects the average duration of all established calls made within a 15-minute interval.





The Average Call Duration page is applicable only to SBC calls.

➤ **To view number of active calls and average call duration:**

1. Open the Average Call Duration page (**Monitor** menu > **Monitor** tab > **Performance Monitoring** folder > **Average Call Duration**).



2. From the 'SRD / IP Group' drop-down list, select the configuration entity (SRD or IP Group).
3. From the 'Index' drop-down list, select the specific SRD or IP Group index.

Use the **Zoom In**  button to increase the displayed time resolution or the **Zoom Out**  button to decrease it. Instead of using these buttons, you can use the slide ruler. As you increase the resolution, more data is displayed on the graph. The minimum resolution is about 30 seconds; the maximum resolution is about an hour.

To pause the graph, click the **Pause** button; click **Play** to resume.

## Viewing Trunk Utilization

You can view the number of active channels per trunk over time in the Web interface's Trunk Utilization page. The page displays a graph, where the x-axis indicates the time (hh:mm:ss) and the y-axis the number of active trunk channels.



- The Trunk Utilization page is applicable only to the Gateway application.
- To view the graph, your device must be connected to and configured with trunks.
- To view the graph, you must first disable the SBC application.
- If you navigate to a different page, the data displayed on the graph and all its settings are cleared.

### ➤ To view the number of active trunk channels:



1. Open the Trunk Utilization page (**Monitor** menu > **Monitor** tab > **Performance Monitoring** folder > **Trunk Utilization**).



2. From the 'Trunk' drop-down list, select the trunk for which you want to view active channels.
3. For more graph functionality, see the following table:

**Table 53-1: Additional Graph Functionality for Trunk Utilization**

Button	Description
<b>Add</b> button	Displays additional trunks in the graph. Up to five trunks can be displayed simultaneously. To view another trunk, click the button and then from the new 'Trunk' drop-down list, select the required trunk. The graph displays each trunk in a different color, according to the legend shown in the top-left corner of the graph.
<b>Remove</b> button	Removes the corresponding trunk from the graph.
<b>Disable</b> check box	Hides or shows an already selected trunk. Select the check box to hide the trunk display; clear the check box to show the trunk. This is useful if you do not want to remove the trunk entirely (using the <b>Remove</b> button).
<b>Get Most Active</b> button	Displays only the trunk with the most active channels (i.e., trunk with the most calls).
<b>Pause</b> button	Pauses the display in the graph.
<b>Play</b> button	Resumes the display in the graph.

Button	Description
<b>Zoom</b> slide ruler and buttons	Increases or reduces the trunk utilization display resolution concerning time. The <b>Zoom In</b>  button increases the time resolution; the <b>Zoom Out</b>  button decreases it. Instead of using the buttons, you can use the slide ruler. As you increase the resolution, more data is displayed on the graph. The minimum resolution is about 30 seconds; the maximum resolution is about an hour.

## Configuring Performance Profiles

The Performance Profile table lets you configure up to 432 Performance Profile rules. A Performance Profile rule defines thresholds of performance monitoring call metrics for Major and Minor severity alarms. If the threshold is crossed, the device raises the corresponding severity alarm. You can configure a Performance Profile rule for all calls (*globally*), or per SRD or IP Group.

You can configure the alarm thresholds for the following call metrics:

- **Answer Success Ratio or ASR (also known as Answer Seizure Ratio):** The number (in percentage) of answered calls (i.e. number of seizures resulting in an answer signal) out of the total number of attempted calls (seizures). The metric is calculated for the outgoing call leg. The metric includes the following SNMP performance monitoring MIBs:
  - PM\_gwSBCASR: ASR for all (global) entities (i.e., all IP Groups and SRDs)
  - PM\_gwSBCIPGroupASR: ASR per IP Group
  - PM\_gwSBCSRDASR: ASR per SRD

If the configured ASR minor or major thresholds are crossed, the device raises the SNMP alarm, acASRThresholdAlarm (OID 1.3.6.1.4.1.5003.9.10.1.21.2.0.111).

To view ASR in the Web interface, see [Viewing Call Success and Failure Ratio](#).

- **Network Effectiveness Ratio (NER):** The number (in percentage) of successfully connected calls out of the total number of attempted calls (seizures). The metric measures the ability of the network to deliver a call to the called terminal. In addition to answered calls, the following SIP response codes are regarded as successfully connected calls: 408 (Request Timeout), 480 (Temporarily Unavailable), and 486 (Busy Here). The metric is calculated for the outgoing call leg. The metric includes the following SNMP performance monitoring MIBs:

- PM\_gwSBCNER: NER for all (global) entities (i.e., all IP Groups and SRDs)
- PM\_gwSBCIPGroupNER: NER per IP Group
- PM\_gwSBCSRDNER: NER per SRD

If the configured NER minor or major thresholds are crossed, the device raises the SNMP alarm, AcNERThresholdAlarm (OID 1.3.6.1.4.1.5003.9.10.1.21.2.0.113).

■ **Average Call Duration (ACD):** The ACD plus the session disconnect time (SDD) is the duration from when the SIP 200 OK is received to when the SIP Bye message is sent. The metric is calculated for both incoming and outgoing call legs. The metric includes the following SNMP performance monitoring MIBs:

- PM\_gwSBCACD: ACD for all (global) entities (i.e., all IP Groups and SRDs)
- PM\_gwSBCIPGroupACD: ACD per IP Group
- PM\_gwSBCSRDACD: ACD per SRD

If the configured ACD minor or major thresholds are crossed, the device raises the SNMP alarm, acACDThresholdAlarm (OID 1.3.6.1.4.1.5003.9.10.1.21.2.0.112).

To view ACD in the Web interface, see [Viewing Average Call Duration](#).

At any given time during a call, a voice metric can be in one of the following color-coded quality states (as displayed in OVOC):

- **Green:** Indicates good call quality
- **Yellow:** Indicates fair call quality
- **Red:** Indicates poor call quality

When the threshold of a voice metric is crossed, the device changes the alarm severity and corresponding color-coded quality state of the call:

- **Minor Threshold (Yellow):** Lower threshold that indicates changes from Green or Red to Yellow.
- **Major Threshold (Red):** Higher threshold that indicates changes from Green or Yellow to Red.

The device also uses hysteresis to determine whether the threshold has indeed been crossed. Hysteresis defines the amount of fluctuation from the threshold in order for the threshold to be considered as crossed (i.e., change in color state). Hysteresis is used to avoid false reports being sent by the device. Hysteresis is used only for threshold crossings toward a lesser severity (i.e., from Red to Yellow, Red to Green, or Yellow to Green).

The following example is used to explain how the device considers threshold crossings. The example is based on the ASR of a call, where the Major threshold is configured to 70%, the Minor threshold to 90% and the hysteresis for both thresholds to 2%:

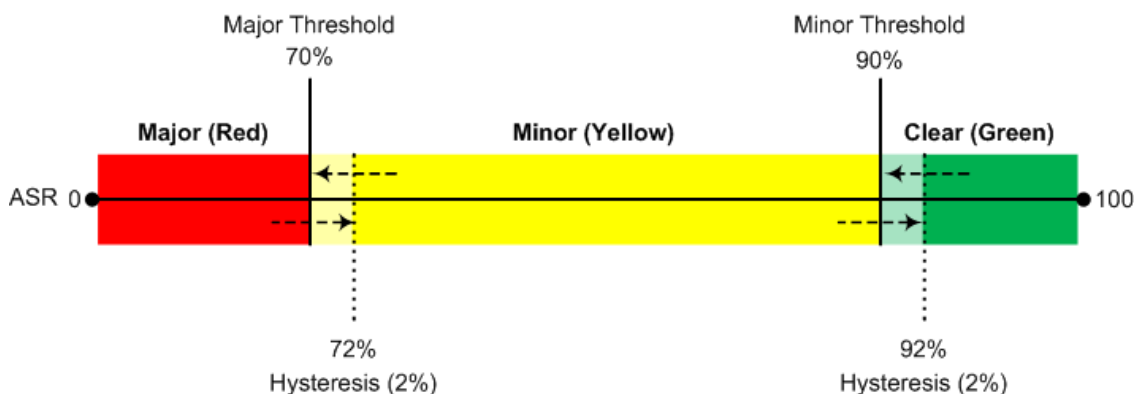

**Table 53-2: Threshold Crossings based on Threshold and Hysteresis**

Threshold Crossing	Calculation	Threshold based on Example
Green to Yellow (Minor alarm)	The change occurs if the measured metric crosses the configured Minor threshold only (i.e., hysteresis is not used).	90%
Green to Red (Major alarm)	The change occurs if the measured metric crosses the configured Major threshold only (i.e., hysteresis is not used).	70%
Yellow to Red (Major alarm)	The change occurs if the measured metric crosses the configured Major threshold only (i.e., hysteresis is not used).	70%
Red to Yellow (Minor alarm)	The change occurs if the measured metric crosses the configured Major threshold with hysteresis.	72% (i.e., 70 + 2)
Red to Green (alarm cleared)	The change occurs if the measured metric crosses the configured Minor threshold with hysteresis.	92 (i.e., 90 + 2)
Yellow to Green (alarm cleared)	The change occurs if the measured metric crosses the configured Minor threshold with hysteresis.	92 (i.e., 90 + 2)



- Forwarded calls are not considered in the calculation for ASR and NER.
- If you don't configure thresholds for a specific metric, the device still provides current performance monitoring values of the metric, but does not raise any threshold alarms for it.
- You can configure the device to perform certain actions, for example, reject calls to the IP Group for a user-defined duration, if a threshold is crossed. For more information, see [Configuring Quality of Service Rules](#).
- The section is applicable only to the SBC application.

The following procedure describes how to configure Performance Profile rules through the Web interface. You can also configure it through ini file [PerformanceProfile] or CLI (`configure system > performance-profile`).

➤ **To configure a Performance Profile rule:**

1. Open the Performance Profile table (**Monitor** menu > **Monitor** tab > **Performance Monitoring** folder > **Performance Profile**).
2. Click **New**; the following dialog box appears:



3. Configure the rule according to the parameters described in the table below.
4. Click **Apply**.

**Table 53-3: Performance Profile Table Parameter Descriptions**

Parameter	Description
'Index' [PerformanceProfile_ Index]	Defines an index number for the new table row. <b>Note:</b> Each row must be configured with a unique index.
<b>Match</b>	
'Entity' entity [PerformanceProfile_ Entity]	Defines a configuration entity type to which you want to apply the rule.  <ul style="list-style-type: none"> <li>■ [0] <b>Global</b> = (Default) The device calculates call metrics for all calls.</li> <li>■ [1] <b>SRD</b> = Assigns an SRD. To specify the SRD, use the 'SRD' parameter (see below).</li> <li>■ [2] <b>IP Group</b> = Assigns an IP Group. To specify the IP Group, use the 'IP Group' parameter (see below).</li> </ul>
'IP Group' ip-group-name [PerformanceProfile_ IPGroupName]	Assigns an IP Group to the rule. <b>Note:</b> The parameter is applicable only if you configure the 'Entity' parameter to <b>IP Group</b> .
'SRD' srd-name [PerformanceProfile_ SRDName]	Assigns an SRD to the rule. <b>Note:</b> The parameter is applicable only if you configure the 'Entity' parameter to <b>SRD</b> .
'PM Type'	Defines the type of performance monitoring metric for which you

Parameter	Description
pmtype [PerformanceProfile_ PMType]	want to configure thresholds. <ul style="list-style-type: none"> <li>■ [16] <b>ASR</b> (Default)</li> <li>■ [17] <b>ACD</b></li> <li>■ [18] <b>NER</b></li> </ul>
<b>Action</b>	
'Minor Threshold' minor- threshold [PerformanceProfile_ MinorThreshold]	Defines the Minor threshold (in percentage) of the selected performance monitoring metric, which is the lower threshold located between the Yellow and Green states.  To consider a threshold crossing: <ul style="list-style-type: none"> <li>■ <b>Increase in severity (i.e., Green to Yellow):</b> Only this value is used.</li> <li>■ <b>Decrease in severity (Red to Green, or Yellow to Green):</b> This value is used with the hysteresis, configured by the 'Hysteresis' parameter (see below).</li> </ul> The valid range is 0 to 100. The default is 0.
'Major Threshold' major- threshold [PerformanceProfile_ MajorThreshold]	Defines the Major threshold (in percentage) of the selected performance monitoring metric, which is the upper threshold located between the Yellow and Red states.  To consider a threshold crossing: <ul style="list-style-type: none"> <li>■ <b>Increase in severity (i.e., Yellow to Red, or Green to Red):</b> Only this value is used.</li> <li>■ <b>Decrease in severity (Red to Yellow):</b> This value is used with the hysteresis, configured by the 'Hysteresis' parameter (see below).</li> </ul> The valid range is 0 to 100. The default is 0.
'Hysteresis' hysteresis [PerformanceProfile_ Hysteresis]	Defines the amount of fluctuation (hysteresis) from the configured threshold in order for the threshold to be considered as crossed. Hysteresis is used to avoid false reports being sent by the device. Hysteresis is used only when the severity level decreases (i.e., from Red to Yellow, Yellow to Green, or Red to Green).  The valid value is 0 to 15 (in percentage). The default is 5.  For example, if you configure the 'Major Threshold' parameter to 70% and the 'Hysteresis' parameter to 2%, the device considers a threshold crossing from Red to Yellow only if the ASR crosses 72%

Parameter	Description
	(i.e., 70% + 2%).
'Minimum Samples' minimum-samples [PerformanceProfile_MinimumSample]	<p>Defines the minimum number of call sessions (sample) that is required for the device to calculate the performance monitoring metrics (per window size). If the number of call sessions is less than the configured value, no calculation is done.</p> <p>The default is 10 calls.</p> <p><b>Note:</b> The calculation also depends on the configured sampling window size (see 'Window Size' parameter). For example, if the parameter is configured to 10 calls, but only 5 calls were processed during the configured sampling window, no calculation is done.</p>
'Window Size' window-size [PerformanceProfile_WindowSize]	<p>Defines the time interval (in minutes) during which the device calculates the performance monitoring metrics. For example, if the parameter is configured to five minutes, the calculation is done for the last five minutes.</p> <p>The default is 5 minutes.</p> <p><b>Note:</b> The calculation depends on the configured minimum samples (see 'Minimum Samples' parameter). For example, if the parameter is configured to five minutes, but the number of calls during the interval is less than the configured minimum samples, no calculation is done.</p>

## 54 Viewing VoIP Status

This section describes how to view VoIP-related status.

### Viewing Tel-to-IP and IP-to-Tel Call Counters

You can view statistical information on IP-to-Tel and Tel-to-IP calls in the Web interface's IP-to-Tel Calls Count page and Tel-to-IP Calls Count page. The information is updated according to the release reason that is received after a call is terminated (during the same time as the end-of-call CDR message is sent). The release reason can be viewed in the 'Termination Reason' field in the CDR message.

You can reset the statistical data displayed on the page (i.e., refresh the display), by clicking the **Reset Counters** button located below the table.

#### ➤ To view IP-to-Tel and Tel-to-IP call counters:

- Open the IP-to-Tel Calls Count page or Tel-to-IP Calls Count page (**Monitor** menu > **Monitor** tab > **VoIP Status** folder > **IP-to-Tel Calls Count** or **Tel-to-IP Calls Count**); the figure below shows the IP-to-Tel Calls Count page.

Number of Attempted Calls	0	Number of Failed Calls due to No Matched Capabilities	0
Number of Established Calls	0	Number of Failed Calls due to No Resources	0
Percentage of Successful Calls(ASR)	---	Number of Failed Calls due to Other Failures	0
Number of Calls Terminated due to a Busy Line	0	Average Call Duration(ACD)[sec]	0
Number of Calls Terminated due to No Answer	0	Attempted Fax Calls Counter	0
Number of Calls Terminated due to Forward	0	Successful Fax Calls Counter	0
Number of Failed Calls due to No Route	0		

The fields in this page are described in the following table:

**Table 54-1: IP-to-Tel Calls Count and Tel-to-IP Calls Count Description**

Counter	Description
Number of Attempted Calls	Indicates the number of attempted calls. It is composed of established and failed calls. The number of established calls is represented by the 'Number of Established Calls' counter. The number of failed calls is represented by the failed-call counters. Only one of the established / failed call counters is incremented every time.
Number of Established Calls	Indicates the number of established calls. It is incremented as a result of one of the following release reasons if the duration of the call is greater than zero: <ul style="list-style-type: none"> <li>■ GWAPP_REASON_NOT_RELEVANT (0)</li> <li>■ GWAPP_NORMAL_CALL_CLEAR (16)</li> </ul>

Counter	Description
	<ul style="list-style-type: none"> <li>■ GWAPP_NORMAL_UNSPECIFIED (31)</li> </ul> <p>And the internal reasons:</p> <ul style="list-style-type: none"> <li>■ RELEASE_BECAUSE_UNKNOWN_REASON</li> <li>■ RELEASE_BECAUSE_REMOTE_CANCEL_CALL</li> <li>■ RELEASE_BECAUSE_MANUAL_DISC</li> <li>■ RELEASE_BECAUSE_SILENCE_DISC</li> <li>■ RELEASE_BECAUSE_DISCONNECT_CODE</li> </ul> <p><b>Note:</b> When the duration of the call is zero, the release reason GWAPP_NORMAL_CALL_CLEAR increments the 'Number of Failed Calls due to No Answer' counter. The rest of the release reasons increment the 'Number of Failed Calls due to Other Failures' counter.</p>
Percentage of Successful Calls (ASR)	The percentage of established calls from attempted calls, known as Answer Success Ratio (ASR).
Number of Calls Terminated due to a Busy Line	Indicates the number of calls that failed as a result of a busy line. It is incremented as a result of the following release reason: GWAPP_USER_BUSY (17)
Number of Calls Terminated due to No Answer	<p>Indicates the number of calls that weren't answered. It's incremented as a result of one of the following release reasons:</p> <ul style="list-style-type: none"> <li>■ GWAPP_NO_USER_RESPONDING (18)</li> <li>■ GWAPP_NO_ANSWER_FROM_USER_ALERTED (19)</li> <li>■ GWAPP_NORMAL_CALL_CLEAR (16) (when the call duration is zero)</li> </ul>
Number of Calls Terminated due to Forward	Indicates the number of calls that were terminated due to a call forward. The counter is incremented as a result of the following release reason: RELEASE_BECAUSE_FORWARD
Number of Failed Calls due to No Route	<p>Indicates the number of calls whose destinations weren't found. It is incremented as a result of one of the following release reasons:</p> <ul style="list-style-type: none"> <li>■ GWAPP_UNASSIGNED_NUMBER (1)</li> </ul>

Counter	Description
	<ul style="list-style-type: none"> <li>■ GWAPP_NO_ROUTE_TO_DESTINATION (3)</li> </ul>
Number of Failed Calls due to No Matched Capabilities	Indicates the number of calls that failed due to mismatched device capabilities. It is incremented as a result of an internal identification of capability mismatch. This mismatch is reflected to CDR via the value of the parameter DefaultReleaseReason (default is GWAPP_NO_ROUTE_TO_DESTINATION (3)) or by the GWAPP_SERVICE_NOT_IMPLEMENTED_UNSPECIFIED (79) reason.
Number of Failed Calls due to No Resources	Indicates the number of calls that failed due to unavailable resources or a device lock. The counter is incremented as a result of one of the following release reasons: <ul style="list-style-type: none"> <li>■ GWAPP_RESOURCE_UNAVAILABLE_UNSPECIFIED</li> <li>■ RELEASE_BECAUSE_GW_LOCKED</li> </ul>
Number of Failed Calls due to Other Failures	This counter is incremented as a result of calls that failed due to reasons not covered by the other counters.
Average Call Duration (ACD)	The average call duration (ACD) in seconds of established calls. The ACD value is refreshed every 15 minutes and therefore, this value reflects the average duration of all established calls made within a 15 minute period.
Attempted Fax Calls Counter	Indicates the number of attempted fax calls.
Successful Fax Calls Counter	Indicates the number of successful fax calls.

## Viewing SBC Registered Users

You can view SBC users that are registered with the device. For each user, the Address of Record (AOR) and the corresponding contacts are shown. An AOR is a SIP or SIPS URI that points to a domain with a location service that can map the URI to another URI (contact) where the user might be available. A contact is a SIP URI that can be used to contact that specific instance of the user agent for subsequent requests.

➤ **To view registered SBC users:**

- Web: SBC Registered Users page (**Monitor** menu > **Monitor** tab > **VoIP Status** folder > **SBC Registered Users**).

ADDRESS OF RECORD	CONTACT
Joe	UserInfo Contact   Not-Active   IPG:1   SI:-1   ID:23
Sue	UserInfo Contact   Not-Active   IPG:1   SI:-1   ID:24

**Table 54-2: SBC Registered Users Table Description**

Parameter	Description
Address of Record	Displays the AOR, for example, "1000@10.8.5.71" or "Sue".
Contact	<p>Displays the contacts associated with the AOR, for example:            &lt;sip:1000@10.8.5.71:5060&gt;;expires=180; Active status:1</p> <p>The information displayed can include the following:</p> <ul style="list-style-type: none"> <li>■ The origin of the contact:               <ul style="list-style-type: none"> <li>✓ "Userinfo": Contact is from the User Information table (see <a href="#">Configuring SBC User Information Table through Web Interface</a> on page 606)</li> <li>✓ Contact URI if the contact is not from the User Information table.</li> </ul> </li> <li>■ Registration status:               <ul style="list-style-type: none"> <li>✓ No display: The contact has been successfully registered with the device and calls can be routed to the user.</li> <li>✓ "Not-Active": The device has recently received a REGISTER request from the contact, but the contact has yet to be registered. The device removes the contact from the database if no response is received within 10 seconds from the proxy/registrar server.</li> </ul> </li> <li>■ IP Group to which the contact belongs, shown in the format "IPG:&lt;row index of IP Group)".</li> <li>■ ID of the contact.</li> </ul>

- CLI:
  - SBC users:

```
# show voip register db sbc list
```

- SBC contacts of a specified AOR:

```
# show voip register db sbc user <Address Of Record>
```

## Viewing Proxy Set Status

You can view the status of Proxy Sets that are used in your call routing topology. Proxy Sets that are not associated with any routing rule are not displayed. To configure Proxy Sets, see [Configuring Proxy Sets](#).

### ➤ To view the status of Proxy Sets:

- Open the Proxy Sets Status page (**Monitor** menu > **Monitor** tab > **VoIP Status** folder > **Proxy Sets Status**).

PROXY SET ID	NAME	MODE	KEEP ALIVE	ADDRESS	PRIORITY	WEIGHT	SUCCESS COUNT	FAILURE COUNT	STATUS
0	ITSP-1	Load Balancing	Enabled						<b>ONLINE</b>
				10.8.6.88	-	-	0	18	OFFLINE
				10.8.6.89(*)	-	-	3	0	ONLINE
1	IP-PBX	Homing	Enabled						<b>OFFLINE</b>
				10.8.6.66	-	-	0	24	
2	ITSP-2	Parking	Enabled						<b>NOT RESOLVED</b>
				abc.com	-	-	0	0	NOT RESOLVED

**Table 54-3: Proxy Sets Status Table Description**

Parameter	Description
Proxy Set ID	Displays the Proxy Set ID.
Name	Displays the Proxy Set name.
Mode	Displays the Proxy Sets' operational mode: <ul style="list-style-type: none"> <li>■ "Parking" or "Homing": Redundancy mode, as configured by the ProxySet_ProxyRedundancyMode parameter.</li> <li>■ "Load Balancing: Proxy load balancing mode, as configured by the ProxySet_ProxyRedundancyMode parameter.</li> </ul>
Keep Alive	Displays whether the Proxy Keep-Alive feature is enabled ("Enabled") or disabled ("Disabled"), as configured by the ProxySet_EnableProxyKeepAlive parameter.
Address	Displays the IP address of the proxy server. This can be the IP address as configured in dotted-decimal notation for the Proxy Set, or the resolved IP address of a DNS query if an FQDN is configured for the Proxy Set. <ul style="list-style-type: none"> <li>■ IP addresses resolved from FQDNs are displayed as "&lt;FQDN name&gt;</li> </ul>



Parameter	Description
	<p>(&lt;resolved IP address&gt;)", for example, "abc.com(10.8.6.80)".</p> <ul style="list-style-type: none"> <li>■ The IP address that is currently used for routing is indicated with an asterisk, for example, "10.8.6.89(*)".</li> <li>■ If the FQDN failed to be resolved, only the FQDN name is displayed (e.g., "abc.com").</li> </ul>
Priority	<p>Displays the priority of IP addresses resolved from FQDNs.</p> <p><b>Note:</b> The field is applicable only to Proxy Sets configured with FQDNs.</p>
Weight	<p>Displays the weight of IP addresses resolved from FQDNs.</p> <p><b>Note:</b> The field is applicable only to Proxy Sets configured with FQDNs.</p>
Success Count	<p>Displays the total number of successful keep-alive messages (by SIP OPTIONS) sent by the device to the proxy.</p>
Failure Count	<p>Displays the total number of failed keep-alive messages (by SIP OPTIONS) sent by the device to the proxy.</p>
Status	<p>Displays the status of the Proxy Set and its' proxy servers.</p> <ul style="list-style-type: none"> <li>■ "ONLINE": <ul style="list-style-type: none"> <li>✓ Proxy Set ID row: At least one proxy is online as determined by the device's keep-alive feature. The status is also "ONLINE" for IP addresses resolved from DNS queries even if keep-alive is disabled.</li> <li>✓ Proxy server rows (if multiple addresses): The proxy server is online as determined by the device's keep-alive feature.</li> </ul> </li> <li>■ "OFFLINE": The proxy is offline as determined by the device's keep-alive feature and the Proxy Set is configured for Homing ('Redundancy Mode' parameter) or enabled for load balancing ('Proxy Load Balancing Method' parameter): <ul style="list-style-type: none"> <li>✓ Homing: The proxy is the main proxy, but the keep-alive has failed.</li> <li>✓ Load balancing: The keep-alive for the proxy has failed.</li> </ul> </li> <li>■ "NOT RESOLVED": Proxy address is configured as an FQDN, but the DNS resolution has failed.</li> <li>■ Empty field: Keep-alive for the proxy is disabled or the device has yet to send a keep-alive to the proxy.</li> </ul>

## Viewing Registration Status

You can view registration status of the device's endpoints (FXS, FXO and BRI) and SIP Accounts. The registration mode (i.e., per device, endpoint, Account or no registration) is configured in the Trunk Group Settings table (see [Configuring Trunk Group Settings](#)).

### ➤ To view registration status:

- Open the Registration Status page (**Monitor** menu > **Monitor** tab > **VoIP Status** folder > **Registration Status**).

Registered Per Gateway NO

#### Ports Registration Status

GATEWAY PORT		STATUS
Module 3 Port 1	FXO	NOT REGISTERED
Module 3 Port 2	FXO	NOT REGISTERED

#### Accounts Registration Status

INDEX	GROUP TYPE	GROUP NAME	STATUS
1	IP Group		NOT REGISTERED

#### Phone Numbers Status

PHONE NUMBER	GATEWAY PORT	STATUS
--------------	--------------	--------

**Table 54-4: Registration Status Page Description**

Parameter	Description
Registered Per Gateway	<p>Registration status of the device as one entity:</p> <ul style="list-style-type: none"> <li>■ "YES"</li> <li>■ "NO"</li> </ul> <p><b>Note:</b> The parameter is applicable only to the Gateway application.</p>
Ports Registration Status	<p>Displays the registration status per analog (FXS or FXO) port:</p> <ul style="list-style-type: none"> <li>■ "REGISTERED"</li> <li>■ "NOT REGISTERED"</li> </ul>
Accounts Registration Status	<p>Displays the status registration per Account, as configured in the Accounts table (see <a href="#">Configuring Registration Accounts</a>).</p> <ul style="list-style-type: none"> <li>■ <b>Group Type:</b> Served Trunk Group or IP Group</li> <li>■ <b>Group Name:</b> Name of served Trunk Group or IP Group, if applicable</li> <li>■ <b>Status:</b> "REGISTERED" or "NOT REGISTERED"</li> </ul>

Parameter	Description
Phone Number Status	Displays the registration status of BRI endpoints: <ul style="list-style-type: none"> <li>■ Phone Number: Phone number of endpoint.</li> <li>■ Gateway Port: module/port number of endpoint.</li> <li>■ Status: "REGISTERED" or "NOT REGISTERED"</li> </ul>

## Viewing IP Connectivity

You can view on-line, read-only network diagnostic connectivity information on destination IP addresses configured in the Tel-to-IP Routing table (see [Configuring Tel-to-IP Routing Rules](#)).



The table is applicable only to the Gateway application.

### ➤ To view IP connectivity status:

1. Enable alternative Tel-to-IP routing that is triggered by connectivity loss with destination. This is done by configuring the `AltRoutingTel2IPEnable` parameter to **Enable** or **Status Only**. For more information, see [Alternative Routing Based on IP Connectivity](#).
2. Open the IP Connectivity table (**Monitor** menu > **Monitor** tab > **VoIP Status** folder > **IP Connectivity**).

IP ADDRESS	HOST NAME	CONNECTIVITY METHOD	CONNECTIVITY STATUS	QUALITY STATUS	QUALITY INFO	DNS STATUS
------------	-----------	---------------------	---------------------	----------------	--------------	------------

**Table 54-5: IP Connectivity Table Description**

Column Name	Description
<b>IP Address</b>	Displays the destination IP address, which can be one of the following: <ul style="list-style-type: none"> <li>■ Destination IP address as configured in the Tel-to-IP Routing table.</li> <li>■ Destination IP address resolved from the host name (FQDN) as configured in the Tel-to-IP Routing table.</li> </ul>
<b>Host Name</b>	Displays the host name (or IP address) as configured in the Tel-to-IP Routing table.
<b>Connectivity Method</b>	Displays the method according to which the destination IP address is queried periodically by the device to check keep-alive connectivity status (SIP OPTIONS request). To configure the keep-

Column Name	Description
	alive mechanism, see <a href="#">IP Destinations Connectivity Feature</a> .
<b>Connectivity Status</b>	<p>Displays the connectivity status with the destination:</p> <ul style="list-style-type: none"> <li>■ "OK": Remote side responds to periodic connectivity queries.</li> <li>■ "Lost": Remote side didn't respond for a short period.</li> <li>■ "Fail": Remote side doesn't respond.</li> <li>■ "Init": Connectivity queries not started (e.g., IP address not resolved).</li> <li>■ "Disable": The connectivity option is disabled, i.e., parameter 'Alt Routing Tel to IP Mode' (AltRoutingTel2IPMode <i>ini</i>) is set to <b>None</b> or <b>QoS</b>. For more information, see <a href="#">Alternative Routing Based on IP Connectivity</a>.</li> </ul>
<b>Quality Status</b>	<p>Displays the QoS (according to packet loss and delay) of the destination:</p> <ul style="list-style-type: none"> <li>■ "Unknown": Recent quality information isn't available.</li> <li>■ "OK"</li> <li>■ "Poor"</li> </ul> <p><b>Note:</b></p> <ul style="list-style-type: none"> <li>■ The parameter is applicable only if the parameter 'Alt Routing Tel to IP Mode' is set to <b>QoS</b> or <b>Both</b> (AltRoutingTel2IPMode = 2 or 3).</li> <li>■ The parameter is reset if two minutes elapse without a call to the destination.</li> </ul>
<b>Quality Info</b>	<p>Displays QoS information: delay and packet loss, calculated according to previous calls.</p> <p><b>Note:</b></p> <ul style="list-style-type: none"> <li>■ The parameter is applicable only if the parameter 'Alt Routing Tel to IP Mode' is set to 'QoS' or 'Both' (AltRoutingTel2IPMode = 2 or 3).</li> <li>■ The parameter is reset if two minutes elapse without a call to the destination.</li> </ul>
<b>DNS Status</b>	<p>DNS status:</p> <ul style="list-style-type: none"> <li>■ "DNS Disable"</li> <li>■ "DNS Resolved"</li> </ul>

Column Name	Description
	■ "DNS Unresolved"

## Viewing Gateway CDR History

You can view historical Call Detail Records (CDR) of Gateway calls in the Gateway CDR History table. The table displays the last 4,096 CDRs. CDR history information is stored on the device's memory. When a new CDR is generated, the device adds it to the top of the table and all existing entries are shifted one down in the table. If the table has reached maximum capacity of entries and a new CDR is added, the last CDR entry is removed from the table.



- The CDR fields in the table cannot be customized.
- If the device is reset, all CDRs are deleted from memory and from the table.
- You can hide the values of the Caller and Callee fields, as described in [Hiding Caller and Callee CDR Field Values](#) on page 1288.

### ➤ To view Gateway CDR history:

- Web: Open the Gateway CDR History table (**Monitor** menu > **Monitor** tab > **VoIP Status** folder > **Gateway CDR History**).

CALL END TIME	END POINT	CALLER	CALLEE	DIRECTION	REMOTE IP	DURATION	TERMINATION REASON	SESSION ID
03:05:44.506	FXS-3/50	20049	20193	Incoming	10.8.128.82	00:01:03	NORMAL_C	8bd531:46:7570956
03:05:44.503	FXS-1/50	20049	20193	Outgoing	10.8.128.82	00:01:03	NORMAL_C	8bd531:46:7570889
03:05:43.803	FXS-4/5	20076	20220	Incoming	10.8.128.82	00:01:03	NORMAL_C	8bd531:46:7570954
03:05:43.797	FXS-2/5	20076	20220	Outgoing	10.8.128.82	00:01:03	NORMAL_C	8bd531:46:7570887

- CLI:

- All CDR history:

```
# show voip calls history gw
```

- CDR history for a specific SIP session ID:

```
# show voip calls history gw <session ID>
```

**Table 54-6: Gateway CDR History Table**

Field	Description
<b>Call End Time</b>	Displays the time at which the call ended. The time is displayed in the format, hh:mm:ss, where <i>hh</i> is the hour, <i>mm</i> the minutes and <i>ss</i> the seconds (e.g., 15:06:36).

Field	Description
<b>End Point</b>	Displays the device's endpoint involved in the call, displayed in the format: <ul style="list-style-type: none"> <li>■ Analog: <code>&lt;interface&gt;-&lt;module&gt;/&lt;port&gt;</code>. For example, "FXS-3/1" denotes FXS module 3, port 1.</li> <li>■ Digital: <code>&lt;interface&gt;-&lt;module&gt;/&lt;Trunk ID&gt;/&lt;B-channel&gt;</code>. For example, "ISDN-1/2/3" denotes ISDN module 1, Trunk ID 2, B-channel 3.</li> </ul>
<b>Caller</b>	Displays the phone number (source number) of the party who made the call.
<b>Callee</b>	Displays the phone number (destination number) of the party to whom the call was made.
<b>Direction</b>	Displays the direction of the call with regards to IP and Tel sides: <ul style="list-style-type: none"> <li>■ "Incoming": IP-to-Tel call</li> <li>■ "Outgoing": Tel-to-IP call</li> </ul>
<b>Remote IP</b>	Displays the IP address of the call party. For an "Incoming" call, this is the source IP address; for an "Outgoing" call, this is the destination IP address.
<b>Duration</b>	Displays the duration of the call, displayed in the format hh:mm:ss, where <i>hh</i> is hours, <i>mm</i> minutes and <i>ss</i> seconds. For example, 00:01:20 denotes 1 minute and 20 seconds.
<b>Termination Reason</b>	Displays the reason for the call being released (ended). For example, "NORMAL_CALL_CLEAR" indicates a normal off-hook (hang up) of the call party.
<b>Session ID</b>	Displays the SIP session ID of the call.

## Viewing CDR History of SBC and Test Calls

You can view historical Call Detail Records (CDR) of SBC calls and Test calls in the SBC CDR History table. History CDRs are stored on the device's memory. When a new CDR is generated, the device adds it to the top of the table and all existing entries are shifted one down in the table. The table displays the last 4,096 CDRs. If the table reaches maximum capacity of entries and a new CDR is added, the last CDR entry is removed from the table.



- The CDR fields in the table cannot be customized.



- If the device is reset, all CDRs are deleted from memory and from the table.
- You can hide the values of the Caller and Callee fields, as described in [Hiding Caller and Callee CDR Field Values](#) on page 1288.

➤ **To view SBC and Test Call CDR history:**

- **Web:** Open the SBC CDR History table (**Monitor** menu > **Monitor** tab > **VoIP Status** folder > **SBC CDR History**).

CALL END TIME	ENDPOINT TYPE	IP GROUP	CALLER	CALLEE	DIRECTION	REMOTE IP	DURATION	TERMINATION REASON	SESSION ID
11:53:30.140 UTC Sui	TEST	IPGroup_1	200	200	Incoming	10.33.8.52	00:00:41	NORMAL_CALL_CLEAR	f0000d:1.228
11:52:39.415 UTC Sui	TEST	IPGroup_2	201	100	Outgoing	10.33.8.52	00:00:20	NORMAL_CALL_CLEAR	f0000d:1.227
11:52:04.458 UTC Sui	SBC	IPGroup_2	200	236	Incoming	10.33.8.52	00:00:02	NORMAL_CALL_CLEAR	f0000d:1.226
11:52:04.444 UTC Sui	SBC	IPGroup_2	200	236	Outgoing	10.33.8.52	00:00:02	NORMAL_CALL_CLEAR	f0000d:1.226

- **CLI:**

- All CDR history:

```
# show voip calls history sbc
```

- CDR history for a specific SIP session ID:

```
# show voip calls history sbc <session ID>
```

**Table 54-7: SBC CDR History Table**

Field	Description
<b>Call End Time</b>	Displays the time at which the call ended. The time is displayed in the format, hh:mm:ss, where <i>hh</i> is the hour, <i>mm</i> the minutes and <i>ss</i> the seconds (e.g., 15:06:36).
<b>Endpoint Type</b>	Indicates the type of CDR: <ul style="list-style-type: none"> <li>■ "SBC": CDR belongs to an SBC call.</li> <li>■ "TEST": CDR belongs to a Test call.</li> </ul>
<b>IP Group</b>	Displays the IP Group of the leg for which the CDR was generated.
<b>Caller</b>	Displays the phone number (source URI user@host) of the party who made the call.
<b>Callee</b>	Displays the phone number (destination URI user@host) of the party to whom the call was made.

Field	Description
<b>Direction</b>	Displays the direction of the call: <ul style="list-style-type: none"><li>■ "Incoming"</li><li>■ "Outgoing"</li></ul>
<b>Remote IP</b>	Displays the IP address of the call party. For an "Incoming" call, this is the source IP address; for an "Outgoing" call, this is the destination IP address.
<b>Duration</b>	Displays the duration of the call, displayed in the format hh:mm:ss, where <i>hh</i> is hours, <i>mm</i> minutes and <i>ss</i> seconds. For example, 00:01:20 denotes 1 minute and 20 seconds.
<b>Termination Reason</b>	Displays the reason for the call being released (ended). For example, "NORMAL_CALL_CLEAR" indicates a normal termination.
<b>Session ID</b>	Displays the SIP session ID of the call.



## 55 Viewing PSTN Status

This section describes how to view PSTN-related status.

### Viewing Trunks & Channels Status

You can view the status of the device's PSTN trunks and corresponding channels in the Web interface. It also enables you to view trunk configuration and channel information.

➤ **To view trunk and channel status:**

1. Open the Trunks & Channels Status page, by doing one of the following:
  - Navigation tree: **Monitor** menu > **Monitor** tab > **PSTN Status** folder > **Trunks & Channels Status**.
  - Monitor home page:
    - i. Open the Monitor home page (see [Viewing Device Status on Monitor Page](#)).
    - ii. On the graphical display of the device, click a PSTN port; a shortcut menu appears.
    - iii. From the shortcut menu, choose **Port Status**:

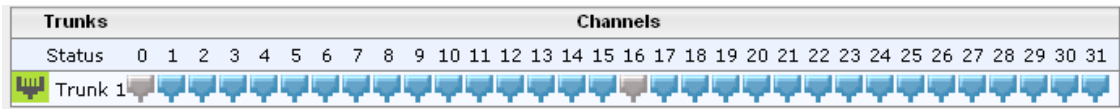



The number of displayed trunks and channels depends on configuration.

The status of the trunks is depicted by color-coded icons, as described in the table below:





**Table 55-1: Description of Color-Coded Icons for Trunk Status**

Icon	Color	Trunk
		Label
	Gray	Disabled
	Green	Active - OK
	Yellow	RAI Alarm
	Red	LOS / LOF Alarm
	Blue	AIS Alarm

Icon	Color	Trunk
		Label
	Light Orange	<b>D-Channel Alarm</b>
	Dark Orange	NFAS Alarm
	Purple	Lower Layer Down (DS3 physical layer is disabled)

The status of the channels is depicted by color-coded icons, as described in the table below:

**Table 55-2: Description of Color-Coded Icons for Channel Status**

Icon	Color	Label	Description
	Light blue	<b>Inactive</b>	Channel is configured, but currently has no calls
	Green	<b>Active</b>	Call in progress (RTP traffic) and no alarms
	Purple	<b>SS7</b>	Channel is configured for SS7 <b>Note:</b> Currently, SS7 is not supported.
	Gray	<b>Non Voice</b>	Channel is not configured
	Blue	<b>ISDN Signaling</b>	Channel is configured as a D-channel
	Yellow	CAS Blocked	-
	Dark Orange	<b>Maintenance</b>	B-channel has been intentionally taken out of service due to maintenance
	Red	<b>Out Of Service</b>	B-channel is out of service

2. To view detailed information on a specific channel, click a channel icon; a page appears with various tabs, displaying information. For more information on the page, see [Viewing Port Information](#).
3. To view configuration of a specific trunk, click a trunk icon, and then from the shortcut menu, choose **Port Settings**; the Trunk Settings page opens, displaying the trunk's settings. For more information on the page, see [Configuring Trunk Settings](#).

## Viewing NFAS Groups and D-Channel Status

You can view the status of the device's D-channels and NFAS groups, if configured. The status of a D-channel and NFAS group can be "In Service" or "Out of Service" and the D-channel can be "Primary" or "Backup".

You can also perform a switchover from active and to standby D-channel belonging to the same NFAS group. This is done using the **Switch Activity** button. For more information, see [Performing Manual D-Channel Switchover in NFAS Group](#).



This page is applicable only to T1 ISDN protocols supporting NFAS, and only if the NFAS group is configured with two D-channels.

### ➤ To view the status of the D-channels and NFAS groups:

- Open the NFAS Group & D-Channel Status page (**Monitor** menu > **Monitor** tab > **PSTN Status** folder > **NFAS Group & D-Channel Status**).

▼ NFAS Group #2

Status: **In Service**

D-Channels:

- Trunk#1
  - Configuration: Primary
  - Status: **In Service**
  - NFAS Status: Active
- Trunk#2
  - Configuration: Backup
  - Status: **Out Of Service**
  - NFAS Status: Not Applicable

**Switch Activity Group #2**

## 56 Viewing Network Status

This section describes how to view network-related status.

### Viewing Active IP Interfaces

You can view the device's active IP interfaces that are configured in the IP Interfaces table (see [Configuring IP Network Interfaces](#)).

➤ **To view active IP network interfaces:**

- Open the IP Interface Status page (**Monitor** menu > **Monitor** tab > **Network Status** folder > **IP Interface Status**).

INDEX	APPLICATION TYPE	IP ADDRESS	INTERFACE MODE	PREFIX LENGTH	DEFAULT GATEWAY	INTERFACE NAME	PRIMARY DNS SERVER IP ADDRESS	SECONDARY DNS SERVER IP ADDRESS	UNDERLYING DEVICE	ADDRESS STATE
0	O+M+C	10.15.7.96	IPv4 Manual	16	10.15.0.1	O+M+C	0.0.0.0	0.0.0.0	vlan 1	Permanent
NA	Internal	169.253.254.254	IPv4 Manual	16	0.0.0.0	Internalf 2	0.0.0.0	0.0.0.0	Internalf 2	Permanent

### Viewing Ethernet Device Status

You can view the status of configured Ethernet Devices that have been successfully applied. To configure Ethernet Devices, see [Configuring Underlying Ethernet Devices](#).

➤ **To view Ethernet Device status:**

- Open the Ethernet Device Status page (**Monitor** menu > **Monitor** tab > **Network Status** folder > **Ethernet Device Status**).

INDEX	VLAN ID	UNDERLYING INTERFACE	NAME
0	1	GROUP_1	vlan 1
1	2	GROUP_2	vlan 2

### Viewing Ethernet Port Information

You can view status information of the device's Ethernet ports. To configure Ethernet ports, see [Configuring Underlying Ethernet Devices](#).

➤ **To view Ethernet port information:**

- Open the Ethernet Port Information table, by doing one of the following:
  - Navigation tree: **Monitor** menu > **Monitor** tab > **Network Status** folder > **Ethernet Port Information**.
  - Monitor home page: Click an Ethernet port on the graphical display of the device (see [Viewing Device Status on Monitor Page](#)).

	PORT NAME	ACTIVE	SPEED	DUPLEX MODE	STATE	GROUP MEMBER
1	GE_0_1	Yes	1 Gbps	Full Duplex	Forwarding	GROUP_1
2	GE_0_2	No	10 Mbps	Half Duplex	Disabled	GROUP_1

Table 56-1: Ethernet Port Information Table Description

Parameter	Description
Port Name	Displays the user-defined name of the port.
Active	Displays if the port is active ("Yes") or not ("No").
Speed	Displays the speed of the Ethernet port.
Duplex Mode	Displays if the port is half- or full-duplex mode.
State	<p>Displays the status of the port.</p> <p>If the Ethernet Group contains a single port, the port status is always "Forwarding" (i.e., data is being transmitted and received on the port).</p> <p>If the Ethernet Group contains two ports (for 1+1 port redundancy):</p> <ul style="list-style-type: none"> <li>■ If the 'Mode' of the port is <b>1RX/1TX</b>, one port is "Forwarding" (i.e., active port) and one port is "Disabled" (i.e., standby port).</li> <li>■ If the 'Mode' of the port is <b>2RX/1TX</b> or <b>2RX/2TX</b>, both ports are "Forwarding".</li> </ul>
Group Member	Displays the Ethernet Group to which the port belongs.

## Viewing Static Routes Status

You can view the status of static IP routes, configured in the Static Routes table (see [Configuring Static IP Routing](#)) and routes through the Default Gateway.

The status of the static routes can be one of the following:

- "Active": Static route is used by the device.
- "Inactive": Static route is not used. When the destination IP address is not on the same segment with the next hop, or the interface does not exist, the route state changes to "Inactive".

### ➤ To view the status of static IP routing:

- Open the Static Route Status table (**Monitor** menu > **Monitor** tab > **Network Status** folder > **Static Route Status**).

INDEX	DESTINATION IP ADDRESS	PREFIX LENGTH	GATEWAY IP ADDRESS	METRIC	DEVICE NAME	STATUS	DESCRIPTION
NA	10.15.0.0	16	0.0.0.0	0	vlan 1	Active	
NA	10.13.0.0	16	0.0.0.0	0	vlan 2	Active	
NA	0.0.0.0	0	10.15.0.1	1	vlan 1	Active	

## Viewing IDS Active Blacklist

You can view remote hosts that are currently blacklisted by the device's Intrusion Detection System (IDS) in the IDS Active Black List table. For more information on IDS configuration and blacklists, see [Intrusion Detection System](#) on page 180

The following procedure describes how to view the IDS Active Black List table through the Web interface. You can also view the table through CLI using the command, `show voip ids blacklist active`.

### ➤ To view the active IDS blacklist:

- Open the IDS Active Black List page (**Monitor** menu > **Monitor** tab > **Network Status** folder > **IDS Active Black List**).

INDEX	NETWORK INTERFACE	IP ADDRESS	PORT	TRANSPORT TYPE	REMAINING TIME	REMOVAL KEY

**Table 56-2: IDS Active Black List Table Description**

Field	Description
Index	Table row index.
Network Interface	The device's IP Interface on which the malicious attack was detected.
IP Address	The IP address of the attacker (remote host).
Port	The port of the attacker (remote host). <b>Note:</b> The field is applicable only if the 'Threshold Scope' (IDSRule_ThresholdScope) parameter of the associated IDS rule is configured to <b>IP+Port</b> .
Transport Type	The transport type used for the attack.
Remaining Time	The duration left until the device deletes the attacker (remote host) from the table and takes it off the IDS blacklist. The blacklisted period is configured by the 'Deny Period' (IDSRule_DenyPeriod) parameter.

Field	Description
Removal Key	A unique number (key) that the device assigns to the blacklisted entry. This is used if you want to remove a specific blacklisted entry from the table, which is done through the CLI command, <code>clear voip ids blacklist &lt;Removal Key&gt;</code> .

## 57 Reporting Information to External Party

This section describes features for reporting various information to an external party.

### Configuring RTCP XR

RTP Control Protocol Extended Reports (RTCP XR) is a VoIP management control that defines a set of metrics containing information for assessing VoIP call quality and for diagnosing problems. RTCP XR (RFC 3611) extends the RTCP reports defined in RFC 3550 by providing additional VoIP metrics (Quality of Experience). RTCP XR information publishing is implemented in the device according to RFC 6035. The draft defines how a SIP User Agent (UA) publishes the detailed information to a defined collector. RTCP XR measures VoIP call quality such as packet loss, delay, signal / noise / echo levels, estimated R-factor, and mean opinion score (MOS). RTCP XR measures these parameters using metrics as listed in the table below. RTCP XR messages containing key call-quality-related metrics are exchanged periodically (user-defined) between the device and the SIP UA. This allows an analyzer to monitor these metrics midstream, or a device to retrieve them through SNMP.



- The RTCP XR feature is available only if the device is installed with a License Key that includes this feature. For installing a License Key, see [License Key](#).
- If the RTCP XR feature is unavailable (not licensed or disabled), the R-factor VoIP metrics are not provided in CDRs (CDR fields, Local R Factor and Remote R Factor) generated by the device. Instead, these CDR fields are sent with the value 127, meaning that information is unavailable.
- While the device attempts to determine the signal level, it reports a MOS value of "127 (NA)". Once it has determined the signal level, it reports the estimated MOS.
- Packet loss effects voice quality estimation only during periods of voice. During periods of silence, packet loss does not effect or degrade voice quality.

You can configure the device to send RTCP XR to a specific IP Group. The device sends RTCP XR in SIP PUBLISH messages. The PUBLISH message contains the following RTCP XR related header values:

- From and To: Telephone extension number of the user
- Request-URI: IP Group name to where RTCP XR is sent
- Event: "vq-rtcpxr"
- Content-Type: "application/vq-rtcpxr"

You can also configure the stage of the call at which you want the device to send RTCP XR:

- End of the call.
- Periodically, according to a user-defined interval between consecutive reports.
- (Gateway Application Only) End of a media segment. A media segment is a change in media, for example, when the coder is changed or when the caller toggles between two called parties (using call hold/retrieve). The RTCP XR sent at the end of a media segment



contains information only of that segment. For call hold, the device sends RTCP XR each time the call is placed on hold and each time it is retrieved. In addition, the Start timestamp in the RTCP XR indicates the start of the media segment; the End timestamp indicates the time of the last sent periodic RTCP XR (typically, up to 5 seconds before reported segment ends).

The type of RTCP XR report event (VQReportEvent) supported by the device is VQSessionReport (SessionReport). The device can include local and remote metrics in the RTCP XR. Local metrics are generated by the device while remote metrics are provided by the remote endpoint. The following table lists the supported voice metrics (parameters) published in the RTCP XR.

**Table 57-1: RTCP XR Published VoIP Metrics**

Metric	Parameter	Description
<b>CallID</b>	-	Call ID - call ID from the SIP dialog
<b>LocalID</b>	-	Local ID - identifies the reporting endpoint for the media session
<b>RemoteID</b>	-	Remote ID - identifies the remote endpoint of the media session
<b>OrigID</b>	-	Originating ID - Identifies the endpoint which originated the session
<b>LocalAddr</b>	-	Local Address - IP address, port, and SSRC of the endpoint/UA which is the receiving end of the stream being measured
<b>RemoteAddr</b>	-	Remote Address - IP address, port, and SSRC of the the source of the stream being measured
<b>LocalGroup</b>	-	Local Group ID - identification for the purposes of aggregation for the local endpoint
<b>RemoteGroup</b>	-	Remote Group ID - identification for the purposes of aggregation for the remote endpoint
<b>LocalMAC</b>	-	Media Access Control (MAC) address of the local SIP device
<b>Timestamps</b>	START	Start time of the media session, or of the media segment for the Gateway application.
	STOP	End time of the media session, or media segment (last sent RTCP XR packet) for the Gateway

Metric	Parameter	Description
		application.
<b>SessionDesc</b>	PT	Payload Type - 'payload type' parameter in the RTP packets (i.e., the codec).
	PD	Payload Description - description of the codec
	SR	Sample Rate - rate at which the voice was sampled
	FD	Frame Duration (msec) - packetization rate
	FO	Frame Octets - number of octets in each frame per RTP packet
	FPP	Frames per Packets - number of frames per RTP packet
	PLC	Packet Loss Concealment - indicates whether a PLC algorithm was used for the session ("0" - unspecified; "1" - disabled; "2" - enhanced; "3" - standard)
	SSUP	Silence Suppression State - indicates whether silence suppression, also known as Voice Activity Detection (VAD) is enabled ("on" or "off")
<b>JitterBuffer</b>	JBA	Jitter Buffer Adaptive - indicates the jitter buffer in the endpoint ("0" - unknown; "1" - reserved; "2" - non-adaptive; "3" - adaptive)
	JBR	Jitter Buffer Rate
	JBN	Jitter Buffer Nominal
	JBM	Jitter Buffer Max
	JBX	Jitter Buffer Abs Max
<b>PacketLoss</b>	NLR	Network Packet Loss Rate
	JDR	Jitter Buffer Discard Rate

Metric	Parameter	Description
<b>BurstGapLoss</b>	BLD	Burst Loss Density
	BD	Burst Duration
	GLD	Gap Loss Density
	GD	Gap Duration
	GMIN	Minimum Gap Threshold
<b>Delay</b>	RTD	Round Trip Delay (msec)
	ESD	End System Delay (msec)
	OWD	One Way Delay (msec)
	IAJ	Inter-Arrival Jitter (msec)
	MAJ	Mean Absolute Jitter (msec)
<b>Signal</b>	SL	Signal Level (dB) - ratio of the signal level to a 0 dBm0 reference
	NL	Noise Level (dB) - ratio of the silent period background noise level to a 0 dBm0 reference
	RERL	Residual Echo Return Noise (dB) - ratio between the original signal and the echo level as measured after echo cancellation or suppression has been applied
<b>QualityEst</b>	RLQ	Listening Quality R - listening quality expressed as an R factor (0-95 for narrowband calls and 0-120 for wideband calls)
	RLQEstAlg	RLQ Est. Algorithm - name (string) of the algorithm used to estimate RLQ
	RCQ	Conversational Quality R - cumulative measurement of voice quality from the start of the session to the reporting time (R is 0-95 for narrowband calls and 0-120 for wideband calls)
	RCQEstAlg	RCQ Est. Algorithm - name (string) of the algorithm used to estimate RCQ
	EXTRI	External R In - voice quality as measured by the local

Metric	Parameter	Description
		endpoint for incoming connection on "other" side (R is 0-95 for narrowband calls and 0-120 for wideband calls)
	ExtRIEstAlg	Ext. R In Est. Algorithm - name (string) of the algorithm used to estimate EXTRI
	EXTRO	External R Out - value is copied from RTCP XR received from the remote endpoint on the "other" side of this endpoint (R is 0-95 for narrowband calls and 0-120 for wideband calls)
	ExtROEstAlg	Ext. R Out Est. Algorithm - name (string) of the algorithm used to estimate EXTRO
	MOSLQ	MOS-LQ - estimated mean opinion score for listening voice quality on a scale from 1 to 5, in which 5 represents excellent and 1 represents unacceptable
	MOSLQEstAlg	MOS-LQ Est. Algorithm - name (string) of the algorithm used to estimate MOSLQ
	MOSCQ	MOS-CQ - estimated mean opinion score for conversation voice quality on a scale from 1 to 5, in which 5 represents excellent and 1 represents unacceptable
	MOSCQEstAlg	MOS-CQ Est. Algorithm - name (string) of the algorithm used to estimate MOSCQ
	QoEEstAlg	QoE Est. Algorithm - name (string) of the algorithm used to estimate all voice quality metrics
<b>DialogID</b>	-	Identification of the SIP dialog with which the media session is related

Below shows an example of a SIP PUBLISH message sent with RTCP XR and QoE information:

```
PUBLISH sip:172.17.116.201 SIP/2.0
Via: SIP/2.0/UDP 172.17.116.201:5060;branch=z9hG4bKac2055925925
Max-Forwards: 70
From: <sip:172.17.116.201>;tag=1c2055916574
To: <sip:172.17.116.201>
Call-ID: 20559160721612201520952@172.17.116.201
```

CSeq: 1 PUBLISH  
Contact: <sip:172.17.116.201:5060>  
Allow:  
REGISTER,OPTIONS,INVITE,ACK,CANCEL,BYE,NOTIFY,PRACK,REFER,INFO,SUBSCRIBE,UPDATE  
Event: vq-rtcpxr  
Expires: 3600  
User-Agent: device/7.20A.260.005  
Content-Type: application/vq-rtcpxr  
Content-Length: 1066

VQSessionReport  
CallID=20328634741612201520943@172.17.116.201  
LocalID: <sip:1000@172.17.116.201>  
RemoteID: <sip:2000@172.17.116.202;user=phone>  
OrigID: <sip:1000@172.17.116.201>  
LocalAddr: IP=172.17.116.201 Port=6000 SSRC=0x54c62a13  
RemoteAddr: IP=172.17.116.202 Port=6000 SSRC=0x243220dd  
LocalGroup:  
RemoteGroup:  
LocalMAC: 00:90:8f:57:d9:71

LocalMetrics:  
Timestamps: START=2015-12-16T20:09:45Z STOP=2015-12-16T20:09:52Z  
SessionDesc: PT=8 PD=PCMA SR=8000 FD=20 PLC=3 SSUP=Off  
JitterBuffer: JBA=3 JBR=0 JBN=7 JBM=10 JBX=300  
PacketLoss: NLR=0.00 JDR=0.00  
BurstGapLoss: BLD=0.00 BD=0 GLD=0.00 GD=6325 GMIN=16  
Delay: RTD=0 ESD=11  
Signal: SL=-34 NL=-67 RERL=17  
QualityEst: RLQ=93 MOSLQ=4.1  
MOSCQ=4.10

RemoteMetrics:  
Timestamps: START=2015-12-16T20:09:45Z STOP=2015-12-16T20:09:52Z  
JitterBuffer: JBA=3 JBR=0 JBN=0 JBM=0 JBX=300  
PacketLoss: NLR=0.00 JDR=0.00  
BurstGapLoss: BLD=0.00 BD=0 GLD=0.00 GD=0 GMIN=16  
Delay: RTD=65535 ESD=0  
QualityEst:  
DialogID: 20328634741612201520943@172.17.116.201;to-tag=1c1690611502;from-tag=1c2032864069

➤ **To configure RTCP XR:**

1. Open the RTP/RTCP Settings page (**Setup** menu > **Signaling & Media** tab > **Media** folder > **RTP/RTCP Settings**).
2. Under the RTCP-XR group, configure the following:
  - 'Enable RTCP XR' (*VQMonEnable*) - enables voice quality monitoring and RTCP XR.
  - 'Tx RTCP Packets Interval' (*RTCPInterval*) - defines the time interval between adjacent RTCP reports.
  - 'Disable RTCP XR Interval Randomization' (*DisableRTCPRandomize*) - determines whether RTCP report intervals are randomized or whether each report interval accords exactly to the parameter RTCPInterval.
  - 'Burst Threshold' (*VQMonBurstTHR*) - defines the voice quality monitoring excessive burst alert threshold.
  - 'Delay Threshold' (*VQMonDelayTHR*) - defines the voice quality monitoring excessive delay alert threshold.
  - 'R-Value Delay Threshold' (*VQMonEOCRValTHR*) - defines the voice quality monitoring end of call low quality alert threshold.
  - 'Minimum Gap Size' (*VQMonGMin*) - defines the voice quality monitoring minimum gap size (number of frames).

<b>Enable RTCP XR</b>	Enable Fully <input type="button" value="v"/>
Tx RTCP Packets Interval (in msec)	5000
Disable RTCP XR Interval Randomization	Disable <input type="button" value="v"/>
Burst Threshold	-1
Delay Threshold	-1
R-Value Delay Threshold	-1
Minimum Gap Size	16

3. Under the RTCP-XR Collection Server group, configure the following:
  - 'Publication IP Group ID' (*PublicationIPGroupID*): Configures the IP Group to where you want the device to send RTCP XR reports.
  - (Gateway Application Only) 'Gateway RTCP XR Report Mode' (*RTCPXRReportMode*): Enables the sending of RTCP XR reports and configures at what stage of the call they are sent.

- (SBC Application Only) 'SBC RTCP XR Report Mode' (SBCRtcpXrReportMode): Enables the sending of RTCP XR reports of QoE metrics at the end of each call session (i.e., after a SIP BYE).

RTCP-XR COLLECTION SERVER	
Gateway RTCP XR Report Mode	Disable ▼
Publication IP GroupID	-1
SBC RTCP XR Report Mode	Disable ▼

4. Click **Apply**, and then reset the device with a save-to-flash for your settings to take effect.

## Call Detail Records

Call Detail Records (CDR) contains vital statistic information on calls made from the device. The device can generate and report CDRs at various stages of the call - end of call, or only at the start and end of call. In addition, CDRs can be generated for SIP signaling and/or media. The device can send CDRs to any of the following:

- Syslog server. The CDR Syslog message complies with RFC 3164 and is identified by Facility 17 ("local1") and Severity 6 (Informational).
- RADIUS server. For CDR in RADIUS format, see [Configuring RADIUS Accounting](#). To configure RADIUS servers for CDR reporting, see [Configuring RADIUS Servers](#).



- To view Gateway CDRs stored on the device's memory, see [Viewing Gateway CDR History](#).
- To view SBC and Test Call CDRs stored on the device's memory, see [Viewing SBC CDR History](#).

## Enabling CDR Generation and Configuring the CDR Server Address

For the device to generate CDRs, you need to enable the Syslog feature and configure a collecting server address. The collecting server can be a dedicated CDR server or the server used for Syslog messages.

### ➤ To enable CDR generation and configure the CDR server address:

1. Enable the Syslog feature (see [Enabling Syslog](#)).
2. Open the Call Detail Record Settings page (**Troubleshoot** menu > **Troubleshoot** tab > **Call Detail Record** folder > **Call Detail Record Settings**).
3. In the 'CDR Server IP Address' [CDRSyslogServerIP] field, enter the IP address of the server to where you want the CDRs sent.

CDR Server IP Address

4. Click **Apply**.



If you do not configure an IP address for a CDR server, the device sends the CDRs to the address that you configured for the Syslog server (see [Enabling Syslog](#)).

## Configuring CDR Filters and Report Level

You can configure various CDR filters and the stage of the call at which you want the device to generate and send CDRs. For a detailed description of the parameters described in this section, see [Syslog, CDR and Debug Parameters](#).

➤ **To configure CDR filters and report level:**

1. Open the Call Detail Record Settings page (**Troubleshoot** menu > **Troubleshoot** tab > **Call Detail Record** folder > **Call Detail Record Settings**).
2. Configure CDR filters:
  - In the 'Call-End CDR SIP Reasons Filter' [CallEndCDRSIPReasonsFilter] field, configure the SIP release cause codes that if received for calls, the device does not generate and send Call-End CDRs.
  - From the 'Call-End CDR Zero Duration Filter' [CallEndCDRZeroDurationFilter] drop-down list, select **Enable** if you want the device to not generate and send Call-End CDRs for calls of zero (0) duration.

Call-End CDR SIP Reasons Filter

Call-End CDR Zero Duration Filter  ▼

3. Configure the call stage at which CDRs are generated and sent:
  - From the 'CDR Report Level' [CDRReportLevel] drop-down list, select the stage of the call at which you want signaling-related CDRs to be generated and sent.
  - (SBC Application Only) From the 'Media CDR Report Level' [MediaCDRReportLevel] drop-down list, select the stage of the call at which you want media-related CDRs to be generated and sent.

CDR Report Level  ▼

Media CDR Report Level  ▼

4. Click **Apply**.



## Configuring CDR Reporting to REST Server

You can configure the device to send signaling-related CDRs to a REST server using AudioCodes REST API. The CDRs are sent in JSON format.



You can customize the CDRs that are sent to the REST server, by adding CDR fields or changing their names. For more information, see [Customizing CDRs for SBC Calls and Test Calls](#) on page 1279 for SBC calls and [Customizing CDRs for Gateway Calls](#) on page 1273 for Gateway calls.

### ➤ To configure CDR reporting to a REST server:

1. Enable the Syslog feature for sending log messages (CDRs) generated by the device to a collecting log message server. For more information, see [Enabling Syslog](#).
2. Configure the REST server:
  - a. Open the Remote Web Services table (see [Configuring Remote Web Services](#) on page 299).
  - b. Click **New**, and then configure an HTTP/S-based server to represent the REST server. Make sure that you configure the 'Type' parameter to **General**. Configure the remaining HTTP/S server parameters according to your requirements.
  - c. Click **Apply**.
3. Open the Call Detail Record Settings page (**Troubleshoot** menu > **Troubleshoot** tab > **Call Detail Record** folder > **Call Detail Record Settings**), and then do the following:
  - a. From the 'REST CDR Report Level' drop-down list, select the stage of the call at which you want the CDRs to be generated and sent.
  - b. In the 'REST CDR HTTP Server Name' field, enter the name of the REST server that you configured in the Remote Web Services table (see Step 2). This is the server where the device sends the CDRs.

#### REST CDR REPORT

REST CDR Report Level

Start & End Call

REST CDR HTTP Server Name

REST-Server

- c. Click **Apply**.

## Miscellaneous CDR Configuration

Miscellaneous but important CDR configuration parameters are listed below:

- To enable or disable the inclusion of the sequence number (S=) in CDR Syslog messages, use the 'CDR Syslog Sequence Number' [CDRSyslogSeqNum] parameter.

- The device sends CDRs only for dialog-initiating INVITE messages (call start), 200 OK responses (call connect) and BYE messages (call end). For SBC calls only: If you want to enable the generation of CDRs for non-call SIP dialogs (such as SUBSCRIBE, OPTIONS, and REGISTER), use the [EnableNonCallCdr] parameter.
- To configure the units of measurement for the call duration in CDRs ("Duration" CDR field), use the [CallDurationUnits] parameter.
- To configure the time zone (e.g., GMT+1) that is displayed with the timestamp in CDRs ("Connect Time", "Release Time", and "Setup Time" CDR fields), use the [TimeZoneFormat] parameter

## Storing CDRs on the Device

CDRs generated by the device can be stored locally on the device (RAM).

You can specify the calls for which you wish to create locally stored CDRs. This is done using Logging Filter rules in the Logging Filters table. For example, you can configure a rule to create locally stored CDRs for traffic belonging only to IP Group #2.

Locally stored CDRs are saved in a comma-separated values file (\*.csv), where each CDR is on a dedicated row or line. An example of a CSV file with two CDRs are shown below :

- CSV file viewed in Excel:

	A	B	C	D	E	F	G	H
1	3b463e:215:1	CALL_END	4	14:34:40.000 UTC Wed Dec 16 2015	14:34:35.000 UTC Wed Dec 16 2015	14:34:33.000 UTC Wed Dec 16 2015	RMT	GWAPP_NORMAL
2	3b463e:215:1	CALL_END	4	14:34:40.000 UTC Wed Dec 16 2015	14:34:35.000 UTC Wed Dec 16 2015	14:34:33.000 UTC Wed Dec 16 2015	LCL	GWAPP_NORMAL
3								

- CSV file viewed in a text editor (Notepad):

```

1 3b463e:215:1,CALL_END,4,14:34:40.000 UTC Wed Dec 16 2015,14:34:35.000 UTC Wed Dec 16 2015,14:34:33.000 UTC Wed Dec 16 2015,RMT,GWAPP_NORMAL
2 3b463e:215:1,CALL_END,4,14:34:40.000 UTC Wed Dec 16 2015,14:34:35.000 UTC Wed Dec 16 2015,14:34:33.000 UTC Wed Dec 16 2015,LCL,GWAPP_NORMAL
3

```

The device's CLI provides enhanced support for performing various actions on locally stored CDRs:

- To view the CDR column headers corresponding to the CDR data in the CSV file:

- SBC CDRs:

```

(config-system)# cdr
(cdr)# cdr-format show-title local-storage-sbc
session id,report type,call duration, call end time, call connect time,call start
time, call originator, termination reason, call id, srce uri, dest uri

```

- Gateway CDRs:

```
(config-system)# cdr
```

```
(cdr)# cdr-format show-title local-storage-gw
```

■ To view stored CDR files:

- View all stored CDR files:

```
# show storage-history
```

- View all stored, unused CDR files:

```
# show storage-history unused
```

■ To delete stored CDR files:

- To delete all stored files:

```
# clear storage-history cdr-storage-history all
```

- To delete all unused stored CDR files:

```
# clear storage-history cdr-storage-history unused
```

■ To copy stored CDR files to a remote destination:

```
# copy storage-history cdr-storage-history <filename> to  
<protocol://destination>
```

Where:

- *filename*: name you want to assign the file. Any file extension name can be used, but as the file content is in CSV format, it is recommended to use the .csv file extension.
- *protocol*: protocol over which the file is sent (tftp, http, or https).

For example:

```
copy storage-history cdr-storage-history my_cdrs.csv to  
tftp://company.com/cdrs
```



- If the device is reset or powered off, locally stored CDRs are deleted.
- Locally stored CDRs are applicable only to "CALL\_END" CDR Report Types and to SBC signaling and Gateway CDRs.
- You can customize the CDR fields for local storage. For SBC calls, see [Customizing CDRs for SBC Calls](#). For Gateway calls, see [Customizing CDRs for Gateway Calls](#).

➤ **To configure local CDR storage:**

1. Open the Logging Filters table (see [Configuring Log Filter Rules](#)), and then enable CDR local storage by configuring a log filtering rule with the following settings:
  - 'Filter Type' and 'Value': (as desired)
  - 'Log Destination': **Local Storage**
  - 'Log Type': **CDR Only**
  - 'Mode': **Enable**
2. Open the Call Detail Record Settings page (**Troubleshoot** menu > **Troubleshoot** tab > **Call Detail Record** folder > **Call Detail Record Settings**), and then configure the following parameters:
  - 'File Size' [CDRLocalMaxFileSize]: Enter the maximum size (in kilobytes) of the CDR file. When the Current file reaches this size, the device creates a CDR file. However, if the 'Rotation Period' is reached before the file has reached this maximum size, the CDR file is created.
  - 'Number of Files' [CDRLocalMaxNumOfFiles]: Enter the maximum number of CDR files. If this maximum is reached, any new CDR file replaces the oldest CDR file (i.e., FIFO).
  - 'Rotation Period' [CDRLocalInterval]: Enter the periodic duration (in minutes) of how often a CDR file is created from the Current file (even if empty). For example, if configured to 60, a file is created every hour (or before, if the maximum size has been reached).

For a detailed description of each parameter, see [Syslog, CDR and Debug Parameters](#).

File Size (KBytes)	<input type="text" value="1024"/>
Number Of Files	<input type="text" value="5"/>
Rotation period (min)	<input type="text" value="60"/>



If the CDR storage feature is enabled and you later change the maximum number of files ([CDRLocalMaxNumOfFiles]) to a lower value (e.g., from 50 to 10), the device stores the remaining files (e.g., 40) in its memory as *unused* files.

## CDR Field Description

This section describes the CDR fields that can be generated by the device. Some are generated by default, while others are generated only if you customize the CDR to include them, as described in [Customizing CDRs for Gateway Calls](#) and [Customizing CDRs for SBC Calls](#).

- For SBC calls, the device generates a signaling CDR and a media CDR:

- **Media CDR:** This CDR is published per active media stream. Each media CDR has a unique call ID that corresponds to its signaling CDR. There are three different CDR Report Types (CDRReportType), which the device sends to the CDR server at different stages of the SIP dialog session:
  - ◆ "MEDIA\_START": This CDR is sent upon an INVITE message.
  - ◆ "MEDIA\_UPDATE": This CDR is sent upon a re-INVITE message (e.g., the established call is placed on hold by one of the call parties).
  - ◆ "MEDIA\_END": This CDR is sent upon a BYE message (i.e., call ends).

The CDR Report Types for SBC media and the SIP dialog stages at which they are sent are shown in the following figure:

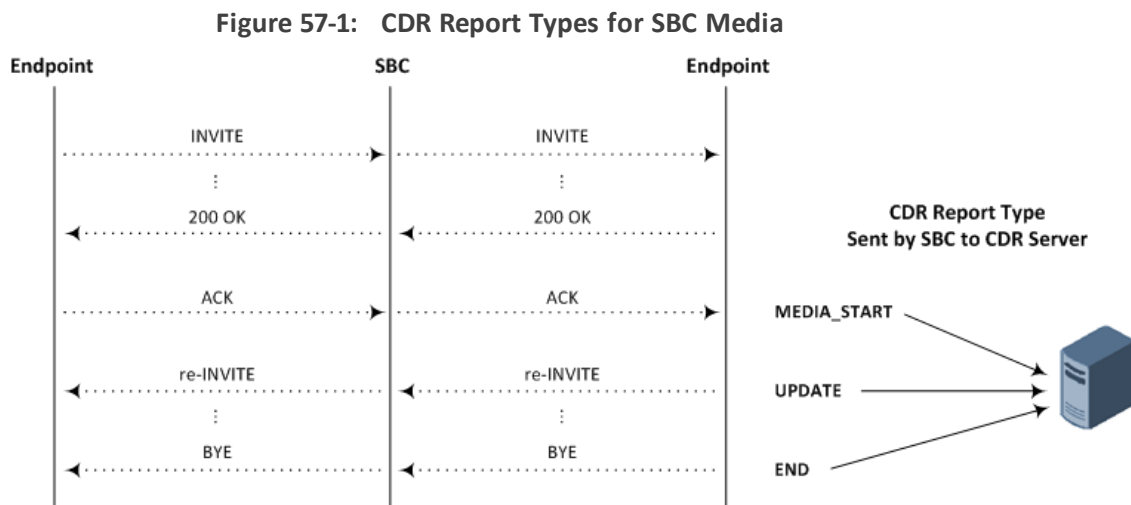

- **Signaling CDR:** This CDR contains SIP signaling information. A typical SBC session consists of two SBC legs. Each leg generates its own signaling CDRs. Each leg generates three different CDR Report Types (CDRReportType), which the device sends to the CDR server at different stages of the SIP dialog:
  - ◆ "CALL\_START": This CDR is sent upon an INVITE message.
  - ◆ "CALL\_CONNECT": This CDR is sent upon an ACK message (i.e., call is established).
  - ◆ "CALL\_END": This CDR is sent upon a BYE message (i.e., call ends).

The CDR Report Types for SBC signaling and the SIP dialog stages at which they are sent are shown in the following figure:

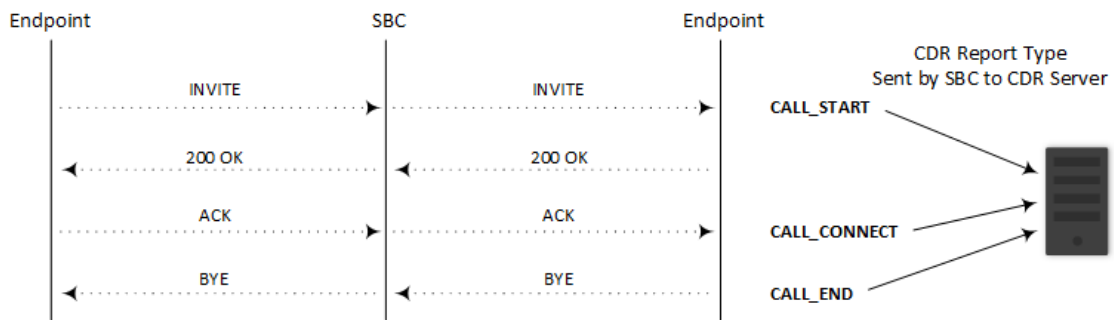
**Figure 57-2: CDR Report Types for SBC Signaling**

You can customize the signaling CDR that is sent at the end of the SBC call ("CALL\_END") to also include media-related CDR fields. This is applicable only to syslog CDRs, local storage CDRs, and RADIUS CDRs. For customizing SBC CDRs, see [Customizing CDRs for SBC Calls](#). When there is more than one media stream in the SBC session, the added media-related fields only represent the first audio media.

CDRs belonging to the same SBC session (both incoming and outgoing legs) have the same Session ID (SessionId CDR field). CDRs belonging to the same SBC leg have the same Leg ID (LegId CDR field).

For billing applications, the CDR that the device sends at the end of the call ("CALL\_END" CDR Report Type) is usually sufficient. This CDR may be based on the following CDR fields:

- Leg ID
  - Source URI
  - Destination URI
  - Call originator (i.e., caller)
  - Call duration
  - Call time
- For Gateway calls, the CDR includes both media and signaling CDR fields. The CDR can be one of the following report types (CDRReportType field), depending at which stage of the SIP dialog it was sent:
- "CALL\_START": This CDR is sent upon an INVITE message.
  - "CALL\_CONNECT": This CDR is sent upon a 200 OK response (i.e., call is established).
  - "CALL\_END": This CDR is sent upon a BYE message (i.e., call ends).

The CDR Report Types and the SIP dialog stages at which they are sent are shown in the following figure:

Figure 57-3: CDR Report Types for Gateway Calls

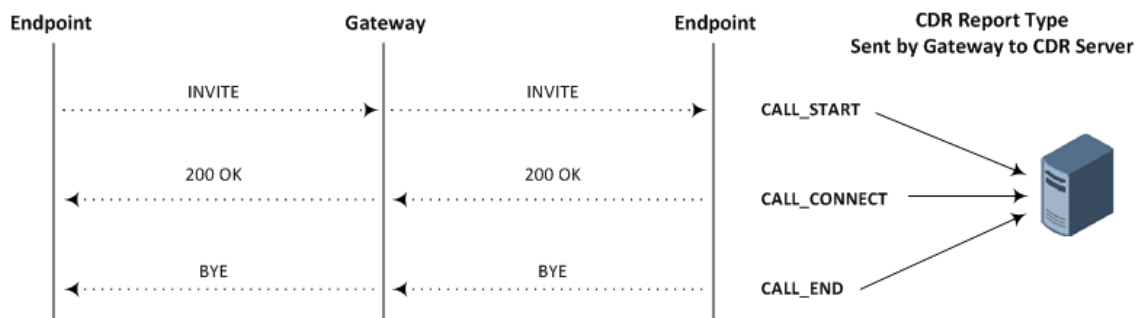

The Syslog displays CDRs in tabular format, whereby the CDR field names (titles) are displayed on the first lines and their corresponding values on the subsequent lines. Below shows an example of an SBC signaling CDR sent at the end of a normally terminated call:

```
[S=40] |CDRReportType |EPTyp |SIPCallId |SessionId |Orig |SourceIp
|SourcePort |DestIp |DestPort |TransportType |SrcURI |SrcURIBeforeMap
|DstURI |DstURIBeforeMap |Durat |TrmSd |TrmReason |TrmReasonCategory
|SetupTime |ConnectTime |ReleaseTime |RedirectReason |RedirectURINum
|RedirectURINumBeforeMap |TxSig|PDiffServ|IPGroup (description) |SrdId
(name) |SIPInterfaceld (name) |ProxySetId (name) |IpProfileId (name)
|MediaRealmlId (name) |DirectMedia |SIPTrmReason |SIPTermDesc |Caller
|Callee
```

```
[S=40] |CALL_END |SBC |20767593291410201017029@10.33.45.80
|1871197419|LCL |10.33.45.80 |5060 |10.33.45.72 |5060 |UDP |9001@10.8.8.10
|9001@10.8.8.10 |6001@10.33.45.80 |6001@10.33.45.80 |15 |LCL |GWAPP_
NORMAL_CALL_CLEAR |NORMAL_CALL_CLEAR |17:00:29.954 UTC Thu Oct
14 2014 |17:00:49.052 UTC Thu Oct 14 2014 |17:01:04.953 UTC Thu Oct 14 2014
|-1 || |40 |1 |0 (SRD_GW) |1 |1 |1 |() |0 (MR_1) |no |BYE |Q.850 ;cause=16
;text="loc |user 9928019 |
```

If all CDR field values are within a specific number of characters, they appear aligned under their corresponding field names. However, if some of the values exceed their specific number of characters for Syslog tabular alignment, the values do not appear fully aligned with their corresponding field names. If you customize the title of a CDR field and it contains more characters than the default title, the maximum number of characters to ensure Syslog tabular alignment will be updated accordingly to fit the customized title. For example, if you customize the default CDR field title "Duration" (8 characters) to "Duration in Sec" (15 characters), the tabular alignment of field names to corresponding values will be updated to 15 as well. The maximum number of characters for Syslog tabular alignment when CDR field titles are not customized are given in the table below.

**Table 57-2: CDR Field Descriptions**

Field	Description
Accounting Status Type [305]	<p>Displays the CDR Report Type in numeric representation (integer), used mainly for the RADIUS Accounting Status Type attribute (40):</p> <ul style="list-style-type: none"> <li>■ "1" = "Accounting Start" for "CALL_START" or "CALL_CONNECT"</li> <li>■ "2" = "Accounting Stop" for "CALL_END"</li> </ul> <p><b>Note:</b></p> <ul style="list-style-type: none"> <li>■ By default, the field is included in the CDR.</li> <li>■ The field is applicable to SBC media and signaling, and Gateway CDRs (all CDR Report Types).</li> <li>■ The maximum number of characters for Syslog tabular alignment is 5.</li> </ul>
Alerting Time [443]	<p>Displays the duration (in milliseconds) between ringing (SIP 180 Ringing) and call answered (SIP 200 OK) or unanswered (CANCEL).</p> <p><b>Note:</b></p> <ul style="list-style-type: none"> <li>■ The field is optional. You can include it in the CDR by CDR customization using the SBC CDR Format and Gateway CDR Format tables.</li> <li>■ The field is applicable only to SBC signaling and Gateway CDRs ("CALL_CONNECT" and "CALL_END" Report Types).</li> <li>■ The maximum number of characters for Syslog tabular alignment is 5.</li> </ul>
AMD Decision Probability [630]	<p>Displays the success (in percentage) that the answering type (probability) was correctly detected for the Answering Machine Detection (AMD) feature.</p> <p><b>Note:</b></p> <ul style="list-style-type: none"> <li>■ By default, the field is included in the CDR.</li> <li>■ The field is applicable only to SBC media CDRs ("MEDIA_END" CDR Report Type) and Gateway CDRs ("CALL_END" CDR Report Type).</li> <li>■ The default field title is "%" for Syslog.</li> <li>■ The maximum number of characters for Syslog tabular alignment is 3.</li> </ul>
AMD Decision [629]	<p>Displays the detected answering type for the AMD feature:</p> <ul style="list-style-type: none"> <li>■ "V": voice</li> <li>■ "A": answer machine</li> <li>■ "S": silence</li> </ul>



Field	Description
	<ul style="list-style-type: none"> <li>■ "U": unknown</li> </ul> <p><b>Note:</b></p> <ul style="list-style-type: none"> <li>■ By default, the field is included in the CDR.</li> <li>■ The field is applicable only to SBC media CDRs ("MEDIA_END" CDR Report Type) and Gateway CDRs ("CALL_END" CDR Report Type).</li> <li>■ The default field title is "AMD" for Syslog.</li> <li>■ The maximum number of characters for Syslog tabular alignment is 3.</li> </ul>
AOC Amount [523]	<p>Displays the total amount charged for the call for the Advice of Charge (AOC) feature. The field is an integer from 0 to 999999.</p> <p>Data is stored per call and sent in the syslog as follows:</p> <ul style="list-style-type: none"> <li>■ currency-type: amount multiplier for currency charge (euro or usd)</li> <li>■ recorded-units: for unit charge (1-999999)</li> </ul> <p><b>Note:</b></p> <ul style="list-style-type: none"> <li>■ By default, the field is included in the CDR.</li> <li>■ The field is applicable only to Gateway CDRs ("CALL_END" CDR Report Type).</li> <li>■ The default field title is "Amount" for Syslog.</li> <li>■ The maximum number of characters for Syslog tabular alignment is 9.</li> </ul>
AOC Currency [522]	<p>Displays the currency of the AOC (e.g., "EUR").</p> <p><b>Note:</b></p> <ul style="list-style-type: none"> <li>■ The field is optional. You can include it in the CDR by CDR customization using the Gateway CDR Format table.</li> <li>■ The field is applicable only to Gateway CDRs ("CALL_END" CDR Report Type).</li> <li>■ The maximum number of characters for Syslog tabular alignment is 3.</li> </ul>
AOC Multiplier [524]	<p>Displays the AOC multiplier information. The field is an integer from 0,001 to 1000 (in steps of 10).</p> <p><b>Note:</b></p> <ul style="list-style-type: none"> <li>■ By default, the field is included in the CDR.</li> <li>■ The field is applicable only to Gateway CDRs ("CALL_END" CDR Report Type).</li> <li>■ The default field title is "Mult" for Syslog.</li> </ul>

Field	Description
	<ul style="list-style-type: none"> <li>■ The maximum number of characters for Syslog tabular alignment is 5.</li> </ul>
B-Channel [501]	<p>Displays the B-channel.</p> <p><b>Note:</b></p> <ul style="list-style-type: none"> <li>■ By default, the field is included in the CDR.</li> <li>■ The field is applicable only to Gateway CDRs (all CDR Report Types).</li> <li>■ The default field title is "BChan" for Syslog.</li> <li>■ The maximum number of characters for Syslog tabular alignment is 5.</li> </ul>
Blank [308]	<p>Displays an empty string value " " and 0 for an integer value. This is typically used for RADIUS CDRs.</p> <p><b>Note:</b></p> <ul style="list-style-type: none"> <li>■ The field is optional. You can include it in the CDR by CDR customization using the SBC CDR Format and Gateway CDR Format tables.</li> <li>■ The field is applicable to all CDR Report Types.</li> <li>■ The maximum number of characters for Syslog tabular alignment is 5.</li> </ul>
Call Duration [408]	<p>Displays the duration of the call. The field is an integer.</p> <p><b>Note:</b></p> <ul style="list-style-type: none"> <li>■ To configure the units of measurement (seconds - default, deciseconds, centiseconds, or milliseconds), use the [CallDurationUnits] parameter.</li> <li>■ By default, the field is included in the CDR.</li> <li>■ The field is applicable only to SBC signaling and Gateway CDRs ("CALL_END" CDR Report Type).</li> <li>■ The default field title is "Duration" for Syslog and Local Storage, and none for RADIUS (ACCT_SESSION_TIME standard ID 46).</li> <li>■ The maximum number of characters for Syslog tabular alignment is 8.</li> </ul>
Call End Sequence Number [442]	<p>Displays the sequence number of the call. The field is an integer. For each call-end CDR, the field is assigned the next consecutive number. For example, for the first terminated call processed by the device, the field is assigned the value "1"; for the second terminated call, the field is assigned the value "2", and so on. The field value resets to 1 upon a device reset, an HA switchover (for HA-supporting products), or when it reaches the value FFFFFFFF (hexadecimal).</p> <p>As the field is consecutive, you can use this field to check whether there</p>

Field	Description
	<p>are any missing CDRs.</p> <p><b>Note:</b></p> <ul style="list-style-type: none"> <li>■ The field is optional. You can include it in the CDR by CDR customization using the SBC CDR Format and Gateway CDR Format tables.</li> <li>■ The field is applicable only to SBC signaling and Gateway CDRs ("CALL_END" CDR Report Type).</li> <li>■ The maximum number of characters for Syslog tabular alignment is 10.</li> </ul>
Call ID [301]	<p>Displays the unique ID of the call, which appears in the SIP Call-ID header. The field is a string of up to 130 characters.</p> <p><b>Note:</b></p> <ul style="list-style-type: none"> <li>■ By default, the field is included in the CDR.</li> <li>■ The field is applicable to SBC media and signaling, and Gateway CDRs (all CDR Report Types).</li> <li>■ The default field title is "SIPCallId" for Syslog and Local Storage, and "call-id=" for RADIUS.</li> <li>■ The maximum number of characters for Syslog tabular alignment is 50.</li> </ul>
Call Orig RADIUS [434]	<p>Displays the originator of the call:</p> <ul style="list-style-type: none"> <li>■ "answer": Call originated from the IP side (Gateway) or incoming leg (SBC)</li> <li>■ "originate": Call originated from the Tel side (Gateway) or outgoing leg (SBC)</li> </ul> <p><b>Note:</b></p> <ul style="list-style-type: none"> <li>■ By default, the field is included in the CDR.</li> <li>■ The field is applicable to CDR Report Types "Start Acc" and "Stop Acc".</li> <li>■ The field is applicable to all types, but mainly to RADIUS (SBC and Gateway CDRs).</li> <li>■ The default field title is "h323-call-origin=" for RADIUS.</li> <li>■ The maximum number of characters for Syslog tabular alignment is 10.</li> </ul>
Call Orig	Displays which side originated the call for the specific leg.

Field	Description
[401]	<ul style="list-style-type: none"> <li>■ "LCL": SBC Outgoing leg (called party side) or Tel side</li> <li>■ "RMT": SBC Incoming leg (i.e., caller party side) or IP side</li> </ul> <p><b>Note:</b></p> <ul style="list-style-type: none"> <li>■ By default, the field is included in the CDR.</li> <li>■ The field is applicable only to SBC signaling and Gateway CDRs (all CDR Report Types).</li> <li>■ The default field title is "Orig" for Syslog and "Direction" in the Web SBC CDR History and Web Gateway CDR History tables.</li> <li>■ The maximum number of characters for Syslog tabular alignment is 5.</li> </ul>
Callee Display ID [432]	<p>Displays the name of the called party. The field is a string of up to 36 characters.</p> <p><b>Note:</b></p> <ul style="list-style-type: none"> <li>■ By default, the field is included in the CDR.</li> <li>■ The field is applicable only to SBC signaling and Gateway CDRs (all CDR Report Types).</li> <li>■ The default field title is "Callee" in the sent CDR.</li> <li>■ The maximum number of characters for Syslog tabular alignment is 37.</li> </ul>
Caller Display ID [431]	<p>Displays the name of the caller (caller ID). The field is a string of up to 50 characters.</p> <p><b>Note:</b></p> <ul style="list-style-type: none"> <li>■ By default, the field is included in the CDR.</li> <li>■ The field is applicable only to SBC signaling and Gateway CDRs (all CDR Report Types).</li> <li>■ The default field title is "Caller" in the CDR.</li> <li>■ The maximum number of characters for Syslog tabular alignment is 51.</li> </ul>
CDR Type [300]	<p>Displays the application type of the CDR. The field is an integer:</p> <ul style="list-style-type: none"> <li>■ "2": Gateway CDR</li> <li>■ "3": SBC signaling CDR</li> <li>■ "4": SBC media CDR</li> </ul> <p><b>Note:</b></p>

Field	Description
	<ul style="list-style-type: none"> <li>■ The field is optional. You can include it in the CDR by CDR customization using the Gateway CDR Format and SBC CDR Format tables.</li> <li>■ The field is applicable only to SBC media and signaling, and Gateway CDRs (all CDR Report Types).</li> <li>■ The maximum number of characters for Syslog tabular alignment is 6.</li> </ul>
Channel ID [600]	<p>Displays the port (channel) ID.</p> <p><b>Note:</b></p> <ul style="list-style-type: none"> <li>■ By default, the field is included in the CDR.</li> <li>■ The field is applicable only to SBC media CDRs ("MEDIA_START" and "MEDIA_END" CDR Report Types) and Gateway CDRs ("CALL_START", "CALL_CONNECT" and "CALL_END" CDR Report Types).</li> <li>■ The default field title is "Cid" in the CDR.</li> <li>■ The maximum number of characters for Syslog tabular alignment is 5.</li> </ul>
Coder Type [601]	<p>Displays the coder used for the call. The field is a string, for example, "g711Alaw64k", "g711Ulaw64k" and "g729".</p> <p><b>Note:</b></p> <ul style="list-style-type: none"> <li>■ By default, the field is included in the CDR.</li> <li>■ The field is applicable only to SBC media CDRs ("MEDIA_START" and "MEDIA_END" CDR Report Types) and Gateway CDRs ("CALL_CONNECT" and "CALL_END" CDR Report Types).</li> <li>■ The default field title is "Coder" in the CDR.</li> <li>■ The maximum number of characters for Syslog tabular alignment is 15.</li> </ul>
Conn ID [502]	<p>Displays the Digital Connection ID.</p> <p><b>Note:</b></p> <ul style="list-style-type: none"> <li>■ By default, the field is included in the CDR.</li> <li>■ The field is applicable only to Gateway CDRs (all CDR Report Types).</li> <li>■ The default field title is "ConId" in the CDR.</li> <li>■ The maximum number of characters for Syslog tabular alignment is 5.</li> </ul>
Connect Time [412]	<p>Displays the date and time that the call was connected. The field is a string of up to 35 characters and in the following format: &lt;hh:mm:ss:ms&gt; UTC &lt;DDD&gt; &lt;MMM&gt; &lt;DD&gt; &lt;YYYY&gt;. For example, "17:00:49.053 UTC Thu</p>

Field	Description
	<p>Dec 14 2017"</p> <p><b>Note:</b></p> <ul style="list-style-type: none"> <li>■ To configure the time zone string (e.g., "UTC" - default, "GMT+1" and "EST"), use the TimeZoneFormat parameter.</li> <li>■ By default, the field is included in the CDR.</li> <li>■ The field is applicable only to SBC signaling and Gateway CDRs ("CALL_CONNECT" and "CALL_END" CDR Report Types).</li> <li>■ The default field title is "ConnectTime" for Syslog and Local Storage, and "h323-connect-time=" for RADIUS.</li> <li>■ The maximum number of characters for Syslog tabular alignment is 35.</li> </ul>
Dest Port [406]	<p>Displays the SIP signaling destination UDP port. The field is an integer of up to 10 digits.</p> <p><b>Note:</b></p> <ul style="list-style-type: none"> <li>■ By default, the field is included in the CDR.</li> <li>■ The field is applicable only to SBC signaling and Gateway CDRs (all CDR Report Types).</li> <li>■ The default field title is "SigDestPort" for Gateway Syslog and Local Storage, and "DestPort" for SBC Syslog and Local Storage.</li> <li>■ The maximum number of characters for Syslog tabular alignment is 11.</li> </ul>
Destination Host Before Manipulation [815]	<p>Displays the original destination hostname (before manipulation, if any).</p> <p><b>Note:</b></p> <ul style="list-style-type: none"> <li>■ The field is optional. You can include it in the CDR by CDR customization using the SBC CDR Format table.</li> <li>■ The field is applicable only to SBC signaling CDRs (all CDR Report Types).</li> <li>■ The maximum number of characters for Syslog tabular alignment is 20.</li> </ul>
Destination Host Name Before Manipulation [518]	<p>Displays the original destination hostname (before manipulation, if any).</p> <p><b>Note:</b></p> <ul style="list-style-type: none"> <li>■ By default, the field is included in the CDR.</li> <li>■ The field is applicable only to Gateway CDRs (all CDR Report Types).</li> </ul>

Field	Description
	<ul style="list-style-type: none"> <li>■ The default field title is "DstHostBeforeMap".</li> <li>■ The maximum number of characters for Syslog tabular alignment is 20.</li> </ul>
Destination Host Name [519]	<p>Displays the destination hostname (after manipulation, if any).</p> <p><b>Note:</b></p> <ul style="list-style-type: none"> <li>■ By default, the field is included in the CDR.</li> <li>■ The field is applicable only to Gateway CDRs (all CDR Report Types).</li> <li>■ The default field title is "DstHost".</li> <li>■ The maximum number of characters for Syslog tabular alignment is 20.</li> </ul>
Destination Host [813]	<p>Displays the destination hostname (after manipulation, if any).</p> <p><b>Note:</b></p> <ul style="list-style-type: none"> <li>■ The field is optional. You can include it in the CDR by CDR customization using the SBC CDR Format table.</li> <li>■ The field is applicable only to SBC CDRs (all CDR Report Types).</li> <li>■ The maximum number of characters for Syslog tabular alignment is 20.</li> </ul>
Destination IP [403]	<p>Displays the destination IP address. The field is a string of up to 20 characters.</p> <p><b>Note:</b></p> <ul style="list-style-type: none"> <li>■ By default, the field is included in the CDR.</li> <li>■ The field is applicable only to SBC signaling and Gateway CDRs (all CDR Report Types).</li> <li>■ The default field title is "DestIp".</li> <li>■ The maximum number of characters for Syslog tabular alignment is 20.</li> </ul>
Destination Number Before Manipulation [510]	<p>Displays the original destination number (before manipulation, if any).</p> <p><b>Note:</b></p> <ul style="list-style-type: none"> <li>■ By default, the field is included in the CDR.</li> <li>■ The field is applicable only to Gateway CDRs (all CDR Report Types).</li> <li>■ The default field title is "DstNumBeforeMap".</li> <li>■ The maximum number of characters for Syslog tabular alignment is</li> </ul>

Field	Description
	20.
Destination Number Plan [513]	<p>Displays the destination Numbering Plan Identification (NPI).</p> <p><b>Note:</b></p> <ul style="list-style-type: none"> <li>■ By default, the field is included in the CDR.</li> <li>■ The field is applicable only to Gateway CDRs (all CDR Report Types).</li> <li>■ The default field title is "NPI".</li> <li>■ The maximum number of characters for Syslog tabular alignment is 5.</li> </ul>
Destination Number Type [512]	<p>Displays the destination Type of Number (TON).</p> <p><b>Note:</b></p> <ul style="list-style-type: none"> <li>■ By default, the field is included in the CDR.</li> <li>■ The field is applicable only to Gateway CDRs (all CDR Report Types).</li> <li>■ The default field title is "TON".</li> <li>■ The maximum number of characters for Syslog tabular alignment is 5.</li> </ul>
Destination Number [511]	<p>Displays the destination phone number.</p> <p><b>Note:</b></p> <ul style="list-style-type: none"> <li>■ By default, the field is included in the CDR.</li> <li>■ The field is applicable only to Gateway CDRs (all CDR Report Types).</li> <li>■ The default field title is "DstPhoneNum" for Syslog, "" (empty string) for RADIUS (CALLED_STATION_ID standard ID 31), and "Callee" in the Web Gateway CDR History table.</li> <li>■ The maximum number of characters for Syslog tabular alignment is 20.</li> </ul>
Destination Tags [441]	<p>Displays destination tags.</p> <p><b>Note:</b></p> <ul style="list-style-type: none"> <li>■ The field is optional. You can include it in the CDR by CDR customization using the SBC CDR Format and Gateway CDR Format tables.</li> <li>■ The field is applicable only to SBC signaling and Gateway CDRs (all CDR Report Types).</li> <li>■ The maximum number of characters for Syslog tabular alignment is 32.</li> </ul>



Field	Description
Destination URI Before Manipulation [803]	<p>Displays the original destination URI (username@host) before manipulation, if any. The field is a string of up to 150 characters.</p> <p><b>Note:</b></p> <ul style="list-style-type: none"> <li>■ By default, the field is included in the CDR.</li> <li>■ The field is applicable only to SBC signaling CDRs (all CDR Report Types).</li> <li>■ The default field title is "DstURIBeforeMap".</li> <li>■ The maximum number of characters for Syslog tabular alignment is 41.</li> </ul>
Destination URI [801]	<p>Displays the destination URI (username@host) after manipulation, if any. The field is a string of up to 150 characters.</p> <p><b>Note:</b></p> <ul style="list-style-type: none"> <li>■ By default, the field is included in the CDR.</li> <li>■ The field is applicable only to SBC signaling CDRs (all CDR Report Types).</li> <li>■ The default field title is "DstURI".</li> <li>■ The maximum number of characters for Syslog tabular alignment is 41.</li> </ul>
Destination Username Before Manipulation [811]	<p>Displays the original destination username (before manipulation, if any).</p> <p><b>Note:</b></p> <ul style="list-style-type: none"> <li>■ The field is optional. You can include it in the CDR by CDR customization using the SBC CDR Format tables.</li> <li>■ The field is applicable only to SBC signaling CDRs (all CDR Report Types).</li> <li>■ The maximum number of characters for Syslog tabular alignment is 20.</li> </ul>
Destination Username [809]	<p>Displays the destination username (after manipulation, if any).</p> <p><b>Note:</b></p> <ul style="list-style-type: none"> <li>■ The field is optional. You can include it in the CDR by CDR customization using the SBC CDR Format tables.</li> <li>■ The field is applicable only to SBC signaling CDRs (all CDR Report Types).</li> <li>■ The maximum number of characters for Syslog tabular alignment is 20.</li> </ul>

Field	Description
Direct Media [807]	<p>Displays whether the call session flowed directly between the endpoints (i.e., Direct Media). The field is a string:</p> <ul style="list-style-type: none"> <li>■ "yes": The call is a direct media call session.</li> <li>■ "no": The call traversed the device.</li> </ul> <p><b>Note:</b></p> <ul style="list-style-type: none"> <li>■ By default, the field is included in the CDR.</li> <li>■ The field is applicable only to SBC signaling CDRs (all CDR Report Types).</li> <li>■ The default field title is "DirectMedia".</li> <li>■ The maximum number of characters for Syslog tabular alignment is 11.</li> </ul>
Endpoint Type [400]	<p>Displays the endpoint type. The field is a string:</p> <ul style="list-style-type: none"> <li>■ "NONE"</li> <li>■ "FXO"</li> <li>■ "FXS"</li> <li>■ "ISDN"</li> <li>■ "CAS"</li> <li>■ "TRANSPARNT" (E1/T1 calls without D-channel / signaling)</li> <li>■ "SBC" (SBC calls)</li> <li>■ "TEST" (for Test Call calls)</li> <li>■ "3WCONF" (three-way conferencing calls)</li> <li>■ "SIPREC" (SIPRec calls)</li> <li>■ "MOH" (Music-on-Hold calls)</li> </ul> <p><b>Note:</b></p> <ul style="list-style-type: none"> <li>■ By default, the field is included in the CDR.</li> <li>■ The field is applicable only to SBC signaling and Gateway CDRs (all CDR Report Types).</li> <li>■ The default field title is "EPTyp".</li> <li>■ The maximum number of characters for Syslog tabular alignment is 10.</li> </ul>
Fax On Call	Displays whether a fax transaction was detected during the call. The field

Field	Description
[505]	<p>is an integer:</p> <ul style="list-style-type: none"> <li>■ "0": No</li> <li>■ "1": Yes</li> </ul> <p><b>Note:</b></p> <ul style="list-style-type: none"> <li>■ By default, the field is included in the CDR.</li> <li>■ The field is applicable only to Gateway CDRs ("CALL_END" CDR Report Type).</li> <li>■ The default field title is "Fax".</li> <li>■ The maximum number of characters for Syslog tabular alignment is 5.</li> </ul>
Global Session ID [309]	<p>Displays the global session ID.</p> <p><b>Note:</b></p> <ul style="list-style-type: none"> <li>■ The field is optional. You can include it in the CDR by CDR customization using the SBC CDR Format and Gateway CDR Format tables.</li> <li>■ The field is applicable to SBC signaling and media, and Gateway CDRs.</li> <li>■ The default field title is "h323-gw-id=" for RADIUS (A_ACCT_SESSION_TIME).</li> <li>■ The maximum number of characters for Syslog tabular alignment is 16.</li> <li>■ For more information on the global session ID, see <a href="#">Enabling Same Call Session ID over Multiple Devices</a> on page 1341.</li> </ul>
H323 ID [306]	<p>Displays the device ID which can configured by the H323IDString parameter. It is typically used for RADIUS CDRs. The field is a string.</p> <p><b>Note:</b></p> <ul style="list-style-type: none"> <li>■ The field is included in the default RADIUS CDR.</li> <li>■ The field is applicable only to RADIUS SBC and Gateway CDRs (all CDR Report Types).</li> <li>■ The default field title is "h323-gw-id for RADIUS.</li> <li>■ The maximum number of characters for Syslog tabular alignment is 33.</li> </ul>
IP Group ID [416]	<p>Displays the IP Group ID. The field is an integer.</p> <p><b>Note:</b></p>

Field	Description
	<ul style="list-style-type: none"> <li>■ The field is optional. You can include it in the CDR by CDR customization using the SBC CDR Format and Gateway CDR Format tables.</li> <li>■ The field is applicable only to SBC signaling and Gateway CDRs (all CDR Report Types).</li> <li>■ The maximum number of characters for Syslog tabular alignment is 5.</li> </ul>
IP Group Name [417]	Displays the IP Group name. The field is a string of up to 40 characters. <b>Note:</b> <ul style="list-style-type: none"> <li>■ By default, the field is included in the CDR.</li> <li>■ The field is applicable only to SBC signaling and Gateway CDRs (all CDR Report Types).</li> <li>■ The default field title is "IPG (name)" for Gateway Syslog and Local Storage, "IPGroup (name)" for SBC Syslog and Local Storage, and "IP Group" in the Web SBC CDR History table.</li> <li>■ The maximum number of characters for Syslog tabular alignment is 32.</li> </ul>
IP Profile ID [425]	Displays the IP Profile ID. The field is an integer. <b>Note:</b> <ul style="list-style-type: none"> <li>■ The field is optional. You can include it in the CDR by CDR customization using the SBC CDR Format and Gateway CDR Format tables.</li> <li>■ The field is applicable only to SBC signaling and Gateway CDRs (all CDR Report Types).</li> <li>■ The maximum number of characters for Syslog tabular alignment is 5.</li> </ul>
IP Profile Name [426]	Displays the IP Profile name. The field is a string of up to 40 characters. <b>Note:</b> <ul style="list-style-type: none"> <li>■ By default, the field is included in the CDR.</li> <li>■ The field is applicable only to SBC signaling and Gateway CDRs (all CDR Report Types).</li> <li>■ The default field title is "IpProfileId (name)".</li> <li>■ The maximum number of characters for Syslog tabular alignment is 32.</li> </ul>
ISDN Line	Displays the ISDN line type. The field is an integer:

Field	Description
Type [525]	<ul style="list-style-type: none"> <li>■ "10": E1</li> <li>■ "11": T1</li> <li>■ "12": BRI</li> <li>■ "21": Unknown</li> </ul> <p><b>Note:</b></p> <ul style="list-style-type: none"> <li>■ The field is optional. You can include it in the CDR by CDR customization using the Gateway CDR Format tables.</li> <li>■ The field is applicable only to Gateway CDRs (all CDR Report Types).</li> <li>■ The maximum number of characters for Syslog tabular alignment is 5.</li> </ul>
Latched RTP IP [631]	<p>Displays the remote IP address of the incoming RTP stream that the device "latched" onto as a result of the RTP latching mechanism for NAT traversal.</p> <p><b>Note:</b></p> <ul style="list-style-type: none"> <li>■ By default, the field is included in the CDR.</li> <li>■ The field is applicable only to SBC media CDRs ("MEDIA_END" CDR Report Type) and Gateway CDRs ("CALL_END" CDR Report Type).</li> <li>■ The default field title is "LatchedRtpIp".</li> <li>■ The maximum number of characters for Syslog tabular alignment is 20.</li> </ul>
Latched RTP Port [632]	<p>Displays the remote RTP port of the incoming RTP stream that the device "latched" onto as a result of the RTP latching mechanism for NAT traversal. The field is an integer 0 to 0xFFFF.</p> <p><b>Note:</b></p> <ul style="list-style-type: none"> <li>■ By default, the field is included in the CDR.</li> <li>■ The field is applicable only to SBC media CDRs ("MEDIA_END" CDR Report Type) and Gateway CDRs ("CALL_END" CDR Report Type).</li> <li>■ The default field title is "LatchedRtpPort".</li> <li>■ The maximum number of characters for Syslog tabular alignment is 15.</li> </ul>
Latched T38 IP [633]	<p>Displays the latching of a new T.38 stream (new IP address).</p> <p><b>Note:</b></p> <ul style="list-style-type: none"> <li>■ By default, the field is included in the CDR.</li> </ul>

Field	Description
	<ul style="list-style-type: none"> <li>■ The field is applicable only to SBC media CDRs ("MEDIA_END" CDR Report Type) and Gateway CDRs ("CALL_END" CDR Report Type).</li> <li>■ The default field title is "LatchedT38lp".</li> <li>■ The maximum number of characters for Syslog tabular alignment is 20.</li> </ul>
Latched T38 Port [634]	<p>Displays the latching of a new T.38 stream (new port). The field is an integer 0 to 0xFFFF.</p> <p><b>Note:</b></p> <ul style="list-style-type: none"> <li>■ By default, the field is included in the CDR.</li> <li>■ The field is applicable only to SBC CDRs ("MEDIA_END" CDR Report Type) and Gateway CDRs ("CALL_END" CDR Report Type).</li> <li>■ The default field title is "LatchedT38Port".</li> <li>■ The maximum number of characters for Syslog tabular alignment is 15.</li> </ul>
Leg ID [310]	<p>Displays the unique ID of the call leg within a specific call session. The field is an integer.</p> <p>A basic SBC call consists of two legs (incoming and outgoing) and thus, two leg IDs are generated for the session, one for each leg.</p> <p>A basic Gateway call consists of only one leg ID.</p> <p>For each new call, the device assigns leg ID "1" to the first leg. The device then increments the leg ID for subsequent legs according to the leg sequence in the call session.</p> <p>For example, the device generates leg ID "1" for the SBC incoming leg and leg ID "2" for the SBC outgoing leg. If the call is transferred, the device generates leg ID "3" for the leg belonging to the call transfer target.</p> <p>Another example is a call forking session where the leg ID sequence may be as follows: incoming leg is "1", outgoing leg to user's office phone is "2" and outgoing leg to the user's mobile phone is "3". If the call is then transferred, the leg ID for the transfer leg is "4".</p> <p><b>Note:</b></p> <ul style="list-style-type: none"> <li>■ By default, the field is included in the CDR.</li> <li>■ The field is applicable only to SBC signaling and media, and Gateway CDRs ("CALL_START", "CALL_CONNECT" and "CALL_END" CDR Report Types).</li> <li>■ The default field title is "LegId".</li> <li>■ The maximum number of characters for Syslog tabular alignment is 5.</li> </ul>

Field	Description
Local Input Octets [606]	<p>Displays the local input octets (bytes).</p> <p><b>Note:</b></p> <ul style="list-style-type: none"> <li>■ The field is optional. You can include it in the CDR by CDR customization using the Gateway CDR Format and SBC CDR Format tables.</li> <li>■ The field is applicable only to SBC media CDRs ("MEDIA_END" CDR Report Type) and Gateway CDRs ("CALL_END" CDR Report Type).</li> <li>■ The default field title is empty for RADIUS (ACCT_INPUT_OCTETS standard ID 42).</li> <li>■ The maximum number of characters for Syslog tabular alignment is 10.</li> </ul>
Local Input Packets [604]	<p>Displays the number of packets received by the device. The field is an integer from 0 to 0xFFFFFFFF.</p> <p><b>Note:</b></p> <ul style="list-style-type: none"> <li>■ By default, the field is included in the CDR.</li> <li>■ The field is applicable only to SBC media CDRs ("MEDIA_END" CDR Report Type) and Gateway CDRs ("CALL_END" CDR Report Type).</li> <li>■ The default field title is "InPackets" for Syslog and Local Storage, and empty for RADIUS (ACCT_INPUT_PACKETS).</li> <li>■ The maximum number of characters for Syslog tabular alignment is 10.</li> </ul>
Local Jitter [610]	<p>Displays the RTP jitter. The field is an integer from 0 to 40000 samples (-1 if unavailable).</p> <p><b>Note:</b></p> <ul style="list-style-type: none"> <li>■ By default, the field is included in the CDR.</li> <li>■ The field is applicable only to SBC media CDRs ("MEDIA_END" CDR Report Type) and Gateway CDRs ("CALL_END" CDR Report Type).</li> <li>■ The default field title is "RTPjitter".</li> <li>■ The maximum number of characters for Syslog tabular alignment is 9.</li> </ul>
Local MOS CQ [627]	<p>Displays the local MOS for conversation quality. The field is an integer from 10 to 46 (127 if information is unavailable).</p> <p><b>Note:</b></p> <ul style="list-style-type: none"> <li>■ By default, the field is included in the CDR.</li> </ul>

Field	Description
	<ul style="list-style-type: none"> <li>■ The field is applicable only to SBC media CDRs ("MEDIA_END" CDR Report Type) and Gateway CDRs ("CALL_END" CDR Report Type).</li> <li>■ The default field title is "LocalMosCQ".</li> <li>■ The maximum number of characters for Syslog tabular alignment is 10.</li> </ul>
Local Output Octets [607]	<p>Displays the local output octets (bytes).</p> <p><b>Note:</b></p> <ul style="list-style-type: none"> <li>■ The field is optional. You can include it in the CDR by CDR customization using the Gateway CDR Format and SBC CDR Format tables.</li> <li>■ The field is applicable only to SBC media CDRs ("MEDIA_END" CDR Report Type) and Gateway CDRs ("CALL_END" CDR Report Type).</li> <li>■ The default field title is empty for RADIUS (ACCT_OUTPUT_OCTETS standard ID 43).</li> <li>■ The maximum number of characters for Syslog tabular alignment is 10.</li> </ul>
Local Output Packets [605]	<p>Displays the number of packets sent by the device. The field is an integer from 0 to 0xFFFFFFFF.</p> <p><b>Note:</b></p> <ul style="list-style-type: none"> <li>■ By default, the field is included in the CDR.</li> <li>■ The field is applicable only to SBC media CDRs ("MEDIA_END" CDR Report Type) and Gateway CDRs ("CALL_END" CDR Report Type).</li> <li>■ The default field title is "OutPackets" for Syslog and Local Storage, and empty for RADIUS (ACCT_OUTPUT_PACKETS standard ID 48).</li> <li>■ The maximum number of characters for Syslog tabular alignment is 10.</li> </ul>
Local Packet Loss [608]	<p>Displays the number of packets lost of the entire stream. The field is an integer from 0 to 0xFFFFFFFF (-1 if information is unavailable).</p> <p><b>Note:</b></p> <ul style="list-style-type: none"> <li>■ By default, the field is included in the CDR.</li> <li>■ The field is applicable only to SBC media CDRs ("MEDIA_END" CDR Report Type) and Gateway CDRs ("CALL_END" CDR Report Type).</li> <li>■ The default field title is "PackLoss" for Gateway Syslog and Local Storage, and "LocalPackLoss" for SBC Syslog.</li> </ul>



Field	Description
	<ul style="list-style-type: none"> <li>■ The maximum number of characters for Syslog tabular alignment is 10.</li> </ul>
Local R Factor [625]	<p>Displays the local R-factor conversation quality. The field is an integer from 0 to 120 (127 if information is unavailable).</p> <p><b>Note:</b></p> <ul style="list-style-type: none"> <li>■ By default, the field is included in the CDR.</li> <li>■ The field is applicable only to SBC media CDRs ("MEDIA_END" CDR Report Type) and Gateway CDRs ("CALL_END" CDR Report Type).</li> <li>■ The default field title is "LocalRFactor".</li> <li>■ If the RTCP XR feature is unavailable (not licensed or disabled), this R-factor VoIP metric is not provided. Instead, the device sends the CDR field with the value 127, meaning that information is unavailable.</li> <li>■ The maximum number of characters for Syslog tabular alignment is 12.</li> </ul>
Local Round Trip Delay [609]	<p>Displays the average round-trip delay time of the entire RTP stream. The field is an integer from 0 to 10000 ms (-1 if information is unavailable).</p> <p><b>Note:</b></p> <ul style="list-style-type: none"> <li>■ By default, the field is included in the CDR.</li> <li>■ The field is applicable only to SBC media CDRs ("MEDIA_END" CDR Report Type) and Gateway CDRs ("CALL_END" CDR Report Type).</li> <li>■ The default field title is "RTPdelay".</li> <li>■ The maximum number of characters for Syslog tabular alignment is 9.</li> </ul>
Local RTP IP [620]	<p>Displays the local RTP IP address.</p> <p><b>Note:</b></p> <ul style="list-style-type: none"> <li>■ By default, the field is included in the CDR.</li> <li>■ The field is applicable only to SBC media CDRs ("MEDIA_START" and "MEDIA_END" CDR Report Types) and Gateway CDRs ("CALL_CONNECT" and "CALL_END" CDR Report Types).</li> <li>■ The default field title is "LocalRtpIp".</li> <li>■ The maximum number of characters for Syslog tabular alignment is 20.</li> </ul>
Local RTP Port	<p>Displays the local RTP port. This field is an integer from 0 to 0xFFFF.</p> <p><b>Note:</b></p>

Field	Description
[621]	<ul style="list-style-type: none"> <li>■ By default, the field is included in the CDR.</li> <li>■ The field is applicable only to SBC media CDRs ("MEDIA_START" and "MEDIA_END" CDR Report Types) and Gateway CDRs ("CALL_CONNECT" and "CALL_END" CDR Report Types).</li> <li>■ The default field title is "LocalRtpPort".</li> <li>■ The maximum number of characters for Syslog tabular alignment is 15.</li> </ul>
Local SSRC Sender [611]	<p>Displays the local RTP synchronization source (SSRC). The field is an integer from 0 to 0xFFFFFFFF.</p> <p><b>Note:</b></p> <ul style="list-style-type: none"> <li>■ By default, the field is included in the CDR.</li> <li>■ The field is applicable only to SBC media CDRs ("MEDIA_END" CDR Report Type) and Gateway CDRs ("CALL_END" CDR Report Type).</li> <li>■ The default field title is "RTPssrc" for Gateway Syslog and Local Storage, and "TxRTPssrc" for SBC Syslog.</li> <li>■ The maximum number of characters for Syslog tabular alignment is 14.</li> </ul>
Media List [819]	<p>Displays all the media types (e.g., "audio", "text", "msrp", and "video") that was used for the call session. The field is a string.</p> <p><b>Note:</b></p> <ul style="list-style-type: none"> <li>■ The field is optional. You can include it in the CDR by CDR customization using the SBC CDR Format table.</li> <li>■ The field is applicable only to SBC signaling CDRs ("CALL_END" CDR Report Type).</li> <li>■ The maximum number of characters for Syslog tabular alignment is 40.</li> </ul>
Media Realm ID [427]	<p>Displays the Media Realm ID. The field is an integer.</p> <p><b>Note:</b></p> <ul style="list-style-type: none"> <li>■ The field is optional. You can include it in the CDR by CDR customization using the Gateway CDR Format and SBC CDR Format tables.</li> <li>■ The field is applicable only to SBC signaling and Gateway CDRs (all CDR Report Types).</li> <li>■ The maximum number of characters for Syslog tabular alignment is 5.</li> </ul>

Field	Description
Media Realm Name [428]	<p>Displays the Media Realm name. The field is a string of up to 40 characters.</p> <p><b>Note:</b></p> <ul style="list-style-type: none"> <li>■ By default, the field is included in the CDR.</li> <li>■ The field is applicable only to SBC signaling and Gateway CDRs (all CDR Report Types).</li> <li>■ The default field title is "MediaRealmId (name)".</li> <li>■ The maximum number of characters for Syslog tabular alignment is 32.</li> </ul>
Media Type [304]	<p>Displays the media type (e.g., "audio", "text", or "video").</p> <p><b>Note:</b></p> <ul style="list-style-type: none"> <li>■ By default, the field is included in the CDR.</li> <li>■ The field is applicable only to SBC media and Gateway CDRs ("CALL_END" and "MEDIA_END" CDR Report Type).</li> <li>■ The default field title is "MediaType".</li> <li>■ The maximum number of characters for Syslog tabular alignment is 10.</li> </ul>
Metering Pulses Generated [504]	<p>Displays the number of generated metering pulses.</p> <p><b>Note:</b></p> <ul style="list-style-type: none"> <li>■ By default, the field is included in the CDR.</li> <li>■ The field is applicable only to Gateway CDRs ("CALL_END" CDR Report Types).</li> <li>■ The default field title is "MeteringPulses".</li> <li>■ The maximum number of characters for Syslog tabular alignment is 20.</li> </ul>
Module And Port [521]	<p>Displays the module and port used.</p> <p><b>Note:</b></p> <ul style="list-style-type: none"> <li>■ The field is optional. You can include it in the CDR by CDR customization using the Gateway CDR Format table.</li> <li>■ The field is applicable only to Gateway CDRs (all CDR Report Types).</li> <li>■ The default field title is "End Point" in the Web Gateway CDR History tables.</li> <li>■ The maximum number of characters for Syslog tabular alignment is</li> </ul>

Field	Description
	15.
Packet Interval [602]	<p>Displays the coder packet interval. The field is an integer from 10 to 200 ms.</p> <p><b>Note:</b></p> <ul style="list-style-type: none"> <li>■ By default, the field is included in the CDR.</li> <li>■ The field is applicable only to SBC media CDRs ("MEDIA_START", "MEDIA_UPDATE" and "MEDIA_END" CDR Report Types) and Gateway CDRs ("CALL_CONNECT" and "CALL_END" CDR Report Types).</li> <li>■ The default field title is "Intrv".</li> <li>■ The maximum number of characters for Syslog tabular alignment is 5.</li> </ul>
Payload Type [603]	<p>Displays the RTP payload type. The field is an integer, for example:</p> <ul style="list-style-type: none"> <li>■ "0" for G.711 U-law</li> <li>■ "8" for G.711 A-law</li> <li>■ "18" for G.729</li> </ul> <p><b>Note:</b></p> <ul style="list-style-type: none"> <li>■ The field is optional. You can include it in the CDR by CDR customization using the SBC CDR Format and Gateway CDR Format tables.</li> <li>■ The field is applicable only to SBC media CDRs ("MEDIA_START", "MEDIA_UPDATE" and "MEDIA_END" CDR Report Types) and Gateway CDRs ("CALL_CONNECT" and "CALL_END" CDR Report Types).</li> <li>■ The maximum number of characters for Syslog tabular alignment is 5.</li> </ul>
Proxy Set ID [424]	<p>Displays the Proxy Set ID.</p> <p><b>Note:</b></p> <ul style="list-style-type: none"> <li>■ The field is optional. You can include it in the CDR by CDR customization using the SBC CDR Format and Gateway CDR Format tables.</li> <li>■ The field is applicable only to SBC signaling and Gateway CDRs (all CDR Report Types).</li> <li>■ The maximum number of characters for Syslog tabular alignment is 10.</li> </ul>
Proxy Set Name	<p>Displays the Proxy Set name. The field is a string of up to 40 characters.</p> <p><b>Note:</b></p>

Field	Description
[438]	<ul style="list-style-type: none"> <li>■ By default, the field is included in the CDR.</li> <li>■ The field is applicable only to SBC signaling and Gateway CDRs (all CDR Report Types).</li> <li>■ The default field title is "ProxySetId (name)".</li> <li>■ The maximum number of characters for Syslog tabular alignment is 32.</li> </ul>
PSTN Termination Reason [520]	Displays the Q.850 protocol termination reason. The field is an integer from 0 to 127. <b>Note:</b> <ul style="list-style-type: none"> <li>■ By default, the field is included in the CDR.</li> <li>■ The field is applicable only to Gateway CDRs ("CALL_END" CDR Report Types).</li> <li>■ The default field title is "PstnTermReason".</li> <li>■ The maximum number of characters for Syslog tabular alignment is 14.</li> </ul>
RADIUS Call ID [307]	Displays the RADIUS call ID. <b>Note:</b> <ul style="list-style-type: none"> <li>■ The field is optional. You can include it in the CDR by CDR customization using the SBC CDR Format and Gateway CDR Format tables.</li> <li>■ The field is applicable only to SBC and Gateway RADIUS CDRs (all CDR Report Types).</li> <li>■ The default field title is "h323-conf-id=" in RADIUS CDRs.</li> <li>■ The maximum number of characters for Syslog tabular alignment is 50.</li> </ul>
Redirect Number Before Manipulation [514]	Displays the redirect phone number before manipulation, if any. <b>Note:</b> <ul style="list-style-type: none"> <li>■ The field is optional. You can include it in the CDR by CDR customization using the SBC CDR Format and Gateway CDR Format tables.</li> <li>■ The field is applicable only to Gateway CDRs ("CALL_END" CDR Report Types).</li> <li>■ The default field title is "RedirectNumBeforeMap".</li> </ul>

Field	Description
	<ul style="list-style-type: none"> <li>■ The maximum number of characters for Syslog tabular alignment is 20.</li> </ul>
Redirect Number Plan [527]	<p>Displays the redirect Numbering Plan Identification (NPI).</p> <p><b>Note:</b></p> <ul style="list-style-type: none"> <li>■ The field is optional. You can include it in the CDR by CDR customization using the Gateway CDR Format tables.</li> <li>■ The field is applicable only to Gateway CDRs (all CDR Report Types).</li> <li>■ The maximum number of characters for Syslog tabular alignment is 5.</li> </ul>
Redirect Number Type [526]	<p>Displays the redirect Type of Number (TON).</p> <p><b>Note:</b></p> <ul style="list-style-type: none"> <li>■ The field is optional. You can include it in the CDR by CDR customization using the Gateway CDR Format tables.</li> <li>■ The field is applicable only to Gateway CDRs (all CDR Report Types).</li> <li>■ The maximum number of characters for Syslog tabular alignment is 5.</li> </ul>
Redirect Number [515]	<p>Displays the original redirect number (before manipulation, if any).</p> <p><b>Note:</b></p> <ul style="list-style-type: none"> <li>■ By default, the field is included in the CDR.</li> <li>■ The field is applicable only to Gateway CDRs ("CALL_END" CDR Report Types).</li> <li>■ The default field title is "RedirectPhonNum".</li> <li>■ The maximum number of characters for Syslog tabular alignment is 20.</li> </ul>
Redirect Reason [414]	<p>Displays the reason for the call redirection. The field is an integer of up to 15 digits:</p> <ul style="list-style-type: none"> <li>■ "-1": Not relevant</li> <li>■ "0": Unknown reason</li> <li>■ "1": Call forward busy (CFB)</li> <li>■ "2": Call forward no reply (CFNR)</li> <li>■ "3": Call forward network busy</li> <li>■ "4": Call deflection</li> <li>■ "5": Immediate call deflection</li> </ul>

Field	Description
	<ul style="list-style-type: none"> <li>■ "6": Mobile subscriber not reachable</li> <li>■ "9": DTE out of order</li> <li>■ "10": Call forwarding DTE</li> <li>■ "13": Call transfer</li> <li>■ "14": Call pickup</li> <li>■ "15": Call systematic or call forward unconditional (CFU)</li> </ul> <p><b>Note:</b></p> <ul style="list-style-type: none"> <li>■ By default, the field is included in the CDR.</li> <li>■ The field is applicable only to SBC signaling and Gateway CDRs ("CALL_END" CDR Report Types).</li> <li>■ The default field title is "RedirectReason".</li> <li>■ The maximum number of characters for Syslog tabular alignment is 15.</li> </ul>
Redirect URI Before Manipulation [805]	<p>Displays the original call redirect URI (username@host) before manipulation, if any. The field is a string of up to 150 characters.</p> <p><b>Note:</b></p> <ul style="list-style-type: none"> <li>■ By default, the field is included in the CDR.</li> <li>■ The field is applicable only to SBC signaling CDRs ("CALL_END" CDR Report Types).</li> <li>■ The default field title is "RedirectURINumBeforeMap".</li> <li>■ The maximum number of characters for Syslog tabular alignment is 41.</li> </ul>
Redirect URI [804]	<p>Displays the original call redirect URI (username@host) after manipulation, if any. The field value is a string of up to 150 characters.</p> <p><b>Note:</b></p> <ul style="list-style-type: none"> <li>■ By default, the field is included in the CDR.</li> <li>■ The field is applicable only to SBC signaling CDRs ("CALL_END" CDR Report Types).</li> <li>■ The default field title is "RedirectURINum".</li> <li>■ The maximum number of characters for Syslog tabular alignment is 41.</li> </ul>
Release Time	Displays the date and time the call ended (disconnected). The field is a

Field	Description
[413]	<p>string of up to 35 characters and presented in the following format: &lt;hh:mm:ss:ms&gt; UTC &lt;DDD&gt; &lt;MMM&gt; &lt;DD&gt; &lt;YYYY&gt;. For example, "17:00:55.002 UTC Thu Dec 14 2017".</p> <p><b>Note:</b></p> <ul style="list-style-type: none"> <li>■ To configure the time zone string (e.g., "UTC" - default, "GMT+1" and "EST"), use the TimeZoneFormat parameter.</li> <li>■ By default, the field is included in the CDR.</li> <li>■ The field is applicable only to SBC signaling and Gateway CDRs ("CALL_END" CDR Report Types).</li> <li>■ The default field title is "ReleaseTime" for Syslog, "h323-disconnect-time=" for RADIUS, and "Call End Time" in the Web SBC CDR History and Web Gateway CDR History tables.</li> <li>■ The maximum number of characters for Syslog tabular alignment is 35.</li> </ul>
Remote Input Octets [614]	<p>Displays the remote input octets (bytes).</p> <p><b>Note:</b></p> <ul style="list-style-type: none"> <li>■ The field is optional. You can include it in the CDR by CDR customization using the Gateway CDR Format and SBC CDR Format tables.</li> <li>■ The field is applicable only to SBC media CDRs ("MEDIA_END" CDR Report Type) and Gateway CDRs ("CALL_END" CDR Report Type).</li> <li>■ The maximum number of characters for Syslog tabular alignment is 10.</li> </ul>
Remote Input Packets [612]	<p>Displays the number of packets that the remote side reported it received. The field is an integer from 0 to 0xFFFFFFFF.</p> <p><b>Note:</b></p> <ul style="list-style-type: none"> <li>■ The field is optional. You can include it in the CDR by CDR customization using the Gateway CDR Format and SBC CDR Format tables.</li> <li>■ The field is applicable only to SBC media CDRs ("MEDIA_END" CDR Report Type) and Gateway CDRs ("CALL_END" CDR Report Type).</li> <li>■ The maximum number of characters for Syslog tabular alignment is 10.</li> </ul>
Remote IP [404]	<p>Displays the remote SIP IP address.</p> <p><b>Note:</b></p>



Field	Description
	<ul style="list-style-type: none"> <li>■ The field is optional. You can include it in the CDR by CDR customization using the Gateway CDR Format and SBC CDR Format tables.</li> <li>■ The field is applicable only to SBC signaling and Gateway CDRs ("CALL_START", "CALL_CONNECT", and "CALL_END" CDR Report Types).</li> <li>■ The field is applicable to Syslog, RADIUS, Local Storage, and Web History CDRs.</li> <li>■ The default CDR title is "Remote IP" in the Web SBC CDR History and Web Gateway CDR History tables.</li> <li>■ The maximum number of characters for Syslog tabular alignment is 20.</li> </ul>
Remote Jitter [618]	<p>Displays the remote RTP jitter. The field is an integer from 0 to 40000 samples (-1 if unavailable).</p> <p><b>Note:</b></p> <ul style="list-style-type: none"> <li>■ The field is optional. You can include it in the CDR by CDR customization using the Gateway CDR Format and SBC CDR Format tables.</li> <li>■ The field is applicable only to SBC media CDRs ("MEDIA_END" CDR Report Type) and Gateway CDRs ("CALL_END" CDR Report Type).</li> <li>■ The maximum number of characters for Syslog tabular alignment is 9.</li> </ul>
Remote MOS CQ [628]	<p>Displays the remote MOS for conversation quality. The field is an integer from 10 to 46 (127 if information is unavailable).</p> <p><b>Note:</b></p> <ul style="list-style-type: none"> <li>■ By default, the field is included in the CDR.</li> <li>■ The field is applicable only to SBC media CDRs ("MEDIA_END" CDR Report Type) and Gateway CDRs ("CALL_END" CDR Report Type).</li> <li>■ The default field title is "RemoteMosCQ".</li> <li>■ The maximum number of characters for Syslog tabular alignment is 11.</li> </ul>
Remote Output Octets [615]	<p>Displays the remote output octets (bytes).</p> <p><b>Note:</b></p> <ul style="list-style-type: none"> <li>■ The field is optional. You can include it in the CDR by CDR customization using the Gateway CDR Format and SBC CDR Format table.</li> </ul>

Field	Description
	<ul style="list-style-type: none"> <li>■ The field is applicable only to SBC media CDRs ("MEDIA_END" CDR Report Type) and Gateway CDRs ("CALL_END" CDR Report Type).</li> <li>■ The maximum number of characters for Syslog tabular alignment is 10.</li> </ul>
Remote Output Packets [613]	<p>Displays the number of packets received by the device. The field is an integer from 0 to 0xFFFFFFFF.</p> <p><b>Note:</b></p> <ul style="list-style-type: none"> <li>■ The field is optional. You can include it in the CDR by CDR customization using the Gateway CDR Format and SBC CDR Format table.</li> <li>■ The field is applicable only to SBC media CDRs ("MEDIA_END" CDR Report Type) and Gateway CDRs ("CALL_END" CDR Report Type).</li> <li>■ The maximum number of characters for Syslog tabular alignment is 10.</li> </ul>
Remote Packet Loss [616]	<p>Displays the number of packets lost of the entire remote stream. The field is an integer from 0 to 0xFFFFFFFF (-1 if information is unavailable).</p> <p><b>Note:</b></p> <ul style="list-style-type: none"> <li>■ By default, the field is included in the CDR.</li> <li>■ The field is applicable only to SBC media CDRs ("MEDIA_END" CDR Report Type) and Gateway CDRs ("CALL_END" CDR Report Type).</li> <li>■ The default field title is "RemotePackLoss".</li> <li>■ The maximum number of characters for Syslog tabular alignment is 14.</li> </ul>
Remote Port [407]	<p>Displays the remote SIP port. This field is an integer from 0 to 0xFFFF.</p> <p><b>Note:</b></p> <ul style="list-style-type: none"> <li>■ The field is optional. You can include it in the CDR by CDR customization using the Gateway CDR Format and SBC CDR Format table.</li> <li>■ The field is applicable only to SBC signaling and Gateway CDRs ("CALL_START", "CALL_CONNECT", and "CALL_END" CDR Report Types).</li> <li>■ The maximum number of characters for Syslog tabular alignment is 5.</li> </ul>
Remote R Factor [626]	<p>Displays the remote R-factor conversation quality. The field is an integer from 0 to 120 (127 if information is unavailable).</p> <p><b>Note:</b></p>

Field	Description
	<ul style="list-style-type: none"> <li>■ By default, the field is included in the CDR.</li> <li>■ The field is applicable only to SBC media CDRs ("MEDIA_END" CDR Report Type) and Gateway CDRs ("CALL_END" CDR Report Type).</li> <li>■ The default field title is "RemoteRFactor".</li> <li>■ If the RTCP XR feature is unavailable (not licensed or disabled), this R-factor VoIP metric is not provided. Instead, the device sends the CDR field with the value 127, meaning that information is unavailable.</li> <li>■ The maximum number of characters for Syslog tabular alignment is 13.</li> </ul>
Remote Round Trip Delay [617]	<p>Displays the average round-trip delay time of the remote RTP stream. The field is an integer from 0 to 10000 ms (-1 if information is unavailable).</p> <p><b>Note:</b></p> <ul style="list-style-type: none"> <li>■ The field is optional. You can include it in the CDR by CDR customization using the SBC CDR Format tables.</li> <li>■ The field is applicable only to SBC media CDRs ("MEDIA_END" CDR Report Type) and Gateway CDRs ("CALL_END" CDR Report Type).</li> <li>■ The maximum number of characters for Syslog tabular alignment is 9.</li> </ul>
Remote RTP IP [622]	<p>Displays the remote RTP IP address.</p> <p><b>Note:</b></p> <ul style="list-style-type: none"> <li>■ By default, the field is included in the CDR.</li> <li>■ The field is applicable only to SBC media CDRs ("MEDIA_START", "MEDIA_UPDATE" and "MEDIA_END" CDR Report Types) and Gateway CDRs ("CALL CONNECT" and "CALL_END" CDR Report Types).</li> <li>■ The default field title is "RtpIp" for Syslog Signaling and Local Storage, "RemoteRtpIp" for Syslog Media, and "h323-remote-address=" for RADIUS.</li> <li>■ The maximum number of characters for Syslog tabular alignment is 20.</li> </ul>
Remote RTP Port [623]	<p>Displays the remote RTP port. This field is an integer from 0 to 0xFFFF.</p> <p><b>Note:</b></p> <ul style="list-style-type: none"> <li>■ By default, the field is included in the CDR.</li> <li>■ The field is applicable only to SBC media CDRs ("MEDIA_START", "MEDIA_UPDATE" and "MEDIA_END" CDR Report Types) and Gateway CDRs ("CALL CONNECT" and "CALL_END" CDR Report Types).</li> </ul>

Field	Description
	<ul style="list-style-type: none"> <li>■ The default field title is ""Port" for Syslog Signaling and "RemoteRtpPort" for Syslog Media.</li> <li>■ The maximum number of characters for Syslog tabular alignment is 5.</li> </ul>
Remote SIP User Agent [818]	<p>Displays the remote SIP User-Agent header value.</p> <p><b>Note:</b></p> <ul style="list-style-type: none"> <li>■ The field is optional. You can include it in the CDR by CDR customization using the SBC CDR Format table.</li> <li>■ The field is applicable only to SBC signaling ("CALL_START", "CALL_CONNECT" and "CALL_END" CDR Report Types).</li> <li>■ The maximum number of characters for Syslog tabular alignment is 41.</li> </ul>
Remote SSRC Sender [619]	<p>Displays the remote (sender) RTP synchronization source (SSRC). The field is an integer from 0 to 0xFFFFFFFF.</p> <p><b>Note:</b></p> <ul style="list-style-type: none"> <li>■ By default, the field is included in the CDR.</li> <li>■ The field is applicable only to SBC media CDRs ("MEDIA_END" CDR Report Type) and Gateway CDRs ("CALL_END" CDR Report Type).</li> <li>■ The default field title is "RemoteRTPssrc" for Gateway Syslog and "RxRTPssrc" for SBC Syslog Media.</li> <li>■ The maximum number of characters for Syslog tabular alignment is 14.</li> </ul>
Report Type [303]	<p>Displays the type of CDR report. The field is a string:</p> <ul style="list-style-type: none"> <li>■ "CALL_START": The CDR is sent upon an INVITE message.</li> <li>■ "CALL_CONNECT": The CDR is sent upon a 200 OK response.</li> <li>■ "CALL_END": The CDR is sent upon a BYE message.</li> <li>■ "DIALOG_START": The CDR is sent upon the start of a non-INVITE session (only when enabled, using the EnableNonCallCdr parameter).</li> <li>■ "DIALOG_END": The CDR is sent upon the end of a non-INVITE session (only when enabled, using the EnableNonCallCdr parameter).</li> <li>■ "DIALOG_CONNECT ": The CDR is sent upon establishment of a non-INVITE session (only when enabled, using the EnableNonCallCdr parameter).</li> <li>■ "MEDIA_START": The CDR is sent upon 200 OK response or early</li> </ul>

Field	Description
	<p>media</p> <ul style="list-style-type: none"> <li>■ "MEDIA_UPDATE": The CDR is sent upon a re-INVITE message</li> <li>■ "MEDIA_END": The CDR sent is upon a BYE message</li> </ul> <p><b>Note:</b></p> <ul style="list-style-type: none"> <li>■ By default, the field is included in the CDR.</li> <li>■ The field is applicable to SBC media and signaling, and Gateway CDRs.</li> <li>■ The default field title is "GWReportType" for Gateway Syslog and Local Storage, "SBCReportType" for SBC Syslog and Local Storage, and "MediaReportType" for SBC Syslog Media.</li> <li>■ The maximum number of characters for Syslog tabular alignment is 15.</li> </ul>
RTP IP DiffServ [624]	<p>The field displays the RTP IP DiffServ. The valid value is an integer from 0 to 63.</p> <p><b>Note:</b></p> <ul style="list-style-type: none"> <li>■ By default, the field is included in the CDR.</li> <li>■ The field is applicable only to SBC media CDRs ("MEDIA_START", "MEDIA_UPDATE" and "MEDIA_END" CDR Report Types) and Gateway CDRs ("CALL CONNECT" and "CALL_END" CDR Report Types).</li> <li>■ The default field title is "TxRTPIPDiffServ".</li> <li>■ The maximum number of characters for Syslog tabular alignment is 15.</li> </ul>
Session ID [302]	<p>Displays the unique session ID. The field value is a string of up to 24 characters.</p> <p><b>Note:</b></p> <ul style="list-style-type: none"> <li>■ By default, the field is included in the CDR.</li> <li>■ The field is applicable to SBC media and signaling, and Gateway CDRs (all CDR Report Types).</li> <li>■ The default field title is "SessionId".</li> <li>■ The maximum number of characters for Syslog tabular alignment is 24.</li> </ul>
Setup Time [411]	<p>Displays the date and time that the call was setup. The field value is a string of up to 35 characters and presented in the following format: &lt;hh:mm:ss:ms&gt; UTC &lt;DDD&gt; &lt;MMM&gt; &lt;DD&gt; &lt;YYYY&gt;. For example,</p>

Field	Description
	<p>"17:00:49.052 UTC Thu Dec 14 2017"</p> <p><b>Note:</b></p> <ul style="list-style-type: none"> <li>■ To configure the time zone string (e.g., "UTC" - default, "GMT+1", and "EST"), use the TimeZoneFormat parameter.</li> <li>■ By default, the field is included in the CDR.</li> <li>■ The field is applicable only to SBC signaling and Gateway CDRs (all CDR Report Types).</li> <li>■ The default field title is "SetupTime" for Syslog and Local Storage, and "h323-setup-time=" for RADIUS.</li> <li>■ The maximum number of characters for Syslog tabular alignment is 35.</li> </ul>
Signaling IP DiffServ [422]	<p>Displays the signaling IP DiffServ. The field value is an integer of up to 15 digits.</p> <p><b>Note:</b></p> <ul style="list-style-type: none"> <li>■ By default, the field is included in the CDR.</li> <li>■ The field is applicable only to SBC signaling and Gateway CDRs (all CDR Report Types).</li> <li>■ The default field title is "TxSigIPDiffServ".</li> <li>■ The maximum number of characters for Syslog tabular alignment is 15.</li> </ul>
SIP Interface ID [420]	<p>Displays the SIP Interface table row index (integer).</p> <p><b>Note:</b></p> <ul style="list-style-type: none"> <li>■ The field is optional. You can include it in the CDR by CDR customization using the Gateway CDR Format and SBC CDR Format tables.</li> <li>■ The field is applicable only to SBC signaling and Gateway CDRs (all CDR Report Types).</li> <li>■ The maximum number of characters for Syslog tabular alignment is 5.</li> </ul>
SIP Interface Name [433]	<p>Displays the SIP Interface name. The field value is a string of up to 40 characters.</p> <p><b>Note:</b></p> <ul style="list-style-type: none"> <li>■ By default, the field is included in the CDR.</li> <li>■ The field is applicable only to SBC signaling and Gateway CDRs (all CDR Report Types).</li> </ul>

Field	Description
	<ul style="list-style-type: none"> <li>■ The default field title is "SIPInterfaceId (name)".</li> <li>■ The maximum number of characters for Syslog tabular alignment is 32.</li> </ul>
SIP Local Tag [445]	<p>Displays the 'tag' parameter of the SIP From / To headers that is generated by the device in the outgoing SIP message. The field value is a string of up to 100 characters.</p> <p><b>Note:</b></p> <ul style="list-style-type: none"> <li>■ The field is optional. You can include it in the CDR by CDR customization using the Gateway CDR Format and SBC CDR Format tables.</li> <li>■ The field is applicable to all CDR Report Types, but it may not be added to some Report Types in all call scenarios.</li> <li>■ The field is applicable only to SBC signaling and Gateway CDRs.</li> <li>■ The maximum number of characters for Syslog tabular alignment is 20.</li> </ul>
SIP Method [806]	<p>Displays the SIP message type (method). The field value is a string of up to 10 characters:</p> <ul style="list-style-type: none"> <li>■ "INVITE"</li> <li>■ "OPTIONS"</li> <li>■ "REGISTER"</li> <li>■ "NOTIFY"</li> <li>■ "INFO"</li> <li>■ "SUBSCRIBE"</li> <li>■ "MESSAGE"</li> <li>■ "BENOTIFY"</li> <li>■ "SERVICE"</li> </ul> <p><b>Note:</b></p> <ul style="list-style-type: none"> <li>■ By default, the field is included in the CDR.</li> <li>■ The field is applicable only to SBC signaling CDRs (all CDR Report Types).</li> <li>■ The default field title is "SIPMethod".</li> <li>■ The maximum number of characters for Syslog tabular alignment is 10.</li> </ul>

Field	Description
SIP Remote Tag [446]	<p>Displays the 'tag' parameter of the SIP From / To headers that is received by the device in the incoming SIP message. The field value is a string of up to 100 characters.</p> <p><b>Note:</b></p> <ul style="list-style-type: none"> <li>■ The field is optional. You can include it in the CDR by CDR customization using the Gateway CDR Format and SBC CDR Format tables.</li> <li>■ The field is applicable to all CDR Report Types, but it may not be added to some Report Types in all call scenarios.</li> <li>■ The field is applicable only to SBC signaling and Gateway CDRs.</li> <li>■ The maximum number of characters for Syslog tabular alignment is 20.</li> </ul>
SIP Termination Description [430]	<p>Displays the description of the SIP call termination reason. The field value is a string of up to 70 characters and is set to one of the following:</p> <ul style="list-style-type: none"> <li>■ SIP Reason header, if exists, for example: SIP ;cause=200 ;text="Call completed elsewhere".</li> <li>■ If no SIP Reason header exists, the description is taken from the reason text, if exists, of the SIP response code, for example: "417 Unknown Resource-Priority".</li> <li>■ If no reason text exists in the SIP response code, the description is taken from an internal SIP response mapping mechanism. For example, if the device receives a SIP response "422", it sends in the CDR "422 Session Interval Too Small method" as the description.</li> </ul> <p><b>Note:</b></p> <ul style="list-style-type: none"> <li>■ By default, the field is included in the CDR.</li> <li>■ The field is applicable only to SBC signaling and Gateway CDRs ("CALL_END" CDR Report Types).</li> <li>■ The default field title is "SipTermDesc".</li> <li>■ The maximum number of characters for Syslog tabular alignment is 26.</li> </ul>
SIP Termination Reason [429]	<p>Displays the SIP reason for call termination. The field value is a string of up to 12 characters and is set to one of the following:</p> <ul style="list-style-type: none"> <li>■ "BYE"</li> <li>■ "CANCEL"</li> </ul>



Field	Description
	<ul style="list-style-type: none"> <li>■ SIP error codes (e.g., "404")</li> </ul> <p><b>Note:</b></p> <ul style="list-style-type: none"> <li>■ By default, the field is included in the CDR.</li> <li>■ The field is applicable only to SBC signaling and Gateway CDRs ("CALL_END" CDR Report Types).</li> <li>■ The default field title is "SIPTrmReason".</li> <li>■ The maximum number of characters for Syslog tabular alignment is 12.</li> </ul>
Source Host Before Manipulation [814]	<p>Displays the original source hostname (before manipulation, if any).</p> <p><b>Note:</b></p> <ul style="list-style-type: none"> <li>■ The field is optional. You can include it in the CDR by CDR customization using the SBC CDR Format table.</li> <li>■ The field is applicable only to SBC signaling CDRs (all CDR Report Types).</li> <li>■ The maximum number of characters for Syslog tabular alignment is 20.</li> </ul>
Source Host Name Before Manipulation [516]	<p>Displays the original source hostname (before manipulation, if any).</p> <p><b>Note:</b></p> <ul style="list-style-type: none"> <li>■ By default, the field is included in the CDR.</li> <li>■ The field is applicable only to Gateway CDRs (all CDR Report Types).</li> <li>■ The default field title is "SrcHostBeforeMap".</li> <li>■ The maximum number of characters for Syslog tabular alignment is 20.</li> </ul>
Source Host Name [517]	<p>Displays the source hostname (after manipulation, if any).</p> <p><b>Note:</b></p> <ul style="list-style-type: none"> <li>■ By default, the field is included in the CDR.</li> <li>■ The field is applicable only to Gateway CDRs (all CDR Report Types).</li> <li>■ The default field title is "SrcHost".</li> <li>■ The maximum number of characters for Syslog tabular alignment is 20.</li> </ul>
Source Host [812]	<p>Displays the source hostname (after manipulation, if any).</p> <p><b>Note:</b></p>

Field	Description
	<ul style="list-style-type: none"> <li>■ The field is optional. You can include it in the CDR by CDR customization using the SBC CDR Format table.</li> <li>■ The field is applicable only to SBC signaling CDRs (all CDR Report Types).</li> <li>■ The maximum number of characters for Syslog tabular alignment is 20.</li> </ul>
Source IP [402]	<p>Displays the source IP address. The field value is a string of up to 20 characters.</p> <p><b>Note:</b></p> <ul style="list-style-type: none"> <li>■ By default, the field is included in the CDR.</li> <li>■ The field is applicable only to SBC signaling and Gateway CDRs (all CDR Report Types).</li> <li>■ The default field title is "SourceIp".</li> <li>■ The maximum number of characters for Syslog tabular alignment is 20.</li> </ul>
Source Number Before Manipulation [506]	<p>Displays the source number (before manipulation, if any).</p> <p><b>Note:</b></p> <ul style="list-style-type: none"> <li>■ By default, the field is included in the CDR.</li> <li>■ The field is applicable only to Gateway CDRs (all CDR Report Types).</li> <li>■ The default field title is "SrcNumBeforeMap" for Syslog, and "Caller" for Web CDR History.</li> <li>■ The maximum number of characters for Syslog tabular alignment is 20.</li> </ul>
Source Number Plan [509]	<p>Displays the source Numbering Plan Identification (NPI).</p> <p><b>Note:</b></p> <ul style="list-style-type: none"> <li>■ By default, the field is included in the CDR.</li> <li>■ The field is applicable only to Gateway CDRs (all CDR Report Types).</li> <li>■ The default field title is "NPI".</li> <li>■ The maximum number of characters for Syslog tabular alignment is 5.</li> </ul>
Source Number Type	<p>Displays the source Type of Number (TON).</p> <p><b>Note:</b></p> <ul style="list-style-type: none"> <li>■ By default, the field is included in the CDR.</li> </ul>

Field	Description
[508]	<ul style="list-style-type: none"> <li>■ The field is applicable only to Gateway CDRs (all CDR Report Types).</li> <li>■ The default field title is "TON".</li> <li>■ The maximum number of characters for Syslog tabular alignment is 5.</li> </ul>
Source Number [507]	<p>Displays the source number (after manipulation).</p> <p><b>Note:</b></p> <ul style="list-style-type: none"> <li>■ By default, the field is included in the CDR.</li> <li>■ The field is applicable only to Gateway CDRs (all CDR Report Types).</li> <li>■ The default field title is "SrcPhoneNum" for Syslog and Local Storage, and "" for RADIUS (A_CALLING_STATION_ID).</li> <li>■ The maximum number of characters for Syslog tabular alignment is 20.</li> </ul>
Source Port [405]	<p>Displays the SIP signaling source UDP port. The field value is an integer of up to 10 digits.</p> <p><b>Note:</b></p> <ul style="list-style-type: none"> <li>■ By default, the field is included in the CDR.</li> <li>■ The field is applicable only to SBC signaling and Gateway CDRs (all CDR Report Types).</li> <li>■ The default field title is "SigSourcePort" for Gateway Syslog, and "SourcePort" for SBC Syslog and Local Storage.</li> <li>■ The maximum number of characters for Syslog tabular alignment is 13.</li> </ul>
Source Tags [440]	<p>Displays source tags.</p> <p><b>Note:</b></p> <ul style="list-style-type: none"> <li>■ The field is optional. You can include it in the CDR by CDR customization using the SBC CDR Format and Gateway CDR Format tables.</li> <li>■ The field is applicable only to SBC signaling and Gateway CDRs (all CDR Report Types).</li> <li>■ The maximum number of characters for Syslog tabular alignment is 32.</li> </ul>
Source URI Before Manipulation	<p>Displays the source URI (username@host) before manipulation. The field value is a string of up to 150 characters.</p> <p><b>Note:</b></p>

Field	Description
[802]	<ul style="list-style-type: none"> <li>■ By default, the field is included in the CDR.</li> <li>■ The field is applicable only to SBC signaling CDRs (all CDR Report Types).</li> <li>■ The default field title is "SrcURIBeforeMap".</li> <li>■ The maximum number of characters for Syslog tabular alignment is 41.</li> </ul>
Source URI [800]	<p>Displays the source URI (username@host). The field value is a string of up to 150 characters.</p> <p><b>Note:</b></p> <ul style="list-style-type: none"> <li>■ By default, the field is included in the CDR.</li> <li>■ The field is applicable only to SBC signaling CDRs (all CDR Report Types).</li> <li>■ The default field title is "SrcURI".</li> <li>■ The maximum number of characters for Syslog tabular alignment is 41.</li> </ul>
Source Username Before Manipulation [810]	<p>Displays the original source username (before manipulation, if any).</p> <p><b>Note:</b></p> <ul style="list-style-type: none"> <li>■ The field is optional. You can include it in the CDR by CDR customization using the SBC CDR Format tables.</li> <li>■ The field is applicable only to SBC signaling CDRs (all CDR Report Types).</li> <li>■ The default field title is "Caller" in the Web SBC CDR History table.</li> <li>■ The maximum number of characters for Syslog tabular alignment is 20.</li> </ul>
Source Username [808]	<p>Displays the source username (after manipulation, if any).</p> <p><b>Note:</b></p> <ul style="list-style-type: none"> <li>■ The field is optional. You can include it in the CDR by CDR customization using the SBC CDR Format tables.</li> <li>■ The field is applicable only to SBC signaling CDRs (all CDR Report Types).</li> <li>■ The maximum number of characters for Syslog tabular alignment is 20.</li> </ul>
SRD ID	Displays the SRD table row index.

Field	Description
[418]	<p><b>Note:</b></p> <ul style="list-style-type: none"> <li>■ The field is optional. You can include it in the CDR by CDR customization using the Gateway CDR Format and SBC CDR Format tables.</li> <li>■ The field is applicable only to SBC signaling and Gateway CDRs (all CDR Report Types).</li> <li>■ The maximum number of characters for Syslog tabular alignment is 5.</li> </ul>
SRD Name [419]	<p>Displays the SRD name. The field value is a string of up to 40 characters.</p> <p><b>Note:</b></p> <ul style="list-style-type: none"> <li>■ The field is optional. You can include it in the CDR by CDR customization using the Gateway CDR Format and SBC CDR Format tables.</li> <li>■ The field is applicable only to SBC signaling and Gateway CDRs (all CDR Report Types).</li> <li>■ The default field title is "SrdId (name)".</li> <li>■ The maximum number of characters for Syslog tabular alignment is 32.</li> </ul>
Call Success [447]	<p>Displays whether the call succeeded ("yes") or failed ("no").</p> <p><b>Note:</b></p> <ul style="list-style-type: none"> <li>■ The field is optional. You can include it in the CDR by CDR customization using the SBC CDR Format and Gateway CDR Format tables.</li> <li>■ The field is applicable only to SBC signaling and Gateway CDRs ("CALL_END" CDR Report Types).</li> </ul>
Termination Reason Category [423]	<p>Displays the category of the call termination reason. The field value is up to 17 characters and is set to one of the following:</p> <p><b>Calls with duration 0 (i.e., not connected):</b></p> <ul style="list-style-type: none"> <li>■ "NO_ANSWER": <ul style="list-style-type: none"> <li>✓ "GWAPP_NORMAL_CALL_CLEAR"</li> <li>✓ "GWAPP_NO_USER_RESPONDING"</li> <li>✓ "GWAPP_NO_ANSWER_FROM_USER_ALERTED"</li> </ul> </li> <li>■ "BUSY": <ul style="list-style-type: none"> <li>✓ "GWAPP_USER_BUSY"</li> </ul> </li> </ul>

Field	Description
	<ul style="list-style-type: none"> <li>■ "NO_RESOURCES":               <ul style="list-style-type: none"> <li>✓ "GWAPP_RESOUUCE_UNAVAILABLE_UNSPECIFIED"</li> <li>✓ "RELEASE_BECAUSE_NO_CONFERENCE_RESOURCES_LEFT"</li> <li>✓ "RESOURCE_BECAUSE_NO_TRANSCODING_RESOURCES_LEFT"</li> <li>✓ "RELEASE_BECAUSE_GW_LOCKED"</li> </ul> </li> <li>■ "NO_MATCH":               <ul style="list-style-type: none"> <li>✓ "RELEASE_BECAUSE_UNMATCHED_CAPABILITIES"</li> </ul> </li> <li>■ "FORWARDED":               <ul style="list-style-type: none"> <li>✓ "RELEASE_BECAUSE_FORWARD"</li> </ul> </li> <li>■ "GENERAL_FAILED": Any other reason</li> </ul> <p><b>Calls with duration:</b></p> <ul style="list-style-type: none"> <li>■ "NORMAL_CALL_CLEAR":               <ul style="list-style-type: none"> <li>✓ "GWAPP_NORMAL_CALL_CLEAR"</li> </ul> </li> <li>■ "ABNORMALLY_TERMINATED": Anything else</li> </ul> <p><b>Note:</b></p> <ul style="list-style-type: none"> <li>■ By default, the field is included in the CDR.</li> <li>■ The field is applicable only to SBC signaling and Gateway CDRs ("CALL_END" CDR Report Types).</li> <li>■ The default field title is "TrmReasonCategory" for Syslog and Local Storage, and "Termination Reason" for Web CDR History.</li> <li>■ The maximum number of characters for Syslog tabular alignment is 17.</li> </ul>
Termination Reason Value [437]	<p>Displays the Q.850 reason codes (1-127) for call termination. For example, "16" for Normal Termination.</p> <p><b>Note:</b></p> <ul style="list-style-type: none"> <li>■ By default, the field is included in the CDR for RADIUS CDRs.</li> <li>■ The field is applicable only to SBC signaling and Gateway CDRs ("CALL_END" CDR Report Types).</li> <li>■ The default field title is "h323-disconnect-cause=" (e.g., "h323-disconnect-cause=16").</li> <li>■ The maximum number of characters for Syslog tabular alignment is 5.</li> </ul>

Field	Description
Termination Reason [410]	<p>Displays the reason for the call termination. The field value is a string of up to 40 characters and is set to one of the following:</p> <ul style="list-style-type: none"> <li>■ Standard Call Termination Reasons: <ul style="list-style-type: none"> <li>✓ "GWAPP_REASON_NOT_RELEVANT" (0)</li> <li>✓ "GWAPP_ALL_RELEASE_REASONS" (0)</li> <li>✓ "GWAPP_UNASSIGNED_NUMBER" (1)</li> <li>✓ "GWAPP_NO_ROUTE_TO_TRANSIT_NET" (3)</li> <li>✓ "GWAPP_NO_ROUTE_TO_DESTINATION" (3)</li> <li>✓ "GWAPP_SEND_SPECIAL_INFORMATION_TONE" (4)</li> <li>✓ "GWAPP_MISDIALED_TRUNK_PREFIX" (5)</li> <li>✓ "GWAPP_CHANNEL_UNACCEPTABLE" (6)</li> <li>✓ "GWAPP_CALL_AWARDED_AND" (7)</li> <li>✓ "GWAPP_PREEMPTION" (8)</li> <li>✓ "GWAPP_PREEMPTION_CIRCUIT_RESERVED_FOR_REUSE" (9)</li> <li>✓ "GWAPP_NORMAL_CALL_CLEAR" (16)</li> <li>✓ "GWAPP_USER_BUSY" (17)</li> <li>✓ "GWAPP_NO_USER_RESPONDING" (18)</li> <li>✓ "GWAPP_NO_ANSWER_FROM_USER_ALERTED" (19)</li> <li>✓ "MFCR2_ACCEPT_CALL" (20)</li> <li>✓ "GWAPP_CALL_REJECTED" (21)</li> <li>✓ "GWAPP_NUMBER_CHANGED" (22)</li> <li>✓ "GWAPP_REDIRECTION" (23)</li> <li>✓ "GWAPP_EXCHANGE_ROUTING_ERROR" (25)</li> <li>✓ "GWAPP_NON_SELECTED_USER_CLEARING" (26)</li> <li>✓ "GWAPP_INVALID_NUMBER_FORMAT" (28)</li> <li>✓ "GWAPP_FACILITY_REJECT" (29)</li> <li>✓ "GWAPP_RESPONSE_TO_STATUS_ENQUIRY" (30)</li> <li>✓ "GWAPP_NORMAL_UNSPECIFIED" (31)</li> <li>✓ "GWAPP_CIRCUIT_CONGESTION" (32)</li> <li>✓ "GWAPP_USER_CONGESTION" (33)</li> </ul> </li> </ul>

Field	Description
	✓ "GWAPP_NO_CIRCUIT_AVAILABLE" (34)
	✓ "GWAPP_NETWORK_OUT_OF_ORDER" (38)
	✓ "GWAPP_PERM_FR_MODE_CONN_OUT_OF_S" (39)
	✓ "GWAPP_PERM_FR_MODE_CONN_OPERATIONAL" (40)
	✓ "GWAPP_NETWORK_TEMPORARY_FAILURE" (41)
	✓ "GWAPP_NETWORK_CONGESTION" (42)
	✓ "GWAPP_ACCESS_INFORMATION_DISCARDED" (43)
	✓ "GWAPP_REQUESTED_CIRCUIT_NOT_AVAILABLE" (44)
	✓ "GWAPP_PRECEDENCE_CALL_BLOCKED" (46)
	✓ "GWAPP_RESOURCE_UNAVAILABLE_UNSPECIFIED" (47)
	✓ "GWAPP_QUALITY_OF_SERVICE_UNAVAILABLE" (49)
	✓ "GWAPP_REQUESTED_FAC_NOT_SUBSCRIBED" (50)
	✓ "GWAPP_BC_NOT_AUTHORIZED" (57)
	✓ "GWAPP_BC_NOT_PRESENTLY_AVAILABLE" (58)
	✓ "GWAPP_SERVICE_NOT_AVAILABLE" (63)
	✓ "GWAPP_CUG_OUT_CALLS_BARRED" (53)
	✓ "GWAPP_CUG_INC_CALLS_BARRED" (55)
	✓ "GWAPP_ACCES_INFO_SUBS_CLASS_INCONS" (62)
	✓ "GWAPP_BC_NOT_IMPLEMENTED" (65)
	✓ "GWAPP_CHANNEL_TYPE_NOT_IMPLEMENTED" (66)
	✓ "GWAPP_REQUESTED_FAC_NOT_IMPLEMENTED" (69)
	✓ "GWAPP_ONLY_RESTRICTED_INFO_BEARER" (70)
	✓ "GWAPP_SERVICE_NOT_IMPLEMENTED_UNSPECIFIED" (79)
	✓ "GWAPP_INVALID_CALL_REF" (81)
	✓ "GWAPP_IDENTIFIED_CHANNEL_NOT_EXIST" (82)
	✓ "GWAPP_SUSPENDED_CALL_BUT_CALL_ID_NOT_EXIST" (83)
	✓ "GWAPP_CALL_ID_IN_USE" (84)
	✓ "GWAPP_NO_CALL_SUSPENDED" (85)
	✓ "GWAPP_CALL_HAVING_CALL_ID_CLEARED" (86)
	✓ "GWAPP_INCOMPATIBLE_DESTINATION" (88)



Field	Description
	✓ "GWAPP_INVALID_TRANSIT_NETWORK_SELECTION" (91)
	✓ "GWAPP_INVALID_MESSAGE_UNSPECIFIED" (95)
	✓ "GWAPP_NOT_CUG_MEMBER" (87)
	✓ "GWAPP_CUG_NON_EXISTENT" (90)
	✓ "GWAPP_MANDATORY_IE_MISSING" (96)
	✓ "GWAPP_MESSAGE_TYPE_NON_EXISTENT" (97)
	✓ "GWAPP_MESSAGE_STATE_INCONSISTENCY" (98)
	✓ "GWAPP_NON_EXISTENT_IE" (99)
	✓ "GWAPP_INVALID_IE_CONTENT" (100)
	✓ "GWAPP_MESSAGE_NOT_COMPATIBLE" (101)
	✓ "GWAPP_RECOVERY_ON_TIMER_EXPIRY" (102)
	✓ "GWAPP_PARAMETER_NON_EXISTENT" (103)
	✓ "GWAPP_MESSAGE_WITH_UNRECOGNIZED_PARAM" (110)
	✓ "GWAPP_PROTOCOL_ERROR_UNSPECIFIED" (111)
	✓ "GWAPP_UNKNOWN_ERROR" (112)
	✓ "GWAPP_INTERWORKING_UNSPECIFIED" (127)
	■ AudioCodes Proprietary:
	✓ "RELEASE_BECAUSE_UNKNOWN_REASON" (304)
	✓ "RELEASE_BECAUSE_TRUNK_DISCONNECTED" (305)
	✓ "RELEASE_BECAUSE_REMOTE_CANCEL_CALL" (306)
	✓ "RELEASE_BECAUSE_UNMATCHED_CAPABILITIES" (307)
	✓ "RELEASE_BECAUSE_UNMATCHED_CREDENTIALS" (308)
	✓ "RELEASE_BECAUSE_UNABLE_TO_HANDLE_REMOTE_REQUEST" (309)
	✓ "RELEASE_BECAUSE_NO_CONFERENCE_RESOURCES_LEFT" (310)
	✓ "RELEASE_BECAUSE_CONFERENCE_FULL" (311)
	✓ "RELEASE_BECAUSE_MANUAL_DISC" (315)
	✓ "RELEASE_BECAUSE_SILENCE_DISC" (316)
	✓ "RELEASE_BECAUSE_NORTEL_XFER_SUCCESS" (317)
	✓ "RELEASE_BECAUSE_RTP_CONN_BROKEN" (318)

Field	Description
	✓ "RELEASE_BECAUSE_DISCONNECT_CODE" (319)
	✓ "RELEASE_BECAUSE_GW_LOCKED" (320)
	✓ "RELEASE_BECAUSE_FAIL" (321)
	✓ "RELEASE_BECAUSE_FORWARD" (322)
	✓ "RELEASE_BECAUSE_ANONYMOUS_SOURCE" (323)
	✓ "PREEMPTION_ANALOG_CIRCUIT_RESERVED_FOR_REUSE" (324)
	✓ "RELEASE_BECAUSE_PRECEDENCE_CALL_BLOCKED" (325)
	✓ "RELEASE_BECAUSE_HELD_TIMEOUT" (326)
	✓ "RELEASE_BECAUSE_MEDIA_MISMATCH" (327)
	✓ "RELEASE_BECAUSE_MAX_DURATION_TIMER_EXPIRED" (328)
	✓ "RELEASE_BECAUSE_TRANSCODING_FULL" (329)
	✓ "RELEASE_BECAUSE_NO_TRANSCODING_RESOURCES_LEFT" (330)
	✓ "RELEASE_POSTPONE_POSSIBLE" (331)
	✓ "RELEASE_BECAUSE_PREEMPTION_DUE_TO_HIGH_PRIORITY" (332)
	✓ "RELEASE_BECAUSE_PREEMPTION_FAILED" (333)
	✓ "RELEASE_BECAUSE_IP_PROFILE_CALL_LIMIT" (805)
	✓ "RELEASE_BECAUSE_OUT_MEDIA_LIMITS_EXCEEDED" (806)
	✓ "RELEASE_BECAUSE_CALL_TRANSFERRED" (807)
	✓ "RELEASE_BECAUSE_CLASSIFICATION_FAILED" (808)
	✓ "RELEASE_BECAUSE_AUTHENTICATION_FAILED" (809)
	✓ "RELEASE_BECAUSE_ARM_DROP" (811)
	✓ "RELEASE_BECAUSE_MEDIA_DEST_UNREACHABLE" (812)
	✓ "RELEASE_BECAUSE_START_ARM_ROUTING" (813)
	✓ "RELEASE_BECAUSE_FORWARD_SUPPLEMENTARY" (814)
	✓ "RELEASE_BECAUSE_FAX_REROUTING" (815)
	✓ "RELEASE_BECAUSE_LDAP_FAILURE" (816)
	✓ "RELEASE_BECAUSE_CALLSETUPRULES_FAILURE" (817)
	✓ "RELEASE_BECAUSE_NO_USER_FOUND" (818)
	✓ "RELEASE_BECAUSE_IN_ADMISSION_FAILED" (819)

Field	Description
	<ul style="list-style-type: none"> <li>✓ "RELEASE_BECAUSE_OUT_ADMISSION_FAILED" (820)</li> <li>✓ "RELEASE_BECAUSE_IN_MEDIA_LIMITS_EXCEEDED" (821)</li> <li>✓ "RELEASE_BECAUSE_USER_BLOCKED" (822)</li> <li>✓ "RELEASE_BECAUSE_BAD_INFO_PACKAGE" (823)</li> <li>✓ "RELEASE_BECAUSE_SRC_IP_IS_NOT_DEDICATED_REGISTRAR" (824)</li> <li>✓ "RELEASE_BECAUSE_ACD_THRESHOLD_CROSSED" (850)</li> <li>✓ "RELEASE_BECAUSE_ASR_THRESHOLD_CROSSED" (851)</li> <li>✓ "RELEASE_BECAUSE_NER_THRESHOLD_CROSSED" (852)</li> <li>✓ "RELEASE_BECAUSE_IPGROUP_REGISTRATION_MODE" (853)</li> <li>✓ "RELEASE_BECAUSE_FEATUREKEY_CHANGED" (854)</li> <li>✓ "RELEASE_BECAUSE_INTERNAL_ROUTE" (855)</li> <li>✓ "RELEASE_BECAUSE_CID_CMD_FAILURE" (856)</li> <li>✓ "RELEASE_BECAUSE_OTHER_FORKED_CALL_ANSWERED" (857)</li> <li>✓ "RELEASE_BECAUSE_MEDIA_SYNC_FAILED" (858)</li> <li>✓ "RELEASE_BECAUSE_REG_MAX_THRESHOLD_CROSSED" (859)</li> <li>✓ "RELEASE_BECAUSE_PUSH_NOTIFICATION_FAILED" (860)</li> </ul> <p><b>Note:</b></p> <ul style="list-style-type: none"> <li>■ By default, the field is included in the CDR.</li> <li>■ The field is applicable only to SBC signaling and Gateway CDRs ("CALL_END" CDR Report Types).</li> <li>■ The default field title is "TrmReason".</li> <li>■ The maximum number of characters for Syslog tabular alignment is 40.</li> </ul>
Termination Side RADIUS [435]	<p>Displays the party that terminated the call. The field value is a string:</p> <ul style="list-style-type: none"> <li>■ "originate": SBC incoming leg or IP side for Gateway calls</li> <li>■ "answer": SBC outgoing leg or Tel side for Gateway calls</li> </ul> <p><b>Note:</b></p> <ul style="list-style-type: none"> <li>■ By default, the field is included in the CDR.</li> <li>■ The field is mainly relevant to RADIUS CDRs, but can also be used in Syslog and Local Storage.</li> </ul>

Field	Description
	<ul style="list-style-type: none"> <li>■ The default field title is "terminator=".</li> <li>■ The maximum number of characters for Syslog tabular alignment is 10.</li> </ul>
Termination Side Yes No [436]	<p>Displays the party that terminated the call. The field value is a string:</p> <ul style="list-style-type: none"> <li>■ "yes": SBC outgoing leg or Tel side for Gateway calls</li> <li>■ "no": SBC incoming leg or IP side for Gateway calls</li> </ul> <p>The field is applicable to RADIUS CDRs</p> <p><b>Note:</b></p> <ul style="list-style-type: none"> <li>■ By default, the field is included in the CDR.</li> <li>■ The field is mainly relevant to RADIUS CDRs, but can also be used in Syslog and Local Storage.</li> <li>■ The default field title is "terminator=" (e.g., "terminator=yes").</li> <li>■ The maximum number of characters for Syslog tabular alignment is 5.</li> </ul>
Termination Side [409]	<p>Displays the party that terminated the call. The field value is a string:</p> <ul style="list-style-type: none"> <li>■ "LCL": SBC Outgoing leg or Tel side.</li> <li>■ "RMT": SBC Incoming leg or IP side.</li> <li>■ "UNKN": Unknown</li> </ul> <p>For example, if the Orig field is "RMT" and this Termination Side field is "LCL", then the called party ended the call.</p> <p><b>Note:</b></p> <ul style="list-style-type: none"> <li>■ By default, the field is included in the CDR.</li> <li>■ The field is applicable only to SBC signaling and Gateway CDRs ("CALL_END" CDR Report Types).</li> <li>■ The default field title is "TrmSd".</li> <li>■ The maximum number of characters for Syslog tabular alignment is 5.</li> </ul>
Transport Type [421]	<p>Displays the SIP signaling transport type protocol. The field value is a string:</p> <ul style="list-style-type: none"> <li>■ "UDP"</li> <li>■ "TCP"</li> <li>■ "TLS"</li> </ul> <p><b>Note:</b></p>

Field	Description
	<ul style="list-style-type: none"> <li>■ By default, the field is included in the CDR.</li> <li>■ The field is applicable only to SBC signaling and Gateway CDRs (all CDR Report Types).</li> <li>■ The default field title is "SigTransportType" for Gateway Syslog and Local Storage, and "TransportType" for SBC Syslog and Local Storage.</li> <li>■ The maximum number of characters for Syslog tabular alignment is 16.</li> </ul>
Trigger [439]	<p>Displays the reason for the call (i.e., what triggered it):</p> <ul style="list-style-type: none"> <li>■ "Normal": regular call</li> <li>■ "Refer": call transfer</li> <li>■ "AltRoute": alternative routing</li> <li>■ "Forward": call forward</li> <li>■ "Reroute": When a broken connection on the outgoing leg occurs, the call is rerouted to another destination according to the IP-to-IP Routing table (where matching characteristics includes the trigger for reroute).</li> </ul> <p><b>Note:</b></p> <ul style="list-style-type: none"> <li>■ By default, the field is included in the CDR.</li> <li>■ The field is applicable only to SBC signaling and Gateway CDRs (all CDR Report Types).</li> <li>■ The default field title is "Trigger".</li> <li>■ The maximum number of characters for Syslog tabular alignment is 8.</li> </ul>
Trunk Group ID [503]	<p>Displays the Trunk Group ID (integer).</p> <p><b>Note:</b></p> <ul style="list-style-type: none"> <li>■ By default, the field is included in the CDR.</li> <li>■ The field is applicable only to Gateway CDRs (all CDR Report Types).</li> <li>■ The default field title is "TG".</li> <li>■ The maximum number of characters for Syslog tabular alignment is 5.</li> </ul>
Trunk ID [500]	<p>Displays the physical trunk number (integer).</p> <p><b>Note:</b></p> <ul style="list-style-type: none"> <li>■ By default, the field is included in the CDR.</li> <li>■ The field is applicable only to Gateway CDRs (all CDR Report Types).</li> </ul>

Field	Description
	<ul style="list-style-type: none"> <li>■ The default field title is "Trunk".</li> <li>■ The maximum number of characters for Syslog tabular alignment is 5.</li> </ul>
Var Call User Defined 1-5 [448-452]	<p>Displays the SIP header data obtained from call variables (Var.Call.Src/Dst.UserDefined1-5) in Message Manipulation rules.</p> <p><b>Note:</b></p> <ul style="list-style-type: none"> <li>■ The field is optional. You can include it in the CDR by CDR customization using the SBC CDR Format table.</li> <li>■ The field is applicable only to SBC signaling (all CDR Report Types).</li> <li>■ The field is applicable only to Syslog, RADIUS, Local Storage, and JSON.</li> <li>■ For each variable-based field, the maximum number of characters for Syslog tabular alignment is 20.</li> <li>■ The maximum characters for all five variable-based CDR fields together is 200. For example, if the summation of Var Call User Defined 1 and Var Call User Defined 2 is 200 characters, no characters are displayed for the other variables.</li> </ul>
Was Call Started [415]	<p>Displays if the call was started or not (i.e., if a "CALL_START" CDR Report was generated).</p> <ul style="list-style-type: none"> <li>■ "0": No INVITE was sent to the IP side for the Tel-to-IP call, or no Setup message was sent to the Tel side for the IP-to-Tel call. Note that the first "CALL_START" CDR report type of a new signaling leg has value "0".</li> <li>■ "1": The call was started – an INVITE was sent to the IP side for the Tel-to-IP call, or a Setup message was sent to the Tel side for the IP-to-Tel call.</li> </ul> <p><b>Note:</b></p> <ul style="list-style-type: none"> <li>■ The field is optional. You can include it in the CDR by CDR customization using the Gateway CDR Format and SBC CDR Format table.</li> <li>■ The field is applicable only to SBC signaling and Gateway CDRs ("CALL_END" CDR Report Types).</li> <li>■ The field is applicable only to Syslog, RADIUS, and Local Storage.</li> <li>■ The maximum number of characters for Syslog tabular alignment is 5.</li> </ul>
Coder	<p>Displays whether there was coder transcoding for the SBC call. The field is</p>

Field	Description
Transcoding [635]	<p>a string:</p> <ul style="list-style-type: none"> <li>■ "TRANSCODING"</li> <li>■ "NO_TRANSCODING"</li> </ul> <p><b>Note:</b></p> <ul style="list-style-type: none"> <li>■ The field is optional. You can include it in the CDR by CDR customization using the SBC CDR Format table.</li> <li>■ The field is applicable only to SBC media CDRs ("MEDIA_END" CDR Report Types).</li> <li>■ The field is applicable only to Syslog and RADIUS.</li> <li>■ The maximum number of characters for Syslog tabular alignment is 17.</li> </ul>
Voice AI Connector ID [820]	<p>Displays the ID of the Voice.AI Gateway when the device is used as a Voice.AI Gateway.</p> <p><b>Note:</b></p> <ul style="list-style-type: none"> <li>■ The field is optional. You can include it in the CDR by CDR customization using the SBC CDR Format table.</li> <li>■ The field is applicable only to SBC signaling (all CDR Report Types).</li> <li>■ The default field title is "VoiceAIConnectorName".</li> <li>■ For more information on the Voice.AI Gateway, refer to the relevant documents on AudioCodes <a href="#">website</a>.</li> </ul>
Voice AI Connector Name [821]	<p>Displays the name of the Voice.AI Gateway when the device is used as a Voice.AI Gateway.</p> <p><b>Note:</b></p> <ul style="list-style-type: none"> <li>■ By default, the field is included in the CDR.</li> <li>■ The field is applicable only to SBC signaling (all CDR Report Types).</li> <li>■ The default field title is "VoiceAIConnectorName".</li> <li>■ For more information on the Voice.AI Gateway, refer to the relevant documents on AudioCodes <a href="#">website</a>.</li> </ul>

## Customizing CDRs for Gateway Calls

The Gateway CDR Format table lets you configure CDR customization rules for Gateway-related CDRs that are generated by the device for the following:

- CDRs (media and SIP signaling) sent in Syslog messages. For CDRs sent in Syslog messages, you can customize the name of CDR fields. You can configure up to 128 Syslog CDR customization rules.
- CDRs related to RADIUS accounting and sent in RADIUS accounting request messages. For RADIUS accounting CDRs, you can customize the RADIUS Attribute's prefix name and ID, for standard RADIUS Attributes and vendor-specific RADIUS Attributes (VSA). For example, instead of the default VSA name, "h323-connect-time" with RADIUS Attribute ID 28, you can change the name to "Call-Connect-Time" with ID 29. You can configure up to 40 RADIUS-accounting CDR customization rules. For more information on RADIUS accounting, see [Configuring RADIUS Accounting](#).
- CDRs stored locally on the device. For local storage of CDRs, you can customize the name of CDR fields. You can configure up to 64 locally-stored CDR customization rules. For more information on local storage of CDRs, see [Storing CDRs on the Device](#).
- CDRs (signaling only) sent to the REST server in JSON format using the device's REST API. You can configure up to 64 JSON CDR customization rules. For more information on CDRs and REST, see [Configuring CDR Reporting to REST Server](#) on page 1219.

Customizing the CDR means the following:

- Defining which CDR fields are included in the CDR. For example, if you configure only one customization rule for the Syslog CDR type with the Call Duration CDR field, the device generates these CDR types with only this single CDR field.
- Changing the default name (`title`) of the CDR field. For example, you can change the title of the Call Duration CDR field to "Call Length".
- (RADIUS Only) Changing the RADIUS Attribute's prefix name and ID, for standard RADIUS Attributes and vendor-specific RADIUS Attributes (VSA).



- If you don't customize the CDR for a specific CDR type, the device generates the CDR in a default format (fields and titles). For a detailed description of the fields that can be included in the CDR (customized and default), see [CDR Field Description](#).
- To return to the default CDR format for a specific CDR type, remove all your customization rules of that CDR type.



- To view Gateway CDRs in the Web interface, see [Viewing Gateway CDR History](#) on page 1199.
- The following standard RADIUS Attributes cannot be customized: 1 through 6, 18 through 20, 22, 23, 27 through 29, 32, 34 through 39, 41, 44, 52, 53, 55, 60 through 85, 88, 90, and 91.
- If the RTCP XR feature is unavailable (not licensed or disabled), the R-factor VoIP metrics are not provided in CDRs (CDR fields, Local R Factor and Remote R Factor) generated by the device. Instead, these CDR fields are sent with the value 127, meaning that information is unavailable.



 • To customize CDRs for Test Calls, use the SBC CDR Format table (see [Customizing CDRs for SBC Calls and Test Calls](#) on page 1279).

The following procedure describes how to customize Gateway CDRs through the Web interface. You can also configure it through ini file [GWCDRFormat] or CLI (`configure troubleshoot > cdr > cdr-format gw-cdr-format`).

➤ **To customize Gateway CDRs:**

1. Open the Gateway CDR Format table (**Troubleshoot** menu > **Troubleshoot** tab > **Call Detail Record** folder > **Gateway CDR Format**).
2. Click **New**; the following dialog box appears:

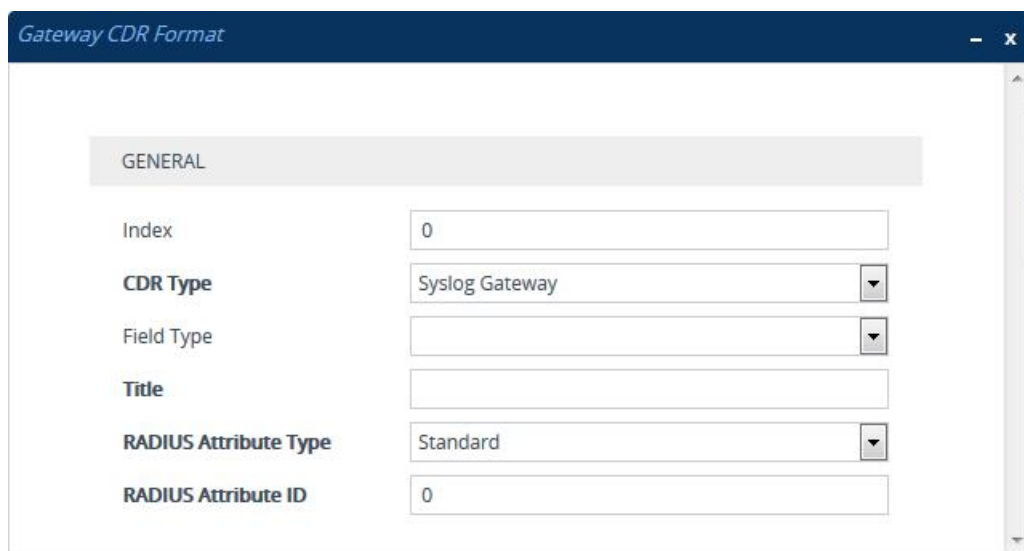

3. Configure CDR format rules according to the parameters described in the table below.
4. Click **Apply**.

An example of CDR customization rules configured in the table is shown below:

INDEX	CDR TYPE	FIELD TYPE	TITLE	RADIUS ATTRIBUTE TYPE	RADIUS ATTRIBUTE ID
0	Syslog Gateway	Call Orig	Caller	Standard	0
1	Syslog Gateway	Destination IP	"Destination IP Address"	Vendor Specific	0
2	Syslog Gateway	Setup Time	setup-time=	Standard	0
3	Local Storage Gateway	Call Duration	call-duration=	Standard	0

- Index 0: The default CDR field "Call Orig" for Syslog is changed to "Caller".
- Index 1: The default CDR field "Destination IP" for Syslog is changed to "Destination IP Address" (enclosed by quotation marks).
- Index 2: The default CDR field "Setup Time" for Syslog is changed to "setup-time=".
- Index 3: The default CDR field "Call Duration" for local CDR storage is changed to "call-duration=".

**Table 57-3: Gateway CDR Format Table Parameter Descriptions**

Parameter	Description
'Index' [GWCDRFormat_Index]	Defines an index number for the new table row. <b>Note:</b> Each row must be configured with a unique index.
'CDR Type' cdr-type [GWCDRFormat_CDRTYPE]	Defines the application type for which you want to customize CDRs. <ul style="list-style-type: none"><li>■ [0] <b>Syslog Gateway</b> = (Default) Customizes CDR field names for CDRs (media and signaling) sent in Syslog messages.</li><li>■ [6] <b>RADIUS Gateway</b> = Customizes CDR field names (RADIUS Attribute prefix names) for CDRs (media and signaling) sent in RADIUS accounting requests.</li><li>■ [9] <b>Local Storage Gateway</b> = Customizes CDR fields (media and signaling) that are stored locally on the device.</li><li>■ [10] <b>JSON Gateway</b> = Customizes CDR field names for CDRs (signaling only) that are sent in JSON format to the REST server using the device's REST API.</li></ul>
'Field Type' col-type [GWCDRFormat_FieldType]	Defines the CDR field (column) that you want to customize. [300] <b>CDR Type</b> (default); [301] <b>Call ID</b> ; [302] <b>Session ID</b> ; [303] <b>Report Type</b> ; [304] <b>Media Type</b> ; [305] <b>Accounting Status Type</b> ; [306] <b>H323 ID</b> ; [307] <b>RADIUS Call ID</b> ; [308] <b>Blank</b> ; [309] <b>Global Session ID</b> ; [310] <b>Leg ID</b> ; [400] <b>Endpoint Type</b> ; [401] <b>Call Orig</b> ; [402] <b>Source IP</b> ; [403] <b>Destination IP</b> ; [404] <b>Remote IP</b> ; [405] <b>Source Port</b> ; [406] <b>Dest Port</b> ; [407] <b>Remote Port</b> ; [408] <b>Call Duration</b> ; [409] <b>Termination Side</b> ; [410] <b>Termination Reason</b> ; [411] <b>Setup Time</b> ; [412] <b>Connect Time</b> ; [413] <b>Release Time</b> ; [414] <b>Redirect Reason</b> ; [415] <b>Was Call Started</b> ; [416] <b>IP Group ID</b> ; [417] <b>IP Group Name</b> ; [418] <b>SRD ID</b> ; [419] <b>SRD Name</b> ; [420] <b>SIP Interface ID</b> ; [421] <b>Transport Type</b> ; [422] <b>Signaling IP DiffServ</b> ; [423] <b>Termination Reason Category</b> ; [424] <b>Proxy Set ID</b> ; [425] <b>IP Profile ID</b> ; [426] <b>IP Profile Name</b> ; [427] <b>Media Realm ID</b> ; [428] <b>Media Realm Name</b> ; [429] <b>SIP Termination Reason</b> ; [430] <b>SIP Termination Description</b> ; [431] <b>Caller Display ID</b> ; [432] <b>Callee Display ID</b> ; [433] <b>SIP Interface Name</b> ; [434] <b>Call Orig RADIUS</b> ; [435] <b>Termination Side RADIUS</b> ; [436] <b>Termination Side Yes No</b> ;

Parameter	Description
	<p>[437] <b>Termination Reason Value</b>; [438] <b>Proxy Set Name</b>; [439] <b>Trigger</b>; [442] <b>Call End Sequence Number</b>; [443] <b>Alerting Time</b>; [445] <b>SIP Local Tag</b>; [446] <b>SIP Remote Tag</b>; [447] <b>Call Success</b>; [500] <b>Trunk ID</b>; [501] <b>B-Channel</b>; [502] <b>Conn ID</b>; [503] <b>Trunk Group ID</b>; [504] <b>Metering Pulses Generated</b>; [505] <b>Fax On Call</b>; [506] <b>Source Number Before Manipulation</b>; [507] <b>Source Number</b>; [508] <b>Source Number Type</b>; [509] <b>Source Number Plan</b>; [510] <b>Destination Number Before Manipulation</b>; [511] <b>Destination Number</b>; [512] <b>Destination Number Type</b>; [513] <b>Destination Number Plan</b>; [514] <b>Redirect Number Before Manipulation</b>; [515] <b>Redirect Number</b>; [526] <b>Redirect Number Type</b>; [527] <b>Redirect Number Plan</b>; [516] <b>Source Host Name Before Manipulation</b>; [517] <b>Source Host Name</b>; [518] <b>Destination Host Name Before Manipulation</b>; [519] <b>Destination Host Name</b>; [520] <b>PSTN Termination Reason</b>; [521] <b>Module And Port</b>; [522] <b>AOC Currency</b>; [523] <b>AOC Amount</b>; [524] <b>AOC Multiplier</b>; [525] <b>ISDN Line Type</b>; [600] <b>Channel ID</b>; [601] <b>Coder Type</b>; [602] <b>Packet Interval</b>; [603] <b>Payload Type</b>; [604] <b>Local Input Packets</b>; [605] <b>Local Output Packets</b>; [606] <b>Local Input Octets</b>; [607] <b>Local Output Octets</b>; [608] <b>Local Packet Loss</b>; [609] <b>Local Round Trip Delay</b>; [610] <b>Local Jitter</b>; [611] <b>Local SSRC Sender</b>; [612] <b>Remote Input Packets</b>; [613] <b>Remote Output Packets</b>; [614] <b>Remote Input Octets</b>; [615] <b>Remote Output Octets</b>; [616] <b>Remote Packet Loss</b>; [617] <b>Remote Round Trip Delay</b>; [618] <b>Remote Jitter</b>; [619] <b>Remote SSRC Sender</b>; [620] <b>Local RTP IP</b>; [621] <b>Local RTP Port</b>; [622] <b>Remote RTP IP</b>; [623] <b>Remote RTP Port</b>; [624] <b>RTP IP DiffServ</b>; [625] <b>Local R Factor</b>; [626] <b>Remote R Factor</b>; [627] <b>Local MOS CQ</b>; [628] <b>Remote MOS CQ</b>; [629] <b>AMD Decision</b>; [630] <b>AMD Decision Probability</b>; [631] <b>Latched RTP IP</b>; [632] <b>Latched RTP Port</b>; [633] <b>Latched T38 IP</b>; [634] <b>Latched T38 Port</b>.</p>
<p>'Title' title [GWCDRFormat_Title]</p>	<p>Defines a new name for the CDR field (for Syslog) or for the RADIUS Attribute prefix name (for RADIUS accounting) that you selected in the 'Column Type' parameter.</p> <p>The valid value is a string of up to 31 characters.</p> <p>You can configure the name to be enclosed by quotation marks (single or double). For example, if you want the CDR field name to appear as 'Phone Duration', you must configure the parameter to 'Phone Duration'. You can also</p>

Parameter	Description
	<p>configure the CDR field name with an equals (=) sign, for example "call-connect-time=".</p> <p><b>Note:</b></p> <ul style="list-style-type: none"> <li>■ For RADIUS Attributes that do not require a prefix name, leave the parameter undefined.</li> <li>■ The parameter's value is case-sensitive. For example, if you want the CDR field name to be Phone-Duration, you must configure the parameter to "Phone-Duration" (i.e., uppercase "P" and "D").</li> </ul>
<p>'RADIUS Attribute Type' radius-type [GWCDRFormat_ RadiusType]</p>	<p>Defines whether the RADIUS Attribute of the CDR field is a standard or vendor-specific attribute.</p> <ul style="list-style-type: none"> <li>■ [0] <b>Standard</b> = (Default) For standard RADIUS Attributes.</li> <li>■ [1] <b>Vendor Specific</b> = For vendor-specific RADIUS Attributes (VSA).</li> </ul> <p><b>Note:</b> The parameter is applicable only for RADIUS accounting (i.e., 'CDR Type' parameter configured to <b>RADIUS Gateway</b>).</p>
<p>'RADIUS Attribute ID' radius-id [GWCDRFormat_RadiusID]</p>	<p>Defines an ID for the RADIUS Attribute. For vendor-specific Attributes, this represents the VSA ID; for standard attributes, this represents the Attribute ID (first byte of the Attribute).</p> <p>The valid value is 0 to 255 (one byte). The default is 0.</p> <p><b>Note:</b></p> <ul style="list-style-type: none"> <li>■ The parameter is applicable only for RADIUS accounting (i.e., 'CDR Type' parameter configured to <b>RADIUS Gateway</b>).</li> <li>■ For VSA's (i.e., 'RADIUS Attribute Type' parameter configured to <b>Vendor Specific</b>), the parameter must be configured to any value other than 0.</li> <li>■ For standard RADIUS Attributes (i.e., 'RADIUS Attribute Type' parameter configured to <b>Standard</b>), the value <b>must</b> be a "known" RADIUS ID (per RFC for RADIUS). However, if you configure the ID to 0 (default) for any of the RADIUS Attributes (configured in the 'Column Type' parameter) listed below and then apply your rule (Click <b>Apply</b>), the device automatically replaces the value</li> </ul>

Parameter	Description
	<p>with the RADIUS Attribute's ID according to the RFC:</p> <ul style="list-style-type: none"> <li>✓ <b>Destination Number:</b> 30</li> <li>✓ <b>Source Number:</b> 31</li> <li>✓ <b>Accounting Status Type:</b> 40</li> <li>✓ <b>Local Input Octets:</b> 42</li> <li>✓ <b>Local Output Octets:</b> 43</li> <li>✓ <b>Call Duration:</b> 46</li> <li>✓ <b>Local Input Packets:</b> 47</li> <li>✓ <b>Local Output Packets:</b> 48</li> </ul> <p>If you configure the value to 0 and the RADIUS Attribute is not any of the ones listed above, the configuration is invalid.</p>

## Customizing CDRs for SBC Calls and Test Calls

The SBC CDR Format table lets you customize CDRs for SBC calls and CDRs for Test Calls that are generated by the device for the following CDR types:

- CDRs for SIP signaling or media sent in Syslog messages. For CDRs sent in Syslog messages, you can customize the name of the CDR field. You can configure up to 128 Syslog CDR customization rules.
- CDRs for RADIUS accounting and sent in RADIUS accounting request messages. For RADIUS accounting CDRs, you can customize the RADIUS Attribute's prefix name and RADIUS Attribute's ID, for standard RADIUS Attributes and vendor-specific RADIUS Attributes (VSA). For example, instead of the default VSA name "h323-connect-time" with RADIUS Attribute ID 28, you can change the name to "Call-Connect-Time" with ID 29. You can configure up to 70 RADIUS-Accounting CDR customization rules (i.e., maximum number of RADIUS Attributes that the device can include in the CDR). For more information on RADIUS accounting, see [Configuring RADIUS Accounting](#).
- CDRs stored locally on the device. For local storage of CDRs, you can customize the name of the CDR field. You can configure up to 64 locally-stored CDR customization rules. For more information on storing CDRs on the device, see [Storing CDRs on the Device](#).
- CDRs (signaling only) sent to the REST server in JSON format using the device's REST API. You can configure up to 64 JSON CDR customization rules. For more information on CDRs and REST, see [Configuring CDR Reporting to REST Server](#) on page 1219.

Customizing the CDR means the following:

- Defining which CDR fields are included in the CDR. For example, if you configure only one customization rule for the Syslog signaling (SBC) CDR type with the Call Duration CDR field, the device generates these CDR types with only this single CDR field.

You can also customize the CDR to include a user-defined CDR field based on any SIP header information. This is done by using Message Manipulation rules with the call variables `Var.Call.Src/Dst.<Variable Name>`, where `Variable Name` is `UserDefined1`, `UserDefined2`, `UserDefined3`, `UserDefined4` or `UserDefined5`. The Message Manipulation rule stores the SIP header value in the variable. When you customize the CDR in the SBC CDR Format table, you need to select the same variable (**Var Call User Defined 1-5**) in the 'CDR Field Type' parameter that you used in the Message Manipulation rule. When the device generates the CDR, it retrieves the stored information from the variable and adds it to the CDR under your customized CDR field title. If a variable is not added or modified in the Message Manipulation rule, and the CDR is customized to include its stored value, the CDR displays an empty string for the value. For an example, see [Example of Call Variables for CDR Customization](#) on page 1285.

- Changing the default name (`title`) of the CDR field. For example, you can change the title of the Call Duration CDR field to "Call Length".
- Changing the RADIUS Attribute's prefix name and ID, for standard RADIUS Attributes and vendor-specific RADIUS Attributes (VSA).



- If you don't customize the CDR, the device generates the CDR in a default format (fields and titles). For a detailed description of the fields that can be included in the CDR (customized and default), see [CDR Field Description](#).
- To return to the default CDR format for a specific CDR type, remove all the customization rules of that CDR type.
- When customizing the RADIUS CDR:
  - ✓ The following standard RADIUS Attributes cannot be customized: 1 through 6, 18 through 20, 22, 23, 27 through 29, 32, 34 through 39, 41, 44, 52, 53, 55, 60 through 85, 88, 90, and 91.
  - ✓ You must add the following RADIUS Attribute as the **first** rule in the SBC CDR Format table to ensure uniqueness (and to differentiate) between Call Connect (START) and Call End (STOP) RADIUS packets:

GENERAL	
Index	0
CDR Type	RADIUS SBC
Field Type	Accounting Status Type
Title	
RADIUS Attribute Type	Standard
RADIUS Attribute ID	40

 • If the RTCP XR feature is unavailable (not licensed or disabled), the R-factor VoIP metrics are not provided in CDRs (CDR fields, Local R Factor and Remote R Factor) generated by the device. Instead, these CDR fields are sent with the value 127, meaning that information is unavailable.

• Test Call CDRs include "CALL\_START", "CALL\_CONNECT" and "CALL\_END" CDR Report Types.

• By default, SBC signaling CDRs that are sent at the end of the call ("CALL\_END" CDR Report Type) include only signaling-related CDR fields. However, by using the SBC CDR Format table, you can customize this CDR to also include media-related fields.

• To view historical CDRs stored on the device see [Viewing CDR History of SBC and Test Calls](#) on page 1200.

The following procedure describes how to customize SBC and Test Call CDRs through the Web interface. You can also configure it through ini file [SBCCDRFormat] or CLI (`configure troubleshoot > cdr > cdr-format sbc-cdr-format`).

➤ **To customize SBC and Test Call CDRs:**

1. Open the SBC CDR Format table (**Troubleshoot** menu > **Troubleshoot** tab > **Call Detail Record** folder > **SBC CDR Format**).
2. Click **New**; the following dialog box appears:

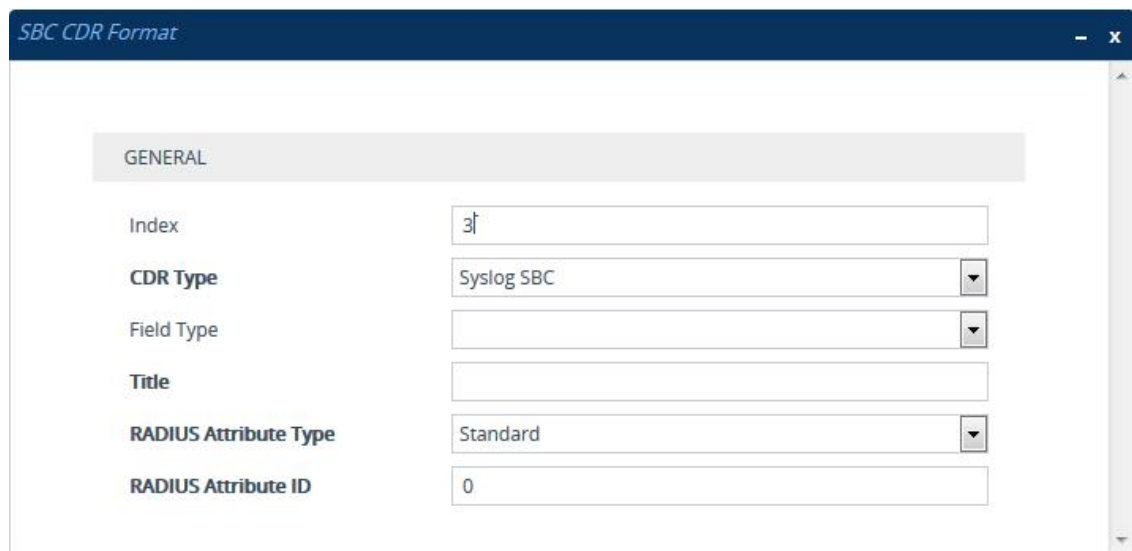

3. Configure the CDR according to the parameters described in the table below.
4. Click **Apply**.

Examples of configured CDR customization rules are shown below:

INDEX	CDR TYPE	FIELD TYPE	TITLE	RADIUS ATTRIBUTE TYPE	RADIUS ATTRIBUTE ID
0	Syslog SBC	Source IP	"Source IP Address"	Standard	0
1	RADIUS SBC	Release Time	disconnect-time=	Vendor Specific	29
2	Local Storage SBC	Call Duration	Length of Call	Standard	0

**Table 57-4: SBC CDR Format Table Parameter Descriptions**

Parameter	Description
'Index' [SBCCDRFormat_ Index]	<p>Defines an index number for the new table row.</p> <p><b>Note:</b> Each row must be configured with a unique index.</p>
'CDR Type' cdr-type [SBCCDRFormat_ CDRType]	<p>Defines the application type for which you want to customize CDRs.</p> <ul style="list-style-type: none"> <li>■ [1] <b>Syslog SBC</b> = (Default) Customizes CDR fields for SIP signaling-related CDRs sent in Syslog messages. However, for SBC signaling "CALL_END" CDR Report Types (sent at the end of the call), you can also customize the CDR to include media-related CDR fields (e.g., Local Packet Loss).</li> <li>■ [3] <b>Syslog Media</b> = Customizes CDR fields for media-related CDRs sent in Syslog messages.</li> <li>■ [5] <b>Local Storage SBC</b> = Customizes CDR fields that are stored locally on the device. Only signaling-related CDRs are stored locally on the device. However, for SBC signaling "CALL_END" CDR Report Types (sent at the end of the call), you can also customize the CDR to include media-related CDR fields (e.g., Local Packet Loss).</li> <li>■ [7] <b>RADIUS SBC</b> = Customizes CDR fields (i.e., RADIUS Attributes) for CDRs sent in RADIUS accounting request messages.</li> <li>■ [11] <b>JSON SBC</b> = Customizes CDR fields for SIP signaling-related CDRs that are sent in JSON format to the REST server using the device's REST API.</li> </ul>
'Field Type' col-type [SBCCDRFormat_ FieldType]	<p>Defines the CDR field (column) that you want to customize. The applicable CDR field depends on the settings of the 'CDR Type' parameter:</p> <ul style="list-style-type: none"> <li>■ For all types: [300] <b>CDR Type</b> (default); [301] <b>Call ID</b>; [302] <b>Session ID</b>; [303] <b>Report Type</b>; [304] <b>Media Type</b>; [305] <b>Accounting Status Type</b>; [306] <b>H323 ID</b>; [307] <b>RADIUS Call ID</b>; [308] <b>Blank</b>; [309] <b>Global Session ID</b>; [310] <b>Leg ID</b></li> <li>■ <b>Syslog SBC</b> (signaling), <b>Local Storage SBC</b>, <b>RADIUS SBC</b>, and <b>JSON SBC</b>: [400] <b>Endpoint Type</b>; [401] <b>Call Orig</b>; [402] <b>Source IP</b>; [403] <b>Destination IP</b>; [404] <b>Remote IP</b>; [405] <b>Source Port</b>; [406] <b>Dest Port</b>; [407] <b>Remote Port</b>; [408] <b>Call Duration</b>; [409] <b>Termination Side</b>; [410] <b>Termination Reason</b>; [411] <b>Setup Time</b>; [412] <b>Connect Time</b>; [413]</li> </ul>



Parameter	Description
	<p><b>Release Time; [414] Redirect Reason; [415] Was Call Started; [416] IP Group ID; [417] IP Group Name; [418] SRD ID; [419] SRD Name; [420] SIP Interface ID; [421] Transport Type; [422] Signaling IP DiffServ; [423] Termination Reason Category; [424] Proxy Set ID; [425] IP Profile ID; [426] IP Profile Name; [427] Media Realm ID; [428] Media Realm Name; [429] SIP Termination Reason; [430] SIP Termination Description; [431] Caller Display ID; [432] Callee Display ID; [433] SIP Interface Name; [434] Call Orig RADIUS; [435] Termination Side RADIUS; [436] Termination Side Yes No; [437] Termination Reason Value; [438] Proxy Set Name; [439] Trigger; [442] Call End Sequence Number; [443] Alerting Time; [445] SIP Local Tag; [446] SIP Remote Tag; [447] Call Success; [448] Var Call User Defined 1; [449] Var Call User Defined 2; [450] Var Call User Defined 3; [451] Var Call User Defined 4; [452] Var Call User Defined 5</b></p> <p>■ <b>Syslog Media, RADIUS SBC, Local Storage SBC, and Syslog SBC:</b></p> <p>[600] Channel ID; [601] Coder Type; [602] Packet Interval; [603] Payload Type; [604] Local Input Packets; [605] Local Output Packets; [606] Local Input Octets; [607] Local Output Octets; [608] Local Packet Loss; [609] Local Round Trip Delay; [610] Local Jitter; [611] Local SSRC Sender; [612] Remote Input Packets; [613] Remote Output Packets; [614] Remote Input Octets; [615] Remote Output Octets; [616] Remote Packet Loss; [617] Remote Round Trip Delay; [618] Remote Jitter; [619] Remote SSRC Sender; [620] Local RTP IP; [621] Local RTP Port; [622] Remote RTP IP; [623] Remote RTP Port; [624] RTP IP DiffServ; [625] Local R Factor; [626] Remote R Factor; [627] Local MOS CQ; [628] Remote MOS CQ; [629] AMD Decision; [630] AMD Decision Probability; [631] Latched RTP IP; [632] Latched RTP Port; [633] Latched T38 IP; [634] Latched T38 Port; [635] Coder Transcoding</p> <p><b>Note:</b> For 'CDR Types' <b>Syslog SBC, Local Storage SBC, and RADIUS SBC</b>, the above media-related CDR fields are added only to "CALL_END" SBC signaling CDR report Types (which by default, include only signaling CDR fields).</p> <p>■ <b>Syslog SBC (signaling), Local Storage SBC, RADIUS SBC, and JSON SBC:</b></p> <p>[800] Source URI; [801] Destination URI; [802] Source URI Before Manipulation; [803] Destination URI Before Manipulation; [804] Redirect URI; [805] Redirect URI Before Manipulation; [806] SIP Method; [807] Direct Media; [808] Source Username; [809] Destination Username; [810] Source Username Before Manipulation;</p>

Parameter	Description
	<p>[811] <b>Destination Username Before Manipulation</b>; [812] <b>Source Host</b>; [813] <b>Destination Host</b>; [814] <b>Source Host Before Manipulation</b>; [815] <b>Destination Host Before Manipulation</b>; [816] <b>Source Dial Plan Tags</b>; [817] <b>Destination Dial Plan Tags</b>; [818] <b>Remote SIP User Agent</b>; [819] <b>Media List</b>; [820] <b>Voice AI Connector ID</b>; [821] <b>Voice AI Connector Name</b></p>
<p>'Title' title [SBCCDRFormat_ Title]</p>	<p>Defines a new name for the CDR field (for Syslog or local storage) or for the RADIUS Attribute prefix name (for RADIUS accounting) that you selected in the 'Column Type' parameter.</p> <p>The valid value is a string of up to 31 characters. You can also configure the name to be enclosed by quotation marks (single or double). For example, if you want the CDR field name to appear as 'Phone Duration', you must configure the parameter to 'Phone Duration'. You can also configure the CDR field name with an equals (=) sign, for example "call-connect-time=".</p> <p><b>Note:</b></p> <ul style="list-style-type: none"> <li>■ For VSA's that do not require a prefix name, leave the parameter undefined.</li> <li>■ The parameter's value is case-sensitive. For example, if you want the CDR field name to be Phone-Duration, you must configure the parameter to "Phone-Duration" (i.e., uppercase "P" and "D").</li> </ul>
<p>'RADIUS Attribute Type' radius-type [SBCCDRFormat_ RadiusType]</p>	<p>Defines whether the RADIUS Attribute of the CDR field is a standard or vendor-specific attribute.</p> <ul style="list-style-type: none"> <li>■ [0] <b>Standard</b> = (Default) For standard RADIUS Attributes.</li> <li>■ [1] <b>Vendor Specific</b> = For vendor-specific RADIUS Attributes (VSA).</li> </ul> <p><b>Note:</b> The parameter is applicable only to RADIUS accounting (i.e., 'CDR Type' parameter configured to <b>RADIUS SBC</b>).</p>
<p>'RADIUS Attribute ID' radius-id [SBCCDRFormat_ RadiusID]</p>	<p>Defines an ID for the RADIUS Attribute. For VSAs, this represents the VSA ID; for standard Attributes, this represents the Attribute ID (first byte of the Attribute).</p> <p>The valid value is 0 to 255 (one byte). The default is 0.</p> <p><b>Note:</b></p> <ul style="list-style-type: none"> <li>■ The parameter is applicable only to RADIUS accounting (i.e., 'CDR Type' parameter configured to <b>RADIUS SBC</b>).</li> <li>■ For VSA's (i.e., 'RADIUS Attribute Type' parameter configured to <b>Vendor Specific</b>), the parameter must be configured to any value other than 0.</li> </ul>

Parameter	Description
	<ul style="list-style-type: none"> <li>■ For standard RADIUS Attributes (i.e., 'RADIUS Attribute Type' parameter configured to <b>Standard</b>), the value <b>must</b> be a "known" RADIUS ID (per RFC for RADIUS). However, if you configure the ID to 0 (default) for any of the RADIUS Attributes (configured in the 'Column Type' parameter) listed below and then apply your rule (Click <b>Apply</b>), the device automatically replaces the value with the RADIUS Attribute's ID according to the RFC: <ul style="list-style-type: none"> <li>✓ <b>Destination Username: 30</b></li> <li>✓ <b>Source Username: 31</b></li> <li>✓ <b>Accounting Status Type: 40</b></li> <li>✓ <b>Local Input Octets: 42</b></li> <li>✓ <b>Local Output Octets: 43</b></li> <li>✓ <b>Call Duration: 46</b></li> <li>✓ <b>Local Input Packets: 47</b></li> <li>✓ <b>Local Output Packets: 48</b></li> </ul> </li> </ul> <p>If you configure the value to 0 and the RADIUS Attribute is not any of the ones listed above, the configuration is invalid.</p>

### Example of Call Variables for CDR Customization

This section provides an example of using a call variable to customize the Syslog SBC (signaling) CDR. The example includes the following:

- Uses the call variable `Var.Call.Src.UserDefined1` in a Message Manipulation rule to store the value of the SIP header "X-AccountNumber" received in a 200 OK response.
- Customizes the SBC CDR format to add a CDR field titled "Account" whose value is obtained from the call variable, `Var.Call.Src.UserDefined1` used in the Message Manipulation rule.

#### ➤ To customize CDR using a call variable:

1. In the Message Manipulations table (see [Configuring SIP Message Manipulation](#) on page 647), configure the following rule:
  - 'Index': **0**
  - 'Name': **Store X-AccountNumber header**
  - 'Manipulation Set ID': **0**
  - 'Message Type': **Invite.Response.2xx**

- 'Action Subject': **Var.Call.Src.UserDefined1**
  - 'Action Type': **Modify**
  - 'Action Value': **Header.X-AccountNumber**
2. In the SBC CDR Format table, configure the following rule:
- 'Index': **0**
  - 'CDR Type': **Syslog SBC**
  - 'Field Type': **Var Call User Defined 1**
  - 'Title': **Account**

The following shows an example of a received SIP 200 OK response message with the X-InContact-BusNo header:

```
SIP/2.0 200 OK
Via: SIP/2.0/UDP 172.28.244.31:5060;branch=z9hG4bKac166782921
Contact: <sip:Stack@10.21.19.151:5060>
To: <sip:+18017155444@abc.com>;tag=87245f3d
From: "usera"<sip:usera@abc.com>;tag=1c1187059515
Call-ID: 628022773122202022133@172.28.244.31
CSeq: 1 INVITE
Session-Expires: 1200;refresher=uas
Content-Type: application/sdp
Supported: timer
X-AccountNumber: 87654321
```

The following shows the generated CDR:

```
|Orig |Account|
|LCL |87654321 |
```

## Customizing CDR Indication for Call Success or Failure based on Responses

The CDR can indicate if a call was successful ("yes") or a failure ("no"), using the 'Call Success' CDR field. This is an optional field that you can include in CDRs, by customizing the CDR format (as described in [Customizing CDRs for Gateway Calls](#) and [Customizing CDRs for SBC Calls](#)).

The device determines if a call is a success or failure based on the release (termination) reason of the call, which can be a SIP response code received from the SIP User Agent or an internal response generated by the device. However, you can change the device's default mapping of call success and failure with these responses. For example, by default, the device considers a call that is released with a SIP 486 (Busy Here) response as a call failure (i.e., 'Call Success' CDR

field displays "no"). Using this feature, you can configure the device to consider SIP 486 (Busy Here) responses as call success.

➤ **To customize CDR indication for call success and failure:**

1. Open the Call Detail Record Settings page (**Troubleshoot** menu > **Troubleshoot** tab > **Call Detail Record** folder > **Call Detail Record Settings**).
2. To customize call success or failure indication for SIP reasons:
  - In the 'Call Success SIP Reasons' [CallSuccessSIPReasons] field, configure the SIP response codes that you want the device to consider as call success.
  - In the 'Call Failure SIP Reasons' [CallFailureSIPReasons] field, configure the SIP response codes that you want the device to consider as call failure.

Call Success SIP Reasons

Call Failure SIP Reasons



If your configuration results in overlapping reasons between the two parameters above, preference is given to the parameter with the specific response code instead of the parameter with the range ("xx"). For example, if 'Call Success SIP Reasons' is configured to "486,5xx" and 'Call Failure SIP Reasons' to "502", a call with SIP response code 502 is considered a call failure, as the 'Call Failure SIP Reasons' parameter is configured with the specific code while the 'Call Success SIP Reasons' is configured with the code range (5xx).

3. To customize call success or failure indication for internal reasons:
  - In the 'Call Success Internal Reasons' [CallSuccessInternalReasons] field, configure the internal response codes that you want the device to consider as call success.
  - In the 'Call Failure Internal Reasons' [CallFailureInternalReasons] field, configure the internal response codes that you want the device to consider as call failure.

Call Success Internal Reasons

Call Failure Internal Reasons



For a list of the internal response codes, see the 'Termination Reason' [410] CDR field in [CDR Field Description](#) on page 1222.

4. To customize call success or failure indication for the internal response "GWAPP\_NO\_USER\_RESPONDING" (18) before or after call connect (SIP 200 OK):
  - From the 'No User Response Before Connect' [NoUser-ResponseBeforeConnectSuccess] drop-down list, select **Call Failure** if you want the device to consider a call as a failure when this response is received before call connect.

- From the 'No User Response After Connect' [NoUserResponseAfterConnectSuccess] drop-down list, select **Call Success** if you want the device to consider a call as a success when this response is received after call connect.

**No User Response Before Connect**  ▾

**No User Response After Connect**  ▾

- To customize call success or failure indication for the internal response 'RELEASE\_BECAUSE\_CALL\_TRANSFERRED' (807) before or after call connect (SIP 200 OK):
  - From the 'Call Transferred before Connect' [CallTransferredBeforeConnectSuccess] drop-down list, select **Call Success** if you want the device to consider the call as a success when this response is received before call connect (SIP 200 OK).
  - From the 'Call Transferred after Connect' [CallTransferredAfterConnectSuccess] drop-down list, select **Call Failure** if you want the device to consider the call as a failure when this response is received after call connect (SIP 200 OK).

**Call Transferred Before Connect**  ▾

**Call Transferred After Connect**  ▾

## Hiding Caller and Callee CDR Field Values

You can enable the device to hide (using an \* asterisk) the values of the Caller and Callee fields in CDRs that are displayed by the following:

- Web interface:
  - SBC CDR History table (see [Viewing CDR History of SBC and Test Calls](#) on page 1200)
  - Gateway CDR History table (see [Viewing Gateway CDR History](#) on page 1199)
- CLI (refer to the *CLI Reference Guide*):
  - `show voip calls history`
  - `show voip calls active`

### ➤ To hide Caller and Callee CDR field values:

- ini file:

```
CDRHistoryPrivacy = 1
```

- CLI:

```
(config-troubleshoot)# cdr
(cdr)# cdr-history-privacy hide-caller-and-callee
```

## Configuring RADIUS Accounting

The device supports RADIUS Accounting (per RFC 2866) and sends accounting data of SIP calls as call detail records (CDR) to a RADIUS Accounting server. CDR-based accounting messages can be sent upon call release, call connection and release, or call setup and release. This section lists the CDR attributes for RADIUS accounting.

The following figure shows the interface between the device and the RADIUS server, based on the RADIUS Accounting protocol. For each CDR that the device sends to the RADIUS server, it sends an Accounting-Request Stop with all the CDR attributes. When the RADIUS server successfully receives all the CDR attributes, it responds with an Accounting-Response Stop ACK message to the device. If the device does not receive the Accounting-Response ACK message, it can resend the Accounting-Request Stop with all CDR attributes again, up to a user-defined number of re-tries (see [Configuring RADIUS Packet Retransmission](#)).

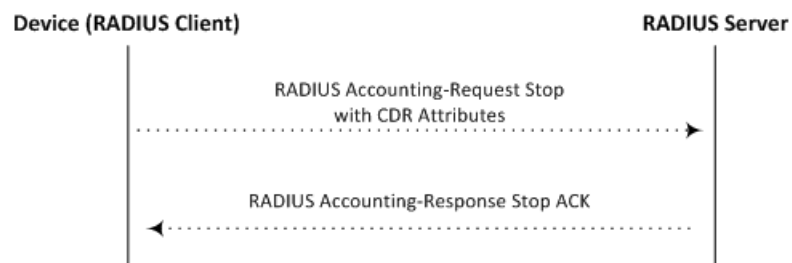

There are two types of data that can be sent to the RADIUS server. The first type is the accounting-related attributes and the second type is the vendor specific attributes (VSA):

- **Standard RADIUS Attributes (per RFC):** A typical standard RADIUS attribute is shown below. The RADIUS attribute ID depends on the attribute.

```

2e 06 00 00 00 03 --- Data
| |
| Length (including header)
RADIUS ID
    
```

The following figure shows a standard RADIUS attribute collected by Wireshark. The bottom pane shows the RADIUS attribute information as sent in the packet; the upper pane is Wireshark's interpretation of the RADIUS information in a more readable format. The example shows the attribute in numeric format (32-bit number in 4 bytes).

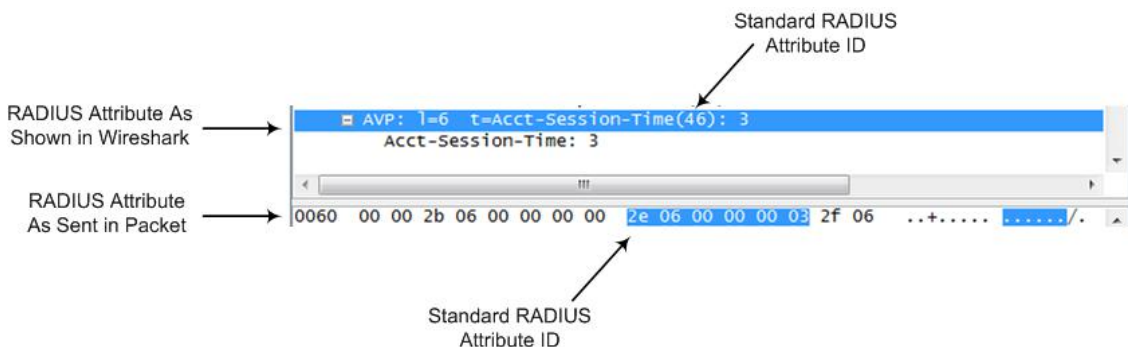

- Vendor-specific RADIUS Attributes:** RADIUS attributes that are specific to the device (company) are referred to as Vendor-specific attributes (VSA). The CDR of VSAs are sent with a general RADIUS ID of 26 to indicate that they are vendor-specific (non-standard). In addition, the company's registered vendor ID (as registered with the Internet Assigned Numbers Authority or IANA) is also included in the packet. The device's default vendor ID is 5003, which can be changed (see [Configuring the RADIUS Vendor ID](#)). The VSA ID is also included in the packet.

```

1a 13 00 00 13 8b 21 0d 68 33 32 33 2d 67 77 2d 69 64 3d --- Data
| | | | | | | | | |
| | Vendor ID | Vendor part length
| | (5003) | Vendor-Specific Attribute (VSA) ID
| | Length (including header)
RADIUS ID indicating vendor-specific (26)
    
```

The following figure shows a vendor-specific RADIUS attribute collected by Wireshark. The bottom pane shows the RADIUS attribute information as sent in the packet; the upper pane is Wireshark's interpretation of the RADIUS information in a more readable format. The example shows the attribute in string-of-characters format.

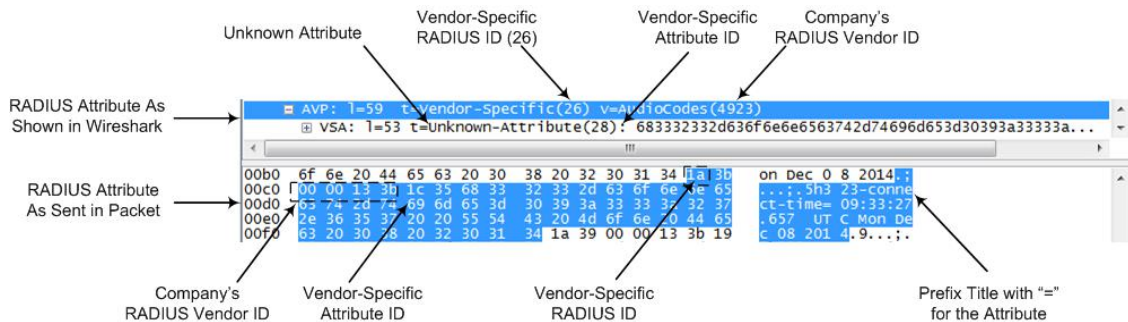



- From the 'AAA Indications' [AAAIndications] drop-down list, select whether you want Authentication, Authorization and Accounting (AAA) indications.

For a detailed description of the parameters, see [RADIUS Parameters](#).

**RADIUS ACCOUNTING SETTING**

**Enable RADIUS Access Control** Disable

**RADIUS Accounting Type** At Call Release

**AAA Indications** None

- Click **Apply**, and then reset the device with a save-to-flash for your settings to take effect.

The table below lists the RADIUS Accounting CDR attributes included in the communication packets transmitted between the device and a RADIUS server.

**Table 57-5: Default RADIUS Accounting CDR Attributes**

Attribute ID	Attribute Name	Vendor-Specific Attribute (VSA) ID	Description	Value Format	Example	AAA
<b>Request Attributes</b>						
1	user-name	(Standard)	Account number or calling party number or blank	String up to 15 digits long	5421385747	Start Acc Stop Acc
4	nas-ip-address	(Standard)	IP address of the requesting device	Numeric	192.168.14.43	Start Acc Stop Acc
6	service-type	(Standard)	Type of service requested	Numeric	1: login	Start Acc Stop Acc
26	h323-	1	SIP call identifier	Up to	h323-incoming-	Sta

Attribute ID	Attribute Name	Vendor-Specific Attribute (VSA) ID	Description	Value Format	Example	AAA
	incoming-conf-id			32 octets	conf-id=38393530	rt Acc Stop Acc
26	h323-remote-address	23	IP address of the remote gateway	Numeric	-	Stop Acc
26	h323-conf-id	24	H.323/SIP call identifier	Up to 32 octets	-	Start Acc Stop Acc
26	h323-setup-time	25	Setup time in NTP format 1	String	h323-setup-time=09:33:26.6 21 Mon Dec 2014	Start Acc Stop Acc
26	h323-call-origin	26	Originator of call: <ul style="list-style-type: none"> <li>■ "answer": Call originated from the IP side (Gateway) or incoming leg (SBC)</li> <li>■ "originate": Call originated from the Tel side (Gateway) or outgoing leg (SBC)</li> </ul>	String	h323-call-origin=answer	Start Acc Stop Acc
26	h323-	27	Protocol type or	String	h323-call-	Sta

Attribute ID	Attribute Name	Vendor-Specific Attribute (VSA) ID	Description	Value Format	Example	AAA
	call-type		family used on this leg of the call. The value is always "VOIP".		type=VOIP	rt Acc Stop Acc
26	h323-connect-time	28	Connect time in NTP format	String	h323-connect-time=09:33:37.657 UTC Mon Dec 08 2015	Stop Acc
26	h323-disconnect-time	29	Disconnect time in NTP format	String	-	Stop Acc
26	h323-disconnect-cause	30	Disconnect cause code (Q.850)	Numeric	h323-disconnect-cause=16	Stop Acc
26	h323-gw-id	33	Name of the gateway	String	h323-gw-id=<SIP ID string>	Start Acc Stop Acc
26	sip-call-id	34	SIP Call ID	String	sip-call-id=abcde@ac.com	Start Acc Stop Acc
26	call-terminator	35	Terminator of the call: <ul style="list-style-type: none"> <li>■ "yes": Call terminated by the Tel side (Gateway) or outgoing leg</li> </ul>	String	call-terminator=yes	Stop Acc

Attribute ID	Attribute Name	Vendor-Specific Attribute (VSA) ID	Description	Value Format	Example	AAA
			(SBC) <ul style="list-style-type: none"> <li>"no": Call terminated by the IP side (Gateway) or incoming leg (SBC)</li> </ul>			
26	terminator	37	Terminator of the call: <ul style="list-style-type: none"> <li>"answer": Call originated from the IP side (Gateway) or incoming leg (SBC)</li> <li>"originate": Call originated from the Tel side (Gateway) or outgoing leg (SBC)</li> </ul>	String	terminator=originate	Stop Acc
30	called-station-id	(Standard)	Gateway call: Called (destination) phone number  SBC call: Destination URI	String	8004567145	Start Acc
31	calling-station-id	(Standard)	Calling Party Number (ANI) (Gateway call) or Source URI (SBC call)	String	5135672127	Start Acc Stop Acc
40	acct-status-	(Standard)	Account Request Type:	Numeric	1	Start

Attribute ID	Attribute Name	Vendor-Specific Attribute (VSA) ID	Description	Value Format	Example	AAA
	type		<ul style="list-style-type: none"> <li>■ "1" (start): Sent in Call Start or Call Connect CDRs</li> <li>■ "2" (stop): Sent in Call End CDRs only.</li> </ul> <p><b>Note:</b> It is highly recommended to add this attribute if you are customizing the RADIUS CDR format (see <a href="#">Customizing CDRs for SBC Calls and Test Calls</a> on page 1279 for SBC calls and <a href="#">Customizing CDRs for Gateway Calls</a> on page 1273 for Gateway calls).</p>			Acc Stop Acc
41	acct-delay-time	(Standard)	No. of seconds tried in sending a particular record	Numeric	5	Start Acc Stop Acc
42	acct-input-octets	(Standard)	Number of octets received for that call duration (for SBC calls, applicable only if media anchoring)	Numeric	-	Stop Acc

Attribute ID	Attribute Name	Vendor-Specific Attribute (VSA) ID	Description	Value Format	Example	AA A
43	acct-output-octets	(Standard)	Number of octets sent for that call duration (for SBC calls, applicable only if media anchoring)	Numeric	-	Stop Acc
44	acct-session-id	(Standard)	<p>A unique accounting identifier that corresponds to the acct-status-type attribute and thus, the identifier of the start CDR is identical to the stop CDR ID of the same call.</p> <p>This attribute is composed of the Session ID of the call (e.g., [SID=9be7fc:152:99757]) followed by a colon (:) and the leg ID (e.g., 9be7fc:152:99757:1 for the SBC incoming leg or Gateway call, and 9be7fc:152:99757:2 for the SBC outgoing leg).</p>	String	34832	Start Acc Stop Acc
46	acct-session-time	(Standard)	For how many seconds the user received the service	Numeric	-	Stop Acc

Attribute ID	Attribute Name	Vendor-Specific Attribute (VSA) ID	Description	Value Format	Example	AAA
47	acct-input-packets	(Standard)	Number of packets received during the call	Numeric	-	Stop Acc
48	acct-output-packets	(Standard)	Number of packets sent during the call	Numeric	-	Stop Acc
61	nas-port-type	(Standard)	Physical port type of device on which the call is active	String	0: Asynchronous	Start Acc Stop Acc
<b>Response Attributes</b>						
26	h323-return-code	103	The reason for failing authentication (0 = ok, other number failed)	Numeric	0 Request accepted	Stop Acc
44	acct-session-id	(Standard)	A unique accounting identifier – match start & stop	String	-	Stop Acc

Below is an example of RADIUS Accounting, where non-standard parameters are preceded with brackets:

```
Accounting-Request (4)
user-name = 111
acct-session-id = 1
nas-ip-address = 212.179.22.213
nas-port-type = 0
acct-status-type = 2
acct-input-octets = 4841
acct-output-octets = 8800
acct-session-time = 1
acct-input-packets = 122
```

```
acct-output-packets = 220
called-station-id = 201
calling-station-id = 202
```

```
// Accounting non-standard parameters:
(4923 33) h323-gw-id =
(4923 23) h323-remote-address = 212.179.22.214
(4923 1) h323-ivr-out = h323-incoming-conf-id:02102944 600a1899 3fd61009
0e2f3cc5
(4923 30) h323-disconnect-cause = 22 (0x16)
(4923 27) h323-call-type = VOIP
(4923 26) h323-call-origin = Originate
(4923 24) h323-conf-id = 02102944 600a1899 3fd61009 0e2f3cc5
```

## Querying Device Channel Resources using SIP OPTIONS

The device reports its maximum and available channel resources in SIP 200 OK responses upon receipt of SIP OPTIONS messages. The device sends this information in the SIP X-Resources header with the following parameters:

- **telchs:** Specifies the total telephone channels and the number of free (available) telephone channels.
- **mediachs:** Specifies the total and the free number of channels associated with media services (e.g., announcements and conferencing)

Below is an example of the X-Resources:

```
X-Resources: telchs= 12/4;mediachs=0/0
```

In the example above, "telchs" specifies the number of available channels and the number of occupied channels (4channels are occupied and 12channels are available).



This feature is applicable only to the Gateway application.



## 58 Remote Monitoring of Device behind NAT

When the device is located behind a NAT, you can configure it to periodically send monitoring reports to a third-party, remote HTTP-based monitoring server. This third-party server is configured on the device as a Remote Web Service (HTTP host), where the 'Type' parameter is set to **Remote Monitoring**. The device sends the reports over HTTP/S using RESTful API (in JSON format), where the device acts as the client.

You can choose to send various reports to the monitoring server:

- **Status reports:** These reports contain status information of the device, for example, software version, network configuration (IP network interfaces, Ethernet port interfaces, and proxy addresses), IP Groups, Trunk Groups, PSTN trunks, analog ports, and serial number).
- **Active alarms reports:** These reports contain currently active alarms.
- **Key performance indicators reports:** These reports contain performance monitoring statistics, for example, number of active SBC sessions, average call duration, and number of established inbound calls.
- **Registration status reports:** These reports contain status information of SIP User Agents (UA) currently registered with the device.

If the device receives an HTTP failure response (4xx/5xx/6xx) from the Remote Web Service when it attempts to send it a monitoring report, the device raises the SNMP alarm, acRemoteMonitoringAlarm (with Warning severity level). This alarm is cleared only when it receives an HTTP successful response (2xx) from the server.



- Currently, you can configure the device to send monitoring reports to only one Remote Web Service.
- If the report contains the **more** attribute with value "True", it means that the report has reached its maximum file size and the device will send another report with more information. The last report doesn't contain this attribute.

### ➤ To enable remote monitoring of device behind NAT:

1. In the Remote Web Services table (see [Configuring Remote Web Services](#) on page 299), configure a Remote Web Service with the 'Type' parameter set to **Remote Monitoring**.
2. Open the Web Service Settings page (**Setup** menu > **IP Network** tab > **Web Services** folder > **Web Service Settings**).

REMOTE MONITORING	
Remote Monitoring	<input checked="" type="checkbox"/>
Reporting Period (sec)	<input type="text" value="60"/>
Device Status	<input type="checkbox"/>
Active Alarms	<input checked="" type="checkbox"/>
Performance Indicators	<input type="checkbox"/>
Registration Status	<input checked="" type="checkbox"/>

3. Select the 'Remote Monitoring' check box to enable the feature.
4. In the 'Reporting Period' field, configure the interval (in seconds) between each sent report.
5. Select the check boxes of the corresponding report types (information) that you want the device to send:
  - 'Device Status': Report contains status information of the device
  - 'Active Alarms': Report contains currently active alarms
  - 'Performance Indicators': Report contains performance monitoring statistics
  - 'Registration Status': Report contains information of users registered with the device
6. Click **Apply**.

# Part X

## Diagnostics

## 59 Syslog and Debug Recording

For debugging and troubleshooting, you can use the device's Syslog and/or Debug Recording capabilities:

- **Syslog:** Syslog is an event notification protocol that enables a device to send event notification messages across IP networks to event message collectors, also known as Syslog servers. The device contains an embedded Syslog client, which sends error reports / events that it generates to a remote Syslog server using the IP / UDP protocol. This information is a collection of error, warning, and system messages that records every internal operation of the device.
- **Debug Recording:** The device can send debug recording packets to a debug capturing server. When the debug recording is activated, the device duplicates all messages that are sent and/or received by it and then sends them to an external server defined by IP address. The debug recording can be done for different types of traffic such as RTP/RTCP, T.38, ISDN, CAS, and SIP. Debug recording is used for advanced debugging when you need to analyze internal messages and signals. Debug recording is also useful for recording network traffic in environments where hub or port mirroring is unavailable and for recording internal traffic between two endpoints on the same device.



You can include Syslog messages in debug recording (see [Configuring Log Filter Rules](#)).

### Configuring Log Filter Rules

The Logging Filters table lets you configure up to 60 rules for filtering debug recording packets, Syslog messages, and Call Detail Records (CDR). The log filter determines the calls for which you want to generate debug recording packets, Syslog messages or CDRs. For example, you can add a rule to generate Syslog messages only for calls belonging to IP Groups 2 and 4, or for calls belonging to all IP Groups except IP Group 3.

You can also configure log filters for generating CDRs only and saving them on the device (local storage). Debug recording log filters can include signaling information (such as SIP messages), Syslog messages, PSTN traces (ISDN and CAS), CDRs, media (RTP, RTCP, and T.38), and pulse-code modulation (PCM) of voice signals from and to the TDM.

If you don't configure any rules in the Logging Filters table and you have globally enabled debug recording (by configuring the Debug Recording server's address - see Note below), Syslog (global parameter - see Note below), and/or CDR generation (global parameter for enabling Syslog - see Note below), logs are generated for all calls. Thus, the benefit of log filtering is that it allows you to create logs per specific calls, eliminating the need for additional device resources (CPU consumption) otherwise required when logs are generated for all calls.

You can enable and disable configured Log Filter rules. Enabling a rule activates the rule, whereby the device starts generating the debug recording packets, Syslog messages, or CDRs.

Disabling a rule is useful, for example, if you no longer require the rule, but may need it in the future. Thus, instead of deleting the rule entirely, you can simply disable it.



- If you want to configure a Log Filter rule that logs Syslog messages to a Syslog server (i.e., not to a Debug Recording server), you must enable Syslog functionality, using the 'Enable Syslog' (EnableSyslog) parameter (see [Enabling Syslog](#)). Enabling Syslog functionality is not required for rules that include Syslog messages in the debug recording sent to the Debug Recording server.
- To configure the Syslog server's address, see [Configuring the Syslog Server Address](#). To configure additional, global Syslog settings, see [Configuring Syslog](#).
- To configure the Debug Recording server's address, see [Configuring the Debug Recording Server Address](#).
- To configure additional, global CDR settings such as at what stage of the call the CDR is generated (e.g., start and end of call), see [Configuring CDR Reporting](#).

The following procedure describes how to configure Log Filter rules through the Web interface. You can also configure it through ini file [LoggingFilters] or CLI (`configure troubleshoot > logging logging-filters`).

➤ **To configure a Log Filter rule:**

1. Open the Logging Filters table (**Troubleshoot** menu > **Troubleshoot** tab > **Logging** folder > **Logging Filters**).
2. Click **New**; the following dialog box appears:

GENERAL	
Index	d
Filter Type	Any
Value	
Log Destination	Debug Recording Server
Log Type	
Mode	Enable

3. Configure a Log Filtering rule according to the parameters described in the table below.
4. Click **Apply**.

**Table 59-1: Logging Filters Table Parameter Descriptions**

Parameter	Description
'Index' [LoggingFilters_Index]	<p>Defines an index number for the new table row.</p> <p><b>Note:</b> Each row must be configured with a unique index.</p>
'Filter Type' filter-type [LoggingFilters_FilterType]	<p>Defines the filter type criteria.</p> <ul style="list-style-type: none"> <li>■ [1] <b>Any=</b> (Default) Debug recording is done for all calls.</li> <li>■ [2] <b>Trunk ID</b> = Filters the log by Trunk ID.</li> </ul> <p><b>Note:</b> This option is applicable only to the Gateway application.</p> <ul style="list-style-type: none"> <li>■ [3] <b>Trunk Group ID</b> = Filters the log by Trunk Group ID. To configure Trunk Groups, see <a href="#">Configuring Trunk Groups</a>.</li> </ul> <p><b>Note:</b> Applicable only to the Gateway application.</p> <ul style="list-style-type: none"> <li>■ [4] <b>Trunk &amp; B-channel</b> = Filters the log by Trunk and B-channel.</li> </ul> <p><b>Note:</b> This option is applicable only to the Gateway application.</p> <ul style="list-style-type: none"> <li>■ [5] <b>FXS or FXO</b> = Filters the log by FXS or FXO port.</li> </ul> <p><b>Note:</b> This option is applicable only to the Gateway application.</p> <ul style="list-style-type: none"> <li>■ [6] <b>Tel-to-IP</b> = Filters the log by Tel-to-IP Routing rule. To configure Tel-to-IP Routing rules, see <a href="#">Configuring Tel-to-IP Routing Rules</a>.</li> </ul> <p><b>Note:</b> This option is applicable only to the Gateway application.</p> <ul style="list-style-type: none"> <li>■ [7] <b>IP-to-Tel</b> = Filters the log by IP-to-Tel Routing rule. To configure IP-to-Tel Routing rules, see <a href="#">Configuring IP-to-Tel Routing Rules</a>.</li> </ul> <p><b>Note:</b> This option is applicable only to the Gateway application.</p> <ul style="list-style-type: none"> <li>■ [8] <b>IP Group</b> = Filters the log by IP Group. To configure IP Groups, see <a href="#">Configuring IP Groups</a>.</li> <li>■ [9] <b>SRD</b> = Filters the log by SRD. To configure SRDs, see <a href="#">Configuring SRDs</a>.</li> <li>■ [10] <b>Classification</b> = Filters the log by Classification rule. To configure Classification rules, see <a href="#">Configuring Classification</a></li> </ul>

Parameter	Description
	<p><a href="#">Rules.</a></p> <p><b>Note:</b> This option is applicable only to the SBC application.</p> <ul style="list-style-type: none"> <li>■ [11] <b>IP-to-IP Routing</b> = Filters the log by IP-to-IP Routing rule. To configure IP-to-IP Routing rules, see <a href="#">Configuring SBC IP-to-IP Routing Rules.</a></li> </ul> <p><b>Note:</b> This option is applicable only to the SBC application.</p> <ul style="list-style-type: none"> <li>■ [12] <b>User</b> = Filters the log by user. The user is defined by username or username@hostname in the Request-URI of the SIP Request-Line. For example, "2222@10.33.45.201" (without quotation marks), which represents the following INVITE: <pre>INVITE sip:2222@10.33.45.201;user=phone SIP/2.0</pre> <ul style="list-style-type: none"> <li>■ [13] <b>IP Trace</b> = Filters the log by an IP network trace, using Wireshark-like expressions. For more information, see <a href="#">Filtering IP Network Traces.</a></li> <li>■ [14] <b>SIP Interface</b> = Filters the log by SIP Interface. To configure SIP Interfaces, see <a href="#">Configuring SIP Interfaces.</a></li> </ul> </li></ul>
<p>'Value' value [LoggingFilters_Value]</p>	<p>Defines the value for the filtering type configured in the 'Filter Type' parameter.</p> <p>The value can include the following:</p> <ul style="list-style-type: none"> <li>■ A single value.</li> <li>■ A range, using a hyphen "-" between the two values. For example, to specify IP Groups 1, 2 and 3, configure the parameter to "1-3" (without quotation marks).</li> <li>■ Multiple, non-contiguous values, using commas "," between each value. For example, to specify IP Groups 1, 3 and 9, configure the parameter to "1,3,9" (without quotation marks).</li> <li>■ Trunks, FXS, or FXO pertaining to a module, using the syntax module number/port or port, for example: <ul style="list-style-type: none"> <li>✓ "1/2" (without quotation marks) means module 1, port 2</li> <li>✓ "1/[2-4]" (without quotation marks) means module 1, ports 2 through 4</li> </ul> </li> </ul>

Parameter	Description
	<ul style="list-style-type: none"> <li>■ The exclamation (!) wildcard character can be used for excluding a specific configuration entity from the filter. For example, to include all IP Groups in the filter except IP Group ID 2, configure the 'Filter Type' parameter to <b>IP Group</b> and the 'Value' parameter to "!2" (without quotation marks).</li> </ul> <p><b>Note:</b> For SBC calls, a Logging Filter rule applies to the entire session, which is both legs (i.e., not per leg). For example, a call between IP Groups 1 and 2 are logged for both legs even if the 'Value' parameter is configured to "!2" (without quotation marks).</p> <p><b>Note:</b></p> <ul style="list-style-type: none"> <li>■ You can use the index number or string name to specify the configuration entity for the following 'Filter Types': Tel-to-IP, IP-to-Tel, <b>IP Group</b>, <b>SRD</b>, <b>Classification</b>, <b>IP-to-IP Routing</b>, or <b>SIP Interface</b>. For example, to specify IP Group at Index 2 with the name "SIP Trunk", configure the parameter to either "2" or "SIP Trunk" (without quotation marks).</li> <li>■ For IP trace expressions, see <a href="#">Filtering IP Network Traces</a>.</li> </ul>
<p>'Log Destination'</p> <p>log-dest</p> <p>[LoggingFilters_</p> <p>LogDestination]</p>	<p>Defines where the device sends the log file.</p> <ul style="list-style-type: none"> <li>■ [0] <b>Syslog Server</b> = The device generates Syslog messages based on the configured log filter and sends them to a user-defined Syslog server. The Syslog messages can contain one of the following types of information, depending on the settings of the 'Log Type' parameter (described later): <ul style="list-style-type: none"> <li>✓ <b>Not configured (default):</b> Syslog messages include regular syslog information.</li> <li>✓ <b>CDR Only:</b> Syslog messages include only CDRs (no system information and alerts).</li> </ul> </li> <li>■ [1] <b>Debug Recording Server</b> = (Default) The device generates debug recording packets based on the configured log filter and sends them to a user-defined Debug Recording server.</li> <li>■ [2] <b>Local Storage</b> = The device generates CDRs based on the configured log filter and stores them locally on the device. For more information on local CDR storage, see <a href="#">Storing CDRs on the Device</a></li> <li>■ [3] <b>Call Flow Server</b> = The device sends SIP messages to a call flow server (i.e., OVOC) for displaying SIP call dialog sessions as SIP call flow diagrams. For this functionality, you</li> </ul>



Parameter	Description
	<p>also need to configure the 'Log Type' parameter to <b>Call Flow</b>. For enabling this functionality, see <a href="#">Enabling SIP Call Flow Diagrams in OVOC</a> on page 1339.</p> <p><b>Note:</b></p> <ul style="list-style-type: none"> <li>■ If the 'Filter Type' parameter is configured to <b>IP Trace</b>, you must configure the parameter to <b>Debug Recording Server</b>.</li> <li>■ If you configure the parameter to <b>Local Storage</b>, you must configure the 'Log Type' parameter to <b>CDR Only</b>.</li> <li>■ If you configure the parameter to <b>Syslog Server</b> and the debug level, using the [GwDebugLevel] parameter, is configured to <b>No Debug</b> (see <a href="#">Configuring Syslog Debug Level</a>), the Syslog messages include only system Warnings and Errors.</li> <li>■ If you configure the parameter to <b>Debug Recording Server</b>, you can also include Syslog messages in the debug recording packets sent to the debug recording server. To include Syslog messages, configure the 'Log Type' parameter (see below) to the relevant option.</li> </ul>
<p>'Log Type' log-type [LoggingFilters_ CaptureType]</p>	<p>Defines the type of messages to include in the log file.</p> <ul style="list-style-type: none"> <li>■ [0] = (Default) Not configured. The option is applicable only for sending Syslog messages to a Syslog server (i.e., 'Log Destination' parameter is configured to <b>Syslog Server</b>).</li> <li>■ [1] <b>Signaling</b> = The option is applicable only to debug recording (i.e., 'Log Destination' parameter is configured to <b>Debug Recording Server</b>). The debug recording includes signaling information such as SIP signaling messages, Syslog messages, CDRs, and the device's internal processing messages.</li> <li>■ [2] <b>Signaling &amp; Media</b> = The option is applicable only to debug recording (i.e., 'Log Destination' parameter is configured to <b>Debug Recording Server</b>). The debug recording includes media (RTP/RTCP/T.38), and only signaling and Syslog messages associated with the recorded media.</li> </ul> <p><b>Note:</b> The device requires a lot of resources for media debug recording. The number of media sessions (and associated signaling) that the device records depends on available resources. Therefore, when many media sessions need to be</p>

Parameter	Description
	<p>recorded (e.g., when the 'Filter Type' parameter is configured to <b>Any</b>) not all media sessions (and associated signaling) are recorded. If the device has no resources to debug record any media, it doesn't debug record any signaling as well. As debug recording of signaling requires less resources than media debug recording, if you want to perform debug recording only on signaling, then it is recommended to configure the parameter to <b>Signaling</b>.</p> <ul style="list-style-type: none"> <li>■ [3] <b>Signaling &amp; Media &amp; PCM</b> = The option is applicable only to debug recording (i.e., 'Log Destination' parameter is configured to <b>Debug Recording Server</b>). The debug recording includes signaling, Syslog messages, media, and PCM (voice signals from and to TDM).</li> <li>■ [4] <b>PSTN Trace</b> = The option is applicable only to debug recording (i.e., 'Log Destination' parameter is configured to <b>Debug Recording Server</b>) and if the 'Filter Type' parameter is configured to <b>Trunk ID</b>. The debug recording includes ISDN and CAS traces.</li> </ul> <p><b>Note:</b></p> <ul style="list-style-type: none"> <li>✓ This option is applicable only to digital interfaces.</li> <li>✓ To capture traffic of all trunks, configure the 'Value' parameter (above) to "-1" (without quotation marks).</li> <li>✓ You must configure the trace level for the trunks that you want to trace. This is done using the 'Trace Level' parameter on the Trunk Settings page (see <a href="#">Configuring Trunk Settings</a> on page 668).</li> </ul> <ul style="list-style-type: none"> <li>■ [5] <b>CDR Only</b> = Only CDRs are generated. The option is applicable only if the 'Log Destination' parameter is configured to <b>Syslog Server</b> or <b>Local Storage</b>. When configured to <b>Syslog Server</b>, only CDRs are included in the Syslog messages (excluding all system logs and alerts) sent to the Syslog server.</li> <li>■ [6] <b>Call Flow</b> = The device sends SIP messages (in XML format), as they occur in real-time, to OVOC for displaying SIP call dialog sessions as call flow diagrams. For this functionality, you also need to configure the 'Log Destination' parameter to <b>Call Flow Server</b>. For enabling this functionality, see <a href="#">Enabling SIP Call Flow Diagrams in OVOC</a> on page 1339.</li> </ul>

Parameter	Description
	<ul style="list-style-type: none"> <li>■ [7] <b>SIP Only</b> = The option is applicable only to debug recording (i.e. the 'Log Destination' parameter is configured to <b>Debug Recording Server</b> or <b>Syslog Server</b>). The debug recording includes only SIP messages.</li> </ul> <p><b>Note:</b></p> <ul style="list-style-type: none"> <li>■ If you configure the 'Log Destination' parameter to <b>Local Storage</b>, you must configure the 'Log Type' parameter to <b>CDR Only</b>.</li> <li>■ PSTN debug traces may affect performance.</li> <li>■ The parameter is not applicable when the 'Filter Type' parameter is configured to <b>IP Trace</b>.</li> <li>■ To include Syslog messages in debug recording, it is unnecessary to enable Syslog functionality.</li> </ul>
'Mode' mode [LoggingFilters_Mode]	<p>Enables and disables the rule.</p> <ul style="list-style-type: none"> <li>■ [0] <b>Disable</b></li> <li>■ [1] <b>Enable</b> (default)</li> </ul>

## Filtering IP Network Traces

You can filter Syslog and debug recording messages for IP network traces, by configuring the 'Filter Type' parameter to **IP Trace** in the Logging Filters table. IP traces record any IP stream, according to destination and/or source IP address, or port and Layer-4 protocol (UDP, TCP or any other IP type as defined by <http://www.iana.com>). Network traces are typically used to record HTTP.

When the **IP Trace** option is selected, only the 'Value' parameter is applicable ('Syslog' and 'Capture Type' parameters are not applicable). The 'Value' parameter configures the Wireshark-like filtering expressions for your IP trace. The following Wireshark-like expressions are supported:

**Table 59-2: Supported Wireshark-like Expressions for 'Value' Parameter**

Expression	Description
ip.src	Defines the source IPv4 address.
ipv6.src	Defines the source IPv6 address.
ip.dst	Defines the destination IPv4 address.

Expression	Description
ipv6.dst	Defines the destination IPv6 address.
ip.addr	Defines IPv4 addresses (up to two).
ipv6.addr	Defines IPv6 addresses (up to two).
ip.proto	Defines the IP protocol type (PDU), entered as an enumeration value (e.g., 1 is ICMP, 6 is TCP, 17 is UDP).
udp, tcp, icmp, sip, ldap, http, https	Defines single expressions for the protocol type.
udp.port, tcp.port	Defines the transport layer.
udp.srcport, tcp.srcport	Defines the transport layer for the source port.
udp.dstport, tcp.dstport	Defines the transport layer for the destination port.
and, &&, ==, <, >	Comparison operators used between expressions.

Below are examples of configured expressions for the 'Value' parameter:

- `udp && ip.addr==10.8.6.55`
- `ip.src==10.8.6.55 && udp.port>=5000 and udp.port<6000`
- `ip.dst==10.8.0.1/16`
- `ip.addr==10.8.6.40`
- `ipv6.addr==2001:0db8:85a3:0000:0000:8a2e:0370:7334`
- `ipv6.src==2001:db8:abcd:0012::0/64`

For conditions requiring the "or" / "|" expression, add multiple table rows. For example, the Wireshark condition (`ip.src == 1.1.1.1 or ip.src == 2.2.2.2`) and `ip.dst == 3.3.3.3` can be configured using the following two table row entries:

1. `ip.src == 1.1.1.1 and ip.dst == 3.3.3.3`
2. `ip.src == 2.2.2.2 and ip.dst == 3.3.3.3`



- If you don't configure the 'Value' parameter, the device records all IP traffic types.
- You cannot configure the 'Value' parameter with IPv4 addresses together with IPv6 addresses.



- You cannot configure the 'Value' parameter with ip.addr or udp/tcp.port together with ip.src/dst or udp/tcp.srcport/dstport. For example, "ip.addr==1.1.1.1 and ip.src==2.2.2.2" (without quotation marks) is an invalid configuration value.
- You cannot configure the 'Value' parameter with ipv6.addr or udp/tcp.port together with ipv6.src/dst or udp/tcp.srcport/dstport. For example, "ipv6.addr==2001:0db8:85a3:0000:0000:8a2e:0370:7334 and ipv6.src==2001:db8:abcd:0012::0/64" (without quotation marks) is an invalid configuration value.

## Debugging PSTN Calls through CLI

You can also troubleshoot and debug digital (PSTN) calls through the device's CLI.

- **To configure the debug (trace) level:** The debug (trace) level determines the level of information included in the PSTN trace. For all PSTN traces, the trace level is configured per PSTN interface, using the following command:

```
configure voip > interface {e1-t1|bri} {Slot/Port} > trace-level {full-isdn|full-isdn-with-duplications|layer3|layer3-no-duplications|no-trace|q921-raw-data|q931|q931-q921-raw-data|q931-raw-data}
```

For example:

```
# configure voip
(config-voip)# interface e1-t1 1/1
(e1-t1 1/1)# trace-level full-isdn
```

- **To start a PSTN trace:**

- Per trunk: Debugging per trunk is configured in the Logging Filters where there is an option to start and stop the trace:

```
(config-troubleshoot)# logging logging-filters <Table Row Index>
```

For more information on the Logging Filters table, see [Configuring Log Filter Rules](#) on page 1302.

**Note:** The trace level is configured using the interface command described in the beginning of this section.

- All trunks: You can perform PSTN traces for all trunks for which you have configured trace levels (using the interface command described in the beginning of this section). To start the trace for all these trunks, use the following command:

```
# debug debug-recording <IP Address of Debug Recording Server> pstn-trace
```

- **To enable sending traces to Syslog:** To send the PSTN traces to a Syslog server, use the following command:

```
(config-troubleshoot)# pstn-debug on
```

**Note:**

- If you send traces to a Syslog server, you must configure the trace level to **q931-raw-data**.
- Changing the command to on or off requires a device reset.



PSTN traces may affect performance.

## Configuring Syslog

This section describes how to configure Syslog. To filter Syslog messages, see [Configuring Log Filter Rules](#).

### Syslog Message Format

The Syslog message is sent from the device to a Syslog server as an ASCII (American Standard Code for Information Interchange) message. Syslog uses UDP as its underlying transport layer mechanism. By default, UDP port 514 is assigned to Syslog, but this can be changed (see [Enabling Syslog](#)).

Syslog includes two types of log messages:

- **SIP Call Session Logs:** Logs relating to call sessions (e.g., call established). These logs are identified by a session ID ("SID"), described in detail in the table below. For example:

```
10:44:11.299 10.15.77.55 local0.notice [S=511941] [SID=50dcb2:31:12079]
(N 483455) ReleaseAddress. IPv4IF=1 IPv6IF=-1 Port=7500 [Time:10-
09@09:42:56.938]
```

- **Board Logs:** Logs relating to the operation of the device (infrastructure) that are non-call session related (e.g., device reset or Web login). These logs are identified by a board ID ("BID"), described in detail in the table below. For example:

```
11:58:30.820 10.15.77.55 local0.notice [S=534370] [BID=50dcb2:31] Activity
Log: WEB: User logout. User: Admin. Session: WEB (10.15.77.100) [Time:10-
09@10:57:16.360]
```

The format of the Syslog message is described in the following table:

Table 59-3: Syslog Message Format Description

Message Item	Description
<b>Timestamp</b>	<p>When the Network Time Protocol (NTP) is enabled, a timestamp string [hour:minutes:seconds.msec] is added to all Syslog messages, for example (in bold):</p> <pre><b>10:44:11.299</b> 10.15.77.55 local0.notice [S=511941] [SID=50dcb2:31:12079] (N 483455) ReleaseAddress. IPv4IF=1 IPv6IF=-1 Port=7500 [Time:10-09@09:42:56.938]</pre>
<b>IP Address</b>	The device that generated the Syslog message, defined by IP address.
<b>Severity Type</b>	<p>Each Syslog message is generated with a severity level in the format &lt;FacilityCode.Severity&gt;, for example:</p> <pre>10:44:11.299 10.15.77.55 local0.<b>notice</b> [S=511941] [SID=50dcb2:31:12079] (N 483455) ReleaseAddress. IPv4IF=1 IPv6IF=-1 Port=7500 [Time:10-09@09:42:56.938]</pre> <p>The severity level can be one of the following:</p> <ul style="list-style-type: none"> <li>■ Error: Indicates that a problem has been identified that requires immediate handling.</li> <li>■ Warning: Indicates an error that might occur if measures are not taken to prevent it.</li> <li>■ Notice: Indicates that an unusual event has occurred.</li> <li>■ Info: Indicates an operational message.</li> <li>■ Debug: Messages used for debugging.</li> </ul> <p><b>Note:</b></p> <ul style="list-style-type: none"> <li>■ The Info and Debug severity-level messages are required only for advanced debugging. By default, they are not sent by the device.</li> <li>■ Syslog messages displayed in the Web interface (see <a href="#">Viewing Syslog Messages</a> on page 1323) are color coded according to severity level.</li> </ul>
<b>Sequence Number [S=&lt;number&gt;]</b>	<p>By default, Syslog messages are sequentially numbered in the format [S=&lt;number&gt;], for example, "[S=538399]". A skip in the number sequence of messages indicates a loss in message packets. The following example of a Syslog shows two missing messages (S=538402 and S=538403):</p> <pre>12:11:42.709 10.15.77.55 local0.notice</pre>

Message Item	Description
	<pre>[S=538399] [SID=50dcb2:31:12754] (N 508552) CAC: Remove SBC Outgoing Other, IPG 2 (Teams): 0, SRD 0 (DefaultSRD): 0, SipIF 1 (Teams): 0 [Time:10-09@11:10:28.848] 12:11:42.709 10.15.77.55 local0.notice [S=538400] [SID=50dcb2:31:12754] (N 508553) States: (#2698)SBCCall[Deallocated] [Time:10- 09@11:10:28.848] 12:11:42.709 10.15.77.55 local0.notice [S=538401] [SID=50dcb2:31:12754] (N 508554) CAC: Remove SBC Incoming Other, IPG 2 (Teams): 0, SRD 0 (DefaultSRD): 0, SipIF 1 (Teams): 0 [Time:10-09@11:10:28.848] 12:11:42.710 10.15.77.55 local0.notice [S=538404] [SID=50dcb2:31:12754] (N 508555) States: (#2699)SBCCall[Deallocated] [Time:10- 09@11:10:28.848]</pre> <p><b>Note:</b> To exclude the message sequence number from Syslog messages, configure the 'CDR Syslog Sequence Number' parameter to <b>Disable</b> (see <a href="#">Configuring Syslog</a>).</p>
<b>Session ID (SID)</b>	<p>The SID is a unique SIP call session and device identifier. The device identifier facilitates debugging by clearly identifying the specific device that sent the log message, which is especially useful in deployments consisting of multiple devices. In addition, the benefit of unique numbering is that it enables you to filter information (such as SIP, Syslog, and media) according to device or session ID.</p> <p>The syntax of the session and device identifiers is as follows:</p> <p><i>[SID=&lt;last 6 characters of device's MAC address&gt;:&lt;number of times device has reset&gt;:&lt;unique SID counter indicating the call session, which increments consecutively for each new session and resets to 1 after a device reset&gt;]</i></p> <p>For example:</p> <pre>10:44:11.299 10.15.77.55 local0.notice [S=511941] [SID=50dcb2:31:12079] (N 483455) ReleaseAddress. IPv4IF=1 IPv6IF=-1 Port=7500 [Time:10-09@09:42:56.938]</pre> <p>Where:</p> <ul style="list-style-type: none"> <li>■ 50dcb2 is the device's MAC address.</li> <li>■ 31 is the number of times the device has reset.</li> </ul>



Message Item	Description
	<ul style="list-style-type: none"> <li>■ 12079 is a unique SID session number (in other words, this is call session 12,079 since the last device reset).</li> <li>✓ Gateway application: A call session is considered as a Tel-to-IP leg or an IP-to-Tel leg, where each leg is assigned a unique session number.</li> <li>✓ SBC application: A session includes both the outgoing and incoming legs, where both legs share the same session number.</li> <li>✓ Forked legs and alternative legs share the same session number.</li> </ul>
<b>Board ID (BID)</b>	<p>The BID is a unique non-SIP session related (e.g., device reset or a Trunk alarm) and device identifier. The device identifier facilitates debugging by clearly identifying the specific device that sent the log message, which is especially useful in deployments consisting of multiple devices. In addition, the benefit of unique numbering is that it enables you to filter information according to device.</p> <p>The syntax of the BID is as follows:</p> <p><i>[BID=&lt;last 6 characters in MAC&gt;:&lt;number of times device has reset&gt;]</i></p> <p>For example:</p> <pre>11:58:30.820 10.15.77.55 local0.notice [S=534370] [<b>BID=50dcb2:31</b>] Activity Log: WEB: User logout. User: Admin. Session: WEB (10.15.77.100) [Time:10-09@10:57:16.360]</pre> <p>Where:</p> <ul style="list-style-type: none"> <li>■ 50dcb2 is the device's MAC address.</li> <li>■ 31 is the number of times the device has reset.</li> </ul>
<b>Message Body</b>	<p>Describes the message. For example, the body (shown in bold) of the following Syslog message indicates that the user logged out of the Web interface:</p> <pre>11:58:30.820 10.15.77.55 local0.notice [S=534370] [BID=50dcb2:31] <b>Activity Log: WEB: User logout. User: Admin. Session: WEB (10.15.77.100) [Time:10-09@10:57:16.360]</b></pre>

### Event Representation in Syslog Messages

The device denotes events in Syslog message using unique abbreviations, as listed in the following table. For example, if an invalid payload length event occurs, the Syslog message

uses the abbreviated event string "IP":

```
Apr 4 12:00:12 172.30.1.14 IP:5 [Code:0x5004] [CID:3294] [Time: 20:17:00]
```



For Syslog messages sent for packet loss events, see Packet Loss Indication in Syslog.

**Table 59-4: Syslog Error Event Abbreviations**

Error Abbreviation	Error Name Description
AA	Invalid Accumulated Packets Counter
AC	Invalid Channel ID
AL	Invalid Header Length
AO	Invalid Codec Type
AP	Unknown Aggregation Payload Type
AR	Invalid Routing Flag Received
AT	Simple Aggregation Packets Lost
CC	Command Checksum Error
CE	Invalid Cell Coder Code
CS	Command Sequence Error
ES	8 sec Timeout Before Disconnect
HO	Host Received Overrun
IA	Invalid AMR Payload
IC	Invalid CID Error
IG	Invalid G723 Code
IP	Invalid payload length
IR	Invalid RTCP Packet
IS	Invalid SID Length

Error Abbreviation	Error Name Description
<b>LC</b>	Transmitter Received Illegal Command
<b>LF</b>	Lost Fax Frames In High Speed Mode
<b>LM</b>	Lost Modem Frames In High Speed Mode
<b>MI</b>	Misalignment Error
<b>MR</b>	Modem Relay Is Not Supported
<b>PD</b>	RTP Packet Duplicated
<b>OR</b>	DSP JB Overrun
<b>PH</b>	Packet Header Error
<b>RB</b>	Counts the number of BFI Frames Received From The Host
<b>RD</b>	No Available Release Descriptor
<b>RO</b>	RTP Reorder
<b>RP</b>	Unknown RTP Payload Type
<b>RS</b>	RTP SSRC Error
<b>UF</b>	Unrecognized Fax Relay Command

### Syslog Fields for Answering Machine Detection (AMD)

The Syslog message can include information relating to the Answering Machine Detection (AMD) feature. AMD is used to detect whether a human (including a fax machine), an answering machine, silence, or answering machine beeps have answered the call on the remote side.

■ **AMDSignal** – the field can acquire one of the following values:

- voice (V)
- answer machine (A)
- silence (S)
- unknown (U)

■ **AMDDecisionProbability** – probability (in %) success that correctly detects answering type

Below is an example of such a Syslog message with AMD information:

```
CallMachine:EVENT_DETECTED_EV - AMDSignal = <type - V/A/S/U>,
AMDDecisionProbability = <percentage> %
```

If there is no AMD detection, the AMDSignal field is shown empty (i.e. AMDSignal = ).

For more information on the AMD feature, see [Answering Machine Detection \(AMD\)](#).

## SNMP Alarms in Syslog Messages

SNMP alerts are sent to the Syslog server using the following formats:

- **Raised Alarms:** RAISE-ALARM: <Alarm Name>; Textual Description: <Textual Description>; Severity <Alarm Severity>; Source <Alarm Source>; Unique ID: <Alarm Unique ID >.

If additional information exists in the alarm, then these are also added: Additional Info1:/ Additional Info2:/ Additional Info3

The Messages' Severity is as follows:

**Table 59-5: Syslog Message Severity**

ITU Perceived Severity (SNMP Alarm's Severity)	AudioCodes Syslog Severity
<b>Critical</b>	RecoverableMsg
<b>Major</b>	RecoverableMsg
<b>Minor</b>	RecoverableMsg
<b>Warning</b>	Notice
<b>Indeterminate</b>	Notice
<b>Cleared</b>	Notice

- **Cleared Alarms:** CLEAR-ALARM: <Alarm Name>; Textual Description: <Textual Description>; Severity <Alarm Severity>; Source <Alarm Source>; Unique ID: <Alarm Unique ID >; If exists Additional Info1:/ Additional Info2:/ Additional Info3:

## Enabling Syslog

To use Syslog, you first need to enable it.

### ➤ To enable Syslog:

1. Open the Logging Settings page (**Troubleshoot** menu > **Troubleshoot** tab > **Logging** folder > **Logging Settings**).
2. From the 'Enable Syslog' drop-down list, select **Enable**.

SYSLOG

Enable Syslog Disable

3. Click **Apply**.

## Configuring the Syslog Server Address

The device sends the Syslog messages to the Syslog server's address.

### ➤ To configure the Syslog server address:

1. Open the Logging Settings page (**Troubleshoot** menu > **Troubleshoot** tab > **Logging** folder > **Logging Settings**).
2. In the 'Syslog Server IP' field [SyslogServerIP], enter the IP address of the Syslog server.
3. In the 'Syslog Server Port' field, enter the port of the Syslog server.

Syslog Server IP 0.0.0.0

Syslog Server Port 514

4. Click **Apply**.

## Configuring Syslog Message Severity Level

You can configure the minimum severity level of messages that you want to include in Syslog messages that are generated by the device. The severity levels are described in the following table.

Severity Level (Highest to Lowest)	Syslog String	Description
Fatal	emerg	A panic condition (system is unstable).
Alert	alert	A problem has been identified and an action must be taken immediately.
Critical	crit	A problem has been identified that is critical.
Error	error	An error has been identified.
Warning	warning	An error that might occur if measures are not taken to prevent it.
Notice	notice	An unusual event has occurred.

Severity Level (Highest to Lowest)	Syslog String	Description
Informational	info	An operational message.
Debug	debug	Debug message.

The specified severity level and all higher severity levels are included in the Syslog message. For example, if you configure the parameter to **Alert**, the Syslog includes messages with **Alert** severity level and messages with **Fatal** severity level.

When viewing Syslog messages in the Web interface (see [Viewing Syslog Messages](#) on page 1323), each severity level is displayed in a different color.

➤ **To configure the minimum message severity level to include in Syslog:**

1. Open the Logging Settings page (**Troubleshoot** menu > **Troubleshoot** tab > **Logging** folder > **Logging Settings**).
2. From the 'Log Severity Level' [SyslogLogLevel] drop-down list, select the severity level.

Log Severity Level

3. Click **Apply**.

## Configuring Syslog Debug Level

You can configure the amount of information (debug level) to include in Syslog messages. You can also enable the device to send multiple Syslog messages bundled into a single packet, and enable a protection mechanism that automatically lowers the debug level when the device's CPU resources become low, ensuring sufficient CPU resources are available for processing voice traffic.

➤ **To configure the Syslog debug level:**

1. Open the Logging Settings page (**Troubleshoot** menu > **Troubleshoot** tab > **Logging** folder > **Logging Settings**).

Syslog CPU Protection

Syslog Optimization

VoIP Debug Level

2. From the 'VoIP Debug Level' [GwDebugLevel] drop-down list, select the debug level of Syslog messages:
  - **No Debug:** Disables Syslog and no Syslog messages are sent.
  - **Basic:** Sends debug logs of incoming and outgoing SIP messages.

- **Detailed:** Sends debug logs of incoming and outgoing SIP message as well as many other logged processes.
3. From the 'Syslog Optimization' [SyslogOptimization] drop-down list, select whether you want the device to accumulate and bundle multiple debug messages into a single UDP packet before sending it to a Syslog server. The benefit of the feature is that it reduces the number of UDP Syslog packets, thereby improving (optimizing) CPU utilization. The size of the bundled message is configured by the [MaxBundleSyslogLength] parameter.
  4. From the 'Syslog CPU Protection' [SyslogCpuProtection] drop-down list, select whether you want to enable the protection feature for the device's CPU resources during debug reporting, ensuring voice traffic is unaffected. If CPU resources drop (i.e., high CPU usage) to a critical level (user-defined threshold), the device automatically lowers the debug level to free up CPU resources that were required for the previous debug-level functionality. When CPU resources become available again, the device increases the debug level to its' previous setting. For example, if you set the 'Debug Level' to **Detailed** and CPU resources decrease to the defined threshold, the device automatically changes the level to **Basic**, and if that is not enough, it changes the level to **No Debug**. Once CPU resources are returned to normal, the device automatically changes the debug level back to its' original setting (i.e., **Detailed**). The threshold is configured by the [DebugLevelHighThreshold] parameter.
  5. Click **Apply**.

## Reporting Management User Activities

The device can report operations (activities) performed in the device's management interfaces (e.g., Web and CLI) by management users, in Syslog messages. The Syslog message indicates these logs with the string "Activity Log". Each logged user activity includes the following information:

- Username (e.g., "Admin") of the user that performed the action
- IP address of the client PC from where the Web user accessed the management interface
- Protocol used for the session (e.g., SSH or HTTP)

The following example shows a Web-user activity log (indicating a login action) with the above-mentioned information:

```
14:07:46.300 : 10.15.7.95 : Local 0 :NOTICE : [S=3149] [BID=3aad56:32]  
Activity Log: WEB: Successful login at 10.15.7.95:80. User: Admin. Session:  
HTTP (10.13.22.54)
```

The device can report the following user activities:

- Modifications of individual parameters, for example:

```
14:33:00.162 : 10.15.7.95 : Local 0 :NOTICE : [S=3403] [BID=3aad56:32]
Activity Log: Max Login Attempts was changed from '3' to '2'. User: Admin.
Session: HTTP (10.13.22.54)
```

- Modifications of table fields, and addition and deletion of table rows, for example:

```
14:42:48.334 : 10.15.7.95 : NOTICE : [S=3546] [BID=3aad56:32] Activity Log:
Classification - remove line 2. User: Admin. Session: HTTP (10.13.22.54)
```

- Entered CLI commands (modifications of security-sensitive commands are logged without the entered value).
- Configuration file load (reported without per-parameter notifications).
- Auxiliary file load and software update.
- Device reset and burn to flash memory.
- Access to unauthorized Web pages according to the Web user's access level.
- Modifications of "sensitive" parameters.
- Login and logout.
- Actions not related to parameter changes (for example, file uploads, file delete, lock-unlock maintenance actions, LDAP clear cache, register-unregister, and start-stop trunk). In the Web, these actions are typically done by clicking a button (e.g., the LOCK button).

For more information on each of the above listed options, see [Syslog, CDR and Debug Parameters](#).

The following procedure describes how to configure management user activity logging through the Web interface. You can also configure it through ini file [ActivityListToLog] or CLI (`configure troubleshoot > activity-log`).

➤ **To configure reporting of management user activities:**

1. Open the Logging Settings page (**Troubleshoot** tab > **Troubleshoot** menu > **Logging** folder > **Logging Settings**).
2. Under the Activity Types to Report group, select the actions to report to the Syslog server. To select (or deselect) all activity types, click the 'Select All' check box.



## ACTIVITY TYPES TO REPORT

Select All	<input type="checkbox"/>
Parameters Value Change	<input type="checkbox"/>
Auxiliary Files Loading	<input type="checkbox"/>
Device Reset	<input type="checkbox"/>
Flash Memory Burning	<input type="checkbox"/>
Device Software Upgrade	<input type="checkbox"/>
Non-Authorized Access	<input type="checkbox"/>
Sensitive Parameters Value Change	<input type="checkbox"/>
Login and Logout	<input type="checkbox"/>
CLI Activity	<input type="checkbox"/>
Action Executed	<input type="checkbox"/>

3. Click **Apply**.

- You can also view logged user activities in the Web interface (see [Viewing Web User Activity Logs](#)).
- Logging of CLI commands can only be configured through CLI or ini file.
- You can configure the device to send an SNMP trap each time a user performs an action. For more information, see [Enabling SNMP Traps for Web Activity](#) on page 83.

## Viewing Syslog Messages

You can view Syslog messages generated by the device using any of the following Syslog server types:

- **Device's Web Interface:** The device provides an embedded Syslog server, which is accessed through the Web interface (**Troubleshoot** tab > **Troubleshoot** menu > **Message Log** ). You can select the Syslog messages displayed on the page, and then copy-and-paste them into a text editor such as Notepad. This text file (*txt*) can then be sent to AudioCodes support team for diagnosis and troubleshooting.

Message Log

```

Aug 13 16:19:19 local0.notice [S=7782952] [BID=Sb1035:19] Opening Log Web Page - printing error messages sent to Syslog [Code:0x40529
Aug 13 16:19:19 local0.notice [S=7782951] [SID=Sb1035:19:246258] ( sip_stack) ( 7459456) SIPTransaction(#290)::SendMsgBuffer -
Aug 13 16:19:19 local0.notice [S=7782950] [SID=Sb1035:19:246258] ( sip_stack) ( 7459455) UdpRtxMgr::Transmit 1 OPTIONS Rtx Le:
Aug 13 16:19:18 local0.warn [S=7782949] [BID=Sb1035:19] SNMP Authentication Failure - source: IP = 172.17.118.219, Port = 1161, failer
Aug 13 16:19:18 local0.notice [S=7782948] [SID=Sb1035:19:246257] ( sip_stack) ( 7459454) SIPTransaction(#313)::SendMsgBuffer -
Aug 13 16:19:18 local0.notice [S=7782947] [SID=Sb1035:19:246257] ( sip_stack) ( 7459453) UdpRtxMgr::Transmit 1 OPTIONS Rtx Le:
Aug 13 16:19:18 local0.notice [S=7782946] [SID=Sb1035:19:246258] OPTIONS sip:10.15.7.96 SIP/2.0
Via: SIP/2.0/UDP 10.15.7.96:5060;branch=z9hG4bKac1759650396
Max-Forwards: 70
From: <sip:10.15.7.96>;tag=1c455863529
To: <sip:10.15.7.96>
Call-ID: 2306087331382018161918@10.15.7.96
CSeq: 1 OPTIONS
    
```

Start Stop Clear

The displayed logged messages are color-coded based on message type:

- "notice": Dark green
- "error", "crit", "alert", "emerg": Red
- "debug": Black
- "info": Blue
- "warn": Magenta

The page provides various buttons to do the following actions:

Table 59-6: Buttons on Message Log Page

Button	Description
Start	Resumes the message log after it has been stopped (see the <b>Stop</b> button).
Stop	Stops the message log, allowing you to easily scroll through the messages to a specific message.
Clear	Clears the message log. The button can only be clicked after you have stopped the message log (see the <b>Stop</b> button). <b>Note:</b> If you navigate away from the Message Log page to another page, the Message Log is stopped and cleared.



- It's not recommended to keep a Message Log session open for a prolonged period. This may cause the device to overload. For prolonged (and detailed) debugging, use an external Syslog server.
- The Message Log page provides limited Syslog server functionality.

■ **Device's CLI:** The device sends error messages (e.g., Syslog messages) to the CLI as well as to the configured destination.

- To start debug recording:

debug log

- To stop debug recording:

no debug log

- To stop all debug recording:

no debug log all

- Wireshark:** Third-party, network protocol analyzer (<http://www.wireshark.org>).



When debug recording is enabled and Syslog messages are also included in the debug recording, to view Syslog messages using Wireshark, you must install AudioCodes' Wireshark plug-in (acsyslog.dll). Once the plug-in is installed, Syslog messages are decoded as "AC SYSLOG" and displayed using the "acsyslog" filter (instead of the regular "syslog" filter). For more information on debug recording, see [Debug Recording](#).

- AudioCodes Syslog Viewer:** This utility can be used for two major tasks:

- Recording and displaying syslog messages from the device
- Analyzing recorded logs (including support for interactive SIP ladder diagrams)

You can download the Syslog Viewer installation file from AudioCodes website at <https://www.audiocodes.com/library/firmware>.

**Figure 59-1: Example of Syslog Messages in Syslog Viewer**

```

Syslog Viewer
File Edit View Tools Help
[Icons]
[Search: <type text>]

10:53:35.000 172.31.12.241 local0.notice [S=55552] [SID=3f32bb:12:4293] (N 47065) SBCTofferAnswerMgr(#120)::AddPreviousSDPToMess
10:53:35.000 172.31.12.241 local0.notice [S=55553] [SID=3f32bb:12:4293] (N 47066) AcSIPCall(#1238): Handling CONNECT_REQ in state
10:53:35.000 172.31.12.241 local0.notice [S=55554] [SID=3f32bb:12:4293] (N 47067) UdpRtxMgr::Transmit 200 Response 4525 INVITE f
10:53:35.000 172.31.12.241 local0.notice [S=55555] [SID=3f32bb:12:4293] (N 47068) ---- Outgoing SIP Message to 172.31.6.166:56218
10:53:35.000 172.31.12.241 local0.notice [S=55556] [SID=3f32bb:12:4293] SIP/2.0 200 OK
Via: SIP/2.0/UDP 172.31.6.166:56218;received=172.31.6.166;rport=56218;branch=z9hG4bKPjC0097:
From: <sip:+18489001700@172.31.12.241>;tag=8a73c497cb0f433d9d525d869286ccb
To: <sip:+1800444444@172.31.12.241>;tag=4eF0mrg1SBQH
Call-ID: d4830ad76295451f9dd21ce8d281032f
CSeq: 4525 INVITE
Contact: <sip:172.31.12.241:5060>
Supported: sdp-anat
Server: Mediant SW/v.7.20A-u9001.256.393
Content-Type: application/sdp
Content-Length: 256
v=0
o=Sonus_UAC 105113295 2066628126 IN IP4 172.31.12.241
s=SIP Media Capabilities
t=0 0
m=audio 6000 RTP/AVP 0 101
c=IN IP4 172.31.12.241
a=rtpmap:0 PCMU/8000
a=rtpmap:101 telephone-event/8000
a=fmtp:101 0-15
a=sendrecv
a=rtp:6001
a=ptime:20
[File:TransportObject.cpp Line:133] [Time:13-02@10:53:34.845]
10:53:35.000 172.31.12.241 local0.notice [S=55557] [SID=3f32bb:12:4293] (N 47069) States: (#1238)AcSIPCall[Invited->LocalAccepte
10:53:35.000 172.31.12.241 local0.notice (#318)SBCTFeature[Deallocated] [File:Logger.cpp Line:417] [Time:13-02@10:53:34.845]
10:53:35.000 172.31.12.241 local0.notice [S=55558] [SID=3f32bb:12:4293] (N 47070) ---- Incoming SIP Message from 172.31.6.166:56:
10:53:35.000 172.31.12.241 local0.notice [S=55559] [SID=3f32bb:12:4293] ACK sip:172.31.12.241:5060 SIP/2.0
Via: SIP/2.0/UDP 172.31.6.166:56218;rport=56218;branch=z9hG4bKPjBb497f7a0e34fdf910cb154563245d0
Max-Forwards: 70

Line: 586 Column: 0 Syslog Listener: UDP Write Log: OFF Web Connection: 172.31.12.241 Total: 586 Error: 0 Warning: 0
  
```

Figure 59-2: Example of SIP Ladder Diagram in Syslog Viewer

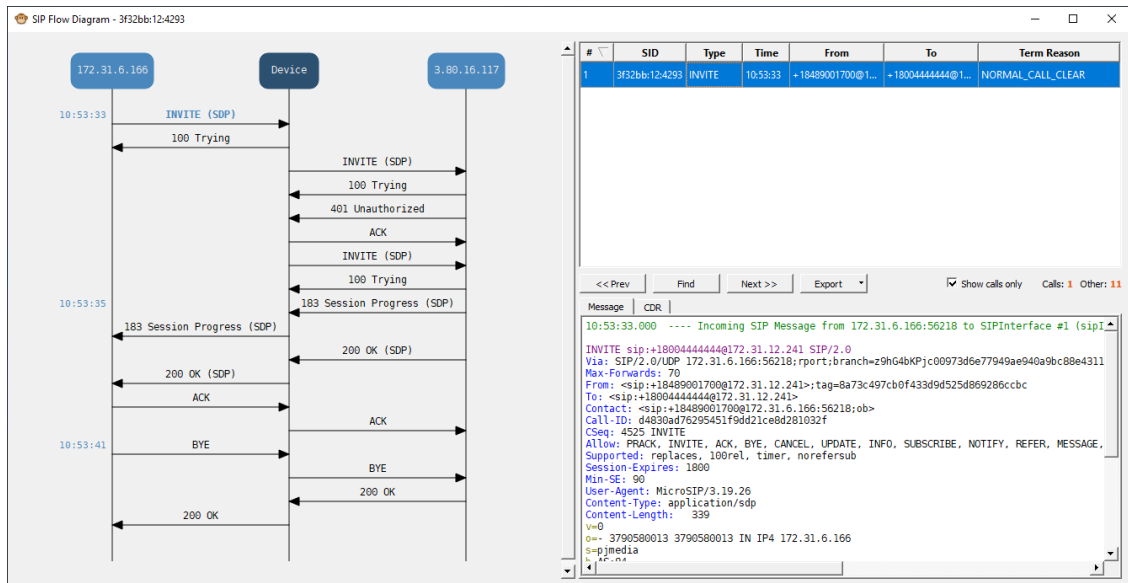

■ **Third-party, Syslog Server:** Any third-party, Syslog server program that enables filtering of messages according to parameters such as priority, IP sender address, time, and date.

### Syslog Message Description for CPU Overload

Whenever the device detects a CPU overload, it sends a Syslog message that shows CPU utilization of the different processes (tasks) per core. This information can help in identifying the cause of the overload. When the device detects a CPU overload, it sends a Syslog message every 10 seconds until it returns to normal state.



You can also view CPU utilization through the CLI, by using the following command:  
show system utilization

The figure below shows an example of a Syslog message generated because of a CPU overload. CPU utilization information is shown under the "CPUUtilMonitor" section (shown in pink). The subsequent table describes the displayed information.

```

CPUUtilMonitor: System CPU overload condition [Core 0/96] (CPU Util=98%; period=1000 [msec])
CPU utilization task report (monitored period=1000 [msec]; total=1000 [msec]) [File:CPUUtiliz
  Name(TID) Core Usage[ms] Usage[%] ( Total[ms] #Switch) [File:CPUUtilize.cpp
Task BKGR( 47)  0  952 ms  95.2% ( 952 ms 95.2%  1 ms  1863) [File:CPUUtilize.cpp
Task TLSA( 21)  0   8 ms   0.8% (   8 ms 0.8%  0 ms   975) [File:CPUUtilize.cpp
Task DSPD( 11)  0   7 ms   0.7% (   7 ms 0.7%  0 ms   201) [File:CPUUtilize.cpp
Task LPPT( 40)  0   0 ms   0.0% (   0 ms 0.0%  0 ms    1) [File:CPUUtilize.cpp
Task cli0( 42)  0   0 ms   0.0% (   0 ms 0.0%  0 ms    1) [File:CPUUtilize.cpp
Task STWR( 30)  0   0 ms   0.0% (   0 ms 0.0%  0 ms    1) [File:CPUUtilize.cpp
OS CPU Statistics Report [File:ErrorHandler.cpp Line:1946] [Time:13-02@12:20:00.040]
CPU#  User Nice System Idle IOWait IRQ SoftIRQ [File:ErrorHandler.cpp Line:1946] [Time:13-02
cpu0   4%  0%   2% 92%   0%  0%   0% [File:ErrorHandler.cpp Line:1946] [Time:13-02@
cpu1   4%  0%   6% 87%   0%  0%   0% [File:ErrorHandler.cpp Line:1946] [Time:13-02
cpu2   0%  0%   0% 99%   0%  0%   0% [File:ErrorHandler.cpp Line:1946] [Time:13-02
cpu3   7%  0%   1% 90%   0%  0%   0% [File:ErrorHandler.cpp Line:1946] [Time:13-02
    
```

**Table 59-7: CPU Overload Fields Description in Syslog Message**

Field	Description
First line (shown in pink)	
"Core"	Index of the CPU core.
"CPU Util"	CPU utilization (in percentage).
"period"	Total period (in msec).
Second line	
"monitored period"	Duration (in msec) of CPU overload within the total monitored period.
"total"	Monitored period (in msec).
Statistics per task (process) in overloaded cores only <b>Note:</b> By default, the Syslog message only shows the five most used tasks in the last period.	
"Name (TID)"	Name of task (process).
"Core"	Index of the CPU core.
"Usage [ms]"	Total time (msec) of monitored period that the task utilized CPU.
"Usage [%]"	Percentage of time of monitored period that the task utilized CPU.
"Total [ms (%)]"	Total time (in msec) and percentage that task utilized CPU during entire period.
"peak [ms]"	Maximum lasting time (msec) that the task utilized CPU during the period.
"#Switch"	Context switch time - number of consecutive periods that were allocated for this task.
Statistics per CPU core	
"CPU#"	Index of the CPU core.
"User"	Percentage of CPU utilization that occurred while executing at the user level (application).

Field	Description
"Nice"	Percentage of CPU utilization that occurred while executing at the user level with nice priority (Linux systems).
"System"	Percentage of CPU utilization that occurred while executing at the system level (kernel).
"Idle"	Percentage of time that the CPU was idle (%) during which no tasks were using the CPU core.
"IOWait"	Percentage of time that the CPU was idle (5) during which tasks were using the CPU core.
"IRQ"	IRQ time (in percentage).
"SoftIRQ"	SoftIRQ time (in percentage%).

## Configuring Debug Recording

This section describes how to configure debug recording and how to collect debug recording packets.



- Debug recording is collected only on the device's OAMP interface.
- For a detailed description of the debug recording parameters, see [Syslog, CDR and Debug Parameters](#).

## Configuring the Debug Recording Server Address

The procedure below describes how to configure the address of the debug recording server to where the device sends the captured traffic. Once you configure an address, the device generates debug recording packets for all calls. However, you can configure the device to generate debug recording packets for specific calls, using Logging Filter rules in the Logging Filters table (see [Configuring Log Filter Rules](#)).

### ➤ To configure the debug recording server's address:

1. Open the Logging Settings page (**Troubleshoot** tab > **Troubleshoot** menu > **Logging** folder > **Logging Settings**).

DEBUG RECORDING	
Debug Recording Destination IP	<input type="text" value="0.0.0.0"/>
Debug Recording Destination Port	<input type="text" value="925"/>

2. In the 'Debug Recording Destination IP' field, configure the IP address of the debug capturing server.
3. In the 'Debug Recording Destination Port' field, configure the port of the debug capturing server.
4. Click **Apply**.

## Collecting Debug Recording Messages

To collect debug recording packets, use the open source packet capturing program, Wireshark. To analyze AudioCodes debug recording protocol, proprietary Wireshark plug-in files are required.



- The default debug recording port is 925. You can change the port in Wireshark (**Edit** menu > **Preferences** > **Protocols** > **AC DR**).
- The plug-in files are per major software release of Wireshark. For more information, contact the sales representative of your purchased device.
- Make sure that you download the plug-in files that match your computer's Windows operating system (32-bit or 64-bit processor).
- The source IP address of the messages is always the OAMP IP address of the device.

### ➤ To view debug recording messages using Wireshark:

1. Install Wireshark on your computer (which can be downloaded from <https://www.wireshark.org>).
2. Download AudioCodes proprietary Wireshark plug-in files according to the type of installation (32-bit or 64-bit):
  - a. Got to AudioCodes firmware download website page at <https://www.audiocodes.com/library/firmware>, and then navigate to the page for the "Wireshark Plugins":







## Wireshark Plugins

[Click here to download](#)

- b. Click the area shown above; folders containing the plug-in files for different Wireshark versions are displayed, as shown in the example below:

Wireshark

Select All Sort By Name ▾ ☰ ⋮

<input type="checkbox"/>	<input type="checkbox"/>	<input type="checkbox"/>	<input type="checkbox"/>
			
Wireshark 2.0 91 MB	Wireshark 2.4 12 MB	Wireshark 3.0 2 MB	Wireshark 3.2 2 MB

I agree: [Terms and Conditions](#)



0 Items Selected Download

- c. Click the folder icon of the required Wireshark version; zipped folders of the selected Wireshark version are displayed:

Wireshark > Wireshark 3.2

Wireshark 3.2

Select All Sort By Name ▾ ☰ ⋮

<input type="checkbox"/>	<input type="checkbox"/>	<input type="checkbox"/>
		
dtlds.zip 2 KB	plugins.zip 731 KB	Plugins_x64.zip 896 KB

I agree: [Terms and Conditions](#)

0 Items Selected Download

- d. Select the check box of the required zipped plug-in files, select the **I agree** (to the terms and conditions) check box, and then click **Download**; the zipped folder is downloaded to your computer.

 Make sure that you select the zipped plug-in folder that matches your computer's





Windows operating system (32-bit or 64-bit processor):

- **plugins.zip**: For 32-bit
- **Plugins\_x64.zip**: for 64-bit

- e. Unzip the downloaded plug-in folder; a folder containing all the plug-in files (.dll) is created.
- f. Copy all the .dll files to the *plugin* folder (or for Wireshark Version 3.0 or later, to *plugins\<Wireshark version>\epan*) of the Wireshark installation. If the folder already has existing .dll files with the same name, overwrite them.

3. Start your Wireshark program.

4. In the filter field, type "acdr" to view the debug recording messages.

The device adds the header "AUDIOCODES DEBUG RECORDING" to each debug recording message, as shown below:

The screenshot shows the Wireshark interface with the filter field set to "acdr". The packet list pane shows several Syslog and SIP/SDP packets. The packet details pane is expanded to show a "Proprietary" header "AUDIOCODES DEBUG RECORDING" followed by a "User Datagram Protocol" section. The status bar at the bottom indicates "AUDIOCODES DEBUG RECORDING (acdr), 42 bytes".

## Debug Capturing on Physical VoIP Interfaces

You can capture traffic on the device's physical (Ethernet LAN) VoIP interfaces (Layer-2 VLAN tagged packets). The captured traffic can be saved in a PCAP-format file (suitable for Wireshark) to a TFTP (default) or an FTP server. The generated PCAP file is in the Extensible Record Format (ERF). The maximum file size of debug captures that can be saved to the device is 20 MB/100 MB.

To capture traffic on physical VoIP interfaces, use the following CLI commands:

- Starts physical VoIP debug capture:

```
# debug capture voip physical eth-lan
# debug capture voip physical start
```

- Captures packets continuously in a cyclical buffer (packets always captured until stop command):

```
# debug capture VoIP physical cyclic buffer
```

- Retrieves latest capture (PCAP file) saved on a specified server:

```
# debug capture VoIP physical get_last_capture <TFTP/FTP server IP address>
```

The file is saved to the device's memory (not flash) and erased after a device reset.

- Marks the captured file (useful for troubleshooting process):

```
# debug capture VoIP physical insert-pad
```

Before running this command, the debug capture must be started.

- Displays debug status and configured rules:

```
# debug capture VoIP physical show
```

- Specifies the destination (FTP, TFTP, or USB) where you want the PCAP file sent:

```
# debug capture VoIP physical target <ftp|tftp|usb>
```

- Stops the debug capture, creates a file named debug-capture-voip-<timestamp>.pcap, and sends it to the TFTP or FTP server:

```
# debug capture voip physical stop <TFTP/FTP server IP address>
```

If no IP address is defined, the capture is saved on the device for later retrieval.

## Debug Capturing on VoIP Interfaces

You can capture network traffic on the device's VoIP interfaces per VLAN device that is configured in the Ethernet Devices table (see [Configuring Underlying Ethernet Devices](#) on page 117). You can send the captured traffic to the following:

- CLI terminal screen (tcpdump format): The captured network packets are displayed in the CLI until you end the capture by pressing the CTRL + C key combination.
- Remote server (TFTP or FTP): The capture is saved as a PCAP file (suitable for Wireshark) and sent to a specified server (default is TFTP). The generated PCAP file is in the Extensible Record Format (ERF) and is saved on the device during the capture. The maximum file size that can be saved to the device is 10 MB and as long as the capture continues, the packets are written to this 10-MB file in a cyclic manner. When you end the capture (by pressing the CTRL + C key-combination), the device sends the capture file to the server.

➤ **To capture traffic on a VLAN VoIP device:**

1. Define the VLAN ID on which you want to do the capture:

```
# debug capture voip interface vlan <VLAN ID>
```

2. Define the protocol that you want to capture (all | arp | icmp | ip | ipv6 | tcp | udp):

```
# debug capture voip interface vlan <VLAN ID> proto <Protocol>
```

3. Define a source and/or destination IP address to be captured (any | ipv4\_address | ipv6\_address):

```
# debug capture voip interface vlan <VLAN ID> proto <Protocol> host <IP Address>
```

At this stage, you can press Enter to output the capture to the CLI terminal window, or you can continue with the next step to configure additional commands.

4. Define a source and/or destination port number to be captured (any | [1-65535]):

```
# debug capture voip interface vlan <VLAN ID> proto <Protocol> host <IP Address> port <Port>
```

At this stage, you can press Enter to output the capture to the CLI terminal window, or you can continue with the next step to configure additional commands.

5. Define the IP address (IPv4) of the server (TFTP or FTP) to where you want the device to send the captured file:

```
# debug capture voip interface vlan <VLAN ID> proto <Protocol> host <IP Address> ftp-server|tftp-server <IP Address>
```

6. Press Enter to save the capture to a file on the device.
7. Press the CTRL + C key-combination to stop the capture and to send the file to the defined server.

## 60 Self-Testing

The device features the following self-testing modes to identify faulty hardware components:

- **Detailed Test (Configurable):** This test verifies the correct functioning of the different hardware components on the device. This test is done when the device is taken out of service (i.e., not in regular service for processing calls). The test is performed on startup when initialization of the device completes.

To enable this test, set the ini file parameter, `EnableDiagnostics` to 1 or 2, and then reset the device. Upon completion of the test and if the test fails, the device sends information on the test results of each hardware component to the Syslog server.

The following hardware components are tested:

- DSPs - when `EnableDiagnostics` = 1 or 2
- Analog interfaces - when `EnableDiagnostics` = 1 or 2



- To return the device to regular operation and service, disable the test by setting the ini file parameter, `EnableDiagnostics` to 0, and then reset the device.
- While the test is enabled, ignore errors sent to the Syslog server.

- **Startup Test (automatic):** This hardware test has minor impact in real-time. While this test is executed, the regular operation of the device is disabled. If an error is detected, an error message is sent to the Syslog.

## 61 Creating Core Dump and Debug Files upon Device Crash

For debugging, you can configure the device to create a core dump file and/or debug file. The files may assist you in identifying the cause of the crash. The core dump can either be included in or excluded from the debug file, or alternatively, sent separately to a TFTP server. You can then provide the files to AudioCodes support team for troubleshooting.

- **Core Dump File:** You can enable the device to send a core dump file to a remote destination upon a device crash. The core dump is a copy of the memory image at the time of the crash. It provides a powerful tool for determining the root cause of the crash. When enabled, the core dump file is sent to a user-defined TFTP server (IP address). If no address is configured, the core dump file is saved to the device's flash memory (if it has sufficient memory) and can be included in the debug file (see below). Each time the device crashes, the new core dump file replaces the previous core dump file, if exists.

The core dump file is saved as a binary file with the following file name: "**core\_<device name>\_ver\_<firmware version>\_mac\_<MAC address>\_<date>\_<time>**". For example, *core\_acDevice\_ver\_720-8-4\_mac\_00908F099096\_1-02-2015\_3-29-29*.

- **Debug File:** You can manually retrieve the debug file from the device (flash memory) and save it to a folder on your local PC. The device creates the debug file when an exception occurs. Each time the device creates a new debug file, it overwrites the existing file. The debug file contains the following information:

- Exception information, indicating the specific point in the code where the crash occurred and a list of up to 50 of the most recent SNMP alarms that were raised by the device before it crashed.
- Latest syslog messages that were recorded prior to the crash.
- Core dump. The core dump is only included in the debug file if all the following conditions are met:
  - ◆ You have enabled core dump generation (see below).
  - ◆ You have not configured an IP address to send the core dump to a remote server (see below).
  - ◆ The device has sufficient memory on its flash memory.
- The debug file may include additional application-proprietary debug information.

The debug file is saved as a zipped file with the following file name: "**debug\_<device name>\_ver\_<firmware version>\_mac\_<MAC address>\_<date>\_<time>**". For example, *debug\_acDevice\_ver\_720-8-4\_mac\_00908F099096\_1-03-2015\_3-29-29*.

The following procedure describes how to configure core dump file creation through the Web interface.

➤ **To enable core dump file generation:**

1. (Optional) Set up a TFTP server to where you want to send the core dump file.
2. Open the Debug Files page (**Troubleshoot** menu > **Troubleshoot** tab > **Debug** folder > **Debug Files**).

CORE DUMP SETTINGS	
Enable Core Dump	Disable
Core Dump Destination IP	0.0.0.0

3. From the 'Enable Core Dump' drop-down list, select **Enable**.
4. (Optional) If you want the device to send the core dump file to a remote TFTP server, then in the 'Core Dump Destination IP' field, enter the IP address of the remote server.
5. Click **Apply**, and then reset the device with a save-to-flash for your settings to take effect.

You can also delete the core dump file through CLI, as described in the following procedure:

➤ **To delete the core dump file:**

- Navigate to the root CLI directory (enable mode), and then enter the following command:

```
# clear debug-file
```

The following procedure describes how to download the debug file from the device through the Web interface.

➤ **To download the debug file:**

- In the Debug Files page, click the **Save Debug File** button.

SAVE THE **DEBUG** FILE TO THE PC

Save Debug File



- Downloading the debug file may take a few minutes. Depending on file size, it may even take more than 10 minutes.
- You can also download (Get) the debug file from the device through SFTP. The file is located in the device's **/debug** folder. Your SFTP client needs to authenticate itself with the SFTP server (i.e., the device) and access is granted only to users with Security Administrator level. In addition, you must enable SSH on the device.
- The device may take a long time to prepare the debug file for SFTP transfer when it contains much information. Some SFTP clients (for example, WinSCP and FileZilla) have a short default connection timeout and if the file transfer is not



started within this timeout, the transfer attempt is aborted. Therefore, it is recommended to configure a longer timeout for your SFTP client application.

## 62 Debugging Web Services

If you have configured remote Web services (see [Remote Web Services](#)), you can enable debugging of the remote HTTP clients. You can configure the debug level from 1 to 3, where 3 is the most detailed. The debug messages are sent to the Syslog server.

➤ **To configure debugging of Web services:**

1. Open the Web Service Settings page (**Setup** menu > **IP Network** tab > **Web Services** folder > **Web Service Settings**).
2. In the 'Debug Level' field (RestDebugMode), enter the debug level (or disable debugging by configuring it to 0):

Debug Level

•

3. Click **Apply**.





2. To send call flow messages of specific calls only (e.g., for a specific IP Group), configure a Log Filter rule:
  - a. Open the Logging Filters table (see [Configuring Log Filter Rules](#) on page 1302)
  - b. Click **New** , and then configure the rule as desired, but with the following parameter settings:
    - ◆ 'Log Destination': **Call Flow Server**
    - ◆ 'Log Type': **Call Flow**

The screenshot shows a configuration window titled "Logging Filters". It has a "GENERAL" tab selected. The settings are as follows:

Index	0
Filter Type	IP Group
Value	
Log Destination	Call Flow Server
Log Type	Call Flow
Mode	Enable

- c. Click **Apply**.



- If you have not configured any filtering rule for SIP call flow in the Logging Filters table, the device sends call flow messages to OVOC for all calls.
- The device does not send OVOC SIP messages that fail authentication (SIP 4xx challenge).
- The feature does not support REGISTER messages.
- If the device experiences a CPU overload, it stops sending SIP call flow messages to OVOC until the CPU returns to normal levels.

## 64 Enabling Same Call Session ID over Multiple Devices

You can enable the use of a Global Session ID to identify call sessions traversing multiple devices. The Global Session ID is a randomly assigned ID number that identifies each call session. The ID is unique to the call session and remains the same throughout the session even if the call traverses multiple devices.

The Global Session ID appears in SIP messages using the AudioCodes proprietary SIP header, AC-Session-ID, as shown in the example below:

```
INVITE sip:2000@172.17.113.123;user=phone SIP/2.0
```

```
...
```

```
AC-Session-ID: 7f6941530b31d715
```

```
...
```

If the device receives an incoming SIP message containing the Global Session ID, it sends the same Global Session ID in the outgoing SIP message. If the incoming SIP message does not contain a Global Session ID or if a new session is initiated by the device, the device generates a new, unique Global Session ID and adds it to the outgoing SIP message.

To enable the Global Session ID, load an ini file to the device with the `SendAcSessionIdHeader` parameter configured to 1.



- The Global Session ID is not included in Syslog messages.
- By default, the device does not include the Global Session ID in CDRs. However, you can customize CDRs to include it. For more information, see [Customizing CDRs for Gateway Calls](#) on page 1273 and [Customizing CDRs for SBC Calls and Test Calls](#) on page 1279.
- If you disable this feature, the device sends outgoing SIP messages without a Global Session ID (even if a Global Session ID was received in the incoming SIP message).

## 65 Analog Line Testing

This section describes analog line testing.

### FXO Line Testing

The device can test the telephone lines connected to its FXO ports through SNMP using the SNMP `acAnalogFxoLineTestTable` table. The tests provide various line measurements. In addition to the tests, a keep-alive test is also done every 100 msec on each of the analog ports to detect communication problems with the analog equipment:

- Line Current (mA)
- Line Voltage (V)
- Hook (0 = on-hook; 1 = off-hook)
- Ring (0 - Off; 1 - On)
- Line Connected (0 = Disconnected; 1 = Connected)
- Polarity state (0 = Normal; 1 = Reversed, 2 = N\A)
- Line polarity (0 = Positive; 1 = Negative)
- Message Waiting Indication (0 = Off; 1 = On)

You can also view the above information through the Web interface (see [Viewing Port Information](#)).



Analog line testing is traffic affecting and therefore, do the test only for monitoring and when there are no active calls in progress.

### FXS Line Testing

You can test FXS telephone lines that are connected to the device's FXS ports. The test is done per FXS port and FXS country coefficient type - USA (70) or TBR21 (66). The output of the test displays various line statuses and electrical line measurements. Some of the supported FXS status and line measurements include:

- Hazardous Potential Tests (HPT) - hazardous AC or DC voltage is present on the tip and ring or both.
- Foreign Electromotive Force Tests (FEMT) - foreign voltage is present on the tip, ring or both
- Resistive Fault Tests (RFT) - tip or ring is shorted to ground, or they are shorted to each other
- Receiver Off-hook Tests (ROH) - one or more phones are off hook on phone line during test.

- Ringer Impedance Tests (RIT)
- AC/DC line voltage
- AC/DC line current
- Line resistance
- Line capacity
- Hook status (on or off)
- Message Waiting Indication (MWI) status (on or off)
- Ring status (on or off)
- Reversal polarity status (on or off)

The FXS line test is currently supported only through CLI.



FXS line testing is supported only by the FXS module type that supports outdoor FXS cabling.

➤ **To run the FXS line test:**

1. Access the VoIP command set:

```
# configure voip
```

2. Access the FXS interface command set:

```
(config-voip)# interface fxs-fxo
```

3. Type the following command:

```
(fxs-fxo)# fxs-line-testing < Module/Port > {66|70}
```

For example, to test FXS port 4 on FXS module1 with coefficient type USA:

```
(fxs-fxo)# fxs-line-testing 1/4 70
```

## FXO Line Impedance Matching Testing

This feature enables you to determine the best impedance value to configure for an analog FXO line. This option tests several impedance values to determine which value returns the best Echo Return Loss (ERL). Once this value is determined, you can configure it on the FXO channel.

Voice quality problems may be experienced in analog lines especially when long physical lines are plugged into the device's FXO ports. Poor quality in analog lines is mostly due to low ERL. These problems may be diminished if the appropriate adjustments are made to best match the FXO interface to the characteristics of the analog line in the particular country in which you have installed the device.

## Running the Line Impedance Test

Line impedance testing is done using the `AnalogLineTest` command through the device's Command Shell. The command runs the line test on a specified channel and for every specified impedance level (configured by a range), and then saves the results.



Before performing the line impedance test, you must load a Voice Prompt file to the device.

### ➤ To run the line impedance test:

1. Access the device's Command Shell, which is done by appending "FAE" to the device's IP address in your Web browser's URL (e.g., `http://10.13.4.13/FAE`), and then clicking the **Cmd Shell** option located in the left pane.
2. On the command-line prompt, enter the `AnalogLineTest` command in the following format:

```
AnalogLineTest <FXO Channel> <Impedance Low Limit> <Impedance High Limit> <Display Syslog>
```

Where:

- *<FXO Channel>*: FXO channel that you want to test and configure.
- *<Impedance Low limit>*: Low level impedance value (0-15) that you want to test
- *<Impedance High limit>*: High level impedance value (0-15) that you want to test
- *<Display Syslog>*: Defines (0/1) if information is sent to Syslog during the test

The following example runs the test on FXO channel 4 with impedance levels 0 to 5 and sends the output to Syslog (1):

```
>/VoiceEngn/AnalogLineTest>AnalogLineTest 4 0 5 1
Starting.....
Check syslog for more information.
This command starts a test on channel 4.
Impedances 0-5 will be tested.
Messages are displayed in syslog during the test.
```

The following describes the sequence of events when you run the impedance matching test:

3. The test is run using the AnalogLineTest command.
4. The tested channel is opened with default parameters and set to off-hook state.
5. The channel is configured with the low level impedance value.
6. A call involving the channel is started.
7. A PCM Voice Prompt file is played in the TDM direction.
8. The returned echo is recorded in a second PCM file.
9. Both of these files are scanned simultaneously and an ERL value is obtained.
10. The above steps are repeated for each of the specified impedance levels.
11. When the test completes, the channel is on-hooked and closed.

The figure below shows the correlation between the impedance values in binary (0-15) and the actual impedance values (Ohms).

#### AC Impedance Selection.

The off-hook ac termination is selected from the following:

0000 = 600  $\Omega$

0001 = 900  $\Omega$

0010 = 270  $\Omega$  + (750  $\Omega$  || 150 nF) (TBR21) and 275  $\Omega$  + (780  $\Omega$  || 150 nF)

0011 = 220  $\Omega$  + (820  $\Omega$  || 120 nF) (Australia/New Zealand) and 220  $\Omega$  + (820  $\Omega$  || 115 nF) (Slovakia/South Africa/Germany/Austria/Bulgaria)

0100 = 370  $\Omega$  + (620  $\Omega$  || 310 nF) (New Zealand #2/India)

0101 = 320  $\Omega$  + (1050  $\Omega$  || 230 nF) (England)

0110 = 370  $\Omega$  + (820  $\Omega$  || 110 nF)

0111 = 275  $\Omega$  + (780  $\Omega$  || 115 nF)

1000 = 120  $\Omega$  + (820  $\Omega$  || 110 nF)

1001 = 350  $\Omega$  + (1000  $\Omega$  || 210 nF)

1010 = 0  $\Omega$  + (900  $\Omega$  || 30 nF)

1011 = 600  $\Omega$  + 2.16  $\mu$ F

1100 = 900  $\Omega$  + 1  $\mu$ F

1101 = 900  $\Omega$  + 2.16  $\mu$ F

1110 = 600  $\Omega$  + 1  $\mu$ F

1111 = Global impedance

## Displaying Line Impedance Test Results

After you have run the line impedance test (as described in [Running the Line Impedance Test](#) on the previous page), you can view the test results. The results include a list of impedance values and DC levels relative to the measured ERL values. The higher the ERL, the better the impedance.

### ➤ To view line impedance test results:

1. Access the device's Command Shell.
2. On the command-line prompt, enter the following command:

```
/VoiceEngn/AnalogLineTest>AnalogLineTestResults
```

The following example displays test results of FXO channel 4, where the Impedance 0 (600 Ohms) returns the best (highest) ERL (25.66):

```
/VoiceEngn/AnalogLineTest>AnalogLineTestResults
The Analog Line Test Measurements for CID 4:
```

Impedance	ERL in DB	DC level	Offset
0. 600 OHMS	25.66	-48.48	60.82
1. 900 OHMS	15.87	-46.02	80.71
2. 270 OHMS +(750 OHMS    150 nF)	13.51	-46.56	75.81
3. 220 OHMS +(820 OHMS    120 nF)	12.90	-47.22	70.31
4. 370 OHMS +(620 OHMS    310 nF)	15.16	-45.88	82.04
5. 320 OHMS +(1050 OHMS    230 nF)	11.92	-47.24	70.10

Analog Line Test successfully completed.



The AnalogLineTestResults command only displays the results of the last test that was run.

## Configuring the Best Impedance Level

After you have run the test, you can configure the FXO channel with the best impedance value obtained from the test result.

### ➤ To configure the FXO channel with best impedance value:

1. Access the device's Command Shell.
2. On the command-line prompt, enter the following command:

```
/VoiceEngn/AnalogLineTest>AnalogLineTestConfigureImpedance
```

In our example, where the impedance test of FXO channel 4 resulted in the best ERL (25.66) for 0 to 600 Ohms, the command automatically configures the channel with this ERL:

```
/VoiceEngn/AnalogLineTest>AnalogLineTestConfigureImpedance
```

Best ERL (25.66) was measured with impedance 0. Channel 4 configured with this impedance



## 66 Out-of-Service Physical Reasons for FXS Port

The device takes an FXS physical port out of service when any one of the following occurs:

- The Serial Peripheral Interface (SPI) connection with the port is lost. The device sends the SNMP alarm `acAnalogPortSPIOutOfService` for this out-of-service reason.
- The temperature of the port has exceeded the temperature threshold for normal operation. The device sends the SNMP alarm `acAnalogPortHighTemperature` for this out-of-service reason.
- The port is inactive due to a ground fault. The device sends the SNMP alarm `acAnalogPortGroundFaultOutOfService` for this out-of-service reason.

When the FXS is taken out of service due to any one of the above, the device sends the SNMP alarm `acPortServiceAlarm`.



Old FXS module hardware versions support out-of-service for SPI only.

## 67 Testing SIP Signaling Calls

A simulated endpoint can be configured on the device to test SIP signaling of calls between it and a remote destination. This feature is useful in that it can remotely verify SIP message flow without involving the remote end side in the debug process. The SIP test call simulates the SIP signaling process - call setup, SIP 1xx responses, through to completing the SIP transaction with a 200 OK.

The test call sends Syslog messages to a Syslog server, showing the SIP message flow, tone signals (e.g., DTMF), termination reasons, as well as voice quality statistics and thresholds (e.g., MOS).

### Configuring Test Call Endpoints

The Test Call Rules table lets you test SIP signaling (setup and registration) and media (DTMF signals) of calls between a simulated phone on the device and a remote IP endpoint. These tests involve both incoming and outgoing calls, where the test endpoint can be configured as the caller or called party. The simulated phone and remote endpoints are defined as SIP URIs (user@host) and the remote endpoint can be defined as an IP Group or IP address.

Test calls can be dialed automatically at a user-defined interval and/or manually when required. When a SIP test call is initiated, the device generates a SIP INVITE towards the remote endpoint (e.g., a SIP proxy server or softswitch). It simulates the SIP call setup process, managing SIP 1xx responses and completing the SIP transaction with a 200 OK.



- By default, you can configure up to five test call rules. However, you can increase this number by installing a License Key that licenses the required number. For more information, contact the sales representative of your purchased device.
- The device's Call Admission Control (CAC) feature (see [Configuring Call Admission Control](#) on page 947) does not apply to Test Calls.

The following procedure describes how to configure test call rules through the Web interface. You can also configure it through ini file [Test\_Call] or CLI (`configure troubleshoot > test-call test-call-table`).

#### ➤ To configure a test call rule:

1. Open the Test Call Rules table (**Troubleshoot** menu > **Troubleshoot** tab > **Test Call** folder > **Test Call Rules**).
2. Click **New**; the following dialog box appears:

3. Configure a test call according to the parameters described in the table below.
4. Click **Apply**, and then save your settings to flash memory.

**Table 67-1: Test Call Rules Table Parameter Descriptions**

Parameter	Description
Common	
'Index'	<p>Defines an index number for the new table row.</p> <p><b>Note:</b> Each row must be configured with a unique index.</p>
'Endpoint URI' endpoint-uri [Test_Call_EndpointURI]	<p>Defines the endpoint's URI. This can be defined as a user or user@host. The device identifies this endpoint only by the URI's user part. The URI's host part is used in the SIP From header in REGISTER requests.</p> <p>The valid value is a string of up to 150 characters. By default, the parameter is not configured.</p> <p><b>Note:</b> The parameter is mandatory.</p>
'Called URI' called-uri [Test_Call_CalledURI]	<p>Defines the destination (called) URI (user@host).</p> <p>The valid value is a string of up to 150 characters. By default, the parameter is not configured.</p>
'Route By' route-by [Test_Call_RouteBy]	<p>Defines the type of routing method. This applies to incoming and outgoing calls.</p> <ul style="list-style-type: none"> <li>■ [1] <b>IP Group</b> = (Default) Calls are matched by (or routed to) an IP Group. To specify the IP Group,</li> </ul>

Parameter	Description
	<p>see the 'IP Group' parameter in the table.</p> <ul style="list-style-type: none"> <li>■ [2] <b>Dest Address</b> = Calls are matched by (or routed to) a destination IP address. To configure the address, see the 'Destination Address' parameter in the table.</li> </ul> <p><b>Note:</b></p> <ul style="list-style-type: none"> <li>■ If configured to <b>Dest Address</b>: <ul style="list-style-type: none"> <li>✓ You must assign a SIP Interface (see the 'SIP Interface' below).</li> <li>✓ The IP Profile of the default IP Group (ID 0) is used. You can use a different IP Profile, by specifying an IP Group in the 'IP Group' parameter (below).</li> </ul> </li> <li>■ For REGISTER messages, if configured to <b>IP Group</b>, only Server-type IP Groups can be used.</li> </ul>
<p>'IP Group' ip-group-id [Test_Call_IPGroupName]</p>	<p>Assigns an IP Group. This is the IP Group that the test call is sent to or received from.</p> <p>By default, no value is defined.</p> <p>To configure IP Groups, see <a href="#">Configuring IP Groups</a>.</p> <p><b>Note:</b></p> <ul style="list-style-type: none"> <li>■ The parameter is applicable if you configure the 'Route By' parameter to <b>IP Group</b>.</li> <li>■ You can also use this parameter if you configure the 'Route By' parameter to <b>Dest Address</b>. This allows you to associate an IP Profile (that is assigned to the specified IP Group) with the Test Call. The Test Call is not routed to the IP Group, but uses only its IP Profile.</li> <li>■ The IP Group is used for incoming and outgoing calls.</li> </ul>
<p>'Destination Address' dst-address [Test_Call_DestAddress]</p>	<p>Defines the destination host.</p> <p>The valid value is an IP address[:port] in dotted-decimal notation or a DNS name[:port].</p> <p><b>Note:</b> The parameter is applicable only if you configure the 'Route By' parameter to <b>Dest Address</b>.</p>
<p>'SIP Interface'</p>	<p>Assigns a SIP Interface. This is the SIP Interface to</p>

Parameter	Description
sip-interface-name [Test_Call_SIPInterfaceName]	which the test call is sent and received from. By default, no value is defined. To configure SIP Interfaces, see <a href="#">Configuring SIP Interfaces</a> . <b>Note:</b> The parameter is applicable only if the 'Route By' parameter is configured to <b>Dest Address</b> .
'Application Type' application-type [Test_Call_ApplicationType]	Defines the application type for the endpoint. This associates the IP Group and SRD to a specific SIP interface. For example, assume two SIP Interfaces are configured in the SIP Interfaces table where one is set to "GW" and one to "SBC" for the 'Application Type'. If you configure the parameter to <b>SBC</b> , the device uses the SIP Interface set to "SBC". <ul style="list-style-type: none"> <li>■ [0] <b>GW</b> = (Default) Gateway application</li> <li>■ [2] <b>SBC</b> = SBC application</li> </ul>
'Destination Transport Type' dst-transport [Test_Call_DestTransportType]	Defines the transport type for outgoing calls. <ul style="list-style-type: none"> <li>■ [-1] = Not configured (default)</li> <li>■ [0] <b>UDP</b></li> <li>■ [1] <b>TCP</b></li> <li>■ [2] <b>TLS</b></li> <li>■ [3] <b>SCTP</b></li> </ul> <b>Note:</b> The parameter is applicable only if you configure the 'Route By' parameter to <b>Dest Address</b> .
'QoE Profile' qoe-profile [Test_Call_QOEProfile]	Assigns a QoE Profile to the test call. By default, no value is defined. To configure QoE Profiles, see <a href="#">Configuring Quality of Experience Profiles</a> .
'Bandwidth Profile' bandwidth-profile [Test_Call_BWProfile]	Assigns a Bandwidth Profile to the test call. By default, no value is defined. To configure Bandwidth Profiles, see <a href="#">Configuring Bandwidth Profiles</a> .
Media	
'Offered Audio Coders Group'	Assigns a Coder Group, configured in the Coder

Parameter	Description
<p>offered-audio-coders-group-name</p> <p>[Test_Call_ OfferedCodersGroupName]</p>	<p>Groups table, whose coders are added to the SDP Offer in the outgoing Test Call.</p> <p>If not configured, the device uses the Coder Group specified by the 'Extension Coders Group' parameter of the IP Profile associated with the rule's IP Group (see the 'IP Group' parameter above).</p> <p>To configure Coder Groups, see <a href="#">Configuring Coder Groups</a>.</p> <p><b>Note:</b></p> <ul style="list-style-type: none"> <li>■ The parameter's settings override the corresponding SBC parameter of the IP Profile associated with the rule's IP Group.</li> <li>■ If you don't configure this parameter nor the corresponding parameter of the associated IP Profile, the device uses Coder Group ID 0.</li> </ul>
<p>'Allowed Audio Coders Group'</p> <p>allowed-audio-coders-group-name</p> <p>[Test_Call_ AllowedAudioCodersGroupName]</p>	<p>Assigns an Allowed Audio Coders Group, configured in the Allowed Audio Coders Groups table, which defines only the coders that can be used for the test call. For incoming test calls, the device accepts the first offered coder that is supported and allowed.</p> <p>If not configured, the device uses the Allowed Audio Coders Group specified by the 'Allowed Audio Coders' parameter of the IP Profile associated with the rule's IP Group (see the 'IP Group' parameter above).</p> <p>To configure Allowed Audio Coders Groups, see <a href="#">Configuring Allowed Audio Coder Groups</a>.</p> <p><b>Note:</b> The parameter's settings override the corresponding SBC parameter of the IP Profile associated with the rule's IP Group.</p>
<p>'Allowed Coders Mode'</p> <p>allowed-coders-mode</p> <p>[Test_Call_AllowedCodersMode]</p>	<p>Defines the mode of the Allowed Coders feature for the Test Call.</p> <ul style="list-style-type: none"> <li>■ [-1] <b>Not Configured</b> = (Default) The mode is according to the 'Allowed Coders Mode' parameter of the IP Profile associated with the rule's IP Group (see the 'IP Group' parameter above).</li> <li>■ [0] <b>Restriction</b> = The device uses only allowed coders as configured in the 'Allowed Audio Coders</li> </ul>

Parameter	Description
	<p>Group' parameter (above) and removes all other coders from the SDP offer. If you have also configured additional coders in the 'Offered Audio Coders Group' parameter (above), then these coders are added to the SDP offer if they appear in the assigned Allowed Audio Coders Group.</p> <ul style="list-style-type: none"> <li>■ [1] <b>Preference</b> = The device re-arranges the priority (order) of the coders in the incoming SDP offer according to their order of appearance in the Allowed Audio Coders Group. The coders in the original SDP offer are listed after the allowed coders.</li> <li>■ [2] <b>Restriction and Preference</b> = The device uses both the <b>Restriction</b> and <b>Preference</b> options.</li> </ul> <p><b>Note:</b> Except for <b>Not Configured</b>, the parameter's settings override the corresponding SBC parameter of the IP Profile associated with the rule's IP Group.</p>
<p>'Media Security Mode' media-security-mode [Test_Call_MediaSecurityMode]</p>	<p>Defines the handling of RTP and SRTP.</p> <ul style="list-style-type: none"> <li>■ [-1] <b>Not Configured</b> = (Default) Handling is according to the 'SBC Media Security Mode' parameter of the IP Profile associated with the rule's IP Group (see the 'IP Group' parameter above).</li> <li>■ [0] <b>As is</b> = No special handling for RTP\SRTP is done.</li> <li>■ [1] <b>SRTP</b> = Only SRTP media lines are negotiated and RTP media lines are removed from the incoming SDP offer-answer.</li> <li>■ [2] <b>RTP</b> = Only RTP media lines are negotiated and SRTP media lines are removed from the incoming SDP offer-answer.</li> <li>■ [3] <b>Both</b> = Each SDP offer-answer is extended (if not already) to two media lines - one for RTP and one for SRTP.</li> </ul> <p><b>Note:</b></p> <ul style="list-style-type: none"> <li>■ To enable SRTP, configure the [EnableMediaSecurity] parameter to [1].</li> </ul>

Parameter	Description
	<ul style="list-style-type: none"> <li>■ Except for <b>Not Configured</b>, the parameter's settings override the corresponding SBC parameter of the IP Profile that is associated with the rule's IP Group.</li> </ul>
<p>'Play DTMF Method' play-dtmf-method [Test_Call_PlayDTMFMethod]</p>	<p>Defines the method used by the device for sending DTMF digits that are played to the called party when the call is answered.</p> <ul style="list-style-type: none"> <li>■ [-1] <b>Not Configured</b> = The mode is according to the 'Alternative DTMF Method' and 'RFC 2833 Mode' parameters of the IP Profile associated with the rule's IP Group (see the 'IP Group' parameter above).</li> <li>■ [0] <b>RFC 2833</b> = (Default) The device sends the DTMF digits using the RFC 2833 method (out-of-band).</li> <li>■ [1] <b>In Band</b> = The device sends the DTMF digits in-band (in the RTP stream).</li> </ul> <p><b>Note:</b></p> <ul style="list-style-type: none"> <li>■ The parameter is applicable only if you configure the 'Play' parameter to <b>DTMF</b>.</li> <li>■ Playing DTMF digits requires DSP resources when the DTMF method is <b>In Band</b>.</li> <li>■ If the Test Call sends the SDP offer, the recommended DTMF configuration of the associated IP Profile is as follows: <ul style="list-style-type: none"> <li>✓ For RFC 2833: 'RFC 2833 Mode' = <b>Extend</b>; 'Alternative DTMF Method' = <b>As Is</b></li> <li>✓ For In Band: 'RFC 2833 Mode' = <b>Disallow</b>; 'Alternative DTMF Method' = <b>As Is</b></li> </ul> </li> <li>■ If the Test Call receives the SDP offer, the recommended configuration is as follows (i.e., incoming SDP offer determines the method): 'RFC 2833 Mode' = <b>As Is</b>; 'Alternative DTMF Method' = <b>As Is</b></li> </ul>
<p>Authentication</p> <p><b>Note:</b> These parameters are applicable only if the 'Call Party' parameter (below) is configured to <b>Caller</b>.</p>	



Parameter	Description
'Auto Register' auto-register [Test_Call_AutoRegister]	<p>Enables automatic registration of the endpoint. The endpoint can register to the device itself or to the 'Destination Address' or 'IP Group' parameter settings (see above).</p> <ul style="list-style-type: none"> <li>■ [0] <b>Disable</b> (default)</li> <li>■ [1] <b>Enable</b></li> </ul>
'Username' user-name [Test_Call_UserName]	<p>Defines the authentication username.</p> <p>The valid value is a string of up to 60 characters. By default, no value is defined.</p>
'Password' password [Test_Call_Password]	<p>Defines the authentication password.</p> <p>By default, no password is defined.</p> <p><b>Note:</b> The parameter cannot be configured with wide characters.</p>
Test Setting	
'Call Party' call-party [Test_Call_CallParty]	<p>Defines whether the test endpoint is the initiator (caller) or receiving side (called) of the test call.</p> <ul style="list-style-type: none"> <li>■ [0] <b>Caller</b> (default)</li> <li>■ [1] <b>Called</b></li> </ul>
'Maximum Channels for Session' max-channels [Test_Call_MaxChannels]	<p>Defines the maximum number of concurrent channels for the test session. For example, if you have configured an endpoint "101" and you configure the parameter to "3", the device automatically creates three simulated endpoints - "101", "102" and "103" (i.e., consecutive endpoint URIs are assigned).</p> <p>The default is 1.</p>
'Call Duration' call-duration [Test_Call_CallDuration]	<p>Defines the call duration (in seconds).</p> <p>The valid value is -1 to 100000. The default is 20. A value of 0 means infinite. A value of -1 means that the parameter value is automatically calculated according to the values of the 'Calls per Second' and 'Maximum Channels for Session' parameters.</p> <p><b>Note:</b> The parameter is applicable only if you configure 'Call Party' to <b>Caller</b>.</p>

Parameter	Description
'Calls per Second' calls-per-second [Test_Call_CallsPerSecond]	Defines the number of calls per second. <b>Note:</b> The parameter is applicable only if you configure 'Call Party' to <b>Caller</b> .
'Test Mode' test-mode [Test_Call_TestMode]	Defines the test session mode. <ul style="list-style-type: none"> <li>■ [0] <b>Once</b> = (Default) The test runs until the lowest value between the following is reached:               <ul style="list-style-type: none"> <li>✓ Maximum channels is reached for the test session, configured by 'Maximum Channels for Session'.</li> <li>✓ Call duration ('Call Duration') multiplied by calls per second ('Calls per Second').</li> <li>✓ Test duration expires, configured by 'Test Duration'.</li> </ul> </li> <li>■ [1] <b>Continuous</b> = The test runs until the configured test duration is reached. If it reaches the maximum channels configured for the test session (in the 'Maximum Channels for Session'), it waits until the configured call duration of a currently established tested call expires before making the next test call. In this way, the test session stays within the configured maximum channels.</li> </ul> <b>Note:</b> The parameter is applicable only if you configure 'Call Party' to <b>Caller</b> .
'Test Duration' test-duration [Test_Call_TestDuration]	Defines the test duration (in minutes). The valid value is 0 to 100000. The default is 0 (i.e., unlimited). <b>Note:</b> The parameter is applicable only if you configure 'Call Party' to <b>Caller</b> .
'Play' play [Test_Call_Play]	Enables the playing of a tone to the answered side of the call. <ul style="list-style-type: none"> <li>■ [0] <b>Disable</b> = No tone is played.</li> <li>■ [1] <b>DTMF</b> = (Default) Plays (loop) a user-defined DTMF string, which is configured in <a href="#">Configuring DTMF Tones for Test Calls</a>.</li> </ul>

Parameter	Description
	<p>■ [2] <b>PRT</b> = Plays (loop) a pre-recorded tone (audio file) from the PRT file that is installed on the device. You can either specify the tone (by index) to play from the PRT file in the 'Play Tone Index' parameter (below), or implement a basic NetAnn feature whereby the tone from the PRT file (and other characteristics) are specified by NetAnn parameters in the Request-URI of the incoming SIP INVITE message. When using NetAnn, instead of connecting the call (i.e., 200 OK), the device replies with a SIP 183 containing SDP.</p> <p>The NetAnn parameters include the following:</p> <ul style="list-style-type: none"> <li>● <b>early=yes</b>: Indicates that NetAnn is used for playing the tone.</li> <li>● <b>play=&lt;Prompt/Tone Index in PRT file&gt;</b>: Defines the tone to play from the PRT file.</li> <li>● <b>repeat=&lt;Times&gt;</b>: Defines how many times the tone is played (loops) before the device disconnects the call.</li> <li>● <b>delay=&lt;Delay Time&gt;</b>: Defines the delay time (in msec) between each played (loop) tone. If the parameter is not present, the default is 2,000 ms (2 seconds).</li> </ul> <p>The following shows an example of a Request-URI with NetAnn parameters that instruct the device to play three times (loops) the tone that is defined at Index 15 in the PRT file:</p> <pre data-bbox="804 1469 1375 1644">INVITE sip:200@1.1.1.1;early=yes;play=15;repeat=3</pre> <p><b>Note:</b></p> <ul style="list-style-type: none"> <li>■ You can configure the DTMF signaling type (RFC 2833 or in-band), using the 'Play DTMF Method' parameter (above).</li> <li>■ Playing a tone from the PRT file requires DSP resources if the coder with which the tone was created is different to the coder used for the Test</li> </ul>

Parameter	Description
	<p>Call.</p> <ul style="list-style-type: none"> <li>■ You can also use NetAnn parameters to play a specific recorded tone to the caller (source) when the destination fails for a regular IP-to-IP SBC call. To configure this: <ul style="list-style-type: none"> <li>✓ Configure a Message Manipulation rule that adds the NetAnn parameters, based on the tone that you want played, to the INVITE message's Request-URI.</li> <li>✓ Configure a Number Manipulation rule that changes the destination number to the Test Call ID.</li> <li>✓ Configure an IP Group to represent the device itself (which will be the Test Call module) and assign it the Message Manipulation rule and the Number Manipulation rule.</li> <li>✓ Configure an alternative routing rule in the IP-to-IP Routing table that re-routes the call to the IP Group presenting the Test Call module.</li> </ul> </li> </ul> <p>When the IP-to-IP call fails, the device uses the alternative routing rule to re-route the call to the Test Call module, which sends a SIP 183 response to the caller, playing the specified tone.</p>
<p>'Play Tone Index' play-tone-index [Test_Call_PlayToneIndex]</p>	<p>Defines the tone that you want played from the installed PRT file, to the called party when the call is answered.</p> <p>The valid value is the index number (0-79) of the tone in the PRT file. By default (-1), the device plays the tone defined at index 22 "acDialTone2".</p> <p><b>Note:</b></p> <ul style="list-style-type: none"> <li>■ The parameter is applicable only if you configure the 'Play' parameter to <b>PRT</b>.</li> <li>■ To play user-defined tones, you need to record your tones and then install them on the device using a loadable Prerecorded Tones (PRT) file, which is created using AudioCodes DConvert utility. When you create the PRT file, each recorded tone file must be added to the PRT file</li> </ul>

Parameter	Description
	with the tone type "acUserDefineTone<Index>". For more information, see <a href="#">Prerecorded Tones File</a> .
'Schedule Interval' schedule-interval [Test_Call_ScheduleInterval]	Defines the interval (in minutes) between automatic outgoing test calls. The valid value range is 0 to 100000. The default is 0 (i.e., scheduling is disabled). <b>Note:</b> The parameter is applicable only if you configure 'Call Party' to <b>Caller</b> .

## Starting and Stopping Test Calls

The following procedure describes how to start, stop, and restart test calls.

### ➤ To start, stop, and restart a test call:

1. In the Test Call Rules table, select the required test call entry.
2. From the **Action** drop-down list, choose the required command:
  - **Dial:** Starts the test call (applicable only if the test call party is the caller).
  - **Drop Call:** Stops the test call.
  - **Restart:** Ends all established calls and then starts the test call session again.

## Viewing Test Call Status

You can view the status of test call rules in the 'Test Status' field of the Test Call Rules table. The status can be one of the following:

**Table 67-2: Test Call Status Description**

Status	Description
"Idle"	Test call is not active.
"Scheduled"	Test call is planned to run (according to the 'Schedule Interval' parameter).
"Running"	Test call has been started (i.e., by clicking <b>Dial</b> from the 'Action' drop-down list).
"Receiving":	Test call has been automatically activated by calls received from the remote endpoint for the test call endpoint (when all these calls end, the status returns to "Idle").

Status	Description
"Terminating"	Test call is in the process of terminating currently established calls (when <b>Drop Call</b> is clicked from the 'Action' drop-down list to stop the test).
"Done"	Test call has successfully completed (or was prematurely stopped by clicking the <b>Drop Call</b> from the 'Action' drop-down list).

## Viewing Test Call Statistics

You can view statistical information on the test call.



- On the receiving side, when the first call is accepted in "Idle" state, statistics are reset.
- The device also generates CDRs for test calls if you have enabled CDR generation (see [Configuring CDR Reporting](#)). To view CDRs of test calls, see [Viewing Gateway CDR History](#) on page 1199.

### ➤ To view statistics of a test call:

1. In the Test Call Rules table, select the required test call row.
2. Scroll down the page to the area below the table. Statistics of the selected test call are displayed under the **Statistics** group, as shown in the example below:

STATISTICS	
Active Calls	0
Call Attempts	1
Total Established Calls	1
Total Failed Attempts	0
Remote Disconnections Count	1
Average CPS	1.00
Elapsed Time [HH:MM:SS]	00:00:20
Test Status	Done
Detailed Status	Done - Established Calls: 1, ASR: 100%
MOS Status	Local:N/A, Remote:N/A
Delay Status	Local:6 msec (Green), Remote:N/A
Jitter Status	Local:75 msec (Red), Remote:0 msec (Green)
Packet Loss Status	Local:0% (Green), Remote:0% (Green)
Bandwidth Status	Rx:0 KBytes/s (Green), Tx:0 KBytes/s (Green)

The statistics fields are described in the following table:

Table 67-3: Test Call Statistics Description

Statistics Field	Description
<b>Active Calls</b>	Number of currently established test calls.
<b>Call Attempts</b>	Number of calls that were attempted.
<b>Total Established Calls</b>	Total number of calls that were successfully established.
<b>Total Failed Attempts</b>	Total number of call attempts that failed.
<b>Remote Disconnections Count</b>	Number of calls that were disconnected by the remote side.
<b>Average CPS</b>	Average calls per second.
<b>Elapsed Time</b>	Duration of the test call since it was started (or restarted).
<b>Test Status</b>	Status (brief description) as displayed in the 'Test Status' field (see <a href="#">Viewing Test Call Status</a> ).
<b>Detailed Status</b>	<p>Displays a detailed description of the test call status:</p> <ul style="list-style-type: none"> <li>■ "Idle": Test call is currently not active.</li> <li>■ "Scheduled - Established Calls: &lt;number of established calls&gt;, ASR: &lt;ASR&gt;%": Test call is planned to run (according to 'Schedule Interval' parameter settings) and also shows the following summary of completed test calls: <ul style="list-style-type: none"> <li>✓ Total number of test calls that were established.</li> <li>✓ Number of successfully answered calls out of the total number of calls attempted (ASR).</li> </ul> </li> <li>■ "Running (Calls: &lt;number of active calls&gt;, ASR: &lt;ASR&gt;%)": Test call has been started (i.e., the <b>Dial</b> command was clicked) and shows the following: <ul style="list-style-type: none"> <li>✓ Number of currently active test calls.</li> <li>✓ Number of successfully answered calls out of the total number of calls attempted (Answer Success Ratio or ASR).</li> </ul> </li> <li>■ "Receiving (&lt;number of active calls&gt;)": Test call has been automatically activated by calls received for this configured test call</li> </ul>

Statistics Field	Description
	<p>endpoint from the configured remote endpoint. When all these calls terminate, the status returns to "Idle".</p> <ul style="list-style-type: none"> <li>■ "Terminating (&lt;number of active calls&gt;)": The <b>Drop Call</b> command has been clicked to stop the test call and the test call is in the process of terminating the currently active test calls.</li> <li>■ "Done - Established Calls: &lt;number of established calls&gt;, ASR: &lt;ASR&gt;%": Test call has been successfully completed (or was prematurely stopped by clicking the <b>Drop Call</b> command) and shows the following: <ul style="list-style-type: none"> <li>✓ Total number of test calls that were established.</li> <li>✓ Number of successfully answered calls out of the total number of calls attempted (ASR).</li> </ul> </li> </ul>
<b>MOS Status</b>	MOS count and color threshold status of local and remote sides according to the assigned QoE Profile.
<b>Delay Status</b>	Packet delay count and color-threshold status of local and remote sides according to the assigned QoE Profile.
<b>Jitter Status</b>	Jitter count and color-threshold status of local and remote sides according to the assigned QoE Profile.
<b>Packet Loss Status</b>	Packet loss count and color-threshold status of local and remote sides according to the assigned QoE Profile.
<b>Bandwidth Status</b>	Tx/Rx bandwidth and color-threshold status according to the assigned Bandwidth Profile.

## Configuring DTMF Tones for Test Calls

By default, the device plays the DTMF signal tone "3212333" to remote tested endpoints for answered calls (incoming and outgoing). For basic test calls (as described in [Configuring Basic Test Calls](#)), the device can play only the configured DTMF tones (or none, if not configured). For test call endpoints that are configured in the Test Call Rules table, you can configure the device to play either DTMF tones or a tone from an installed PRT file (Test Call Tone). For more information, see [Configuring Test Call Endpoints](#).



- You can configure the DTMF signaling type (e.g., out-of-band or in-band) using the 'DTMF Transport Type' [DTMFTransportType] parameter.
- To generate DTMF tones, the device's DSP resources are required.



➤ **To configure played DTMF signal to answered test call:**

1. Open the Test Call Settings page (**Troubleshoot** menu > **Troubleshoot** tab > **Test Call** folder > **Test Call Settings**).
2. In the 'Test Call DTMF String' field, enter the DTMF string (up to 15 digits):

Test Call DTMF String

3. Click **Apply**.

## Configuring Basic Test Calls

The Basic Test Call feature tests **incoming** calls from remote SIP (IP) endpoints to a single simulated test endpoint on the device. The only required configuration is to assign a prefix number (*test call ID*) to the simulated endpoint. Incoming calls with this called (destination) prefix number are identified by the device as test calls and sent to the simulated endpoint. The figure below displays a basic test call example:

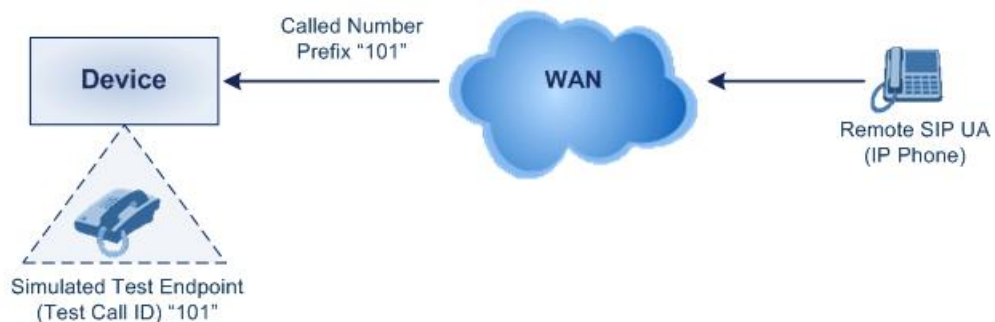

➤ **To configure basic call testing:**

1. Open the Test Call Settings page (**Troubleshoot** menu > **Troubleshoot** tab > **Test Call** folder > **Test Call Settings**).
2. In the 'Test Call ID' field, enter a prefix for the simulated endpoint:

GENERAL  
Test Call ID

For a full description of the parameter, see [SIP Test Call Parameters](#).

3. Click **Apply**.



- The device can play DTMF tones to the remote endpoint. For more information, see [Configuring DTMF Tones for Test Calls](#).
- The Basic Test Call feature uses the default IP Group (ID #0) and its associated IP Profile (if exists).
- Test calls are done on all SIP Interfaces.

## Test Call Configuration Examples

Below are a few examples of test call configurations.

- **Single Test Call Scenario:** This example describes the configuration of a simple test call scenario that includes a single test call between a simulated test endpoint on the device and a remote endpoint.

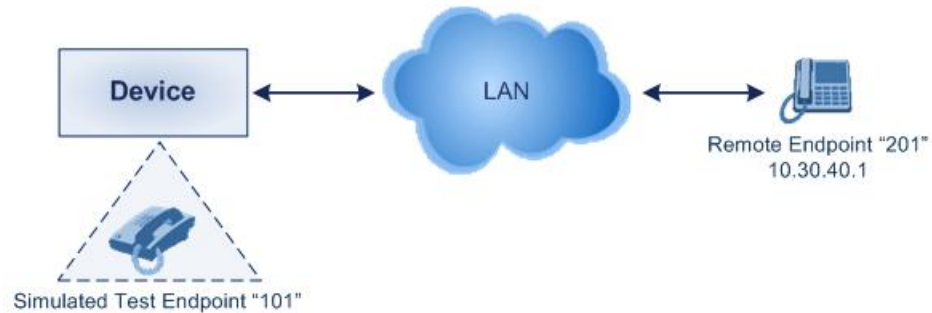

- Test Call Rules table configuration:
  - ◆ Endpoint URI: "101"
  - ◆ Called URI: "201"
  - ◆ Route By: **Dest Address**
  - ◆ Destination Address: "10.30.40.01"
  - ◆ SIP Interface: SIPInterface\_0
  - ◆ Call Party: **Caller**
  - ◆ Test Mode: **Once**

Alternatively, if you want to route the test call using the Tel-to-IP Routing table for the Gateway application, configure the following:

- Test Call Rules table configuration:
  - ◆ Endpoint URI: 101@10.0.0.1
  - ◆ Route By: Tel-to-IP
  - ◆ SIP Interface: SIPInterface\_0
  - ◆ Called URI: 201@10.30.40.1
  - ◆ Call Party: Caller
- Tel-to-IP Routing table configuration:
  - ◆ Destination Phone Prefix: 201 (i.e., the Called URI user-part)
  - ◆ Source Phone Prefix: 101 (i.e., the Endpoint URI user-part)
  - ◆ Destination IP Address: 10.30.40.1

- Batch Test Call Scenario:** This example describes the configuration of a batch test call setup for scheduled and continuous call testing of multiple endpoints. The test call is done between two AudioCodes devices - Device A and Device B - with simulated test endpoints. This eliminates the need for phone users, who would otherwise need to answer and end calls many times for batch testing. The calls are initiated from Device A, where Device B serves as the remote answering endpoint.

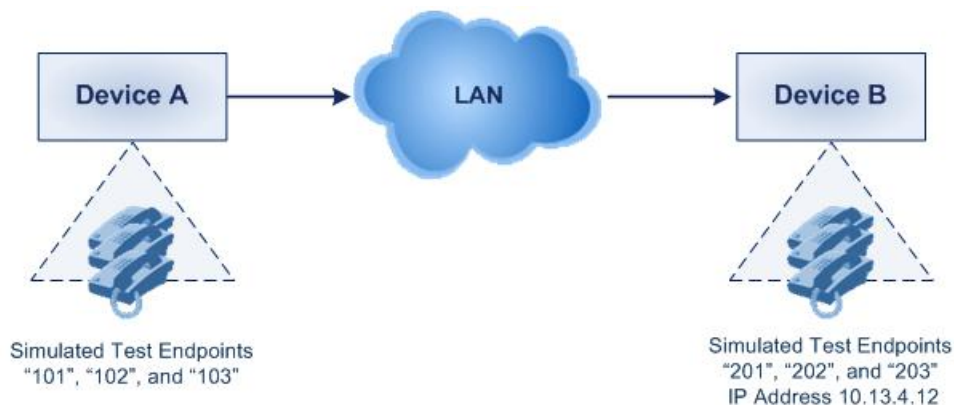

- Test Call Rules table configuration at Device A:
  - ◆ Endpoint URI: "101"
  - ◆ Called URI: "201"
  - ◆ Route By: **Dest Address**
  - ◆ Destination Address: "10.13.4.12"
  - ◆ SIP Interface: SIPInterface\_0
  - ◆ Call Party: **Caller**
  - ◆ Maximum Channels for Session: "3" (configures three endpoints - "101", "102" and "103")
  - ◆ Call Duration: "5" (seconds)
  - ◆ Calls per Sec: "1"
  - ◆ Test Mode: **Continuous**
  - ◆ Test Duration: "3" (minutes)
  - ◆ Schedule Interval: "180" (minutes)
- Test Call Rules table configuration at Device B:
  - ◆ Endpoint URI: "201"
  - ◆ Maximum Channels for Session: "3" (configures three endpoints - "201", "202" and "203")

- Registration Test Call Scenario:** This example describes the configuration for testing the registration and authentication (i.e., username and password) process of a simulated test endpoint on the device with an external proxy/registrar server. This is useful, for example,

for verifying that endpoints located in the LAN can register with an external proxy and subsequently, communicate with one another.

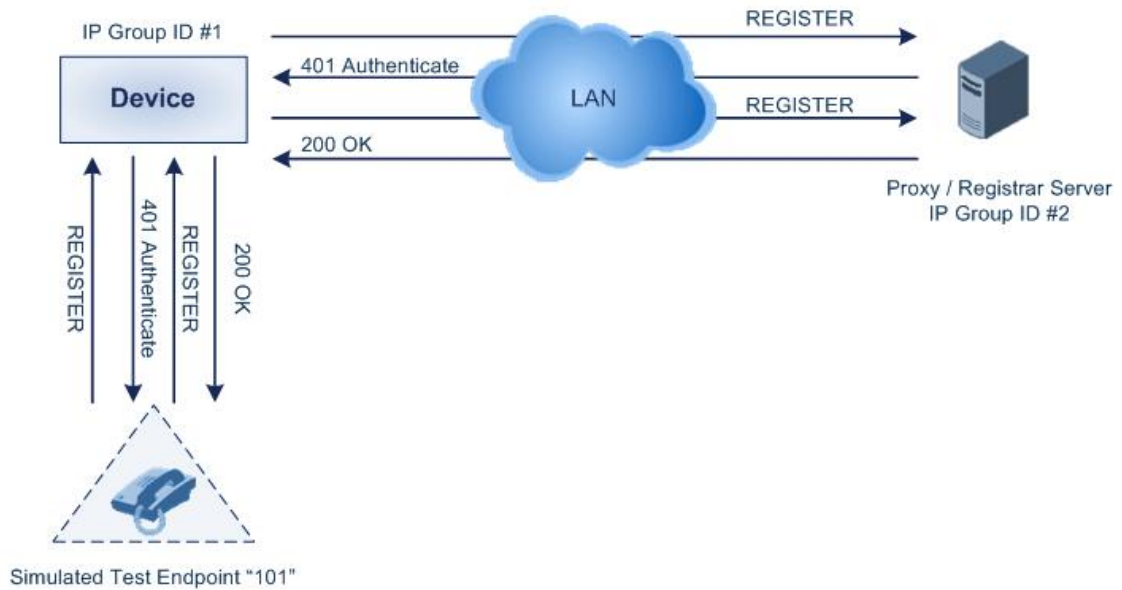

This example assumes that you have configured your device for communication between LAN phone users such as IP Groups to represent the device (10.13.4.12) and the proxy server, and IP-to-IP routing rules to route calls between these IP Groups.

- Test Call Rules table configuration:
  - ◆ Endpoint URI: "101"
  - ◆ Called URI: "itsp"
  - ◆ Route By: **Dest Address**
  - ◆ Destination Address: "10.13.4.12" (this is the IP address of the device itself)
  - ◆ SIP Interface: SIPInterface\_0
  - ◆ Auto Register: **Enable**
  - ◆ User Name: "testuser"
  - ◆ Password: "12345"
  - ◆ Call Party: **Caller**

## 68 Pinging a Remote Host or IP Address

You can verify the network connectivity with a remote host or IP address by pinging the network entity.

- IPv4: The ping to an IPv4 address can be done from any of the device's VoIP interfaces that is configured with an IPv4 address. The ping is done using the following CLI command:

```
# ping <IPv4 ip address or hostname> source [voip] interface
```

For a complete description of the ping command, refer to the *CLI Reference Guide*.

# Part XI

## Appendix

## 69 Patterns for Denoting Phone Numbers and SIP URIs

The table below lists the supported patterns (notations) that you can use in various configuration tables for matching rules, based on source and/or destination phone numbers and SIP URIs (user@host parts).



When configuring phone numbers in the Web interface, enter them only as digits without any other characters. For example, if you wish to enter the phone number 555-1212, type it as 5551212 without the hyphen (-). If the hyphen is entered, the entry is invalid.

**Table 69-1: Supported Patterns for Phone Numbers and SIP URIs**

Pattern	Description
x (letter "x")	Wildcard that denotes any single digit or character.
# (pound symbol)	<ul style="list-style-type: none"> <li>■ When located at the end of a pattern, it denotes the end of a number. For example, <b>54324#</b> denotes a 5-digit number that starts with the digits 54324.</li> <li>■ When located anywhere in the pattern except at the end, it is part of the number (pound key). For example, <b>3#45</b> represents the prefix number 3#45.</li> <li>■ To denote the # key when it appears at the end of the number, enclose it in square brackets. For example, <b>134[#]</b> denotes any number that starts with 134#.</li> </ul>
* (asterisk symbol)	<ul style="list-style-type: none"> <li>■ When used on its own, it denotes any number or string.</li> <li>■ When used as part of a number, it denotes the asterisk (*) key. For example, <b>*345</b> denotes a number that starts with *345.</li> </ul>
\$ (dollar sign)	<p>For incoming IP calls: Denotes a Request-URI that does not have a user part.</p> <p>For incoming Tel calls: Denotes a Tel-to-IP call that does not have a called or calling number.</p> <p>This pattern is used for the following matching criteria:</p> <ul style="list-style-type: none"> <li>■ Source and Destination Phone</li> <li>■ Source and Destination Username</li> <li>■ Source and Destination Calling Name</li> </ul>
Range of	<b>Note:</b>

Pattern	Description
Digits	<ul style="list-style-type: none"> <li>■ To denote a prefix that is a range, enclose it in square brackets, for example, <b>[4-8]</b> or <b>23xx[456]</b>.</li> <li>■ To denote a prefix that is not a range, do not enclose in brackets, for example, <b>12345#</b>.</li> <li>■ To denote a suffix, enclose it in parenthesis, for example, <b>(4)</b> and <b>(4-8)</b>.</li> <li>■ To denote a suffix that includes multiple ranges, enclose the range in square brackets, for example, <b>(23xx[4,5,6])</b>.</li> </ul> <p>Example of using both a prefix and a suffix in a pattern: Assume you want to match a rule whose destination phone prefix is 4 through 8, and suffix is 234, 235, or 236. The pattern for this would be: <b>[4-8](23[4,5,6])</b>.</p>
<b>[n-m]</b> or <b>(n-m)</b>	<p>Denotes a range of numbers. Examples:</p> <ul style="list-style-type: none"> <li>■ To denote prefix numbers from 5551200 to 5551300: <ul style="list-style-type: none"> <li>✓ <b>[5551200-5551300]#</b></li> </ul> </li> <li>■ To denote prefix numbers from 123100 to 123200: <ul style="list-style-type: none"> <li>✓ <b>123[100-200]#</b></li> </ul> </li> <li>■ To denote prefix and suffix numbers together: <ul style="list-style-type: none"> <li>✓ <b>03(100)</b>: for any number that starts with 03 and ends with 100.</li> <li>✓ <b>[100-199](100,101,105)</b>: for a number that starts with 100 to 199 and ends with 100, 101 or 105.</li> <li>✓ <b>03(abc)</b>: for any number that starts with 03 and ends with abc.</li> <li>✓ <b>03(5xx)</b>: for any number that starts with 03 and ends with 5xx.</li> <li>✓ <b>03(400,401,405)</b>: for any number that starts with 03 and ends with 400 or 401 or 405.</li> </ul> </li> </ul> <p><b>Note:</b></p> <ul style="list-style-type: none"> <li>■ The value <i>n</i> must be less than the value <i>m</i>.</li> <li>■ Only numerical ranges are supported (not letters).</li> <li>■ For suffix ranges, the starting (<i>n</i>) and ending (<i>m</i>) numbers in the range must include the same number of digits. For example, (23-34) is correct, but (3-12) is not.</li> </ul>
<b>[n,m]</b> or <b>(n,m)</b>	<p>Denotes multiple numbers. The value can include digits or characters. Examples:</p>



Pattern	Description
	<ul style="list-style-type: none"> <li>■ To denote a one-digit number starting (prefix) with 2, 3, 4, 5, or 6: <b>[2,3,4,5,6]</b></li> <li>■ To denote a one-digit number ending (suffix) with 7, 8, or 9: <b>(7,8,9)</b></li> <li>■ Prefix with suffix: <b>[2,3,4,5,6](7,8,9)</b> - prefix is denoted in square brackets; suffix in parenthesis</li> </ul> <p>For <b>prefix only</b>, the patterns <math>d[n,m]e</math> and <math>d[n-m]e</math> can also be used:</p> <ul style="list-style-type: none"> <li>■ To denote a five-digit number that starts with 11, 22, or 33: <b>[11,22,33]xxx#</b></li> <li>■ To denote a six-digit number that starts with 111 or 222: <b>[111,222]xxx#</b></li> </ul>
<b>[n1-m1,n2-m2,a,b,c,n3-m3] or (n1-m1,n2-m2,a,b,c,n3-m3)</b>	<p>Denotes a mixed pattern of single numbers and multiple number ranges. For example, to denote numbers 123 through 130, 455, 766, and 780 through 790:</p> <ul style="list-style-type: none"> <li>■ Prefix: <b>[123-130,455,766,780-790]</b></li> <li>■ Suffix: <b>(123-130,455,766,780-790)</b></li> </ul> <p><b>Note:</b> The ranges and the single numbers in the mixed pattern must have the same number of digits. For example, each number range and single number in the examples above consists of three digits (e.g., 780).</p>
<b>Special ASCII Characters</b>	<p>The device does not support the use of ASCII characters in manipulation rules and therefore, for LDAP-based queries, the device can use the hexadecimal (HEX) format of the ASCII characters for phone numbers instead. The HEX value must be preceded by a backslash “\”.</p> <p>For example, you can configure a manipulation rule that changes the received number <b>+49 (7303) 165-xxxxx</b> to <b>+49 \287303\29 165-xxxxx</b>, where <b>\28</b> is the ASCII HEX value for “(” and <b>\29</b> is the ASCII HEX value for “)”. The manipulation rule in this example would denote the parenthesis in the destination number prefix using “x” wildcards (e.g., <b>xx165xxxx#</b>); the prefix to add to the number would include the HEX values (e.g., <b>+49 \287303\29 165-</b>).</p> <p>Below is a list of common ASCII characters and their corresponding HEX values:</p> <ul style="list-style-type: none"> <li>■ *: \2a</li> <li>■ (: \28</li> <li>■ ): \29</li> <li>■ \: \5c</li> <li>■ /: \2f</li> </ul>

## 70 Configuration Parameters Reference

The device's VoIP functionality configuration parameters, default values, and their descriptions are documented in this section.



Parameters and values enclosed in square brackets [...] represent ini file parameters and their enumeration values.

### Management Parameters

This section describes the device's management-related parameters.

#### General Parameters

The general management parameters are described in the table below.

**Table 70-1: General Management Parameters**

Parameter	Description
Host Name <pre>configure network &gt; network-settings &gt; hostname</pre> [Hostname]	Defines a hostname for the device. This can be used, for example, to access the Web interface instead of using the IP address.  The valid value is a string of up to 18 characters. By default, no value is defined.  For more information, see <a href="#">Configuring a Hostname for the Device</a> on page 106.
[WebLoginBlockAutoComplete]	Disables autocompletion when entering the management login username in the 'Username' field of the device's Web interface. Disabling autocompletion may be useful for security purposes by hiding previously entered usernames and thereby, preventing unauthorized access to the device's management interface. <ul style="list-style-type: none"> <li>■ [0] <b>Disable</b> = (Default) Autocompletion is enabled and the 'Username' field automatically offers previously logged in usernames.</li> <li>■ [1] <b>Enable</b> = Autocompletion is disabled.</li> </ul>
<pre>configure system &gt; web &gt; enforce-password-complexity</pre> [EnforcePasswordComplexity]	Enables the enforcement of the management user's login password complexity requirements to ensure strong passwords. <ul style="list-style-type: none"> <li>■ [0] <b>Disable</b> (default)</li> </ul>

Parameter	Description
	<ul style="list-style-type: none"> <li>■ [1] <b>Enable</b></li> </ul> <p>For more information on password complexity requirements, see the 'Password' parameter in <a href="#">Configuring Management User Accounts</a>.</p>
<pre>[MinWebPasswordLen] configure system &gt; web &gt; min-web-password-len</pre>	<p>Defines the minimum length (number of characters) of the management user's login password when password complexity is enabled (using the [EnforcePasswordComplexity] parameter).</p> <p>The valid value is a string of 8 to 20 characters. The default is 8.</p> <p>For more information on password complexity requirements, see the 'Password' parameter in <a href="#">Configuring Management User Accounts</a>.</p>
<pre>'Lock' admin state lock [AdminState]</pre>	<p>Locks the device, whereby existing calls are terminated (optionally, after a graceful period) and new calls are rejected.</p> <ul style="list-style-type: none"> <li>■ [0] <b>Lock</b></li> <li>■ [2] <b>Unlock</b> (default)</li> </ul> <p>For more information, see <a href="#">Locking and Unlocking the Device</a> on page 1067.</p>
<pre>'Graceful Option' admin state lock graceful [AdminStateLockControl]</pre>	<p>Defines a graceful period (in seconds) before the device locks. During this period, the device does not accept any new calls, allowing only existing calls to continue until the timeout expires. If all existing calls end before the timeout expires, the device locks. If there are still existing calls when the timeout expires, the device terminates them and then locks.</p> <p>The valid value is 0 to 32,768 seconds. The default is 0, meaning no graceful lock (i.e., immediate lock). A value of -1 means that the device locks only after all the existing calls end (on their own accord).</p> <p>For more information, see <a href="#">Locking and Unlocking the Device</a> on page 1067.</p>
<pre>'Disconnect Client Connections' admin state lock no- graceful disconnect- client-connections</pre>	<p>Enables the device to close existing TLS/TCP client connections and reject incoming TLS/TCP client connections when the device is in locked state.</p> <ul style="list-style-type: none"> <li>■ [0] <b>Disable</b> (default)</li> </ul>

Parameter	Description
[AdminStateRestrictConnections]	<ul style="list-style-type: none"> <li>■ [1] <b>Enable</b></li> </ul> <p>For more information, see <a href="#">Locking and Unlocking the Device</a> on page 1067.</p>
'Floating License' configure system > floating-license > floating-license [EnableFloatingLicense]	<p>Enables the device to operate with the Floating License.</p> <ul style="list-style-type: none"> <li>■ [0] <b>Disable</b> (default)</li> <li>■ [1] <b>Enable</b></li> </ul> <p>For more information, see <a href="#">Floating License Model</a> on page 1104.</p> <p><b>Note:</b> For the parameter to take effect, a device reset is required.</p>
'Allocation Profile' configure system > floating-license > allocation-profile [AllocationProfile]	<p>Defines an SBC capacity profile (Allocation Profile) for the Floating License feature.</p> <ul style="list-style-type: none"> <li>■ [0] <b>SIP Trunking</b> = (Default) Profile suited for SIP Trunking applications.</li> <li>■ [1] <b>Registered Users</b> = Profile suited for applications requiring registered users.</li> <li>■ [2] <b>Custom</b> = Customized Allocation Profile.</li> </ul> <p><b>Note:</b> For the parameter to take effect, a device reset is required.</p>
'Allocation - Far End Users' configure system > floating-license > allocation-registered-users [AllocationRegisteredUsers]	<p>Defines registered users capacity for a customized Allocation Profile for the Floating License feature.</p> <p><b>Note:</b></p> <ul style="list-style-type: none"> <li>■ For the parameter to take effect, a device reset is required.</li> <li>■ The parameter is applicable only when the 'Allocation Profile' is configured to <b>Custom</b>.</li> </ul>
'Allocation – SBC Media Sessions' configure system > floating-license > allocation-media-sessions [AllocationMediaSessions]	<p>Defines SBC media session capacity for a customized Allocation Profile for the Floating License feature.</p> <p><b>Note:</b></p> <ul style="list-style-type: none"> <li>■ For the parameter to take effect, a device reset is required.</li> <li>■ The parameter is applicable only when the 'Allocation Profile' is configured to <b>Custom</b>.</li> </ul>

Parameter	Description
<p>'Allocation – SBC Signaling Sessions'</p> <pre>configure system &gt; floating-license &gt; allocation-signaling- sessions</pre> <p>[AllocationSignalingSessions]</p>	<p>Defines SBC signaling session capacity for a customized Allocation Profile for the Floating License feature.</p> <p><b>Note:</b></p> <ul style="list-style-type: none"> <li>■ For the parameter to take effect, a device reset is required.</li> <li>■ The parameter is applicable only when the 'Allocation Profile' is configured to <b>Custom</b>.</li> </ul>
<p>'Limit - Far End Users'</p> <pre>configure system &gt; floating-license &gt; limit-registered-users</pre> <p>[LimitRegisteredUsers]</p>	<p>Defines a limit of the registered user capacity for a customized Allocation Profile for the Floating License feature.</p> <p><b>Note:</b> The parameter is applicable only when the 'Allocation Profile' is configured to <b>Custom</b>.</p>
<p>'Limit – SBC Media Sessions'</p> <pre>configure system &gt; floating-license &gt; limit-media-sessions</pre> <p>[LimitMediaSessions]</p>	<p>Defines a limit of the SBC media session capacity for a customized Allocation Profile for the Floating License feature.</p> <p><b>Note:</b> The parameter is applicable only when the 'Allocation Profile' is configured to <b>Custom</b>.</p>
<p>'Limit – SBC Signaling Sessions'</p> <pre>configure system &gt; floating-license &gt; limit-signaling- sessions</pre> <p>[LimitSignalingSessions]</p>	<p>Defines a limit of the SBC SIP signaling session capacity for a customized Allocation Profile for the Floating License feature.</p> <p><b>Note:</b> The parameter is applicable only when the 'Allocation Profile' is configured to <b>Custom</b>.</p>
<p>'Limit – Transcoding Sessions'</p> <pre>configure system &gt; floating-license &gt; limit-transcoding- sessions</pre> <p>[LimitTranscodingSessions]</p>	<p>Defines a limit of the transcoding session capacity for a customized Allocation Profile for the Floating License feature.</p> <p><b>Note:</b> The parameter is applicable only when the 'Allocation Profile' is configured to <b>Custom</b>.</p>
<p>[CustomerSN]</p>	<p>Defines a serial number (S/N) for the device.</p> <p><b>Note:</b> The device's original S/N is automatically added at the end of the configured S/N. For example, if the original S/N is 8906721 and the configured S/N is "abc123", the resultant S/N is "abc1238906721".</p>

## Web Parameters

The Web parameters are described in the table below.

**Table 70-2: Web Parameters**

Parameter	Description
'Enable web access from all interfaces' web-access-from-all-interfaces [EnableWebAccessFromAllInterfaces]	<p>Enables Web access from any of the device's IP network interfaces. The feature applies to HTTP and HTTPS protocols.</p> <ul style="list-style-type: none"> <li>■ [0] = (Default) Disable – Web access is only through the OAMP interface.</li> <li>■ [1] = Enable - Web access is through any network interface.</li> </ul> <p><b>Note:</b></p> <ul style="list-style-type: none"> <li>■ For the parameter to take effect, a device reset is required.</li> <li>■ Instead of using this parameter, you can use the Additional Management Interfaces table to assign specific IP network interfaces for management interfaces (as well as assign them TLS Contexts). For more information, see <a href="#">Configuring Additional Management Interfaces</a>.</li> </ul>
'Password Change Interval' web-password-change-interval [WebPassChangeInterval]	<p>Defines the minimum duration (in minutes) between login password changes. For example, if you configure the parameter to 60, you can only change the password if at least 60 minutes has elapsed since the password was last changed.</p> <p>The valid value is 0 to 100,000. The default is 0, meaning that the password can be changed at any time.</p>
'User Inactivity Timer' [UserInactivityTimer]	<p>Defines the duration (in days) for which a user has not logged in to the Web interface, after which the status of the user becomes inactive and can no longer access the Web interface. These users can only log in to the Web interface if their status is changed (to New or Valid) by a Security Administrator or Master user.</p> <p>The valid value is 0 to 10000, where 0 means inactive. The default is 90.</p> <p><b>Note:</b> The parameter is applicable only when using the</p>

Parameter	Description
	Local Users table.
'Session Timeout' [WebSessionTimeout]	<p>Defines the duration (in minutes) of inactivity of a logged-in user in the Web interface, after which the user is automatically logged off the Web session. In other words, the session expires when the user has not performed any operations (activities) in the Web interface for the configured duration.</p> <p>The valid value is 0, or 2 to 100000, where 0 means no timeout. The default is 15.</p> <p><b>Note:</b> You can also configure the feature per user in the Local Users table (see <a href="#">Configuring Management User Accounts</a>), which overrides this global setting.</p>
'Deny Access On Fail Count' [DenyAccessOnFailCount]	<p>Defines the maximum number of failed login attempts, after which the requesting IP address is blocked.</p> <p>The valid value range is 0 to 10. The values 0 and 1 mean immediate block. The default is 3.</p>
'Deny Authentication Timer' [DenyAuthenticationTimer]	<p>Defines the duration (in seconds) for which login to the Web interface is denied from a specific IP address (for all users) when the number of failed login attempts has exceeded the maximum. This maximum is configured by the [DenyAccessOnFailCount] parameter. Only after this time expires can users attempt to log in from this same IP address.</p> <p>The valid value is 0 to 100000, where 0 means that login is not denied regardless of the number of failed login attempts. The default is 60.</p>
'Display Last Login Information' [DisplayLoginInformation]	<p>Enables the display of the user's login information upon each successful login attempt.</p> <ul style="list-style-type: none"> <li>■ [0] <b>Disable</b> (default)</li> <li>■ [1] <b>Enable</b></li> </ul>
'Enable Management Two Factor Authentication' [EnableMgmtTwoFactorAuthentication]	<p>Enables Web login authentication using a third-party, smart card (two-factor authentication).</p> <ul style="list-style-type: none"> <li>■ [0] <b>Disable</b> (default)</li> <li>■ [1] <b>Enable</b></li> </ul> <p>For more information, see <a href="#">Web Login Authentication</a></p>

Parameter	Description
	<p>using <a href="#">Smart Cards</a> on page 66.</p>
[CSRFProtection]	<p>Enables cross-site request forgery (CSRF) protection of the device's embedded Web server.</p> <ul style="list-style-type: none"> <li>■ [0] = Disable</li> <li>■ [1] = (Default) Enable</li> </ul> <p>For more information, see <a href="#">Enabling CSRF Protection</a> on page 65.</p>
http-port [HTTPport]	<p>Defines the LAN HTTP port for Web management. To enable Web management from the LAN, configure the desired port.</p> <p>The default is 80.</p> <p><b>Note:</b> For the parameter to take effect, a device reset is required.</p>
[DisableWebConfig]	<p>Defines if the entire Web interface is read-only.</p> <ul style="list-style-type: none"> <li>■ [0] = (Default) Enables modifications of parameters.</li> <li>■ [1] = Web interface is read-only.</li> </ul> <p>When in read-only mode, parameters can't be modified and the following pages can't be accessed: Web User Accounts, TLS Contexts, Time and Date, Maintenance Actions, Load Auxiliary Files, Software Upgrade Wizard, and Configuration File.</p> <p><b>Note:</b></p> <ul style="list-style-type: none"> <li>■ For the parameter to take effect, a device reset is required.</li> </ul>
[ResetWebPassword]	<p>Enables the device to restore the default management user accounts.</p> <ul style="list-style-type: none"> <li>■ [0] = (Default) Disabled - currently configured user accounts (usernames and passwords) are retained.</li> <li>■ [1] = Enabled - default user accounts (listed below) are restored and all other configured users (in the Local Users table) are deleted: <ul style="list-style-type: none"> <li>✓ Security Administrator user (username <b>Admin</b> and password <b>Admin</b>)</li> </ul> </li> </ul>



Parameter	Description
	<ul style="list-style-type: none"> <li>✓ Monitor user (username <b>User</b> and password <b>User</b>)</li> </ul> <p><b>Note:</b></p> <ul style="list-style-type: none"> <li>■ You can also restore the default management user accounts (and delete all other configured users) through SNMP, by setting acSysGenericINILine to "ResetWebPassword = 1".</li> <li>■ You can change username and password through SNMP:               <ul style="list-style-type: none"> <li>✓ To change the current username, use the following syntax (but without angled brackets) in the acSysWEBAccessEntry table:                   <div style="border: 1px solid #ccc; background-color: #f9f9f9; padding: 10px; margin: 10px 0;"> <pre>acSysWEBAccessUserName:&lt;current username&gt;/&lt;password&gt;/&lt;new username&gt;</pre> </div> </li> <li>✓ To change the current password, use the following syntax (but without angled brackets) in the acSysWEBAccessEntry table:                   <div style="border: 1px solid #ccc; background-color: #f9f9f9; padding: 10px; margin: 10px 0;"> <pre>acSysWEBAccessUserCode:&lt;username&gt;/&lt;current password&gt;/&lt;new password&gt;</pre> </div> </li> </ul> </li> </ul>
<pre>[WelcomeMessage] configure system &gt; welcome-msg</pre>	<p>Defines a welcome message displayed on the Web interface's Web Login page.</p> <p>The format of the ini file table parameter is:</p> <pre>[WelcomeMessage ] FORMAT WelcomeMessage_Index = WelcomeMessage_Text [\WelcomeMessage]</pre> <p>For Example:</p> <pre>FORMAT WelcomeMessage_Index = WelcomeMessage_Text WelcomeMessage 1 = "*****"; WelcomeMessage 2 = "***** This is a Welcome message ***" ;</pre>

Parameter	Description
	<p>WelcomeMessage 3 =            "*****";</p> <p>For more information, see <a href="#">Creating a Login Welcome Message</a>.</p> <p><b>Note:</b></p> <ul style="list-style-type: none"> <li>■ Each index row represents a line of text. Up to 20 lines (or rows) of text can be defined.</li> <li>■ The configured text message must be enclosed in double quotation marks (i.e., "...").</li> <li>■ If the parameter is not configured, no Welcome message is displayed.</li> </ul>
[UseProductName]	<p>Enables the option to customize the name of the device (product) that appears in the management interfaces.</p> <ul style="list-style-type: none"> <li>■ [0] = Disabled (default).</li> <li>■ [1] = Enables the display of a user-defined name, which is configured by the [UserProductName] parameter.</li> </ul> <p>For more information, see <a href="#">Customizing the Product Name</a>.</p>
[UserProductName]	<p>Defines a name for the device instead of the default name.</p> <p>The value can be a string of up to 29 characters.</p> <p>For more information, see <a href="#">Customizing the Product Name</a>.</p> <p><b>Note:</b> To enable customization of the device name, see the [UseProductName] parameter.</p>
[UseWebLogo]	<p>Defines whether the Web interface displays a logo image or text.</p> <ul style="list-style-type: none"> <li>■ [0] = (Default) The Web interface displays a logo image, configured by the LogoFileName parameter.</li> <li>■ [1] = The Web interface displays text, configured by the [WebLogoText] parameter.</li> </ul> <p>For more information, see <a href="#">Replacing the Corporate Logo</a>.</p>

Parameter	Description
[WebLogoText]	<p>Defines the text that is displayed instead of the logo in the Web interface.</p> <p>The valid value is a string of up to 15 characters.</p> <p>For more information, see <a href="#">Replacing the Corporate Logo with Text</a>.</p> <p><b>Note:</b> The parameter is applicable only when the [UseWebLogo] parameter is configured to [1].</p>
[LogoFileName]	<p>Defines the name of the image file that you want loaded to the device. This image is displayed as the logo in the Web interface (instead of the AudioCodes logo).</p> <p>The file name can be up to 47 characters.</p> <p>For more information, see <a href="#">Replacing the Corporate Logo with an Image</a>.</p> <p><b>Notes:</b></p> <ul style="list-style-type: none"> <li>■ The image file type can be one of the following: GIF, PNG, JPG, or JPEG.</li> <li>■ The size of the image file can be up to 64 Kbytes.</li> <li>■ The parameter is applicable only when the [UseWebLogo] parameter is configured to [0].</li> </ul>

## Telnet and CLI Parameters

The Telnet parameters are described in the table below.

**Table 70-3: Telnet Parameters**

Parameter	Description
'Embedded Telnet Server' configure system > cli-settings > telnet [TelnetServerEnable]	<p>Enables the device's embedded Telnet server.</p> <ul style="list-style-type: none"> <li>■ [0] <b>Disable</b></li> <li>■ [1] <b>Enable Unsecured</b> (default)</li> <li>■ [2] <b>Enable Secured</b></li> </ul> <p><b>Note:</b> Only management users with Security Administrator or Master user levels can access the CLI's Privileged command mode.</p>
'Telnet Server TCP Port' configure system >	<p>Defines the port number for the embedded Telnet server.</p>

Parameter	Description
<pre>cli-settings &gt; telnet-port [TelnetServerPort]</pre>	<p>The valid range is all valid port numbers. The default port is 23.</p>
<pre>'Telnet Server Idle Timeout' configure system &gt; cli-settings &gt; idle- timeout [TelnetServerIdleDisconnect]</pre>	<p>Defines the duration of an idle CLI (Telnet or SSH) session after which the session is automatically disconnected.</p> <p>The valid range is any value. The default is 5. When configured to 0, idle sessions are not disconnected.</p> <p><b>Note:</b> If you change the parameter's value when there are current Telnet/SSH sessions, the parameter's previous setting is still applied to these current sessions and the parameter's new setting is applied only to new sessions.</p>
<pre>'Maximum Telnet Sessions' configure system &gt; cli-settings &gt; telnet-max-sessions [TelnetMaxSessions]</pre>	<p>Defines the maximum number of permitted, concurrent Telnet or SSH sessions.</p> <p>The valid range is 1 to 5 sessions. The default is 2.</p> <p><b>Note:</b> Before changing the value, make sure that not more than this number of sessions are currently active; otherwise, the new setting will not take effect.</p>
<pre>[CLIEnableModePassword]</pre>	<p>Defines the password to access the Enable configuration mode in the CLI.</p> <p>The valid value is a string of up to 50 characters. The default is "Admin".</p> <p><b>Note:</b></p> <ul style="list-style-type: none"> <li>■ The password is case-sensitive.</li> <li>■ The parameter cannot be configured with wide characters.</li> </ul>
<pre>'Default Terminal Window Height' configure system &gt; cli-settings &gt; default-window-height [DefaultTerminalWindowHeight]</pre>	<p>Defines the number (height) of output lines displayed in the CLI terminal window. This applies to all new CLI sessions and is preserved after device resets.</p> <p>The valid value range is -1 (default) and 0-65535:</p> <ul style="list-style-type: none"> <li>■ A value of -1 means that the parameter is disabled and the settings of the CLI command <b>window-height</b> is used.</li> <li>■ A value of 0 means that all the CLI output is displayed in the window.</li> </ul>

Parameter	Description
	<ul style="list-style-type: none"> <li>■ A value of 1 or greater displays that many output lines in the window and if there is more output, the “—MORE—” prompt is displayed. For example, if you configure the parameter to 4, up to four output lines are displayed in the window and if there is more output, the “—MORE—” prompt is displayed (at which you can press the spacebar to display the next four output lines).</li> </ul> <p><b>Note:</b> You can override this parameter for a specific CLI session and configure a different number of output lines, by using the <b>window-height</b> CLI command in the currently active CLI session.</p>
<pre>configure system &gt; mgmt-auth &gt; obscure- password-mode [CliObscuredPassword]</pre>	<p>Enables the device to enforce obscured (i.e., encrypted) passwords whenever you create a new management user or modify the password of an existing user, through CLI (<code>configure system &gt; user</code>).</p> <ul style="list-style-type: none"> <li>■ [0] = (Default) Disabled - passwords are configured in plain text.</li> <li>■ [1] = Enabled - passwords must be configured in encrypted format. To obtain an encrypted (obscured) password: <ol style="list-style-type: none"> <li>a. Enable the parameter.</li> <li>b. Configure the user's password in the Web interface's Local Users table (see <a href="#">Configuring Management User Accounts</a> on page 49).</li> <li>c. Save the device's CLI Script file to your local PC (see <a href="#">Saving and Loading CLI Script Files</a> on page 1115).</li> <li>d. Open the file, and then copy the encrypted password to the CLI where you are configuring the user.</li> </ol> </li> </ul>

## ini File Parameters

The parameters relating to ini-file management are described in the table below.

**Table 70-4: ini File Parameters**

Parameter	Description
[INIPasswordsDisplayType]	<p>Defines how passwords are displayed in the ini file.</p> <ul style="list-style-type: none"> <li>■ [0] = (default) Disable. Passwords are obscured ("encoded"). The passwords are displayed in the following syntax: \$1\$&lt;obscured password&gt; (e.g., \$1\$S3p+fno=).</li> <li>■ [1] = Enable. All passwords are hidden and replaced by an asterisk (*).</li> </ul>

## SNMP Parameters

The SNMP parameters are described in the table below.

**Table 70-5: SNMP Parameters**

Parameter	Description
<p>'Disable SNMP'</p> <pre>configure system &gt; snmp settings &gt; disable</pre> <p>[DisableSNMP]</p>	<p>Enables and disables SNMP.</p> <ul style="list-style-type: none"> <li>■ [0] <b>No</b> = (Default) SNMP is enabled.</li> <li>■ [1] <b>Yes</b> = SNMP is disabled.</li> </ul> <p><b>Note:</b></p> <ul style="list-style-type: none"> <li>■ For the parameter to take effect, a device reset is required.</li> </ul>
<pre>configure system &gt; snmp settings &gt; port</pre> <p>[SNMPPort]</p>	<p>Defines the device's local (LAN) UDP port used for SNMP Get/Set commands.</p> <p>The range is 100 to 3999. The default port is 161.</p> <p><b>Note:</b> For the parameter to take effect, a device reset is required.</p>
[ChassisPhysicalAlias]	<p>Defines the 'alias' name object for the physical entity as specified by a network manager, and provides a non-volatile 'handle' for the physical entity.</p> <p>The valid range is a string of up to 255 characters.</p>
[ChassisPhysicalAssetID]	<p>Defines the user-assigned asset tracking identifier object for the device's chassis as specified by OVOC, and provides non-</p>

Parameter	Description
	<p>volatile storage of this information.</p> <p>The valid range is a string of up to 255 characters.</p>
[ifAlias]	<p>Defines the textual name of the interface.</p> <p>The value is equal to the ifAlias SNMP MIB object.</p> <p>The valid range is a string of up to 64 characters.</p>
<pre>configure system &gt; snmp trap &gt; auto-send-keep-alive [SendKeepAliveTrap]</pre>	<p>Enables the device to send NAT keep-alive traps to the port of the SNMP network management station (e.g., AudioCodes OVOC). This is used for NAT traversal, and allows SNMP communication with OVOC management platform, located in the WAN, when the device is located behind NAT. It is needed to keep the NAT pinhole open for the SNMP messages sent from OVOC to the device. The device sends the trap periodically - every 9/10 of the time configured by the NATBindingDefaultTimeout parameter. The trap that is sent is acKeepAlive. For more information on the SNMP trap, refer to the <i>SNMP Reference Guide</i>.</p> <ul style="list-style-type: none"> <li>■ [0] = (Default) Disable</li> <li>■ [1] = Enable</li> </ul> <p>To configure the port number, use the KeepAliveTrapPort parameter.</p> <p><b>Note:</b> For the parameter to take effect, a device reset is required.</p>
[KeepAliveTrapPort]	<p>Defines the port of the SNMP network management station to which the device sends keep-alive traps.</p> <p>The valid range is 0 - 65534. The default is port 162.</p> <p>To enable NAT keep-alive traps, use the [SendKeepAliveTrap] parameter.</p>

Parameter	Description
<p>[PM_EnableThresholdAlarms]</p>	<p>Enables the sending of the SNMP trap event</p> <p>acPerformanceMonitoringThresholdCrossing, which is sent every time the threshold (high or low) of a Performance Monitored object (e.g., acPMSIPSBCAttemptedCallsTable) is crossed.</p> <ul style="list-style-type: none"> <li>■ [0] = (Default) Disable</li> <li>■ [1] = Enable</li> </ul> <p><b>Note:</b> Once enabled, you can change the low and high threshold values per performance monitored object. For more information, see the <i>SNMP Reference Guide for Gateways-SBCs-MSBRs</i>.</p>
<p>'Call Duration for Short Calls'</p> <pre>configure voip &gt; sbc settings &gt; short-call-seconds</pre> <p>[ShortCallSeconds]</p>	<p>Defines the duration (in seconds) of an SBC call for it to be considered as a short call and thus, included in the count of the performance monitoring SNMP MIBs for short calls (acPMSBCInShortCallsTable, acPMSBCOutShortCallsTable, acPMSBCSRDInShortCallsTable, acPMSBCSRDOutShortCallsTable, acPMSBCIPGroupInShortCallsTable, and acPMSBCIPGroupOutShortCallsTable).</p> <p>The valid value is 0 to 60. The default is 2. A value of 0 indicates calls of zero duration, which are calls that do not pass the device's Classification, Manipulation or Routing stages.</p> <p><b>Note:</b> The parameter is applicable only to the SBC application.</p>
<pre>configure system &gt; snmp settings &gt; sys-oid</pre> <p>[SNMPSysOid]</p>	<p>Defines the SNMP MIB OID for the base product system.</p> <p>The default is 1.3.6.1.4.1.5003.8.1.1.</p> <p><b>Note:</b></p> <ul style="list-style-type: none"> <li>■ For the parameter to take effect, a device reset is required.</li> </ul>



Parameter	Description
	<ul style="list-style-type: none"> <li>■ The device automatically adds the device's unique product identifier number at the end of your OID.</li> </ul>
[SNMPTrapEnterpriseOid]	<p>Defines the SNMP MIB OID for the Trap Enterprise.</p> <p>The default is 1.3.6.1.4.1.5003.9.10.1.21.</p> <p><b>Note:</b></p> <ul style="list-style-type: none"> <li>■ For the parameter to take effect, a device reset is required.</li> <li>■ The device automatically adds the device's unique product identifier number at the end of your OID.</li> </ul>
[acUserInputAlarmDescription]	Defines the description of the input alarm.
[acUserInputAlarmSeverity]	Defines the severity of the input alarm.
[AlarmHistoryTableMaxSize]	<p>Defines the maximum number of rows in the Alarm History table. The parameter can be controlled by the Config Global Entry Limit MIB (located in the Notification Log MIB).</p> <p>The valid range is 50 to 1000. The default is 500.</p> <p><b>Note:</b> For the parameter to take effect, a device reset is required.</p>
[ActiveAlarmTableMaxSize]	<p>Defines the maximum number of currently active alarms that can be displayed in the Active Alarms table. When the table reaches this user-defined maximum capacity (i.e., full), the device sends the SNMP trap event, acActiveAlarmTableOverflow. If the table is full and a new alarm is raised by the device, the new alarm is not displayed in the table.</p> <p>The valid range is 50 to 300. The default is 120.</p> <p>For more information on the Active Alarms table, see <a href="#">Viewing Active Alarms</a>.</p>

Parameter	Description
	<p><b>Note:</b></p> <ul style="list-style-type: none"> <li>■ For the parameter to take effect, a device reset is required.</li> <li>■ To clear the <code>acActiveAlarmTableOverflow</code> trap, you must reset the device. The reset also deletes all the alarms in the Active Alarms table.</li> </ul>
<p><code>no-alarm-for-disabled-port</code> [NoAlarmForDisabledPort]</p>	<p>Enables the device to not send the SNMP trap <code>acBoardControllerFailureAlarm</code> alarm. This alarm indicates a "disabled" telephony port, which is one that is not configured at all or that is configured but without a Trunk Group ID (i.e., Trunk Group ID is 0), in the Trunk Group table.</p> <ul style="list-style-type: none"> <li>■ [0] = (Default) Disabled. The device sends the SNMP trap for non-configured ports.</li> <li>■ [1] = Enabled. The device does not send the SNMP trap for non-configured ports.</li> </ul> <p><b>Note:</b></p> <ul style="list-style-type: none"> <li>■ The parameter is applicable to all telephony (analog and digital) port types.</li> <li>■ The parameter is applicable only to the Gateway application.</li> </ul>
<p><code>configure voip &gt; gateway</code> <code>analog fxs-setting fxs-</code> <code>offhook-timeout-alarm</code> [FXSOffhookTimeoutAlarm]</p>	<p>Defines the duration (in seconds) of an FXS phone in off-hook state after which the device sends the SNMP alarm, <code>acAnalogLineLeftOffhookAlarm</code>. The device starts this timer once the reorder tone begins playing when the phone goes off-hook. The alarm is cleared when the phone's hook-flash button is pressed or the phone returns to on-hook state.</p> <p>The valid value is 0 to 180,000. The default is 0, meaning that this alarm is not sent</p>

Parameter	Description
	<p>when the phone goes off-hook.</p> <p><b>Note:</b></p> <ul style="list-style-type: none"> <li>■ The parameter is applicable only to FXS interfaces.</li> <li>■ The parameter's setting is applied only to phones that go off-hook after you have configured the parameter.</li> </ul>
[ContextEngineID]	<p>Defines the contextEngineID as mentioned in RFC 3411. An SNMP context is a collection of management information accessible by an SNMP entity. An item of management information may exist in more than one context and an SNMP entity potentially has access to many contexts. A context is identified by the snmpEngineID value of the entity hosting the management information (also called a contextEngineID) and a context name that identifies the specific context (also called a contextName).</p> <p><b>Note:</b></p> <ul style="list-style-type: none"> <li>■ For the parameter to take effect, a device reset is required.</li> </ul>
<pre>configure system &gt; snmp settings &gt; engine-id</pre> <p>[SNMPEngineIDString]</p>	<p>Defines the SNMP engine ID for SNMPv2/SNMPv3 agents. This is used for authenticating a user attempting to access the SNMP agent on the device.</p> <p>The ID can be a string of up to 36 characters. The default is 00:00:00:00:00:00:00:00:00:00:00:00 (12 Hex octets characters). The provided key must be set with 12 Hex values delimited by a colon (":") in the format xx:xx:...:xx. For example,</p> <p>00:11:22:33:44:55:66:77:88:99:aa:bb</p> <p><b>Note:</b></p> <ul style="list-style-type: none"> <li>■ For the parameter to take effect, a device reset is required.</li> </ul>

Parameter	Description
	<ul style="list-style-type: none"> <li>■ Before setting the parameter, all SNMPv3 users must be deleted; otherwise, the parameter setting is ignored.</li> <li>■ If the supplied key does not pass validation of the 12 Hex values input or it is set with the default value, the engine ID is generated according to RFC 3411.</li> </ul>
Trap Manager Host Name <code>manager-host-name</code> [SNMPTrapManagerHostName]	Defines an FQDN of the remote host used as an SNMP manager to receive traps sent by the device. The device sends the traps to the DNS-resolved IP address.  The valid range is a string of up to 99 characters.  For more information, see <a href="#">Configuring an SNMP Trap Destination with FQDN</a> .
'Activity Trap' <code>configure troubleshoot &gt; activity-trap</code> [EnableActivityTrap]	Enables the device to send an SNMP trap to notify of Web user activities in the Web interface. The activities to report are configured by the [ActivityListToLog] parameter (see <a href="#">Reporting Management User Activities</a> on page 1321).  <ul style="list-style-type: none"> <li>■ [0] <b>Disable</b> (default)</li> <li>■ [1] <b>Enable</b></li> </ul>
<b>SNMP Community String Parameters</b>	
'Read Only Community Strings' <code>configure system &gt; snmp settings &gt; ro-community-string</code> [SNMPReadOnlyCommunityStringsPassword_x]	Defines a read-only SNMP community string. Up to five read-only community strings can be configured. For more information, see <a href="#">Configuring SNMP Community Strings</a> on page 77.  <b>Note:</b> The parameter cannot be configured with wide characters.
'Read/Write Community Strings' <code>configure system &gt; snmp settings &gt; rw-community-string</code>	Defines a read-write SNMP community string. Up to five read-write community strings can be configured. For more information, see <a href="#">Configuring SNMP</a>

Parameter	Description
[SNMPReadWriteCommunityStringsPassword_x]	<a href="#">Community Strings</a> on page 77. <b>Note:</b> The parameter cannot be configured with wide characters.
'Trap Community String' configure system > snmp trap > community-string [SNMPTrapCommunityStringPassword]	Defines the community string for SNMP traps. For more information, see <a href="#">Configuring SNMP Community Strings</a> on page 77. <b>Note:</b> The parameter cannot be configured with wide characters.

## WebSocket Tunneling with OVOC Parameters

The WebSocket tunneling with OVOC parameters are described in the table below. For more information on WebSocket tunneling between the device and OVOC, see [Configuring WebSocket Tunnel with OVOC](#) on page 90.

**Table 70-6: WebSocket Tunneling with OVOC Parameters**

Parameter	Description
'OVOC WebSocket Tunnel Server Address' configure network > ovoc- tunnel-settings > address [WSTunServer]	Defines the address of the WebSocket tunnel server (OVOC). The valid value is an IPv4 address (in dotted-decimal notation) or a hostname. By default, no value is defined. <b>Note:</b> <ul style="list-style-type: none"> <li>■ For the parameter to take effect, a device reset is required.</li> <li>■ To resolve the domain name into an IP address, the device uses the DNS server that is configured in the IP Interfaces table for its <b>OAMP</b> IP interface type, by the 'Primary DNS' parameter and optionally, the 'Secondary DNS' parameter (see <a href="#">Configuring IP Network Interfaces</a> on page 121).</li> </ul>
'Path' configure network > ovoc-	Defines the path of the WebSocket tunnel server.

Parameter	Description
tunnel-settings > path [WSTunServerPath]	Configure the parameter to "tun" (without quotation marks) to match the default OVOC configuration. <b>Note:</b> For the parameter to take effect, a device reset is required.
'Username' configure network > ovoc-tunnel-settings > username [WSTunUsername]	Defines the username for connecting the device to the WebSocket tunnel server (OVOC). The valid value is a string of up to 30 characters. Configure the parameter to "VPN" (without quotation marks) to match the default OVOC configuration. <b>Note:</b> <ul style="list-style-type: none"> <li>■ For the parameter to take effect, a device reset is required.</li> <li>■ The username must be the same as that configured on OVOC.</li> </ul>
'Password' configure network > ovoc-tunnel-settings > password [WSTunPassword]	Defines the password for connecting the device to the WebSocket tunnel server (OVOC). The valid value is a string of up to 30 characters. Configure the parameter to "123456" (without quotation marks) to match the default OVOC configuration. <b>Note:</b> <ul style="list-style-type: none"> <li>■ For the parameter to take effect, a device reset is required.</li> <li>■ The password must be the same as that configured on OVOC.</li> </ul>
'Secured (HTTPS)' configure network > ovoc-tunnel-settings > secured [WSTunSecured]	Enables secured (HTTPS) WebSocket tunneling connection. <ul style="list-style-type: none"> <li>■ [0] = Disable</li> <li>■ [1] = (Default) Enable</li> </ul> <b>Note:</b> For the parameter to take effect, a

Parameter	Description
	device reset is required.
<p>'Verify Server'</p> <pre>configure network &gt; ovoc- tunnel-settings &gt; verify- server</pre> <p>[WSTunVerifyPeer]</p>	<p>Enables the device to verify the TLS certificate that is presented by OVOC when establishing the WebSocket tunneling connection.</p> <p>You should load the corresponding CA certificate to the device's Trusted Root store of the default TLS Context (Index #0).</p> <ul style="list-style-type: none"> <li>■ [0] = Disable - no certificate verification is done.</li> <li>■ [1] = (Default) Enable. The device verifies that the TLS certificate presented by OVOC is signed by one of the known CAs.</li> </ul> <p><b>Note:</b></p> <ul style="list-style-type: none"> <li>■ For the parameter to take effect, a device reset is required.</li> <li>■ The parameter is applicable only if you configure the [WSTunSecured] parameter to [1].</li> </ul>

## Serial Parameters

The serial interface parameters are described in the table below.

**Table 70-7: Serial Parameters**

Parameter	Description
[DisableRS232]	<p>Enables the device's RS-232 (serial) port.</p> <ul style="list-style-type: none"> <li>■ [0] = Enabled</li> <li>■ [1] = (Default) Disabled</li> </ul> <p>The RS-232 serial port can be used to change the networking parameters and view error/notification messages. To establish serial communication with the device, see <a href="#">Establishing a CLI Session</a>.</p> <p><b>Note:</b> For the parameter to take effect, a device reset is required.</p>

Parameter	Description
[SerialBaudRate]	<p>Defines the serial communication baud rate.</p> <p>The valid values include the following: 1200, 2400, 9600, 14400, 19200, 38400, 57600, or 115200 (default).</p> <p><b>Note:</b> For the parameter to take effect, a device reset is required.</p>
[SerialData]	<p>Defines the serial communication data bit.</p> <ul style="list-style-type: none"> <li>■ [7] = 7-bit</li> <li>■ [8] = (Default) 8-bit</li> </ul> <p><b>Note:</b> For the parameter to take effect, a device reset is required.</p>
[SerialParity]	<p>Defines the serial communication polarity.</p> <ul style="list-style-type: none"> <li>■ [0] = (Default) None</li> <li>■ [1] = Odd</li> <li>■ [2] = Even</li> </ul> <p><b>Note:</b> For the parameter to take effect, a device reset is required.</p>
[SerialStop]	<p>Defines the serial communication stop bit.</p> <ul style="list-style-type: none"> <li>■ [1] = (Default) 1-bit (default)</li> <li>■ [2] = 2-bit</li> </ul> <p><b>Note:</b> For the parameter to take effect, a device reset is required.</p>
[SerialFlowControl]	<p>Defines the serial communication flow control.</p> <ul style="list-style-type: none"> <li>■ [0] = (Default) None</li> <li>■ [1] = Hardware</li> </ul> <p><b>Note:</b> For the parameter to take effect, a device reset is required.</p>

## Auxiliary and Configuration File Name Parameters

The table below lists the parameters associated with the Auxiliary files. For more information on Auxiliary files, see [Loading Auxiliary Files](#).

**Table 70-8: Auxiliary and Configuration File Parameters**

Parameter	Description
<b>General Parameters</b>	
[SetDefaultOnIniFileProcess]	Determines if all the device's parameters are set to their



Parameter	Description
	<p>defaults before processing the updated <i>ini</i> file.</p> <ul style="list-style-type: none"> <li>■ [0] = Disable - parameters not included in the downloaded ini file are not returned to default settings (i.e., retain their current settings).</li> <li>■ [1] = Enable (default).</li> </ul> <p><b>Note:</b> The parameter is applicable only for automatic HTTP update or Web <i>ini</i> file upload (not applicable if the <i>ini</i> file is loaded using BootP).</p>
[SaveConfiguration]	<p>Determines if the device's configuration (parameters and files) is saved to flash (non-volatile memory).</p> <ul style="list-style-type: none"> <li>■ [0] = Configuration isn't saved to flash memory.</li> <li>■ [1] = (Default) Configuration is saved to flash memory.</li> </ul>
<b>Auxiliary Filename Parameters</b>	
'Call Progress Tones File' [CallProgressTonesFilename]	<p>Defines the name of the file containing the Call Progress Tones definitions.</p> <p>For the ini file, the name must be enclosed by a single quotation mark (e.g., 'cpt_us.dat').</p> <p>For more information on how to create and load this file, refer to <i>DConvert Utility User's Guide</i>.</p> <p><b>Note:</b> For the parameter to take effect, a device reset is required.</p>
'Voice Prompts File' [VoicePromptsFileName]	<p>Defines the name of the file containing the Voice Prompts.</p> <p>For the ini file, the name must be enclosed by a single quotation mark (e.g., 'vp_us.dat').</p> <p><b>Note:</b></p> <ul style="list-style-type: none"> <li>■ For the parameter to take effect, a device reset is required.</li> <li>■ For more information on this file, see <a href="#">Voice Prompts File</a>.</li> </ul>
'Prerecorded Tones File' [PrerecordedTonesFileName]	<p>Defines the name of the file containing the Prerecorded Tones.</p> <p><b>Note:</b> For the parameter to take effect, a device reset is required.</p>

Parameter	Description
'CAS File' [CASFileName_x]	<p>Defines the CAS file name (e.g., 'E_M_WinkTable.dat'), which defines the CAS protocol (where x denotes the CAS file ID 0 to 7). It is possible to define up to eight different CAS files by repeating the parameter. Each CAS file can be associated with one or more of the device's trunks, using the parameter CASTableIndex or it can be associated per B-channel using the parameter CASChannelIndex.</p> <p>For the ini file, the name must be enclosed by a single quotation mark (e.g., 'cas_us.dat').</p> <p><b>Note:</b> For the parameter to take effect, a device reset is required.</p>
'Dial Plan' [CasTrunkDialPlanName_x]	<p>Defines the Dial Plan name (up to 11-character strings) per trunk.</p> <p>For the ini file, the name must be enclosed by a single quotation mark (e.g., 'dial_plan_2.dat').</p> <p><b>Note:</b> The x in the ini file parameter name denotes the trunk number, where 0 is Trunk 1.</p>
'Dial Plan File' [DialPlanFileName]	<p>Defines the name of the Dial Plan file.</p> <p>For the ini file, the name must be enclosed by a single quotation mark (e.g., 'dial_plan.dat').</p> <p><b>Note:</b> This parameter is used only for backward compatibility. For loading (importing) Dial Plan files, use the Dial Plan table instead (see <a href="#">Importing Dial Plans</a> on page 632).</p>
[UserInfoFileName]	<p>Defines the name of the file containing the User Information data.</p> <p>For the ini file, the name must be enclosed by a single quotation mark (e.g., 'userinfo_us.dat').</p> <p><b>Note:</b> The parameter is only used for backward compatibility.</p>

## Automatic Update Parameters

The automatic update of software and configuration files parameters are described in the table below.



Auxiliary file upload through TFTP is not supported by HA mode.

**Table 70-9: Automatic Update of Software and Configuration Files Parameters**

Parameter	Description
<b>General Automatic Update Parameters</b>	
CLI path: <code>configure system &gt; automatic-update</code>	
<code>update-firmware</code> [AutoUpdateCmpFile]	<p>Enables the Automatic Update mechanism for the cmp file.</p> <ul style="list-style-type: none"> <li>■ [0] = (Default) The Automatic Update mechanism doesn't apply to the cmp file.</li> <li>■ [1] = The Automatic Update mechanism includes the cmp file.</li> </ul> <p><b>Note:</b> For the parameter to take effect, a device reset is required.</p>
<code>update-frequency</code> [AutoUpdateFrequency]	<p>Defines the periodic interval (in minutes) that the device waits between consecutive automatic updates.</p> <p>The default is 0 (i.e., the update at fixed intervals mechanism is disabled).</p> <p><b>Note:</b> For the parameter to take effect, a device reset is required.</p>
<code>predefined-time</code> [AutoUpdatePredefinedTime]	<p>Defines the time of day at which the device performs automatic updates.</p> <p>The format syntax of the parameter is 'hh:mm', where <i>hh</i> denotes the hour and <i>mm</i> the minutes. The value must be enclosed by a single quotation mark (e.g., '20:18').</p> <p><b>Note:</b></p> <ul style="list-style-type: none"> <li>■ For the parameter to take effect, a device reset is required.</li> <li>■ By default, the actual update time is randomized by five minutes to reduce the load on the Web servers. To change this randomized time, use the [AutoUpdatePredefinedRandomTime] parameter.</li> </ul>
[AutoUpdatePredefinedRandomTime]	<p>Defines the maximum randomization interval (in seconds) for the daily scheduled automatic update (configured by the [AutoUpdatePredefinedTime] parameter). For example, if you configure the</p>

Parameter	Description
	<p>[AutoUpdatePredefinedTime] parameter to '13:00' (i.e., 1 pm) and [AutoUpdatePredefinedRandomTime] to '300' (i.e., 5 min.), the actual update can start anywhere between the time 13:00 and 13:05.</p> <p>The valid value range 60 to 86400. The default is 300.</p>
<p>aupd-graceful-shutdown [AupdGracefulShutdown]</p>	<p>Enables the device to gracefully lock for the Automatic Update feature when updating the ini configuration file. When the file is downloaded from the provisioning server, the device gracefully locks. During this graceful period (configured by the [AdminStateLockControl] ini file parameter), no new calls are accepted. If all existing calls end before the timeout expires, the device locks and applies the settings of the file. If there are still existing calls when the timeout expires, the device terminates them and applies the settings of the file. For more information, see <a href="#">Applying Downloaded ini File after Graceful Timeout</a> on page 1131.</p> <ul style="list-style-type: none"> <li>■ [0] = (Default) Disable</li> <li>■ [1] = Enable</li> </ul>
<p>http-user-agent [AupdHttpUserAgent]</p>	<p>Defines the information sent in the HTTP User-Agent header in the HTTP Get requests sent by the device to the provisioning server for the Automatic Update mechanism.</p> <p>The valid value is a string of up to 511 characters. The information can include any user-defined string or the following string variable tags (case-sensitive):</p> <ul style="list-style-type: none"> <li>■ &lt;NAME&gt;: product name, according to the installed License Key</li> <li>■ &lt;MAC&gt;: device's MAC address</li> <li>■ &lt;VER&gt;: software version currently installed on the device, e.g., "7.00.200.001"</li> <li>■ &lt;CONF&gt;: configuration version, as configured by the ini file parameter, [INIFileVersion] or CLI command <code>configuration-version</code></li> </ul> <p>The device automatically populates these tag variables with actual values in the sent header. By</p>

Parameter	Description
	<p>default, the device sends the following in the User-Agent header:</p> <pre>User-Agent: Mozilla/4.0 (compatible; AudioCodes; &lt;NAME&gt;;&lt;VER&gt;;&lt;MAC&gt;;&lt;CONF&gt;)</pre> <p>For example, if you set <code>AupdHttpUserAgent = MyWorld-&lt;NAME&gt;;&lt;VER&gt;(&lt;MAC&gt;)</code>, the device sends the following User-Agent header:</p> <pre>User-Agent: MyWorld- Mediant;7.00.200.001(00908F1DD0D3)</pre> <p><b>Note:</b></p> <ul style="list-style-type: none"> <li>■ The variable tags are case-sensitive.</li> <li>■ If you configure the parameter with the <code>&lt;CONF&gt;</code> variable tag, you must reset the device with a save-to-flash for your settings to take effect.</li> <li>■ The tags can be defined in any order.</li> <li>■ The tags must be defined adjacent to one another (i.e., no spaces).</li> </ul>
<code>auto-firmware</code> [AutoCmpFileUrl]	<p>Defines the filename and path (URL) to the provisioning server from where the software file (.cmp) can be downloaded, based on timestamp for the Automatic Updated mechanism.</p> <p>The valid value is an IP address in dotted-decimal notation or an FQDN.</p>
<code>aupd-verify-cert</code> [AUPDVerifyCertificates]	<p>Determines whether the Automatic Update mechanism verifies the TLS certificate received from the provisioning server when the connection is HTTPS.</p> <ul style="list-style-type: none"> <li>■ [0] = Disable (default)</li> <li>■ [1] = Enables TLS certificate verification when the connection with the provisioning server is based on HTTPS. The device verifies the authentication of the certificate received from the provisioning server. The device authenticates the certificate</li> </ul>

Parameter	Description
	<p>against its trusted root certificate store (see <a href="#">Configuring TLS Certificates</a> on page 154) and if ok, allows communication with the provisioning server. If authentication fails, the device denies communication (i.e., handshake fails).</p>
<p>credentials [AUPDUserPassword]</p>	<p>Defines the username and password for digest (MD5 cryptographic hashing) and basic access authentication with the HTTP server on which the files to download are located for the Automatic Update feature.</p> <p>The valid value is a string of up to 128 characters. The syntax is 'username:password' (e.g., 'joe:1234'). By default, no value is defined.</p> <p><b>Note:</b> The device only uses the username and password configured by this parameter if no username and password has been configured for the parameter used to configure the URL of the server with the name of the file, for example, [CmpFileURL].</p>
<p>crc-check regular [AUPDCheckIfIniChanged]</p>	<p>Enables the device to perform cyclic redundancy checks (CRC) on downloaded configuration files during the Automatic Update process. The CRC checks whether the content (raw data) of the downloaded file is different to the content of the previously downloaded file from the previous Automatic Update process. The device compares the CRC check value (code) result with the check value of the previously downloaded file. If the check values are identical, it indicates that the file has no new configuration settings, and the device discards the file. If the check values are different, the device installs the downloaded file and applies the new configuration settings.</p> <ul style="list-style-type: none"> <li>■ [0] = (Default) Disable - the device does not perform CRC and installs the downloaded file regardless.</li> <li>■ [1] = Enable CRC for the entire file, including line order (i.e., same text must be on the same lines). If there are differences between the files, the device installs the downloaded file. If there are no differences, the device discards the newly</li> </ul>

Parameter	Description
	<p>downloaded file.</p> <ul style="list-style-type: none"> <li>■ [2] = Enable CRC for individual lines only. Same as option [1], except that the CRC ignores the order of lines (i.e., same text can be on different lines).</li> </ul>
<p>tftp-block-size [AUPDTftpBlockSize]</p>	<p>Defines the size of the TFTP data blocks (packets) when downloading a file from a TFTP server for the Automatic Update mechanism. This is in accordance to RFC 2348. TFTP block size is the physical packet size (in bytes) that a network can transmit. When configured to a value higher than the default (512 bytes), but lower than the client network's Maximum Transmission Unit (MTU), the file download speed can be significantly increased. The valid value is 512 to 8192. The default is 512.</p> <p><b>Note:</b></p> <ul style="list-style-type: none"> <li>■ A higher value does not necessarily mean better performance.</li> <li>■ The block size should be small enough to avoid IP fragmentation in the client network (i.e., below MTU).</li> <li>■ This feature is applicable only to TFTP servers that support this option.</li> </ul>
<p>[ResetNow]</p>	<p>Invokes an immediate device reset. This option can be used to activate offline (i.e., not on-the-fly) parameters that are loaded using the parameter IniFileUrl.</p> <ul style="list-style-type: none"> <li>■ [0] = (Default) The immediate restart mechanism is disabled.</li> <li>■ [1] = The device immediately resets after an <i>ini</i> file with the parameter set to 1 is loaded.</li> </ul> <p><b>Note:</b> If you use the parameter in an ini file for periodic automatic provisioning with non-HTTP (e.g., TFTP) and without CRC, the device resets upon every file download.</p>
<p><b>Software and Configuration File URL Path for Automatic Update Parameters</b></p> <pre>configure system &gt; automatic-update &gt;</pre>	

Parameter	Description
firmware [CmpFileURL]	<p>Defines the name of the <i>cmp</i> file and the URL address (IP address or FQDN) of the server where the file is located. Optionally, the username and password (username:password) for access authentication with the server can also be configured.</p> <p>Example syntax:</p> <pre>'http://192.168.0.1/&lt;filename&gt;' 'https://&lt;username&gt;:&lt;password&gt;@&lt;IP address&gt;/&lt;file name&gt;'</pre> <p><b>Note:</b></p> <ul style="list-style-type: none"> <li>■ For the parameter to take effect, a device reset is required.</li> <li>■ When the parameter is configured, the device always loads the <i>cmp</i> file after it is reset.</li> <li>■ The <i>cmp</i> file is validated before it's burned to flash. The checksum of the <i>cmp</i> file is also compared to the previously burnt checksum to avoid unnecessary resets.</li> <li>■ The maximum length of the URL address is 255 characters.</li> <li>■ When using the ini file, the value must be enclosed by single quotation marks ('...').</li> </ul>
ini-file [IniFileURL]	<p>Defines the name of the <i>ini</i> file and the URL address (IP address or FQDN) of the server where the file is located. Parameters that are not included in the ini file are restored to default settings. Optionally, the username and password ('https://username:password@10.1.1.1/&lt;file name&gt;') for access authentication with the server can also be configured.</p> <p>Example syntax:</p> <pre>'http://192.168.0.1/&lt;filename&gt;' 'http://192.8.77.13/config_&lt;MAC&gt;.ini' 'https://&lt;username&gt;:&lt;password&gt;@&lt;IP address&gt;/&lt;filename&gt;'</pre>



Parameter	Description
	<p><b>Note:</b></p> <ul style="list-style-type: none"> <li>■ For the parameter to take effect, a device reset is required.</li> <li>■ When using HTTP or HTTPS, the date and time of the <i>ini</i> file are validated. Only more recently dated <i>ini</i> files are loaded.</li> <li>■ The case-sensitive string "&lt;MAC&gt;" can be used in the filename, which is automatically replaced with the device's MAC address. This option allows the loading of specific configurations for specific devices. For more information, see <a href="#">MAC Address Placeholder in Configuration File Name</a>.</li> <li>■ The maximum length of the URL address is 99 characters.</li> <li>■ When using the ini file, the value must be enclosed by single quotation marks ('...').</li> </ul>
<p><code>incremental-ini-file</code> [IncrementalIniFileURL]</p>	<p>Defines the name of the incremental <i>ini</i> file and the URL address (IP address or FQDN) of the server where the file is located. Parameters that are not included in the ini file remain at their current settings. Optionally, the username and password ('https://username:password@10.1.1.1/&lt;filename&gt;') for access authentication with the server can also be configured.</p> <p>Example syntax:</p> <pre>'http://192.168.0.1/&lt;filename&gt;' 'http://192.8.77.13/config_&lt;MAC&gt;.ini' 'https://&lt;username&gt;:&lt;password&gt;@&lt;IP address&gt;/&lt;filename&gt;'</pre> <p><b>Note:</b></p> <ul style="list-style-type: none"> <li>■ For the parameter to take effect, a device reset is required.</li> <li>■ When using HTTP or HTTPS, the date and time of the <i>ini</i> file are validated. Only more recently dated <i>ini</i> files are loaded.</li> <li>■ The case-sensitive string "&lt;MAC&gt;" can be used in</li> </ul>

Parameter	Description
	<p>the filename, which is automatically replaced with the device's MAC address. This option allows the loading of specific configurations for specific devices. For more information, see <a href="#">MAC Address Placeholder in Configuration File Name</a>.</p> <ul style="list-style-type: none"> <li>■ The maximum length of the URL address is 99 characters.</li> <li>■ When using the ini file, the value must be enclosed by single quotation marks ('...').</li> </ul>
<pre>cli-script &lt;URL&gt; [CLIScriptURL]</pre>	<p>Defines the URL of the server where the CLI Script file containing the device's configuration is located. This file is used for automatic provisioning. Optionally, the username and password ('https://username:password@10.1.1.1/&lt;filename&gt;') for access authentication with the server can also be configured.</p> <p><b>Note:</b> The case-sensitive string, "&lt;MAC&gt;" can be used in the filename, which is automatically replaced with the device's MAC address. For more information, see <a href="#">MAC Address Placeholder in Configuration File Name</a>.</p>
<pre>startup-script &lt;URL&gt; [CLIScriptURL]</pre>	<p>Defines the URL address of the server where the CLI Startup Script file containing the device's configuration is located. This file is used for automatic provisioning. Optionally, the username and password ('https://username:password@10.1.1.1/&lt;filename&gt;') for access authentication with the server can also be configured.</p> <p><b>Note:</b></p> <ul style="list-style-type: none"> <li>■ The case-sensitive string, "&lt;MAC&gt;" can be used in the file name for instructing the device to replace it with the device's MAC address. For more information, see <a href="#">MAC Address Placeholder in Configuration File Name</a>.</li> <li>■ When using the ini file, the value must be enclosed by single quotation marks ('...').</li> </ul>
<pre>prerecorded-tones</pre>	<p>Defines the name of the Prerecorded Tones (PRT) file</p>

Parameter	Description
[PrtFileURL]	<p>and the URL address (IP address or FQDN) of the server where the file is located. Optionally, the username and password ('https://username:password@10.1.1.1/&lt;file name&gt;') for access authentication with the server can also be configured.</p> <p>Example syntax:</p> <pre data-bbox="758 571 1377 705">'http://&lt;server_name&gt;/&lt;filename&gt;' 'https://&lt;server_name&gt;/&lt;filename&gt;'</pre> <p><b>Note:</b></p> <ul style="list-style-type: none"> <li>■ The maximum length of the URL address is 99 characters.</li> <li>■ When using the ini file, the value must be enclosed by single quotation marks ('...').</li> </ul>
call-progress-tones [CptFileURL]	<p>Defines the name of the CPT file and the URL address (IP address or FQDN) of the server where the file is located. Optionally, the username and password ('https://username:password@10.1.1.1/&lt;file name&gt;') for access authentication with the server can also be configured.</p> <p>Example syntax:</p> <pre data-bbox="758 1276 1377 1411">'http://&lt;server_name&gt;/&lt;filename&gt;' 'https://&lt;server_name&gt;/&lt;filename&gt;'</pre> <p><b>Note:</b></p> <ul style="list-style-type: none"> <li>■ The maximum length of the URL address is 99 characters.</li> <li>■ When using the ini file, the value must be enclosed by single quotation marks ('...').</li> </ul>
voice-prompts [VpFileURL]	<p>Defines the name of the Voice Prompts file and the URL address (IP address or FQDN) of the server on which the file is located. Optionally, the username and password ('https://username:password@10.1.1.1/&lt;file name&gt;') for access authentication with the server can also be configured.</p>

Parameter	Description
	<p>Example syntax:</p> <pre>'http://&lt;server_name&gt;/&lt;filename&gt;' 'https://&lt;server_name&gt;/&lt;filename&gt;'</pre> <p><b>Note:</b></p> <ul style="list-style-type: none"> <li>■ The maximum length of the URL address is 99 characters.</li> <li>■ When using the ini file, the value must be enclosed by single quotation marks ('...').</li> </ul>
<p>cas-table [CasFileURL]</p>	<p>Defines the name of the CAS file and the URL address (IP address or FQDN) of the server where the file is located. Optionally, the username and password ('https://username:password@10.1.1.1/&lt;filename&gt;') for access authentication with the server can also be configured.</p> <p>Example syntax:</p> <pre>'http://&lt;server_name&gt;/&lt;filename&gt;' 'https://&lt;server_name&gt;/&lt;filename&gt;'</pre> <p><b>Note:</b></p> <ul style="list-style-type: none"> <li>■ The maximum length of the URL address is 99 characters.</li> <li>■ When using the ini file, the value must be enclosed by single quotation marks ('...').</li> </ul>
<p>dial-plan [DialPlanCSVFileUrl]</p>	<p>Defines the name of the Dial Plan file (.csv) and the URL address of the server where the file is located. Optionally, the username and password ('https://username:password@10.1.1.1/&lt;filename&gt;') for access authentication with the server can also be configured.</p> <p><b>Note:</b> When using the ini file, the value must be enclosed by single quotation marks ('...').</p>
<p>tls-root-cert [TLSRootFileUrl]</p>	<p>Defines the name of the TLS trusted root certificate file and the URL address of the server where the file is located. Optionally, the username and password ('https://username:password@10.1.1.1/&lt;filename&gt;') for access authentication with the server</p>

Parameter	Description
	<p>can also be configured.</p> <p><b>Note:</b></p> <ul style="list-style-type: none"> <li>■ For the parameter to take effect, a device reset is required.</li> <li>■ When using the ini file, the value must be enclosed by single quotation marks ('...').</li> </ul>
<p><code>tls-cert</code> [TLSCertFileUrl]</p>	<p>Defines the name of the TLS certificate file and the URL address of the server where the file is located. Optionally, the username and password ('https://username:password@10.1.1.1/&lt;file name&gt;') for access authentication with the server can also be configured.</p> <p><b>Note:</b></p> <ul style="list-style-type: none"> <li>■ For the parameter to take effect, a device reset is required.</li> <li>■ When using the ini file, the value must be enclosed by single quotation marks ('...').</li> </ul>
<p><code>tls-private-key</code> [TLSPkeyFileUrl]</p>	<p>Defines the URL address of the server on which the TLS private key file is located. Optionally, the username and password ('https://username:password@10.1.1.1/&lt;file name&gt;') for access authentication with the server can also be configured.</p> <p><b>Note:</b> When using the ini file, the value must be enclosed by single quotation marks ('...').</p>
<p><code>gw-user-info</code> [GWUserInfoFileUrl]</p>	<p>Defines the name of the Gateway User Information file and the URL address (IP address or FQDN) of the server where the file is located. Optionally, the username and password ('https://username:password@10.1.1.1/&lt;file name&gt;') for access authentication with the server can also be configured. For example:</p> <div style="border: 1px solid #ccc; border-radius: 10px; padding: 10px; background-color: #f9f9f9; margin-top: 10px;"> <p>'https://www.company.com/GW-User_Info.csv'</p> </div>
<p><code>sbc-user-info</code> [SBCUserInfoFileUrl]</p>	<p>Defines the name of the SBC User Information file</p>

Parameter	Description
	<p>and the URL address (IP address or FQDN) of the server where the file is located. Optionally, the username and password ('https://username:password@10.1.1.1/&lt;file name&gt;') for access authentication with the server can also be configured. For example:</p> <pre data-bbox="756 528 1377 663">'https://www.company.com/SBC-User-Info.csv'</pre> <p><b>Note:</b> When using the ini file, the value must be enclosed by single quotation marks ('...').</p>
<p>user-info [UserInfoFileURL]</p>	<p>Defines the name of the User Information file and the URL address (IP address or FQDN) of the server where the file is located. Optionally, the username and password ('https://username:password@10.1.1.1/&lt;file name&gt;') for access authentication with the server can also be configured.</p> <p>The maximum length of the URL address is 99 characters.</p> <p>Example syntax:</p> <pre data-bbox="756 1200 1377 1335">'http://&lt;server_name&gt;/&lt;filename&gt;' 'https://&lt;server_name&gt;/filename'</pre> <p><b>Note:</b></p> <ul style="list-style-type: none"> <li data-bbox="756 1406 1377 1559">■ The parameter is used for <b>backward compatibility only</b>. Use the [GWUserInfoFileUrl] or [SBCUserInfoFileUrl] parameter (above) instead.</li> <li data-bbox="756 1585 1377 1653">■ When using the ini file, the value must be enclosed by single quotation marks ('...').</li> </ul>
<p>feature-key [FeatureKeyURL]</p>	<p>Defines the name of the License Key file and the URL address of the server where the file is located. Optionally, the username and password ('https://username:password@10.1.1.1/&lt;filename&gt;') for access authentication with the server can also be configured.</p> <p><b>Note:</b> When using the ini file, the value must be</p>

Parameter	Description
	enclosed by single quotation marks ('...').
template-url [TemplateUrl]	Defines the URL address in the File Template for automatic updates, of the provisioning server where the files to download are located. Optionally, the username and password ('https://username:password@10.1.1.1/<filename>') for access authentication with the server can also be configured. For more information, see <a href="#">File Template for Automatic Provisioning</a> . <b>Note:</b> When using the ini file, the value must be enclosed by single quotation marks ('...').
template-files-list [AupdFilesList]	Defines the list of file types in the File Template for automatic updates, to download from the provisioning server. For more information, see <a href="#">File Template for Automatic Provisioning</a> .
web-favicon [WebFaviconFileUrl]	Defines the name of the favicon image file and the URL address of the server where the file is located. This is used for the Automatic Update feature. For more information, see <a href="#">Customizing the Favicon</a> . <b>Note:</b> When using the ini file, the value must be enclosed by single quotation marks ('...').
configuration-pkg [ConfPackageURL]	Defines the name of the Configuration Package file (.tar.gz) and the URL address (IP address or FQDN) of the server where the file is located. Optionally, the username and password ('https://username:password@10.1.1.1/<filename>') for access authentication with the server can also be configured. For example: <div style="background-color: #f0f0f0; padding: 10px; border: 1px solid #ccc; margin: 10px 0;"> <pre>ConfPackageURL = 'http://www.corp.com/ConfBackupPkg5967 925.tar.gz'</pre> </div> <b>Note:</b> When using the ini file, the value must be enclosed by single quotation marks ('...').

Parameter	Description
[MatrixCsvFileUrl]	<p>Defines a configuration table as a Comma-Separated Values (CSV) file and the URL address of the server where the file is located.</p> <p>The filename must include the name of the configuration table, for example:</p> <pre>MatrixCsvFileUrl = 'http://www.corp.com/device_IPGroup.csv'</pre> <p>You can also include in the filename the string variable tag "MAC" (case-sensitive), which the device automatically replaces with its MAC address, for example:</p> <pre>MatrixCsvFileUrl = 'http://www.corp.com/device_&lt;MAC&gt;_ IPGroup.csv'</pre> <p><b>Note:</b></p> <ul style="list-style-type: none"> <li>■ The parameter is applicable only to tables that support importing CSV files (e.g., Dial Plan table and User Information table).</li> <li>■ The filename extension must be ".csv".</li> <li>■ When using the ini file, the value must be enclosed by single quotation marks ('...').</li> </ul>

## Networking Parameters

This subsection describes the device's networking parameters.

### Ethernet Parameters

The Ethernet parameters are described in the table below.

**Table 70-10: Ethernet Parameters**

Parameter	Description
[MIIRedundancyEnable]	Enables the Ethernet Interface Redundancy feature. When enabled, the device performs a switchover to the second (redundant) Ethernet port upon detection of a link failure in the primary Ethernet port. When disabled, the device



Parameter	Description
	<p>operates with a single port (i.e. no redundancy support).</p> <ul style="list-style-type: none"> <li>■ [0] = Disable</li> <li>■ [1] = (Default) Enable</li> </ul> <p>For more information on Ethernet interface redundancy, see Ethernet Interface Redundancy.</p> <p>Note: For the parameter to take effect, a device reset is required.</p>

## Multiple VoIP Network Interfaces and VLAN Parameters

The IP network interfaces and VLAN parameters are described in the table below.

**Table 70-11:IP Network Interfaces and VLAN Parameters**

Parameter	Description
<b>VLAN Parameters</b>	
[EnableNTPasOAM]	<p>Defines the application type for Network Time Protocol (NTP) services.</p> <ul style="list-style-type: none"> <li>■ [1] = OAMP (default)</li> <li>■ [0] = Control</li> </ul> <p><b>Note:</b> For the parameter to take effect, a device reset is required.</p>

## Routing Parameters

The IP network routing parameters are described in the table below.

**Table 70-12:IP Network Routing Parameters**

Parameter	Description
<p>'Don't Send ICMP Unreachable Messages'</p> <pre>configure network &gt; network- settings &gt; icmp-disable- unreachable</pre> <p>[DisableICMPUnreachable]</p>	<p>Defines whether or not the device generates and sends ICMP messages, if required.</p> <ul style="list-style-type: none"> <li>■ [0] <b>Disable</b> = (Default) Device sends ICMP Unreachable messages.</li> <li>■ [1] <b>Enable</b> = Device does not send ICMP Unreachable messages.</li> </ul>

Parameter	Description
'Send and Receive ICMP Redirect Messages' configure network > network- settings > icmp-disable-redirect [DisableICMPRedirects]	Enables sending and receiving ICMP Redirect messages. <ul style="list-style-type: none"> <li>■ [0] <b>Enable</b> = (Default) Device sends and accepts these messages.</li> <li>■ [1] <b>Disable</b> = Device rejects these messages and also does not send them.</li> </ul>

## Open Solution Network (OSN) Parameters

The OSN server parameters are described in the table below.

**Table 70-13:OSN Parameters**

Parameter	Description
'OSN Native VLAN ID' configure system > interface osn > native-vlan <id> [OSNAccessVlan]	Defines the OSN Native VLAN ID.  The valid value is 0 to 4000. When set to 0 (default), the OSN uses the device's OAMP VLAN ID. When set to any other value, it specifies a VLAN ID configured in the Ethernet Devices table and which is assigned to a Media and/or Control application in the IP Interfaces table.
'Block OSN Port' configure system > interface osn > shutdown [OSNBlockPort]	Enables or disables the Ethernet port of the internal switch that interfaces with the OSN. <ul style="list-style-type: none"> <li>■ [0] <b>Enable</b> (default)</li> <li>■ [1] <b>Disable</b></li> </ul>
configure network > network- settings > osn- internal- vlan	Enables a single management platform when the device is deployed as a Survivable Branch Appliance (SBA) in a Microsoft Skype for Business environment. It allows configuration and monitoring of the Gateway/SBC device through the SBA Management Interface. <ul style="list-style-type: none"> <li>■ [0] = Disable (default)</li> <li>■ [1] = Enable</li> </ul>

Parameter	Description
[OSNInternalVLAN]	For more information, refer to the SBA Installation and Maintenance Manual.

## Quality of Service Parameters

The Quality of Service (QoS) parameters are described in the table below.

**Table 70-14:QoS Parameters**

Parameter	Description
<b>Layer-2 Class Of Service (CoS) Parameters (VLAN Tag Priority Field)</b>	
<b>Layer-3 Class of Service (TOS/DiffServ) Parameters</b>	
CLI path: <code>configure network &gt; qos application-mapping</code>	
'Media Premium QoS' media-qos [PremiumServiceClassMediaDiffServ]	Global parameter defining the DiffServ value for Premium Media CoS content.  You can also configure this feature per specific calls, using IP Profiles (IpProfile_IPDiffServ) or Tel Profiles (TelProfile_IPDiffServ). For a detailed description of the parameter and To configure the feature, see <a href="#">Configuring IP Profiles</a> or <a href="#">Configuring Tel Profiles</a> .  <b>Note:</b> If the feature is configured for a specific profile, the settings of this global parameter is ignored for calls associated with the profile.
'Control Premium QoS' control-qos [PremiumServiceClassControlDiffServ]	Global parameter defining the DiffServ value for Premium Control CoS content (Call Control applications).  You can also configure the feature per specific calls, using IP Profiles (IpProfile_SigIPDiffServ) or Tel Profiles (TelProfile_SigIPDiffServ). For a detailed description of the parameter and To configure the feature in the IP Profiles table, see <a href="#">Configuring IP Profiles</a> or <a href="#">Configuring Tel Profiles</a> .  <b>Note:</b> If the feature is configured for a specific profile, the settings of this global parameter is ignored for calls associated with the profile.
'Gold QoS' gold-qos	Defines the DiffServ value for the Gold CoS content (Streaming applications).  The valid range is 0 to 63. The default is 26.

Parameter	Description
[GoldServiceClassDiffServ]	
'Bronze QoS' bronze-qos [BronzeServiceClassDiffServ]	Defines the DiffServ value for the Bronze CoS content (OAMP applications). The valid range is 0 to 63. The default is 10.

## NAT and STUN Parameters

The Network Address Translation (NAT) and Simple Traversal of UDP through NAT (STUN) parameters are described in the table below.

**Table 70-15:NAT and STUN Parameters**

Parameter	Description
<b>STUN Parameters</b>	
<b>NAT Parameters</b>	
'NAT Traversal' configure voip > media settings > disable-NAT- traversal [NATMode]	<p>Enables the NAT traversal feature for media when the device communicates with UAs located behind NAT.</p> <ul style="list-style-type: none"> <li>■ [0] <b>Enable NAT Only if Necessary</b> = NAT traversal is performed only if the UA is located behind NAT: <ul style="list-style-type: none"> <li>✓ UA behind NAT: The device sends the media packets to the IP address:port obtained from the source address of the first media packet received from the UA.</li> <li>✓ UA not behind NAT: The device sends the packets to the IP address:port specified in the SDP 'c=' line (Connection) of the first received SIP message.</li> </ul> </li> </ul> <p><b>Note:</b> If the SIP session is established (ACK) and the device (not the UA) sends the first packet, it sends it to the address obtained from the SIP message and only after the device receives the first packet from the UA does it determine whether the UA is behind NAT.</p> <ul style="list-style-type: none"> <li>■ [1] <b>Disable NAT</b> = (Default) The device considers the UA as not located behind NAT and sends media packets to the UA using the IP address:port specified in the SDP 'c=' line (Connection) of the first received SIP message.</li> <li>■ [2] <b>Force NAT</b> = The device always considers the UA as</li> </ul>

Parameter	Description
	<p>behind NAT and sends the media packets to the IP address:port obtained from the source address of the first media packet received from the UA. The device only sends packets to the UA after it receives the first packet from the UA (to obtain the IP address).</p> <ul style="list-style-type: none"> <li>■ [3] <b>NAT by Signaling</b> = The device identifies whether or not the UA is located behind NAT based on SIP signaling. The device assumes that if signaling is behind NAT that the media is also behind NAT, and vice versa. <ul style="list-style-type: none"> <li>✓ UA behind NAT: The device sends media according to option <b>Force NAT</b> (2).</li> <li>✓ UA not behind NAT: The device sends media according to option <b>Disable NAT</b> (1).</li> </ul> </li> </ul> <p><b>Note:</b> : This option is applicable only to SBC calls. If the parameter is configured to this option, Gateway calls use option <b>Enable NAT Only if Necessary</b> (0), by default.</p> <ul style="list-style-type: none"> <li>■ [4] <b>NAT by Signaling Restricted IP</b> = The device identifies whether or not the UA is located behind NAT based on SIP signaling. The device assumes that if signaling is behind NAT that the media is also behind NAT, and vice versa. <ul style="list-style-type: none"> <li>● UA behind NAT: The device sends media only when the source of the media packets is the signaling IP address (source of the INVITE).</li> <li>● UA not behind NAT: The device sends media according to option <b>Disable NAT</b> (1).</li> </ul> </li> </ul> <p><b>Note:</b> This option is applicable only to SBC calls. For more information on NAT traversal, see <a href="#">First Incoming Packet Mechanism</a>.</p>
<p>'NAT IP Address'</p> <pre>configure voip &gt; sip-definition general-settings &gt; nat-ip-addr [StaticNatIP]</pre>	<p>Defines the global (public) IP address of the device to enable static NAT between the device and the Internet. For more information, see <a href="#">Configuring a Static NAT IP Address for All Interfaces</a> on page 136.</p> <p><b>Note:</b> The parameter is applicable only to the Gateway application.</p>

Parameter	Description
[NATBindingDefaultTimeout]	<p>The device sends SNMP keep-alive traps periodically - every 9/10 of the time configured by the parameter (in seconds). Therefore, the parameter is applicable only if you configure the [SendKeepAliveTrap] parameter to [1].</p> <p>The parameter is used to allow SNMP communication with AudioCodes One Voice Operations Center (OVOC) management platform, located in the WAN, when the device is located behind NAT. It is needed to keep the NAT pinhole open for the SNMP messages sent from OVOC to the device.</p> <p>The valid range is 0 to 2,592,000. The default is 30.</p> <p><b>Note:</b> For the parameter to take effect, a device reset is required.</p>
[EnableIPAddrTranslation]	<p>Enables IP address translation for RTP, RTCP, and T.38 packets.</p> <ul style="list-style-type: none"> <li>■ [0] = Disable IP address translation.</li> <li>■ [1] = (Default) Enable IP address translation.</li> </ul> <p>When enabled, the device compares the source IP address of the first incoming packet to the remote IP address stated in the opening of the channel. If the two IP addresses don't match, the NAT mechanism is activated. Consequently, the IP address of the outgoing media stream to the remote destination is obtained by the source IP address of the first incoming packet.</p> <p><b>Note:</b> The NAT mechanism must be enabled for the parameter to take effect. To enable NAT, see the NATMode parameter).</p>
[EnableUDPPortTranslation]	<p>Enables UDP port translation.</p> <ul style="list-style-type: none"> <li>■ [0] = (Default) Disables UDP port translation.</li> <li>■ [1] = Enables UDP port translation. The device compares the source UDP port of the first incoming packet to the remote UDP port stated in the opening of the channel. If the two UDP ports don't match, the NAT mechanism is activated. Consequently, the remote UDP port of the outgoing stream is replaced by the source UDP port of the first incoming packet.</li> </ul> <p><b>Note:</b></p>

Parameter	Description
	<ul style="list-style-type: none"> <li>■ For the parameter to take effect, a device reset is required.</li> <li>■ The NAT mechanism and IP address translation must be enabled for the parameter to take effect, using the NATMode parameter and the EnableIpAddrTranslation parameter, respectively.</li> </ul>
'SIP NAT Detection' configure voip > sip-definition advanced-settings > sip-nat-detect [SIPNatDetection]	Enables the device to detect whether the incoming INVITE message is sent from an endpoint located behind NAT. <ul style="list-style-type: none"> <li>■ [0] <b>Disable</b> = Disables the device's NAT Detection mechanism. Incoming SIP messages are processed as received from endpoints that are not located behind NAT and sent according to the SIP standard.</li> <li>■ [1] <b>Enable</b> = (Default) Enables the device's NAT Detection mechanism.</li> </ul>

## DNS Parameters

The Domain name System (DNS) parameters are described in the table below.

**Table 70-16:DNS Parameters**

Parameter	Description
'Default Primary DNS Server IP' configure network > dns settings > dns- default-primary-server-ip [DefaultPrimaryDnsServerIp]	Defines the address of the default primary DNS server.  The valid value is an IP address in dotted-decimal notation. The default is 8.8.8.8.  For more information, see <a href="#">Configuring Default DNS Servers</a> on page 148.
'Default Secondary DNS Server IP' configure network > dns settings > dns- default-secondary-server-ip [DefaultSecondaryDnsServerIp]	Defines the address of the default secondary DNS server.  The valid value is an IP address in dotted-decimal notation. The

Parameter	Description
	<p>default is 8.8.4.4.</p> <p>For more information, see <a href="#">Configuring Default DNS Servers</a> on page 148.</p>

## DHCP Parameters

The Dynamic Host Control Protocol (DHCP) parameters are described in the table below.

**Table 70-17:DHCP Parameters**

Parameter	Description
'Enable DHCP' [DHCPEnable]	<p>Enables DHCP client functionality.</p> <ul style="list-style-type: none"> <li>■ [0] <b>Disable</b> (default)</li> <li>■ [1] <b>Enable</b></li> </ul> <p><b>Note:</b></p> <ul style="list-style-type: none"> <li>■ For the parameter to take effect, a device reset is required.</li> <li>■ For a detailed description of DHCP, see <a href="#">DHCP-based Provisioning</a>.</li> <li>■ The parameter is a "hidden" parameter. Once defined and saved to flash memory, its value doesn't revert to default even if the parameter doesn't appear in the <i>ini</i> file.</li> </ul>
[DhcpOption160Support]	<p>Enables the use of DHCP Option 160.</p> <ul style="list-style-type: none"> <li>■ [0] = (Default) Disable</li> <li>■ [1] = Enable</li> </ul> <p>For more information, see <a href="#">Provisioning the Device using DHCP Option 160</a> on page 1122.</p> <p><b>Note:</b> For the parameter to take effect, a device reset is required.</p>
[DHCP120OptionMode]	<p>Enables the acceptance of DHCP Option 120 in DHCP responses sent by a DHCP server.</p> <ul style="list-style-type: none"> <li>■ [0] = DHCP Option 120 is not supported and ignored if received in the DHCP response.</li> <li>■ [1] = (Default) DHCP Option 120 is supported and if</li> </ul>



Parameter	Description
	received, the device adds the SIP server information to the Proxy Set.
[DHCPSpeedFactor]	<p>Defines the device's DHCP renewal speed for a leased IP address from a DHCP server.</p> <ul style="list-style-type: none"> <li>■ [0] = Disable</li> <li>■ [1] = (Default) Normal</li> <li>■ [2] to [10] = Fast</li> </ul> <p>When set to 0, the DHCP lease renewal is disabled. Otherwise, the renewal time is divided by this factor. Some DHCP-enabled routers perform better when set to 4.</p> <p><b>Note:</b> For the parameter to take effect, a device reset is required.</p>

## Clock (Date and Time) Synchronization Parameters

The device's clock synchronization parameters are described in the table below.

**Table 70-18: Device Clock Synchronization Parameters**

Parameter	Description
<p><b>NTP</b></p> <p>CLI path: <code>configure system &gt; ntp</code></p> <p><b>Note:</b> For more information on Network Time Protocol (NTP), see <a href="#">Simple Network Time Protocol Support</a>.</p>	
<p>'Primary NTP Server Address'</p> <p><code>primary-server</code></p> <p>[NTPServerIP]</p>	<p>Defines the IP address (in dotted-decimal notation or as an FQDN) of the NTP server. The advantage of using an FQDN is that multiple IP addresses can be resolved from the DNS server, providing NTP server redundancy.</p> <p>The default IP address is 0.0.0.0 (i.e., internal NTP client is disabled).</p>
<p>'Secondary NTP Server Address'</p> <p><code>secondary-server</code></p> <p>[NTPSecondaryServerIP]</p>	<p>Defines a second NTP server's address as an FQDN or an IP address (in dotted-decimal notation). This NTP is used for redundancy; if the primary NTP server fails, then this NTP server is used.</p> <p>The default IP address is 0.0.0.0.</p>
<p>'NTP Update Interval'</p> <p><code>update-interval</code></p>	<p>Defines the time interval (in seconds) that the NTP client requests for a time update.</p>

Parameter	Description
[NTPUpdateInterval]	<p>The default interval is 86400 (i.e., 24 hours). The range is 0 to 214783647.</p> <p><b>Note:</b> It is not recommend to set the parameter to beyond one month (i.e., 2592000 seconds).</p>
'NTP Authentication Key Identifier' auth-key-id [NtpAuthKeyId]	<p>Defines the NTP authentication key identifier for authenticating NTP messages. The identifier must match the value configured on the NTP server. The NTP server may have several keys configured for different clients; this number identifies which key is used.</p> <p>The valid value is 1 to 65535. The default is 0 (i.e., no authentication is done).</p>
'NTP Authentication Secret Key' auth-key-md5 [ntpAuthMd5KeyPassword]	<p>Defines the secret authentication key shared between the device (client) and the NTP server for authenticating NTP messages.</p> <p>The valid value is a string of up to 32 characters. By default, no key is defined.</p> <p><b>Note:</b> The parameter cannot be configured with wide characters.</p>
<b>Regional Clock and Daylight Saving Time</b>	
'UTC Offset' configure system > clock > utc-offset [NTPServerUTCOffset]	<p>Defines the Universal Time Coordinate (UTC) offset (in seconds) from the local time.</p> <p>The valid range is -86400 seconds (i.e., -24 hours) to +86400 seconds (i.e., +24 hours). The default is 0.</p> <p><b>Note:</b> The offset setting is applied only on the hour. For example, if you configure the parameter at 15:42, the device applies the setting only at 16:00.</p>
'Daylight Saving Time' configure system > clock > summer- time > summer-time  [DayLightSavingTimeEnable]	<p>Enables daylight saving time (DST).</p> <ul style="list-style-type: none"> <li>■ [0] Disable (default)</li> <li>■ [1] Enable</li> </ul>
'Start Time / Day of Month Start' configure system > clock > summer- time > start	<p>Defines the date and time when DST begins. This value can be configured using any of the following formats:</p> <ul style="list-style-type: none"> <li>■ Day of year - <i>mm:dd:hh:mm</i>, where: <ul style="list-style-type: none"> <li>✓ <i>mm</i> denotes month</li> </ul> </li> </ul>

Parameter	Description
[DayLightSavingTimeStart]	<ul style="list-style-type: none"> <li>✓ <i>dd</i> denotes date of the month</li> <li>✓ <i>hh</i> denotes hour</li> <li>✓ <i>mm</i> denotes minutes</li> </ul> <p>For example, "05:01:08:00" denotes daylight saving starting from May 1 at 8 A.M.</p> <ul style="list-style-type: none"> <li>■ Day of month - <i>mm:day/wk:hh:mm</i>, where: <ul style="list-style-type: none"> <li>✓ <i>mm</i> denotes month (e.g., 04)</li> <li>✓ <i>day</i> denotes day of week (e.g., FRI)</li> <li>✓ <i>wk</i> denotes week of the month (e.g., 03)</li> <li>✓ <i>hh</i> denotes hour (e.g., 23)</li> <li>✓ <i>mm</i> denotes minutes (e.g., 10)</li> </ul> </li> </ul> <p>For example, "04:FRI/03:23:00" denotes Friday, the third week of April, at 11 P.M. The week field can be 1-5, where 5 denotes the last occurrence of the specified day in the specified month. For example, "04:FRI/05:23:00" denotes the last Friday of April, at 11 P.M.</p>
'End Time / Day of Month End' <pre>configure system &gt; clock &gt; summer- time &gt; end</pre> [DayLightSavingTimeEnd]	<p>Defines the date and time when DST ends. For a description of the format of this value, see the DayLightSavingTimeStart parameter.</p>
'Offset' <pre>configure system &gt; clock &gt; summer- time &gt; offset</pre> [DayLightSavingTimeOffset]	<p>Defines the DST offset (in minutes).</p> <p>The valid range is 0 to 120. The default is 60.</p> <p><b>Note:</b> The offset setting is applied only on the hour. For example, if you configure the parameter at 15:42, the device applies the setting only at 16:00.</p>

## Debugging and Diagnostics Parameters

This subsection describes the device's debugging and diagnostic parameters.

### General Parameters

The general debugging and diagnostic parameters are described in the table below.

**Table 70-19:General Debugging and Diagnostic Parameters**

Parameter	Description
[EnableDiagnostics]	<p>Determines the method for verifying correct functioning of the different hardware components on the device. On completion of the check and if the test fails, the device sends information on the test results of each hardware component to the Syslog server.</p> <ul style="list-style-type: none"> <li>■ [0] = (Default) Rapid and Enhanced self-test mode.</li> <li>■ [1] = Detailed self-test mode (full test of DSPs, PCM, Switch, LAN, PHY and Flash).</li> <li>■ [2] = A quicker version of the Detailed self-test mode (full test of DSPs, PCM, Switch, LAN, PHY, but partial test of Flash).</li> </ul> <p><b>Note:</b> For the parameter to take effect, a device reset is required.</p>
[LifelineType]	<p>Defines the condition (i.e., loss of power to the device) upon which the device activates the Lifeline feature for FXS interfaces. When the analog Lifeline is triggered, the device automatically connects a specific FXS port, which is connected to a "lifeline" POTS phone, to the PSTN (or PBX). Therefore, this allows the FXS endpoint user to continue making and receiving calls with the PSTN despite the loss of power.</p> <ul style="list-style-type: none"> <li>■ [0] = (Default) Lifeline is activated upon the loss of power to the device, for example, due to a power outage or the unplugging of the device's power cable.</li> </ul> <p><b>Note:</b></p> <ul style="list-style-type: none"> <li>■ The parameter has only one valid value.</li> <li>■ For the parameter to take effect, a reset is required.</li> <li>■ The parameter is applicable only to the Gateway application and FXS interfaces.</li> </ul>

Parameter	Description
	<ul style="list-style-type: none"> <li>■ If the device is in Lifeline mode and the condition that triggered it (e.g., a power outage) no longer exists (e.g., power returns), the device exits Lifeline mode and performs normal call routing.</li> <li>■ For information on Lifeline cabling, refer to the <i>Hardware Installation Manual</i>.</li> </ul>
<p>'Delay After Reset [sec]'</p> <pre>configure voip &gt; sip- definition advanced-settings &gt; delay-after-reset</pre> <p>[GWAppDelayTime]</p>	<p>Defines the time interval (in seconds) that the device's operation is delayed after a reset.</p> <p>The valid range is 0 to 45. The default is 7 seconds.</p> <p><b>Note:</b> This feature helps overcome connection problems caused by some LAN routers or IP configuration parameters' modifications by a DHCP server.</p>
<p>[Mediant1000DualPowerSupplySupported]</p>	<p>Enables the device to send an alarm (to the SNMP client and Web interface) if one of the Power Supply modules is removed from the chassis or not operating correctly (failure).</p> <ul style="list-style-type: none"> <li>■ [1] = (Default) Disable - no alarm is sent.</li> <li>■ [2] = Enable - an alarm is sent.</li> </ul> <p><b>Note:</b></p> <ul style="list-style-type: none"> <li>■ For the parameter to take effect, a device reset is required.</li> <li>■ If the parameter is set to [2], for this feature to be functional, both Main and Redundant Power Supply modules must be housed in the chassis.</li> <li>■ If the device is intentionally installed with only one Power Supply module, then make sure that the parameter is set to [1]; otherwise, an alarm will be raised.</li> </ul>
<p>[GroundKeyDetection]</p>	<p>Defines loop- or ground-start signaling for all the device's FXS and FXO ports.</p> <ul style="list-style-type: none"> <li>■ [0] = (Default) Loop-start signaling</li> </ul>

Parameter	Description
	<ul style="list-style-type: none"> <li>■ [1] = Ground-start signaling</li> </ul> <p><b>Note:</b></p> <ul style="list-style-type: none"> <li>■ For the parameter to take effect, a device reset is required.</li> <li>■ To configure the signaling method per port and for a detailed description of this feature, see <a href="#">Configuring Ground- or Loop-Start Signaling per Analog Port</a>.</li> </ul>
'Port Ground Start' [GroundKeyDetection_x]	<p>The table defines loop- or ground-start signaling per analog (FXS or FXO) port. For the ini file parameter, the x denotes the port number, where 0 represents Port I. For example,</p> <pre>GroundKeyDetection_0 = 1 GroundKeyDetection_1 = 0 GroundKeyDetection_2 = 0</pre> <ul style="list-style-type: none"> <li>■ [0] Disable = (Default) Port uses loop-start signaling.</li> <li>■ [1] Enable = Port uses ground-start signaling.</li> </ul> <p>For more information, see <a href="#">Configuring Ground- or Loop-Start Signaling per Analog Port</a>.</p> <p><b>Note:</b></p> <ul style="list-style-type: none"> <li>■ For the parameter to take effect, a device reset is required.</li> <li>■ To configure the same signaling method for all ports, use the ini file parameter GroundKeyDetection.</li> </ul>
[EnableAutoRAITransmitBER]	<p>Enables the device to send a remote alarm indication (RAI) when the bit error rate (BER) is greater than 0.001.</p> <ul style="list-style-type: none"> <li>■ [0] = Disable (default)</li> <li>■ [1] = Enable</li> </ul>
'Ignore BRI LOS Alarm'	<p>Enables the device to ignore LOS alarms</p>

Parameter	Description
<pre>ignore-bri-los-alarm</pre> [IgnoreBRILOSAlarm]	<p>received from the BRI user-side trunk and attempts to make a call (relevant for IP-to-Tel calls).</p> <ul style="list-style-type: none"> <li>■ [0] <b>Disable</b></li> <li>■ [1] <b>Enable</b> (default)</li> </ul> <p><b>Note:</b> The parameter is applicable only to BRI interfaces.</p>

## SIP Test Call Parameters

The SIP Signaling Test Call parameters are described in the table below.

**Table 70-20: SIP Test Call Parameters**

Parameter	Description
<p>'Test Call DTMF String'</p> <pre>configure troubleshoot &gt; test-call settings &gt; testcall-dtmf-string</pre> [TestCallDtmfString]	<p>Defines the DTMF tone that is played for answered test calls (incoming and outgoing).</p> <p>The DTMF string can be up to 15 strings. The default is "3212333". If no string is defined (empty), DTMF is not played.</p>
<p>'Test Call ID'</p> <pre>configure troubleshoot &gt; test-call settings &gt; testcall-id</pre> [TestCallID]	<p>Defines the test call prefix number (<i>ID</i>) of the simulated phone on the device. Incoming calls received with this called prefix number are identified as test calls.</p> <p>This can be any string of up to 15 characters. By default, no number is defined.</p> <p><b>Note:</b> The parameter is only for testing incoming calls destined to this prefix number.</p>

## Syslog, CDR and Debug Parameters

The Syslog, CDR and debug parameters are described in the table below.

**Table 70-21: Syslog, CDR and Debug Parameters**

Parameter	Description
<p>'Enable Syslog'</p> <pre>configure troubleshoot &gt; syslog &gt; syslog</pre>	<p>Determines whether the device sends logs and error messages (e.g., CDRs) generated by the device to a Syslog server.</p>

Parameter	Description
[EnableSyslog]	<ul style="list-style-type: none"> <li>■ [0] <b>Disable</b> (default)</li> <li>■ [1] <b>Enable</b></li> </ul> <p><b>Note:</b></p> <ul style="list-style-type: none"> <li>■ If you enable Syslog, you must enter an IP address of the Syslog server, using the [SyslogServerIP] parameter.</li> <li>■ Syslog messages may increase the network traffic.</li> <li>■ To configure Syslog SIP message logging levels, use the [GwDebugLevel] parameter.</li> <li>■ By default, logs are also sent to the RS-232 serial port. On how to establish serial communication with the device, refer to the <i>Installation Manual</i>.</li> </ul>
'Syslog Server IP' configure troubleshoot > syslog > syslog-ip [SyslogServerIP]	Defines the IP address (in dotted-decimal notation) of the computer on which the Syslog server is running. The Syslog server is an application designed to collect the logs and error messages generated by the device. The default IP address is 0.0.0.0.
'Syslog Server Port' configure troubleshoot > syslog > syslog-port [SyslogServerPort]	Defines the UDP port of the Syslog server. The valid range is 0 to 65,535. The default port is 514.
'Log Severity Level' log-level [SyslogLogLevel]	<p>Defines the minimum severity level of messages included in the Syslog message that is generated by the device. The specified severity level and all higher severity levels are included in the Syslog message. For example, if you configure the parameter to <b>Alert</b>, the Syslog will include messages with <b>Alert</b> severity level and messages with <b>Fatal</b> severity level. The severity levels are listed below from highest to lowest.</p> <ul style="list-style-type: none"> <li>■ [0] <b>Fatal</b></li> </ul>



Parameter	Description
	<ul style="list-style-type: none"> <li>■ [1] Alert</li> <li>■ [2] Critical</li> <li>■ [3] Error</li> <li>■ [4] Warning</li> <li>■ [5] Notice (default)</li> <li>■ [6] Info</li> <li>■ [7] Debug</li> </ul>
<p>'CDR Server IP Address'</p> <pre>configure troubleshoot &gt; cdr &gt; cdr-srvr-ip-adrr</pre> <p>[CDRSyslogServerIP]</p>	<p>Defines the destination IP address to where CDR logs are sent.</p> <p>The default value is a null string, which causes CDR messages to be sent with all Syslog messages to the Syslog server.</p> <p><b>Note:</b></p> <ul style="list-style-type: none"> <li>■ The CDR messages are sent to UDP port 514 (default Syslog port).</li> <li>■ This mechanism is active only when Syslog is enabled (i.e., the parameter [EnableSyslog] is set to [1]).</li> </ul>
<p>'Call-End CDR SIP Reasons Filter'</p> <pre>configure troubleshoot &gt; cdr &gt; call-end-cdr-sip- reasons-filter</pre> <p>[CallEndCDRSIPReasonsFilter]</p>	<p>Defines SIP release cause codes that if received for the call, the device does not send Call-End CDRs for the call.</p> <p>The valid value is 300 through to 699. You can configure the parameter with multiple codes using a comma to separate them (e.g., 301,400,404). You can also use "xx" to denote a range (e.g., 3xx).</p>
<p>'Call-End CDR Zero Duration Filter'</p> <pre>configure troubleshoot &gt; cdr &gt; call-end-cdr-zero- duration-filter</pre> <p>[CallEndCDRZeroDurationFilter]</p>	<p>Enables the device to not send Call-End CDRs if the call's duration is zero (0).</p> <ul style="list-style-type: none"> <li>■ [0] Disable (default)</li> <li>■ [1] Enable</li> </ul>
<p>'CDR Report Level'</p> <pre>configure troubleshoot &gt; cdr &gt; cdr-report-level</pre> <p>[CDRReportLevel]</p>	<p>Enables media and signaling-related CDRs to be sent to a Syslog server and defines the call stage at which they are sent.</p> <ul style="list-style-type: none"> <li>■ [0] <b>None</b> = (Default) CDRs are not used.</li> </ul>

Parameter	Description
	<ul style="list-style-type: none"> <li>■ [1] <b>End Call</b> = CDR is sent to the Syslog server at the end of each call.</li> <li>■ [2] <b>Start &amp; End Call</b> = CDR report is sent to Syslog at the start and end of each call.</li> <li>■ [3] <b>Connect &amp; End Call</b> = CDR report is sent to Syslog at connection and at the end of each call.</li> <li>■ [4] <b>Start &amp; End &amp; Connect Call</b> = CDR report is sent to Syslog at the start, at connection, and at the end of each call.</li> </ul> <p><b>Note:</b></p> <ul style="list-style-type: none"> <li>■ For the SBC application: The parameter enables only signaling-related CDRs. To enable media-related CDRs for SBC calls, use the [MediaCDRReportLevel] parameter.</li> <li>■ The CDR Syslog message complies with RFC 3164 and is identified by: Facility = 17 (local1) and Severity = 6 (Informational).</li> <li>■ This mechanism is active only when Syslog is enabled (i.e., the parameter [EnableSyslog] is set to [1]).</li> </ul>
<p>'Media CDR Report Level'</p> <pre>configure troubleshoot &gt; cdr &gt; media-cdr-rprt-level [MediaCDRReportLevel]</pre>	<p>Enables media-related CDRs of SBC calls to be sent to a Syslog server and defines the call stage at which they are sent.</p> <ul style="list-style-type: none"> <li>■ [0] <b>None</b> = (Default) No media-related CDR is sent.</li> <li>■ [1] <b>End Media</b> = Sends a CDR only at the end of the call.</li> <li>■ [2] <b>Start &amp; End Media</b> = Sends a CDR once the media starts. In some calls it may only be after the call is established, but in other calls the media may start at ringback tone. A CDR is also sent upon termination (end) of the media in the call.</li> <li>■ [3] <b>Update &amp; End Media</b> = Sends a CDR when an update occurs in the media of</li> </ul>

Parameter	Description
	<p>the call. For example, a call starts and a ringback tone occurs, a re-INVITE is sent for a fax call and as a result, a CDR with the MediaReportType field set to "Update" is sent, as the media was changed from voice to T.38. A CDR is also sent upon termination (end) of the media in the call.</p> <ul style="list-style-type: none"> <li>■ [4] <b>Start &amp; End &amp; Update Media</b> = Sends a CDR at the start of the media, upon an update in the media (if occurs), and at the end of the media.</li> </ul> <p><b>Note:</b></p> <ul style="list-style-type: none"> <li>■ The parameter is applicable only to the SBC application.</li> <li>■ To enable CDR generation as well as enable signaling-related CDRs, use the CDRReportLevel parameter.</li> </ul>
<p>'REST CDR Report Level'  <code>configure system &gt; cdr &gt;  rest-cdr-report-level</code>  [RestCdrReportLevel]</p>	<p>Enables signaling-related CDRs to be sent to a REST server and defines the call stage at which they are sent.</p> <ul style="list-style-type: none"> <li>■ [0] <b>None</b> = (Default) CDRs are not sent.</li> <li>■ [1] <b>End Call</b> = CDRs are sent at the end (SIP BYE) of each call.</li> <li>■ [2] <b>Start &amp; End Call</b> = CDRs are sent at the start (SIP INVITE) and end of each call.</li> <li>■ [3] <b>Connect &amp; End Call</b> = CDRs are sent at call connection (200 OK) and end of each call.</li> <li>■ [4] <b>Start &amp; End &amp; Connect Call</b> = CDRs are sent at the start, connection, and end of each call.</li> <li>■ [5] <b>Connect Only</b> = CDRs are sent at call connection.</li> </ul> <p><b>Note:</b></p> <ul style="list-style-type: none"> <li>■ To specify the REST server, use the [RestCdrHttpServer] parameter.</li> </ul>

Parameter	Description
	<ul style="list-style-type: none"> <li>■ For the device to generate CDRs, you must enable Syslog messaging (see the [EnableSyslog] parameter).</li> <li>■ CDRs are sent in JSON format.</li> </ul>
<p>'REST CDR HTTP Server Name'</p> <pre>configure system &gt; cdr &gt; rest-cdr-http-server [RestCdrHttpServer]</pre>	<p>Defines the REST server (by name as configured in the Remote Web Services table) to where the device sends CDRs through REST API.</p> <p>The valid value is a string (i.e., name of the REST server). By default, no value is defined.</p> <p><b>Note:</b></p> <ul style="list-style-type: none"> <li>■ The parameter value is case sensitive.</li> <li>■ To enable CDR generation for the REST server, see the [RestCdrReportLevel] parameter.</li> <li>■ The REST server is configured in the Remote Web Services table (see <a href="#">Configuring Remote Web Services</a> on page 299).</li> </ul>
<pre>configure troubleshoot &gt; cdr &gt; cdr-history-privacy [CDRHistoryPrivacy]</pre>	<p>Enables the device to hide the values of the Caller and Callee fields in CDRs of certain report outputs.</p> <ul style="list-style-type: none"> <li>■ [0] = (Default) Field values are shown.</li> <li>■ [1] = Field values are hidden (replaced by an * asterisk).</li> </ul> <p>For more information, see <a href="#">Hiding Caller and Callee CDR Field Values</a> on page 1288.</p>
<p>'Call Success SIP Reasons'</p> <pre>configure troubleshoot &gt; cdr &gt; call-success-sip- reasons [CallSuccessSIPReasons]</pre>	<p>Defines the SIP response code that you want the device to consider as call success, which is indicated by the optional 'Call Success' field in the sent CDR. This parameter overrides the device's default behavior of how it considers calls a success or failure based on SIP responses.</p> <p>The valid value is string of up to 128 characters to represent SIP response codes</p>

Parameter	Description
	<p>(e.g., 486). You can configure the parameter with multiple response codes, whereby each code is separated by a comma without spaces before or after (e.g., 486,408,406). You can also configure a range of responses using the "xx" wildcard (e.g., 4xx,502). By default, no value is defined.</p> <p><b>Note:</b> If an overlap of a SIP response occurs between the configured 'Call Success SIP Reasons' and 'Call Failure SIP Reasons' parameters, the device uses the parameter that is configured with the specific response code, instead of the parameter configured with the range ("xx"). For example, if you configure the 'Call Success SIP Reasons' parameter with "486,5xx" and the 'Call Failure SIP Reasons' parameter with "502", for 502 responses, the device uses the settings of the 'Call Failure SIP Reasons' parameter only. In other words, a call with SIP response code 502 is considered as a call failure.</p>
<p>'Call Failure SIP Reasons'  <code>call-failure-sip-reasons</code>            [CallFailureSIPReasons]</p>	<p>Defines the SIP response codes that you want the device to consider as call failure, which is indicated by the optional 'Call Success' field in the sent CDR. This parameter overrides the device's default behavior of how it considers calls a success or failure based on SIP responses.</p> <p>The valid value is string of up to 128 characters to represent SIP response codes (e.g., 486). You can configure the parameter with multiple response codes, whereby each code is separated by a comma without spaces before or after (e.g., 486,408,406). You can also configure a range of responses using the "xx" wildcard (e.g., 4xx,502). By default, no value is defined.</p> <p><b>Note:</b> If an overlap of a SIP response occurs between the configured 'Call Success SIP Reasons' and 'Call Failure SIP Reasons' parameters, the device uses the parameter</p>

Parameter	Description
	<p>that is configured with the specific response code, instead of the parameter configured with the range ("xx"). For example, if you configure the 'Call Success SIP Reasons' parameter with "486,5xx" and the 'Call Failure SIP Reasons' parameter with "502", for 502 responses, the device uses the settings of the 'Call Failure SIP Reasons' parameter only. In other words, a call with SIP response code 502 is considered as a call failure.</p>
<p>'Call Success Internal Reasons'  <code>call-success-internal-reasons</code>            [CallSuccessInternalReasons]</p>	<p>Defines the internal response codes (generated by the device) that you want the device to consider as call success, which is indicated by the optional 'Call Success' field in the sent CDR. This parameter overrides the device's default behavior of how it considers calls a success or failure based on internally responses.</p> <p>The valid value is string of up to 128 characters to represent internal response codes (e.g., 851). You can configure the parameter with multiple response codes, whereby each code is separated by a comma without spaces before or after (e.g., 851,320). You can also configure a range of responses using the "xx" wildcard (e.g., 8xx,320). By default, no value is defined.</p> <p><b>Note:</b></p> <ul style="list-style-type: none"> <li>■ For a list of the internal response codes, see the 'Termination Reason' [410] CDR field in <a href="#">CDR Field Description</a> on page 1222.</li> <li>■ If an overlap of a SIP response occurs between the configured 'Call Success SIP Reasons' and 'Call Failure SIP Reasons' parameters, the device uses the parameter that is configured with the specific response code, instead of the parameter configured with the range ("xx"). For example, if you configure the 'Call Success SIP Reasons' parameter with</li> </ul>

Parameter	Description
	<p>"320,8xx" and the 'Call Failure SIP Reasons' parameter with "851", for 851 responses, the device uses the settings of the 'Call Failure SIP Reasons' parameter only. In other words, a call with response code 851 is considered as a call failure.</p>
<p>'Call Failure Internal Reasons' call-failure-internal-reasons [CallFailureInternalReasons]</p>	<p>Defines the internal response codes (generated by the device) that you want the device to consider as call failure, which is indicated by the optional 'Call Success' field in the sent CDR. This parameter overrides the device's default behavior of how it considers calls a success or failure based on internally responses.</p> <p>The valid value is string of up to 128 characters to represent internal response codes (e.g., 851). You can configure the parameter with multiple response codes, whereby each code is separated by a comma without spaces before or after (e.g., 851,320). You can also configure a range of responses using the "xx" wildcard (e.g., 8xx,320). By default, no value is defined.</p> <p><b>Note:</b></p> <ul style="list-style-type: none"> <li>■ For a list of the internal response codes, see the 'Termination Reason' [410] CDR field in <a href="#">CDR Field Description</a> on page 1222.</li> <li>■ If an overlap of a SIP response occurs between the configured 'Call Success SIP Reasons' and 'Call Failure SIP Reasons' parameters, the device uses the parameter that is configured with the specific response code, instead of the parameter configured with the range ("xx"). For example, if you configure the 'Call Success SIP Reasons' parameter with "320,8xx" and the 'Call Failure SIP Reasons' parameter with "851", for 851 responses, the device uses the settings of the 'Call Failure SIP Reasons' parameter</li> </ul>

Parameter	Description
	only. In other words, a call with response code 851 is considered as a call failure.
'No User Response Before Connect' no-user-response-before-connect [NoUserResponseBeforeConnectSuccess]	Defines if the device considers a call as a success or failure when the internal response (generated by the device) "GWAPP_NO_USER_RESPONDING" (18) is received before call connect (SIP 200 OK). <ul style="list-style-type: none"> <li>■ [0] <b>Call Failure</b></li> <li>■ [1] <b>Call Success</b> (default)</li> </ul>
'No User Response After Connect' no-user-response-after-connect [NoUserResponseAfterConnectSuccess]	Defines if the device considers a call as a success or failure when the internal response (generated by the device) "GWAPP_NO_USER_RESPONDING" (18) is received after call connect (SIP 200 OK). <ul style="list-style-type: none"> <li>■ [0] <b>Call Failure</b> (default)</li> <li>■ [1] <b>Call Success</b></li> </ul>
'Call Transferred before Connect' call-transferred-before-connect [CallTransferredBeforeConnectSuccess]	Defines if the device considers a call as a success or failure when the internal response (generated by the device) "RELEASE_BECAUSE_CALL_TRANSFERRED" (807) is generated before call connect (SIP 200 OK). <ul style="list-style-type: none"> <li>■ [0] <b>Call Failure</b> (default)</li> <li>■ [1] <b>Call Success</b></li> </ul>
'Call Transferred after Connect' call-transferred-after-connect [CallTransferredAfterConnectSuccess]	Defines if the device considers a call as a success or failure when the internal response (generated by the device) "RELEASE_BECAUSE_CALL_TRANSFERRED" (807) is generated after call connect (SIP 200 OK). <ul style="list-style-type: none"> <li>■ [0] <b>Call Failure</b></li> <li>■ [1] <b>Call Success</b> (default)</li> </ul>
'File Size' configure troubleshoot > cdr > file-size [CDRLocalMaxFileSize]	Defines the size (in kilobytes) of each locally stored CDR file. When the Current file reaches this size, the device creates a CDR file containing all the CDRs from the Current file. The valid value is 100 to 10,000. The default is



Parameter	Description
	<p>1024.</p> <p><b>Note:</b></p> <ul style="list-style-type: none"> <li>■ CDR file creation works together with the 'Rotation Period' parameter, whereby the file is created as soon as one of the parameter's ('File Size' or 'Rotation Period') settings are fulfilled (whichever is met earlier). For example, if the 'File Size' parameter is 100 and 'Rotation Period' is 60, and the file size reaches 100 kbytes after only 30 minutes has passed, the device creates the CDR file.</li> <li>■ The parameter is applicable only to local storage of CDRs.</li> </ul>
<p>'Number of Files'</p> <pre>configure troubleshoot &gt; cdr &gt; files-num</pre> <p>[CDRLocalMaxNumOfFiles]</p>	<p>Defines the maximum number of locally stored CDR files. If the maximum number is reached and a new file is created, the oldest file is deleted to make space for the new file (i.e., FIFO).</p> <p>The valid value is 2 to 4096 . The default is 5.</p> <p><b>Note:</b> The parameter is applicable only to local storage of CDRs.</p>
<p>'Rotation Period'</p> <pre>configure troubleshoot &gt; cdr &gt; rotation-period</pre> <p>[CDRLocalInterval]</p>	<p>Defines how often (in minutes) the device creates a new CDR file for locally stored CDRs. For example, if configured to 60, every hour it creates a CDR file containing all the CDRs from the Current file.</p> <p>The valid value is 2 to 1440. The default is 60.</p> <p><b>Note:</b></p> <ul style="list-style-type: none"> <li>■ CDR file creation works together with the 'File Size' parameter, whereby the file is created as soon as one of the parameter's ('File Size' or 'Rotation Period') settings are fulfilled (whichever is met earlier). For example, if the 'Rotation Period' parameter is 60 and 'File Size' is 100, and an hour has passed but the file size is only 50 kbytes, the device creates the CDR file.</li> </ul>

Parameter	Description
	<ul style="list-style-type: none"> <li>■ The CDR file is created even if there are no CDRs in the Current file.</li> <li>■ The parameter is applicable only to local storage of CDRs.</li> </ul>
<p>'VoIP Debug Level'</p> <pre>configure troubleshoot &gt; syslog &gt; debug-level [GwDebugLevel]</pre>	<p>Enables Syslog debug reporting and logging level.</p> <ul style="list-style-type: none"> <li>■ [0] <b>No Debug</b> = (Default) Debug is disabled and Syslog messages are not sent.</li> <li>■ [1] <b>Basic</b> = Sends debug logs of incoming and outgoing SIP messages.</li> <li>■ [5] <b>Detailed</b> = Sends debug logs of incoming and outgoing SIP message as well as many other logged processes.</li> </ul>
<pre>configure system &gt; cdr &gt; non-call-cdr-rprt [EnableNonCallCdr]</pre>	<p>Enables creation of CDR messages for non-call SIP dialogs (such as SUBSCRIBE, OPTIONS, and REGISTER).</p> <ul style="list-style-type: none"> <li>■ [0] = (Default) Disable</li> <li>■ [1] = Enable</li> </ul> <p><b>Note:</b> The parameter is applicable only to the SBC application.</p>
<p>'Syslog Optimization'</p> <pre>configure troubleshoot &gt; syslog &gt; syslog- optimization [SyslogOptimization]</pre>	<p>Enables the device to accumulate and bundle multiple debug messages into a single UDP packet and then send it to a Syslog server. The benefit of this feature is that it reduces the number of UDP Syslog packets, thereby improving (optimizing) CPU utilization.</p> <ul style="list-style-type: none"> <li>■ [0] <b>Disable</b> (default)</li> <li>■ [1] <b>Enable</b></li> </ul> <p><b>Note:</b> The size of the bundled message is configured by the MaxBundleSyslogLength parameter.</p>
<pre>mx-syslog-lgth [MaxBundleSyslogLength]</pre>	<p>Defines the maximum size (in bytes) threshold of logged Syslog messages bundled into a single UDP packet, after which they are sent to a Syslog server.</p>

Parameter	Description
	<p>The valid value range is 0 to 1220 (where 0 indicates that no bundling occurs). The default is 1220.</p> <p><b>Note:</b> The parameter is applicable only if the [GWDebugLevel] parameter is enabled.</p>
<p>'Syslog CPU Protection'</p> <pre>configure troubleshoot &gt; syslog &gt; syslog-cpu- protection</pre> <p>[SyslogCpuProtection]</p>	<p>Enables the protection of the device's CPU resources during debug reporting, ensuring voice traffic is unaffected. If CPU resources drop (i.e., high CPU usage) to a critical level (threshold), the device automatically lowers the debug level to free up CPU resources that were required for the previous debug-level functionality. When sufficient CPU resources become available again, the device increases the debug level. The threshold is configured by the 'Debug Level High Threshold' parameter (see below).</p> <ul style="list-style-type: none"> <li>■ [0] <b>Disable</b></li> <li>■ [1] <b>Enable</b> (default)</li> </ul>
<p>'Debug Level High Threshold'</p> <pre>configure troubleshoot &gt; syslog &gt; debug-level-high- threshold</pre> <p>[DebugLevelHighThreshold]</p>	<p>Defines the threshold (in percentage) for automatically switching to a different debug level, depending on CPU usage. The parameter is applicable only if the 'Syslog CPU Protection' parameter is enabled.</p> <p>The valid value is 0 to 100. The default is 90.</p> <p>The debug level is changed upon the following scenarios:</p> <ul style="list-style-type: none"> <li>■ CPU usage equals threshold: Debug level is reduced one level.</li> <li>■ CPU usage is at least 5% greater than threshold: Debug level is reduced another level.</li> <li>■ CPU usage is 5 to 19% less than threshold: Debug level is increased by one level.</li> <li>■ CPU usage is at least 20% less than threshold: Debug level is increased by another level.</li> </ul>

Parameter	Description
	<p>For example, assume that the threshold is set to 70% and the Debug Level to Detailed (5). When CPU usage reaches 70%, the debug level is reduced to Basic (1). When CPU usage increases by 5% or more than the threshold (i.e., greater than 75%), the debug level is disabled - No Debug (0). When the CPU usage decreases to 5% less than the threshold (e.g., 65%), the debug level is increased to Basic (1). When the CPU usage decreases to 20% less than the threshold (e.g., 50%), the debug level changes to Detailed (5).</p> <p><b>Note:</b> The device does not increase the debug level to a level that is higher than what you configured for the 'Debug Level' parameter.</p>
<pre>configure troubleshoot &gt; cdr &gt; time-zone-format [TimeZoneFormat]</pre>	<p>Defines the time zone that is displayed with the timestamp in CDRs. The timestamp appears in the CDR fields "Setup Time", "Connect Time", and "Release Time".</p> <p>The valid value is a string of up to six characters. The default is UTC. For example, if you configure the parameter TimeZoneFormat = GMT+11, the timestamp in CDRs are generated with the following time zone display:</p> <p>17:47:45.411 <b>GMT+11</b> Sun Jan 03 2018</p> <p><b>Note:</b> The time zone is only for display purposes; it does not configure the actual time zone.</p>
<pre>configure troubleshoot &gt; cdr &gt; call-duration-units [CallDurationUnits]</pre>	<p>Defines the unit of measurement for call duration ("Duration" field) in CDRs generated by the device.</p> <ul style="list-style-type: none"> <li>■ [0] Seconds (default)</li> <li>■ [1] Deciseconds</li> <li>■ [2] Centiseconds</li> <li>■ [3] Milliseconds</li> </ul> <p>The parameter applies to CDRs for Syslog,</p>

Parameter	Description
	RADIUS, local-device storage, and CDR history displayed in the Web interface.
'CDR Syslog Sequence Number' <code>configure system &gt; cdr &gt; cdr-seq-num</code> [CDRSyslogSeqNum]	Enables or disables the inclusion of the sequence number (S=) in CDR Syslog messages. <ul style="list-style-type: none"> <li>■ [0] <b>Disable</b></li> <li>■ [1] <b>Enable</b> (default)</li> </ul>
[SendAcSessionIDHeader]	Enables the use of the Global Session ID in SIP messages (AC-Session-ID header), which is a unique identifier of the call session, even if it traverses multiple devices. <ul style="list-style-type: none"> <li>■ [0] = (Default) Disables the feature. The device sends outgoing SIP messages without a Global Session ID (even if a Global Session ID was received in the incoming SIP message).</li> <li>■ [1] = Enables the feature. If the device receives an incoming SIP message containing a Global Session ID, it sends the same Global Session ID in the outgoing SIP message. If the incoming SIP message does not contain a Global Session ID or if a new session is initiated by the device, the device generates a new, unique Global Session ID and adds it to the outgoing SIP message.</li> </ul> For more information, see <a href="#">Enabling Same Call Session ID over Multiple Devices</a> on page 1341.
'Activity Types to Report via Activity Log Messages' <code>configure troubleshoot &gt; activity-log</code> [ActivityListToLog]	Defines the operations (activities) performed in the Web interface that are reported to a Syslog server. <ul style="list-style-type: none"> <li>■ [pvc] <b>Parameters Value Change</b> = Changes made on-the-fly to parameters and tables, and Configuration file load. Note that the ini file parameter, EnableParametersMonitoring can also be used to set this option.</li> </ul>

Parameter	Description
	<ul style="list-style-type: none"> <li data-bbox="842 286 1374 353">■ [af] <b>Auxiliary Files Loading</b> = Loading of Auxiliary files.</li> <li data-bbox="842 383 1362 533">■ [dr] <b>Device Reset</b> = Resetting the device from the Maintenance Actions page. Note: For this option to take effect, a device reset is required.</li> <li data-bbox="842 562 1378 674">■ [fb] <b>Flash Memory Burning</b> = Saving configuration with burn to flash from the Maintenance Actions page.</li> <li data-bbox="842 703 1390 815">■ [swu] <b>Device Software Update</b> = Software updates (i.e., loading of cmp file) through the Software Upgrade Wizard.</li> <li data-bbox="842 844 1378 956">■ [naa] <b>Non-Authorized Access</b> = Attempts to log in to the Web interface with a false or empty username or password.</li> <li data-bbox="842 985 1390 1317">■ [spc] <b>Sensitive Parameters Value Change</b> = Changes made to "sensitive" parameters: <ul style="list-style-type: none"> <li data-bbox="890 1115 1098 1149">✓ (1) IP Address</li> <li data-bbox="890 1171 1134 1205">✓ (2) Subnet Mask</li> <li data-bbox="890 1227 1305 1261">✓ (3) Default Gateway IP Address</li> <li data-bbox="890 1283 1177 1317">✓ (4) ActivityListToLog</li> </ul> </li> <li data-bbox="842 1346 1337 1413">■ [ll] <b>Login and Logout</b> = Web login and logout attempts.</li> <li data-bbox="842 1442 1378 1509">■ [cli] <b>CLI Activity</b> = CLI commands entered by the user.</li> <li data-bbox="842 1538 1378 1890">■ [ae] <b>Action Executed</b> = Logs user actions that are not related to parameter changes. The actions can include, for example, file uploads, file delete, lock-unlock maintenance actions, LDAP clear cache, register-unregister, and start-stop trunk. In the Web, these actions are typically done by clicking a button (e.g., the <b>LOCK</b> button).</li> </ul> <p data-bbox="842 1919 1321 1986"><b>Note:</b> For the <i>ini</i> file parameter, enclose values in single quotation marks, for</p>

Parameter	Description
	example: ActivityListToLog = 'pvc', 'aff', 'dr', 'fb', 'swu', 'naa', 'spc'.
[EnableParametersMonitoring]	<p>Enables the monitoring, through Syslog messages, of parameters that are modified on-the-fly.</p> <ul style="list-style-type: none"> <li>■ [0] = (Default) Disable</li> <li>■ [1] = Enable</li> </ul>
<p>ISDN Facility Trace isdn-facility-trace [FacilityTrace]</p>	<p>Enables ISDN traces of Facility Information Elements (IE) for ISDN call diagnostics. This allows you to trace all the parameters contained in the Facility IE and view them in the Syslog.</p> <ul style="list-style-type: none"> <li>■ [0] <b>Disable</b> (default)</li> <li>■ [1] <b>Enable</b></li> </ul> <p><b>Note:</b></p> <ul style="list-style-type: none"> <li>■ For the feature to be functional, configure the [GWDebugLevel] parameter to at least level [1].</li> <li>■ The parameter is applicable only to digital interfaces.</li> </ul>
<p>'Debug Recording Destination IP' configure troubleshoot &gt; logging settings &gt; dbg-rec- dest-ip [DebugRecordingDestIP]</p>	<p>Defines the IP address of the server for capturing debug recording.</p>
<p>'Debug Recording Destination Port' configure troubleshoot &gt; logging settings &gt; dbg-rec- dest-port [DebugRecordingDestPort]</p>	<p>Defines the UDP port of the server for capturing debug recording. The default is 925.</p>
<p>'Enable Core Dump' [EnableCoreDump]</p>	<p>Enables the automatic generation of a Core Dump file upon a device crash.</p> <ul style="list-style-type: none"> <li>■ [0] <b>Disable</b> (default)</li> <li>■ [1] <b>Enable</b></li> </ul>

Parameter	Description
	<b>Note:</b> For the parameter to take effect, a device reset is required.
'Core Dump Destination IP' [CoreDumpDestIP]	Defines the IP address of the remote server where you want the device to send the Core Dump file.  By default, no IP address is defined.
'Call Flow Report Mode' call-flow-report [CallFlowReportMode]	Enables the device to send SIP call messages to OVOC so that OVOC can display SIP call dialog sessions as SIP call flow diagrams.  <ul style="list-style-type: none"> <li>■ [0] <b>Disable</b> (default)</li> <li>■ [1] <b>Enable</b></li> </ul> For more information, see <a href="#">Enabling SIP Call Flow Diagrams in OVOC</a> on page 1339.
configure troubleshoot > syslog > system-log-size [SystemLogSize]	Defines the size (in Kbytes) of the system log file.  The maximum size is 200. The default is 200.  To view the logged information in this file, use the CLI command <code>show system log</code> .

## Resource Allocation Indication Parameters

The Resource Allocation Indication (RAI) parameters are described in the table below.

**Table 70-22:RAI Parameters**

Parameter	Description
[EnableRAI]	<p>Enables Resource Available Indication (RAI) alarm generation if the device's busy endpoints exceed a user-defined threshold, configured by the RAIHighThreshold parameter. When enabled and the threshold is crossed, the device sends the SNMP trap, acBoardCallResourcesAlarm.</p> <ul style="list-style-type: none"> <li>■ [0] = (Default) Disable</li> <li>■ [1] = Enable</li> </ul> <p><b>Note:</b></p> <ul style="list-style-type: none"> <li>■ For the parameter to take effect, a device reset is required.</li> <li>■ The parameter is applicable only to the Gateway application.</li> </ul>



Parameter	Description
[RAIHighThreshold]	<p>Defines the high threshold percentage of total calls that are active (busy endpoints). When the percentage of the device's busy endpoints exceeds this high threshold, the device sends the SNMP acBoardCallResourcesAlarm alarm trap with a 'major' alarm status. The range is 0 to 100. The default is 90.</p> <p><b>Note:</b></p> <ul style="list-style-type: none"> <li>■ The percentage of busy endpoints is calculated by dividing the number of busy endpoints by the total number of “enabled” endpoints (trunks are physically connected and synchronized without alarms and endpoints are defined in the Trunk Group table).</li> <li>■ The parameter is applicable only to the Gateway application.</li> </ul>
[RAILowThreshold]	<p>Defines the low threshold percentage of total calls that are active (busy endpoints). When the percentage of the device's busy endpoints falls below this low threshold, the device sends an SNMP acBoardCallResourcesAlarm alarm trap with a 'cleared' alarm status. The range is 0 to 100%. The default is 90%.</p> <p><b>Note:</b> The parameter is applicable only to the Gateway application.</p>
[RAILoopTime]	<p>Defines the time interval (in seconds) that the device periodically checks call resource availability. The valid range is 1 to 200. The default is 10.</p> <p><b>Note:</b> The parameter is applicable only to the Gateway application.</p>

## Security Parameters

This subsection describes the device's security parameters.

### General Security Parameters

The general security parameters are described in the table below.

**Table 70-23:General Security Parameters**

Parameter	Description
'DNS Rebinding Protection' configure system > web > dns-rebinding-	<p>Enables protection against DNS rebinding attacks. This may occur when management users access the device using its hostname, configured by the</p>

Parameter	Description
protection-enabled [DNSRebindingProtectionEnabled]	[HostName] parameter, instead of the IP address. <ul style="list-style-type: none"> <li>■ [0] <b>Disable</b> (default)</li> <li>■ [1] <b>Enable</b></li> </ul> For more information, see <a href="#">Enabling DNS Rebinding Protection</a> on page 66

## HTTPS Parameters

The Secure Hypertext Transport Protocol (HTTPS) parameters are described in the table below.

**Table 70-24:HTTPS Parameters**

Parameter	Description
'Secured Web Connection (HTTPS)' configure system > web > secured-connection [HTTPSOnly]	Defines the protocol for accessing the Web interface. <ul style="list-style-type: none"> <li>■ [0] <b>HTTP and HTTPS</b> (default)</li> <li>■ [1] <b>HTTPS Only</b> = Unencrypted HTTP packets are blocked.</li> </ul> <b>Note:</b> For the parameter to take effect, a device reset is required.
configure system > web > https-port [HTTPSPort]	Defines the local Secured HTTPS port of the device. The parameter allows secure remote device Web management from the LAN. To enable secure Web management from the LAN, configure the desired port. The valid range is 1 to 65535 (other restrictions may apply within this range). The default port is 443. <b>Note:</b> For the parameter to take effect, a device reset is required.
'Require Client Certificates for HTTPS connection' configure system > web > req-client-cert [HTTPSRequireClientCertificate]	Enables the requirement of client certificates for HTTPS connection. <ul style="list-style-type: none"> <li>■ [0] <b>Disable</b> = (Default) Client certificates are not required.</li> <li>■ [1] <b>Enable</b> = Client certificates are required. The client certificate must be preloaded to the device and its matching private key must be installed on the managing PC. Time and date must be correctly set on the device for the client certificate to be verified.</li> </ul>

Parameter	Description
	<p><b>Note:</b></p> <ul style="list-style-type: none"> <li>■ For the parameter to take effect, a device reset is required.</li> <li>■ For a description on implementing client certificates, see <a href="#">TLS for Remote Device Management</a>.</li> </ul>

## SRTP Parameters

The Secure Real-Time Transport Protocol (SRTP) parameters are described in the table below.

**Table 70-25:SRTP Parameters**

Parameter	Description
<p>'Media Security'</p> <pre>configure voip &gt; media security &gt; media-security-enable</pre> <p>[EnableMediaSecurity]</p>	<p>Enables Secure Real-Time Transport Protocol (SRTP).</p> <ul style="list-style-type: none"> <li>■ [0] <b>Disable</b> (default)</li> <li>■ [1] <b>Enable</b></li> </ul> <p><b>Note:</b></p> <ul style="list-style-type: none"> <li>■ For the parameter to take effect, a device reset is required.</li> </ul>
<p>'Media Security Behavior'</p> <pre>configure voip &gt; media security &gt; media-sec-bhavior</pre> <p>[MediaSecurityBehaviour]</p>	<p>Global parameter that defines the handling of SRTP (when the EnableMediaSecurity parameter is set to 1). You can also configure this feature per specific calls, using IP Profiles (IpProfile_MediaSecurityBehaviour). For a detailed description of the parameter and for configuring this feature in the IP Profiles table, see <a href="#">Configuring IP Profiles</a>.</p> <p><b>Note:</b></p> <ul style="list-style-type: none"> <li>■ If this feature is configured for a specific IP Profile, the settings of this global parameter is ignored for calls associated with the IP Profile.</li> </ul>

Parameter	Description
	<ul style="list-style-type: none"> <li>■ The parameter is applicable only to the Gateway application.</li> </ul>
<p>'Master Key Identifier (MKI) Size'</p> <pre>configure voip &gt; media security &gt; srtp-tx-packet-mki-size</pre> <p>[SRTPTxPacketMKISize]</p>	<p>Global parameter that defines the size (in bytes) of the Master Key Identifier (MKI) in SRTP Tx packets. You can also configure this feature per specific calls, using IP Profiles (IpProfile_MKISize). For a detailed description of the parameter and for configuring this feature in the IP Profiles table, see <a href="#">Configuring IP Profiles</a>.</p> <p><b>Note:</b> If this feature is configured for a specific IP Profile, the settings of this global parameter is ignored for calls associated with the IP Profile.</p>
<p>'Symmetric MKI Negotiation'</p> <pre>configure voip &gt; media security &gt; symmetric-mki</pre> <p>[EnableSymmetricMKI]</p>	<p>Global parameter that enables symmetric MKI negotiation. You can also configure this feature per specific calls, using IP Profiles (IpProfile_EnableSymmetricMKI). For a detailed description of the parameter and for configuring this feature in the IP Profiles table, see <a href="#">Configuring IP Profiles</a>.</p> <p><b>Note:</b> If this feature is configured for a specific IP Profile, the settings of this global parameter is ignored for calls associated with the IP Profile.</p>
<p>'Offered SRTP Cipher Suites'</p> <pre>configure voip &gt; media security &gt; offer-srtp-cipher</pre> <p>[SRTPofferedSuites]</p>	<p>Defines the offered crypto suites (cipher encryption algorithms) for SRTP.</p> <ul style="list-style-type: none"> <li>■ [0] <b>All</b> = (Default) All available crypto suites.</li> <li>■ [1] <b>AES-CM-128-HMAC-SHA1-80</b> = device uses AES-CM encryption with a 128-bit key and HMAC-SHA1 message authentication with a 80-bit tag.</li> </ul>

Parameter	Description
	<ul style="list-style-type: none"> <li data-bbox="938 286 1394 479">■ [2] <b>AES-CM-128-HMAC-SHA1-32</b> = device uses AES-CM encryption with a 128-bit key and HMAC-SHA1 message authentication with a 32-bit tag.</li> <li data-bbox="938 501 1394 658">■ [16] <b>AES-256-CM-HMAC-SHA1-32</b> = AES-CM encryption with a 256-bit key and HMAC-SHA1 message authentication with a 32-bit tag.</li> <li data-bbox="938 680 1394 837">■ [32] <b>AES-256-CM-HMAC-SHA1-80</b> = AES-CM encryption with a 256-bit key and HMAC-SHA1 message authentication with an 80-bit tag.</li> </ul> <p data-bbox="938 860 1011 891"><b>Note:</b></p> <ul style="list-style-type: none"> <li data-bbox="938 913 1394 1352">■ For the Gateway application, if you configure the parameter to <b>All</b>, the device sends only four crypto lines ('a=crypto') in the SDP Offer, which excludes the AES 256 crypto suites. Therefore, if you want to offer an AES 256 crypto suite, you need to configure the parameter to <b>AES-256-CM-HMAC-SHA1-32</b> or <b>AES-256-CM-HMAC-SHA1-80</b>.</li> <li data-bbox="938 1375 1394 1800">■ The parameter also affects the selection of the crypto in the device's answer. For example, if the device receives an offer with two crypto lines ('a=crypto:') containing HMAC_SHA1_80 and HMAC_SHA_32, it uses the HMAC_SHA_32 key in its SIP 200 OK response if the parameter is configured to <b>AES-CM-128-HMAC-SHA1-32</b>.</li> </ul>
<p data-bbox="312 1843 879 1955">'Authentication on Transmitted RTP Packets'  configure voip &gt; media security  &gt; RTP-authentication-disable-tx</p>	<p data-bbox="943 1843 1390 1955">Enables authentication on transmitted RTP packets in a secured RTP session.</p>

Parameter	Description
[RTPAuthenticationDisableTx]	<ul style="list-style-type: none"> <li>■ [0] <b>Enable</b> (default)</li> <li>■ [1] <b>Disable</b></li> </ul>
'Encryption on Transmitted RTP Packets' configure voip > media security > RTP-encryption-disable-tx [RTPEncryptionDisableTx]	<p>Enables encryption on transmitted RTP packets in a secured RTP session.</p> <ul style="list-style-type: none"> <li>■ [0] <b>Enable</b> (default)</li> <li>■ [1] <b>Disable</b></li> </ul>
'Encryption on Transmitted RTCP Packets' configure voip > media security > RTCP-encryption-disable-tx [RTCPEncryptionDisableTx]	<p>Enables encryption on transmitted RTCP packets in a secured RTP session.</p> <ul style="list-style-type: none"> <li>■ [0] <b>Enable</b> (default)</li> <li>■ [1] <b>Disable</b></li> </ul>
'SRTP Tunneling Authentication for RTP' configure voip > media security > srtp-tnl-vld-rtp-auth [SRPTunnelingValidateRTPRxAuthentication]	<p>Enables validation of SRTP tunneling authentication for RTP.</p> <ul style="list-style-type: none"> <li>■ [0] <b>Disable</b> = (Default) The device does not perform any validation and forwards the packets as is.</li> <li>■ [1] <b>Enable</b> = The device validates the packets (e.g., sequence number) and if successful, forwards the packets. If validation fails, it drops the packets.</li> </ul> <p><b>Note:</b></p> <ul style="list-style-type: none"> <li>■ The parameter is applicable only to SRTP-to-SRTP calls and when both endpoints use the same authentication keys.</li> <li>■ The parameter is applicable only to the SBC application.</li> </ul>
'SRTP Tunneling Authentication for RTCP' configure voip > media security > srtp-tnl-vld-rtcp-auth [SRPTunnelingValidateRTCPRxAuthentication]	<p>Enables validation of RTP tunneling authentication for RTCP.</p> <ul style="list-style-type: none"> <li>■ [0] <b>Disable</b> = (Default) The device does not perform any validation and forwards the packets as is.</li> <li>■ [1] <b>Enable</b> = The device validates</li> </ul>

Parameter	Description
	<p>the packets (e.g., sequence number) and if successful, forwards the packets. If validation fails, it drops the packets.</p> <p><b>Note:</b></p> <ul style="list-style-type: none"> <li>■ The parameter is applicable only to SRTP-to-SRTP calls and when both endpoints use the same authentication keys.</li> <li>■ The parameter is applicable only to the SBC application.</li> </ul>
<pre>configure voip &gt; sip-definition settings &gt; srtp-state-behavior- mode</pre> <p>[ResetSRTPStateUponRekey]</p>	<p>Global parameter that enables synchronization of the SRTP state between the device and a server when a new SRTP key is generated upon a SIP session expire. You can also configure this feature per specific calls, using IP Profiles (IpProfile_ ResetSRTPStateUponRekey). For a detailed description of the parameter and for configuring this feature in the IP Profiles table, see <a href="#">Configuring IP Profiles</a>.</p> <p><b>Note:</b> If this feature is configured for a specific IP Profile, the settings of this global parameter is ignored for calls associated with the IP Profile.</p>

## TLS Parameters

The Transport Layer Security (TLS) parameters are described in the table below.

**Table 70-26: TLS Parameters**

Parameter	Description
<p>'TLS Client Re-Handshake Interval'</p> <pre>configure network &gt; security-settings &gt; tls-re- hndshk-int</pre> <p>[TLSReHandshakeInterval]</p>	<p>Defines the time interval (in minutes) between TLS Re-Handshakes initiated by the device.</p> <p>The interval range is 0 to 1,500 minutes. The default is 0 (i.e., no TLS Re-Handshake).</p>

Parameter	Description
<p>'TLS Mutual Authentication'</p> <pre>configure network &gt; security-settings &gt; SIPSREQUIRECLIENTCERTIFICATE [SIPSRequireClientCertificate]</pre>	<p>Defines the device's mode of operation regarding mutual authentication and certificate verification for TLS connections.</p> <ul style="list-style-type: none"> <li>■ [0] <b>Disable</b> = (Default) <ul style="list-style-type: none"> <li>✓ Device acts as a client: Verification of the server's certificate depends on the VerifyServerCertificate parameter.</li> <li>✓ Device acts as a server: The device does not request the client certificate.</li> </ul> </li> <li>■ [1] <b>Enable</b> = <ul style="list-style-type: none"> <li>✓ Device acts as a client: Verification of the server certificate is required to establish the TLS connection.</li> <li>✓ Device acts as a server: The device requires the receipt and verification of the client certificate to establish the TLS connection.</li> </ul> </li> </ul> <p><b>Note:</b></p> <ul style="list-style-type: none"> <li>■ This feature can be configured per SIP Interface (see <a href="#">Configuring SIP Interfaces</a>).</li> <li>■ The SIPS certificate files can be changed using the parameters HTTPSCertFileName and HTTPSRootFileName.</li> </ul>
<p>'Peer Host Name Verification Mode'</p> <pre>configure network &gt; security-settings &gt; PEERHOSTNAMEVERIFICATIONMODE [PeerHostNameVerificationMode]</pre>	<p>Enables the device to verify the Subject Name of a TLS certificate received from SIP entities for authentication and establishing TLS connections.</p> <ul style="list-style-type: none"> <li>■ [0] <b>Disable</b> (default)</li> <li>■ [1] <b>Server Only</b> = Verify Subject Name only when acting as a client for the TLS connection.</li> <li>■ [2] <b>Server &amp; Client</b> = Verify Subject Name when acting as a server or client for the TLS connection.</li> </ul>



Parameter	Description
	<p>If the device receives a certificate from a SIP entity (IP Group) and the parameter is configured to <b>Server Only</b> or <b>Server &amp; Client</b>, it attempts to authenticate the certificate based on the certificate's address. The device searches for a Proxy Set that contains the same address (IP address or FQDN) as that specified in the certificate's SubjectAltName (Subject Alternative Names). For Proxy Sets with an FQDN, the device checks the FQDN itself and <b>not</b> the DNS-resolved IP addresses. If a Proxy Set is found with a matching address, the device establishes a TLS connection.</p> <p>If a matching Proxy Set is not found, one of the following occurs:</p> <ul style="list-style-type: none"> <li>■ If the certificate's SubjectAltName is marked as "critical", the device rejects the call.</li> <li>■ If the SubjectAltName is not marked as "critical", the device checks if the FQDN in the certificate's Common Name (CN) of the SubjectName is the same as that configured for the TLSRemoteSubjectName parameter or for the Proxy Set. If they are the same, the device establishes a TLS connection; otherwise, the device rejects the call.</li> </ul> <p><b>Note:</b></p> <ul style="list-style-type: none"> <li>■ If you configure the parameter to <b>Server &amp; Client</b>, you also need to configure the SIPRequireClientCertificate parameter to <b>Enable</b>.</li> <li>■ For FQDN, the certificate may use wildcards (*) to replace parts of the domain name.</li> </ul>
<p>'TLS Client Verify Server Certificate'  <code>configure network &gt;</code>  <code>security-settings &gt; tls-</code></p>	<p>Determines whether the device, when acting as a client for TLS connections, verifies the Server certificate. The certificate is verified</p>

Parameter	Description
vrfy-srvr-cert [VerifyServerCertificate]	with the Root CA information. <ul style="list-style-type: none"> <li>■ [0] <b>Disable</b> (default)</li> <li>■ [1] <b>Enable</b></li> </ul> <p><b>Note:</b> If Subject Name verification is necessary, the parameter PeerHostNameVerificationMode must be used as well.</p>
'TLS Remote Subject Name' configure network > security-settings > tls-rmt- subs-name [TLSRemoteSubjectName]	Defines the Subject Name that is compared with the name defined in the remote side certificate when establishing TLS connections. If the SubjectAltName of the received certificate is not equal to any of the defined Proxies Host names/IP addresses and is not marked as 'critical', the Common Name (CN) of the Subject field is compared with this value. If not equal, the TLS connection is not established. If the CN uses a domain name, the certificate can also use wildcards ('*') to replace parts of the domain name. The valid range is a string of up to 49 characters. <p><b>Note:</b> The parameter is applicable only if the parameter PeerHostNameVerificationMode is set to 1 or 2.</p>
'TLS Expiry Check Start' expiry-check-start [TLSExpiryCheckStart]	Defines when the device sends an SNMP alarm (acCertificateExpiryAlarm) to notify that the installed TLS server certificate is about to expire. This is defined by the number of days before the certificate's expiration date. For example, if configured to 5, the alarm is sent 5 days before the expiration date. For more information on the alarm, refer to the <i>SNMP Reference Guide</i> . The valid value is 0 to 3650. The default is 60.
'TLS Expiry Check Period' expiry-check-period	Defines the periodical interval (in days) for checking the TLS server certificate expiry date.

Parameter	Description
[TLSExpiryCheckPeriod]	The valid value is 1 to 3650. The default is 7.

## SSH Parameters

Secure Shell (SSH) parameters are described in the table below.

**Table 70-27:SSH Parameters**

Parameter	Description
'Enable SSH Server' configure system > cli-settings > ssh [SSHServerEnable]	Enables the device's embedded SSH server.  <ul style="list-style-type: none"> <li>■ [0] <b>Disable</b></li> <li>■ [1] <b>Enable</b> (default)</li> </ul>
'Server Port' configure system > cli-settings > ssh- port [SSHServerPort]	Defines the port number for the embedded SSH server. Range is any valid port number. The default port is 22.
'Public Key' configure system > cli-settings > ssh- require-public-key [SSHRequirePublicKey]	Enables RSA public keys for SSH.  <ul style="list-style-type: none"> <li>■ [0] <b>Disable</b> = (Default) RSA public keys are optional if a public key is configured.</li> <li>■ [1] <b>Enable</b> = RSA public keys are mandatory.</li> </ul> <p><b>Note:</b></p> <ul style="list-style-type: none"> <li>■ Public keys are configured per management user in the Local Users table (see <a href="#">Configuring Management User Accounts</a> on page 49).</li> <li>■ To define the key size, use the TLSPkeySize parameter.</li> </ul>
'Max Payload Size' ssh-max-payload- size [SSHMaxPayloadSize]	Defines the maximum uncompressed payload size (in bytes) for SSH packets. The valid value is 550 to 32768. The default is 32768.
'Max Binary Packet Size' configure system > cli-settings > ssh- max-binary-packet-	Defines the maximum packet size (in bytes) for SSH packets. The valid value is 582 to 35000. The default is 35000.

Parameter	Description
size [SSHMaxBinaryPacketSize]	
'Maximum SSH Sessions' configure system > cli-settings > ssh- max-sessions [SSHMaxSessions]	Defines the maximum number of simultaneous SSH sessions.  The valid range is 1 to 5. The default 5.
'Enable Last Login Message' configure system > cli-settings > ssh- last-login-message [SSHEnableLastLoginMessage]	Enables message display in SSH sessions of the time and date of the last SSH login. The SSH login message displays the number of unsuccessful login attempts since the last successful login.  <ul style="list-style-type: none"> <li>■ [0] <b>Disable</b></li> <li>■ [1] <b>Enable</b> (default)</li> </ul> <p><b>Note:</b> The last SSH login information is cleared when the device is reset.</p>
'Max Login Attempts' configure system > cli-settings > ssh- max-login-attempts [SSHMaxLoginAttempts]	Defines the maximum SSH login attempts allowed for entering an incorrect password by an administrator before the SSH session is rejected.  The valid range is 1 to 5. The default is 3.  <b>Note:</b> The new setting takes effect only for new subsequent SSH connections.

## IDS Parameters

The Intrusion Detection System (IDS) parameters are described in the table below.

**Table 70-28:IDS Parameters**

Parameter	Description
'Intrusion Detection System (IDS)' enable-ids [EnableIDS]	Enables the IDS feature.  <ul style="list-style-type: none"> <li>■ [0] <b>Disable</b> (default)</li> <li>■ [1] <b>Enable</b></li> </ul>
'Alarm Clear Period' alarm-clear-period [IDSAlarmClearPeriod]	Defines the interval (in seconds) after which an IDS alarm is cleared from the Active Alarms table if no thresholds are crossed during this time. However, this "quiet" period must be at least twice the Threshold Window value. For

Parameter	Description
	<p>example, if IDSArmClearPeriod is set to 20 sec and the Threshold Window is set to 15 sec, the IDSArmClearPeriod parameter is ignored and the alarm is cleared only after 30 seconds (2 x 15 sec).</p> <p>The valid value is 0 to 86400. The default is 300.</p>
'Excluded Response Codes' excluded-responses [IDSExcludedResponseCodes]	<p>Defines the SIP response codes that are excluded from the IDS count for SIP dialog establishment failures.</p> <p>The valid value is 400 through to 699. The maximum length is 100 characters. You can configure the parameter with multiple codes, where each code is separated by a comma (without spaces). The default is 408,422,423,480,481,486,487,500,501,502,503,504,505,600.</p> <p>For more information, see <a href="#">Configuring SIP Response Codes to Exclude from IDS</a> on page 192.</p> <p><b>Note:</b></p> <ul style="list-style-type: none"> <li>■ The parameter applies only to rejected responses received from the remote network; not rejected responses generated by the device (except for 404).</li> <li>■ The response codes 401 and 407 are considered authentication failures and therefore, are not applicable to this parameter.</li> </ul>

## OCSP Parameters

The Online Certificate Status Protocol (OCSP) parameters are described in the table below.

**Table 70-29:OCSP Parameters**

Parameter	Description
'Enable OCSP Server' configure network > ocsp > enable [OCSPEnable]	<p>Enables or disables certificate checking using OCSP.</p> <ul style="list-style-type: none"> <li>■ [0] <b>Disable</b> (default)</li> <li>■ [1] <b>Enable</b></li> </ul> <p>For a description of OCSP, see <a href="#">Configuring Certificate Revocation Checking (OCSP)</a>.</p>
'Primary Server IP'	Defines the IP address of the OCSP

Parameter	Description
<pre>configure network &gt; ocsp &gt; server- ip</pre> <p>[OCSPServerIP]</p>	<p>server.</p> <p>The default IP address is 0.0.0.0.</p>
<p>'Secondary Server IP'</p> <pre>configure network &gt; ocsp &gt; secondary-server-ip</pre> <p>[OCSPSecondaryServerIP]</p>	<p>Defines the IP address (in dotted-decimal notation) of the secondary OCSP server (optional).</p> <p>The default IP address is 0.0.0.0.</p>
<p>'Server Port'</p> <pre>configure network &gt; ocsp &gt; server- port</pre> <p>[OCSPServerPort]</p>	<p>Defines the OCSP server's TCP port number.</p> <p>The default port number is 2560.</p>
<p>'Default Response When Server Unreachable'</p> <pre>configure network &gt; ocsp &gt; default-response</pre> <p>[OCSPDefaultResponse]</p>	<p>Determines whether the device allows or rejects peer certificates when the OCSP server cannot be contacted.</p> <ul style="list-style-type: none"> <li>■ [0] <b>Reject</b> (default)</li> <li>■ [1] <b>Allow</b></li> </ul>

## Proxy, Registration and Authentication Parameters

The proxy server, registration and authentication SIP parameters are described in the table below.

**Table 70-30:Proxy, Registration and Authentication SIP Parameters**

Parameter	Description
<p>'Use Default Proxy'</p> <pre>configure voip &gt; sip- definition proxy-and- registration &gt; enable- proxy</pre> <p>[IsProxyUsed]</p>	<p>Enables the use of Proxy Set ID 0 (for backward compatibility).</p> <ul style="list-style-type: none"> <li>■ [0] <b>No</b> = (Default) Proxy Set 0 is not used.</li> <li>■ [1] <b>Yes</b> = Proxy Set ID 0 is used.</li> </ul> <p><b>Note:</b></p> <ul style="list-style-type: none"> <li>■ The parameter must be used only for backward compatibility. If not required for backward compatibility, make sure that the parameter is disabled and use the Proxy Sets table for configuring all your Proxy Sets (except for Proxy</li> </ul>

Parameter	Description
	<p>Set #0).</p> <ul style="list-style-type: none"> <li>■ If you are not using a proxy server, you must configure routing rules to route the call.</li> <li>■ The parameter is applicable only to the Gateway application.</li> </ul>
<p>'Proxy Name'</p> <pre>configure voip &gt; sip- definition proxy-and- registration &gt; proxy- name</pre> <p>[ProxyName]</p>	<p>Defines the Home Proxy domain name. If specified, this name is used as the Request-URI in REGISTER, INVITE and other SIP messages, and as the host part of the To header in INVITE messages. If not specified, the Proxy IP address is used instead.</p> <p>The valid value is a string of up to 49 characters.</p> <p><b>Note:</b> The parameter functions together with the UseProxyIPasHost parameter.</p>
<p>'Use Proxy IP as Host'</p> <pre>configure voip &gt; sip- definition proxy-and- registration &gt; use- proxy-ip-as-host</pre> <p>[UseProxyIPasHost]</p>	<p>Enables the use of the proxy server's IP address (in dotted-decimal notation) as the host name in SIP From and To headers in REGISTER requests.</p> <ul style="list-style-type: none"> <li>■ [0] <b>Disable</b> (default)</li> <li>■ [1] <b>Enable</b></li> </ul> <p>If the parameter is disabled and the device registers to an IP Group (i.e., proxy server), it uses the string configured by the ProxyName parameter as the host name in the REGISTER's Request-URI and uses the string configured by the IP Groups table parameter, SIPGroupName as the host name in the To and From headers. If the IP Group is configured with a Proxy Set that has multiple IP addresses, all the REGISTER messages sent to these proxies are sent with the same host name.</p> <p><b>Note:</b> If the parameter is disabled and the ProxyName parameter is not configured, the proxy's IP address is used as the host name in the REGISTER Request-URI.</p>
<p>'Redundancy Mode'</p> <pre>configure voip &gt; sip- definition proxy-and- registration &gt; redundancy-mode</pre>	<p>Determines whether the device switches back to the primary Proxy after using a redundant Proxy.</p> <ul style="list-style-type: none"> <li>■ [0] <b>Parking</b> = (Default) The device continues working with a redundant (now active) Proxy until the next failure, after which it works with</li> </ul>

Parameter	Description
<p>[ProxyRedundancyMode]</p>	<p>the next redundant Proxy.</p> <ul style="list-style-type: none"> <li>■ [1] <b>Homing</b> = The device always tries to work with the primary Proxy server (i.e., switches back to the primary Proxy whenever it's available).</li> </ul> <p><b>Note:</b> To use this Proxy Redundancy mechanism, you need to enable the keep-alive with Proxy option, by setting the parameter EnableProxyKeepAlive to 1 or 2.</p>
<p>'Proxy IP List Refresh Time'</p> <pre>configure voip &gt; sip- definition proxy-and- registration &gt; proxy- ip-lst-rfrsh-time</pre> <p>[ProxyIPListRefreshTime]</p>	<p>Defines the periodic rate (in seconds) at which the device performs DNS queries to resolve FQDNs (host names) into IP addresses. For example, if a Proxy Set is configured with an FQDN and the parameter is configured to 60, the device queries the DNS server every 60 seconds, which refreshes the Proxy Set's list of DNS-resolved IP addresses. The valid value is 0, or 5 to 2,000,000. The default is 60. The value 0 disables periodic DNS queries and DNS resolution is done only once - upon device reset, device power up, or new and modified configuration.</p>
<p>'Enable Fallback to Routing Table'</p> <pre>configure voip &gt; sip- definition proxy-and- registration &gt; fallback-to-routing</pre> <p>[IsFallbackUsed]</p>	<p>Determines whether the device falls back to the Tel-to-IP Routing table for call routing when Proxy servers are unavailable.</p> <ul style="list-style-type: none"> <li>■ [0] <b>Disable</b> = (Default) Fallback is not used.</li> <li>■ [1] <b>Enable</b> = The Tel-to-IP Routing table is used when Proxy servers are unavailable.</li> </ul> <p>When the device falls back to the Tel-to-IP Routing table, it continues scanning for a Proxy. When the device locates an active Proxy, it switches from internal routing back to Proxy routing.</p> <p><b>Note:</b> To enable the redundant Proxies mechanism, set the parameter EnableProxyKeepAlive to 1 or 2.</p>
<p>'Prefer Routing Table'</p> <pre>configure voip &gt; sip- definition proxy-and- registration &gt; prefer- routing-table</pre>	<p>Determines whether the device's routing table takes precedence over a Proxy for routing calls.</p> <ul style="list-style-type: none"> <li>■ [0] <b>No</b> = (Default) Only a Proxy server is used to route calls.</li> </ul>



Parameter	Description
[PreferRouteTable]	<ul style="list-style-type: none"> <li>■ [1] <b>Yes</b> = The device checks the routing rules in the Tel-to-IP Routing table for a match with the Tel-to-IP call. Only if a match is not found is a Proxy used.</li> </ul>
<p>'Always Use Proxy'</p> <pre>configure voip &gt; sip- definition proxy-and- registration &gt; always- use-proxy</pre> <p>[AlwaysSendToProxy]</p>	<p>Determines whether the device sends SIP messages and responses through a Proxy server.</p> <ul style="list-style-type: none"> <li>■ [0] <b>Disable</b> = (Default) Use standard SIP routing rules.</li> <li>■ [1] <b>Enable</b> = All SIP messages and responses are sent to the Proxy server.</li> </ul> <p><b>Note:</b> The parameter is applicable only if a Proxy server is used (i.e., the parameter IsProxyUsed is set to 1).</p>
<p>'SIP ReRouting Mode'</p> <pre>configure voip &gt; sip- definition proxy-and- registration &gt; sip- rerouting-mode</pre> <p>[SIPReroutingMode]</p>	<p>Determines the routing mode after a call redirection (i.e., a 3xx SIP response is received) or transfer (i.e., a SIP REFER request is received).</p> <ul style="list-style-type: none"> <li>■ [0] <b>Standard</b> = (Default) INVITE messages that are generated as a result of Transfer or Redirect are sent directly to the URI, according to the Refer-To header in the REFER message, or Contact header in the 3xx response.</li> <li>■ [1] <b>Proxy</b> = Sends a new INVITE to the Proxy. Note: This option is applicable only if a Proxy server is used and the parameter AlwaysSendtoProxy is set to 0.</li> <li>■ [2] <b>Routing Table</b> = Uses the Routing table to locate the destination and then sends a new INVITE to this destination.</li> </ul> <p><b>Note:</b></p> <ul style="list-style-type: none"> <li>■ The parameter is applicable only to the Gateway application.</li> <li>■ When the parameter is set to [1] and the INVITE sent to the Proxy fails, the device re-routes the call according to the Standard mode [0].</li> <li>■ When the parameter is set to [2] and the INVITE fails, the device re-routes the call according to the Standard mode [0]. If DNS resolution fails,</li> </ul>

Parameter	Description
	<p>the device attempts to route the call to the Proxy. If routing to the Proxy also fails, the Redirect/Transfer request is rejected.</p> <ul style="list-style-type: none"> <li>■ When the parameter is set to [2], the XferPrefix parameter can be used to define different routing rules for redirect calls.</li> <li>■ The parameter is disregarded if the parameter AlwaysSendToProxy is set to 1.</li> </ul>
<p>'DNS Query Type'  <code>configure voip &gt; sip-definition proxy-and-registration &gt; dns-query</code>            [DNSQueryType]</p>	<p>Enables the use of DNS Naming Authority Pointer (NAPTR) and Service Record (SRV) queries to resolve Proxy and Registrar servers and to resolve all domain names that appear in the SIP Contact and Record-Route headers.</p> <ul style="list-style-type: none"> <li>■ [0] <b>A-Record</b> = (Default) No NAPTR or SRV queries are performed.</li> <li>■ [1] <b>SRV</b> = If the Proxy/Registrar IP address parameter, Contact/Record-Route headers, or IP address configured in the routing tables contain a domain name, an SRV query is performed. The device uses the first host name received from the SRV query. The device then performs a DNS A-record query for the host name to locate an IP address.</li> <li>■ [2] <b>NAPTR</b> = An NAPTR query is performed. If it is successful, an SRV query is sent according to the information received in the NAPTR response. If the NAPTR query fails, an SRV query is performed according to the configured transport type.</li> </ul> <p><b>Note:</b></p> <ul style="list-style-type: none"> <li>■ If the Proxy/Registrar IP address parameter, the domain name in the Contact/Record-Route headers, or the IP address configured in the routing tables contain a domain name with a port definition, the device performs a regular DNS A-record query.</li> <li>■ If a specific Transport Type is configured, a NAPTR query is not performed.</li> </ul>

Parameter	Description
	<ul style="list-style-type: none"> <li>■ To enable NAPTR/SRV queries for Proxy servers only, use the global parameter ProxyDNSQueryType, or use the Proxy Sets table.</li> </ul>
<p>'Proxy DNS Query Type'</p> <pre>configure voip &gt; sip- definition proxy-and- registration &gt; proxy- dns-query</pre> <p>[ProxyDNSQueryType]</p>	<p>Global parameter that defines the DNS query record type for resolving the Proxy server's configured domain name (FQDN) into an IP address.</p> <ul style="list-style-type: none"> <li>■ [0] <b>A-Record</b> = (Default) A-record DNS query.</li> <li>■ [1] <b>SRV</b> = If the Proxy IP address parameter contains a domain name without port definition (e.g., ProxyIP = domain.com), an SRV query is performed. The SRV query returns up to four Proxy host names and their weights. The device then performs DNS A-record queries for each Proxy host name (according to the received weights) to locate up to four Proxy IP addresses. Thus, if the first SRV query returns two domain names and the A-record queries return two IP addresses each, no additional searches are performed.</li> <li>■ [2] <b>NAPTR</b> = NAPTR query is done. If successful, an SRV query is sent according to the information received in the NAPTR response. If the NAPTR query fails, an SRV query is done according to the configured transport type. If the Proxy IP address parameter contains a domain name with port definition (e.g., ProxyIP = domain.com:5080), the device performs a regular DNS A-record query. If a specific Transport Type is defined, a NAPTR query is not performed.</li> </ul> <p><b>Note:</b></p> <ul style="list-style-type: none"> <li>■ This feature can be configured per Proxy Set in the Proxy Sets table (see <a href="#">Configuring Proxy Sets</a>).</li> <li>■ When enabled, NAPTR/SRV queries are used to discover Proxy servers even if the parameter DNSQueryType is disabled.</li> </ul>

Parameter	Description
<p>'Use Gateway Name for OPTIONS'</p> <pre>configure voip &gt; sip- definition proxy-and- registration &gt; use-gw- name-for-opt</pre> <p>[UseGatewayNameForOptions]</p>	<p>Defines if the device's IP address, proxy's IP address, or device's name is used as the host part for the Request-URI in keep-alive SIP OPTIONS messages sent to the proxy (if enabled). The device uses the OPTIONS messages as a keep-alive with its primary and redundant SIP proxy servers. Proxy keep-alive by SIP OPTIONS is enabled per Proxy Set in the Proxy Sets table, by configuring the [ProxySet_EnableProxyKeepAlive] parameter to [1]). For more information, see <a href="#">Configuring Proxy Sets</a>.</p> <ul style="list-style-type: none"> <li>■ [0] <b>No</b> = (Default) The device's IP address is used in the keep-alive OPTIONS messages.</li> <li>■ [1] <b>Yes</b> = The device's name, configured by the [SIPGatewayName] parameter, is used in the keep-alive OPTIONS messages.</li> <li>■ [2] <b>Server</b> = The proxy's IP address is used in the SIP From and To headers in the keep-alive OPTIONS messages.</li> </ul>
<p>[FailedOptionsRetryTime]</p>	<p>Defines how long the device waits (in seconds) before re-sending a SIP OPTIONS keep-alive message to the proxy once the device considers the proxy as offline (i.e., after all retransmissions, configured by the [ProxySet_FailureDetectionRetransmissions] parameter, have failed).</p> <p>The valid value range is 1 to 3600. The default is 1.</p> <p><b>Note:</b></p> <ul style="list-style-type: none"> <li>■ The parameter is applicable only if you enable proxy keep-alive by SIP OPTIONS messages (i.e., [ProxySet_EnableProxyKeepAlive] = [1]).</li> <li>■ A failed SIP response can be no response or a response specified by the [ProxySet_KeepAliveFailureResp] parameter.</li> </ul>
<p>'User Name'</p> <pre>configure voip &gt; sip- definition proxy-and- registration &gt; user- name-4-auth</pre>	<p>Defines the username for registration and Basic/Digest authentication with a Proxy/Registrar server.</p> <p>The valid value is a string of up to 60 characters. By default, no value is defined.</p>

Parameter	Description
[UserName]	<p><b>Note:</b></p> <ul style="list-style-type: none"> <li>■ The parameter is applicable only to the Gateway application.</li> <li>■ The parameter is applicable only if single device registration is used (i.e., 'Authentication Mode' parameter is configured to <b>Per Gateway</b> [AuthenticationMode]).</li> <li>■ Analog interfaces: Instead of configuring the parameter, the Authentication table can be used (see <a href="#">Authentication</a>).</li> </ul>
<p>'Password'</p> <pre>configure voip &gt; sip- definition proxy-and- registration &gt; password-4-auth</pre> <p>[Password]</p>	<p>Defines the password for Basic/Digest authentication with a Proxy/Registrar server. A single password is used for all device ports. The default is 'Default_Passwd'.</p> <p><b>Note:</b></p> <ul style="list-style-type: none"> <li>■ Analog interfaces: Instead of configuring the parameter, the Authentication table can be used (see <a href="#">Authentication</a>).</li> <li>■ The parameter cannot be configured with wide characters.</li> </ul>
<p>'Cnonce'</p> <pre>configure voip &gt; sip- definition proxy-and- registration &gt; cnonce- 4-auth</pre> <p>[Cnonce]</p>	<p>Defines the Cnonce string used by the SIP server and client to provide mutual authentication. The value is free format, i.e., 'Cnonce = 0a4f113b'. The default is 'Default_Cnonce'.</p>
<p>'Challenge Caching Mode'</p> <pre>configure voip &gt; sip- definition proxy-and- registration &gt; challenge-caching</pre> <p>[SIPChallengeCachingMode]</p>	<p>Enables local caching of SIP message authorization challenges from Proxy servers.</p> <p>The device sends the first request to the Proxy without authorization. The Proxy sends a 401/407 response with a challenge for credentials. The device saves (caches) the response for further uses. The device sends a new request with the appropriate credentials. Subsequent requests to the Proxy are automatically sent with credentials (calculated from the saved challenge). If the Proxy doesn't accept the new request and sends another</p>

Parameter	Description
	<p>challenge, the old challenge is replaced with the new one. One of the benefits of the feature is that it may reduce the number of SIP messages transmitted through the network.</p> <ul style="list-style-type: none"> <li>■ [0] <b>None</b> = (Default) Challenges are not cached. Every new request is sent without preliminary authorization. If the request is challenged, a new request with authorization data is sent.</li> <li>■ [1] <b>INVITE Only</b> = Challenges issued for INVITE requests are cached. This prevents a mixture of REGISTER and INVITE authorizations.</li> <li>■ [2] <b>Full</b> = Caches all challenges from the proxies.</li> </ul> <p><b>Note:</b></p> <ul style="list-style-type: none"> <li>■ Challenge caching is used with all proxies and not only with the active one.</li> <li>■ For the Gateway application: The challenge can be cached per endpoint or per Account.</li> <li>■ For the SBC application: The challenge can be cached per Account or per user whose credentials are configured in the User Information table.</li> </ul>
<b>Registrar Parameters</b>	
<p>'Enable Registration'</p> <pre>configure voip &gt; sip- definition proxy-and- registration &gt; enable- registration</pre> <p>[IsRegisterNeeded]</p>	<p>Enables the device to register to a Proxy/Registrar server.</p> <ul style="list-style-type: none"> <li>■ [0] <b>Disable</b> = (Default) The device doesn't register to Proxy/Registrar server.</li> <li>■ [1] <b>Enable</b> = The device registers to Proxy/Registrar server when the device is powered up and at every user-defined interval (configured by the parameter RegistrationTime).</li> </ul> <p><b>Note:</b></p> <ul style="list-style-type: none"> <li>■ The parameter is applicable only to the Gateway application.</li> <li>■ The device sends a REGISTER request for each channel or for the entire device (according to</li> </ul>

Parameter	Description
	the 'Authentication Mode' parameter).
<p>'Registrar Name'</p> <pre>configure voip &gt; sip- definition proxy-and- registration &gt; registrar-name</pre> <p>[RegistrarName]</p>	<p>Defines the Registrar domain name. If specified, the name is used as the Request-URI in REGISTER messages. If it isn't specified (default), the Registrar IP address, or Proxy name or IP address is used instead.</p> <p>The valid range is up to 100 characters.</p> <p><b>Note:</b> The parameter is applicable only to the Gateway application.</p>
<p>'Registrar IP Address'</p> <pre>configure voip &gt; sip- definition proxy-and- registration &gt; ip- addr-rgstr</pre> <p>[RegistrarIP]</p>	<p>Defines the IP address (or FQDN) and port number (optional) of the Registrar server. The IP address is in dotted-decimal notation, e.g., 201.10.8.1:&lt;5080&gt;.</p> <p><b>Note:</b></p> <ul style="list-style-type: none"> <li>■ The parameter is applicable only to the Gateway application.</li> <li>■ If not specified, the REGISTER request is sent to the primary Proxy server.</li> <li>■ When a port number is specified, DNS NAPTR/SRV queries aren't performed, even if the parameter DNSQueryType is set to 1 or 2.</li> <li>■ If the parameter RegistrarIP is set to an FQDN and is resolved to multiple addresses, the device also provides real-time switching (hotswap mode) between different Registrar IP addresses (the parameter IsProxyHotSwap is set to 1). If the first Registrar doesn't respond to the REGISTER message, the same REGISTER message is sent immediately to the next Proxy. To allow this mechanism, the parameter EnableProxyKeepAlive must be set to 0.</li> <li>■ When a specific transport type is defined using the parameter RegistrarTransportType, a DNS NAPTR query is not performed even if the parameter DNSQueryType is set to 2.</li> </ul>
<p>'Registrar Transport Type'</p> <pre>configure voip &gt; sip-</pre>	<p>Determines the transport layer used for outgoing SIP dialogs initiated by the device to the Registrar.</p>

Parameter	Description
<pre>definition proxy-and- registration &gt; registrar-transport [RegistrarTransportType]</pre>	<ul style="list-style-type: none"> <li>■ [-1] <b>Not Configured</b> (default)</li> <li>■ [0] <b>UDP</b></li> <li>■ [1] <b>TCP</b></li> <li>■ [2] <b>TLS</b></li> </ul> <p><b>Note:</b></p> <ul style="list-style-type: none"> <li>■ The parameter is applicable only to the Gateway application.</li> <li>■ When set to 'Not Configured', the value of the parameter SIPTransportType is used.</li> </ul>
<p>'Registration Time'</p> <pre>configure voip &gt; sip- definition proxy-and- registration &gt; registration-time [RegistrationTime]</pre>	<p>Defines the time interval (in seconds) for registering to a Proxy server. The value is used in the SIP Expires header. The parameter also defines the time interval between Keep-Alive messages when the parameter EnableProxyKeepAlive is set to 2 (REGISTER).</p> <p>Typically, the device registers every 3,600 sec (i.e., one hour). The device resumes registration according to the parameter RegistrationTimeDivider.</p> <p>The valid range is 10 to 2,000,000. The default is 180.</p>
<p>'Re-registration Timing [%]'</p> <pre>configure voip &gt; sip- definition proxy-and- registration &gt; re- registration-timing [RegistrationTimeDivider]</pre>	<p>Defines the re-registration timing (in percentage). The timing is a percentage of the re-register timing set by the Registrar server.</p> <p>The valid range is 50 to 100. The default is 50.</p> <p>For example: If the parameter is set to 70% and the Registration Expires time is 3600, the device re-sends its registration request after 3600 x 70% (i.e., 2520 sec).</p> <p><b>Note:</b> The parameter may be overridden if the parameter RegistrationTimeThreshold is greater than 0.</p>
<p>'Registration Retry Time'</p> <pre>configure voip &gt; sip- definition proxy-and- registration &gt; registration-retry-time</pre>	<p>Defines the time interval (in seconds) after which a registration request is re-sent if registration fails with a 4xx response or if there is no response from the Proxy/Registrar server.</p> <p>The default is 30 seconds. The range is 10 to 3600.</p>



Parameter	Description
[RegistrationRetryTime]	<p><b>Note:</b> Registration retry time can also be configured with the MaxRegistrationBackoffTime parameter.</p>
<p>'Max Registration Backoff Time'</p> <pre>configure voip &gt; sip- definition proxy-and- registration &gt; max- registration-backoff- time</pre> <p>[MaxRegistrationBackoffTime]</p>	<p>Defines a dynamic time-to-wait interval before the device attempts to register the SIP entity again after a registration failure. The parameter is applicable only to registrations initiated by the device on behalf of SIP entities (for example, User Info, Accounts, Endpoints or the device itself) with a SIP proxy server (registrar).</p> <p>The valid value is 0 to 3000000 (i.e., 3 million seconds). The default is 0 (i.e., disabled).</p> <p>In contrast to the RegistrationRetryTime parameter, which defines a fixed time to wait between registration attempts due to registration failure, this parameter configures the device to increase the time-to-wait interval for each subsequent registration attempt (per RFC 5626, Section 4.5) for a specific registration flow. In other words, the interval changes between registration attempts.</p> <p>The parameter operates together with the RegistrationRetryTime parameter. When the MaxRegistrationBackoffTime parameter is configured, the wait-time before another registration attempt increases after each failed registration (until it reaches the maximum value specified by the parameter).</p> <p>The device uses the following algorithm to calculate the incremental augmented wait-time between each registration attempt:</p> $\text{Wait Time} = \min(\text{max-time}, (\text{base-time} * (2 ^ \text{consecutive-failures})))$ <p>Where:</p> <ul style="list-style-type: none"> <li>■ <i>max-time</i> is the value configured by MaxRegistrationBackoffTime</li> <li>■ <i>base-time</i> is the value configured by RegistrationRetryTime</li> </ul> <p>For example, if <i>max-time</i> is 1800 seconds and <i>base-</i></p>

Parameter	Description
	<p><i>time</i> is 30 seconds, and there were three consecutive registration failures, then the upper-bound wait time is the minimum of (1800, <math>30 * (2^3)</math>), which is (1800, 240) and thus, the minimum of the two values is 240 (seconds). The actual time the device waits before retrying registration is computed by a uniform random time between 50% and 100% of the upper-bound wait time (e.g., for an upper-bound wait-time of 240, the actual wait-time is between 120 and 240 seconds). As can be seen from the algorithm, the upper-bound wait time can never exceed the value of the <code>MaxRegistrationBackoffTime</code> parameter.</p>
<p>'Registration Time Threshold'  <code>configure voip &gt; sip-definition proxy-and-registration &gt; registration-time-thres</code>    <b>[RegistrationTimeThreshold]</b></p>	<p>Defines a threshold (in seconds) for re-registration timing. If the parameter is greater than 0, but lower than the computed re-registration timing (according to the parameter <code>RegistrationTimeDivider</code>), the re-registration timing is set to the following: timing set by the Registration server in the SIP Expires header minus the value of the parameter <code>RegistrationTimeThreshold</code>. The valid range is 0 to 2,000,000. The default is 0.</p>
<p>'Re-register On INVITE Failure'  <code>configure voip &gt; sip-definition proxy-and-registration &gt; reg-on-invite-fail</code>    <b>[RegisterOnInviteFailure]</b></p>	<p>Enables immediate re-registration if no response is received for an INVITE request sent by the device.</p> <ul style="list-style-type: none"> <li>■ [0] <b>Disable</b> (default)</li> <li>■ [1] <b>Enable</b> = The device immediately expires its re-registration timer and commences re-registration to the same Proxy upon any of the following scenarios: <ul style="list-style-type: none"> <li>✓ The response to an INVITE request is 407 (Proxy Authentication Required) without an authentication header included.</li> <li>✓ The remote SIP UA abandons a call before the device has received any provisional response (indicative of an outbound proxy server failure).</li> <li>✓ The remote SIP UA abandons a call and the only provisional response the device has received for the call is 100 Trying (indicative</li> </ul> </li> </ul>

Parameter	Description
	<p>of a home proxy server failure, i.e., the failure of a proxy in the route after the outbound proxy).</p> <ul style="list-style-type: none"> <li>✓ The device terminates a call due to the expiration of RFC 3261 Timer B or due to the receipt of a 408 (Request Timeout) response and the device has not received any provisional response for the call (indicative of an outbound proxy server failure).</li> <li>✓ The device terminates a call due to the receipt of a 408 (Request Timeout) response and the only provisional response the device has received for the call is the 100 Trying provisional response (indicative of a home proxy server failure).</li> </ul> <p><b>Note:</b> The parameter is applicable only to the Gateway application.</p>
<p>'ReRegister On Connection Failure'  <code>configure voip &gt; sip-definition proxy-and-registration &gt; reg-on-conn-failure</code>  [ReRegisterOnConnectionFailure]</p>	<p>Enables the device to perform SIP re-registration upon TCP/TLS connection failure.</p> <ul style="list-style-type: none"> <li>■ [0] <b>Disable</b> (default)</li> <li>■ [1] <b>Enable</b></li> </ul>
<p>'Gateway Registration Name'  <code>configure voip &gt; sip-definition proxy-and-registration &gt; gw-registration-name</code>  [GWRegistrationName]</p>	<p>Defines the user part in the From and To headers in SIP REGISTER messages. If no value is specified (default) for the parameter, the [UserName] parameter is used instead.</p> <p><b>Note:</b></p> <ul style="list-style-type: none"> <li>■ The parameter is applicable only to the Gateway application.</li> <li>■ The parameter is applicable only for single registration per device (i.e., 'Authentication Mode' parameter is configured to <b>Per Gateway</b> [AuthenticationMode]). When the device registers each channel separately (i.e., 'Authentication Mode' parameter is configured to <b>Per Endpoint</b>), the username is set to the channel's phone number.</li> </ul>

Parameter	Description
<p>'Authentication Mode'</p> <pre>configure voip &gt; sip- definition proxy-and- registration &gt; authentication-mode [AuthenticationMode]</pre>	<p>Defines the device's registration and authentication method.</p> <ul style="list-style-type: none"> <li>■ [0] <b>Per Endpoint</b> = The device registers and authenticates each endpoint (B-channel, FXS, and FXO) separately with the endpoint's authentication username and password.</li> <li>■ [1] <b>Per Gateway</b> = (Default) Single registration and authentication is done for the entire device. This is typically used for FXO interfaces and digital interfaces.</li> <li>■ [3] <b>Per FXS</b> = The device registers and authenticates only endpoints that are FXS endpoints.</li> </ul> <p><b>Note:</b></p> <ul style="list-style-type: none"> <li>■ The parameter is applicable only to endpoints that are either not associated with any row configured in the Trunk Group Settings table, or are associated with a row and the row's 'Registration Mode' parameter is not configured (see <a href="#">Configuring Trunk Group Settings</a> on page 725).</li> <li>■ The parameter is applicable only to the Gateway application.</li> </ul>
<p>'Set Out-Of-Service On Registration Failure'</p> <pre>configure voip &gt; sip- definition proxy-and- registration &gt; set-oos- on-reg-failure [OOSOnRegistrationFail]</pre>	<p>Enables setting the endpoint, trunk, or entire device (i.e., all endpoints) to out-of-service if registration fails.</p> <ul style="list-style-type: none"> <li>■ [0] <b>Disable</b> (default)</li> <li>■ [1] <b>Enable</b></li> </ul> <p>If registration is per endpoint (i.e., 'Authentication Mode' parameter is configured to <b>Per Endpoint</b>) or per Account (see <a href="#">Configuring Trunk Group Settings</a>) and a specific endpoint/Account registration fails (SIP 4xx or no response), then that endpoint is set to out-of-service until a success response is received in a subsequent registration request. If registration is per the entire device (i.e., 'Authentication Mode' parameter is configured to <b>Per Gateway</b>) and registration fails, all endpoints</p>

Parameter	Description
	<p>are set to out-of-service. If all the Accounts of a specific Trunk Group fail registration and if the Trunk Group comprises a complete trunk, then the entire trunk is set to out-of-service.</p> <p><b>Note:</b></p> <ul style="list-style-type: none"> <li>■ The parameter is applicable only to the Gateway application.</li> <li>■ The out-of-service method is configured using the [FXSOOSBehavior] parameter.</li> </ul>
<pre>configure voip &gt; sip- definition proxy-and- registration &gt; expl-un- reg [UnregistrationMode]</pre>	<p>Enables the device to perform explicit unregisters.</p> <ul style="list-style-type: none"> <li>■ [0] <b>Disable</b> (default)</li> <li>■ [1] <b>Enable</b> = The device sends an asterisk ("*") value in the SIP Contact header, instructing the Registrar server to remove all previous registration bindings. The device removes SIP User Agent (UA) registration bindings in a Registrar, according to RFC 3261. Registrations are soft state and expire unless refreshed, but they can also be explicitly removed. A client can attempt to influence the expiration interval selected by the Registrar. A UA requests the immediate removal of a binding by specifying an expiration interval of "0" for that contact address in a REGISTER request. UA's should support this mechanism so that bindings can be removed before their expiration interval has passed. Use of the "*" Contact header field value allows a registering UA to remove all bindings associated with an address-of-record (AOR) without knowing their precise values.</li> </ul> <p><b>Note:</b> The REGISTER-specific Contact header field value of "*" applies to all registrations, but it can only be used if the Expires header field is present with a value of "0".</p>
<pre>'Add Empty Authorization Header' configure voip &gt; sip- definition settings &gt; add-empty-author-hdr [EmptyAuthorizationHeader]</pre>	<p>Enables the inclusion of the SIP Authorization header in initial registration (REGISTER) requests sent by the device.</p> <ul style="list-style-type: none"> <li>■ [0] <b>Disable</b> (default)</li> </ul>

Parameter	Description
	<p>■ [1] <b>Enable</b></p> <p>The Authorization header carries the credentials of a user agent (UA) in a request to a server. The sent REGISTER message populates the Authorization header with the following parameters:</p> <ul style="list-style-type: none"> <li>■ username - set to the value of the private user identity</li> <li>■ realm - set to the domain name of the home network</li> <li>■ uri - set to the SIP URI of the domain name of the home network</li> <li>■ nonce - set to an empty value</li> <li>■ response - set to an empty value</li> </ul> <p>For example:</p> <p>Authorization: Digest username=alice_private@home1.net, realm="home1.net", nonce="", response="e56131d19580cd833064787ecc"</p> <p><b>Note:</b> This registration header is according to the IMS 3GPP TS24.229 and PKT-SP-24.220 specifications.</p>
<p>'Add initial Route Header'</p> <pre>configure voip &gt; sip- definition proxy-and- registration &gt; add- init-rte-hdr [InitialRouteHeader]</pre>	<p>Enables the inclusion of the SIP Route header in initial registration or re-registration (REGISTER) requests sent by the device.</p> <ul style="list-style-type: none"> <li>■ [0] <b>Disable</b> (default)</li> <li>■ [1] <b>Enable</b></li> </ul> <p>When the device sends a REGISTER message, the Route header includes either the Proxy's FQDN, or IP address and port according to the configured Proxy Set, for example:</p> <p>Route:  &lt;sip:10.10.10.10;lr;transport=udp&gt;  <b>or</b>  Route: &lt;sip: pcscf-  gm.ims.rr.com;lr;transport=udp&gt;</p>
<pre>configure voip &gt; sip-</pre>	<p>Enables the use of the carriage-return and line-feed</p>

Parameter	Description
<pre>definition proxy-and- registration &gt; ping- pong-keep-alive [UsePingPongKeepAlive]</pre>	<p>sequences (CRLF) Keep-Alive mechanism, according to RFC 5626 “Managing Client-Initiated Connections in the Session Initiation Protocol (SIP)” for reliable, connection-orientated transport types such as TCP.</p> <ul style="list-style-type: none"> <li>■ [0] <b>Disable</b> (default)</li> <li>■ [1] <b>Enable</b></li> </ul> <p>The SIP user agent/client (i.e., device) uses a simple periodic message as a keep-alive mechanism to keep their flow to the proxy or registrar alive (used for example, to keep NAT bindings open). For connection-oriented transports such as TCP/TLS this is based on CRLF. This mechanism uses a client-to-server "ping" keep-alive and a corresponding server-to-client "pong" message. This ping-pong sequence allows the client, and optionally the server, to tell if its flow is still active and useful for SIP traffic. If the client does not receive a pong in response to its ping, it declares the flow “dead” and opens a new flow in its place. In the CRLF Keep-Alive mechanism the client periodically (defined by the PingPongKeepAliveTime parameter) sends a double-CRLF (the "ping") then waits to receive a single CRLF (the "pong"). If the client does not receive a "pong" within an appropriate amount of time, it considers the flow failed.</p> <p><b>Note:</b> The device sends a CRLF message to the Proxy Set only if the Proxy Keep-Alive feature (EnableProxyKeepAlive parameter) is enabled and its transport type is set to TCP or TLS. The device first sends a SIP OPTION message to establish the TCP/TLS connection and if it receives any SIP response, it continues sending the CRLF keep-alive sequences.</p>
<pre>configure voip &gt; sip- definition proxy-and- registration &gt; ping- pong-keep-alive-time [PingPongKeepAliveTime]</pre>	<p>Defines the periodic interval (in seconds) after which a “ping” (double-CRLF) keep-alive is sent to a proxy/registrar, using the CRLF Keep-Alive mechanism.</p> <p>The default range is 5 to 2,000,000. The default is 120.</p> <p>The device uses the range of 80-100% of this user-</p>

Parameter	Description
	<p>defined value as the actual interval. For example, if the parameter value is set to 200 sec, the interval used is any random time between 160 to 200 seconds. This prevents an “avalanche” of keep-alive by multiple SIP UAs to a specific server.</p>
<p>'Max Generated Register Rate'  <code>configure voip &gt; sip-  definition proxy-and-  registration &gt; max-gen-  reg-rate</code>  [MaxGeneratedRegistersRate]</p>	<p>Defines the maximum number of user register requests (REGISTER messages) that the device sends (to a proxy or registrar server) at a user-defined rate configured by the GeneratedRegistersInterval parameter. The parameter is useful in that it may be used to prevent an overload on the device's CPU caused by sending many registration requests at a given time. The valid value is 30 to 300 register requests per second. The default is 150.</p> <p>For configuration examples, see the description of the GeneratedRegistersInterval parameter.</p>
<p>'Generated Register Interval'  <code>configure voip &gt; sip-  definition proxy-and-  registrationsip-  definition settings &gt;  gen-reg-int</code>  [GeneratedRegistersInterval]</p>	<p>Defines the rate (in seconds) at which the device sends user register requests (REGISTER messages). The parameter is based on the maximum number of REGISTER messages that can be sent at this rate, configured by the MaxGeneratedRegistersRate parameter.</p> <p>The valid value is 1 to 5. The default is 1.</p> <p>Configuration examples:</p> <ul style="list-style-type: none"> <li>■ If you configure the MaxGeneratedRegistersRate parameter to 100 and the GeneratedRegistersInterval to 5, the device sends a maximum of 20 REGISTER messages per second (i.e., 100 messages divided by 5 sec; 100 per 5 seconds).</li> <li>■ If you configure the MaxGeneratedRegistersRate parameter to 100 and the GeneratedRegistersInterval to 1, the device sends a maximum of a 100 REGISTER messages per second.</li> </ul>
<p><code>configure voip &gt; sip-  definition settings &gt;  account-invite-failure-</code></p>	<p>Defines SIP response codes that if received for a failed INVITE message sent for an Account, triggers the device to re-register the Account. The</p>



Parameter	Description
trigger-codes [AccountInviteFailureTriggerCodes]	<p>parameter is applicable only if the Account's 'Re-Register on Invite Failure' parameter in the Accounts table is configured to <b>Enable</b> (see <a href="#">Configuring Registration Accounts</a> on page 583).</p> <p>The valid value is a SIP response code. Multiple response codes can be configured, where each value is separated by a comma. The default is "403,408,480" (without quotation marks).</p> <p><b>Note:</b> SIP response code 408 also refers to an INVITE timeout (i.e., no reply from server). Therefore, if re-registration is needed for such a scenario, make sure that you configure the parameter with "408" as well.</p>

## Network Application Parameters

The SIP network application parameters are described in the table below.

**Table 70-31: SIP Network Application Parameters**

Parameter	Description
<pre>configure voip &gt; sip-definition settings &gt; tcp-keepalive-time</pre> [TCPKeepAliveTime]	<p>Defines the interval (in sec) between the last data packet sent and the first keep-alive probe to send.</p> <p>The valid value is 10 to 65,000. The default is 60.</p> <p><b>Note:</b></p> <ul style="list-style-type: none"> <li>■ Simple ACKs such as keepalives are not considered data packets.</li> <li>■ TCP keepalive is enabled per SIP Interface in the SIP Interfaces table.</li> </ul>
<pre>configure voip &gt; sip-definition settings &gt; tcp-keepalive-interval</pre> [TCPKeepAliveInterval]	<p>Defines the interval (in sec) between consecutive keep-alive probes, regardless of what the connection has</p>

Parameter	Description
	<p>exchanged in the meantime.</p> <p>The valid value is 10 to 65,000. The default is 10.</p> <p><b>Note:</b> TCP keepalive is enabled per SIP Interface in the SIP Interfaces table.</p>
<pre>configure voip &gt; sip-definition settings &gt; tcp-keepalive-retry [<b>TCPKeepAliveRetry</b>]</pre>	<p>Defines the number of unacknowledged keep-alive probes to send before considering the connection down.</p> <p>The valid value is 1 to 100. The default is 5.</p> <p><b>Note:</b> TCP keepalive is enabled per SIP Interface in the SIP Interfaces table.</p>

## General SIP Parameters

The general SIP parameters are described in the table below.

**Table 70-32:General SIP Parameters**

Parameter	Description
[MaxSDPSessionVersionId]	<p>Defines the maximum number of characters allowed in the SDP body's "o=" (originator and session identifier) field for the session ID and session version values. An example of an "o=" line with session ID and session version values (in bold) is shown below:</p> <pre>o=jdoe <b>2890844526 2890842807</b> IN IP4 10.47.16.5</pre> <p>The valid value range is 1,000 to 214,748,3647 (default).</p>
[UseRandomUser]	<p>Enables the device to assign a random string value for the user part of the SIP Contact header in the REGISTER message (generated by the device) for new user Account registrations with the device.</p> <ul style="list-style-type: none"> <li>■ [0] = (Default) Disable</li> <li>■ [1] = Enable</li> </ul>

Parameter	Description
	<p>The string includes letters and may include numbers, but it always begins with a letter. The string is unique to each Account. An example of a randomly assigned user part is shown (in bold) below:</p> <p>Contact:</p> <pre>&lt;sip:HRaNEmZnfX6xZ14@pc33.atlanta.com&gt;</pre> <p>When enabled, each Account registers with its unique user part, and all INVITE messages for this new Account are sent with this unique user part. The assigned user parts are also used for registration refreshes and for un-registering these Accounts. The device stops using the random user part in the following scenarios:</p> <ul style="list-style-type: none"> <li>■ The user sends an unregister request.</li> <li>■ The device sends a REGISTER request for the user, but does not receive a SIP 200 OK in response.</li> <li>■ The parameter is disabled. When enabled again, new random user parts are assigned to the Accounts.</li> </ul> <p>To configure Accounts, see <a href="#">Configuring Registration Accounts</a>.</p>
[UnregisterOnStartup]	<p>Enables the device to unregister all user Accounts that were registered with the device, upon a device reset. During device start-up, each Account sends a REGISTER message (containing "Contact: *") to unregister all contact URIs belonging to its Address-of-Record (AOR), and then a second after they are unregistered, the device re-registers the Account.</p> <ul style="list-style-type: none"> <li>■ [0] = (Default) Disable</li> <li>■ [1] = Enable</li> </ul> <p>To configure Accounts, see <a href="#">Configuring Registration Accounts</a>.</p>
'Send Reject (503) upon Overload' configure voip > sip-definition settings > reject-on-ovrld [SendRejectOnOverload]	<p>Disables the sending of SIP 503 (Service Unavailable) responses upon receipt of new SIP dialog-initiating requests when the device's CPU is overloaded and thus, unable to accept and process new SIP messages.</p> <ul style="list-style-type: none"> <li>■ [0] <b>Disable</b> = No SIP 503 response is sent when CPU overloaded.</li> <li>■ [1] <b>Enable</b> = (Default) SIP 503 response is sent when CPU overloaded.</li> </ul> <p><b>Note:</b> Even if the parameter is disabled (i.e., 503 is not sent), the</p>

Parameter	Description
	device still discards the new SIP dialog-initiating requests when the CPU is overloaded.
'SIP 408 Response upon non-INVITE' configure voip > sip-definition settings > enbl-non-inv-408 [EnableNonInvite408 Reply]	Enables the device to send SIP 408 responses (Request Timeout) upon receipt of non-INVITE transactions. Disabling this response complies with RFC 4320/4321. By default, and in certain circumstances such as a timeout expiry, the device sends a SIP 408 Request Timeout in response to non-INVITE requests (e.g., REGISTER). <ul style="list-style-type: none"> <li>■ [0] <b>Disable</b> = SIP 408 response is not sent upon receipt of non-INVITE messages (to comply with RFC 4320).</li> <li>■ [1] <b>Enable</b> = (Default) SIP 408 response is sent upon receipt of non-INVITE messages, if necessary.</li> </ul>
'Remote Management by SIP NOTIFY' configure voip > sip-definition settings > sip-remote-reset [EnableSIPRemoteReset]	Enables a specific device action upon the receipt of a SIP NOTIFY request, where the action depends on the value in the Event header. <ul style="list-style-type: none"> <li>■ [0] <b>Disable</b> (default)</li> <li>■ [1] <b>Enable</b></li> </ul> The action depends on the Event header value: <ul style="list-style-type: none"> <li>■ "Event: check-sync;reboot=false": Triggers the regular Automatic Update feature (if Automatic Update has been enabled on the device).</li> <li>■ "Event: check-sync;reboot=true": Triggers a device reset.</li> <li>■ "Event: soft-sync": Triggers the device to disconnect all current calls.</li> </ul> <p><b>Note:</b> The Event header value is proprietary to AudioCodes.</p>
'Max SIP Message Length' [MaxSIPMessageLength]	Defines the maximum size (in Kbytes) for each SIP message that can be sent over the network. The device rejects messages exceeding this user-defined size. The valid value range is 1 to 100. The default is 100.
[SIPForceRport]	Determines whether the device sends SIP responses to the UDP port from where SIP requests are received even if the 'rport' parameter is not present in the SIP Via header. <ul style="list-style-type: none"> <li>■ [0] = (Default) Disabled. The device sends the SIP response to the UDP port defined in the Via header. If the Via header contains the 'rport' parameter, the response is sent to the</li> </ul>

Parameter	Description
	<p>UDP port from where the SIP request is received.</p> <ul style="list-style-type: none"> <li>■ [1] = Enabled. SIP responses are sent to the UDP port from where SIP requests are received even if the 'rport' parameter is not present in the Via header.</li> </ul>
<p>'Reject Cancel after Connect'</p> <pre>configure voip &gt; sip- definition settings &gt; reject-cancel- after-connect [RejectCancelAfterCo nnect]</pre>	<p>Enables or disables the device to accept or reject SIP CANCEL requests received after the receipt of a 200 OK in response to an INVITE (i.e., call established). According to the SIP standard, a CANCEL can be sent only during the INVITE transaction (before 200 OK), and once a 200 OK response is received the call can be rejected only by a BYE request.</p> <ul style="list-style-type: none"> <li>■ [0] <b>Disable</b> = (Default) Accepts a CANCEL request received during the INVITE transaction by sending a 200 OK response and terminates the call session.</li> <li>■ [1] <b>Enable</b> = Rejects a CANCEL request received during the INVITE transaction by sending a SIP 481 (Call/Transaction Does Not Exist) response and maintains the call session.</li> </ul>
<pre>configure voip &gt; sip- definition settings &gt; verify-rcvd- requi [VerifyRecievedReque stUri]</pre>	<p>Enables the device to reject SIP requests (e.g., ACK, BYE, or re-INVITE) whose user part in the Request-URI is different from the user part in the Contact header of the last sent SIP request.</p> <ul style="list-style-type: none"> <li>■ [0] = (Default) Disable. Even if the user part is different, the device accepts the SIP request.</li> <li>■ [1] = Enable. If the user part in the Contact header of the previous SIP request is different to the user part in the Request-URI for in-dialog requests, the device rejects the SIP request. A BYE request is responded with a SIP 481, a re-INVITE request is responded with a SIP 404, and an ACK request is ignored.</li> <li>■ [2] = If the user part in the Contact header of the previous SIP request is different to the user part in the Request-URI for dialog-initiating INVITE requests, the device rejects the SIP request.</li> <li>■ Verify dialog-initiating INVITE for all required conditions (Via, Source IP and user in Request-URI)</li> <li>■ [3] = Verify dialog-initiating INVITE and in-dialog requests.</li> </ul> <p>The VerifyRecievedRequestUri parameter functions together with the RegistrarProxySetID parameter, as follows:</p>

Parameter	Description
	<p>■ <b>Handling Dialog-Initiating INVITES:</b> If the VerifyRecievedRequestUri parameter is configured to [2] or [3] and the RegistrarProxySetID parameter is configured to some Proxy Set, the device accepts dialog-initiating INVITE requests received from the registrar at which the Accounts (configured in the Accounts table) are registered. For dialog-initiating INVITE requests received from the registrar on a specific SIP Interface, the following rules apply (listed according to priority):</p> <ul style="list-style-type: none"> <li>✓ The top-most Via header must contain a host-resolved IP address of the registrar; otherwise, the device drops the INVITE request.</li> <li>✓ The source IP address must be the same as the IP address of the registrar; otherwise, the device rejects the requests and sends a SIP 403 (Forbidden) response to the registrar.</li> <li>✓ The user part, specified in the Request-URI header, must be identical to the Contact user part configured for the associated Account, and the Account must be registered. Otherwise, the device rejects the request with a SIP 404 (Not Found) response. If the RegistrarProxySetID parameter is not configured or no Accounts are configured, the device accepts the dialog-initiating INVITE request.</li> </ul> <p><b>Note:</b> This handling is applicable only to the SBC application.</p> <p>■ <b>Handling In-dialog Requests:</b> If the VerifyRecievedRequestUri parameter is configured to [1] or [3], for all incoming in-dialog requests (including ACK and CANCEL), the device checks if the Request-URI user part matches the remote Contact user part (i.e., the Contact user configured for the Account). If there is no match, the device rejects the request and sends a SIP 481 response for requests such as BYE and CANCEL, or a SIP 404 for other requests, and for ACK it does not send any response.</p> <p><b>Note:</b> This handling is applicable to the Gateway and SBC applications.</p>
[RegistrarProxySetID]	Defines a Proxy Set for the registrar. The parameter functions together with the VerifyRecievedRequestUri parameter. For more information, see the description of the VerifyRecievedRequestUri

Parameter	Description
	<p>parameter.</p> <p>The default value is -1 (not defined).</p> <p><b>Note:</b> This setting assumes that the SIP Interface has only one registrar.</p>
<p>'Max Number of Active Calls'</p> <pre>configure voip &gt; sip- definition settings &gt; max-nb-of-- act-calls [MaxActiveCalls]</pre>	<p>Defines the maximum number of simultaneous active calls supported by the device. If the maximum number of calls is reached, new calls are not established.</p> <p>The valid range is 1 to the maximum number of supported channels. The default value is the maximum available channels (i.e., no restriction on the maximum number of calls).</p>
<p>'QoS Statistics in Release Msg'</p> <pre>configure voip &gt; sip- definition settings &gt; qos- statistics-in- release-msg [QoSStatistics]</pre>	<p>Enables the device to include call Quality of Service (QoS) statistics in SIP BYE messages and SIP 200 OK responses to BYE messages, using the proprietary SIP header X-RTP-Stat.</p> <ul style="list-style-type: none"> <li>■ [0] <b>Disable</b> (default)</li> <li>■ [1] <b>Enable</b></li> </ul> <p>The X-RTP-Stat header contains the following statistics:</p> <ul style="list-style-type: none"> <li>■ Number of received and sent voice packets</li> <li>■ Number of received and sent voice octets</li> <li>■ Received packet loss, jitter (in ms), and latency (in ms)</li> </ul> <p>The X-RTP-Stat header contains the following fields:</p> <ul style="list-style-type: none"> <li>■ PS=&lt;voice packets sent&gt;</li> <li>■ OS=&lt;voice octets sent&gt;</li> <li>■ PR=&lt;voice packets received&gt;</li> <li>■ OR=&lt;voice octets received&gt;</li> <li>■ PL=&lt;receive packet loss&gt;</li> <li>■ JI=&lt;jitter in ms&gt;</li> <li>■ LA=&lt;latency in ms&gt;</li> </ul> <p>Below is an example of the X-RTP-Stat header in a SIP BYE message:</p> <pre>BYE sip:302@10.33.4.125 SIP/2.0</pre>

Parameter	Description
	<p>Via: SIP/2.0/UDP 10.33.4.126;branch=z9hG4bKac2127550866 Max-Forwards: 70 From: &lt;sip:401@10.33.4.126;user=phone&gt;;tag=1c2113553324 To: &lt;sip:302@company.com&gt;;tag=1c991751121 Call-ID: 991750671245200001912@10.33.4.125 CSeq: 1 BYE <b>X-RTP-Stat:</b> <b>PS=207;OS=49680;;PR=314;OR=50240;PL=0;JI=600;LA=40;</b> Supported: em,timer,replaces,path,resource-priority Allow: REGISTER,OPTIONS,INVITE,ACK,CANCEL,BYE,NOTIFY,PRACK,REFER,INFO,SUBSCRIBE,UPDATE User-Agent: Sip-Gateway-/7.20A.260.005 Reason: Q.850 ;cause=16 ;text="local" Content-Length: 0 <b>Note:</b> The parameter is applicable only to the Gateway application.</p>
'PRACK Mode' prack-mode [PrackMode]	<p>Determines the PRACK (Provisional Acknowledgment) mechanism mode for SIP 1xx reliable responses.</p> <ul style="list-style-type: none"> <li>■ [0] <b>Disable</b></li> <li>■ [1] <b>Supported</b> (default)</li> <li>■ [2] <b>Required</b></li> </ul> <p><b>Note:</b></p> <ul style="list-style-type: none"> <li>■ The Supported and Required headers contain the '100rel' tag.</li> <li>■ The device sends PRACK messages if 180/183 responses are received with '100rel' in the Supported or Required headers.</li> <li>■ The parameter is applicable only to the Gateway application.</li> </ul>
'Enable Early Media' early-media [EnableEarlyMedia]	<p>Global parameter enabling the Early Media feature for sending media (e.g., ringing) before the call is established. You can also configure this feature per specific calls, using IP</p>



Parameter	Description
	<p>Profiles (IpProfile_EnableEarlyMedia) or Tel Profiles (TelProfile_EnableEarlyMedia). For a detailed description of the parameter and for configuring the feature, see <a href="#">Configuring IP Profiles</a> or <a href="#">Configuring Tel Profiles</a>.</p> <p><b>Note:</b> If the feature is configured for a specific profile, the settings of the global parameter is ignored for calls associated with the profile.</p>
'Enable Early 183' early-183 [EnableEarly183]	<p>Global parameter that enables the device to send SIP 183 responses with SDP to the IP upon receipt of INVITE messages. You can also configure this feature per specific calls, using IP Profiles (IpProfile_EnableEarly183). For a detailed description of the parameter and for configuring this feature in the IP Profiles table, see <a href="#">Configuring IP Profiles</a>.</p> <p><b>Note:</b> If this feature is configured for a specific IP Profile, the settings of this global parameter is ignored for calls associated with the IP Profile.</p>
[IgnoreAlertAfterEarly Media]	<p>Defines the device's interworking of Alerting messages for IP-to-Tel calls (ISDN). It determines whether the device sends a 180 Ringing response to the caller after the device sends a 183 Session Progress response to the caller. The 180 Ringing response indicates that the INVITE has been received by the ISDN side and that alerting is taking place (i.e., ISDN Progress message), indicating to the IP PBX to play a ringback tone. The 183 Session Progress response allows an early media session to be established prior to the call being answered, for example, to hear a ring tone, busy tone or recorded announcement.</p> <ul style="list-style-type: none"> <li>■ [0] = (Default) Disable. If the device sends a 183 response with SDP (due to a received ISDN Progress or Proceeding with PI messages, i.e., a ring tone, busy tone or recorded announcement played to the ISDN side) and an Alerting message is then received from the ISDN side (with or without Progress Indicator), the device also sends a 180 Ringing response to the caller. Therefore, in this case, early media is played to the ISDN side and then the ringback tone is played by the IP PBX.</li> <li>■ [1] = Enable. If the device sends a 183 response with SDP (due to a received ISDN Progress or Proceeding with PI messages) and an Alerting message is then received from the ISDN side (with or without Progress Indicator), the device does not send a 180 Ringing response to the caller and the voice</li> </ul>

Parameter	Description
	<p>channel remains open. Therefore, in this case, early media is played to the ISDN side and a ringback tone is not played by the IP PBX.</p> <p><b>Note:</b></p> <ul style="list-style-type: none"> <li>■ The parameter is applicable only to digital interfaces.</li> <li>■ The parameter is applicable only if the EnableEarlyMedia parameter is set to 1 (i.e., enabled).</li> </ul>
<p>'183 Message Behavior'</p> <pre>configure voip &gt; sip- definition settings &gt; 183-msg- behavior [SIP183Behaviour]</pre>	<p>Digital: Defines the ISDN message that is sent when the 183 Session Progress message is received for IP-to-Tel calls.</p> <p>Analog: Defines the response of the device upon receipt of a SIP 183 response.</p> <ul style="list-style-type: none"> <li>■ [0] <b>Progress</b> = (Default) <ul style="list-style-type: none"> <li>✓ Digital: The device sends a Progress message.</li> <li>✓ Analog: A 183 response (without SDP) does not cause the device to play a ringback tone.</li> </ul> </li> <li>■ [1] <b>Alert</b> = <ul style="list-style-type: none"> <li>✓ Digital: The device sends an Alerting message (upon receipt of a 183 response) instead of an ISDN Progress message.</li> <li>✓ Analog: 183 response is handled by the device as if a 180 Ringing response is received, and the device plays a ringback tone.</li> </ul> </li> </ul> <p><b>Note:</b> The parameter is applicable only to the Gateway application.</p>
<p>[ReleaseIP2ISDNCallOnProgressWithCause]</p>	<p>Typically, if an Q.931 Progress message with a Cause is received from the PSTN for an outgoing IP-to-ISDN call and the EnableEarlyMedia parameter is set to 1 (i.e., the Early Media feature is enabled), the device interworks the Progress to 183 + SDP to enable the originating party to hear the PSTN announcement about the call failure. Conversely, if EnableEarlyMedia is set to 0, the device disconnects the call by sending a SIP 4xx response to the originating party. However, if the ReleaseIP2ISDNCallOnProgressWithCause parameter is set to 1, then the device sends a SIP 4xx response even if the EnableEarlyMedia parameter is set to 1.</p> <ul style="list-style-type: none"> <li>■ [0] = (Default) If a Progress with Cause message is received</li> </ul>

Parameter	Description
	<p>from the PSTN for an outgoing IP-to-ISDN call, the device does not disconnect the call by sending a SIP 4xx response to the originating party.</p> <ul style="list-style-type: none"> <li>■ [1] = The device sends a SIP 4xx response when the EnableEarlyMedia parameter is set to 0.</li> <li>■ [2] = The device always sends a SIP 4xx response, even if the EnableEarlyMedia parameter is set to 1.</li> </ul> <p><b>Note:</b> The parameter is applicable only to digital interfaces.</p>
<p>'Session-Expires Time'  <code>configure voip</code>  <code>&gt; sbc settings</code>  <code>&gt; session-  expires-time</code>  [SessionExpires]</p>	<p>Defines the numerical value sent in the Session-Expires header in the first SIP INVITE request or response (if the call is answered). The valid range is 1 to 86,400 sec. The default is 0 (i.e., the Session-Expires header is disabled).</p> <p><b>Note:</b> The parameter is applicable only to the Gateway application.</p>
<p>'Minimum Session-Expires'  <code>configure voip</code>  <code>&gt; sbc settings</code>  <code>&gt; min-session-  expires</code>  [MinSE]</p>	<p>Defines the time (in seconds) in the SIP Min-SE header. The header defines the minimum time that the user agent refreshes the session.</p> <p>The valid range is 10 to 100,000. The default is 90.</p> <p><b>Note:</b> The parameter is applicable only to the Gateway application.</p>
<p>'Session Expires Disconnect Time'  <code>configure voip</code>  <code>&gt; sip-  definitions  settings &gt;</code>  <code>sess-exp-disc-  time</code>  [SessionExpiresDisconnectTime]</p>	<p>Defines a session expiry timeout.</p> <p>The new session expiry timeout is calculated by subtracting the configured value from the original timeout as specified in the Session-Expires header. However, the new timeout must be greater than or equal to one-third (1/3) of the Session-Expires value. If the refresher does not send a refresh request within the new timeout, the device disconnects the session (i.e., sends a SIP BYE).</p> <p>For example, if you configure the parameter to 32 seconds and the Session-Expires value is 180 seconds, the session timeout occurs 148 seconds (i.e., 180 minus 32) after the last session refresh. If the Session-Expires header value is 90 seconds, the timeout occurs 60 seconds after the last refresh. This is because 90 minus 32 is 58 seconds, which is less than one third of the Session-Expires value (i.e., 60/3 is 30, and 90 minus 30 is 60).</p> <p>The valid range is 0 to 32 (in seconds). The default is 32.</p> <p><b>Note:</b> The parameter is applicable only to the Gateway</p>

Parameter	Description
	application.
<p>'Session Expires Method'</p> <pre>configure voip &gt; sip- definitions settings &gt; session-exp- method</pre> <p>[SessionExpiresMethod]</p>	<p>Defines the SIP method used for session-timer updates.</p> <ul style="list-style-type: none"> <li>■ [0] <b>Re-INVITE</b> = (Default) Uses re-INVITE messages for session-timer updates.</li> <li>■ [1] <b>UPDATE</b> = Uses UPDATE messages.</li> </ul> <p><b>Note:</b></p> <ul style="list-style-type: none"> <li>■ The parameter is applicable only to the Gateway application.</li> <li>■ The device can receive session-timer refreshes using both methods.</li> <li>■ The UPDATE message used for session-timer is excluded from the SDP body.</li> </ul>
<p>[RemoveToTagInFailureResponse]</p>	<p>Determines whether the device removes the 'to' header tag from final SIP failure responses to INVITE transactions.</p> <ul style="list-style-type: none"> <li>■ [0] = (Default) Do not remove tag.</li> <li>■ [1] = Remove tag.</li> </ul>
<p>[EnableRTCPAttribute]</p>	<p>Enables the use of the 'rtcp' attribute in the outgoing SDP.</p> <ul style="list-style-type: none"> <li>■ [0] = Disable (default)</li> <li>■ [1] = Enable</li> </ul> <p><b>Note:</b> The parameter is applicable only to the Gateway application.</p>
<p>[OPTIONSUserPart]</p>	<p>Defines the user part value of the Request-URI for outgoing SIP OPTIONS requests. If no value is configured, the endpoint number (analog) or configuration parameter 'Username' value (digital) is used.</p> <p>A special value is 'empty', indicating that no user part in the Request-URI (host part only) is used.</p> <p>The valid range is a 30-character string. By default, this value is not defined.</p>
<p>'Trunk Status Reporting Mode'</p> <pre>configure voip &gt; gw digitalgw digital-gw-</pre>	<p>Enables the device to not respond to received SIP OPTIONS messages from, and/or not to send keep-alive messages to, a proxy server associated with Trunk Group ID 1 if all its member trunks are down.</p> <ul style="list-style-type: none"> <li>■ [0] <b>Disable</b> = (Default) Device responds to SIP OPTIONS</li> </ul>

Parameter	Description
<pre>parameters &gt; trunk-status- reporting</pre> <p>[TrunkStatusReportingMode]</p>	<p>messages from, and sends keep-alive messages to, a proxy server associated with Trunk Group ID 1 if all its member trunks are down.</p> <ul style="list-style-type: none"> <li>■ [1] <b>Don't reply OPTIONS</b> = The device does not respond to SIP OPTIONS received from the proxy associated with Trunk Group 1 when all its trunks are down.</li> <li>■ [2] <b>Don't send Keep-Alive</b> = The device does not send keep-alive messages to the proxy associated with Trunk Group 1 when all its trunks are down.</li> <li>■ [3] <b>Don't Reply and Send</b> = Both options [1] and [2] are applied.</li> </ul> <p><b>Note:</b></p> <ul style="list-style-type: none"> <li>■ The parameter is applicable only to digital interfaces.</li> <li>■ When the parameter is set to not respond to SIP OPTIONS received from the proxy, it is applicable only if the OPTIONS message does not include a user part in the Request-URI.</li> <li>■ The proxy server is determined by the Proxy Set that is associated with the Serving IP Group of the Trunk Group in the Trunk Group Settings table.</li> </ul>
<p>'TDM Over IP Minimum Calls For Trunk Activation'</p> <p>[TDMOverIPMinCallsForTrunkActivation]</p>	<p>Defines the minimal number of SIP dialogs that must be established when using TDM Tunneling, for the specific trunk to be considered active.</p> <p>When using TDM Tunneling, if calls from this defined number of B-channels pertaining to a specific Trunk fail (i.e., SIP dialogs are not correctly set up), an AIS alarm is sent on this trunk toward the PSTN and all current calls are dropped. The originator gateway continues the INVITE attempts. When this number of calls succeed (i.e., SIP dialogs are correctly set up), the AIS alarm is cleared.</p> <p>The valid range is 0 to 31. The default is 0 (i.e., don't send AIS alarms).</p> <p><b>Note:</b> TDM Tunneling is applicable only to E1/T1 interfaces.</p>
<p>[TDMoIPInitiateInvite Time]</p>	<p>Defines the time (in msec) between the first INVITE issued within the same trunk when implementing the TDM tunneling application.</p> <p>The valid value range is 500 to 1,000. The default is 500.</p> <p><b>Note:</b> TDM Tunneling is applicable only to E1/T1 interfaces.</p>

Parameter	Description
[TDMoIPInviteRetryTime]	<p>Defines the time (in msec) between call release and a new INVITE when implementing the TDM tunneling application.</p> <p>The valid value range is 10,000 to 20,000. The default is 10,000.</p> <p><b>Note:</b> TDM Tunneling is applicable only to E1/T1 interfaces.</p>
'Fax Signaling Method' <code>fax-sig-method</code>  [IsFaxUsed]	<p>Global parameter defining the SIP signaling method for establishing and transmitting a fax session when the device detects a fax.</p> <p>You can also configure this feature per specific calls, using IP Profiles (IpProfile_IsFaxUsed) and Tel Profiles (TelProfile_IsFaxUsed). For a detailed description of the parameter, see <a href="#">Configuring IP Profiles</a> and <a href="#">Configuring Tel Profiles</a>.</p> <p><b>Note:</b> If this feature is configured for a specific IP Profile or Tel Profile, the settings of this global parameter is ignored for calls associated with the IP Profile or Tel Profile.</p>
<code>fax-vbd-behvr</code> [FaxVBDBehavior]	<p>Determines the device's fax transport behavior when G.711 VBD coder is negotiated at call start.</p> <ul style="list-style-type: none"> <li>■ [0] = (Default) If the device is configured with a VBD coder (see the CodersGroup parameter) and is negotiated OK at call start, then both fax and modem signals are sent over RTP using the bypass payload type (and no mid-call VBD or T.38 Re-INVITES occur).</li> <li>■ [1] = If the IsFaxUsed parameter is set to 1, the channel opens with the FaxTransportMode parameter set to 1 (relay). This is required to detect mid-call fax tones and to send T.38 Re-INVITE messages upon fax detection. If the remote party supports T.38, the fax is relayed over T.38.</li> </ul> <p><b>Note:</b></p> <ul style="list-style-type: none"> <li>■ If VBD coder negotiation fails at call start and if the IsFaxUsed parameter is set to 1 (or 3), then the channel opens with the FaxTransportMode parameter set to 1 (relay) to allow future detection of fax tones and sending of T.38 Re-INVITES. In such a scenario, the FaxVBDBehavior parameter has no effect.</li> <li>■ This feature can be used only if the remote party supports T.38 fax relay; otherwise, the fax fails.</li> </ul>
[NoAudioPayloadType]	<p>Defines the payload type of the outgoing SDP offer.</p> <p>The valid value range is 96 to 127 (dynamic payload type). The</p>

Parameter	Description
	<p>default is 0 (i.e. NoAudio is not supported). For example, if set to 120, the following is added to the INVITE SDP:</p> <pre>a=rtpmap:120 NoAudio/8000\r\n</pre> <p>Note: For incoming SDP offers, NoAudio is always supported.</p>
<p>'SIP Transport Type'</p> <pre>configure voip &gt; sip- definition settings &gt; app-sip- transport-type</pre> <p>[SIPTransportType]</p>	<p>Determines the default transport layer for outgoing SIP calls initiated by the device.</p> <ul style="list-style-type: none"> <li>■ [0] <b>UDP</b> (default)</li> <li>■ [1] <b>TCP</b></li> <li>■ [2] <b>TLS (SIPS)</b></li> </ul> <p><b>Note:</b></p> <ul style="list-style-type: none"> <li>■ It's recommended to use TLS for communication with a SIP Proxy and not for direct device-to-device communication.</li> <li>■ For received calls (i.e., incoming), the device accepts all these protocols.</li> </ul>
<p>'Display Default SIP Port'</p> <pre>configure voip &gt; sip- definition settings &gt; display- default-sip- port</pre> <p>[DisplayDefaultSIPPort]</p>	<p>Enables the device to add the default SIP port 5060 (UDP/TCP) or 5061 (TLS) to outgoing messages that are received without a port. This condition also applies to manipulated messages where the resulting message has no port number. The device adds the default port number to the following SIP headers: Request-Uri, To, From, P-Asserted-Identity, P-Preferred-Identity, and P-Called-Party-ID. If the message is received with a port number other than the default, for example, 5070, the port number is not changed.</p> <p>An example of a SIP From header with the default port is shown below:</p> <pre>From: &lt;sip:+4000@10.8.4.105:5060 ;user=phone&gt;;tag=f25419a96a;epid=009FAB8F3E</pre> <ul style="list-style-type: none"> <li>■ [0] <b>Disable</b> (default)</li> <li>■ [1] <b>Enable</b></li> </ul>
<p>'SIPS'</p> <pre>configure voip &gt; sip- definition settings &gt; enable-sips</pre>	<p>Enables secured SIP (SIPS URI) connections over multiple hops.</p> <ul style="list-style-type: none"> <li>■ [0] <b>Disable</b> (default)</li> <li>■ [1] <b>Enable</b></li> </ul> <p>When the SIPTransportType parameter is set to 2 (i.e., TLS) and the parameter EnableSIPS is disabled, TLS is used for the next</p>

Parameter	Description
[EnableSIPS]	<p>network hop only. When the parameter SIPTransportType is set to 2 or 1 (i.e., TCP or TLS) and EnableSIPS is enabled, TLS is used through the entire connection (over multiple hops).</p> <p><b>Note:</b> If the parameter is enabled and the parameter SIPTransportType is set to 0 (i.e., UDP), the connection fails.</p>
'TCP/TLS Connection Reuse' tcp-conn-reuse  [EnableTCPConnectionReuse]	<p>Enables the reuse of an established TCP or TLS connection between the device and a SIP user agent (UA) for subsequent SIP requests sent to the UA. Any new out-of-dialog requests (e.g., INVITE or REGISTER) use the same secured connection. One of the benefits of enabling the parameter is that it may improve performance by eliminating the need for additional TCP/TLS handshakes with the UA, allowing sessions to be established rapidly.</p> <ul style="list-style-type: none"> <li>■ [0] Disable = The device uses a new TCP or TLS connection with the UA.</li> <li>■ [1] Enable = (Default) The device uses the same TCP or TLS connection for all SIP requests with the UA.</li> </ul> <p><b>Note:</b></p> <ul style="list-style-type: none"> <li>■ For SIP responses, the device always uses the same TCP/TLS connection, regardless of the parameter settings.</li> </ul>
configure voip > sip- definition settings > fake-tcp-alias  [FakeTCPalias]	<p>Enables the re-use of the same TCP/TLS connection for sessions with the same user, even if the "alias" parameter is not present in the SIP Via header of the first INVITE.</p> <ul style="list-style-type: none"> <li>■ [0] <b>Disable</b> = (Default) TCP/TLS connection reuse is done only if the "alias" parameter is present in the Via header of the first INVITE (according to RFC 5923).</li> <li>■ [1] <b>Enable</b></li> </ul> <p><b>Note:</b> To enable TCP/TLS connection re-use, set the [EnableTCPConnectionReuse] parameter to 1.</p>
'Reliable Connection Persistent Mode'  configure voip > sip- definition settings > reliable-conn- persistent	<p>Enables setting of all TCP/TLS connections as persistent and therefore, not released.</p> <ul style="list-style-type: none"> <li>■ [0] <b>Disable</b> = (Default) All TCP connections (except those that are set to a proxy IP) are released if not used by any SIP dialog\transaction.</li> <li>■ [1] <b>Enable</b> = TCP connections to all destinations are persistent and not released unless the device reaches 70% of</li> </ul>



Parameter	Description
[ReliableConnectionPersistentMode]	<p>its maximum TCP resources.</p> <p>While trying to send a SIP message connection, reuse policy determines whether live connections to the specific destination are re-used.</p> <p>Persistent TCP connection ensures less network traffic due to fewer setting up and tearing down of TCP connections and reduced latency on subsequent requests due to avoidance of initial TCP handshake. For TLS, persistent connection may reduce the number of costly TLS handshakes to establish security associations, in addition to the initial TCP connection set up.</p> <p><b>Note:</b> If the destination is a Proxy server, the TCP/TLS connection is persistent regardless of the settings of the parameter.</p>
'TCP Timeout' <pre>configure voip &gt; sip- definition settings &gt; tcp-timeout [SIPTCPTimeout]</pre>	<p>Defines the Timer B (INVITE transaction timeout timer) and Timer F (non-INVITE transaction timeout timer), as defined in RFC 3261, when the SIP transport type is TCP.</p> <p>The valid range is 0 to 60 sec. The default is 64 * the value of the [SipT1Rtx] parameter. For example, if you configure [SipT1Rtx] to 500 msec, the default of [SIPTCPTimeout] is 32 sec.</p>
'SIP Destination Port' <pre>configure voip &gt; sip- definition settings &gt; sip-dst-port [SIPDestinationPort]</pre>	<p>Defines the SIP destination port for sending initial SIP requests.</p> <p>The valid range is 1 to 65534. The default port is 5060.</p> <p><b>Note:</b> SIP responses are sent to the port specified in the Via header.</p>
'Use user=phone in SIP URL' <pre>configure voip &gt; sip- definition settings &gt; user=phone-in- url [IsUserPhone]</pre>	<p>Defines if the 'user=phone' string is added to the SIP URI and SIP To header.</p> <ul style="list-style-type: none"> <li>■ [0] No</li> <li>■ [1] Yes (default)</li> </ul> <p><b>Note:</b> The parameter is applicable only to the Gateway application.</p>
'Use user=phone in From Header'	<p>Defines if the 'user=phone' string is added to the From and Contact SIP headers.</p>

Parameter	Description
<pre>configure voip &gt; sip- definition settings &gt; phone-in-from- hdr [IsUserPhoneInFrom]</pre>	<ul style="list-style-type: none"> <li>■ [0] <b>No</b> (default)</li> <li>■ [1] <b>Yes</b></li> </ul>
<pre>'Use Tel URI for Asserted Identity' configure voip &gt; sip- definition settings &gt; uri-for- assert-id [UseTelURIForAsserte dID]</pre>	<p>Defines the format of the URI in the P-Asserted-Identity and P-Preferred-Identity headers.</p> <ul style="list-style-type: none"> <li>■ [0] <b>Disable</b> = (Default) The format is 'sip:'.</li> <li>■ [1] <b>Enable</b> = The format is 'tel:'.</li> </ul>
<pre>configure voip &gt; sip- definition settings &gt; p- preferred-id- list [PPreferredIdListMod e]</pre>	<p>Defines the number of P-Preferred-Identity SIP headers included in the outgoing SIP message when the header contains multiple values.</p> <ul style="list-style-type: none"> <li>■ [0] = (Default) The device includes multiple P-Preferred-Identity SIP headers in the outgoing message, for example: <ul style="list-style-type: none"> <li>✓ Incoming message containing a P-Preferred-Identity header with multiple values: <div style="border: 1px solid #ccc; border-radius: 10px; padding: 10px; margin: 10px 0; background-color: #f9f9f9;"> P-Preferred-Identity: &lt;sip:someone@test.org&gt;,&lt;tel:+123456789&gt; </div> </li> <li>✓ Outgoing message sent with multiple P-Preferred-Identity headers, each with a value: <div style="border: 1px solid #ccc; border-radius: 10px; padding: 10px; margin: 10px 0; background-color: #f9f9f9;"> P-Preferred-Identity: &lt;sip:someone@test.org&gt; P-Preferred-Identity: &lt;tel:+123456789&gt; </div> </li> </ul> </li> <li>■ [1] = The device includes only one P-Preferred-Identity header in the outgoing message, for example: <ul style="list-style-type: none"> <li>✓ Incoming message containing multiple P-Preferred-Identity headers:</li> </ul> </li> </ul>

Parameter	Description
	<div style="border: 1px solid #ccc; padding: 10px; margin-bottom: 10px;">           P-Preferred-Identity:            &lt;sip:someone@test.org&gt;            P-Preferred-Identity: &lt;tel:+123456789&gt;         </div> <p>✓ Outgoing message sent with a single P-Preferred-Identity header containing the multiple values:</p> <div style="border: 1px solid #ccc; padding: 10px; margin-bottom: 10px;">           P-Preferred-Identity:            &lt;sip:someone@test.org&gt;,&lt;tel:+123456789&gt;         </div> <p><b>Note:</b></p> <ul style="list-style-type: none"> <li>■ If more than two P-Preferred-Identity headers are received in the incoming message, the device keeps the first two headers (if configured to 0) or the first header (if configured to 1), and removes the others in the outgoing message.</li> <li>■ The parameter is applicable only to the SBC application.</li> </ul>
<p>'Tel to IP No Answer Timeout'</p> <pre>configure voip &gt; gateway advanced &gt; tel2ip-no-ans- timeout [IPAlertTimeout]</pre>	<p>Defines the time (in seconds) that the device waits for a 200 OK response from the called party (IP side) after sending an INVITE message, for Tel-to-IP calls. If the timer expires, the call is released.</p> <p>The valid range is 0 to 3600. The default is 180.</p>
<p>'Remote Party ID'</p> <pre>configure voip &gt; sip- definition settings &gt; remote-party- id [EnableRPIheader]</pre>	<p>Enables Remote-Party-Identity headers for calling and called numbers for Tel-to-IP calls.</p> <ul style="list-style-type: none"> <li>■ [0] <b>Disable</b> (default).</li> <li>■ [1] <b>Enable</b> = Remote-Party-Identity headers are generated in SIP INVITE messages for both called and calling numbers.</li> </ul>
<p>'History-Info Header'</p> <pre>configure voip &gt; sip- definition settings &gt; hist-info-hdr</pre>	<p>Enables usage of the SIP History-Info header.</p> <ul style="list-style-type: none"> <li>■ [0] <b>Disable</b> (default)</li> <li>■ [1] <b>Enable</b></li> </ul> <p>User Agent Client (UAC) Behavior:</p>

Parameter	Description												
[EnableHistoryInfo]	<ul style="list-style-type: none"> <li>■ Initial request: The History-Info header is equal to the Request-URI. If a PSTN Redirect number is received, it is added as an additional History-Info header with an appropriate reason.</li> <li>■ Upon receiving the final failure response, the device copies the History-Info as is, adds the reason of the failure response to the last entry, and concatenates a new destination to it (if an additional request is sent). The order of the reasons is as follows:               <ol style="list-style-type: none"> <li>a. Q.850 Reason</li> <li>b. SIP Reason</li> <li>c. SIP Response code</li> </ol> </li> <li>■ Upon receiving the final response (success or failure), the device searches for a Redirect reason in the History-Info (i.e., 3xx/4xx SIP reason). If found, it is passed to ISDN according to the following table:               <table border="1" data-bbox="616 1025 1391 1615" style="margin: 10px auto;"> <thead> <tr> <th>SIP Reason Code</th> <th>ISDN Redirecting Reason</th> </tr> </thead> <tbody> <tr> <td>302 - Moved Temporarily</td> <td>Call Forward Universal (CFU)</td> </tr> <tr> <td>408 - Request Timeout</td> <td>Call Forward No Answer (CFNA)</td> </tr> <tr> <td>480 - Temporarily Unavailable</td> <td rowspan="3">Call Forward Busy (CFB)</td> </tr> <tr> <td>487 - Request Terminated</td> </tr> <tr> <td>486 - Busy Here</td> </tr> <tr> <td>600 - Busy Everywhere</td> <td></td> </tr> </tbody> </table> </li> </ul> <p>■ If history reason is a Q.850 reason, it is translated to the SIP reason (according to the SIP-ISDN tables) and then to ISDN Redirect reason according to the table above.</p> <p>User Agent Server (UAS) Behavior:</p> <ul style="list-style-type: none"> <li>■ The History-Info header is sent only in the final response.</li> <li>■ Upon receiving a request with History-Info, the UAS checks the policy in the request. If a 'session', 'header', or 'history'</li> </ul>	SIP Reason Code	ISDN Redirecting Reason	302 - Moved Temporarily	Call Forward Universal (CFU)	408 - Request Timeout	Call Forward No Answer (CFNA)	480 - Temporarily Unavailable	Call Forward Busy (CFB)	487 - Request Terminated	486 - Busy Here	600 - Busy Everywhere	
SIP Reason Code	ISDN Redirecting Reason												
302 - Moved Temporarily	Call Forward Universal (CFU)												
408 - Request Timeout	Call Forward No Answer (CFNA)												
480 - Temporarily Unavailable	Call Forward Busy (CFB)												
487 - Request Terminated													
486 - Busy Here													
600 - Busy Everywhere													

Parameter	Description
	<p>policy tag is found, the (final) response is sent without History-Info; otherwise, it is copied from the request.</p> <p><b>Note:</b> The parameter is applicable only to digital interfaces.</p>
<p>'Use Tgrp Information'</p> <pre>configure voip &gt; sip- definition settings &gt; use-tgrp-inf [UseSIPtgrp]</pre>	<p>Enables the use of the SIP 'tgrp' parameter. This parameter specifies the Trunk Group to which the call belongs (according to RFC 4904). For example, the SIP message below indicates that the call belongs to Trunk Group ID 1:</p> <pre>INVITE sip::+16305550100;tgrp=1;trunk- context=example.com@10.1.0.3;user=phone SIP/2.0</pre> <ul style="list-style-type: none"> <li>■ [0] <b>Disable</b> = (Default) The 'tgrp' parameter isn't used.</li> <li>■ [1] <b>Send Only</b> = The Trunk Group number or name (configured in the Trunk Group Settings table) is added to the 'tgrp' parameter value in the Contact header of outgoing SIP messages. If a Trunk Group number / name is not associated with the call, the 'tgrp' parameter isn't included. If a 'tgrp' value is specified in incoming messages, it is ignored.</li> <li>■ [2] <b>Send and Receive</b> = The functionality of outgoing SIP messages is identical to the functionality described for option [1]. In addition, for incoming SIP INVITEs (IP-to-Tel), if the Request-URI includes a 'tgrp' parameter, the device routes the call according to that value (if possible). The Contact header in the outgoing SIP INVITE (Tel-to-IP call) contains "tgrp=&lt;source trunk group ID&gt;;trunk-context=&lt;gateway IP address&gt;". The &lt;source trunk group ID&gt; is the Trunk Group ID where incoming calls from Tel is received. For IP-to-Tel calls, the SIP 200 OK device's response contains "tgrp=&lt;destination trunk group ID&gt;;trunk-context=&lt;gateway IP address&gt;". The &lt;destination trunk group ID&gt; is the Trunk Group ID used for outgoing Tel calls. You can configure the &lt;gateway IP address&gt; in "trunk-context", using the [SIPGatewayName] parameter.</li> <li>■ [3] <b>Hotline</b> = Interworks the hotline "Off Hook Indicator" parameter between SIP and ISDN. This option is applicable only to digital interfaces. <ul style="list-style-type: none"> <li>✓ IP-to-ISDN calls: <ul style="list-style-type: none"> <li>- The device interworks the SIP tgrp=hotline parameter (received in INVITE) to ISDN Setup with the Off Hook Indicator IE of "Voice", and "Speech" Bearer Capability</li> </ul> </li> </ul> </li> </ul>

Parameter	Description
	<p>IE. Note that the Off Hook Indicator IE is described in UCR 2008 specifications.</p> <ul style="list-style-type: none"> <li>- The device interworks the SIP tgrp=hotline-ccdata parameter (received in INVITE) to ISDN Setup with an Off Hook Indicator IE of "Data", and with "Unrestricted 64k" Bearer Capability IE. The following is an example of the INVITE with tgrp=hotline-ccdata:</li> </ul> <pre data-bbox="620 577 1347 651">INVITE sip:1234567;tgrp=hotline-ccdata;trunk-context=dsn.mil@example.com</pre> <ul style="list-style-type: none"> <li> <span style="color: blue;">✔</span> ISDN-to-IP calls:           <ul style="list-style-type: none"> <li>- The device interworks ISDN Setup with an Off Hook Indicator of "Voice" to SIP INVITE with "tgrp=hotline;trunk-context=dsn.mil" in the Contact header.</li> <li>- The device interworks ISDN Setup with an Off Hook indicator of "Data" to SIP INVITE with "tgrp=hotline-ccdata;trunk-context=dsn.mil" in the Contact header.</li> <li>- If ISDN Setup does not contain an Off Hook Indicator IE and the Bearer Capability IE contains "Unrestricted 64k", the outgoing INVITE includes "tgrp=ccdata;trunk-context=dsn.mil". If the Bearer Capability IE contains "Speech", the INVITE in this case does not contain tgrp and trunk-context parameters.</li> </ul> </li> <li> <span style="color: blue;">■</span> [4] <b>Hotline Extended</b> = Interworks the ISDN Setup message's hotline "OffHook Indicator" Information Element (IE) to SIP INVITE's Request-URI and Contact headers. (Note: For IP-to-ISDN calls, the device handles the call as described in option [3].) This option is applicable only to digital interfaces.           <ul style="list-style-type: none"> <li> <span style="color: blue;">✔</span> The device interworks ISDN Setup with an Off Hook Indicator of "Voice" to SIP INVITE Request-URI and Contact header with "tgrp=hotline;trunk-context=dsn.mil".               </li> <li> <span style="color: blue;">✔</span> The device interworks ISDN Setup with an Off Hook indicator of "Data" to SIP INVITE Request-URI and Contact header with "tgrp=hotline-ccdata;trunk-context=dsn.mil".               </li> <li> <span style="color: blue;">✔</span> If ISDN Setup does not contain an Off Hook Indicator IE and the Bearer Capability IE contains "Unrestricted 64k", the outgoing INVITE Request-URI and Contact header includes "tgrp=ccdata;trunk-context=dsn.mil". If the             </li> </ul> </li> </ul>

Parameter	Description
	<p>Bearer Capability IE contains “Speech”, the INVITE in this case does not contain tgrp and trunk-context parameters.</p> <p><b>Note:</b> IP-to-Tel configuration (using the PSTNPrefix parameter) overrides the 'tgrp' parameter in incoming INVITE messages.</p>
<pre>configure voip &gt; gateway routing settings &gt; tgrp-routing- prec [TGRProuingPrecedence]</pre>	<p>Determines the precedence method for routing IP-to-Tel calls - according to the IP-to-Tel Routing table or according to the SIP 'tgrp' parameter.</p> <ul style="list-style-type: none"> <li>■ [0] = (Default) IP-to-Tel routing is determined by the IP-to-Tel Routing table (PSTNPrefix parameter). If a matching rule is not found in this table, the device uses the Trunk Group parameters for routing the call.</li> <li>■ [1] = The device first places precedence on the 'tgrp' parameter for IP-to-Tel routing. If the received INVITE Request-URI does not contain the 'tgrp' parameter or if the Trunk Group number is not defined, the IP-to-Tel Routing table is used for routing the call.</li> </ul> <p>Below is an example of an INVITE Request-URI with the 'tgrp' parameter, indicating that the IP call should be routed to Trunk Group 7:</p> <pre>INVITE sip:200;tgrp=7;trunk- context=example.com@10.33.2.68;user=phone SIP/2.0</pre> <p><b>Note:</b></p> <ul style="list-style-type: none"> <li>■ For enabling routing based on the 'tgrp' parameter, the UseSIPTrgp parameter must be set to 2.</li> <li>■ For IP-to-Tel routing based on the 'dtg' parameter (instead of the 'tgrp' parameter), use the parameter UseBroadsoftDTG.</li> </ul>
<pre>configure voip &gt; sip- definition settings &gt; use-dtg [UseBroadsoftDTG]</pre>	<p>Determines whether the device uses the 'dtg' parameter for routing IP-to-Tel calls to a specific Trunk Group.</p> <ul style="list-style-type: none"> <li>■ [0] = Disable (default)</li> <li>■ [1] = Enable</li> </ul> <p>When the parameter is enabled, if the Request-URI in the received SIP INVITE includes the 'dtg' parameter, the device routes the call to the Trunk Group according to its value. The parameter is used instead of the 'tgrp/trunk-context' parameters. The 'dtg' parameter appears in the INVITE Request-</p>

Parameter	Description
	<p>URI (and in the To header).</p> <p>For example, the received SIP message below routes the call to Trunk Group ID 56:</p> <pre>INVITE sip:123456@192.168.1.2;dtg=56;user=phone SIP/2.0</pre> <p><b>Note:</b> If the Trunk Group is not found based on the 'dtg' parameter, the IP-to-Tel Routing table is used instead for routing the call to the appropriate Trunk Group.</p>
<p>'GRUU'</p> <pre>configure voip &gt; sbc settings &gt; enable-gruu [EnableGRUU]</pre>	<p>Determines whether the Globally Routable User Agent URIs (GRUU) mechanism is used, according to RFC 5627. This is used for obtaining a GRUU from a registrar and for communicating a GRUU to a peer within a dialog.</p> <ul style="list-style-type: none"> <li>■ [0] <b>Disable</b> (default)</li> <li>■ [1] <b>Enable</b></li> </ul> <p>A GRUU is a SIP URI that routes to an instance-specific UA and can be reachable from anywhere. There are a number of contexts in which it is desirable to have an identifier that addresses a single UA (using GRUU) rather than the group of UA's indicated by an Address of Record (AOR). For example, in call transfer where user A is talking to user B, and user A wants to transfer the call to user C. User A sends a REFER to user C:</p> <pre>REFER sip:C@domain.com SIP/2.0 From: sip:A@domain.com;tag=99asd To: sip:C@domain.com Refer-To: (URI that identifies B's UA)</pre> <p>The Refer-To header needs to contain a URI that user C can use to place a call to user B. This call needs to route to the specific UA instance that user B is using to talk to user A. User B should provide user A with a URI that has to be usable by anyone. It needs to be a GRUU.</p> <ul style="list-style-type: none"> <li>■ Obtaining a GRUU: The mechanism for obtaining a GRUU is through registrations. A UA can obtain a GRUU by generating a REGISTER request containing a Supported header field with the value "gruu". The UA includes a "+sip.instance" Contact header parameter of each contact for which the GRUU is desired. This Contact parameter contains a globally unique ID that identifies the UA instance. The global unique ID is created from one of the following:</li> </ul>



Parameter	Description
	<ul style="list-style-type: none"> <li>✓ If the REGISTER is per the device's client (endpoint), it is the MAC address concatenated with the phone number of the client.</li> <li>✓ If the REGISTER is per device, it is the MAC address only.</li> <li>✓ When using TP, "User Info" can be used for registering per endpoint. Thus, each endpoint can get a unique id – its phone number. The globally unique ID in TP is the MAC address concatenated with the phone number of the endpoint.</li> </ul> <p>If the remote server doesn't support GRUU, it ignores the parameters of the GRUU. Otherwise, if the remote side also supports GRUU, the REGISTER responses contain the "gruu" parameter in each Contact header. The parameter contains a SIP or SIPS URI that represents a GRUU corresponding to the UA instance that registered the contact. The server provides the same GRUU for the same AOR and instance-id when sending REGISTER again after registration expiration. RFC 5627 specifies that the remote target is a GRUU target if its' Contact URL has the "gr" parameter with or without a value.</p> <ul style="list-style-type: none"> <li>■ Using GRUU: The UA can place the GRUU in any header field that can contain a URI. It must use the GRUU in the following messages: INVITE request, its 2xx response, SUBSCRIBE request, its 2xx response, NOTIFY request, REFER request and its 2xx response.</li> </ul>
[IsCiscoSCEMode]	<p>Determines whether a Cisco gateway exists at the remote side.</p> <ul style="list-style-type: none"> <li>■ [0] = (Default) No Cisco gateway exists at the remote side.</li> <li>■ [1] = A Cisco gateway exists at the remote side.</li> </ul> <p>When a Cisco gateway exists at the remote side, the device must set the value of the 'annexb' parameter of the fmp attribute in the SDP to 'no'. This logic is used if the coder is enabled for Silenced Suppression. In this case, Silence Suppression is used on the channel but not declared in the SDP.</p> <p><b>Note:</b></p> <ul style="list-style-type: none"> <li>■ The parameter is applicable only to the Gateway application.</li> <li>■ The IsCiscoSCEMode parameter is applicable only when the selected coder is G.729.</li> </ul>
'User-Agent	Defines the string that is used in the SIP User-Agent and Server

Parameter	Description
<pre>Information' configure voip &gt; sip- definition settings &gt; user-agent- info [UserAgentDisplayInfo]</pre>	<p>response headers. When configured, the string <code>&lt;UserAgentDisplayInfo value&gt;/software version'</code> is used, for example:</p> <pre>User-Agent: myproduct/7.20A.260.005</pre> <p>If not configured, the default string, "<code>&lt;product-name&gt;/&lt;&lt;software version&gt;&gt;</code>" is used, for example:</p> <pre>User-Agent: AudioCodes-Sip-Gateway/&lt;swver&gt;</pre> <p>The maximum string length is 50 characters.</p> <p><b>Note:</b> The software version number and preceding forward slash (/) cannot be modified. Therefore, it is recommended not to include a forward slash in the parameter's value (to avoid two forward slashes in the SIP header, which may cause problems).</p>
<pre>'SDP Session Owner' configure voip &gt; sip- definition settings &gt; sdp-session- owner [SIPSDPSessionOwner]</pre>	<p>Defines the value of the Owner line ('o' field) in outgoing SDP messages.</p> <p>The valid range is a string of up to 39 characters. The default is "AudioCodesGW".</p> <p>For example:</p> <pre>o=AudioCodesGW 1145023829 1145023705 IN IP4 10.33.4.126</pre> <p><b>Note:</b> The parameter is applicable only to the SBC application when the device creates a new SIP message (and SDP) such as when the device plays a ringback tone. The parameter is not applicable to SIP messages that the device receives from one end and sends to another (i.e., does not modify the SDP's 'o' field).</p>
<pre>configure voip &gt; sip- definition settings &gt; sdp-ver-nego [EnableSDPVersionNegotiation]</pre>	<p>Enables the device to ignore new SDP re-offers (from the media negotiation perspective) in certain scenarios (such as session expires). According to RFC 3264, once an SDP session is established, a new SDP offer is considered a new offer only when the SDP origin value is incremented. In scenarios such as session expires, SDP negotiation is irrelevant and thus, the origin field is not changed.</p> <p>Even though some SIP devices don't follow this behavior and don't increment the origin value even in scenarios where they want to re-negotiate, the device can assume that the remote party operates according to RFC 3264, and in cases where the origin field is not incremented, the device does not re-negotiate SDP capabilities.</p> <ul style="list-style-type: none"> <li>■ [0] Disable = (Default) The device negotiates any new SDP re-offer, regardless of the origin field.</li> </ul>

Parameter	Description
	<ul style="list-style-type: none"> <li>■ [1] Enable = The device negotiates only an SDP re-offer with an incremented origin field.</li> </ul>
[GwSDPConnectionMode]	<p>Defines how the device displays the Connection ("c=") line ("c=") in the SDP Offer/Answer model.</p> <ul style="list-style-type: none"> <li>■ [0] = (Default) The Connection ("c=") line is displayed as follows: <ul style="list-style-type: none"> <li>✓ Offer: In the session description only.</li> <li>✓ Answer: In the session description and in each media ("m=") description.</li> </ul> </li> <li>■ [1] = For Offer and Answer, the Connection ("c=") line is displayed only in the session description; not in any media ("m=") descriptions.</li> <li>■ [2] = The Connection ("c=") line is displayed only in media ("m=") descriptions.</li> </ul> <p><b>Note:</b> The parameter is applicable only to the Gateway application.</p>
'Subject' configure voip > sip- definition settings > usr-def- subject [SIPSubject]	<p>Defines the Subject header value in outgoing INVITE messages. If not specified, the Subject header isn't included (default). The maximum length is up to 50 characters.</p>
configure voip > sip- definition settings > coder- priority-nego [CoderPriorityNegotiation]	<p>Defines the priority for coder negotiation in the incoming SDP offer, between the device's or remote UA's coder list.</p> <ul style="list-style-type: none"> <li>■ [0] = (Default) Coder negotiation is given higher priority to the remote UA's list of supported coders.</li> <li>■ [1] = Coder negotiation is given higher priority to the device's (local) supported coders list.</li> </ul> <p><b>Note:</b> The parameter is applicable only to the Gateway application.</p>
'Send All Coders on Retrieve' configure voip	<p>Enables coder re-negotiation in the sent re-INVITE for retrieving an on-hold call.</p> <ul style="list-style-type: none"> <li>■ [0] <b>Disable</b> = (Default) Sends only the initially chosen coder</li> </ul>

Parameter	Description
<pre>&gt; gateway dtmf-supp- service supp- service- settings &gt; send-all-cdrs- on-rtrv [SendAllCodersOnRet rieve]</pre>	<p>when the call was first established and then put on-hold.</p> <ul style="list-style-type: none"> <li>■ [1] <b>Enable</b> = Includes all supported coders in the SDP of the re-INVITE sent to the call made un-hold (retrieved). The used coder is therefore, re-negotiated.</li> </ul> <p>The parameter is useful in the following call scenario example:</p> <ol style="list-style-type: none"> <li>1. Party A calls party B and coder G.711 is chosen.</li> <li>2. Party B is put on-hold while Party A blind transfers Party B to Party C.</li> <li>3. Party C answers and Party B is made un-hold. However, as Party C supports only G.729 coder, re-negotiation of the supported coder is required.</li> </ol> <p><b>Note:</b> The parameter is applicable only to the Gateway application.</p>
<pre>'Multiple Packetization Time Format' configure voip &gt; sip- definition settings &gt; mult-ptime- format [MultiPtimeFormat]</pre>	<p>Determines whether the 'mptime' attribute is included in the outgoing SDP.</p> <ul style="list-style-type: none"> <li>■ [0] <b>None</b> = (Default) Disabled.</li> <li>■ [1] <b>PacketCable</b> = Includes the 'mptime' attribute in the outgoing SDP - PacketCable-defined format.</li> </ul> <p>The 'mptime' attribute enables the device to define a separate packetization period for each negotiated coder in the SDP. The 'mptime' attribute is only included if the parameter is enabled even if the remote side includes it in the SDP offer. Upon receipt, each coder receives its 'ptime' value in the following precedence: from 'mptime' attribute, from 'ptime' attribute, and then from default value.</p>
<pre>configure voip &gt; sip- definition settings &gt; enable-ptime [EnablePtime]</pre>	<p>Determines whether the 'ptime' attribute is included in the SDP.</p> <ul style="list-style-type: none"> <li>■ [0] = Remove the 'ptime' attribute from SDP.</li> <li>■ [1] = (Default) Include the 'ptime' attribute in SDP.</li> </ul>
<pre>'3xx Behavior' 3xx-behavior [3xxBehavior]</pre>	<p>Determines the device's behavior regarding call identifiers when a 3xx response is received for an outgoing INVITE request. The device can use the same call identifiers (Call-ID, To, and From tags) or change them in the new initiated INVITE.</p> <ul style="list-style-type: none"> <li>■ [0] <b>Forward</b> = (Default) Use different call identifiers for a</li> </ul>

Parameter	Description
	<p>redirected INVITE message.</p> <ul style="list-style-type: none"> <li>■ [1] <b>Redirect</b> = Use the same call identifiers in the new INVITE as the original call.</li> </ul>
<p>'P-Charging Vector' p-charging- vector [EnablePChargingVect or]</p>	<p>Enables the inclusion of the P-Charging-Vector header to all outgoing INVITE messages.</p> <ul style="list-style-type: none"> <li>■ [0] <b>Disable</b> (default)</li> <li>■ [1] <b>Enable</b></li> </ul> <p><b>Note:</b> The parameter is applicable only to the Gateway application.</p>
<p>[RetryAfterMode]</p>	<p>Defines the device's behavior when it receives a SIP 503 (Service Unavailable) containing a Retry-After header, in response to a SIP message (e.g., REGISTER) sent to the proxy server.</p> <p>In certain scenarios (depending on the value of this parameter), the device considers the proxy as offline (down) for the number of seconds specified in the Retry-After header. During this timeout, the device does not send any SIP messages to the proxy. This condition is indicated in the Syslog message as "server is now Unavailable - setting Retry-After timer to x secs".</p> <ul style="list-style-type: none"> <li>■ [1] = (Default) Handle Locally. The device considers the proxy as offline regardless of the type of SIP message sent to the proxy for which the 503 response was received.</li> <li>■ [0] = Transparent. The behavior depends on the type of SIP message sent to the proxy for which the 503 response was received: <ul style="list-style-type: none"> <li>✓ SIP OPTIONS message: The device considers the proxy as offline.</li> <li>✓ SIP REGISTER message generated (created) by the device: The device does not send REGISTER messages to the proxy for this <b>specific</b> registration process (i.e., Accounts table or User Information table) during the timeout specified in the Retry-After header of the 503 response. However, the device considers the proxy as online and therefore, it continues sending traffic of other entities to the proxy.</li> <li>✓ All other SIP dialogs (e.g., INVITE): The device ignores the Retry-After header and forwards the 503 response transparently to the other user agent.</li> </ul> </li> </ul>

Parameter	Description
<p>'Retry-After Time'</p> <pre>configure voip &gt; sip- definition settings &gt; retry-aftr- time</pre> <p>[RetryAfterTime]</p>	<p>Defines the time (in seconds) used in the Retry-After header when a 503 (Service Unavailable) response is generated by the device.</p> <p>The time range is 0 to 3,600. The default is 0.</p>
<p>'Fake Retry After'</p> <pre>fake-retry- after</pre> <p>[FakeRetryAfter]</p>	<p>Determines whether the device, upon receipt of a SIP 503 response without a Retry-After header, behaves as if the 503 response included a Retry-After header and with the period (in seconds) specified by the parameter.</p> <ul style="list-style-type: none"> <li>■ [0] Disable (default)</li> <li>■ Any positive value (in seconds) for defining the period</li> </ul> <p>When enabled, this feature allows the device to operate with Proxy servers that do not include the Retry-After SIP header in SIP 503 (Service Unavailable) responses to indicate an unavailable service.</p> <p>The Retry-After header is used with the 503 (Service Unavailable) response to indicate how long the service is expected to be unavailable to the requesting SIP client. The device maintains a list of available proxies, by using the Keep-Alive mechanism. The device checks the availability of proxies by sending SIP OPTIONS every keep-alive timeout to all proxies.</p> <p>If the device receives a SIP 503 response to an INVITE, it also marks that the proxy is out of service for the defined "Retry-After" period.</p>
<p>'P-Associated-URI Header'</p> <pre>p-associated- uri-hdr</pre> <p>[EnablePAssociatedURIHeader]</p>	<p>Determines the device usage of the P-Associated-URI header. This header can be received in 200 OK responses to REGISTER requests. When enabled, the first URI in the P-Associated-URI header is used in subsequent requests as the From/P-Asserted-Identity headers value.</p> <ul style="list-style-type: none"> <li>■ [0] <b>Disable</b> (default)</li> <li>■ [1] <b>Enable</b></li> </ul> <p><b>Note:</b> P-Associated-URIs in registration responses is handled only if the device is registered per endpoint (using the User Information file).</p>

Parameter	Description
<pre>configure voip &gt; gateway digital settings &gt; format-dst- phone-number [FormatDestPhoneNu mber]</pre>	<p>Defines if the destination phone number that the device sends to the Tel side (for IP-to-Tel calls), includes the user-part parameters (e.g., 'password' and 'phone-context') of the destination URI received in the incoming SIP INVITE message.</p> <ul style="list-style-type: none"> <li>■ [0] = (Transparent) The device includes the user-part parameters (if exist) in the destination phone number sent to the Tel side.</li> <li>■ [1] = (Default) The device excludes the user-part parameters and letters (if exist) from the destination phone number sent to the Tel side.</li> </ul> <p><b>Note:</b> The parameter is applicable only to the Gateway application.</p>
<p>'Source Number Preference'</p> <pre>configure voip &gt; sip- definition settings &gt; src-nb- preference [SourceNumberPrefer ence]</pre>	<p>Defines the SIP header from which the source (calling) number is obtained in incoming INVITE messages.</p> <ul style="list-style-type: none"> <li>■ If not configured or if any string other than "From" or "Pai2" is configured, the calling number is obtained from a specific header using the following logic: <ol style="list-style-type: none"> <li>a. P-Preferred-Identity header.</li> <li>b. If the above header is not present, then the first P-Asserted-Identity header is used.</li> <li>c. If the above header is not present, then the Remote-Party-ID header is used.</li> <li>d. If the above header is not present, then the From header is used.</li> </ol> </li> <li>■ <b>"From"</b> = The calling number is obtained from the From header.</li> <li>■ <b>"Pai2"</b> = The calling number is obtained using the following logic: <ol style="list-style-type: none"> <li>e. If a P-Preferred-Identity header is present, the number is obtained from it.</li> <li>f. If no P-Preferred-Identity header is present and two P-Asserted-Identity headers are present, the number is obtained from the second P-Asserted-Identity header.</li> <li>g. If only one P-Asserted-Identity header is present, the calling number is obtained from it.</li> </ol> </li> </ul> <p><b>Note:</b></p>

Parameter	Description
	<ul style="list-style-type: none"> <li>■ The "From" and "Pai2" values are not case-sensitive.</li> <li>■ Once a URL is selected, all the calling party parameters are set from this header. If P-Asserted-Identity is selected and the Privacy header has the value 'id', the calling number is assumed restricted.</li> </ul>
<pre>configure voip &gt; sip- definition settings &gt; sec-call-src [SecondCallingNumberSource]</pre>	<p>Defines if the device sends a second source (calling) number, obtained from the incoming SIP INVITE message, to the Tel side. The valid value is "P-Asserted" (without quotation marks). By default, no value is defined.</p> <p>If the parameter is not configured to any value (i.e., default) or configured to any value other than "P-Asserted", the device doesn't send a second source number. If the parameter is configured to "P-Asserted" and the incoming INVITE message contains a P-Asserted-Identity header(s), the device sends a second source number that is obtained from the first listed P-Asserted-Identity header in the message. If the message doesn't include a P-Asserted-Identity header, the device sends a second source number that it obtains from the first source number (i.e., same number).</p> <p><b>Note:</b> The parameter is applicable only to the Gateway application.</p>
<p>'Source Header For Called Number'</p> <pre>configure voip &gt; sip- definition settings &gt; src-hdr-4- called-nb [SelectSourceHeaderForCalledNumber]</pre>	<p>Defines the SIP header from which the called (destination) number is obtained for IP-to-Tel calls.</p> <ul style="list-style-type: none"> <li>■ [0] <b>use RequestURI header</b> = (Default) Obtains the destination number from the user part of the Request-URI.</li> <li>■ [1] <b>use To header</b> = Obtains the destination number from the user part of the To header.</li> <li>■ [2] <b>use P-Called-Party-ID header</b> = Obtains the destination number from the P-Called-Party-ID header.</li> </ul> <p><b>Note:</b> The parameter is applicable only to the Gateway application.</p>
<p>'Reason Header'</p> <pre>configure voip &gt; sip- definition settings &gt; reason-header</pre>	<p>Enables the usage of the SIP Reason header.</p> <ul style="list-style-type: none"> <li>■ [0] <b>Disable</b></li> <li>■ [1] <b>Enable</b> (default)</li> </ul>



Parameter	Description
[EnableReasonHeader]	
<p>'Gateway Name'</p> <pre>configure voip &gt; sip- definition settings &gt; gw- name</pre> <p>[SIPGatewayName]</p>	<p>Defines a name for the device (e.g., device123.com), which is used as the host part for the SIP URI in the From header for outgoing messages. If not configured, the device's IP address is used instead (default).</p> <p>The valid value is a string of up to 100 characters. By default, no value is defined.</p> <p><b>Note:</b></p> <ul style="list-style-type: none"> <li>■ Ensure that the parameter value is the one with which the proxy has been configured with to identify the device.</li> <li>■ If you enable keep-alive by SIP OPTIONS messages with the proxy (see the [ProxySet_EnableProxyKeepAlive] parameter), you can configure, using the [UseGatewayNameForOptions] parameter, if the device's IP address, the proxy's IP address, or the device's name (configured by the [SIPGatewayName] parameter) is used in the keep-alive SIP OPTIONS messages (host part of the Request-URI).</li> <li>■ The parameter can also be configured for an IP Group (in the IP Groups table).</li> </ul>
<pre>configure voip &gt; sip- definition settings &gt; zero-sdp- behavior</pre> <p>[ZeroSDPHandling]</p>	<p>Determines the device's response to an incoming SDP that includes an IP address of 0.0.0.0 in the SDP's Connection Information field (i.e., "c=IN IP4 0.0.0.0").</p> <ul style="list-style-type: none"> <li>■ [0] = (Default) Sets the IP address of the outgoing SDP's c= field to 0.0.0.0.</li> <li>■ [1] = Sets the IP address of the outgoing SDP c= field to the IP address of the device. If the incoming SDP doesn't contain the "a=inactive" line, the returned SDP contains the "a=recvonly" line.</li> </ul>
<p>'Delayed Offer'</p> <pre>configure voip &gt; sip- definition settings &gt; delayed-offer</pre> <p>[EnableDelayedOffer]</p>	<p>Determines whether the device sends the initial INVITE message with or without an SDP. Sending the first INVITE without SDP is typically done by clients for obtaining the far-end's full list of capabilities before sending their own offer. (An alternative method for obtaining the list of supported capabilities is by using SIP OPTIONS, which is not supported by every SIP agent.)</p> <ul style="list-style-type: none"> <li>■ [0] <b>Disable</b> = (Default) The device sends the initial INVITE message with an SDP.</li> </ul>

Parameter	Description
	<ul style="list-style-type: none"> <li>■ [1] <b>Enable</b> = The device sends the initial INVITE message without an SDP.</li> </ul>
[SIPDigestAuthorizationURIMode]	<p>Defines whether the device includes or excludes URI parameters for the Digest URI in the SIP Proxy-Authorization or Authorization headers of the request that the device sends in reply to a received SIP 401 (Unauthorized) or 407 (Proxy Authentication Required) response. Below shows an example of a request with an Authorization header containing a Digest URI (shown in bold):</p> <pre>Authorization: Digest username="alice at AudioCodes.com", realm="AudioCodes.com", nonce="", response="", uri="sip:<b>AudioCodes.com</b>"</pre> <ul style="list-style-type: none"> <li>■ [0] = (Default) The device sends the request without a Digest URI.</li> <li>■ [1] = The device sends the request with a Digest URI, which is set to the same value as the URI in the original Request-URI.</li> </ul>
<pre>configure voip &gt; sip- definition settings &gt; crypto-life- time-in-sdp [DisableCryptoLifeTimeInSDP]</pre>	<p>Enables the device to send "a=crypto" lines without the lifetime parameter in the SDP. For example, if the SDP contains "a=crypto:12 AES_CM_128_HMAC_SHA1_80 inline:hhQe10yZRcRcpIFPkH5xYY9R1de37ogh9G1MpvNp 2^31", it removes the lifetime parameter "2^31".</p> <ul style="list-style-type: none"> <li>■ [0] Disable (default)</li> <li>■ [1] Enable</li> </ul>
'Contact Restriction' contact-restriction [EnableContactRestriction]	<p>Determines whether the device sets the Contact header of outgoing INVITE requests to 'anonymous' for restricted calls.</p> <ul style="list-style-type: none"> <li>■ [0] <b>Disable</b> (default)</li> <li>■ [1] <b>Enable</b></li> </ul>
<pre>configure voip &gt; sip- definition settings &gt; anonymous-mode [AnonymousMode]</pre>	<p>Defines if the device's IP address is used as the URI host part instead of "anonymous.invalid" in the INVITE's From header for Tel-to-IP calls.</p> <ul style="list-style-type: none"> <li>■ [0] = (Default) If the device receives a call from the Tel with blocked caller ID, it sends an INVITE with From: "anonymous"&lt;anonymous@anonymous.invalid&gt;</li> <li>■ [1] = The device's IP address is used as the URI host part instead of "anonymous.invalid".</li> </ul>

Parameter	Description
	<p>The parameter may be useful, for example, for service providers who identify their SIP Trunking customers by their source phone number or IP address, reflected in the From header of the SIP INVITE. Therefore, even customers blocking their Caller ID can be identified by the service provider. Typically, if the device receives a call with blocked Caller ID from the PSTN side (e.g., Trunk connected to a PBX), it sends an INVITE to the IP with a From header as follows: "From: "anonymous" &lt;anonymous@anonymous.invalid&gt;". This is in accordance with RFC 3325. However, when the parameter is set to 1, the device replaces the "anonymous.invalid" with its IP address.</p>
<pre>configure voip &gt; sip- definition settings &gt; p- assrtd-usr- name [PAssertedUserName]</pre>	<p>Defines a 'representative number' (up to 50 characters) that is used as the user part of the Request-URI in the P-Asserted-Identity header of an outgoing INVITE for Tel-to-IP calls. The default is null.</p>
<pre>configure voip &gt; sip- definition settings &gt; use-aor-in- refer-to- header [UseAORInReferToHeader]</pre>	<p>Defines the source for the SIP URI set in the Refer-To header of outgoing REFER messages.</p> <ul style="list-style-type: none"> <li>■ [0] = (Default) Use SIP URI from Contact header of the initial call.</li> <li>■ [1] = Use SIP URI from To/From header of the initial call.</li> </ul>
<p>'User-Information Usage'</p> <pre>configure voip &gt; sip- definition settings &gt; user-inf-usage [EnableUserInfoUsage]</pre>	<p>Enables the usage of the User Information, which is loaded to the device in the User Information Auxiliary file. For more information on User Information, see <a href="#">User Information File</a>.</p> <ul style="list-style-type: none"> <li>■ [0] <b>Disable</b> (default)</li> <li>■ [1] <b>Enable</b></li> </ul> <p><b>Note:</b> For the parameter to take effect, a device reset is required.</p>
<pre>configure voip &gt; sip-</pre>	<p>Determines whether the device uses the value of the incoming SIP Reason header for Release Reason mapping.</p>

Parameter	Description
<pre>definition settings &gt; handle-reason- header [HandleReasonHeade r]</pre>	<ul style="list-style-type: none"> <li>■ [0] = Disregard Reason header in incoming SIP messages.</li> <li>■ [1] = (Default) Use the Reason header value for Release Reason mapping.</li> </ul>
<pre>[EnableSilenceSuppln SDP]</pre>	<p>Determines the device's behavior upon receipt of SIP Re-INVITE messages that include the SDP's 'silencesupp:off' attribute.</p> <ul style="list-style-type: none"> <li>■ [0] = (Default) Disregard the 'silecesupp' attribute.</li> <li>■ [1] = Handle incoming Re-INVITE messages that include the 'silencesupp:off' attribute in the SDP as a request to switch to the Voice-Band-Data (VBD) mode. In addition, the device includes the attribute 'a=silencesupp:off' in its SDP offer.</li> </ul> <p><b>Note:</b> The parameter is applicable only if the G.711 coder is used.</p>
<pre>configure voip &gt; sip- definition settings &gt; rport-support [EnableRport]</pre>	<p>Enables the usage of the 'rport' parameter in the Via header.</p> <ul style="list-style-type: none"> <li>■ [0] = Disabled (default)</li> <li>■ [1] = Enabled</li> </ul> <p>The device adds an 'rport' parameter to the Via header of each outgoing SIP message. The first Proxy that receives this message sets the 'rport' value of the response to the actual port from where the request was received. This method is used, for example, to enable the device to identify its port mapping outside a NAT.</p> <p>If the Via header doesn't include the 'rport' parameter, the destination port of the response is obtained from the host part of the Via header.</p> <p>If the Via header includes the 'rport' parameter without a port value, the destination port of the response is the source port of the incoming request.</p> <p>If the Via header includes 'rport' with a port value (e.g., rport=1001), the destination port of the response is the port indicated in the 'rport' parmeter.</p>
<pre>'Enable X-Channel Header' configure voip &gt; sip- definition</pre>	<p>Enables the device to add the SIP X-Channel header to outgoing SIP messages. The header provides information on the physical analog channel or Trunk/B-channel on which the call is received or sent.</p> <ul style="list-style-type: none"> <li>■ [0] <b>Disable</b> = (Default) X-Channel header is not used.</li> </ul>

Parameter	Description
<pre>settings &gt; x- channel-header</pre> <p>[XChannelHeader]</p>	<ul style="list-style-type: none"> <li>■ [1] <b>Enable</b> = X-Channel header is generated by the device and sent in SIP INVITE requests and 180, 183, and 200 OK responses. The header includes the analog channel or Trunk/B-channel and the device's IP address, using the following syntax:</li> </ul> <pre>x-channel: ds/ds1-&lt;digital Trunk number&gt;/&lt;analog channel or Trunk/B-channel&gt;;IP=&lt;device's IP address&gt;</pre> <p>For example, the below shows a call on Trunk 1, channel 4 of the device with IP address 192.168.13.1:</p> <pre>x-channel: ds/ds1-1/4;IP=192.168.13.1</pre>
<pre>'Progress Indicator to IP' configure voip &gt; sip- definition settings &gt; prog-ind-2ip</pre> <p>[ProgressIndicator2IP]</p>	<p>Global parameter defining the progress indicator (PI) sent to the IP.</p> <p>You can also configure the feature per specific calls, using IP Profiles (IpProfile_ProgressIndicator2IP) or Tel Profiles (TelProfile_ProgressIndicator2IP). For a detailed description of the parameter and for configuring the feature, see <a href="#">Configuring IP Profiles</a> or <a href="#">Configuring Tel Profiles</a>.</p> <p><b>Note:</b> If this feature is configured for a specific profile, the settings of this global parameter is ignored for calls associated with the profile.</p>
<p>[EnableRekeyAfter181]</p>	<p>Enables the device to send a re-INVITE with a new (different) SRTP key (in the SDP) if a SIP 181 response is received ("call is being forwarded"). The re-INVITE is sent immediately upon receipt of the 200 OK (when the call is answered).</p> <ul style="list-style-type: none"> <li>■ [0] = Disable (default)</li> <li>■ [1] = Enable</li> </ul> <p><b>Note:</b> The parameter is applicable only if SRTP is used.</p>
<pre>configure voip &gt; sip- definition settings &gt; number-of- active-dialogs</pre> <p>[NumberOfActiveDialogs]</p>	<p>Defines the maximum number of concurrent, outgoing SIP REGISTER dialogs. The parameter is used to control the registration rate.</p> <p>The valid range is 1 to 20. The default is 20.</p> <p><b>Note:</b></p> <ul style="list-style-type: none"> <li>■ Once a 200 OK is received in response to a REGISTER message, the REGISTER message is not considered in this maximum count limit.</li> <li>■ The parameter applies only to outgoing REGISTER messages (i.e., incoming is unlimited).</li> </ul>

Parameter	Description
[TransparentCoderOnDataCall]	<ul style="list-style-type: none"> <li>■ [0] = (Default) Only use coders from the coder list.</li> <li>■ [1] = Use Transparent coder for data calls (according to RFC 4040).</li> </ul> <p>The Transparent coder can be used on data calls. When the device receives a Setup message from the ISDN with 'TransferCapabilities = data', it can initiate a call using the coder 'Transparent' (even if the coder is not included in the coder list). The initiated INVITE includes the following SDP attribute:  <code>a=rtpmap:97 CLEARMODE/8000</code></p> <p>The default payload type is set according to the CodersGroup parameter. If the Transparent coder is not defined, the default is set to 56. The payload type is negotiated with the remote side, i.e., the selected payload type is according to the remote side selection. The receiving device must include the 'Transparent' coder in its coder list.</p> <p><b>Note:</b> The parameter is applicable only to digital interfaces.</p>
'Default Release Cause' <pre>configure voip &gt; sip- definition settings &gt; dflt-release- cse</pre> [DefaultReleaseCause]	<p>Defines the default Release Cause (sent to IP) for IP-to-Tel calls when the device initiates a call release and an explicit matching cause for this release is not found.</p> <p>The default release cause is NO_ROUTE_TO_DESTINATION (3). Other common values include NO_CIRCUIT_AVAILABLE (34), DESTINATION_OUT_OF_ORDER (27), etc.</p> <p><b>Note:</b></p> <ul style="list-style-type: none"> <li>■ The default release cause is described in the Q.931 notation and is translated to corresponding SIP 40x or 50x values (e.g., 3 to SIP 404, and 34 to SIP 503).</li> <li>■ Analog: For more information on mapping PSTN release causes to SIP responses, see <a href="#">Mapping PSTN Release Cause to SIP Response</a>.</li> <li>■ Digital: When the Trunk is disconnected or is not synchronized, the internal cause is 27. This cause is mapped, by default, to SIP 502.</li> <li>■ For mapping SIP-to-Q.931 and Q.931-to-SIP release causes, see <a href="#">Configuring Release Cause Mapping</a>.</li> <li>■ For a list of SIP responses-Q.931 release cause mapping, see <a href="#">Alternative Routing to Trunk upon Q.931 Call Release Cause Code</a>.</li> </ul>

Parameter	Description
<pre>'Enable Microsoft Extension' configure voip &gt; sip- definition settings &gt; microsoft-ext [EnableMicrosoftExt]</pre>	<p>Enables the modification of the called and calling number for numbers received with Microsoft's proprietary "ext=xxx" parameter in the SIP INVITE URI user part. Microsoft Office Communications Server sometimes uses this proprietary parameter to indicate the extension number of the called or calling party.</p> <ul style="list-style-type: none"> <li>■ [0] <b>Disable</b> (default)</li> <li>■ [1] <b>Enable</b></li> </ul> <p>For example, if a calling party makes a call to telephone number 622125519100 Ext. 104, the device receives the SIP INVITE (from Microsoft's application) with the URI user part as INVITE sip:622125519100;ext=104@10.1.1.10 (or INVITE tel:622125519100;ext=104). If the parameter EnableMicrosoftExt is enabled, the device modifies the called number by adding an "e" as the prefix, removing the "ext=" parameter, and adding the extension number as the suffix (e.g., e622125519100104). Once modified, the device can then manipulate the number further, using the Number Manipulation tables to leave only the last 3 digits (for example) for sending to a PBX.</p>
<pre>configure voip &gt; sip- definition settings &gt; sip-uri-for- diversion- header [UseSIPURIForDiversi onHeader]</pre>	<p>Defines the URI format in the SIP Diversion header.</p> <ul style="list-style-type: none"> <li>■ [0] = 'tel:' (default)</li> <li>■ [1] = 'sip:'</li> </ul>
<pre>configure voip &gt; sip- definition settings &gt; 100-to-18x- timeout [TimeoutBetween100 And18x]</pre>	<p>Defines the timeout (in msec) between receiving a 100 Trying response and a subsequent 18x response. If a 18x response is not received within this timeout period, the call is disconnected. The valid range is 0 to 180,000 (i.e., 3 minutes). The default is 32000 (i.e., 32 sec).</p>
<pre>configure voip &gt; sip- definition</pre>	<p>Determines if and when the device sends a 100 Trying in response to an incoming INVITE request.</p>

Parameter	Description
<pre>settings &gt; immediate- trying [EnableImmediateTryi ng]</pre>	<ul style="list-style-type: none"> <li>■ [0] = 100 Trying response is sent upon receipt of a Proceeding message from the PSTN.</li> <li>■ [1] = (Default) 100 Trying response is sent immediately upon receipt of INVITE request.</li> </ul>
<pre>configure voip &gt; sip- definition settings &gt; trans-coder- present [TransparentCoderPr esentation]</pre>	<p>Determines the format of the Transparent coder representation in the SDP.</p> <ul style="list-style-type: none"> <li>■ [0] = clearmode (default)</li> <li>■ [1] = X-CCD</li> </ul>
<pre>configure voip &gt; sip- definition settings &gt; ignore-remote- sdp-mki [IgnoreRemoteSDPM KI]</pre>	<p>Determines whether the device ignores the Master Key Identifier (MKI) if present in the SDP received from the remote side.</p> <ul style="list-style-type: none"> <li>■ [0] = (Default) Disable</li> <li>■ [1] = Enable</li> </ul>
<p>'Comfort Noise Generation Negotiation'</p> <pre>configure voip &gt; media rtp- rtcp &gt; com- noise-gen-nego [ComfortNoiseNegoti ation]</pre>	<p>Enables negotiation and usage of Comfort Noise (CN) for Gateway calls.</p> <ul style="list-style-type: none"> <li>■ [0] <b>Disable</b></li> <li>■ [1] <b>Enable</b> (default)</li> </ul> <p>The use of CN is indicated by including a payload type for CN on the media description line of the SDP. The device can use CN with a codec whose RTP time stamp clock rate is 8,000 Hz (G.711/G.726). The static payload type 13 is used. The use of CN is negotiated between sides. Therefore, if the remote side doesn't support CN, it is not used. Regardless of the device's settings, it always attempts to adapt to the remote SIP UA's request for CNG, as described below.</p> <p>To determine CNG support, the device uses the ComfortNoiseNegotiation parameter and the codec's SCE (silence suppression setting) using the CodersGroup parameter. If the ComfortNoiseNegotiation parameter is enabled, then the following occurs:</p>



Parameter	Description
	<ul style="list-style-type: none"> <li>■ If the device is the initiator, it sends a “CN” in the SDP only if the SCE of the codec is enabled. If the remote UA responds with a “CN” in the SDP, then CNG occurs; otherwise, CNG does not occur.</li> <li>■ If the device is the receiver and the remote SIP UA does not send a “CN” in the SDP, then no CNG occurs. If the remote side sends a “CN”, the device attempts to be compatible with the remote side and even if the codec’s SCE is disabled, CNG occurs.</li> </ul> <p>If the ComfortNoiseNegotiation parameter is disabled, then the device does not send “CN” in the SDP. However, if the codec’s SCE is enabled, then CNG occurs.</p> <p><b>Note:</b> The parameter is applicable only to the Gateway application.</p>
<pre>configure voip &gt; sip- definition settings &gt; sdp-ecan-frmt [SDPEcanFormat]</pre>	<p>Defines the echo canceller format in the outgoing SDP. The 'ecan' attribute is used in the SDP to indicate the use of echo cancellation.</p> <ul style="list-style-type: none"> <li>■ [0] = (Default) The 'ecan' attribute appears on the 'a=gpmdd' line.</li> <li>■ [1] = The 'ecan' attribute appears as a separate attribute.</li> <li>■ [2] = The 'ecan' attribute is not included in the SDP.</li> <li>■ [3] = The 'ecan' attribute and the 'vbd' parameter are not included in the SDP.</li> </ul> <p><b>Note:</b> The parameter is applicable only when the IsFaxUsed parameter is set to 2, and for re-INVITE messages generated by the device as result of modem or fax tone detection.</p>
<pre>'First Call Ringback Tone ID' configure voip &gt; sip- definition settings &gt; 1st-call-rbt- id [FirstCallRBTid]</pre>	<p>Defines the index of the first ringback tone in the CPT file. This option enables an Application server to request the device to play a distinctive ringback tone to the calling party according to the destination of the call. The tone is played according to the Alert-Info header received in the 180 Ringing SIP response (the value of the Alert-Info header is added to the value of the parameter).</p> <p>The valid range is -1 to 1,000. The default is -1 (i.e., play standard ringback tone).</p> <p><b>Note:</b></p> <ul style="list-style-type: none"> <li>■ It is assumed that all ringback tones are defined in sequence</li> </ul>

Parameter	Description
	<p>in the CPT file.</p> <ul style="list-style-type: none"> <li>■ In case of an MLPP call, the device uses the value of the parameter plus 1 as the index of the ringback tone in the CPT file (e.g., if this value is set to 1, then the index is 2, i.e., 1 + 1).</li> </ul>
<p>'Reanswer Time'  <code>configure voip</code>  <code>&gt; sip-</code>  <code>definition</code>  <code>settings &gt;</code>  <code>reanswer-time</code>  <b>[RegretTime]</b></p>	<p>Analog: Defines the time interval from when the user hangs up the phone until the call is disconnected (FXS). This allows the user to hang up and then pick up the phone (before this timeout) to continue the call conversation. Thus, it's also referred to as regret time.</p> <p>Digital: Defines the time period the device waits for an MFC R2 Resume (Reanswer) signal once a Suspend (Clear back) signal is received from the PBX. If this timer expires, the call is released. Note that this is applicable only to the MFC-R2 CAS Brazil variant.</p> <p>The valid range is 0 to 255 (in seconds). The default is 0.</p>
<p><code>configure voip</code>  <code>&gt; gateway</code>  <code>advanced &gt;</code>  <code>reans-info-</code>  <code>enbl</code>  <b>[EnableReansweringI</b>  <b>NFO]</b></p>	<p>For FXS interfaces: Enables the device to send a SIP INFO message with the On-Hook/Off-Hook parameter when the FXS phone goes on-hook during an ongoing call and then off-hook again, within the user-defined regret timeout (configured by the parameter RegretTime). Therefore, the device notifies the far-end that the call has been re-answered.</p> <p>Digital: The parameter is used for private wire services (see <a href="#">Configuring Private Wire Interworking</a>).</p> <ul style="list-style-type: none"> <li>■ [0] = (Default) Disable</li> <li>■ [1] = Enable</li> </ul> <p>For FXS interfaces: The parameter is typically implemented for incoming IP-to-Tel collect calls to the FXS port. If the FXS user does not wish to accept the collect call, the user disconnects the call by on-hooking the phone. The device notifies the softswitch (or Application server) of the unanswered collect call (on-hook) by sending a SIP INFO message. As a result, the softswitch disconnects the call (sends a BYE message to the device). If the call is a regular incoming call and the FXS user on-hooks the phone without intending to disconnect the call, the softswitch does not disconnect the call (during the regret time).</p> <p>The INFO message format is as follows:</p> <pre>INFO sip:12345@10.50.228.164:5082 SIP/2.0 Via: SIP/2.0/UDP 127.0.0.1;branch=z9hG4bK_</pre>

Parameter	Description
	<p>05_905924040-90579</p> <p>From: &lt;sip:+551137077803@ims.acme.com.br:5080;user=phone&gt;;tag=008277765</p> <p>To: &lt;sip:notavailable@unknown.invalid&gt;;tag=svw-0-1229428367</p> <p>Call-ID: ConorCCR-0-LU-1229417827103300@dtas-stdn.fs5000group0-000.1</p> <p>CSeq: 1 INFO</p> <p>Contact: sip:10.20.7.70:5060</p> <p>Content-Type: application/On-Hook (application/Off-Hook)</p> <p>Content-Length: 0</p> <p><b>Note:</b></p> <ul style="list-style-type: none"> <li>■ The parameter is applicable only if the parameter RegretTime is configured.</li> <li>■ For digital interfaces, the parameter is applicable only to E1/T1 CAS.</li> <li>■ For analog interfaces, the parameter is applicable only to FXS interfaces.</li> </ul>
'Presence Publish IP Group ID' [PresencePublishIPGroupID]	<p>Assigns the IP Group (by ID) configured for the Skype for Business Server (presence server). This is where the device sends SIP PUBLISH messages to notify of changes in presence status of Skype for Business users when making and receiving calls using third-party endpoint devices.</p> <p>For more information on integration with Microsoft presence, see <a href="#">Microsoft Skype for Business Presence of Third-Party Endpoints</a>.</p>
'Microsoft Presence Status' [EnableMSPresence]	<p>Enables the device to notify (using SIP PUBLISH messages) Skype for Business Server (presence server) of changes in presence status of Skype for Business users when making and receiving calls using third-party endpoint devices.</p> <ul style="list-style-type: none"> <li>■ [0] <b>Disable</b> (default)</li> <li>■ [1] <b>Enable</b></li> </ul> <p>For more information on integration with Microsoft presence, see <a href="#">Microsoft Skype for Business Presence of Third-Party</a></p>

Parameter	Description
<pre>'PSTN Alert Timeout' configure voip &gt; sip- definition settings &gt; pstn-alert- timeout [PSTNAlertTimeout]</pre>	<p><a href="#">Endpoints.</a></p> <p>Digital: Defines the Alert Timeout (in seconds) for calls sent to the PSTN. This timer is used between the time a Setup message is sent to the Tel side (IP-to-Tel call establishment) and a Connect message is received. If an Alerting message is received, the timer is restarted. If the timer expires before the call is answered, the device disconnects the call and sends a SIP 408 request timeout response to the SIP party that initiated the call.</p> <p>Analog: Defines the Alert Timeout (in seconds) for calls to the Tel side. This timer is used between the time a ring is generated (FXS) or a line is seized (FXO), until the call is connected. For example: If the FXS device receives an INVITE, it generates a ring to the phone and sends a SIP 180 Ringing response to the IP. If the phone is not answered within the time interval set by the parameter, the device cancels the call by sending a SIP 408 response.</p> <p>The valid value range is 1 to 600 (in seconds). The default is 180.</p> <p><b>Note:</b>Digital: If per trunk configuration (using TrunkPSTNAlertTimeout) is set to other than default, the PSTNAlertTimeout parameter value is overridden.</p>
<pre>'RTP Only Mode' configure voip &gt; sip- definition settings &gt; rtp-only-mode [RTPOnlyMode]</pre>	<p>Enables the device to send and receive RTP packets to and from remote endpoints without the need to establish a SIP session. The remote IP address is determined according to the Tel-to-IP Routing table (Prefix parameter). The port is the same port as the local RTP port (configured by the [BaseUDPPort] parameter and the channel on which the call is received).</p> <ul style="list-style-type: none"> <li>■ [0] <b>Disable</b> (default)</li> <li>■ [1] <b>Transmit &amp; Receive</b> = Send and receive RTP packets.</li> <li>■ [2] <b>Transmit Only</b>= Send RTP packets only.</li> <li>■ [3] <b>Receive Only</b>= Receive RTP packets only.</li> </ul> <p><b>Note:</b></p> <ul style="list-style-type: none"> <li>■ The parameter is applicable only to the Gateway application.</li> <li>■ Digital interfaces: To activate the RTP Only feature without using ISDN / CAS signaling, you must do the following: <ul style="list-style-type: none"> <li>✓ Configure E1/T1 Transparent protocol type (set the ProtocoType parameter to 5 or 6).</li> <li>✓ Enable the TDM-over-IP feature (set the</li> </ul> </li> </ul>

Parameter	Description
	<p>EnableTDMoverIP parameter to 1).</p> <ul style="list-style-type: none"> <li>■ To configure the RTP Only mode per trunk, use the RTPOnlyModeForTrunk_x parameter.</li> <li>■ If per trunk configuration (using the RTPOnlyModeForTrunk_ID parameter) is set to a value other than the default, the RTPOnlyMode parameter value is ignored.</li> </ul>
[RTPOnlyModeForTrunk_x]	<p>Enables the RTP Only feature per trunk. The x in the parameter name denotes the trunk number, where 0 is Trunk 1. For a description of the parameter, see the RTPOnlyMode parameter.</p> <p>Note: For using the global parameter (i.e., setting the RTP Only feature for all trunks), set the parameter to -1 (default).</p>
'Media IP Version Preference' media-ip-ver-pref [MediaIPVersionPreference]	<p>Global parameter that defines the preferred RTP media IP addressing version (IPv4 or IPv6) for outgoing SIP calls. You can also configure this feature per specific calls, using IP Profiles (IpProfile_MediaIPVersionPreference). For a detailed description of the parameter and for configuring this feature in the IP Profiles table, see <a href="#">Configuring IP Profiles</a>.</p>
'SIT Q850 Cause' configure voip > sip- definition settings > sit-q850-cause [SITQ850Cause]	<p>Defines the Q.850 cause value specified in the SIP Reason header that is included in a 4xx response when a Special Information Tone (SIT) is detected on an IP-to-Tel call.</p> <p>The valid range is 0 to 127. The default is 34.</p> <p><b>Note:</b> For mapping specific SIT tones, you can use the SITQ850CauseForNC, SITQ850CauseForIC, SITQ850CauseForVC, and SITQ850CauseForRO parameters.</p>
'SIT Q850 Cause For NC' configure voip > sip- definition settings > release-cause- for-sit-nc [SITQ850CauseForNC]	<p>Defines the Q.850 cause value specified in the SIP Reason header that is included in a 4xx response when SIT-NC (No Circuit Found Special Information Tone) is detected from the Tel side for IP-to-Tel calls.</p> <p>The valid range is 0 to 127. The default is 34.</p> <p><b>Note:</b> When not configured (i.e., default), the SITQ850Cause parameter is used.</p>
'SIT Q850 Cause For IC'	<p>Defines the Q.850 cause value specified in the SIP Reason header that is included in a 4xx response when SIT-IC (Operator</p>

Parameter	Description
<pre>configure voip &gt; sip- definition settings &gt; q850-cause- for-sit-ic [SITQ850CauseForIC]</pre>	<p>Intercept Special Information Tone) is detected from the Tel for IP-to-Tel calls.</p> <p>The valid range is 0 to 127. The default is -1 (not configured).</p> <p><b>Note:</b> When not configured (i.e., default), the SITQ850Cause parameter is used.</p>
<p>'SIT Q850 Cause For VC'</p> <pre>configure voip &gt; sip- definition settings &gt; q850-cause- for-sit-vc [SITQ850CauseForVC]</pre>	<p>Defines the Q.850 cause value specified in the SIP Reason header that is included in a 4xx response when SIT-VC (Vacant Circuit - non-registered number Special Information Tone) is detected from the Tel for IP-to-Tel calls.</p> <p>The valid range is 0 to 127. The default is -1 (not configured).</p> <p><b>Note:</b> When not configured (i.e., default), the SITQ850Cause parameter is used.</p>
<p>'SIT Q850 Cause For RO'</p> <pre>configure voip &gt; sip- definition settings &gt; q850-cause- for-sit-ro [SITQ850CauseForRO]</pre>	<p>Defines the Q.850 cause value specified in the SIP Reason header that is included in a 4xx response when SIT-RO (Reorder - System Busy Special Information Tone) is detected from the Tel for IP-to-Tel calls.</p> <p>The valid range is 0 to 127. The default is -1 (not configured).</p> <p><b>Note:</b> When not configured (i.e., default), the SITQ850Cause parameter is used.</p>
<pre>configure voip &gt; message settings &gt; inbound-map- set [GWInboundManipulationSet]</pre>	<p>Gateway application only: Assigns a Manipulation Set ID for manipulating all inbound INVITE messages.</p> <p>Gateway and SBC applications: Assigns a Manipulation Set ID for manipulating incoming responses of requests that the device initiates.</p> <p>The Manipulation Set is defined using the MessageManipulations parameter. By default, no manipulation is done (i.e. Manipulation Set ID is set to -1).</p> <p>For more information, see <a href="#">Configuring SIP Message Manipulation</a> on page 647.</p>
<pre>configure voip &gt; message</pre>	<p>Gateway application only: Assigns a Manipulation Set ID for manipulating all outbound INVITE messages.</p>

Parameter	Description
<pre>settings &gt; outbound-map- set [GWOutboundManip- ulationSet]</pre>	<p>Gateway and SBC applications: Assigns a Manipulation Set ID for manipulating outgoing requests that the device initiates.</p> <p>The Manipulation Set is defined using the MessageManipulations parameter. By default, no manipulation is done (i.e. Manipulation Set ID is set to -1).</p> <p>For more information, see <a href="#">Configuring SIP Message Manipulation</a> on page 647.</p>
<b>Out-of-Service (Busy Out) Parameters</b>	
<pre>'Enable Busy Out' configure voip &gt; sip- definition settings &gt; busy-out [EnableBusyOut]</pre>	<p>Enables the Busy Out feature.</p> <ul style="list-style-type: none"> <li>■ [0] <b>Disable</b> (Default)</li> <li>■ [1] <b>Enable</b></li> </ul> <p>When enabled and certain scenarios exist, the device does the following:</p> <ul style="list-style-type: none"> <li>■ Analog: The FXS port behaves according to the settings of the [FXSOOSBehavior] parameter such as plays a reorder tone when the phone is off-hooked, or changes the line polarity.</li> <li>■ Digital: All trunks are automatically taken out-of-service by taking down the D-Channel, or for T1 PRI trunks, by sending a Service Out message supporting these messages (NI-2, 4/5-ESS, DMS-100, and Meridian).</li> </ul> <p>The above behavior is done upon one of the following scenarios:</p> <ul style="list-style-type: none"> <li>■ The device is physically disconnected from the network (i.e., Ethernet cable is disconnected).</li> <li>■ The device can't communicate with the Proxy Sets (according to the Proxy Keep-Alive mechanism) associated with the destination IP Groups of matching routing rules in the Tel-to-IP Routing table and no other alternative route exists to send the call.</li> <li>■ The IP Connectivity mechanism is enabled (by the [AltRoutingTel2IPEnable] parameter) and there is no connectivity to any destination IP address of matching routing rules in the Tel-to-IP Routing table.</li> </ul> <p><b>Note:</b></p> <ul style="list-style-type: none"> <li>■ If you enable the [AltRoutingTel2IPEnable] parameter, the Busy Out feature does not function with the Proxy Set keep-</li> </ul>

Parameter	Description
	<p>alive mechanism. To use the Busy Out feature with the Proxy Set keep-alive mechanism (for IP Groups), disable the [AltRoutingTel2IPEnable] parameter.</p> <ul style="list-style-type: none"> <li>■ Analog: The [FXSOOSBehavior] parameter defines the behavior of the FXS endpoints when a Busy Out or Graceful Lock occurs.</li> <li>■ Analog: FXO endpoints during Busy Out and Lock are inactive.</li> <li>■ Digital: The Busy Out behavior depends on the PSTN protocol type.</li> <li>■ Digital: The Busy Out condition is also applied per Trunk Group. This occurs if there is no connectivity to the Serving IP Group of a specific Trunk Group configured in the Trunk Group Settings table. In such a scenario, all the physical trunks of the Trunk Group are set to the Busy Out condition. Each trunk uses the out-of-service method according to the ISDN/ CAS variant.</li> <li>■ Digital: To configure the method for taking trunks/channels out-of-service, see the [DigitalOOSBehaviorForTrunk_x] parameter for per trunk or the [DigitalOOSBehavior] parameter for all trunks.</li> </ul>
<p>'Graceful Busy Out Timeout'</p> <pre>configure voip &gt; sip- definition settings &gt; graceful-busy- out-t-out [GracefulBusyOutTimeout]</pre>	<p>Defines the timeout interval (in seconds) for out-of-service graceful shutdown mode for busy trunks (per trunk) if communication fails with a Proxy server (or Proxy Set). In such a scenario, the device rejects new calls from the PSTN (i.e., Serving Trunk Group), but maintains currently active calls for this user-defined timeout. Once this timeout elapses and there are still active calls, the device terminates the calls and takes the trunk out-of-service (sending the PSTN busy-out signal). Trunks without any active calls are immediately taken out-of-service regardless of the timeout.</p> <p>The parameter is applicable to the locking of Trunk Groups feature (see <a href="#">Locking and Unlocking Trunk Groups</a>) and the Busy Out feature (see the [EnableBusyOut] parameter), where trunks/channels are taken out-of-service.</p> <p>The range is 0 to 86,400. The default is 0.</p> <p><b>Note:</b></p> <ul style="list-style-type: none"> <li>■ The parameter is applicable only to digital interfaces.</li> </ul>



Parameter	Description
	<ul style="list-style-type: none"> <li>■ To configure the method for taking trunks/channels out-of-service, see the [DigitalOOSBehaviorForTrunk_x] parameter for per trunk or the [DigitalOOSBehavior] parameter for all trunks.</li> </ul>
<p>'Out-Of-Service Behavior'</p> <pre>configure voip &gt; sip- definition settings &gt; oos-behavior [FXSOOSBehavior]</pre>	<p>Defines the behavior of FXS endpoints when a Busy Out condition exists.</p> <ul style="list-style-type: none"> <li>■ [0] <b>None</b> = Silence is heard when the FXS endpoint goes off-hook.</li> <li>■ [1] <b>Reorder Tone</b> = (Default) The device plays a reorder tone to the connected phone / PBX.</li> <li>■ [2] <b>Polarity Reversal</b> = The device reverses the polarity of the endpoint making it unusable (relevant, for example, for PBX DID lines).</li> <li>■ [3] <b>Reorder Tone + Polarity Reversal</b> = Same as options [1] and [2].</li> <li>■ [4] <b>Current Disconnect</b> = The device disconnects the current to the FXS endpoint.</li> </ul> <p><b>Note:</b></p> <ul style="list-style-type: none"> <li>■ A device reset is required for the parameter to take effect when it is set to [2], [3], or [4].</li> <li>■ The parameter is applicable only to FXS interfaces.</li> </ul>
<pre>configure voip &gt; gateway digital settings &gt; isdn-busy-out- based-on-table [ISDNBusyOutBasedOnTable]</pre>	<p>Defines which configuration table (Trunk Group Settings table or Tel-to-IP Routing table) the device uses to determine busy out for a Trunk Group.</p> <ul style="list-style-type: none"> <li>■ [0] = (Default) Busy Out is determined by the Trunk Group Settings table (see <a href="#">Configuring Trunk Group Settings</a> on page 725). Busy Out of a Trunk Group occurs if its associated Serving IP Group in the table is down.</li> <li>■ [1] = Busy Out is determined by the Tel-to-IP Routing table (see <a href="#">Configuring Tel-to-IP Routing Rules</a> on page 734). Busy Out of a Trunk Group occurs only when all its associated destination IP Groups in the table are down. Busy Out is cleared when at least one IP Group is up.</li> </ul> <p><b>Note:</b></p> <ul style="list-style-type: none"> <li>■ The parameter is applicable only to digital (ISDN) interfaces.</li> </ul>

Parameter	Description
	<ul style="list-style-type: none"> <li>■ For this Busy Out feature, you need to enable proxy keep-alive for the Proxy Set associated with the IP Group.</li> <li>■ For the parameter to take effect, a device reset is required.</li> </ul>
<b>Retransmission Parameters</b>	
<p>'SIP T1 Retransmission Timer'</p> <pre>configure voip &gt; sip- definition settings &gt; t1- re-tx-time [SipT1Rtx]</pre>	<p>Defines the time interval (in msec) between the first transmission of a SIP message and the first retransmission of the same message.</p> <p>The default is 500.</p> <p><b>Note:</b> The time interval between subsequent retransmissions of the same SIP message starts with SipT1Rtx. For INVITE requests, it is multiplied by two for each new retransmitted message. For all other SIP messages, it is multiplied by two until SipT2Rtx. For example, assuming SipT1Rtx = 500 and SipT2Rtx = 4000:</p> <ul style="list-style-type: none"> <li>■ The first retransmission is sent after 500 msec.</li> <li>■ The second retransmission is sent after 1000 (2*500) msec.</li> <li>■ The third retransmission is sent after 2000 (2*1000) msec.</li> <li>■ The fourth retransmission and subsequent retransmissions until [SIPMaxRtx] are sent after 4000 (2*2000) msec.</li> </ul>
<p>'SIP T2 Retransmission Timer'</p> <pre>configure voip &gt; sip- definition settings &gt; t2- re-tx-time [SipT2Rtx]</pre>	<p>Defines the maximum interval (in msec) between retransmissions of SIP messages (except for INVITE requests).</p> <p>The default is 4000.</p> <p><b>Note:</b> The time interval between subsequent retransmissions of the same SIP message starts with SipT1Rtx and is multiplied by two until SipT2Rtx.</p>
<p>'SIP Maximum RTX'</p> <pre>configure voip &gt; sip- definition settings &gt; sip-max-rtx [SIPMaxRtx]</pre>	<p>Defines the maximum number of UDP transmissions of SIP messages (first transmission plus retransmissions).</p> <p>The range is 1 to 30. The default is 7.</p>
<p>'Number of RTX Before Hot-Swap'</p>	<p>Defines the number of retransmitted INVITE/REGISTER messages before the call is routed (hot swap) to another Proxy/Registrar.</p> <p>The valid range is 1 to 30. The default is 3.</p>

Parameter	Description
<pre>configure voip &gt; sip- definition proxy-and- registration &gt; nb-of-rtx-b4- hot-swap [HotSwapRtx]</pre>	<p>For example, if configured to 3 and no response is received from an IP destination, the device attempts another three times to send the call to the IP destination. If still unsuccessful, it attempts to redirect the call to another IP destination.</p> <p><b>Note:</b> The parameter is also used for alternative routing (see <a href="#">Alternative Routing Based on IP Connectivity</a>).</p>
<pre>configure voip &gt; sip- definition settings &gt; message- policy-reject- response-type [MessagePolicyReject ResponseType]</pre>	<p>Defines the SIP response code that the device sends when it rejects an incoming SIP message due to a matched Message Policy in the Message Policies table, whose 'Send Reject' (MessagePolicy_SendRejection) parameter is configured to Policy Reject [0].</p> <p>The default is 400 "Bad Request".</p> <p>To configure Message Policies, see <a href="#">Configuring SIP Message Policy Rules</a>.</p>

## Channel Parameters

This section describes the device's channel parameters.

## Voice Parameters

The voice parameters are described in the table below.

**Table 70-33:Voice Parameters**

Parameter	Description
<p>'Input Gain'</p> <pre>configure voip &gt; media voice &gt; input- gain [InputGain]</pre>	<p>Global parameter defining the pulse-code modulation (PCM) input (received) gain control level (in decibels).</p> <p>You can also configure the feature per specific calls, using IP Profiles (IpProfile_InputGain) or Tel Profiles (TelProfile_InputGain). For a detailed description of the parameter and for configuring the feature, see <a href="#">Configuring IP Profiles</a> or <a href="#">Configuring Tel Profiles</a>.</p> <p><b>Note:</b> If the feature is configured for a specific profile, the settings of the global parameter is ignored for calls associated with the profile.</p>
<p>'Voice Volume'</p>	<p>Global parameter defining the voice gain control (in</p>

Parameter	Description
<pre>configure voip &gt; media voice &gt; voice- volume</pre> <p>[VoiceVolume]</p>	<p>decibels). This defines the level of the transmitted signal (for the Gateway application, in IP-to-Tel calls).</p> <p>You can also configure the feature per specific calls, using IP Profiles (IpProfile_VoiceVolume) or Tel Profiles (TelProfile_VoiceVolume). For a detailed description of the parameter and for configuring the feature, see <a href="#">Configuring IP Profiles</a> or <a href="#">Configuring Tel Profiles</a>.</p> <p><b>Note:</b> If the feature is configured for a specific profile, the settings of the global parameter is ignored for calls associated with the profile.</p>
<pre>configure voip &gt; media voice codecs &gt; G726-voice-payload- format</pre> <p>[VoicePayloadFormat]</p>	<p>Determines the bit ordering of the G.726 voice payload format.</p> <ul style="list-style-type: none"> <li>■ [0] = (Default) Little Endian</li> <li>■ [1] = Big Endian</li> </ul> <p><b>Note:</b> To ensure high voice quality when using G.726, both communicating ends should use the same endianness format. Therefore, when the device communicates with a third-party entity that uses the G.726 voice coder and voice quality is poor, change the settings of the parameter (between Big Endian and Little Endian).</p>
<p>'Echo Canceller'</p> <pre>configure voip &gt; media voice &gt; echo- canceller-enable</pre> <p>[EnableEchoCanceller]</p>	<p>Global parameter enabling echo cancellation (i.e., echo from voice calls is removed).</p> <p>You can also configure this feature per specific calls, using IP Profiles (IpProfile_EnableEchoCanceller) or Tel Profiles (TelProfile_EnableEC). For a detailed description of the parameter and for configuring the feature, see <a href="#">Configuring IP Profiles</a> or <a href="#">Configuring Tel Profiles</a>.</p> <p><b>Note:</b> If the feature is configured for a specific profile, the settings of this global parameter is ignored for calls associated with the profile.</p>
<p>'Max Echo Canceller Length'</p> <pre>configure voip &gt; media voice &gt; max- echo-canceller- length</pre> <p>[MaxEchoCancellerLength]</p>	<p>Defines the maximum Echo Canceller Length (in msec), which is the maximum echo path delay (tail length) for which the echo canceller is designed to operate:</p> <ul style="list-style-type: none"> <li>■ [0] <b>Default</b> = (Default) Based on various internal device settings to attain maximum channel capacity</li> <li>■ [11] <b>64 msec</b></li> </ul>

Parameter	Description
	<ul style="list-style-type: none"> <li>■ [22] <b>128 msec</b></li> </ul> <p><b>Note:</b></p> <ul style="list-style-type: none"> <li>■ For the parameter to take effect, a device reset is required.</li> <li>■ Using 128 msec may reduce channel capacity. For example: with DSP Template 0 and number of spans 4, the capacity is reduced from 120 to 100. The reduction depends on the combination of “DSP Template” and “Number of Spans”.</li> <li>■ When housed with an analog/BRI module, the device can use a max. echo canceller length of 64 msec.</li> <li>■ When housed with PRI TRUNKS module, the device can use a max. echo canceller length of 128 msec.</li> <li>■ When housed with an MPM (in Slot #6), no channel reduction occurs.</li> <li>■ It is unnecessary to configure the parameter EchoCancellerLength, as it automatically acquires its value from the parameter.</li> </ul>
<pre>configure voip &gt; media voice &gt; echo- canceller-hybrid- loss [ECHybridLoss]</pre>	<p>Defines the four-wire to two-wire worst-case Hybrid loss, the ratio between the signal level sent to the hybrid and the echo level returning from the hybrid.</p> <ul style="list-style-type: none"> <li>■ [0] = (Default) 6 dB</li> <li>■ [1] = N/A</li> <li>■ [2] = 0 dB</li> <li>■ [3] = 3 dB</li> </ul>
<pre>configure voip &gt; media voice &gt; echo- canceller-NLP-mode [ECNLPMode]</pre>	<p>Global parameter enabling Non-Linear Processing (NLP) mode for echo cancellation.</p> <p>You can also configure the feature per specific calls, using Tel Profiles (TelProfile_ECNIpMode). For a detailed description of the parameter and for configuring the feature in the Tel Profiles table, see <a href="#">Configuring Tel Profiles</a>.</p> <p><b>Note:</b> If the feature is configured for a specific Tel Profile, the settings of the global parameter is ignored for calls associated with the Tel Profile.</p>

Parameter	Description
<pre>configure voip &gt; media voice &gt; echo- canceller- aggressive-NLP [EchoCancellerAggressiveNLP]</pre>	<p>Enables the Aggressive NLP at the first 0.5 second of the call.</p> <ul style="list-style-type: none"> <li>■ [0] = Disable</li> <li>■ [1] = (Default) Enable. The echo is removed only in the first half of a second of the incoming IP signal.</li> </ul> <p><b>Note:</b> For the parameter to take effect, a device reset is required.</p>
<pre>configure voip &gt; media RTP-RTCP &gt; number-of-SID- coefficients [RTPSIDCoeffNum]</pre>	<p>Defines the number of spectral coefficients added to an SID packet being sent according to RFC 3389.</p> <p>The valid values are [0] (default), [4], [6], [8] and [10].</p>

## Coder Parameters

The coder parameters are described in the table below.

**Table 70-34: Coder Parameters**

Parameter	Description
<pre>configure voip &gt; media settings &gt; EVRC-VAD- enable [EnableEVRCVAD]</pre>	<p>Enables the EVRC voice activity detector.</p> <ul style="list-style-type: none"> <li>■ [0] = Disable (default)</li> <li>■ [1] = Enable</li> </ul> <p><b>Note:</b> The parameter is applicable only to the EVRC and EVRC-B coders.</p>
<pre>configure voip &gt; media settings &gt; EVRC-dtx- min [EVRCDTXMin]</pre>	<p>Defines the minimum gap between two SID frames when using the EVRC voice activity detector. Units are in EVRC frame size (20 msec).</p> <p>The range is 0 to 20000. The default is 12.</p> <p><b>Note:</b> The parameter is applicable only to the EVRC and EVRC-B coders.</p>
<pre>configure voip &gt; media settings &gt; EVRC-dtx- max [EVRCDTXMax]</pre>	<p>Defines the maximum gap between two SID frames when using the EVRC voice activity detector. Units are in EVRC frame size (20 msec).</p> <p>The range is 0 to 20000. The default is 32.</p> <p><b>Note:</b> The parameter is applicable only to the EVRC and EVRC-B coders.</p>

Parameter	Description
<pre>configure voip &gt; media settings &gt; vbr-coder- header-format</pre> [VBRCoderHeaderFormat]	Determines the format of the RTP header for VBR coders. <ul style="list-style-type: none"> <li>■ [0] = (Default) Payload only (no header, TOC, or m-factor) - similar to RFC 3558 Header Free format.</li> <li>■ [1] = Supports RFC 2658 - 1 byte for interleaving header (always 0), TOC, no m-factor.</li> <li>■ [2] = Payload including TOC only, allow m-factor.</li> <li>■ [3] = RFC 3558 Interleave/Bundled format.</li> </ul>
<pre>configure voip &gt; media settings &gt; vbr-coder- hangover</pre> [VBRCoderHangover]	Defines the required number of silence frames at the beginning of each silence period when using the VBR coder silence suppression. The range is 0 to 255. The default is 1.
'AMR Payload Format' [AmrOctetAlignedEnable]	Defines the AMR payload format type. <ul style="list-style-type: none"> <li>■ [0] <b>Bandwidth Efficient</b></li> <li>■ [1] <b>Octet Aligned</b> (default)</li> </ul> <p><b>Note:</b> The AMR payload type can also be configured per Coder Group (see <a href="#">Configuring Coder Groups</a>). The Coder Group configuration overrides the parameter.</p>
<pre>configure voip &gt; media settings &gt; amr-header- format</pre> [AMRCoderHeaderFormat]	Determines the payload format of the AMR header. <ul style="list-style-type: none"> <li>■ [0] = Non-standard multiple frames packing in a single RTP frame. Each frame has a CMR and TOC header.</li> <li>■ [1] = AMR frame according to RFC 3267 bundling.</li> <li>■ [2] = AMR frame according to RFC 3267 interleaving.</li> <li>■ [3] = AMR is passed using the AMR IF2 format.</li> </ul> <p><b>Note:</b> Bandwidth Efficient mode is not supported; the mode is always Octet-aligned.</p>
'DSP Version Template Number' <pre>configure voip &gt; media settings &gt; DSP- version-template- number</pre> [DSPVersionTemplateName]	Determines the DSP template used by the device. Each DSP template supports specific coders, channel capacity, and features. The default is DSP Template 0. You can load different DSP templates to analog and digital modules using the syntax

Parameter	Description
	<p>DSPVersionTemplateNumber=xy where:</p> <ul style="list-style-type: none"> <li>■ x = 0 or 1 for DSP templates of analog modules</li> <li>■ y = 0 to 5 for DSP templates of digital and MPM modules</li> </ul> <p><b>Note:</b></p> <ul style="list-style-type: none"> <li>■ For the parameter to take effect, a device reset is required.</li> <li>■ For a list of supported DSP templates, see <a href="#">Channel Capacity</a>.</li> </ul>
<p>'Fax/Modem Bypass Packing Factor'</p> <pre>configure voip &gt; media fax-modem &gt; packing- factor</pre> <p>[FaxModemBypassM]</p>	<p>Defines the number (20 msec) of coder payloads used to generate a fax/modem bypass packet.</p> <p>The valid range is 1, 2, or 3 coder payloads. The default is 1 coder payload.</p>

## DTMF Parameters

The dual-tone multi-frequency (DTMF) parameters are described in the table below.

**Table 70-35:DTMF Parameters**

Parameter	Description
<p>'DTMF Transport Type'</p> <pre>configure voip &gt; media voice &gt; DTMF-transport- type</pre> <p>[DTMFTransportType]</p>	<p>Defines the DTMF transport type.</p> <ul style="list-style-type: none"> <li>■ [0] <b>Mute DTMF</b> = DTMF digits are removed from the voice stream and are not relayed to remote side.</li> <li>■ [2] <b>Transparent DTMF</b> = DTMF digits remain in the voice stream.</li> <li>■ [3] <b>RFC 2833 Relay DTMF</b> = (Default) DTMF digits are removed from the voice stream and are relayed to the remote side according to RFC 2833.</li> <li>■ [7] <b>RFC 2833 Relay Decoder Mute</b> = DTMF digits are sent according to RFC 2833 and muted when received.</li> </ul> <p><b>Note:</b> The parameter is automatically updated if the parameters [FirstTxDTMFOption] or [RxDTMFOption] are configured.</p>



Parameter	Description
'DTMF Volume' (-31 to 0 dB) configure voip > media voice > DTMF-volume [DTMFVolume]	Global parameter defining the DTMF gain control value (in decibels). For analog interfaces, this is the gain control to the Tel side.  You can also configure the feature per specific calls, using Tel Profiles (TelProfile_DtmfVolume). For a detailed description of the parameter and for configuring the feature in the Tel Profiles table, see <a href="#">Configuring Tel Profiles</a> .  <b>Note:</b> If the feature is configured for a specific Tel Profile, the settings of the global parameter is ignored for calls associated with the Tel Profile.
DTMF Generation Twist configure voip > media voice > DTMF-generation-twist [DTMFGenerationTwist]	Defines the range (in decibels) between the high and low frequency components in the DTMF signal. Positive decibel values cause the higher frequency component to be stronger than the lower one. Negative values cause the opposite effect. For any parameter value, both components change so that their average is constant.  The valid range is -10 to 10 dB. The default is 0 dB.  <b>Note:</b> For the parameter to take effect, a device reset is required.
inter-digit-interval [DTMFInterDigitInterval]	Defines the time (in msec) between generated DTMF digits (to the Tel side for the Gateway application) if FirstTxDTMFOption = 1, 2 or 3.  The valid range is 0 to 32767. The default is 100.
[DTMFDigitLength]	Defines the time (in msec) for generating DTMF tones (to the Tel side for the Gateway application) if FirstTxDTMFOption = 1, 2 or 3. It also configures the duration that is sent in INFO (Cisco) messages.  The valid range is 0 to 32767. The default is 100.
configure voip > media voice > digit-hangover-time-rx [RxDTMFHangOverTime]	Defines the Voice Silence time (in msec) after playing DTMF or MF digits (to the Tel side for the Gateway application) that arrive as Relay (from the IP side for the Gateway application).  Valid range is 0 to 2,000 msec. The default is 1,000 msec.
configure voip > media voice > digit-hangover-time-tx [TxDTMFHangOverTime]	Defines the Voice Silence time (in msec) after detecting the end of DTMF or MF digits (on the Tel side for the Gateway application) when the DTMF Transport Type is either Relay or Mute.  Valid range is 0 to 2,000 msec. The default is 1,000 msec.

Parameter	Description
'NTE Max Duration' configure voip > media voice > telephony- events-max- duration [NTEMaxDuration]	Defines the maximum time for sending Named Telephony Events / NTEs -- RFC 4733/2833 DTMF relay -- (to the IP side for the Gateway application), regardless of the DTMF signal duration on the other side (TDM for the Gateway application). The range is -1 to 200,000,000 msec. The default is -1 (i.e., NTE stops only upon detection of an End event).

## RTP, RTCP and T.38 Parameters

The RTP, RTCP and T.38 parameters are described in the table below.

**Table 70-36:RTP/RTCP and T.38 Parameters**

Parameter	Description
'Dynamic Jitter Buffer Minimum Delay' configure voip > media rtp-rtcp > jitter- buffer-minimum-delay [DJBufMinDelay]	Global parameter defining the minimum delay (in msec) of the device's dynamic Jitter Buffer.  You can also configure the feature per specific calls, using IP Profiles (IpProfile_JitterBufMinDelay) or Tel Profiles (TelProfile_JitterBufMinDelay). For a detailed description of the parameter and for configuring the feature, see <a href="#">Configuring IP Profiles</a> or <a href="#">Configuring Tel Profiles</a> .  <b>Note:</b> If the feature is configured for a specific profile, the settings of the global parameter is ignored for calls associated with the profile.
'Dynamic Jitter Buffer Optimization Factor' configure voip > media rtp-rtcp > jitter- buffer-optimization- factor [DJBufOptFactor]	Global parameter defining the Dynamic Jitter Buffer frame error/delay optimization factor.  You can also configure the feature per specific calls, using IP Profiles (IpProfile_JitterBufOptFactor) or Tel Profiles (TelProfile_JitterBufOptFactor). For a detailed description of the parameter and for configuring the feature, see <a href="#">Configuring IP Profiles</a> or <a href="#">Configuring Tel Profiles</a> .  <b>Note:</b> If the feature is configured for a specific profile, the settings of the global parameter is ignored for calls associated with the profile.
'Analog Signal Transport Type' [AnalogSignalTransportType]	Defines the analog signal transport type.  ■ [0] <b>Ignore Analog Signals</b> = (Default) Ignore.

Parameter	Description
	<ul style="list-style-type: none"> <li>■ [1] <b>RFC 2833 Analog Signal Relay</b> = Transfer hookflash using RFC 2833.</li> </ul> <p><b>Note:</b> The parameter is applicable only to FXS and FXO interfaces.</p>
<p>'RTP Redundancy Depth'</p> <pre>configure voip &gt; media   rtp-rtcp &gt; RTP-   redundancy-depth</pre> <p>[RTPRedundancyDepth]</p>	<p>Global parameter that enables the device to generate RFC 2198 redundant packets. You can also configure this feature per specific calls, using IP Profiles (IpProfile_RTPRedundancyDepth). For a detailed description of the parameter and for configuring this feature in the IP Profiles table, see <a href="#">Configuring IP Profiles</a>.</p> <p><b>Note:</b> If this feature is configured for a specific IP Profile, the settings of this global parameter is ignored for calls associated with the IP Profile.</p>
<p>'Enable RTP Redundancy Negotiation'</p> <pre>configure voip &gt; sip-   definition settings &gt;   rtp-rcdy-nego-enbl</pre> <p>[EnableRTPRedundancyNegotiation]</p>	<p>Enables the device to include the RTP redundancy dynamic payload type in the SDP (according to RFC 2198).</p> <ul style="list-style-type: none"> <li>■ [0] <b>Disable</b> (default)</li> <li>■ [1] <b>Enable</b> = The device includes in the SDP message the RTP payload type "RED" and the payload type configured by the parameter RFC2198PayloadType.</li> </ul> <pre>a=rtpmap:&lt;PT&gt; RED/8000</pre> <p>Where &lt;PT&gt; is the payload type as defined by RFC2198PayloadType. The device sends the INVITE message with "a=rtpmap:&lt;PT&gt; RED/8000" and responds with a 18x/200 OK and "a=rtpmap:&lt;PT&gt; RED/8000" in the SDP.</p> <p><b>Note:</b></p> <ul style="list-style-type: none"> <li>■ The parameter is applicable only to the Gateway application.</li> <li>■ For this feature to be functional, you must also set the parameter RTPRedundancyDepth to 1 (i.e., enabled).</li> <li>■ Currently, the negotiation of "RED" payload type is not supported and therefore, it should be configured to the same PT value for both</li> </ul>

Parameter	Description
	parties.
'RFC 2198 Payload Type' configure voip > media rtp-rtcp > RTP- redundancy-payload-type [RFC2198PayloadType]	Defines the RTP redundancy packet payload type (according to RFC 2198). The valid value is 96 to 127. The default is 104. <b>Note:</b> The parameter is applicable only if the RTPRedundancyDepth parameter is set to 1.
'Packing Factor' [RTPPackingFactor]	N/A (controlled internally by the device according to the selected coder).
'RFC 2833 TX Payload Type' configure voip > gateway dtmf-supp- service dtmf-and- dialing > telephony- events-payload-type-tx [RFC2833TxPayloadType]	Defines the Tx RFC 2833 DTMF relay dynamic payload type for outbound calls. The valid range is 96 to 127. The default is 96. <b>Note:</b> When RFC 2833 payload type negotiation is used (i.e., the parameter FirstTxDTMFOption is set to 4), this payload type is used for the received DTMF packets. If negotiation isn't used, this payload type is used for receive and for transmit.
'RFC 2833 RX Payload Type' telephony-events- payload-type-rx [RFC2833RxPayloadType]	Defines the Rx RFC 2833 DTMF relay dynamic payload type for inbound calls. The valid range is 96 to 127. The default is 96. <b>Note:</b> When RFC 2833 payload type negotiation is used (i.e., the parameter FirstTxDTMFOption is set to 4), this payload type is used for the received DTMF packets. If negotiation isn't used, this payload type is used for receive and for transmit.
[EnableDetectRemoteMACChange]	Determines whether the device changes the RTP packets according to the MAC address of received RTP packets and according to Gratuitous Address Resolution Protocol (GARP) messages. <ul style="list-style-type: none"><li>■ [0] = Nothing is changed.</li><li>■ [1] = If the device receives RTP packets with a different source MAC address (than the MAC address of the transmitted RTP packets), then it sends RTP packets to this MAC address and removes this IP entry from the device's ARP cache table.</li><li>■ [2] = (Default) The device uses the received</li></ul>

Parameter	Description
	<p>GARP packets to change the MAC address of the transmitted RTP packets.</p> <ul style="list-style-type: none"> <li>■ [3] = Options 1 and 2 are used.</li> </ul> <p><b>Note:</b></p> <ul style="list-style-type: none"> <li>■ For the parameter to take effect, a device reset is required.</li> <li>■ If the device is located in a network subnet which is connected to other gateways using a router that uses Virtual Router Redundancy Protocol (VRRP) for redundancy, then set the parameter to 0 or 2.</li> </ul>
'Forward Invalid RTP Packets' [RTPFWInvalidPacketHandling]	<p>Defines the device's handling of invalid RTP and RTCP packets.</p> <ul style="list-style-type: none"> <li>■ [0] <b>Forward Packets</b> = Forwards the invalid packets as is.</li> <li>■ [1] <b>Forward Packets and Issue Warnings</b> = (Default) Forwards the invalid packets and issues warnings (sent to the Syslog) to notify of the invalid packets.</li> <li>■ [2] <b>Drop Packets and Issue Warnings</b> = Drops the invalid packets and issues warnings to notify of the invalid packets.</li> </ul> <p><b>Note:</b></p> <ul style="list-style-type: none"> <li>■ The parameter is applicable only if the IPProfile_TranscodingMode parameter is configured to <b>RTP Forwarding</b>.</li> <li>■ The parameter is applicable only to the SBC application.</li> </ul>
'Forward Unknown RTP Payload Types' [RtpFWNonConfiguredPTHHandling]	<p>Defines the device's handling of RTP packets that are received with non-configured (unknown) payload types.</p> <ul style="list-style-type: none"> <li>■ [0] <b>Handle as Invalid Packet</b> = (Default) Handles the packet as an invalid packet, according to the RTPFWInvalidPacketHandling parameter.</li> <li>■ [1] <b>Handle as Valid Packet</b> = Handles the</li> </ul>

Parameter	Description
	<p>packet as a valid packet.</p> <p><b>Note:</b></p> <ul style="list-style-type: none"> <li>■ The parameter is applicable only if the <code>IPProfile_TranscodingMode</code> parameter is configured to <b>RTP Forwarding</b>.</li> <li>■ The parameter is applicable only to the SBC application.</li> </ul>
<p>'RTP Base UDP Port'</p> <pre>configure voip &gt; media rtp-rtcp &gt; base-udp- port</pre> <p>[BaseUDPport]</p>	<p>Global parameter that defines the lower boundary of the UDP port used for RTP, RTCP (RTP port + 1) and T.38 (RTP port + 2). For more information on configuring the UDP port range, see <a href="#">Configuring RTP Base UDP Port</a>.</p> <p>The range of possible UDP ports is 6,000 to 65,535. The default base UDP port is 6000.</p> <p><b>Note:</b> For the parameter to take effect, a device reset is required.</p>
<pre>rtcp-act-mode</pre> <p>[RTCPActivationMode]</p>	<p>Disables RTCP traffic when there is no RTP traffic. This feature is useful, for example, to stop RTCP traffic that is typically sent when calls are put on hold (by an INVITE with 'a=inactive' in the SDP).</p> <ul style="list-style-type: none"> <li>■ [0] Active Always = (Default) RTCP is active even during inactive RTP periods, i.e., when the media is in 'recvonly' or 'inactive' mode.</li> <li>■ [1] Inactive Only If RTP Inactive = No RTCP is sent when RTP is inactive.</li> </ul> <p><b>Note:</b> The parameter is applicable only to the Gateway application.</p>
<p>'T.38 Fax Session'</p> <pre>configure voip &gt; sip- definition settings &gt; t38-sess-imm-strt</pre> <p>[T38FaxSessionImmediateStart]</p>	<p>Enables fax transmission of T.38 "no-signal" packets to the terminating fax machine.</p> <ul style="list-style-type: none"> <li>■ [0] <b>Disable</b> (default)</li> <li>■ [1] <b>Immediate Start on Fax</b> = Device activates T.38 fax relay upon receipt of a re-INVITE with T.38 only in the SDP.</li> <li>■ [2] <b>Immediate Start on Fax &amp; Voice</b> = Device activates T.38 fax relay upon receipt of a re-INVITE with T.38 and audio media in the SDP.</li> </ul>

Parameter	Description
	<p>The parameter is used for transmission from fax machines connected to the device and located inside a NAT. Generally, the firewall blocks T.38 (and other) packets received from the WAN, unless the device behind NAT sends at least one IP packet from the LAN to the WAN through the firewall. If the firewall blocks T.38 packets sent from the termination IP fax, the fax fails.</p> <p>To overcome this, the device sends No-Op (“no-signal”) packets to open a pinhole in the NAT for the answering fax machine. The originating fax does not wait for an answer, but immediately starts sending T.38 packets to the terminating fax machine.</p> <p><b>Note:</b> To enable No-Op packet transmission, use the [NoOpEnable] and [NoOpInterval] parameters.</p>
<pre>configure voip &gt; sip- definition settings &gt; t38-use-rtpport [T38UseRTPPort]</pre>	<p>Defines the port (with relation to RTP port) for sending and receiving T.38 packets.</p> <ul style="list-style-type: none"> <li>■ [0] = (Default) Use the RTP port +2 to send/receive T.38 packets.</li> <li>■ [1] = Use the same port as the RTP port to send/receive T.38 packets.</li> </ul> <p><b>Note:</b></p> <ul style="list-style-type: none"> <li>■ For the parameter to take effect, you must reset the device.</li> <li>■ When the device is configured to use V.152 to negotiate audio and T.38 coders, the UDP port published in SDP for RTP and for T38 must be different. Therefore, set the T38UseRTPPort parameter to 0.</li> </ul>
<p>'T38 Fax Max Buffer'</p> <pre>configure voip &gt; sip- definition settings &gt; t38-fax-mx-buff [T38FaxMaxBufferSize]</pre>	<p>Defines the maximum size (in bytes) of the device's T.38 buffer. This value is included in the outgoing SDP when T.38 is used for fax relay over IP.</p> <p>The valid range is 500 to 3000. The default is 1,024.</p>
<b>No-Op Packets Parameters</b>	
no-operation-enable	Enables the device to send RTP or T.38 No-Op

Parameter	Description
[NoOpEnable]	<p>packets during RTP or T.38 silence periods. This mechanism ensures that the NAT binding remains open.</p> <ul style="list-style-type: none"> <li>■ [0] = Disable (default)</li> <li>■ [1] = Enable</li> </ul>
[NoOpInterval]	<p>Defines the interval (msec) between each RTP or T.38 No-Op packet sent by the device during the silence period (i.e., no RTP/T.38 traffic).</p> <p>The valid range is 20 to 600,000. The default is 1,000.</p> <p><b>Note:</b> To enable No-Op packet transmission, use the [NoOpEnable] parameter.</p>
no-operation-interval [RTPNoOpPayloadType]	<p>Defines the payload type of No-Op packets.</p> <p>The valid range is 96 to 127 (for the range of Dynamic RTP Payload Type for all types of non hard-coded RTP Payload types, refer to RFC 3551). The default is 120.</p> <p><b>Note:</b> When configuring the parameter, ensure that its settings don't cause collisions with other payload types.</p>
<p><b>RTP Control Protocol Extended Reports (RTCP XR) Parameters</b></p> <p>For more information on RTCP XR, see <a href="#">Configuring RTCP XR</a>.</p>	
<p>'Enable RTCP XR'</p> <pre>configure voip &gt; media rtp-rtcp &gt; voice- quality-monitoring- enable</pre> <p>[VQMonEnable]</p>	<p>Enables voice quality monitoring and RTCP XR, according to RFC 3611.</p> <ul style="list-style-type: none"> <li>■ [0] <b>Disable</b> (default)</li> <li>■ [1] <b>Enable Fully</b> = Calculates voice quality metrics, uses them for QoE calculations, reports them to OVOC (if configured), and sends them to remote side using RTCP XR.</li> <li>■ [2] <b>Enable Calculation Only</b> = Calculates voice quality metrics, uses them for QoE calculations, reports them to OVOC (if configured), but does not send them to remote side using RTCP XR.</li> </ul> <p><b>Note:</b> For the parameter to take effect, a device reset is required.</p>



Parameter	Description
'Minimum Gap Size' [VQMonGMin]	Defines the voice quality monitoring - minimum gap size (number of frames). The default is 16.
'Burst Threshold' [VQMonBurstHR]	Defines the voice quality monitoring - excessive burst alert threshold. The default is -1 (i.e., no alerts are issued).
'Delay Threshold' [VQMonDelayTHR]	Defines the voice quality monitoring - excessive delay alert threshold. The default is -1 (i.e., no alerts are issued).
'R-Value Delay Threshold' [VQMonEOCRValTHR]	Defines the voice quality monitoring - end of call low quality alert threshold. The default is -1 (i.e., no alerts are issued).
'Tx RTCP Packets Interval' <code>configure voip &gt; media rtp-rtcp &gt; rtcp- interval</code> [RTCPInterval]	Defines the time interval (in msec) between adjacent RTCP XR reports. This interval starts from call establishment. Thus, the device can send RTCP XR reports during the call, in addition to at the end of the call. If the duration of the call is shorter than this interval, RTCP XR is sent only at the end of the call. The valid value range is 0 to 65,535. The default is 5,000.
'Disable RTCP XR Interval Randomization' <code>configure voip &gt; media rtp-rtcp &gt; disable- RTCP-randomization</code> [DisableRTCPRandomize]	Determines whether RTCP report intervals are randomized or whether each report interval accords exactly to the parameter RTCPInterval. <ul style="list-style-type: none"> <li>■ [0] <b>Disable</b> = (Default) Randomize</li> <li>■ [1] <b>Enable</b> = No Randomize</li> </ul>
'Gateway RTCP XR Report Mode' <code>configure voip &gt; sip- definition settings &gt; rtcp-xr-rep-mode</code> [RTCPXRReportMode]	Enables the device to send RTCP XR in SIP PUBLISH messages and defines the interval at which they are sent. <ul style="list-style-type: none"> <li>■ [0] <b>Disable</b> = (Default) RTCP XR is not sent.</li> <li>■ [1] <b>End Call</b> = RTCP XR is sent at the end of the call.</li> <li>■ [2] <b>End Call &amp; Periodic</b> = RTCP XR is sent at the end of the call and periodically according to the RTCPInterval parameter.</li> </ul>

Parameter	Description
	<ul style="list-style-type: none"> <li>■ [3] <b>End Call &amp; End Segment</b> = RTCP XR is sent at the end of the call and at the end of each media segment of the call. A media segment is a change in media, for example, when the coder is changed or when the caller toggles between two called parties (using call hold/retrieve). The RTCP XR sent at the end of a media segment contains information only of that segment. If the segment does not contain RTP/RTCP content, the RTCP XR is not sent. For call hold, the device sends an RTCP XR each time the call is placed on hold and each time it is retrieved. In addition, the Start timestamp in the RTCP XR indicates the start of the media segment; the End timestamp indicates the time of the last sent periodic RTCP XR (typically, up to 5 seconds before reported segment ends).</li> </ul> <p><b>Note:</b> The parameter is applicable only to the Gateway application.</p>
'Publication IP Group ID' publication-ip-group-id [PublicationIPGroupID]	<p>Defines the IP Group to where the device sends RTCP XR reports.</p> <p>By default, no value is defined.</p>
'SBC RTCP XR Report Mode' configure voip > sip- definition settings > sbc-rtcpxr-report-mode [SBCRtcpXrReportMode]	<p>Enables the sending of RTCP XR reports of QoE metrics at the end of each call session (i.e., after a SIP BYE). The RTCP XR is sent in the SIP PUBLISH message.</p> <ul style="list-style-type: none"> <li>■ [0] <b>Disable</b> (default)</li> <li>■ [1] <b>End of Call</b></li> </ul> <p><b>Note:</b> The parameter is applicable only to the SBC application.</p>

## Gateway Application Parameters

this section describes the parameters of the Gateway application.

## Fax and Modem Parameters

The fax and modem parameters are described in the table below.

Table 70-37: Fax and Modem Parameters

Parameter	Description
'Fax Transport Mode' configure voip > media fax- modem > fax-transport-mode [FaxTransportMode]	<p>Determines the fax transport mode used by the device.</p> <ul style="list-style-type: none"> <li>■ [0] <b>Disable</b> = transparent mode</li> <li>■ [1] <b>T.38 Relay</b> (default)</li> <li>■ [2] <b>Bypass</b></li> <li>■ [3] <b>Events Only</b></li> </ul> <p><b>Note:</b> The parameter is overridden by the parameter [IsFaxUsed]. If the parameter [IsFaxUsed] is set to 1 (T.38 Relay) or 3 (Fax Fallback), then [FaxTransportMode] is always set to 1 (T.38 relay).</p>
v34-fax-transport-type [V34FaxTransportType]	<p>Determines the V.34 fax transport method (whether V34 fax falls back to T.30 or pass over Bypass).</p> <ul style="list-style-type: none"> <li>■ [0] = Transparent</li> <li>■ [1] = (Default) Relay</li> <li>■ [2] = Bypass</li> <li>■ [3] = Transparent with Events</li> </ul> <p><b>Note:</b> To configure [V34FaxTransportType] to [1] (i.e., fax relay), you also need to configure [FaxTransportMode] to [1] (fax relay).</p>
'V.21 Modem Transport Type' configure voip > media fax- modem > v21-modem-transport- type [V21ModemTransportType]	<p>Determines the V.21 modem transport type.</p> <ul style="list-style-type: none"> <li>■ [0] <b>Disable</b> = (Default) Transparent.</li> <li>■ [2] <b>Enable Bypass</b></li> <li>■ [3] <b>Events Only</b> = Transparent with Events.</li> </ul> <p><b>Note:</b> You can also configure this feature per specific calls, using IP Profiles (IpProfile_VxxTransportType). For more information, see <a href="#">Configuring IP Profiles</a>.</p>
'V.22 Modem Transport Type'	Determines the V.22 modem transport

Parameter	Description
<pre>configure voip &gt; media fax- modem &gt; V22-modem-transport- type</pre> <p>[V22ModemTransportType]</p>	<p>type.</p> <ul style="list-style-type: none"> <li>■ [0] <b>Disable</b> = Transparent.</li> <li>■ [2] <b>Enable Bypass</b> (default)</li> <li>■ [3] <b>Events Only</b> = Transparent with Events.</li> </ul> <p><b>Note:</b> You can also configure this feature per specific calls, using IP Profiles (IpProfile_VxxTransportType). For more information, see <a href="#">Configuring IP Profiles</a>.</p>
<p>'V.23 Modem Transport Type'</p> <pre>configure voip &gt; media fax- modem &gt; V23-modem-transport- type</pre> <p>[V23ModemTransportType]</p>	<p>Determines the V.23 modem transport type.</p> <ul style="list-style-type: none"> <li>■ [0] <b>Disable</b> = Transparent.</li> <li>■ [2] <b>Enable Bypass</b> (default)</li> <li>■ [3] <b>Events Only</b> = Transparent with Events.</li> </ul> <p><b>Note:</b> You can also configure this feature per specific calls, using IP Profiles (IpProfile_VxxTransportType). For more information, see <a href="#">Configuring IP Profiles</a>.</p>
<p>'V.32 Modem Transport Type'</p> <pre>configure voip &gt; media fax- modem &gt; V32-modem-transport- type</pre> <p>[V32ModemTransportType]</p>	<p>Determines the V.32 modem transport type.</p> <ul style="list-style-type: none"> <li>■ [0] <b>Disable</b> = Transparent.</li> <li>■ [2] <b>Enable Bypass</b> (default)</li> <li>■ [3] <b>Events Only</b> = Transparent with Events.</li> </ul> <p><b>Note:</b></p> <ul style="list-style-type: none"> <li>■ The parameter applies only to V.32 and V.32bis modems.</li> <li>■ You can also configure this feature per specific calls, using IP Profiles (IpProfile_VxxTransportType). For more information, see <a href="#">Configuring IP Profiles</a>.</li> </ul>
<p>'V.34 Modem Transport Type'</p>	<p>Determines the V.90/V.34 modem</p>

Parameter	Description
<pre>configure voip &gt; media fax- modem &gt; V34-modem-transport- type</pre> <p>[V34ModemTransportType]</p>	<p>transport type.</p> <ul style="list-style-type: none"> <li>■ [0] <b>Disable</b> = Transparent.</li> <li>■ [2] <b>Enable Bypass</b> (default)</li> <li>■ [3] <b>Events Only</b> = Transparent with Events.</li> </ul> <p><b>Note:</b> You can also configure this feature per specific calls, using IP Profiles (IpProfile_VxxTransportType). For more information, see <a href="#">Configuring IP Profiles</a>.</p>
<pre>bell-modem-transport-type</pre> <p>[BellModemTransportType]</p>	<p>Determines the Bell modem transport method.</p> <ul style="list-style-type: none"> <li>■ [0] <b>Disable</b> = Transparent.</li> <li>■ [2] <b>Enable Bypass</b> (default)</li> <li>■ [3] <b>Events Only</b> = Transparent with Events.</li> </ul>
<p>'Fax CNG Mode'</p> <pre>configure voip &gt; media fax- modem &gt; fax_cng_mode</pre> <p>[FaxCNGMode]</p>	<p>Determines the device's handling of fax relay upon detection of a fax CNG tone from originating faxes.</p> <ul style="list-style-type: none"> <li>■ [0] <b>Doesn't send T.38 Re-INVITE</b> = (Default) SIP re-INVITE is not sent.</li> <li>■ [1] <b>Sends on CNG tone</b> = Sends a SIP re-INVITE with T.38 parameters in SDP to the terminating fax upon detection of a fax CNG tone, if the CNGDetectorMode parameter is set to 1.</li> </ul> <p><b>Note:</b></p> <ul style="list-style-type: none"> <li>■ This feature is applicable only if the IsFaxUsed parameter is set to [1] or [3].</li> <li>■ The device also sends T.38 re-INVITE if the CNGDetectorMode parameter is set to [2], regardless of the FaxCNGMode parameter settings.</li> </ul>
<p>'CNG Detector Mode'</p>	<p>Global parameter that enables the</p>

Parameter	Description
<pre>configure voip &gt; media fax- modem &gt; coder [CNGDetectorMode]</pre>	<p>detection of the fax calling tone (CNG) and defines the detection method. You can also configure this feature per specific calls, using IP Profiles (IpProfile_CNGmode). For a detailed description of the parameter and for configuring this feature in the IP Profiles table, see <a href="#">Configuring IP Profiles</a>.</p> <p><b>Note:</b> If this feature is configured for a specific IP Profile, the settings of this global parameter is ignored for calls associated with the IP Profile.</p>
<pre>'Fax Detect Timeout Since Connect' fax-detect-timeout-since- connect [FaxDetectTimeoutSinceConnect]</pre>	<p>Defines a timeout (in msec) for detecting fax from the Tel side during an established voice call. The interval starts from when the voice call is established. If the device detects a fax tone within the interval, it ends the voice session and sends a T.38 or VBD re-INVITE message to the IP side and processes the fax. If the interval expires without any received fax event, the device ignores all subsequent fax events during the voice session.</p> <p>The valid value is 0 to 120000. The default is 0. If set to 0, the device can detect fax during the entire voice call.</p> <p><b>Note:</b> The parameter is applicable only to the Gateway application.</p>
<pre>'SIP T.38 Version' configure voip &gt; sip- definition settings &gt; sip- t38-ver [SIPT38Version]</pre>	<p>Defines the T.38 fax relay version.</p> <ul style="list-style-type: none"> <li>■ [-1] <b>Not Configured</b> = (Default) No T.38</li> <li>■ [0] <b>Version 0</b></li> </ul> <p><b>Note:</b></p> <ul style="list-style-type: none"> <li>■ For a description on V.34 over T.38 fax relay, see <a href="#">V.34 Fax Support</a>.</li> </ul>
<pre>'Fax Relay Enhanced Redundancy Depth' configure voip &gt; media fax- modem &gt; enhanced-redundancy-</pre>	<p>Defines the number of times that control packets are retransmitted when using the T.38 standard.</p>

Parameter	Description
depth [FaxRelayEnhancedRedundancyDepth]	The valid range is 0 to 4. The default is 2.
'Fax Relay Redundancy Depth' configure voip > media fax- modem > redundancy-depth [FaxRelayRedundancyDepth]	Defines the number of times that each fax relay payload is retransmitted to the network. <ul style="list-style-type: none"> <li>■ [0] <b>0</b> = (Default) No redundancy</li> <li>■ [1] <b>1</b> = One-packet redundancy</li> <li>■ [2] <b>2</b> = Two-packet redundancy</li> </ul> <p><b>Note:</b> The parameter is applicable only to non-V.21 packets.</p>
'Fax Relay Max Rate' (bps) configure voip > media fax- modem > max-rate [FaxRelayMaxRate]	Defines the maximum rate (in bps) at which fax relay messages are transmitted (outgoing calls). <ul style="list-style-type: none"> <li>■ [0] <b>2400</b> = 2.4 kbps</li> <li>■ [1] <b>4800</b> = 4.8 kbps</li> <li>■ [2] <b>7200</b> = 7.2 kbps</li> <li>■ [3] <b>9600</b> = 9.6 kbps</li> <li>■ [4] <b>12000</b> = 12.0 kbps</li> <li>■ [5] <b>14400</b> = 14.4 kbps</li> </ul> <p><b>Note:</b></p> <ul style="list-style-type: none"> <li>■ The rate is negotiated between both sides (i.e., the device adapts to the capabilities of the remote side). Negotiation of the T.38 maximum supported fax data rate is provided in SIP's SDP T38MaxBitRate parameter. The negotiated T38MaxBitRate is the minimum rate supported between the local and remote endpoints.</li> </ul>
'Fax Relay ECM Enable' configure voip > media fax- modem > ecm-mode [FaxRelayECMEnable]	Enables Error Correction Mode (ECM) mode during fax relay. <ul style="list-style-type: none"> <li>■ [0] <b>Disable</b></li> <li>■ [1] <b>Enable</b> (default)</li> </ul>

Parameter	Description
'Fax/Modem Bypass Coder Type' [FaxModemBypassCoderType]	Determines the coder used by the device when performing fax/modem bypass. Typically, high-bit-rate coders such as G.711 should be used. <ul style="list-style-type: none"> <li>■ [0] <b>G.711Alaw</b> = (Default) G.711 A-law 64</li> <li>■ [1] <b>G.711Mulaw</b> = G.711 Mu-law</li> </ul>
configure voip > media fax-modem > fax-modem-telephony-events-mode [FaxModemNTEMode]	Determines whether the device sends RFC 2833 ANS/ANSam events upon detection of fax and/or modem Answer tones (i.e., CED tone). <ul style="list-style-type: none"> <li>■ [0] = Disabled (default)</li> <li>■ [1] = Enabled</li> </ul> <p><b>Note:</b> The parameter is applicable only when the fax or modem transport type is set to bypass or Transparent-with-Events.</p>
'Fax Bypass Payload Type' configure voip > media rtp-rtcp > fax-bypass-payload-type [FaxBypassPayloadType]	Defines the fax bypass RTP dynamic payload type. The valid range is 0 to 127. The default is 102.
configure voip > media rtp-rtcp > modem-bypass-payload-type [ModemBypassPayloadType]	Defines the modem bypass dynamic payload type. The range is 0 to 127. The default is 103.
volume [FaxModemRelayVolume]	Defines the fax gain control. The range is -18 to -3, corresponding to -18 dBm to -3 dBm in 1-dB steps. The default is -6 dBm fax gain control.
'Fax Bypass Output Gain' configure voip > media fax-modem > fax-bypass-output-gain [FaxBypassOutputGain]	Defines the fax bypass output gain control. The range is -31 to +31 dB, in 1-dB steps. The default is 0 (i.e., no gain).
'Modem Bypass Output Gain'	Defines the modem bypass output gain



Parameter	Description
<pre>configure voip &gt; media fax- modem &gt; modem-bypass-output- gain</pre> <p>[ModemBypassOutputGain]</p>	<p>control.</p> <p>The range is -31 dB to +31 dB, in 1-dB steps. The default is 0 (i.e., no gain).</p>
<pre>modem-bypass-output-gain</pre> <p>[FaxModemBypassBasicRTTPacketInterval]</p>	<p>Defines the basic frame size used during fax/modem bypass sessions.</p> <ul style="list-style-type: none"> <li>■ [0] = (Default) Determined internally</li> <li>■ [1] = 5 msec (not recommended)</li> <li>■ [2] = 10 msec</li> <li>■ [3] = 20 msec</li> </ul> <p><b>Note:</b> When set to 5 msec (1), the maximum number of simultaneous channels supported is 120.</p>
<pre>jitter-buffer-minimum-delay</pre> <p>[FaxModemBypasDJBufMinDelay]</p>	<p>Defines the Jitter Buffer delay (in milliseconds) during fax and modem bypass session.</p> <p>The range is 0 to 150 msec. The default is 40.</p>
<pre>enable-fax-modem-inband- network-detection</pre> <p>[EnableFaxModemInbandNetworkDetection]</p>	<p>Enables in-band network detection related to fax/modem.</p> <ul style="list-style-type: none"> <li>■ [0] = (Default) Disable.</li> <li>■ [1] = Enable. When the parameter is enabled on Bypass and transparent with events mode (VxxTransportType is set to 2 or 3), a detection of an Answer Tone from the network triggers a switch to bypass mode in addition to the local Fax/Modem tone detections. However, only a high bit-rate coder voice session effectively detects the Answer Tone sent by a remote endpoint. This can be useful when, for example, the payload of voice and bypass is the same, allowing the originator to switch to bypass mode as well.</li> </ul>

Parameter	Description
NSE-mode [NSEMode]	<p>Global parameter that enables Cisco's compatible fax and modem bypass mode, Named Signaling Event (NSE) packets. You can also configure this feature per specific calls, using IP Profiles (IpProfile_ NSEMode). For a detailed description of the parameter and for configuring this feature in the IP Profiles table, see <a href="#">Configuring IP Profiles</a>.</p> <p><b>Note:</b> If this feature is configured for a specific IP Profile, the settings of this global parameter is ignored for calls associated with the IP Profile.</p>
NSE-payload-type [NSEPayloadType]	<p>Defines the NSE payload type for Cisco Bypass compatible mode.</p> <p>The valid range is 96-127. The default is 105.</p> <p><b>Note:</b> Cisco gateways usually use NSE payload type of 100.</p>
'T.38 Max Datagram Size' configure voip > sip- definition settings > t38-mx- datagram-sz [T38MaxDatagramSize]	<p>Defines the maximum size of a T.38 datagram that the device can receive. This value is included in the outgoing SDP when T.38 is used.</p> <p>The valid range is 120 to 600. The default is 238.</p>
'Detect Fax on Answer Tone' det-fax-on-ans-tone [DetFaxOnAnswerTone]	<p>Determines when the device initiates a T.38 session for fax transmission.</p> <ul style="list-style-type: none"> <li>■ [0] <b>Initiate T.38 on Preamble</b> = (Default) The device to which the called fax is connected initiates a T.38 session on receiving HDLC (analog) . Preamble signal from the fax.</li> <li>■ [1] <b>Initiate T.38 on CED</b> = The device to which the called fax is connected initiates a T.38 session on receiving a CED answer tone from the fax. This option can only be used to relay fax signals, as the device sends T.38 Re-INVITE on detection of any</li> </ul>

Parameter	Description
	<p>fax/modem Answer tone (2100 Hz, amplitude modulated 2100 Hz, or 2100 Hz with phase reversals). The modem signal fails when using T.38 for fax relay.</p> <p><b>Note:</b> The parameters is applicable only if the IsFaxUsed parameter is set to 1 (T.38 Relay) or 3 (Fax Fallback).</p>
<p>'CED Transfer Mode'</p> <pre>configure voip &gt; media fax- modem &gt; ced-transfer-mode [CETransferMode]</pre>	<p>Defines the method for sending fax/modem CED (answering) tones.</p> <ul style="list-style-type: none"> <li>■ [0] <b>Fax Relay or VBD</b> = (Default) The device transfers the CED tone in Relay mode and starts the fax session immediately.</li> <li>■ [1] <b>Voice Mode or VBD</b> = The device transfers the CED tone in either Voice or Bypass mode and starts the fax session on V21 preamble.</li> <li>■ [2] <b>RFC 4733 Blocking RTP VBD</b> = The device transfers the CED tone in RFC 2833.</li> <li>■ [3] <b>RFC 4733 Along with RTP VBD</b> = The device transfers the CED tone in RFC 2833 and bypass, in parallel.</li> </ul>

## DTMF and Hook-Flash Parameters

The DTMF and hook-flash parameters are described in the table below.

**Table 70-38:DTMF and Hook-Flash Parameters**

Parameter	Description
<b>Hook-Flash Parameters</b>	
<p>'Hook-Flash Code'</p> <pre>configure voip &gt; gateway dtmf-supp-service supp- service-settings &gt; hook- flash-code</pre>	<p>Analog interfaces: Defines the digit pattern that when received from the Tel side, indicates a Hook Flash event.</p> <p>Digital interfaces: Defines the digit pattern used by the PBX to indicate a Hook Flash event. When</p>

Parameter	Description
[HookFlashCode]	<p>this pattern is detected from the Tel side, the device responds as if a Hook Flash event has occurred and sends a SIP INFO message if the HookFlashOption parameter is set to 1, 5, 6, or 7 (indicating a Hook Flash). If configured and a Hook Flash indication is received from the IP side, the device generates this pattern to the Tel side.</p> <p>The valid range is a 25-character string. The default is a null string.</p> <p><b>Note:</b> The parameter can also be configured in a Tel Profile.</p>
<p>'Hook-Flash Option'</p> <pre>configure voip &gt; gateway dtmf-supp-service dtmf- and-dialing &gt; hook-flash- option</pre> <p>[HookFlashOption]</p>	<p>Defines the hook-flash transport type (i.e., method by which hook-flash is sent and received).</p> <p>Digital interfaces: The feature is applicable only if the HookFlashCode parameter is configured.</p> <ul style="list-style-type: none"> <li>■ [0] <b>Not Supported</b> = (Default) Hook-Flash indication is not sent.</li> <li>■ [1] <b>INFO</b> = Sends proprietary INFO message (Broadsoft) with Hook-Flash indication. <p>Digital interfaces: The device sends the INFO message as follows:</p> <pre>Content-Type: application/broadsoft; version=1.0</pre> <p>Content-Length: 17</p> <pre>event flashhook</pre> </li> <li>■ [4] <b>RFC 2833</b> = This option is currently not supported for digital interfaces.</li> <li>■ [5] <b>INFO (Lucent)</b> = Sends proprietary SIP INFO message with Hook-Flash indication. <p>The device sends the INFO message as follows:</p> <pre>Content-Type: application/hook- flash</pre> <p>Content-Length: 11</p> <pre>signal=hf</pre> </li> </ul>

Parameter	Description
	<ul style="list-style-type: none"> <li>■ [6] <b>INFO (NetCentrex)</b> = Sends proprietary SIP INFO message with Hook-Flash indication. The device sends the INFO message as follows:  Content-Type: application/dtmf-relay Signal=16  Where 16 is the DTMF code for hook flash.</li> <li>■ [7] <b>INFO (HUAWEI)</b> = Sends a SIP INFO message with Hook-Flash indication. The device sends the INFO message as follows:  Content-Length: 17 Content-Type: application/sscc event=flashhook</li> </ul> <p><b>Note:</b></p> <ul style="list-style-type: none"> <li>■ Digital interfaces: The device can interwork DTMF HookFlashCode to SIP INFO messages with Hook Flash indication.</li> <li>■ FXO interfaces support only the receipt of RFC 2833 Hook-Flash signals and INFO [1] type.</li> <li>■ FXS interfaces send Hook-Flash signals only if the EnableHold parameter is set to 0.</li> </ul>
<pre>configure voip &gt; gw dtmf- and-suppl &gt; gw digitalgw digital-gw-parameters &gt; flash-from-media-ip [HookFlashFromMediaIP]</pre>	<p>Defines the device's handling of hook-flash telephony events that are received in the media (RTP) from the IP side (typically, RFC 2833) and then sent to the PSTN CAS side.</p> <ul style="list-style-type: none"> <li>■ [0] = (Default) The device ignores incoming hook-flash events from the media IP.</li> <li>■ [1] = The device generates a wink to the CAS side when it receives a hook-flash event from the media IP.</li> </ul> <p><b>Note:</b> The parameter is applicable only to E1/T1 CAS.</p>
<p>'Min. Flash-Hook Detection Period' configure voip &gt;</p>	<p>Defines the minimum time (in msec) for detection of a hook-flash event. Detection is</p>

Parameter	Description
<pre>interface fxs-fxo &gt; min- flash-hook-time</pre> <p>[MinFlashHookTime]</p>	<p>guaranteed for hook-flash periods of at least 60 msec (when setting the minimum time to 25). Hook-flash signals that last a shorter period of time are ignored.</p> <p>The valid range is 25 to 300. The default is 300.</p> <p><b>Note:</b></p> <ul style="list-style-type: none"> <li>■ The parameter is applicable only to FXS interfaces.</li> <li>■ It's recommended to reduce the detection time by 50 msec from the desired value. For example, if you want to set the value to 200 msec, then enter 150 msec (i.e., 200 minus 50).</li> </ul>
<p>'Max. Flash-Hook Detection Period'</p> <pre>configure voip &gt; interface fxs-fxo &gt; flash-hook-period</pre> <p>[FlashHookPeriod]</p>	<p>Global parameter defining the hook-flash period (in msec) for Tel and IP sides.</p> <p>You can also configure the feature per specific calls, using Tel Profiles (TelProfile_ FlashHookPeriod). For a detailed description of the parameter and for configuring the feature in the Tel Profiles table, see <a href="#">Configuring Tel Profiles</a>.</p> <p><b>Note:</b></p> <ul style="list-style-type: none"> <li>■ The parameter is applicable only to FXS and FXO interfaces.</li> <li>■ If the feature is configured for a specific Tel Profile, the settings of the global parameter is ignored for calls associated with the Tel Profile.</li> </ul>
<b>DTMF Parameters</b>	
<pre>notify-on-sig-end</pre> <p>[MGCPDTMFDetectionPoint]</p>	<p>Determines when the detection of DTMF events is notified.</p> <ul style="list-style-type: none"> <li>■ [0] = DTMF event is reported at the end of a detected DTMF digit.</li> <li>■ [1] = (Default) DTMF event is reported at the start of a detected DTMF digit.</li> </ul>
<p>'Declare RFC 2833 in SDP'</p> <pre>configure voip &gt; gateway</pre>	<p>Global parameter that enables the device to declare the RFC 2833 'telephony-event'</p>

Parameter	Description
<pre>dtmf-suppress-service dtmf- and-dialing &gt; rfc-2833- in-sdp</pre> <p>[RxDTMFOption]</p>	<p>parameter in the SDP. You can also configure this feature per specific calls, using IP Profiles (IpProfile_RxDTMFOption). For a detailed description of the parameter and for configuring this feature in the IP Profiles table, see <a href="#">Configuring IP Profiles</a>.</p> <p><b>Note:</b> If this feature is configured for a specific IP Profile, the settings of this global parameter is ignored for calls associated with the IP Profile.</p>
<p>'First Tx DTMF Option'</p> <pre>configure voip &gt; gateway dtmf-suppress-service dtmf- and-dialing &gt; first-dtmf- option-type</pre> <p>[FirstTxDTMFOption]</p>	<p>Defines the first preferred transmit (Tx) DTMF negotiation method.</p> <ul style="list-style-type: none"> <li>■ [0] <b>Not Supported</b> = (Default) No negotiation. DTMF digits are sent according to the [DTMFTransportType] and [RFC2833PayloadType] parameters. The RFC 2833 payload type is according to the [RFC2833PayloadType] parameter for transmit and receive.</li> <li>■ [1] <b>Info NORTEL</b> = Sends DTMF digits according to IETF Internet-Draft draft-choudhuri-sip-info-digit-00.</li> <li>■ [2] <b>NOTIFY</b> = Sends DTMF digits according to IETF Internet-Draft draft-mahy-sipping-sigaled-digits-01.</li> <li>■ [3] <b>Info Cisco</b> = Sends DTMF digits according to Cisco format.</li> <li>■ [4] <b>RFC 2833</b> = The device handles DTMF as follows: <ul style="list-style-type: none"> <li>✓ Negotiates RFC 2833 payload type using local and remote SDPs.</li> <li>✓ Sends DTMF packets using RFC 2833 payload type according to the payload type in the received SDP.</li> <li>✓ Expects to receive RFC 2833 packets with the same payload type according to the RFC2833PayloadType parameter.</li> <li>✓ Removes DTMF digits in transparent mode (as part of the voice stream).</li> </ul> </li> </ul>

Parameter	Description
	<ul style="list-style-type: none"> <li>■ [5] <b>Info KOREA</b> = Sends DTMF digits according to Korea Telecom format.</li> </ul> <p><b>Note:</b></p> <ul style="list-style-type: none"> <li>■ When out-of-band DTMF transfer is used -- [1], [2], [3], or [5] -- the [DTMFTransportType] parameter is automatically set to [0] (i.e., DTMF digits are erased from the RTP stream).</li> <li>■ Digital interfaces: If an ISDN phone user presses digits (e.g., for interactive voice response / IVR applications such as retrieving voice mail messages), ISDN Information messages received by the device for each digit are sent in the voice channel to the IP network as DTMF signals, according to the settings of the parameter.</li> <li>■ For more information on DTMF transport, see <a href="#">Configuring DTMF Transport Types</a>.</li> <li>■ You can also configure the parameter per specific calls, using IP Profiles (IpProfile_FirstTxDtmfOption). To configure IP Profiles, see <a href="#">Configuring IP Profiles</a>.</li> </ul>
<p>'Second Tx DTMF Option'</p> <pre>configure voip &gt; gateway dtmf-supp-service dtmf- and-dialing &gt; second- dtmf-option-type [SecondTxDTMFOption]</pre>	<p>Defines the second preferred transmit (Tx) DTMF negotiation method. The first preferred method is configured by the FirstTxDTMFOption parameter. For a description of the optional values for the parameter, see the FirstTxDTMFOption parameter above.</p> <p><b>Note:</b> You can also configure the parameter per specific calls, using IP Profiles (IpProfile_SecondTxDtmfOption). To configure IP Profiles, see <a href="#">Configuring IP Profiles</a>.</p>
<p>[AdditionalOutOfBandDtmfFormat]</p>	<p>Enables the device to simultaneously send DTMF tones (signals) in SIP messages such as INFO messages (out-of-band) and in RTP media streams (in-band) with a special payload type (as defined in RFC 2833), when the FirstTxDTMFOption parameter is configured to 4. The parameter must be configured to the method for transporting DTMF digits over the IP</p>



Parameter	Description
	<p>network to the remote endpoint. For more information on DTMF transport, see <a href="#">Configuring DTMF Transport Types</a>.</p> <ul style="list-style-type: none"> <li>■ [0] = (Default) DTMF is sent according to FirstTxDTMFOption.</li> <li>■ [1] = Nortel</li> <li>■ [2] = Cisco</li> <li>■ [3] = Threecom</li> <li>■ [4] = Korea</li> </ul>
<pre>configure voip &gt; gateway dtmf-supp-service dtmf- and-dialing &gt; auto-dtmf- mute [DisableAutoDTMFMute]</pre>	<p>Enables the automatic muting of DTMF digits when out-of-band DTMF transmission is used.</p> <ul style="list-style-type: none"> <li>■ [0] = (Default) Automatic mute is used.</li> <li>■ [1] = No automatic mute of in-band DTMF.</li> </ul> <p>When the parameter is set to [1], the DTMF transport type is set according to the parameter [DTMFTransportType] and the DTMF digits aren't muted if out-of-band DTMF mode is selected -- [FirstTxDTMFOption] set to [1], [2] or [3]. This enables the sending of DTMF digits in-band (transparent of RFC 2833) in addition to out-of-band DTMF messages.</p> <p><b>Note:</b> This mode is usually not recommended.</p>
<p>'Enable Digit Delivery to IP'</p> <pre>configure voip &gt; sip- definition settings &gt; digit-delivery-2ip [EnableDigitDelivery2IP]</pre>	<p>Enables the Digit Delivery feature whereby DTMF digits are sent to the destination IP address after the Tel-to-IP call is answered.</p> <ul style="list-style-type: none"> <li>■ [0] <b>Disable</b> (default)</li> <li>■ [1] <b>Enable</b> = Enable digit delivery to IP.</li> </ul> <p>To enable this feature, modify the called number to include at least one 'p' character. The device uses the digits before the 'p' character in the initial INVITE message. After the call is answered, the device waits for the required time (number of 'p' multiplied by 1.5 seconds), and then sends the rest of the DTMF digits using the method chosen (in-band or out-of-band).</p> <p><b>Note:</b> The called number can include several 'p'</p>

Parameter	Description
<p>'Enable Digit Delivery to Tel'</p> <pre>configure voip &gt; sip- definition settings &gt; digit-delivery-2tel</pre> <p>[EnableDigitDelivery]</p>	<p>characters (1.5 seconds pause), for example, 1001pp699, 8888p9p300.</p> <p>Global parameter enabling the Digit Delivery feature, which sends DTMF digits of the called number to the Tel side (analog port or B-channel for digital interfaces) after the call is answered (i.e., line is off-hooked for FXS, or seized for FXO) for IP-to-Tel calls.</p> <p>You can also configure the feature per specific calls, using Tel Profiles (TelProfile_ EnableDigitDelivery). For a detailed description of the parameter and To configure the feature in the Tel Profiles table, see <a href="#">Configuring Tel Profiles</a>.</p> <p><b>Note:</b> If the feature is configured for a specific Tel Profile, the settings of the global parameter is ignored for calls associated with the Tel Profile.</p>
<p>Replace Number Sign With Escape</p> <pre>configure voip &gt; sip- definition settings &gt; replace-nb-sign-w-esc</pre> <p>[ReplaceNumberSignWithEscapeChar]</p>	<p>Determines whether to replace the number sign (#) with the escape character (%23) in outgoing SIP messages for Tel-to-IP calls.</p> <ul style="list-style-type: none"> <li>■ [0] <b>Disable</b> (default).</li> <li>■ [1] <b>Enable</b> = All number signs #, received in the dialed DTMF digits are replaced in the outgoing SIP Request-URI and To headers with the escape sign %23.</li> </ul> <p><b>Note:</b></p> <ul style="list-style-type: none"> <li>■ The parameter is applicable only if the parameter IsSpecialDigits is set 1.</li> <li>■ The parameter is applicable only to analog interfaces.</li> </ul>
<p>'Special Digit Representation'</p> <pre>configure voip &gt; gateway dtmf-supp-service dtmf- and-dialing &gt; special- digit-rep</pre> <p>[UseDigitForSpecialDTMF]</p>	<p>Defines the representation for 'special' digits ('*' and '#') that are used for out-of-band DTMF signaling (using SIP INFO/NOTIFY).</p> <ul style="list-style-type: none"> <li>■ [0] <b>Special</b> = (Default) Uses the strings '*' and '#'.</li> <li>■ [1] <b>Numeric</b> = Uses the numerical values 10 and 11.</li> </ul>

Parameter	Description
<code>isdn-keypad-mode</code> [ISDNKeypadMode]	<p>Enables the device to send DTMF digits received in the called party number from the IP side, as Keypad facility IE in ISDN INFORMATION messages to PSTN.</p> <ul style="list-style-type: none"> <li>■ [0] = (Default) Don't send - all digits are sent as DTMF to PSTN (i.e., not sent as Keypad).</li> <li>■ [1] = During Call Establishment - DTMF digits after * or # (inclusive) are sent as Keypad only during call establishment and call disconnect. During an established call, all digits are sent as DTMF.</li> <li>■ [2] = Always - DTMF digits after * or # (inclusive) are always sent as Keypad (call establishment, connect, and disconnect).</li> </ul> <p>For more information, see <a href="#">Interworking Keypad DTMFs for SIP-to-ISDN Calls</a>.</p> <p><b>Note:</b></p> <ul style="list-style-type: none"> <li>■ This feature is not applicable to re-INVITE messages.</li> <li>■ The parameter is applicable only to digital interfaces.</li> </ul>

## Digit Collection and Dial Plan Parameters

The digit collection and dial plan parameters are described in the table below.

**Table 70-39: Digit Collection and Dial Plan Parameters**

Parameter	Description
'Dial Plan Index' <code>configure voip &gt; gateway            dtmf-supp-service dtmf-and-            dialing &gt; dial-plan-index</code> [DialPlanIndex]	<p>Defines the Dial Plan index to use in the external Dial Plan file. The Dial Plan file is loaded to the device as a .dat file (converted using the DConvert utility). The Dial Plan index can be defined globally or per Tel Profile.</p> <p>The valid value range is 0 to 7, where 0 denotes PLAN1, 1 denotes PLAN2, and so on. The default is -1, indicating that no Dial Plan file is used.</p> <p><b>Note:</b></p>

Parameter	Description
	<ul style="list-style-type: none"> <li>■ If the parameter is configured to select a Dial Plan index, the settings of the parameter DigitMapping are ignored.</li> <li>■ If the parameter is configured to select a Dial Plan index from an external Dial Plan file, the device first attempts to locate a matching digit pattern in the Dial Plan file, and if not found, then attempts to locate a matching digit pattern in the Digit Map rules configured by the DigitMapping parameter.</li> <li>■ Digital interfaces: The parameter is also applicable to ISDN with overlap dialing.</li> <li>■ Digital interfaces: or E1 CAS MFC-R2 variants (which don't support terminating digit for the called party number, usually I-15), the parameter and the DigitMapping parameter are ignored. Instead, you can define a Dial Plan template per trunk using the parameter CasTrunkDialPlanName_x (or in the Trunk Settings page).</li> <li>■ The parameter can also be configured in a Tel Profile.</li> <li>■ For more information on the Dial Plan file, see <a href="#">Dialing Plans for Digit Collection</a>.</li> </ul>
<pre>configure voip &gt; gateway manipulation settings &gt; tel2ip-src-nb-map-dial- index [Tel2IPSourceNumberMappingDialPlanIn dex]</pre>	<p>Defines the Dial Plan index in the external Dial Plan file for the Tel-to-IP Source Number Mapping feature.</p> <p>The valid value range is 0 to 7, defining the Dial Plan index [Plan x] in the Dial Plan file. The default is -1 (disabled).</p> <p>For more information on this feature, see <a href="#">Modifying ISDN-to-IP Calling Party Number using Dial Plan File</a>.</p>
<p>'Digit Mapping Rules'</p> <pre>configure voip &gt; gateway dtmf-supp-service dtmf-and- dialing &gt; digitmapping</pre>	<p>Defines the digit map pattern. If the digit string (i.e., dialed number) matches one of the patterns in the digit map, the device stops collecting digits and establishes a call with the collected number. For digital interfaces: This is</p>

Parameter	Description
[DigitMapping]	<p>used to reduce the dialing period for ISDN overlap dialing.</p> <p>The digit map pattern can contain up to 52 options (rules), each separated by a vertical bar ( ). The maximum length of the entire digit pattern is 152 characters. The available notations include the following:</p> <ul style="list-style-type: none"> <li>■ <b>[n-m]</b>: Range of numbers (not letters).</li> <li>■ <b>.</b> (single dot): Repeat digits until next notation (e.g., T).</li> <li>■ <b>x</b>: Any single digit.</li> <li>■ <b>T</b>: Dial timeout (configured by the TimeBetweenDigits parameter).</li> <li>■ <b>S</b>: Short timer (configured by the TimeBetweenDigits parameter; default is two seconds) that can be used when a specific rule is defined after a more general rule. For example, if the digit map is 99 998, then the digit collection is terminated after the first two 9 digits are received. Therefore, the second rule of 998 can never be matched. But when the digit map is 99s 998, then after dialing the first two 9 digits, the device waits another two seconds within which the caller can enter the digit 8.</li> </ul> <p>An example of a digit map is shown below:  11xS 00T [1-7]xxx 8xxxxxxx #xxxxxxx *xx 91xxxxxxxxxx 9011x.T</p> <p>In the example above, the last rule can apply to International numbers: 9 for dialing tone, 011 Country Code, and then any number of digits for the local number ('x.').</p> <p><b>Note:</b></p> <ul style="list-style-type: none"> <li>■ For ISDN interfaces, the digit map mechanism is applicable only when ISDN overlap dialing is used (ISDNRxOverlap is set to 1).</li> </ul>

Parameter	Description
	<ul style="list-style-type: none"> <li>■ If the DialPlanIndex parameter is configured (to select a Dial Plan index), then the device first attempts to locate a matching digit pattern in the Dial Plan file, and if not found, then attempts to locate a matching digit pattern in the Digit Map rules configured by the DigitMapping parameter.</li> <li>■ For more information on digit mapping, see <a href="#">Digit Mapping</a>.</li> </ul>
<p>'Max Digits in Phone Num'</p> <pre>configure voip &gt; gateway dtmf-supp-service dtmf-and- dialing &gt; mxdig-b4-dialing [MaxDigits]</pre>	<p>Defines the maximum number of collected destination number digits that can be received from the Tel side for analog interfaces or for digital interfaces, when ISDN Tel-to-IP overlap dialing is performed. When the number of collected digits reaches this maximum, the device uses these digits for the called destination number.</p> <p>The valid range is 1 to 49. The default is 5 for analog interfaces and 30 for digital interfaces.</p> <p><b>Note:</b></p> <ul style="list-style-type: none"> <li>■ Instead of using the parameter, Digit Mapping rules can be configured.</li> <li>■ Analog: Dialing ends when any of the following scenarios occur: <ul style="list-style-type: none"> <li>✓ Maximum number of digits is dialed</li> <li>✓ Interdigit Timeout (TimeBetweenDigits) expires</li> <li>✓ Pound (#) key is pressed</li> <li>✓ Digit map pattern is matched</li> </ul> </li> </ul>
<p>'Inter Digit Timeout for Overlap Dialing'</p> <pre>configure voip &gt; gateway dtmf-supp-service dtmf-and- dialing &gt; time-btwn-dial- digs [TimeBetweenDigits]</pre>	<p>Analog: Defines the time (in seconds) that the device waits between digits that are dialed by the user.</p> <p>ISDN overlap dialing: Defines the time (in seconds) that the device waits between digits that are received from the PSTN or IP during overlap dialing.</p>

Parameter	Description
	<p>When this inter-digit timeout expires, the device uses the collected digits to dial the called destination number.</p> <p>The valid range is 1 to 10. The default is 4.</p>
<p>'Enable Special Digits'</p> <pre>configure voip &gt; gateway dtmf-supp-service dtmf-and- dialing &gt; special-digits [IsSpecialDigits]</pre>	<p>Enables the use of the asterisk (*) and pound (#) digits in dialed telephone numbers.</p> <ul style="list-style-type: none"> <li>■ [0] <b>Disable</b> = Use '*' or '#' to terminate number collection (refer to the parameter UseDigitForSpecialDTMF). (Default.)</li> <li>■ [1] <b>Enable</b> = Allows '*' and '#' for telephone numbers dialed by a user or for the endpoint telephone number.</li> </ul> <p><b>Note:</b></p> <ul style="list-style-type: none"> <li>■ The symbols can always be used as the first digit of a dialed number even if you disable the parameter.</li> <li>■ The parameter is applicable only to analog interfaces.</li> </ul>

## Voice Mail Parameters

The voice mail parameters are described in the table below. For more information on the Voice Mail application, refer to the *CPE Configuration Guide for Voice Mail*.

**Table 70-40:Voice Mail Parameters**

Parameter	Description
<p>'Voice Mail Interface'</p> <pre>configure voip &gt; gateway voice-mail-setting &gt; vm- interface [VoiceMailInterface]</pre>	<p>Enables the device's Voice Mail application and determines the communication method between the device and PBX.</p> <ul style="list-style-type: none"> <li>■ [0] <b>None</b> (default)</li> <li>■ [1] <b>DTMF</b></li> <li>■ [2] <b>SMDI</b></li> <li>■ [3] <b>QSIG</b></li> <li>■ [4] <b>SETUP Only</b> = Applicable only to ISDN.</li> <li>■ [5] <b>MATRA/AASTRA QSIG</b></li> </ul>

Parameter	Description
	<ul style="list-style-type: none"> <li>■ [6] <b>QSIG SIEMENS</b> = QSIG MWI activate and deactivate messages include Siemens Manufacturer Specific Information (MSI)</li> <li>■ [8] <b>ETSI</b> = Euro ISDN, according to ETS 300 745-1 V1.2.4, section 9.5.1.1. Enables MWI interworking from IP to Tel , typically used for BRI phones.</li> <li>■ [9] <b>NI2</b> = ISDN PRI trunks set to NI-2. This is used for interworking the SIP Message Waiting Indication (MWI) NOTIFY message to ISDN PRI NI-2 Message Waiting Notification (MWN) that is sent in the ISDN Facility IE message. This option is applicable when the device is connected to a PBX through an ISDN PRI trunk configured to NI-2.</li> </ul> <p><b>Note:</b> To disable voice mail per Trunk Group, you can use a Tel Profile with the EnableVoiceMailDelay parameter set to disabled (0). This eliminates the phenomenon of call delay on Trunks not implementing voice mail when voice mail is enabled using this global parameter.</p>
<p>'Enable VoiceMail URI' voicemail-uri [EnableVMURI]</p>	<p>Enables the interworking of target and cause for redirection from Tel to IP and vice versa, according to RFC 4468.</p> <ul style="list-style-type: none"> <li>■ [0] <b>Disable</b> (default)</li> <li>■ [1] <b>Enable</b></li> </ul> <p>Digital interfaces: Upon receipt of an ISDN Setup message with Redirect values, the device maps the Redirect phone number to the SIP 'target' parameter and the Redirect number reason to the SIP 'cause' parameter in the Request-URI.</p> <p>Redirecting Reason &gt;&gt; SIP Response Code</p> <p>Unknown &gt;&gt; 404</p> <p>User busy &gt;&gt; 486</p> <p>No reply &gt;&gt; 408</p> <p>Deflection &gt;&gt; 487/480</p>



Parameter	Description
	<p>Unconditional &gt;&gt; 302 Others &gt;&gt; 302</p> <p>If the device receives a Request-URI that includes a 'target' and 'cause' parameter, the 'target' is mapped to the Redirect phone number and the 'cause' is mapped to the Redirect number reason.</p>
[WaitForBusyTime]	<p>Defines the time (in msec) that the device waits to detect busy and/or reorder tones. This feature is used for semi-supervised PBX call transfers (i.e., the LineTransferMode parameter is set to 2).</p> <p>The valid value range is 0 to 20000 (i.e., 20 sec). The default is 2000 (i.e., 2 sec).</p>
<p>'Line Transfer Mode'</p> <pre>configure voip &gt; gateway voice-mail-setting &gt; line-transfer-mode</pre> <p>[LineTransferMode]</p>	<p>Defines the call transfer method used by the device. The parameter is applicable to the following:</p> <ul style="list-style-type: none"> <li>■ Analog interfaces: FXO call transfer</li> <li>■ Digital interfaces: E1/T1 CAS call transfer if the TrunkTransferMode_x parameter is set to 3 (CAS Normal) or 1 (CAS NFA)</li> </ul> <p>The valid values are:</p> <ul style="list-style-type: none"> <li>■ [0] <b>None</b> = (Default) IP.</li> <li>■ [1] <b>Blind</b> = PBX blind transfer: <ul style="list-style-type: none"> <li>✓ Analog (FXO): After receiving a SIP REFER message from the IP side, the device (FXO) sends a hook-flash to the PBX, dials the digits (that are received in the Refer-To header), and then immediately releases the line (i.e., on-hook). The PBX performs the transfer internally.</li> <li>✓ E1/T1 CAS: When a SIP REFER message is received, the device performs a blind transfer, by performing a CAS wink, waiting a user-defined time (configured by the WaitForDialTime parameter), dialing the Refer-To number, and then</li> </ul> </li> </ul>

Parameter	Description
	<p>releasing the call. The PBX performs the transfer internally.</p> <ul style="list-style-type: none"> <li>■ [2] <b>Semi Supervised</b> = PBX semi-supervised transfer: <ul style="list-style-type: none"> <li>✓ Analog (FXO): After receiving a SIP REFER message from the IP side, the device sends a hook-flash to the PBX, and then dials the digits (that are received in the Refer-To header). If no busy or reorder tones are detected (within the user-defined interval set by the WaitForBusyTime parameter), the device completes the call transfer by releasing the line. If these tones are detected, the transfer is cancelled, the device sends a SIP NOTIFY message with a failure reason in the NOTIFY body (such as 486 if busy tone detected), and generates an additional hook-flash toward the FXO line to restore connection to the original call.</li> <li>✓ E1/T1 CAS: The device performs a CAS wink, waits a user-defined time (configured by the WaitForDialTime parameter), and then dials the Refer-To number. If during the user-defined interval set by the WaitForBusyTime parameter, no busy or reorder tones are detected, the device completes the call transfer by releasing the line. If during this interval, the device detects these tones, the transfer operation is cancelled, the device sends a SIP NOTIFY message with a failure reason (e.g., 486 if a busy tone is detected), and then generates an additional wink toward the CAS line to restore connection with the original call.</li> </ul> </li> <li>■ [3] <b>Supervised</b> = PBX Supervised transfer: <ul style="list-style-type: none"> <li>✓ Analog (FXO): After receiving a SIP</li> </ul> </li> </ul>

Parameter	Description
	<p>REFER message from the IP side, the device sends a hook-flash to the PBX, and then dials the digits (that are received in the Refer-To header). The device waits for connection of the transferred call and then completes the call transfer by releasing the line. If speech is not detected, the transfer is cancelled, the device sends a SIP NOTIFY message with a failure reason in the NOTIFY body (such as 486 if busy tone detected) and generates an additional hook-flash toward the FXO line to restore connection to the original call.</p> <p>✓ E1/T1 CAS: The device performs a supervised transfer to the PBX. The device performs a CAS wink, waits a user-defined time (configured by the WaitForDialTime parameter), and then dials the Refer-To number. The device completes the call transfer by releasing the line only after detection of the transferred party answer. To enable answer supervision, you also need to do the following:</p> <ol style="list-style-type: none"> <li>1) Enable voice detection (i.e., set the EnableVoiceDetection parameter to 1).</li> <li>2) Set the EnabledSPIPMDetectors parameter to 1.</li> <li>3) Install the IPMDetector DSP option Feature License Key.</li> </ol>
<b>SMDI Parameters</b>	
<p>'Enable SMDI'  <code>configure voip &gt; gateway</code>  <code>voice-mail-setting &gt;</code>  <code>enable-smdi</code>                      [SMDI]</p>	<p>Enables Simplified Message Desk Interface (SMDI) interface on the device.</p> <ul style="list-style-type: none"> <li>■ [0] <b>Disable</b> = (Default) Normal serial</li> <li>■ [1] <b>Enable (Bellcore)</b></li> <li>■ [2] <b>Ericsson MD-110</b></li> <li>■ [3] <b>NEC (ICS)</b></li> </ul>

Parameter	Description
	<p><b>Note:</b></p> <ul style="list-style-type: none"> <li>■ For the parameter to take effect, a device reset is required.</li> <li>■ When the RS-232 connection is used for SMDI messages (Serial SMDI), it cannot be used for other applications, for example, to access the Command Line Interface (CLI).</li> </ul>
<p>'SMDI Timeout'</p> <pre>configure voip &gt; gateway voice-mail-setting &gt; smdi-timeout-[msec] [SMDITimeout]</pre>	<p>Defines the time (in msec) that the device waits for an SMDI Call Status message before or after a Setup message is received. The parameter synchronizes the SMDI and analog CAS interfaces.</p> <p>If the timeout expires and only an SMDI message is received, the SMDI message is dropped. If the timeout expires and only a Setup message is received, the call is established.</p> <p>The valid range is 0 to 10000 (i.e., 10 seconds). The default is 2000.</p>
<b>Message Waiting Indication (MWI) Parameters</b>	
<p>'MWI Off Digit Pattern'</p> <pre>configure voip &gt; gateway voice-mail-setting &gt; mwi- off-dig-ptrn [MWIOffCode]</pre>	<p>Defines the digit code used by the device to notify the PBX that there are no messages waiting for a specific extension. This code is added as prefix to the dialed number.</p> <p>The valid range is a 25-character string.</p>
<p>'MWI On Digit Pattern'</p> <pre>configure voip &gt; gateway voice-mail-setting &gt; mwi- on-dig-ptrn [MWIONCode]</pre>	<p>Defines the digit code used by the device to notify the PBX of messages waiting for a specific extension. This code is added as prefix to the dialed number.</p> <p>The valid range is a 25-character string.</p>
<p>'MWI Suffix Pattern'</p> <pre>configure voip &gt; gateway voice-mail-setting &gt; mwi- suffix-pattern [MWISuffixCode]</pre>	<p>Defines the digit code used by the device as a suffix for 'MWI On Digit Pattern' and 'MWI Off Digit Pattern'. This suffix is added to the generated DTMF string after the extension number.</p> <p>The valid range is a 25-character string.</p>

Parameter	Description
<p>'MWI Source Number'</p> <pre>configure voip &gt; gateway voice-mail-setting &gt; mwi- source-number</pre> <p>[MWISourceNumber]</p>	<p>Defines the calling party's phone number used in the Q.931 MWI Setup message to PSTN. If not configured, the channel's phone number is used as the calling number.</p>
<pre>configure voip &gt; gateway dtmf-supp-service supp- service-settings &gt; mwi- subs-ipgrp-id</pre> <p>[MWISubscribeIPGroupID]</p>	<p>Defines the IP Group ID used when subscribing to an MWI server. The 'The SIP Group Name' field value of the IP Groups table is used as the Request-URI host name in the outgoing MWI SIP SUBSCRIBE message. The request is sent to the IP address defined for the Proxy Set that is associated with the IP Group. The Proxy Set's capabilities such as proxy redundancy and load balancing are also applied to the message.</p> <p>For example, if the 'SIP Group Name' field of the IP Group is set to "company.com", the device sends the following SUBSCRIBE message:</p> <pre>SUBSCRIBE sip:company.com...</pre> <p>Instead of:</p> <pre>SUBSCRIBE sip:10.33.10.10...</pre> <p><b>Note:</b> If the parameter is not configured, the MWI SUBSCRIBE message is sent to the MWI server as defined by the MWIServerIP parameter.</p>
<p>Notification IP Group ID</p> <pre>configure voip &gt; gateway digital settings &gt; notification-ip-group-id</pre> <p>[NotificationIPGroupID]</p>	<p>Defines the IP Group ID to which the device sends SIP NOTIFY MWI messages.</p> <p><b>Note:</b></p> <ul style="list-style-type: none"> <li>■ This is used for MWI Interrogation. For more information on the interworking of QSIG MWI to IP, see <a href="#">Message Waiting Indication</a>.</li> <li>■ To determine the handling method of MWI Interrogation messages, use the TrunkGroupSettings_MWIIterrogationType, parameter (in the Trunk Group Settings table).</li> </ul>
<p>'MWI Notification Timeout'</p> <pre>configure voip &gt; gateway</pre>	<p>Global parameter defining the maximum duration (timeout) that a message waiting</p>

Parameter	Description
<pre>dtmf-supp-service supp- service-settings &gt; mwi- ntf-timeout</pre> <p>[MWINotificationTimeout]</p>	<p>indication (MWI) is displayed on endpoint equipment (phones' LED, screen notification or voice tone).</p> <p>You can also configure the feature for specific calls, using Tel Profiles (TelProfile_MWInotificationTimeout). For a detailed description of the parameter or for configuring the feature in the Tel Profiles table, see <a href="#">Configuring Tel Profiles</a>.</p> <p><b>Note:</b></p> <ul style="list-style-type: none"> <li>■ The parameter is applicable only to FXS interfaces.</li> <li>■ If the feature is configured for a specific Tel Profile, the settings of the global parameter is ignored for calls associated with the Tel Profile.</li> </ul>
<pre>configure voip &gt; gateway dtmf-supp-service supp- service-settings &gt; mwi- qsig-party-num</pre> <p>[MWIQsigMsgCentreIDPartyNumber]</p>	<p>Defines the Message Centred ID party number used for QSIG MWI messages. If not configured (default), the parameter is not included in MWI (activate and deactivate) QSIG messages. The valid value is a string.</p>
<p><b>Digit Patterns</b> The following digit pattern parameters apply only to voice mail applications that use the DTMF communication method. For available pattern syntaxes, refer to the <i>CPE Configuration Guide for Voice Mail</i>.</p>	
<p>'Forward on Busy Digit Pattern (Internal)'</p> <pre>configure voip &gt; gateway voice-mail-setting &gt; fwd- bsy-dig-ptrn-int</pre> <p>[DigitPatternForwardOnBusy]</p>	<p>Defines the digit pattern used by the PBX to indicate 'call forward on busy' when the original call is received from an internal extension. The valid range is a 120-character string.</p>
<p>'Forward on No Answer Digit Pattern (Internal)'</p> <pre>configure voip &gt; gateway voice-mail-setting &gt; fwd- no-ans-dig-pat-int</pre> <p>[DigitPatternForwardOnNoAnswer]</p>	<p>Defines the digit pattern used by the PBX to indicate 'call forward on no answer' when the original call is received from an internal extension. The valid range is a 120-character string.</p>

Parameter	Description
<p>'Forward on Do Not Disturb Digit Pattern (Internal)'</p> <pre>configure voip &gt; gateway voice-mail-setting &gt; fwd- dnd-dig-ptrn-int</pre> <p>[DigitPatternForwardOnDND]</p>	<p>Defines the digit pattern used by the PBX to indicate 'call forward on do not disturb' when the original call is received from an internal extension.</p> <p>The valid range is a 120-character string.</p>
<p>'Forward on No Reason Digit Pattern (Internal)'</p> <pre>configure voip &gt; gateway voice-mail-setting &gt; fwd- no-rsn-dig-ptrn-int</pre> <p>[DigitPatternForwardNoReason]</p>	<p>Defines the digit pattern used by the PBX to indicate 'call forward with no reason' when the original call is received from an internal extension.</p> <p>The valid range is a 120-character string.</p>
<p>'Forward on Busy Digit Pattern (External)'</p> <pre>configure voip &gt; gateway voice-mail-setting &gt; fwd- bsy-dig-ptrn-ext</pre> <p>[DigitPatternForwardOnBusyExt]</p>	<p>Defines the digit pattern used by the PBX to indicate 'call forward on busy' when the original call is received from an external line (not an internal extension).</p> <p>The valid range is a 120-character string.</p>
<p>'Forward on No Answer Digit Pattern (External)'</p> <pre>configure voip &gt; gateway voice-mail-setting &gt; fwd- no-ans-dig-pat-ext</pre> <p>[DigitPatternForwardOnNoAnswerExt]</p>	<p>Defines the digit pattern used by the PBX to indicate 'call forward on no answer' when the original call is received from an external line (not an internal extension).</p> <p>The valid range is a 120-character string.</p>
<p>'Forward on Do Not Disturb Digit Pattern (External)'</p> <pre>configure voip &gt; gateway voice-mail-setting &gt; fwd- dnd-dig-ptrn-ext</pre> <p>[DigitPatternForwardOnDNDExt]</p>	<p>Defines the digit pattern used by the PBX to indicate 'call forward on do not disturb' when the original call is received from an external line (not an internal extension).</p> <p>The valid range is a 120-character string.</p>
<p>'Forward on No Reason Digit Pattern (External)'</p> <pre>configure voip &gt; gateway voice-mail-setting &gt; fwd- no-rsn-dig-ptrn-ext</pre> <p>[DigitPatternForwardNoReasonExt]</p>	<p>Defines the digit pattern used by the PBX to indicate 'call forward with no reason' when the original call is received from an external line (not an internal extension).</p> <p>The valid range is a 120-character string.</p>

Parameter	Description
'Internal Call Digit Pattern' configure voip > gateway voice-mail-setting > int- call-dig-ptrn [DigitPatternInternalCall]	Defines the digit pattern used by the PBX to indicate an internal call. The valid range is a 120-character string.
'External Call Digit Pattern' configure voip > gateway voice-mail-setting > ext- call-dig-ptrn [DigitPatternExternalCall]	Defines the digit pattern used by the PBX to indicate an external call. The valid range is a 120-character string.
'Disconnect Call Digit Pattern' configure voip > gateway voice-mail-setting > disc-call-dig-ptrn [TelDisconnectCode]	Defines a digit pattern that when received from the Tel side, indicates the device to disconnect the call. The valid range is a 25-character string.
'Digit To Ignore Digit Pattern' configure voip > gateway voice-mail-setting > dig- to-ignore-dig-pattern [DigitPatternDigitToIgnore]	Defines a digit pattern that if received as Src (S) or Redirect (R) numbers is ignored and not added to that number. The valid range is a 25-character string.

## Supplementary Services Parameters

This subsection describes the device's supplementary telephony services parameters.

### Caller ID Parameters

The caller ID parameters are described in the table below.

**Table 70-41: Caller ID Parameters**

Parameter	Description
'Enable Caller ID' configure voip > gateway dtmf- supp-service supp-service- settings > enable-caller-id	Global parameter that enables Caller ID. <ul style="list-style-type: none"> <li>■ [0] <b>Disable</b> (default)</li> <li>■ [1] <b>Enable</b> = <ul style="list-style-type: none"> <li>✓ FXS: The calling number and display text (from IP) are sent to the device's port.</li> </ul> </li> </ul>



Parameter	Description
[EnableCallerID]	<p>✓ FXO and CAS: The device detects the Caller ID signal received from the Tel and sends it to the IP in the SIP INVITE message (as the 'Display' element).</p> <p>To configure the Caller ID string per port, see <a href="#">Configuring Caller Display Information</a>. To enable or disable caller ID generation / detection per port, see <a href="#">Configuring Caller ID Permissions</a>.</p>
<p>'Caller ID Type'</p> <pre>configure voip &gt; gateway dtmf- supp-service supp-service- settings &gt; caller-id-type [CallerIDType]</pre>	<p>Determines the standard used for detection (FXO) and generation (FXS) of Caller ID, and detection (FXO) / generation (FXS) of MWI (when specified) signals:</p> <ul style="list-style-type: none"> <li>■ [0] <b>Standard Bellcore</b> = (Default) Caller ID and MWI</li> <li>■ [1] <b>Standard ETSI</b> = Caller ID and MWI</li> <li>■ [2] <b>Standard NTT</b></li> <li>■ [4] <b>Standard BT</b> = Britain</li> <li>■ [16] <b>Standard DTMF Based ETSI</b></li> <li>■ [17] <b>Standard Denmark</b> = Caller ID and MWI</li> <li>■ [18] <b>Standard India</b></li> <li>■ [19] <b>Standard Brazil</b></li> </ul> <p><b>Note:</b></p> <ul style="list-style-type: none"> <li>■ The parameter is applicable only to analog interfaces.</li> <li>■ Typically, the Caller ID signals are generated / detected between the first and second rings. However, sometimes the Caller ID is detected before the first ring signal. In such a scenario, set the [RingsBeforeCallerID] parameter to 0.</li> <li>■ Caller ID detection for Britain [4] is not supported on the device's FXO ports. Only FXS ports can generate the Britain [4] Caller ID.</li> <li>■ To select the Bellcore Caller ID sub standard, use the [BellcoreCallerIDTypeOneSubStandard] parameter. To select the ETSI Caller ID substandard, use the [ETSCallerIDTypeOneSubStandard] parameter.</li> <li>■ To select the Bellcore MWI sub standard, use the [BellcoreVMWITypeOneStandard] parameter. To select the ETSI MWI sub standard, use the</li> </ul>

Parameter	Description																		
	<p>[ETSIVMWITypeOneStandard] parameter.</p> <ul style="list-style-type: none"> <li>■ If you define Caller ID Type as NTT [2], you need to define the NTT DID signaling form (FSK or DTMF) using the [NTTDIDSignallingForm] parameter.</li> </ul>																		
<p>'Enable FXS Caller ID Category Digit For Brazil Telecom'</p> <p><code>fxs-callid-cat-brazil</code></p> <p>[AddCPCPrefix2BrazilCaller ID]</p>	<p>Enables the interworking of Calling Party Category (cpc) code from SIP INVITE messages to FXS Caller ID first digit.</p> <ul style="list-style-type: none"> <li>■ [0] <b>Disable</b> (default)</li> <li>■ [1] <b>Enable</b></li> </ul> <p>When the parameter is enabled, the device sends the Caller ID number (calling number) with the cpc code (received in the SIP INVITE message) to the device's FXS port. The cpc code is added as a prefix to the caller ID (after IP-to-Tel calling number manipulation). For example, assuming that the incoming INVITE contains the following From (or P-Asserted-Id) header:</p> <pre>From:&lt;sip:+551137077801;cpc=payphone@10.20.7.35&gt;;tag=53700</pre> <p>The calling number manipulation removes "+55" (leaving 10 digits), and then adds the prefix 7, the cpc code for payphone user. Therefore, the Caller ID number that is sent to the FXS port, in this example is 71137077801.</p> <p>If the incoming INVITE message doesn't contain the 'cpc' parameter, nothing is added to the Caller ID number.</p> <table border="1" data-bbox="663 1326 1393 1955"> <thead> <tr> <th>CPC Value in Received INVITE</th> <th>CPC Code Prefixed to Caller ID (Sent to FXS Endpoint)</th> <th>Description</th> </tr> </thead> <tbody> <tr> <td>cpc=unknown</td> <td>1</td> <td>Unknown user</td> </tr> <tr> <td>cpc=subscribe</td> <td>1</td> <td>-</td> </tr> <tr> <td>cpc=ordinary</td> <td>1</td> <td>Ordinary user</td> </tr> <tr> <td>cpc=priority</td> <td>2</td> <td>Pre-paid user</td> </tr> <tr> <td>cpc=test</td> <td>3</td> <td>Test user</td> </tr> </tbody> </table>	CPC Value in Received INVITE	CPC Code Prefixed to Caller ID (Sent to FXS Endpoint)	Description	cpc=unknown	1	Unknown user	cpc=subscribe	1	-	cpc=ordinary	1	Ordinary user	cpc=priority	2	Pre-paid user	cpc=test	3	Test user
CPC Value in Received INVITE	CPC Code Prefixed to Caller ID (Sent to FXS Endpoint)	Description																	
cpc=unknown	1	Unknown user																	
cpc=subscribe	1	-																	
cpc=ordinary	1	Ordinary user																	
cpc=priority	2	Pre-paid user																	
cpc=test	3	Test user																	

Parameter	Description									
	<table border="1" data-bbox="663 282 1391 542"> <tr> <td data-bbox="663 282 896 353">cpc=operator</td> <td data-bbox="896 282 1214 353">5</td> <td data-bbox="1214 282 1391 353">Operator</td> </tr> <tr> <td data-bbox="663 353 896 425">cpc=data</td> <td data-bbox="896 353 1214 425">6</td> <td data-bbox="1214 353 1391 425">Data call</td> </tr> <tr> <td data-bbox="663 425 896 542">cpc=payphone</td> <td data-bbox="896 425 1214 542">7</td> <td data-bbox="1214 425 1391 542">Payphone user</td> </tr> </table> <p data-bbox="663 555 740 586"><b>Note:</b></p> <ul data-bbox="663 613 1378 743" style="list-style-type: none"> <li data-bbox="663 613 1310 645">■ The parameter is applicable only to FXS interfaces.</li> <li data-bbox="663 669 1378 743">■ For the parameter to be enabled, you must also set the parameter EnableCallingPartyCategory to 1.</li> </ul>	cpc=operator	5	Operator	cpc=data	6	Data call	cpc=payphone	7	Payphone user
cpc=operator	5	Operator								
cpc=data	6	Data call								
cpc=payphone	7	Payphone user								
[EnableCallerIDTypeTwo]	<p data-bbox="663 784 1398 936">Disables the generation of Caller ID type 2 when the phone is off-hooked. Caller ID type 2 (also known as off-hook Caller ID) is sent to a currently busy telephone to display the caller ID of the waiting call.</p> <ul data-bbox="663 958 1174 1048" style="list-style-type: none"> <li data-bbox="663 958 1098 990">■ [0] = Caller ID type 2 isn't played.</li> <li data-bbox="663 1014 1174 1046">■ [1] = (Default) Caller ID type 2 is played.</li> </ul> <p data-bbox="663 1072 1342 1104"><b>Note:</b> The parameter is applicable only to FXS interfaces.</p>									
<pre data-bbox="312 1146 624 1384">configure voip &gt; interface fxs-fxo &gt; caller-id- timing-mode [AnalogCallerIDTimingMode]</pre>	<p data-bbox="663 1146 1139 1178">Determines when Caller ID is generated.</p> <ul data-bbox="663 1205 1394 1415" style="list-style-type: none"> <li data-bbox="663 1205 1394 1281">■ [0] = (Default) Caller ID is generated between the first two rings.</li> <li data-bbox="663 1305 1378 1415">■ [1] = The device attempts to find an optimized timing to generate the Caller ID according to the selected Caller ID type.</li> </ul> <p data-bbox="663 1442 740 1473"><b>Note:</b></p> <ul data-bbox="663 1500 1398 1765" style="list-style-type: none"> <li data-bbox="663 1500 1310 1532">■ The parameter is applicable only to FXS interfaces.</li> <li data-bbox="663 1556 1398 1666">■ If the parameter is set to 1 and used with distinctive ringing, the Caller ID signal doesn't change the distinctive ringing timing.</li> <li data-bbox="663 1691 1299 1765">■ For the parameter to take effect, a device reset is required.</li> </ul>									
<pre data-bbox="312 1805 624 1995">configure voip &gt; interface fxs-fxo &gt; bellcore- callerid-type- one-sub-standard</pre>	<p data-bbox="663 1805 1235 1836">Determines the Bellcore Caller ID sub-standard.</p> <ul data-bbox="663 1863 1054 1953" style="list-style-type: none"> <li data-bbox="663 1863 1054 1895">■ [0] = (Default) Between rings.</li> <li data-bbox="663 1919 963 1951">■ [1] = Not ring related.</li> </ul>									

Parameter	Description
[BellcoreCallerIDTypeOneSubStandard]	<p><b>Note:</b></p> <ul style="list-style-type: none"> <li>■ For the parameter to take effect, a device reset is required.</li> <li>■ The parameter is applicable only to FXS interfaces.</li> </ul>
<pre>configure voip &gt; interface fxs-fxo &gt; etsi-callerid- type-one-sub- standard</pre> <p>[ETSICallerIDTypeOneSubStandard]</p>	<p>Determines the ETSI FSK Caller ID Type 1 sub-standard (FXS only).</p> <ul style="list-style-type: none"> <li>■ [0] = (Default) ETSI between rings.</li> <li>■ [1] = ETSI before ring DT_AS.</li> <li>■ [2] = ETSI before ring RP_AS.</li> <li>■ [3] = ETSI before ring LR_DT_AS.</li> <li>■ [4] = ETSI not ring related DT_AS.</li> <li>■ [5] = ETSI not ring related RP_AS.</li> <li>■ [6] = ETSI not ring related LR_DT_AS.</li> </ul> <p><b>Note:</b></p> <ul style="list-style-type: none"> <li>■ For the parameter to take effect, a device reset is required.</li> <li>■ The parameter is applicable only to FXS interfaces.</li> </ul>
<p>'Asserted Identity Mode'</p> <pre>asserted- identity-m</pre> <p>[AssertedIdMode]</p>	<p>Determines whether the SIP header P-Asserted-Identity or P-Preferred-Identity is added to the sent INVITE, 200 OK, or UPDATE request for Caller ID (or privacy). These headers are used to present the calling party's Caller ID, which is composed of a Calling Number and a Calling Name (optional).</p> <ul style="list-style-type: none"> <li>■ [0] <b>Disabled</b> = (Default) P-Asserted-Identity and P-Preferred-Identity headers are not added.</li> <li>■ [1] <b>Add P-Asserted-Identity</b></li> <li>■ [2] <b>Add P-Preferred-Identity</b></li> </ul> <p>The used header also depends on the calling Privacy (allowed or restricted). These headers are used together with the Privacy header. If Caller ID is restricted (i.e., P-Asserted-Identity is not sent), the Privacy header includes the value 'id' ('Privacy: id'). Otherwise, for allowed Caller ID, 'Privacy: none' is used. If Caller ID is restricted (received from Tel or for analog interfaces, configured on the device), the</p>

Parameter	Description
	<p>From header is set to &lt;anonymous@anonymous.invalid&gt;.</p> <p>Digital Interfaces: The 200 OK response can contain the connected party CallerID - Connected Number and Connected Name. For example, if the call is answered by the device, the 200 OK response includes the P-Asserted-Identity with Caller ID. The device interworks (in some ISDN variants), the Connected Party number and name from Q.931 Connect message to SIP 200 OK with the P-Asserted-Identity header. In the opposite direction, if the ISDN device receives a 200 OK with P-Asserted-Identity header, it interworks it to the Connected party number and name in the Q.931 Connect message, including its privacy.</p>
<p>'Use Destination As Connected Number'</p> <pre>configure voip &gt; sip-definition settings &gt; use- dst-as-connected- num</pre> <p>[UseDestinationAsConnectedNumber]</p>	<p>Enables the device to include the Called Party Number, from outgoing Tel calls (after number manipulation), in the SIP P-Asserted-Identity header. The device includes the SIP P-Asserted-Identity header in 180 Ringing and 200 OK responses for IP-to-Tel calls.</p> <ul style="list-style-type: none"> <li>■ [0] <b>Disable</b> (default)</li> <li>■ [1] <b>Enable</b></li> </ul> <p><b>Note:</b></p> <ul style="list-style-type: none"> <li>■ For this feature to function, you also need to enable the device to include the P-Asserted-Identity header in 180/200 OK responses, by setting the [AssertedIDMode] parameter to <b>Add P-Asserted-Identity</b>.</li> <li>■ If the received Q.931 Connect message contains a Connected Party Number, this number is used in the P-Asserted-Identity header in 200 OK response.</li> <li>■ The parameter is applicable to FXO, ISDN and CAS interfaces.</li> </ul>
<p>'Caller ID Transport Type'</p> <pre>configure voip &gt; media fax-modem &gt; caller-ID- transport-type</pre> <p>[CallerIDTransportType]</p>	<p>Determines the device's behavior for Caller ID detection.</p> <ul style="list-style-type: none"> <li>■ [0] <b>Disable</b> = The caller ID signal is not detected - DTMF digits remain in the voice stream.</li> <li>■ [1] <b>Relay</b> = (Currently not applicable.)</li> <li>■ [3] <b>Mute</b> = (Default) The caller ID signal is detected from the Tel side and then erased from the voice stream.</li> </ul> <p><b>Note:</b> Caller ID detection is applicable only to FXO interfaces.</p>

## Call Waiting Parameters

The call waiting parameters are described in the table below.

**Table 70-42: Call Waiting Parameters**

Parameter	Description
<p>'Enable Call Waiting'</p> <pre>configure voip &gt; gateway dtmf- supp-service supp-service- settings &gt; call- waiting</pre> <p>[EnableCallWaiting]</p>	<p>Enables the Call Waiting feature.</p> <ul style="list-style-type: none"> <li>■ [0] <b>Disable</b></li> <li>■ [1] <b>Enable</b> (default)</li> </ul> <p>Digital interfaces: If enabled and the device initiates a Tel-to-IP call to a destination that is busy, it plays a call waiting ringback tone to the caller. The tone is played only if the destination returns a 182 "Queued" SIP response.</p> <p>FXS interfaces: If enabled, when an FXS interface receives a call on a busy endpoint, it responds with a 182 response (and not with a 486 busy). The device plays a call waiting indication signal. When hook-flash is detected, the device switches to the waiting call. The device that initiated the waiting call plays a call waiting ringback tone to the calling party after a 182 response is received.</p> <p><b>Note:</b></p> <ul style="list-style-type: none"> <li>■ The device's Call Progress Tones (CPT) file must include a Call Waiting ringback tone-- for analog interfaces: (caller side) and a call waiting tone (called side, FXS only).</li> <li>■ FXS interfaces: The EnableHold parameter must be enabled on both the calling and the called side.</li> <li>■ Analog interfaces: You can use the table parameter CallWaitingPerPort to enable Call Waiting per port.</li> <li>■ Analog interfaces: For information on the Call Waiting feature, see <a href="#">Enabling Call Waiting</a>.</li> </ul>
<pre>configure voip &gt; sip-definition settings &gt; send- 180-for-call- waiting</pre> <p>[Send180ForCallWaiting]</p>	<p>Determines the SIP response code for indicating Call Waiting.</p> <ul style="list-style-type: none"> <li>■ [0] = (Default) Use 182 Queued response to indicate call waiting.</li> <li>■ [1] = Use 180 Ringing response to indicate call waiting.</li> </ul>
<p>'Number of Call Waiting Indications'</p>	<p>Defines the number of call waiting indications that are played to the called telephone that is connected to the device for Call Waiting.</p>

Parameter	Description
<pre>configure voip &gt; gateway dtmf- supp-service supp-service- settings &gt; nb-of- cw-ind</pre> <p>[NumberOfWaitingIndications]</p>	<p>The valid range is 1 to 100 indications. The default is 2.</p> <p><b>Note:</b> The parameter is applicable only to FXS ports.</p>
<p>'Time Between Call Waiting Indications'</p> <pre>configure voip &gt; gateway dtmf- supp-service supp-service- settings &gt; time- between-cw</pre> <p>[TimeBetweenWaitingIndications]</p>	<p>Defines the time (in seconds) between consecutive call waiting indications for call waiting.</p> <p>The valid range is 1 to 100. The default is 10.</p> <p><b>Note:</b> The parameter is applicable only to FXS ports.</p>
<p>'Time Before Waiting Indications'</p> <pre>configure voip &gt; gateway dtmf- supp-service supp-service- settings &gt; time- b4-cw-ind</pre> <p>[TimeBeforeWaitingIndications]</p>	<p>Defines the interval (in seconds) before a call waiting indication is played to the port that is currently in a call.</p> <p>The valid range is 0 to 100. The default time is 0 seconds.</p> <p><b>Note:</b> The parameter is applicable only to FXS ports.</p>
<p>'Waiting Beep Duration'</p> <pre>configure voip &gt; gateway dtmf- supp-service supp-service- settings &gt; waiting-beep-dur</pre> <p>[WaitingBeepDuration]</p>	<p>Defines the duration (in msec) of call waiting indications that are played to the port that is receiving the call.</p> <p>The valid range is 100 to 65535. The default is 300.</p> <p><b>Note:</b> The parameter is applicable only to FXS ports.</p>
<p>[FirstCallWaitingToneID]</p>	<p>Defines the index of the first Call Waiting Tone in the CPT file. This feature enables the called party to distinguish between different call origins (e.g., external versus internal calls).</p>

Parameter	Description
	<p>There are three ways to use the distinctive call waiting tones:</p> <ul style="list-style-type: none"> <li>■ Playing the call waiting tone according to the SIP Alert-Info header in the received 180 Ringing SIP response. The value of the Alert-Info header is added to the value of the FirstCallWaitingToneID parameter.</li> <li>■ Playing the call waiting tone according to PriorityIndex in the ToneIndex table parameter.</li> <li>■ Playing the call waiting tone according to the parameter "CallWaitingTone#" of a SIP INFO message.</li> </ul> <p>The device plays the tone received in the 'play tone CallWaitingTone#' parameter of an INFO message plus the value of the parameter minus 1.</p> <p>The valid range is -1 to 1,000. The default is -1 (i.e., not used).</p> <p><b>Note:</b></p> <ul style="list-style-type: none"> <li>■ The parameter is applicable only to analog interfaces.</li> <li>■ It is assumed that all Call Waiting Tones are defined in sequence in the CPT file.</li> <li>■ SIP Alert-Info header examples: <ul style="list-style-type: none"> <li>✓ Alert-Info:&lt;Bellcore-dr2&gt;</li> <li>✓ Alert-Info:&lt;http://.../Bellcore-dr2&gt; (where "dr2" defines call waiting tone #2)</li> </ul> </li> <li>■ The SIP INFO message is according to Broadsoft's application server definition. Below is an example of such an INFO message:</li> </ul> <pre>INFO sip:06@192.168.13.2:5060 SIP/2.0 Via:SIP/2.0/UDP 192.168.13.40:5060;branch=z9hG4bK040066 422630 From: &lt;sip:4505656002@192.168.13.40:5060&gt;;tag =1455352915 To: &lt;sip:06@192.168.13.2:5060&gt; Call-ID:0010-0008@192.168.13.2 CSeq:342168303 INFO Content-Length:28 Content-Type:application/broadsoft</pre>



Parameter	Description
	play tone CallWaitingTone1

## Call Forwarding Parameters

The call forwarding parameters are described in the table below.

**Table 70-43: Call Forwarding Parameters**

Parameter	Description
'Enable Call Forward' <pre>configure voip &gt; gateway dtmf-supp-service supp- service-settings &gt; call- forward</pre> [EnableForward]	Enables call forwarding. <ul style="list-style-type: none"> <li>■ [0] <b>Disable</b></li> <li>■ [1] <b>Enable</b> (default)</li> </ul> For FXS interfaces: You must configure the Call Forward table (FwdInfo parameter) to use the Call Forward feature (see <a href="#">Configuring Call Forward</a> on page 879). The device uses SIP 302 (Moved Temporarily) responses for call forwarding. <p><b>Note:</b></p> <ul style="list-style-type: none"> <li>■ To use this service, the devices at both ends must support call forwarding.</li> <li>■ For the device to respond to SIP 3xx responses with a new SIP request (forwarding the original request), configure the parameter to <b>Enable</b>.</li> </ul>
Call Forward Reminder Ring Parameters <p><b>Note:</b></p> <ul style="list-style-type: none"> <li>■ These parameters are applicable only to FXS interfaces.</li> <li>■ For a description of this feature, see <a href="#">Call Forward Reminder Ring</a>.</li> </ul>	
'Enable NRT Subscription' <pre>configure voip &gt; gateway dtmf-supp-service supp- service-settings &gt; nrt- subscription</pre> [EnableNRTSubscription]	Enables endpoint subscription for Ring reminder event notification feature. <ul style="list-style-type: none"> <li>■ [0] <b>Disable</b> (default)</li> <li>■ [1] <b>Enable</b></li> </ul>
'AS Subscribe IP Group ID'	Defines the IP Group ID that contains the

Parameter	Description
<pre>configure voip &gt; gateway dtmf-supp-service supp- service-settings &gt; as-subs- ipgroupid</pre> <p>[ASSubscribeIPGroupID]</p>	<p>Application server for Subscription.</p> <p>The valid value range is 1 to 8. The default is -1 (i.e., not configured).</p>
<p>'NRT Subscribe Retry Time'</p> <pre>configure voip &gt; gateway dtmf-supp-service supp- service-settings &gt; nrt-sub- retry-time</pre> <p>[NRTSubscribeRetryTime]</p>	<p>Defines the Retry period (in seconds) for Dialog subscription if a previous request failed.</p> <p>The valid value range is 10 to 7200. The default is 120.</p>
<p>'Call Forward Ring Tone ID'</p> <pre>configure voip &gt; gateway dtmf-supp-service supp- service-settings &gt; cfe-ring- tone-id</pre> <p>[CallForwardRingToneID]</p>	<p>Defines the ringing tone type played when call forward notification is accepted.</p> <p>The valid value range is 1 to 5. The default is 1.</p>

### Message Waiting Indication Parameters

The message waiting indication (MWI) parameters are described in the table below.

**Table 70-44:MWI Parameters**

Parameter	Description
<p>'Enable MWI'</p> <pre>configure voip &gt; gateway dtmf-supp- service supp-service- settings &gt; enable-mwi</pre> <p>[EnableMWI]</p>	<p>Enables Message Waiting Indication (MWI).</p> <ul style="list-style-type: none"> <li>■ [0] <b>Disable</b> (default)</li> <li>■ [1] <b>Enable</b></li> </ul> <p><b>Note:</b></p> <ul style="list-style-type: none"> <li>■ The parameter is applicable only to FXS interfaces.</li> <li>■ The device supports only the receipt of SIP MWI NOTIFY messages (the device doesn't generate these messages).</li> <li>■ For more information on MWI, see <a href="#">Message Waiting Indication</a>.</li> </ul>
<p>'MWI Analog Lamp'</p>	<p>Global parameter enabling the visual display of</p>

Parameter	Description
<pre>configure voip &gt; gateway dtmf-supp- service supp-service- settings &gt; mwi-analog- lamp</pre> <p>[MWIAnalogLamp]</p>	<p>MWI.</p> <p>You can also configure the feature per specific calls, using Tel Profiles (TelProfile_MWIAAnalog). For a detailed description of the parameter and for configuring the feature in the Tel Profiles table, see <a href="#">Configuring Tel Profiles</a>.</p> <p><b>Note:</b></p> <ul style="list-style-type: none"> <li>■ If the feature is configured for a specific Tel Profile, the settings of the global parameter is ignored for calls associated with the Tel Profile.</li> <li>■ The parameter is applicable only to FXS interfaces.</li> </ul>
<p>'MWI Display'</p> <pre>configure voip &gt; gateway dtmf-supp- service supp-service- settings &gt; enable-mwi</pre> <p>[MWIDisplay]</p>	<p>Global parameter enabling the sending of MWI information to the phone display.</p> <p>You can also configure the feature per specific calls, using Tel Profiles (TelProfile_MWIDisplay). For a detailed description of the parameter and for configuring the feature in the Tel Profiles table, see <a href="#">Configuring Tel Profiles</a>.</p> <p><b>Note:</b></p> <ul style="list-style-type: none"> <li>■ If the feature is configured for a specific Tel Profile, the settings of the global parameter is ignored for calls associated with the Tel Profile.</li> <li>■ The parameter is applicable only to FXS interfaces.</li> </ul>
<p>'Subscribe to MWI'</p> <pre>configure voip &gt; gateway dtmf-supp- service supp-service- settings &gt; subscribe- to-mwi</pre> <p>[EnableMWISubscription]</p>	<p>Enables subscription to an MWI server.</p> <ul style="list-style-type: none"> <li>■ [0] <b>No</b> (default)</li> <li>■ [1] <b>Yes</b></li> </ul> <p><b>Note:</b></p> <ul style="list-style-type: none"> <li>■ To configure the MWI server address, use the MWIServerIP parameter.</li> <li>■ To configure whether the device subscribes per endpoint or per the entire device, use the parameter SubscriptionMode.</li> </ul>
<p>'MWI Server IP Address'</p>	<p>Defines the MWI server's IP address. If provided, the device subscribes to this IP address. The MWI</p>

Parameter	Description
<pre>configure voip &gt; gateway dtmf-supp- service supp-service- settings &gt; mwi-srvr-ip- addr</pre> <p>[MWIServerIP]</p>	<p>server address can be configured as a numerical IP address or as a domain name. If not configured, the Proxy IP address is used instead.</p>
<p>'MWI Server Transport Type'</p> <pre>configure voip &gt; gateway dtmf-supp- service supp-service- settings &gt; mwi-srvr- transp-type</pre> <p>[MWIServerTransportType]</p>	<p>Determines the transport layer used for outgoing SIP dialogs initiated by the device to the MWI server.</p> <ul style="list-style-type: none"> <li>■ [-1] <b>Not Configured</b> (default)</li> <li>■ [0] <b>UDP</b></li> <li>■ [1] <b>TCP</b></li> <li>■ [2] <b>TLS</b></li> </ul> <p><b>Note:</b> When set to 'Not Configured', the value of the parameter SIPTransportType is used.</p>
<p>'MWI Subscribe Expiration Time'</p> <pre>configure voip &gt; gateway dtmf-supp- service supp-service- settings &gt; mwi-subs- expr-time</pre> <p>[MWIExpirationTime]</p>	<p>Defines the MWI subscription expiration time in seconds.</p> <p>The default is 7200 seconds. The range is 10 to 2,000,000.</p>
<p>'MWI Subscribe Retry Time'</p> <pre>configure voip &gt; gateway dtmf-supp- service supp-service- settings &gt; mwi-subs- rtry-time</pre> <p>[SubscribeRetryTime]</p>	<p>Defines the subscription retry time (in seconds) after last subscription failure.</p> <p>The default is 120 seconds. The range is 10 to 2,000,000.</p>
<p>'Subscription Mode'</p> <pre>configure voip &gt; sip- definition proxy-and- registration &gt; subscription-mode</pre> <p>[SubscriptionMode]</p>	<p>Determines the method the device uses to subscribe to an MWI server.</p> <ul style="list-style-type: none"> <li>■ [0] <b>Per Endpoint</b> = (Default) Each endpoint subscribes separately - typically used for FXS interfaces.</li> <li>■ [1] <b>Per Gateway</b> = Single subscription for the entire device - typically used for FXO interfaces.</li> </ul>

Parameter	Description
<pre>configure voip &gt; interface fxs-fxo &gt; etsi-vmwi-type-one- standard [ETSIVMWITypeOneStandard]</pre>	<p>Determines the ETSI Visual Message Waiting Indication (VMWI) Type 1 sub-standard.</p> <ul style="list-style-type: none"> <li>■ [0] = (Default) ETSI VMWI between rings</li> <li>■ [1] = ETSI VMWI before ring DT_AS</li> <li>■ [2] = ETSI VMWI before ring RP_AS</li> <li>■ [3] = ETSI VMWI before ring LR_DT_AS</li> <li>■ [4] = ETSI VMWI not ring related DT_AS</li> <li>■ [5] = ETSI VMWI not ring related RP_AS</li> <li>■ [6] = ETSI VMWI not ring related LR_DT_AS</li> </ul> <p><b>Note:</b> For the parameter to take effect, a device reset is required.</p>
<pre>configure voip &gt; interface fxs-fxo &gt; bellcore-vmwi-type-one- standard [BellcoreVMWITypeOneStandard]</pre>	<p>Determines the Bellcore VMWI sub-standard.</p> <ul style="list-style-type: none"> <li>■ [0] = (Default) Between rings.</li> <li>■ [1] = Not ring related.</li> </ul> <p><b>Note:</b> For the parameter to take effect, a device reset is required.</p>

### Call Hold Parameters

The call hold parameters are described in the table below.

**Table 70-45:Call Hold Parameters**

Parameter	Description
<pre>'Enable Hold' configure voip &gt; gateway dtmf- supp-service supp-service- settings &gt; hold [EnableHold]</pre>	<p>Global parameter that enables the following:</p> <ul style="list-style-type: none"> <li>■ Analog interfaces: Call Hold feature</li> <li>■ Digital interfaces: Interworking of the Hold/Retrieve supplementary service from ISDN to SIP.</li> </ul> <p>You can also configure this feature per specific calls, using IP Profiles (IpProfile_EnableHold). For a detailed description of the parameter and for configuring this feature in the IP Profiles table, see <a href="#">Configuring IP Profiles</a>.</p> <p><b>Note:</b> If this feature is configured for a specific IP Profile, the settings of this global parameter is ignored for calls associated with the IP Profile.</p>

Parameter	Description
<p>'Hold Format'</p> <pre>configure voip &gt; gateway dtmf- supp-service supp-service- settings &gt; hold- format</pre> <p>[HoldFormat]</p>	<p>Defines the format of the SDP in the sent re-INVITE hold request.</p> <ul style="list-style-type: none"> <li>■ [0] <b>0.0.0.0</b> = (Default) The SDP 'c=' field contains the IP address "0.0.0.0" and the 'a=inactive' attribute.</li> <li>■ [1] <b>Send Only</b> = The SDP 'c=' field contains the device's IP address and the 'a=sendonly' attribute.</li> <li>■ [2] <b>x.y.z.t</b> = The SDP 'c=' field contains the device's IP address and the 'a=inactive' attribute.</li> </ul> <p><b>Note:</b></p> <ul style="list-style-type: none"> <li>■ The device does not send any RTP packets when it is in hold state.</li> <li>■ Digital interfaces: The parameter is applicable only to QSIG and Euro ISDN protocols.</li> </ul>
<p>'Held Timeout'</p> <pre>configure voip &gt; gateway dtmf- supp-service supp-service- settings &gt; held- timeout</pre> <p>[HeldTimeout]</p>	<p>Defines the time interval that the device allows for a call to remain on hold. If a Resume (un-hold Re-INVITE) message is received before the timer expires, the call is renewed. If this timer expires, the call is released (terminated).</p> <ul style="list-style-type: none"> <li>■ [-1] = (Default) The call is placed on hold indefinitely until the initiator of the on hold retrieves the call again.</li> <li>■ [0 - 2400] = Time to wait (in seconds) after which the call is released.</li> </ul>
<p>'Call Hold Reminder Ring Timeout'</p> <pre>configure voip &gt; gateway dtmf- supp-service supp-service- settings &gt; call- hold-remnd-rng</pre> <p>[CHRRTimeout]</p>	<p>Defines the duration (in seconds) that the Call Hold Reminder Ring is played. If a user hangs up while a call is still on hold or there is a call waiting, then the FXS interface immediately rings the extension for the duration specified by the parameter. If the user off-hooks the phone, the call becomes active.</p> <p>The valid range is 0 to 600. The default is 30.</p> <p><b>Note:</b></p> <ul style="list-style-type: none"> <li>■ The parameter is applicable only to FXS interfaces.</li> <li>■ This Reminder Ring feature can be disabled using the DisableReminderRing parameter.</li> </ul>
<pre>configure voip &gt; gateway dtmf- supp-service supp-service-</pre>	<p>Disables the reminder ring, which notifies the FXS user of a call on hold or a waiting call when the phone is returned to on-hook position.</p>

Parameter	Description
<pre>settings &gt; dis-reminder-ring</pre> <p>[DisableReminderRing]</p>	<ul style="list-style-type: none"> <li>■ [0] = (Default) The reminder ring feature is active. In other words, if a call is on hold or there is a call waiting and the phone is changed from offhook to onhook, the phone rings (for a duration defined by the CHRRTIMEOUT parameter) to "remind" you of the call hold or call waiting.</li> <li>■ [1] = Disables the reminder ring. If a call is on hold or there is a call waiting and the phone is changed from offhook to onhook, the call is released (and the device sends a SIP BYE to the IP).</li> </ul> <p><b>Note:</b></p> <ul style="list-style-type: none"> <li>■ The parameter is applicable only to FXS interfaces.</li> <li>■ The parameter is typically used for MLPP, allowing preemption to clear held calls.</li> </ul>
<pre>configure voip &gt; gateway dtmf-suppress-service-suppress-service-settings &gt; dtmf-during-hold</pre> <p>[PlayDTMFduringHold]</p>	<p>Determines whether the device sends DTMF signals (or DTMF SIP INFO message) when a call is on hold.</p> <ul style="list-style-type: none"> <li>■ [0] = (Default) Disable.</li> <li>■ [1] = Enable - If the call is on hold, the device stops playing the Held tone (if it is played) and sends DTMF: <ul style="list-style-type: none"> <li>✓ To Tel side: plays DTMF digits according to the received SIP INFO message(s). (The stopped held tone is not played again.)</li> <li>✓ To IP side: sends DTMF SIP INFO messages to an IP destination if it detects DTMF digits from the Tel side.</li> </ul> </li> </ul>

### Call Transfer Parameters

The call transfer parameters are described in the table below.

**Table 70-46:Call Transfer Parameters**

Parameter	Description
<p>'Enable Transfer'</p> <pre>configure voip &gt; gateway dtmf-suppress-service-suppress-service-settings &gt; enable-transfer</pre>	<p>Enables the Call Transfer feature.</p> <ul style="list-style-type: none"> <li>■ [0] <b>Disable</b></li> <li>■ [1] <b>Enable</b> = (Default) <ul style="list-style-type: none"> <li>✓ Digital interfaces: The device responds to a REFER message with the Referred-To header</li> </ul> </li> </ul>

Parameter	Description
[EnableTransfer]	<p>to initiate a call transfer.</p> <ul style="list-style-type: none"> <li>✓ Analog interfaces: If the transfer service is enabled, the user can activate Transfer using hook-flash signaling. If this service is enabled, the remote party performs the call transfer.</li> </ul> <p><b>Note:</b></p> <ul style="list-style-type: none"> <li>■ To use call transfer, the devices at both ends must support this option.</li> <li>■ To use call transfer, set the parameter EnableHold to 1.</li> </ul>
<p>'Transfer Prefix'</p> <pre>configure voip &gt; gateway dtmf-supp- service supp-service- settings &gt; transfer- prefix [xferPrefix]</pre>	<p>Defines the string that is added as a prefix to the transferred/forwarded called number when the REFER/3xx message is received.</p> <p><b>Note:</b></p> <ul style="list-style-type: none"> <li>■ The number manipulation rules apply to the user part of the Refer-To and Contact URI before it is sent in the INVITE message.</li> <li>■ The parameter can be used to apply different manipulation rules to differentiate the transferred/forwarded call number from the originally dialed number.</li> </ul>
<p>'Transfer Prefix IP 2 Tel'</p> <pre>xfer-prefix-ip2tel [XferPrefixIP2Tel]</pre>	<p>Defines the prefix that is added to the destination number received in the SIP Refer-To header (for IP-to-Tel calls). The parameter is applicable only to FXO and CAS blind transfer modes (i.e., LineTransferMode = 1, 2 or 3, and TrunkTransferMode = 1 or 3 for CAS).</p> <p>The valid range is a string of up to 9 characters. By default, no value is defined.</p> <p><b>Note:</b> The parameter is also applicable to ISDN Blind Transfer, according to AT&amp;T Toll Free Transfer Connect Service (TR 50075) "Courtesy Transfer-Human-No Data". To support this transfer mode, you need to configure the parameter [XferPrefixIP2Tel] to "*8" (without quotation marks) and the parameter [TrunkTransferMode] to "5" (without quotation marks).</p>



Parameter	Description
'Enable Semi-Attended Transfer' <code>semi-att-transfer</code> [EnableSemiAttendedTransfer]	Determines the device behavior when Transfer is initiated while in Alerting state. <ul style="list-style-type: none"> <li>■ [0] <b>Disable</b> = (Default) Send REFER with the Replaces header.</li> <li>■ [1] <b>Enable</b> = Send CANCEL, and after a 487 response is received, send REFER without the Replaces header.</li> </ul>
'Blind' <code>configure voip &gt;</code> <code>gateway analog keypad-</code> <code>features &gt; blind-</code> <code>transfer</code> [KeyBlindTransfer]	Defines the keypad sequence to activate blind transfer for established Tel-to-IP calls. The Tel user can perform blind transfer by dialing the KeyBlindTransfer digits, followed by a transferee destination number. <p>After the KeyBlindTransfer DTMF digits sequence is dialed, the current call is put on hold (using a Re-INVITE message), a dial tone is played to the channel, and then the phone number collection starts.</p> <p>After the destination phone number is collected, it is sent to the transferee in a SIP REFER request in a Refer-To header. The call is then terminated and a confirmation tone is played to the channel. If the phone number collection fails due to a mismatch, a reorder tone is played to the channel.</p> <p><b>Note:</b> For analog interfaces, it is possible to configure whether the KeyBlindTransfer code is added as a prefix to the dialed destination number, by using the parameter KeyBlindTransferAddPrefix.</p>
<code>blind-xfer-add-prefix</code> [KeyBlindTransferAddPrefix]	Determines whether the device adds the Blind Transfer code (defined by the KeyBlindTransfer parameter) to the dialed destination number. <ul style="list-style-type: none"> <li>■ [0] = Disable (default)</li> <li>■ [1] = Enable</li> </ul> <p><b>Note:</b> The parameter is applicable only to analog interfaces.</p>
<code>blind-xfer-disc-tmo</code> [BlindTransferDisconnectTimeout]	Defines the duration (in milliseconds) for which the device waits for a disconnection from the Tel side after the Blind Transfer Code (KeyBlindTransfer) has been identified. When this timer expires, a SIP

Parameter	Description
	<p>REFER message is sent toward the IP side. If the parameter is set to 0, the REFER message is immediately sent.</p> <p>The valid value range is 0 to 1,000,000. The default is 0.</p>
<p>'QSIG Path Replacement Mode'  <code>qsig-path-replacement-md</code>            [QSIGPathReplacementMode]</p>	<p>Enables QSIG transfer for IP-to-Tel and Tel-to-IP calls.</p> <ul style="list-style-type: none"> <li>■ [0] <b>IP2QSIGTransfer</b> = (Default) Enables IP-to-QSIG transfer.</li> <li>■ [1] <b>QSIG2IPTransfer</b> = Enables QSIG-to-IP transfer.</li> </ul> <p><b>Note:</b> The parameter is applicable only to digital interfaces.</p>
<p><code>replace-tel2ip-calnum-to</code>            [ReplaceTel2IPCallingNumTimeout]</p>	<p>Defines the maximum duration (timeout) to wait between call Setup and Facility with Redirecting Number for replacing the calling number (for Tel-to-IP calls).</p> <p>The valid value range is 0 to 10,000 msec. The default is 0.</p> <p>The interworking of the received Setup message to a SIP INVITE is suspended when the parameter is set to any value greater than 0. This means that the redirecting number in the Setup message is not checked. When a subsequent Facility with Call Transfer Complete/Update is received with a non-empty Redirection Number, the Calling Number is replaced with the received redirect number in the sent INVITE message.</p> <p>If the timeout expires, the device sends the INVITE without changing the calling number.</p> <p><b>Note:</b></p> <ul style="list-style-type: none"> <li>■ The suspension of the INVITE message occurs for all calls.</li> <li>■ The parameter is applicable only to QSIG.</li> </ul>
<p>'Call Transfer using re-INVITES'  <code>configure voip &gt; sip-definition settings &gt;</code></p>	<p>Enables call transfer using re-INVITES.</p> <ul style="list-style-type: none"> <li>■ [0] <b>Disable</b> = (Default) Call transfer is done using REFER messages.</li> </ul>

Parameter	Description
<pre>enable-call-transfer- using-reinvites</pre> <p>[EnableCallTransferUsingReinvites]</p>	<ul style="list-style-type: none"> <li>■ [1] <b>Enable</b> = Call transfer is done by sending re-INVITE messages (instead of REFER).</li> </ul> <p><b>Note:</b></p> <ul style="list-style-type: none"> <li>■ To support the feature, the device must be installed with an MPM.</li> <li>■ The device uses two DSP channels per transferred call. Therefore, make sure that the device's License Key includes a license for DSP resources ('DSP Channels').</li> <li>■ The parameter is applicable only to FXS interfaces.</li> </ul>

### Three-Way Conferencing Parameters

The three-way conferencing parameters are described in the table below.

**Table 70-47: Three-Way Conferencing Parameters**

Parameter	Description
<pre>'Enable 3-Way Conference'</pre> <pre>configure voip &gt;</pre> <pre>gateway dtmf-supp-</pre> <pre>service supp-service-</pre> <pre>settings &gt; enable-3w-</pre> <pre>conf</pre> <p>[Enable3WayConference]</p>	<p>Enables the 3-Way Conference feature.</p> <ul style="list-style-type: none"> <li>■ [0] <b>Disable</b> (default)</li> <li>■ [1] <b>Enable</b></li> </ul> <p><b>Note:</b> For the parameter to take effect, a device reset is required.</p>
<pre>'3-Way Conference Mode'</pre> <pre>configure voip &gt;</pre> <pre>gateway dtmf-supp-</pre> <pre>service supp-service-</pre> <pre>settings &gt; 3w-conf-</pre> <pre>mode</pre> <p>[3WayConferenceMode]</p>	<p>Defines the mode of operation for three-way conferencing.</p> <ul style="list-style-type: none"> <li>■ [0] <b>AudioCodes Media Server</b> = (Default) The conference-initiating INVITE sent by the device, uses the ConferenceID concatenated with a unique identifier as the Request-URI. This same Request-URI is set as the Refer-To header value in the REFER messages that are sent to the two remote parties. This conference mode is used when operating with AudioCodes IPMedia conferencing server.</li> <li>■ [1] <b>Non-AudioCodes Media Server</b> = The</li> </ul>

Parameter	Description
	<p>conference-initiating INVITE sent by the device, uses only the ConferenceID as the Request-URI. The Conference server sets the Contact header of the 200 OK response to the actual unique identifier (Conference URI) to be used by the participants. This Conference URI is then included by the device in the Refer-To header value in the REFER messages sent by the device to the remote parties. The remote parties join the conference by sending INVITE messages to the conference using this conference URI.</p> <ul style="list-style-type: none"> <li data-bbox="746 741 1394 1211">■ [2] <b>On Board</b> = On-board, three-way conference. The conference is established on the device without the need of an external Conference server. You can limit the number of simultaneous, on-board 3-way conference calls, by using the MaxInBoardConferenceCalls parameter. The device utilizes resources from idle ports to establish the conference call. You can designate ports that you do not want to use as resources for on-board, conference calls initiated by other ports. This is configured using the 3WayConfNoneAllocateablePorts parameter.</li> </ul> <p>Each on-board three-way conference uses two DSP channels. As one channel is already provided by the FXS port interface to which the calling party (initiator of the three-way conference) is connected, the device obtains an additional DSP channel from another FXS port interface that is idle. However, if your device is installed with an MPM module(s), it obtains the DSP channel from the module. If the device is not installed with any MPM modules and all FXS ports are busy, the three-way conference call cannot be made.</p> <ul style="list-style-type: none"> <li data-bbox="746 1693 1394 1962">■ [3] <b>Huawei Media Server</b> = The conference is managed by an external, third-party Conferencing server. The conference-initiating INVITE sent by the device, uses only the ConferenceID as the Request-URI. The Conferencing server sets the Contact header of the 200 OK response to the actual unique identifier (Conference URI) to be</li> </ul>

Parameter	Description
	<p>used by the participants. The Conference URI is included in the URI of the REFER with a Replaces header sent by the device to the Conferencing server. The Conferencing server then sends an INVITE with a Replaces header to the remote participants.</p> <p><b>Note:</b></p> <ul style="list-style-type: none"> <li>■ The parameter is applicable only to FXS and BRI interfaces.</li> <li>■ Three-way conferencing using an external conference server is supported only by FXS interfaces.</li> <li>■ When using an external Conferencing server, a conference call with up to six participants can be established.</li> </ul>
<p>'Max. 3-Way Conference'  <code>configure voip &gt;</code>  <code>gateway dtmf-supp-</code>  <code>service supp-service-</code>  <code>settings &gt; mx-3w-conf-</code>  <code>onboard</code>  [MaxInBoardConferenceCalls]</p>	<p>Defines the maximum number of simultaneous, on-board three-way conference calls.</p> <p>The valid range is 0 to 5. The default is 2.</p> <p><b>Note:</b></p> <ul style="list-style-type: none"> <li>■ For enabling on-board, three-way conferencing, use the 3WayConferenceMode parameter.</li> <li>■ The parameter is applicable only to FXS and BRI interfaces.</li> </ul>
<p>'Non Allocatable Ports'  [3WayConfNoneAllocateablePorts]</p>	<p>Defines the ports that are not allocated as resources for on-board three-way conference calls that are initiated by other ports. Ports that are not configured with this parameter (and that are idle) are used by the device as a resources for establishing these type of conference calls if there are no DSP resources available.</p> <p>The valid range is up to 8 ports. To add multiple ports, use the comma separator. For example, for not allowing the use of ports 2, 4 and 6 as resources, configure the parameter to "2,4,6" (without quotation marks). The order of the entered values is not relevant (i.e., the example above can be entered as 6,2,4). The default is 0.</p> <p><b>Notes:</b></p>

Parameter	Description
	<ul style="list-style-type: none"> <li>■ To enable on-board, three-way conferencing, use the <code>3WayConferenceMode</code> and <code>MaxInBoardConferenceCalls</code> parameters.</li> <li>■ This parameter is applicable only to FXS interfaces.</li> </ul>
<p>'Establish Conference Code'</p> <pre>configure voip &gt; gateway dtmf-supp- service supp-service- settings &gt; estb-conf- code</pre> <p>[ConferenceCode]</p>	<p>Defines the DTMF digit pattern, which upon detection generates the conference call when three-way conferencing is enabled (<code>Enable3WayConference</code> is set to 1).</p> <p>The valid range is a 25-character string. The default is "!" (Hook-Flash).</p> <p><b>Note:</b> If the <code>FlashKeysSequenceStyle</code> parameter is set to 1 or 2, the setting of the <code>ConferenceCode</code> parameter is overridden.</p>
<p>'Conference ID'</p> <pre>configure voip &gt; gateway dtmf-supp- service supp-service- settings &gt; conf-id</pre> <p>[ConferenceID]</p>	<p>Defines the Conference Identification string.</p> <p>The valid value is a string of up to 16 characters. The default is "conf".</p> <p>For three-way conferencing using an external media server: The device uses this identifier in the Conference-initiating INVITE that is sent to the media server when the <code>Enable3WayConference</code> parameter is set to 1.</p> <p>When using the Media Processing Module (MPM): To join a conference, the INVITE URI must include this Conference ID string preceded by the number of the participants in the conference and terminated by a unique number. For example:</p> <pre>INVITE sip:4conf1234@10.1.10.10.</pre> <p>INVITE messages with the same URI join the same conference.</p>
<p>'Use Different RTP port After Hold'</p> <pre>configure voip &gt; sip- definition settings &gt; dfrnt-port-after-hold</pre> <p>[UseDifferentRTPportAfterHold]</p>	<p>Enables the use of different RTP ports for the two calls involved in a three-way conference call made by the FXS endpoint in the initial outgoing INVITE requests.</p> <ul style="list-style-type: none"> <li>■ [0] <b>Disable</b> = (Default) The FXS endpoint makes the first and second calls on the same RTP port in the initial outgoing INVITE request. If a three-way conference is then made, the device sends a re-INVITE to the held call to retrieve it and to change</li> </ul>

Parameter	Description
	<p>the RTP port to a different port number.</p> <p>For example: A first calls B on port 6000 and places B on hold. A then calls C, also on port 6000. The device sends a re-INVITE to the held call to retrieve it and changes the port to 6010.</p> <ul style="list-style-type: none"> <li>■ [1] <b>Enable</b> = The FXS endpoint makes the first and second calls on different RTP ports in the initial outgoing INVITE request. If a three-way conference is then made, the device sends a re-INVITE to the held call to retrieve it, without changing the port of the held call.</li> </ul> <p>For example: A first calls B on port 6000 and places B on hold. A then calls C on port 6010. The device sends a re-INVITE to the held call to retrieve it (without changing the port, i.e., remains 6010).</p> <p><b>Note:</b></p> <ul style="list-style-type: none"> <li>■ When this feature is enabled and only one RTP port is available, only one call can be made by the FXS endpoint, as there is no free RTP port for a second call.</li> <li>■ When this feature is enabled and you are using the Call Forking feature, every forked call is sent with a different RTP port. As the device can fork a call to up to 10 destinations, the device requires at least 10 free RTP ports.</li> <li>■ The parameter is applicable only to FXS interfaces.</li> </ul>

### MLPP and Emergency Call Parameters

The Multilevel Precedence and Preemption (MLPP) and emergency E911 call parameters are described in the table below.

**Table 70-48:MLPP and Emergency E911 Call Parameters**

Parameter	Description
<p>'Call Priority Mode'</p> <pre>configure voip &gt; gateway dtmf-supp-</pre>	<p>Global parameter defining call priority handling. You can also configure the feature per specific calls, using Tel Profiles (TelProfile_CallPriorityMode). For</p>

Parameter	Description
<pre>service supp-service- settings &gt; call-prio- mode</pre> <p>[CallPriorityMode]</p>	<p>a detailed description of the parameter and for configuring the feature in the Tel Profiles table, see <a href="#">Configuring Tel Profiles</a>.</p> <p><b>Note:</b> If the feature is configured for a specific Tel Profile, the settings of the global parameter is ignored for calls associated with the Tel Profile.</p>
<b>Emergency E911 Parameters</b>	
<p>'E911 Gateway'</p> <pre>configure voip &gt; sip- definition settings &gt; e911-gateway</pre> <p>[E911Gateway]</p>	<p>Enables Enhanced 9-1-1(E9-1-1) support for ELIN handling in a Microsoft Skype for Business environment and routing to a PSTN-based emergency service provider.</p> <ul style="list-style-type: none"> <li>■ [0] <b>Disable</b> (default)</li> <li>■ [1] <b>NG911 Callback Gateway</b> = Enables the ELIN Gateway.</li> <li>■ [2] <b>Location Based Manipulations</b> = Enables ELIN Gateway and location-based manipulation. For more information, see <a href="#">Location Based Emergency Routing</a>.</li> </ul> <p>For more information on E9-1-1 in a Skype for Business environment, see <a href="#">E9-1-1 Support for Microsoft Skype for Business</a>.</p> <p><b>Note:</b> The parameter is applicable only to digital interfaces.</p>
<p>'E911 Callback Timeout'</p> <pre>configure voip &gt; sip-definition settings &gt; e911-callback-timeout</pre> <p>[E911CallbackTimeout]</p>	<p>Defines the maximum interval within which the PSAP can use the ELIN to call back the E9-1-1 caller. This interval starts from when the initial call established with the PSAP is terminated.</p> <p>The valid range is 1 to 60 (minutes). The default is 30.</p> <p><b>Note:</b> The parameter is applicable only to digital interfaces.</p>
<p>'Emergency Special Release Cause'</p> <pre>configure voip &gt; sip- definition settings &gt; emrg-spcl-rel-cse</pre> <p>[EmergencySpecialReleaseCause]</p>	<p>Enables the device to send a SIP 503 "Service Unavailable" response if an emergency call cannot be established (i.e., rejected). This can occur, for example, due to the PSTN (for example, the destination is busy or not found) or ELIN Gateway (for example, lack of resources or an internal</p>



Parameter	Description
	<p>error).</p> <ul style="list-style-type: none"> <li>■ [0] <b>Disable</b> (default)</li> <li>■ [1] <b>Enable</b></li> </ul> <p><b>Note:</b> The parameter is applicable only to digital interfaces.</p>
[Enable911PSAP]	<p>Global parameter enabling the support for the E911 DID protocol, according to the Bellcore GR-350-CORE standard.</p> <p>You can also configure the feature per specific calls, using Tel Profiles. For a detailed description of the parameter and for configuring the feature in the Tel Profiles table, see <a href="#">Configuring Tel Profiles</a>.</p> <p><b>Note:</b> If the feature is configured for a specific Tel Profile, the settings of the global parameter is ignored for calls associated with the Tel Profile.</p>
<p>'Emergency Number'</p> <pre>configure voip &gt; sip- definition settings &gt; emerg-nbs</pre> <p>[EmergencyNumbers]</p>	<p>Defines a list of “emergency” numbers.</p> <p>FXS interfaces: When one of these numbers is dialed, the outgoing INVITE message includes the SIP Priority and Resource-Priority headers. If the user places the phone on-hook, the call is not disconnected. Instead, a Hold Re-INVITE request is sent to the remote party. Only if the remote party disconnects the call (i.e., a BYE is received) or a timer expires (set by the EmergencyRegretTimeout parameter) is the call terminated.</p> <p>FXO, CAS, and ISDN interfaces: These emergency numbers are used for the preemption of E911 IP-to-Tel calls when there are unavailable or busy channels. In this scenario, the device terminates one of the busy channels and sends the emergency call to this channel. This feature is enabled by setting the CallPriorityMode parameter to 2 (“Emergency”). For a description of this feature, see <a href="#">Pre-empting Existing Call for E911 IP-to-Tel Call</a>.</p> <p>The list can include up to four different numbers, where each number can be up to four digits long. For example:</p> <pre>EmergencyNumbers =</pre>

Parameter	Description
	'100', '911', '112'
<p>'Emergency Calls Regret Timeout'</p> <pre>configure voip &gt; sip- definition settings &gt; emerg-calls-regrt-t-out</pre> <p>[EmergencyRegretTimeout]</p>	<p>Defines the time (in minutes) that the device waits before tearing-down an emergency call (defined by the parameter EmergencyNumbers). Until this time expires, an emergency call can only be disconnected by the remote party, typically, by a Public Safety Answering Point (PSAP).</p> <p>The valid range is 1 to 30. The default is 10.</p> <p><b>Note:</b> The parameter is applicable only to FXS interfaces.</p>
<b>Multilevel Precedence and Preemption (MLPP) Parameters</b>	
<p>'MLPP Default Namespace'</p> <pre>mlpp-dflt-namespace</pre> <p>[MLPPDefaultNamespace]</p>	<p>Determines the namespace used for MLPP calls received from the ISDN side without a Precedence IE and destined for an Application server. This value is used in the Resource-Priority header of the outgoing SIP INVITE request.</p> <ul style="list-style-type: none"> <li>■ [1] <b>DSN</b> (default)</li> <li>■ [2] <b>DOD</b></li> <li>■ [3] <b>DRSN</b></li> <li>■ [5] <b>UC</b></li> <li>■ [7] <b>CUC</b></li> </ul> <p><b>Note:</b></p> <ul style="list-style-type: none"> <li>■ If the ISDN message contains a Precedence IE, the device automatically interworks the "network identity" digits in the IE to the network domain subfield in the Resource-Priority header. For more information, see <a href="#">Multilevel Precedence and Preemption</a>.</li> <li>■ The parameter is applicable only to digital interfaces.</li> </ul>
<p>[ResourcePriorityNetworkDomains]</p>	<p>Defines up to 32 user-defined MLPP network domain names (namespaces). This value is used in the AS-SIP Resource-Priority header of the outgoing SIP INVITE request. The parameter is used in combination with the MLPPDefaultNamespace parameter, where you</p>

Parameter	Description
	<p>need to enter the table row index as its value.</p> <p>The parameter is also used for mapping the Resource-Priority field value of the SIP Resource-Priority header to the ISDN Precedence Level IE. The mapping is configured by the field, EnableIp2TelInterworking:</p> <ul style="list-style-type: none"> <li>■ Disabled: The network-domain field in the Resource-Priority header is set to "0 1 0 0" (i.e., "routine") in the Precedence Level field.</li> <li>■ Enabled: The network-domain field in the Resource-Priority header is set in the Precedence Level field according to Table 5.3.2.12-4 (Mapping of RPH r-priority Field to ISDN Precedence Level Value).</li> </ul> <p>The domain name can be a string of up to 10 characters.</p> <p>The format of this table ini file parameter is as follows:</p> <pre>FORMAT ResourcePriorityNetworkDomains_Index = ResourcePriorityNetworkDomains_Name, ResourcePriorityNetworkDomains_ EnableIp2TelInterworking; ResourcePriorityNetworkDomains 1 = dsn, 0; ResourcePriorityNetworkDomains 2 = dod, 0; ResourcePriorityNetworkDomains 3 = drsn, 0; ResourcePriorityNetworkDomains 5 = uc, 1; ResourcePriorityNetworkDomains 7 = cuc, 0; [ \ResourcePriorityNetworkDomains ]</pre> <p><b>Note:</b></p> <ul style="list-style-type: none"> <li>■ Indices 1, 2, 3, 5, and 7 cannot be modified and are defined for DSN, DOD, DRSN, UC, and CUC, respectively.</li> <li>■ If the MLPPDefaultNamespace parameter is set to -1, interworking from PSTN NI digits is done automatically.</li> <li>■ The parameter is applicable only to digital interfaces.</li> </ul>
'Default Call Priority'	Determines the default call priority for MLPP calls.

Parameter	Description
dflt-call-prio [SIPDefaultCallPriority]	<ul style="list-style-type: none"> <li>■ [0] 0 = (Default) ROUTINE</li> <li>■ [2] 2 = PRIORITY</li> <li>■ [4] 4 = IMMEDIATE</li> <li>■ [6] 6 = FLASH</li> <li>■ [8] 8 = FLASH-OVERRIDE</li> <li>■ [9] 9 = FLASH-OVERRIDE-OVERRIDE</li> </ul> <p>If the incoming SIP INVITE request doesn't contain a valid priority value in the SIP Resource-Priority header, the default value is used in the Precedence IE (after translation to the relevant ISDN Precedence value) of the outgoing ISDN Setup message.</p> <p>If the incoming Setup message doesn't contain a valid Precedence Level value, the default value is used in the Resource-Priority header of the outgoing SIP INVITE request. In this scenario, the character string is sent without translation to a numerical value.</p> <p><b>Note:</b> The parameter is applicable only to digital interfaces.</p>
'MLPP DiffServ' configure voip/gateway dtmf-supp-service supp- service-settings/mlpp- diffserv [MLPPDiffserv]	<p>Defines the DiffServ value (differentiated services code point/DSCP) used in IP packets containing SIP messages that are related to MLPP calls. The parameter defines DiffServ for incoming and, for digital interfaces, outgoing MLPP calls with the Resource-Priority header.</p> <p>The valid range is 0 to 63. The default is 50.</p>
'Preemption Tone Duration' preemp-tone-dur [PreemptionToneDuration]	<p>Defines the duration (in seconds) in which the device plays a preemption tone to the Tel and IP sides if a call is preempted.</p> <p>The valid range is 0 to 60. The default is 3.</p> <p><b>Note:</b></p> <ul style="list-style-type: none"> <li>■ If set to 0, no preemption tone is played.</li> <li>■ The parameter is applicable only to digital interfaces.</li> </ul>
'MLPP Normalized Service Domain'	<p>Defines the MLPP normalized service domain</p>

Parameter	Description
mlpp-norm-ser-dmn [MLPPNormalizedServiceDomain]	<p>string. If the device receives an MLPP ISDN incoming call, it uses the parameter (if different from 'FFFFFF') as a Service domain in the SIP Resource-Priority header in outgoing INVITE messages. If the parameter is configured to 'FFFFFF', the Resource-Priority header is set to the MLPP Service Domain obtained from the Precedence IE.</p> <p>The valid value is 6 hexadecimal digits. The default is '000000'.</p> <p><b>Note:</b></p> <ul style="list-style-type: none"> <li>■ The parameter is applicable only to the MLPP NI-2 ISDN variant with CallPriorityMode set to 1.</li> <li>■ The parameter is applicable only to digital interfaces.</li> </ul>
mlpp-nwrk-id [MLPPNetworkIdentifier]	<p>Defines the MLPP network identifier (i.e., International prefix or Telephone Country Code/TCC) for IP-to-ISDN calls, according to the UCR 2008 and ITU Q.955 specifications.</p> <p>The valid range is 1 to 999. The default is 1 (i.e., USA).</p> <p>The MLPP network identifier is sent in the Facility IE of the ISDN Setup message. For example:</p> <ul style="list-style-type: none"> <li>■ MLPPNetworkIdentifier set to default (i.e., USA, 1):</li> </ul> <pre>PlaceCall- MLPPNetworkID:0100 MlppServiceDomain:123abc, MlppPrecLevel:5 Fac(1c): 91 a1 15 02 01 05 02 01 19 30 0d 0a 01 05 0a 01 01 04 05 01 00 12 3a bc</pre> <ul style="list-style-type: none"> <li>■ MLPPNetworkIdentifier set to 490:</li> </ul> <pre>PlaceCall- MLPPNetworkID:9004 MlppServiceDomain:123abc, MlppPrecLevel:5 Fac(1c): 91 a1 15 02 01 0a 02 01 19 30 0d 0a 01 05 0a 01 01 04 05</pre>

Parameter	Description
	<p>90 04 12 3a bc</p> <p><b>Note:</b> The parameter is applicable only to digital interfaces.</p>
<p>'MLPP Default Service Domain' mlpp-dflt-srv-domain [MLPPDefaultServiceDomain]</p>	<p>Defines the MLPP default service domain string. If the device receives a non-MLPP ISDN incoming call (without a Precedence IE), it uses the parameter (if different than "FFFFFF") as a Service domain in the SIP Resource-Priority header in outgoing (Tel-to-IP calls) INVITE messages. The parameter is used in conjunction with the parameter SIPDefaultCallPriority.</p> <p>If MLPPDefaultServiceDomain is set to 'FFFFFF', the device interworks the non-MLPP ISDN call to non-MLPP SIP call, and the outgoing INVITE does not contain the Resource-Priority header.</p> <p>The valid value is a 6 hexadecimal digits. The default is "000000".</p> <p><b>Note:</b></p> <ul style="list-style-type: none"> <li>■ The parameter is applicable only to the MLPP NI-2 ISDN variant with CallPriorityMode set to 1.</li> <li>■ The parameter is applicable only to digital interfaces.</li> </ul>
<p>'Precedence Ringing Type' precedence-ringing [PrecedenceRingingType]</p>	<p>Defines the index of the Precedence Ringing tone in the Call Progress Tones (CPT) file. This tone is used when the parameter CallPriorityMode is set to 1 and a Precedence call is received from the IP side.</p> <p>The valid range is -1 to 16. The default is -1 (i.e., plays standard ringing tone).</p> <p><b>Note:</b> The parameter is applicable only to analog interfaces.</p>
<p>e911-mlpp-bhvr [E911MLPPBehavior]</p>	<p>Defines the E911 (or Emergency Telecommunication Services/ETS) MLPP Preemption mode:</p> <ul style="list-style-type: none"> <li>■ [0] = (Default) Standard Mode - ETS calls have the highest priority and preempt any MLPP call.</li> </ul>

Parameter	Description														
	<ul style="list-style-type: none"> <li>■ [1] = Treat as routine mode - ETS calls are handled as routine calls.</li> </ul> <p><b>Note:</b> The parameter is applicable only to analog interfaces.</p>														
<p>resource-prio-req [RPRequired]</p>	<p>Defines if the device adds the SIP 'resource-priority' tag to the SIP Require header of INVITE messages for Tel-to-IP calls.</p> <ul style="list-style-type: none"> <li>■ [0] = Disable. The device excludes the SIP 'resource-priority' tag from the SIP Require header.</li> <li>■ [1] = (Default) Enable. The device adds the SIP 'resource-priority' tag to the SIP Require header.</li> </ul> <p><b>Note:</b> The parameter is applicable only to MLPP priority call handling (i.e., only when the CallPriorityMode parameter is configured to [1]).</p>														
<p><b>Multiple Differentiated Services Code Points (DSCP) per MLPP Call Priority Level (Precedence) Parameters</b></p> <p>The MLPP service allows placement of priority calls, where properly validated users can preempt (terminate) lower-priority phone calls with higher-priority calls. For each MLPP call priority level, the DSCP can be set to a value from 0 to 63. The Resource Priority value in the Resource-Priority SIP header can be one of the following:</p> <table border="1" data-bbox="308 1305 1393 1809"> <thead> <tr> <th data-bbox="308 1305 679 1377">MLPP Precedence Level</th> <th data-bbox="679 1305 1393 1377">Precedence Level in Resource-Priority SIP Header</th> </tr> </thead> <tbody> <tr> <td data-bbox="308 1377 679 1449">0 (lowest)</td> <td data-bbox="679 1377 1393 1449">routine</td> </tr> <tr> <td data-bbox="308 1449 679 1520">2</td> <td data-bbox="679 1449 1393 1520">priority</td> </tr> <tr> <td data-bbox="308 1520 679 1592">4</td> <td data-bbox="679 1520 1393 1592">immediate</td> </tr> <tr> <td data-bbox="308 1592 679 1664">6</td> <td data-bbox="679 1592 1393 1664">flash</td> </tr> <tr> <td data-bbox="308 1664 679 1736">8</td> <td data-bbox="679 1664 1393 1736">flash-override</td> </tr> <tr> <td data-bbox="308 1736 679 1809">9 (highest)</td> <td data-bbox="679 1736 1393 1809">flash-override-override</td> </tr> </tbody> </table>		MLPP Precedence Level	Precedence Level in Resource-Priority SIP Header	0 (lowest)	routine	2	priority	4	immediate	6	flash	8	flash-override	9 (highest)	flash-override-override
MLPP Precedence Level	Precedence Level in Resource-Priority SIP Header														
0 (lowest)	routine														
2	priority														
4	immediate														
6	flash														
8	flash-override														
9 (highest)	flash-override-override														
<p>'RTP DSCP for MLPP Routine' dscp-4-mlpp-rtn [MLPPRoutineRTPDSCP]</p>	<p>Defines the RTP DSCP for MLPP Routine precedence call level.</p> <p>The valid range is -1 to 63. The default is -1.</p>														

Parameter	Description
	<p><b>Note:</b> If set to -1, the DiffServ value is taken from the global parameter PremiumServiceClassMediaDiffServ or as defined in IP Profiles per call.</p>
<p>'RTP DSCP for MLPP Priority' dscp-4-mlpp-prio [MLPPPriorityRTPDSCP]</p>	<p>Defines the RTP DSCP for MLPP Priority precedence call level.</p> <p>The valid range is -1 to 63. The default is -1.</p> <p><b>Note:</b> If set to -1, the DiffServ value is taken from the global parameter PremiumServiceClassMediaDiffServ or as defined in IP Profiles per call.</p>
<p>'RTP DSCP for MLPP Immediate' dscp-4-mlpp-immed [MLPPImmediateRTPDSCP]</p>	<p>Defines the RTP DSCP for MLPP Immediate precedence call level.</p> <p>The valid range is -1 to 63. The default is -1.</p> <p><b>Note:</b> If set to -1, the DiffServ value is taken from the global parameter PremiumServiceClassMediaDiffServ or as defined in IP Profiles per call.</p>
<p>'RTP DSCP for MLPP Flash' dscp-4-mlpp-flsh [MLPPFlashRTPDSCP]</p>	<p>Defines the RTP DSCP for MLPP Flash precedence call level.</p> <p>The valid range is -1 to 63. The default is -1.</p> <p><b>Note:</b> If set to -1, the DiffServ value is taken from the global parameter PremiumServiceClassMediaDiffServ or as defined in IP Profiles per call.</p>
<p>'RTP DSCP for MLPP Flash Override' dscp-4-mlpp-flsh-ov [MLPPFlashOverRTPDSCP]</p>	<p>Defines the RTP DSCP for MLPP Flash-Override precedence call level.</p> <p>The valid range is -1 to 63. The default is -1.</p> <p><b>Note:</b> If set to -1, the DiffServ value is taken from the global parameter PremiumServiceClassMediaDiffServ or as defined in IP Profiles per call.</p>
<p>'RTP DSCP for MLPP Flash-Override-Override' dscp-4-mlpp-flsh-ov-ov [MLPPFlashOverOverRTPDSCP]</p>	<p>Defines the RTP DSCP for MLPP Flash-Override-Override precedence call level.</p> <p>The valid range is -1 to 63. The default is -1.</p> <p><b>Note:</b> If set to -1, the DiffServ value is taken from the global parameter PremiumServiceClassMediaDiffServ or as defined in IP Profiles per call.</p>



Parameter	Description
	PremiumServiceClassMediaDiffServ or as defined in IP Profiles per call.

## Call Cut-through Parameters

The call cut-through parameters are described in the table below.

**Table 70-49: Call Cut-Through Parameters**

Parameter	Description
'Enable Calls Cut Through' <code>configure voip &gt; sip-definition settings &gt; calls-cut-through</code> [CutThrough]	<p>Global parameter enabling FXS endpoints to receive incoming IP calls while the port is in off-hook state.</p> <p>You can also configure the feature per specific calls, using Tel Profiles (TelProfile_IP2TelCutThroughCallBehavior). For a detailed description of the parameter and for configuring the feature in the Tel Profiles table, see <a href="#">Configuring Tel Profiles</a>.</p> <p><b>Note:</b></p> <ul style="list-style-type: none"> <li>■ The parameter is applicable only to FXS interfaces.</li> <li>■ If the feature is configured for a specific Tel Profile, the settings of the global parameter is ignored for calls associated with the Tel Profile.</li> </ul>
<code>cut-through-anable</code> [DigitalCutThrough]	<p>Global parameter enabling PSTN CAS channels/endpoints to receive incoming IP calls even if the B-channels are in off-hook state.</p> <p>You can also configure the feature per specific calls, using Tel Profiles (TelProfile_DigitalCutThrough). For a detailed description of the parameter and for configuring the feature in the Tel Profiles table, see <a href="#">Configuring Tel Profiles</a>.</p> <p><b>Note:</b></p> <ul style="list-style-type: none"> <li>■ If the feature is configured for a specific Tel Profile, the settings of the global parameter is ignored for calls associated with the Tel Profile.</li> <li>■ The parameter is applicable only to digital interfaces (CAS).</li> </ul>

## Direct Inward Dialing Parameters

The Direct Inward Dialing (DID) parameters are described in the table below.

Table 70-50: DID Parameters

Parameter	Description
<p>'DID Wink'</p> <pre>configure voip &gt; sip-definition settings &gt; did- wink-enbl</pre> <p>[EnableDIDWink]</p>	<p>Global parameter enabling Direct Inward Dialing (DID) using Wink-Start signaling, typically used for signaling between an E-911 switch and the PSAP.</p> <p>You can also configure the feature per specific calls, using Tel Profiles (TelProfile_EnableDIDWink). For a detailed description of the parameter and for configuring the feature in the Tel Profiles table, see <a href="#">Configuring Tel Profiles</a>.</p> <p><b>Note:</b></p> <ul style="list-style-type: none"> <li>■ The parameter is applicable to FXS and FXO interfaces.</li> <li>■ If the feature is configured for a specific Tel Profile, the settings of the global parameter is ignored for calls associated with the Tel Profile.</li> </ul>
<p>'Time Between DID Winks'</p> <pre>configure voip &gt; sip-definition settings &gt; time- between-did-winks</pre> <p>[TimeBetweenDIDWinks]</p>	<p>Defines the interval (in msec) for wink signaling:</p> <ul style="list-style-type: none"> <li>■ Double-wink signaling [2]: interval between the first and second wink</li> <li>■ Wink and Polarity signaling [3]: interval between wink and polarity change</li> </ul> <p>The valid range is 100 to 2000. The default is 1000.</p> <p><b>Note:</b> See the EnableDIDWink parameter for configuring the wink signaling type.</p>
<p>'Delay Before DID Wink'</p> <pre>configure voip &gt; sip-definition settings &gt; delay- b4-did-wink</pre> <p>[DelayBeforeDIDWink]</p>	<p>Defines the time interval (in msec) between the detection of the off-hook and the generation of the DID Wink.</p> <p>The valid range is 0 to 1,000. The default is 0.</p> <p><b>Note:</b> The parameter is applicable only to FXS interfaces.</p>
<p>NTT-DID- signaling-form</p> <p>[NTTDIDSignallingForm]</p>	<p>Determines the type of DID signaling support for NTT (Japan) modem: DTMF- or Frequency Shift Keying (FSK)-based signaling. The devices can be connected to Japan's NTT PBX using 'Modem' DID lines. These DID lines are used to deliver a called number to the PBX.</p> <ul style="list-style-type: none"> <li>■ [0] = (Default) FSK-based signaling</li> <li>■ [1] = DTMF-based signaling</li> </ul> <p><b>Note:</b> The parameter is applicable only to FXS interfaces.</p>

Parameter	Description
<pre>configure voip &gt; sip-definition settings &gt; enable-did [EnableDID]</pre>	<p>This table parameter enables support for Japan NTT 'Modem' DID. FXS interfaces can be connected to Japan's NTT PBX using 'Modem' DID lines. These DID lines are used to deliver a called number to the PBX. The DID signal can be sent alone or combined with an NTT Caller ID signal. The format of the ini file table parameter is as follows:</p> <pre>[EnableDID] FORMAT EnableDID_Index = EnableDID_IsEnable; EnableDID_Port, EnableDID_Module; [\EnableDID]</pre> <p>Where,</p> <ul style="list-style-type: none"> <li>■ IsEnable = Enables [1] or disables [0] (default) Japan NTT Modem DID support.</li> <li>■ Port = Port number.</li> <li>■ Module = Module number.</li> </ul> <p>For example: EnableDID 0 = 1,1,2; (DID is enabled on Port 1 of Module 2)</p> <p><b>Note:</b> The parameter is applicable only to FXS interfaces.</p>
<pre>configure voip &gt; interface fxs-fxo &gt; wink-time [WinkTime]</pre>	<p>Defines the time (in msec) elapsed between two consecutive polarity reversals. The parameter can be used for DID signaling, for example, E911 lines to the Public Safety Answering Point (PSAP), according to the Bellcore GR-350-CORE standard (refer to the ini file parameter Enable911PSAP).</p> <p>The valid range is 0 to 4,294,967,295. The default is 200.</p> <p><b>Note:</b> For the parameter to take effect, a device reset is required.</p>

### ISDN BRI Parameters

The ISDN BRI call forwarding service parameters are described in the table below.

**Table 70-51: BRI Call Forwarding Services Parameters**

Parameter	Description
<p><b>BRI-to-SIP Supplementary Services Codes for Call Forward</b></p> <p>For more information, see <a href="#">BRI Call Forwarding</a>.</p>	
'Call Forward Unconditional'	Defines the prefix code for activating Call Forward

Parameter	Description
<pre>configure voip &gt; gateway dtmf-supp- service supp- service- settingscfu-code [SuppServCodeCFU]</pre>	<p>Unconditional sent to the softswitch.</p> <p>The valid value is a string. By default, no value is defined.</p> <p><b>Note:</b> The string must be enclosed by a single quotation mark (e.g., '*72').</p>
<p>'Call Forward Unconditional Deactivation'</p> <pre>configure voip &gt; gateway dtmf-supp- service supp- service- settingscfu- deactivation-code [SuppServCodeCFUDeact]</pre>	<p>Defines the prefix code for deactivating Call Forward Unconditional Deactivation sent to the softswitch.</p> <p>The valid value is a string. By default, no value is defined.</p> <p><b>Note:</b> The string must be enclosed by a single quotation mark (e.g., '*72').</p>
<p>'Call Forward on Busy'</p> <pre>configure voip &gt; gateway dtmf-supp- service supp- service- settingscfb-code [SuppServCodeCFB]</pre>	<p>Defines the prefix code for activating Call Forward on Busy sent to the softswitch.</p> <p>The valid value is a string. By default, no value is defined.</p> <p><b>Note:</b> The string must be enclosed by a single quotation mark (e.g., '*72').</p>
<p>'Call Forward on Busy Deactivation'</p> <pre>configure voip &gt; gateway dtmf-supp- service supp- service- settingscfb- deactivation-code [SuppServCodeCFBDeact]</pre>	<p>Defines the prefix code for deactivating Call Forward on Busy Deactivation sent to the softswitch.</p> <p>The valid value is a string. By default, no value is defined.</p> <p><b>Note:</b> The string must be enclosed by a single quotation mark (e.g., '*72').</p>
<p>'Call Forward on No Reply'</p> <pre>configure voip &gt; gateway dtmf-supp- service supp- service- settingscfnr-code [SuppServCodeCFNR]</pre>	<p>Defines the prefix code for activating Call Forward on No Reply sent to the softswitch.</p> <p>The valid value is a string. By default, no value is defined.</p> <p><b>Note:</b> The string must be enclosed by a single quotation mark (e.g., '*72').</p>

Parameter	Description
'Call Forward on No Reply Deactivation' configure voip > gateway dtmf-supp- service supp- service- settingscfnr- deactivation-code [SuppServCodeCFNRDeact]	Defines the prefix code for deactivating Call Forward on No Reply Deactivation sent to the softswitch. The valid value is a string. By default, no value is defined. <b>Note:</b> The string must be enclosed by a single quotation mark (e.g., '*72').
configure voip > gateway dtmf-supp- service supp- service- settingsuse- facility-in-req [UseFacilityInRequest]	Enables the device to indicate the type of call forwarding service in the Request-URI of the outgoing SIP INVITE message, using a proprietary header parameter, "facility=<call forward service>". <ul style="list-style-type: none"><li>■ [0] = (Default) Disable</li><li>■ [1] = Enable</li></ul>
[BRICallForwardHandling]	Enables the device to handle BRI call forwarding. <ul style="list-style-type: none"><li>■ [0] Disable = (Default) BRI call forwarding is handled by a remote server. The device interworks Facility message from the BRI endpoint to SIP messages sent to the server. For more information, see <a href="#">Remote Handling of BRI Call Forwarding</a>.</li><li>■ [1] Enable = BRI call forwarding is handled by the device. For more information, see <a href="#">Local Handling of BRI Call Forwarding</a>.</li></ul>

## PSTN Parameters

This subsection describes the device's PSTN parameters.

### General Parameters

The general PSTN parameters are described in the table below.

**Table 70-52:General PSTN Parameters**

Parameter	Description
[ISDNTimerT310]	Defines the T310 override timer for DMS, Euro ISDN, and ISDN NI-2 variants. An ISDN timer is started when a Q.931 Call Proceeding message is received. The

Parameter	Description
	<p>timer is stopped when a Q.931 Alerting, Connect, or Disconnect message is received from the other end. If no ISDN Alerting, Progress, or Connect message is received within the duration of T310 timer, the call clears.</p> <p>The valid value range is 0 to 600 seconds. The default is 0 (i.e., use the default timer value according to the protocol's specifications).</p> <p><b>Note:</b></p> <ul style="list-style-type: none"> <li>■ For the parameter to take effect, a device reset is required.</li> <li>■ When both the parameters ISDNDmsTimerT310 and ISDNTimerT310 are configured, the value of the parameter ISDNTimerT310 prevails.</li> </ul>
[ISDNMSTimerT310]	<p>Defines the override T310 timer for the DMS-100 ISDN variant. T310 defines the timeout between the receipt of a Proceeding message and the receipt of an Alerting/Connect message.</p> <p>The valid range is 10 to 30. The default is 10 (seconds).</p> <p><b>Note:</b></p> <ul style="list-style-type: none"> <li>■ Instead of configuring the parameter, it is recommended to use the parameter ISDNTimerT310.</li> <li>■ The parameter is applicable only to Nortel DMS and Nortel MERIDIAN PRI variants (ProtocolType = 14 and 35).</li> </ul>
[ISDNTimerT301]	<p>Defines the override T301 timer (in seconds). The T301 timer is started when a Q.931 Alert message is received. The timer is stopped when a Q.931 Connect/Disconnect message is received from the other side. If no Connect or Disconnect message is received within the duration of T301, the call is cleared.</p> <p>The valid range is 0 to 2400. The default is 0 (i.e., the default T301 timer value - 180 seconds - is used). If set to any value other than 0, it overrides the timer with this value.</p> <p><b>Note:</b></p>

Parameter	Description
	<ul style="list-style-type: none"> <li>■ For the parameter to take effect, a device reset is required.</li> <li>■ The parameter is applicable only to the QSIG variant.</li> </ul>
[ISDNJapanNTTTimerT3JA]	<p>Defines the T3_JA timer (in seconds). The parameter overrides the internal PSTN T301 timeout on the Users Side (TE side). If an outgoing call from the device to ISDN is not answered during this timeout, the call is released.</p> <p>The valid value is -1 to 300. The default is 0 (meaning 50 sec). The value -1 means that no timer is activated.</p> <p><b>Note:</b></p> <ul style="list-style-type: none"> <li>■ This timer is also affected by the parameter PSTNAlertTimeout.</li> <li>■ The parameter is applicable only to the Japan NTT PRI variant (ProtocolType = 16).</li> </ul>
[TrunkLifeLineType]	<p>Defines the scenarios upon which the device activates PSTN Fallback for digital interfaces. When PSTN Fallback is triggered, the device automatically routes incoming Tel calls to the PSTN (instead of to the IP).</p> <ul style="list-style-type: none"> <li>■ [0] = (Default) PSTN Fallback is activated upon the loss of power to the device, for example, due to a power outage or the unplugging of the device's power cable.</li> <li>■ [1] = PSTN Fallback is activated upon one of the following: <ul style="list-style-type: none"> <li>✓ Loss of power to the device.</li> <li>✓ Cable connecting the device to the LAN has been physically disconnected.</li> </ul> </li> </ul> <p>PSTN Fallback is provided by two ports, where one port is connected to the PBX, for example, and the other to the PSTN. When PSTN Fallback is triggered, for example, due to a power outage, the device automatically connects the two ports using a metallic relay switch. In such a scenario, calls originating from the PBX are routed directly to the PSTN (instead of</p>

Parameter	Description
	<p>the IP network). For more information on PSTN Fallback cabling, refer to the <i>Hardware Installation Manual</i>.</p> <p><b>Note:</b></p> <ul style="list-style-type: none"> <li>■ For the parameter to take effect, a device reset is required.</li> <li>■ The parameter is applicable only to the Gateway application and digital interfaces.</li> <li>■ PSTN Fallback is supported only on specific hardware configurations and where dual digital ports are provided. For more information, refer to the <i>Hardware Installation Manual</i>.</li> <li>■ The PSTN Fallback feature has no relation to the PSTN Fallback License Key.</li> </ul>
[TrunkLifeLineType]	<p>Defines the scenarios upon which the device activates PSTN Fallback for digital interfaces (BRI). PSTN Fallback automatically re-routes Tel calls initially destined to the IP network to the PSTN instead, upon power outage, a LAN disconnection, or loss of IP connectivity (i.e., no ping), thereby guaranteeing call continuity.</p> <p>PSTN Fallback is provided by two ports, where in the event of a PSTN Fallback, the device automatically connects the two ports using a metallic relay switch. For example, if one port is connected to a PBX and the other port to the PSTN, upon a power outage, calls originating from the PBX are routed directly to the PSTN (instead of to the IP network).</p> <p>PSTN Fallback is supported on modules providing two or four ports. In the event of a PSTN fallback, the module's metallic relay switch automatically connects Port 1 (I) to Port 2 (II), and/or Port 3 (III) to Port 4 (IIII) of the same module. For example, if a PBX trunk is connected to Port 1 and the PSTN network to Port 2, when PSTN fallback is activated, calls from the PBX are routed directly to the PSTN through Port 2.</p> <ul style="list-style-type: none"> <li>■ [0] = (Default) PSTN Fallback is activated only upon power outage.</li> <li>■ [1] = PSTN Fallback is activated upon one of the</li> </ul>



Parameter	Description
	<p>following:</p> <ul style="list-style-type: none"> <li>✓ Power outage</li> <li>✓ Detection of LAN disconnection</li> </ul> <p>■ [2] = PSTN Fallback is activated upon one of the following:</p> <ul style="list-style-type: none"> <li>✓ Power outage</li> <li>✓ Detection of LAN disconnection</li> <li>✓ Loss of IP network connectivity (i.e., no ping)</li> </ul> <p><b>Note:</b></p> <ul style="list-style-type: none"> <li>■ For the parameter to take effect, a device reset is required.</li> <li>■ PSTN Fallback is supported only on specific hardware configurations and where dual digital ports are provided.</li> <li>■ PSTN Fallback is supported only between ports on the same module.</li> <li>■ For ISDN E1/T1, PSTN Fallback is supported only when the number of supported channels (e.g., 30) is less than the maximum number of possible channels provided by the physical ports (e.g., two E1 trunks). When the number of supported channels (e.g., 60) equals the maximum number of channels provided by the physical ports (e.g., two E1 trunks), other protocols such as CAS are also supported.</li> <li>■ The PSTN Fallback feature has no relation to the PSTN Fallback License Key.</li> <li>■ For more information on cabling the device for PSTN Fallback, refer to the Hardware Installation Manual.</li> </ul>
[AdminState]	<p>Defines the administrative state for all trunks.</p> <ul style="list-style-type: none"> <li>■ [0] = Lock the trunk; stops trunk traffic to configure the trunk protocol type.</li> <li>■ [1] = Shutting down (read only).</li> <li>■ [2] = (Default) Unlock the trunk; enables trunk</li> </ul>

Parameter	Description
	<p>traffic.</p> <p><b>Note:</b></p> <ul style="list-style-type: none"> <li>■ For the parameter to take effect, a device reset is required.</li> <li>■ When the device is locked from the Web interface, the parameter changes to 0.</li> <li>■ To define the administrative state per trunk, use the TrunkAdministrativeState parameter.</li> </ul>
[TrunkAdministrativeState_x]	<p>Defines the administrative state per trunk, where x denotes the trunk number.</p> <ul style="list-style-type: none"> <li>■ [0] = Lock the trunk; stops trunk traffic to configure the trunk protocol type.</li> <li>■ [1] = shutting down (read only).</li> <li>■ [2] = (Default) Unlock the trunk; enables trunk traffic.</li> </ul>
[TDMHairPinning]	<p>Defines static TDM hair-pinning (cross-connection) performed at initialization. The connection is between trunks with an option to exclude a single B-channel in each trunk. Format example: T0-T1/B3,T2-T3,T4-T5/B2.</p> <p><b>Note:</b></p> <ul style="list-style-type: none"> <li>■ For the parameter to take effect, a device reset is required.</li> <li>■ The parameter is applicable only to PRI.</li> </ul>
[TDMHairPinningAlarmIndication]	<p>Enables two trunks that are connected through TDM hairpinning to signal the Far-End about the presence of PSTN alarms. When the trunk with TDM hairpinning receives a PSTN alarm, its' connected trunk sends an AIS alarm to its' Far-End.</p> <ul style="list-style-type: none"> <li>■ [0] = (Default) Disable</li> <li>■ [1] = Enable</li> </ul> <p><b>Note:</b></p> <ul style="list-style-type: none"> <li>■ For the parameter to take effect, a device reset is required.</li> </ul>

Parameter	Description
'Enable TDM Tunneling' tdm-tunneling [EnableTDMOverIP]	<ul style="list-style-type: none"> <li>■ The parameter is applicable only to PRI.</li> </ul> <p>Enables TDM tunneling for all calls.</p> <ul style="list-style-type: none"> <li>■ [0] <b>Disable</b> (default)</li> <li>■ [1] <b>Enable</b> = Enables TDM tunneling. For more information, see <a href="#">TDM Tunneling</a>.</li> <li>■ [2] <b>Private Wire</b> = Enables TDM tunneling for private wire services. For more information, see <a href="#">Configuring Private Wire Interworking</a>.</li> </ul> <p><b>Note:</b></p> <ul style="list-style-type: none"> <li>■ For the parameter to take effect, a device reset is required.</li> <li>■ The parameter is applicable only to ISDN PRI.</li> <li>■ To enable the parameter per trunk, see the EnableTDMOverIPforTrunk parameter.</li> </ul>
[EnableTDMOverIPforTrunk]	Enables TDM tunneling for a specific trunk. For a description of the parameter, see EnableTDMOverIP.
iso8859-charset [ISO8859CharacterSet]	<p>Defines the ISO 8859 character set type (languages) for representing the alphanumeric string of the calling name (caller ID) in the forwarded message, for IP-to-Tel and Tel-to-IP calls.</p> <ul style="list-style-type: none"> <li>■ [0] = No Accented - proprietary method where incoming INVITE messages with any accented characters (e.g., á, é, í, ó, and ü), which are represented in a 2-byte unicode character, are translated to Latin-only, which are normal one-byte ASCII characters (a, e, i, o, and u, respectively).</li> <li>■ [1] = Western European (Default)</li> <li>■ [2] = Central European</li> <li>■ [3] = South European</li> <li>■ [4] = North European</li> <li>■ [5] = Cyrillic</li> <li>■ [6] = Arabic</li> <li>■ [7] = Hebrew</li> </ul>

Parameter	Description
	<ul style="list-style-type: none"> <li>■ [8] = Turkish</li> </ul>
'Time to Wait before Dialing' [WaitForDialTime]	<p>Defines the delay after hook-flash is generated and until dialing begins. Applies to call transfer (i.e., the parameter TrunkTransferMode is set to 3) on CAS protocols.</p> <p>The valid range (in milliseconds) is 0 to 20,000 (i.e., 20 seconds). The default is 1,000 (i.e., 1 second).</p> <p><b>Note:</b> The parameter is also applicable to analog interfaces. For more information, see <a href="#">FXO and FXS Parameters</a> on page 1664.</p>

### TDM Bus and Clock Timing Parameters

The TDM Bus parameters are described in the table below.

**Table 70-53:TDM Bus and Clock Timing Parameters**

Parameter	Description
TDM Bus Parameters	
Digital PCM	
'PCM Law Select' <pre>configure voip &gt; media tdm &gt; pcm-law-select</pre> [PCMLawSelect]	<p>Defines the type of pulse-code modulation (PCM) companding algorithm law in input and output TDM bus.</p> <ul style="list-style-type: none"> <li>■ [1] <b>Alaw</b></li> <li>■ [3] <b>MuLaw</b></li> </ul> <p>The default value is automatically selected according to the Protocol Type of the selected trunk (E1 defaults to A-Law; T1 defaults to Mu-Law). If the Protocol Type is set to NONE, the default is MuLaw.</p> <p><b>Note:</b></p> <ul style="list-style-type: none"> <li>■ For the parameter to take effect, a device reset is required.</li> <li>■ Typically, A-Law is used for E1 spans; Mu-Law for T1/J1 spans.</li> <li>■ Typically, A-Law is used for most BRI variants.</li> </ul>

Parameter	Description
<p>'Idle PCM Pattern'</p> <pre>configure voip &gt; media tdm &gt; idle-pcm-pattern</pre> <p>[IdlePCMPattern]</p>	<p>Defines the PCM Pattern that is applied to the PSTN timeslot (B-channel) when the channel is idle.</p> <p>The range is 0 to 255. The default is set internally according to the Law select 1 (0xFF for Mu-Law; 0x55 for A-law).</p> <p><b>Note:</b> For the parameter to take effect, a device reset is required.</p>
<p>'Idle ABCD Pattern'</p> <pre>configure voip &gt; media tdm &gt; idle-abcd-pattern</pre> <p>[IdleABCDPattern]</p>	<p>Defines the ABCD (CAS) Pattern that is applied to the CAS signaling bus when the channel is idle.</p> <p>The valid range is 0x0 to 0xF. The default is -1 (i.e., default pattern is 0000).</p> <p><b>Note:</b></p> <ul style="list-style-type: none"> <li>■ For the parameter to take effect, a device reset is required.</li> <li>■ The parameter is applicable only when using PSTN interface with the RAW_CAS protocol.</li> </ul>
<b>General</b>	
<p>'TDM Bus Clock Source'</p> <p>[TDMBusClockSource]</p>	<p>Defines the clock source to which the device synchronizes.</p> <ul style="list-style-type: none"> <li>■ [1] <b>Internal</b> = (Default) Generate clock from local source.</li> <li>■ [4] <b>Network</b> = Recover clock from PSTN line.</li> </ul> <p><b>Note:</b></p> <ul style="list-style-type: none"> <li>■ For the parameter to take effect, a device reset is required.</li> </ul>
<p>'TDM Bus Local Reference'</p> <pre>configure voip &gt; media tdm &gt; tdm-bus-local-reference</pre> <p>[TDMBusLocalReference]</p>	<p>Defines the physical Trunk ID from which the device recovers (receives) its clock synchronization.</p> <p>The range is 0 to the maximum number of Trunks. The default is 0.</p> <p><b>Note:</b> The parameter is applicable only if the parameter TDMBusClockSource is set to 4</p>

Parameter	Description
	and the parameter TDMBusPSTNAutoClockEnable is set to 0.
'TDM Bus Enable Fallback' [TDMBusEnableFallback]	Defines the automatic fallback of the clock. <ul style="list-style-type: none"> <li>■ [0] <b>Manual</b> (default)</li> <li>■ [1] <b>Auto Non-Revertive</b></li> <li>■ [2] <b>Auto Revertive</b></li> </ul>
'TDM Bus Net Reference Speed' [TDMBusNetrefSpeed]	Defines the NetRef frequency (for both generation and synchronization). <ul style="list-style-type: none"> <li>■ [0] <b>8 kHz</b> (default)</li> <li>■ [1] <b>1.544 MHz</b></li> <li>■ [2] <b>2.048 MHz</b></li> </ul>
'TDM Bus PSTN Auto FallBack Clock' configure voip > media tdm > pstn-bus-auto-clock [TDMBusPSTNAutoClockEnable]	Enables the PSTN trunk Auto-Fallback Clock feature. <ul style="list-style-type: none"> <li>■ [0] <b>Disable</b> = (Default) Recovers the clock from the trunk line defined by the parameter TDMBusLocalReference.</li> <li>■ [1] <b>Enable</b> = Recovers the clock from any connected synchronized slave trunk line. If this trunk loses its synchronization, the device attempts to recover the clock from the next trunk. Note that initially, the device attempts to recover the clock from the trunk defined by the parameter TDMBusLocalReference.</li> </ul> <p><b>Note:</b></p> <ul style="list-style-type: none"> <li>■ For the parameter to take effect, a device reset is required.</li> <li>■ The parameter is applicable only if the TDMBusClockSource parameter is set to 4.</li> </ul>
'TDM Bus PSTN Auto Clock Reverting' configure voip > media tdm > pstn-bus-auto-clock-reverting	Enables the PSTN trunk Auto-Fallback Reverting feature. If enabled and a trunk returning to service has an AutoClockTrunkPriority parameter value that

Parameter	Description
[TDMBusPSTNAutoClockRevertingEnable]	<p>is higher than the priority of the local reference trunk (set in the TDMBusLocalReference parameter), the local reference reverts to the trunk with the higher priority that has returned to service for the device's clock source.</p> <ul style="list-style-type: none"> <li>■ [0] <b>Disable</b> (default)</li> <li>■ [1] <b>Enable</b></li> </ul> <p><b>Note:</b></p> <ul style="list-style-type: none"> <li>■ For the parameter to take effect, a device reset is required.</li> <li>■ The parameter is applicable only when the TDMBusPSTNAutoClockEnable parameter is set to 1.</li> </ul>

### CAS Parameters

The Common Channel Associated (CAS) parameters are described in the table below.



CAS is applicable only to ISDN PRI interfaces.

**Table 70-54: CAS Parameters**

Parameter	Description
'CAS Transport Type' cas-transport-type [CASTransportType]	<p>Determines the ABCD signaling transport type over IP.</p> <ul style="list-style-type: none"> <li>■ [0] <b>CAS Events Only</b> = (Default) Disable CAS relay.</li> <li>■ [1] <b>CAS RFC2833 Relay</b> = Enable CAS relay mode using RFC 2833.</li> </ul> <p>The CAS relay mode can be used with the TDM tunneling feature to enable tunneling over IP for both voice and CAS signaling bearers.</p>
[CASAddressingDelimiters]	<p>Enables the addition of delimiters to the received address or received ANI digits string.</p>

Parameter	Description
	<ul style="list-style-type: none"> <li>■ [0] = (default) Disable. The address and ANI strings remain without delimiters.</li> <li>■ [1] = Enable. Delimiters such as '*', '#', and 'ST' are added to the received address or received ANI digits string.</li> </ul>
<pre>configure voip &gt; interface e1-t1 &gt; cas-delimiters-types</pre> <p>[CASDelimitersPaddingUsage]</p>	<p>Defines the digits string delimiter padding usage per trunk.</p> <ul style="list-style-type: none"> <li>■ [0] = (Default) Default address string padding: '*XXX#' (where XXX is the digit string that begins with '*' and ends with '#', when using padding).</li> <li>■ [1] = Special use of asterisks delimiters: '*XXX*YYY*' (where XXX is the address, YYY is the source phone number, and '*' is the only delimiter padding).</li> </ul> <p><b>Note:</b> For the parameter to take effect, a device reset is required.</p>
[CASFileName_x]	<p>Defines the CAS file name (e.g., 'E_M_WinkTable.dat') that defines the CAS protocol, where x denotes the CAS file ID (0-7). It is possible to define up to eight different CAS files by repeating the parameter. Each CAS file can be associated with one or more of the device's trunks, using the parameter CASTableIndex_x.</p> <p><b>Note:</b> For the parameter to take effect, a device reset is required.</p>
[CASTablesNum]	<p>Defines the number of loaded CAS protocol configurations files. The valid range is 1 to 8.</p> <p><b>Note:</b> For the parameter to take effect, a device reset is required.</p>
<b>CAS State Machines Parameters</b>	



Parameter	Description
<p><b>Note:</b> To configure the CAS State Machine table using the Web interface, see <a href="#">Configuring CAS State Machines</a>. The CAS state machine can be configured only through the Web-based management tool.</p>	
<p>'Generate Digit On Time' [CASStateMachineGenerateDigitOnTime]</p>	<p>Generates digit on-time (in msec). The value must be a positive value. The default is -1.</p>
<p>'Generate Inter Digit Time' [CASStateMachineGenerateInterDigitTime]</p>	<p>Generates digit off-time (in msec). The value must be a positive value. The default is -1.</p>
<p>'DTMF Max Detection Time' [CASStateMachineDTMFMaxOnDetectionTime]</p>	<p>Detects digit maximum on time (according to DSP detection information event) in msec units. The value must be a positive value. The default is -1.</p>
<p>'DTMF Min Detection Time' [CASStateMachineDTMFMinOnDetectionTime]</p>	<p>Detects digit minimum on time (according to DSP detection information event) in msec units. The digit time length must be longer than this value to receive a detection. Any number may be used, but the value must be less than CasStateMachineDTMFMaxOnDetectionTime. The value must be a positive value. The default is -1.</p>
<p>'MAX Incoming Address Digits' [CASStateMachineMaxNumOfIncomingAddressesDigits]</p>	<p>Defines the limitation for the maximum address digits that need to be collected. After reaching this number of digits, the collection of address digits is stopped. The value must be an integer. The default is -1.</p>
<p>'MAX Incoming ANI Digits' [CASStateMachineMaxNumOfIncomingANIDigits]</p>	<p>Defines the limitation for the maximum ANI digits that need to be collected. After reaching this number of digits, the collection of ANI digits is stopped. The value must be an integer. The default is -1.</p>

Parameter	Description
'Collect ANI' [CASStateMachineCollectANI]	<p>In some cases, when the state machine handles the ANI collection (not related to MFCR2), you can enable the state machine to collect ANI or discard ANI.</p> <ul style="list-style-type: none"> <li>■ [0] <b>No</b> = Don't collect ANI.</li> <li>■ [1] <b>Yes</b> = Collect ANI.</li> <li>■ [-1] <b>Default</b> = Default value.</li> </ul>
'Digit Signaling System' [CASStateMachineDigitSignalingSystem]	<p>Defines which Signaling System to use in both directions (detection\generation).</p> <ul style="list-style-type: none"> <li>■ [0] <b>DTMF</b> = DTMF signaling.</li> <li>■ [1] <b>MF</b> = (Default) MF signaling.</li> <li>■ [-1] <b>Default</b> = Default value.</li> </ul>

### ISDN Parameters

The ISDN parameters are described in the table below.

**Table 70-55:ISDN Parameters**

Parameter	Description
ign-isdn-disc-w-pi [KeepISDNCallOnDisconnectWithPI]	<p>Enables the device to ignore ISDN Disconnect messages with Progress Indicator (PI) information element (IE) values 1 or 8.</p> <ul style="list-style-type: none"> <li>■ [1] = The call (in connected state) is not released if a Q.931 Disconnect with PI (PI = 1 or 8) message is received during the call.</li> <li>■ [0] = (Default) The call is disconnected.</li> </ul>
pi-4-setup-msg [PIForSetupMsg]	<p>Defines if and which Progress Indicator (PI) information element (IE) is added to the sent ISDN Setup message. Some ISDN protocols such as NI-2 or Euro ISDN can optionally contain PI = 1 or PI = 3 in the Setup message.</p> <ul style="list-style-type: none"> <li>■ [0] = PI is not added (default).</li> <li>■ [1] = PI 1 is added to a sent ISDN Setup message - call is not end-to-end ISDN.</li> </ul>

Parameter	Description
	<ul style="list-style-type: none"> <li>■ [3] = PI 3 is added to a sent ISDN Setup message - calling equipment is not ISDN.</li> </ul>
<pre>no-sdp-for-isdn-pi</pre> <p>[NoSdpForIsdnPi]</p>	<p>Defines the value of the Progress Indicator (PI) information element (IE) that if present in the received ISDN Progress message, the device sends SIP 180 messages <b>without</b> an SDP body (for Tel-to-IP calls).</p> <p>The valid value is a bit field, allowing you to specify more than one PI. The default is 0, meaning that SDP is included in the outgoing SIP 180 message, regardless of PI value.</p>
<p>'B-channel Negotiation'</p> <pre>configure voip &gt; interface e1-t1 bri &gt; b-ch-negotiation</pre> <p>[BchannelNegotiation]</p>	<p>Defines the ISDN B-channel negotiation mode.</p> <ul style="list-style-type: none"> <li>■ [0] <b>Preferred</b></li> <li>■ [1] <b>Exclusive</b> (default)</li> <li>■ [2] <b>Any</b></li> </ul> <p><b>Note:</b></p> <ul style="list-style-type: none"> <li>■ For some ISDN variants, when 'Any' (2) is selected, the Setup message excludes the Channel Identification IE.</li> <li>■ The Any' (2) option is applicable only if the following conditions are met: <ul style="list-style-type: none"> <li>✓ The parameter TerminationSide is set to 0 ('User side').</li> <li>✓ The PSTN protocol type (ProtocolType) is configured as Euro ISDN.</li> </ul> </li> </ul>
<p>[PSTNExtendedParams]</p>	<p>Determines the bit map for special PSTN behavior parameters:</p> <ul style="list-style-type: none"> <li>■ [0] = (Default) Applicable for NI-2 ISDN and QSIG "Networking Extensions". This bit (i.e., bit #0) is responsible for the Invoke ID size: <ul style="list-style-type: none"> <li>✓ If this bit is not set (default), then the Invoke ID size is always one byte, with a value of 01 to 7f.</li> <li>✓ If this bit is set, then the Invoke ID size is one or two bytes according to the Invoke</li> </ul> </li> </ul>

Parameter	Description
	<p>ID value.</p> <ul style="list-style-type: none"> <li>■ [2] = Applicable to the ROSE format (according to the old QSIG specifications). This bit (i.e., bit #1) is responsible for the QSIG octet 3. According to the ECMA-165 new version, octet 3 in all QSIG supplementary services Facility messages should be 0x9F = Networking Extensions. However, according to the old version, the value should be 0x91 = ROSE: <ul style="list-style-type: none"> <li>✓ If this bit is not set (default): 0x9F = Networking Extensions.</li> <li>✓ If this bit is set: 0x91 = ROSE.</li> </ul> </li> <li>■ [3] = Use options [0] and [2] above.</li> </ul> <p><b>Note:</b> For the parameter to take effect, a device reset is required.</p>
<b>BRI Parameters</b>	
<pre>configure voip &gt; interface bri &gt; tei- config-p2p [BriTEIConfigP2P_x]</pre>	<p>Defines the BRI terminal endpoint identifier (TEI) when in point-to-point (P2P) mode. The valid value is 0 to 63, 127. The default is 0.</p> <ul style="list-style-type: none"> <li>■ Network Side: <ul style="list-style-type: none"> <li>✓ 0-63: Only one specified static TEI is accepted.</li> <li>✓ 127: Any possible TEI is accepted. Dynamic TEI allocation procedure is supported.</li> </ul> </li> <li>■ User Side: <ul style="list-style-type: none"> <li>✓ 0-63: Static TEI is used.</li> <li>✓ 127: The TEI is obtained through dynamic TEI request procedure.</li> </ul> </li> </ul>
<pre>configure voip &gt; interface bri &gt; tei- config-p2mp [BriTEIConfigP2MP_x]</pre>	<p>Defines the BRI TEI when in point-to-multipoint (P2MP) mode. The valid value is 0 to 63, 127. The default is 127.</p> <ul style="list-style-type: none"> <li>■ Network Side: Not applicable - in Network side in P2MP configuration, any TEI must be accepted.</li> </ul>

Parameter	Description
	<ul style="list-style-type: none"> <li>■ User Side: <ul style="list-style-type: none"> <li>✓ 0-63: Static TEI is used.</li> <li>✓ 127: Dynamic TEI allocation is supported (TEI request procedure initiated).</li> </ul> </li> </ul>
<pre>configure voip &gt; interface bri &gt; tei- assign-trigger [BriTEIAssignTrigger_x]</pre>	<p>Defines when TEI assignment procedure is triggered (when dynamic TEI allocation is configured).</p> <p>The valid values are (bit-field parameter):</p> <ul style="list-style-type: none"> <li>■ Bit #0: BRI Layer 1 (physical) is activated.</li> <li>■ Bit #1: BRI port configuration has completed.</li> <li>■ Bit #2: Call setup is initiated.</li> </ul> <p>The default is 0x04 (Bit #2).</p> <p><b>Note:</b> The parameter is applicable only to the User side and for dynamic TEI assignment.</p>
<pre>configure voip &gt; interface bri &gt; tei- remove-trigger [BriTEIRemoveTrigger_x]</pre>	<p>Defines when to clear existing dynamic TEI(s) assignment.</p> <p>The valid values are (bit-field parameter):</p> <ul style="list-style-type: none"> <li>■ Bit #0: BRI layer 1 is deactivated (disconnected).</li> <li>■ Bit #1: BRI Layer 2 (data link) is released (disconnected).</li> </ul> <p>The default is 0x00 (no one bit is configured).</p>

## ISDN and CAS Interworking Parameters

The ISDN and CAS interworking parameters are described in the table below.

**Table 70-56:ISDN and CAS Interworking Parameters**

Parameter	Description
<b>ISDN Parameters</b>	
'Send Local Time To ISDN Connect' [SendLocalTimeToISDN Connect]	<p>Determines the device's handling of the date and time sent in the ISDN Connect message (Date / Time IE) upon receipt of SIP 200 OK messages.</p> <ul style="list-style-type: none"> <li>■ [0] <b>Disable</b> = (Default) If the SIP 200 OK includes the Date header, the device sends its value in the ISDN Connect</li> </ul>

Parameter	Description
	<p>Date / Time IE. If the 200 OK does not include this header, it does not add the Date / Time IE to the sent ISDN Connect message.</p> <ul style="list-style-type: none"> <li>■ [1] <b>Enable</b> = If the SIP 200 OK includes the Date header, the device sends its value (i.e. date and time) in the ISDN Connect Date / Time IE. If the 200 OK does not include this header, the device uses its internal, local date and time for the Date / Time IE, which it adds to the sent ISDN Connect message.</li> <li>■ [2] <b>Always Send Local Date and Time</b> = The device always sends its local date and time (obtained from its internal clock) to PBXs in ISDN Q.931 Connect messages (Date / Time IE). It does this regardless of whether or not the incoming SIP 200 OK includes the Date header. If the SIP 200 OK includes the Date header, the device ignores its value.</li> </ul> <p><b>Note:</b></p> <ul style="list-style-type: none"> <li>■ This feature is applicable only to Tel-to-IP calls.</li> <li>■ For IP-to-Tel calls, the parameter is not applicable. Only if the incoming ISDN Connect message contains the Date / Time IE does the device add the Date header to the sent SIP 200 OK message.</li> </ul>
<p>'Min Routing Overlap Digits'</p> <pre>configure voip &gt; gateway dtmf- supp-service dtmf-and-dialing &gt; min-dg-b4- routing [MinOverlapDigitsForRouting]</pre>	<p>Defines the minimum number of overlap digits to collect (for ISDN overlap dialing) before sending the first SIP message for routing Tel-to-IP calls.</p> <p>The valid value range is 0 to 49. The default is 1.</p> <p><b>Note:</b> The parameter is applicable when the ISDNRxOverlap parameter is set to [2] or [3].</p>
<p>'ISDN Overlap IP to Tel Dialing'</p> <pre>configure voip &gt; gateway dtmf- supp-service dtmf-and-dialing</pre>	<p>Enables ISDN overlap dialing for IP-to-Tel calls. This feature is part of ISDN-to-SIP overlap dialing according to RFC 3578.</p> <ul style="list-style-type: none"> <li>■ [0] <b>Disable</b> (default)</li> <li>■ [1] <b>Through SIP</b> = The device sends the first received digits from the initial INVITE to the Tel side in an ISDN Setup</li> </ul>

Parameter	Description
<pre>&gt; isdn-tx- overlap [ISDNTxOverlap]</pre>	<p>message. For each subsequently received re-INVITE message of the same dialog session, the device sends the collected digits to the Tel side in ISDN Info Q.931 messages. For each received re-INVITE, the device sends a SIP 484 Address Incomplete response to maintain the current dialog session and to receive additional digits from subsequent re-INVITEs.</p> <ul style="list-style-type: none"> <li>■ [2] <b>Through SIP INFO</b> = The device sends the first received digits from the initial INVITE to the Tel side in an ISDN Setup message and then responds to the IP side with a SIP 183. For each subsequently received SIP INFO message with additional digits of the same dialog session, the device sends the collected digits to the Tel side in ISDN Info Q.931 messages. For each received SIP INFO, the device sends a SIP 200 OK response to maintain the current dialog session and to receive additional digits from subsequent INFOS.</li> </ul> <p><b>Note:</b> When IP-to-Tel overlap dialing is enabled, to send ISDN Setup messages without the Sending Complete IE, the ISDNOutCallsBehavior parameter must be set to USER SENDING COMPLETE (2).</p>
<pre>'Mute DTMF In Overlap' configure voip &gt; gateway dtmf- supp-service supp-service- settings &gt; mute- dtmf-in-overlap [MuteDTMFInOverlap]</pre>	<p>Enables the muting of in-band DTMF detection until the device receives the complete destination number from the ISDN (for Tel-to-IP calls). In other words, the device does not accept DTMF digits received in the voice stream from the PSTN, but only accepts digits from ISDN Info messages.</p> <ul style="list-style-type: none"> <li>■ [0] <b>Don't Mute</b> (default).</li> <li>■ [1] <b>Mute DTMF in Overlap Dialing</b> = The device ignores in-band DTMF digits received during ISDN overlap dialing (disables the DTMF in-band detector).</li> </ul> <p><b>Note:</b> The parameter is applicable to ISDN Overlap mode only when dialed numbers are sent using Q.931 Information messages.</p>
<pre>[ConnectedNumberType]</pre>	<p>Defines the Numbering Type of the ISDN Q.931 Connected Number IE that the device sends in the Connect message to the ISDN (for Tel-to-IP calls). This is interworked from the P-Asserted-Identity header in SIP 200 OK. The default is [0] (i.e., unknown).</p>
<pre>configure voip &gt;</pre>	<p>Defines the Numbering Plan of the ISDN Q.931 Connected</p>

Parameter	Description
<pre>gateway dtmf-   supp-service   supp-service-   settings &gt;   connected-   number-type [ConnectedNumberPla n]</pre>	<p>Number IE that the device sends in the Connect message to the ISDN (for Tel-to-IP calls). This is interworked from the P-Asserted-Identity header in SIP 200 OK.</p> <p>The default is [0] (i.e., unknown).</p>
<pre>'Enable ISDN Tunneling Tel to IP' isdn-tnl-tel2ip [EnableISDNTunnelingT el2IP]</pre>	<p>Enables ISDN Tunneling.</p> <ul style="list-style-type: none"> <li>■ [0] <b>Disable</b> (default).</li> <li>■ [1] <b>Using Header</b> = Enable ISDN Tunneling from ISDN to SIP using a proprietary SIP header.</li> <li>■ [2] <b>Using Body</b> = Enable ISDN Tunneling from ISDN to SIP using a dedicated message body.</li> </ul> <p>When ISDN Tunneling is enabled, the device sends all ISDN messages using the correlated SIP messages. The ISDN Setup message is tunneled using SIP INVITE, all mid-call messages are tunneled using SIP INFO, and ISDN Disconnect/Release message is tunneled using SIP BYE messages. The raw data from the ISDN is inserted into a proprietary SIP header (X-ISDNTunnelingInfo) or a dedicated message body (application/isdn) in the SIP messages.</p> <p><b>Note:</b></p> <ul style="list-style-type: none"> <li>■ For this feature to function, you must set the parameter ISDNDuplicateQ931BuffMode to 128 (i.e., duplicate all messages).</li> <li>■ ISDN tunneling is applicable for all ISDN variants as well as QSIG.</li> </ul>
<pre>'Enable ISDN Tunneling IP to Tel' isdn-tnl-ip2tel [EnableISDNTunnelingIP 2Tel]</pre>	<p>Enables ISDN Tunneling for IP-to-Tel calls.</p> <ul style="list-style-type: none"> <li>■ [0] <b>Disable</b> (default)</li> <li>■ [1] <b>Enable ISDN Tunneling from IP to ISDN</b></li> </ul> <p>When ISDN Tunneling is enabled, the device extracts raw data received in the proprietary SIP header, x-isdntunnelinginfo, or a dedicated message body (application/isdn) in the SIP message and then sends the data in an ISDN message to the PSTN.</p>



Parameter	Description
	<p>If the raw data in this SIP header is suffixed with the string "ADDE", then the raw data is extracted and added as Informational Elements (IE) in the outgoing Q.931 message. The tunneling of the x-isdntunnelinginfo SIP header with IEs is converted from INVITE, 180, and 200 OK SIP messages to Q.931 SETUP, ALERT, and CONNECT respectively.</p> <p>For example, if the following SIP header is received,</p> <pre>x-isdntunnelinginfo: ADDE1C269FAA 06 800100820100A10F020136 0201F0A00702010102021F69</pre> <p>then it is added as an IE to the outgoing Q.931 message as 1C269FAA 06 800100820100A10F020136 0201F0A00702010102021F69, where, for example, "1C269F" is a 26 byte length Facility IE.</p> <p><b>Note:</b> The feature is similar to that of the AddIEinSetup parameter. If both parameters are configured, the AddIEinSetup parameter is ignored.</p>
'Enable QSIG Tunneling' qsig-tunneling [EnableQSIGTunneling]	<p>Global parameter that enables QSIG tunneling-over-SIP for all calls. You can also configure this feature per specific calls, using IP Profiles (IpProfile_EnableQSIGTunneling). For a detailed description of the parameter and for configuring this feature in the IP Profiles table, see <a href="#">Configuring IP Profiles</a>.</p> <p><b>Note:</b> If this feature is configured for a specific IP Profile, the settings of this global parameter is ignored for calls associated with the IP Profile.</p>
qsig-tunneling-mode [QSIGTunnelingMode]	<p>Defines the format of encapsulated QSIG message data in the SIP message MIME body.</p> <ul style="list-style-type: none"> <li>■ [0] = (Default) ASCII presentation of Q.931 QSIG message.</li> <li>■ [1] = Binary encoding of Q.931 QSIG message (according to ECMA-355, RFC 3204, and RFC 2025).</li> </ul> <p><b>Note:</b> The parameter is applicable only if the QSIG Tunneling feature is enabled, using the [EnableQSIGTunneling] parameter.</p>
'Enable Hold to ISDN' configure voip > gateway dtmf- supp-service supp-service-	<p>Enables SIP-to-ISDN interworking of the Hold/Retrieve supplementary service.</p> <ul style="list-style-type: none"> <li>■ [0] <b>Disable</b> (default)</li> <li>■ [1] <b>Enable</b></li> </ul>

Parameter	Description
<pre>settings &gt; hold- to-isdn [EnableHold2ISDN]</pre>	<p><b>Note:</b></p> <ul style="list-style-type: none"> <li>■ The parameter is applicable to Euro ISDN variants - from TE (user) to NT (network).</li> <li>■ The parameter is applicable to QSIG BRI.</li> <li>■ If the parameter is disabled, the device plays a held tone to the Tel side when a SIP request with 0.0.0.0 or "inactive" in SDP is received. An appropriate CPT file with the held tone should be used.</li> </ul>
<pre>'ISDN SubAddress Format' isdn-subaddr- frmt [ISDNSubAddressForma t]</pre>	<p>Determines the encoding format of the SIP Tel URI parameter 'isub', which carries the encoding type of ISDN subaddresses. This is used to identify different remote ISDN entities under the same phone number (ISDN Calling and Called numbers) for interworking between ISDN and SIP networks.</p> <ul style="list-style-type: none"> <li>■ [0] <b>ASCII</b> = (Default) IA5 format that allows up to 20 digits. Indicates that the 'isub' parameter value needs to be encoded using ASCII characters.</li> <li>■ [1] <b>BCD</b> = (Binary Coded Decimal) - allows up to 40 characters (digits and letters). Indicates that the 'isub' parameter value needs to be encoded using BCD when translated to an ISDN message.</li> <li>■ [2] <b>User Specified</b></li> </ul> <p>For IP-to-Tel calls, if the incoming SIP INVITE message includes subaddress values in the 'isub' parameter for the Called Number (in the Request-URI) and/or the Calling Number (in the From header), these values are mapped to the outgoing ISDN Setup message.</p> <p>If the incoming ISDN Setup message includes 'subaddress' values for the Called Number and/or the Calling Number, these values are mapped to the outgoing SIP INVITE message's 'isub' parameter in accordance with RFC 4715.</p>
<pre>configure voip &gt; gateway dtmf- supp-service supp-service- settings &gt; ignore-isdn- subaddress [IgnoreISDNSubaddres</pre>	<p>Determines whether the device ignores the Subaddress from the incoming ISDN Called and Calling numbers when sending to IP.</p> <ul style="list-style-type: none"> <li>■ [0] = (Default) If an incoming ISDN Q.931 Setup message contains a Called/Calling Number Subaddress, the Subaddress is interworked to the SIP 'isub' parameter according to RFC.</li> </ul>

Parameter	Description
s]	<ul style="list-style-type: none"> <li>■ [1] = The device removes the ISDN Subaddress and does not include the 'isub' parameter in the Request-URI and does not process INVITEs with the parameter.</li> </ul>
[ISUBNumberOfDigits]	<p>Defines the number of digits (from the end) that the device takes from the called number (received from the IP) for the isub number (in the sent ISDN Setup message). This feature is applicable only for IP-to-ISDN calls.</p> <p>The valid value range is 0 to 36. The default is 0.</p> <p>This feature operates as follows:</p> <ol style="list-style-type: none"> <li>1. If an isub parameter is received in the Request-URI, for example,  INVITE sip:9565645;<b>isub</b>=1234@host.domain:user=phone SIP/2.0  then the isub value is sent in the ISDN Setup message as the destination subaddress.</li> <li>2. If the isub parameter is not received in the user part of the Request-URI, the device searches for it in the URI parameters of the To header, for example,  To: "Alex" &lt;sip: 9565645@host.domain;<b>isub</b>=1234&gt;  If present, the isub value is sent in the ISDN Setup message as the destination subaddress.</li> <li>3. If the isub parameter is not present in the Request-URI header nor To header, the device does the following: <ul style="list-style-type: none"> <li>✓ If the called number (that appears in the user part of the Request-URI) starts with zero (0), for example,  INVITE sip:<b>0</b>5694564@host.domain:user=phone SIP/2.0  then the device maps this called number to the destination number of the ISDN Setup message, and the destination subaddress in this ISDN Setup message remains empty.</li> <li>✓ If the called number (that appears in the user part of the Request-URI) does not start with zero, for example,  INVITE sip:5694564@host.domain:user=phone SIP/2.0  then the device maps this called number to the destination number of the ISDN Setup message, and the destination subaddress in this ISDN Setup message then contains y digits from the end of the called number. The y number of digits can be configured</li> </ul> </li> </ol>

Parameter	Description
	<p>using the ISUBNumberOfDigits parameter. The default value of ISUBNumberOfDigits is 0, thus, if the parameter is not configured, and 1) and 2) scenarios (described above) have not provided an isub value, the subaddress remains empty.</p>
<p>'Default Cause Mapping From ISDN to SIP'  <code>dflt-cse-map-isdn2sip</code>            [DefaultCauseMapISDN 2IP]</p>	<p>Defines a single default ISDN release cause that is used (in ISDN-to-IP calls) instead of all received release causes, except when the following Q.931 cause values are received: Normal Call Clearing (16), User Busy (17), No User Responding (18), or No Answer from User (19).            The range is any valid Q.931 release cause (0 to 127). The default is 0 (i.e., not configured - static mapping is used).</p>
<p>'Enable Calling Party Category'  <code>ni2-cpc</code>            [EnableCallingPartyCategory]</p>	<p>Enables the mapping of the calling party category (CPC) between the incoming PSTN message and outgoing SIP message, and vice versa (i.e., for IP-to-Tel and Tel-to-IP calls). The CPC characterizes the station used to originate a call (e.g., a payphone or an operator).</p> <ul style="list-style-type: none"> <li>■ [0] <b>Disable</b> = (Default) CPC is not relayed between SIP and PSTN.</li> <li>■ [1] <b>Enable</b></li> </ul> <p>The CPC is denoted in the PSTN message as follows:</p> <ul style="list-style-type: none"> <li>■ ISDN PRI NI-2: In the Originating Line Information (OLI) Information Element (IE) of the ISDN Setup message.</li> <li>■ MFC-R2: ANI II digits. The device supports the Brazilian and Argentinian variants. This regional support is configured using the CallingPartyCategoryMode.</li> </ul> <p>The CPC is denoted in the SIP INVITE message using the 'cpc=' parameter in the From or P-Asserted-Identity headers. For example, the 'cpc=' parameter in the below INVITE message is set to "payphone":</p> <pre>INVITE sip:bob@biloxi.example.com SIP/2.0  To: "Bob" &lt;sip:bob@biloxi.example.com&gt; From: &lt;tel:+17005554141;cpc=payphone&gt;;tag=1928301774</pre> <p>The table below shows the mapping of CPC between SIP and PSTN:</p>

Parameter	Description			
	SIP CPC	NI-2 PRI	MFC-R2	
			Argentina	Brazil
	ordinary	23	II-1	II-1
	priority	n/a	II-2	II-2
	data	n/a	II-6	II-6
	test	n/a	II-3	II-3
	operator	35	II-5	II-5
	payphone	70	II-4	II-7
	unknown	n/a	II-1	II-1
	subscriber	23	n/a	II-1
	cellular	61	II-13	n/a
	locutorio	n/a	II-11	n/a
	servicio-publico	n/a	II-12	n/a
	red-privada-virtual / private-virtual-network	n/a	II-14	n/a
	linea-especial / special-operator-handling-required	n/a	II-15	n/a
	operadora-con-intervencion / telco-operator-handled-call	n/a	II-5	n/a
	prison	29	n/a	n/a
	hotel	66	n/a	n/a
	cellular-roaming	63	n/a	n/a

**Note:** This feature is applicable only to the NI-2 PRI and E1 MFC-R2 variants.

Parameter	Description
'Calling Party Category Mode' cpc-mode [CallingPartyCategoryMode]	Defines the regional Calling Party Category (CPC) mapping variant between SIP and PSTN for MFC-R2. <ul style="list-style-type: none"> <li>■ [0] <b>None</b> (default)</li> <li>■ [1] <b>Brazil R2</b></li> <li>■ [2] <b>Argentina R2</b></li> </ul> <p><b>Note:</b></p> <ul style="list-style-type: none"> <li>■ To enable CPC mapping, set the EnableCallingPartyCategory parameter to 1.</li> <li>■ The parameter is applicable only to the E1 MFC-R2 variant.</li> </ul>
usr2usr-hdr-frmt [UserToUserHeaderFormat]	Defines the interworking between the SIP INVITE's User-to-User header and the ISDN User-to-User (UU) IE data. <ul style="list-style-type: none"> <li>■ [0] = (Default) SIP header format: X-UserToUser.</li> <li>■ [1] = SIP header format: User-to-User with Protocol Discriminator (pd) attribute (according to IETF Internet-Draft draft-johnston-sipping-cc-uu-04). For example:                 User-to-User=3030373435313734313635353b313233343b3834;pd=4</li> <li>■ [2] = SIP header format: User-to-User with encoding=hex at the end and pd embedded as the first byte (according to IETF Internet-Draft draft-johnston-sipping-cc-uu-03). For example:                 User-to-User=043030373435313734313635353b313233343b3834; encoding=hex                 where "04" at the beginning of this message is the pd.</li> <li>■ [3] = Interworks the SIP User-to-User header containing text format to ISDN UUIE in hexadecimal format, and vice versa. For example:                 SIP Header in text format:                 User-to-User=01800213027b712a;NULL;4582166;                 Translated to hexadecimal in the ISDN UUIE:                 303138303032313330323762373132613b4e554c4c3b343538323136363b</li> </ul>

Parameter	Description
	<p>The Protocol Discriminator (pd) used in UUIE is "04" (IUA characters).</p> <p><b>Note:</b> The parameter is applicable for Tel-to-IP and IP-to-Tel calls.</p>
<p>'Remove CLI when Restricted'</p> <p>rmv-cli-when-restr</p> <p>[RemoveCLIWhenRestricted]</p>	<p>Determines (for IP-to-Tel calls) whether the Calling Number and Calling Name IEs are removed from the ISDN Setup message if the presentation is set to Restricted.</p> <ul style="list-style-type: none"> <li>■ [0] <b>No</b> = (Default) IE's are not removed.</li> <li>■ [1] <b>Yes</b> = IE's are removed.</li> </ul>
<p>'Remove Calling Name'</p> <p>rmv-calling-name</p> <p>[RemoveCallingName]</p>	<p>Enables the device to remove the Calling Name from SIP-to-ISDN calls for all trunks.</p> <ul style="list-style-type: none"> <li>■ [0] <b>Disable</b> = (Default) Does not remove Calling Name.</li> <li>■ [1] <b>Enable</b> = Removes Calling Name.</li> </ul> <p><b>Note:</b> Some PSTN switches / PBXs may not be configured to support the receipt of the "Calling Name" information. These switches might respond to an ISDN Setup message (including the Calling Name) with an ISDN "REQUESTED_FAC_NOT_SUBSCRIBED" failure. The parameter can be set to Enable (1) to remove the "Calling Name" from SIP-to-ISDN calls and allow the call to proceed.</p>
<p>gateway digital settings &gt; cid-notification</p> <p>[CIDNotification]</p>	<p>Enables presentation in the outgoing SIP message when the incoming ISDN message doesn't include presentation. This applies to Tel-to-IP calls.</p> <ul style="list-style-type: none"> <li>■ [0] = (Default) The device restricts presentation. The device sends the SIP message with "anonymous" in the From header (e.g., From: "anonymous" &lt;sip:anonymous@anonymous.invalid&gt;).</li> <li>■ [1] = The device allows presentation in the SIP message (e.g., From: "Bob" &lt;sip:12345@10.33.1.6&gt;;tag=1c172113195).</li> </ul>
<p>[ConnectOnProgressIn d]</p>	<p>Enables the play of announcements from IP to Tel without the need to answer the Tel-to-IP call. It can be used with PSTN networks that don't support the opening of a TDM channel before an ISDN Connect message is received.</p> <ul style="list-style-type: none"> <li>■ [0] = (Default) Connect message isn't sent after SIP 183</li> </ul>

Parameter	Description
	<p>Session Progress message is received.</p> <ul style="list-style-type: none"> <li>■ [1] = Connect message is sent after SIP 183 Session Progress message is received.</li> </ul>
<pre>configure voip &gt; gateway dtmf- supp-service supp-service- settings &gt; snd- isdn-ser-aftr- restart</pre> <p>[SendISDNServiceAfterRestart]</p>	<p>Enables the device to send an ISDN SERVICE message per trunk upon device reset. The message (transmitted on the trunk's D-channel) indicates the availability of the trunk's B-channels (i.e., trunk in service).</p> <ul style="list-style-type: none"> <li>■ [0] = Disable (default)</li> <li>■ [1] = Enable</li> </ul>
<pre>configure voip &gt; sip-definition proxy-and- registration &gt; redirect-in- facility</pre> <p>[SupportRedirectInFacility]</p>	<p>Determines whether the Redirect Number is retrieved from the Facility IE.</p> <ul style="list-style-type: none"> <li>■ [0] = (Default) Not supported.</li> <li>■ [1] = Supports partial retrieval of Redirect Number (number only) from the Facility IE in ISDN Setup messages. This is applicable to Redirect Number according to ECMA-173 Call Diversion Supplementary Services.</li> </ul> <p><b>Note:</b> To enable this feature, the parameter ISDNDuplicateQ931BuffMode must be set to 1.</p>
<p>[EnableCIC]</p>	<p>Enables the relay of the Carrier Identification Code (CIC) to the ISDN.</p> <ul style="list-style-type: none"> <li>■ [0] = (Default) Disabled - CIC is not relayed to the ISDN.</li> <li>■ [1] = Enabled - CIC (received in the INVITE Request-URI) is relayed to the ISDN in the Transit Network Selection (TNS) IE of the Setup message. For example: INVITE sip:555666;cic=2345@100.2.3.4 sip/2.0.</li> </ul> <p><b>Note:</b></p> <ul style="list-style-type: none"> <li>■ This feature is supported only for SIP-to-ISDN calls.</li> <li>■ The parameter AddCicAsPrefix can be used to add the CIC as a prefix to the destination phone number for routing IP-to-Tel calls.</li> </ul>
<p>'AoC Support'</p> <pre>configure voip &gt;</pre>	<p>Enables the interworking of ISDN Advice of Charge (AOC) messages to SIP.</p>



Parameter	Description
gateway dtmf- supp-service supp-service- settings > aoc- support [EnableAOC]	<ul style="list-style-type: none"> <li>■ [0] <b>Disable</b> (default)</li> <li>■ [1] <b>Enable</b></li> </ul> <p>For more information on AOC, see <a href="#">Advice of Charge Services for Euro ISDN</a>.</p>
'Add IE in SETUP' add-ie-in-setup [AddIEinSetup]	<p>Global parameter that defines an optional Information Element (IE) data (in hex format) to add to ISDN Setup messages. You can also configure this feature per specific calls, using IP Profiles (IpProfile_AddIEinSetup). For a detailed description of the parameter and for configuring this feature in the IP Profiles table, see <a href="#">Configuring IP Profiles</a>.</p> <p><b>Note:</b> If this feature is configured for a specific IP Profile, the settings of this global parameter is ignored for calls associated with the IP Profile.</p>
'Trunk Groups to Send IE' trkgrps-to-snd- ie [SendIEonTG]	<p>Defines Trunk Group IDs (up to 50 characters) from where the optional ISDN IE (defined by the parameter AddIEinSetup) is sent. For example: '1,2,4,10,12,6'.</p> <p><b>Note:</b></p> <ul style="list-style-type: none"> <li>■ You can configure different IE data for Trunk Groups by defining the parameter for different IP Profile IDs (using the parameter IPProfile), and then assigning the required IP Profile ID in the IP-to-Tel Routing table (PSTNPrefix).</li> <li>■ When IP Profiles are used for configuring different IE data for Trunk Groups, the parameter is ignored.</li> </ul>
'Enable User-to-User IE for Tel to IP' uui-ie-for- tel2ip [EnableUUITel2IP]	<p>Enables transfer of User-to-User (UU) IE from ISDN to SIP.</p> <ul style="list-style-type: none"> <li>■ [0] <b>Disable</b> (default)</li> <li>■ [1] <b>Enable</b></li> </ul> <p>The device supports the following ISDN-to-SIP interworking: Setup to SIP INVITE, Connect to SIP 200 OK, User Information to SIP INFO, Alerting to SIP 18x response, and Disconnect to SIP BYE response messages.</p> <p><b>Note:</b> The interworking of ISDN User-to-User IE to SIP INFO is applicable only to the Euro ISDN, QSIG, and 4ESS ISDN variants.</p>
'Enable User-to-User IE for IP to Tel'	<p>Enables interworking of SIP user-to-user information (UUI) to User-to-User IE in ISDN Q.931 messages.</p>

Parameter	Description
uui-ie-for- ip2tel [EnableUUIP2Tel]	<ul style="list-style-type: none"> <li>■ [0] <b>Disable</b> = (Default) Received UUI is not sent in ISDN message.</li> <li>■ [1] <b>Enable</b> = The device interworks UUI from SIP to ISDN messages. The device supports the following SIP-to-ISDN interworking of UUI:               <ul style="list-style-type: none"> <li>✓ SIP INVITE to Q.931 Setup</li> <li>✓ SIP REFER to Q.931 Setup</li> <li>✓ SIP 200 OK to Q.931 Connect</li> <li>✓ SIP INFO to Q.931 User Information</li> <li>✓ SIP 18x to Q.931 Alerting</li> <li>✓ SIP BYE to Q.931 Disconnect</li> </ul> </li> </ul> <p><b>Note:</b></p> <ul style="list-style-type: none"> <li>■ The interworking of ISDN User-to-User IE to SIP INFO is applicable only to the Euro ISDN, QSIG, and 4ESS ISDN variants.</li> <li>■ To interwork the UUIE header from SIP-to-ISDN messages with the 4ESS ISDN variant, the ISDNGeneralCCBehavior parameter must be set to 16384.</li> </ul>
[Enable911LocationIdIP 2Tel]	<p>Enables interworking of Emergency Location Identification from SIP to PRI.</p> <ul style="list-style-type: none"> <li>■ [0] = Disabled (default)</li> <li>■ [1] = Enabled</li> </ul> <p>When enabled, the From header received in the SIP INVITE is translated into the following ISDN IE's:</p> <ul style="list-style-type: none"> <li>■ Emergency Call Control.</li> <li>■ Generic Information - to carry the Location Identification Number information.</li> <li>■ Generic Information - to carry the Calling Geodetic Location information.</li> </ul> <p><b>Note:</b> The parameter is applicable only to the NI-2 ISDN variant.</p>
early-answer- timeout	<p>Global parameter that defines the duration (in seconds) that the device waits for an ISDN Connect message from the called</p>

Parameter	Description														
[EarlyAnswerTimeout]	<p>party (Tel side), started from when it sends a Setup message. You can also configure this feature per specific calls, using IP Profiles (IpProfile_EarlyAnswerTimeout). For a detailed description of the parameter and for configuring this feature in the IP Profiles table, see <a href="#">Configuring IP Profiles</a>.</p> <p><b>Note:</b> If this feature is configured for a specific IP Profile, the settings of this global parameter is ignored for calls associated with the IP Profile.</p>														
<p>'Trunk Transfer Mode'                      configure voip &gt;                      interface e1-                      t1 bri &gt; trk-                      xfer-mode-type                      [TrunkTransferMode]</p>	<p>Determines the trunk transfer method (for all trunks) when a SIP REFER message is received. The transfer method depends on the Trunk's PSTN protocol (configured by the parameter ProtocolType) and is applicable only when one of these protocols are used:</p> <table border="1" data-bbox="639 842 1393 1666"> <thead> <tr> <th data-bbox="639 842 970 958">PSTN Protocol</th> <th data-bbox="970 842 1393 958">Transfer Method (Described Below)</th> </tr> </thead> <tbody> <tr> <td data-bbox="639 958 970 1025">E1 Euro ISDN [1]</td> <td data-bbox="970 958 1393 1025">ECT [2] or InBand [5]</td> </tr> <tr> <td data-bbox="639 1025 970 1182">E1 QSIG [21], T1 QSIG [23]</td> <td data-bbox="970 1025 1393 1182">Single Step Transfer [4], Path Replacement Transfer [2], or InBand [5]</td> </tr> <tr> <td data-bbox="639 1182 970 1330">T1 NI2 ISDN [10], T1 4ESS ISDN [11], T1 5ESS 9 ISDN [12]</td> <td data-bbox="970 1182 1393 1330">TBCT [2] or InBand [5]</td> </tr> <tr> <td data-bbox="639 1330 970 1397">T1 DMS-100 ISDN [14]</td> <td data-bbox="970 1330 1393 1397">RTL [2] or InBand [5]</td> </tr> <tr> <td data-bbox="639 1397 970 1554">T1 RAW CAS [3], T1 CAS [2], E1 CAS [8], E1 RAW CAS [9]</td> <td data-bbox="970 1397 1393 1554">[1] CAS NFA DMS-100 or [3] CAS Normal transfer</td> </tr> <tr> <td data-bbox="639 1554 970 1666">T1 DMS-100 Meridian ISDN [35]</td> <td data-bbox="970 1554 1393 1666">RTL [2] or InBand [5]</td> </tr> </tbody> </table> <p>The valid values of the parameter are described below:</p> <ul style="list-style-type: none"> <li>■ [0] = Not supported (default).</li> <li>■ [1] = Supports CAS NFA DMS-100 transfer. When a SIP REFER message is received, the device performs a Blind Transfer by executing a CAS Wink, waits for an acknowledged Wink from the remote side, dials the Refer-to number to the switch, and then releases the call.</li> </ul>	PSTN Protocol	Transfer Method (Described Below)	E1 Euro ISDN [1]	ECT [2] or InBand [5]	E1 QSIG [21], T1 QSIG [23]	Single Step Transfer [4], Path Replacement Transfer [2], or InBand [5]	T1 NI2 ISDN [10], T1 4ESS ISDN [11], T1 5ESS 9 ISDN [12]	TBCT [2] or InBand [5]	T1 DMS-100 ISDN [14]	RTL [2] or InBand [5]	T1 RAW CAS [3], T1 CAS [2], E1 CAS [8], E1 RAW CAS [9]	[1] CAS NFA DMS-100 or [3] CAS Normal transfer	T1 DMS-100 Meridian ISDN [35]	RTL [2] or InBand [5]
PSTN Protocol	Transfer Method (Described Below)														
E1 Euro ISDN [1]	ECT [2] or InBand [5]														
E1 QSIG [21], T1 QSIG [23]	Single Step Transfer [4], Path Replacement Transfer [2], or InBand [5]														
T1 NI2 ISDN [10], T1 4ESS ISDN [11], T1 5ESS 9 ISDN [12]	TBCT [2] or InBand [5]														
T1 DMS-100 ISDN [14]	RTL [2] or InBand [5]														
T1 RAW CAS [3], T1 CAS [2], E1 CAS [8], E1 RAW CAS [9]	[1] CAS NFA DMS-100 or [3] CAS Normal transfer														
T1 DMS-100 Meridian ISDN [35]	RTL [2] or InBand [5]														

Parameter	Description
	<p>Note: A specific NFA CAS table is required.</p> <ul style="list-style-type: none"> <li>■ [2] = Supports ISDN PRI and BRI transfer - Release Link Trunk (RLT) (DMS-100), Two B Channel Transfer (TBCT) (NI2), Explicit Call Transfer (ECT) (EURO ISDN), and Path Replacement (QSIG). When a SIP REFER message is received, the device performs a transfer by sending Facility messages to the PBX with the necessary information on the call's legs to be connected. The different ISDN variants use slightly different methods (using Facility messages) to perform the transfer. <ul style="list-style-type: none"> <li><b>Note:</b></li> <li>✓ For RLT ISDN transfer, the parameter <code>SendISDNTransferOnConnect</code> must be set to 1.</li> <li>✓ The parameter <code>SendISDNTransferOnConnect</code> can be used to define if the TBCT/ECT transfer is performed after receipt of Alerting or Connect messages. For RLT, the transfer is always done after receipt of Connect (<code>SendISDNTransferOnConnect</code> is set to 1).</li> <li>✓ This transfer can be performed between B-channels from different trunks or Trunk Groups, by using the parameter <code>EnableTransferAcrossTrunkGroups</code>.</li> <li>✓ The device initiates the ECT process after receiving a SIP REFER message only for trunks that are configured to User side.</li> </ul> </li> <li>■ [3] = Supports CAS Normal transfer. When a SIP REFER message is received, the device performs a Blind Transfer by executing a CAS Wink, dialing the Refer-to number to the switch, and then releasing the call.</li> <li>■ [4] = Supports QSIG Single Step transfer PRI and BRI: <ul style="list-style-type: none"> <li>✓ IP-to-Tel: When a SIP REFER message is received, the device performs a transfer by sending a Facility message to the PBX, initiating Single Step transfer. Once a success return result is received, the transfer is completed.</li> <li>✓ Tel-to-IP: When a Facility message initiating Single Step transfer is received from the PBX, a SIP REFER message is sent to the IP side.</li> </ul> </li> <li>■ [5] = IP-to-Tel Blind Transfer mode supported for ISDN PRI</li> </ul>

Parameter	Description
	<p>and BRI protocols and implemented according to AT&amp;T Toll Free Transfer Connect Service (TR 50075) "Courtesy Transfer-Human-No Data". When the device receives a SIP REFER message, it performs a blind transfer by first dialing the DTMF digits (transfer prefix) defined by the parameter XferPrefixIP2Tel (configured to "*8" for AT&amp;T service), and then (after 500 msec) the device dials the DTMF of the number (referred) from the Refer-To header sip:URI userpart. If the hostpart of the Refer-To sip:URI contains the device's IP address, and if the Trunk Group selected according to the IP-to-Tel Routing table is the same Trunk Group as the original call, then the device performs the in-band DTMF transfer; otherwise, the device sends the INVITE according to regular transfer rules.</p> <p>After completing the in-band transfer, the device waits for the ISDN Disconnect message. If the Disconnect message is received during the first 5 seconds, the device sends a SIP NOTIFY with 200 OK message; otherwise, the device sends a NOTIFY with 4xx message.</p> <ul style="list-style-type: none"> <li>■ [6] = Supports AT&amp;T toll free out-of-band blind transfer for trunks configured with the 4ESS ISDN protocol. AT&amp;T courtesy transfer is a supplementary service which enables a user (e.g., user "A") to transform an established call between it and user "B" into a new call between users "B" and "C", whereby user "A" does not have a call established with user "C" prior to call transfer. The device handles this feature as follows: <ul style="list-style-type: none"> <li>✓ IP-to-Tel (user side): When a SIP REFER message is received, the device initiates a transfer by sending a Facility message to the PBX.</li> <li>✓ Tel-to-IP (network side): When a Facility message initiating an out-of-band blind transfer is received from the PBX, the device sends a SIP REFER message to the IP side (if the EnableNetworkISDNTransfer parameter is set to 1).</li> </ul> </li> </ul> <p><b>Note:</b> To configure trunk transfer mode per trunk, use the parameter TrunkTransferMode_x.</p>
[TrunkTransferMode_x]	<p>Determines the trunk transfer mode per trunk (where x denotes the Trunk number). To configure trunk transfer mode for all trunks and for a description of the parameter options,</p>

Parameter	Description
	refer to the parameter TrunkTransferMode.
[EnableTransferAcrossTrunkGroups]	<p>Determines whether the device allows ISDN ECT, RLT or TBCT IP-to-Tel call transfers between B-channels of different Trunk Groups.</p> <ul style="list-style-type: none"> <li>■ [0] = (Default) Disable - ISDN call transfer is only between B-channels of the same Trunk Group.</li> <li>■ [1] = Enable - the device performs ISDN transfer between any two PSTN calls (between any Trunk Group) handled by the device.</li> </ul> <p>Note: The ISDN transfer also requires that you configure the parameter TrunkTransferMode_x to 2.</p>
[TransferCapabilityForDataCalls]	<p>Defines the ISDN Transfer Capability for data calls.</p> <ul style="list-style-type: none"> <li>■ [0] = (Default) ISDN Transfer Capability for data calls is 64k unrestricted (data).</li> <li>■ [1] = ISDN Transfer Capability for data calls is determined according to the ISDNTransferCapability parameter.</li> </ul>
'ISDN Transfer On Connect' isdn-trsfr-on-conn [SendISDNTransferOnConnect]	<p>The parameter is used for the ECT/TBCT/RLT/Path Replacement ISDN transfer methods. Usually, the device requests the PBX to connect an incoming and outgoing call. The parameter determines if the outgoing call (from the device to the PBX) must be connected before the transfer is initiated.</p> <ul style="list-style-type: none"> <li>■ [0] <b>Alert</b> = (Default) Enables ISDN Transfer if the outgoing call is in Alerting or Connect state.</li> <li>■ [1] <b>Connect</b> = Enables ISDN Transfer only if the outgoing call is in Connect state.</li> </ul> <p><b>Note:</b> For RLT ISDN transfer (TrunkTransferMode = 2 and ProtocolType = 14 DMS-100), the parameter must be set to 1.</p>
configure voip > gateway dtmf-suppress-service settings > isdn-xfer-complete-timeout [ISDNTransferCompleteTimeout]	<p>Defines the timeout (in seconds) for determining ISDN call transfer (ECT, RLT, or TBCT) failure. If the device does not receive any response to an ISDN transfer attempt within this user-defined time, the device identifies this as an ISDN transfer failure and subsequently performs a hairpin TDM connection or sends a SIP NOTIFY message with a SIP 603 response (depending whether hairpin is enabled or disabled, using the parameter DisableFallbackTransferToTDM).</p> <p>The valid range is 1 to 10. The default is 4.</p>

Parameter	Description
'Enable Network ISDN Transfer' <pre>configure voip &gt; sip-definition settings &gt; network-isdn-xfer</pre> [EnableNetworkISDNTransfer]	Determines whether the device allows interworking of network-side received ECT/TBCT Facility messages (NI-2 TBCT - Two B-channel Transfer and ETSI ECT - Explicit Call Transfer) to SIP REFER.  <ul style="list-style-type: none"> <li>■ [0] <b>Disable</b> = Rejects ISDN transfer requests.</li> <li>■ [1] <b>Enable</b> = (Default) The device sends a SIP REFER message to the remote call party if ECT/TBCT Facility messages are received from the ISDN side (e.g., from a PBX).</li> </ul>
[DisableFallbackTransferToTDM]	Enables "hairpin" TDM transfer upon ISDN (ECT, RLT, or TBCT) call transfer failure. When this feature is enabled and an ISDN call transfer failure occurs, the device sends a SIP NOTIFY message with a SIP 603 Decline response.  <ul style="list-style-type: none"> <li>■ [0] = (Default) The device performs a hairpin TDM transfer upon ISDN call transfer.</li> <li>■ [1] = Hairpin TDM transfer is disabled.</li> </ul>
<pre>gateway digital settings &gt; isdn-ignore-18x-without-sdp</pre> [ISDNIgnore18xWithoutSDP]	Enables interworking SIP 18x without SDP and ISDN Q.931 Progress/Alerting messages.  <ul style="list-style-type: none"> <li>■ [0] = Disable. Incoming SIP 18x messages without SDP are replied by the device by PRACK (if required), but the device doesn't interwork these SIP messages with Q.931 Progress or Alerting messages (i.e., doesn't send to PSTN).</li> <li>■ [1] = (Default) Enable. The device interworks 18x SIP messages with Q.931 Progress and Alerting messages (if required) and sends them to the PSTN.</li> </ul>
<pre>gateway digital settings &gt; isdn-send-progress-for-te</pre> [ISDNSendProgressForTE]	Defines whether the device sends Q.931 Progress messages to the ISDN trunk if the trunk is configured as User side (TE) and/or Network (NT) side, for IP-to-Tel calls.  <ul style="list-style-type: none"> <li>■ [0] = Disable. The device sends Progress messages to the trunk only if the trunk is configured as NT.</li> <li>■ [1] = (Default) Enable. The device sends Q.931 Progress messages to the trunk if the trunk is configured as TE or NT.</li> </ul> <p><b>Note:</b> To configure the trunk's ISDN termination side (TE or NT), use the 'ISDN Termination Side' parameter.</p>

Parameter	Description
<p>'Enable QSIG Transfer Update'</p> <p><code>qsig-xfer-update</code></p> <p>[EnableQSIGTransferUpdate]</p>	<p>Determines whether the device interworks QSIG Facility messages with CallTransferComplete or CallTransferUpdate invoke application protocol data units (APDU) to SIP UPDATE messages with P-Asserted-Identity and optional Privacy headers. This feature is supported for IP-to-Tel and Tel-to-IP calls.</p> <ul style="list-style-type: none"> <li>■ [0] <b>Disable</b> = (Default) Ignores QSIG Facility messages with CallTransferComplete or CallTransferUpdate invokes.</li> <li>■ [1] <b>Enable</b></li> </ul> <p>For example, assume A and C are PBX call parties and B is the SIP IP phone:</p> <ol style="list-style-type: none"> <li>1. A calls B; B answers the call.</li> <li>2. A places B on hold and calls C; C answers the call.</li> <li>3. A performs a call transfer (the transfer is done internally by the PBX); B and C are connected to one another.</li> </ol> <p>In the above example, the PBX updates B that it is now talking with C. The PBX updates this by sending a QSIG Facility message with CallTransferComplete invoke APDU. The device interworks this message to a SIP UPDATE message containing a P-Asserted-Identity header with the number and name derived from the QSIG CallTransferComplete RedirectionNumber and RedirectionName.</p> <p><b>Note:</b></p> <ul style="list-style-type: none"> <li>■ For IP-to-Tel calls, the RedirectionNumber and RedirectionName in the CallTransferComplete invoke is derived from the P-Asserted-Identity and Privacy headers in the received SIP INFO message.</li> <li>■ To include the P-Asserted-Identity header in outgoing SIP UPDATE messages, set the AssertedIDMode parameter to <b>Add P-Asserted-Identity</b>.</li> </ul>
<p><code>is-cas-sndhook-flsh</code></p> <p>[CASSendHookFlash]</p>	<p>Enables sending Wink signal toward CAS trunks.</p> <ul style="list-style-type: none"> <li>■ [0] = Disable (default)</li> <li>■ [1] = Enable</li> </ul> <p>If the device receives a mid-call SIP INFO message with flashhook event body (as shown below) and the parameter is set to 1, the device generates a wink signal toward the CAS</p>



Parameter	Description
	<p>trunk. The CAS wink signal is done by changing the A bit from 1 to 0, and then back to 1 for 450 msec.</p> <pre>INFO sip:4505656002@192.168.13.40:5060 SIP/2.0 Via: SIP/2.0/UDP 192.168.13.2:5060 From: &lt;sip:06@192.168.13.2:5060&gt; To: &lt;sip:4505656002@192.168.13.40:5060&gt;;tag=1 32878796-1040067870294 Call-ID: 0010-0016-D69A7DA8- 1@192.168.13.2 CSeq:2 INFO Content-Type: application/broadsoft Content-Length: 17 event flashhook</pre> <p><b>Note:</b> The parameter is applicable only to T1 CAS protocols.</p>

## Tone Parameters

This subsection describes the device's tone parameters.

### Telephony Tone Parameters

The telephony tone parameters are described in the table below.

**Table 70-57:Tone Parameters**

Parameter	Description
<p>'Maximum simultaneous streaming calls'</p> <pre>max-streaming-calls</pre> <p>[MaxStreamingCalls]</p>	<p>Defines the maximum number of concurrent call parties that have been placed on hold to which the device can play Music on Hold (MoH) that originates from an external media player.</p> <p>The maximum is 20. The default is 0.</p> <p>For more information, see <a href="#">Configuring MoH from External Audio Source</a> on page 816.</p> <p><b>Note:</b></p> <ul style="list-style-type: none"> <li>■ The parameter is applicable only to FXS interfaces.</li> <li>■ Each FXS port supports up to 20 concurrent MoH sessions.</li> <li>■ For the parameter to take effect, a device reset</li> </ul>

Parameter	Description
	is required.
<pre>configure voip &gt; gateway dtmf-supp- service supp-service- settings &gt; music-on- hold</pre> <p>[EnableMOH]</p>	<p>Enables the option for using an external audio source that is connected to the device's AUDIO connector (on the CPU module). When enabled, the device uses the incoming audio from this connector instead of playing the held tone defined in the Call Progress Tones (CPT) file.</p> <ul style="list-style-type: none"> <li>■ [0] = (Default) Disable</li> <li>■ [1] = Enable</li> </ul> <p><b>Note:</b> EnableHold must be set to 1 to enable this feature.</p>
<p>'SIP Hold Behavior'</p> <pre>configure voip &gt; sip- definition settings &gt; sip-hold-behavior</pre> <p>[SIPHoldBehavior]</p>	<p>Enables the device to handle incoming re-INVITE messages with the "a=sendonly" attribute in the SDP, in the same way as if an "a=inactive" is received in the SDP. When enabled, the device plays a held tone to the Tel phone and responds with a SIP 200 OK containing the "a=recvnonly" attribute in the SDP.</p> <ul style="list-style-type: none"> <li>■ [0] <b>Disable</b> (default)</li> <li>■ [1] <b>Enable</b></li> </ul> <p><b>Note:</b> The parameter is applicable only to analog interfaces.</p>
<p>'Dial Tone Duration'</p> <pre>configure voip &gt; gateway dtmf-supp- service dtmf-and- dialing &gt; dt-duration</pre> <p>[TimeForDialTone]</p>	<p>Defines the duration (in seconds) that the dial tone is played.</p> <p>Digital interfaces: The tone is played to an ISDN terminal. The parameter is applicable for overlap dialing when ISDNInCallsBehavior is set to 65536. The dial tone is played if the ISDN Setup message doesn't include the called number. The valid range is 0 to 60. The default is 5.</p> <p>Analog interfaces: FXS interfaces play the dial tone after the phone is picked up (off-hook). FXO interfaces play the dial tone after the port is seized in response to ringing (from PBX/PSTN). The valid range is 0 to 60. The default time is 16.</p> <p><b>Note:</b></p> <ul style="list-style-type: none"> <li>■ Analog interfaces: During play of dial tone, the</li> </ul>

Parameter	Description
	<p>device waits for DTMF digits.</p> <ul style="list-style-type: none"> <li>■ Analog interfaces: The parameter is not applicable when Automatic Dialing is enabled.</li> </ul>
<p>'Stutter Tone Duration'</p> <pre>configure voip &gt; gateway dtmf-supp- service supp-service- settings &gt; sttr-tone- duration [StutterToneDuration]</pre>	<p>Defines the duration (in msec) of the confirmation tone. A stutter tone is played (instead of a regular dial tone) when a Message Waiting Indication (MWI) is received. The stutter tone is composed of a confirmation tone (Tone Type #8), which is played for the defined duration (StutterToneDuration) followed by a stutter dial tone (Tone Type #15). Both these tones are defined in the CPT file.</p> <p>The range is 1,000 to 60,000. The default is 2,000 (i.e., 2 seconds).</p> <p><b>Note:</b></p> <ul style="list-style-type: none"> <li>■ The parameter is applicable only to FXS interfaces.</li> <li>■ If you want to configure the duration of the confirmation tone to longer than 16 seconds, you must increase the value of the parameter TimeForDialTone accordingly.</li> <li>■ The MWI tone overrides the call forwarding reminder tone. For more information on MWI, see <a href="#">Message Waiting Indication</a>.</li> </ul>
<p>'FXO AutoDial Play BusyTone'</p> <pre>configure voip &gt; gateway analog fxo- setting &gt; fxo-autodial- play-bsytn [FXOAutoDialPlayBusyTone]</pre>	<p>Determines whether the device plays a busy / reorder tone to the PSTN side if a Tel-to-IP call is rejected by a SIP error response (4xx, 5xx or 6xx). If a SIP error response is received, the device seizes the line (off-hook), and then plays a busy / reorder tone to the PSTN side (for the duration defined by the parameter TimeForReorderTone). After playing the tone, the line is released (on-hook).</p> <ul style="list-style-type: none"> <li>■ [0] = Disable (default)</li> <li>■ [1] = Enable</li> </ul> <p><b>Note:</b> The parameter is applicable only to FXO interfaces.</p>
<p>'Hotline Dial Tone Duration'</p> <pre>configure voip &gt;</pre>	<p>Defines the duration (in seconds) of the hotline dial tone. If no digits are received during this duration,</p>

Parameter	Description
<pre>gateway dtmf-supp- service dtmf-and- dialing &gt; hotline-dt- dur</pre> <p>[HotLineToneDuration]</p>	<p>the device initiates a call to a user-defined number (configured in the Automatic Dialing table - TargetOfChannel - see <a href="#">Configuring Automatic Dialing</a>).</p> <p>The valid range is 0 to 60. The default is 16.</p> <p><b>Note:</b></p> <ul style="list-style-type: none"> <li>■ The parameter is applicable only to analog interfaces.</li> <li>■ You can define the Hotline duration per FXS /FXO port using the Automatic Dialing table.</li> </ul>
<p>'Reorder Tone Duration'</p> <pre>configure voip &gt; gateway analog fxo- setting &gt; reorder-tone- duration</pre> <p>[TimeForReorderTone]</p>	<p>Global parameter defining the duration (in seconds) that the device plays a busy or reorder tone before releasing the line.</p> <p>You can also configure the feature per specific calls, using Tel Profiles (TelProfile_TimeForReorderTone). For a detailed description of the parameter and for configuring the feature in the Tel Profiles table, see <a href="#">Configuring Tel Profiles</a>.</p> <p><b>Note:</b> If the feature is configured for a specific Tel Profile, the settings of the global parameter is ignored for calls associated with the Tel Profile.</p>
<p>'Time Before Reorder Tone'</p> <pre>time-b4-reordr-tn</pre> <p>[TimeBeforeReorderTone]</p>	<p>Defines the delay interval (in seconds) from when the device receives a SIP BYE message (i.e., remote party terminates call) until the device starts playing a reorder tone to the FXS phone.</p> <p>The valid range is 0 to 60. The default is 0.</p> <p><b>Note:</b> The parameter is applicable only to FXS interfaces.</p>
<p>'Cut Through Reorder Tone Duration'</p> <pre>cut-thru-reord-dur</pre> <p>[CutThroughTimeForReOrderTone]</p>	<p>Defines the duration (in seconds) of the reorder tone played to the Tel side after the IP call party releases the call, for the Cut-Through feature. After the tone stops playing, an incoming call is immediately answered if:</p> <ul style="list-style-type: none"> <li>■ Analog interfaces: The FXS is off-hooked.</li> <li>■ Digital interfaces: The PSTN is connected.</li> </ul> <p>The valid values are 0 to 30. The default is 0 (i.e., no reorder tone is played).</p>

Parameter	Description
	<p><b>Note:</b> To enable the Cut-Through feature:</p> <ul style="list-style-type: none"> <li>■ CAS channels: DigitalCutThrough parameter</li> <li>■ FXS channels: CutThrough parameter</li> </ul>
<p>'Enable Comfort Tone' comfort-tone [EnableComfortTone]</p>	<p>Determines whether the device plays a comfort tone (Tone Type #18) to the FXS /FXO endpoint after a SIP INVITE is sent and before a SIP 18x response is received.</p> <ul style="list-style-type: none"> <li>■ [0] <b>Disable</b> (default)</li> <li>■ [1] <b>Enable</b></li> </ul> <p><b>Note:</b> The parameter is applicable to FXS and FXO interfaces.</p>
<p>[WarningToneDuration]</p>	<p>Defines the duration (in seconds) for which the offhook warning tone is played to the user. The valid range is -1 to 2,147,483,647. The default is 600.</p> <p><b>Note:</b></p> <ul style="list-style-type: none"> <li>■ A negative value indicates that the tone is played infinitely.</li> <li>■ The parameter is applicable only to analog interfaces.</li> </ul>
<p>'Play Busy Tone to Tel' configure voip &gt; sip- definition settings &gt; play-bsy-tone-2tel [PlayBusyTone2ISDN]</p>	<p>Enables the device to play a busy or reorder tone to the PSTN after a Tel-to-IP call is released.</p> <ul style="list-style-type: none"> <li>■ [0] <b>Don't Play</b> = (Default) Immediately sends an ISDN Disconnect message.</li> <li>■ [1] <b>Play when Disconnecting</b> = Sends an ISDN Disconnect message with PI = 8 and plays a busy or reorder tone to the PSTN (depending on the release cause).</li> <li>■ [2] <b>Play before Disconnect</b> = Delays the sending of an ISDN Disconnect message for a user-defined time (configured by the TimeForReorderTone parameter) and plays a busy or reorder tone to the PSTN. This is applicable only if the call is released from the IP [Busy Here (486) or Not Found (404)] before it reaches the Connect state; otherwise, the</li> </ul>

Parameter	Description
	<p>Disconnect message is sent immediately and no tones are played.</p> <p><b>Note:</b> The parameter is applicable only to digital interfaces.</p>
<p>q850-reason-code-2play-user-tone [Q850ReasonCode2PlayUserTone]</p>	<p>Defines an ISDN Q.8931 release cause code(s), which if mapped to the SIP release reason received from the IP side, causes the device to play a user-defined tone from the installed PRT file to the Tel side. For example, if the the received SIP release cause is 480 Temporarily Unavailable and you configure the parameter with Q.931 release code 18 (No User Responding), the device plays the user-defined tone to the Tel side.</p> <p>The user-defined tone is configured when creating the PRT file, using AudioCodes DConvert utility. The tone must be assigned to the "acSpecialConditionTone" (Tone Type 21) option in DConvert.</p> <p>The parameter can be configured with up to 10 release codes. When configuring multiple codes, separate the codes by commas (without spaces). For example:</p> <pre>Q850ReasonCode2PlayUserTone = 1, 18, 24</pre> <p>If the SIP release reason received from the IP side is mapped to the Q.931 release code specified by the parameter, the device plays the user-defined tone. Otherwise, if not specified and the release code is 17 (User Busy), the device plays the busy tone and for all other release codes, the device plays the reorder tone.</p> <p><b>Note:</b></p> <ul style="list-style-type: none"> <li>■ The parameter is applicable only to digital interfaces.</li> <li>■ To enable the feature, the 'Play Busy Tone to Tel' (PlayBusyTone2ISDN) parameter must be enabled (set to 1 or 2).</li> </ul>
<p>'Play Ringback Tone to Tel' configure voip &gt; sip-</p>	<p>Determines the playing method of the ringback tone to the Tel side. Digital interfaces: The</p>

Parameter	Description
<pre>definition settings &gt; play-rbt2tel [PlayRBTone2Tel]</pre>	<p>parameter applies to all trunks that are not configured by the PlayRBTone2Trunk parameter (which defines ringback tone per Trunk).</p> <ul style="list-style-type: none"> <li>■ [0] <b>Don't Play</b> = <ul style="list-style-type: none"> <li>✓ Analog Interfaces: Ringback tone is not played.</li> <li>✓ Digital Interfaces: The device doesn't play a ringback tone. No PI is sent to the PSTN unless the [ProgressIndicator2ISDN_x] parameter is configured differently.</li> </ul> </li> <li>■ [1] <b>Play on Local</b> = <ul style="list-style-type: none"> <li>✓ Analog interfaces: Plays a ringback tone to the Tel side of the call when a SIP 180/183 response is received.</li> <li>✓ Digital interfaces: <ul style="list-style-type: none"> <li>CAS: The device plays a local ringback tone to the PSTN upon receipt of a SIP 180 Ringing response (with or without SDP). Note that the receipt of a 183 response does not cause the device to play a ringback tone (unless the SIP183Behaviour parameter is set to 1).</li> <li>ISDN: The device operates according to the LocalISDNRBSsource parameter: <ol style="list-style-type: none"> <li>1) If the device receives a 180 Ringing response (with or without SDP) and the LocalISDNRBSsource parameter is set to 1, it plays a ringback tone and sends an ISDN Alert with PI = 8 (unless the [ProgressIndicator2ISDN_x] parameter is configured differently).</li> <li>2) If the LocalISDNRBSsource parameter is set to 0, the device doesn't play a ringback tone and an Alert message without PI is sent to the ISDN. In this case, the PBX / PSTN plays the ringback tone to the originating terminal. Note that the receipt of a 183 response does not cause the device configured for ISDN to play a ringback tone; the device issues a Progress</li> </ol> </li> </ul> </li> </ul> </li> </ul>

Parameter	Description
	<p>message (unless SIP183Behaviour is set to 1). If the SIP183Behaviour parameter is set to 1, the 183 response is handled the same way as a 180 Ringing response.</p> <p>■ [2] <b>Prefer IP</b> = (Default):</p> <ul style="list-style-type: none"> <li>✓ Analog interfaces: Plays a ringback tone to the Tel side only if a 180/183 response without SDP is received. If 180/183 with SDP message is received, the device cuts through the voice channel and doesn't play the ringback tone.</li> <li>✓ Digital interfaces: Plays according to 'Early Media'. If a SIP 180 response is received and the voice channel is already open (due to a previous 183 early media response or due to an SDP in the current 180 response), the device doesn't play the ringback tone; PI = 8 is sent in an ISDN Alert message (unless the [ProgressIndicator2ISDN_x] parameter is configured differently). CAS: If a 180 response is received, but the 'early media' voice channel is not opened, the device plays a ringback tone to the PSTN. ISDN: The device operates according to the LocalISDNRBSsource parameter: 1) If LocalISDNRBSsource is set to 1, the device plays a ringback tone and sends an ISDN Alert with PI = 8 to the ISDN (unless the [ProgressIndicator2ISDN_x] parameter is configured differently). 2) If LocalISDNRBSsource is set to 0, the device doesn't play a ringback tone. No PI is sent in the ISDN Alert message (unless the [ProgressIndicator2ISDN_x] parameter is configured differently). In this case, the PBX / PSTN plays a ringback tone to the originating terminal. Note that the receipt of a 183 response results in an ISDN Progress message (unless SIP183Behaviour is set to 1). If SIP183Behaviour is set to 1</li> </ul>



Parameter	Description
	<p>(183 is handled the same way as a 180 + SDP), the device sends an Alert message with PI = 8, without playing a ringback tone.</p> <ul style="list-style-type: none"> <li>■ [3] <b>Play Local Until Remote Media Arrive</b> = Plays a ringback tone according to received media. The behaviour is similar to [2]. If a SIP 180 response is received and the voice channel is already open (due to a previous 183 early media response or due to an SDP in the current 180 response), the device plays a local ringback tone if there are no prior received RTP packets. The device stops playing the local ringback tone as soon as it starts receiving RTP packets. At this stage, if the device receives additional 18x responses, it does not resume playing the local ringback tone.</li> </ul> <p>Note that for ISDN trunks, this option is applicable only if the LocalISDNRBSource parameter is set to 1.</p>
<p>'Play Ringback Tone to IP'  <code>configure voip &gt; sip-definition settings &gt; play-rbt-2ip</code>  [PlayRBTone2IP]</p>	<p>Global parameter that enables the device to play a ringback tone to the IP side for IP-to-Tel calls. You can also configure this feature per specific calls, using IP Profiles (IpProfile_PlayRBTone2IP). For a detailed description of the parameter and for configuring this feature in the IP Profiles table, see <a href="#">Configuring IP Profiles</a>.</p> <p><b>Note:</b> If this feature is configured for a specific IP Profile, the settings of this global parameter is ignored for calls associated with the IP Profile.</p>
<p>'Play Local RBT on ISDN Transfer'  <code>play-l-rbt-isdn-trsfr</code>  [PlayRBTONISDNTransfer]</p>	<p>Determines whether the device plays a local ringback tone for ISDN's Two B Channel Transfer (TBCT), Release Line Trunk (RLT), or Explicit Call Transfer (ECT) call transfers to the originator when the second leg receives an ISDN Alerting or Progress message.</p> <ul style="list-style-type: none"> <li>■ [0] <b>Don't Play</b> (default)</li> <li>■ [1] <b>Play</b></li> </ul> <p><b>Note:</b></p>

Parameter	Description
	<ul style="list-style-type: none"> <li>■ For Blind transfer, the local ringback tone is played to first call PSTN party when the second leg receives the ISDN Alerting or Progress message.</li> <li>■ For Consulted transfer, the local ringback tone is played when the second leg receives ISDN Alerting or Progress message if the Progress message is received after a SIP REFER.</li> <li>■ The parameter is applicable only if the parameter <code>SendISDNTransferOnConnect</code> is set to 1.</li> <li>■ The parameter is applicable only to digital interfaces.</li> </ul>
'MFC R2 Category' <code>mfc_r2_category</code> [R2Category]	<p>Defines the tone for MFC R2 calling party category (CPC). The parameter provides information on the calling party such as National or International call, Operator or Subscriber and Subscriber priority.</p> <p>The value range is 1 to 15 (defining one of the MFC R2 tones). The default is 1.</p> <p><b>Note:</b> The parameter is applicable only to digital interfaces.</p>

### Tone Detection Parameters

The signal tone detection parameters are described in the table below.

**Table 70-58:Tone Detection Parameters**

Parameter	Description
<code>dtmf-detector-enable</code> [DTMFDetectorEnable]	<p>Enables the detection of DTMF signaling.</p> <ul style="list-style-type: none"> <li>■ [0] = Disable</li> <li>■ [1] = (Default) Enable</li> </ul>
<code>mfr1-detector-enable</code> [MFR1DetectorEnable]	<p>Enables the detection of MF-R1 signaling.</p> <ul style="list-style-type: none"> <li>■ [0] = (Default) Disable</li> <li>■ [1] = Enable</li> </ul>
<code>mf-transport-type</code> [MFTransportType]	<p>Defines the method for sending MF digits over the network to the remote side.</p>

Parameter	Description
	<ul style="list-style-type: none"> <li>■ [0] = (Mute) MF digits are erased from the audio stream and are not relayed to the remote side. Instead, silence is sent in the RTP stream.</li> <li>■ [2] = (Transparent) MF digits are left in the audio stream and MF relay is disabled.</li> <li>■ [3] = (Default) (RFC 2833 Relay) MF digits are relayed to the remote side using the RFC 2833 Relay syntax.</li> </ul>
[R1DetectionStandard]	<p>Determines the MF-R1 protocol used for detection.</p> <ul style="list-style-type: none"> <li>■ [0] = (Default) ITU</li> <li>■ [1] = R1.5</li> </ul> <p><b>Note:</b> For the parameter to take effect, a device reset is required.</p>
user-defined-tones-detector-enable [UserDefinedToneDetectorEnable]	<p>Enables the detection of User Defined Tones signaling, applicable for Special Information Tone (SIT) detection.</p> <ul style="list-style-type: none"> <li>■ [0] = (Default) Disable</li> <li>■ [1] = Enable</li> </ul>
sit-detector-enable [SITDetectorEnable]	<p>Enables SIT detection according to the ITU-T recommendation E.180/Q.35.</p> <ul style="list-style-type: none"> <li>■ [0] = (Default) Disable</li> <li>■ [1] = Enable</li> </ul> <p>Digital interfaces: To disconnect IP-to-ISDN calls when a SIT tone is detected, configure the following parameters:</p> <ul style="list-style-type: none"> <li>■ [SITDetectorEnable = 1]</li> <li>■ [UserDefinedToneDetectorEnable = 1]</li> <li>■ [ISDNDisconnectOnBusyTone = 1] (applicable for Busy, Reorder and SIT tones)</li> </ul> <p>Digital interfaces: Another parameter for handling the SIT tone is [SITQ850Cause], which defines the Q.850 cause value specified in the SIP Reason header that is included in a 4xx response when a SIT tone is detected on an IP-to-Tel call.</p>

Parameter	Description
	<p>To disconnect IP-to-Tel calls when a SIT tone is detected, configure the following parameters:</p> <ul style="list-style-type: none"> <li>■ [SITDetectorEnable = 1]</li> <li>■ [UserDefinedToneDetectorEnable = 1]</li> <li>■ [DisconnectOnBusyTone = 1] (applicable for busy, reorder, and SIT tones)</li> </ul> <p><b>Note:</b></p> <ul style="list-style-type: none"> <li>■ For the parameter to take effect, a device reset is required.</li> <li>■ The IP-to-ISDN call is disconnected on detection of a SIT tone only in call alert state. If the call is in connected state, the SIT does not disconnect the call. Detection of busy or reorder tones disconnect these calls also in call connected state.</li> <li>■ For IP-to-CAS calls, detection of busy, reorder, or SIT tones disconnect the call in any call state.</li> </ul>
udt-detector-frequency-deviation [UDTDetectorFrequencyDeviation]	<p>Defines the deviation (in Hz) allowed for the detection of each signal frequency.</p> <p>The valid range is 1 to 50. The default is 50.</p> <p><b>Note:</b> For the parameter to take effect, a device reset is required.</p>
cpt-detector-frequency-deviation [CPTDetectorFrequencyDeviation]	<p>Defines the deviation (in Hz) allowed for the detection of each CPT signal frequency.</p> <p>The valid range is 1 to 30. The default is 10.</p> <p><b>Note:</b> For the parameter to take effect, a device reset is required.</p>

### Metering Tone Parameters

The metering tone parameters are described in the table below.

**Table 70-59: Metering Tone Parameters**

Parameter	Description
'Generate Metering Tones' configure voip >	Defines the method for configuring metering tones that are generated to the Tel side.

Parameter	Description
<pre>gateway analog metering-tones &gt; gen- mtr-tones [PayPhoneMeteringMode]</pre>	<ul style="list-style-type: none"> <li data-bbox="746 286 1337 353">■ [0] <b>Disable</b> = (Default) Metering tones are not generated.</li> <li data-bbox="746 383 1374 533">■ [1] <b>Charge Code Table</b> = Metering tones are generated by the device according to the Charge Code table (see <a href="#">Configuring Charge Codes</a>) and sent to the Tel side.</li> <li data-bbox="746 562 1394 949">■ [2] <b>SIP Interval Provided</b> = (Proprietary method of TELES Communications Corporation) Advice-of-Charge service toward the PSTN. Periodic generation of AOC-D and AOC-E toward the PSTN. Calculation is based on seconds. The time interval is calculated according to the scale and tariff provided in the proprietary formatted file included in SIP INFO messages, which is always sent before 200 OK. The device ignores tariffs sent after the call is established.  <b>Note:</b> This option is applicable only to digital interfaces.</li> <li data-bbox="746 1070 1390 1503">■ [3] <b>SIP RAW Data Provided</b> = (Proprietary method of Cirpack) Advice-of-Charge service toward the PSTN. The received AOC-D messages contain a subtotal. When receiving AOC-D in raw format, provided in the header of SIP INFO messages, the device parses AOC-D raw data to obtain the number of units. This number is sent in the Facility message with AOC-D. In addition, the device stores the latest number of units in order to send them in AOC-E IE when the call is disconnected.  <b>Note:</b> This option is applicable only to digital interfaces.</li> <li data-bbox="746 1624 1394 1980">■ [4] <b>SIP RAW Data Incremental Provided</b> = (Proprietary method of Cirpack) Advice-of-Charge service toward the PSTN. The AOC-D message in the payload is an increment. When receiving AOC-D in raw format, provided in the header of SIP INFO messages, the device parses AOC-D raw data to obtain the number of units. This number is sent in the Facility message with AOC-D. The device generates the AOC-E. Parsing every AOC-D</li> </ul>

Parameter	Description
	<p>received and summing the values is required to obtain the total sum (that is placed in the AOC-E).</p> <p><b>Note:</b> This option is applicable only to digital interfaces.</p> <ul style="list-style-type: none"> <li>■ [5] <b>SIP-to-Tel Interworking</b> = Enables IP-to-Tel AOC, using the AudioCodes proprietary SIP header, AOC.</li> </ul> <p><b>Note:</b> This option is applicable only to digital interfaces.</p> <p><b>Note:</b> The parameter is applicable only to FXS and ISDN Euro trunks for sending AOC Facility messages (see <a href="#">Advice of Charge Services for Euro ISDN</a>).</p>
<p>'Analog Metering Type'  <code>configure voip &gt;</code>  <code>interface fxs-fxo &gt;</code>  <code>metering-type</code>  [MeteringType]</p>	<p>Defines the metering method for generating pulses (sinusoidal metering burst frequency) by the FXS port.</p> <ul style="list-style-type: none"> <li>■ [0] <b>12 KHz sinusoidal bursts</b> (default)</li> <li>■ [1] <b>16 kHz sinusoidal bursts</b></li> <li>■ [2] <b>Polarity Reversal pulses</b></li> </ul> <p><b>Note:</b></p> <ul style="list-style-type: none"> <li>■ For the parameter to take effect, a device reset is required.</li> <li>■ The parameter is applicable only to FXS interfaces.</li> </ul>
<p>'Analog TTX Voltage Level'  [AnalogTTXVoltageLevel ]</p>	<p>Determines the metering signal/pulse voltage level (TTX).</p> <ul style="list-style-type: none"> <li>■ [0] <b>0V</b> = 0 Vrms sinusoidal bursts.</li> <li>■ [1] <b>0.5V</b> = (Default) 0.5 Vrms sinusoidal bursts.</li> <li>■ [2] <b>1V</b> = 1 Vrms sinusoidal bursts</li> </ul> <p><b>Note:</b></p> <ul style="list-style-type: none"> <li>■ For the parameter to take effect, a device reset is required.</li> <li>■ The parameter is applicable only to FXS interfaces.</li> </ul>
<p>[ISDNAoCAmountPerInterval]</p>	<p>Defines the amount (units) charged per interval.</p>

Parameter	Description
	<p>The default is 1.</p> <p><b>Note:</b> The parameter is applicable only to the Euro ISDN protocol (Advice of Charge supplementary services).</p>
[ISDNAoCMinIntervalGeneration]	<p>Defines the interval for sending the AOC messages. The default is 0 (meaning that the interval is according to the Charge Codes table).</p> <p><b>Note:</b></p> <ul style="list-style-type: none"> <li>■ The parameter is applicable only to the Euro ISDN protocol (Advice of Charge supplementary services).</li> <li>■ The parameter does not affect the interval charge amount.</li> <li>■ The parameter is ignored if its' value is less than the interval configured in the Charge Codes table (ChargeCode_PulseInterval).</li> </ul>

## Telephone Keypad Key Sequence Parameters

The telephony keypad key sequence parameters are described in the table below.

**Table 70-60:Telephone Keypad Key Sequence Parameters**

Parameter	Description
<p>'Call Pickup Key'</p> <pre>configure voip &gt; sip- definition settings &gt; call-pickup-key [KeyCallPickup]</pre>	<p>Defines the key sequence on the phone's keypad for performing a call pick-up. Call pick-up allows the FXS endpoint to answer another telephone's incoming call by pressing this user-defined sequence of digits. When the user dials these digits (e.g., #77), incoming calls from another phone is forwarded to the user's phone. The valid value is a string of up to 15 characters (0-9, #, and *). By default, no value is defined.</p> <p><b>Note:</b></p> <ul style="list-style-type: none"> <li>■ Call pick-up is configured only for FXS endpoints pertaining to the same Trunk Group.</li> <li>■ The parameter is applicable only to FXS interfaces.</li> </ul>
<pre>configure voip &gt; gateway analog</pre>	<p>Defines the key sequence on the phone's keypad for configuring a phone number for the FXS phone that is</p>

Parameter	Description
<pre>keypad-features key- port-configure [KeyPortConfigure]</pre>	<p>connected to the device's FXS port.</p> <p>To configure the phone number:</p> <ol style="list-style-type: none"> <li>1. Press the keys on the keypad to enter the configured key sequence.</li> <li>2. Press the keys on the keypad to enter the phone number.</li> <li>3. Press the number sign key (#) to complete configuration.</li> </ol> <p>For example, if you configured the parameter to "*81" and you want the phone number to be 9764004, press the following keys on the keypad: *819764004#.</p> <p>To delete the phone number, simply press the configured key sequence with the # key at the end (e.g., *81#).</p> <p>The valid value is a string of up to 16 characters. By default, no value is defined.</p> <p><b>Note:</b></p> <ul style="list-style-type: none"> <li>■ You must assign the FXS port to a Trunk Group (in the Trunk Group table) that is dedicated <b>only</b> to this port. The Trunk Group can be configured with or without a phone number, which you can change or delete by using this parameter.</li> <li>■ The parameter is applicable only to FXS interfaces.</li> </ul>
<pre>[Prefix2ExtLine]</pre>	<p>Defines a string prefix (e.g., '9' dialed for an external line) that when dialed, the device plays a secondary dial tone (i.e., stutter tone) to the FXS line and then starts collecting the subsequently dialed digits from the FXS line.</p> <p>The valid range is a one-character string. By default, no value is defined.</p> <p><b>Note:</b></p> <ul style="list-style-type: none"> <li>■ You can enable the device to add this string as the prefix to the collected (and sent) digits, using the [AddPrefix2ExtLine] parameter.</li> <li>■ The parameter is applicable only to FXS interfaces.</li> </ul>
<pre>configure voip &gt; gateway manipulation</pre>	<p>Enables the device to add the prefix string for accessing an external line (configured by the</p>



Parameter	Description
<pre>settings &gt; prefix-2- ext-line [AddPrefix2ExtLine]</pre>	<p>Prefix2ExtLine parameter) to the dialed (called) number as the prefix, which is sent to the IP destination (for Tel-to-IP calls).</p> <ul style="list-style-type: none"> <li>■ [0] = (Default) Disabled - the device does not add the prefix string for accessing the external line to the collected and sent dialed number. For example, if you configure the Prefix2ExtLine parameter to "9" and the FXS endpoint makes a call to destination number "123", the device collects and sends only the destination number digits "123" (i.e., without the prefix string) to the IP destination.</li> <li>■ [1] = Enables the device to add the prefix string for accessing the external line to the dialed number as the prefix, which is sent to the IP destination. For example, if you configure the Prefix2ExtLine parameter to "9" and the FXS endpoint makes a call to destination number "123", the device collects and sends all the dialed digits, including the prefix string "9", as "9123" to the IP destination.</li> <li>■ [2] = Same as option [1], but in addition, the device uses the prefix string for accessing the external line as the first digit in configured patterns of Digit Maps and/or Dial Plans. This option is useful in that it allows you to configure separate patterns for internal and external dialing. For example, if you configure the Prefix2ExtLine parameter to "9" and configure digit map patterns "2xxx 92xxxxxx", the device considers dialed numbers between 2000 and 2999 (2xxx) as internal extensions (i.e., when "9" is not dialed for an external line), and if the first dialed digit (prefix) is "9" (for accessing the external line), considers dialed numbers between 20000000 and 29999999 (92xxxxxx) as external numbers.</li> </ul> <p><b>Note:</b></p> <ul style="list-style-type: none"> <li>■ The parameter is applicable only to FXS interfaces.</li> <li>■ The parameter is applicable only to Tel-to-IP calls.</li> </ul>
<b>Hook Flash Parameters</b>	

Parameter	Description
<p>'Flash Keys Sequence Style'</p> <pre>configure voip &gt; gateway dtmf-supp- service supp-service- settings &gt; flash-key- seq-style</pre> <p>[FlashKeysSequenceStyle]</p>	<p>Determines the hook-flash key sequence for FXS interfaces.</p> <ul style="list-style-type: none"> <li>■ [0] <b>Flash hook</b> = (Default) Only the phone's flash button is used for the following scenarios: <ul style="list-style-type: none"> <li>✓ During an existing call, if the user presses the flash button, the call is put on hold; a dial tone is heard and the user is able to initiate a second call. Once the second call is established, on-hooking transfers the first (held) call to the second call.</li> <li>✓ During an existing call, if a call comes in (call waiting), pressing the flash button places the active call on hold and answers the waiting call; pressing flash again toggles between these two calls.</li> </ul> </li> <li>■ [1] <b>Sequence 1</b> = Sequence of flash button with digit: <ul style="list-style-type: none"> <li>✓ Flash + 1: holds a call or toggles between two existing calls</li> <li>✓ Flash + 2: makes a call transfer.</li> <li>✓ Flash + 3: makes a three-way conference call (if the Three-Way Conference feature is enabled, i.e., the parameter Enable3WayConference is set to 1 and the parameter 3WayConferenceMode is set to 2).</li> </ul> </li> <li>■ [2] <b>Sequence 2</b> = Sequence of flash button with digit: <ul style="list-style-type: none"> <li>✓ Flash only: Places a call on hold.</li> <li>✓ Flash + 1: <ol style="list-style-type: none"> <li>1) When the device handles two calls (an active and a held call) and this key sequence is dialed, it sends a SIP BYE message to the active call and the previously held call becomes the active call.</li> <li>2) When there is an active call and an incoming waiting call, if this key sequence is dialed, the device disconnects the active call and the waiting call becomes an active call.</li> </ol> </li> </ul> </li> </ul>

Parameter	Description
	<ul style="list-style-type: none"> <li>✓ Flash + 2: Places a call on hold and answers a call-waiting call, or toggles between active and on-hold calls.</li> <li>✓ Flash + 3: Makes a three-way conference call. This is applicable only if the Enable3WayConference parameter is set to 1 and the 3WayConferenceMode parameter is set to 2, and the device houses MPMs. Note that the settings of the ConferenceCode parameter is ignored.</li> <li>✓ Flash + 4: Makes a call transfer.</li> </ul> <p><b>Note:</b> The parameter is applicable only to FXS interfaces.</p>
'Flash Keys Sequence Timeout' flash-key-seq-tmout [FlashKeysSequenceTimeout]	Defines the Flash keys sequence timeout - the time (in msec) that the device waits for digits after the user presses the flash button (Flash Hook + Digit mode - when the parameter FlashKeysSequenceStyle is set to 1 or 2).  The valid range is 100 to 5,000. The default is 2,000.
<b>Keypad Feature - Call Forward Parameters</b>	
'Forward Unconditional' configure voip > gateway analog keypad-features > fwd-unconditional [KeyCFUnCond]	Defines the key sequence on the keypad to activate the immediate call forward option.
'Forward No Answer' configure voip > gateway analog keypad-features > fwd-no-answer [KeyCFNoAnswer]	Defines the key sequence on the keypad to activate the forward on no answer option.
'Forward On Busy' configure voip > gateway analog keypad-features > fwd-on-busy	Defines the key sequence on the keypad to activate the forward on busy option.

Parameter	Description
[KeyCFBusy]	
'Forward On Busy or No Answer' configure voip > gateway analog keypad-features > fwd-busy-or-no-ans [KeyCFBusyOrNoAnswer]	Defines the key sequence on the keypad to activate the forward on 'busy or no answer' option.
'Do Not Disturb' configure voip > gateway analog keypad-features > fwd-dnd [KeyCFDoNotDisturb]	Defines the key sequence on the keypad to activate the Do Not Disturb option (immediately reject incoming calls).
<p>To activate the required forward method from the telephone:</p> <ol style="list-style-type: none"> <li>1. Dial the user-defined sequence number on the keypad; a dial tone is heard.</li> <li>2. Dial the telephone number to which the call is forwarded (terminate the number with #); a confirmation tone is heard.</li> </ol>	
'Forward Deactivate' configure voip > gateway analog keypad-features > fwd-deactivate [KeyCFDeact]	Defines the key sequence on the keypad to deactivate any of the call forward options. After the sequence is pressed, a confirmation tone is heard.
<b>Keypad Feature - Caller ID Restriction Parameters</b>	
'Restricted Caller ID Activate' configure voip > gateway analog keypad-features > id- restriction-act [KeyCLIR]	Defines the key sequence on the keypad to activate the restricted Caller ID option. After the sequence is pressed, a confirmation tone is heard.
'Restricted Caller ID Deactivate' configure voip > gateway analog keypad-features > id- restriction-deact	Defines the key sequence on the keypad to deactivate the restricted Caller ID option. After the sequence is pressed, a confirmation tone is heard.

Parameter	Description
[KeyCLIRDeact]	
<b>Keypad Feature - Hotline Parameters</b>	
'Hot-line Activate' configure voip > gateway analog keypad-features > hotline-act [KeyHotLine]	Defines the key sequence on the keypad to activate the delayed hotline option. To activate the delayed hotline option from the telephone: <ol style="list-style-type: none"><li>1. Dial the user-defined sequence number on the keypad; a dial tone is heard.</li><li>2. Dial the telephone number to which the phone automatically dials after a configurable delay (terminate the number with #); a confirmation tone is heard.</li></ol>
'Hot-line Deactivate' configure voip > gateway analog keypad-features > hotline-deact [KeyHotLineDeact]	Defines the key sequence on the keypad to deactivate the delayed hotline option. After the sequence is pressed, a confirmation tone is heard.
<b>Keypad Feature - Transfer Parameters</b>	
<b>Note:</b> See the description of the [KeyBlindTransfer] parameter for this feature.	
<b>Keypad Feature - Call Waiting Parameters</b>	
'Call Waiting Activate' configure voip > gateway analog keypad-features > cw-act [KeyCallWaiting]	Defines the key sequence on the keypad to activate the Call Waiting option. After the sequence is pressed, a confirmation tone is heard.
'Call Waiting Deactivate' configure voip > gateway analog keypad-features > cw-deact [KeyCallWaitingDeact]	Defines the key sequence on the keypad to deactivate the Call Waiting option. After the sequence is pressed, a confirmation tone is heard.
<b>Keypad Feature - Reject Anonymous Call Parameters</b>	

Parameter	Description
'Reject Anonymous Call Activate' configure voip > gateway analog keypad-features > reject-anony-call- activate [KeyRejectAnonymousCall]	Defines the key sequence on the keypad to activate the reject anonymous call option, whereby the device rejects incoming anonymous calls. After the sequence is pressed, a confirmation tone is heard.
'Reject Anonymous Call Deactivate' configure voip > gateway analog keypad-features > reject-anony-call- deactivate [KeyRejectAnonymousCallDeact]	Defines the key sequence on the keypad that deactivates the reject anonymous call option. After the sequence is pressed, a confirmation tone is heard.

## FXO and FXS Parameters

The general FXO and FXS parameters are described in the table below.

**Table 70-61:General FXO and FXS Parameters**

Parameter	Description
'Update Port Info' [AnalogPortInfo_x]	<p>Defines a descriptive name for an analog port. This can be used to easily identify the port.</p> <p>The valid value is a string of up to 40 characters. By default, the value is undefined.</p> <p><b>Note:</b></p> <ul style="list-style-type: none"> <li>■ For the ini file parameter, the x denotes the port number.</li> <li>■ To configure a port name through the Web interface, see <a href="#">Configuring Name for Telephony Ports</a>.</li> </ul>
<b>FXS Parameters</b>	
'FXS Coefficient Type' configure voip > interface fxs-fxo > fxs-country-	<p>Determines the FXS line characteristics (AC and DC) according to USA or Europe (TBR21) standards.</p> <ul style="list-style-type: none"> <li>■ [66] <b>Europe</b> = TBR21</li> </ul>

Parameter	Description
<code>coefficients</code> [FXSCountryCoefficients]	<ul style="list-style-type: none"> <li>■ [70] <b>USA</b> = (Default) United States</li> </ul> <p><b>Note:</b> For the parameter to take effect, a device reset is required.</p>
<b>FXO Parameters</b>	
'FXO Coefficient Type' <code>configure voip &gt;</code> <code>interface fxs-fxo &gt;</code> <code>fxo-country-</code> <code>coefficients</code> [CountryCoefficients]	<p>Determines the FXO line characteristics (AC and DC) according to USA or TBR21 standard.</p> <ul style="list-style-type: none"> <li>■ [66] <b>Europe</b> = TBR21</li> <li>■ [70] <b>USA</b> = (Default) United States</li> </ul> <p><b>Note:</b> For the parameter to take effect, a device reset is required.</p>
<code>configure voip &gt;</code> <code>interface fxs-fxo &gt;</code> <code>fxo-dc-termination</code> [FXODCTermination]	<p>Defines the FXO line DC termination (i.e., resistance).</p> <ul style="list-style-type: none"> <li>■ [0] = (Default) DC termination is set to 50 Ohms.</li> <li>■ [1] = DC termination set to 800 Ohms. The termination changes from 50 to 800 Ohms only when moving from onhook to offhook.</li> </ul> <p><b>Note:</b> For the parameter to take effect, a device reset is required.</p>
<code>configure voip &gt;</code> <code>interface fxs-fxo &gt;</code> <code>enable-fxo-current-</code> <code>limit</code> [EnableFXOCurrentLimit]	<p>Enables limiting the FXO loop current to a maximum of 60 mA (according to the TBR21 standard).</p> <ul style="list-style-type: none"> <li>■ [0] = (Default) FXO line current limit is disabled.</li> <li>■ [1] = FXO loop current is limited to a maximum of 60 mA.</li> </ul> <p><b>Note:</b> For the parameter to take effect, a device reset is required.</p>
[EnableAnalogOverloadProtection]	<p>Enables electrical overload protection on FXO interfaces.</p> <ul style="list-style-type: none"> <li>■ [0] = (Default) Disable.</li> <li>■ [1] = Enable. Port impedance is set to 800 Ohm for 1,500 msec to overcome the load. Overload threshold is 160 mA. If you configure the FXODCTermination parameter to 1, the threshold is set to 60 mA.</li> </ul>

Parameter	Description
	<p><b>Note:</b> For the parameter to take effect, a device reset is required.</p>
<pre>configure voip &gt; gateway analog fxo- setting &gt; fxo-number- of-rings</pre> <p>[FXNumberOfRings]</p>	<p>Defines the number of rings before the device's FXO interface answers a call by seizing the line. The valid range is 0 to 10. The default is 0. When set to 0, the FXO seizes the line after one ring. When set to 1, the FXO seizes the line after two rings.</p> <p><b>Note:</b></p> <ul style="list-style-type: none"> <li>■ The parameter is applicable only if automatic dialing is not used.</li> <li>■ If caller ID is enabled and if the number of rings defined by the parameter RingsBeforeCallerID is greater than the number of rings defined by the parameter, the greater value is used.</li> </ul>
<p>'Dialing Mode'</p> <pre>configure voip &gt; gateway analog fxo- setting &gt; dialing-mode</pre> <p>[IsTwoStageDial]</p>	<p>Global parameter defining the dialing mode for IP-to-Tel (FXO) calls. You can also configure the feature per specific calls, using Tel Profiles (TelProfile_IsTwoStageDial). For a detailed description of the parameter and for configuring the feature in the Tel Profiles table, see <a href="#">Configuring Tel Profiles</a>.</p> <p><b>Note:</b> If the feature is configured for a specific Tel Profile, the settings of the global parameter is ignored for calls associated with the Tel Profile.</p>
<p>'Waiting For Dial Tone'</p> <pre>configure voip &gt; gateway analog fxo- setting &gt; waiting-4- dial-tone</pre> <p>[IsWaitForDialTone]</p>	<p>Determines whether or not the device waits for a dial tone before dialing the phone number for IP-to-Tel (FXO) calls.</p> <ul style="list-style-type: none"> <li>■ [0] <b>No</b></li> <li>■ [1] <b>Yes</b> (default)</li> </ul> <p>When one-stage dialing and the parameter are enabled, the device dials the phone number (to the PSTN/PBX line) only after it detects a dial tone. If the parameter is disabled, the device immediately dials the phone number after seizing the PSTN/PBX line without 'listening' for a dial tone.</p> <p><b>Note:</b></p>



Parameter	Description
	<ul style="list-style-type: none"> <li>■ The correct dial tone parameters must be configured in the CPT file.</li> <li>■ The device may take 1 to 3 seconds to detect a dial tone (according to the dial tone configuration in the CPT file). If the dial tone is not detected within 6 seconds, the device releases the call and sends a SIP 500 "Server Internal Error" response.</li> </ul>
<p>'Time to Wait before Dialing'</p> <pre>configure voip &gt; gateway analog fxo- setting &gt; time-wait- b4-dialing [WaitForDialTime]</pre>	<p>Defines the delay before the device starts dialing on the FXO line in the following scenarios:</p> <ul style="list-style-type: none"> <li>■ The delay between the time the line is seized and dialing begins during the establishment of an IP-to-Tel call. <b>Note:</b> Applicable only for one-stage dialing when the parameter <code>IsWaitForDialTone</code> is disabled.</li> <li>■ The delay between detection of a Wink and the start of dialing during the establishment of an IP-to-Tel call (for DID lines, see the <code>EnabledDIDWink</code> parameter).</li> <li>■ For call transfer - the delay after hook-flash is generated and dialing begins.</li> </ul> <p>The valid range (in milliseconds) is 0 to 20,000 (i.e., 20 seconds). The default is 1,000 (i.e., 1 second).</p>
<p>'Ring Detection Timeout'</p> <pre>configure voip &gt; gateway analog fxo- setting &gt; ring- detection-tout [FXOBetweenRingTime]</pre>	<p>Defines the timeout (in seconds) for detecting the second ring after the first detected ring.</p> <p>If automatic dialing is not used and Caller ID is enabled, the device seizes the line after detection of the second ring signal (allowing detection of caller ID sent between the first and the second rings). If the second ring signal is not received within this timeout, the device doesn't initiate a call to IP.</p> <p>If automatic dialing is used, the device initiates a call to IP when the ringing signal is detected. The FXO line is seized only if the remote IP party answers the call. If the remote party doesn't answer the call and the second ring signal is not received within this timeout, the device releases the IP call.</p> <p>The parameter is typically set to between 5 and 8. The default is 8.</p>

Parameter	Description
	<p><b>Note:</b></p> <ul style="list-style-type: none"> <li>■ The parameter is applicable only for Tel-to-IP calls.</li> <li>■ This timeout is calculated from the end of the ring until the start of the next ring. For example, if the ring cycle is two seconds on and four seconds off, the timeout value should be configured to five seconds (i.e., greater than the off time, e.g., four).</li> </ul>
<p>'Rings before Detecting Caller ID'</p> <pre>configure voip &gt; gateway analog fxo- setting &gt; rings-b4- det-callerid</pre> <p>[RingsBeforeCallerID]</p>	<p>Determines the number of rings before the device starts detecting Caller ID.</p> <ul style="list-style-type: none"> <li>■ [0] 0 = Before first ring.</li> <li>■ [1] 1 = (Default) After first ring.</li> <li>■ [2] 2 = After second ring.</li> </ul>
<p>'Guard Time Between Calls'</p> <pre>configure voip &gt; gateway analog fxo- setting &gt; guard-time- btwn-calls</pre> <p>[GuardTimeBetweenCalls]</p>	<p>Defines the time interval (in seconds) after a call has ended and a new call can be accepted for IP-to-Tel (FXO) calls.</p> <p>The valid range is 0 to 10. The default is 1.</p> <p><b>Note:</b> Occasionally, after a call ends and on-hook is applied, a delay is required before placing a new call (and performing off-hook). This is necessary to prevent incorrect hook-flash detection or other glare phenomena.</p>
<p>'FXO Double Answer'</p> <pre>configure voip &gt; gateway analog fxo- setting &gt; fxo-dbl-ans</pre> <p>[EnableFXODoubleAnswer]</p>	<p>Global parameter enabling the FXO Double Answer feature, which rejects (disconnects) incoming Tel-to-IP collect calls and signals (informs) this call denial to the PSTN.</p> <p>You can also configure the feature per specific calls, using Tel Profiles (TelProfile_ EnableFXODoubleAnswer). For a detailed description of the parameter and for configuring the feature in the Tel Profiles table, see <a href="#">Configuring Tel Profiles</a>.</p> <p><b>Note:</b> If the feature is configured for a specific Tel Profile, the settings of the global parameter is ignored for calls associated with the Tel Profile.</p>
<p>'FXO Ring Timeout'</p>	<p>Defines the delay (in msec) before the device</p>

Parameter	Description
<pre>configure voip &gt; gateway analog fxo- setting &gt; fxo-ring- timeout</pre> <p>[FXORingTimeout]</p>	<p>generates a SIP INVITE (call) to the IP side upon detection of a RING_START event from the Tel (FXO) side. This occurs instead of waiting for a RING_END event.</p> <p>This feature is useful for telephony services that employ constant ringing (i.e., no RING_END is sent). For example, Ringdown circuit is a service that sends a constant ringing current over the line, instead of cadence-based 2 second on, 4 second off. For example, when a telephone goes off-hook, a phone at the other end instantly rings.</p> <p>If a RING_END event is received before the timeout expires, the device does not initiate a call and ignores the detected ring. The device ignores RING_END events detected after the timeout expires.</p> <p>The valid value range is 0 to 50 (msec), in steps of 100-msec. For example, a value of 50 represents 5 sec. The default value is 0 (i.e., standard ring operation - the FXO interface sends an INVITE upon receipt of the RING_END event).</p> <p><b>Note:</b> The parameter can be configured for a Tel Profile.</p>
<pre>configure voip &gt; gateway analog fxo- setting &gt; fxo-voice- delay-on-200ok</pre> <p>[FXOVoiceDelayon200OK]</p>	<p>Defines the time (in msec) that the device waits before opening the RTP (voice) channel with the FXO endpoint, after receiving a 200 OK from the IP side. This delay may be useful in scenarios in which a 'click' noise is audible when the FXO interface (PBX) seizes the line. A delay in opening the voice channel eliminates this noise.</p> <p>The valid range is 0 (default) to 500, where 0 means that the device opens the voice channel immediately upon the receipt of the 200 OK.</p>

## Trunk Group and Routing Parameters

The routing parameters are described in the table below.

**Table 70-62:Routing Parameters**

Parameter	Description
'Channel Select Mode'	Defines the method for allocating incoming IP-to-Tel calls to

Parameter	Description
ch-select-mode [ChannelSelectMode]	<p>a channel. The parameter applies to the following:</p> <ul style="list-style-type: none"> <li>■ Trunks configured without a channel select mode in the Trunk Group Settings table (see <a href="#">Configuring Trunk Group Settings</a>).</li> <li>■ Channels and trunks configured without a Trunk Group ID.</li> </ul> <p>For all channels that are configured without a Trunk Group ID:</p> <ul style="list-style-type: none"> <li>■ [0] <b>By Dest Phone Number</b></li> <li>■ [1] <b>Cyclic Ascending</b> (default)</li> <li>■ [2] <b>Ascending</b></li> <li>■ [3] <b>Cyclic Descending</b></li> <li>■ [4] <b>Descending</b></li> <li>■ [5] <b>Dest Number + Cyclic Ascending</b></li> <li>■ [6] <b>By Source Phone Number</b></li> <li>■ [7] <b>Trunk Cyclic Ascending</b></li> <li>■ [8] <b>Trunk &amp; Channel Cyclic Ascending</b></li> <li>■ [9] <b>Ring to Hunt Group</b></li> </ul> <p><b>Note:</b> This option is applicable only to FXS interfaces.</p> <ul style="list-style-type: none"> <li>■ [10] <b>Select Trunk By Supplementary Service Table</b></li> </ul> <p><b>Note:</b> This option is applicable only to BRI interfaces.</p> <ul style="list-style-type: none"> <li>■ [11] <b>Dest Number + Ascending</b></li> </ul> <p>For a detailed description of the parameter's options, see <a href="#">Configuring Trunk Group Settings</a>.</p>
'Default Destination Number' <pre>configure voip &gt; gateway dtmf- supp-service dtmf-and-dialing &gt; ddf1t-dest-nb</pre> [DefaultNumber]	<p>Defines the default destination phone number if the received message doesn't contain a called party number and a phone number is not configured in the Trunk Group table. The parameter is used as a starting number for the list of channels comprising all the trunks.</p> <p>The default is 1000.</p>
'Source IP Address Input'	<p>Defines which IP address the device uses to determine the</p>

Parameter	Description
<pre>configure voip &gt; gateway routing settings &gt; src- ip-addr-input [SourceIPAddressInput]</pre>	<p>source of incoming INVITE messages for IP-to-Tel routing.</p> <ul style="list-style-type: none"> <li>■ [-1] <b>Not Configure</b> = (Default) The parameter is automatically set to SIP Contact header (1).</li> <li>■ [0] <b>SIP Contact Header</b> = The IP address in the Contact header of the incoming INVITE message is used.</li> <li>■ [1] <b>Layer 3 Source IP</b> = The actual IP address (Layer 3) from where the SIP packet is received is used.</li> </ul>
<p>'Use Source Number As Display Name'</p> <pre>configure voip &gt; sip-definition settings &gt; src- nb-as-disp-name [UseSourceNumberAsDisplay Name]</pre>	<p>Defines the use of the Tel Source Number and Display Name for Tel-to-IP calls.</p> <ul style="list-style-type: none"> <li>■ [0] <b>No</b> = (Default) If a Tel Display Name is received, the Tel Source Number is used as the IP Source Number and the Tel Display Name is used as the IP Display Name. If no Display Name is received from the Tel side, the IP Display Name remains empty.</li> <li>■ [1] <b>Yes</b> = If a Tel Display Name is received, the Tel Source Number is used as the IP Source Number and the Tel Display Name is used as the IP Display Name. If no Display Name is received from the Tel side, the Tel Source Number is used as the IP Source Number and also as the IP Display Name.</li> <li>■ [2] <b>Overwrite</b> = The Tel Source Number is used as the IP Source Number and also as the IP Display Name (even if the received Tel Display Name is not empty).</li> <li>■ [3] <b>Original</b> = Similar to option [2], except that the operation is done before regular calling number manipulation.</li> </ul>
<p>'Use Display Name as Source Number'</p> <pre>configure voip &gt; sip-definition settings &gt; disp- name-as-src-nb [UseDisplayNameAsSource Number]</pre>	<p>Defines how the display name (caller ID) received from the IP side (in the SIP From header) effects the source number sent to the Tel side, for IP-to-Tel calls.</p> <ul style="list-style-type: none"> <li>■ [0] <b>No</b> = (Default) If a display name is received from the IP side, the source number of the IP side is used as the Tel source number.</li> <li>■ [1] <b>Yes</b> = If a display name is received from the IP side, the display name of the IP side is used as the Tel source number and Presentation is set to Allowed (0). If no display name is received from the IP side, the source number of the IP side is used as the Tel source number</li> </ul>

Parameter	Description
	<p>and Presentation is set to Restricted (1). For example:</p> <ul style="list-style-type: none"> <li>✓ If 'From: 100 &lt;sip:200@201.202.203.204&gt;' is received from the IP side, the outgoing source number (and display name) are set to "100" and Presentation is set to Allowed (0).</li> <li>✓ If 'From: &lt;sip:400@101.102.103.104&gt;' is received from the IP side, the outgoing source number is set to "400" and Presentation is set to Restricted (1).</li> </ul> <p>■ [2] <b>Preferred</b> = If a display name is received from the IP side, the display name of the IP side is used as the Tel source number. If no display name is received from the IP side, this setting does not affect the Tel source number.</p>
<p>'ENUM Resolution'  <code>configure voip &gt;  sip-definition  settings &gt; enum-  service-domain</code>  [EnumService]</p>	<p>Defines the ENUM service for translating telephone numbers to IP addresses or domain names (FQDN), for example, e164.arpa, e164.customer.net, or NREnum.net. The valid value is a string of up to 50 characters. The default is "e164.arpa".</p> <p><b>Note:</b> ENUM-based routing is configured in the Tel-to-IP Routing table using the "ENUM" string value as the destination address to denote the parameter's value.</p>
<p>'Use Routing Table for Host Names and Profiles'  <code>configure voip &gt;  sip-definition  settings &gt; rte-  tbl-4-host-names</code>  [AlwaysUseRouteTable]</p>	<p>Determines whether to use the device's routing table to obtain the URI host name and optionally, an IP profile (per call) even if a Proxy server is used.</p> <ul style="list-style-type: none"> <li>■ [0] <b>Disable</b> = (Default) Don't use the Tel-to-IP Routing table.</li> <li>■ [1] <b>Enable</b> = Use the Tel-to-IP Routing table.</li> </ul> <p><b>Note:</b></p> <ul style="list-style-type: none"> <li>■ The parameter appears only if the 'Use Default Proxy' parameter is enabled.</li> <li>■ The domain name is used instead of a Proxy name or IP address in the INVITE SIP URI.</li> </ul>
<p>'Tel to IP Routing Mode'  <code>configure voip &gt; gateway  routing settings &gt; tel2ip-  rte-mode</code></p>	<p>Determines whether to route Tel calls to an IP destination before or after manipulation of the destination number. This applies to Tel-to-IP routing rules configured in the Tel-to-IP Routing table.</p>

Parameter	Description
[RouteModeTel2IP]	<ul style="list-style-type: none"> <li>■ [0] <b>Route calls before manipulation</b> = Calls are routed before the number manipulation rules are applied (default).</li> <li>■ [1] <b>Route calls after manipulation</b> = Calls are routed after the number manipulation rules are applied.</li> </ul> <p><b>Note:</b></p> <ul style="list-style-type: none"> <li>■ The parameter is not applicable if outbound proxy routing is used.</li> <li>■ For number manipulation, see <a href="#">Configuring Source/Destination Number Manipulation</a>.</li> <li>■ To configure Tel-to-IP routing rules, see <a href="#">Configuring Tel-to-IP Routing Rules</a>.</li> </ul>
'IP-to-Tel Routing Mode' <pre>configure voip &gt; gateway routing settings &gt; ip2tel-rte-mode</pre> [RouteModeIP2Tel]	<p>Determines whether to route IP calls to the Trunk Group before or after manipulation of the destination number (configured in <a href="#">Configuring Source/Destination Number Manipulation Rules</a>).</p> <ul style="list-style-type: none"> <li>■ [0] <b>Route calls before manipulation</b> = (Default) Calls are routed before the number manipulation rules are applied.</li> <li>■ [1] <b>Route calls after manipulation</b> = Calls are routed after the number manipulation rules are applied.</li> </ul>
'IP Security' <pre>configure voip &gt; sip-definition settings &gt; ip- security</pre> [SecureCallsFromIP]	<p>Defines the device's policy for accepting or blocking SIP calls (IP-to-Tel calls). This is useful in preventing unwanted SIP calls, SIP messages, and/or VoIP spam.</p> <ul style="list-style-type: none"> <li>■ [0] <b>Disable</b> = (Default) The device accepts all SIP calls.</li> <li>■ [1] <b>Secure Incoming calls</b> = The device accepts SIP calls only from IP addresses that are configured in the Tel-to-IP Routing table or Proxy Sets table, or IP addresses resolved by DNS servers from FQDN values configured in the Proxy Sets table. All other incoming calls are rejected.</li> <li>■ [2] <b>Secure All calls</b> = The device accepts SIP calls only from IP addresses (in dotted-decimal notation format) that are configured in the Tel-to-IP Routing table and rejects all other incoming calls. In addition, if an FQDN is configured in the Tel-to-IP Routing table or Proxy Sets table, the call is allowed to be sent only if the resolved DNS IP address appears in one of these tables;</li> </ul>

Parameter	Description
	<p>otherwise, the call is rejected. Therefore, the difference between this option and option [1] is that this option is concerned only about numerical IP addresses that are defined in the tables.</p> <p><b>Note:</b> If the parameter is set to [0] or [1], when using Proxies or Proxy Sets, it is unnecessary to configure the Proxy IP addresses in the routing table. The device allows SIP calls received from the Proxy IP addresses even if these addresses are not configured in the routing table.</p>
<p>'Filter Calls to IP'</p> <pre>configure voip &gt; sip-definition settings &gt; filter-calls-to- ip [FilterCalls2IP]</pre>	<p>Enables filtering of Tel-to-IP calls when a Proxy Set is used.</p> <ul style="list-style-type: none"> <li>■ [0] <b>Don't Filter</b> = (Default) The device doesn't filter calls when using a proxy.</li> <li>■ [1] <b>Filter</b> = Filtering is enabled.</li> </ul> <p>When the parameter is enabled and a proxy is used, the device first checks the Tel-to-IP Routing table before making a call through the proxy. If the number is not allowed (i.e., number isn't listed in the table or a call restriction routing rule of IP address 0.0.0.0 is applied), the call is released.</p> <p><b>Note:</b> When no proxy is used, the parameter must be disabled and filtering is according to the Tel-to-IP Routing table.</p>
<p>'Tel-to-IP Dial Plan Name'</p> <pre>configure voip &gt; gateway routing settings &gt; tel- dial-plan-name [Tel2IPDialPlanName]</pre>	<p>Assigns the Dial Plan (by name) to be used for tag-based IP-to-Tel routing rules. The Dial Plan's tags can be used as matching criteria (source and destination) for routing rules in the IP-to-Tel Routing table.</p> <p>For more information, see <a href="#">Using Dial Plans for IP-to-Tel or Tel-to-IP Call Routing</a> on page 641.</p>
<p>'IP-to-Tel Dial Plan Name'</p> <pre>configure voip &gt; gateway routing settings &gt; ip- dial-plan-name [IP2TelDialPlanName]</pre>	<p>Assigns the Dial Plan (by name) to be used for tag-based Tel-to-IP routing rules. The Dial Plan's tags can be used as matching criteria (source and destination) for routing rules in the Tel-to-IP Routing table.</p> <p>For more information, see <a href="#">Using Dial Plans for IP-to-Tel or Tel-to-IP Call Routing</a> on page 641.</p>
<p>'IP-to-Tel Tagging Destination Dial Plan Index'</p> <pre>configure voip &gt;</pre>	<p>Defines the Dial Plan index in the Dial Plan file for called prefix tags for representing called number prefixes in Inbound Routing rules.</p> <p>The valid values are 0 to 7, where 0 denotes PLAN1, 1</p>



Parameter	Description
<pre>gateway routing settings &gt; ip2tel-tagging- dst [IP2TelTaggingDestDialPlan Index]</pre>	<p>denotes PLAN2, and so on. The default is -1 (i.e., no dial plan file used).</p> <p>For more information on this feature, see <a href="#">Dial Plan Prefix Tags for IP-to-Tel Routing</a>.</p> <p><b>Note:</b> The parameter is applicable only to digital interfaces.</p>
<pre>'IP to Tel Tagging Source Dial Plan Index' cconfigure voip &gt; gateway routing settings &gt; ip-to- tel-tagging-src [IP2TelTaggingSourceDialPI anIndex]</pre>	<p>Defines the Dial Plan index in the Dial Plan file for calling prefix tags for representing calling number prefixes in Inbound Routing rules.</p> <p>The valid values are 0 to 7, where 0 denotes PLAN1, 1 denotes PLAN2, and so on. The default is -1 (i.e., no dial plan file used).</p> <p>For more information on this feature, see <a href="#">Dial Plan Prefix Tags for IP-to-Tel Routing</a>.</p> <p><b>Note:</b> The parameter is applicable only to digital interfaces.</p>
<pre>etsi-diversion [EnableETSIDiversion]</pre>	<p>Determines the method in which the Redirect Number is sent to the Tel side.</p> <ul style="list-style-type: none"> <li>■ [0] = (Default) Q.931 Redirecting Number Information Element (IE).</li> <li>■ [1] = ETSI DivertingLegInformation2 in a Facility IE.</li> </ul> <p><b>Note:</b> The parameter is applicable only to digital interfaces.</p>
<pre>'Add CIC' configure voip &gt; gateway manipulation settings &gt; add- cic [AddCicAsPrefix]</pre>	<p>Determines whether to add the Carrier Identification Code (CIC) as a prefix to the destination phone number for IP-to-Tel calls. When the parameter is enabled, the 'cic' parameter in the incoming SIP INVITE can be used for IP-to-Tel routing decisions. It routes the call to the appropriate Trunk Group based on the parameter's value.</p> <ul style="list-style-type: none"> <li>■ [0] <b>No</b> (default)</li> <li>■ [1] <b>Yes</b></li> </ul> <p>Digital interfaces: The SIP 'cic' parameter enables the transmission of the 'cic' parameter from the SIP network to the ISDN. The 'cic' parameter is a three- or four-digit code used in routing tables to identify the network that serves the remote user when a call is routed over many different networks. The 'cic' parameter is carried in the SIP INVITE and maps to the ISDN Transit Network Selection Information Element (TNS IE) in the outgoing ISDN Setup message (if the</p>

Parameter	Description
	<p>EnableCIC parameter is set to 1). The TNS IE identifies the requested transportation networks and allows different providers equal access support, based on customer choice. For example, as a result of receiving the below INVITE, the destination number after number manipulation is cic+167895550001:</p> <pre>INVITE sip:5550001;cic=+16789@172.18.202.60:5060;user=phone SIP/2.0</pre> <p><b>Note:</b> After the cic prefix is added, the IP-to-Tel Routing table can be used to route this call to a specific Trunk Group. The Destination Number IP to Tel Manipulation table must be used to remove this prefix before placing the call to the Tel side.</p>
[FaxReroutingMode]	<p>Enables the re-routing of incoming Tel-to-IP calls that are identified as fax calls. If a CNG tone is detected on the Tel side of a Tel-to-IP call, the device adds the string, "FAX" as a prefix to the destination number before routing and manipulation. A routing rule in the Tel-to-IP Routing table having the value "FAX" (case-sensitive) as the destination number is then used to re-route the call to a fax destination and the destination number manipulation mechanism is used to remove the "FAX" prefix before sending the fax, if required. If the initial INVITE used to establish the voice call (not fax) was already sent, a CANCEL (if not connected yet) or a BYE (if already connected) is sent to release the voice call.</p> <ul style="list-style-type: none"> <li>■ [0] <b>Disable</b> (default)</li> <li>■ [1] <b>Rerouting without Delay</b> = Upon detection of a CNG tone, the device immediately releases the call of the initial INVITE and then sends a new INVITE to a specific IP Group or fax server according to the Tel-to-IP Routing table. To enable this feature, set the CNGDetectorMode parameter to 2 and the IsFaxUsed parameter to 1, 2, or 3.</li> <li>■ [2] <b>Progress and Delay</b> = Incoming ISDN calls are delayed until a CNG tone detection or timeout, set by the FaxReroutingDelay parameter. If the EnableComfortTone parameter is set to 1, a Q.931</li> </ul>

Parameter	Description
	<p>Progress message with Protocol Discriminator set to 1 is sent to the PSTN and a comfort tone is played accordingly to the PSTN. When the timeout expires, the device sends an INVITE to a specific IP Group or to a fax server, according to the Tel-to-IP Routing table rules.</p> <p><b>Note:</b> The option is applicable only to ISDN.</p> <p>■ [3] <b>Connect and Delay</b> = Incoming ISDN calls are delayed until a CNG tone detection or timeout, set by the FaxReroutingDelay parameter. A Q.931 Connect message is sent to the PSTN. If the EnableComfortTone parameter is set to 1, a comfort tone is played to the PSTN. When the timeout expires, the device sends an INVITE to a specific IP Group or to a fax server according to the Tel-to-IP Routing table rules.</p> <p><b>Note:</b> The option is applicable only to ISDN.</p> <p><b>Note:</b> The parameter has replaced the EnableFaxRerouting parameter. For backward compatibility, the EnableFaxRerouting parameter set to 1 is equivalent to the FaxReroutingMode parameter set to 1.</p>
[FaxReroutingDelay]	<p>Defines the maximum time interval (in seconds) that the device waits for CNG detection before re-routing calls identified as fax calls to fax destinations (terminating fax machine).</p> <p>The valid value range is 1-10. The default is 5.</p>
<b>Call Forking Parameters</b>	
'Forking Handling Mode' forking-handling [ForkingHandlingMode]	<p>Defines how the device handles the receipt of multiple SIP 18x forking responses for Tel-to-IP calls. The forking 18x response is the response with a different SIP to-tag than the previous 18x response. These responses are typically generated (initiated) by Proxy / Application servers that perform call forking, sending the device's originating INVITE (received from SIP clients) to several destinations, using the same Call ID.</p> <p>■ [0] <b>Parallel handling</b> = (Default) If SIP 18x with SDP is received, the device opens a voice stream according to the received SDP and disregards any subsequently received 18x forking responses (with or without SDP). If the first response is 180 without SDP, the device</p>

Parameter	Description
	<p>responds according to the PlayRBTone2TEL parameter and disregards the subsequent forking 18x responses.</p> <ul style="list-style-type: none"> <li>■ [1] <b>Sequential handling</b> = If 18x with SDP is received, the device opens a voice stream according to the received SDP. The device re-opens the stream according to subsequently received 18x responses with SDP, or plays a ringback tone if 180 response without SDP is received. If the first received response is 180 without SDP, the device responds according to the PlayRBTone2TEL parameter and processes the subsequent 18x forking responses.</li> </ul> <p><b>Note:</b> Regardless of the parameter setting, once a SIP 200 OK response is received, the device uses the RTP information and re-opens the voice stream, if necessary.</p>
<p>'Forking Timeout'  <pre>configure voip &gt; gateway advanced &gt; forking-timeout</pre>             [ForkingTimeOut]</p>	<p>Defines the timeout (in seconds) that is started after the first SIP 2xx response has been received for a User Agent when a Proxy server performs call forking (Proxy server forwards the INVITE to multiple SIP User Agents). The device sends a SIP ACK and BYE in response to any additional SIP 2xx received from the Proxy within this timeout. Once this timeout elapses, the device ignores any subsequent SIP 2xx.</p> <p>The number of supported forking calls per channel is 20. In other words, for an INVITE message, the device can receive up to 20 forking responses from the Proxy server.</p> <p>The valid range is 0 to 30. The default is 30.</p>
<p>'Tel2IP Call Forking Mode'  <pre>configure voip &gt; sip-definition settings &gt; tel2ip-call- forking-mode</pre>             [Tel2IPCallForkingMode]</p>	<p>Enables Tel-to-IP call forking, whereby a Tel call can be routed to multiple IP destinations.</p> <ul style="list-style-type: none"> <li>■ [0] <b>Disable</b> (default)</li> <li>■ [1] <b>Enable</b></li> </ul> <p><b>Note:</b> Once enabled, routing rules must be assigned Forking Groups in the Tel-to-IP Routing table.</p>
<pre>configure voip &gt; sip-definition settings &gt; forking-delay- time-invite</pre> [ForkingDelayTimeForInvite]	<p>Defines the interval (in seconds) to wait before sending INVITE messages to the other members of the forking group. The INVITE is immediately sent to the first member.</p> <p>The valid value range is 0 to 40. The default is 0 (i.e., sends immediately).</p>

## IP Connectivity Parameters

The IP connectivity parameters are described in the table below.

**Table 70-63:IP Connectivity Parameters**

Parameter	Description
<p>'Enable Alt Routing Tel to IP'</p> <pre>configure voip &gt; gateway routing settings &gt; alt- routing-tel2ip</pre> <p>[AltRoutingTel2IPEnable]</p>	<p>Enables the device to check the connectivity status of IP destinations of configured Tel-to-IP routing rules in the Tel-to-IP Routing table. This can then be used to trigger alternative routing for Tel-to-IP calls if connectivity with an IP destination is down and an alternative routing rule has been configured.</p> <ul style="list-style-type: none"> <li>■ [0] <b>Disable</b> = (Default) Disables the IP Connectivity feature.</li> <li>■ [1] <b>Enable</b> = Enables the IP Connectivity feature.</li> <li>■ [2] <b>Status Only</b> = The IP Connectivity feature is disabled, but read-only information on the QoS of the IP destination is provided.</li> </ul> <p><b>Note:</b> If the parameter is enabled, the Busy Out feature (see EnableBusyOut parameter) does not function with the Proxy Set keep-alive mechanism. To use the Busy Out feature with the Proxy Set keep-alive mechanism (for IP Groups), disable the parameter.</p>
<p>'Alt Routing Tel to IP Mode'</p> <pre>configure voip &gt; gateway routing settings &gt; alt-rte- tel2ip-mode</pre> <p>[AltRoutingTel2IPMode]</p>	<p>Determines the IP Connectivity event(s) reason for triggering Alternative Routing.</p> <ul style="list-style-type: none"> <li>■ [0] <b>None</b> = Alternative routing is not used.</li> <li>■ [1] <b>Connectivity</b> = Alternative routing is performed if SIP OPTIONS message to the initial destination fails (determined according to the AltRoutingTel2IPConnMethod parameter).</li> <li>■ [2] <b>QoS</b> = Alternative routing is performed if poor QoS is detected.</li> <li>■ [3] <b>Both</b> = (Default) Alternative routing is performed if a SIP OPTIONS to initial destination fails, poor QoS is detected, or the DNS host name is not resolved.</li> </ul> <p><b>Note:</b></p>

Parameter	Description
	<ul style="list-style-type: none"> <li>■ QoS is quantified according to delay and packet loss calculated according to previous calls. QoS statistics are reset if no new data is received within two minutes.</li> <li>■ To receive quality information (displayed in the 'Quality Status' and 'Quality Info.' fields in <a href="#">Viewing IP Connectivity</a>) per destination, the parameter must be set to 2 or 3.</li> </ul>
<p>'Alt Routing Tel to IP Connectivity Method'</p> <pre>configure voip &gt; gateway routing settings &gt; alt-rte- tel2ip-method</pre> <p>[AltRoutingTel2IPConnMethod]</p>	<p>Determines the method used by the device for periodically querying the connectivity status of a destination IP address.</p> <ul style="list-style-type: none"> <li>■ [0] <b>ICMP Ping</b> = (Default) Internet Control Message Protocol (ICMP) ping messages.</li> <li>■ [1] <b>SIP OPTIONS</b> = The remote destination is considered offline if the latest OPTIONS transaction timed out. Any response to an OPTIONS request, even if indicating an error, brings the connectivity status to online.</li> </ul> <p><b>Note:</b> ICMP Ping is currently not supported for the IP Connectivity feature.</p>
<p>'Alt Routing Tel to IP Keep Alive Time'</p> <pre>configure voip &gt; gateway routing settings &gt; alt-rte- tel2ip-keep-alive</pre> <p>[AltRoutingTel2IPKeepAliveTime]</p>	<p>Defines the time interval (in seconds) between SIP OPTIONS Keep-Alive messages used for the IP Connectivity application.</p> <p>The valid range is 5 to 2,000,000. The default is 60.</p>
<p>'Max Allowed Packet Loss for Alt Routing'</p> <pre>configure voip &gt; gateway routing settings &gt; mx-pkt- loss-4-alt-rte</pre> <p>[IPConnQoSMaxAllowedPL]</p>	<p>Defines the packet loss (in percentage) at which the IP connection is considered a failure and Alternative Routing mechanism is activated.</p> <p>The default is 20%.</p>
<p>'Max Allowed Delay for Alt Routing'</p> <pre>configure voip &gt;</pre>	<p>Defines the transmission delay (in msec) at which the IP connection is considered a failure and the Alternative Routing mechanism is activated.</p>

Parameter	Description
gateway routing settings > mx-all-dly-4-alt-rte [IPConnQoSMaxAllowedDelay]	The range is 100 to 10,000. The default is 250.

## Alternative Routing Parameters

The alternative routing parameters are described in the table below.

**Table 70-64: Alternative Routing Parameters**

Parameter	Description
'3xx Use Alt Route Reasons' configure voip > sip-definition settings > 3xx-use-alt-route [UseAltRouteReasonsFor3xx]	<p>Defines the handling of received SIP 3xx responses regarding call redirection to listed contacts in the Contact header.</p> <ul style="list-style-type: none"> <li>■ [0] <b>No</b> = (Default) Upon receipt of a 3xx response, the device tries each contact, one by one, listed in the Contact headers, until a successful destination is found. However, if a contact responds with a 486 or 600, the device does not try to redirect the call to next contact, and drops the call.</li> <li>■ [1] <b>No if 6xx</b> = Upon receipt of a 3xx response, the device tries each contact, one by one, listed in the Contact headers. However, if a 6xx Global Failure response is received during this process (e.g., 600 Busy Everywhere) the device does not try to redirect the call to the next contact, and drops the call.</li> <li>■ [2] <b>Yes</b> = Upon receipt of a 3xx response, the device redirects the call to the first contact listed in the Contact header. If the contact responds with a SIP response that is defined in the Reasons for Tel-to-IP Alternative Routing table, the device tries to redirect the call to the next contact, and so on. If a contact responds with a response that is not configured in the table, the device does not try to redirect the call to the next contact, and drops the call.</li> </ul>
'Redundant Routing Mode' configure voip > sip-definition settings >	<p>Determines the type of redundant routing mechanism when a call can't be completed using the main route.</p> <ul style="list-style-type: none"> <li>■ [0] <b>Disable</b> = No redundant routing is used. If the call can't be completed using the main route (using the</li> </ul>

Parameter	Description
redundant-routing-m [RedundantRoutingMode]	<p>active Proxy or the first matching rule in the Routing table), the call is disconnected.</p> <ul style="list-style-type: none"> <li>■ [1] <b>Routing Table</b> = (Default) Routing table is used to locate a redundant route.</li> <li>■ [2] <b>Proxy</b> = Proxy list is used to locate a redundant route.</li> </ul> <p><b>Note:</b> To implement the Redundant Routing Mode mechanism, you first need to configure the parameter [AltRouteCauseTEL2IP] (Reasons for Alternative Routing table), as described in <a href="#">Alternative Routing Based on SIP Responses</a> on page 760.</p>
'Disconnect Call With PI If Alt' [DisconnectCallwithPIifAlt]	<p>Defines when the device sends the IP-to-Tel call to an alternative route (if configured) when it receives an ISDN Q.931 Disconnect message from the Tel side.</p> <ul style="list-style-type: none"> <li>■ [0] <b>Disable</b> = (Default) The device forwards early media to the IP side if Disconnect includes PI, and disconnects the call when a Release message is received. Only after the call is disconnected does the device send the call to an alternative route.</li> <li>■ [1] <b>Enable</b> = The device immediately sends the call to the alternative route.</li> </ul> <p>For more information, see <a href="#">Alternative Routing upon ISDN Disconnect</a>.</p> <p><b>Note:</b> The parameter is applicable only to digital interfaces.</p>
configure voip > gateway manipulation settings > alt-map- tel-to-ip [EnableAltMapTel2IP]	<p>Enables different Tel-to-IP destination number manipulation rules per routing rule when several (up to three) Tel-to-IP routing rules are defined and if alternative routing using release causes is used. For example, if an INVITE message for a Tel-to-IP call is returned with a SIP 404 Not Found response, the call can be re-sent to a different destination number, configured by the [NumberMapTel2IP] parameter.</p> <ul style="list-style-type: none"> <li>■ [0] = Disable (default)</li> <li>■ [1] = Enable</li> </ul>
[TR104FXOSwitchover]	<p>Enables the device to automatically switch the destination of an FXS call from the FXO (PSTN) to the IP (SIP Trunk)</p>



Parameter	Description
	<p>when the PSTN disconnects the FXS subscriber.</p> <ul style="list-style-type: none"> <li>■ [0] = (Default) Disable</li> <li>■ [1] = Enable</li> </ul> <p>For more information, see <a href="#">Alternative Routing from FXO to IP</a>.</p> <p><b>Note:</b> The parameter is applicable only to analog interfaces.</p>
<p>'Alternative Routing Tone Duration'</p> <pre>configure voip &gt; gateway routing settings &gt; alt-rte-tone-duration</pre> <p>[AltRoutingToneDuration]</p>	<p>Defines the duration (in milliseconds) for which the device plays a tone to the endpoint on each attempt for Tel-to-IP alternative routing. When the device finishes playing the tone, a new SIP INVITE message is sent to the new IP destination. The tone played is the call forward tone (Tone Type #25 in the CPT file).</p> <p>The valid range is 0 to 20,000. The default is 0 (i.e., no tone is played).</p> <p><b>Note:</b></p> <ul style="list-style-type: none"> <li>■ The parameter is applicable only to analog interfaces.</li> <li>■ The parameter is applicable only to Tel-to-IP alternative routing based on SIP responses (see <a href="#">Alternative Routing Based on SIP Responses</a>).</li> </ul>

## Number Manipulation Parameters

The number manipulation parameters are described in the table below.

**Table 70-65: Number Manipulation Parameters**

Parameter	Description
<pre>configure voip &gt; gateway manipulation settings &gt; map-ip-to-pstn-refer-to</pre> <p>[ManipulateIP2PSTNReferTo]</p>	<p>Enables the manipulation of the called party (destination) number according to the SIP Refer-To header received by the device for TDM (PSTN) blind transfer. The number in the SIP Refer-To header is manipulated for all types of blind transfers to the PSTN (CAS, FXO, TBCT, ECT, RLT, and QSIG ).</p> <ul style="list-style-type: none"> <li>■ [0] = Disable (default)</li> <li>■ [1] = Enable</li> </ul>

Parameter	Description
	<p>During the blind transfer, the device initiates a new call to the PSTN and the destination number of this call can be manipulated if the parameter is enabled. When enabled, the manipulation is done as follows:</p> <ol style="list-style-type: none"> <li>1. If you configure a value for the xfer-Prefix parameter, the value (string) is added as a prefix to the number in the Refer-To header.</li> <li>2. This called party number is then manipulated using the Destination Phone Number Manipulation for IP-to-Tel Calls table. The source number of the transferred call is taken from the original call, according to its initial direction: <ul style="list-style-type: none"> <li>✓ Source number of the original call if it is a Tel-to-IP call</li> <li>✓ Destination number of the original call if it is an IP-to-Tel call</li> </ul> </li> </ol> <p>This source number can also be used as the value for the 'Source Phone Pattern' field in the Destination Phone Number Manipulation for IP-to-Tel Calls table. The local IP address is used as the value for the 'Source IP Address' field.</p> <p><b>Note:</b></p> <ul style="list-style-type: none"> <li>■ This manipulation does not affect IP-to-Trunk Group routing rules.</li> <li>■ The parameter is applicable only to digital interfaces.</li> </ul>
<p>'Use Endpoint Number as Calling Number Tel-to-IP'  epn-as-cpn-tel2ip  [UseEPLNumAsCallingNumTel2IP]</p>	<p>Enables the use of the B-channel number as the calling number (sent in the From field of the INVITE) instead of the number received in the Q.931 Setup message, for Tel-to-IP calls.</p>

Parameter	Description
	<ul style="list-style-type: none"> <li>■ [0] <b>Disable</b> (default)</li> <li>■ [1] <b>Enable</b></li> </ul> <p>For example, if the incoming calling party number in the Q.931 Setup message is "12345" and the B-channel number is 17, then the outgoing INVITE From header is set to "17" instead of "12345".</p> <p><b>Note:</b></p> <ul style="list-style-type: none"> <li>■ When enabled, this feature is applied before routing and manipulation on the source number.</li> <li>■ The parameter is applicable only to digital interfaces.</li> </ul>
<p>'Use Endpoint Number as Calling Number IP-to-Tel'</p> <pre>eptn-as-cpn-ip2tel</pre> <p>[UseEPNumAsCallingNumIP2Tel]</p>	<p>Enables the use of the B-channel number as the calling party number (sent in the Q.931 Setup message) instead of the number received in the From header of the INVITE, for IP-to-Tel calls.</p> <ul style="list-style-type: none"> <li>■ [0] <b>Disable</b> (default)</li> <li>■ [1] <b>Enable</b></li> </ul> <p>For example, if the incoming INVITE From header contains "12345" and the destined B-channel number is 17, then the outgoing calling party number in the Q.931 Setup message is set to "17" instead of "12345".</p> <p><b>Note:</b></p> <ul style="list-style-type: none"> <li>■ When enabled, this feature is applied after routing and manipulation on the source number (i.e., just before sending to the Tel side).</li> <li>■ The parameter is applicable only to digital interfaces.</li> </ul>
<p>'Tel2IP Default Redirect Reason'</p> <pre>configure voip &gt; gateway manipulation settings &gt; tel- to-ip-dflt-redir-rsn</pre>	<p>Determines the default redirect reason for Tel-to-IP calls when no redirect reason (or "unknown") exists in the received Q931 ISDN Setup message. The device</p>

Parameter	Description
<p>[Tel2IPDefaultRedirectReason]</p>	<p>includes this default redirect reason in the SIP History-Info header of the outgoing INVITE.</p> <p>If a redirect reason exists in the received Setup message, the parameter is ignored and the device sends the INVITE message with the reason according to the received Setup message. If the parameter is not configured (-1), the outgoing INVITE is sent with the redirect reason as received in the Setup message (if none or “unknown” reason, then without a reason).</p> <ul style="list-style-type: none"> <li>■ [-1] <b>Not Configured</b> = (Default) Received redirect reason is not changed</li> <li>■ [1] <b>Busy</b> = Call forwarding busy</li> <li>■ [2] <b>No Reply</b> = Call forwarding no reply</li> <li>■ [9] <b>DTE Out of Order</b> = Call forwarding DTE out of order</li> <li>■ [10] <b>Deflection</b> = Call deflection</li> <li>■ [15] <b>Systematic/Unconditional</b> = Call forward unconditional</li> </ul> <p><b>Note:</b> The parameter is applicable only to digital interfaces.</p>
<p>'Redirect Number IP-to-Tel'  <pre>configure voip &gt; gateway routing settings &gt; redir-nb- si-2tel</pre> </p> <p>[SetIp2TelRedirectScreeningInd]</p>	<p>Defines the value of the Redirect Number screening indicator in ISDN Setup messages.</p> <ul style="list-style-type: none"> <li>■ [-1] <b>Not Configured</b> (default)</li> <li>■ [0] <b>User Provided</b></li> <li>■ [1] <b>User Passed</b></li> <li>■ [2] <b>User Failed</b></li> <li>■ [3] <b>Network Provided</b></li> </ul> <p><b>Note:</b> The parameter is applicable only to digital interfaces.</p>

Parameter	Description
<p>'Set IP-to-Tel Redirect Reason'</p> <pre>configure voip &gt; gateway manipulation settings &gt; ip2tel-redir-reason</pre> <p>[SetIp2TelRedirectReason]</p>	<p>Defines the redirect reason for IP-to-Tel calls. If redirect (diversion) information is received from the IP, the redirect reason is set to the value of the parameter before the device sends it on to the Tel.</p> <ul style="list-style-type: none"> <li>■ [-1] <b>Not Configured</b> (default)</li> <li>■ [0] <b>Unkown</b></li> <li>■ [1] <b>Busy</b></li> <li>■ [2] <b>No Reply</b></li> <li>■ [3] <b>Network Busy</b></li> <li>■ [4] <b>Deflection</b></li> <li>■ [9] <b>DTE out of Order</b></li> <li>■ [10] <b>Forwarding DTE</b></li> <li>■ [13] <b>Transfer</b></li> <li>■ [14] <b>PickUp</b></li> <li>■ [15] <b>Systematic/Unconditional</b></li> </ul> <p><b>Note:</b> The parameter is applicable only to digital interfaces.</p>
<p>'Set Tel-to-IP Redirect Reason'</p> <pre>configure voip &gt; gateway manipulation settings &gt; tel2ip-redir-reason</pre> <p>[SetTel2IpRedirectReason]</p>	<p>Defines the redirect reason for Tel-to-IP calls. If redirect (diversion) information is received from the Tel, the redirect reason is set to the value of the parameter before the device sends it on to the IP.</p> <ul style="list-style-type: none"> <li>■ [-1] <b>Not Configured</b> (default)</li> <li>■ [0] <b>Unkown</b></li> <li>■ [1] <b>Busy</b></li> <li>■ [2] <b>No Reply</b></li> <li>■ [3] <b>Network Busy</b></li> <li>■ [4] <b>Deflection</b></li> <li>■ [9] <b>DTE out of Order</b></li> <li>■ [10] <b>Forwarding DTE</b></li> <li>■ [13] <b>Transfer</b></li> </ul>

Parameter	Description
	<ul style="list-style-type: none"> <li>■ [14] <b>PickUp</b></li> <li>■ [15] <b>Systematic/Unconditional</b></li> </ul> <p><b>Note:</b> The parameter is applicable only to digital interfaces.</p>
<p>'Send Screening Indicator to IP'</p> <pre>configure voip &gt; gateway digital settings &gt; send- screen-to-ip</pre> <p>[ScreeningInd2IP]</p>	<p>Overrides the calling party's number (CPN) screening indication in the received ISDN SETUP message for Tel-to-IP calls.</p> <ul style="list-style-type: none"> <li>■ [-1] <b>Not Configured</b> = (Default) Not configured (interworking from ISDN to IP) or set to 0 for CAS.</li> <li>■ [0] <b>User Provided</b> = CPN set by user, but not screened (verified).</li> <li>■ [1] <b>User Passed</b> = CPN set by user, verified and passed.</li> <li>■ [2] <b>User Failed</b> = CPN set by user, and verification failed.</li> <li>■ [3] <b>Network Provided</b> = CPN set by network.</li> </ul> <p><b>Note:</b></p> <ul style="list-style-type: none"> <li>■ The parameter is applicable only if the Remote Party ID (RPID) header is enabled.</li> <li>■ The parameter is applicable only to digital interfaces.</li> </ul>
<p>'Send Screening Indicator to ISDN'</p> <pre>configure voip &gt; gateway digital settings &gt; send- screen-to-isdn</pre> <p>[ScreeningInd2ISDN]</p>	<p>Defines (overrides) the screening indicator of the calling party's number in the ISDN Setup message for IP-to-Tel ISDN calls. This is applicable only when the device includes one calling party number in the outgoing ISDN Setup message.</p> <ul style="list-style-type: none"> <li>■ [-1] <b>Not Configured</b> = (Default) Not configured (interworking from IP to ISDN).</li> <li>■ [0] <b>User Provided</b> = Screening indicator is set to "user provided, not</li> </ul>

Parameter	Description
	<p>screened".</p> <ul style="list-style-type: none"> <li>■ [1] <b>User Passed</b> = Screening indicator is set to "user provided, verified and passed".</li> <li>■ [2] <b>User Failed</b> = Screening indicator is set to "user provided, verified and failed".</li> <li>■ [3] <b>Network Provided</b> = Screening indicator is set to "network provided".</li> </ul> <p><b>Note:</b></p> <ul style="list-style-type: none"> <li>■ The parameter is applicable only to digital (ISDN) interfaces.</li> <li>■ If the device includes two calling party numbers in the outgoing ISDN Setup message, this parameter is ignored and the screening indicator of the first and second calling party numbers are configured by the [ScreeningInd2ISDN1] and [ScreeningInd2ISDN2] parameters, respectively.</li> </ul>
<pre>configure voip &gt; gateway digital settings &gt; send- screen-to-isdn-1 [ScreeningInd2ISDN1]</pre>	<p>Defines (overrides) the screening indicator for the first calling party number when the device includes two calling party numbers in the outgoing ISDN Setup message for IP-to-Tel ISDN calls.</p> <ul style="list-style-type: none"> <li>■ [-1] <b>Not Configured</b> = Not configured (interworking from IP to ISDN).</li> <li>■ [0] <b>User Provided</b> = (Default) Screening indicator is set to "user provided, not screened".</li> <li>■ [1] <b>User Passed</b> = Screening indicator is set to "user provided, verified and passed".</li> <li>■ [2] <b>User Failed</b> = Screening indicator</li> </ul>

Parameter	Description
	<p>is set to "user provided, verified and failed".</p> <ul style="list-style-type: none"> <li>■ [3] <b>Network Provided</b> = Screening indicator is set to "network provided".</li> </ul> <p><b>Note:</b></p> <ul style="list-style-type: none"> <li>■ The parameter is applicable only to digital (ISDN) interfaces.</li> <li>■ If the device includes only one calling party number in the outgoing ISDN Setup message, the screening indicator is configured by the [ScreeningInd2ISDN] parameter.</li> </ul>
<pre>configure voip &gt; gateway digital settings &gt; send- screen-to-isdn-2 [ScreeningInd2ISDN]</pre>	<p>Defines (overrides) the screening indicator for the second calling party number when the device includes two calling party numbers in the outgoing ISDN Setup message for IP-to-Tel ISDN calls.</p> <ul style="list-style-type: none"> <li>■ [-1] <b>Not Configured</b> = Not configured (interworking from IP to ISDN).</li> <li>■ [0] <b>User Provided</b> = Screening indicator is set to "user provided, not screened".</li> <li>■ [1] <b>User Passed</b> = Screening indicator is set to "user provided, verified and passed".</li> <li>■ [2] <b>User Failed</b> = Screening indicator is set to "user provided, verified and failed".</li> <li>■ [3] <b>Network Provided</b> = (Default) Screening indicator is set to "network provided".</li> </ul> <p><b>Note:</b></p> <ul style="list-style-type: none"> <li>■ The parameter is applicable only to digital (ISDN) interfaces.</li> </ul>



Parameter	Description
	<ul style="list-style-type: none"> <li>■ The SIP header in the incoming INVITE message from where the device obtains the second calling party number is configured by the [SecondCallingNumberSource] parameter.</li> <li>■ If the device includes only one calling party number in the outgoing ISDN Setup message, the screening indicator is configured by the [ScreeningInd2ISDN] parameter.</li> </ul>
<p>'Copy Destination Number to Redirect Number'</p> <p><code>cp-dst-nb-2-redirect-nb</code></p> <p>[CopyDest2RedirectNumber]</p>	<p>Enables the device to copy the called number (from the received ISDN message for digital interfaces) to the outgoing SIP Diversion header for Tel-to-IP calls (even if a Redirecting Number IE is not received in the ISDN Setup message for digital interfaces). Therefore, the called number is used as a redirect number. Call redirection information is typically used for Unified Messaging and voice mail services to identify the recipient of a message.</p> <ul style="list-style-type: none"> <li>■ [0] <b>Don't copy</b> = (Default) Disable.</li> <li>■ [1] <b>Copy after phone number manipulation</b> = Copies the called number after manipulation. The device first performs Tel-to-IP destination phone number manipulation (i.e., on the SIP To header), and only then copies the manipulated called number to the SIP Diversion header for the Tel-to-IP call. Therefore, with this option, the called and redirect numbers are identical.</li> <li>■ [2] <b>Copy before phone number manipulation</b> = Copies the called number before manipulation. The device first copies the original called number to the SIP Diversion header,</li> </ul>

Parameter	Description
	<p>and then performs Tel-to-IP destination phone number manipulation. Therefore, this allows you to have different numbers for the called (i.e., SIP To header) and redirect (i.e., SIP Diversion header) numbers.</p> <p><b>Note:</b></p> <ul style="list-style-type: none"> <li>■ Digital interfaces: If the incoming ISDN-to-IP call includes a Redirect Number, this number is overridden by the new called number if the parameter is set to [1] or [2].</li> <li>■ Digital interfaces: You can also use this feature for IP-to-Tel calls, by configuring the parameter per IP Profile (IpProfile_CopyDest2RedirectNum). For more information, see <a href="#">Configuring IP Profiles</a>.</li> </ul>
<pre>configure voip &gt; sip- definition settings &gt; rep- calling-w-redir [ReplaceCallingWithRedirectNumber]</pre>	<p>Enables the replacement of the calling number with the redirect number for ISDN-to-IP calls.</p> <ul style="list-style-type: none"> <li>■ [0] = Disable (default)</li> <li>■ [1] = The calling name is removed and left blank. The outgoing INVITE message excludes the redirect number that was used to replace the calling number. The replacement is done only if a redirect number is present in the incoming Tel call.</li> <li>■ [2] = Manipulation is done on the new calling party number (after manipulation of the original calling party number, using the Tel2IPSourceNumberMappingDialPlan Index parameter), but before the regular calling or redirect number manipulation: <ul style="list-style-type: none"> <li>✓ If a redirect number exists, it</li> </ul> </li> </ul>

Parameter	Description
	<p>replaces the calling party number. If there is no redirect number, the calling number is left unchanged.</p> <ul style="list-style-type: none"> <li>✓ If there is a calling “display” name, it remains unchanged.</li> <li>✓ The redirect number remains unchanged and is included in the SIP Diversion header.</li> </ul> <p><b>Note:</b> The parameter is applicable only to digital interfaces.</p>
<p>'Add Trunk Group ID as Prefix'</p> <pre>configure voip &gt; gateway routing settings &gt; trkgrp-id- prefix</pre> <p>[AddTrunkGroupAsPrefix]</p>	<p>Determines whether the Trunk Group ID is added as a prefix to the destination phone number (i.e., called number) for Tel-to-IP calls.</p> <ul style="list-style-type: none"> <li>■ [0] <b>No</b> = (Default) Don't add Trunk Group ID as prefix.</li> <li>■ [1] <b>Yes</b> = Add Trunk Group ID as prefix to called number.</li> </ul> <p><b>Note:</b></p> <ul style="list-style-type: none"> <li>■ This option can be used to define various routing rules.</li> <li>■ To use this feature, you must configure the Trunk Group IDs (see <a href="#">Configuring Trunk Groups</a>).</li> </ul>
<p>'Add Trunk ID as Prefix'</p> <pre>configure voip &gt; gateway routing settings &gt; trk-id-as- prefix</pre> <p>[AddPortAsPrefix]</p>	<p>Defines if the slot number / port number / Trunk ID is added as a prefix to the called (destination) number for Tel-to-IP calls.</p> <ul style="list-style-type: none"> <li>■ [0] <b>No</b> (Default)</li> <li>■ [1] <b>Yes</b></li> </ul> <p>If enabled, the device adds the following prefix to the called phone number: slot number (a single digit in the range of 1 to 6) and port number/Trunk ID (single digit in the range 1 to 8). For example, for the</p>

Parameter	Description
	<p>first trunk/channel located in the first slot, the number "11" is added as the prefix.</p> <p>This option can be used to define various routing rules.</p>
<p>'Add Trunk Group ID as Prefix to Source'</p> <pre>trkgrp-id-pref2source</pre> <p>[AddTrunkGroupAsPrefixToSource]</p>	<p>Enables the device to add the Trunk ID (from where the call originated) as the prefix to the calling number (i.e. source number).</p> <ul style="list-style-type: none"> <li>■ [0] <b>No</b> (default)</li> <li>■ [1] <b>Yes</b></li> </ul>
<p>'Replace Empty Destination with B-channel Phone Number'</p> <pre>configure voip &gt; gateway routing settings &gt; empty-dst- w-bch-nb</pre> <p>[ReplaceEmptyDstWithPortNumber]</p>	<p>Determines whether the internal channel number is used as the destination number if the called number is missing.</p> <ul style="list-style-type: none"> <li>■ [0] <b>No</b> (default)</li> <li>■ [1] <b>Yes</b></li> </ul> <p><b>Note:</b></p> <ul style="list-style-type: none"> <li>■ The parameter is applicable only to Tel-to-IP calls and if the called number is missing.</li> <li>■ The parameter is applicable only to digital interfaces.</li> </ul>
<p>[CopyDestOnEmptySource]</p>	<p>Determines whether the destination number is copied to the source number if no source number is present, for Tel-to-IP calls.</p> <ul style="list-style-type: none"> <li>■ [0] = (Default) Source Number is left empty.</li> <li>■ [1] = If the Source Number of a Tel-to-IP call is empty, the Destination Number is copied to the Source Number.</li> </ul> <p><b>Note:</b> The parameter is applicable only to digital interfaces.</p>
<p>'Add NPI and TON to Calling Number'</p>	<p>Determines whether the Numbering Plan</p>

Parameter	Description
<pre>configure voip &gt; gateway routing settings &gt; np-i-n-ton- to-cng-nb</pre> <p>[AddNPIandTON2CallingNumber]</p>	<p>Indicator (NPI) and Type of Numbering (TON) are added to the Calling Number for Tel-to-IP calls.</p> <ul style="list-style-type: none"> <li>■ [0] <b>No</b> = (Default) Do not change the Calling Number.</li> <li>■ [1] <b>Yes</b> = Add NPI and TON to the Calling Number ISDN Tel-to-IP call.</li> </ul> <p>For example: After receiving a Calling Number of 555, NPI of 1, and TON of 3, the modified number becomes 13555. This number can later be used for manipulation and routing.</p> <p><b>Note:</b> The parameter is applicable only to digital interfaces.</p>
<p>'Add NPI and TON to Called Number'</p> <pre>configure voip &gt; gateway routing settings &gt; np-i-n-ton- to-cld-nb</pre> <p>[AddNPIandTON2CalledNumber]</p>	<p>Determines whether NPI and TON are added to the Called Number for Tel-to-IP calls.</p> <ul style="list-style-type: none"> <li>■ [0] <b>No</b> = (Default) Do not change the Called Number.</li> <li>■ [1] <b>Yes</b> = Add NPI and TON to the Called Number of ISDN Tel-to-IP call.</li> </ul> <p>For example: After receiving a Called Number of 555, NPI of 1 and TON of 3, the modified number becomes 13555. This number can later be used for manipulation and routing.</p> <p><b>Note:</b> The parameter is applicable only to digital interfaces.</p>
<p>'Add NPI and TON to Redirect Number'</p> <pre>np-n-ton-2-redirnb</pre> <p>[AddNPIandTON2RedirectNumber]</p>	<p>Determines whether the NPI and TON values are added as the prefix to the Redirect number in INVITE messages' Diversion or History-Info headers, for ISDN Tel-to-IP calls.</p> <ul style="list-style-type: none"> <li>■ [0] <b>Yes</b> (Default)</li> <li>■ [1] <b>No</b></li> </ul> <p><b>Note:</b> The parameter is applicable only to digital interfaces.</p>

Parameter	Description
<p>'IP-to-Tel Remove Routing Table Prefix'</p> <pre>configure voip &gt; gateway routing settings &gt; ip2tel-rmv- rte-tbl</pre> <p>[RemovePrefix]</p>	<p>Determines whether or not the device removes the prefix, as configured in the IP-to-Tel Routing table (see <a href="#">Configuring IP-to-Tel Routing Rules</a>) from the destination number for IP-to-Tel calls, before sending it to the Tel.</p> <ul style="list-style-type: none"> <li>■ [0] <b>No</b> (default)</li> <li>■ [1] <b>Yes</b></li> </ul> <p>For example: To route an incoming IP-to-Tel call with destination number "21100", the IP-to-Tel Routing table is scanned for a matching prefix. If such a prefix is found (e.g., "21"), then before the call is routed to the corresponding Trunk Group, the prefix "21" is removed from the original number, and therefore, only "100" remains.</p> <p><b>Note:</b></p> <ul style="list-style-type: none"> <li>■ The parameter is applicable only if number manipulation is performed after call routing for IP-to-Tel calls (i.e., RouteModelIP2Tel parameter is set to 0).</li> <li>■ Similar operation (of removing the prefix) is also achieved by using the usual number manipulation rules.</li> </ul>
<p>'Swap Redirect and Called Numbers'</p> <pre>swap-rdr-n-called-nb</pre> <p>[SwapRedirectNumber]</p>	<ul style="list-style-type: none"> <li>■ [0] <b>No</b> = (Default) Don't change numbers.</li> <li>■ [1] <b>Yes</b> = Incoming ISDN call that includes a redirect number (sometimes referred to as 'original called number') uses the redirect number instead of the called number.</li> </ul> <p><b>Note:</b> The parameter is applicable only to digital interfaces.</p>
<pre>configure voip &gt; gateway manipulation settings &gt; use-</pre>	<p>Determines whether the device uses the number from the URI in the SIP Referred-</p>

Parameter	Description
<pre>refer-by-for-calling-num</pre> <p>[UseReferredByForCallingNumber]</p>	<p>By header as the calling number in the outgoing Q.931 Setup message, when SIP REFER messages are received.</p> <ul style="list-style-type: none"> <li>■ [0] = (Default) No</li> <li>■ [1] = Yes</li> </ul> <p><b>Note:</b></p> <ul style="list-style-type: none"> <li>■ The parameter is applicable to all ISDN (TBCT, RLT, ECT) and CAS blind call transfers (except for in-band) and when the device receives SIP REFER messages with a Referred-By header.</li> <li>■ This manipulation is done before regular IP-to-Tel source number manipulation.</li> <li>■ The parameter is applicable only to digital interfaces.</li> </ul>
<pre>configure voip &gt; gateway manipulation settings &gt; swap- tel-to-ip-phone-num</pre> <p>[SwapTel2IPCalled&amp;CallingNumbers]</p>	<p>Global parameter enabling the device to swap the calling and called numbers received from the Tel side (for Tel-to-IP calls).</p> <p>You can also configure the feature per specific calls, using Tel Profiles (TelProfile_SwapTelToIpPhoneNumbers). For a detailed description of the parameter and for configuring the feature in the Tel Profiles table, see <a href="#">Configuring Tel Profiles</a>.</p> <p><b>Note:</b> If the feature is configured for a specific Tel Profile, the settings of the global parameter is ignored for calls associated with the Tel Profile.</p>
<p>'Add Prefix to Redirect Number'</p> <pre>add-pref-to-redir-nb</pre> <p>[Prefix2RedirectNumber]</p>	<p>Defines a string prefix that is added to the Redirect number received from the Tel side. This prefix is added to the Redirect Number in the SIP Diversion header.</p> <p>The valid range is an 8-character string. By default, no value is defined.</p> <p><b>Note:</b> The parameter is applicable only to digital interfaces.</p>

Parameter	Description
<p>'Add Number Plan and Type to RPI Header'</p> <pre>np-n-type-to-rpi-hdr</pre> <p>[AddTON2RPI]</p>	<p>Determines whether the TON/PLAN parameters are included in the Remote-Party-ID (RPID) header.</p> <ul style="list-style-type: none"> <li>■ [0] <b>No</b></li> <li>■ [1] <b>Yes</b> (default)</li> </ul> <p>If the Remote-Party-ID header is enabled (EnableRPIHeader = 1) and AddTON2RPI = 1, it's possible to configure the calling and called number type and number plan using the Number Manipulation tables for Tel-to-IP calls.</p>
<p>'Source Manipulation Mode'</p> <pre>configure voip &gt; gateway routing settings &gt; src- manipulation</pre> <p>[SourceManipulationMode]</p>	<p>Determines the SIP headers containing the source number after manipulation:</p> <ul style="list-style-type: none"> <li>■ [0] <b>From and P-Asserted-Identity after Manipulation</b> = (Default) The SIP From and P-Asserted-Identity headers contain the source number after manipulation.</li> <li>■ [1] <b>Only From after Manipulation</b> = Only SIP From header contains the source number after manipulation, while the P-Asserted-Identity header contains the source number before manipulation.</li> </ul>
<pre>configure voip &gt; gateway manipulation settings &gt; prfm- ip-to-tel-dst-map</pre> <p>[PerformAdditionalIP2TELDestinationManipulation]</p>	<p>Enables additional destination number manipulation for IP-to-Tel calls. The additional manipulation is done on the initially manipulated destination number, and this additional rule is also configured in the manipulation table (NumberMapIP2Tel parameter). This enables you to configure only a few manipulation rules for complex number manipulation requirements (that generally require many rules).</p> <ul style="list-style-type: none"> <li>■ [0] = Disable (default)</li> <li>■ [1] = Enable</li> </ul>



Parameter	Description
<pre>configure voip &gt; gateway manipulation settings &gt; prfm- ip-to-tel-src-map</pre> <p>[PerformAdditionalIP2TELSrcManipulation]</p>	<p>Enables additional source number manipulation for IP-to-Tel calls. The additional manipulation is done on the initially manipulated source number, and this additional rule is also configured in the manipulation table (SourceNumberMapIP2Tel parameter). This enables you to configure only a few manipulation rules for complex number manipulation requirements (that generally require many rules).</p> <ul style="list-style-type: none"> <li>■ [0] = Disable (default)</li> <li>■ [1] = Enable</li> </ul>
<p>'Add Phone Context As Prefix'</p> <pre>configure voip &gt; gateway manipulation settings &gt; add- ph-cntxt-as-pref</pre> <p>[AddPhoneContextAsPrefix]</p>	<p>Determines whether the received Phone-Context parameter is added as a prefix to the outgoing called and calling numbers (in ISDN Setup messages for digital interfaces).</p> <ul style="list-style-type: none"> <li>■ [0] <b>Disable</b> (default)</li> <li>■ [1] <b>Enable</b></li> </ul>

## Answer and Disconnect Supervision Parameters

The answer and disconnect supervision parameters are described in the table below.

**Table 70-66: Answer and Disconnect Parameters**

Parameter	Description
<p>'Wait before PSTN Release-Ack'</p> <pre>wait-befor-pstn-rel-ack</pre> <p>[TimeToWaitForPstnReleaseAck]</p>	<p>Defines a timeout (in milliseconds) that the device waits for the receipt of an ISDN Q.931 Release message from the PSTN side before releasing the channel. The Release ACK is typically sent by the PSTN in response to the device's Disconnect message to end the call. If the timeout expires and a Release message has not yet been received, the device releases the call channel.</p> <p>The valid value is 1 to 360,000. The default is 6,000.</p>

Parameter	Description
<pre>configure voip &gt; interface e1-t1 &gt; isdn- japan-ntt-timer-t305 [ISDNJapanNttTimerT305]</pre>	<p><b>Note:</b> The parameter is applicable only to digital interfaces.</p> <p>Defines a timeout (in seconds) that the device waits before sending an ISDN Release message after it has sent a Disconnect message, if no SIP message (e.g., 4xx response) is received within the timeout. The parameter is applicable when the device's trunk is configured for the Japanese NTT ISDN PRI (T1) variant (i.e., [ProtocolType] is [16], as described in <a href="#">Configuring Trunk Settings</a> on page 668).</p> <p>The valid value is 0 to 480. The default is 0 (i.e., timeout is 30 seconds).</p> <p>For more information on this feature, see <a href="#">SIP-to-ISDN Disconnect Release Cause Code Mapping</a> on page 797.</p> <p><b>Note:</b></p> <ul style="list-style-type: none"> <li>■ For the parameter to take effect, a device reset is required.</li> <li>■ The parameter is applicable only to digital interfaces (T1 NTT).</li> </ul>
<p>'Answer Supervision'</p> <pre>configure voip &gt; gateway analog fxo-setting &gt; answer-supervision [EnableVoiceDetection]</pre>	<p>Enables the sending of SIP 200 OK upon detection of speech, fax, or modem.</p> <ul style="list-style-type: none"> <li>■ [1] <b>Yes</b> = The device sends a SIP 200 OK (in response to an INVITE message) when speech, fax, or modem is detected (from the Tel side, for analog interfaces).</li> <li>■ [0] <b>No</b> = (Default) The device sends a SIP 200 OK only after it completes dialing (to the Tel side, for analog interfaces).</li> </ul> <p>Typically, this feature is used only when early media, enabled by the [EnableEarlyMedia] parameter, is used to establish the voice path before the call is answered.</p> <p><b>Note:</b></p> <ul style="list-style-type: none"> <li>■ The parameter is applicable only to the Gateway application.</li> </ul>

Parameter	Description
	<ul style="list-style-type: none"> <li>■ FXO interfaces: The feature is applicable only to one-stage dialing (FXO).</li> <li>■ Digital interfaces:               <ul style="list-style-type: none"> <li>✓ The parameter is applicable only when the protocol type is CAS.</li> <li>✓ To activate the feature, set the <code>EnableDSIPMDetectors</code> parameter to 1.</li> </ul> </li> </ul>
<p>'GW Max Call Duration'</p> <pre>configure voip &gt; sip- definition settings &gt; gw-mx-call-duration [GWMaxCallDuration]</pre>	<p>Defines the maximum duration (in minutes) per Gateway call. If this duration is reached, the device terminates the call. This feature is useful for ensuring available resources for new calls, by ensuring calls are properly terminated.</p> <p>The valid range is 0 to 35,791, where 0 is unlimited duration. The default is 0.</p> <p><b>Note:</b> The parameter is applicable only to the Gateway application.</p>
<pre>configure voip &gt; sip- definition settings &gt; mn-call-duration [MinCallDuration]</pre>	<p>Defines the minimum call duration (in seconds) for the Tel side. If an established call is terminated by the IP side before this duration expires, the device terminates the call with the IP side, but delays the termination toward the Tel side until this timeout expires.</p> <p>The valid value range is 0 to 10 seconds, where 0 (default) disables this feature.</p> <p>For example: assume the minimum call duration is set to 10 seconds and an IP phone hangs up a call established with a BRI phone after 2 seconds. As the call duration is less than the minimum call duration, the device does not disconnect the call on the Tel side. However, it sends a SIP 200 OK immediately upon receipt of the BYE to disconnect from the IP phone. The call is disconnected from the Tel side only when the call duration is greater than or equal to the minimum call duration.</p> <p><b>Note:</b></p> <ul style="list-style-type: none"> <li>■ The parameter is applicable only to the Gateway application.</li> </ul>

Parameter	Description
	<ul style="list-style-type: none"> <li>■ The parameter is applicable to IP-to-Tel and Tel-to-IP calls.</li> <li>■ The parameter is applicable only to ISDN and CAS protocols.</li> </ul>
<p>'Disconnect on Dial Tone'</p> <pre>configure voip &gt; gateway analog fxo-setting &gt; disc-on-dial-tone [DisconnectOnDialTone]</pre>	<p>Determines whether the device disconnects a call when a dial tone is detected from the PBX.</p> <ul style="list-style-type: none"> <li>■ [0] <b>Disable</b> = (Default) Call is not released.</li> <li>■ [1] <b>Enable</b> = Call is released if a dial tone is detected on the device's FXO port.</li> </ul> <p><b>Note:</b></p> <ul style="list-style-type: none"> <li>■ The parameter is applicable only to FXO interfaces.</li> <li>■ This option is in addition to the mechanism that disconnects a call when either busy or reorder tones are detected.</li> </ul>
<p>'Send Digit Pattern on Connect'</p> <pre>configure voip &gt; sip- definition settings &gt; digit-pttrn-on-conn [TelConnectCode]</pre>	<p>Defines a digit pattern to send to the Tel side after a SIP 200 OK is received from the IP side. The digit pattern is a user-defined DTMF sequence that is used to indicate an answer signal (e.g., for billing).</p> <p>The valid value is up to 8 characters.</p> <p><b>Note:</b> The parameter is applicable only to FXO and CAS.</p>
<p>'Broken Connection Mode'</p> <pre>configure voip &gt; sip- definition settings &gt; disc-broken-conn [DisconnectOnBrokenConnection]</pre>	<p>Global parameter that defines the device's handling of calls if RTP packets are not received within a user-defined timeout, configured by the [BrokenConnectionEventTimeout] parameter. You can also configure this feature per specific calls, using IP Profiles (IpProfile_ DisconnectOnBrokenConnection). For a detailed description of the parameter and for configuring this feature in the IP Profiles table, see <a href="#">Configuring IP Profiles</a>.</p> <p><b>Note:</b> If this feature is configured for a specific IP Profile, the settings of this global parameter is ignored for calls associated with the IP Profile.</p>

Parameter	Description
<p>'Broken Connection Timeout'</p> <pre>configure voip &gt; sip- definition settings &gt; broken-connection-event- timeout</pre> <p>[BrokenConnectionEventTimeout]</p>	<p>Defines the timeout interval (in 100-msec units) after which a call is disconnected if RTP packets are not received during an established call (i.e., RTP flow suddenly stops during the call).</p> <p>The valid range is from 3 (i.e., 300 msec) to approx. 2684354 (i.e., 74.5 hours). The default is 100 (i.e., 10,000 msec or 10 seconds).</p> <p><b>Note:</b></p> <ul style="list-style-type: none"> <li>■ The parameter is applicable only if the [DisconnectOnBrokenConnection] parameter is configured to [1].</li> <li>■ Currently, the feature functions only if Silence Suppression is disabled.</li> </ul>
<pre>configure voip &gt; sbc settings &gt; no-rtp- detection-timeout</pre> <p>[NoRTPDetectionTimeout]</p>	<p>Defines the timeout interval (in msec) after which a call is disconnected if RTP packets are not received within the interval. The timer begins from call setup and if no packets are received when the timer expires, the device disconnects the call.</p> <p>The valid range is 0 to 50000. The default is 0, which means that this timeout feature is disabled and that the device does not disconnect the call due to RTP packets not being received.</p> <p><b>Note:</b></p> <ul style="list-style-type: none"> <li>■ If a call is already established and there is RTP, if at any stage during the call RTP packets are not detected for a user-defined interval, configured by [BrokenConnectionEventTimeout], the device disconnects the call, or routes it to an alternative destination, configured by the [IpProfile_DisconnectOnBrokenConnection] parameter.</li> <li>■ The parameter is not applicable to direct media calls for the SBC application (see <a href="#">Direct Media Calls</a> on page 915).</li> </ul>
<p>'Disconnect Call on Silence Detection'</p> <pre>configure voip &gt; sip- definition settings &gt;</pre>	<p>Enables the device to disconnect calls upon detection of silence.</p>

Parameter	Description
disc-on-silence-det [EnableSilenceDisconnect]	<ul style="list-style-type: none"> <li>■ [0] <b>No</b> = (Default) Call is not disconnected when silence is detected.</li> <li>■ [1] <b>Yes</b> = The device disconnects calls in which silence occurs (in both call directions) for more than a user-defined time, configured by the FarEndDisconnectSilencePeriod parameter.</li> </ul> <p><b>Note:</b></p> <ul style="list-style-type: none"> <li>■ The parameter is applicable only to analog interfaces.</li> <li>■ To activate the feature, enable Silence Suppression for the coder used and configure the FarEndDisconnectSilenceMethod parameter to 1.</li> </ul>
'Silence Detection Period' [FarEndDisconnectSilencePeriod]	Defines the duration of the silence period (in seconds) after which the call is disconnected. The range is 10 to 28,800 (i.e., 8 hours). The default is 120 seconds. <p><b>Note:</b></p> <ul style="list-style-type: none"> <li>■ The parameter is applicable only to analog interfaces.</li> <li>■ For the parameter to take effect, a device reset is required.</li> </ul>
'Silence Detection Method' [FarEndDisconnectSilenceMethod]	Defines the device's silence detection method. <ul style="list-style-type: none"> <li>■ [0] <b>None</b> = Silence detection is disabled.</li> <li>■ [1] <b>Packets Count</b> = According to packet count.</li> </ul> <p><b>Note:</b></p> <ul style="list-style-type: none"> <li>■ The parameter is applicable only to analog interfaces.</li> <li>■ For the parameter to take effect, a device reset is required.</li> </ul>
[FarEndDisconnectSilenceThreshold]	Defines the threshold of the packet count (in percentages) below which is considered silence by the device.

Parameter	Description
	<p>The valid range is 1 to 100%. The default is 8%.</p> <p><b>Note:</b></p> <ul style="list-style-type: none"> <li>■ The parameter is applicable only to analog interfaces.</li> <li>■ The parameter is applicable only if silence is detected according to packet count (FarEndDisconnectSilenceMethod is set to 1).</li> <li>■ For the parameter to take effect, a device reset is required.</li> </ul>
[BrokenConnectionDuringSilence]	<p>Enables the generation of the BrokenConnection event during a silence period if the channel's NoOp feature is enabled (see the [NoOpEnable] parameter) and if the channel stops receiving NoOp RTP packets.</p> <ul style="list-style-type: none"> <li>■ [0] = Disable (default)</li> <li>■ [1] = Enable</li> </ul> <p><b>Note:</b> The parameter is applicable only to the Gateway application.</p>
'Trunk Alarm Call Disconnect Timeout' trk-alm-call-disc-to [TrunkAlarmCallDisconnectTimeout]	<p>Defines the duration (in seconds) to wait after a digital trunk Red alarm (LOS / LOF) is raised, before the device disconnects the SIP call. If this timeout expires and the alarm is still raised, the device sends a SIP BYE message to terminate the call. If the alarm is cleared before this timeout expires, the call is not terminated, but continues as normal.</p> <p>The range is 1 to 3600. The default is 0 (20 for BRI, 20 for E1 and 40 for T1).</p> <p><b>Note:</b> The parameter is applicable only to the Gateway application.</p>
'Disconnect Call on Busy Tone Detection (ISDN)' disc-on-busy-tone-i [ISDNDisconnectOnBusyTone]	<p>Determines whether a call is disconnected upon detection of a busy tone (for ISDN).</p> <ul style="list-style-type: none"> <li>■ [0] <b>Disable</b> = (Default) Do not disconnect call upon detection of busy tone.</li> <li>■ [1] <b>Enable</b> = Disconnect call upon detection of busy tone.</li> </ul>

Parameter	Description
	<p><b>Note:</b></p> <ul style="list-style-type: none"> <li>■ The parameter is applicable only to ISDN protocols.</li> <li>■ IP-to-ISDN calls are disconnected on detection of SIT tones only in call alert state. If the call is in connected state, the SIT does not disconnect the calls. Detection of busy or reorder tones disconnects the IP-to-ISDN calls also in call connected state.</li> <li>■ For IP-to-CAS calls, detection of busy, reorder, or SIT tones disconnect the calls in any call state.</li> </ul>
<p>'Disconnect Call on Busy Tone Detection (CAS)'</p> <pre>configure voip &gt; gateway analog fxo-setting &gt; disc-on-busy-tone-c [DisconnectOnBusyTone]</pre>	<p>Global parameter enabling call disconnection upon detection of a busy tone.</p> <p>You can also configure the feature per specific calls, using Tel Profiles (TelProfile_DisconnectOnBusyTone). For a detailed description of the parameter and for configuring the feature in the Tel Profiles table, see <a href="#">Configuring Tel Profiles</a>.</p> <p><b>Note:</b></p> <ul style="list-style-type: none"> <li>■ The parameter is applicable only to the Gateway application.</li> <li>■ If the feature is configured for a specific Tel Profile, the settings of the global parameter is ignored for calls associated with the Tel Profile.</li> </ul>
<b>Polarity (Current) Reversal for Call Release (Analog Interfaces) Parameters</b>	
<pre>configure voip &gt; interface fxs-fxo &gt; default-linepolarity- state [SetDefaultLinePolarityState]</pre>	<p>Defines the FXO line polarity, required for DID signaling.</p> <ul style="list-style-type: none"> <li>■ [0] = Positive line polarity</li> <li>■ [1] = Negative line polarity</li> <li>■ [2] = (Default) Auto - The device detects the polarity upon power-up or upon insertion of the RJ-11 cable, and uses it as a reference polarity.</li> </ul>



Parameter	Description
	<p>Typically, if the RJ-11 cabling is connected correctly (without crossing, Tip to Tip, Ring to Ring), the Tip line is positive compared to the Ring line. In this case, set the parameter to 0. With this configuration, the device assumes that the idle line polarity is Tip line positive.</p> <p>When the device receives a SIP INVITE, it checks the FXO line polarity. If the polarity is "Reversed", it skips this FXO line and goes to the next line.</p> <p><b>Note:</b></p> <ul style="list-style-type: none"> <li>■ For the parameter to take effect, a device reset is required.</li> <li>■ To take advantage of this new feature, configure all FXO lines as a single Trunk Group with ascending or descending channel select mode, and configure routing rules to route incoming INVITE messages to this Trunk Group.</li> <li>■ The parameter is applicable only to FXO interfaces.</li> </ul>
<p>'Enable Polarity Reversal'</p> <pre>configure voip &gt; sip- definition settings &gt; polarity-rvrsl [EnableReversalPolarity]</pre>	<p>Global parameter enabling the Line Polarity Reversal feature for call release.</p> <p>You can also configure the feature per specific calls, using Tel Profiles (TelProfile_ EnableReversePolarity). For a detailed description of the parameter and for configuring the feature in the Tel Profiles table, see <a href="#">Configuring Tel Profiles</a>.</p> <p><b>Note:</b></p> <ul style="list-style-type: none"> <li>■ The parameter is applicable to FXS and FXO interfaces.</li> <li>■ If the feature is configured for a specific Tel Profile, the settings of the global parameter is ignored for calls associated with the Tel Profile.</li> </ul>
<p>'Enable Current Disconnect'</p> <pre>configure voip &gt; sip- definition settings &gt;</pre>	<p>Global parameter enabling call release upon detection of a Current Disconnect signal.</p> <p>You can also configure the feature per specific</p>

Parameter	Description
<pre>current-disc</pre> <p>[EnableCurrentDisconnect]</p>	<p>calls, using Tel Profiles (TelProfile_ EnableCurrentDisconnect). For a detailed description of the parameter and for configuring the feature in the Tel Profiles table, see <a href="#">Configuring Tel Profiles</a>.</p> <p><b>Note:</b></p> <ul style="list-style-type: none"> <li>■ The parameter is applicable to FXS and FXO interfaces.</li> <li>■ If the feature is configured for a specific Tel Profile, the settings of the global parameter is ignored for calls associated with the Tel Profile.</li> </ul>
<pre>configure voip &gt; interface fxs-fxo &gt; polarity-reversal-type</pre> <p>[PolarityReversalType]</p>	<p>Defines the voltage change slope during polarity reversal or wink.</p> <ul style="list-style-type: none"> <li>■ [0] = (Default) Soft reverse polarity.</li> <li>■ [1] = Hard reverse polarity.</li> </ul> <p><b>Note:</b></p> <ul style="list-style-type: none"> <li>■ The parameter is applicable only to FXS interfaces.</li> <li>■ Some Caller ID signals use reversal polarity or Wink signals, or both. In these cases, it is recommended to configure the parameter to [1] (Hard).</li> <li>■ For the parameter to take effect, a device reset is required.</li> </ul>
<pre>configure voip &gt; interface fxs-fxo &gt; current-disconnect- duration</pre> <p>[CurrentDisconnectDuration]</p>	<p>Defines the duration (in msec) of the current disconnect pulse.</p> <p>The range is 200 to 1500. The default is 900.</p> <p><b>Note:</b></p> <ul style="list-style-type: none"> <li>■ The parameter is applicable for FXS and FXO interfaces.</li> <li>■ The FXO interface detection window is 100 msec below the parameter's value and 350 msec above the parameter's value. For example, if the parameter is set to 400 msec, then the detection window is 300 to 750</li> </ul>

Parameter	Description
	<p>msec.</p> <ul style="list-style-type: none"> <li>■ For the parameter to take effect, a device reset is required.</li> </ul>
[CurrentDisconnectDefaultThreshold]	<p>Defines the line voltage threshold at which a current disconnect detection is considered. The valid range is 0 to 20 Volts. The default is 4 Volts.</p> <p><b>Note:</b></p> <ul style="list-style-type: none"> <li>■ The parameter is applicable only to FXO interfaces.</li> <li>■ For the parameter to take effect, a device reset is required.</li> </ul>
<pre>configure voip &gt; interface fxs-fxo &gt; time-to-sample-analog- line-voltage</pre> <p>[TimeToSampleAnalogLineVoltage]</p>	<p>Defines the frequency at which the analog line voltage is sampled (after offhook), for detection of the current disconnect threshold. The valid range is 100 to 2500 msec. The default is 1000 msec.</p> <p><b>Note:</b></p> <ul style="list-style-type: none"> <li>■ The parameter is applicable only to FXO interfaces.</li> <li>■ For the parameter to take effect, a device reset is required.</li> </ul>

## SBC Parameters

The SBC and CRP parameters are described in the table below.

**Table 70-67:SBC and CRP Parameters**

Parameter	Description
CRP-specific Parameters	
<pre>configure voip &gt; application &gt; enable-crp</pre> <p>[EnableCRPApplication]</p>	<p>Enables the CRP application.</p> <ul style="list-style-type: none"> <li>■ [0] = Disable (default)</li> <li>■ [1] = Enable</li> </ul> <p><b>Note:</b> For the parameter to take effect, a device reset is required.</p>

Parameter	Description
'CRP Survivability Mode' configure voip > sbc settings > crp- survivability-mode [CRPSurvivabilityMode]	Defines the CRP mode. <ul style="list-style-type: none"> <li>■ [0] <b>Standard Mode</b> (default)</li> <li>■ [1] <b>Always Emergency Mode</b></li> <li>■ [2] <b>Auto-answer REGISTER</b></li> </ul>
'CRP Gateway Fallback' configure voip > sbc settings > crp-gw-fallback [CRPGatewayFallback]	Enables fallback routing from the proxy server to the Gateway (PSTN). <ul style="list-style-type: none"> <li>■ [0] <b>Disable</b> (default)</li> <li>■ [1] <b>Enable</b></li> </ul>
<b>SBC-specific Parameters</b>	
configure voip > application > enable-sbc [EnableSBCApplication]	Enables the Session Border Control (SBC) application. <ul style="list-style-type: none"> <li>■ [0] = Disable</li> <li>■ [1] = Enable (default)</li> </ul> <p><b>Note:</b></p> <ul style="list-style-type: none"> <li>■ For the parameter to take effect, a device reset is required.</li> <li>■ The parameter is enabled by default only if the License Key contains at least one of the SBC-related capacity features (e.g., "SBC-Signaling"); otherwise, the parameter is disabled.</li> </ul>
<b>SBC and CRP Parameters</b>	
'Unclassified Calls' configure voip > sbc settings > unclassified- calls [AllowUnclassifiedCalls]	Determines whether incoming calls that cannot be classified (i.e. classification process fails) to a Source IP Group are rejected or processed. <ul style="list-style-type: none"> <li>■ [0] <b>Reject</b> = (Default) Call is rejected if classification fails.</li> <li>■ [1] <b>Allow</b> = If classification fails, the incoming packet is assigned to a source IP Group (and subsequently processed) as follows: <ul style="list-style-type: none"> <li>✓ The source SRD is determined</li> </ul> </li> </ul>

Parameter	Description
	<p>according to the SIP Interface to where the SIP-initiating dialog request is sent. The source IP Group is set to the default IP Group associated with this SRD.</p> <ul style="list-style-type: none"> <li>✓ If the source SRD is ID 0, then source IP Group ID 0 is chosen. In case of any other SRD, then the first IP Group associated with this SRD is chosen as the source IP Group or the call. If no IP Group is associated with this SRD, the call is rejected.</li> </ul>
<p>'SBC Max Call Duration'</p> <pre>configure voip &gt; sbc settings &gt; sbc-mx-call- duration</pre> <p>[SBCMaxCallDuration]</p>	<p>Defines the maximum duration (in minutes) per SBC call (global). If the duration is reached, the device terminates the call. The valid range is 0 to 35,791, where 0 is unlimited duration. The default is 0.</p> <p><b>Note:</b> You can also configure this feature per specific calls, using IP Profiles (IpProfile_SBCMaxCallDuration). For a detailed description of the parameter and for configuring this feature in the IP Profiles table, see <a href="#">Configuring IP Profiles</a>. If this feature is configured for a specific IP Profile, the settings of this global parameter is ignored for calls associated with the IP Profile.</p>
<p>'SBC No Answer Timeout'</p> <pre>configure voip &gt; sbc settings &gt; sbc-no-arelt- timeout</pre> <p>[SBCAlertTimeout]</p>	<p>Defines the timeout (in seconds) for SBC outgoing (outbound IP routing) SIP INVITE messages. If the called IP party does not answer the call within this user-defined interval, the device disconnects the session. The device starts the timeout count upon receipt of a SIP 180 Ringing response from the called party. If no other SIP response (for example, 200 OK) is received thereafter within this timeout, the call is released. The valid range is 0 to 3600 seconds. the default is 600.</p>

Parameter	Description
<pre>configure voip &gt; sbc settings &gt; num-of-subscribes</pre> <p>[NumOfSubscribes]</p>	<p>Defines the maximum number of concurrent SIP SUBSCRIBE sessions permitted on the device.</p> <p>The valid value is any value between 0 and the maximum supported SUBSCRIBE sessions. When set to -1, the device uses the default value. For more information, contact the sales representative of your purchased device.</p> <p><b>Note:</b> For the parameter to take effect, a device reset is required.</p>
<pre>configure voip &gt; sbc settings &gt; sbc-dialog-subsc- route-mode</pre> <p>[SBCInDialogSubscribeRouteMode]</p>	<p>Enables the device to route in-dialog, refresh SIP SUBSCRIBE requests to the "working" (has connectivity) proxy.</p> <ul style="list-style-type: none"> <li>■ [0] = (Default) Disable – the device sends in-dialog, refresh SUBSCRIBES according to the address in the Contact header of the 200 OK response received from the proxy to which the initial SUBSCRIBE was sent (as per the SIP standard).</li> <li>■ [1] = Enable – the device routes in-dialog, refresh SUBSCRIBES to the "working" proxy (regardless of the Contact header). The "working" proxy (address) is determined by the device's keep-alive mechanism for the Proxy Set that was used to route the initial SUBSCRIBE.</li> </ul> <p><b>Note:</b> For this feature to be functional, ensure the following:</p> <ul style="list-style-type: none"> <li>■ Keep-alive mechanism is enabled for the Proxy Set ('Proxy Keep-Alive' parameter is set to any value other than <b>Disable</b>).</li> <li>■ Load-balancing between proxies is disabled ('Proxy Load Balancing Method' parameter is set to <b>Disable</b>).</li> </ul>
<pre>configure voip &gt; sbc settings &gt; sbc-max-fwd-limit</pre> <p>[SBCMaxForwardsLimit]</p>	<p>Defines the Max-Forwards SIP header value. The Max-Forwards header is used to limit the number of servers (such as proxies) that</p>

Parameter	Description
	<p>can forward the SIP request. The Max-Forwards value indicates the remaining number of times this request message is allowed to be forwarded. This count is decremented by each server that forwards the request.</p> <p>The parameter affects the Max-Forwards header in the received message as follows:</p> <ul style="list-style-type: none"> <li>■ If the received header's original value is 0, the message is not passed on and is rejected.</li> <li>■ If the received header's original value is less than the parameter's value, the header's value is decremented before being sent on.</li> <li>■ If the received header's original value is greater than the parameter's value, the header's value is replaced by the user-defined parameter's value.</li> </ul> <p>The valid value range is 1-70. The default is 10.</p>
<pre>configure voip &gt; sip- definition settings &gt; force- generate-to-tag [ForceGenerateToTag]</pre>	<p>Enables the device to generate the 'tag' parameter's value in the SIP To header. This is applied to the first SIP response, received from the called party, which the device sends to the dialog-initiating SIP user agent (caller). In other words, this device-generated To tag overwrites the original To tag generated by the called party. All SIP messages between the device and caller use this generated To tag, while all SIP messages between the device and called party use the To tag generated by the called party. As the device-generated To tag value is short (up to 12 characters), this feature may be useful for SIP UAs that cannot handle long tag values.</p> <p>An example of the To tag:</p> <pre>To: Alice@company.com; tag = 9777484849@10.10.1.110</pre>

Parameter	Description
	<ul style="list-style-type: none"> <li>■ [0] = Disable (default). The device forwards the To tag transparently between the SIP UAs.</li> <li>■ [1] = Enable. The device generates the To tag in the response sent to the initiator of the SIP dialog.</li> </ul> <p><b>Note:</b> The feature is applicable only if the 'SBC Operation Mode' parameter is configured to <b>B2BUA</b>. This can be configured in the SRD and IP Groups table. However:</p> <ul style="list-style-type: none"> <li>■ The IP Group's 'SBC Operation Mode' parameter takes precedence over the SRD's 'SBC Operation Mode' parameter. For example, if the IP Group is configured for B2BUA but its' associated SRD is not, then the tag-generation feature can function.</li> <li>■ If the IP Group's 'SBC Operation Mode' parameter is not configured (-1), the tag-generation feature for the IP Group is functional only if its' associated SRD is configured for B2BUA.</li> <li>■ For call routing between IP Groups, the feature can only function if both IP Groups are configured for B2BUA, or if one or both of them is not configured (-1), but the associated SRD is configured for B2BUA.</li> </ul>
<p>'Session-Expires'</p> <pre>configure voip &gt; sbc settings &gt; sbc-sess-exp-time</pre> <p>[SBCSessionExpires]</p>	<p>Defines the SBC session refresh timer (in seconds) in the Session-Expires header of outgoing INVITE messages.</p> <p>The valid value range is 90 (according to RFC 4028) to 86400. The default is 180.</p> <p><b>Note:</b> The parameter is applicable only to the SBC application.</p>
<p>'Minimum Session-Expires'</p> <pre>configure voip &gt; sbc</pre>	<p>Defines the minimum amount of time (in seconds) between session refresh requests in a dialog before the session is considered</p>



Parameter	Description
<pre>settings &gt; min-session- expires</pre> <p>[SBCMinSE]</p>	<p>timed out. This value is conveyed in the SIP Min-SE header.</p> <p>The valid range is 0 (default) to 1,000,000, where 0 means that the device does not limit Session-Expires.</p> <p><b>Note:</b> The parameter is applicable only to the SBC application.</p>
<pre>configure voip &gt; sbc settings &gt; sbc-session- refresh-policy</pre> <p>[SBCSessionRefreshingPolicy]</p>	<p>Defines the SIP user agent responsible for periodically sending refresh requests for established sessions (active calls). The session refresh allows SIP UAs or proxies to determine the status of the SIP session. When a session expires, the session is considered terminated by the UAs, regardless of whether a SIP BYE was sent by one of the UAs.</p> <p>The SIP Session-Expires header conveys the lifetime of the session, which is sent in re-INVITE or UPDATE requests (session refresh requests). The 'refresher=' parameter in the Session-Expires header (sent in the initial INVITE or subsequent 2xx response) indicates who sends the session refresh requests. If the parameter contains the value 'uac', the device performs the refreshes; if the parameter contains the value 'uas', the remote proxy performs the refreshes. An example of the Session-Expires header is shown below:</p> <pre>Session-Expires: 4000;refresher=uac</pre> <p>Thus, the parameter is useful when a UA does not support session refresh requests or does not support the indication of who performs session refresh requests. In such a scenario, the device can be configured to perform the session refresh requests.</p> <ul style="list-style-type: none"> <li>■ [0] = (Default) Remote Refresher. The UA (proxy) performs the session refresh requests. The device indicates this to the UA by sending the SIP message with the</li> </ul>

Parameter	Description
	<p>'refresher=' parameter in the Session-Expires header set to 'uas'.</p> <ul style="list-style-type: none"> <li>■ [1] = SBC Refresher. The device performs the session refresh requests. The device indicates this to the UA by sending the SIP message with the 'refresher=' parameter in the Session-Expires header set to 'uac'.</li> </ul> <p><b>Note:</b></p> <ul style="list-style-type: none"> <li>■ The time values of the Session-Expires (session refresh interval) and Min-SE (minimum session refresh interval) headers can be configured using the [SBCSessionExpires] and [SBCMinSE] parameters, respectively.</li> </ul> <p><b>Note:</b> The parameter is applicable only to the SBC application.</p>
<p>'User Registration Grace Time'</p> <pre>configure voip &gt; sbc settings &gt; sbc-usr-reg- grace-time</pre> <p>[SBCUserRegistrationGraceTime]</p>	<p>Defines additional time (in seconds) to add to the registration expiry time of users that are registered with the device.</p> <p>The valid value is 0 to 15,500,000. The default is 0.</p> <p>For more information, see <a href="#">Registration Refreshes</a>.</p>
<p>'DB Routing Search Mode'</p> <pre>configure voip &gt; sbc settings &gt; sbc-db- route-mode</pre> <p>[SBCDBRoutingSearchMode]</p>	<p>Defines the method for searching a registered user in the device's User Registration database when a SIP INVITE message is received for routing to or from a user. If the registered user is found (i.e., destination URI in INVITE), the device routes the call to the user's corresponding contact address specified in the database.</p> <ul style="list-style-type: none"> <li>■ [0] <b>All permutations</b> = (Default) <ul style="list-style-type: none"> <li>✓ <b>To User:</b> Device searches for the user in the database using the entire Request-URI (user@host). If not found, it searches for the user part of the Request-URI. For example, it</li> </ul> </li> </ul>

Parameter	Description
	<p>first searches for "4709@joe.company.com" and if not found, it searches for "4709".</p> <ul style="list-style-type: none"> <li>✓ <b>From User:</b> Device searches for the user in the database using the entire From header AOR (user@host). If not found, it searches for the user part of the From header AOR. For example, it first searches for "4709@domain.com" and if not found, it searches for "4709".</li> </ul> <p>■ [1] <b>Dest URI dependant =</b></p> <ul style="list-style-type: none"> <li>✓ <b>To User:</b> Device searches for the user in the database using the entire Request-URI (user@host) <b>only</b>. For example, it searches for "4709@joe.company.com".</li> <li>✓ <b>From User:</b> Device searches for the user in the database using the entire From header AOR (user@host) <b>only</b>. For example, for "From: &lt;sip:4709@domain.com&gt;", the device searches for "4709@domain.com".</li> </ul> <p><b>Note:</b> If the Request-URI contains the "tel:" URI or "user=phone" parameter, the device searches only for the user part.</p>
<p>'Skype Capabilities Header'  configure voip &gt; sip-  definition settings &gt; skype-  cap-hdr-enable  [DeclareAudcClient]</p>	<p>Enables the device to be identified by an AudioCodes SBC device as an AudioCodes analog device deployed in a Microsoft Skype for Business environment.</p> <ul style="list-style-type: none"> <li>■ [0] <b>Disable</b> (default)</li> <li>■ [1] <b>Enable</b> = Upon initial registration (REGISTER message) of the analog device with the SBC device, the SBC identifies the analog device as belonging to AudioCodes and enabled for operating in the Skype for Business environment. Once registered, all subsequent calls</li> </ul>

Parameter	Description
	<p>(i.e., INVITE messages) received from the analog device or destined to it are processed by the SBC.</p> <p><b>Note:</b> The parameter is applicable only to analog interfaces.</p>
<p>'Handle P-Asserted-Identity'</p> <pre>configure voip &gt; sbc settings &gt; p-assert-id</pre> <p>[SBCAssertIdentity]</p>	<p>Global parameter that defines the handling of the SIP P-Asserted-Identity header. You can also configure this feature per specific calls, using IP Profiles (IpProfile_SBCAssertIdentity). For a detailed description of the parameter and for configuring this feature in the IP Profiles table, see <a href="#">Configuring IP Profiles</a>.</p> <p><b>Note:</b> If this feature is configured for a specific IP Profile, the settings of this global parameter is ignored for calls associated with the IP Profile.</p>
<p>'Keep original user in Register'</p> <pre>configure voip &gt; sbc settings &gt; keep-contact- user-in-reg</pre> <p>[SBCKeepContactUserinRegister]</p>	<p>Defines the device's handling of the SIP Contact header in REGISTER requests which it forwards as the outgoing message.</p> <ul style="list-style-type: none"> <li>■ [0] <b>Do not keep user; override with unique identifier</b> = (Default) The device replaces the user part of the Contact header with a unique value, for example: <ul style="list-style-type: none"> <li>✓ Incoming Contact Header: &lt;sip:123@domain.com&gt;</li> <li>✓ Outgoing Contact Header: &lt;sip:FEU1-7-1-3@SBC&gt;</li> </ul> </li> <li>■ [1] <b>keep user without unique identifier</b> = The device retains the original user part value of the Contact header in the outgoing REGISTER request.</li> <li>■ [2] <b>Keep user; add unique identifier as URI parameter</b> = The device retains the original user part value of the Contact header in the outgoing REGISTER request. In addition, it adds the special URI parameter "ac-feu=&lt;identifier&gt;" to</li> </ul>

Parameter	Description
	<p>the Contact header, which is used to differentiate between two SIP entities with the same user part. The identifier value is generated by the device.</p> <ul style="list-style-type: none"> <li>✓ Incoming Contact Header: &lt;sip:123@domain.com&gt;</li> <li>✓ Outgoing Contact Header: &lt;sip:123@SBC;ac-feu=1-7-1-3&gt;</li> </ul> <p><b>Note:</b></p> <ul style="list-style-type: none"> <li>■ The parameter is applicable only to REGISTER messages received from User-type IP Groups which are sent to Server-type IP Groups.</li> <li>■ Depending on the 'Remote Representation Mode' parameter of the IP Profiles table (IpProfile_SBCRemoteRepresentationMode), the host part in the SIP Contact header can be replaced by the device's IP address or by the value of the 'SIP Group Name' parameter (configured in the IP Groups table).</li> </ul>
<p>'URI Comparison Excluded Parameters'  <code>config-voip &gt; sbc settings &gt; uri-comparison-excluded-params</code>  [SBCURIComparisonExcludedParams]</p>	<p>Defines which URI parameters are excluded when the device compares the URIs of two incoming dialog-initiating SIP requests (e.g., INVITEs) to determine if they were sent from a user that is registered in the device's registration database (registered AOR and corresponding Contact URI), during Classification.</p> <p>The value of the parameter is a free-text string, which cannot be empty. You can configure it to any sequence of parameters, separated by commas (e.g., "transport, maddr, ttl"). Alternatively, you can configure it to one of the following values (case-insensitive):</p> <ul style="list-style-type: none"> <li>■ <b>All</b> = (Default) All URI parameters (except the "gr" (gruu) parameter,</li> </ul>

Parameter	Description
	<p>"user=phone" parameter, and the AudioCodes proprietary "ac-int" parameter) and ports are excluded in the comparison of the two URIs. Therefore, if there are two different registrations of the same user whose Contacts are differentiated only by ports and/or a proprietary parameter, the device considers them to be the same single registration, even though they are different registrations.</p> <ul style="list-style-type: none"> <li>■ <b>None</b> = All URI parameters and ports are included in the comparison of the two URIs.</li> <li>■ <b>Port</b> = The ports of the URIs are excluded in the comparison of the two URIs, but all other URI parameters are included in the comparison. "port" can be combined with other URI parameters that you want excluded (e.g., port, transport, proprietary-param).</li> </ul> <p>For example, if two SIP requests are received with different Contact header values, as shown below (in bold) and the parameter is configured to <b>All</b>, then the device considers these requests as received from the same registered user as it disregards the port (5060 and 5070), 'transport', and 'ttl' parameters in its comparison. If configured to <b>None</b>, the device considers these requests as received from two different registered users.</p> <pre>Contact: &lt;sip:1000@172.17.142.105: <b>5060</b>;transport=<b>tcp</b>;ttl=<b>10</b>&gt; Contact: &lt;sip:1000@172.17.142.105: <b>5070</b>;transport=<b>tls</b>;ttl=<b>20</b>&gt;</pre> <p><b>Note:</b> The AudioCodes proprietary "feu" string value for the user part must be included in the Contact header of REGISTER</p>

Parameter	Description
	<p>requests that the device forwards to the registrar server when the parameter is configured to a non-default value (i.e., not <b>All</b>). Therefore, if you configure the parameter to a non-default value, the SBCKeepContactUserInRegister parameter must not be configured to <b>Keep User Without Unique Identifier (1)</b>.</p>
<p>'SBC REFER Behavior'  <code>configure voip &gt; sbc  settings &gt; sbc-refer-bhvr</code>  [SBCReferBehavior]</p>	<p>Global parameter that defines the handling of SIP REFER requests. You can also configure this feature per specific calls, using IP Profiles (IpProfile_  SBCRemoteReferBehavior). For a detailed description of the parameter and for configuring this feature in the IP Profiles table, see <a href="#">Configuring IP Profiles</a>.</p> <p><b>Note:</b> If this feature is configured for a specific IP Profile, the settings of this global parameter is ignored for calls associated with the IP Profile.</p>
<p><code>configure voip &gt; sbc  settings &gt; sbc-xfer-prefix</code>  [SBCXferPrefix]</p>	<p>When the SBCReferBehavior is set to 1, the device, while interworking the SIP REFER message, adds the prefix "T~&amp;R-" to the user part of the URI in the Refer-To header. After this, the device can receive an INVITE with such a prefix (the INVITE is sent by the UA that receives the REFER message or 302 response). If the device receives an INVITE with such a prefix, it replaces the prefix with the value defined for the SBCXferPrefix parameter.</p> <p>By default, no value is defined.</p> <p><b>Note:</b> This feature is also applicable to 3xx redirect responses. The device adds the prefix "T~&amp;R-" to the URI user part in the Contact header if the SBC3xxBehavior parameter is set to 1.</p>
<p><code>configure voip &gt; sbc  settings &gt; sbc-3xx-bhvt</code>  [SBC3xxBehavior]</p>	<p>Global parameter that defines the handling of SIP 3xx redirect responses. You can also configure this feature per specific calls, using</p>

Parameter	Description
	<p>IP Profiles (IpProfile_SBCRemote3xxBehavior). For a detailed description of the parameter and for configuring this feature in the IP Profiles table, see <a href="#">Configuring IP Profiles</a>.</p> <p><b>Note:</b> If this feature is configured for a specific IP Profile, the settings of this global parameter is ignored for calls associated with the IP Profile.</p>
<pre>configure voip &gt; sbc settings &gt; enforce-media- order [SBCEnforceMediaOrder]</pre>	<p>Enables the device to include all previously negotiated media lines within the current session ('m=' line) in the SDP offer-answer exchange (RFC 3264).</p> <ul style="list-style-type: none"> <li>■ [0] = (Default) Disable</li> <li>■ [1] = Enable</li> </ul> <p>For example, assume a call (audio) has been established between two endpoints and one endpoint wants to subsequently send an image in the same call session. If the parameter is enabled, the endpoint includes the previously negotiated media type (i.e., audio) with the new negotiated media type (i.e., image) in its SDP offer:</p> <pre>v=0 o=bob 2890844730 2890844731 IN IP4 host.example.com s= c=IN IP4 host.example.com t=0 0 m=audio 0 RTP/AVP 0 m=image 12345 udpt1 t38</pre> <p>If the parameter is disabled, the only 'm=' line included in the SDP is the newly negotiated media (i.e., image).</p>
<pre>'SBC Diversion URI Type' configure voip &gt; sbc settings &gt; sbc-diversion- uri-type [SBCDiversionUriType]</pre>	<p>Defines the URI type to use in the SIP Diversion header of the outgoing SIP message.</p> <ul style="list-style-type: none"> <li>■ [0] <b>Transparent</b> = (Default) The device does not change the URI and leaves it as</li> </ul>



Parameter	Description
	<p>is.</p> <ul style="list-style-type: none"> <li>■ [1] <b>Sip</b> = The "sip" URI is used.</li> <li>■ [2] <b>Tel</b> = The "tel" URI is used.</li> </ul> <p><b>Note:</b> The parameter is applicable only if the Diversion header is used. The SBCDiversionsMode and SBCHistoryInfoMode parameters in the IP Profiles table determine the call redirection (diversion) SIP header to use - History-Info or Diversion.</p>
<pre>configure voip &gt; sbc settings &gt; sbc-server-auth- mode</pre> <p>[SBCServerAuthMode]</p>	<p>Defines whether authentication of the SIP client is done locally (by the device) or by a RADIUS server.</p> <ul style="list-style-type: none"> <li>■ [0] = (Default) Authentication is done by the device (locally).</li> <li>■ [1] = Authentication is done by an RFC 5090 compliant RADIUS server.</li> <li>■ [2] = Authentication is done according to the Draft Sterman-aaa-sip-01 method.</li> </ul> <p><b>Note:</b></p> <ul style="list-style-type: none"> <li>■ Currently, option [1] is not supported.</li> <li>■ The parameter is overridden by the IP Group parameter, 'SBC Server Authentication' (IPGroup_TypeSBCServerAuthType).</li> </ul>
<p>'Lifetime of nonce'</p> <pre>configure voip &gt; sbc settings &gt; lifetime-of-nonce</pre> <p>[AuthNonceDuration]</p>	<p>Defines the lifetime (in seconds) that the current nonce is valid for server-based authentication. The device challenges a message that attempts to use a server nonce beyond this period. The parameter is used to provide replay protection (i.e., ensures that old communication streams are not used in replay attacks).</p> <p>The valid value range is 30 to 600. The default is 300.</p>
<p>'Authentication Challenge Method'</p>	<p>Defines the type of server-based</p>

Parameter	Description
<pre>configure voip &gt; sbc settings &gt; auth-chlng-mthd</pre> <p>[AuthChallengeMethod]</p>	<p>authentication challenge.</p> <ul style="list-style-type: none"> <li>■ [0] <b>0</b> = (Default) Send SIP 401 "Unauthorized" with a WWW-Authenticate header as the authentication challenge response.</li> <li>■ [1] <b>1</b> = Send SIP 407 "Proxy Authentication Required" with a Proxy-Authenticate header as the authentication challenge response.</li> </ul>
<p>'Authentication Quality of Protection'</p> <pre>configure voip &gt; sbc settings &gt; auth-qop</pre> <p>[AuthQOP]</p>	<p>Defines the authentication and integrity level of quality of protection (QoP) for digest authentication offered to the client. When the device challenges a SIP request (e.g., INVITE), it sends a SIP 401 response with the Proxy-Authenticate header or WWW-Authenticate header containing the 'qop' parameter. The QoP offered in the 401 response can be 'auth', 'auth-int', both 'auth' and 'auth-int', or the 'qop' parameter can be omitted from the 401 response. In response to the 401, the client needs to send the device another INVITE with the MD5 hash of the INVITE message and indicate the selected auth type.</p> <ul style="list-style-type: none"> <li>■ [0] <b>0</b> = The device sends 'qop=auth' in the SIP response, requesting authentication (i.e., validates user by checking user name and password). This option does not authenticate the message body (i.e., SDP).</li> <li>■ [1] <b>1</b> = The device sends 'qop=auth-int' in the SIP response, indicating required authentication and authentication with integrity (e.g., checksum). This option restricts the client to authenticating the entire SIP message, including the body, if present.</li> <li>■ [2] <b>2</b> = (Default) The device sends 'qop=auth, auth-int' in the SIP response,</li> </ul>

Parameter	Description
	<p>indicating either authentication or integrity. This enables the client to choose 'auth' or 'auth-int'. If the client chooses 'auth-int', then the body is included in the authentication. If the client chooses 'auth', then the body is not authenticated.</p> <p>■ [3] 3 = No 'qop' parameter is offered in the SIP 401 challenge message.</p>
<p>'SBC User Registration Time'  <code>configure voip &gt; sbc  settings &gt; sbc-usr-rgstr-  time</code>  [SBCUserRegistrationTime]</p>	<p>Global parameter that defines the duration (in seconds) of the periodic registrations that occur between the user and the device (the device responds with this value to the user). You can also configure this feature per specific calls, using IP Profiles (IpProfile_SBCUserRegistrationTime). For a detailed description of the parameter and for configuring this feature in the IP Profiles table, see <a href="#">Configuring IP Profiles</a>.</p> <p><b>Note:</b> If this feature is configured for a specific IP Profile, the settings of this global parameter is ignored for calls associated with the IP Profile.</p>
<p>'SBC Proxy Registration Time'  <code>configure voip &gt; sbc  settings &gt; sbc-prxy-rgstr-  time</code>  [SBCProxyRegistrationTime]</p>	<p>Defines the duration (in seconds) for which the user is registered in the proxy database (after the device forwards the REGISTER message). This value is sent in the Expires header. When set to 0, the device sends the Expires header's value as received from the user to the proxy.</p> <p>The valid range is 0 to 2,000,000 seconds. The default is 0.</p>
<p><code>configure voip &gt; sbc  settings &gt; sbc-rand-expire</code>  [SBCRandomizeExpires]</p>	<p>Enables the device to change the expiry time in the Expires header of SIP 200 OK responses for user registration or subscription requests.</p> <p>The feature is useful in scenarios where multiple users may refresh their registration or subscription simultaneously, causing the</p>

Parameter	Description
	<p>device to handle many such sessions at a given time. This may result in an overload of the device (reaching maximum session capacity), preventing the establishment of new calls or preventing the handling of some user registration or subscription requests. However, when this feature is enabled, the device assigns a random expiry time to each user registration or subscription, ensuring future user registration and subscription requests are more distributed over time (i.e., do not all occur simultaneously).</p> <p>The valid value is 0 (disabled) to 20 (any value from 1 to 20 is considered enabled). The default is enabled (10). If disabled (i.e., 0), the device does not change the expiry time. If enabled, the device assigns a random expiry time as follows:</p> <ul style="list-style-type: none"> <li>■ If the received expiry time is less than 610 sec, the device reduces the time by up to 10 sec. For example, if the received expiry time is 110 sec, the device reduces it to anywhere between 100 (i.e., 110 – 10) and 110 sec.</li> <li>■ If the received expiry time is greater than 610 sec, the device reduces the time to anywhere between 600 sec and the received expiry time. For example, if the received expiry time is 700 sec, the device reduces it to anywhere between 600 and 700 sec.</li> <li>■ Minimum expiry time: <ul style="list-style-type: none"> <li>✓ The minimum expiry time that the device can reduce REGISTER messages to is 30 sec and SUBSCRIBE messages to 120 sec. For example, if the received expiry time in a REGISTER message is 35 sec, the device reduces the time to any value between 30 and 35 sec (and not by</li> </ul> </li> </ul>

Parameter	Description
	<p>10 seconds -- between 25 and 35).</p> <ul style="list-style-type: none"> <li>✓ If the received expiry time is less than the minimum (as stated above), the expiry time remains unchanged. For example, if the received expiry time in a REGISTER message is 18 sec, the device forwards the message with this same expiry time (i.e., 18).</li> </ul> <p><b>Note:</b></p> <ul style="list-style-type: none"> <li>■ This feature does not apply to refresh REGISTER or SUBSCRIBE messages.</li> <li>■ You can configure the device to change the received expiry time before forwarding it, using the SBCUserRegistrationTime parameter.</li> </ul>
<p>'SBC Survivability Registration Time'</p> <pre>configure voip &gt; sbc settings &gt; sbc-surv-rgstr- time</pre> <p>[SBCSurvivabilityRegistrationTime]</p>	<p>Defines the duration of the periodic registrations between the user and the device, when the device is in survivability state (i.e., when REGISTER requests cannot be forwarded to the proxy and are terminated by the device). When set to 0, the device uses the value set by the SBCUserRegistrationTime parameter for the device's response.</p> <p>The valid range is 0 to 2,000,000 seconds. The default is 0.</p>
<pre>configure voip &gt; sbc settings &gt; sas-notice</pre> <p>[SBCEnableSurvivabilityNotice]</p>	<p>Enables the device to notify Aastra IP phones that the device is currently operating in Survivability mode.</p> <ul style="list-style-type: none"> <li>■ [0] = Disable</li> <li>■ [1] = Enable</li> </ul> <p>For more information, see <a href="#">Enabling Survivability Display on Aastra IP Phones</a>.</p>
<p>'SBC Dialog-Info Interworking'</p> <pre>configure voip &gt; sbc settings &gt; sbc-dialog-info-</pre>	<p>Enables the interworking of dialog information (parsing of call identifiers in XML body) in SIP NOTIFY messages received from</p>

Parameter	Description
<pre>interwork</pre> <p>[EnableSBCDialogInfoInterworking]</p>	<p>a remote application server.</p> <ul style="list-style-type: none"> <li>■ [0] <b>Disable</b> (default)</li> <li>■ [1] <b>Enable</b></li> </ul> <p>For more information, see <a href="#">Interworking Dialog Information in SIP NOTIFY Messages</a>.</p>
<pre>configure voip &gt; sbc settings &gt; sbc-keep-call-id</pre> <p>[SBCKeepOriginalCallId]</p>	<p>Global parameter that enables the device to use the same call identification (SIP Call-ID header value) received in incoming messages for the call identification in outgoing messages. The call identification value is contained in the SIP Call-ID header. You can also configure the feature per specific calls, using IP Profiles. For a detailed description of the parameter and for configuring the feature in the IP Profiles table, see <a href="#">Configuring IP Profiles</a>.</p>
<p>'Routing Timeout'</p> <pre>configure voip &gt; sbc settings &gt; sbc-routing- timeout</pre> <p>[SbcRoutingTimeout]</p>	<p>Defines the maximum duration (in seconds) that the device is prepared to wait for a response from external servers when a routing rule is configured to query an external server (e.g., LDAP server) on whose response the device uses to determine the routing destination.</p> <p>The valid value is 0 to 60. The default is 10.</p> <p>For more information, see <a href="#">Configuring a Routing Response Timeout</a> on page 992.</p>
<p>'SBC GRUU Mode'</p> <pre>configure voip &gt; sbc settings &gt; sbc-gruu-mode</pre> <p>[SBCGruuMode]</p>	<p>Determines the Globally Routable User Agent (UA) URI (GRUU) support, according to RFC 5627.</p> <ul style="list-style-type: none"> <li>■ [0] <b>None</b> = No GRUU is supplied to users.</li> <li>■ [1] <b>As Proxy</b> = (Default) The device provides same GRUU types as the proxy provided the device's GRUU clients.</li> <li>■ [2] <b>Temporary only</b> = Supply only temporary GRUU to users. (Currently not supported.)</li> <li>■ [3] <b>Public only</b> = The device provides</li> </ul>

Parameter	Description
	<p>only public GRUU to users.</p> <ul style="list-style-type: none"> <li>■ [4] <b>Both</b> = The device provides temporary and public GRUU to users. (Currently not supported.)</li> </ul> <p>The parameter allows the device to act as a GRUU server for its SIP UA clients, providing them with public GRUU's, according to RFC 5627. The public GRUU provided to the client is denoted in the SIP Contact header parameters, "pub-gruu". Public GRUU remains the same over registration expirations. On the other SBC leg communicating with the Proxy/Registrar, the device acts as a GRUU client.</p> <p>The device creates a GRUU value for each of its registered clients, which is mapped to the GRUU value received from the Proxy server. In other words, the created GRUU value is only used between the device and its clients (endpoints).</p> <p>Public-GRUU:  sip:userA@domain.com;gr=unique-id</p>
<p>'BYE Authentication'  configure voip &gt; sbc  settings &gt; sbc-bye-auth  [SBCEnableByeAuthentication]</p>	<p>Enables authenticating a SIP BYE request before disconnecting the call. This feature prevents, for example, a scenario in which the SBC SIP client receives a BYE request from a third-party imposer assuming the identity of a participant in the call and as a consequence, the call between the first and second parties is inappropriately disconnected.</p> <ul style="list-style-type: none"> <li>■ [0] <b>Disable</b> (default)</li> <li>■ [1] <b>Enable</b> = The device forwards the SIP authentication response (for the BYE request) to the request sender and waits for the user to authenticate it. The call is disconnected only if the authenticating server responds with a 200 OK.</li> </ul>

Parameter	Description
<p>'SUBSCRIBE Trying'</p> <pre>configure voip &gt; sbc settings &gt; sbc-subs-try</pre> <p>[SBCSendTryingToSubscribe]</p>	<p>Enables the device to send a SIP 100 Trying response upon receipt of a SUBSCRIBE or NOTIFY message.</p> <ul style="list-style-type: none"> <li>■ [0] <b>Disable</b> (default)</li> <li>■ [1] <b>Enable</b></li> </ul>
<pre>configure voip &gt; sbc settings &gt; sbc-100trying- upon-reinvite</pre> <p>[SBC100TryingUponReinvite]</p>	<p>Enables the device to send a SIP 100 Trying response upon receipt of a re-INVITE request.</p> <ul style="list-style-type: none"> <li>■ [0] = (Default) Disable</li> <li>■ [1] = Enable</li> </ul>
<p>'BroadWorks Survivability Feature'</p> <pre>configure voip &gt; sbc settings &gt; sbc-broadworks- survivability</pre> <p>[SBCExtensionsProvisioningMode]</p>	<p>Enables SBC user registration for interoperability with BroadSoft's BroadWorks server, to provide call survivability in case of connectivity failure with the BroadWorks server.</p> <ul style="list-style-type: none"> <li>■ [0] <b>Disable</b> = (Default) Normal processing of REGISTER messages.</li> <li>■ [1] <b>Enable</b> = Registration method for BroadWorks server. In a failure scenario with BroadWorks, the device acts as a backup SIP proxy server, maintaining call continuity between the enterprise LAN users (subscribers) and between the subscribers and the PSTN (if provided).</li> </ul> <p><b>Note:</b> For a detailed description of this feature, see <a href="#">Enabling Auto-Provisioning of Subscriber-Specific Information of BroadWorks Server for Survivability</a>.</p>
<p>'SBC Direct Media'</p> <pre>configure voip &gt; sip- interface &gt; sbc-direct-media</pre> <p>[SBCDirectMedia]</p>	<p>Enables the Direct Media feature (i.e., no Media Anchoring) for all SBC calls, whereby SIP signaling is handled by the device without handling the RTP/SRTP (media) flow between the user agents (UA). The RTP packets do not traverse the device. Instead, the two SIP UAs establish a direct RTP/SRTP flow between one another. Signaling continues to traverse the device with</p>



Parameter	Description
	<p>minimal intermediation and involvement to enable certain SBC abilities such as routing</p> <ul style="list-style-type: none"> <li>■ [0] <b>Disable</b> = (Default) All calls traverse the device (i.e., no direct media).</li> <li>■ [1] <b>Enable</b> = Direct media flow between endpoints for all SBC calls.</li> </ul> <p><b>Note:</b></p> <ul style="list-style-type: none"> <li>■ The setting of direct media in the SIP Interfaces table overrides this global parameter. In other words, even if the parameter is disabled for direct media (i.e., Media Anchoring is enabled), if direct media is enabled for a SIP Interface (in the SIP Interfaces table), calls between endpoints belonging to the SIP Interface employ direct media.</li> <li>■ For more information on No Media Anchoring, see <a href="#">Direct Media</a>.</li> </ul>
<p>'Transcoding Mode'  <code>configure voip &gt; sbc</code>  <code>settings &gt; transcoding-mode</code>            [TranscodingMode]</p>	<p>Global parameter that defines the voice transcoding mode (media negotiation). You can also configure this feature per specific calls, using IP Profiles (IpProfile_TranscodingMode). For a detailed description of the parameter and for configuring this feature in the IP Profiles table, see <a href="#">Configuring IP Profiles</a>.</p> <p><b>Note:</b> If this feature is configured for a specific IP Profile, the settings of this global parameter is ignored for calls associated with the IP Profile.</p>
<p>'Preferences Mode'  <code>configure voip &gt; sbc</code>  <code>settings &gt; sbc-preferences</code>            [SBCPreferencesMode]</p>	<p>Determines the order of the Extension coders (coders added if there are no common coders between SDP offered coders and Allowed coders) and Allowed coders (configured in the Allowed Audio Coders Groups table) in the outgoing SIP message (in the SDP).</p> <ul style="list-style-type: none"> <li>■ [0] <b>Doesn't Include Extensions</b> =</li> </ul>

Parameter	Description
	<p>(Default) Extension coders are added at the end of the coder list.</p> <ul style="list-style-type: none"> <li>■ [1] <b>Include Extensions</b> = Extension coders and Allowed coders are arranged according to their order of appearance in the Allowed Audio Coders Groups table.</li> </ul> <p><b>Note:</b></p> <ul style="list-style-type: none"> <li>■ The parameter is applicable only if a Coders Group for Extension coders is assigned to the IP Profile (IPProfile_SBCExtensionCodersGroupName).</li> </ul>
<p>'Reserve DSP on SDP Offer'</p> <pre>configure voip &gt; sbc settings &gt; reserve-dsp-on- sdp-offer</pre> <p>[ReserveDSPOnSDPOffer]</p>	<p>Enables the device to allocate DSP resources for a call at the SDP Offer or SDP Answer stage.</p> <ul style="list-style-type: none"> <li>■ [0] <b>Disable</b> = The device allocates DSPs if available and required (e.g., for transcoding) for the call at the SDP Answer stage.</li> <li>■ [1] <b>Enable</b> = (Default) The device allocates and reserves DSPs (if available) for the call at the SDP Offer.</li> </ul> <p>For more information on this feature, see <a href="#">Allocating DSPs on SDP Offer or Answer</a> on page 923.</p>
<p>'SBC RTCP Mode'</p> <pre>configure voip &gt; sbc settings &gt; sbc-rtcp-mode</pre> <p>[SBCRTCPMode]</p>	<p>Global parameter that defines the handling of RTCP packets. You can also configure this feature per specific calls, using IP Profiles (IPProfile_SBCRTCPMode). For a detailed description of the parameter and for configuring this feature in the IP Profiles table, see <a href="#">Configuring IP Profiles</a>.</p> <p><b>Note:</b> If this feature is configured for a specific IP Profile, the settings of this global parameter is ignored for calls associated with the IP Profile.</p>
<pre>configure voip &gt; sbc settings &gt; sbc-send-invite-</pre>	<p>Enables call forking of INVITE message</p>

Parameter	Description
<p>to-all-contacts [SBCSendInviteToAllContacts]</p>	<p>received with a Request-URI of a specific contact registered in the device's database, to all users under the same AOR as the contact.</p> <ul style="list-style-type: none"> <li>■ [0] <b>Disable</b> = (Default) Sends the INVITE only to the contact of the received Request-URI.</li> <li>■ [1] <b>Enable</b></li> </ul> <p>To configure call forking initiated by the device, see <a href="#">Initiating SIP Call Forking</a>.</p>
<p>'SBC Shared Line Registration Mode' configure voip &gt; sbc settings &gt; sbc-shared-line- reg-mode [SBCSharedLineRegMode]</p>	<p>Enables the termination on the device of SIP REGISTER messages from secondary lines that belong to the Shared Line feature.</p> <ul style="list-style-type: none"> <li>■ [0] <b>Disable</b> = (Default) Device forwards the REGISTER messages as is (i.e., not terminated on the device).</li> <li>■ [1] <b>Enable</b> = REGISTER messages of secondary lines are terminated on the device.</li> </ul> <p><b>Note:</b> The device always forwards REGISTER messages of the primary line.</p>
<p>'SBC Forking Handling Mode' configure voip &gt; sbc settings &gt; sbc-forking- handling-mode [SBCForkingHandlingMode]</p>	<p>Defines the handling of SIP 18x responses that are received due to call forking of an INVITE.</p> <ul style="list-style-type: none"> <li>■ [0] <b>Latch On First</b> = (Default) Only the first 18x is forwarded to the INVITE-initiating UA. If SIP 18x with SDP is received, the device opens a voice stream according to the received SDP and disregards any subsequent 18x forking responses (with or without SDP). If the first response is 180 without SDP, the device sends it to the other side.</li> <li>■ [1] <b>Sequential</b> = All 18x responses are forwarded, one at a time (sequentially) to the INVITE-initiating UA. If a 18x arrives with an offer only, then only the first offer is forwarded to the INVITE-</li> </ul>

Parameter	Description
	<p>initiating UA and subsequent 18x responses are discarded.</p>
<p>'Gateway Direct Route Prefix'  <code>configure voip &gt; sbc  settings &gt; gw-direct-route-  prefix</code>  [GWDirectRoutePrefix]</p>	<p>Defines the prefix destination Request-URI user part that is appended to the original user part for alternative IP-to-IP call routing from SBC to Gateway (Tel) interfaces.</p> <p>The valid value is a string of up to 16 characters. The default is "acgateway-&lt;original prefix destination number&gt;". For example, "acgateway-200".</p> <p>For more information, see <a href="#">Configuring SBC IP-to-IP Routing Rules</a>.</p>
<p><code>configure voip &gt; sbc  settings &gt; sbc-media-sync</code>  [EnableSBCMediaSync]</p>	<p>Enables synchronization of media between two SIP user agents when a call is established between them. Media synchronization means that the media is properly negotiated (SDP offer/answer) between the user agents. In some scenarios, the call is established despite the media not being synchronized. This may occur, for example, in call transfer (SIP REFER) where the media between the transfer target and transferee are not synchronized. The device performs media synchronization by sending a re-INVITE immediately after the call is established in order for the user agents to negotiate the media (SDP offer/answer).</p> <ul style="list-style-type: none"> <li>■ [0] = (Default) Disable. Media synchronization is performed only if the RTP mode (e.g., a=sendrecv, a=sendonly, a=recvonly, and a=inactive) between the user agents are different and synchronization is required.</li> <li>■ [1] = Enable. Media synchronization is performed if the media, including RTP mode or any other media such as coders, is different and has not been negotiated between the user agents.</li> </ul>

Parameter	Description
<p>'Remove SIPs from Non-Secured Transport'</p> <pre>configure voip &gt; sbc settings &gt; sbc-remove-sips- non-sec-transp</pre> <p>[SBCRemoveSIPsFromNonSecuredTransport]</p>	<ul style="list-style-type: none"> <li>■ [2] = Never. Media synchronization is never performed.</li> </ul> <p>Defines the SIP headers for which the device replaces “sips:” with “sip:” in the outgoing SIP-initiating dialog request (e.g., INVITE) when the destination transport type is unsecured (e.g., UDP). (The “sips:” URI scheme indicates secured transport, for example, TLS.)</p> <ul style="list-style-type: none"> <li>■ [0] <b>Disable</b> = (Default) The device replaces “sips:” with “sip:” for the Request-URI and Contact headers only (and retains “sips:” for all other headers).</li> <li>■ [1] <b>Enable</b> = The device replaces “sips:” with “sip:” for the Request-URI, Contact, From, To, P-Asserted, P-Preferred, and Route headers.</li> </ul>
<p>'SBC Fax Detection Timeout'</p> <pre>configure voip &gt; sbc settings &gt; sbc-fax- detection-timeout</pre> <p>[SBCFaxDetectionTimeout]</p>	<p>Defines the duration (in seconds) for which the device attempts to detect fax (CNG tone) immediately upon the establishment of a voice session. The interval starts from the establishment of the voice call.</p> <p>The valid value is 1 to any integer. The default is 10.</p> <p>The feature applies to faxes that are sent immediately after the voice channel is established (i.e., after 200 OK).</p> <p>You can configure the handling of fax negotiation by the device for specific calls, using IP Profiles configured in the IP Profiles table (see the IpProfile_ SBCRemoteRenegotiateOnFaxDetection parameter in <a href="#">Configuring IP Profiles</a>).</p>
<p>'SIP Topology Hiding Mode'</p> <pre>configure voip &gt; sbc settings &gt; sip-topology- hiding-mode</pre> <p>[SIPTopologyHidingMode]</p>	<p>Enables the device to overwrite the host part in SIP headers with IP addresses, unless the relevant host name parameters of the IP Group ('SIP Group Name' and 'SIP Source Host Name') are configured:</p>

Parameter	Description
	<ul style="list-style-type: none"> <li>■ Headers concerned with the source of the message are overwritten with the IP address of the IP Interface from where the device sends the message.</li> <li>■ Headers concerned with the destination of the message are overwritten with the destination IP address.</li> </ul> <p>The parameter can be configured to one of the following values:</p> <ul style="list-style-type: none"> <li>■ <b>[0] By Host Name Parameters Only = (Default)</b> The device overwrites the host part in the SIP headers according to the configuration of the IP Group's 'SIP Group Name' and 'SIP Source Host Name' parameters. If these parameters are empty, the device doesn't overwrite the host part of the headers.</li> <li>■ <b>[1] Fallback to IP Addresses =</b> This option is applicable only to dialog-initiating requests and in-dialog REFER requests. <ul style="list-style-type: none"> <li>✓ If the 'SIP Group Name' parameter of the destination IP Group is empty, the device overwrites the host part of the following destination-related SIP headers with the destination IP address: Request-URI and P-Called-Party-ID for all types of requests, and To header for non-REGISTER requests. If the 'SIP Group Name' parameter is configured, the device overwrites the host part in these headers with the configured value.</li> <li>✓ The source-related headers which are overwritten when the 'SIP Source Host Name' parameter is configured (From, P-Asserted-Identity, P-Preferred-Identity,</li> </ul> </li> </ul>

Parameter	Description
	<p>Referred-By, P-Charge-Info, Remote-Party-ID, P-Associated-URI, Diversion, and History-info) are always overwritten. If the 'SIP Source Host Name' parameter of the destination IP Group is configured, the device overwrites the host part with the configured value. If the 'SIP Source Host Name' parameter of the destination IP Group is empty, the device overwrites the host part of the mentioned headers with the IP address of the device's IP Interface from where it sends the message.</p> <p>For more information on the IP Group parameters 'SIP Group Name' and 'SIP Source Host Name', see <a href="#">Configuring IP Groups</a> on page 431.</p>
<b>Push Notification Service</b>	
<pre>configure voip &gt; sbc settings &gt; pns-reminder- period [PNSReminderPeriod]</pre>	<p>Defines the time (in seconds) before the user's registration with the device expires, at which the device sends an HTTP message to the Push Notification Server to trigger it into sending a push notification to the user to remind the user to send a REGISTER refresh message to the device.</p> <p>The valid value range is 30 to 300. The default is 120.</p>
<pre>configure voip &gt; sbc settings &gt; pns-register- timeout [PNSRegisterTimeout]</pre>	<p>Defines the maximum time (in seconds) that the device waits for a SIP REGISTER refresh message from the user, before it forwards an incoming SIP dialog-initiating request (e.g., INVITE) to the user.</p> <p>The valid value range is 5 to 50. The default is 30.</p> <p>When the device receives an incoming SIP dialog-initiating request whose destination is the user, it sends an HTTP message to the Push Notification Server to trigger it into</p>

Parameter	Description
	<p>sending the user a push notification so that the user can send a REGISTER refresh message to the device. If the device receives the REGISTER refresh message within this timeout, it forwards the incoming SIP request to the user. If the timeout expires and the device still hasn't received the REGISTER refresh message, the device rejects the call.</p>

## Supplementary Services

The SBC and CRP supplementary services parameters are described in the table below.

**Table 70-68:SBC and CRP Supplementary Services Parameters**

Parameter	Description
<p><b>Emergency Call Preemption Parameters</b></p> <p>For more information on SBC emergency call preemption, <a href="#">Configuring Call Preemption for SBC Emergency Calls</a>.</p>	
<p>'SBC Preemption Mode'</p> <pre>configure voip &gt; sbc settings &gt; sbc- preemption-mode [SBCPreemptionMode]</pre>	<p>Enables SBC emergency call preemption.</p> <ul style="list-style-type: none"> <li>■ [0] <b>Disable</b> (default)</li> <li>■ [1] <b>Enable</b></li> </ul>
<p>'Emergency Message Condition'</p> <pre>configure voip &gt; sbc settings &gt; sbc-emerg- condition [SBCEmergencyCondition]</pre>	<p>Defines the index of the Message Condition rule in the Message Conditions table that is used to identify emergency calls.</p> <p><b>Note:</b> The device applies the rule only after call classification (but before inbound manipulation).</p>
<p>'Emergency RTP DiffServ'</p> <pre>configure voip &gt; sbc settings &gt; sbc-emerg- rtp-diffserv [SBCEmergencyRTPDiffserv]</pre>	<p>Defines DiffServ bits sent in the RTP for SBC emergency calls.</p> <p>The valid value is 0 to 63. The default is 46.</p>
<p>'Emergency Signaling DiffServ'</p> <pre>configure voip &gt; sbc settings &gt; sbc-emerg-</pre>	<p>Defines DiffServ bits sent in SIP signaling messages for SBC emergency calls. This is included in the SIP Resource-Priority header.</p>



Parameter	Description
sig-diffserv [SBCEmergencySignalingDiffServ]	The valid value is 0 to 63. The default is 40.

## IP Media Parameters

The IP media parameters are described in the table below.

**Table 70-69:IP Media Parameters**

Parameter	Description
'IPMedia Detectors' configure voip > media ipmedia > ipm- detectors-enable [EnableDSPIPMDetectors]	<p>Enables the device's DSP detectors for detection features such as AMD.</p> <ul style="list-style-type: none"> <li>■ [0] <b>Disable</b> (default)</li> <li>■ [1] <b>Enable</b></li> </ul> <p><b>Note:</b></p> <ul style="list-style-type: none"> <li>■ For the parameter to take effect, a device reset is required.</li> <li>■ The DSP Detectors feature is available only if the device is installed with a License Key that includes this feature. For installing a License Key, see <a href="#">License Key</a>.</li> <li>■ When enabled (1), the number of available channels is reduced.</li> </ul>
'Number of Media Channels' configure voip > sbc settings > media- channels [MediaChannels]	<p>Defines the maximum number of DSP channels that can be used for features requiring DSP resources, for example, coder transcoding, DTMF transcoding, and answer machine detection (AMD). This parameter is used to limit the use of DSP channels. The default is -1, meaning that the maximum number of DSP channels, as licensed in the License Key ('DSP Channels') are made available.</p> <p><b>Note:</b></p> <ul style="list-style-type: none"> <li>■ Most SBC features that require DSP resources use two DSP channels. For example, if the device needs to perform coder transcoding between two endpoints where one uses the G.711 coder and the other G.729, and a maximum of 100 concurrent transcoding sessions need to be</li> </ul>

Parameter	Description
	<p>supported, the device would use 200 DSP channels. For this scenario, you would configure the parameter to 200.</p> <ul style="list-style-type: none"> <li>■ If you modify the parameter to a value that is less than the number of DSP channels currently being used by the device for currently active calls, the device allows these calls to continue (and does not terminate them).</li> <li>■ The device can obtain additional DSP resources for SBC functionality requiring DSP resources from PRI interfaces (if installed) and MPM modules (if installed). For more information, see <a href="#">DSP Channel Resources for Transcoding</a> on page 230.</li> </ul>
<p>IP-media-channels-enable [EnableIPMediaChannels]</p>	<p>Enables IP media channel support.</p> <ul style="list-style-type: none"> <li>■ [0] = Disable (default)</li> <li>■ [1] = Enable</li> </ul> <p><b>Note:</b></p> <ul style="list-style-type: none"> <li>■ When the device is installed with an MPM, the parameter is enabled by default.</li> <li>■ For the parameter to take effect, a device reset is required.</li> </ul>
<p>[IPmediaChannels]</p>	<p>This table ini file parameter defines the number of DSP channels that are "borrowed" from each of the device's digital modules for IP media feature. The format of the ini file table parameter is as follows:</p> <pre>[ IPMediaChannels ] FORMAT IPMediaChannels_Index = IPMediaChannels_ModuleID, IPMediaChannels_ DSPChannelsReserved; [ \IPMediaChannels ]</pre> <p>For example, the below settings use 15 and 10 DSP channels from modules 1 and 2, respectively:</p> <pre>IPMediaChannels 1 = 1, 15; IPMediaChannels 2 = 2, 10;</pre> <p><b>Note:</b></p> <ul style="list-style-type: none"> <li>■ The value of DSPChannelsReserved must be in</li> </ul>

Parameter	Description
	<p>multiples of 5 (since the reservation is done per DSP device and not per DSP channel).</p> <ul style="list-style-type: none"> <li>■ By default, the MPM is set to the maximum value of IPM channels, therefore, there is no need to define it.</li> <li>■ By default, a digital module (i.e., TRUNKS module) is set to 0 IPM channels.</li> <li>■ For DSP utilization options, see <a href="#">DSP Channel Resources</a>.</li> </ul>
<b>Conferencing Parameters</b>	
<p>'Conference ID'</p> <pre>configure voip &gt; gateway dtmf-supp- service supp-service- settings &gt; conf-id [ConferenceID]</pre>	<p>Defines the Conference Identification string. The valid value is a string of up to 16 characters. The default is "conf".</p> <p><b>Note:</b> To join a conference, the INVITE URI must include the Conference ID string preceded by the number of the participants in the conference and terminated by a unique number. For example:</p> <pre>INVITE sip:4conf1234@10.1.10.10</pre> <p>INVITE messages with the same URI join the same conference.</p>
<b>Automatic Gain Control (AGC) Parameters</b>	
<p>'Enable AGC'</p> <pre>configure voip &gt; media ipmedia &gt; agc-enable [EnableAGC]</pre>	<p>Global parameter enabling the AGC feature. You can also configure the feature per specific calls, using Tel Profiles (TelProfile_EnableAGC). For a detailed description of the parameter and for configuring the feature in the Tel Profiles table, see <a href="#">Configuring Tel Profiles</a>.</p> <p>Note: If the feature is configured for a specific Tel Profile, the settings of the global parameter is ignored for calls associated with the Tel Profile. For a description of AGC, see <a href="#">Automatic Gain Control (AGC)</a>.</p>
<p>'AGC Slope'</p> <pre>configure voip &gt; media ipmedia &gt; agc-gain- slope</pre>	<p>Determines the AGC convergence rate:</p> <ul style="list-style-type: none"> <li>■ [0] <b>0</b> = 0.25 dB/sec</li> <li>■ [1] <b>1</b> = 0.50 dB/sec</li> </ul>

Parameter	Description
[AGCGainSlope]	<ul style="list-style-type: none"> <li data-bbox="767 286 1034 320">■ [2] <b>2</b> = 0.75 dB/sec</li> <li data-bbox="767 342 1139 376">■ [3] <b>3</b> = 1.00 dB/sec (default)</li> <li data-bbox="767 398 1034 432">■ [4] <b>4</b> = 1.25 dB/sec</li> <li data-bbox="767 454 1034 488">■ [5] <b>5</b> = 1.50 dB/sec</li> <li data-bbox="767 510 1034 544">■ [6] <b>6</b> = 1.75 dB/sec</li> <li data-bbox="767 566 1034 600">■ [7] <b>7</b> = 2.00 dB/sec</li> <li data-bbox="767 622 1034 656">■ [8] <b>8</b> = 2.50 dB/sec</li> <li data-bbox="767 678 1034 712">■ [9] <b>9</b> = 3.00 dB/sec</li> <li data-bbox="767 734 1062 768">■ [10] <b>10</b> = 3.50 dB/sec</li> <li data-bbox="767 790 1062 824">■ [11] <b>11</b> = 4.00 dB/sec</li> <li data-bbox="767 846 1062 880">■ [12] <b>12</b> = 4.50 dB/sec</li> <li data-bbox="767 902 1062 936">■ [13] <b>13</b> = 5.00 dB/sec</li> <li data-bbox="767 958 1062 992">■ [14] <b>14</b> = 5.50 dB/sec</li> <li data-bbox="767 1014 1062 1048">■ [15] <b>15</b> = 6.00 dB/sec</li> <li data-bbox="767 1070 1062 1104">■ [16] <b>16</b> = 7.00 dB/sec</li> <li data-bbox="767 1126 1062 1160">■ [17] <b>17</b> = 8.00 dB/sec</li> <li data-bbox="767 1182 1062 1216">■ [18] <b>18</b> = 9.00 dB/sec</li> <li data-bbox="767 1238 1075 1272">■ [19] <b>19</b> = 10.00 dB/sec</li> <li data-bbox="767 1294 1075 1328">■ [20] <b>20</b> = 11.00 dB/sec</li> <li data-bbox="767 1350 1075 1384">■ [21] <b>21</b> = 12.00 dB/sec</li> <li data-bbox="767 1406 1075 1440">■ [22] <b>22</b> = 13.00 dB/sec</li> <li data-bbox="767 1462 1075 1496">■ [23] <b>23</b> = 14.00 dB/sec</li> <li data-bbox="767 1518 1075 1552">■ [24] <b>24</b> = 15.00 dB/sec</li> <li data-bbox="767 1574 1075 1608">■ [25] <b>25</b> = 20.00 dB/sec</li> <li data-bbox="767 1630 1075 1664">■ [26] <b>26</b> = 25.00 dB/sec</li> <li data-bbox="767 1686 1075 1720">■ [27] <b>27</b> = 30.00 dB/sec</li> <li data-bbox="767 1742 1075 1776">■ [28] <b>28</b> = 35.00 dB/sec</li> <li data-bbox="767 1798 1075 1832">■ [29] <b>29</b> = 40.00 dB/sec</li> <li data-bbox="767 1854 1075 1888">■ [30] <b>30</b> = 50.00 dB/sec</li> <li data-bbox="767 1910 1075 1944">■ [31] <b>31</b> = 70.00 dB/sec</li> </ul>

Parameter	Description
'AGC Redirection' configure voip > media ipmedia > agc- redirection [AGCRedirection]	Determines the AGC direction.  ■ [0] <b>0</b> = (Default) AGC works on signals from the TDM side.  ■ [1] <b>1</b> = AGC works on signals from the IP side.
'AGC Target Energy' configure voip > media ipmedia > agc-target- energy [AGCTargetEnergy]	Defines the signal energy value (dBm) that the AGC attempts to attain.  The valid range is 0 to -63 dBm. The default is -19 dBm.
'AGC Minimum Gain' configure voip > media ipmedia > agc-min-gain [AGCMinGain]	Defines the minimum gain (in dB) by the AGC when activated.  The range is 0 to -31. The default is -20.  <b>Note:</b> For the parameter to take effect, a device reset is required.
AGC Maximum Gain configure voip > media ipmedia > agc-max-gain [AGCMaxGain]	Defines the maximum gain (in dB) by the AGC when activated.  The range is 0 to 18. The default is 15.  <b>Note:</b> For the parameter to take effect, a device reset is required.
'AGC Disable Fast Adaptation' configure voip > media ipmedia > agc-disable- fast-adaptation [AGCDisableFastAdaptation]	Enables the AGC Fast Adaptation mode.  ■ [0] <b>Disable</b> (default)  ■ [1] <b>Enable</b>  Note: For the parameter to take effect, a device reset is required.
<b>Answering Machine Detector (AMD) Parameters</b>	
For more information on AMD, see <a href="#">Answering Machine Detection (AMD)</a> .	
'Answer Machine Detector Sensitivity Parameter Suite' configure voip > media ipmedia > amd- sensitivity-parameter- suit [AMDSensitivityParameterSuit]	Global parameter that defines the AMD Parameter Suite to use. You can also configure this feature per specific calls, using IP Profiles (IpProfile_ AMDSensitivityParameterSuit). For a detailed description of the parameter and for configuring this feature in the IP Profiles table, see <a href="#">Configuring IP Profiles</a> .  <b>Note:</b> If this feature is configured for a specific IP

Parameter	Description
	Profile, the settings of this global parameter is ignored for calls associated with the IP Profile.
<p>'Answer Machine Detector Sensitivity Level'</p> <pre>configure voip &gt; media ipmedia &gt; amd- sensitivity-level [AMDSensitivityLevel]</pre>	<p>Global parameter that defines the AMD detection sensitivity level of the selected AMD Parameter Suite. You can also configure this feature per specific calls, using IP Profiles (IpProfile_ AMDSensitivityLevel). For a detailed description of the parameter and for configuring this feature in the IP Profiles table, see <a href="#">Configuring IP Profiles</a>.</p> <p><b>Note:</b> If this feature is configured for a specific IP Profile, the settings of this global parameter is ignored for calls associated with the IP Profile.</p>
<p>'AMD Sensitivity File'</p> <p>[AMDSensitivityFileName]</p>	<p>Defines the name of the AMD Sensitivity file that contains the AMD Parameter Suites.</p> <p><b>Note:</b></p> <ul style="list-style-type: none"> <li>■ This file must be in binary format (.dat). You can use the DConvert utility to convert the original file format from XML to .dat.</li> <li>■ You can load this file using the Web interface (see <a href="#">Loading Auxiliary Files</a>).</li> </ul>
<p>[AMDSensitivityFileUrl]</p>	<p>Defines the URL path to the AMD Sensitivity file for downloading from a remote server for the Automatic Update mechanism.</p>
<p>[AMDMinimumVoiceLength]</p>	<p>Defines the AMD minimum voice activity detection duration (in 5-ms units). Voice activity duration below this threshold is ignored and considered as non-voice.</p> <p>The valid value range is 10 to 100. The default is 42 (i.e., 210 ms).</p>
<p>[AMDMaxGreetingTime]</p>	<p>Global parameter that defines the maximum duration that the device can take to detect a greeting message. You can also configure this feature per specific calls, using IP Profiles (IpProfile_ AMDMaxGreetingTime). For a detailed description of the parameter and for configuring this feature in the IP Profiles table, see <a href="#">Configuring IP Profiles</a>.</p> <p><b>Note:</b> If this feature is configured for a specific IP</p>

Parameter	Description
	Profile, the settings of this global parameter is ignored for calls associated with the IP Profile.
[AMDMaxPostGreetingSilenceTime]	<p>Global parameter that defines the maximum duration of silence from after the greeting time is over, configured by [AMDMaxGreetingTime], until the device's AMD decision. You can also configure this feature per specific calls, using IP Profiles (IpProfile_AMDMaxPostSilenceGreetingTime). For a detailed description of the parameter and for configuring this feature in the IP Profiles table, see <a href="#">Configuring IP Profiles</a>.</p> <p><b>Note:</b> If this feature is configured for a specific IP Profile, the settings of this global parameter is ignored for calls associated with the IP Profile.</p>
<pre>configure voip &gt; gateway digital settings &gt; amd-timeout [AMDDTimeout]</pre>	<p>Defines the timeout (in msec) between receiving Connect messages from the Tel side and sending AMD results.</p> <p>The valid range is 1 to 30,000. The default is 2,000 (i.e., 2 seconds).</p>
<p>'AMD Beep Detection Mode'</p> <pre>configure voip &gt; sip- definition settings &gt; amd-beep-detection [AMDBeepDetectionMode]</pre>	<p>Defines the AMD beep detection mode. This mode detects the beeps played at the end of an answering machine message, by using the X-Detect header extension. The device sends a SIP INFO message containing the field values 'Type=AMD' and 'SubType=Beep'. This feature allows users of certain third-party, Application servers to leave a voice message after an answering machine plays the "beep".</p> <ul style="list-style-type: none"> <li>■ [0] <b>Disabled</b> (default)</li> <li>■ [1] <b>Start After AMD</b></li> <li>■ [2] <b>Start Immediately</b></li> </ul>
<p>'Answer Machine Detector Beep Detection Timeout'</p> <pre>configure voip &gt; media ipmedia &gt; amd-beep- detection-timeout [AMDBeepDetectionTimeout]</pre>	<p>Defines the AMD beep detection timeout (i.e., the duration that the beep detector functions from when detection is initiated). This is used for detecting beeps at the end of an answering machine message.</p> <p>The valid value is in units of 100 milliseconds, from 0 to 1638. The default is 200 (i.e., 20 seconds).</p>

Parameter	Description
<p>'Answer Machine Detector Beep Detection Sensitivity'</p> <pre>configure voip &gt; media ipmedia &gt; amd-beep- detection-sensitivity [AMDBeepDetectionSensitivity]</pre>	<p>Defines the AMD beep detection sensitivity for detecting beeps at the end of an answering machine message.</p> <p>The valid value is 0 to 3, where 0 (default) is the least sensitive.</p>
<pre>early-amd [EnableEarlyAMD]</pre>	<p>Enables AMD detection to be activated upon receipt of an ISDN Alerting or Connect message.</p> <ul style="list-style-type: none"> <li>■ [0] = (Default) Disable - AMD is activated upon receipt of ISDN Connect message.</li> <li>■ [1] = Enable - AMD is activated upon receipt of ISDN Alerting message.</li> </ul> <p><b>Note:</b> The parameter is applicable only to the Gateway application (digital interfaces).</p>
<p>'AMD Mode'</p> <pre>configure voip &gt; sip- definition settings &gt; amd-mode [AMDmode]</pre>	<p>Global parameter that enables the device to disconnect the IP-to-Tel call upon detection of an answering machine on the Tel side. You can also configure this feature per specific calls, using IP Profiles (IpProfile_AmdMode). For a detailed description of the parameter and for configuring this feature in the IP Profiles table, see <a href="#">Configuring IP Profiles</a>.</p> <p><b>Note:</b></p> <ul style="list-style-type: none"> <li>■ The parameter is applicable only to the Gateway application (digital interfaces).</li> <li>■ If this feature is configured for a specific IP Profile, the settings of this global parameter is ignored for calls associated with the IP Profile.</li> </ul>
<b>Energy Detector Parameters</b>	
<p>'Enable Energy Detector'</p> <pre>configure voip &gt; media ipmedia &gt; energy- detector-enable [EnableEnergyDetector]</pre>	<p>Enables the Energy Detector feature. This feature generates events (notifications) when the signal received from the PSTN is higher or lower than a user-defined threshold, configured by the [EnergyDetectorThreshold] parameter.</p> <ul style="list-style-type: none"> <li>■ [0] <b>Disable</b> (default)</li> <li>■ [1] <b>Enable</b></li> </ul>



Parameter	Description
'Energy Detector Quality Factor' configure voip > media ipmedia > energy- detector-sensitivity [EnergyDetectorQualityFactor]	Defines the Energy Detector's sensitivity level. The valid range is 0 to 10, where 0 is the lowest sensitivity and 10 the highest sensitivity. The default is 4.
'Energy Detector Threshold' configure voip > media ipmedia > energy- detector-threshold [EnergyDetectorThreshold]	Defines the Energy Detector's threshold. A signal below or above this threshold invokes an 'Above' or 'Below' event. The threshold is calculated as follows: $-44 \text{ dBm} + (\text{EnergyDetectorThreshold} * 6)$ The valid value range is 0 to 7. The default is 3 (i.e., -26 dBm).
Pattern Detection Parameters <b>Note:</b> For an overview on the pattern detector feature for TDM tunneling, see <a href="#">DSP Pattern Detector</a> .	
'Enable Pattern Detector' [EnablePatternDetector]	Enables the Pattern Detector (PD) feature. <ul style="list-style-type: none"> <li>■ [0] <b>Disable</b> (default)</li> <li>■ [1] <b>Enable</b></li> </ul>
[PDPattern]	Defines the patterns that can be detected by the Pattern Detector. The valid range is 0 to 0xFF. <b>Note:</b> For the parameter to take effect, a device reset is required.
[PDThreshold]	Defines the number of consecutive patterns to trigger the pattern detection event. The valid range is 0 to 31. The default is 5. <b>Note:</b> For the parameter to take effect, a device reset is required.

## Services

This section describes services-related parameters.

### RADIUS and LDAP Parameters

This section describes the RADIUS and LDAP parameters.

## General Parameters

The general RADIUS and LDAP parameters are described in the table below.

**Table 70-70: General RADIUS and LDAP Parameters**

Parameter	Description
<p>'Use Local Users Database'</p> <pre>configure system &gt; mgmt-auth &gt; use- local-users-db</pre> <p>[MgmtUseLocalUsersDatabase]</p>	<p>Defines when the device uses the Local Users table and Authentication server (LDAP or RADIUS) for authenticating users (based on login username-password credentials) attempting to log in to the device's management interface (e.g., Web or CLI).</p> <ul style="list-style-type: none"> <li>■ [0] <b>When No Auth Server Defined</b> = (Default) If the Authentication server denies user access, no "fallback" to the device's Local Users table occurs and the user is denied access.</li> <li>■ [1] <b>Always</b> = If the Authentication server denies user access, the device uses the Local Users table to authenticate the user.</li> </ul> <p><b>Note:</b></p> <ul style="list-style-type: none"> <li>■ If there is no response from the Authentication server (connection timeout), you can configure (using the MgmtBehaviorOnTimeout parameter) whether the device denies access or whether it uses the Local Users table to authenticate the user.</li> <li>■ If you have not configured an Authentication server, the device uses the Local Users table to authenticate the user.</li> </ul>
<p>'Behavior upon Authentication Server Timeout'</p> <pre>configure system &gt; mgmt-auth &gt; timeout- behavior</pre> <p>[MgmtBehaviorOnTimeout]</p>	<p>Defines the device's response when a connection timeout occurs with the LDAP/RADIUS server.</p> <ul style="list-style-type: none"> <li>■ [0] <b>Deny Access</b> = User is denied access to the management platform.</li> <li>■ [1] <b>Verify Access Locally</b> = (Default) Device verifies the user's credentials in its Local Users table (local database).</li> </ul> <p><b>Note:</b> The parameter is applicable to LDAP- and RADIUS-based management-user login authentication.</p>
<p>'Default Access Level'</p> <pre>configure system &gt;</pre>	<p>Defines the default access level for the device when the LDAP/RADIUS response doesn't include an access level</p>

Parameter	Description
<pre>mgmt-auth &gt; default- access-level</pre> <p>[DefaultAccessLevel]</p>	<p>attribute for determining the user's management access level.</p> <p>The valid range is 0 to 255. The default is 200 (i.e., Security Administrator).</p> <p><b>Note:</b></p> <ul style="list-style-type: none"> <li>■ The parameter is applicable to LDAP- and RADIUS-based management-user login authentication and authorization.</li> <li>■ If a user is not associated with any LDAP Group (at the LDAP server), the device automatically uses the value of this parameter as the access level.</li> </ul>

## RADIUS Parameters

The RADIUS parameters are described in the table below.

**Table 70-71:RADIUS Parameters**

Parameter	Description
<b>General RADIUS Parameters</b>	
<p>'Enable RADIUS Access Control'</p> <pre>configure system &gt; radius settings &gt; enable</pre> <p>[EnableRADIUS]</p>	<p>Enables the RADIUS application.</p> <ul style="list-style-type: none"> <li>■ [0] <b>Disable</b> (default)</li> <li>■ [1] <b>Enable</b></li> </ul> <p><b>Note:</b> For the parameter to take effect, a device reset is required.</p>
[RadiusTrafficType]	<p>Defines the device's network interface for communicating (RADIUS traffic) with the RADIUS server(s).</p> <ul style="list-style-type: none"> <li>■ [0] = (Default) OAMP</li> <li>■ [1] = Control</li> </ul> <p><b>Note:</b> If set to Control, only one Control interface must be configured in the IP Interfaces table; otherwise, RADIUS communication will fail.</p>
<p>'RADIUS VSA Vendor ID'</p> <pre>configure system &gt; radius settings &gt; vsa-vendor-id</pre>	<p>Defines the vendor ID that the device accepts when parsing a RADIUS response packet.</p> <p>The valid range is 0 to 0xFFFFFFFF. The default is 5003.</p>

Parameter	Description
[RadiusVSAVendorID]	
[MaxRADIUSSessions]	Defines the number of concurrent calls that can communicate with the RADIUS server (optional). The valid range is 0 to 240. The default is 240.
'RADIUS Packets Retransmission' [RADIUSRetransmission]	Defines the number of RADIUS retransmission retries when no response is received from the RADIUS server. See also the RadiusTo parameter. The valid range is 1 to 10. The default is 1.
'RADIUS Response Time Out' [RadiusTO]	Defines the time interval (in seconds) that the device waits for a response before it performs a RADIUS retransmission. See also the RADIUSRetransmission parameter. The valid range is 1 to 30. The default is 2.
<b>RADIUS Accounting Parameters</b>	
'RADIUS Accounting Type' configure voip > sip-definition settings > radius- accounting [RADIUSAccountingType]	Defines at what stage of the call RADIUS accounting messages are sent to the RADIUS accounting server. <ul style="list-style-type: none"> <li>■ [0] <b>At Call Release</b> = (Default) Sent at call release only.</li> <li>■ [1] <b>At Connect &amp; Release</b> = Sent at call connect and release.</li> <li>■ [2] <b>At Setup &amp; Release</b> = Sent at call setup and release.</li> </ul>
'AAA Indications' configure system > cdr > aaa- indications [AAAIndications]	Enables the Authentication, Authorization and Accounting (AAA) indications. <ul style="list-style-type: none"> <li>■ [0] <b>None</b> = (Default) No indications.</li> <li>■ [3] <b>Accounting Only</b> = Only accounting indications are used.</li> </ul>
<b>RADIUS User Authentication Parameters</b>	
'Use RADIUS for Web/Telnet Login' configure system > radius settings > enable-mgmt-login [WebRADIUSLogin]	Enables RADIUS queries for Web and Telnet login authentication. When enabled, logging into the device's Web and Telnet embedded servers is done through a RADIUS server. The device communicates with a user-defined RADIUS server and verifies the given username and password against a remote database in a secure manner.

Parameter	Description
	<ul style="list-style-type: none"> <li>■ [0] <b>Disable</b> (default)</li> <li>■ [1] <b>Enable</b></li> </ul> <p><b>Note:</b></p> <ul style="list-style-type: none"> <li>■ For RADIUS login authentication to function, you must also configure the EnableRADIUS parameter to 1 (Enable).</li> <li>■ RADIUS authentication requires HTTP basic authentication, where the username and password are transmitted in clear text over the network. Therefore, it's recommended to set the HTTPOnly parameter to 1 to force the use of HTTPS, since the transport is encrypted.</li> </ul>
<p>'Password Local Cache Mode'</p> <pre>configure system &gt; radius settings &gt; local-cache-mode</pre> <p>[RadiusLocalCacheMode]</p>	<p>Defines the device's mode of operation regarding the timer (configured by the parameter RadiusLocalCacheTimeout) that determines the validity of the username and password (verified by the RADIUS server).</p> <ul style="list-style-type: none"> <li>■ [0] <b>Absolute Expiry Timer</b> = When you access a Web page, the timeout doesn't reset, instead it continues decreasing.</li> <li>■ [1] <b>Reset Timer Upon Access</b> = (Default) Upon each access to a Web page, the timeout always resets (reverts to the initial value configured by RadiusLocalCacheTimeout).</li> </ul>
<p>'Password Local Cache Timeout'</p> <pre>configure system &gt; radius settings &gt; local-cache- timeout</pre> <p>[RadiusLocalCacheTimeout]</p>	<p>Defines the time (in seconds) the locally stored username and password (verified by the RADIUS server) are valid. When this time expires, the username and password become invalid and a must be re-verified with the RADIUS server.</p> <p>The valid range is 1 to 0xFFFFFFFF. The default is 300 (5 minutes).</p> <ul style="list-style-type: none"> <li>■ [-1] = Never expires.</li> <li>■ [0] = Each request requires RADIUS authentication.</li> </ul>
<p>'RADIUS VSA Access Level Attribute'</p> <pre>configure system &gt;</pre>	<p>Defines the code that indicates the access level attribute in the Vendor Specific Attributes (VSA) section of the received RADIUS packet.</p> <p>The valid range is 0 to 255. The default is 35.</p>

Parameter	Description
radius settings > vsa-access-level [RadiusVSAAccessAttribute]	

## LDAP Parameters

The Lightweight Directory Access Protocol (LDAP) parameters are described in the table below.

**Table 70-72:LDAP Parameters**

Parameter	Description
'LDAP Service' configure system > ldap settings > ldap-service [LDAPServiceEnable]	Enables the LDAP feature.  ■ [0] <b>Disable</b> (default) ■ [1] <b>Enable</b>  <b>Note:</b> For the parameter to take effect, a device reset is required.
'LDAP Authentication Filter' configure system > ldap settings > auth-filter [LDAPAuthFilter]	Defines the LDAP search filter attribute for searching the login username in the directory's subtree for LDAP-based user authentication and authorization.  You can use the dollar (\$) sign to represent the username. For example, if the parameter is set to "(sAMAccountName=*)" and the user logs in with the username "SueM", the LDAP query is run for sAMAccountName=SueM.
'Use LDAP for Web > Telnet Login' configure system > ldap settings > enable-mgmt- login [MgmtLDAPLogin]	Enables LDAP-based management-user login authentication and authorization.  ■ [0] <b>Disable</b> (default) ■ [1] <b>Enable</b>  <b>Note:</b> For the parameter to take effect, a device reset is required.
[LDAPDebugMode]	Determines whether to enable the LDAP task debug messages. This is used for providing debug information regarding LDAP tasks.  The valid value range is 0 to 3. The default is 0.
'LDAP Numeric Attribute'	Defines up to five LDAP Attributes (separated by

Parameter	Description
ldap-numeric-attr [LDAPNumericAttributes]	commas) for which the device employs LDAP query searches in the AD for numbers that may have characters between the digits.  For more information, see <a href="#">Enabling LDAP Searches for Numbers with Characters</a> .
'LDAP OCS Number Attribute Name' configure voip > sip- definition settings > ldap-ocs-nm-attr [MSLDAPOCSNumAttributeName]	Defines the name of the attribute that represents the user's Skype for Business number in the Microsoft AD database.  The valid value is a string of up to 49 characters. The default is "msRTCSIP-Line".
LDAP PBX Number Attribute Name configure voip > sip- definition settings > ldap-pbx-nm-attr [MSLDAPPBXNumAttributeName]	Defines the name of the attribute that represents the user PBX number in the Microsoft AD database.  The valid value is a string of up to 49 characters. The default is "telephoneNumber".
LDAP MOBILE Number Attribute Name configure voip > sip- definition settings > ldap-mobile-nm-attr [MSLDAPMobileNumAttributeName]	Defines the name of the attribute that represents the user Mobile number in the Microsoft AD database.  The valid value is a string of up to 49 characters. The default is "mobile".
LDAP PRIVATE Number Attribute Name configure voip > sip- definition settings > ldap-private-nm-attr [MSLDAPPrivateNumAttributeName]	Defines the name of the attribute that represents the user's private number in the AD. If this value equals the value of the MSLDAPPrimaryKey or MSLDAPSecondaryKey parameter, then the device queries the AD for the destination number in this private attribute name; otherwise, the parameter is not used as a search key.  The default is "msRTCSIP-PrivateLine".
'LDAP DISPLAY Name Attribute Name' configure voip > sip- definition settings > ldap-display-nm-attr [MSLDAPDisplayNameAttributeName]	Defines the attribute name that represents the Calling Name in the AD for LDAP queries based on calling number.  The valid value is a string of up to 49 characters. The default is "displayName".
LDAP Primary Key	Defines the name of the attribute used as a

Parameter	Description
<pre>configure voip &gt; sip- definition settings &gt; ldap-primary-key</pre> <p>[MSLDAPPrimaryKey]</p>	<p>query search key for the destination number in the AD. This is used instead of the "PBX" attribute name (configured by the MSLDAPPBXNumAttributeName parameter). The default is not configured.</p>
<p>LDAP Secondary Key</p> <pre>configure voip &gt; sip- definition settings &gt; ldap-secondary-key</pre> <p>[MSLDAPSecondaryKey]</p>	<p>Defines the name of the attribute used as the second query search key for the destination number in the AD, if the primary search key or PBX search is not found.</p>
<p>'LDAP Cache Service'</p> <pre>configure system &gt; ldap settings &gt; ldap-cache- enable</pre> <p>[LDAPCacheEnable]</p>	<p>Enables the LDAP cache service.</p> <ul style="list-style-type: none"> <li>■ [0] <b>Disable</b> (default)</li> <li>■ [1] <b>Enable</b></li> </ul> <p><b>Note:</b></p> <ul style="list-style-type: none"> <li>■ For the parameter to take effect, a device reset is required.</li> <li>■ For more information on LDAP caching, see <a href="#">Configuring the Device's LDAP Cache</a>.</li> </ul>

## HTTP-based Services

The HTTP-based service parameters are described in the table below.

**Table 70-73:HTTP-based Service Parameters**

Parameter	Description
<p>'GW Routing Server'</p> <pre>configure voip &gt; gw routing general- setting &gt; gw-routing-server</pre> <p>[GWRoutingServer]</p>	<p>Enables routing by a Routing server.</p> <ul style="list-style-type: none"> <li>■ [0] <b>Disable</b> (default)</li> <li>■ [1] <b>Enable</b></li> </ul> <p>For more information, see <a href="#">Centralized Third-Party Routing Server</a>.</p> <p><b>Note:</b> The parameter is applicable only to the Gateway application.</p>



Parameter	Description
<p>'Quality Status'</p> <pre>configure system &gt; http-services &gt; routing-qos-status</pre> <p>[RoutingServerQualityStatus]</p>	<p>Enables QoS-based routing by the routing server. The device collects QoS metrics (media and signaling) and sends them to the routing server.</p> <ul style="list-style-type: none"> <li>■ [0] <b>Disable</b> (default)</li> <li>■ [1] <b>Enable</b></li> </ul> <p>For more information, see <a href="#">Configuring QoS-Based Routing by Routing Server</a>.</p>
<p>'Quality Status Rate'</p> <pre>configure system &gt; http-services &gt; routing-qos-status-rate</pre> <p>[RoutingServerQualityStatusRate]</p>	<p>Defines the rate (in sec) at which the device sends QoS reports to the routing server. The valid range is 15-3600. The default is 60.</p> <p>For more information, see <a href="#">Configuring QoS-Based Routing by Routing Server</a>.</p>
<p>'Topology Status'</p> <pre>configure system &gt; http-services &gt; routing-server-group-status</pre> <p>[RoutingServerGroupStatus]</p>	<p>Enables the reporting of the device's topology status (using the REST TopologyStatus API command) to remote HTTP hosts.</p> <ul style="list-style-type: none"> <li>■ [0] <b>Disable</b> (default)</li> <li>■ [1] <b>Enable</b></li> </ul> <p>For more information, see <a href="#">Configuring Remote Web Services</a> on page 299</p>
<p>'Routing Server Registration Status'</p> <pre>configure system &gt; http-services &gt; routing-server-registration-status</pre> <p>[RoutingServerRegistrationStatus]</p>	<p>Enables the synchronization of the device's registration database (using the REST registrationStatus API command) with remote HTTP hosts.</p> <ul style="list-style-type: none"> <li>■ [0] <b>Disable</b> (default)</li> <li>■ [1] <b>Enable</b></li> </ul>

Parameter	Description
	For more information, see <a href="#">Configuring Remote Web Services</a> on page 299
<b>Remote Monitoring</b> For more information, see <a href="#">Remote Monitoring of Device behind NAT</a> on page 1299.	
<b>'Remote Monitoring'</b> <pre>configure system &gt; http-services &gt; remote-monitoring</pre> [RemoteMonitoringEnable]	Enables the device to send monitoring reports to a remote monitoring server when the device is located behind NAT. <ul style="list-style-type: none"> <li>■ [0] = Disable (default)</li> <li>■ [1] = Enable</li> </ul>
<b>'Reporting Period'</b> <pre>configure system &gt; http-services &gt; remote-monitor-reporting-period</pre> [RemoteMonitoringPeriod]	Defines the time interval (in seconds) between each remote monitoring report that is sent to the monitoring server. The valid value is 30 to 65535. The default is 300.
<b>'Device Status'</b> <pre>configure system &gt; http-services &gt; remote-monitor-status</pre> [RemoteMonitoringDeviceEnable]	Enables the device to send a remote monitoring report of its status to the monitoring server. <ul style="list-style-type: none"> <li>■ [0] = Disable (default)</li> <li>■ [1] = Enable</li> </ul>
<b>'Active Alarms'</b> <pre>configure system &gt; http-services &gt; remote-monitor-alarms</pre> [RemoteMonitoringAlarmsEnable]	Enables the device to send a remote monitoring report of currently active alarms to the monitoring server. <ul style="list-style-type: none"> <li>■ [0] = Disable (default)</li> <li>■ [1] = Enable</li> </ul>
<b>'Performance Indicators'</b> <pre>configure system &gt; http-services &gt; remote-monitor-kpi</pre> [RemoteMonitoringPMEnable]	Enables the device to send a remote monitoring report of performance monitoring statistics to the monitoring server. <ul style="list-style-type: none"> <li>■ [0] = Disable (default)</li> </ul>

Parameter	Description
	<ul style="list-style-type: none"> <li>■ [1] = Enable</li> </ul>
'Registration Status' configure system > http-services > remote-monitor-registration [RemoteMonitoringSIPUsersEnable]	Enables the device to send a remote monitoring report of users registered with the device to the monitoring server. <ul style="list-style-type: none"> <li>■ [0] = Disable (default)</li> <li>■ [1] = Enable</li> </ul>

## HTTP Proxy Parameters

The HTTP Proxy service parameters are described in the table below.

**Table 70-74: HTTP Proxy Service Parameters**

Parameter	Description
'HTTP Proxy Application' configure network > http-proxy > http-proxy-app [HTTPProxyApplication]	Enables the HTTP Proxy application. <ul style="list-style-type: none"> <li>■ [0] <b>Disable</b> (default)</li> <li>■ [1] <b>Enable</b></li> </ul> <p><b>Note:</b> For the parameter to take effect, a device reset is required.</p>
'HTTP Proxy Debug Level' configure network > http-proxy > http-proxy-debug-level [HTTPProxySyslogDebugLevel]	Enables debugging of HTTP services and filtering messages sent to the Syslog server by severity (debug) level. <ul style="list-style-type: none"> <li>■ [0] <b>No Debug</b> = (Default) Disable.</li> <li>■ [1] <b>Info</b> = Enables debug and sends basic information in Syslog.</li> <li>■ [2] <b>Notice</b> = Enables debug and sends normal but significant information in Syslog.</li> <li>■ [3] <b>Warning</b> = Enables debug and sends warning conditions in Syslog.</li> <li>■ [4] <b>Error</b> = Enables debug and</li> </ul>

Parameter	Description
	<p>sends error conditions in Syslog.</p> <ul style="list-style-type: none"> <li>■ [5] <b>Critical</b> = Enables debug and sends critical conditions in Syslog.</li> <li>■ [6] <b>Alert</b> = Enables debug and sends conditions in Syslog that require immediate action.</li> <li>■ [7] <b>Emergency</b> = Enables debug and sends conditions indicating unstable system in Syslog.</li> </ul> <p><b>Note:</b> The NGINX Directive for this parameter is "error_log, access_log".</p>
<p>'Primary DNS Server IP'  <code>dns-primary-server</code>  [HTTPPrimaryDNS]</p>	<p>Defines the primary DNS server (in dotted-decimal notation), which is used for translating domain names into IP addresses for the HTTP service.</p> <p>By default, no IP address is defined.</p>
<p>'Secondary DNS Server IP'  <code>dns-secondary-server</code>  [HTTPSecondaryDNS]</p>	<p>Defines the secondary DNS server (in dotted-decimal notation), which is used for translating domain names into IP addresses for the HTTP service.</p> <p>By default, no IP address is defined.</p>
<p>'HTTP Proxy Global Address'  <code>configure network &gt; http-proxy &gt;</code>  <code>http-proxy-global-address</code>  [HttpProxyGlobalAddress]</p>	<p>Defines the device's public IP address for the HTTP Proxy service, when the device is located behind NAT.</p> <p>The valid value is an IP address in dotted-decimal notation. The default is 0.0.0.0.</p> <p>For more information, see <a href="#">Configuring a Public IP Address for NGINX NAT Traversal</a> on page 349.</p>

## 71 Capacity for Signaling, Media and User Registrations

For supported capacity (SIP signaling, media and user registrations), refer to the device's *Release Notes*, which can be downloaded from AudioCodes [website](#).

## 72 Technical Specifications

For technical specifications, see the device's Datasheet, which can be downloaded from AudioCodes [website](#).

**This page is intentionally left blank.**

### **International Headquarters**

1 Hayarden Street,

Airport City

Lod 7019900, Israel

Tel: +972-3-976-4000

Fax: +972-3-976-4040

### **AudioCodes Inc.**

200 Cottontail Lane

Suite A101E

Somerset NJ 08873

Tel: +1-732-469-0880

Fax: +1-732-469-2298

**Contact us:** <https://www.audiocodes.com/corporate/offices-worldwide>

**Website:** <https://www.audiocodes.com/>

**Documentation Feedback:** <https://online.audiocodes.com/documentation-feedback>

©2020 AudioCodes Ltd. All rights reserved. AudioCodes, AC, HD VoIP, HD VoIP Sounds Better, IPmedia, Mediant, MediaPack, What's Inside Matters, OSN, SmartTAP, User Management Pack, VMAS, VoIPerfect, VoIPerfectHD, Your Gateway To VoIP, 3GX, VocaNom, AudioCodes One Voice, AudioCodes Meeting Insights, AudioCodes Room Experience and CloudBond are trademarks or registered trademarks of AudioCodes Limited. All other products or trademarks are property of their respective owners. Product specifications are subject to change without notice.

Document #: LTRT-29220

