



# IP Office

## 1608/1616 Phone User Guide

# Contents

## 1. Introduction

1.1 Important Safety Information	6
1.2 '08 Phones	7
1.3 '16 Phones	8
1.4 Button Modules	9
1.5 Phone Keys	10
1.6 The Phone Stand	11
1.7 Labels	12
1.8 IP Phone Features (1608 and 1616)	12
1.9 The Main Phone Menus	13
1.10 Other Menus	15
1.11 Phone Status Letters	16
1.12 Appearance Buttons/Menu	17
1.12.1 Using the Appearance Menu	18
1.12.2 Call Appearance Buttons	19
1.12.3 Bridged Appearance Buttons	21
1.12.4 Call Coverage Buttons	23
1.12.5 Line Appearance Buttons	25

## 2. Making Calls

2.1 Calling a Person from the Contacts List	29
2.2 Calling a Person from the Call Log	29
2.3 Redialling a Previous Number	30
2.4 Making a Page Call	30
2.5 Call Soft Key Options	31
2.6 Busy Indication	32
2.7 En-Bloc Dialing	32
2.8 Withholding Your Number	33
2.9 Adjust the Call Volume	34
2.10 Muting a Call	34
2.11 Ending Calls	34

## 3. Answering Calls

3.1 Answering Another Call	37
3.2 Divert a Call to Voicemail	38
3.3 Ignore/Silence an Incoming Call	38
3.4 Dropping an Incoming Call	38
3.5 Answering a Page Call	38
3.6 Displaying Other Calls	39
3.7 Auto Answer	39
3.8 Call Pickup	40

## 4. Redialling

4.1 Redial a Call (One Mode)	42
4.2 Redial a Call (List Mode)	42
4.3 Selecting Your Redial Mode	43
4.4 View Call Details	44
4.5 Add a Call to Your Contacts	44

## 5. Redirecting Calls

5.1 Follow Me	47
5.1.1 Follow Me To (Features Menu)	48
5.1.2 Follow Me (Status Menu)	48
5.1.3 Follow Me Here (Features Menu)	49
5.2 Forwarding Calls	50

5.2.1 Forward Unconditional (Status Menu)	52
5.2.2 Forward Unconditional (Features Menu)	53
5.2.3 Forward On No Answer (Status Menu)	54
5.2.4 Forward On Busy (Status Menu)	55
5.2.5 Forward On Busy/No Answer (Features Menu)	56
5.3 Do Not Disturb	57
5.3.1 DND On/Off (Features Menu)	58
5.3.2 DND Off (Status Menu)	58
5.3.3 Do Not Disturb Exceptions	58
5.4 Twinning	59
5.4.1 Mobile Twinning Control	60
5.4.2 Transferring a Call to Your Mobile Phone	61
5.4.3 Reclaiming a Twinned Call	61
5.4.4 Switching Twinning Off (Status Menu)	61

## 6. Holding and Parking Calls

6.1 Holding Calls	65
6.1.1 Holding a Call	65
6.1.2 Taking a Call Off Hold	65
6.1.3 Switching Between Calls	66
6.1.4 Transfer a Held Call	66
6.2 Parking Calls	67
6.2.1 Park Using the Menu	68
6.2.2 Unpark (Features Menu)	68
6.2.3 Unpark (Status Menu)	68
6.2.4 Park & Page	69

## 7. Transferring Calls

7.1 Transfer to Voicemail	72
7.2 Transferring a Held Call	73
7.3 Transfer to Your Mobile Phone	73

## 8. Account Codes

8.1 Forced Account Code Entry	76
8.2 Manual Account Code Entry	76

## 9. Conference Calls

9.1 Starting a Conference	78
9.2 Adding a Call to a Conference	78
9.3 Viewing Conference Details	79
9.4 Dropping/Muting Parties	79
9.5 Holding a Conference Call	79
9.6 Context Sensitive Conferencing	80

## 10. Headset/Handsfree Operation

10.1 Headset Operation	82
10.1.1 Headset Volume	83
10.1.2 Default Handsfree Audio Path	83
10.1.3 Automatic Gain Control	83
10.2 Handsfree Speaker Operation	84
10.2.1 Speaker Volume	85
10.2.2 Default Handsfree Audio Path	85
10.2.3 Automatic Gain Control	85

## 11. Contacts/Directory

11.1 How the Directory Search Works	89
11.2 Viewing Contacts Details	90
11.3 Make a Call from the Directory	91

11.4 Using the Directory for Other Functions .....	91	16.2.6 Call Park.....	132
11.5 Adding a New Contact.....	92	16.2.7 Call Park to Other.....	132
11.5.1 Add a Contact from the Call Log.....	93	16.2.8 Call Pickup.....	133
11.5.2 Add a Contact from the Redial List.....	93	16.2.9 Call Pickup Any.....	133
11.6 Editing a Contact.....	94	16.2.10 Conf Meet Me.....	133
11.7 Deleting a Contact.....	95	16.2.11 Drop Call.....	133
<b>12.Call Log</b>		16.2.12 Flash Hook.....	133
12.1 Using the Call Log.....	99	16.2.13 Group BLF.....	133
12.2 Making a Call from the Call Log.....	99	16.2.14 Page.....	133
12.3 Viewing Call Details.....	100	16.2.15 Park and Page.....	133
12.4 Deleting a Record.....	101	16.2.16 Ringer Off.....	133
12.5 Deleting All Records.....	101	16.2.17 Self-Administer.....	133
12.6 Adding a Record to Your Contacts.....	102	16.2.18 Send All Calls .....	134
<b>13.Voicemail</b>		16.2.19 Suppress Digits .....	134
13.1 Message Waiting Indication.....	104	16.2.20 Timer.....	134
13.2 Checking Messages.....	105	16.2.21 Twinning.....	134
13.3 Sending a Message.....	106	16.2.22 User BLF.....	134
13.4 Mailbox Greeting.....	107	<b>17.Phone Settings</b>	
13.5 Mailbox Name .....	108	17.1 Mobile Twinning.....	139
13.6 Email Mode .....	109	17.2 Withhold Number.....	139
13.7 Changing Your Voicemail Code.....	110	17.3 Redial Mode .....	140
13.8 Voicemail On/Off.....	110	17.4 En-Bloc Dialing.....	141
13.9 Transfer to Voicemail.....	111	17.5 Auto Lock .....	141
13.10 Send a Call to Voicemail .....	111	17.6 Ringer Controls .....	142
13.11 Visual Voice.....	111	17.6.1 Disabling the Ringer.....	142
<b>14.Logging In/Out</b>		17.6.2 Ring Pattern/Sound.....	143
14.1 Logging In .....	115	17.6.3 Visual Alerting.....	145
14.1.1 Logging In on a Phone Already in Use.....	115	17.6.4 Audible Alerting.....	145
14.1.2 Logging In on a "Not Logged In" Phone.....	115	17.6.5 Coverage Ring.....	145
14.1.3 Logging In on an Unregistered Phone.....	116	17.6.6 Ringer Volume.....	146
14.2 Logout .....	116	17.6.7 Internal Auto Answer.....	146
14.3 Changing Your Login Code.....	116	17.7 Display Controls.....	147
14.4 Locking the Phone.....	118	17.7.1 Display Brightness.....	147
14.5 Unlocking the Phone.....	118	17.7.2 Display Contrast.....	147
14.6 Auto Lock .....	119	17.7.3 Call Timer Display.....	148
14.7 Unregistering.....	119	17.7.4 Last Call Duration Display.....	148
<b>15.Groups</b>		17.7.5 Display Language.....	149
15.1 Group Membership.....	123	17.7.6 Display Name.....	150
15.1.1 Group Membership On/Off (Status Menu).....	123	17.7.7 A-Menu Auto Exit.....	150
15.1.2 Group Membership On/Off (Features Menu)...	124	17.7.8 Auto Show Call Waiting.....	151
15.2 Group Service Status and Fallback.....	125	17.7.9 Inactivity Timer (Auto Return).....	151
15.2.1 Changing the Group Service Status		17.8 Volume and Sound.....	152
(Features Menu).....	126	17.8.1 Button Clicks .....	153
15.2.2 Changing the Group Service Status (Status		17.8.2 Error Tones.....	153
Menu) .....	127	17.8.3 Ringer Volume.....	153
15.2.3 Changing the Fallback Destinations.....	128	17.8.4 Handset Volume.....	153
<b>16.Button Features</b>		17.8.5 Headset Volume.....	153
16.1 Programming a Button.....	130	17.8.6 Speaker Volume.....	154
16.2 Features .....	131	17.8.7 Automatic Gain Control.....	154
16.2.1 Abbreviated Dial.....	132	17.8.8 Default Handsfree Audio Path.....	154
16.2.2 Absence Text.....	132	17.9 Backup/Restore.....	155
16.2.3 Account Code.....	132	17.9.1 Backup.....	155
16.2.4 Auto Answer.....	132	17.9.2 Restore.....	156
16.2.5 Call Forwarding All.....	132	17.10 Viewing Information.....	157
		<b>18.Status Menu</b>	

18.1 Do Not Disturb.....	160	22.18 Idle Line Preference.....	200
18.2 Follow Me To.....	160	22.19 Internal Twinning.....	200
18.3 Follow Me Here.....	161	22.20 Line Appearance Button.....	200
18.4 Forward On Busy.....	161	22.21 Logged Out.....	200
18.5 Forward On No Answer.....	162	22.22 Login Code.....	200
18.6 Forward Unconditional.....	162	22.23 Missed Call.....	200
18.7 Forwarded Here.....	163	22.24 Missed Group Call.....	200
18.8 Group Membership.....	163	22.25 Mobile Twinning.....	201
18.9 Group Service Status.....	163	22.26 Park Call.....	201
18.10 Mobile Twinning.....	164	22.27 Park Slot Number.....	201
18.11 Parked Calls.....	164	22.28 Ringing Line Preference.....	201
18.12 System Alarms.....	164	22.29 Short Codes.....	201

**19.Short Codes**

**20.System Administration**

20.1 Checking the System and Software Version.....	172
20.2 Checking the Time Settings.....	173
20.3 Setting the Date.....	173
20.4 Setting the Time.....	174
20.5 Setting the Time Offset.....	174
20.6 System Shutdown.....	175
20.7 Memory Card Management.....	176
20.8 System Alarms.....	177

**21.The Phone Menus**

21.1 Features Menu.....	181
21.2 Self-Administer Menu.....	183
21.3 Visual Voice Menu.....	184
21.4 Status Menu.....	185
21.5 Phone A-Menu.....	186
21.6 Call Log Menu.....	187
21.7 Contacts Menu.....	188
21.8 Redial Menu.....	189
21.9 Phone Locked Menu.....	190
21.10 System Admin Menu.....	191
21.11 Error Screens.....	192
21.12 Menu Access Control.....	193
21.13 Entering Characters.....	194

**22.Glossary**

22.1 Abbreviated Ring.....	198
22.2 Appearance Button.....	198
22.3 Attention Ring.....	198
22.4 Auto Hold.....	198
22.5 Bridged Appearance Button.....	198
22.6 Call Appearance Button.....	198
22.7 Call Coverage Button.....	198
22.8 Coverage Ring.....	198
22.9 Do Not Disturb.....	198
22.10 Do Not Disturb Exceptions.....	199
22.11 Follow Me.....	199
22.12 Follow Me Here.....	199
22.13 Follow Me To.....	199
22.14 Forward on Busy.....	199
22.15 Forward on No Answer.....	199
22.16 Forward Unconditional.....	199
22.17 Group.....	200

**23.Document History**

Index.....	209
------------	-----

# Chapter 1.

# Introduction

# 1. Introduction

This guide is for 1608 and 1616 phones when being used on an IP Office telephone system running in any mode other than Basic Edition mode.

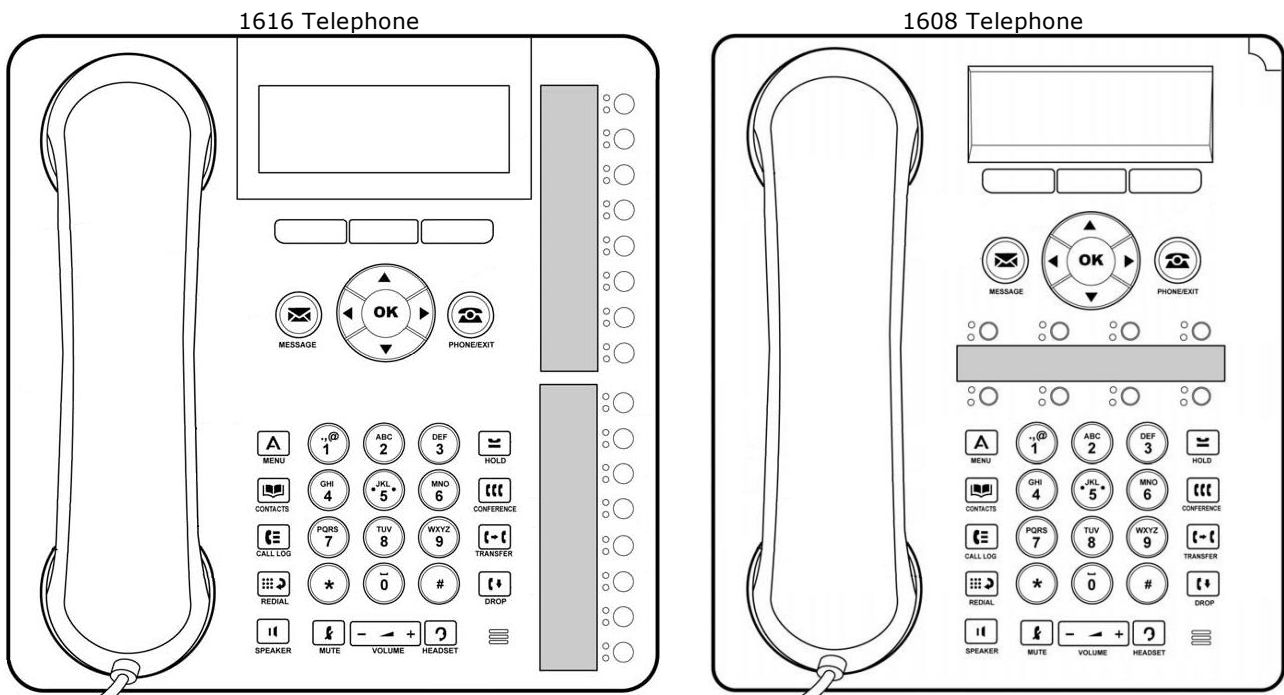

## 1.1 Important Safety Information

- **! Warning:** This handset may pickup small metal objects such as metal pins or staples.
- During a power surge, EFT or ESD, calls may be dropped. After a power surge, EFT or ESD, it is normal for the phone to restart.
- Using a cell phone, mobile phone, GSM phone or two-way radio in close proximity to an Avaya telephone might cause interference.
- The phone should not be connected directly to the outdoor telecommunication network.

## 1.2 '08 Phones

The diagram below shows the main features of a 1608 phone.

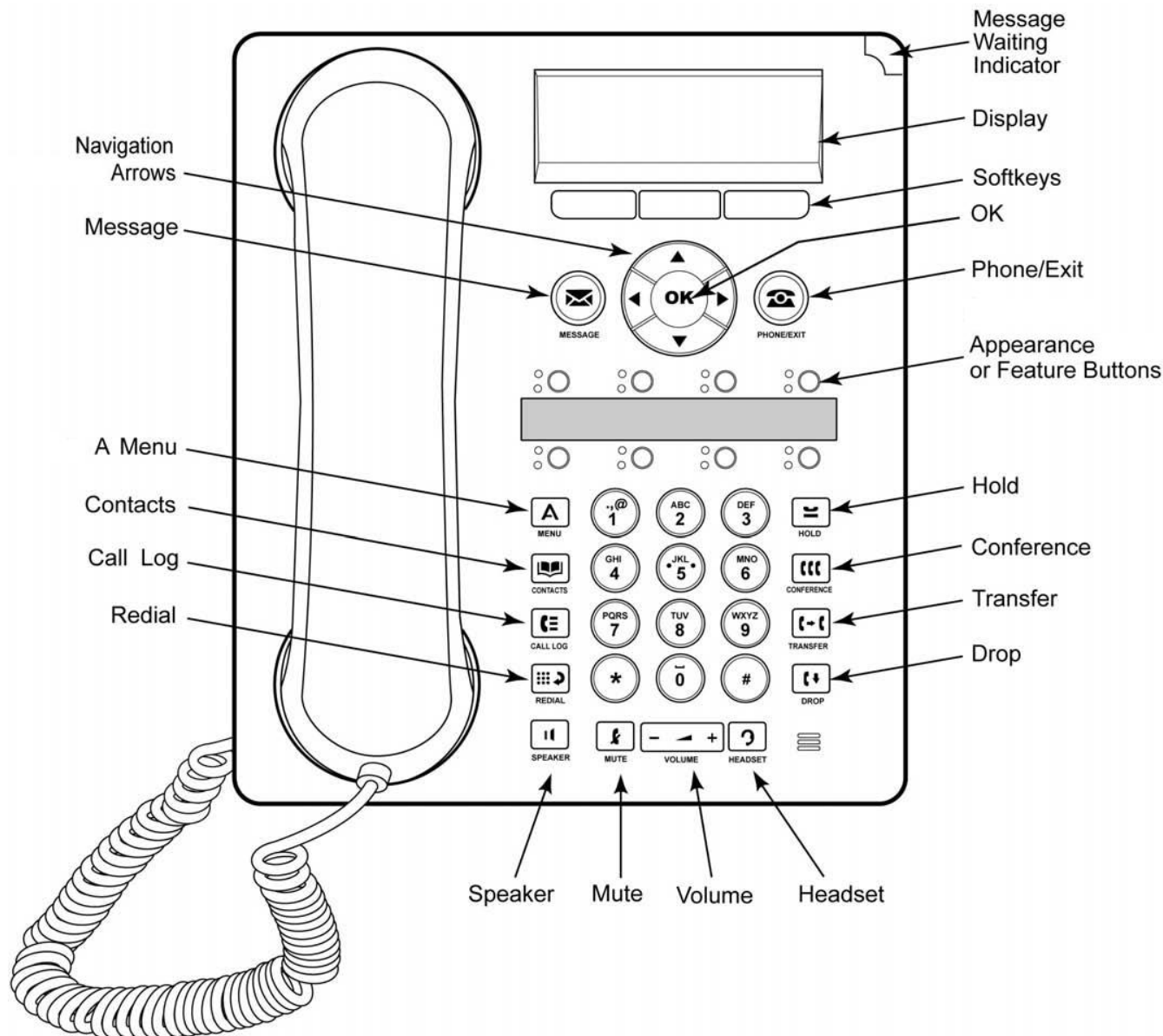

- This phone has 8 programmable buttons.
  - By default the first 3 buttons are used as appearance buttons for calls you make and receive. Your system administrator can configure additional appearance buttons.
  - Any button not configured as appearance buttons can be configured for a range of telephone system features. These are called feature buttons. Your system administrator can do this or, for a limited number of functions, you can do this using the phones [self-administration](#) <sup>[13]</sup> menu.
- The phone includes an integral stand that can be flipped to either of two positions without needing any tools. When used in the upright position, a plastic peg in the earpiece rest area for the handset can be reversed if a more secure grip on the handset when not in use is required.
- The phone includes a handsfree speaker and microphone for operation as a handsfree speakerphone. The speaker is located under the handset. The microphone is located at the bottom right of the keypad.
- The phone includes a headset socket for connection of phone headsets.
- The 1608 and 1616 phones are connect to the telephone system via the IP data network and so have some additional options, see [IP Phone Features](#) <sup>[12]</sup>.

## 1.3 '16 Phones

The diagram below shows the main features of a 1616 phone.

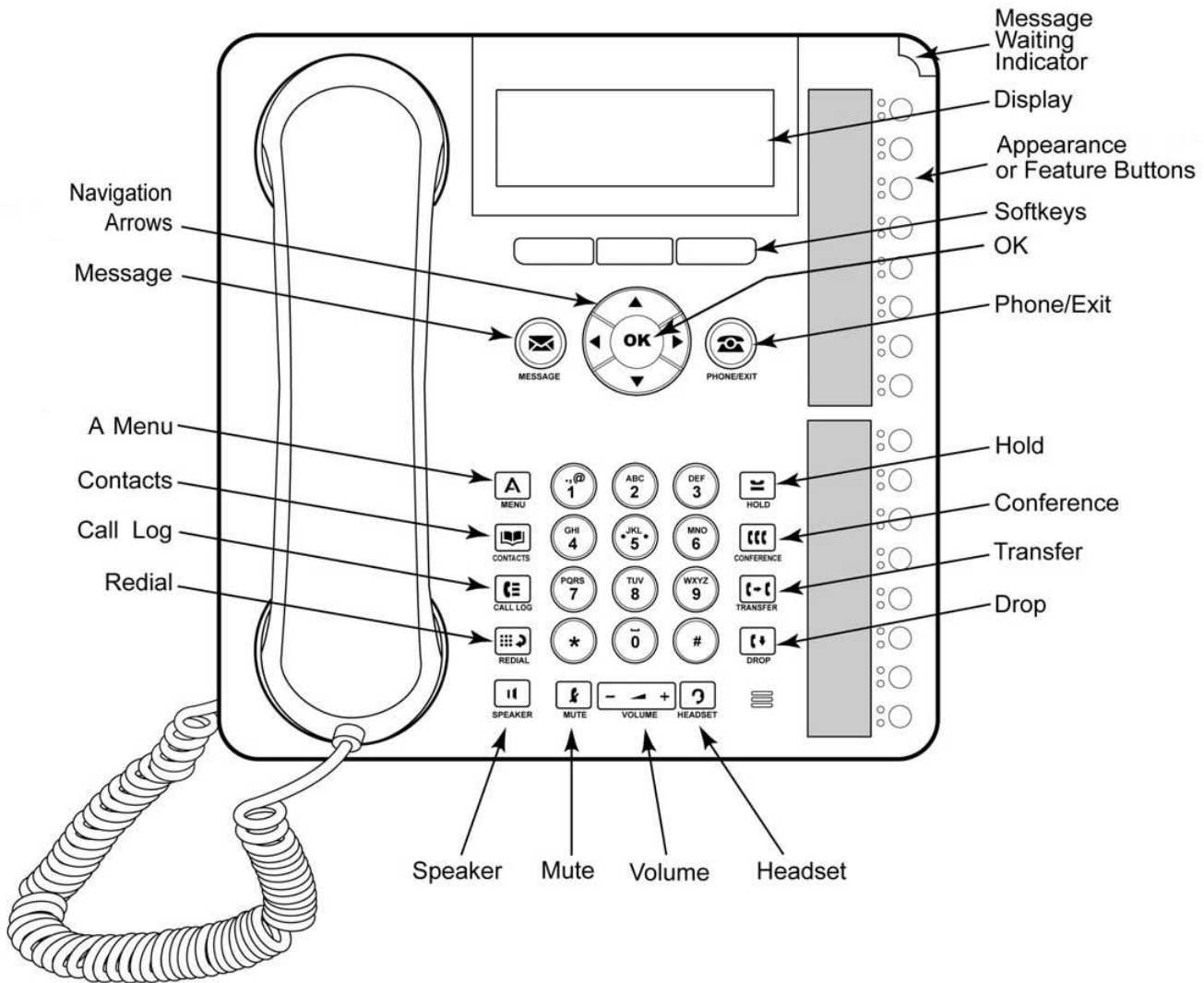

- The display angle can be adjusted for optimal viewing.
- This phone has 16 programmable buttons.
- The phone also supports up to 3 add-on button modules, each providing an addition 32 buttons.
  - By default the first 3 buttons are used as appearance buttons for calls you make and receive. Your system administrator can configure additional appearance buttons.
  - Any button not configured as appearance buttons can be configured for a range of telephone system features. These are called feature buttons. Your system administrator can do this or, for a limited number of functions, you can do this using the phones [self-administration](#) <sup>[130]</sup> menu.
- The phone includes an integral stand that can be flipped to either of two positions without needing any tools. When used in the upright position, a plastic peg in the earpiece rest area for the handset can be reversed if a more secure grip on the handset when not in use is required.
- The phone includes a handsfree speaker and microphone for operation as a handsfree speakerphone. The speaker is located under the handset. The microphone is located at the bottom right of the keypad.
- The phone includes a headset socket for connection of phone headsets.
- The 1608 and 1616 phones are connect to the telephone system via the IP data network and so have some additional options, see [IP Phone Features](#) <sup>[12]</sup>.



## 1.4 Button Modules

The 1416 and 1616 phones can support addition units called button modules. Each button module provides the phone with an additional 32 buttons which can be used as [appearance buttons](#)<sup>[17]</sup> and or [feature buttons](#)<sup>[130]</sup>.

Up to 3 button modules can be attached to the phone. However, the number of button modules supported by the telephone system may be limited by the total number of button modules attached to other phones on the telephone system.

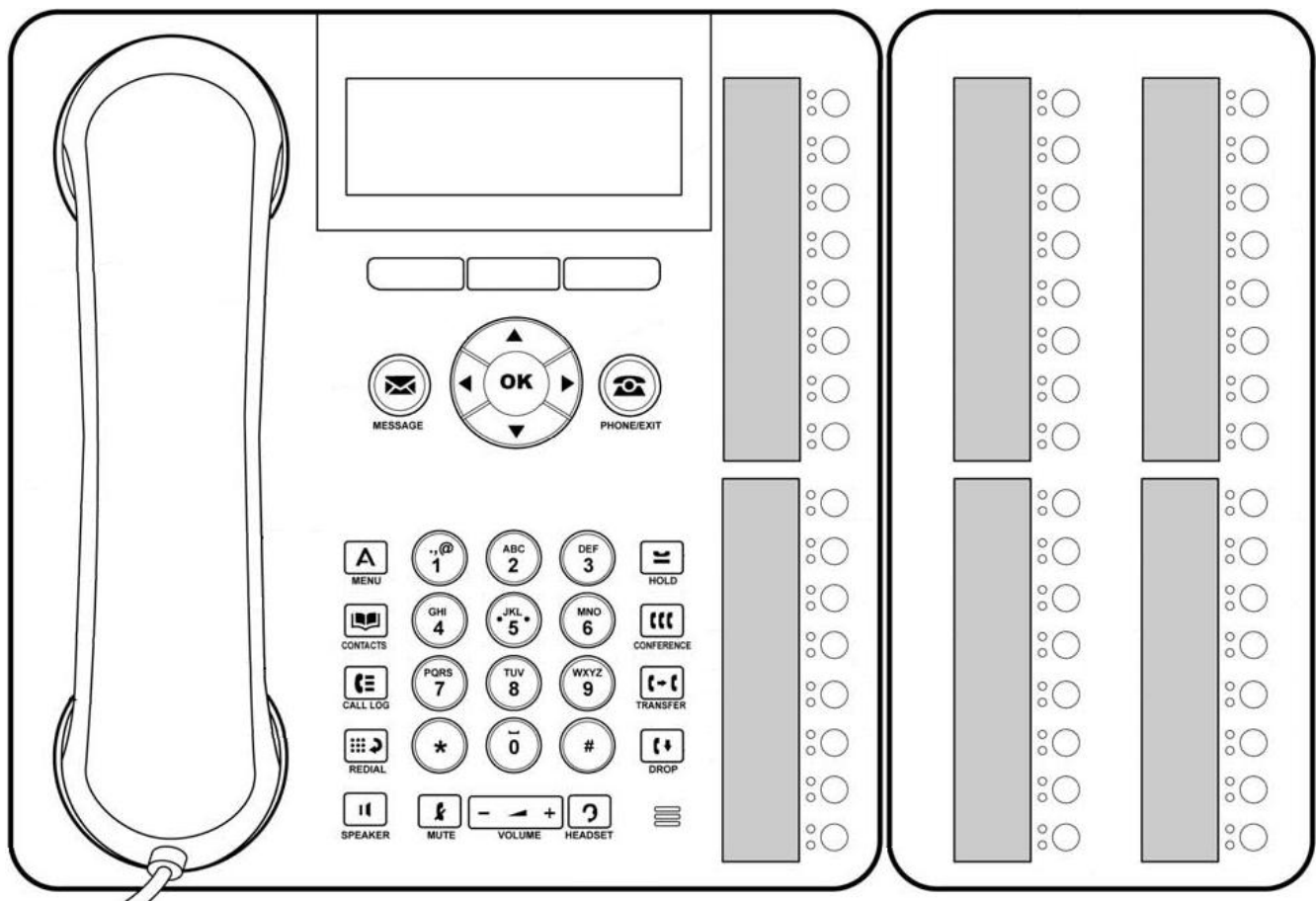

- Do not connect or disconnect a button module yourself. Your system administrator will arrange this if necessary. Failure to connect and restart the equipment in the correct order may cause the phone to not function correctly.
- When used with buttons modules, the telephone needs a separate power supply unit. It cannot use Power over Ethernet (PoE) to drive the phone and the button modules.
- The button module used for 1416 phones is not interchangeable with that used for 1616 phones and vice versa.

## 1.5 Phone Keys

The following keys are found on the phone:

Key	Description
	<b>Soft Keys</b> - These 3 keys below the display have variable functions. When the key is active, its function is indicated by the text label above it. The left hand key is usually linked to the <b>OK</b> key.
	<b>Message</b> - This key is used to access your voicemail system. By default this uses a series of menus on your phone's display.
	<b>Navigation Keys</b> - Press the ▲ up and down ▼ arrow keys to scroll through lists. The ↓ ↑ arrow icons indicate where you are in a list. In some menus, you can also use the ◀ left and right ▶ arrow keys to enter and exit different levels of the menu. A menu option that accesses a sub-menu is indicated by the ... dots (ellipsis) icon after its name. In some menus, the ◀ and ▶ symbols in the display indicate a value that can be changed by pressing the ◀ left and right ▶ arrow keys.
	<b>OK</b> - The <b>OK</b> key normally matches the function offered by the left hand soft key below the screen.
	<b>PHONE/EXIT</b> - This key is used to exit any menu you are in and return to the appearance buttons menu. During a call it can also be used to toggle the options displayed on the appearance menu.
	<b>MENU</b> - This key is used to access a menu for phone settings and information. These are settings stored by the phone itself rather than the telephone system.
	<b>CONTACTS</b> <sup>[88]</sup> - This key is used to display the various directories (personal and shared) of names and telephone numbers to which you have access.
	<b>CALL LOG</b> <sup>[98]</sup> - This key displays a record of you most recent answered, missed and outgoing calls. The button is illuminated when you have new missed calls.
	<b>REDIAL</b> <sup>[42]</sup> - This key is used to either redial the last call you made or to show a list of the last calls you made from which you can select the number to redial.
	<b>HOLD</b> <sup>[65]</sup> - This key is used to put the call you are currently talking to on hold.
	<b>CONFERENCE</b> <sup>[78]</sup> - This key is used to start a conference call and to add callers to an existing conference.
	<b>TRANSFER</b> <sup>[72]</sup> - This key is used to transfer calls to another number.
	<b>DROP</b> <sup>[34]</sup> - Press the <b>Drop</b> key to drop the active call. It can also be used to redirect a ringing call to voicemail. While on a conference call, you can press the <b>Drop</b> key to drop a person from the conference call.
	<b>VOLUME</b> <sup>[153]</sup> - Press + plus or - minus on the <b>Volume</b> key to adjust the volume of the incoming call. Separate volumes can be adjusted for the ringer, handset, headset and speaker.
	<b>HEADSET</b> <sup>[82]</sup> - This key is used to answer and end calls using a headset connected to the phones headset socket. The button is lit when you are connected to a call using the headset.
	<b>MUTE</b> <sup>[34]</sup> - This key can be used to mute your speech to the currently connected call. The button is lit while mute is active.
	<b>SPEAKER</b> <sup>[84]</sup> - This key is used to answer and end calls using the phone's handsfree speaker and microphone. The button is lit when you are connected to a call handsfree.
	These keys have two roles: <ul style="list-style-type: none"> <li><b>Appearance Keys</b><sup>[17]</sup> - These button represent calls that you can make or receive.</li> <li><b>Feature Buttons</b><sup>[130]</sup> - Those key not configured as appearance keys can be used for other functions.</li> </ul>

## 1.6 The Phone Stand

The phones all include a two-position stand that clips to the base of the phone as shown below. Once attached the stand can be used in either position to change the angle of the phone.

When changing the position of the stand, be sure to check that the stand has locked into the chosen position. A small plastic peg is located just under the phone's handset. This peg can be reversed to more securely anchor the handset when the stand places the phone in an upright position.

On the 1416 and 1616 phones, the angle of the phone display can also be adjusted as shown below.

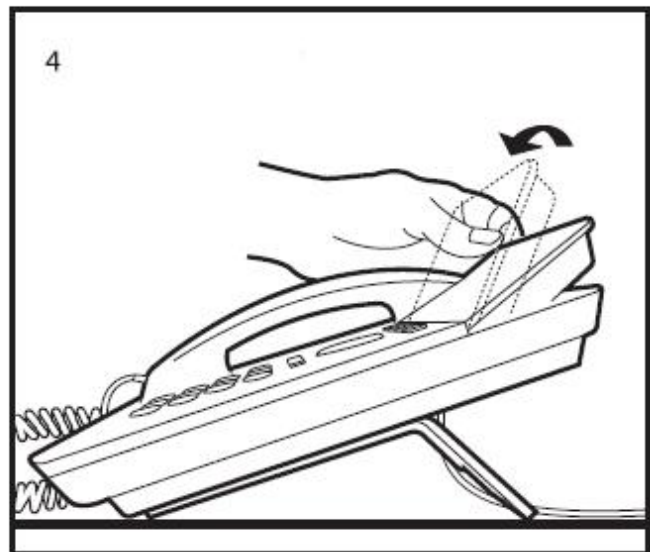
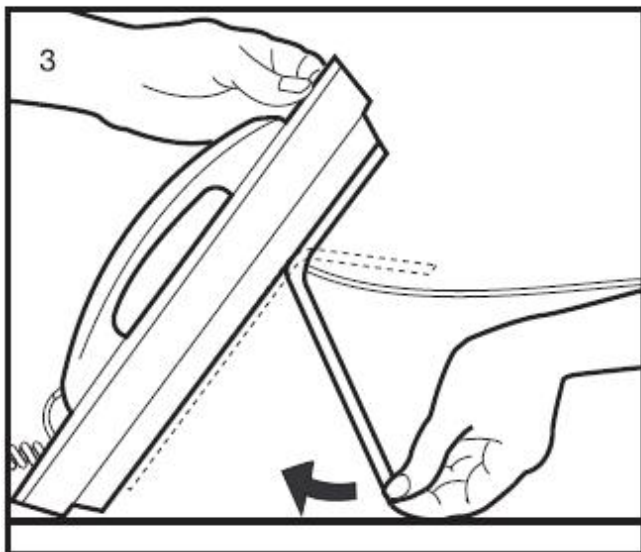
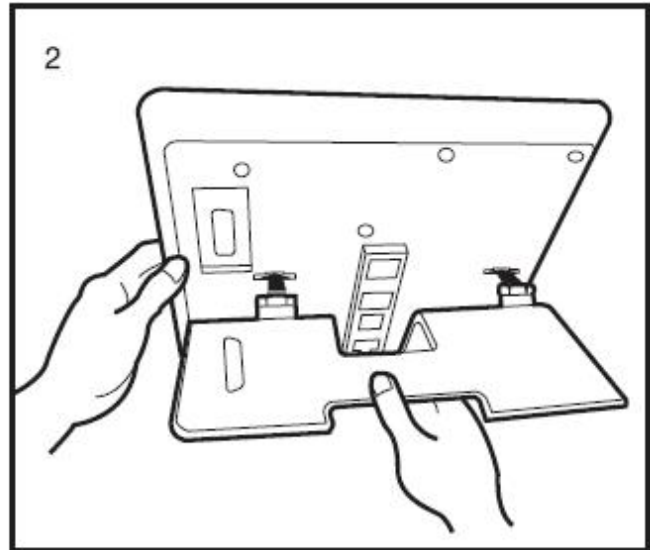
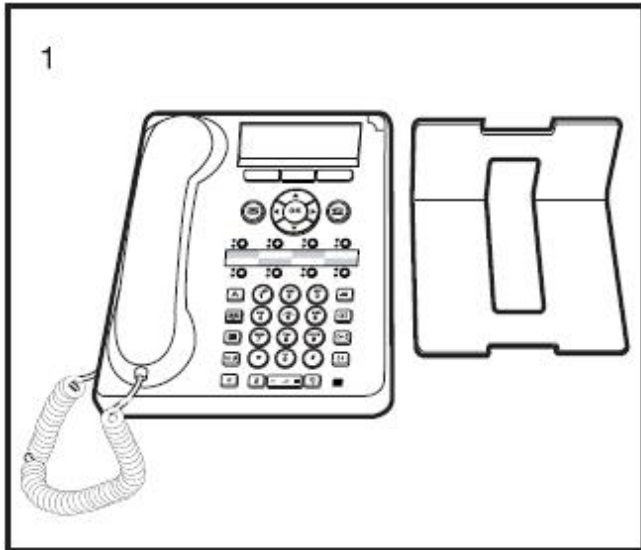

---

## 1.7 Labels

Next to each call appearance button and feature button is a paper label. The label identifies the feature that has been programmed on the button by your system administrator. You can remove the labels if you want to change a label or write on a blank one. Printed labels are also available for your telephone. See your system administrator for more information.

## 1.8 IP Phone Features (1608 and 1616)

The 1608 and 1616 phones connect to the phone system using an IP connection and support a number of additional features:

- The phone uses a 10/100 Ethernet connection to connect to the telephone system via the IP network.
- The phone includes a PC pass through 10/100 Ethernet port that can be used to also connect a computer to the network through the same connection as the phone. Use of this port can be disabled by the system administrator if not supported.
- The phone may be powered from the network if Power over Ethernet (PoE) is available. Otherwise the phone needs its own power supply unit.

## 1.9 The Main Phone Menus



The main menus are detailed below. You can move between them using the **PHONE** key. You can do this even during a call including when a call is alerting. In addition the menus are accessible from the call appearance menu by pressing the **Status** and **Features** soft keys when they are displayed.

### The Appearance Menu

#### Idle

G	299 11:00 01/26	a=
↓	Status	Features

This menu is used to display information about the  buttons that have been configured for appearance functions. These will normally be the first 3 button on the phone but the system administrator can configure additional buttons.

Using the  up and down  arrow keys you can scroll through the details of each of the buttons.

#### Active

Call: Incoming		
↓ a=Extn307	0:00:12	
307	>>	

The display for buttons that currently have a call in progress will show details of the associated call.

The display for buttons that are idle will show the default label for the button and also soft key labels for accessing the other main menus.

Those buttons that have not been configured as appearance buttons can be used as [feature buttons](#)<sup>[130]</sup>.

### The Status Menu

Status		
↓ Mobile Twinning	[on]	
Off	Exit	

The **Status** menu is not always visible. It is shown when you have any special call routing features active. For example do not disturb switched on.

It is also shown if the system administrator has given you the rights to change the status of your hunt group memberships or to change the service status of the hunt groups.

A summary of the menu options is shown in the [Status Menu diagram](#)<sup>[185]</sup>.

### The Features Menu

Features		
↓ Pickup...		
Select	Exit	



The Features menu is used to access and configure range of your user settings. The system administrator can control some of the options that will be available to you within the menu. Typically these are settings stored by the telephone system which will be applicable even if you login at another phone.

A summary of the menu options is shown in the [Features menu diagram](#)<sup>[187]</sup>.

### The Button Features Menu

Button Features		
↓ GrpPg		
Select	Exit	

Those  buttons not configured by the system administrators as appearance buttons can be used for other special features.

The button feature can be accessed by pressing the appropriate button. However they can also be accessed through the Button Features section of the **Features** menu (press the **Features** soft key and selecting **Button Features**). The  up and down  arrow keys can then be used to scroll through the programmed buttons. The associated button will briefly flash its red lamp.

The action of each button is normally set by the system administrator. However you can also use the [self-administer menu](#)<sup>[130]</sup> to select and assign actions to the buttons.

---

## Switching Menus

With a call connected, you can still access the other main menus. Press the **PHONE** key to toggle between the normal appearance menu or one that lists the other menus accessible.

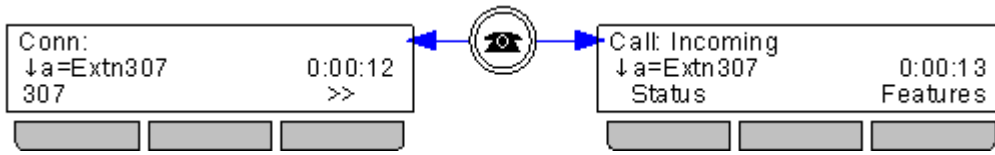

You can also use the **←** left arrow key to switch between the Appearance menu , **Features** menu and **Button Features** menu.

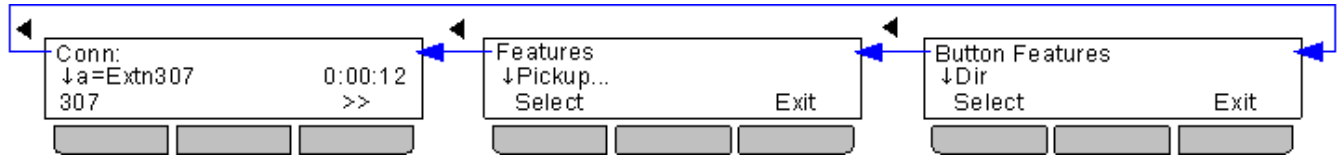

## 1.10 Other Menus

In addition to the [main phone menus](#)<sup>[13]</sup>, there are a number of additional menus which are accessed by pressing specific keys.

### - The Redial Menu<sup>[42]</sup>

Redial
↓Extn 307 307 16:12 01/26
Call Details Exit
<input type="button" value="Call"/> <input type="button" value="Details"/> <input type="button" value="Exit"/>

This menu accesses by pressing the  key. It shows a list of up to the 10 last outgoing calls that you have made.

You can [configure your phone](#)<sup>[43]</sup> to simply redial the last number dialed in which case the menu is not shown.

### **A** - The A Menu

Menu: Top
↓Screen/Sounds...
Select Exit
<input type="button" value="Screen/Sounds..."/> <input type="button" value="Select"/> <input type="button" value="Exit"/>

Pressing the **A MENU** key accesses a menu that can be used to control various phone settings. These are mainly settings stored by the phone rather than user settings that move with you.

The [Phone A-Menu diagram](#)<sup>[186]</sup> shows a summary of the menu options.

### - The Contacts/Directory Menu<sup>[88]</sup>

Directory: ◀All▶
DIAL NAME
List New Exit
<input type="button" value="List"/> <input type="button" value="New"/> <input type="button" value="Exit"/>

This menu is accessed by pressing the  key. It is used to display names and numbers that you can then use for making calls.

The directory includes names stored for use by all users, names stored for use by just you and the name and numbers of all the other users and groups on the phone system.

The [Contact Menu](#)<sup>[188]</sup> diagram shows a summary of the menu options.

### - The Call Log Menu<sup>[98]</sup>

Call Log: ◀All▶
↓Extn201 15:19 01/26
Call Details More
<input type="button" value="Call"/> <input type="button" value="Details"/> <input type="button" value="More"/>

This menu is accessed by pressing the  **Call Log** key. The call log you see is a call log stored on the telephone system. If you login at another phone that does this, your call log moves with you.

Your call log contains your 10 most recent answered calls, 10 most recent calls you made and 10 most recent missed calls.

If configured by the system administrator, it can also include calls missed by hunt groups of which you are a member.

The [Call Log](#)<sup>[187]</sup> menu diagram shows a summary of the menu options.

### - The Visual Voice Menu<sup>[104]</sup>

Visual Voice
↓Listen 4/0/1
Select - Exit
<input type="button" value="Listen"/> <input type="button" value="Select"/> <input type="button" value="Exit"/>

This menu is accessed by pressing the  key. It is used to access the voicemail system and to then play messages in your voicemail mailbox, record and send messages to other users and to change various mailbox settings.

The [Visual Voice menu diagram](#)<sup>[184]</sup> shows a summary of the menu options.

---

## 1.11 Phone Status Letters

The series of letters that appear in the top left of the display are used to indicate the status of various features. Multiple letter may be displayed, for example **NG** or **SG**, indicating a combination of states.

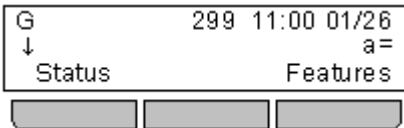

- **B = Barred**  
A **B** is shown on your phone's display when the system administrator has set you to outgoing call barred status. You will only be able to make internal calls while this is applied.
- **D = Diverting (Forwarding) Calls**  
A **D** is shown on your phone's display when you have forward unconditional enabled.
- **G = Group Member (In Group)**  
A **G** is shown on your phone's display when have been configured as a member of a hunt group and your membership is enabled. While this is the case, you may receive calls targeted to the hunt group.
- **N = No Calls (Do Not Disturb)**  
An **N** is shown on your phone's display when you have do not disturb enabled.
- **O = Out of Service**  
An **O** is shown on your phone's display when any of the groups of which you are enabled as a member is set to night service mode. In that mode calls to that group are diverted to its fallback if set or otherwise to voicemail if available.
- **R = Resilience**  
An **R** is shown on your phone's display your phone is working in resilience mode. This is used when there may have been a problem with the telephone system to which your phone was registered and another system is currently providing temporary support for your phone. In this mode, some features may not be available and calls may be routed differently.
- **S = System Alarm**  
If you are configured as a system administrator, an **S** in the phone's display indicates a [system alarm](#)<sup>17A</sup>.
- **T = Twinned**  
A **T** is shown on a phone's display if it is internally twinned with your phone. Calls to you will alert on both phones and can be answered by you at either phone.
- **! = Cannot retrieve user settings**  
An **!** is shown if the telephone system at which you have logged in could not contact the telephone system that stores your user settings. If this happens it limits the telephone functions, including making and receiving calls, that you can use. Contact your system administrator.



## 1.12 Appearance Buttons/Menu

Appearance buttons are used to represent calls made and received by you and other users on the telephone system. They are configured by your system administrator. Normally your first 3 buttons are call appearance buttons but additional buttons can be configured as appearance buttons.

There are 4 different types of appearance keys that your system administrator can configure:

- [Call Appearance Buttons](#) <sup>[19]</sup>  
These represent ordinary phone calls. Each call appearance that you have can be used to make and or receive calls. By default you normally have 3 call appearance keys and no other appearance keys.
- [Bridged Appearance Buttons](#) <sup>[21]</sup>  
These appearance keys each match a specific call appearance key of another user. They allow you to answer the other user's calls on the matching call appearance or to make a call that the other user can then pickup using their matched call appearance.
- [Call Coverage Buttons](#) <sup>[23]</sup>  
These appearance keys represent another user. When that other user has any calls alerting unanswered, the call coverage key for that user will start alerting and can be used to answer the call.
- [Line Appearance Buttons](#) <sup>[25]</sup>  
These represent specific phone lines connected to the telephone system. You can use the button to make calls using that line or to answer calls on that line. Several users can have line appearance keys that represent the same line. Your phone's display and the key lamps will indicate when the line is being used by other users as well as by yourself.

### Appearance Button Display /Menu

#### Idle

G	299 11:00 01/26
↓	a=
Status	Features



This menu is used to display information about the  buttons that have been configured for appearance functions. These will normally be the first 3 button on the phone but the system administrator can configure additional buttons.

Using the ▲ up and down ▼ arrow keys you can scroll through the details of each of the buttons.

#### Active

Call: Incoming	
↓ a=Extn307	0:00:12
307	>>



The display for buttons that currently have a call in progress will show details of the associated call.

The display for buttons that are idle will show the default label for the button and also soft key labels for accessing the other main menus.

Those buttons that have not been configured as appearance buttons can be used as [feature buttons](#) <sup>[130]</sup>.

---





## 1.12.1 Using the Appearance Menu

These icons are shown to indicate the status of the call on the currently displayed appearance button:

1. Use the ▲ up and down ▼ arrow keys to scroll through details of the current call on each appearance button.



2. If there is currently a call on the appearance button, an icon will be displayed indicating the status of the call.

-  **Alerting**  
The call is alerting your phone.
  -  **Connected**  
The call is the currently connected call to which you are talking.
  -  **On Hold**  
The call is on hold.
  -  **Held Elsewhere**  
The call has been put on hold by someone else who answered the call using an appearance button on their phone.
  -  **Conference**  
The call is a conference call.
3. A >> double-arrow at the bottom left indicates that there are [soft key options](#)<sup>31</sup> available that could be applied to the call. To access these, press the >> double-arrow soft key and select the required function.









## 1.12.2 Call Appearance Buttons

Call appearance buttons are used to display calls to and from your phone. By having several call appearance buttons, you are able to answer and make several calls, switch between calls and perform other actions.

When all your call appearance buttons are in use, any further calls to your number follow your forward on busy setting if set or otherwise go to voicemail if available.

### Call Appearance Button Lamps

The following lamp states are used by appearance buttons configured to be call appearance buttons.

Button Lamps	State
 <b>Red off. Green off.</b>	<b>Idle</b> The call appearance is not in use and is not currently selected.
 <b>Red on. Green off.</b>	<b>Idle + Selected</b> The call appearance is not in use but is the current selected button that will be used if the user goes off hook.
 <b>Red off. Green slow flash.</b>	<b>Alerting</b> The matching call appearance is alerting for an incoming call. This is accompanied by ringing. If the user is already on a call, only a single ring is given.
 <b>Red on. Green slow flash.</b>	<b>Alerting + Selected</b> As above but Ringing Line Preference has made this the user's current selected button.
 <b>Red on. Green on.</b>	<b>In Use Here</b> The user has a call connected on the call appearance or is dialing.
 <b>Red off. Green on.</b>	<b>In Use Elsewhere</b> The call appearance button is in use on a bridged appearance.
 <b>Red off. Green fast flash.</b>	<b>On Hold Here</b> The call has been put on hold by this user.
 <b>Red off. Green flash.</b>	<b>On Hold Elsewhere</b> A call on a bridged appearance button matched to the call appearance has been put on hold. Calls on a call appearance that are put on hold by another user will continue to show connected lamp status, though the phone display will indicate a held call.
 <b>Red off. Green broken flash.</b>	<b>Inaccessible</b> The button pressed is not accessible. The call is still dialing, ringing or cannot be bridged into.

## Call Appearance Button Display

G	299	11:00	01/26
↓			a=
Status		Features	

**Idle**  
Indicates that the call appearance is available to be used to make a call or to receive an incoming call.



Call: Incoming			
↓▲ a=Extn307		0:00:12	
307		>>	

**Alerting**  
This call appearance is alerting with an incoming call. You can press the >> double-arrow soft key to select the Ignore or ToVm soft key options.



Call			
↓[ a=Mark		0:00:12	
201		>>	

**Outgoing Call**  
You have made a call with the appearance but it is not yet connected.



Conn:			
↓[ a=Mark		0:00:22	
201		>>	

**Connected**  
The appearance is the one with which you are currently talking.



Held:			
↓[ a=Mark		0:00:22	
201		>>	

**Held**  
The call that you made or received on the call appearance has been put on hold by the other party.



Call: On-Hold			
↓↵ a=Mark		0:00:22	
201		>>	

**Holding**  
You have put the call on hold.



### 1.12.3 Bridged Appearance Buttons









A bridged appearance button shows the state of one of another user's call appearance buttons. It can be used to answer or join calls on that other user's call appearance button. It can also be used to make a call that the call appearance user can then join or retrieve from hold.

- When the user's call appearance button alerts, your matching bridged appearance button also alerts. The bridged appearance button can be used to answer the call on the call appearance button user's behalf.
- When the call appearance button user answers or makes a call using that call appearance, your matching bridged appearance button show the status of that call, for example connected, on hold, etc. The bridged appearance button can be used to retrieve the call if on hold or to join the call if active.
- Bridged appearance buttons are not supported between users on different systems in a [Small Community Network](#)<sup>[20h]</sup>.

If you have any bridged appearance and or call coverage buttons, you can [set the type of ringing \(coverage ring\)](#)<sup>[14b]</sup> that should be used when a call alerts on any of those buttons. The options are to use normal ringing, a single non-repeated ring (abbreviated ring) or no ring. The coverage ring setting is only used if you do not already have a connected call. If you already have a connected call in progress, the shorter of your coverage ring and the system administrator set attention ring settings is used.

#### Bridged Appearance Button Lamps

The following lamp states are used by appearance buttons configured to be bridged appearance buttons.

Button Lamps		Bridge Appearance Button State
	<b>Red off. Green off.</b>	<b>Idle</b> The bridged appearance is not in use.
	<b>Red off. Green slow flash.</b>	<b>Alerting</b> The matching call appearance is alerting for an incoming call. This is accompanied by ringing. If the user is already on a call, only a single ring is given.
	<b>Red on. Green slow flash.</b>	<b>Alerting + Selected</b> As above but Ringing Line Preference has made this the user's current selected button.
	<b>Red off. Green on.</b>	<b>In Use Elsewhere</b> The matching call appearance button is in use.
	<b>Red on. Green on.</b>	<b>In Use Here</b> The user has made a call or answered a call on the bridged appearance, or bridged into it.
	<b>Red off. Green fast flash.</b>	<b>On Hold Here</b> The call has been put on hold by this user.
	<b>Red off. Green flash.</b>	<b>On Hold Elsewhere</b> The call on that call appearance has been put on hold by another user.
	<b>Red off. Green broken flash.</b>	<b>Inaccessible</b> The button pressed is not useable. The call is still dialing, ringing or cannot be bridged into.

---

## Bridged Appearance Button Display

G	299	18:26	01/03
↑		Extn 201	a=

### Idle

By default, a bridged appearance is labeled with the name of the user and the label of their call appearance button that your bridged appearance matches.



G	299	18:27	01/03
↑	[ Extn201	a=	
	Join		

### In Use

The bridged appearance will show when the matching call appearance is in use on a call. The **Join** soft key, if displayed, indicates that you can intrude into the call to make it a conference call by pressing the soft key or the bridged appearance button.



Call: Incoming			
↑▲	Extn201	a=Extn20	0:00:23
203			>>

### Ringing

The bridged appearance will shown when the matching call appearance is being presented a call to answer. Typically just a single ring is given on your phone, however that can be changed by the system administrator. You can answer the call by pressing the bridged appearance button.



Dial: Number?			
↑	[Extn201	a=	
	Dir		

### Making a Call

If idle (see above), you can press the bridged appearance to make a call. The matching call appearance will indicate that it is in use and the other user can join the call by pressing that call appearance.



Call: On-Hold			
↑	Extn201	a=	
	Pickup		

### Held Call

If the other user puts their call on the matching call appearance on hold, your bridged appearance will indicate the held call. You can retrieve the held call by pressing the Pickup soft key or pressing the bridged appearance button.



## 1.12.4 Call Coverage Buttons





Each call coverage button is associated with another user on your telephone system. The button allows you to be alerted when that user has an unanswered call still ringing. You can view the details of the call and answer it if required.

The settings of the user being covered control how long it rings at their phone before it also starts alerting on your call coverage button for that user.

If you have any bridged appearance and or call coverage buttons, you can [set the type of ringing \(coverage ring\)](#) that should be used when a call alerts on any of those buttons. The options are to use normal ringing, a single non-repeated ring (abbreviated ring) or no ring. The coverage ring setting is only used if you do not already have a connected call. If you already have a connected call in progress, the shorter of your coverage ring and the system administrator set attention ring settings is used.

### Call Coverage Button Lamps

The following lamp states are used by appearance buttons configured to be call coverage buttons.

Button Lamps	Call Coverage Button State
 <b>Red off.</b> <b>Green off.</b>	<b>Idle</b> The button is not in use.
 <b>Red off.</b> <b>Green slow flash.</b>	<b>Alerting</b> The call coverage is alerting for an unanswered call at the covered user's phone. This is accompanied by ringing. If the user is already on a call, only a single ring is given.
 <b>Red on.</b> <b>Green slow flash.</b>	<b>Alerting + Selected</b> As above but Ringing Line Preference has made this the user's current selected button.
 <b>Red on.</b> <b>Green on.</b>	<b>In Use Here</b> The user has answered the call requiring coverage.
 <b>Red off.</b> <b>Green fast flash.</b>	<b>On Hold Here</b> The covered call has been put on hold by the call coverage button user.

---

## Call Coverage Button Display

G	299	18:27	01/03
↑		Extn201	Cov

### Idle

By default the display shows the name of the user being covered and **Cov**. In this state the button cannot be used to make calls or perform other actions.



Call: Incoming			
↑▲Extn201	Cov Ext	0:00:23	
203		>>	

### Alerting

If the covered user has any alerting call, when their call coverage time is reached the call will also be alerting on your call coverage button for that user. You can answer the call by pressing the button.



Call:			
↑[ Extn201	Cov Ext	0:00:23	
203		>>	

### Connected

When you use the call coverage button to answer the call, it becomes your call.



Call: On-Hold			
↑◀Extn201	Cov Ext	0:00:03	
203			

### On Hold

When you put the call on hold, the



Held:			
↑[ Extn201	Cov Ext	0:00:23	
203			

### Held

If the call is from another internal user and they put the call on hold, the held state is indicated. You can retrieve the call from hold by pressing the call coverage button again.





## 1.12.5 Line Appearance Buttons

Line appearance buttons allow you to make and receive calls on a specific telephone line connected to your telephone system. The button also allows you to see when the line is in use by other users.









For incoming calls, the telephone system still determines the destination for the call. That may be a user or group. However, if you have a line appearance button for the line, you will see that there is a call alerting and can answer it if required.

- **Private Lines**

Special behaviour is applied to calls where the user has both a line appearance for the line involved and is also the Incoming Call Route destination of that call. Such calls will alert only on the Line Appearance button and not on any other buttons. These calls will also not follow any forwarding.

### Line Appearance Button Lamps

The following lamp states are used by appearance buttons configured to be line appearance buttons.

Button Lamps	Line Appearance Button State
 <b>Red off.</b> <b>Green off.</b>	<b>Idle</b> The associated line is not in use.
 <b>Red on.</b> <b>Green off.</b>	<b>Idle + Selected</b> The associated line is not in use but the button is the user currently selected button.
 <b>Red off.</b> <b>Green slow flash.</b>	<b>Alerting</b> The line is ringing at its incoming call route destination. This is accompanied by ringing. If the user is already on a call, only a single ring is given.
 <b>Red on.</b> <b>Green slow flash.</b>	<b>Alerting + Selected</b> As above but Ringing Line Preference has made this the user's current selected button.
 <b>Red off.</b> <b>Green on.</b>	<b>In Use Elsewhere</b> The line is in use.
 <b>Red on.</b> <b>Green on.</b>	<b>In Use Here</b> The user has answered the line, made a call on it or bridged into the call on the line.
 <b>Red off.</b> <b>Green fast flash.</b>	<b>On Hold Here</b> The call on the line has been put on hold by this user.
 <b>Red off.</b> <b>Green flash.</b>	<b>On Hold Elsewhere</b> The call on the line has been put on hold by another appearance button user.
 <b>Red off.</b> <b>Green broken flash.</b>	<b>Inaccessible</b> The button pressed is not accessible. The call is still dialing, ringing, routing or cannot be bridged into.



# Chapter 2.

# Making Calls

---

## 2. Making Calls

If you are not already on a call, then you can just dial the number. The currently selected appearance button, shown by a red lamp, will be used for the call.

Alternatively, you can press a specific appearance button in order to make a call using that button. Using this method you can press the **Dir** soft key to [select a number from the directory](#) <sup>97</sup>.

If the number you dial matches a user or group on the telephone system, the directory name of the user or group is shown and the call starts altering the target.





If the call is to a user, and they do not answer, press the **>>** double-arrow soft key to access additional options. For example, to set a callback, press the **AutCB** soft key.

If the call is external and no external line is currently available, the message **WAITING FOR LINE** is displayed.

The display will indicate when the call is connected to the destination or to an outgoing line.





## 2.1 Calling a Person from the Contacts List

You can use any directory contacts to make a call. You can also use the directory in almost any telephone function where you need to select the number for a destination, for example during transfers.

1. Access the contacts directory:
  - a. Press the  **CONTACTS** key. The directory menu is displayed.
  - b. Use the  left and right  arrow keys to select which type of directory entries you want displayed.
    - **All** - All directory entries.
    - **External** - Directory entries stored by the telephony system for all users to use.
    - **Groups** - The names and numbers of hunt groups on the telephone system.
    - **Users** - The names and numbers of other users on the telephone system.
    - **Personal** - Your own personal directory entries.
  - c. Either press the **List** soft key to display all the directory entries or start dialing the name to display only matching entries.
    - Pressing a key enters all of the [characters represented by that key](#)<sup>[194]</sup>. Pressing another key adds the characters from that button to the previous key press. For example, dialing **527** matches all names starting with **JAS** (for example "Jason") and with **KAR** (for example "Karl") plus any other letter combinations from those 3 key presses. See [How the Directory Search Works](#)<sup>[89]</sup>.
    - To remove all the characters entered so far press **Clear**.
  - d. Use the  up and down  arrow keys to scroll through the matching entries.
2. When the required entry is displayed, press **Call**.
3. Continue as for a normally dialed call.

## 2.2 Calling a Person from the Call Log

You can use the call log to make calls to the number included in the currently selected call record.

1. Access the call log.
  - a. Press the  **CALL LOG** button.
  - b. The display will change to show your call log records. The caller's name is shown if known, otherwise the number.
  - c. Use the  left and right  arrow keys to select which call log records you are viewing. The options are **All**, **Missed**, **Answered** and **Outgoing**.
    - If you have any new missed call records (ie. the **CALL LOG** button lamp is illuminated) the call log will open showing your missed calls.
  - d. Use the  up and down  arrow keys to scroll through the records.
2. Press the **Call** soft key or **OK** to call the number displayed in the call record. This option is not available if the caller withheld their number.

---

## 2.3 Redialling a Previous Number

Your phone's  **REDIAL** key can work in one of two ways, set by its [redial mode setting](#)<sup>[43]</sup>.

### List Mode

This redial method is used when your phone's [redial mode](#)<sup>[43]</sup> is set to **List**.

1. Access the redial list.
  - a. Press the  **Redial** key. The list of outgoing calls is displayed.
  - b. Use the ▲ up and down ▼ arrow keys to scroll through the 10 most recent outgoing calls.
2. Press the **Call** soft key or **OK** to call the number displayed in the call record.
3. Continue in the same way as for a normal dialed call.

### One Number Mode

This redial method is used when your phone's [redial mode](#)<sup>[43]</sup> is set to **One**.

1. Press the  **REDIAL** key.
2. The number for the most recent outgoing call in your personal call log is redialed.
3. Continue in the same way as for a normal dialed call.

## 2.4 Making a Page Call

In order to make page calls you must have access to a paging short code provided by the system administrator or to a [paging feature button](#)<sup>[133]</sup>.

If the dialing short code or the paging button have been pre-configured with a number, the user or group at that number will be paged if available.

The dialing short code can be configured to accept the number of the user or group to page when dialed. Similarly a paging button can be set to allow number entry when pressed as follows:

1. Press the paging button.
2. Dial the number of the user or group you want to page.
3. When the dialing is completed, the page call is made.
  - If the destination is a user and they already have a call connected, they cannot be paged. If the destination is a group which is not in service or has no available members, it cannot be paged.

### Feature Button

The [self-administer function](#)<sup>[133]</sup> can be used to assign a feature button as a page button using the [Group Paging](#)<sup>[133]</sup> action.

## 2.5 Call Soft Key Options

When making, answering and during a call, a >> double-arrow soft key appears on the display, it indicates that there are additional options that you can access. The options vary according to the type of call and system features available to you.

Note that the soft keys only relate to the call currently displayed. You can use the ▲ up and down ▼ arrow keys to display the details of another call and its related soft keys without interrupting your current connected call.

Some of these options are only be available if enabled by your system administrator.

- **Account**  
Enter an account code to associate with the call.
- **Answer**  
Answer a page call, turning it into a normal call.
- **AutCB**  
Set an automatic callback on the user that you have called but who has not answered. When they next end a call, the telephone system will call you and when answered, will automatically make a call to the user.
- **Complete**  
Complete the transfer of a held call. A **Cancel** option is also shown which will end the transfer attempt.
- **Dir**  
Access the directory in order to select a number by name.
- **Drop**  
End the call.
- **Ignore**  
Silence the ringer for the current alerting call. The call will continue alerting until either answered or it goes to voicemail.
- **Pickup**  
Answer the call that is held or alerting another user.
- **ToVM**  
Send an alerting call to your voicemail.

---

## 2.6 Busy Indication

By default the telephone system does not provide any indication to you if the internal user you call is already on a call or set to do not disturb. Instead the call either just rings or goes to voicemail.

However, your system administrator can enable busy indication for selected users or for the whole system. When this is enabled, calling those users displays "**Do Not Disturb**" or "**On Another Call**" on your phone if not diverted to voicemail.

If you need status indication for a user without needing to make a call, you can add a ['user BLF'](#) button to your phone.

## 2.7 En-Bloc Dialing

By default, when you start dialing a number on your phone, the phone immediately connects to the telephone system and starts passing the digits you dial to the phone system. You cannot correct the digits you have already dialed except by ending the call and starting again. Also if you pause dialing for too long the phone system may think that you have finished dialing and will attempt to connect the call using only the digits you have completed dialing so far.

En-bloc dialing allows you to compose and edit the number to dial on your phone's display before it is sent to the phone system to be dialed.









Through the phone's menus you can select whether you want to use traditional or en-bloc dialing when making calls. Your chosen setting is then applied whenever you are using a phone that supports en-bloc dialing.

### Dialing a Number Using En-Bloc Mode

1. With no connected call on the phone, start dialing. Do not lift the handset or select headset or speaker before dialing.
2. You can use the  right arrow key to delete the previous digit dialed if you need to correct the number.
3. When you have completed the number as required, you can select how you want to make the call.
  - Lift the handset to start a call using the handset.
  - Pressing the **Call** soft key or **OK** button to start the call using the phone's [default handsfree audio path](#) (speaker or headset). You can also press one of your idle call appearance to make the call using that appearance.
  - Press the **Headset** button to start the call on a headset connected to your phone.
  - Press the **Speaker** button to start the call on your phone's handsfree speaker.

### Enabling/Disabling En-Bloc Dialing

You can enable or disable your en-bloc dialing setting through the phone's **Features** menu.

1. Press the **Features** soft key if shown.
  - To access the menu during a call, press the  right arrow key or press the  **PHONE** key and then press the **Features** soft key.
2. Use the  up and down  arrow keys to scroll the display to the option **Call Settings**.
3. Press the **Select** soft key or the **OK** button or the  right arrow key.
4. Use the  up and down  arrow keys to scroll the display to the option **En-Bloc Dial**.
5. Use the  left and right  arrow keys to change the setting or use the indicated soft key.



## 2.8 Withholding Your Number

You can select to withhold your number on external calls. Note that this option may not be supported in all situations. It may depend on the configuration of your phone system and options supported by your telephone line provider.

1. Press the **Features** soft key if shown.
  - To access the menu during a call, press the ► right arrow key or press the **PHONE** key and then press the **Features** soft key.
2. Use the ▲ up and down ▼ arrow keys to scroll the display to the option **Call Settings**.
3. Press the **Select** soft key or the **OK** button or the ► right arrow key.
4. Use the ▲ up and down ▼ menu keys to scroll the menu to **Withhold Number**.
5. Use the ◀ left or right ► arrow keys to change the current setting or press the indicated soft key.

### Access Control

Your system administrator can configure whether you can access this menu option. See [Menu Access Control](#)<sup>193</sup>.

---

## 2.9 Adjust the Call Volume

While talking, you can adjust the volume of the incoming call. The volume is separately adjusted for which every device you are currently using (handset, headset or speaker).



1. With the call connected, press the  key.
2. Use the **+** plus and **-** minus keys to adjust the volume.
3. The display will return to normal after a few seconds.

## 2.10 Muting a Call

Muting a call stops the caller from hearing you. However, you can still hear them.

- The mute setting remains active even if you switch between calls using hold and or appearance buttons.
  - If you change how you are listening to the call, for example switching from the handset to the speaker, the mute setting is canceled.
1. To activate mute, press the  **MUTE** key. The button is lit while mute is active.
  2. To switch mute off, press the key again.

## 2.11 Ending Calls

- The  **DROP** key can be used to end the current call to which you are talking. If the call is a conference call, it displays a menu to allow selection of which [conference party to drop](#)<sup>79</sup>.
- If the call is connected on the phone's speaker, the  **SPEAKER** key is lit. Pressing the key again will end the call.
- If the call is connected on the phone's headset, the  **HEADSET** key is lit. Pressing the key again will end the call.
- If the call is connected on the phone's handset, replacing the handset will end the call.

# Chapter 3.

# Answering Calls

---



## 3. Answering Calls

A slow flashing green lamp on an  appearance button indicates an alerting call. This may also be accompanied by [ringing](#)<sup>[142]</sup> and by the message lamp flashing.

### Selected Button

If the button also has a red lamp () that indicates that it is already the selected button that will be used if you lift the handset or go off hook in any other way. If that in the case you can answer the call in the following ways:

**To answer a call on the selected button:**   = Red on, Slow green flash.

1. Select the method which you want to use to talk to the caller:
  - To silence the ringing, press the >> double-arrow soft key and then press the **Ignore** soft key. The call will still continue alerting visually and can be answered or ignored.
  - To redirect the call to voicemail, press the >> double-arrow soft key and then press the **To VM** soft key.
  - To answer the call using the handset, lift the handset.
  - To answer the call handsfree, press the **SPEAKER** key.
  - To answer the call on a headset, press the **HEADSET** key.
  - Just pressing the  key will answer the call either on the speaker or headset depending on the phones [audio path](#)<sup>[83]</sup> setting.
2. The green lamp will stop its slow flash. Once you have answered the call, you can switch between talk modes:
  - To switch to using the handset, lift the handset.
  - To switch to handsfree, press the **SPEAKER** key. If you were using the handset you can now safely replace it.
  - To switch to headset mode, press the **HEADSET** key. If you were using the handset you can now safely replace it.
  - If you have answered the call on the speaker or headset, pressing the **SPEAKER** or **HEADSET** key again before you select another mode will end the call.
  - Just pressing the  key or any other appearance button will put the call on hold.

## 3.1 Answering Another Call

If the button that with a slow green flash does not have a red light, it is not the currently selected button. That may be because you are already on a call on another button. If that is the case, answering the new call will automatically put the existing call on hold.<sup>[1]</sup>

- You can configure the phone to automatically display details of an additional call waiting to be answered. See [Auto Show Call Waiting](#)<sup>[15]</sup>.

### To answer another call:

1. Using the ▲ up and down ▼ arrow keys, you can scroll the display to see details of the waiting call.
  - To silence the ringing, press the >> double-arrow soft key and then press the **Ignore** soft key. The call will still continue alerting and can be answered or ignored.
  - To redirect the call to voicemail, press the >> double-arrow soft key and then press the **To VM** soft key.
2. Press the flashing green appearance button  to answer the new call and put the existing call on hold. The call will be answered using which ever talk mode you were already using for the existing call.

### Notes

1. This guide assumed that auto hold is enabled (the default). The system administrator can disable auto hold for the system, in which case calls are automatically disconnected rather than held.

---

## 3.2 Divert a Call to Voicemail

You can transfer a call targeted at you directly to voicemail.

### To divert a call to your mailbox:

1. If the call is not the current call on the display, use the ▲ up and down ▼ arrow keys to scroll the display to the alerting call.
2. Press the >> double-arrow soft key.
3. Press the **To VM** soft key. The call is redirected to voicemail.

## 3.3 Ignore/Silence an Incoming Call

You can silence the ringer of a currently alerting call. The call will continue alerting but with no audible ring.

### To ignore (silence) an incoming call:

1. If the call is not the current call on the display, use the ▲ up and down ▼ arrow keys to scroll the display to the alerting call.
2. Press the >> double-arrow soft key.
3. Press the **Ignore** soft key. The call will continue alerting but with no audible ring.

## 3.4 Dropping an Incoming Call

You can attempt to drop an incoming call. Dropping a call has different effects depending on the call type and other options:

- If the call is a hunt group call, dropping the incoming call causes it to be presented to the next agent in the group or follow other hunt group settings (which can include presenting the call to you again).
- If the call is a direct call to you, dropping it causes it to:
  - Go to your forward on no answer destination if set and enabled. See [Forward On Busy/No Answer](#)<sup>[58]</sup>.
  - Else the call goes to your voicemail if available.
  - Else the call continues to ring (drop has no effect).
- If the call is returning from being held or parked for too long you cannot drop it.

### To drop an incoming call:

1. If the call is not the current call on the display, use the ▲ up and down ▼ arrow keys to scroll the display to the alerting call.
2. Press the >> double-arrow soft key.
3. Press the **Drop** key. Depending on your particular phone this may be a soft key on the display or a physical key. You can also assign the drop function to a [programmable key](#)<sup>[130]</sup>.

## 3.5 Answering a Page Call

Your phone can be paged if you have no other connected call in progress and your phone is currently idle. You can hear the caller but they cannot hear you.

The page is heard through the phone's speaker following a single beep. A page call is also indicated in the display by the word **Page**.

### To answer a page call:

1. To answer the page call, press the  **CONFERENCE** key.
  - Alternatively, press the >> double-arrow soft key and press the **Answer** soft key.
2. The call is turned into a normal call.

## 3.6 Displaying Other Calls

The phone can handle multiple calls at the same time. Whilst you can only have one connected call at any time, you can have other calls on [hold](#)<sup>[65]</sup>, [parked](#)<sup>[67]</sup> and further incoming calls alerting. The status of each call (except parked calls) is indicated by a separate call appearance button for each call.

To view the details of another call, use the ▲ up and down ▼ arrow keys to scroll which [appearance button's](#)<sup>[19]</sup> call details are currently displayed. You can do this even whilst you have a connected call. In addition to showing the call details, the [soft key options](#)<sup>[31]</sup> shown change to match actions that you can apply to the displayed call.

Changing the currently displayed call before starting a conference affects which calls are conferenced. See [Context Sensitive Conferencing](#)<sup>[80]</sup>.

The phone can also be configured to automatically display the details of any new incoming call when you are already on a call. See [Auto Show Call Waiting](#)<sup>[151]</sup>.

## 3.7 Auto Answer

You can select to have internal calls automatically connected if you are not already on a call. The call will be connected, after the phone gives a brief tone, using either the phone's speaker or the headset as set by the phone's [audio path setting](#)<sup>[154]</sup>.

### To enable auto internal answer:

1. Press the **A MENU** button.
2. Use the ▲ up and down ▼ arrow keys to locate the option **Call Settings....**
3. Press the **Select** soft key.
4. Use the ▲ up and down ▼ arrow keys to locate the option **Internal Auto-Answer**.
5. Press the **Change** soft key to change the setting.

This function can be assigned to a [feature button](#)<sup>[130]</sup> configured with the [Internal Auto Answer](#)<sup>[132]</sup> action. The button lamp will indicate when internal auto answer is on.

### Access Control

Your system administrator can configure whether you can access this menu option. See [Menu Access Control](#)<sup>[193]</sup>.

---

## 3.8 Call Pickup

Pickup is used to answer a call ringing elsewhere on the phone system.

### To pickup a call:

1. Press the **Features** soft key if shown.
  - To access the menu during a call, press the **▶** right arrow key or press the **PHONE** key and then press the **Features** soft key.
2. Press the **Select** soft key or the **OK** button or the **▶** right arrow key.
  - To answer a ringing call, press the **Any** soft key.
  - To answer a call ringing against a particular target, dial the targets number. Alternatively, press the **Dir** soft key to [select the target from the directory](#)<sup>[91]</sup>.
3. The following menus will depend on the type of number entered:
  - **User Number**
    - To answer a call ringing against the user, press the **Pickup** soft key.
    - To return to entering a number, press the **Clear** key.
  - **Hunt Group Number**
    - To answer a call ringing against the members of the group, press the **Members** soft key. The call does not have to be a call to the hunt group.
    - To answer a call ringing for the hunt group, press the **Group** soft key.
    - To return to entering a number, press the **Clear** key.

### Access Control

Your system administrator can configure whether you can access this menu option. See [Menu Access Control](#)<sup>[193]</sup>.

### Default Short Codes

Short codes are numbers that you can dial to enable and disable various features. The following are default short codes that may be available. However, your system administrator can remove and change the short codes available to you or all users.

- **Pickup Any Call: \*30**  
Answer a call ringing on the telephone system.
- **Pickup a Group Call: \*31**  
Answer a call ringing a group of which you are a member.
- **Pickup a Users Call: \*32\*N#**  
Pickup a call ringing a user's extension number (**N**).
- **Pickup a Group Members Call: \*53\*N#**  
Pickup a call ringing the members of a group (**N**). This does not necessarily have to be a group call.



# Chapter 4.

# Redialling

---

## 4. Redialling

The phones redial operation can work in either of the following modes:

- **List**  
If this mode is selected, pressing the **Redial** will display a menu of the 10 most recent outgoing calls in your call log. You can select the call that you want to redial and perform a number of other functions.
- **One**  
If this mode is selected, pressing **Redial** will immediately repeat the most recent outgoing call in your call log. None of the other redial function will be accessible.

You can [select the redial mode](#)<sup>43</sup> that the phone uses. In either case, the redial function uses the outgoing call records in your [personal call log](#)<sup>98</sup>. If you delete the records in your call log, redial will not work until new outgoing call records exist in your personal call log.

### Notes

1. Use of centralized call log can be switched off by the system administrator. In that case the numbers used for the redial function are stored by the phone. This guide only covers redial using outgoing call records in the users centralized call log.

### 4.1 Redial a Call (One Mode)

This redial method is used when your phone's [redial mode](#)<sup>43</sup> is set to **One**.

1. Press the  **REDIAL** key.
2. The number for the most recent outgoing call in your personal call log is redialed.
3. Continue in the same way as for a normal dialed call.

### 4.2 Redial a Call (List Mode)

This redial method is used when your phone's [redial mode](#)<sup>43</sup> is set to **List**.

1. Access the redial list.
  - a. Press the  **Redial** key. The list of outgoing calls is displayed.
  - b. Use the ▲ up and down ▼ arrow keys to scroll through the 10 most recent outgoing calls.
2. Press the **Call** soft key or **OK** to call the number displayed in the call record.
3. Continue in the same way as for a normal dialed call.

## 4.3 Selecting Your Redial Mode

You can select whether your phone uses the redial list or last call redial mode.

1. Press the **Features** soft key if shown.
  - To access the menu during a call, press the ► right arrow key or press the ☎ **PHONE** key and then press the **Features** soft key.
2. Use the ▲ up and down ▼ arrow keys to scroll the display to the option **Call Settings**.
3. Press the **Select** soft key or the **OK** button or the ► right arrow key.
4. Use the ▲ up and down ▼ arrow keys to scroll the menu to **Redial Action**.
5. The current mode, **List** or **One** is displayed.
  - **List**  
If this mode is selected, pressing the **Redial** will display a menu of the 10 most recent outgoing calls in your call log. You can select the call that you want to redial and perform a number of other functions.
  - **One**  
If this mode is selected, pressing **Redial** will immediately repeat the most recent outgoing call in your call log. None of the other redial function will be accessible.
6. Use either the **Change** soft key or the ◀ left or right ▶ arrow keys to change the mode.
7. When the required mode is displayed, press the **Done** soft key.

---

## 4.4 View Call Details

You can view additional details about the currently shown call.

1. Access the redial list.
  - a. Press the  **Redial** key. The list of outgoing calls is displayed.
  - b. Use the ▲ up and down ▼ arrow keys to scroll through the 10 most recent outgoing calls.
2. Press the **Details** soft key. The individual details of the currently selected call record are displayed.
3. Use the ▲ up and down ▼ arrow keys to scroll through the details. The possible values are:
  - **Time**  
The time of the call.
  - **Ring Time**  
How long the call rang.
  - **Name**  
The name of the caller if known.
  - **Number**  
The number of the caller if available.
  - **Reason**  
The type of call record, ie. *Answered*, *Outgoing* or *Missed*.
  - **Count**  
How many times a call of the same type, name and number has occurred. Only the details of the most recent call are kept in your call log. However the count will indicate if the caller has rung or has been rung several times.
4. While you are in the details of a call record, the soft key functions available are:
  - **Call**  
Call the number shown in the call record. You can also do this by pressing the **OK** button.
  - **+Contact**  
Add the name and number to your personal directory. You can edit the details before they are added.
  - **Back**  
Go back to the normal call screen to select another call record.

## 4.5 Add a Call to Your Contacts

You can add the details of a call in your redial list to your personal contacts.

1. Access the redial list.
  - a. Press the  **Redial** key. The list of outgoing calls is displayed.
  - b. Use the ▲ up and down ▼ arrow keys to scroll through the 10 most recent outgoing calls.
2. Press the **Details** soft key. The individual details of the currently selected call record are displayed.
3. Press the **+Contact** soft key.
4. Use the ▲ up and down ▼ arrow keys to switch between the name and number details for the new contact.
5. Using the telephone keypad and the **Bksp** soft key you can edit the name and the number. See [Entering Characters](#)<sup>194</sup>.
6. When the name and number are set as required, press the **Save** soft key. To return without saving the name and number, press the **Cancel** soft key.

# Chapter 5.

## Redirecting Calls

## 5. Redirecting Calls

This section looks at the different ways that you can redirect your calls to another phone.

- **Follow Me** <sup>47</sup>  
Temporarily redirect all your calls to another phone that you will be sharing with that phone's normal user. This function can be used in two ways:
  - **Follow Me To**  
Set the follow me destination from your own phone.
  - **Follow Me Here**  
Set the follow me destination from the phone that you want to use.
- **Forward** <sup>50</sup>  
Forward calls to an internal or external number.
  - **Forward on Busy**  
Forward calls when you have reached the limit of the number of calls that the phone can present to you.
  - **Forward on No Answer**  
Forward calls if they have rung unanswered at your phone.
  - **Forward Unconditional**  
Immediately forward calls. Forwarding to voicemail as the can be selected as an option.
- **Do Not Disturb** <sup>57</sup>  
Redirect all calls to voicemail if available or otherwise to busy tone.
  - Do not disturb exception numbers can be used to allow calls from specific numbers to ignore do not disturb.
- **Twinning** <sup>59</sup>  
Twinning is a process whereby you can have your calls ring at two different phones. You can answer calls at either phone. There are two variants of twinning, internal twinning which uses two internal extensions and mobile twinning which twins your internal extension with an external number.

Method		Calls Redirected			Destination		
		Internal	External	Group	Internal	External	Voicemail
Follow Me	Follow Me To	✓	✓	✓	✓	✗	✗
	Follow Me Here	✓	✓	✓	✓	✗	✗
Forward	Forward on Busy	✓	✓	✗	✓	✓	✗
	Forward on No Answer	✓	✓	✗	✓	✓	✗
	Forward Unconditional	✓	✓	✓	✓	✓	✓
Do Not Disturb		✓	✓	✗	✗	✗	✓
Twinning		✓	✓	✓	✓	✓	✓

## 5.1 Follow Me

'Follow me to' is used to redirect your calls to another extension where you will be working. The calls are presented with your user name so that they can be distinguished from calls for the extension's normal user. This allows you to share another person's phone without logging them off their phone.

All calls are redirected and the calls are still subject to all your user settings as if they were ringing at your phone.

### Follow Me To

Follow me to is the function used to enable follow me from your own phone.

### Follow Me Here

Follow here the function used to enable follow me at the extension to which you want your calls redirected.

### Default Short Codes

Short codes are numbers that you can dial to enable and disable various features. The following are default short codes that may be available. However, your system administrator can remove and change the short codes available to you or all users.

- **Follow Me Here: \*12\*N#**  
Dialed at the extension to which you want your calls redirected. Use your own extension number (**N**) when dialing the short code.
- **Follow Me Here Cancel: \*13\*N#**  
Dialed at the extension to which you want your calls were redirected. Use your own extension number (**N**) when dialing the short code.
- **Follow Me To: \*14\*N#**  
Dialed at your phone. Dial the extension number (**N**) to which you want your calls redirected. You can dial just **\*14#** to cancel follow me.
- **Cancel All Forwarding: \*00**  
Switch off any forwarding. Includes forward unconditional, forward on busy, forward on no answer, follow me and do not disturb.

---

## 5.1.1 Follow Me To (Features Menu)

Using the user menu you can set and clear follow me to settings.

1. Press the **Features** soft key if shown.
  - To access the menu during a call, press the **▶** right arrow key or press the **PHONE** key and then press the **Features** soft key.
2. Use the **▲** up and down **▼** arrow keys to scroll the menu to **Forward**.
3. Press the **Select** soft key or the **▶** right arrow key.
4. Press the **Select** soft key or the **▶** right arrow key. If you already has a follow me to number set, the display below is skipped.
5. Dial the number of another user. When it matches a user their name is displayed. Alternatively use the **Dir** soft key to [select a user from the directory](#)<sup>191</sup>.
  - **Save**  
Save the selected number as your follow me to destination. All calls to your extension number will be redirected to that destination.
  - **Clear**  
Clear the currently selected or set number.
  - **Back**  
Go back to the previous menu.

### Access Control

Your system administrator can configure whether you can access this menu option. See [Menu Access Control](#)<sup>193</sup>.

## 5.1.2 Follow Me (Status Menu)

If you have set a follow me destination for calls to your phone, you can clear or change the setting through the **Status** menu.

1. Press the **Status** soft key if shown. To access the status menu during a call, press the **PHONE** key and then press the **Status** soft key if shown.
2. Use the **▲** up and down **▼** arrow keys to scroll the menu to **Follow Me To**.
  - To clear the follow me to setting, press the **Clear** soft key.
  - To change the destination of the setting, press the **Edit** soft key.

### Access Control

Your system administrator can configure whether you can access this menu option. See [Menu Access Control](#)<sup>193</sup>.



### 5.1.3 Follow Me Here (Features Menu)

You may be able to change follow me here using the Features menu.

1. Press the **Features** soft key if shown.
  - To access the menu during a call, press the **▶** right arrow key or press the **PHONE** key and then press the **Features** soft key.
2. Use the **▲** up and down **▼** arrow keys to scroll the menu to **Forward**.
3. Press the **Select** soft key or the **OK** button or the **▶** right arrow key.
4. Use the **▲** up and down **▼** arrow keys to scroll the menu to **Follow Me Here**.
5. Press the **Select** soft key or the **OK** button or the **▶** right arrow key.
  - Use the menu to add or remove users.
    - Use the **▲** up and down **▼** arrow keys to scroll through the names.
    - To remove a user, press the **Clear** soft key.
    - To add a user, press the **Add** soft key.
      - Dial the number of another user. When it matches a user their name is displayed. Alternatively, use the **Dir** soft key to [select a user from the directory](#)<sup>[91]</sup>.
      - Press the **Save** soft key to set the follow me here.

#### Access Control

Your system administrator can configure whether you can access this menu option. See [Menu Access Control](#)<sup>[93]</sup>.

---

## 5.2 Forwarding Calls

Forwarding is used to redirect calls to another extension or an external number.

### Forward Unconditional

Forward unconditional can be used to immediately redirect your calls.

- By default this function is only applied to incoming external calls to you. However, if required internal calls and or hunt group calls can also be selected.
- When enabled, all calls matching the settings are forwarded to the number set as your forward unconditional destination. That number can be internal or external.
- You can still use the phone to make outgoing calls. When you go off-hook you will hear broken dial tone.
- If you also have [forward on no answer set](#)<sup>[199]</sup>, if the unconditionally forwarded call is still unanswered after having rung for your no answer time (default 15 seconds), the system will redirect the call to your forward on no answer destination. Note that this is not always possible for calls that have been forwarded to an external number.
- If you also have [voicemail enabled](#)<sup>[110]</sup>, if the the forwarded call is still unanswered after having rung for your no answer time (default 15 seconds), the system will redirect the call to voicemail. Note that this is not always possible for calls that have been forwarded to an external number.
- **D = Diverting (Forwarding) Calls**  
A **D** is shown on your phone's display when you have forward unconditional enabled.

### Forward on Busy

Forward on busy redirects your calls when your phone is not able to present you with any more alerting calls.

- By default this function is only applied to incoming external calls to you. However, if required internal calls can also be selected.
- When enabled, all calls matching the settings are forwarded to the number set as the forward on busy/no answer destination. That number can be internal or external.
- Busy is defined as having no available call appearance buttons on which further calls can be presented.
- Hunt group calls are not presented when you are busy and so are not forwarded by this setting.
- The forward on busy and forward on no answer options use the same forwarding destination number. If no number is set, they use the same destination as set for forward unconditional.
- If you also have [voicemail enabled](#)<sup>[110]</sup>, if the the forwarded call is still unanswered after having rung for your no answer time (default 15 seconds), the system will redirect the call to voicemail. Note that this is not always possible for calls that have been forwarded to an external number.

### Forward on No Answer

Forward on no answer redirect calls that have alerted your phone but have not been answered for some reason.

- By default this function is only applied to incoming external calls to you. However if required internal calls can also be selected.
- When enabled, all calls matching the settings are forwarded to the number set as the forward on busy/no answer destination. That number can be internal or external.
- No answer is defined as having been presented to your phone for your no answer time (default 15 seconds).
- Hunt group calls are not forwarded.
- The forward on busy and forward on no answer options use the same forwarding destination number. If no number is set, they use the same destination as set for forward unconditional.
- If you also have [voicemail enabled](#)<sup>[110]</sup>, if the the forwarded call is still unanswered after having rung for your no answer time (default 15 seconds), the system will redirect the call to voicemail. Note that this is not always possible for calls that have been forwarded to an external number.

## Default Short Codes

Short codes are numbers that you can dial to enable and disable various features. The following are default short codes that may be available. However, your system administrator can remove and change the short codes available to you or all users.

- **Cancel All Forwarding: \*00**  
Switch off any forwarding. Includes forward unconditional, forward on busy, forward on no answer, follow me and do not disturb.
- **Set the Forward Unconditional Destination: \*07\*N#**  
Set the destination number (**N**) for forward unconditional when it is switched on.
  - **Switch Forward Unconditional On: \*01**  
Switch on forward unconditional. A destination must have been set.
  - **Switch Forward Unconditional Off: \*02**
  - **Include Hunt Group Calls in Forward Unconditional: \*50**
  - **Exclude Hunt Group Calls from Forward Unconditional: \*51**
- **Set the Forward On Busy/No Answer Destination: \*57\*N#**  
Set the destination number (**N**) for forward on busy and forward on no answer. If no number has been set, those functions will use the forward unconditional number if set.
  - **Switch Forward On Busy On: \*03**
  - **Switch Forward On Busy Off: \*04**
  - **Switch Forward on No Answer On: \*05**
  - **Switch Forward on No Answer Off: \*06**

---

## 5.2.1 Forward Unconditional (Status Menu)

You can clear or change your forward unconditional settings through the **Status** menu.

1. Press the **Status** soft key if shown. To access the status menu during a call, press the **PHONE** key and then press the **Status** soft key if shown.
2. Use the **▲** up and down **▼** arrow keys to scroll the menu to **Fwd Uncon.**
  - To switch off forward unconditional, press the **Off** soft key.
  - To change the forwarding settings, press the **Edit** soft key.
    - Use the **▲** up and down **▼** arrow keys to scroll through the editing options.
      - Use the **◀** left and right **▶** arrow keys to switch the forwarding on or off.
      - Use the **◀** left and right **▶** arrow keys to select which calls should be forwarded. The options are **External Only**, **External and Group**, **Non Group Calls** and **All Calls**.
      - Select edit to change the number to which calls are forwarded.

### Access Control

Your system administrator can configure whether you can access this menu option. See [Menu Access Control](#)<sup>193</sup>.

## 5.2.2 Forward Unconditional (Features Menu)

You may be able to change your forward unconditional settings using the Features menu.

1. Press the **Features** soft key if shown.
  - To access the menu during a call, press the **▶** right arrow key or press the **PHONE** key and then press the **Features** soft key.
2. Use the **▲** up and down **▼** arrow keys to scroll the menu to **Forward**.
3. Press the **Select** soft key or the **OK** button or the **▶** right arrow key.
4. Use the **▲** up and down **▼** arrow keys to scroll the menu to **Fwd Unconditional**.
5. Press the **Select** soft key or the **OK** button or the **▶** right arrow key. The screen displayed will vary depending on whether you already have a destination set or are forwarding your calls to voicemail.

- **No Number Set**

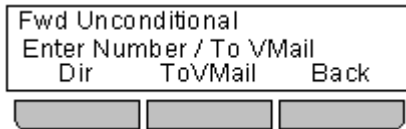

- **Number Set but Forward Unconditional Off**

This menu appears if you already have set a destination number but have turned off forwarding.

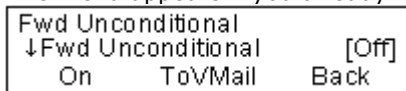

- Press the **On** soft key to switch forward unconditional to the set number on. You can then continue as below.
- Press the **ToVMail** soft key to switch forward unconditional to voicemail on. You can then continue as below.
- **Number Set and Forward Unconditional On**
  - Use the **▲** up and down **▼** arrow keys to scroll through the forwarding settings.
    - Use the **▲** up and down **▼** arrow keys to scroll through the editing options.
      - Use the **◀** left and right **▶** arrow keys to switch the forwarding on or off.
      - Use the **◀** left and right **▶** arrow keys to select which calls should be forwarded. The options are **External Only**, **External and Group**, **Non Group Calls** and **All Calls**.
      - Select edit to change the number to which calls are forwarded.
- **To Voicemail Set and On**
  - Use the **▲** up and down **▼** arrow keys to scroll through the forwarding settings.
    - Select **Off** to disable forwarding.
    - Use the **◀** left and right **▶** arrow keys to select which calls should be forwarded. The options are **External Only**, **External and Group**, **Non Group Calls** and **All Calls**.

### Access Control

Your system administrator can configure whether you can access this menu option. See [Menu Access Control](#)<sup>193</sup>.

---

### 5.2.3 Forward On No Answer (Status Menu)

If your phone is set to [forward on no answer](#)<sup>501</sup>, you can clear or change the forward settings through the **Status** menu.

1. Press the **Status** soft key if shown. To access the status menu during a call, press the **PHONE** key and then press the **Status** soft key if shown.
2. Use the **▲** up and down **▼** arrow keys to scroll the menu to **Fwd NoAns**.
  - To switch off forward on no answer, press the **Off** soft key.
  - To change the destination of the setting, press the **Edit** soft key.
    - Use the **▲** up and down **▼** arrow keys to scroll through the following menu options:
      - Use the **◀** left and right **▶** arrow keys to switch forward on busy as on or off.
      - Use the **◀** left and right **▶** arrow keys to switch forward on no answer on or off.
      - Use the **◀** left and right **▶** arrow keys to select which calls should be forwarded. The options are **All Calls** or **External Calls Only**.
      - The forward destination is shown. Press the **Change** soft key to enter a new destination or clear the destination.
        - If the current destination is shown in ( ) brackets, that indicates that the forward unconditional destination is being used as no specific forward on busy/no answer destination has been set. Selecting Change will set a forward on busy/no answer destination, it will not change the forward unconditional destination.

#### Access Control

Your system administrator can configure whether you can access this menu option. See [Menu Access Control](#)<sup>193</sup>.

## 5.2.4 Forward On Busy (Status Menu)

If your phone is set to forward on busy, you can clear or change the forward settings through the **Status** menu.

1. Press the **Status** soft key if shown. To access the status menu during a call, press the **PHONE** key and then press the **Status** soft key if shown.
2. Use the **▲** up and down **▼** arrow keys to scroll the menu to **Fwd OnBsy**.
  - To switch off forward on busy, press the **Off** soft key.
  - To change the destination of the setting, press the **Edit** soft key.
    - Use the **▲** up and down **▼** arrow keys to scroll through the following menu options:
      - Use the **◀** left and right **▶** arrow keys to switch forward on busy as on or off.
      - Use the **◀** left and right **▶** arrow keys to switch forward on no answer on or off.
      - Use the **◀** left and right **▶** arrow keys to select which calls should be forwarded. The options are **All Calls** or **External Calls Only**.
      - The forward destination is shown. Press the **Change** soft key to enter a new destination or clear the destination.
        - If the current destination is shown in ( ) brackets, that indicates that the forward unconditional destination is being used as no specific forward on busy/no answer destination has been set. Selecting Change will set a forward on busy/no answer destination, it will not change the forward unconditional destination.

### Access Control

Your system administrator can configure whether you can access this menu option. See [Menu Access Control](#)<sup>193</sup>.

---

## 5.2.5 Forward On Busy/No Answer (Features Menu)

You may be able to use the Features menu to switch forward on no answer, forward on busy on or off.

1. Press the **Features** soft key if shown.
  - To access the menu during a call, press the **▶** right arrow key or press the **PHONE** key and then press the **Features** soft key.
2. Use the **▲** up and down **▼** arrow keys to scroll the menu to **Forward**.
3. Press the **Select** soft key or the **OK** button or the **▶** right arrow key.
4. Use the **▲** up and down **▼** arrow keys to scroll the menu to **Fwd Busy/No Answer**.
5. Press the **Select** soft key or the **OK** button or the **▶** right arrow key. The options that appear will depend in whether a valid forwarding destination has already been set:
  - **No Forwarding Destination Set**  
Forward on busy and forward on no answer cannot be used until either a forward unconditional or forward busy/no answer destination is set.
    - If no destination has been set, you are prompted to enter a number.
    - Enter a number or press the **Dir** soft key to [select a number from the directory](#)<sup>191</sup>.
    - When a number is set, press the **Save** soft key.
    - The menu can now be used in the same way as if the number had already been set.
  - **Forwarding Destination Set**
    - Use the **▲** up and down **▼** arrow keys to scroll through the following menu options:
      - Use the **◀** left and right **▶** arrow keys to switch forward on busy as on or off.
      - Use the **◀** left and right **▶** arrow keys to switch forward on no answer on or off.
      - Use the **◀** left and right **▶** arrow keys to select which calls should be forwarded. The options are **All Calls** or **External Calls Only**.
      - The forward destination is shown. Press the **Change** soft key to enter a new destination or clear the destination.
        - If the current destination is shown in ( ) brackets, that indicates that the forward unconditional destination is being used as no specific forward on busy/no answer destination has been set. Selecting Change will set a forward on busy/no answer destination, it will not change the forward unconditional destination.

### Access Control

Your system administrator can configure whether you can access this menu option. See [Menu Access Control](#)<sup>193</sup>.



## 5.3 Do Not Disturb

- When you are in 'do not disturb,' your callers are redirected to voicemail if available. Otherwise, the caller hears busy tone.
- People calling from numbers in your 'do not disturb' exceptions list can still call you. However, forwarding can still be applied to these calls.
  - Calls to any hunt group of which you are a member are not presented to you (unless you are the last available member of the group).
  - Enabling do not disturb will not affect any calls already being presented to your phone.
  - You can still use the phone to make outgoing calls. When you go off-hook you will hear broken dial tone.
  - **N = No Calls (Do Not Disturb)**  
An **N** is shown on your phone's display when you have do not disturb enabled.

### Default Short Codes

Short codes are numbers that you can dial to enable and disable various features. The following are default short codes that may be available. However, your system administrator can remove and change the short codes available to you or all users.

- **Switch Do Not Disturb On: \*08**  
Set your phone to do not disturb.
- **Switch Do Not Disturb Off: \*09**  
Switch off do not disturb.
- **Add a Do Not Disturb Exception Number: \*10\*N#**  
Add a number (**N**) to your list of do not disturb exceptions.
- **Delete a Do Not Disturb Exception Number: \*11\*N#**  
Remove a number (**N**) from your list of do not disturb exceptions.
- **Cancel All Forwarding: \*00**  
Switch off any forwarding. Includes forward unconditional, forward on busy, forward on no answer, follow me and do not disturb.

---

### 5.3.1 DND On/Off (Features Menu)

You can use the Features menu to switch do not disturb on or off. Enabling DND will not affect any calls already being presented to your phone. Hunt group calls will also still be presented if you are the only available member of the group.

1. Press the **Features** soft key if shown.
  - To access the menu during a call, press the **▶** right arrow key or press the **☎ PHONE** key and then press the **Features** soft key.
2. Use the **▲** up and down **▼** arrow keys to scroll the display to the option **Call Settings**.
3. Press the **Select** soft key or the **OK** button or the **▶** right arrow key.
4. Use the **◀** left and right **▶** arrow keys to change the setting or use the indicated soft key.

#### Access Control

Your system administrator can configure whether you can access this menu option. See [Menu Access Control](#)<sup>[193]</sup>.

### 5.3.2 DND Off (Status Menu)

You can use the Status menu to switch off do not disturb.

1. Press the **Status** soft key if shown. To access the status menu during a call, press the **☎ PHONE** key and then press the **Status** soft key if shown.
2. If necessary use the **▲** up and down **▼** arrow keys to scroll the menu to **Do Not Disturb**.
  - To clear the do not disturb setting, press the **Off** soft key.

#### Access Control

Your system administrator can configure whether you can access this menu option. See [Menu Access Control](#)<sup>[193]</sup>.

### 5.3.3 Do Not Disturb Exceptions

These numbers are used to indicate callers who you want to be allowed to call you as normal even when you have do not disturb on. This does not include group calls which are not presented when you are in do not disturb.

1. Press the **Features** soft key if shown.
  - To access the menu during a call, press the **▶** right arrow key or press the **☎ PHONE** key and then press the **Features** soft key.
2. Use the **▲** up and down **▼** arrow keys to scroll the display to the option **Call Settings**.
3. Press the **Select** soft key or the **OK** button or the **▶** right arrow key.
4. Use the **▲** up and down **▼** arrow keys to scroll the menu to **DND Exceptions**.
5. Press the **Select** soft key or the **OK** button or the **▶** right arrow key.
6. The menu will depend on whether any numbers are already set or not.
  - **No Numbers Set**
    - Press the **Add** soft key.
    - Enter the number or press the **Dir** soft key to [select a number from the directory](#)<sup>[914]</sup>.
    - When the number has been entered, press the **Save** soft key.
  - **Numbers Set**
    - Use the **▲** up and down **▼** arrow keys to scroll through the list of numbers. Numbers that contain an **N** or **X** are using wildcards for a range of numbers. These are entered by the system administrator.
    - Use the **Add** soft key to add a new number in the same way as if no numbers had been entered.
    - use the **Delete** soft key to delete the number shown.

#### Access Control

Your system administrator can configure whether you can access this menu option. See [Menu Access Control](#)<sup>[193]</sup>.

## 5.4 Twinning

Twining is a process whereby your calls ring on two phones. Twinning is only available if configured by the system administrator.

There are two methods of twinning supported, [internal twinning](#)<sup>[200]</sup> and [mobile twinning](#)<sup>[201]</sup>.

### Internal Twinning

This method of twinning twins your normal phone with another internal phone. Your incoming calls will ring on both phones. You can also make your calls from either extension.

A typical example for internal twinning would be a user who uses both a normal desk phone and also needs a mobile phone while moving around the building.

Your settings are applied to both phones. Similarly message waiting indication and voicemail access from either phone will be to your mailbox.

If both your twinned phones are use contacts and call log stored on the phone system, the call logs and directory contacts on each will be the same.

- **T = Twinned**

A **T** is shown on a phone's display if it is internally twinned with your phone. Calls to you will alert on both phones and can be answered by you at either phone.

### Mobile Twinning

Mobile twinning is twinning where your calls ring at both your phone and at another number which can include an external number. If you have been configured as a mobile twinning user, you can switch use of mobile twinning on or off through the phone's menus, transfer calls to a mobile phone and can also change the number to which you are twinned.

Using the phone menus you can switch use of mobile twinning on/off and change the destination number for twinned calls.

---

## 5.4.1 Mobile Twinning Control

This menu option is only available if you have been configured by the system administrator to be able to use mobile twinning.

- The addition of a button set to the **Twinning** function is recommended, contact your system administrator. Such a button allows you to transfer a call to your twinning destination, retrieve a call from the twinning destination and access the menu options below to set the twinning destination number and switch twinning on/off.
  1. Press the **Features** soft key if shown.
    - To access the menu during a call, press the ► right arrow key or press the ☎ **PHONE** key and then press the **Features** soft key.
  2. Use the ▲ up and down ▼ arrow keys to scroll the menu to **Forward**.
  3. Press the **Select** soft key or the **OK** button or the ► right arrow key.
  4. Use the ▲ up and down ▼ arrow keys to scroll the menu to **Mobile Twinning**.
  5. Press the **Select** soft key or the **OK** button or the ► right arrow key.
  6. If no twinning number has been set, the menu will prompt you to enter a number.
  7. When a number has been entered, you can access the **Enable** and **Disable** soft keys to turn use of mobile twinning on or off. The **Clear** soft key removes the existing twinning number in order to allow entry of a new number.

## 5.4.2 Transferring a Call to Your Mobile Phone

If you have been configured as a mobile twinning user, you can transfer a call to the mobile device through the feature menu control.

1. Press the **Features** soft key if shown.
  - To access the menu during a call, press the **▶** right arrow key or press the **PHONE** key and then press the **Features** soft key.
2. If necessary, use the **▲** up and down **▼** arrow keys to highlight **Transfer to Mobile**. Press **Select**.

### Access Control

Your system administrator can configure whether you can access this menu option. See [Menu Access Control](#)<sup>193</sup>.

## 5.4.3 Reclaiming a Twinned Call

When using mobile twinning, you can use the status menu to take back a call that has been redirected to and answered at your mobile twinning destination.

1. Press the **Status** soft key if shown. To access the status menu during a call, press the **PHONE** key and then press the **Status** soft key if shown.
2. If necessary use the **▲** up and down **▼** arrow keys to scroll the menu to **Mobile Twinning**.
3. Press **Retrieve**.

## 5.4.4 Switching Twinning Off (Status Menu)

If you have been configured as a mobile twinning user, you can use the status menu to switch mobile twinning mode off.

1. Press the **Status** soft key if shown. To access the status menu during a call, press the **PHONE** key and then press the **Status** soft key if shown.
2. If necessary use the **▲** up and down **▼** arrow keys to scroll the menu to **Mobile Twinning**.
3. To turn twinning off, press the **Off** soft key. Alternatively, to access the mobile twinning settings, press the **Details** soft key. See [Mobile Twinning Control](#)<sup>60</sup>.



# Chapter 6.

## Holding and Parking Calls

---

## 6. Holding and Parking Calls

Holding a call and parking a call are two similar actions. The current caller is placed on hold and hears music on hold if available. The table below summarizes the main differences between parking a call or holding a call.

<b>When used to park or hold a call...</b>	<b>Hold</b>	<b>Park</b>
<b>... the call occupies an appearance button.</b>	Yes	No
<b>... the caller hears music on hold if available.</b>	Yes	Yes
<b>... the calls can be retrieved by other users dialing a short code.</b>	No	Yes
<b>... the calls recalls you automatically if your phone is idle.</b>	Yes Default 15 seconds	Yes Default 5 minutes.
<b>... can be used with conference calls.</b>	Yes	No
<b>... can be used to start or add calls to a conference.</b>	Yes	No
<b>... the call is assigned a unique ID.</b>	No	Yes



## 6.1 Holding Calls

You can hold a call or several calls.







- The held call will still occupy the appearance button on which it was made or answered.
- While held the caller will hear music on hold. If your system does not have music on hold available, the caller will hear double beep tones every few seconds.
- If you have more than one held call, or one held call and a connected call, pressing the  **CONFERENCE** key will start a conference between yourself and the calls.

### Important - Holding Conference Calls

You can hold a conference call in the same way as holding a normal call. Holding the conference call does not affect the other conference parties who can continue talking. You will also still be listed as a member of the conference call in the conference details.





**Warning:** This only applies to conference calls hosted by your own telephone system. Holding your call to a conference hosted on another telephone system may cause that conference to hear your system's music on hold.

### 6.1.1 Holding a Call

1. To you current call on hold, press the  **HOLD** key or the call's  appearance button.
2. The held call will be indicated by its appearance key using a fast flashing green lamp .
3. While held the caller will music on hold. If your system does not have music on hold available, the caller will hear double beep tones every few seconds.
4. You can scroll the display using the  up and down  arrow keys, the held call will appear with a  icon.



### 6.1.2 Taking a Call Off Hold

Either of the following methods can be used to retrieve a call from hold. If you have a currently connected call, that call will be automatically put on hold.

1. Press the appearance button with the fast flashing green lamp .
2. Scroll the display using the  up and down  arrow keys, the held call will appear with a  icon.
  - You can press the >> double-arrow soft key.
  - Press the **Pickup** soft key to take the call off hold.

---

### 6.1.3 Switching Between Calls

With a call on hold (fast-flashing green  appearance button) and another call connected (red and green  appearance button), you can switch between calls by pressing the appearance button of the held call. The current call is automatically put on hold and the previously held call connected.

When you [place a call on hold](#) <sup>[65]</sup> in order to [make a transfer](#) <sup>[73]</sup>, the call is considered 'on hold pending transfer' and is indicated by fast-flashing red *and* green appearance buttons. On phones with only a single appearance button (or icon), the phone displays "On-Hold-Xfer" before the call information on the call's application line.

### 6.1.4 Transfer a Held Call

When you already have a call on hold and a call connected, you can connect them by starting a conference. Press the  **CONFERENCE** key. Your current call and the held call will be connected. You can now [drop yourself](#) <sup>[79]</sup> from the conference.

**Note:** If you are the only internal user in the conference, depending on your telephone systems configuration, dropping yourself might end the conference. Consult your system administrator for details.

## 6.2 Parking Calls

Parking a call is similar to holding a call. However, parked calls can be unparked by other users on the phone system. Each parked call is given a number. By default, the number is your extension number plus a digit.

Calls that you park return to your phone (when idle) if they remain parked for too long. The default return delay is five minutes. This is a system delay that is applied to all users and can be changed by the system administrator. Returning calls ignore any forwarding or do not disturb settings.

A [feature button](#)<sup>[130]</sup> set to the [Call Park](#)<sup>[132]</sup> action can be used to park and unpark calls and to indicate parked calls.

### Default Short Codes

Short codes are numbers that you can dial to enable and disable various features. The following are default short codes that may be available. However, your system administrator can remove and change the short codes available to you or all users.

- **Park Call: \*37\*N#**  
Parks the held call using the park number dialed in place of *N*.
- **Unpark Call: \*38\*N#**  
Unpark the call parked using the park number *N*.

## 6.2.1 Park Using the Menu

1. Press the **Features** soft key if shown.
  - To access the menu during a call, press the **▶** right arrow key or press the **PHONE** key and then press the **Features** soft key.
2. Use the **▲** up and down **▼** arrow keys to scroll the menu to **Park**.
3. Press the **Select** soft key or the **OK** button or the **▶** right arrow key.
4. You can park the call and have the parked call indication sent to your phone or another phone. Use the **▲** up and down **▼** arrow keys to select either the method of parking you want:
  - **Park Here**  
With **Park Here** displayed, press the **Select** soft key or the **OK** button or the **▶** right arrow key.
  - **Park to Other User**
    - With **Park to Other** displayed, press the **Select** soft key or the **OK** button or the **▶** right arrow key.



- Enter the target user extension number. Alternatively, press the **Dir** soft key to [use the directory](#)<sup>193</sup>.
- Press **Done**.

### Access Control

Your system administrator can configure whether you can access this menu option. See [Menu Access Control](#)<sup>193</sup>.

## 6.2.2 Unpark (Features Menu)

1. Press the **Features** soft key if shown.
  - To access the menu during a call, press the **▶** right arrow key or press the **PHONE** key and then press the **Features** soft key.
2. Use the **▲** up and down **▼** arrow keys to scroll the menu to **Park**.
3. Press the **Select** soft key or the **OK** button or the **▶** right arrow key.
4. Press the **Select** soft key or the **OK** button or the **▶** right arrow key. If you have any parked calls, they are listed.
5. Use the **▲** up and down **▼** arrow keys to scroll through the parked calls.
6. To unpark a particular call, press the **CPkUp** soft key.

### Access Control

Your system administrator can configure whether you can access this menu option. See [Menu Access Control](#)<sup>193</sup>.

## 6.2.3 Unpark (Status Menu)

While parked calls are parked on the telephone system and can be unparked by any other user, the parked call indication is sent to a particular extension. If there are any calls parked against your phone, you can view and unpark them using the **Status** menu.

1. Press the **Status** soft key if shown. To access the status menu during a call, press the **PHONE** key and then press the **Status** soft key if shown.
2. If you have any parked calls, the **Parks** option is displayed. The option is not present if you do not have calls parked against your extension.
3. Press the **Details** soft key.
4. Use the **▲** up and down **▼** arrow keys to scroll through the parked calls.
5. To unpark a particular call, press the **CPkUp** soft key.

### Access Control

Your system administrator can configure whether you can access this menu option. See [Menu Access Control](#)<sup>193</sup>.

### Access Control

Your system administrator can configure whether you can access this menu option. See [Menu Access Control](#)<sup>193</sup>.

## 6.2.4 Park & Page

This method of parking calls is available only if specifically configured on your telephone system. To use it, you also need to add a **Park & Page** button on your phone. See [Button Features](#)<sup>[130]</sup>.

Park and page uses a set of park slot numbers, configured by your system administrator, that act like extension numbers. When you parked a call in one of those park slots, you or any other user on the system can dial that park slot number to unpark the call.

Your system administrator can also configure up to 3 hunt groups for paging. When you park a call, after displaying the park slot number used, your phone displays options for paging.

Calls parked using Park & Page are not indicated in your phone's **Status** menu. However, calls that you park will recall to your phone if left parked for too long.

If your phone has any [Call Park](#)<sup>[132]</sup> buttons set to match the park slot numbers configured for Park & Page, those buttons can be used to park/unpark calls and indicate when a call is parked in that park slot. However, when used to park a call, the phone does not display the page options.

### To Park a Call Using Park & Page

1. Press the **Park & Page** button on your phone. The call is parked and the parked slot number needed to unpark the call is displayed.
2. If you want to make a page announcement of the parked call, press **Page**. Otherwise, press **Exit**.
3. There are several methods by which you can select the user or hunt group that you want to page:
  1. Select one of the pre-configured hunt groups.
  2. Dial the extension number of the user or hunt group that you want to page and then press **Done**.
  3. Dial \* and then press **Dir**. Select the required user or hunt group from the directory and press **Page**.

### To Unpark a Call

1. Dial the park slot number that was assigned to the parked call.





# Chapter 7.

# Transferring Calls

---

## 7. Transferring Calls

You are able to transfer calls even if all your current call appearance buttons are in use.

1. Press the  **TRANSFER** key. The current call is automatically put on hold.
2. Dial the number for the transfer. Alternatively, press **Dir** to [select a destination from the directory](#)<sup>[91]</sup> or use the **Redial** option, if applicable.
  - To complete the transfer, press the  **TRANSFER** key or press the **Complete** soft key. You can do this while the call is still ringing.
    - Transferring a call while it is still ringing is called an unsupervised transfer.
    - Transferring a call after ringing finishes is called a supervised transfer.
  - If the transfer destination does not answer or, after answering the call, does not want to accept the call, press the **Cancel** soft key.
3. Press the  **TRANSFER** key to complete the transfer or press the **Complete** soft key. If the transfer destination does not answer or does not want to accept the call, press the **Cancel** soft key.

### Notes

- **Calls and Button Status Indication**  
The status indication for a call on hold pending transfer differs from that used for standard held calls:
  - On phones with dual lamp buttons, both the green and red lamps fast flash (flutter) when the button represents a call on hold pending transfer.
  - On phones with single lamp buttons or status icons, **Xfer:** is shown in front of the caller ID information rather than the button name. For example **Xfer:Extn299** is shown rather than **a = Extn299**.
  - The call status information shown when a call on hold pending transfer is highlight is prefixed with **On-Hold-Xfer** rather than **On-Hold**.
- **Switching Between Calls**  
Switching from a connected call to an existing call on hold pending transfer puts the connected call on hold pending transfer.

## 7.1 Transfer to Voicemail

When set to visual voice mode, the  key can be used to transfer your current call to the voicemail mailbox of another user or group.

1. With the call connected, press the  key. You are still connected to the call and can continue talking.
2. Dial the extension number of the user or group to which you want to transfer the call.
3. When the number matches a user or group, their name is displayed.
  - To transfer the call to the user or group's mailbox, press the **Select** soft key. The caller will hear a few seconds of ringing and then the mailbox greeting.
  - To exit the transfer menu, press the **Exit** soft key.



## 7.2 Transferring a Held Call

There are various call transfer scenarios to consider:

1. If you have multiple calls on hold and you want to transfer a connected call to one of the held calls:
  - Press the **Transfer** soft key and use the ▲ up and down ▼ arrow keys to select the desired call appearance. When you are satisfied, press **Complete** to transfer the call while the other held call(s) remain on hold.
2. If you have calls on hold but you want to connect your current call with a new destination:
  - Press the **Transfer** soft key and enter the destination manually using the numerical keypad and press **Complete**. Alternatively, press **Dir** to [select a destination from the directory](#)<sup>[97]</sup> or use the **Redial** option, if applicable.
3. If you have a destination call connected but you wish to refer back to the originating call before completing the transfer:
  - Do NOT press **Complete** to transfer the destination call as in scenario #2. Select the originating call ('on hold pending transfer') by pressing its call appearance button. This will place the destination call 'on hold pending transfer' so that you can notify the originating caller. With the originating call connected, you can now press **Complete** to connect the two calls. Held calls that are not pending transfer will not be affected. Moreover, it is not possible to have more than one call 'on hold pending transfer.'

## 7.3 Transfer to Your Mobile Phone

If you have been configured as a mobile twinning user, you can transfer a call to the mobile device through the feature menu control.

1. Press the **Features** soft key if shown.
  - To access the menu during a call, press the ► right arrow key or press the ☎ **PHONE** key and then press the **Features** soft key.
2. If necessary, use the ▲ up and down ▼ arrow keys to highlight **Transfer to Mobile**. Press **Select**.

### Access Control

Your system administrator can configure whether you can access this menu option. See [Menu Access Control](#)<sup>[193]</sup>.



# Chapter 8.

# Account Codes

---

## 8. Account Codes

The telephone system can store a number of account codes. Account codes may be used to keep track of calls in relation to particular activities or clients. They can also be used to keep track of calls by particular users or sets of users.

- When an account code is entered while making a call or during a call, that account code is included in the call records output by the system.
- Accounts entered are checked against those stored by the telephone system. If an invalid code is entered, the account code is requested again.
- The system administrator can configure certain numbers or types of numbers to require entry of an account code before you can continue making a call to such a number.
- The system administrator can also configure you to have to enter an account code before making any external call.

### 8.1 Forced Account Code Entry

The system administrator can configure certain numbers or types of numbers to require entry of an account code before you can continue making a call to such a number.

1. **ENTER ACCOUNT** is displayed when you are required to enter an account code.
2. Enter the account code that you want to use.
3. Press the **Done** soft key.
4. If the account code was not a valid account code, the **REENTER ACCOUNT** menu is displayed.

### 8.2 Manual Account Code Entry

You can enter account codes during a call or before making a call. The account code that you enter must match an account code set on the telephone system.

1. Press the **Features** soft key if shown.
  - To access the menu during a call, press the **▶** right arrow key or press the **PHONE** key and then press the **Features** soft key.
2. Use the **▲** up and down **▼** arrow keys to scroll the display to the option **Call Settings**.
3. Press the **Select** soft key or the **OK** button or the **▶** right arrow key.
4. Use the **▲** up and down **▼** arrow keys to scroll the menu to **Account Code**.
5. Press the **Select** soft key or the **OK** button or the **▶** right arrow key.
6. Enter the account code that you want to use.
7. Press the **Done** soft key.
8. If the account code was not a valid account code, the **REENTER ACCOUNT** menu is displayed.

#### Access Control

Your system administrator can configure whether you can access this menu option. See [Menu Access Control](#)<sup>[193]</sup>.

#### Feature Button

Access to the enter account code menu can be assigned to a [feature button](#)<sup>[130]</sup> configured with the [Account Code Entry](#)<sup>[132]</sup> action. The button can also be preset with a specific account code.

# Chapter 9.

# Conference Calls

---

## 9. Conference Calls

Multiple conference calls are supported, with parties addable to each conference call until the system's conference capacity, up to 128, is reached. However, a maximum of 64 parties is supported in any particular conference call.

Conference resources are also used for call recording and other features, reducing the available conference capacity for ordinary conference calls.

**Note:** If you are the only internal user in the conference, depending on your telephone systems configuration, dropping yourself might end the conference. Consult your system administrator for details.



### Default Short Codes

Short codes are numbers that you can dial to enable and disable various features. The following are default short codes that may be available. However, your system administrator can remove and change the short codes available to you or all users.

- **Conference Held Calls: \*47**  
Start a conference between yourself and any calls that you have on hold.

## 9.1 Starting a Conference

If you do not already have a held call, you can use the process below to start a conference. For more complex scenarios, see [Context Sensitive Conferencing](#)<sup>[80]</sup>.



1. Make a call to the first party or answer a call.
2. Press the  **CONFERENCE** key. The current call is automatically put on hold.
3. Dial the party that you want to add to the conference.
4. If they answer and want to join the call, press the  **CONFERENCE** key again or press the **Join** soft key.
5. If they do not want to join the call or do not answer, press  **DROP** and then press the appearance key of the held call (fast green flash).

### Notes About Conference Calls

- You can use the **Conf** key as an alternative method for transferring calls; this is particularly useful for internal users. However, if you are the only internal user in a conference, bear in mind that you are the conference host and dropping yourself from the call would end the conference for all participants.
- If you already have calls on hold, pressing the **Conf** key will create a conference containing the connected call and the call on hold. You can [add more calls](#)<sup>[78]</sup> if you like.
- If you have a call 'on hold pending transfer'<sup>[66]</sup> and you wish to conference yourself, your current call, and the call 'on hold pending transfer,' pressing the **Conf** key will start a conference that includes all three of you. Other held calls will not be included, but you can [add more calls](#)<sup>[78]</sup> or drop yourself if necessary.
- Pressing the **Conf** key against a held call will add that call to the extension's current call (alerting or connected). Any calls 'on hold pending transfer' will also be added to the call.

## 9.2 Adding a Call to a Conference

You can add additional parties to an existing conference.

1. Press the  **HOLD** key to put the conference on hold. This does not affect the other conference parties who can continue talking to each other.
2. Press an available appearance key on which to make a call.
3. Dial the party that you want to add to the conference.
4. If they answer and want to join the call, press the  **CONFERENCE** key again or press the **Join** soft key.
5. If they do not want to join the call or do not answer, press  **DROP** and then press the appearance key of the held call (fast green flash).

## 9.3 Viewing Conference Details

You can display a list of the parties involved in a conference call.

1. If not already displayed, press the ▲ up or down ▼ arrow key to display the conference call.
2. Press the **Details** soft key.
  - To scroll through the list of callers in the conference, use the ▲ up and down ▼ arrow keys.
  - To drop the caller displayed from the conference, press the **Drop** soft key. Pressing the  **DROP** button will also drop the displayed party.
  - To mute a caller, highlight them and press **Mute**. Repeat this to unmute them.
  - To return to the call display, press the **Exit** soft key.

## 9.4 Dropping/Muting Parties

You can drop parties from a conference call, including yourself. You can also mute other parties.

1. While connected to a conference call, if you press the **Details** key, the conference details menu is displayed.
2. You can then perform the following actions:
  - To scroll through the list of callers in the conference, use the ▲ up and down ▼ arrow keys.
  - To drop the caller displayed from the conference, press the **Drop** soft key. Pressing the  **DROP** button will also drop the displayed party.
  - To mute a caller, highlight them and press **Mute**. Repeat this to unmute them.
  - To return to the call display, press the **Exit** soft key.

**Note:** If you are the only internal user in the conference, depending on your telephone systems configuration, dropping yourself might end the conference. Consult your system administrator for details.

## 9.5 Holding a Conference Call

Using the  **HOLD** key you can put a conference call on hold in the same way as you can for a normal call. The appearance key for the conference call will show a fast flashing green lamp.

To take the conference call off hold, press the appearance key.

### Important - Holding Conference Calls

You can hold a conference call in the same way as holding a normal call. Holding the conference call does not affect the other conference parties who can continue talking. You will also still be listed as a member of the conference call in the conference details.

**Warning:** This only applies to conference calls hosted by your own telephone system. Holding your call to a conference hosted on another telephone system may cause that conference to hear your system's music on hold.

## 9.6 Context Sensitive Conferencing

The [starting a conference](#)<sup>[78]</sup> and [adding a call to a conference](#)<sup>[78]</sup> scenarios in this manual cover the simple scenarios where you have no other calls in progress on the phone. In those scenarios, the current call and all held calls are conferenced.

However, in some scenarios where you have multiple calls in progress, you may want to conference just particular calls. This can be done by scrolling the display to change which call is highlighted when you press **Conf** or **Conference**.

For example:

- **To conference the current call and a particular held call:**  
Scroll the call display to highlight the required held call. Press **Conf** or **Conference**. That held call is conference with your current call without affecting any other held calls.

The table below summarizes which calls are conferenced based on which call is currently highlighted on the telephone's display. A 'held pending transfer' call is one which has been put on hold by pressing either **Conference** or **Transfer**.

Highlighted Call	Other conditions in priority order	Result when Conf or Conference is pressed:	Calls Conferenced		
			Current Call	Held Calls	Held Pending Transfer
Connected call	No call held pending transfer	Conferences the connected call and all held calls.	✓	✓	-
	Call held pending transfer	Conferences the connected call and the held pending transfer call. Any other held calls are unaffected.	✓	-	✓
Held call	Connected call	Conferences the held call and the connected call. Any other held calls including held pending transfer are unaffected.	✓	-	-
	Held pending transfer call	Conferences the held and held pending transfer call. All other held calls are unaffected.	-	-	✓
	Held calls	Conferences with all other held calls.	-	✓	-
Held pending transfer call	Connected call	Conferences the held pending transfer call to a connected call. Any other held calls are unaffected.	✓	-	✓
	Held calls	Conferences the call held pending transfer with all other held calls.	-	✓	✓

- **Changing which call is currently highlighted**  
On phones with a set of cursor keys, the up and down cursor keys can be used to select the current highlighted call appearance, even while there is a currently connected call.

Note: The above only applies to conferences initiated from the telephone. The traditional behaviour of conferencing the current and all held calls regardless of hold type still applies if the conference is initiated from elsewhere such as from an application like one-X Portal for IP Office.



# Chapter 10.

## Headset/Handsfree Operation

---

# 10. Headset/Handsfree Operation

## 10.1 Headset Operation

Your phone has a headset socket. This is suitable for the connection of phone headsets that connect via a HIS headset cable.

- If there are no currently connected call, a call answered or made by pressing an appearance button is connected either handsfree or through the headset according to the phone's [audio path setting](#)<sup>[83]</sup>. The same applies to dialing a new call.
- If there is already a connected call to which you are talking through the headset, answering another call by pressing the appearance button will answer that call using the headset.

### Using a Headset

#### To answer a call using a headset:

1. To answer a call using the headset, press the  **HEADSET** button.

#### To end a headset call:

1. To end a headset call, press the  **HEADSET** button.
  - If the other party ends the call, the **HEADSET** button remains active. Press the button to end the headset usage.

#### To switch from the headset to the handset:

1. To switch from the headset to the handset, simply lift the handset.

#### To switch to handsfree from the headset:

1. To switch to handsfree from the headset, press the  **HEADSET** button.
2. Replace the handset.

#### To switch from the headset to handsfree:

1. Press the  **SPEAKER** button. See [Handsfree Speaker Operation](#)<sup>[84]</sup>.

#### To switch to headset from handsfree:

1. Press the  **HEADSET** button. The button remains lit whilst you have a call connected handsfree.

#### To mute the call while on the headset:

1. Press the  **MUTE** button. The button remains lit whilst the call is muted. Note that if you switch to the handset or handsfree, the mute is automatically canceled.

### Headset Operation Settings

You can adjust the following headset settings:

- [Headset Volume](#)<sup>[83]</sup>
- [Default Audio Path](#)<sup>[83]</sup>
- [Headset Automatic Gain Control On/Off](#)<sup>[83]</sup>

### 10.1.1 Headset Volume

While talking via the headset, you can adjust the volume of the incoming call.

1. With the call connected on the headset, press the **↵** key.
2. Use the **+** plus and **-** minus keys to adjust the volume.
3. The display will return to normal after a few seconds.

### 10.1.2 Default Handsfree Audio Path

By default, when you make a call or answer a call without lifting the handset, the audio is played through the phone's speaker while you speak via the phone's microphone.

If you have a headset attached, you can change the phone's behavior so the audio is played through the headset by default rather than the speaker.

1. Press the **A MENU** button.
2. Use the **▲** up and down **▼** arrow keys to locate the option **Call Settings....**
3. Press the **Select** soft key.
4. Use the **▲** up and down **▼** arrow keys to locate the option **Audio Path**.
5. Use the **◀** left and right **▶** arrow keys or press the **Change** soft key to change the setting.
6. When completed, press the **Done** soft key.
7. Press the **Exit** soft key to exit the menus.

### 10.1.3 Automatic Gain Control

When using automatic gain control (AGC), the phone tries to maintain a constant audio level even if the incoming call changes between loud and quiet.

1. Press the **A MENU** button.
2. Use the **▲** up and down **▼** arrow keys to locate the option **Advanced**.
3. Press the **Select** soft key.
4. Use the **▲** up and down **▼** arrow keys to locate the option **Automatic Gain Control**.
5. Press the **Select** soft key.
  - Use the **▲** up and down **▼** arrow keys to switch between the **Handset**, **Headset** or **Speaker** settings for automatic gain control.
  - To change a setting, use the **◀** left and right **▶** arrow keys or press the **On/Off** soft key.
6. When completed, press the **Done** soft key.
7. Press the **Exit** soft key to exit the menus.

---

## 10.2 Handsfree Speaker Operation

Your phone has a speaker and microphone that allows you make and answer calls handsfree. The speaker is located under the handset. The microphone is located near the bottom right of the phone's keypad.

- If there are no currently connected calls to which you are talking, a call answered by pressing its appearance button is connected either handsfree or through the headset according to the phone's [audio path setting](#)<sup>[83]</sup>.
- If there is already a connected call to which you are talking handsfree, answering another call by pressing the appearance button answers that call handsfree.

### Conference Phones

Your phone is not designed as a conference room speakerphone. It is designed for use by a speaker located directly in front of the phone with no obstructions between themselves and the microphone. Phones designed to be used as conference speakerphones typically have multiple microphones and are able to handle sounds coming from multiple directions. For details of conference speakerphones supported by your phone system contact your system administrator.

### Using Handsfree

#### To answer a call handsfree:

1. To answer a call handsfree, press the **|| SPEAKER** button. The button remains lit whilst you have a call connected handsfree.

#### To end a handsfree call:

1. To end a handsfree call, press the **|| SPEAKER** button.

#### To switch from handsfree to the handset:

1. To switch from handsfree to the handset, simply lift the handset.

#### To switch to handsfree from the handset:

1. To switch to handsfree from the handset, press the **|| SPEAKER** button. The button remains lit whilst you have a call connected handsfree.
2. Replace the handset.

#### To switch from handsfree to the headset:

1. Press the **HEADSET** button. See [Headset Operation](#)<sup>[84]</sup>.

#### To switch to handsfree from the headset:

1. Press the **|| SPEAKER** button. The button remains lit whilst you have a call connected handsfree.

#### To mute the call while handsfree:

1. Press the **MUTE** button. The button remains lit whilst the call is muted. Note that if you switch to the handset or headset, the mute is automatically canceled.

### Handsfree Operation Settings

You can adjust the following handsfree settings:

- [Speaker Volume](#)<sup>[85]</sup>
- [Default Audio Path](#)<sup>[85]</sup>
- [Speaker Automatic Gain Control On/Off](#)<sup>[88]</sup>

## 10.2.1 Speaker Volume

While talking handsfree via the phone's speaker, you can adjust the volume of the incoming call.

1. With the call connected on the speaker, press the **▲** key.
2. Use the **+** plus and **-** minus keys to adjust the volume.
3. The display will return to normal after a few seconds.

## 10.2.2 Default Handsfree Audio Path

By default, when you make a call or answer a call without lifting the handset, the audio is played through the phone's speaker while you speak via the phone's microphone.

If you have a headset attached, you can change the phone's behavior so the audio is played through the headset by default rather than the speaker.

1. Press the **A MENU** button.
2. Use the **▲** up and down **▼** arrow keys to locate the option **Call Settings....**
3. Press the **Select** soft key.
4. Use the **▲** up and down **▼** arrow keys to locate the option **Audio Path**.
5. Use the **◀** left and right **▶** arrow keys or press the **Change** soft key to change the setting.
6. When completed, press the **Done** soft key.
7. Press the **Exit** soft key to exit the menus.

## 10.2.3 Automatic Gain Control

When using automatic gain control (AGC), the phone tries to maintain a constant audio level even if the incoming call changes between loud and quiet.

1. Press the **A MENU** button.
2. Use the **▲** up and down **▼** arrow keys to locate the option **Advanced**.
3. Press the **Select** soft key.
4. Use the **▲** up and down **▼** arrow keys to locate the option **Automatic Gain Control**.
5. Press the **Select** soft key.
  - Use the **▲** up and down **▼** arrow keys to switch between the **Handset**, **Headset** or **Speaker** settings for automatic gain control.
  - To change a setting, use the **◀** left and right **▶** arrow keys or press the **On/Off** soft key.
6. When completed, press the **Done** soft key.
7. Press the **Exit** soft key to exit the menus.



# Chapter 11.

## Contacts/Directory

---

# 11. Contacts/Directory



This menu is accessed by pressing the  key. It is used to display names and numbers that you can then use for making calls.

The directory includes names stored for use by all users, names stored for use by just you and the name and numbers of all the other users and groups on the phone system.

The [Contact Menu](#)  diagram shows a summary of the menu options.

The contacts shown in the directory come from a number of sources.

- **Personal Directory Contacts**

These contacts are stored by the telephone system as part of your user settings.

- They are displayed on the phone while you are using it. If you hot desk to another phone that also stores your contacts on the system, your personal contacts move with you.
- You can have up to 250 personal directory entries that you can add, edit and delete through the phone. While you are allowed up to 250 personal directory entries, the total capacity of the system may limit that if it has been reached.
- The system administrator can add, edit and delete your personal directory entries.
- The system administrator can apply an **Exclude from Directory** setting to particular users and hunt groups. They are then not included in the directory seen by other users.

- **User Contacts**

These contacts list all the other users on the telephone system. If your system is part of a network of IP Office telephone systems, it includes users on the other systems.

- **Group Contacts**

These contacts list all the hunt groups on the telephone system. If your system is part of a network of IP Office telephone systems, it includes those hunt groups that the system administrator has configured to be advertised across the network.

- **External Contacts**

These contacts are viewable and useable by all phone users. These are two types of external contacts:

- Some external contacts are entered into the telephone system configuration by the system administrator.
- Other external contacts are those imported by the telephone system from other directory sources.

## Notes

1. If you have been configured as a system phone user by the system administrator, then you can also add, edit, and delete some external directory contacts.
  - This only applies to external directory contacts entered locally into configuration of the system at which you are logged in.
  - External directory contacts imported by the system cannot be edited.
  - However, if a local entry is created with the same name or number as an imported entry, the imported entry is discarded in favor of the local one.



## 11.1 How the Directory Search Works

The phone's directory search works by applying a progressive match as you dial additional keys. For example, to search for "Henry Jones", you can dial HENRY by pressing 43679. As you dial, the possible matches still shown on the display reduces.

Dial	H	E	N	R	Y
Matches	4GHI	plus 3DEF	plus 6MNO	plus 7PQRS	plus 9WXYZ
Adam Johns Bob Smith Claire Greggs Gemma Jones Harold Bishop Henrietta Green Henry Jones Henry Smith Ida James IT Helpdesk London Office John Smith Tony George Simon Henricks Sales Support Sales Help	Claire <b>G</b> reggs <b>G</b> emma Jones <b>H</b> arold Bishop <b>H</b> enrietta <b>G</b> reen <b>H</b> enry Jones <b>H</b> enry Smith <b>I</b> da James <b>I</b> T <b>H</b> elpdesk <b>S</b> ales <b>H</b> elp	<b>G</b> emma Jones <b>H</b> enrietta Green <b>H</b> enry Jones <b>H</b> enry Smith <b>I</b> da James <b>I</b> T <b>H</b> elpdesk <b>S</b> imon <b>H</b> enricks <b>S</b> ales <b>H</b> elp	<b>G</b> emma Jones <b>H</b> enrietta Green <b>H</b> enry Jones <b>H</b> enry Smith <b>T</b> ony <b>G</b> eorge <b>S</b> imon <b>H</b> enricks	<b>H</b> enrietta Green <b>H</b> enry Jones <b>H</b> enry Smith <b>T</b> ony <b>G</b> eorge <b>S</b> imon <b>H</b> enricks	<b>H</b> enry Jones <b>H</b> enry Smith

Alternatively to search for "Henry Jones" you could dial JONES by pressing 56637.

Dial	J	O	N	E	S
Matches	5JKL	plus 6MNO	plus 6MNO	plus 3DEF	plus 7PQRS
Adam Johns Bob Smith Claire Greggs Gemma Jones Harold Bishop Henrietta Green Henry Jones Henry Smith Ida James IT Helpdesk London Office John Smith Peter Johnson Tony George Simon Henricks Sales Support Sales Help	Adam <b>J</b> ohns Gemma <b>J</b> ones Henry <b>J</b> ones Ida <b>J</b> ames <b>J</b> ohn Smith <b>L</b> ondon Office Peter <b>J</b> ohnson	Adam <b>J</b> ohns Gemma <b>J</b> ones Henry <b>J</b> ones <b>J</b> ohn Smith <b>L</b> ondon Office Peter <b>J</b> ohnson	Gemma <b>J</b> ones Henry <b>J</b> ones <b>L</b> ondon Office	Gemma <b>J</b> ones Henry <b>J</b> ones <b>L</b> ondon Office	Gemma <b>J</b> ones Henry <b>J</b> ones

### Dialing Additional and Accented Characters







Though marked with just **ABC**, the 2 key will also match the accented forms of those characters, for example À, Á, Â, Ã, Ä, Å and Ç. The set of additional unmarked characters matched varies depending on the language settings of your system, see [Entering Characters](#)<sup>194</sup>.

### Alternate Search Methods

By default, the name matching is applied simultaneously all parts of the contact names, ie. the first, middle and last parts of the displayed names. Your system administrator can change this to a more traditional search if required; for example to match from just the start of the displayed names. However, this will apply to all phones on the system.





---

## 11.2 Viewing Contacts Details

1. Access the contacts directory:
  - a. Press the  **CONTACTS** key. The directory menu is displayed.
  - b. Use the  left and right  arrow keys to select which type of directory entries you want displayed.
    - **All** - All directory entries.
    - **External** - Directory entries stored by the telephony system for all users to use.
    - **Groups** - The names and numbers of hunt groups on the telephone system.
    - **Users** - The names and numbers of other users on the telephone system.
    - **Personal** - Your own personal directory entries.
  - c. Either press the **List** soft key to display all the directory entries or start dialing the name to display only matching entries.
    - Pressing a key enters all of the [characters represented by that key](#)<sup>[194]</sup>. Pressing another key adds the characters from that button to the previous key press. For example, dialing **527** matches all names starting with **JAS** (for example "Jason") and with **KAR** (for example "Karl") plus any other letter combinations from those 3 key presses. See [How the Directory Search Works](#)<sup>[89]</sup>.
    - To remove all the characters entered so far press **Clear**.
  - d. Use the  up and down  arrow keys to scroll through the matching entries.
2. When the required entry is displayed, press **Details** to display the name and number.
3. Use the  up and down  arrow keys to switch between the name and the number.
4. The range of soft keys available will depend on the type of directory entry:
  - [Call](#)<sup>[94]</sup>  
Make a call to the stored number.
  - **Back**  
Go back to the directory listing.
  - **More**  
If the contact is one of your personal directory entries, the **More** soft key will be present to allow you to access the options below. It is also present for external directory entries if you have been setup as a system phone user by the system administrator.
  - [Edit](#)<sup>[94]</sup>  
Edit the name and number.
  - [Delete](#)<sup>[98]</sup>  
Delete the name and number.

## 11.3 Make a Call from the Directory

You can use any directory contacts to make a call. You can also use the directory in almost any telephone function where you need to select the number for a destination, for example during transfers.

1. Access the contacts directory:
  - a. Press the  **CONTACTS** key. The directory menu is displayed.
  - b. Use the  left and right  arrow keys to select which type of directory entries you want displayed.
    - **All** - All directory entries.
    - **External** - Directory entries stored by the telephony system for all users to use.
    - **Groups** - The names and numbers of hunt groups on the telephone system.
    - **Users** - The names and numbers of other users on the telephone system.
    - **Personal** - Your own personal directory entries.
  - c. Either press the **List** soft key to display all the directory entries or start dialing the name to display only matching entries.
    - Pressing a key enters all of the [characters represented by that key](#)<sup>[194]</sup>. Pressing another key adds the characters from that button to the previous key press. For example, dialing **527** matches all names starting with **JAS** (for example "Jason") and with **KAR** (for example "Karl") plus any other letter combinations from those 3 key presses. See [How the Directory Search Works](#)<sup>[89]</sup>.
    - To remove all the characters entered so far press **Clear**.
  - d. Use the  up and down  arrow keys to scroll through the matching entries.
2. When the required entry is displayed, press **Call**.
3. Continue as for a normally dialed call.

## 11.4 Using the Directory for Other Functions

Within other menus where entry of a number is required, it may be possible to use the the directory to select an existing number by name. If this option is available, it will be indicated by the presence of a **Dir** soft key in the menu.





When using the directory in this way, the names made available will depend on the type of function that is being setup. For example, for some functions only group names will be displayed, for others only user names.

1. Press the **Dir** soft key.
2. Either dial the name to see a list of matches or press the **List** soft key to list all names.
  - To clear the list of names and start entry again, press the **Clear** soft key.
  - To view additional details about the currently displayed name, press the **Details** key.
  - When the required entry is displayed, press **Select**.
3. You will be returned to the menu in which you selected the **Dir** soft key.

---

## 11.5 Adding a New Contact

So long as the telephone system capacity has not been reached, you can add up to 250 personal directory entries.







1. Access your personal directory contacts:
  - a. Press the  **CONTACTS** key. The directory menu is displayed.
  - b. Use the  left and right  arrow keys to select your **Personal** directory.
2. Press the **New** soft key.
  - The menu now allows editing of the name and number. See [Entering Characters](#)<sup>19A</sup>. Use the  up and down  arrow keys to switch between number and name entry.
  - When the name has been entered as required, press the **OK** soft key.
  - When the number has been are required, press the **Save** soft key.
  - To exit without making any changes, press the **Cancel** soft key.

### Notes

1. If you have been configured as a system phone user by the system administrator, then you can also add, edit, and delete some external directory contacts.
  - This only applies to external directory contacts entered locally into configuration of the system at which you are logged in.
  - External directory contacts imported by the system cannot be edited.
  - However, if a local entry is created with the same name or number as an imported entry, the imported entry is discarded in favor of the local one.





### 11.5.1 Add a Contact from the Call Log

You can add a name and number shown in your call log to your personal contacts.

1. Access the call log.
  - a. Press the  **CALL LOG** button.
  - b. The display will change to show your call log records. The caller's name is shown if known, otherwise the number.
  - c. Use the  left and right  arrow keys to select which call log records you are viewing. The options are **All**, **Missed**, **Answered** and **Outgoing**.
    - If you have any new missed call records (ie. the **CALL LOG** button lamp is illuminated) the call log will open showing your missed calls.
  - d. Use the  up and down  arrow keys to scroll through the records.
2. Press the **Details** soft key. The individual details of the currently selected call record are displayed.
3. Press the **+Contact** soft key.
4. Use the  up and down  arrow keys to switch between the name and number details for the new contact.
5. Using the telephone keypad and the **Bksp** soft key you can edit the name and the number. See [Entering Characters](#)<sup>194</sup>.
6. When the name and number are set as required, press the **Save** soft key. To return without saving the name and number, press the **Cancel** soft key.

### 11.5.2 Add a Contact from the Redial List

You can add the details of a call in your redial list to your personal contacts.

1. Access the redial list.
  - a. Press the  **Redial** key. The list of outgoing calls is displayed.
  - b. Use the  up and down  arrow keys to scroll through the 10 most recent outgoing calls.
2. Press the **Details** soft key. The individual details of the currently selected call record are displayed.
3. Press the **+Contact** soft key.
4. Use the  up and down  arrow keys to switch between the name and number details for the new contact.
5. Using the telephone keypad and the **Bksp** soft key you can edit the name and the number. See [Entering Characters](#)<sup>194</sup>.
6. When the name and number are set as required, press the **Save** soft key. To return without saving the name and number, press the **Cancel** soft key.

---

## 11.6 Editing a Contact

You can edit the contacts in your own personal directory.

1. Access your personal directory contacts:
  - a. Press the **CONTACTS** key. The directory menu is displayed.
  - b. Use the left and right arrow keys to select your **Personal** directory.
  - c. Either press the **List** soft key to display all the directory entries or start dialing the name to display only matching entries.
    - Pressing a key enters all of the [characters represented by that key](#)<sup>[194]</sup>. Pressing another key adds the characters from that button to the previous key press. For example, dialing **527** matches all names starting with **JAS** (for example "Jason") and with **KAR** (for example "Karl") plus any other letter combinations from those 3 key presses. See [How the Directory Search Works](#)<sup>[89]</sup>.
    - To remove all the characters entered so far press **Clear**.
  - d. Use the up and down arrow keys to scroll through the matching entries.
2. Locate the required entry.
3. Press the **Details** soft key.
4. Press the **More** soft key and then the **Edit** soft key.
  - The menu now allows editing of the name and number. See [Entering Characters](#)<sup>[194]</sup>. Use the up and down arrow keys to switch between number and name entry.
  - When the name has been entered as required, press the **OK** soft key.
  - When the number has been are required, press the **Save** soft key.
  - To exit without making any changes, press the **Cancel** soft key.

### Notes

1. If you have been configured as a system phone user by the system administrator, then you can also add, edit, and delete some external directory contacts.
  - This only applies to external directory contacts entered locally into configuration of the system at which you are logged in.
  - External directory contacts imported by the system cannot be edited.
  - However, if a local entry is created with the same name or number as an imported entry, the imported entry is discarded in favor of the local one.

## 11.7 Deleting a Contact

You can delete a contact from your own personal directory.

1. Access your personal directory contacts:
  - a. Press the **CONTACTS** key. The directory menu is displayed.
  - b. Use the left and right arrow keys to select your **Personal** directory.
  - c. Either press the **List** soft key to display all the directory entries or start dialing the name to display only matching entries.
    - Pressing a key enters all of the [characters represented by that key](#)<sup>194</sup>. Pressing another key adds the characters from that button to the previous key press. For example, dialing **527** matches all names starting with **JAS** (for example "Jason") and with **KAR** (for example "Karl") plus any other letter combinations from those 3 key presses. See [How the Directory Search Works](#)<sup>89</sup>.
    - To remove all the characters entered so far press **Clear**.
  - d. Use the up and down arrow keys to scroll through the matching entries.
2. Locate the required entry.
3. Press the **Details** soft key.
4. Press the **More** soft key and then the **Delete** soft key.

### Notes

1. If you have been configured as a system phone user by the system administrator, then you can also add, edit, and delete some external directory contacts.
  - This only applies to external directory contacts entered locally into configuration of the system at which you are logged in.
  - External directory contacts imported by the system cannot be edited.
  - However, if a local entry is created with the same name or number as an imported entry, the imported entry is discarded in favor of the local one.





# Chapter 12.

## Call Log

---

## 12. Call Log

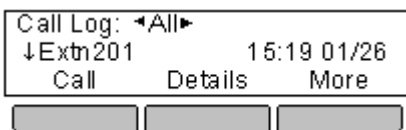

This menu is accessed by pressing the **Call Log** key. The call log you see is a call log stored on the telephone system. If you login at another phone that does this, your call log moves with you.

Your call log contains your 10 most recent answered calls, 10 most recent calls you made and 10 most recent missed calls.

If configured by the system administrator, it can also include calls missed by hunt groups of which you are a member.

The [Call Log](#) menu diagram shows a summary of the menu options.

- [Making a Call](#)
- [Viewing Call Details](#)
- [Deleting a Record](#)
- [Deleting All Records](#)
- [Add a Record to Your Contacts](#)

### Missed Calls

Missed calls are calls to you that you did not answer. Your system administrator can also configure if the log includes calls presented to you but answered by someone else or by voicemail.

The Call Log button is illuminated when you have any new missed calls in your call log. The lamp is extinguished when you have viewed the missed call in the call log or the record of that call is no longer in your call log.

### Missed Group Call

If you are a member of any hunt groups, the system administrator can configure whether your missed calls log should also include missed hunt groups calls. The hunt group does not necessarily have to have rung your phone. It will be recorded as missed if it was presented to the hunt group and not answered by any of the members including you.

### Notes

1. Centralized call log can be turned off by the [system administrator](#). In that case the call log is one stored by the phone and is lost if the phone is reset. This guide only covers the centralized call log stored by the telephone system.
2. The call log on other types of phones is a local call log maintained by that phone. It will not move with you when you hot desk and it will be lost if the phone is restarted.
3. The redial function uses the outgoing call records stored in the call log.

## 12.1 Using the Call Log

1. Access the call log.
  - a. Press the **CALL LOG** button.
  - b. The display will change to show your call log records. The caller's name is shown if known, otherwise the number.
  - c. Use the left and right arrow keys to select which call log records you are viewing. The options are **All**, **Missed**, **Answered** and **Outgoing**.
    - If you have any new missed call records (ie. the **CALL LOG** button lamp is illuminated) the call log will open showing your missed calls.
  - d. Use the up and down arrow keys to scroll through the records.
2. Pressing **OK** will make a call to the number stored with the currently displayed record.
3. You can use the functions listed at the bottom of the display by pressing the soft key below the function name.
  - **Call** 

Make a call to the number stored in the currently displayed call log record.
  - **Details** 

Display more details about the current call log record. You can then also [add the caller details to your personal directory](#)  if required.
  - **More**

Switch between the different sets of available soft key functions.
  - **Delete** 

Deletes the current displayed record.
  - **Del All** 

Delete all the call log records, not just the current types of records being shown.
4. To exit the call log, press the **PHONE/EXIT** button.

## 12.2 Making a Call from the Call Log

You can use the call log to make calls to the number included in the currently selected call record.

1. Access the call log.
  - a. Press the **CALL LOG** button.
  - b. The display will change to show your call log records. The caller's name is shown if known, otherwise the number.
  - c. Use the left and right arrow keys to select which call log records you are viewing. The options are **All**, **Missed**, **Answered** and **Outgoing**.
    - If you have any new missed call records (ie. the **CALL LOG** button lamp is illuminated) the call log will open showing your missed calls.
  - d. Use the up and down arrow keys to scroll through the records.
2. Press the **Call** soft key or **OK** to call the number displayed in the call record. This option is not available if the caller withheld their number.

---

## 12.3 Viewing Call Details

You can view additional details about the currently shown call.

1. Access the call log.
  - a. Press the **CALL LOG** button.
  - b. The display will change to show your call log records. The caller's name is shown if known, otherwise the number.
  - c. Use the **◀** left and right **▶** arrow keys to select which call log records you are viewing. The options are **All**, **Missed**, **Answered** and **Outgoing**.
    - If you have any new missed call records (ie. the **CALL LOG** button lamp is illuminated) the call log will open showing your missed calls.
  - d. Use the **▲** up and down **▼** arrow keys to scroll through the records.
2. Press the **Details** soft key. The individual details of the currently selected call record are displayed.
3. Use the **▲** up and down **▼** arrow keys to scroll through the details. The possible values are:
  - **Time**  
The time of the call.
  - **Ring Time**  
How long the call rang.
  - **Name**  
The name of the caller if known.
  - **Number**  
The number of the caller if available.
  - **Reason**  
The type of call record, ie. **Answered**, **Outgoing** or **Missed**.
  - **Count**  
How many time a call of the same type, name and number has occurred. Only the details of the most recent call are kept in your call log. However the count will indicate if the caller has rung or has been rung several times.
4. While you are in the details of a call record, the soft key functions available are:
  - **Call**  
Call the number shown in the call record. You can also do this by pressing the **OK** button.
  - **+Contact**  
Add the name and number to your personal directory. You can edit the details before they are added.
  - **Back**  
Go back to the normal call screen to select another call record.

## 12.4 Deleting a Record

You can delete the currently displayed call record. If the record is a missed hunt group call, the record is also deleted from the call log of other users configured to see the same hunt group's missed calls.

1. Access the call log.
  - a. Press the **CALL LOG** button.
  - b. The display will change to show your call log records. The caller's name is shown if known, otherwise the number.
  - c. Use the **◀** left and right **▶** arrow keys to select which call log records you are viewing. The options are **All**, **Missed**, **Answered** and **Outgoing**.
    - If you have any new missed call records (ie. the **CALL LOG** button lamp is illuminated) the call log will open showing your missed calls.
  - d. Use the **▲** up and down **▼** arrow keys to scroll through the records.
2. Press the **More** soft key.
3. Press the **Delete** soft key to delete the currently displayed call log record.

## 12.5 Deleting All Records

You can delete all call records from your call log. This action deletes all call log record types (**Answered**, **Missed** and **Outgoing**), not just the type you are currently viewing. This action deletes your personal call records and any hunt group call records.

1. Access the call log.
  - a. Press the **CALL LOG** button.
  - b. The display will change to show your call log records. The caller's name is shown if known, otherwise the number.
  - c. Use the **◀** left and right **▶** arrow keys to select which call log records you are viewing. The options are **All**, **Missed**, **Answered** and **Outgoing**.
    - If you have any new missed call records (ie. the **CALL LOG** button lamp is illuminated) the call log will open showing your missed calls.
  - d. Use the **▲** up and down **▼** arrow keys to scroll through the records.
2. Press the **More** soft key.
3. Press the **Del All** soft key to delete all your call log records.

---

## 12.6 Adding a Record to Your Contacts

You can add a name and number shown in your call log to your personal contacts.

1. Access the call log.
  - a. Press the **CALL LOG** button.
  - b. The display will change to show your call log records. The caller's name is shown if known, otherwise the number.
  - c. Use the **left** and **right** arrow keys to select which call log records you are viewing. The options are **All**, **Missed**, **Answered** and **Outgoing**.
    - If you have any new missed call records (ie. the **CALL LOG** button lamp is illuminated) the call log will open showing your missed calls.
  - d. Use the **up** and **down** arrow keys to scroll through the records.
2. Press the **Details** soft key. The individual details of the currently selected call record are displayed.
3. Press the **+Contact** soft key.
4. Use the **up** and **down** arrow keys to switch between the name and number details for the new contact.
5. Using the telephone keypad and the **Bksp** soft key you can edit the name and the number. See [Entering Characters](#).
6. When the name and number are set as required, press the **Save** soft key. To return without saving the name and number, press the **Cancel** soft key.

# Chapter 13.

## Voicemail

---

## 13. Voicemail

If your telephone system includes a voicemail server, pressing the **MESSAGES** button accesses voicemail. Your system administrator can configure whether the access uses either spoken prompts from the voicemail server or visual menus on the phone called 'visual voice'. This guide assumes the default operation of using the visual voice menus.

Using visual voice, you can access the following functions:

- [Checking Messages](#) <sup>[105]</sup>
- [Record and Send a Message](#) <sup>[106]</sup>
- [Change Your Mailbox Greeting](#) <sup>[107]</sup>
- [Change Your Mailbox Name](#) <sup>[108]</sup>
- [Select a Voicemail Email Mode](#) <sup>[109]</sup>
- [Change Your Voicemail Code](#) <sup>[110]</sup>
- [Turn Use of Voicemail On/Off](#) <sup>[110]</sup>
- [Transfer to Voicemail](#) <sup>[111]</sup>
- [Send a Call to Voicemail](#) <sup>[111]</sup>

### Other Functions

This guide covers just the visual voice functions that you can use from the phone's menus. For the full range of mailbox controls that you may be able to use, contact your system administrator for the mailbox user guide appropriate to the type of voicemail server and mailbox mode that your system uses.

### Default Short Codes

Short codes are numbers that you can dial to enable and disable various features. The following are default short codes that may be available. However, your system administrator can remove and change the short codes available to you or all users.

- **Check Messages: \*17**  
Access mailboxes to check for messages.
- **Voicemail On: \*18**  
Allow voicemail to be used to answer calls.
- **Voicemail Off: \*19**  
Stop voicemail being used to answer calls.
- **Voicemail Ringback On: \*48**  
Have voicemail ring your phone when you have any new messages. It will call when you use the phone.
- **Voicemail Ringback Off: \*49**  
Switch off ringback.

## 13.1 Message Waiting Indication

The Message Waiting Indicator (MWI) indicates new messages in the voicemail mailbox. It remains lit until you play each new message.

The system administrator can also configure it so that you receive new message waiting indication for a hunt group or other users.



## 13.2 Checking Messages

1. Press the **MESSAGES** button. Depending on how your system is configured, you may be required to enter your voicemail password and then press the **Done** soft key. The visual voice menu is displayed.
2. The numbers shown against the **Listen** option indicate the number of new, old and saved messages in your mailbox.
  - If the system administrator has configured you to receive message waiting indication for any hunt group mailboxes, you can also use the **▲** up and down **▼** arrow keys to display the hunt group names and the number of messages in those mailboxes.
3. Press the **Select** soft key.
4. Use the **▲** up and down **▼** arrow keys to select which messages (**New**, **Old** or **Saved**) that you want to listen to and press **Select**. The details of the first message of that type are displayed.
5. You can use the **▲** up and down **▼** arrow keys to scroll through the messages.
6. Use the soft keys to control the playback actions:
  - **Listen / Pause**  
Start/stop playback of the currently displayed message.
    - To select the next message or previous message, use the **▼** and **▲** cursor keys.
    - To fast forward or rewind the current playing message by 5 seconds, use the **◀** and **▶** cursor keys.
  - **Delete**  
Delete the message.
  - **More**  
Switch between the different sets of available soft key functions.
  - **Save**  
Mark the message as saved. Saved messages are not normally automatically deleted.<sup>[1]</sup>
  - **Copy**  
Copy the message to another mailbox. The menu will prompt you to enter the destination number.
  - **Call**  
Call the person who left the message.

### Notes

1. **Automatic Message Deletion**  
By default, messages are automatically deleted a set time after being played. The delay depends on the particular voicemail server (24 hours for embedded voicemail, 30 days for Voicemail Pro). For voicemail messages on a Voicemail Pro system, the system administrator can customize the delay and can also apply automatic deletion times to new and saved messages.

---

## 13.3 Sending a Message

You can use visual voice to record and send a voicemail message to other users' mailboxes.

1. Press the **MESSAGES** button. Depending on how your system is configured, you may be required to enter your voicemail password and then press the **Done** soft key. The visual voice menu is displayed.
2. Use the ▲ up and down ▼ arrow keys to scroll to the option **Message**.
3. Press the **Select** soft key or **OK**.
4. Enter the user to which you want to send the message.
5. Press the **Message** soft key.
6. When you are ready to start recording, press the **Record** soft key.
7. To stop recording, press the **Stop** soft key.
8. You can now use the following soft keys:
  - **Listen**  
Listen to the recording. You can use the **Record** option to record the message again.
  - **Submit**  
Send the message.
  - **More**  
Switch between the different sets of available soft key functions.
  - **Others**  
Add other extension numbers to which you want to send the message.
  - **Record**  
Record the message again.

## 13.4 Mailbox Greeting

While the voicemail system will play a generic greeting to caller, prompting them to leave a message, you can record your own greeting.

1. Press the **MESSAGES** button. Depending on how your system is configured, you may be required to enter your voicemail password and then press the **Done** soft key. The visual voice menu is displayed.
2. Use the **▲** up and down **▼** arrow keys to scroll to the option **Greeting**.
2. Press the **Select** soft key or **OK**.
3. Use the soft keys to listen to and record your mailbox greeting.
  - **Listen**  
Listen to the current greeting or the new greeting just recorded.
  - **Record**  
Record a new greeting. Note that the greeting must be at least 3 seconds long or the voicemail system will discard it.
  - **More**  
Switch between the different sets of available soft key functions.
  - **Submit**  
Submit the new recording as your mailbox greeting.
  - **Delete**  
Delete your current mailbox greeting. The voicemail will use its default greeting.

---

## 13.5 Mailbox Name

Use the following procedure to record a mailbox name. This feature is only available on systems using Embedded Voicemail.

1. Press the **MESSAGES** button. Depending on how your system is configured, you may be required to enter your voicemail password and then press the **Done** soft key. The visual voice menu is displayed.
2. Use the **▲** up and down **▼** arrow keys to scroll to the option **Name**.
2. Press the **Select** soft key or **OK**.
3. Use the soft keys to listen to and record your mailbox name.
  - **Listen**  
Listen to the current name or the name just recorded.
  - **Record**  
Record a new name.
  - **More**  
Switch between the different sets of available soft key functions.
  - **Submit**  
Submit the new recording as your mailbox name.
  - **Delete**  
Delete your current mailbox name. The voicemail will use the default name.

## 13.6 Email Mode

Voicemail email is a feature where emails are sent to your email address when your voicemail mailbox receives a new voicemail message. The email can include the voicemail message as an attachment or it can be just an alert.

Through the visual voice menu you can change the mode of voicemail email operation.

1. Press the **MESSAGES** button. Depending on how your system is configured, you may be required to enter your voicemail password and then press the **Done** soft key. The visual voice menu is displayed.
2. Use the **▲** up and down **▼** arrow keys to scroll to the option **Email**. This option is only available if your email address has been set in your voicemail settings by the system administrator.
3. Press the **Select** soft key or **OK**.
4. The menu displays your current voicemail email mode setting. Use the **▲** up and down **▼** arrow keys to scroll through the possible settings:
  - **Email Mode Off**  
Do not send any emails.
  - **Email Mode Copy**  
Send an email with a copy of the new voicemail message attached.
  - **Email Mode Fwd**  
Send an email with the new voicemail message attached and delete the message from the voicemail mailbox.
  - **Email Mode Alert**  
Send an email telling you there is a new message but do not attach a copy of the message.
5. When the required setting is displayed, press the **Select** soft key. To exit without changing the setting, press the **Exit** soft key.

### Access Control

Your system administrator can configure whether you can access this menu option. See [Menu Access Control](#)<sup>193</sup>.

---

## 13.7 Changing Your Voicemail Code

1. Press the **MESSAGES** button. Depending on how your system is configured, you may be required to enter your voicemail password and then press the **Done** soft key. The visual voice menu is displayed.
2. Use the **▲** up and down **▼** arrow keys to scroll to the option **Passcode**.
3. Press the **Select** soft key or **OK**.
4. Enter your current password and press **Done**.
5. Enter the new password that you want to use.
6. Press **Done**.
  - **Code Enforcement**  
The system administrator can set rules for the required length of the code and to restrict the use of obvious codes (1234, 1111). The system will not allow save the new code until those requirements have been met. Contact your system administrator for details of your systems settings if necessary.

## 13.8 Voicemail On/Off

You can control whether the telephone system uses voicemail to answer your unanswered calls. This does not switch off your mailbox which you can still access to play existing messages and use other functions.

1. Press the **MESSAGES** button. Depending on how your system is configured, you may be required to enter your voicemail password and then press the **Done** soft key. The visual voice menu is displayed.
2. Use the **▲** up and down **▼** arrow keys to scroll the display to the option **Voicemail**.
2. Press the **Select** soft key.
3. Press the **On** or **Off** soft key to change the setting.

## 13.9 Transfer to Voicemail



When set to visual voice mode, the  key can be used to transfer your current call to the voicemail mailbox of another user or group.

1. With the call connected, press the  key. You are still connected to the call and can continue talking.
2. Dial the extension number of the user or group to which you want to transfer the call.
3. When the number matches a user or group, their name is displayed.
  - To transfer the call to the user or group's mailbox, press the **Select** soft key. The caller will hear a few seconds of ringing and then the mailbox greeting.
  - To exit the transfer menu, press the **Exit** soft key.

## 13.10 Send a Call to Voicemail







You can transfer a call targeted at you directly to voicemail.

### To divert a call to your mailbox:

1. If the call is not the current call on the display, use the  up and down  arrow keys to scroll the display to the alerting call.
2. Press the **>>** double-arrow soft key.
3. Press the **To VM** soft key. The call is redirected to voicemail.

## 13.11 Visual Voice

This menu option provides an alternate route into visual voice if the  **MESSAGES** key has not been setup to do that.

1. Press the **Features** soft key if shown.
  - To access the menu during a call, press the  right arrow key or press the  **PHONE** key and then press the **Features** soft key.
2. Use the  up and down  arrow keys to scroll the display to the option **Visual Voice**.
3. Press the **Select** soft key or the **OK** button or the  right arrow key.
4. Use the  up and down  arrow keys to scroll the menu to **Visual Voice**.
5. Press the **Select** soft key.
  - Depending on how your system is configured, you may be required to enter your voicemail password and then press the **Done** soft key.
6. You will now see the [visual voice menu](#)<sup>184</sup>.

### Access Control

Your system administrator can configure whether you can access this menu option. See [Menu Access Control](#)<sup>193</sup>.





# Chapter 14.

## Logging In/Out

---

## 14. Logging In/Out

You may always use the same phone in the same location. However the telephone system provides a number of features that allow you to use any phone on the system to make and receive your calls.

- **Log In**<sup>[119]</sup>  
You can login at any phone that you want to use. All your calls are then directed to that phone and your user settings are applied to calls made and received. Your contacts and call log stored by the telephone system are displayed by the phone.
  - Any existing user of the phone is logged out while you are logged in.
  - If you were logged in on another phone, you are logged out from that phone.
  - If your phone system is in a [Small Community Network](#)<sup>[201]</sup> of phone systems, it may be possible to login at extensions located on other phone systems in the network. Your system administrator will advise you if you can remote hot desk and what features will still be available to you when you do.
- **Log Out**<sup>[119]</sup>  
When you log out from a phone, or are logged out by another user logging in, the telephone system may apply several actions:
  - If you have a normal default extension and no one else is logged in there, you return to being logged in on that phone.
  - If you remain logged out, you are treated the same as being on 'do not disturb' except that all calls to you go to voicemail if available.
  - If you have a mobile twinned number, the system administrator can configure the system so that calls are still presented to your mobile twin while you are logged out.
  - Your system administrator can configure a timeout which automatically logs you out if you do not use the phone in that time to make or answer a call.
- **Lock/Unlock**<sup>[119]</sup>  
Separately from logging in and out, you can lock your phone settings. While locked, the phone can still be used to answer your calls and can be used to make internal and emergency calls. However it cannot be used to make external calls and your user settings cannot be accessed through the phones menus.
  - You can set your phone to [automatically lock](#)<sup>[119]</sup> itself after a period of inactivity.

### Default Short Codes

Short codes are numbers that you can dial to enable and disable various features. The following are default short codes that may be available. However, your system administrator can remove and change the short codes available to you or all users.

- **Login: \*35\*N\*P#**  
Login to a phone using your extension number (**N**) and login code (**P**).
- **Log Out: \*36**  
Log yourself out from the phone where you are currently logged in.

## 14.1 Logging In

When you log in to a phone, you take control of that phone. Incoming calls for you are redirected to that phone and your user information and settings are available. Any existing user on the phone is logged off when you log in.

The method for logging in depends on the current state of the phone:

- **Phone In Use**<sup>[115]</sup>  
If the phone is already in use you can still login. The existing user is logged out.
- **Logged Out - Not Logged In**<sup>[115]</sup>  
If the phone has no current user, it displays a basic menu with just the **Login** option is displayed. Note that in this state the phone can still be used to make internal and emergency calls.
- **Unregistered Phone - Enter Extension**<sup>[116]</sup>  
If the phone is not registered with the phone system, the **Enter Extension** menu is displayed.

### 14.1.1 Logging In on a Phone Already in Use

You can login at a phone that is already in use by another user. The existing user is logged out.

1. If the phone is already in use:
  - Press the **Features** soft key.
  - Use the ▲ up and down ▼ arrow keys to scroll the display to the option **Phone User**.
  - Press the **Select** soft key or the **OK** button or the ► right arrow key.
  - Use the ▲ up and down ▼ arrow keys to scroll the display to the option **Login...**
  - Press the **Select** soft key or the **OK** button or the ► right arrow key.
2. The login menu is displayed. Enter your extension number.
3. Press the **Next** soft key. Enter your login code.
4. Press the **Done** soft key.
  - The response "**Login Failed: No License Available**" indicates that you have not been licensed as a basic user on the telephone system. Contact your system administrator.
- **! = Cannot retrieve user settings**  
An ! is shown if the telephone system at which you have logged in could not contact the telephone system that stores your user settings. If this happens it limits the telephone functions, including making and receiving calls, that you can use. Contact your system administrator.

### Access Control

Your system administrator can configure whether you can access this menu option. See [Menu Access Control](#)<sup>[193]</sup>.

### 14.1.2 Logging In on a "Not Logged In" Phone

This method is used to login at an extension where the previous user has [logged out](#)<sup>[110]</sup> and the phone has no current user. You can recognize a phone in this state as it displays **NOT LOGGED IN**.

1. Press the **Select** soft key or the **OK** button.
2. The login menu is displayed. Enter your extension number.
3. Press the **Next** soft key. Enter your login code.
4. Press the **Done** soft key.
  - The response "**Login Failed: No License Available**" indicates that you have not been licensed as a basic user on the telephone system. Contact your system administrator.
- **! = Cannot retrieve user settings**  
An ! is shown if the telephone system at which you have logged in could not contact the telephone system that stores your user settings. If this happens it limits the telephone functions, including making and receiving calls, that you can use. Contact your system administrator.

---

### 14.1.3 Logging In on an Unregistered Phone

This method is used to login at an [unregistered phone](#)<sup>[119]</sup>. You can recognize an unregistered phone as it displays **Enter Extension**. This method is not supported for hot desking, you can only login using the original base extension number with which the phone was originally installed.

1. Enter your extension number. As you enter it, you can use the **Bksp** and **Clear** soft keys to make corrections.
2. When your number is displayed, press the **OK** soft key.
3. Enter the phone password. Use the **Bksp** and **Clear** soft keys to make corrections. This password is determined by your system administrator and is required for registration.
4. When you have entered the phone password, press the **OK** soft key. If the details are correct, you user details will be loaded into the phone.

## 14.2 Logout

Logging out using the method below disassociates you from the extension. What happens then depends on whether you are the default user of another extension and various other settings.

### To log out:

1. Press the **Features** soft key if shown.
  - To access the menu during a call, press the **▶** right arrow key or press the **PHONE** key and then press the **Features** soft key.
2. Use the **▲** up and down **▼** arrow keys to scroll the display to the option **Phone User**.
3. Press the **Select** soft key or the **OK** button or the **▶** right arrow key.
3. Use the **▲** up and down **▼** arrow keys to highlight **Logout**. Press **Select**.
4. You will be logged out of the phone. The follow actions will depend on several factors:
  - If the phone does not have a default user, or the default user is currently logged on elsewhere, the phone displays **'no user'**<sup>[115]</sup>.
  - If the phone has a default user and they are not current logged on elsewhere, they are automatically logged back in unless they are set to forced login.
  - If you are the default user of another extension that is free (doesn't have anyone else logged in to it), you are automatically logged back in to that extension unless you are set to forced login.

### Access Control

Your system administrator can configure whether you can access this menu option. See [Menu Access Control](#)<sup>[193]</sup>.

## 14.3 Changing Your Login Code

You can change your own security PIN (login code). If set, this PIN is used for logging in at other phones, [locking your phone](#)<sup>[118]</sup>, and [accessing system administration features](#)<sup>[172]</sup>. This is not your [voicemail code](#)<sup>[110]</sup> used for voicemail access.

1. Press the **Features** soft key if shown.
  - To access the menu during a call, press the **▶** right arrow key or press the **PHONE** key and then press the **Features** soft key.
2. Use the **▲** up and down **▼** arrow keys to scroll the display to the option **Phone User**.
3. Press the **Select** soft key or the **OK** button or the **▶** right arrow key.
4. Use the **▲** up and down **▼** arrow keys to scroll the display to the option **Set Password**.
5. Press the **Select** soft key or the **OK** button or the **▶** right arrow key.
6. Enter your current login code if you already have one.
7. Press the **Done** soft key.
8. Enter your new code.
  - **Code Enforcement**  
The system administrator can set rules for the required length of the code and to restrict the use of obvious codes (1234, 1111). The system will not allow save the new code until those requirements have been meet. Contact your system administrator for details of your systems settings if necessary.

## Access Control

Your system administrator can configure whether you can access this menu option. See [Menu Access Control](#)<sup>193</sup>.

---

## 14.4 Locking the Phone

Rather than logging out, you can lock your phone. You can either lock your phone manually using the steps below or have it [automatically locked](#)<sup>[119]</sup> after a period of phone inactivity.

When your phone is locked:

- It can only be used to make internal and emergency calls.
  - None of the menus for your user settings can be accessed.
  - To [unlock the phone](#)<sup>[118]</sup> requires your login code if you have [configured a login code](#)<sup>[116]</sup>.
1. Press the **Features** soft key if shown.
    - To access the menu during a call, press the ► right arrow key or press the **PHONE** key and then press the **Features** soft key.
  2. Use the ▲ up and down ▼ arrow keys to scroll the display to the option **Phone User**.
  3. Press the **Select** soft key or the **OK** button or the ► right arrow key.
  4. Press the **Select** soft key or the **OK** button or the ► right arrow key.
  5. The phone is now locked as indicated by the display.

### Access Control

Your system administrator can configure whether you can access this menu option. See [Menu Access Control](#)<sup>[193]</sup>.

## 14.5 Unlocking the Phone

The message **PHONE LOCKED** indicates that the phone has been [locked](#)<sup>[118]</sup>. While locked, the phone can only be used to make internal calls to other extensions and none of the phone and user menus can be accessed.

1. Press the **Unlock** soft key.
2. Enter your login code.
3. Press the **Done** soft key.

## 14.6 Auto Lock

Rather than logging out, you can lock your phone. You can either [lock your phone manually](#)<sup>[118]</sup> using the steps below or have it automatically locked after a period of phone inactivity.

When your phone is locked:

- It can only be used to make internal and emergency calls.
  - None of the menus for your user settings can be accessed.
  - To [unlock the phone](#)<sup>[118]</sup> requires your login code if you have [configured a login code](#)<sup>[116]</sup>.
1. Press the **Features** soft key if shown.
    - To access the menu during a call, press the **▶** right arrow key or press the **PHONE** key and then press the **Features** soft key.
  2. Use the **▲** up and down **▼** arrow keys to scroll the display to the option **Phone User**.
  3. Press the **Select** soft key or the **OK** button or the **▶** right arrow key.
  4. Use the **▲** up and down **▼** arrow keys to scroll the display to the option **Phone Screen Settings**.
  5. Press the **Select** soft key or the **OK** button or the **▶** right arrow key.
  6. Use the **▲** up and down **▼** arrow keys to scroll the display to the option **Auto Lock**. The **(m)** indicates that the setting is in minutes.
  7. Press the **Change** soft key to change the setting or use the **◀** left or right **▶** arrow keys.
    - **Off**  
Do not use the inactivity timer.
    - **1 / 5 / 30 / 60**  
Lock the phone after the indicated number of minutes.
  8. Press the **Done** soft key.

### Access Control

Your system administrator can configure whether you can access this menu option. See [Menu Access Control](#)<sup>[193]</sup>.

## 14.7 Unregistering

This method of logging out will unregister the phone from the telephone system.

- **WARNING**  
In this state the phone cannot be used to make or answer any calls including emergency calls. It is strongly recommended that you do not use this option unless directly advised to do so by your system administrator. To log out it is recommended that you use the [preferred log out method](#)<sup>[116]</sup> provided.
1. Press the **A MENU** button.
  2. Use the **▲** up and down **▼** arrow keys to locate the option **Log Out....**
  3. Press the **Select** soft key.
  4. Press the **Log Out** soft key.
  5. The phone now displays the menu for [unregistered phone log in](#)<sup>[116]</sup>.





# Chapter 15.

## Groups

---

## 15. Groups

Your system administrator can include you as a member of a group along with other users. Each group has its own extension number which can be used as the destination for call.

When a call is presented to a group, it is presented to the available group members, either one at a time or all at the same time, until answered by one of the members.

How long a group call will ring at each group member before being presented to the next member is controlled by the group's own settings. Hunt groups also use voicemail and have their own settings for when an unanswered call should go to the group's mailbox. For group calls, the hunt group's voicemail settings are used rather than your settings.

The system administrator can enable a number of hunt group menu options on your phone. Each option is enabled for a selected hunt group or hunt groups of which you are a member:

- [Enable/Disable Your Group Membership](#)<sup>[123]</sup>  
When your membership of a hunt group is disabled, you no longer receive hunt group calls for that group. You are still a member of the group and can re-enable your membership.
- [Change the Hunt Group Service Status](#)<sup>[125]</sup>  
Each hunt group can be in service, in night service or out of service. When in night service or out of service, the groups calls are redirected to an alternate group or to voicemail.
- [Change the Hunt Group Fallback Destination](#)<sup>[125]</sup>  
These menus allow you to change the alternate groups used for the groups calls when it is in night service or out of service status.

### Default Short Codes

Short codes are numbers that you can dial to enable and disable various features. The following are default short codes that may be available. However, your system administrator can remove and change the short codes available to you or all users.

- **Night Service Status On: \*20\*N#**  
Set a hunt group into night service status by entering its extension number (**N**).
- **Night Service Status Off: \*21\*N#**  
Take a hunt group out of night service status by entering its extension number (**N**).

---

## 15.1 Group Membership

Only the system administrator can change the groups of which you are a member. However, you can be provided with options to enable or disable your group membership. While your membership of a group is disabled, you will not receive any group calls for that group.

### 15.1.1 Group Membership On/Off (Status Menu)

If the system administrator has allowed you, you can enable/disable your membership of a group through the **Status** menu. When your membership of a group is disabled you do not receive group calls for that group.

1. Press the **Status** soft key if shown. To access the status menu during a call, press the **PHONE** key and then press the **Status** soft key if shown.
2. Use the **▲** up and down **▼** arrow keys to scroll the menu to the hunt group name and your current membership status.
3. Press the **Enable** or **Disable** soft key to change the status of your membership of that group.

### Access Control

The system administrator is able to configure if you can access the **Membership**, **State** and **Fallback** options of a group. If you are not configured for any groups then the **Group** menu is not shown.

---

## 15.1.2 Group Membership On/Off (Features Menu)

You may be able to enable or disable your group membership for some of the groups to which you belong.

1. Press the **Features** soft key if shown.
  - To access the menu during a call, press the ► right arrow key or press the ☎ **PHONE** key and then press the **Features** soft key.
2. Use the ▲ up and down ▼ arrow keys to scroll the menu to **Group**.
3. Press the **Select** soft key or the **OK** button or the ► right arrow key.
4. Press the **Select** soft key or the **OK** button or the ► right arrow key.
5. Use the ▲ up and down ▼ arrow keys to scroll through the list of hunt groups you can configure. Use **All Groups** for all the groups you can configure. The soft keys available will vary depending on whether a particular or all groups is selected and the current state of the selection.
  - **All Groups**
    - **Disable**  
Disable your membership of all groups.
    - **Enable**  
Enable your membership of all groups.
  - **Particular Group**
    - **Change**  
Change your membership of the currently selected group.
    - **Done**  
Exit the menus.

### Access Control

The system administrator is able to configure if you can access the **Membership**, **State** and **Fallback** options of a group. If you are not configured for any groups then the **Group** menu is not shown.

## 15.2 Group Service Status and Fallback

- **Group Service Status**

A hunt group can be in one of the following service modes:

- **InServ** = *In Service*

The group operates a normal, distributing calls to available members of the group.

- **Night** = *Night Service*

The group is in night service mode. Calls are redirected to its night service fallback group [if set](#)<sup>[128]</sup>, otherwise to voicemail if available. A hunt group can also be put into and out of night service automatically by the telephone system using a time profile.

- **OOS** = *Out of Service*

The group is out of service. Calls are redirected to its out of service fallback group [if set](#)<sup>[128]</sup>, otherwise to voicemail if available. The phone displays an **O** when one of the groups of which you are a member is out of service. See [Status Letters](#)<sup>[16]</sup>.

- **TP** = *Time Profile*

This setting indicates that the group's status is being controlled by a time profile on the telephone system. That time profile sets when the group is in service and in night service. You can override this to put the group into the **OOS** state. You can then use the phone to return the group to time profile control when required.

- **Fallback Group**

For the night service and out of service states, the hunt group can be configured with a fallback destination to which its calls are redirected. This destination can be another hunt group or user extension. If no fallback destination is set, the group's voicemail is used (if available). Separate night service and out of service fallback destinations can be set for each group.

### Display Icon

- **O = Out of Service**

An **O** is shown on your phone's display when any of the groups of which you are enabled as a member is set to night service mode. In that mode calls to that group are diverted to its fallback if set or otherwise to voicemail if available.

### Access Control

The system administrator is able to configure if you can access the **Membership**, **State** and **Fallback** options of a group. If you are not configured for any groups then the **Group** menu is not shown.

---

## 15.2.1 Changing the Group Service Status (Features Menu)

Using the Features menu you may be able to change the service status of some groups to which you belong.

1. Press the **Features** soft key if shown.
  - To access the menu during a call, press the **▶** right arrow key or press the **PHONE** key and then press the **Features** soft key.
2. Use the **▲** up and down **▼** arrow keys to scroll the menu to **Group**.
3. Press the **Select** soft key or the **OK** button or the **▶** right arrow key.
4. Use the **▲** up and down **▼** arrow keys to scroll the menu to **State**.
5. Press the **Select** soft key or the **OK** button or the **▶** right arrow key.
6. Use the **▲** up and down **▼** arrow keys to scroll through the list of hunt groups you can configure. The current status of each group is shown next to the group name.
  - **InServ** = *In Service*  
The groups operates a normal, distributing calls to available members of the group.
  - **Night** = *Night Service*  
The group is in night service mode. Calls are redirected to its night service fallback group [if set](#)<sup>12b</sup>, otherwise to voicemail if available. A hunt group can also be put into and out of night service automatically by the telephone system using a time profile.
  - **OOS** = *Out of Service*  
The group is out of service. Calls are redirected to its out of service fallback group [if set](#)<sup>12b</sup>, otherwise to voicemail if available. The phone displays an **O** when one of the groups of which your are a member is out of service. See [Status Letters](#)<sup>16a</sup>.
  - **TP** = *Time Profile*  
This setting indicates that the group's status is being controlled by a time profile on the telephone system. That time profile sets when the group is in service and in night service. You can override this to put the group into the **OOS** state. You can then use the phone to returns the group to time profile control when required.
7. Use the controls at the bottom on the display to change the currently selected group's status.
  - **Change**  
Change the status of the selected group.
  - **Done**  
Exit the menus.

### Access Control

The system administrator is able to configure if you can access the **Membership**, **State** and **Fallback** options of a group. If you are not configured for any groups then the **Group** menu is not shown.

## 15.2.2 Changing the Group Service Status (Status Menu)

If the system administrator has allowed you, you can change the service state of a group through the **Status** menu.

1. Press the **Status** soft key if shown. To access the status menu during a call, press the **PHONE** key and then press the **Status** soft key if shown.
2. Use the **▲** up and down **▼** arrow keys to scroll the menu to the hunt group name and your current membership status.
3. Select the required state using the soft keys:
  - **InServ** = *In Service*  
The groups operates a normal, distributing calls to available members of the group.
  - **Night** = *Night Service*  
The group is in night service mode. Calls are redirected to its night service fallback group [if set](#)<sup>[128]</sup>, otherwise to voicemail if available. A hunt group can also be put into and out of night service automatically by the telephone system using a time profile.
  - **OOS** = *Out of Service*  
The group is out of service. Calls are redirected to it out of service fallback group [if set](#)<sup>[128]</sup>, otherwise to voicemail if available. The phone displays an **O** when one of the groups of which your are a member is out of service. See [Status Letters](#)<sup>[16]</sup>.
  - **TP** = *Time Profile*  
This setting indicates that the group's status is being controlled by a time profile on the telephone system. That time profile sets when the group is in service and in night service. You can override this to put the group into the **OOS** state. You can then use the phone to returns the group to time profile control when required.

### Access Control

The system administrator is able to configure if you can access the **Membership**, **State** and **Fallback** options of a group. If you are not configured for any groups then the **Group** menu is not shown.

---

## 15.2.3 Changing the Fallback Destinations

You may be able to use the Features menu to change the fallback destination for some or all the hunt groups of which you are a member. These are the destinations to which the hunt groups calls are routed when it is in either night service state or the out of service state. The destination can be another group, another user or a dialing code configured by you system administrator.

1. Press the **Features** soft key if shown.
  - To access the menu during a call, press the ► right arrow key or press the ☎ **PHONE** key and then press the **Features** soft key.
2. Use the ▲ up and down ▼ arrow keys to scroll the menu to **Group**.
3. Press the **Select** soft key or the **OK** button or the ► right arrow key.
4. Use the ▲ up and down ▼ arrow keys to scroll the menu to **Fallback**.
5. Press the **Select** soft key or the **OK** button or the ► right arrow key.
  - Use the ▲ up and down ▼ arrow keys to scroll through the list of hunt groups you can configure. Use **All Groups** for all the groups you can configure.
  - Use the ◀ left and right ▶ arrow keys to switch between altering night service or out of service settings.
  - The soft keys **HGNS+**, **HGNS-**, **HGOS+** and **HGOS-** can be used to change the current status of the group.
6. When viewing a particular group, if it already has a fallback destination set it is shown on the right.
7. To change the fallback destination, press the **Change** soft key and select the destination for calls.

### Access Control

The system administrator is able to configure if you can access the **Membership**, **State** and **Fallback** options of a group. If you are not configured for any groups then the **Group** menu is not shown.



# Chapter 16.



## Button Features

---

## 16. Button Features



Those  buttons not configured by the system administrators as appearance buttons can be used for other special features.

The button feature can be accessed by pressing the appropriate button. However they can also be accessed through the Button Features section of the **Features** menu (press the **Features** soft key and selecting **Button Features**). The  up and down  arrow keys can then be used to scroll through the programmed buttons. The associated button will briefly flash its red lamp.

The action of each button is normally set by the system administrator. However you can also use the [self-administer menu](#)<sup>193</sup> to select and assign actions to the buttons.

### Button Lamps













The use of the button lamp or icon will depend on the action associated with the button.

### Fixed Buttons

On all the phones, the programmable button features appear below the call appearance buttons. These cannot be reprogrammed by the phone user.

## 16.1 Programming a Button

This process is used to select and apply a function to a feature key. It can be used to replace or delete existing functions.

1. Press the **Features** soft key if shown.
  - To access the menu during a call, press the  right arrow key or press the  **PHONE** key and then press the **Features** soft key.
2. Use the  up and down  arrow keys to scroll the display to the option **Phone User**.
3. Press the **Select** soft key or the **OK** button or the  right arrow key.
4. Use the  up and down  keys to scroll the display to the option **Self-Administer**.
5. Press the **Select** soft key or the **OK** button or the  right arrow key.
6. Enter your login code.
7. Press the **Done** soft key.
8. The menu and  buttons can now be used in combination to select and apply functions to buttons.
9. **Inspecting/deleting buttons:**
  - a. Press a  buttons to see what function is currently programmed for that button.
  - b. To delete the function press **Delete**. To return to the menu press **Back**.
10. **Programming a button:**
  - a. Use the  up and down  keys to scroll the display to the function you want to apply to a button and press **Select**.
  - b. If the function needs some data, for example an extension number or a number to dial, dial the number.
  - c. Press the  button to which you want the function applied.
  - d. If the button is already configured with a function, you will be prompted whether you want to replace the existing function. To do so press **Replace**.
  - e. Press **Back**.
11. Repeat the process to program another button or press **Back** and then **Exit** to finish.

### Access Control

Your system administrator can configure whether you can access this menu option. See [Menu Access Control](#)<sup>193</sup>.

## 16.2 Features

There are a wide range of actions that can be assigned to the buttons. This guide only includes details of those that you can assign to a button using the [self-administer](#) <sup>[130]</sup> menu. Functions that can only be assigned by your system administrator will be explained by the system administrator.

Some actions are not supported on all phones. However they may be set for users who hot desk between different types of phone.

- [Absence Text](#) <sup>[132]</sup>
- [Abbreviated Dial](#) <sup>[132]</sup>
- [Account Code](#) <sup>[132]</sup>
- [Suppress Digits](#) <sup>[134]</sup>
- [Call Forwarding All](#) <sup>[132]</sup>
- [Call Park](#) <sup>[132]</sup>
- [Call Park to Other](#) <sup>[132]</sup>
- [Call Pickup Any](#) <sup>[133]</sup>
- [Conf. Meet Me](#) <sup>[133]</sup>
- [Call Pickup](#) <sup>[133]</sup>
- [Drop Call](#) <sup>[133]</sup>
- [Flash Hook](#) <sup>[133]</sup>
- [Group BLF](#) <sup>[133]</sup>
- [Page](#) <sup>[133]</sup>
- [Auto Answer](#) <sup>[132]</sup>
- [Park and Page](#) <sup>[133]</sup>
- [Ringer Off](#) <sup>[133]</sup>
- [Self Administer](#) <sup>[133]</sup>
- [Send All Calls](#) <sup>[134]</sup>
- [Timer](#) <sup>[134]</sup>
- [Twinning](#) <sup>[134]</sup>
- [User BLF](#) <sup>[134]</sup>

A self-administer button set with action data 1 can be used to the following functions onto programmable buttons:

- [Abbreviated Dial](#) <sup>[132]</sup>
- [Group](#) <sup>[133]</sup>
- [CPark](#) <sup>[132]</sup>
- [User](#) <sup>[134]</sup>
- [Flash Hook](#) <sup>[133]</sup>

Some actions are not supported on all phones. However they may be set for users who hot desk between different types of phone.

---

## 16.2.1 Abbreviated Dial

This action can be used as a speed dial button. While setting up the button, enter the number you would like it to dial.

You can enter a partial number and complete the dialing after pressing the button. For example pre-program the button with a particular international dialing code.

## 16.2.2 Absence Text

Set or clear an absence text message for display on your phone. This text also appears on the display of the phone making a call to you. When setting the message, you can select from a number of pre-configured messages and then add your own text if you want.

## 16.2.3 Account Code

This action can be setup with or without an account code.

If the button is setup with an account code, that account code is applied to the current call when the button is pressed.

If the button is setup without an account code, pressing the button will display the [enter account code](#)  menu.

## 16.2.4 Auto Answer

A button configured with this action can be used to switch internal auto-answer on or off.

Status	Button
- On	Green on.
- Off	Off.

## 16.2.5 Call Forwarding All

A button with this action can be used to switch forwarding unconditional on/off.

If setup with a preset number, that number is used as the forwarding destination.

If setup without a number, when the button is pressed you will be asked to confirm your existing forward unconditional destination number or to enter a new number.

The button's green lamp is lit when forwarding is enabled. The button can be pressed again to switch forward unconditional off.

## 16.2.6 Call Park

A button set to this action can be used to park and unpark calls. The button can be set with or without a park slot number.

- When associated with a specific park slot number, the button can park and unpark a call from that park slot. When a call has been parked in that park slot, the button's lamp flashes. Green if the call was parked using that button, red if parked by another method. Pressing the button again retrieves the call.
- When not associated with a specific park slot number:
  - If pressed while you have a call connected, that call is parked using a park slot number assigned by the system based on your extension number.
  - If pressed while you have no call connected, your phone displays details of your parked calls and allow you to unpark a selected call.
  - When you have calls that you parked (other than Park & Page) or others parked against your extension, the button's lamp flashes.

## 16.2.7 Call Park to Other

A button setup with this action can be used to park a call against another extension. The park slot number used will be based on your extension number.

The button can be setup with a target user number or left blank for number entry when the button is pressed.

The button can be pressed again to unpark the call.

Status	Button
- Parked Call	Green flash.
- No Parked Call	Off.

### 16.2.8 Call Pickup

Answer a call ringing a user or hunt group.

The target user or group number from which to pickup a call can be set when the button is configured. If no number is set, pressing the button will display a menu for number entry.

### 16.2.9 Call Pickup Any

Answer a call currently ringing on the telephone system.

### 16.2.10 Conf Meet Me

A button programmed to this feature allows you to start or enter a conference by entering the conference ID.

### 16.2.11 Drop Call

This action can be used to drop your current call without having to highlight it on the display. If the call is connected, pressing the key ends the call. If the call is ringing it may follow several routes, see [Dropping an Incoming Call](#)<sup>[38]</sup>.

### 16.2.12 Flash Hook

A button configured for this action will send a hook flash signal to a currently connected analog line.

### 16.2.13 Group BLF

A button set to this function monitors the status of a hunt group queue. This is only supported for hunt groups with queuing enabled. The user does not have to be a member of the group being monitored.

The button will indicate when the group has calls ringing (Green flash) and calls queued (Red flash). Queued means the group has more calls waiting (not including calls ringing) than available group members.

### 16.2.14 Page

A button configured with this action can be used to make a page call.

The button can be configured with the target user or group for the page. If configured with no number, pressing the button will display a menu for number entry before making the page call.

### 16.2.15 Park and Page

If your system administrator has configured your system for [Park & Page](#)<sup>[69]</sup>, this button allows you to use the feature to park calls and announce the parked call to other users.

### 16.2.16 Ringer Off

A button configured with this action can be used to turn your phone's ringer on or off.

Status	Button
- On	Green on.
- Off	Off.

### 16.2.17 Self-Administer

A button configured for this action can be used to access the [self-administer](#)<sup>[130]</sup> menu and assign functions onto programmable buttons. A self-administer button set with the action data 2 can be used to display basic telephone system information like the software version and IP address.

---

## 16.2.18 Send All Calls

A button configured with this action can be used to switch do not disturb on or off.

Status	Button
- On	Green on.
- Off	Off.

## 16.2.19 Suppress Digits

This action can be used to suppress the display of numbers that you dial. When the action is enabled, any numbers that you dial are displayed as **s** characters. When on, the button's green lamp is lit. Pressing the button again toggles the action on or off.

## 16.2.20 Timer

When a call is made or answered on a call appearance, the call appearance line can include a call timer. This is controlled by the phone's [Call Timer](#) <sup>[148]</sup> setting.

During the call you may want to show or hide the call timer associated with the currently selected call appearance. For example in order to see more of the caller ID information. Temporarily turning the call timer of the currently selected call appearance on or off can be done using a Timer button.

Note that after the call, when the call appearance is next used, whether the timer is displayed or not to start with is controlled again by the [Call Timer](#) <sup>[148]</sup> setting.

## 16.2.21 Twinning

A button configured for this feature allows you to control your phone's mobile twinning operation. This is only useable if your system administrator has configured you for mobile twinning.

- If pressed when the phone is idle, the phone displays the [mobile twinning menu](#) <sup>[60]</sup>. You can use the menu to switch mobile twinning on/off and to setting the twinned destination.
- If pressed while a twinned call is connected to the twinned destination, the system attempts to reclaim the call.
- If pressed while connected to a call on the phone, the system attempts to transfer the call to the twinned destination. You do not need twinning switched on to use this feature.

## 16.2.22 User BLF

This type of button can be used to monitor the status of another user. The button lamp indicates the status of the user.

- **Off = Available**  
Pressing the button will make a call to the user. In addition to calling the user, you can use the user button to transfer calls to the user or to start a conference with the user.
- **Slow Flash = Ringing**  
Pressing the button will display options to pickup the call.
- **Fast Flash = On a Call**  
Pressing the button will display a number of options:
  - **Call** - Call the user.
  - **Message** - Cause a single burst of ringing on the user's phone. They will also see the message "**Please Call**" followed by your extension number.
  - **Voicemail** - Call the user's voicemail mailbox to leave a message.
  - **Auto Callback** - Set an automatic callback on the user. The callback will occur when the user ends their current call.

The following options are only available if configured for you by your system administrator:

- **Drop Call** - Disconnect the user's current call.
- **Acquire** - Seize the user's current call.
- **Intrude** - Join the user's current call, turning it into a conference call.
- **Listen** - Start silent monitoring of the user's call.







# Chapter 17.

## Phone Settings

# 17. Phone Settings

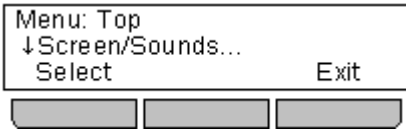









Pressing the **A MENU** key accesses a menu that can be used to control various phone settings. These are mainly settings stored by the phone rather than user settings that move with you.

The [Phone A-Menu diagram](#) <sup>[188]</sup> shows a summary of the menu options.

General	Display Controls
<ul style="list-style-type: none"> <li>• <a href="#">Mobile Twinning</a> <sup>[139]</sup></li> <li>• <a href="#">Withhold Number</a> <sup>[139]</sup></li> <li>• <a href="#">Redial Mode</a> <sup>[140]</sup></li> <li>• <a href="#">Backup/Restore</a> <sup>[150]</sup></li> <li>• <a href="#">En-Bloc Dialing</a> <sup>[141]</sup></li> <li>• <a href="#">Auto Lock</a> <sup>[141]</sup></li> </ul>	<ul style="list-style-type: none"> <li>• <a href="#">Brightness</a> <sup>[147]</sup></li> <li>• <a href="#">Contrast</a> <sup>[147]</sup></li> <li>• <a href="#">Call Timer Display</a> <sup>[148]</sup></li> <li>• <a href="#">Language</a> <sup>[149]</sup></li> <li>• <a href="#">Display Name</a> <sup>[150]</sup></li> <li>• <a href="#">A-Menu Auto Exit</a> <sup>[150]</sup></li> <li>• <a href="#">Exit Menu Timer (Auto Return)</a> <sup>[151]</sup></li> </ul>
Sounds	Ringer Controls
<ul style="list-style-type: none"> <li>• <a href="#">Button Clicks</a> <sup>[153]</sup></li> <li>• <a href="#">Error Tones</a> <sup>[153]</sup></li> <li>• <a href="#">Ringer Volume</a> <sup>[153]</sup></li> <li>• <a href="#">Handset Volume</a> <sup>[153]</sup></li> <li>• <a href="#">Headset Volume</a> <sup>[153]</sup></li> <li>• <a href="#">Speaker Volume</a> <sup>[154]</sup></li> <li>• <b>Automatic Gain Control</b></li> <li>• <a href="#">Default Audio Path</a> <sup>[154]</sup></li> </ul>	<ul style="list-style-type: none"> <li>• <a href="#">Disabling the Ringer</a> <sup>[142]</sup></li> <li>• <a href="#">Visual Alerting</a> <sup>[143]</sup></li> <li>• <a href="#">Audible Alerting</a> <sup>[143]</sup></li> <li>• <a href="#">Coverage Ring</a> <sup>[143]</sup></li> <li>• <a href="#">Ring Sound</a> <sup>[143]</sup></li> <li>• <a href="#">Ringer Volume</a> <sup>[143]</sup></li> <li>• <a href="#">Internal Auto Answer</a> <sup>[146]</sup></li> </ul>









## 17.1 Mobile Twinning

This menu option is only available if you have been configured by the system administrator to be able to use mobile twinning.

- The addition of a button set to the **Twinning** function is recommended, contact your system administrator. Such a button allows you to transfer a call to your twinning destination, retrieve a call from the twinning destination and access the menu options below to set the twinning destination number and switch twinning on/off.
  1. Press the **Features** soft key if shown.
    - To access the menu during a call, press the  right arrow key or press the  **PHONE** key and then press the **Features** soft key.
  2. Use the  up and down  arrow keys to scroll the menu to **Forward**.
  3. Press the **Select** soft key or the **OK** button or the  right arrow key.
  4. Use the  up and down  arrow keys to scroll the menu to **Mobile Twinning**.
  5. Press the **Select** soft key or the **OK** button or the  right arrow key.
  6. If no twinning number has been set, the menu will prompt you to enter a number.
  7. When a number has been entered, you can access the **Enable** and **Disable** soft keys to turn use of mobile twinning on or off. The **Clear** soft key removes the existing twinning number in order to allow entry of a new number.

## 17.2 Withhold Number

You can select to withhold your number on external calls. Note that this option may not be supported in all situations. It may depend on the configuration of your phone system and options supported by your telephone line provider.

1. Press the **Features** soft key if shown.
  - To access the menu during a call, press the  right arrow key or press the  **PHONE** key and then press the **Features** soft key.
2. Use the  up and down  arrow keys to scroll the display to the option **Call Settings**.
3. Press the **Select** soft key or the **OK** button or the  right arrow key.
4. Use the  up and down  menu keys to scroll the menu to **Withhold Number**.
5. Use the  left or right  arrow keys to change the current setting or press the indicated soft key.

### Access Control

Your system administrator can configure whether you can access this menu option. See [Menu Access Control](#)<sup>193</sup>.

---

## 17.3 Redial Mode

You can select whether your phone uses the redial list or last call redial mode.

1. Press the **Features** soft key if shown.
  - To access the menu during a call, press the ► right arrow key or press the ☎ **PHONE** key and then press the **Features** soft key.
2. Use the ▲ up and down ▼ arrow keys to scroll the display to the option **Call Settings**.
3. Press the **Select** soft key or the **OK** button or the ► right arrow key.
4. Use the ▲ up and down ▼ arrow keys to scroll the menu to **Redial Action**.
5. The current mode, **List** or **One** is displayed.
  - **List**  
If this mode is selected, pressing the **Redial** will display a menu of the 10 most recent outgoing calls in your call log. You can select the call that you want to redial and perform a number of other functions.
  - **One**  
If this mode is selecting, pressing **Redial** will immediately repeat the most recent outgoing call in your call log. None of the other redial function will be accessible.
6. Use either the **Change** soft key or the ◀ left or right ▶ arrow keys to change the mode.
7. When the required mode is displayed, press the **Done** soft key.

## 17.4 En-Bloc Dialing

By default, when you start dialing a number on your phone, the phone immediately connects to the telephone system and starts passing the digits you dial to the phone system. You cannot correct the digits you have already dialed except by ending the call and starting again. Also if you pause dialing for too long the phone system may think that you have finished dialing and will attempt to connect the call using only the digits you have completed dialing so far.

En-bloc dialing allows you to compose and edit the number to dial on your phone's display before it is sent to the phone system to be dialed.

Through the phone's menus you can select whether you want to use traditional or en-bloc dialing when making calls. Your chosen setting is then applied whenever you are using a phone that supports en-bloc dialing.

You can enable or disable your en-bloc dialing setting through the phone's **Features** menu.

1. Press the **Features** soft key if shown.
  - To access the menu during a call, press the **▶** right arrow key or press the **☰ PHONE** key and then press the **Features** soft key.
2. Use the **▲** up and down **▼** arrow keys to scroll the display to the option **Call Settings**.
3. Press the **Select** soft key or the **OK** button or the **▶** right arrow key.
4. Use the **▲** up and down **▼** arrow keys to scroll the display to the option **En-Bloc Dial**.
5. Use the **◀** left and right **▶** arrow keys to change the setting or use the indicated soft key.

## 17.5 Auto Lock

Rather than logging out, you can lock your phone. You can either [lock your phone manually](#)<sup>[118]</sup> using the steps below or have it automatically locked after a period of phone inactivity.

When your phone is locked:

- It can only be used to make internal and emergency calls.
- None of the menus for your user settings can be accessed.
- To [unlock the phone](#)<sup>[118]</sup> requires your login code if you have [configured a login code](#)<sup>[116]</sup>.

1. Press the **Features** soft key if shown.
  - To access the menu during a call, press the **▶** right arrow key or press the **☰ PHONE** key and then press the **Features** soft key.
2. Use the **▲** up and down **▼** arrow keys to scroll the display to the option **Phone User**.
3. Press the **Select** soft key or the **OK** button or the **▶** right arrow key.
4. Use the **▲** up and down **▼** arrow keys to scroll the display to the option **Phone Screen Settings**.
5. Press the **Select** soft key or the **OK** button or the **▶** right arrow key.
6. Use the **▲** up and down **▼** arrow keys to scroll the display to the option **Auto Lock**. The **(m)** indicates that the setting is in minutes.
7. Press the **Change** soft key to change the setting or use the **◀** left or right **▶** arrow keys.
  - **Off**  
Do not use the inactivity timer.
  - **1 / 5 / 30 / 60**  
Lock the phone after the indicated number of minutes.
8. Press the **Done** soft key.

### Access Control

Your system administrator can configure whether you can access this menu option. See [Menu Access Control](#)<sup>[193]</sup>.

---







## 17.6 Ringer Controls

This section covers controls for adjusting the ringing used by your phone.

- [Switch the Ringer On/Off](#) <sup>142</sup>
- [Ring Pattern/Sound](#) <sup>143</sup>
- [Visual Alerting](#) <sup>145</sup>
- [Audible Alerting On/Off](#) <sup>145</sup>
- [Coverage Ring](#) <sup>145</sup>
- [Ring Volume](#) <sup>146</sup>
- [Internal Auto Answer](#) <sup>146</sup>

### 17.6.1 Disabling the Ringer

This option can be used to turn off the ringer for all calls. If set to no ring, this disables both the phones [audible alerting](#) <sup>145</sup> and [visual alerting](#) <sup>145</sup> settings.

1. Press the **Features** soft key if shown.
  - To access the menu during a call, press the  right arrow key or press the  **PHONE** key and then press the **Features** soft key.
2. Use the  up and down  arrow keys to scroll the display to the option **Call Settings**.
3. Press the **Select** soft key or the **OK** button or the  right arrow key.
4. Use the  up and down  arrow keys to scroll the menu to **Disable Ringer**.
5. Press the **Change** soft key to change the setting. Selecting **On** will turn the ringer off.

## 17.6.2 Ring Pattern/Sound

The telephone system uses different ring patterns for different types of call. The ring pattern is a combination of the phone's default ring tone followed by your personal ring tone selection. For each call or line appearance button on your telephone, your system administrator can also adjust when ringing is used (immediately, after a small delay or off).

Call Type	Ring (1.2s)		Silence (4.0s)
Internal	Default	Personal ring	Silence
External			
Ringback			
0.1 seconds:			

- Internal Calls:** *Two-tone long ring.*  
 This type of ring is used for internal calls.
- External Calls:** *Double ring (one short ring, one normal ring).*  
 This type of ring is used for external calls. Note that that also includes internal calls where the caller is transferring an external call.
- Ringback/Return Calls:** *Two very short rings followed by a normal ring.*  
 This type of ring is used for calls that are returning to your phone. For example, a call that you put on hold and which is returning due to being left on hold too long.
- Coverage Ring:** *Variable*  
 You can also adjust the ringing used for call coverage and bridged appearance buttons. See [Coverage Ring](#)<sup>143</sup>. The options are normal ringing (internal or external), an abbreviated ring (a non-repeated short ring) or no ring.
- Attention Ring:** *Variable*  
 The system administrator can adjust the ring used for new calls when you are already on a call. The options are an abbreviated ring or no ring. For calls alerting on a call coverage or bridged appearance button when you are already on a call, the shorter of the coverage ring or attention ring settings is used.

### 17.6.2.1 Personal Ring Tone Selection

The telephone system supports 8 different classic ring tones. The selected tone is used for the [personal ring portion of the ring](#)<sup>143</sup>.

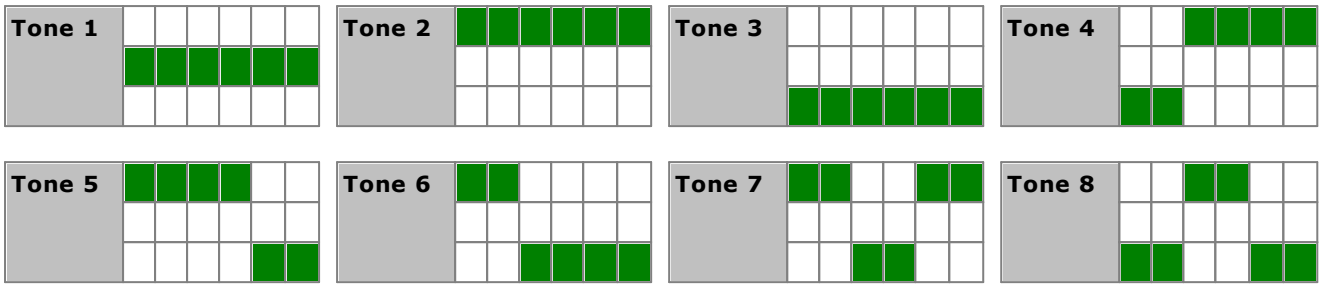

#### To change your personal ring tone:

1. Press the **A MENU** button.
2. Use the ▲ up and down ▼ arrow keys to locate the option **Screen/Sounds** and press the **Select** soft key.
3. Use the ▲ up and down ▼ arrow keys to locate the option **Personal Ringing**. Press the **Select** soft key.
  - Use the ▲ up and down ▼ arrow keys to scroll through the different available ring patterns.
  - Press the **Play** soft key to repeat the currently display ring pattern.
  - To make the currently displayed ring pattern the selected ring pattern for the phone press the **Save** soft key.
  - To leave the menu without making any changes press the **Cancel** soft key.
4. When completed, press the **Done** soft key.
5. Press the **Exit** soft key to exit the menus.



### 17.6.3 Visual Alerting

The message waiting lamp at the top-right corner of the phone can also be used to indicate when you have a call alerting your phone. The lamp is flashed to indicate a call waiting to be answered.

1. Press the **A MENU** button.
2. Use the ▲ up and down ▼ arrow keys to locate the option **Call Settings...**
3. Press the **Select** soft key.
4. Use the ▲ up and down ▼ arrow keys to locate the option **Visual Alerting**.
5. Use the ◀ left and right ▶ arrow keys or press the **On/Off** soft key to change the setting.
6. When completed, press the **Done** soft key.
7. Press the **Exit** soft key to exit the menus.

### 17.6.4 Audible Alerting

The phone's audible ringer can be switched off. Unlike [disabling the ringer](#)<sup>[142]</sup>, this only affects the ring and does not affect the [visual alerting](#)<sup>[143]</sup>.

1. Press the **A MENU** button.
2. Use the ▲ up and down ▼ arrow keys to locate the option **Call Settings...**
3. Press the **Select** soft key.
4. Use the ▲ up and down ▼ arrow keys to locate the option **Audible Alerting**.
5. Use the ◀ left and right ▶ arrow keys or press the **On/Off** soft key to change the setting.
6. When completed, press the **Done** soft key.
7. Press the **Exit** soft key to exit the menus.

### 17.6.5 Coverage Ring

If you have any bridged appearance and or call coverage buttons, you can [set the type of ringing \(coverage ring\)](#)<sup>[145]</sup> that should be used when a call alerts on any of those buttons. The options are to use normal ringing, a single non-repeated ring (abbreviated ring) or no ring. The coverage ring setting is only used if you do not already have a connected call. If you already have a connected call in progress, the shorter of your coverage ring and the system administrator set attention ring settings is used.

This is a user setting which will move with you if you hot desk another phone.

1. Press the **Features** soft key if shown.
  - To access the menu during a call, press the ▶ right arrow key or press the ☎ **PHONE** key and then press the **Features** soft key.
2. Use the ▲ up and down ▼ arrow keys to scroll the display to the option **Call Settings**.
3. Press the **Select** soft key or the **OK** button or the ▶ right arrow key.
4. Use the ▲ up and down ▼ arrow keys to scroll the menu to **Coverage Ring**.
5. Press the **Change** soft key to change the setting.
  - **Ring**  
Use normal ringing.
  - **Abbr**  
Use a single non-repeated ring (abbreviated ring).
  - **Off**  
No ring.

---

## 17.6.6 Ringer Volume

You can adjust the ringer volume while the phone is idle or while it is ringing.

1. With the phone idle or ringing, press the **▲** key.
2. Use the + plus and – minus keys to adjust the volume.
3. The display will return to normal after a few seconds.

## 17.6.7 Internal Auto Answer

You can select to have internal calls automatically connected if you are not already on a call. The call will be connected, after the phone gives a brief tone, using either the phone's speaker or the headset as set by the phone's [audio path setting](#)<sup>[154]</sup>.

### To enable auto internal answer:

1. Press the **A MENU** button.
2. Use the **▲** up and down **▼** arrow keys to locate the option **Call Settings....**
3. Press the **Select** soft key.
4. Use the **▲** up and down **▼** arrow keys to locate the option **Internal Auto-Answer**.
5. Press the **Change** soft key to change the setting.

This function can be assigned to a [feature button](#)<sup>[130]</sup> configured with the [Internal Auto Answer](#)<sup>[132]</sup> action. The button lamp will indicate when internal auto answer is on.

### Access Control

Your system administrator can configure whether you can access this menu option. See [Menu Access Control](#)<sup>[193]</sup>.

## 17.7 Display Controls

This section covers controls for adjusting the phones display and the information shown on the display.

- [Display Brightness](#)<sup>[147]</sup>  
Adjust the brightness of the display.
- [Display Contrast](#)<sup>[147]</sup>  
Adjust the contrast of the display.
- [Call Timer](#)<sup>[148]</sup>  
Adjust whether the ring/call time is displayed for calls on appearance buttons.
- [Show Last Call Duration](#)<sup>[148]</sup>  
Display the duration of a call for a few seconds after the call is ended.
- [Display Language](#)<sup>[149]</sup>  
Select the language used for the phones menus.
- [Display Name](#)<sup>[150]</sup>  
Change the information displayed by the phone when it is not in use.
- [A-Menu Auto Exit](#)<sup>[150]</sup>  
Automatically exit the A-menu screens when a new call alerts your phone.
- [Auto Show Call Waiting](#)<sup>[151]</sup>  
If, when already on a call, there is another call waiting to be answered, automatically display the call information of the waiting call.
- [Exit Menu Inactivity Timer \(Auto Return\)](#)<sup>[151]</sup>  
Return to the normal call display after a period of inactivity in a menu.

### 17.7.1 Display Brightness

1. Press the **A MENU** button.
2. Press the **Select** soft key.
3. Press the **Select** soft key.
4. Use the ◀ up and down ▶ arrow keys to adjust the brightness as required.
5. When completed, press the **Done** soft key.
6. Press the **Exit** soft key to exit the menus.

### 17.7.2 Display Contrast

1. Press the **A MENU** button.
2. Press the **Select** soft key.
3. Use the ▲ up and down ▼ arrow keys to locate the option **Contrast**.
4. Press the **Select** soft key.
5. Use the ◀ left and right ▶ arrow keys to adjust the brightness as required.
6. When completed, press the **Done** soft key.
7. Press the **Exit** soft key to exit the menus.

---

### 17.7.3 Call Timer Display

When you have calls alerting on appearance buttons, the phone can include a timer in the appearance details shown on the display. The timer shows how long the call has been alerting and, if you answer the call, resets to show how long the call has been connected. The timer will also show how long a call has been on hold when you hold the call.

You can turn the timer display on or off. Turning it off provides more space for other call details on the display.

- For the currently selected call appearance, the call timer display can be temporarily turned on or off using a programmable button set to the **Timer** <sup>[134]</sup> function.

1. Press the **A MENU** button.
2. Use the ▲ up and down ▼ arrow keys to locate the option **Call Settings...**
3. Press the **Select** soft key.
4. Use the ▲ up and down ▼ arrow keys to locate the option **Call Timer**.
5. Use the ◀ left and right ▶ arrow keys or press the **On/Off** soft key to change the setting.
6. When completed, press the **Done** soft key.
7. Press the **Exit** soft key to exit the menus.

### 17.7.4 Last Call Duration Display

As an alternate to **call timer** <sup>[148]</sup> display, you can have the phone briefly (4 seconds) display the duration of the call after it is ended.

1. Press the **Features** soft key if shown.
  - To access the menu during a call, press the ▶ right arrow key or press the ☎ **PHONE** key and then press the **Features** soft key.
2. Use the ▲ up and down ▼ arrow keys to scroll the display to the option **Call Settings**.
3. Press the **Select** soft key or the **OK** button or the ▶ right arrow key.
3. Use the ▲ up and down ▼ arrow keys to highlight **Show Last Call Duration**.
4. Press **Change** to change the setting between **On** or **Off**.
5. Press the **Save** soft key.

## 17.7.5 Display Language

The system administrator can configure which languages are available for use by the phone for its own menus. Up to 5 languages can be made available.

Through the phone's menu you can select which of those languages the phone should use.

Note that many of the messages displayed on the phone use text sent from the telephone system. They will use the default language of the telephone system unless the system administrator has set you to use a specific language supported by the phone system.

Phone Languages	Telephone System Languages	
<ul style="list-style-type: none"> <li>• Dutch</li> <li>• English</li> <li>• French</li> <li>• French (Canadian)</li> <li>• German</li> <li>• Italian</li> <li>• Portuguese (Brazilian)</li> <li>• Russian</li> <li>• Spanish (Castilian)</li> <li>• Spanish (Latin American)</li> </ul>	<ul style="list-style-type: none"> <li>• Danish</li> <li>• Dutch</li> <li>• English (UK)</li> <li>• English (US)</li> <li>• Finnish</li> <li>• French</li> <li>• French (Canadian)</li> <li>• German</li> </ul>	<ul style="list-style-type: none"> <li>• Italian</li> <li>• Norwegian</li> <li>• Portuguese</li> <li>• Portuguese (Brazilian)</li> <li>• Russian</li> <li>• Spanish (Castilian)</li> <li>• Spanish (Latin American)</li> <li>• Swedish</li> </ul>

1. Press the **A MENU** button.
2. Use the **▲** up and down **▼** arrow keys to locate the option **Advanced**.
3. Press the **Select** soft key.
4. Use the **▲** up and down **▼** arrow keys to locate the option **Language**.
5. Press the **Select** soft key.
6. Use the **▲** up and down **▼** arrow keys scroll through the different languages available.
7. To select the language currently displayed, press the **Select** soft key or **OK**.
8. When completed, press the **Done** soft key.
9. Press the **Exit** soft key to exit the menus.

---

## 17.7.6 Display Name

The top line of your phone can display different information. Your system administrator can select which information is shown by default. However, you can then select which information you want shown.

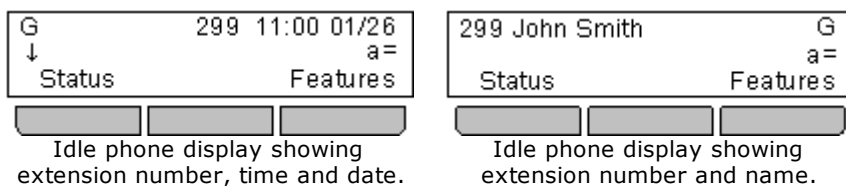

1. Press the **Features** soft key if shown.
  - To access the menu during a call, press the **▶** right arrow key or press the **PHONE** key and then press the **Features** soft key.
2. Use the **▲** up and down **▼** arrow keys to scroll the display to the option **Phone User**.
3. Press the **Select** soft key or the **OK** button or the **▶** right arrow key.
4. Use the **▲** up and down **▼** arrow keys to scroll the display to the option **Phone Screen Settings**.
5. Press the **Select** soft key or the **OK** button or the **▶** right arrow key.
4. Use the **▲** up and down **▼** arrow keys to scroll the display to the option **Display Name**.
5. Press the **Change** soft key to change the setting or use the **◀** left or right **▶** arrow keys.
  - **Off**  
Display your extension number and the date and time on the phone when it is idle.
  - **On**  
Display your extension number and name on the phone when it is idle.
6. Press the **Done** soft key.

## 17.7.7 A-Menu Auto Exit

The **Show Phone Screen** option only applies to the A-menu screens accessed when you press the **A** key. If the option is on, if you receive a call while in the A-menu, the phone will automatically exit the menus and display the call details.

1. Press the **A MENU** button.
2. Use the **▲** up and down **▼** arrow keys to locate the option **Call Settings...**
3. Press the **Select** soft key.
4. Use the **▲** up and down **▼** arrow keys to locate the option **Show Phone Screen**.
5. Use the **◀** left and right **▶** arrow keys or press the **On/Off** soft key to change the setting.
6. When completed, press the **Done** soft key.
7. Press the **Exit** soft key to exit the menus.

## 17.7.8 Auto Show Call Waiting

By default, when you are connected on a call, the phone shows details of that call and soft key actions you can perform for that call. In order to see details of a waiting call, you need to scroll the display using the up and down arrow buttons.

You can opt to have the phone automatically show details of a waiting call when one alerts the phone and soft key actions that you can perform on the waiting call. If you use the scroll keys to return the display focus to the currently connected call, the focus automatically returns to the waiting call after a few seconds.

1. Press the **Features** soft key if shown.
  - To access the menu during a call, press the **▶** right arrow key or press the **☎ PHONE** key and then press the **Features** soft key.
2. Use the **▲** up and down **▼** arrow keys to scroll the display to the option **Phone User**.
3. Press the **Select** soft key or the **OK** button or the **▶** right arrow key.
4. Use the **▲** up and down **▼** arrow keys to scroll the display to the option **Phone Screen Settings**.
5. Press the **Select** soft key or the **OK** button or the **▶** right arrow key.
4. Use the **▲** up and down **▼** arrow keys to scroll the display to the option **Show Waiting Call**.
5. Press the **Change** soft key to change the setting or use the **◀** left or right **▶** arrow keys.
6. Select one of the following settings as desired:
  - **Off** - Show details of the current call only.
  - **On** - Automatically show the details of a waiting call.
7. Press the **Done** soft key.

## 17.7.9 Inactivity Timer (Auto Return)

You can set a timer which will return the phone to its normal call display after a set period of phone inactivity. By default the phone will be set to auto return after 60 seconds.

Note that the timer is not applied to all menus. For example it is not applied to the A-menu and to the visual voice menu. It is also not applied to the **System Admin** section of the **Features** menus.

1. Press the **Features** soft key if shown.
  - To access the menu during a call, press the **▶** right arrow key or press the **☎ PHONE** key and then press the **Features** soft key.
2. Use the **▲** up and down **▼** arrow keys to scroll the display to the option **Phone User**.
3. Press the **Select** soft key or the **OK** button or the **▶** right arrow key.
4. Use the **▲** up and down **▼** arrow keys to scroll the display to the option **Phone Screen Settings**.
5. Press the **Select** soft key or the **OK** button or the **▶** right arrow key.
4. Use the **▲** up and down **▼** arrow keys to scroll the display to the option **Auto Return (s)**.
5. Press the **Change** soft key to change the setting or use the **◀** left or right **▶** arrow keys.
  - **Off**  
Do not use the inactivity timer.
  - **30 / 60**  
Apply the inactivity timer after the selected number of seconds.
6. Press the **Done** soft key.

---

## 17.8 Volume and Sound

This section covers controls that relate to the various sounds that your phone uses and to the volume. These are in addition to the [ringer controls](#) <sup>[142]</sup> available.

- [Button Click](#) <sup>[153]</sup>  
Turn the phone menu key click on or off.
- [Error Tones](#) <sup>[153]</sup>  
Turn the phone menu error tones on or off.
- [Ringer Volume](#) <sup>[153]</sup>  
Adjust the volume of the ringer used by the phone.
- [Handset Volume](#) <sup>[153]</sup>  
Adjust the incoming call volume heard through the phone's handset.
- [Headset Volume](#) <sup>[153]</sup>  
Adjust the incoming call volume heard through a headset attached to the phone.
- [Speaker Volume](#) <sup>[154]</sup>  
Adjust the incoming call volume heard through the phone's speaker.
- [Automatic Gain Control](#) <sup>[154]</sup>  
Switch automatic gain control on or off.

### Note

The system administrator can set your phone to reset its volume after each call.



### 17.8.1 Button Clicks

While using the phone menus, the phone can provide a key press confirmation click sound. This can be turned off if it is annoying.

1. Press the **A MENU** button.
2. Press the **Select** soft key.
3. Use the ▲ up and down ▼ arrow keys to locate the option **Button Clicks**.
4. Use the ◀ left and right ▶ arrow keys or press the **On/Off** soft key to change the setting.
5. When completed, press the **Done** soft key.
6. Press the **Exit** soft key to exit the menus.

### 17.8.2 Error Tones

1. Press the **A MENU** button.
2. Press the **Select** soft key.
3. Use the ▲ up and down ▼ arrow keys to locate the option **Error Tone**.
4. Use the ◀ left and right ▶ arrow keys or press the **On/Off** soft key to change the setting.
5. When completed, press the **Done** soft key.
6. Press the **Exit** soft key to exit the menus.

### 17.8.3 Ringer Volume

You can adjust the ringer volume while the phone is idle or while it is ringing.

1. With the phone idle or ringing, press the ➤ key.
2. Use the + plus and – minus keys to adjust the volume.
3. The display will return to normal after a few seconds.

### 17.8.4 Handset Volume

While talking via the handset, you can adjust the volume of the incoming call.

1. With the call connected on the handset, press the ➤ key.
2. Use the + plus and – minus keys to adjust the volume.
3. The display will return to normal after a few seconds.

### 17.8.5 Headset Volume

While talking via the headset, you can adjust the volume of the incoming call.

1. With the call connected on the headset, press the ➤ key.
2. Use the + plus and – minus keys to adjust the volume.
3. The display will return to normal after a few seconds.

---

## 17.8.6 Speaker Volume

While talking handsfree via the phone's speaker, you can adjust the volume of the incoming call.

1. With the call connected on the speaker, press the **▲** key.
2. Use the **+** plus and **-** minus keys to adjust the volume.
3. The display will return to normal after a few seconds.

## 17.8.7 Automatic Gain Control

When using automatic gain control (AGC), the phone tries to maintain a constant audio level even if the incoming call changes between loud and quiet.

1. Press the **A MENU** button.
2. Use the **▲** up and down **▼** arrow keys to locate the option **Advanced**.
3. Press the **Select** soft key.
4. Use the **▲** up and down **▼** arrow keys to locate the option **Automatic Gain Control**.
5. Press the **Select** soft key.
  - Use the **▲** up and down **▼** arrow keys to switch between the **Handset**, **Headset** or **Speaker** settings for automatic gain control.
  - To change a setting, use the **◀** left and right **▶** arrow keys or press the **On/Off** soft key.
6. When completed, press the **Done** soft key.
7. Press the **Exit** soft key to exit the menus.

## 17.8.8 Default Handsfree Audio Path

By default, when you make a call or answer a call without lifting the handset, the audio is played through the phone's speaker while you speak via the phone's microphone.

If you have a headset attached, you can change the phone's behavior so the audio is played through the headset by default rather than the speaker.

1. Press the **A MENU** button.
2. Use the **▲** up and down **▼** arrow keys to locate the option **Call Settings...**
3. Press the **Select** soft key.
4. Use the **▲** up and down **▼** arrow keys to locate the option **Audio Path**.
5. Use the **◀** left and right **▶** arrow keys or press the **Change** soft key to change the setting.
6. When completed, press the **Done** soft key.
7. Press the **Exit** soft key to exit the menus.

## 17.9 Backup/Restore

If backup/restore has been setup by your system administrator, it is used automatically when you login or log out from the phone.

Backup/restore is used for the phone settings that you have configured within the menu's provided by the phone's **A MENU** button. When you login at another 1600 Series phone extension, your phone settings are restored and applied to that phone. They will remain applied to the phone until another user logs in and their phone settings are applied.

By default your call log and your personal contacts are stored on the telephone system. These will be restored by the telephone system when you login on another 1600 Series phone regardless of whether backup/restore has been configured for 1600 Series phones.

When backup/restore has been configured, the phone menu provides options to manually access backup and restore functions.

- [Manually Backup Phone Settings](#) <sup>[155]</sup>
- [Manually Restore Phone Settings](#) <sup>[156]</sup>

The following settings are included in the backup/restore operation:

- Handset Automatic Gain Control setting
- Headset Automatic Gain Control setting
- Speaker Automatic Gain Control setting
- [Default Audio Path](#) <sup>[154]</sup>
- [Button Clicks](#) <sup>[153]</sup>
- [Error Tones](#) <sup>[153]</sup>
- [Personalized Ringing](#) <sup>[143]</sup>
- [Redial Mode](#) <sup>[140]</sup>
- [Display Call Timer](#) <sup>[148]</sup>
- [Visual Alerting](#) <sup>[146]</sup>
- [Display Language](#) <sup>[149]</sup>

### 17.9.1 Backup

If backup/restore has been setup by your system administrator, it is used automatically when you login or log out from the phone.

In addition, the option below is available to manually trigger a backup of your user settings.

1. Press the **A MENU** button.
2. Use the ▲ up and down ▼ arrow keys to locate the option **Advanced**.
3. Press the **Select** soft key.
4. Press the **Backup** soft key.

### Access Control

This option is only available if your system administrator has configured backup/restore operation.

---

## 17.9.2 Restore

If backup/restore has been setup by your system administrator, it is used automatically when you login or log out from the phone.

In addition, the option below is available to manually trigger a restore of your user settings.

1. Press the **A MENU** button.
2. Use the ▲ up and down ▼ arrow keys to locate the option **Advanced**.
3. Press the **Select** soft key.
4. Use the ▲ up and down ▼ arrow keys to locate the option **Manual Restore**.
5. Press the **Restore** soft key.

### Access Control

This option is only available if your system administrator has configured backup/restore operation.

## 17.10 Viewing Information

You can view a large amount of information about the phone's settings and current operation. When reporting a problem to your system administrator they may ask you to provide some of this information to help resolve the problem.

1. Press the **A MENU** button.
2. Use the ▲ up and down ▼ arrow keys to locate the option **Network Info....**
3. Press the **Select** soft key.
4. Use the ▲ up and down ▼ arrow keys to locate the aspect of phone operation on which you need information.
  - **Audio Parameters**
  - **IP Parameters**  
The IP settings with which the phone has been configured by the installer or by a DHCP server.
  - **Quality of Service**  
Quality of Service (QoS) measurements for the current call.
  - **Interfaces**  
The current speed of the phone's ethernet port and its PC pass-through Ethernet port.
  - **Miscellaneous**  
Details of the phone and the firmware that it current has loaded.
5. Press the **Select** soft key to access the currently displayed option.
6. Use the ▲ up and down ▼ arrow keys to scroll through the different items of information available.
7. To return to the parent menu, press the **Back** soft key.

The diagram below summarizes the information accessible through the menu.

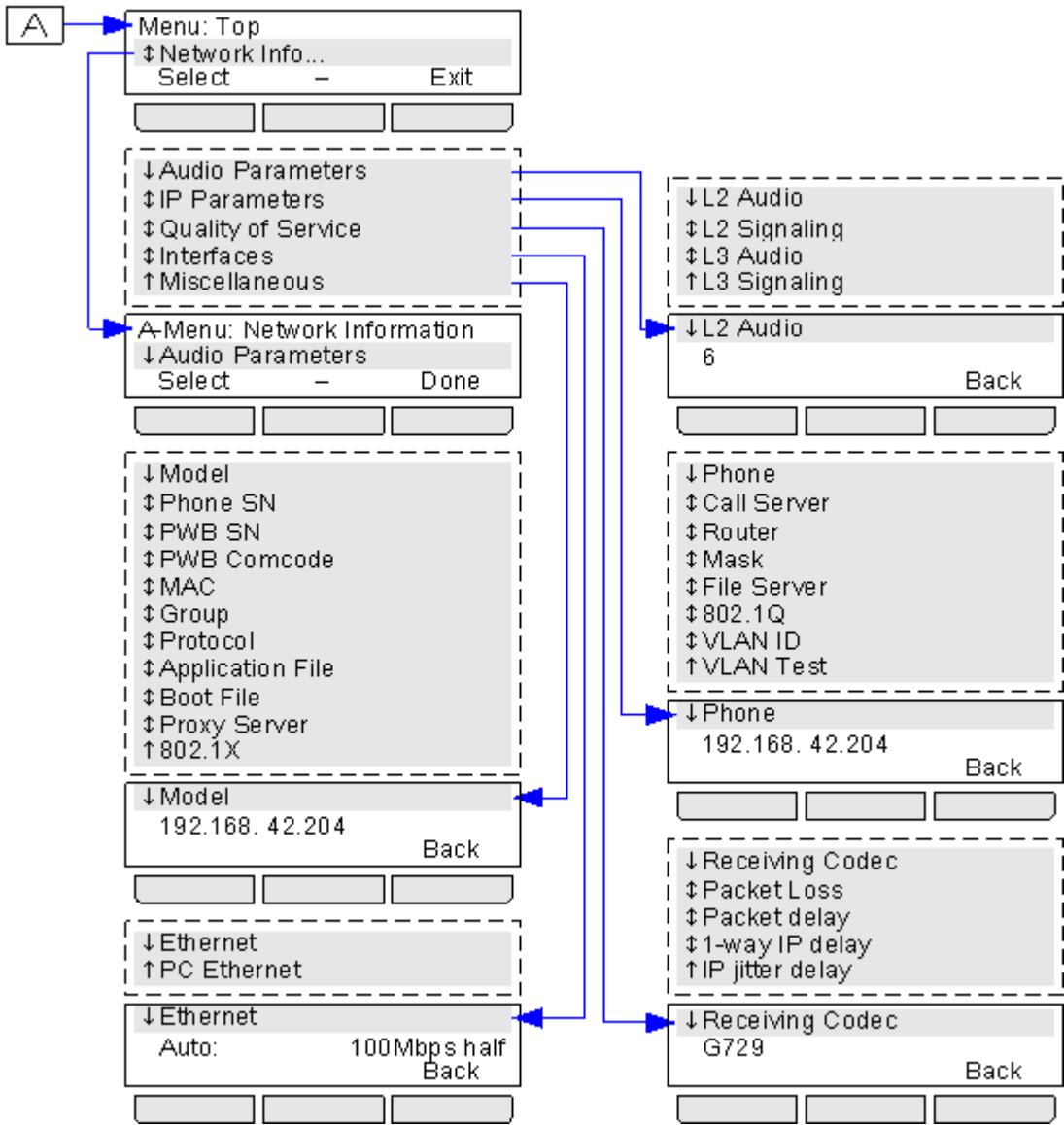

# Chapter 18.

## Status Menu

---

## 18. Status Menu

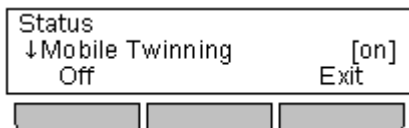

The **Status** menu is not always visible. It is shown when you have any special call routing features active. For example do not disturb switched on.

It is also shown if the system administrator has given you the rights to change the status of your hunt group memberships or to change the service status of the hunt groups.

A summary of the menu options is shown in the [Status Menu diagram](#)<sup>[163]</sup>.

- [Switching mobile twinning off](#)<sup>[164]</sup>
- [View and unpark parked calls](#)<sup>[164]</sup>
- [Clear or change a follow me to setting](#)<sup>[160]</sup>
- [Switch off do not disturb](#)<sup>[160]</sup>
- [Clear or change forward unconditional](#)<sup>[162]</sup>
- [Clear or change forward on no answer](#)<sup>[162]</sup>
- [Clear or change forward on busy](#)<sup>[161]</sup>
- [Clear or change follow me here settings](#)<sup>[161]</sup>
- [Change hunt group membership status](#)<sup>[163]</sup>
- [Change hunt group service status](#)<sup>[163]</sup>
- [View System Alarms](#)<sup>[164]</sup>

### 18.1 Do Not Disturb

You can use the **Status** menu to switch off do not disturb.

1. Press the **Status** soft key if shown. To access the status menu during a call, press the **PHONE** key and then press the **Status** soft key if shown.
2. If necessary use the ▲ up and down ▼ arrow keys to scroll the menu to **Do Not Disturb**.
  - To clear the do not disturb setting, press the **Off** soft key.

#### Access Control

Your system administrator can configure whether you can access this menu option. See [Menu Access Control](#)<sup>[193]</sup>.

### 18.2 Follow Me To

If you have set a follow me destination for calls to your phone, you can clear or change the setting through the **Status** menu.

1. Press the **Status** soft key if shown. To access the status menu during a call, press the **PHONE** key and then press the **Status** soft key if shown.
2. Use the ▲ up and down ▼ arrow keys to scroll the menu to **Follow Me To**.
  - To clear the follow me to setting, press the **Clear** soft key.
  - To change the destination of the setting, press the **Edit** soft key.

#### Access Control

Your system administrator can configure whether you can access this menu option. See [Menu Access Control](#)<sup>[193]</sup>.



## 18.3 Follow Me Here

If other users has a follow me set to you phone, you can clear or change the setting through the **Status** menu.

1. Press the **Status** soft key if shown. To access the status menu during a call, press the **PHONE** key and then press the **Status** soft key if shown.
2. Use the **▲** up and down **▼** arrow keys to scroll the menu to **Follow Me Here**. There will be a separate entry for each user.
  - To clear the follow me to setting, press the **Clear** soft key.
  - To change the destination of the setting, press the **Edit** soft key.
  - Use the menu to add or remove users.
    - Use the **▲** up and down **▼** arrow keys to scroll through the names.
    - To remove a user, press the **Clear** soft key.
    - To add a user, press the **Add** soft key.
      - Dial the number of another user. When it matches a user their name is displayed. Alternatively, use the **Dir** soft key to [select a user from the directory](#)<sup>[193]</sup>.
      - Press the **Save** soft key to set the follow me here.

### Access Control

Your system administrator can configure whether you can access this menu option. See [Menu Access Control](#)<sup>[193]</sup>.

## 18.4 Forward On Busy

If your phone is set to forward on busy, you can clear or change the forward settings through the **Status** menu.

1. Press the **Status** soft key if shown. To access the status menu during a call, press the **PHONE** key and then press the **Status** soft key if shown.
2. Use the **▲** up and down **▼** arrow keys to scroll the menu to **Fwd OnBsy**.
  - To switch off forward on busy, press the **Off** soft key.
  - To change the destination of the setting, press the **Edit** soft key.
    - Use the **▲** up and down **▼** arrow keys to scroll through the following menu options:
      - Use the **◀** left and right **▶** arrow keys to switch forward on busy as on or off.
      - Use the **◀** left and right **▶** arrow keys to switch forward on no answer on or off.
      - Use the **◀** left and right **▶** arrow keys to select which calls should be forwarded. The options are **All Calls** or **External Calls Only**.
      - The forward destination is shown. Press the **Change** soft key to enter a new destination or clear the destination.
        - If the current destination is shown in ( ) brackets, that indicates that the forward unconditional destination is being used as no specific forward on busy/no answer destination has been set. Selecting Change will set a forward on busy/no answer destination, it will not change the forward unconditional destination.

### Access Control

Your system administrator can configure whether you can access this menu option. See [Menu Access Control](#)<sup>[193]</sup>.

---

## 18.5 Forward On No Answer

If your phone is set to [forward on no answer](#)<sup>191</sup>, you can clear or change the forward settings through the **Status** menu.

1. Press the **Status** soft key if shown. To access the status menu during a call, press the **PHONE** key and then press the **Status** soft key if shown.
2. Use the ▲ up and down ▼ arrow keys to scroll the menu to **Fwd NoAns**.
  - To switch off forward on no answer, press the **Off** soft key.
  - To change the destination of the setting, press the **Edit** soft key.
    - Use the ▲ up and down ▼ arrow keys to scroll through the following menu options:
      - Use the ◀ left and right ▶ arrow keys to switch forward on busy as on or off.
      - Use the ◀ left and right ▶ arrow keys to switch forward on no answer on or off.
      - Use the ◀ left and right ▶ arrow keys to select which calls should be forwarded. The options are **All Calls** or **External Calls Only**.
      - The forward destination is shown. Press the **Change** soft key to enter a new destination or clear the destination.
        - If the current destination is shown in ( ) brackets, that indicates that the forward unconditional destination is being used as no specific forward on busy/no answer destination has been set. Selecting Change will set a forward on busy/no answer destination, it will not change the forward unconditional destination.

### Access Control

Your system administrator can configure whether you can access this menu option. See [Menu Access Control](#)<sup>193</sup>.

## 18.6 Forward Unconditional

You can clear or change your forward unconditional settings through the **Status** menu.

1. Press the **Status** soft key if shown. To access the status menu during a call, press the **PHONE** key and then press the **Status** soft key if shown.
2. Use the ▲ up and down ▼ arrow keys to scroll the menu to **Fwd Uncon**.
  - To switch off forward unconditional, press the **Off** soft key.
  - To change the forwarding settings, press the **Edit** soft key.
    - Use the ▲ up and down ▼ arrow keys to scroll through the editing options.
      - Use the ◀ left and right ▶ arrow keys to switch the forwarding on or off.
      - Use the ◀ left and right ▶ arrow keys to select which calls should be forwarded. The options are **External Only**, **External and Group**, **Non Group Calls** and **All Calls**.
      - Select edit to change the number to which calls are forwarded.

### Access Control

Your system administrator can configure whether you can access this menu option. See [Menu Access Control](#)<sup>193</sup>.

## 18.7 Forwarded Here

This option allows you to see the names of users who are currently forwarding calls to you. It includes forward unconditional, forward on no answer and forward on busy. A separate entry is shown for each user.

1. Press the **Status** soft key if shown. To access the status menu during a call, press the **PHONE** key and then press the **Status** soft key if shown.
2. Use the **▲** up and down **▼** arrow keys to scroll the menu to **Fwd To Here**.

### Access Control

Your system administrator can configure whether you can access this menu option. See [Menu Access Control](#)<sup>193</sup>.

## 18.8 Group Membership

If the system administrator has allowed you, you can enable/disable your membership of a group through the **Status** menu. When your membership of a group is disabled you do not receive group calls for that group.

1. Press the **Status** soft key if shown. To access the status menu during a call, press the **PHONE** key and then press the **Status** soft key if shown.
2. Use the **▲** up and down **▼** arrow keys to scroll the menu to the hunt group name and your current membership status.
3. Press the **Enable** or **Disable** soft key to change the status of your membership of that group.

## 18.9 Group Service Status

If the system administrator has allowed you, you can change the service state of a group through the **Status** menu.

1. Press the **Status** soft key if shown. To access the status menu during a call, press the **PHONE** key and then press the **Status** soft key if shown.
2. Use the **▲** up and down **▼** arrow keys to scroll the menu to the hunt group name and your current membership status.
3. Select the required state using the soft keys:
  - **InServ** = *In Service*  
The groups operates a normal, distributing calls to available members of the group.
  - **Night** = *Night Service*  
The group is in night service mode. Calls are redirected to its night service fallback group [if set](#)<sup>128</sup>, otherwise to voicemail if available. A hunt group can also be put into and out of night service automatically by the telephone system using a time profile.
  - **OOS** = *Out of Service*  
The group is out of service. Calls are redirected to it out of service fallback group [if set](#)<sup>128</sup>, otherwise to voicemail if available. The phone displays an **O** when one of the groups of which your are a member is out of service. See [Status Letters](#)<sup>167</sup>.
  - **TP** = *Time Profile*  
This setting indicates that the group's status is being controlled by a time profile on the telephone system. That time profile sets when the group is in service and in night service. You can override this to put the group into the **OOS** state. You can then use the phone to returns the group to time profile control when required.

### Access Control

The system administrator is able to configure if you can access the **Membership**, **State** and **Fallback** options of a group. If you are not configured for any groups then the **Group** menu is not shown.

---

## 18.10 Mobile Twinning

If you have been configured as a mobile twinning user, you can use the status menu to switch mobile twinning mode off.

1. Press the **Status** soft key if shown. To access the status menu during a call, press the **PHONE** key and then press the **Status** soft key if shown.
2. If necessary use the **▲** up and down **▼** arrow keys to scroll the menu to **Mobile Twinning**.
3. To turn twinning off, press the **Off** soft key. Alternatively, to access the mobile twinning settings, press the **Details** soft key. See [Mobile Twinning Control](#)<sup>[60]</sup>.

## 18.11 Parked Calls

While parked calls are parked on the telephone system and can be unparked by any other user, the parked call indication is sent to a particular extension. If there are any calls parked against your phone, you can view and unpark them using the **Status** menu.

1. Press the **Status** soft key if shown. To access the status menu during a call, press the **PHONE** key and then press the **Status** soft key if shown.
2. If you have any parked calls, the **Parks** option is displayed. The option is not present if you do not have calls parked against your extension.
3. Press the **Details** soft key.
4. Use the **▲** up and down **▼** arrow keys to scroll through the parked calls.
5. To unpark a particular call, press the **CPkUp** soft key.

### Access Control

Your system administrator can configure whether you can access this menu option. See [Menu Access Control](#)<sup>[193]</sup>.

## 18.12 System Alarms

An **S** appearing in the [phone status letters](#)<sup>[16]</sup> on the display indicates that a system alarm has occurred. This happens if you are configured as a system administrator (also called a system phone user).

A corresponding alarm message appears in the phone's **Status** menu. This allows you to report the problem to your system maintainer.

You can clear some alarms from the phone. When that is the case, the alarm message includes a **Clear** option. The System Status application can clear all alarms. Note however that the alarm will reoccur if the system maintainer has not resolved the original cause.

Some of the possible alarm messages are:

- **Alarm Log Entry**  
This indicates that a system alarm has been recorded in the telephone system's alarm log. These can only be cleared using the System Status application.
- **Corrupt Date/Time**  
There is an error in the date or time being used by the system. Selecting **Admin** takes you to the system administration menu where see the system's [date](#)<sup>[173]</sup> and [time](#)<sup>[174]</sup> settings.
- **Expansion Failure**  
There is a problem with one of the external expansion modules attached to the telephone system.
- **Memory Card Failure**  
There is a problem with one of the memory cards used by the telephone system. Selecting **Admin** takes you to the system administration menu where you can check the [status of the memory cards](#)<sup>[176]</sup>.
- **Licence Key Failure**  
There is a problem with the memory card used to license features and applications.
- **System Boot Error**  
The telephone system encountered an error while restarting.
- **Voicemail Failure**  
The voicemail system is not available.
- **Voicemail Almost Full**  
The voicemail system is nearly out of storage space for any more messages, prompts and recordings.
- **Voicemail Full**  
The voicemail system cannot store any more messages, prompts and recordings.





# Chapter 19.

## Short Codes

---

## 19. Short Codes

Short codes are numbers that you can dial to enable and disable various features. The following are default short codes that may be available. However, your system administrator can remove and change the short codes available to you or all users.

These are useful as they can be dialed from any phone on the system. For example, this allows you to login at a basic analog extension and still control a number of features.

Some short codes require you to enter some information when you dial them, typically an extension number. That is indicated by **N** in the short codes shown below.

### Park/Unpark

- **Park Call: \*37\*N#**  
Parks the held call using the park number dialed in place of **N**.
- **Unpark Call: \*38\*N#**  
Unpark the call parked using the park number **N**.

### Call Pickup

- **Pickup Any Call: \*30**  
Answer a call ringing on the telephone system.
- **Pickup a Group Call: \*31**  
Answer a call ringing a group of which you are a member.
- **Pickup a Users Call: \*32\*N#**  
Pickup a call ringing a user's extension number (**N**).
- **Pickup a Group Members Call: \*53\*N#**  
Pickup a call ringing the members of a group (**N**). This does not necessarily have to be a group call.

### Conference

- **Conference Held Calls: \*47**  
Start a conference between yourself and any calls that you have on hold.

### Do Not Disturb

- **Switch Do Not Disturb On: \*08**  
Set your phone to do not disturb.
- **Switch Do Not Disturb Off: \*09**  
Switch off do not disturb.
- **Add a Do Not Disturb Exception Number: \*10\*N#**  
Add a number (**N**) to your list of do not disturb exceptions.
- **Delete a Do Not Disturb Exception Number: \*11\*N#**  
Remove a number (**N**) from your list of do not disturb exceptions.
- **Cancel All Forwarding: \*00**  
Switch off any forwarding. Includes forward unconditional, forward on busy, forward on no answer, follow me and do not disturb.

### Follow Me

- **Follow Me Here: \*12\*N#**  
Dialed at the extension to which you want you calls redirected. Use your own extension number (**N**) when dialing the short code.
- **Follow Me Here Cancel: \*13\*N#**  
Dialed at the extension to which you want your calls were redirected. Use your own extension number (**N**) when dialing the short code.
- **Follow Me To: \*14\*N#**  
Dialed at your phone. Dial the extension number (**N**) to which you want your calls redirected. You can dial just **\*14#** to cancel follow me.
- **Cancel All Forwarding: \*00**  
Switch off any forwarding. Includes forward unconditional, forward on busy, forward on no answer, follow me and do not disturb.



## Forwarding

- **Cancel All Forwarding: \*00**  
Switch off any forwarding. Includes forward unconditional, forward on busy, forward on no answer, follow me and do not disturb.
- **Set the Forward Unconditional Destination: \*07\*N#**  
Set the destination number (**N**) for forward unconditional when it is switched on.
  - **Switch Forward Unconditional On: \*01**  
Switch on forward unconditional. A destination must have been set.
  - **Switch Forward Unconditional Off: \*02**
  - **Include Hunt Group Calls in Forward Unconditional: \*50**
  - **Exclude Hunt Group Calls from Forward Unconditional: \*51**
- **Set the Forward On Busy/No Answer Destination: \*57\*N#**  
Set the destination number (**N**) for forward on busy and forward on no answer. If no number has been set, those functions will use the forward unconditional number if set.
  - **Switch Forward On Busy On: \*03**
  - **Switch Forward On Busy Off: \*04**
  - **Switch Forward on No Answer On: \*05**
  - **Switch Forward on No Answer Off: \*06**

## Hunt Group

- **Night Service Status On: \*20\*N#**  
Set a hunt group into night service status by entering its extension number (**N**).
- **Night Service Status Off: \*21\*N#**  
Take a hunt group out of night service status by entering its extension number (**N**).

## Login

- **Login: \*35\*N\*P#**  
Login to a phone using your extension number (**N**) and login code (**P**).
- **Log Out: \*36**  
Log yourself out from the phone where you are currently logged in.

## Voicemail

- **Check Messages: \*17**  
Access mailboxes to check for messages.
- **Voicemail On: \*18**  
Allow voicemail to be used to answer calls.
- **Voicemail Off: \*19**  
Stop voicemail being used to answer calls.
- **Voicemail Ringback On: \*48**  
Have voicemail ring your phone when you have any new messages. It will call when you use the phone.
- **Voicemail Ringback Off: \*49**  
Switch off ringback.



# Chapter 20.

# System Administration

---

## 20. System Administration

If necessary, the system administrator can configure you as a 'system phone' user. This allows you to perform a range of functions that help maintain your phone system. From the System Administration menu, you can do the following:

- [Checking the system and software version](#) <sup>[172]</sup>
- [Checking the time settings](#) <sup>[173]</sup>
- [Setting the date](#) <sup>[173]</sup>
- [Setting the time](#) <sup>[174]</sup>
- [Setting the time offset](#) <sup>[174]</sup>
- [System shutdown](#) <sup>[175]</sup>
- [Memory card/file system management](#) <sup>[176]</sup>
- [System alarms](#) <sup>[177]</sup>

### 20.1 Checking the System and Software Version

Being able to check and report the system name, software version and IP address may be useful when reporting any potential problems to the system maintainer.

#### System Phone User

This method can be used if you have been configured as a system phone user by your system administrator.

1. Press the **Features** soft key if shown.
  - To access the menu during a call, press the **▶** right arrow key or press the **PHONE** key and then press the **Features** soft key.
2. Use the **▲** up and down **▼** arrow keys to scroll the display to the option **Phone User**.
3. Press the **Select** soft key or the **OK** button or the **▶** right arrow key.
4. Use the **▲** up and down **▼** arrow keys to scroll the display to the option **System Admin**.
  - **!Note:** This option is only present if you have been configured as a system phone user by your system administrator.
5. Press the **Select** soft key.
6. Enter your security code (this is the same as your login code) and press the **Done** soft key.
7. Use the up and down arrow keys to scroll the display to the option System Information.
8. Press the **Select** soft key or the **OK** button or the **▶** right arrow key.
9. You can now scroll through information about the system including its IP address and license key serial number.

#### Log Out Method

This method of displaying system information is supported for users who have a login code.

1. [Log out](#) <sup>[118]</sup> from the phone.
2. Check that the phone displays **NOT LOGGED IN**. If the system automatically logs in another user, they need to log out.
3. Press any unused (unlabelled) programmable buttons. The phone displays **System Information**.
4. Press **Select**. The screen displays basic information about the IP Office system.
5. Press **Back** and then **Exit** to return to the normal display for a phone with no logged in user.

## 20.2 Checking the Time Settings

When the phone system is configured to get the time automatically from a time server, you can view the settings through the phone. The details include the address of the time server, the UTC time value obtained and the current local time. If daylight saving time (DST) is being used, the DST setting being applied is also shown.

- **Time Display Format**

The time format (12 or 24-hour) is controlled by the telephone system. It can be set to either 12-hour or 24-hour format for all phones by the system administrator.

1. Press the **Features** soft key if shown.
  - To access the menu during a call, press the ► right arrow key or press the ☎ **PHONE** key and then press the **Features** soft key.
2. Use the ▲ up and down ▼ arrow keys to scroll the display to the option **Phone User**.
3. Press the **Select** soft key or the **OK** button or the ► right arrow key.
4. Use the ▲ up and down ▼ arrow keys to scroll the display to the option **System Admin**.
  - **!Note:** This option is only present if you have been configured as a system phone user by your system administrator.
5. Press the **Select** soft key.
6. Enter your security code (this is the same as your login code) and press the **Done** soft key.
7. Use the up and down arrow keys to scroll the display to the option **Time Server Status**.
8. Press the **Select** soft key or the **OK** button or the ► right arrow key. The current date being used by the telephone system is displayed.
9. Use the ▲ up and down ▼ arrow keys to scroll through the details.

## 20.3 Setting the Date

The process below can be used when the telephone system does not obtain the time and date automatically. On systems that are configured to obtain the time automatically, the current [time server settings](#)<sup>173</sup> can be displayed.

1. Press the **Features** soft key if shown.
  - To access the menu during a call, press the ► right arrow key or press the ☎ **PHONE** key and then press the **Features** soft key.
2. Use the ▲ up and down ▼ arrow keys to scroll the display to the option **Phone User**.
3. Press the **Select** soft key or the **OK** button or the ► right arrow key.
4. Use the ▲ up and down ▼ arrow keys to scroll the display to the option **System Admin**.
  - **!Note:** This option is only present if you have been configured as a system phone user by your system administrator.
5. Press the **Select** soft key.
6. Enter your security code (this is the same as your login code) and press the **Done** soft key.
7. Use the up and down arrow keys to scroll the display to the option **Date**.
8. Press the **Select** soft key or the **OK** button or the ► right arrow key. The current date being used by the telephone system is displayed.
9. Enter the required date, using the either the \* or # keys to enter the / separators. To delete the previous digit or character entered press the ◀ left arrow key.
10. When a complete valid date has been entered, the display will confirm that by showing the full date and the **Done** soft key option.
11. To set the date as the new date to be used by the telephone system press the **Done** soft key.

---

## 20.4 Setting the Time

The process below can be used when the telephone system does not obtain the time and date automatically. On systems that are configured to obtain the time automatically, the current [time server settings](#)<sup>[173]</sup> can be displayed.

- **Time Display Format**

The time format (12 or 24-hour) is controlled by the telephone system. It can be set to either 12-hour or 24-hour format for all phones by the system administrator.

1. Press the **Features** soft key if shown.
  - To access the menu during a call, press the **▶** right arrow key or press the **☎ PHONE** key and then press the **Features** soft key.
2. Use the **▲** up and down **▼** arrow keys to scroll the display to the option **Phone User**.
3. Press the **Select** soft key or the **OK** button or the **▶** right arrow key.
4. Use the **▲** up and down **▼** arrow keys to scroll the display to the option **System Admin**.
  - **!Note:** This option is only present if you have been configured as a system phone user by your system administrator.
5. Press the **Select** soft key.
6. Enter your security code (this is the same as your login code) and press the **Done** soft key.
7. Use the up and down arrow keys to scroll the display to the option **Time**.
8. Press the **Select** soft key or the **OK** button or the **▶** right arrow key. The current time being used by the telephone system is displayed.
9. Enter the required time in 24-hour clock format:
  - Use either the **\*** or **#** keys to enter the **:** separator.
  - To delete the previous digit or character entered press the **◀** left arrow key.
10. When a complete valid time has been entered, the display will confirm that by showing the **Done** soft key option.
11. To set the time as the new time to be used by the telephone system press the **Done** soft key.

## 20.5 Setting the Time Offset

1. Press the **Features** soft key if shown.
  - To access the menu during a call, press the **▶** right arrow key or press the **☎ PHONE** key and then press the **Features** soft key.
2. Use the **▲** up and down **▼** arrow keys to scroll the display to the option **Phone User**.
3. Press the **Select** soft key or the **OK** button or the **▶** right arrow key.
4. Use the **▲** up and down **▼** arrow keys to scroll the display to the option **System Admin**.
  - **!Note:** This option is only present if you have been configured as a system phone user by your system administrator.
5. Press the **Select** soft key.
6. Enter your security code (this is the same as your login code) and press the **Done** soft key.
7. Use the up and down arrow keys to scroll the display to the option **Time Offset** or **UTC Offset**.
8. Press the **Select** soft key or the **OK** button or the **▶** right arrow key. The current offset is displayed.
9. Enter the offset required in hours and minutes:
  - To enter the **:** separator press either the **\*** or **#** key.
  - To delete the previous digit or character entered press the **◀** left arrow key.
  - To change the offset from between positive or negative press the **+/-** soft key.
10. When a valid offset has been entered, the **Done** soft key is displayed.
11. To apply the offset to the current telephone system time press the **Done** soft key.

## 20.6 System Shutdown

You can shutdown the telephone system for a specified number of minutes. Note that this is not a polite shut-down, once you have confirmed the action, any existing calls and services using the telephone system will start being disconnected. The telephone system will then remain unavailable for the duration you specify, the default being 10 minutes. After the shutdown duration it will take up to 5 more minutes for the telephone system to complete its restart.

1. Press the **Features** soft key if shown.
  - To access the menu during a call, press the ► right arrow key or press the ☎ **PHONE** key and then press the **Features** soft key.
2. Use the ▲ up and down ▼ arrow keys to scroll the display to the option **Phone User**.
3. Press the **Select** soft key or the **OK** button or the ► right arrow key.
4. Use the ▲ up and down ▼ arrow keys to scroll the display to the option **System Admin**.
  - **!Note:** This option is only present if you have been configured as a system phone user by your system administrator.
5. Press the **Select** soft key.
6. Enter your security code (this is the same as your login code) and press the **Done** soft key.
7. Use the up and down arrow keys to scroll the display to the option **System Shutdown**.
8. Press the **Select** soft key or the **OK** button or the ► right arrow key.
9. The current default timeout (10 minutes) setting is shown and can be used by pressing **Done** soft key. Otherwise enter the timeout required in hours and minutes and then press the **Done** soft key.
  - The allowable range for the timeout is from **00:05** to **24:00**. Note that the **Done** soft key is not displayed if the timeout entered is not within the allowed range.
  - To enter the : symbol in the timeout press either the \* or # key.
  - To delete the previous digit or character entered press the ◀ left arrow key.
10. After pressing the **Done** soft key, you will be asked to confirm whether you want to shutdown the telephone system. Only proceed if you are sure. If you are not sure press the **Back** soft key.
11. If you press the **Confirm** soft key, the telephone system will switch itself to a shutdown state. This will disconnect all current calls and services.

---

## 20.7 Memory Card Management

The telephone system can be fitted with an additional memory card or cards which are used for various functions. The memory card menu allows you to check the status of the memory card or cards fitted to your telephone system and to perform a number of actions on the cards.

1. Press the **Features** soft key if shown.
  - To access the menu during a call, press the ► right arrow key or press the ☎ **PHONE** key and then press the **Features** soft key.
2. Use the ▲ up and down ▼ arrow keys to scroll the display to the option **Phone User**.
3. Press the **Select** soft key or the **OK** button or the ► right arrow key.
4. Use the ▲ up and down ▼ arrow keys to scroll the display to the option **System Admin**.
  - **!Note:** This option is only present if you have been configured as a system phone user by your system administrator.
5. Press the **Select** soft key.
6. Enter your security code (this is the same as your login code) and press the **Done** soft key.
7. Use the ▲ up and down ▼ arrow keys to scroll the display to the option **Memory Card (IP500/IP500 V2)** or **File System (Server Edition)**. The option shown varies depending on the type of telephone system.
8. Press the **Select** soft key or the **OK** button or the ► right arrow key.
9. The menu lists the current state of the system's memory cards and the actions that you can perform on the card.
  - The status of each memory card listed will be one of **No Card**, **Active** or **Inactive**. Entries are only listed for the types of cards that are supported by the telephone system to which you are connected:
    - **CF** - This refers to the optional compact flash card that can be fitted to IP500 systems.
    - **System** - This refers to the first SD memory card that must be fitted to IP500 V2 systems.
    - **Option** - This refers to the second optional SD memory card that can be fitted to IP500 V2 systems.
  - The actions that can be performed on the memory cards are listed below the status of the card or cards. The actions available depend type of card and its current status. After selecting an action, you can then select the card on which you want the action performed and then press the **Confirm** soft key to start the action.
    - **Shut Down (IP500/IP500 V2)**  
This option is available when an **Active** card is present. It allows the card to be made inactive.
    - **Start Up (IP500/IP500 V2/Server Edition)**  
This option is available when an **Inactive** card is present. It allows the card to be made active again.
    - **System Backup (IP500 V2/Server Edition)**  
This option is available when a **System** card is present and active. It allows the telephone system's current configuration settings to be copied to a backup file on the memory card.
    - **System Restore (IP500 V2/Server Edition)**  
This option is available when a **System** card is present and active. It overwrites the telephone system's current configuration settings with those from a backup file on the card.
    - **Upgrade Config (IP500 V2)**  
Copy configuration files from an **Optional** card to the **System** card in the system control unit.
    - **Upgrade Binaries (IP500 V2)**  
Copy software files from an **Optional** card to the **System** card in the system control unit.
    - **Copy (IP500 V2)**  
This option is available on systems where both a **System** and **Option** memory card are active. It copies the contents of the **System** card to the **Option** card.



## 20.8 System Alarms

An **S** appearing in the [phone status letters](#)<sup>[16]</sup> on the display indicates that a system alarm has occurred. This happens if you are configured as a system administrator (also called a system phone user).

A corresponding alarm message appears in the phone's **Status** menu. This allows you to report the problem to your system maintainer.

You can clear some alarms from the phone. When that is the case, the alarm message includes a **Clear** option. The System Status application can clear all alarms. Note however that the alarm will reoccur if the system maintainer has not resolved the original cause.

Some of the possible alarm messages are:

- **Alarm Log Entry**  
This indicates that a system alarm has been recorded in the telephone system's alarm log. These can only be cleared using the System Status application.
- **Corrupt Date/Time**  
There is an error in the date or time being used by the system. Selecting **Admin** takes you to the system administration menu where see the system's [date](#)<sup>[173]</sup> and [time](#)<sup>[174]</sup> settings.
- **Expansion Failure**  
There is a problem with one of the external expansion modules attached to the telephone system.
- **Memory Card Failure**  
There is a problem with one of the memory cards used by the telephone system. Selecting **Admin** takes you to the system administration menu where you can check the [status of the memory cards](#)<sup>[176]</sup>.
- **Licence Key Failure**  
There is a problem with the memory card used to license features and applications.
- **System Boot Error**  
The telephone system encountered an error while restarting.
- **Voicemail Failure**  
The voicemail system is not available.
- **Voicemail Almost Full**  
The voicemail system is nearly out of storage space for any more messages, prompts and recordings.
- **Voicemail Full**  
The voicemail system cannot store any more messages, prompts and recordings.



# Chapter 21.

## The Phone Menus

---

## 21. The Phone Menus

This section gives summaries of the phone menus.

- [Features Menu](#)<sup>[181]</sup>  
This menu allows you to change a number of your user settings.
  - [Self-Administer Menu](#)<sup>[183]</sup>  
This is a sub-menu of the Features menu. It allows you to assign functions to the feature buttons.
- [Visual Voice Menu](#)<sup>[184]</sup>  
This menu is used to access voicemail messages and other voicemail settings.
- [Status Menu](#)<sup>[185]</sup>  
This menu is used to change the settings of various features when they are enabled.
- [A-Menu](#)<sup>[186]</sup>  
This menu is used to configure various phone settings and to view details of the phone software.
- [Call Log Menu](#)<sup>[187]</sup>  
This menu is used to display a log of missed, outgoing and answered calls.
- [Contacts Menu](#)<sup>[188]</sup>  
This menu is used to display and select personal and system directory entries.
- [Redial Menu](#)<sup>[189]</sup>  
This menu is displayed when the **Redial** key is set to use [List](#)<sup>[43]</sup> mode.
- [Phone Locked Menu](#)<sup>[190]</sup>  
This menu is displayed when you have locked the phone.
- [System Admin Menu](#)<sup>[191]</sup>  
This menu is only available to a user who has been configured as a 'system phone' user by the system maintainer.

## 21.1 Features Menu

This menu is accessed by pressing the **Features** soft key. It can be used to access a range of user settings.

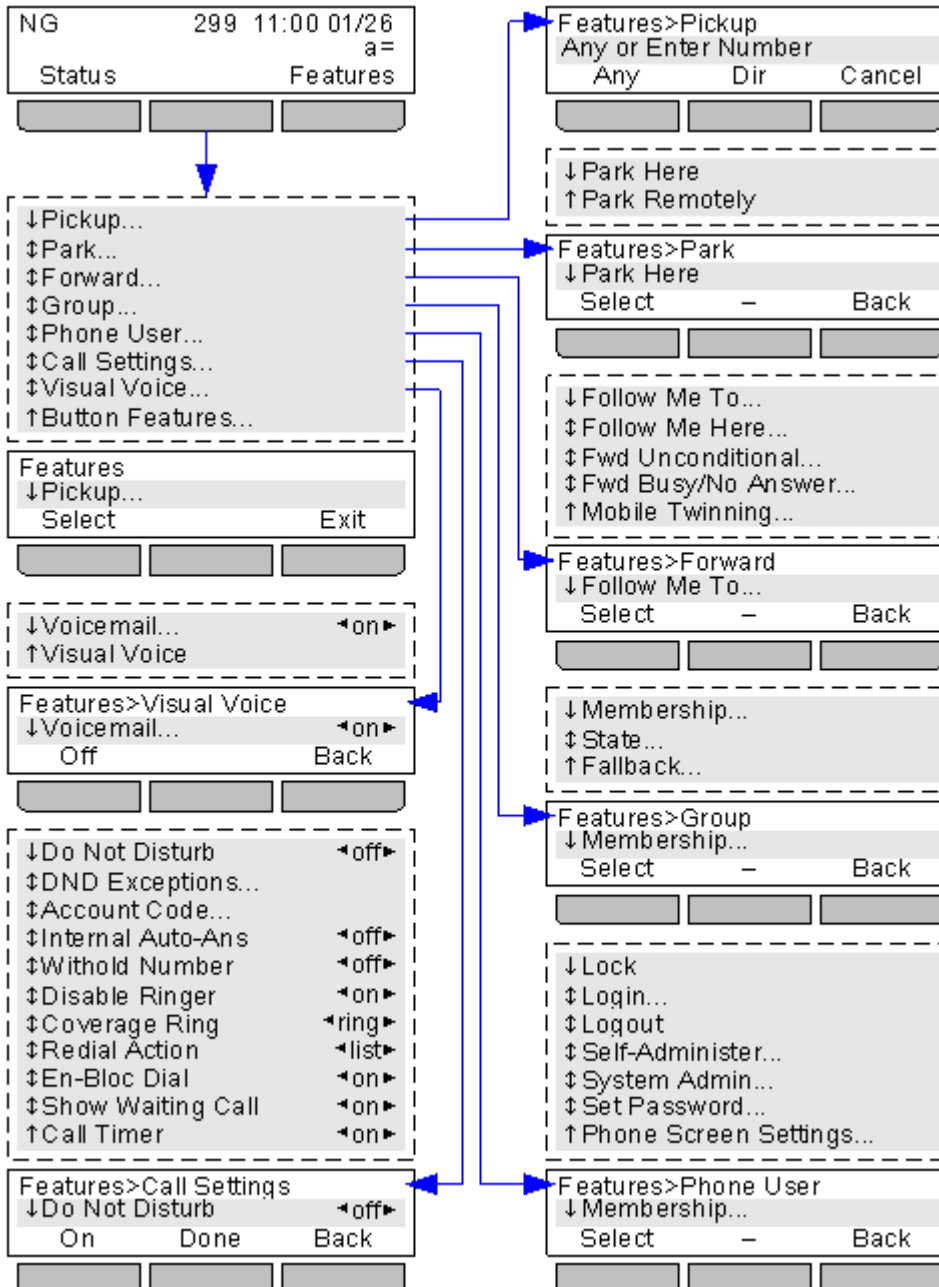

To exit the whole user menu and return to the appearance menu, press the **PHONE/EXIT** button or, if displayed, press the **Exit** soft key.

Within the menu, the ▲ up and down ▼ arrows keys are used to scroll through menu options. The availability of additional options is indicated by the ↓ ↑ arrow icons.

When the menu option displayed has sub menus, that is indicated by the ... 3 dots (ellipsis) icon after the menu option name. Except where they are being used to change the value of a setting (see below), the ◀ left and right ▶ arrow keys can be used to exit and enter sub-menus.

Entering a sub-menu can also be done by pressing the **Select** soft key or the **OK** button.

Exiting a sub-menu can also be done by pressing the **Back** soft key.

Menu options where the current settings is enclosed by ◀ left and right ▶ arrow icons can be changed using the ◀ left and right ▶ arrow keys in addition to the soft key options.

### Access Control

The system administrator controls whether you can access some of the menus. Others are only available if certain prerequisites are met:

- 
- While the phone is [locked](#)<sup>[118]</sup>, the **Features** menu cannot be accessed to change user settings.
  - The system administrator is able to configure if you can access the **Membership, State** and **Fallback** options of a group. If you are not configured for any groups then the **Group** menu is not shown.
  - The system administrator is able to configure whether you can access the **Forward** and **Follow Me** menu and status options.
  - The **Park** menu and status options are only accessible while you are talking to a caller or already have parked calls.
  - The **Account Code** menu is only accessible if the system has been configured with accounts codes.
  - The **Mobile Twinning** options are only shown if you have been configured to use mobile twinning.
  - The **System Admin** option is only shown if you have been configured as a 'System Phone' user.

## 21.2 Self-Administer Menu

This menu is accessed by pressing the **Features** soft key and selecting **Phone User** and then **Self-Administer**.

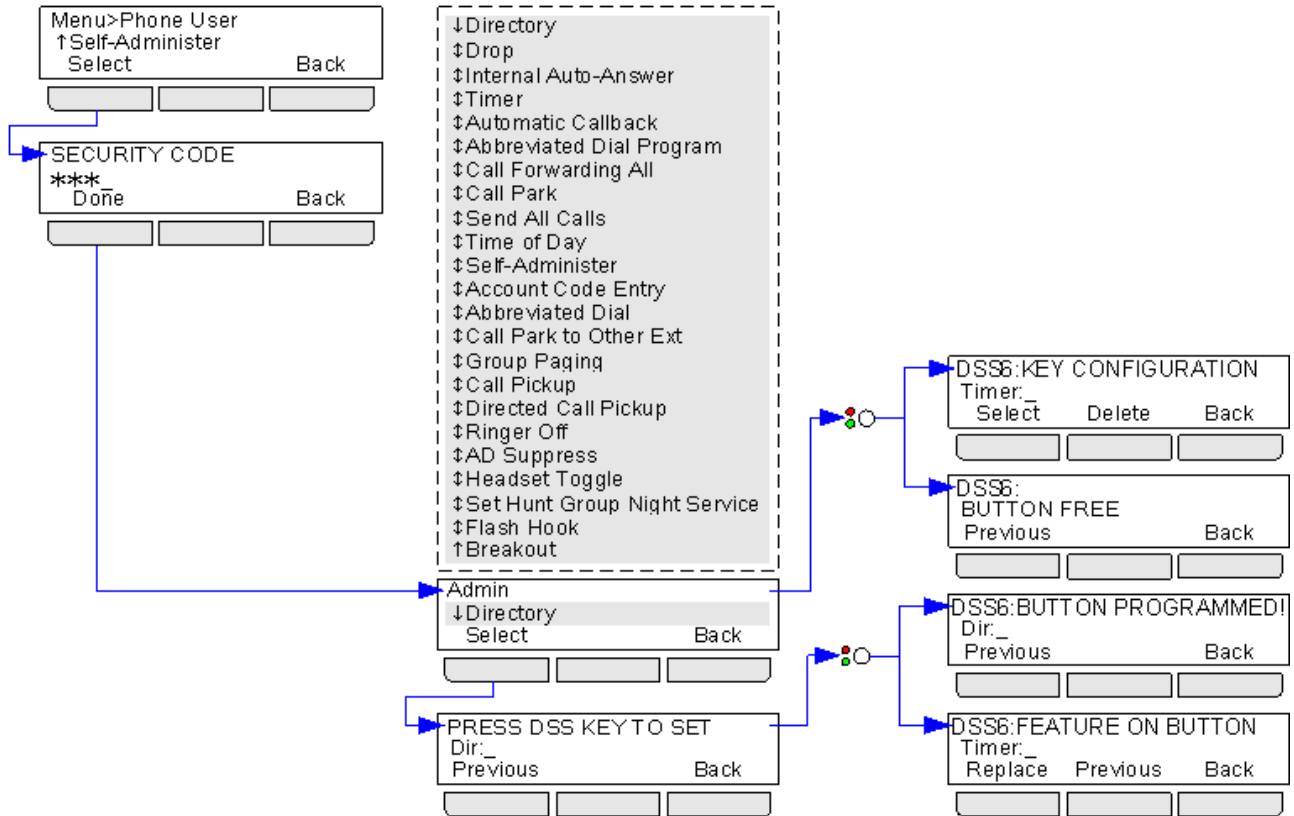

## 21.3 Visual Voice Menu

This menu is accessed by pressing the **☒** key. The system administrator may have configured it so that you are required to enter your voicemail code after pressing the button.

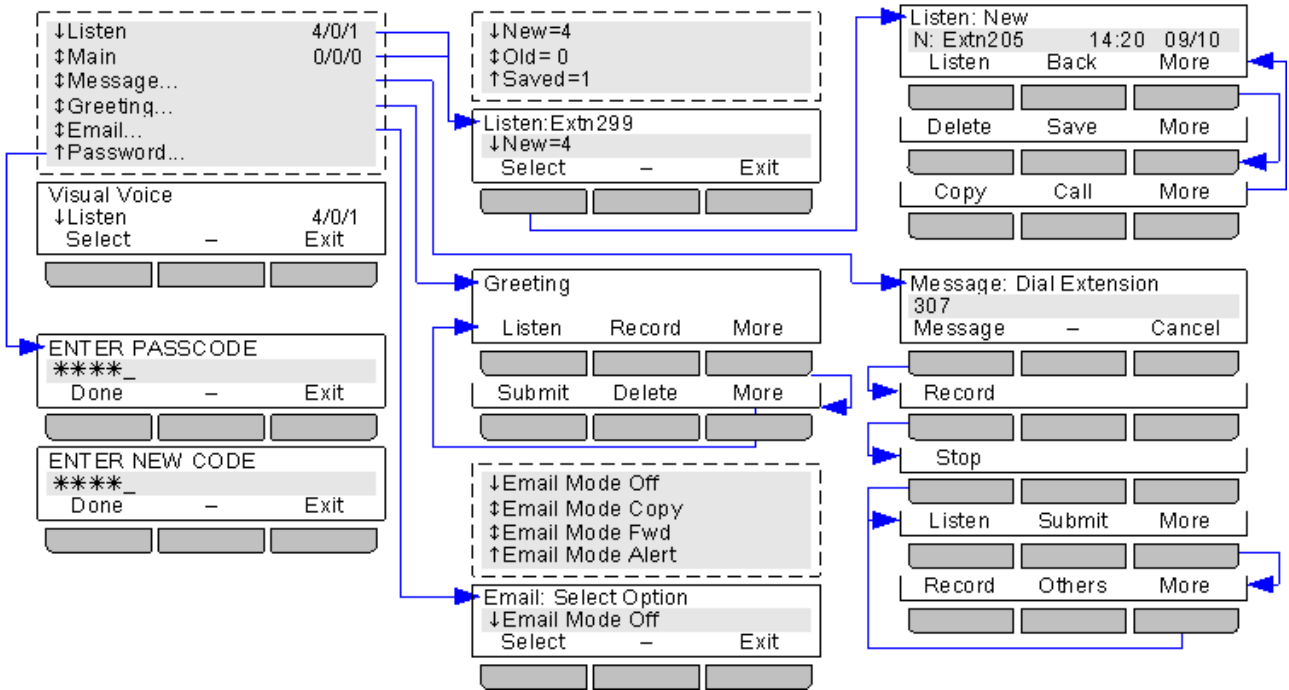

The **Email** option is only available if configured by the system administrator. Hunt group and other user mailbox access is only available if configured by the system administrator.



## 21.4 Status Menu

This menu is accessed by pressing the **Status** soft key.

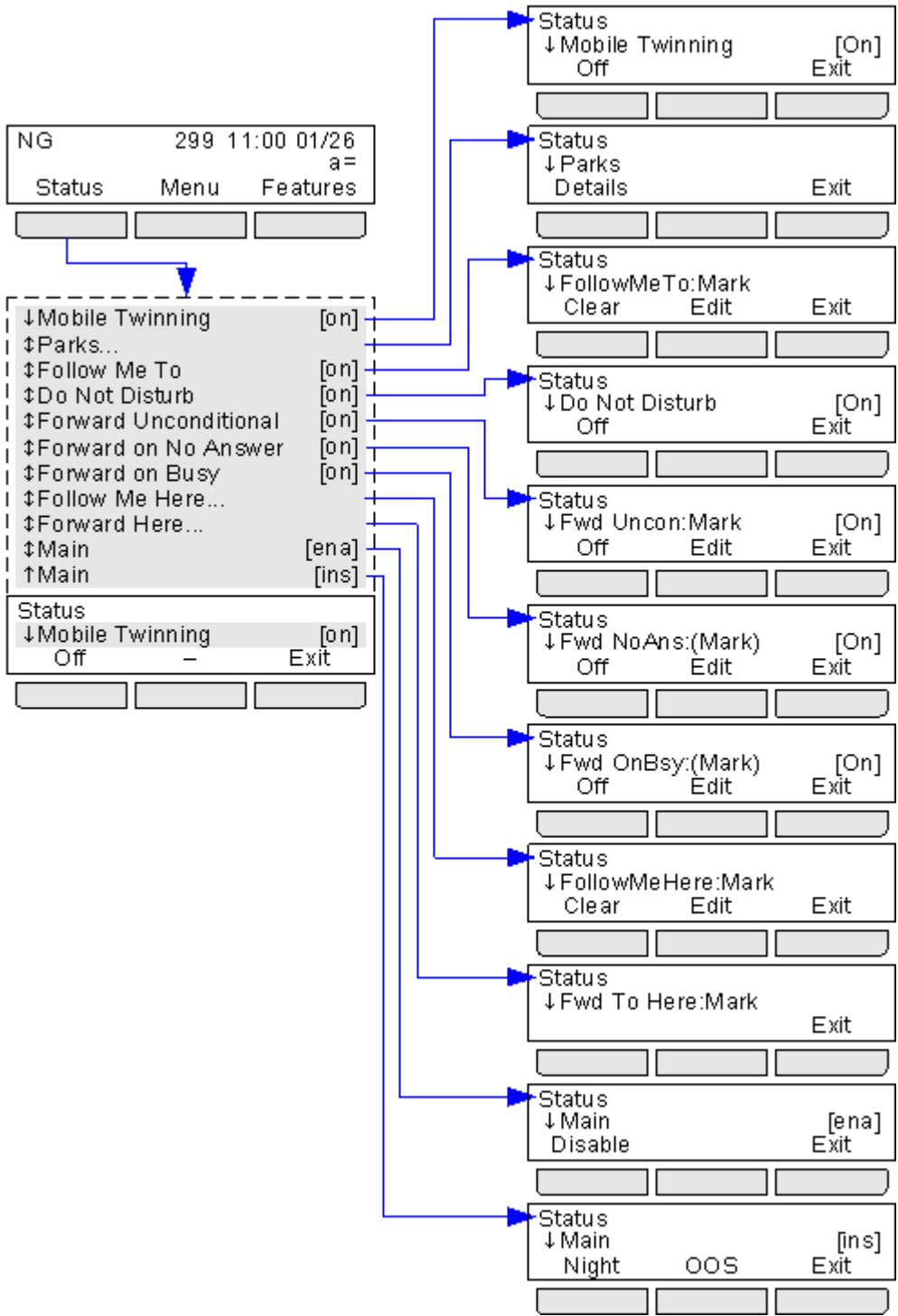

## 21.5 Phone A-Menu

This menu is accessed by pressing the **A** key. It is used mainly for phone specific settings rather than your user settings. It can also be used to view details of the phones software.

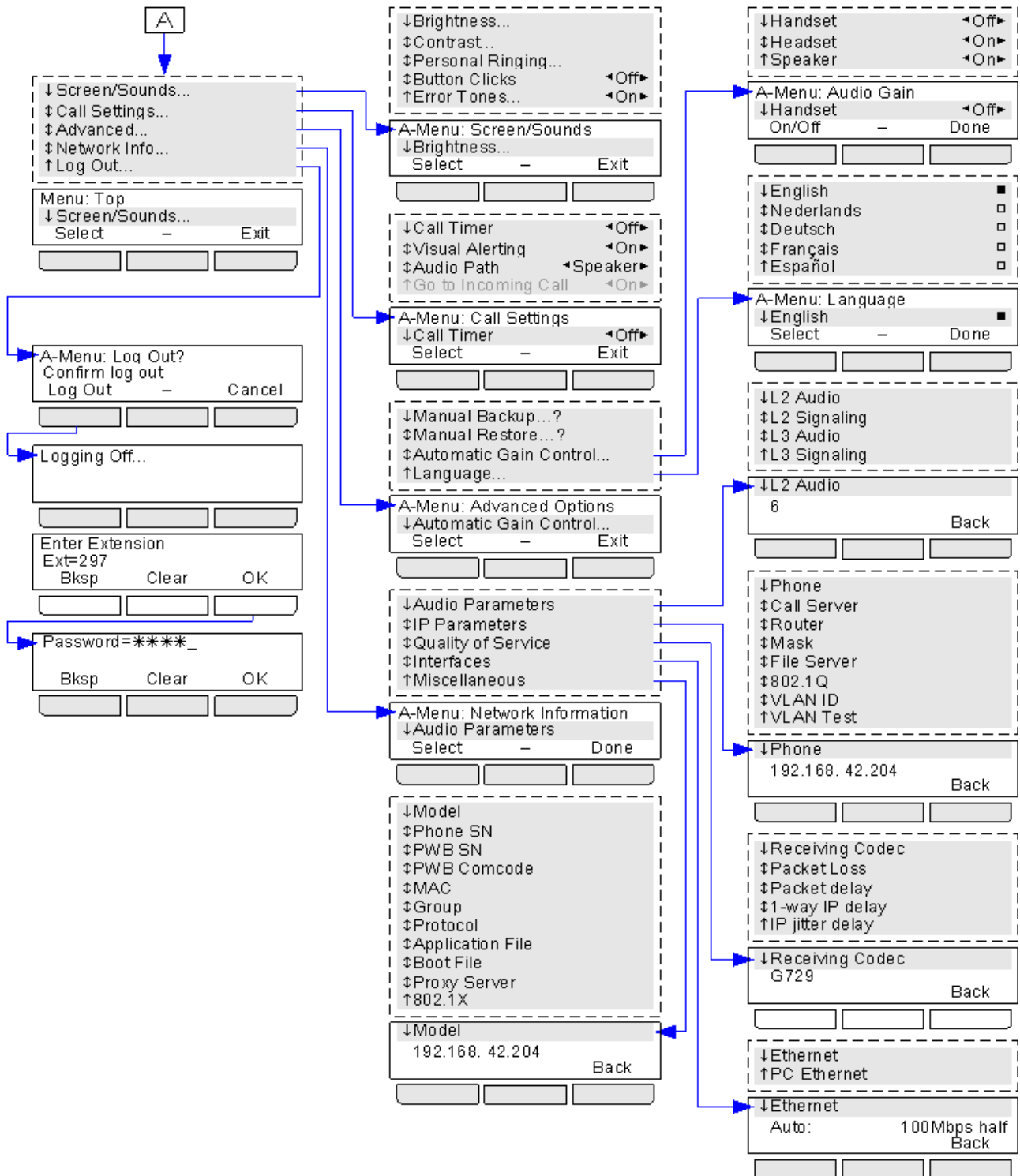

The following options are not used and are not included in this documentation; Go to **Incoming Call**.

## 21.6 Call Log Menu

This menu is accessed by pressing the **☰** key. The diagram below summarizes the structure of the menu.

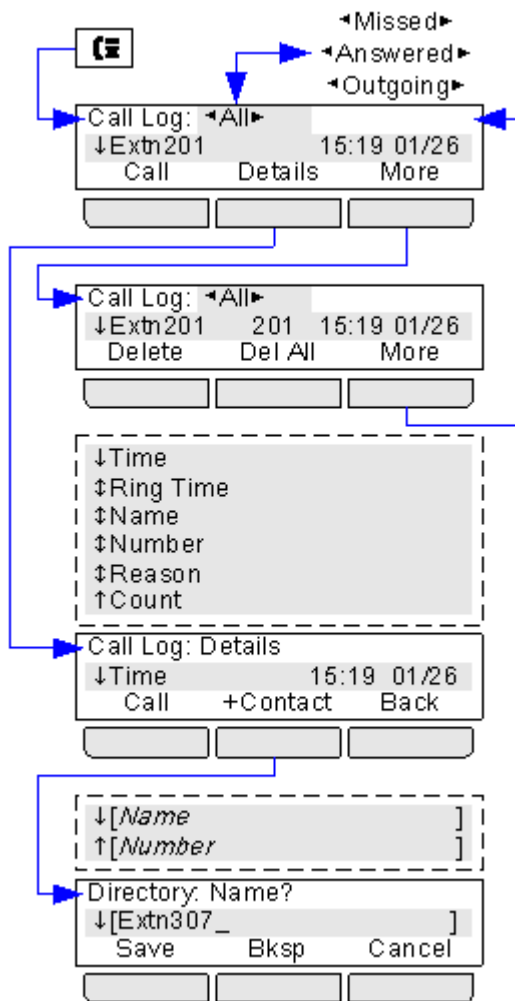

## 21.7 Contacts Menu

This menu is accessed by pressing the  key. This menu is used to access your own personal contacts and the system directory of contacts.

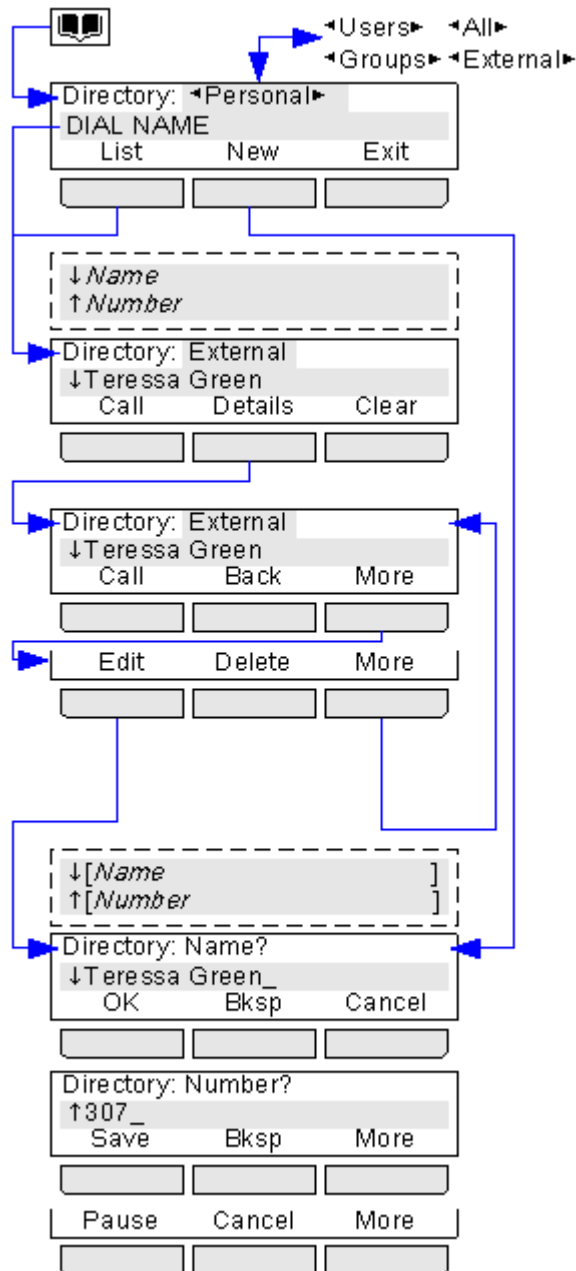

## 21.8 Redial Menu

This menu is accessed by pressing the  key. This menu is only used when you [set your redial mode](#) <sup>43</sup> to **List**. The numbers (up to 10) shown come from your outgoing call log.

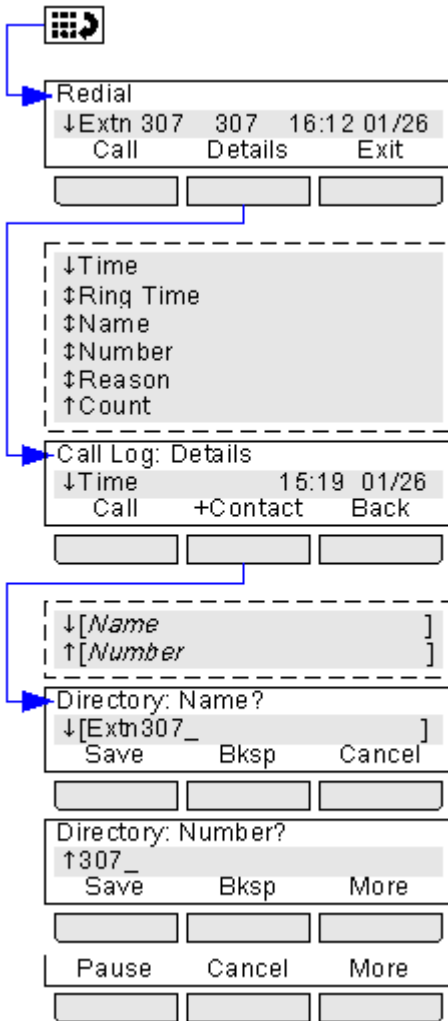

## 21.9 Phone Locked Menu

When your phone is locked:

- It can only be used to make internal and emergency calls.
- None of the menus for your user settings can be accessed.
- To [unlock the phone](#)<sup>[118]</sup> requires your login code if you have [configured a login code](#)<sup>[116]</sup>.

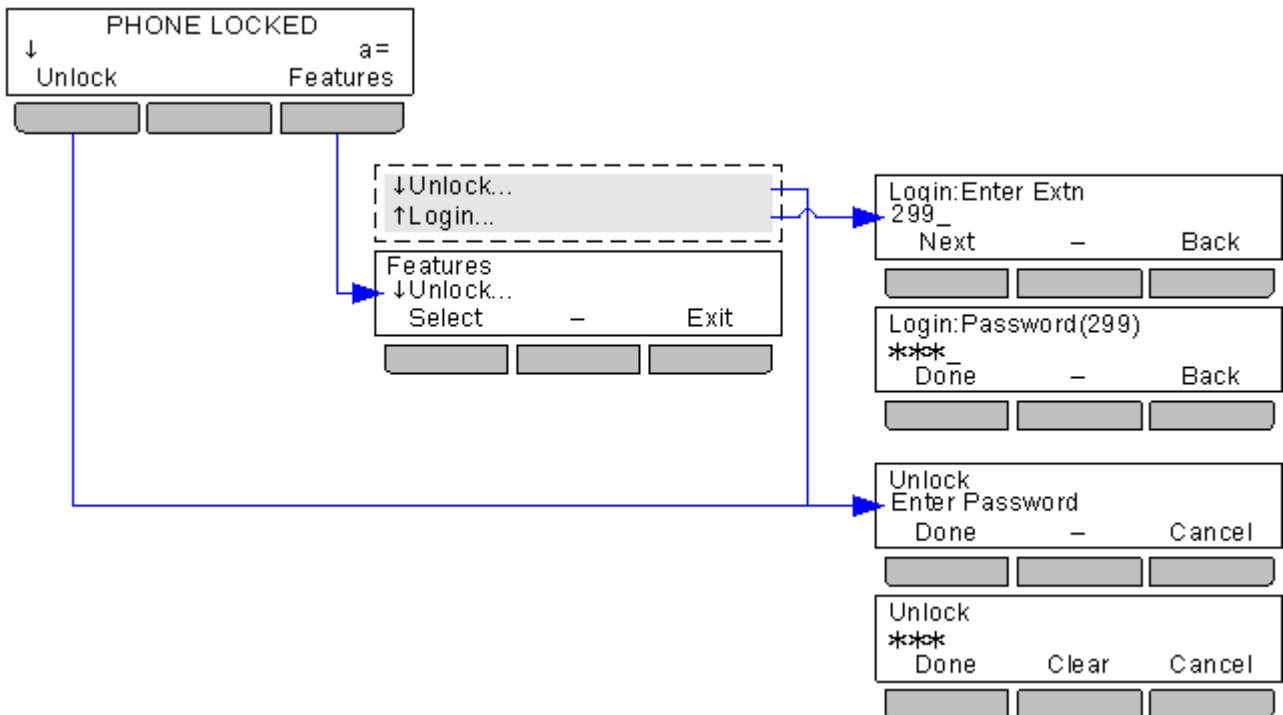





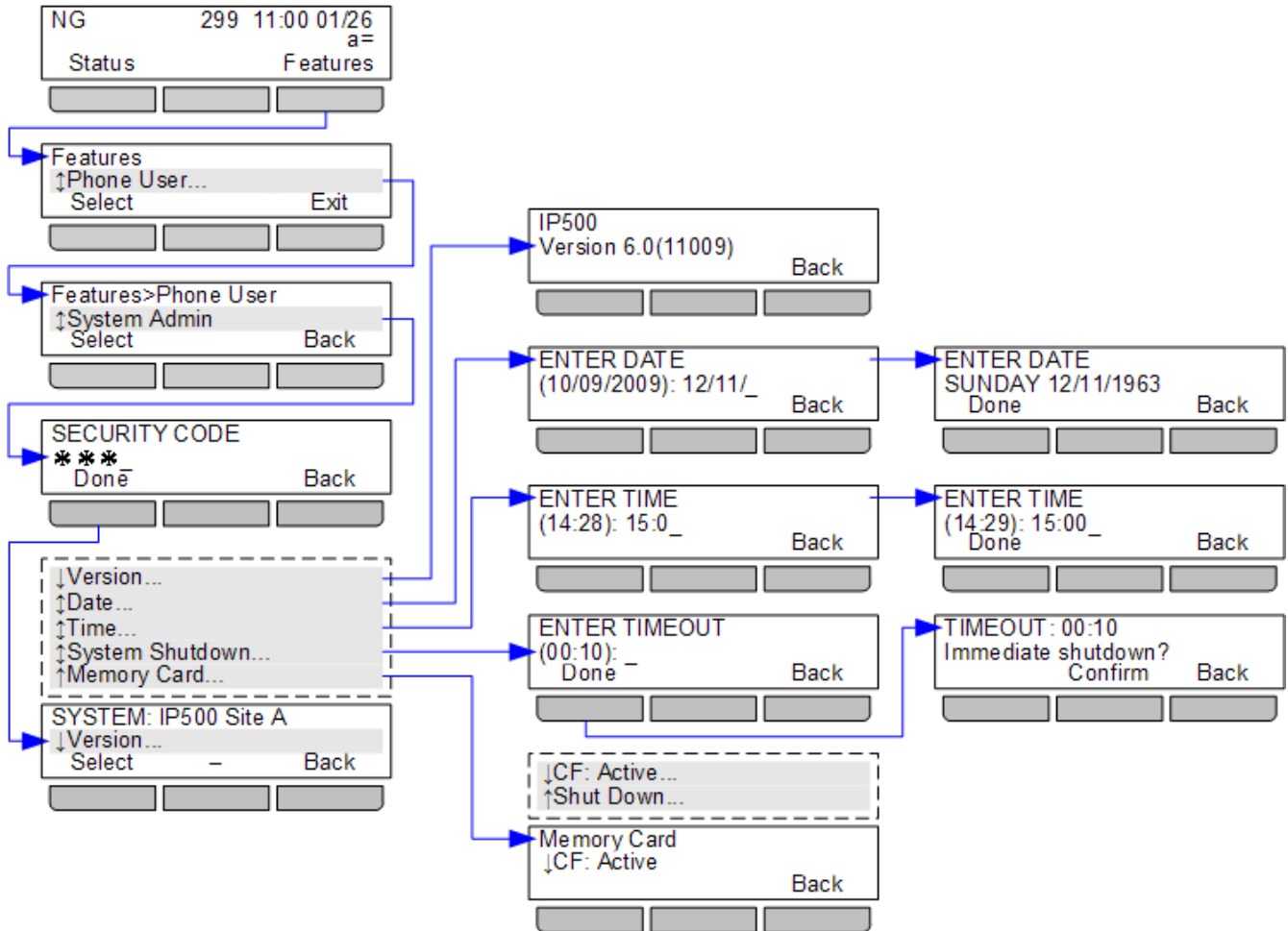

## 21.10 System Admin Menu

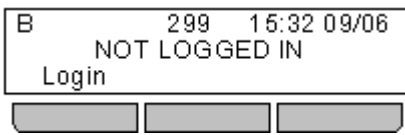
This menu is only available to users who have been configured as a system phone user.

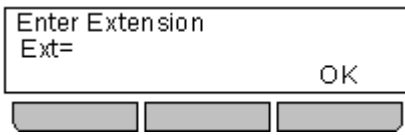
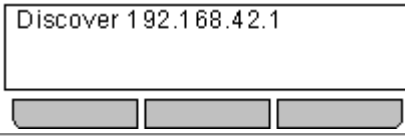
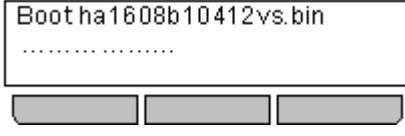

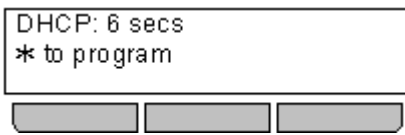
## 21.11 Error Screens

Display	Likely Cause
	<b>NoUser</b> This screen is displayed when there is no user currently logged in on the phone. The phone can still be used for internal and emergency calls. To <a href="#">login</a> <sup>(115)</sup> press <b>Select</b> .
	<b>PHONE LOCKED</b> This screen is displayed if the user has locked it. The phone can still be used to make and receive internal calls and to make emergency calls. If it is your phone you can unlock it using your login code. If it not you phone, you can still <a href="#">login</a> <sup>(115)</sup> .
	<b>Enter Extension</b> This screen is displayed on an unregistered phone. 1608 and 1616 only.
	<b>Discover</b> This screen typically indicates that the phone has lost connection with the telephone system for a period of several minutes. Contact your system administrator if this remains. 1608 and 1616 only.
	<b>Boot</b> This screen is shown by a phone that has just been powered on or has been remotely restarted by the system administrator. It indicates that the phone is loading its own software. This will typically be followed by the screens below in sequence. 1608 and 1616 only.
	<b>Ethernet</b> Shown following a restart of the phone. Indicates the network connection has been established. Do not press * unless you have been instructed to do so by your system administrator. 1608 and 1616 only.
	<b>DHCP</b> Shown following a restart of the phone. The phone is waiting for information from the DHCP server. Do not press * unless you have been instructed to do so by your system administrator. 1608 and 1616 only.
	<b>HTTP/HTTPS</b> Shown following a restart of the phone. The phone may go through a process of requesting files and downloading those files. This should only last a few seconds. However if the system administrator has done this to install new phone software it may take several minutes and should not be interrupted. 1608 and 1616 only.



## 21.12 Menu Access Control

Some menu options are dynamic and only appear when appropriate. For example, the **Features** menu cannot be accessed when the phone is locked. Access to other menu options is controlled by your system administrator. They can set system wide rules for which options phone users can access. They can also set specific rules for each phone user.

Even if you are restricted from accessing an option, it may still be applied for you by your system administrator. For example, the system administrator may configure call forwarding settings for you.

The system administrator can control your menu access to the following groups of functions:

- **Basic Call Functions**  
Controls whether you can access the phone's menu options for call pickup, park, unpark and transfer to mobile functions.
- **Advanced Call Functions**  
Controls whether you can access the phone's menu options for do not disturb, account code, withhold number and internal auto-answer functions. In addition, the **Account Code** menu is only shown if the system has been configured with accounts codes.
- **Forwarding Functions**  
Controls whether you can access the phone's menu options for forwarding and follow me functions.
- **Hot Desk Functions**  
Controls whether you can access the menu options for logging in and out.
- **Passcode Change**  
Controls whether you can change your login code (security credentials).
- **Phone Lock**  
Controls whether you can access the menu options for locking the phone and for setting it to automatically lock.
- **Self Administration**  
Controls whether you can access the Self-Administration menu option.
- **Voicemail Controls**  
Controls whether you can access the **Visual Voice** option through the phone's **Features** menu. Your system administrator can also disable the Messages button from accessing the visual voice menus.
- **Group Controls**  
The system administrator is able to configure if you can access the **Membership, State** and **Fallback** options of a group. If you are not configured for any groups then the **Group** menu is not shown.
- **Mobility Controls**  
The **Mobile Twinning** options are only shown if you have been configured to use mobile twinning.
- **System Administration Controls**  
The **System Admin** option is only shown if you have been configured as a 'System Phone' user.

Note that restricting menu access does not restrict access using available short codes and programmable buttons. However, those can also be removed or added by your system administrator.

## 21.13 Entering Characters

### Entering characters for a directory search

When searching the directory, the matching names are shown as follows:

- Pressing a key matches all the characters represented by that key. Pressing another key adds the characters from that key. For example, dialing **527** simultaneously match all names starting with **JAS** (for example "Jason") and with **KAR** (for example "Karl") plus any other letter combinations from those 3 keys in that order. See [How the Directory Search Works](#).
- To remove all the characters entered so far press **Clear**.

### Entering characters for other functions

- Select a character by re-pressing the indicated button in the charts below until the required character is displayed.
- Pressing another button enters that character and moves to entering the next character from the newly selected button.
- Pausing for more than a second after pressing a button also enters the current character and moves to entering the next character.
- You can select the text entry mode: **abc** (lower-case), **ABC** (upper-case) or **Abc** (capitalized). **123** is shown when only number entry is allowed.
- Use the left and right arrows keys to move the cursor.
- Select **Bksp** to delete the character before the cursor.

### Dialing Pad Characters

Depending on the system language, the keys on the dial pad represent both the letters marked on them, plus accented forms of those letters and in some cases some additional characters.

General (Latin1)		
1.,@-	ABC2 ÀÁÂÃÄÅÇ	DEF3 ÐÈÉÊË
<b>1</b>	<b>2</b>	<b>3</b>
GHI4 ÌÍÎ	JKL 5	MNO6 ÑÒÓÔÕÖØ
<b>4</b>	<b>5</b>	<b>6</b>
PQRS 7ß	TUV8 ÛÜÙÛ	WXYZ9 ÝÞÿ
<b>7</b>	<b>8</b>	<b>9</b>
*	_0	#
<b>*</b>	<b>0</b>	<b>#</b>

French			German		
1.,@-	ABC2 ÀÁÂÃÇ	DEF3 ÉÊËË	1.,@-	ABC2 ÄÅÂÃÇ	DEF3 ÉÊËË
<b>1</b>	<b>2</b>	<b>3</b>	<b>1</b>	<b>2</b>	<b>3</b>
GHI4 ÎÏÏ	JKL 5	MNO6 ÑÒÓÔÖ	GHI4 ÎÏÏ	JKL 5	MNO6 ÑÒÓÔÒ
<b>4</b>	<b>5</b>	<b>6</b>	<b>4</b>	<b>5</b>	<b>6</b>
PQRS 7	TUV8 ÛÜÙÛ	WXYZ 9	PQRS 7ß	TUV8 ÛÜÙÛ	WXYZ 9Ý
<b>7</b>	<b>8</b>	<b>9</b>	<b>7</b>	<b>8</b>	<b>9</b>
*	_0	#	*	_0	#
<b>*</b>	<b>0</b>	<b>#</b>	<b>*</b>	<b>0</b>	<b>#</b>

Italian			Portuguese		
1.,@-	ABC2 ÀÁÂÃÇ	DEF3 ÉÊËË	1.,@-	ABC2 ÁÂÃÄÅÇ	DEF3 ÉÊËË
<b>1</b>	<b>2</b>	<b>3</b>	<b>1</b>	<b>2</b>	<b>3</b>
GHI4 ÌÍÏ	JKL 5	MNO6 ÑÓÔÕÖ	GHI4 ÍÏÏ	JKL 5	MNO6 ÑÓÔÕÖÖ
<b>4</b>	<b>5</b>	<b>6</b>	<b>4</b>	<b>5</b>	<b>6</b>
PQRS 7ß	TUV8 ÙÚÛÜ	WXYZ 9	PQRS 7ß	TUV8 ÚÛÜÛ	WXYZ 9
<b>7</b>	<b>8</b>	<b>9</b>	<b>7</b>	<b>8</b>	<b>9</b>
*	_0	#	*	_0	#
<b>*</b>	<b>0</b>	<b>#</b>	<b>*</b>	<b>0</b>	<b>#</b>

Russian			Spanish		
1.,@-	АБВГ ABC2	ДЕЖЗ DEF3	1.,@-	ABC2 ÁÂÃÄÅÇ	DEF3 ÉÊËË
<b>1</b>	<b>2</b>	<b>3</b>	<b>1</b>	<b>2</b>	<b>3</b>
ИЙКЛ GHI4	МНОП JKL5	РСТУ MNO6	GHI4 ÍÏÏ	JKL 5	MNO6 ÑÓÔÕÖÖ
<b>4</b>	<b>5</b>	<b>6</b>	<b>4</b>	<b>5</b>	<b>6</b>
ФХЦЧ PQRS7	ШЩЪЫ TUV8	ЬЭЮЯ WXYZ9	PQRS 7ß	TUV8 ÚÛÜÛ	WXYZ 9
<b>7</b>	<b>8</b>	<b>9</b>	<b>7</b>	<b>8</b>	<b>9</b>
*	_0	#	*	_0	#
<b>*</b>	<b>0</b>	<b>#</b>	<b>*</b>	<b>0</b>	<b>#</b>



# Chapter 22.

## Glossary

---

## 22. Glossary

### 22.1 Abbreviated Ring

A single non-repeated ring. By default this is the type of ring used when another call alerts you when you already have a call in connected.

### 22.2 Appearance Button

Appearance buttons are used to represent calls made and received by you and other users on the telephone system. They are configured by your system administrator. Normally your first 3 buttons are call appearance buttons but additional buttons can be configured as appearance buttons.

### 22.3 Attention Ring

Your system administrator can set what ringing should be used if another call alerts you when you already have a call connected. The options are a single non-repeated ring (abbreviated ring) or no ring.

### 22.4 Auto Hold

By default, when you have a connected call in progress, if you press another appearance button, the connected call is automatically put on hold. Without auto-hold, the connected call is ended when you press another appearance button.

### 22.5 Bridged Appearance Button

A bridged appearance button shows the state of one of another user's call appearance buttons. It can be used to answer or join calls on that other user's call appearance button. It can also be used to make a call that the call appearance user can then join or retrieve from hold.

- When the user's call appearance button alerts, your matching bridged appearance button also alerts. The bridged appearance button can be used to answer the call on the call appearance button user's behalf.
- When the call appearance button user answers or makes a call using that call appearance, your matching bridged appearance button show the status of that call, for example connected, on hold, etc. The bridged appearance button can be used to retrieve the call if on hold or to join the call if active.
- Bridged appearance buttons are not supported between users on different systems in a [Small Community Network](#)<sup>[20]</sup>.

### 22.6 Call Appearance Button

Call appearance buttons are used to display calls to and from your phone. By having several call appearance buttons, you are able to answer and make several calls, switch between calls and perform other actions.

When all your call appearance buttons are in use, any further calls to your number follow your forward on busy setting if set or otherwise go to voicemail if available.

### 22.7 Call Coverage Button

Each call coverage button is associated with another user on your telephone system. The button allows you to be alerted when that user has an unanswered call still ringing. You can view the details of the call and answer it if required.

The settings of the user being covered control how long it rings at their phone before it also starts alerting on your call coverage button for that user.

### 22.8 Coverage Ring

If you have any bridged appearance and or call coverage buttons, you can [set the type of ringing \(coverage ring\)](#)<sup>[14]</sup> that should be used when a call alerts on any of those buttons. The options are to use normal ringing, a single non-repeated ring (abbreviated ring) or no ring. The coverage ring setting is only used if you do not already have a connected call. If you already have a connected call in progress, the shorter of your coverage ring and the system administrator set attention ring settings is used.

### 22.9 Do Not Disturb

- When you are in 'do not disturb,' your callers are redirected to voicemail if available. Otherwise, the caller hears busy tone.
- People calling from numbers in your 'do not disturb' exceptions list can still call you. However, forwarding can still be applied to these calls.
  - Calls to any hunt group of which you are a member are not presented to you (unless you are the last available member of the group).
  - Enabling do not disturb will not affect any calls already being presented to your phone.
  - You can still use the phone to make outgoing calls. When you go off-hook you will hear broken dial tone.
- **N = No Calls (Do Not Disturb)**  
An **N** is shown on your phone's display when you have do not disturb enabled.

## 22.10 Do Not Disturb Exceptions

- These are numbers for caller's who can call you even when you are set to do not disturb. This only applies for calls to you. It does not apply for calls to a hunt group of which you are a member.

## 22.11 Follow Me

'Follow me to' is used to redirect your calls to another extension where you will be working. The calls are presented with your user name so that they can be distinguished from calls for the extension's normal user. This allows you to share another person's phone without logging them off their phone.

All calls are redirected and the calls are still subject to all your user settings as if they were ringing at your phone.

## 22.12 Follow Me Here

Follow here the function used to enable follow me at the extension to which you want your calls redirected.

## 22.13 Follow Me To

Follow me to is the function used to enable follow me from your own phone.

## 22.14 Forward on Busy

Forward on busy redirects your calls when your phone is not able to present you with any more alerting calls.

- By default this function is only applied to incoming external calls to you. However, if required internal calls can also be selected.
- When enabled, all calls matching the settings are forwarded to the number set as the forward on busy/no answer destination. That number can be internal or external.
- Busy is defined as having no available call appearance buttons on which further calls can be presented.
- Hunt group calls are not presented when you are busy and so are not forwarded by this setting.
- The forward on busy and forward on no answer options use the same forwarding destination number. If no number is set, they use the same destination as set for forward unconditional.
- If you also have [voicemail enabled](#)<sup>[110]</sup>, if the the forwarded call is still unanswered after having rung for your no answer time (default 15 seconds), the system will redirect the call to voicemail. Note that this is not always possible for calls that have been forwarded to an external number.

## 22.15 Forward on No Answer

Forward on no answer redirect calls that have alerted your phone but have not been answered for some reason.

- By default this function is only applied to incoming external calls to you. However if required internal calls can also be selected.
- When enabled, all calls matching the settings are forwarded to the number set as the forward on busy/no answer destination. That number can be internal or external.
- No answer is defined as having been presented to your phone for your no answer time (default 15 seconds).
- Hunt group calls are not forwarded.
- The forward on busy and forward on no answer options use the same forwarding destination number. If no number is set, they use the same destination as set for forward unconditional.
- If you also have [voicemail enabled](#)<sup>[110]</sup>, if the the forwarded call is still unanswered after having rung for your no answer time (default 15 seconds), the system will redirect the call to voicemail. Note that this is not always possible for calls that have been forwarded to an external number.

## 22.16 Forward Unconditional

Forward unconditional can be used to immediately redirect your calls.

- By default this function is only applied to incoming external calls to you. However, if required internal calls and or hunt group calls can also be selected.
- When enabled, all calls matching the settings are forwarded to the number set as your forward unconditional destination. That number can be internal or external.
- You can still use the phone to make outgoing calls. When you go off-hook you will hear broken dial tone.
- If you also have [forward on no answer set](#)<sup>[199]</sup>, if the unconditionally forwarded call is still unanswered after having rung for your no answer time (default 15 seconds), the system will redirect the call to your forward on no answer destination. Note that this is not always possible for calls that have been forwarded to an external number.
- If you also have [voicemail enabled](#)<sup>[110]</sup>, if the the forwarded call is still unanswered after having rung for your no answer time (default 15 seconds), the system will redirect the call to voicemail. Note that this is not always possible for calls that have been forwarded to an external number.

---

- **D = Diverting (Forwarding) Calls**

A **D** is shown on your phone's display when you have forward unconditional enabled.

## 22.17 Group

Your system administrator can include you as a member of a group along with other users. Each group has its own extension number which can be used as the destination for call.

When a call is presented to a group, it is presented to the available group members, either one at a time or all at the same time, until answered by one of the members.

How long a group call will ring at each group member before being presented to the next member is controlled by the group's own settings. Hunt groups also use voicemail and have their own settings for when an unanswered call should go to the group's mailbox. For group calls, the hunt group's voicemail settings are used rather than your settings.

## 22.18 Idle Line Preference

Having one of your phone's call or line appearance buttons set as the currently selected appearance button, means it will be the appearance button used when you go off hook. If this was not the case, you would need to select an appearance button before going off hook.

Idle line preference automatically selects the first available call appearance or line appearance button as your currently selected button when you do not have a call connected.

## 22.19 Internal Twinning

This method of twinning twins your normal phone with another internal phone. Your incoming calls will ring on both phones. You can also make your calls from either extension.

A typical example for internal twinning would be a user who uses both a normal desk phone and also needs a mobile phone while moving around the building.

Your settings are applied to both phones. Similarly message waiting indication and voicemail access from either phone will be to your mailbox.

If both your twinned phones are use contacts and call log stored on the phone system, the call logs and directory contacts on each will be the same.

## 22.20 Line Appearance Button

Line appearance buttons allow you to make and receive calls on a specific telephone line connected to your telephone system. The button also allows you to see when the line is in use by other users.

For incoming calls, the telephone system still determines the destination for the call. That may be a user or group. However, if you have a line appearance button for the line, you will see that there is a call alerting and can answer it if required.

- **Private Lines**

Special behaviour is applied to calls where the user has both a line appearance for the line involved and is also the Incoming Call Route destination of that call. Such calls will alert only on the Line Appearance button and not on any other buttons. These calls will also not follow any forwarding.

## 22.21 Logged Out

If you are logged out from any phone, you are treated as being busy to receiving any calls. Callers follow your forwarding settings if set or go to voicemail if available.

## 22.22 Login Code

You can use a login code to login at any phone on the telephone system and then use that phone as your own. While logged in, you can use the phone's menus to set and change your login code.

## 22.23 Missed Call

Missed calls are calls that ring at your phone but are not answered by you. Your 10 most recent missed calls are included in your call log.

The system administrator can configure whether missed calls should include calls that you did not answer but were answered for you by another user. For example by a user with a call coverage button set for your calls. If this mode is enabled, it will also include calls that were answered by your voicemail.

## 22.24 Missed Group Call

The system administrator can configure whether the telephone system should keep an internal log of missed hunt group calls. They can then also set which groups of which you are a member, should have their missed calls shown as part of your missed calls call log. This does not require the group call to have been presented to you and missed.



## 22.25 Mobile Twinning

Mobile twinning is twinning where your calls ring at both your phone and at another number which can include an external number. If you have been configured as a mobile twinning user, you can switch use of mobile twinning on or off through the phone's menus, transfer calls to a mobile phone and can also change the number to which you are twinned.

## 22.26 Park Call

Parking a call is similar to holding a call. However, parked calls can be retrieved by other users on the telephone system.

A call that you park and leave parked for too long will recall to your phone. The recall will ignore any do not disturb and forwarding settings, recalling to the phone from which it was parked.

## 22.27 Park Slot Number

If you park a call without specifying a park slot number, the system will assign a number based on your extension number plus a single digit. For example for extension 201, the first parked call will use park slot number 2010 if available. If you already have one parked call, the next parked call will use park slot 2011 if available.

Call park buttons can be configured with a specific park slot numbers. A call parked using that button is given that park slot number. Any other users with a call park button set to the same number will see that there is a parked call and can unpark it using their button.

## 22.28 Ringing Line Preference

This setting is controlled by your system administrator and is normally on. When you are not connected to a call, if you receive an incoming call, ringing line preference will make the alerting appearance button your selected appearance button. You can answer the call on the selected appearance button by lifting the handset or pressing the Headset or Speaker button.

Without ringing line preference, to answer the call on the alerting appearance button you must press the appearance button to select it manually.

## 22.29 Short Codes

Short codes are numbers that you can dial to enable and disable various features. The following are default short codes that may be available. However, your system administrator can remove and change the short codes available to you or all users.

## 22.30 Small Community Network

Several IP Office telephone systems can be connected together to form a Small Community Network. You can then dial the user on other systems in the same way as for internal calls on your own system. The remote users are listed in the directory.

The system administrator can also configure which hunt groups are accessible across the network. You may also be able to hot desk to a phone located on another system in the network.

## 22.31 System Administrator

The system administrator is able to make or arrange changes to the telephone system configuration. They are able to see and change most of your user settings.

## 22.32 System Phone User

Your system administrator can configure some user's as system phone users. They will be able to access a range of additional functions such as changing the system date and time. A system phone user is able to add, edit and delete system directory entries.

## 22.33 Twinning

Twining is a process whereby your calls ring on two phones. Twinning is only available if configured by the system administrator.

There are two methods of twinning supported, [internal twinning](#)<sup>[200]</sup> and [mobile twinning](#)<sup>[201]</sup>.



# Chapter 23.

## Document History

---

## 23. Document History

Date	Issue	Changes
5th April 2018	11a	Conversion to new authoring tool.
2nd January 2020	11b	Correct appearance of '1608/1616' in 1400 Series output.
16th April 2020	11c	Clarify appearance of multiple status letter.

#### Notice

While reasonable efforts have been made to ensure that the information in this document is complete and accurate at the time of printing, Avaya assumes no liability for any errors. Avaya reserves the right to make changes and corrections to the information in this document without the obligation to notify any person or organization of such changes.

#### Documentation disclaimer

"Documentation" means information published by Avaya in varying mediums which may include product information, operating instructions and performance specifications that Avaya may generally make available to users of its products and Hosted Services. Documentation does not include marketing materials. Avaya shall not be responsible for any modifications, additions, or deletions to the original published version of documentation unless such modifications, additions, or deletions were performed by Avaya. End User agrees to indemnify and hold harmless Avaya, Avaya's agents, servants and employees against all claims, lawsuits, demands and judgments arising out of, or in connection with, subsequent modifications, additions or deletions to this documentation, to the extent made by End User.

#### Link disclaimer

Avaya is not responsible for the contents or reliability of any linked websites referenced within this site or documentation provided by Avaya. Avaya is not responsible for the accuracy of any information, statement or content provided on these sites and does not necessarily endorse the products, services, or information described or offered within them. Avaya does not guarantee that these links will work all the time and has no control over the availability of the linked pages.

#### Warranty

Avaya provides a limited warranty on Avaya hardware and software. Refer to your sales agreement to establish the terms of the limited warranty. In addition, Avaya's standard warranty language, as well as information regarding support for this product while under warranty is available to Avaya customers and other parties through the Avaya Support website:

<https://support.avaya.com/helpcenter/getGenericDetails?detailId=C20091120112456651010> under the link "Warranty & Product Lifecycle" or such successor site as designated by Avaya. Please note that if You acquired the product(s) from an authorized Avaya Channel Partner outside of the United States and Canada, the warranty is provided to You by said Avaya Channel Partner and not by Avaya.

"Hosted Service" means a hosted service subscription that You acquire from either Avaya or an authorized Avaya Channel Partner (as applicable) and which is described further in Hosted SAS or other service description documentation regarding the applicable hosted service. If You purchase a Hosted Service subscription, the foregoing limited warranty may not apply but You may be entitled to support services in connection with the Hosted Service as described further in your service description documents for the applicable Hosted Service. Contact Avaya or Avaya Channel Partner (as applicable) for more information.

#### Hosted Service

THE FOLLOWING APPLIES IF YOU PURCHASE A HOSTED SERVICE SUBSCRIPTION FROM AVAYA OR AN AVAYA CHANNEL PARTNER (AS APPLICABLE), THE TERMS OF USE FOR HOSTED SERVICES ARE AVAILABLE ON THE AVAYA WEBSITE, [HTTPS://SUPPORT.AVAYA.COM/LICENSEINFO](https://support.avaya.com/licenseinfo) UNDER THE LINK "Avaya Terms of Use for Hosted Services" OR SUCH SUCCESSOR SITE AS DESIGNATED BY AVAYA, AND ARE APPLICABLE TO ANYONE WHO ACCESSES OR USES THE HOSTED SERVICE. BY ACCESSING OR USING THE HOSTED SERVICE, OR AUTHORIZING OTHERS TO DO SO, YOU, ON BEHALF OF YOURSELF AND THE ENTITY FOR WHOM YOU ARE DOING SO (HEREINAFTER REFERRED TO INTERCHANGEABLY AS "YOU" AND "END USER"), AGREE TO THE TERMS OF USE. IF YOU ARE ACCEPTING THE TERMS OF USE ON BEHALF A COMPANY OR OTHER LEGAL ENTITY, YOU REPRESENT THAT YOU HAVE THE AUTHORITY TO BIND SUCH ENTITY TO THESE TERMS OF USE. IF YOU DO NOT HAVE SUCH AUTHORITY, OR IF YOU DO NOT WISH TO ACCEPT THESE TERMS OF USE, YOU MUST NOT ACCESS OR USE THE HOSTED SERVICE OR AUTHORIZE ANYONE TO ACCESS OR USE THE HOSTED SERVICE. YOUR USE OF THE HOSTED SERVICE SHALL BE LIMITED BY THE NUMBER AND TYPE OF LICENSES PURCHASED UNDER YOUR CONTRACT FOR THE HOSTED SERVICE, PROVIDED, HOWEVER, THAT FOR CERTAIN HOSTED SERVICES IF APPLICABLE, YOU MAY HAVE THE OPPORTUNITY TO USE FLEX LICENSES, WHICH WILL BE INVOICED ACCORDING TO ACTUAL USAGE ABOVE THE CONTRACT LICENSE LEVEL. CONTACT AVAYA OR AVAYA'S CHANNEL PARTNER FOR MORE INFORMATION ABOUT THE LICENSES FOR THE APPLICABLE HOSTED SERVICE, THE AVAILABILITY OF ANY FLEX LICENSES (IF APPLICABLE), PRICING AND BILLING INFORMATION, AND OTHER IMPORTANT INFORMATION REGARDING THE HOSTED SERVICE.

#### Licenses

THE SOFTWARE LICENSE TERMS AVAILABLE ON THE AVAYA WEBSITE, [HTTPS://SUPPORT.AVAYA.COM/LICENSEINFO](https://support.avaya.com/licenseinfo), UNDER THE LINK "AVAYA SOFTWARE LICENSE TERMS (Avaya Products)" OR SUCH SUCCESSOR SITE AS DESIGNATED BY AVAYA, ARE APPLICABLE TO ANYONE WHO DOWNLOADS, USES AND/OR INSTALLS AVAYA SOFTWARE, PURCHASED FROM AVAYA INC., ANY AVAYA AFFILIATE, OR AN AVAYA CHANNEL PARTNER (AS APPLICABLE) UNDER A COMMERCIAL AGREEMENT WITH AVAYA OR AN AVAYA CHANNEL PARTNER. UNLESS OTHERWISE AGREED TO BY AVAYA IN WRITING, AVAYA DOES NOT EXTEND THIS LICENSE IF THE SOFTWARE WAS OBTAINED FROM ANYONE OTHER THAN AVAYA, AN AVAYA AFFILIATE OR AN AVAYA CHANNEL PARTNER; AVAYA RESERVES THE RIGHT TO TAKE LEGAL ACTION AGAINST YOU AND ANYONE ELSE USING OR SELLING THE SOFTWARE WITHOUT A LICENSE. BY INSTALLING, DOWNLOADING OR USING THE SOFTWARE, OR AUTHORIZING OTHERS TO DO SO, YOU, ON BEHALF OF YOURSELF AND THE ENTITY FOR WHOM YOU ARE INSTALLING, DOWNLOADING OR USING THE SOFTWARE (HEREINAFTER REFERRED TO INTERCHANGEABLY AS "YOU" AND "END USER"), AGREE TO THESE TERMS AND CONDITIONS AND CREATE A BINDING CONTRACT BETWEEN YOU AND AVAYA INC. OR THE APPLICABLE AVAYA AFFILIATE ("AVAYA").

Avaya grants You a license within the scope of the license types described below, with the exception of Heritage Nortel Software, for which the scope of the license is detailed below. Where the order documentation does not expressly identify a license type, the applicable license will be a Designated System License. The applicable number of licenses and units of capacity for which the license is granted will be one (1), unless a different number of licenses or units of capacity is specified in the documentation or other materials available to You. "Software" means computer programs in object code, provided by Avaya or an Avaya Channel Partner, whether as stand-alone products, pre-installed on hardware products, and any upgrades, updates, patches, bug fixes, or modified versions thereto. "Designated Processor" means a single stand-alone computing device. "Server" means a Designated Processor that hosts a software application to be accessed by multiple users. "Instance" means a single copy of the Software executing at a particular time: (i) on one physical machine; or (ii) on one deployed software virtual machine ("VM") or similar deployment.

#### License type(s)

Designated System(s) License (DS). End User may install and use each copy or an Instance of the Software only on a number of Designated Processors up to the number indicated in the order. Avaya may require the Designated Processor(s) to be identified in the order by type, serial number, feature key, Instance, location or other specific designation, or to be provided by End User to Avaya through electronic means established by Avaya specifically for this purpose.

Concurrent User License (CU). End User may install and use the Software on multiple Designated Processors or one or more Servers, so long as only the licensed number of Units are accessing and using the Software at any given time. A "Unit" means the unit on which Avaya, at its sole discretion, bases the pricing of its licenses and can be, without limitation, an agent, port or user, an e-mail or voice mail account in the name of a person or corporate function (e.g., webmaster or helpdesk), or a directory entry in the administrative database utilized by the Software that permits one user to interface with the Software. Units may be linked to a specific, identified Server or an Instance of the Software.

Database License (DL). End User may install and use each copy or an Instance of the Software on one Server or on multiple Servers provided that each of the Servers on which the Software is installed communicates with no more than one Instance of the same database.

CPU License (CP). End User may install and use each copy or Instance of the Software on a number of Servers up to the number indicated in the order provided that the performance capacity of the Server(s) does not exceed the performance capacity specified for the Software. End User may not re-install or operate the Software on Server(s) with a larger performance capacity without Avaya's prior consent and payment of an upgrade fee.

Named User License (NU). You may: (i) install and use each copy or Instance of the Software on a single Designated Processor or Server per authorized Named User (defined below); or (ii) install and use each copy or Instance of the Software on a Server so long as only authorized Named Users access and use the Software. "Named User", means a user or device that has been expressly authorized by Avaya to access and use the Software. At Avaya's sole discretion, a "Named User" may be, without limitation, designated by name, corporate function (e.g., webmaster or helpdesk), an e-mail or voice mail account in the name of a person or corporate function, or a directory entry in the administrative database utilized by the Software that permits one user to interface with the Software.

Shrinkwrap License (SR). You may install and use the Software in accordance with the terms and conditions of the applicable license agreements, such as "shrinkwrap" or "clickthrough" license accompanying or applicable to the Software ("Shrinkwrap License").

#### Heritage Nortel Software

"Heritage Nortel Software" means the software that was acquired by Avaya as part of its purchase of the Nortel Enterprise Solutions Business in December 2009. The Heritage Nortel Software is the software contained within the list of Heritage Nortel Products located at <https://support.avaya.com/LicenseInfo> under the link "Heritage Nortel Products" or such successor site as designated by Avaya. For Heritage Nortel Software, Avaya grants Customer a license to use Heritage Nortel Software provided hereunder solely to the extent of the authorized activation or authorized usage level, solely for the purpose specified in the Documentation, and solely as embedded in, for execution on, or for communication with Avaya equipment. Charges for Heritage Nortel Software may be based on extent of activation or use authorized as specified in an order or invoice.

#### Copy right

Except where expressly stated otherwise, no use should be made of materials on this site, the Documentation, Software, Hosted Service, or hardware provided by Avaya. All content on this site, the documentation, Hosted Service, and the product provided by Avaya including the selection, arrangement and design of the content is owned either by Avaya or its licensors and is protected by copyright and other intellectual property laws including the sui generis rights relating to the protection of databases. You may not modify, copy, reproduce, republish, upload, post, transmit or distribute in any way any content, in whole or in part, including any code and software unless expressly authorized by Avaya. Unauthorized reproduction, transmission, dissemination, storage, and or use without the express written consent of Avaya can be a criminal, as well as a civil offense under the applicable law.

#### Virtualization

The following applies if the product is deployed on a virtual machine. Each product has its own ordering code and license types. Note that each Instance of a product must be separately licensed and ordered. For example, if the end user customer or Avaya Channel Partner would like to install two Instances of the same type of products, then two products of that type must be ordered.

#### Third Party Components

"Third Party Components" mean certain software programs or portions thereof included in the Software or Hosted Service may contain software (including open source software) distributed under third party agreements ("Third Party Components"), which contain terms regarding the rights to use certain portions of the Software ("Third Party Terms"). As required, information regarding distributed Linux OS source code (for those products that have distributed Linux OS source code) and identifying the copyright holders of the Third Party Components and the Third Party Terms that apply is available in the products, Documentation or on Avaya's website at: <https://support.avaya.com/Copyright> or such successor site as designated by Avaya. The open source software license terms provided as Third Party Terms are consistent with the license rights granted in these Software License Terms, and may contain additional rights benefiting You, such as modification and distribution of the open source software. The Third Party Terms shall take precedence over these Software License Terms, solely with respect to the applicable Third Party Components to the extent that these Software License Terms impose greater restrictions on You than the applicable Third Party Terms.

The following applies if the H.264 (AVC) codec is distributed with the product. THIS PRODUCT IS LICENSED UNDER THE AVC PATENT PORTFOLIO LICENSE FOR THE PERSONAL USE OF A CONSUMER OR OTHER USES IN WHICH IT DOES NOT RECEIVE REMUNERATION TO (i) ENCODE VIDEO IN COMPLIANCE WITH THE AVC STANDARD ("AVC VIDEO") AND/OR (ii) DECODE AVC VIDEO THAT WAS ENCODED BY A CONSUMER ENGAGED IN A PERSONAL ACTIVITY AND/OR WAS OBTAINED FROM A VIDEO PROVIDER LICENSED TO PROVIDE AVC VIDEO. NO LICENSE IS GRANTED OR SHALL BE IMPLIED FOR ANY OTHER USE. ADDITIONAL INFORMATION MAY BE OBTAINED FROM MPEG LA, L.L.C. SEE [HTTP://WWW.MPEGLA.COM](http://www.mpegla.com).

#### Service Provider

THE FOLLOWING APPLIES TO AVAYA CHANNEL PARTNER'S HOSTING OF AVAYA PRODUCTS OR SERVICES. THE PRODUCT OR HOSTED SERVICE MAY USE THIRD PARTY COMPONENTS SUBJECT TO THIRD PARTY TERMS AND REQUIRE A SERVICE PROVIDER TO BE INDEPENDENTLY LICENSED DIRECTLY FROM THE THIRD PARTY SUPPLIER. AN AVAYA CHANNEL PARTNER'S HOSTING OF AVAYA PRODUCTS MUST BE AUTHORIZED IN WRITING BY AVAYA AND IF THOSE HOSTED PRODUCTS USE OR EMBED CERTAIN THIRD PARTY SOFTWARE, INCLUDING BUT NOT LIMITED TO MICROSOFT SOFTWARE OR CODECS, THE AVAYA CHANNEL PARTNER IS REQUIRED TO INDEPENDENTLY OBTAIN ANY APPLICABLE LICENSE AGREEMENTS, AT THE AVAYA CHANNEL PARTNER'S EXPENSE, DIRECTLY FROM THE APPLICABLE THIRD PARTY SUPPLIER.

WITH RESPECT TO CODECS, IF THE AVAYA CHANNEL PARTNER IS HOSTING ANY PRODUCTS THAT USE OR EMBED THE G.729 CODEC, H.264 CODEC, OR H.265 CODEC, THE AVAYA CHANNEL PARTNER ACKNOWLEDGES AND AGREES THE AVAYA CHANNEL PARTNER IS RESPONSIBLE FOR ANY AND ALL RELATED FEES AND/OR ROYALTIES. THE G.729 CODEC IS LICENSED BY SIPRO LAB TELECOM INC. SEE [WWW.SIPRO.COM/CONTACT.HTML](http://www.sipro.com/contact.html). THE H.264 (AVC) CODEC IS LICENSED UNDER THE AVC PATENT PORTFOLIO LICENSE FOR THE PERSONAL USE OF A CONSUMER OR OTHER USES IN WHICH IT DOES NOT RECEIVE REMUNERATION TO: (I) ENCODE VIDEO IN COMPLIANCE WITH THE AVC STANDARD ("AVC VIDEO") AND/OR (II) DECODE AVC VIDEO THAT WAS ENCODED BY A CONSUMER ENGAGED IN A PERSONAL ACTIVITY AND/OR WAS OBTAINED FROM A VIDEO PROVIDER LICENSED TO PROVIDE AVC VIDEO. NO LICENSE IS GRANTED OR SHALL BE IMPLIED FOR ANY OTHER USE. ADDITIONAL INFORMATION FOR H.264 (AVC) AND H.265 (HEVC) CODECS MAY BE OBTAINED FROM MPEG LA, L.L.C. SEE [HTTP://WWW.MPEGLA.COM](http://www.mpegla.com).

#### Compliance with Laws

Customer acknowledges and agrees that it is responsible for complying with any applicable laws and regulations, including, but not limited to laws and regulations related to call recording, data privacy, intellectual property, trade secret, fraud, and music performance rights, in the country or territory where the Avaya product is used.

#### Preventing Toll Fraud

"Toll Fraud" is the unauthorized use of your telecommunications system by an unauthorized party (for example, a person who is not a corporate employee, agent, subcontractor, or is not working on your company's behalf). Be aware that there can be a risk of Toll Fraud associated with your system and that, if Toll Fraud occurs, it can result in substantial additional charges for your telecommunications services.

#### Avaya Toll Fraud intervention

If You suspect that You are being victimized by Toll Fraud and You need technical assistance or support, call Technical Service Center Toll Fraud Intervention Hotline at +1-800-643-2353 for the United States and Canada. For additional support telephone numbers, see the Avaya Support website: <https://support.avaya.com> or such successor site as designated by Avaya.

#### Security Vulnerabilities

Information about Avaya's security support policies can be found in the Security Policies and Support section of <https://support.avaya.com/security>. Suspected Avaya product security vulnerabilities are handled per the Avaya Product Security Support Flow (<https://support.avaya.com/css/P8/documents/100161515>).

#### Downloading Documentation

For the most current versions of Documentation, see the Avaya Support website: <https://support.avaya.com>, or such successor site as designated by Avaya.

#### Contact Avaya Support

See the Avaya Support website: <https://support.avaya.com> for product or Hosted Service notices and articles, or to report a problem with your Avaya product or Hosted Service. For a list of support telephone numbers and contact addresses, go to the Avaya Support website: <https://support.avaya.com> (or such successor site as designated by Avaya), scroll to the bottom of the page, and select Contact Avaya Support.





# Index

## A

Abbreviated ring 21, 23, 145, 198

### Access Control

Fallback 123, 124, 125, 126, 127, 128, 163

Follow Me 33, 39, 40, 48, 49, 52, 53, 54, 55, 56, 58, 61, 68, 73, 76, 109, 111, 115, 116, 118, 119, 130, 139, 141, 146, 160, 161, 162, 163, 164

Forward 33, 39, 40, 48, 49, 52, 53, 54, 55, 56, 58, 61, 68, 73, 76, 109, 111, 115, 116, 118, 119, 130, 139, 141, 146, 160, 161, 162, 163, 164

Membership 123, 124, 125, 126, 127, 128, 163

State 123, 124, 125, 126, 127, 128, 163

### Add

Contact 44, 93, 102

Contact from Redial List 44, 93

External contact 88, 92, 94, 95

to conference call 78

Alarm 164, 177

### All

Call Log 29, 93, 99, 100, 101, 102

Contacts 29, 90, 91

Forward 52, 53, 162

All Calls 52, 53, 162

Almost Full 164, 177

A-Menu 15, 138, 186

Answered 29, 93, 99, 100, 101, 102

Appearance Buttons 19, 23, 25

Attention Ring 143

Audible Alerting 145

Audio Path 83, 85, 154

Auto-Answer 39, 146

## B

B 16

### Backup

Manual backup 155

Barred 16

BM32 9

Boot Error 164, 177

Bridge Appearance Button State 21

Bridged 19, 21, 25

Bridged appearance 19

Coverage ring 21, 23, 145, 198

Lights 21

Bridged Appearance Button Indication 21

Bridged Appearance Buttons 19, 21

broken dial tone 50, 57, 198, 199

### Busy

Forward 54, 55, 56, 161, 162

Button Module 9

## C

### Call

from Call Log 29, 99

from Contacts 29, 91

from redial list 30, 42

Call Appearance 19, 21

Call Appearance Button Indication 19

Call Appearance Button State 19

Call Appearance Buttons 19, 21

### Call coverage

Coverage ring 21, 23, 145, 198

Lights 23

Call Coverage Appearance 23

Call Coverage Button Indication 23

Call Coverage Button State 23

Call Log 29, 93, 99, 100, 101, 102

Call from 29, 99

Details 44, 100

Menu 15, 98, 187

Call Settings 32, 33, 43, 58, 76, 139, 140, 141, 142, 145, 148

Audible alerting on/off 145

Audio Path 83, 85, 154

Auto-Answer 39, 146

Internal Auto-Answer 39, 146

Visual alerting on/off 145

Withhold number 33, 139

Call Waiting 151

### Caller

Details 44, 100

Cannot 19, 21, 25

Cannot Be 19, 21, 25

Channel Name 25

Channels 25

### Conference

Add call 78

Caller details 79

Drop caller 79

End automatically 66, 78, 79

Hold 65, 79

Last internal user 66, 78, 79

Music on hold 65, 79

### Contact

Add 44, 93, 102

add external 88, 92, 94, 95

Add from Redial List 44, 93

delete external 88, 92, 94, 95

Edit 92, 94

edit external 88, 92, 94, 95

Contacts 15, 29, 88, 90, 91, 92, 94, 95

Make call 29, 91

Menu 188

Corrupt Date/Time 164, 177

Count 44, 100

Cover 19, 21, 23, 25

Coverage 23

Coverage ring 21, 23, 143, 145, 198

Covered User 23

CPkUp 68, 164

## D

D 16, 50, 199

Delay 19, 21, 23, 25

### Delete

External contact 88, 92, 94, 95

Follow me here 49, 161

### Details

Call Log 44, 100

Dial 19, 21, 25

### Dial tone

Broken 50, 57, 198, 199

### Directory

Add 44, 93, 102

add external 88, 92, 94, 95

Add from Redial List 44, 93

delete external 88, 92, 94, 95

Edit 92, 94

edit external 88, 92, 94, 95

---

Directory  
  Make call 29, 91  
  Menu 188

Display  
  Call Waiting 151

Divert  
  To voicemail 38, 111

Diverting 16, 50, 199

Do Not Disturb 16, 57, 198  
  Off 58, 160  
  Status 58, 160

**E**

Edit  
  Contact 92, 94  
  External contact 88, 92, 94, 95  
  Follow me here 49, 161

En-bloc 32, 141

En-Bloc Dial 32, 141

Expansion Failure 164, 177

External 29, 90, 91  
  Forward 52, 53, 162  
  Forward on Busy 54, 55, 56, 161, 162

External and Group 52, 53, 162

External Calls 143

external directory 88, 92, 94, 95

External Only 52, 53, 162

**F**

Failure 164, 177

Fast Flash 19, 21, 23, 25

Features  
  Menu 13, 181

Flash 19, 21, 23, 25

Follow me here  
  Clear 49, 161  
  Edit 49, 161  
  Off 161  
  Status 161

Follow Me To  
  Off 48, 160  
  Status 48, 160

Forward  
  All Calls 52, 53, 162  
  External and Group 52, 53, 162  
  External Only 52, 53, 162  
  Non Group Calls 52, 53, 162  
  Off 52, 53, 162  
  on Busy 54, 55, 56, 161, 162

Forward on Busy  
  Off 55, 161  
  Status 55, 161

Forward on No Answer  
  Off 54, 162  
  Status 54, 162

Forward Unconditional 52, 53, 162  
  Off 52, 162  
  Status 52, 162

Forwarded to Here  
  Off 163  
  Status 163

Forwarding 16, 50, 199

Full 164, 177

Fwd To Here 163

**G**  
G 16

Goes Off Hook 19, 23, 25

Group  
  Call log 15, 98  
  Forward 52, 53, 162  
  Membership status 123, 163  
  Missed 15, 98  
  Service status 125, 126, 127, 163

Group listen 84

Group Member 16

Groups 29, 90, 91

**H**

Handset  
  Volume 153

Headset 7, 8  
  Volume 83, 153

Held 19, 21, 23, 25

Held call  
  Transfer 66

Held Calls 19

Hold 19, 21, 23, 25  
  Conference 65, 79  
  Transfer 66

Hold Elsewhere 19, 21, 25

Hold Here 19, 21, 23, 25

Hunt group  
  Call log 15, 98  
  Forward 52, 53, 162  
  Membership status 123, 163  
  Missed 15, 98  
  Service status 127, 163

**I**

In Service 125, 126, 127, 163

Intermittent Flash 19, 21, 25

Internal Auto-Answer 39, 146

Internal Calls 143

**L**

Lamp 145

Line 25

Line Appearance 25

Line Appearance Button Indication 25

Line Appearance Button State 25

Line Appearance Buttons 25

Line Appearance ID 25

List 42, 43, 140

Locked  
  Menu 190

Login 115

**M**

Make call  
  from Call Log 29, 99  
  from Contacts 29, 91  
  from redial list 30, 42

Manual  
  Restore 156

matches 19, 21

Memory Card Failure 164, 177

Menu  
  A-Menu 15, 138, 186  
  Call Log 15, 98, 187  
  Contacts 15, 88, 188  
  Features 13, 181  
  Locked 190  
  Redial 15, 189

- Menu
  - Self Admin 183
  - Status 185
  - Status menu 13, 160
  - System Admin 191
  - Visual Voice 15, 184
- Message waiting lamp 145
- Missed 29, 93, 99, 100, 101, 102
- Missed calls
  - Hunt group calls 15, 98
- Mobile Twinning
  - Number 60, 139
  - Off 61, 164
  - On/Off 60, 139
  - Status 61, 164
- More 99, 105, 106, 107, 108
- Music on hold 65, 79
- N**
- N 16, 57, 198
- New
  - Contact 44, 93, 102
- Night Service
  - Automatic 125, 126, 127, 163
- No answer
  - Forward status 54, 162
- No Calls 16, 57, 198
- No ring 21, 23, 145, 198
- Non Group Calls 52, 53, 162
- number 25
- O**
- O 16, 125
- One 42, 43, 140
- OOS 125, 126, 127, 163
- Out of Service 16, 125, 126, 127, 163
- Outgoing 29, 93, 99, 100, 101, 102
- P**
- Parked calls
  - Status 68, 164
- Password 115
- Personal 29, 90, 91
- Phone User 116, 118, 119, 130, 141, 150, 151, 172, 173, 174, 175, 176
- phones display 19
- R**
- R 16
- Reason 44, 100
- Redial 15, 30, 42, 44, 93
  - Add to Contacts 44, 93
  - List 30, 42
  - Menu 189
- Redial mode 42, 43, 140
- requires 19, 23
- Resilience 16
- Restore 156
- Ring
  - Attention Ring 143
  - Coverage Ring 143
  - External Calls 143
  - Internal Calls 143
  - Ringback 143
- Ring Time 44, 100
- Ringback 143
- Ringer
  - Audible alerting on/off 145
  - Volume 146, 153
- Ringing Line Preference 19, 21, 23, 25
- S**
- S 16
- SBM32 9
- Select 19, 21, 23, 25
- Self Admin
  - Menu 183
- Send All Calls 52, 53, 162
- Socket
  - Headset 7, 8
- Speaker
  - Volume 85, 154
- Stand 7, 8
- Status
  - Do Not Disturb 58, 160
  - Follow Me here 161
  - Follow Me To 48, 160
  - Forward on Busy 55, 161
  - Forward on No Answer 54, 162
  - Forward unconditional 52, 162
  - Forwarded to Here 163
  - Group membership 123, 163
  - Group service status 127, 163
  - Hunt group service status 127, 163
  - Membership 123, 163
  - Menu 185
  - Mobile twinning 61, 164
  - Parked calls 68, 164
  - Service status 127, 163
  - Status menu 13, 160
  - Steady Flash 19, 21, 23, 25
  - System Admin
    - Menu 191
  - System Administrator 164, 177
  - System Alarm 16, 164, 177
  - System Boot Error 164, 177
  - System Phone 88, 92, 94, 95, 164, 177
- T**
- T 16, 59
- Time profile 125, 126, 127, 163
- Transfer
  - Held call 66
  - To voicemail 38, 72, 111
- Twinned 16, 59
- Twinning
  - Number 60, 139
  - Off 61, 164
  - On/Off 60, 139
  - Status 61, 164
- U**
- Use 19, 21, 23, 25
- Use Elsewhere 19, 21, 25
- Use Here 19, 21, 23, 25
- Users 29, 90, 91
- V**
- Visual Alerting 145
- Visual Voice 15
  - Menu 184
- Voicemail
  - Transfer 38, 72, 111
  - Voicemail Almost Full 164, 177

---

Voicemail Failure 164, 177

Voicemail Full 164, 177

Volume

Handset 153

Headset 83, 153

Ringer 146, 153

Speaker 85, 154

## **W**

Waiting Call 151

Withhold Number 33, 139



