



6219 and 6221 Telephones

Quick Reference

Document Ordering No. 555-230-713
Comcode 700195746
Issue 4, July 2001

IMPORTANT INFORMATION

SAFETY INSTRUCTIONS

The most careful attention has been devoted to quality standards in the manufacture of your new telephone. Safety is a major factor in the design of every set, but, safety is YOUR responsibility too.

Please read carefully the helpful tips listed below and on the next page. These suggestions will enable you to take full advantage of your new telephone. Then, retain these tips for later use.

Use

When using your telephone equipment, the following safety precautions should always be followed to reduce the risk of fire, electric shock, and injury to persons.

- Read and understand all instructions.
- Follow all warnings and instructions marked on the telephone.
- This telephone can be hazardous if immersed in water. To avoid the possibility of electric shock, do not use it while you are wet. If you accidentally drop the telephone into water, do not retrieve it until you have first unplugged the line cord from the modular jack. Then, call service personnel to ask about a replacement.
- Avoid using the telephone during electrical storms in your immediate area. There is a risk of electric shock from lightning. Urgent calls should be brief. Even though protective measures may have been installed to limit electrical surges from entering your business, absolute protection from lightning is impossible.
- If you suspect a natural gas leak, report it immediately, but use a telephone away from the area in question. The telephone's electrical contacts could generate a tiny spark. While unlikely, it is possible that this spark could ignite heavy concentrations of gas.
- Never push objects of any kind into the equipment through housing slots since they may touch hazardous voltage points or short out parts that could result in a risk of electric shock. Never spill liquid of any kind on the telephone. If liquid is spilled, however, refer servicing to proper service personnel.
- To reduce the risk of electric shock, do not disassemble this telephone. There are no user serviceable parts. Opening or removing covers may expose you to hazardous voltages. Incorrect reassembly can cause electric shock when the telephone is subsequently used.

Service

- Before cleaning, unplug the telephone from the modular wall jack. Do not use liquid cleaners or aerosol cleaners. Use a damp cloth for cleaning.
- Unplug the telephone from the modular wall jack. Be sure to refer servicing to qualified service personnel when these conditions exist:
 - If liquid has been spilled into the telephone.
 - If the telephone has been exposed to rain or water.
 - If the telephone has been dropped or the housing has been damaged.
 - If you note a distinct change in the performance of the telephone.

SAVE THESE INSTRUCTIONS



When you see this warning symbol on the product, refer to these instructions packed with the product for more information before proceeding further in the installation process.

OTHER INFORMATION

NOTICE

While reasonable efforts were made to ensure that the information in this document was complete and accurate at the time of printing, Avaya can assume no responsibility for any errors. Changes or corrections to the information contained in this document may be incorporated into future issues.

TO ORDER COPIES OF THIS DOCUMENT

Contact: Avaya Publications Center
Attn: Avaya Account Management
200 Ward Hill Avenue
Haverhill, MA 01835
Voice 1 800 457-1235
Fax 1 800 457-1764

Order: Document No. 555-230-713
Issue 4, July 2001

TRADEMARKS

DEFINITY and MERLIN LEGEND are registered trademarks of Avaya Inc.

HEARING AID COMPATIBILITY

These telephones are Hearing Aid Compatible (HAC) and thus have "HAC" printed on them.

ACKNOWLEDGMENT

This document was prepared by the Avaya University, Avaya Inc., Westminster, CO 80234.

THE 6219 and 6221 TELEPHONES

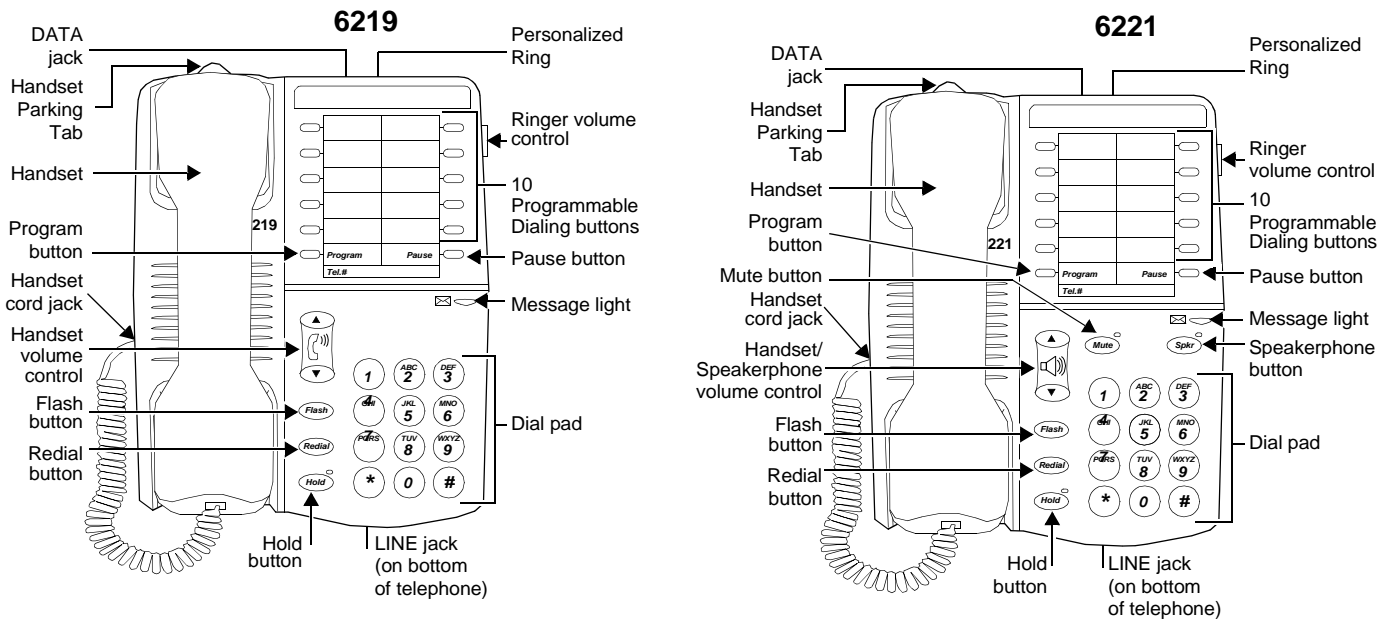











Figure 1. The 6219 and 6221 Telephones, Top View

NOTE: The 6219 and 6221 telephones are designed for use with a DEFINITY®, PARTNER®, or MERLIN LEGEND® system.

NOTE: On all 6219 and 6221 telephones, there is a smooth, indented area in the lower handset cradle (left of the Hold button). This indentation will accept a standard 0.5" x 1.75" label, such as the Avery 5267 Return Address label. The labels are available on 8-1/2" x 11" laser-printable sheets. The extension number, entire telephone number, or other information can be typed on the labels. There is a template in Microsoft Word for Windows '97 or newer that simplifies the preparation of these labels.

- ◆ **DATA jack** — For connecting a device such as a modem to your telephone. This jack is labeled .
- ◆ **Handset Parking tab** — If your telephone is mounted on the wall, you can place the handset on the Handset Parking tab while you tend to other business. In this way you can interrupt a call in progress without disconnecting.
- ◆ **Handset** — For placing and receiving calls.
- ◆ **Program button** — For storing telephone numbers on the programmable dialing buttons.
- ◆ **Mute button (on the 6221 only)** — On the 6221 telephone, this button is used for turning off the microphone associated with the handset or built-in speakerphone so the other person on the call cannot hear you.
- ◆ **Handset cord jack** — For connecting the handset to your telephone.
- ◆ **Handset and Speakerphone volume control** — The volume control (labeled  on the 6219 and  on the 6221) is used for raising or lowering the volume of the handset (on the 6219), or for raising or lowering the volume of the handset or the speakerphone (on the 6221), whichever is active. To raise the volume level, press the upper half of the button labeled ; to lower the volume, press the lower half of the button labeled .
- ◆ **Flash button** — For using features such as Conference with business communications system.
- ◆ **Redial button** — For redialing the last number you dialed from the dial pad or from a programmable dialing button.
- ◆ **Hold button** — The Hold button is used for putting a call on hold. The red light next to  goes on to remind you that you have a call on hold.

- ◆ **Personalized Ring** — Allows you to select one of two different ringing patterns. This two ringing patterns are labeled .
- ◆ **Ringer volume control** — A 3-position switch to control the volume for the tone ringer. Slide it up (away from you) for a louder ring, down (toward you) for a quieter ring. The volume control is labeled .
- ◆ **10 Programmable dialing buttons** — The 10 buttons on which you can program frequently dialed telephone numbers, emergency numbers, or feature codes.
- ◆ **Pause button** — For inserting a 1.5-second pause delay into a telephone number stored on a programmable dialing button.
- ◆ **Message light** — A red light that flashes when a message has been left for you or when a call is coming in (that is, when the telephone is ringing). This light is labeled .
- ◆ **Speaker button (on 6221 only)** — On the 6221 telephone, this button is used to access the built-in two-way speakerphone and microphone combination.
- ◆ **Dial pad** — The standard 12-button pad for dialing telephone numbers. The letters "Q" and "Z" have been added to the appropriate dial pad keys for directory access, and the "5" button on your dial pad has raised bars for visually-impaired users.
- ◆ **LINE jack (on bottom of the telephone)** — For connecting a line cord to your telephone. This jack is labeled LINE.

INSTALLATION

TABLE/DESK INSTALLATION

Use the 14-foot straight line cord that came with your telephone to connect the telephone to a modular jack.

WARNING:

Do not plug the handset cord into the line jack or the data jack on your telephone since it could damage your handset and the telephone.

1. Turn the telephone upside down so that you can see the bottom of the telephone. See Figure 2.

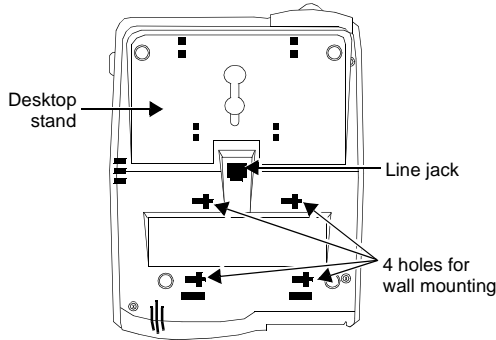

Figure 2. The Bottom of the 6200 Series Telephones

2. Remove the desk stand by sliding it to the left until it is free of the telephone base. See Figure 3.

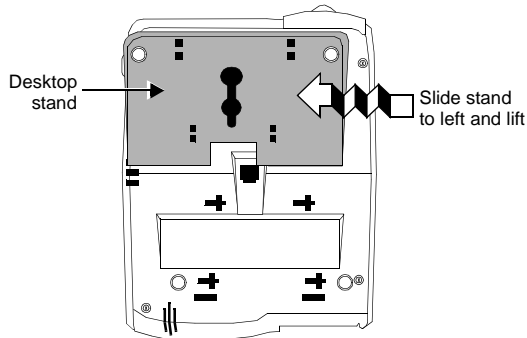

Figure 3. Sliding the Base from the Bottom of the Set

3. Plug one end of the line cord into the line jack on the bottom of the telephone.
4. Align the other end of the line cord so that it is threaded through the slot at the top of the stand. See Figure 4.
5. Reattach the stand to the telephone by sliding the stand into the appropriate tabs and to the right.

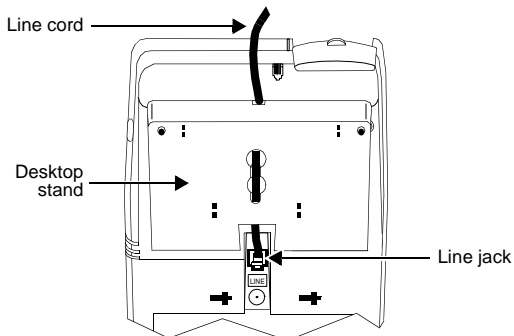

Figure 4. Attaching the Line Cord and Threading It Through the Slot at the Top of the Desktop Stand

6. After you have attached the stand to the telephone, use the screw provided to tighten the stand onto the back of the telephone set.

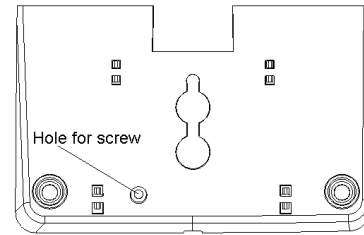



Figure 5. Tightening the Stand to Back of the Telephone

7. Turn the telephone right-side up and place it on your desk or table.
8. Plug one end of the coiled handset cord into the handset jack on the side of the telephone.
9. Plug the other end of the handset cord into the handset.
10. Hang up the handset.
11. Plug the free end of the line cord into a modular wall jack.
12. Lift the handset and listen for dial tone.
13. Set the Ringer volume control (labeled ) to the setting you want.

WALL INSTALLATION

Use the following directions to mount the telephone on a standard wallphone jack with mounting studs.

NOTE: For wall installation, use an 8-inch cord (PEC: 2725-02A; Comcode: 103789293) rather than the 14-foot cord that is packaged with the telephone.

1. You must reverse the handset tab (which holds the handset when you hang up). See Figure 5.
 - Hold down the switchhook and slide the handset tab up and out of its slot.
 - Turn the tab so that the curved end is facing up.
 - Insert the tab back into its slot.

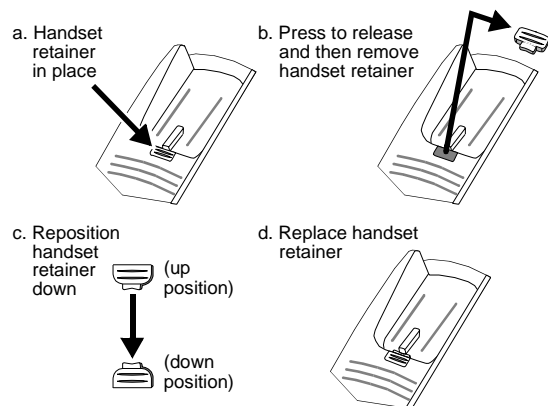

Figure 6. Reversing the Handset Hook

2. Turn the telephone upside down so that you can see the bottom of the telephone.
3. Remove the mounting base by sliding the base to the left until it is free of the telephone. See Figure 3.
4. Turn the base so the larger end is down.
5. Plug one end of the 8-inch line cord into the line jack on the bottom of the telephone.

- Slide the reversed base onto the telephone, to the right, until it snaps into place. See Figure 6.

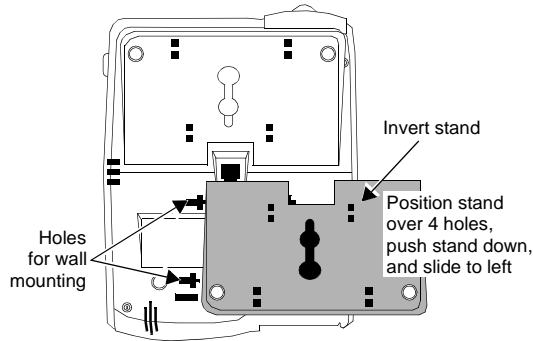

Figure 7. Installing the Stand for Wall Mounting

- After you have attached the stand to the telephone, use the screw provided to tighten the stand onto the back of the telephone set. See Figure 5.
- Plug one end of the coiled handset cord into the handset jack on the side of the telephone.
- Plug the free end of the line cord into a modular wall jack.
- Place the telephone against the wall jack mount and push down so that the base locks into the slots on the telephone.
- Plug the free end of the coiled handset cord into the handset and hang up the handset.
- Lift the handset and listen for dial tone.
- Set the Ringer volume control (labeled to the settings you want.

PROCEDURES

ANSWERING AND PLACING A CALL

To answer or place a call

NOTE: The Message light flashes when a call is coming in (that is, when the telephone is ringing).

- To place a call:** On the 6219 telephone, lift the handset. On the 6221 telephone, you can either lift the handset or press **Spkr**.
To answer a call: On the 6219 telephone, lift the handset. On the 6221 telephone, you can either lift the handset or press **Spkr**.

NOTE: You can also use a programmable dialing button to place a call if you have programmed a button for that number.

- If you press **Spkr** (on the 6221 telephone), the light next to the button goes on.
- To place a call, next, dial the desired number.
 - To end the call:** On the 6219, hang up the handset. On the 6221 telephone, hang up the handset or press **Spkr**, whichever is active.

NOTE: To raise the volume of the handset or speakerphone (on the 6221), whichever is active, use the Volume control button labeled on the 6219 and on the 6221. Press the top half of the Volume control button labeled ; to lower the volume of the handset, press the lower half of the Handset volume control button labeled .

HOLD

To put a call on hold

- Press **Hold**.
 - The red light next to **Hold** goes on.

To return to the held call

- Press **Hold**, or, if you have hung up the handset, pick up the handset again from the cradle.
 - The red light next to **Hold** goes off.
 - You are reconnected to the other party.

MESSAGE

To retrieve a message when your Message light is blinking

See your system manager for instructions about your local message retrieval procedures.

NOTE: The Message light also flashes when a call is coming in (that is, when the telephone is ringing).

MUTE (available only on the 6221 telephone)

To prevent the other party from hearing you (To mute the microphone)

Press **Mute**.

- Red light next to **Mute** goes on, and the other party cannot hear you.

To resume talking to the other party (To turn on the microphone again)

Press **Mute**.

- Red light next to **Mute** goes off, and you can resume conversation with other party.

PERSONALIZED RING and RINGER VOLUME

To select a personalized ringing pattern for your telephone

There are two possible ringing patterns you may select for your telephone.

- Move the switch to either of the two settings, .

To control the volume of the tone ringer

The Ringer volume control on your telephone is labeled to remind you that there are three separate volume settings.

- To raise the volume of the ringer, slide the Ringer volume control upwards; to lower the volume of the ringer, slide the Ringer volume control downwards.

PROGRAMMABLE DIALING

The 10 programmable dialing buttons are provided for one-touch dialing of frequently dialed telephone numbers. You can also store emergency numbers, such as 911, and feature codes on these buttons.

Shipped with each telephone is a button designation card on which you can write the names or numbers or codes stored on each of the programmable dialing buttons. Use the procedure below to label and then reinstall the designation card.

Laser-printable paper Designation Cards are available for labeling the Programmable Dialing buttons. They are available in both 8-1/2" x 11" and A4 size sheets in three different languages (English, Latin American Spanish, and sets with icon-labeled buttons). Contact your Avaya sales representative for ordering information.

You can program up to 24 elements (digits and characters such as a # or *) on a programmable dialing button. If the number you want to store is longer than 24 elements, you can do one of the following:

- Store up to 24 elements on one button; store the remainder of the elements on a second button. To place a call using these buttons, press the first button; when *all* of the elements have been dialed, press the second button in the sequence.
- Store up to 24 elements on one button; dial the remainder of the digits and characters manually.

To label and reinstall the programmable dialing buttons designation card on your telephone

1. Remove the plastic card cover from the telephone by placing your fingers at the top and bottom and flexing the card outward. Then, lift the button designation card from out of its cavity on the telephone.
2. In the blank space next to the appropriate programmable dialing button, write or type the name or telephone number that you want to store there.
3. Place the designation card back on the telephone. Replace the plastic card cover over the designation card by fitting the cover's bottom tabs into the slots on the telephone and pressing down, allowing the tabs on the top to snap into place.

To program any of the 10 programmable dialing buttons (while on-hook)

1. Press the **Program** button to enter programming mode.
 - You hear a low continuous tone while you are in programming mode.
2. Press programmable dialing button on which you want to store the number.
 - Tone is briefly interrupted twice.
3. Dial number you want to program on the button. You can use up to 24 elements (digits and characters, including Pause and Flash).
 - The tone to remind you that you are in programming mode is interrupted at each time you press a dial pad key, the **Pause** button or **Flash**.
 - You hear a rapid error tone if you try to enter more than 24 elements, and you will exit Program mode *without* saving the new number.
 - You can use the **Pause** button to program a 1.5-second pause between a dialing access number, such as 9, and the telephone number, and for certain banking and long-distance services.
 - For example, to put a pause between the dialing access number, 9, and the telephone number, press the **Pause** button, then 12125551234. Several depressions of the **Pause** button will produce a multiple of a 1.5-second pause. (For instance, two depressions of the **Pause** button would equal 3 seconds.)

NOTE: Programmable dialing buttons can also be used to program system features. See your system manager for system feature codes.

4. To program another programmable dialing button, repeat Steps 2 and 3.
5. Press the **Program** button when you are ready to exit programming mode.

To dial a number with a programmable dialing button

1. Pick up handset or press **Spkr**.
2. When you hear dial tone, press the appropriate programmable dialing button.
 - Number programmed on the button is automatically dialed.

To erase a number stored on a programmable dialing button

1. Press the **Program** button.
2. Press the button to be cleared.
3. Press the **Program** button again.



REDIAL

To redial the last number that you dialed

1. While off-hook, press **Redial**.
 - The telephone will redial up to 24 digits.

SPEAKERPHONE (available only on the 6221 telephone)

To place/answer a call without lifting the handset

1. Press **Spkr**.
 - Red light next to **Spkr** goes on.
2. Place or answer call.
 - Adjust speakerphone volume, if desired. On the Volume control button (labeled ) , do the following: To raise the volume level, press the upper half of the button labeled ; to lower the volume, press the lower half of the button labeled .
3. Press **Spkr** again to hang up.
 - Red light next to **Spkr** goes off.

To change from speakerphone to handset

1. Pick up handset and talk.
 - Red light next to **Spkr** goes off.

To change from handset to speakerphone

1. During a call using handset, press **Spkr**.
 - Red light next to **Spkr** goes on.
2. Hang up handset.

FOR THE SYSTEM MANAGER ONLY

The following procedures should be performed only by the system manager.

Enabling and Disabling the System Hold Feature

The Hold button (**Hold**) can be programmed, at each individual set, either as the normal Hold feature or as an alternate feature such as Call Park. The default setting is for normal Hold.

To program **Hold** as an alternate feature such as Call Park

1. Press the **Program** button; then press **Flash**; then press **Hold**.
2. Press "797 (SYS)" on the dial pad.
3. Press **Flash** again; then press the **Program** button again.
4. Program the button with the feature access code of the alternate feature (such as Call Park). For programming instructions, see "Programmable Dialing."

NOTE: As long as **Hold** is not being used for the Hold feature, the light next to **Hold** will not go on when the alternate feature is activated.

To program **Hold for normal Hold (that is, the feature which allows the user to put a call on hold)**

1. Press the **Program** button; then press **Flash**; then press **Hold**.
2. Press **Hold** again; then press **Flash** again; finally, press the **Program** button again.

Locking and Unlocking the Programmable Dialing Buttons

The system manager can lock the 10 programmable dialing buttons so the numbers or features assigned to these buttons CANNOT be changed.

To lock the Programmable Dialing buttons so that their assignment cannot be changed

1. Press the **Program** button; then press **Flash**.
2. Press “752 (RLC)” on the dial pad.
3. Press **Flash** again; then press the **Program** button again.

To unlock the Programmable Dialing buttons

1. Press the **Program** button; then press **Flash**.
2. Press “766 (RNO)” on the dial pad.
3. Press **Flash** again; then press the **Program** button again.

— FCC Information —

FCC REGISTRATION AND REPAIR INFORMATION

Your new Avaya telephone has been registered with the Federal Communications Commission (FCC). This product complies with standards in Part 68 of the FCC rules. The FCC requires us to provide you with the following information:

CONNECTION AND USE WITH THE NATIONWIDE TELEPHONE NETWORK

The FCC requires that you connect your telephone equipment to the nationwide telephone network through a modular telephone outlet or jack. The modular telephone outlet or jack to which the telephone must be connected is a USOC RJ11C or RJ11W. The telephone may not be used on coin service provided by the telephone company. Connection to party lines is subject to state tariffs. (Contact your state public utility commission or corporation commission for information.)

INFORMATION FOR THE TELEPHONE COMPANY

Upon request of your local telephone company, you are required to provide them with the following information: **A.)** Your phone number. **B.)** The telephone equipment’s FCC registration number and ringer equivalence number (REN). These numbers are on the back or bottom of your telephone equipment. The REN is useful to determine how many devices you may connect to your telephone line and still have them ring when your telephone line is called. At most, but not all areas, the sum of all REN’s should be 5 or less. You may want to contact your local telephone company.

REPAIR INSTRUCTIONS

If it is determined that your telephone is malfunctioning, the FCC requires that it not be used and that it be unplugged from the modular outlet until the problem is corrected. Repairs can only be made by the manufacturer or its authorized agents or by others who may be authorized by the FCC.

RIGHT OF THE TELEPHONE COMPANY

If telephone equipment is causing harm to the telephone network, the telephone company may temporarily discontinue your telephone service. If possible, they’ll notify you before they interrupt service. If advance notice isn’t practical, you’ll be notified as soon as possible. You’ll be given the opportunity to correct the problem, and you’ll be informed of your right to file a complaint with the FCC. Your telephone company may make changes in its facilities, equipment, operations or procedures that could affect the proper functioning of your Avaya product. If such changes are planned, you will be notified.

INTERFERENCE INFORMATION

WARNING:

Some telephone equipment generates and uses radio frequency energy and if not installed and used properly, that is, in strict accordance with the manufacturer’s instructions, may cause interference to radio and television reception. These telephones have been type tested and found to comply with the limits for a Class B computing device in accordance with the specifications in Subpart J of Part 15 of FCC Rules, which are designed to provide reasonable protection against such interference in a residential installation.

However, there is no guarantee that interference will not occur in a particular installation. If this equipment does cause interference to radio or television reception, which can be determined by turning the equipment on and off, the user is encouraged to try to correct the interference by one or more of the following measures:

- Reorient the receiving television or radio antennae where this may be done safely.
- To the extent possible, relocate the receiver with respect to the telephone equipment.
- Where the telephone equipment requires ac power, plug the telephone into a different ac outlet so that the telephone equipment and receiver are on different branch circuits.

— Warranty Information —

AVAYA WARRANTY INFORMATION

WHAT IS COVERED: All terms and conditions specified in your agreement with Avaya apply.

TO GET WARRANTY SERVICE FOR YOUR

TELEPHONE: Call the Avaya Customer Service Support Operations toll-free at 1 800 242-2121 or call the distributor from whom the product was purchased. If you are directed to ship your telephone to an authorized service location, you must prepay all shipping costs. We suggest that you retain the original packing material in the event you need to ship the unit. When sending your telephone to a service location, include your name, address, phone number, proof of purchase (or original shipping receipt), and description of the operating problem. After replacing your telephone, Avaya will ship it to you at no cost to you



Prepared by
Avaya University
Avaya Inc.
Westminster, CO 80234

Copyright 2001