

## **FCC Information and Copyright**

This equipment has been tested and found to comply with the limits of a Class B digital device, pursuant to Part 15 of the FCC Rules. These limits are designed to provide reasonable protection against harmful interference in a residential installation. This equipment generates, uses, and can radiate radio frequency energy and, if not installed and used in accordance with the instructions, may cause harmful interference to radio communications. There is no guarantee that interference will not occur in a particular installation.

The vendor makes no representations or warranties with respect to the contents here and specially disclaims any implied warranties of merchantability or fitness for any purpose. Further the vendor reserves the right to revise this publication and to make changes to the contents here without obligation to notify any party beforehand.

Duplication of this publication, in part or in whole, is not allowed without first obtaining the vendor's approval in writing.

The content of this user's manual is subject to be changed without notice and we will not be responsible for any mistakes found in this user's manual. All the brand and product names are trademarks of their respective companies.



**Dichiarazione di conformità  
sintetica**

Ai sensi dell'art. 2 comma 3 del D.M.  
275 del 30/10/2002

Si dichiara che questo prodotto è  
conforme alle normative vigenti e  
soddisfa i requisiti essenziali richiesti  
dalle direttive

2004/108/CE, 2006/95/CE e  
1999/05/CE

quando ad esso applicabili

**Short Declaration of conformity**

We declare this product is complying  
with the laws in force and meeting all  
the essential requirements as specified  
by the directives

2004/108/CE, 2006/95/CE and  
1999/05/CE

whenever these laws may be applied

---

---

## Table of Contents

---

---

<b>Chapter 1: Introduction</b> .....	<b>1</b>
1.1 Before You Start .....	1
1.2 Package Checklist .....	1
1.3 Motherboard Features.....	2
1.4 Rear Panel Connectors.....	3
1.5 Motherboard Layout.....	4
<b>Chapter 2: Hardware Installation</b> .....	<b>5</b>
2.1 Installing Central Processing Unit (CPU).....	5
2.2 Install a Heatsink .....	6
2.3 Fan Headers .....	7
2.4 Installing System Memory.....	8
2.5 Connectors and Slots .....	10
<b>Chapter 3: Headers &amp; Jumpers Setup</b> .....	<b>13</b>
3.1 How to Setup Jumpers .....	13
3.2 Detail Settings.....	13
<b>Chapter 4: UEFI BIOS &amp; Software</b> .....	<b>17</b>
4.1 UEFI BIOS Setup.....	17
4.2 BIOS Update.....	17
4.3 Software.....	22
<b>Chapter 5: Useful Help</b> .....	<b>24</b>
5.1 Driver Installation.....	24
5.2 AMI BIOS Beep Code.....	25
5.3 Troubleshooting.....	25
5.4 RAID Functions .....	27
<b>Appendix: SPEC In Other Languages</b> .....	<b>32</b>
German .....	32
French .....	34
Italian .....	36
Spanish.....	38
Portuguese .....	40
Polish .....	42
Russian .....	44
Arabic.....	46
Japanese.....	48

---

---

## **CHAPTER 1: INTRODUCTION**

### **1.1 Before You Start**

Thank you for choosing our product. Before you start installing the motherboard, please make sure you follow the instructions below:

- Prepare a dry and stable working environment with sufficient lighting.
- Always disconnect the computer from power outlet before operation.
- Before you take the motherboard out from anti-static bag, ground yourself properly by touching any safely grounded appliance, or use grounded wrist strap to remove the static charge.
- Avoid touching the components on motherboard or the rear side of the board unless necessary. Hold the board on the edge, do not try to bend or flex the board.
- Do not leave any unfastened small parts inside the case after installation. Loose parts will cause short circuits which may damage the equipment.
- Keep the computer from dangerous area, such as heat source, humid air and water.
- The operating temperatures of the computer should be 0 to 45 degrees Celsius.
- To avoid injury, be careful of:
  - Sharp pins on headers and connectors
  - Rough edges and sharp corners on the chassis
  - Damage to wires that could cause a short circuit

### **1.2 Package Checklist**

- Serial ATA Cable x2
- Rear I/O Panel for ATX Case x1
- User's Manual x1
- Fully Setup Driver DVD x1

**Note:** The package contents may be different due to the sales region or models in which it was sold. For more information about the standard package in your region, please contact your dealer or sales representative.

## 1.3 Motherboard Features

SPEC		
CPU	Socket AM3+ AMD Sempron / Phenom II / Athlon II / FX processors (Maximum Watt: 140W)	AMD 64 Architecture enables 32 and 64 bit computing Supports Hyper Transport 3.0
FSB	Support HyperTransport 3.0 Supports up to 4.8 GT/s Bandwidth	
Chipset	AMD 970 AMD SB950	
Super I/O	ITE 8728F-BX Provides the most commonly used legacy Super I/O functionality Low Pin Count Interface	Environment Control initiatives HW Monitor Fan Speed Controller ITE's "Smart Guardian" function
Main Memory	DDR3 DIMM Slots x 4 Max Memory Capacity 64GB Each DIMM supports 512MB/ 1GB/2GB/4GB/8GB/16GB DDR3	Dual Channel Mode DDR3 memory module Supports DDR3 800/1066/1333/1600/1866 Supports DDR3 2000 (OC)
SATA III	Integrated Serial ATA Controller	Data transfer rates up to 6 Gb/s. SATA Version 3.0 specification compliant. RAID 0,1,5,10 support
LAN	Realtek RTL 8111F	10 / 100 Mb/s / 1Gb/s auto negotiation Half / Full duplex capability
Sound	ALC892	7.1channels audio out Supports HD Audio
USB3.0	Asmedia ASM1042 A4	Data transfer rates up to 600 MB/s
Slots	PCI Slot x2 PCI Express Gen2 x1 Slot x2 PCI Express Gen2 x16 Slot x2	Supports AMD CrossFireX™ (x16 + x4)
On Board Connectors	SATA Connector x6 Front Panel Connector x1 Front Audio Connector x1 S/PDIF out Connector x1 Consumer IR Connector x1 CPU Fan Header x1 System Fan Header x2 CMOS clear Header x1 USB2.0 Connector x2 Printer Port Connector x1	Each connector supports 1 SATA device Supports front panel facilities Supports front panel audio function Supports digital audio out function Supports infrared function CPU Fan power supply (with Smart Fan function) System Fan Power supply Restore CMOS data to factory default Each connector supports 2 front panel USB2.0 ports Each connector supports 1 Printer port

SPEC			
	Serial Port Connector	x1	Connects to RS-232 Port
	Power Connector (24-Pin)	x1	Connects to Power supply
	Power Connector (4-Pin)	x1	Connects to Power supply
Back Panel I/O	PS/2 Keyboard	x1	Connects to PS/2 Keyboard
	PS/2 Mouse	x1	Connects to PS/2 Mouse
	LAN port	x1	Connect to RJ-45 ethernet cable
	USB2.0 Port	x6	Connect to USB2.0 devices
	USB3.0 Port	x2	Connect to USB3.0 devices (by Asmedia ASM1042 A4) and USB2.0/USB1.X devices (by SB950)
	Audio Jack	x6	Provide Audio-In/Out and Mic. connection
Board Size	305 mm (L) x 225 mm (W)		ATX
OS Support	Windows XP / Vista / 7 / 8		Biostar reserves the right to add or remove support for any OS With or without notice.

### 1.4 Rear Panel Connectors

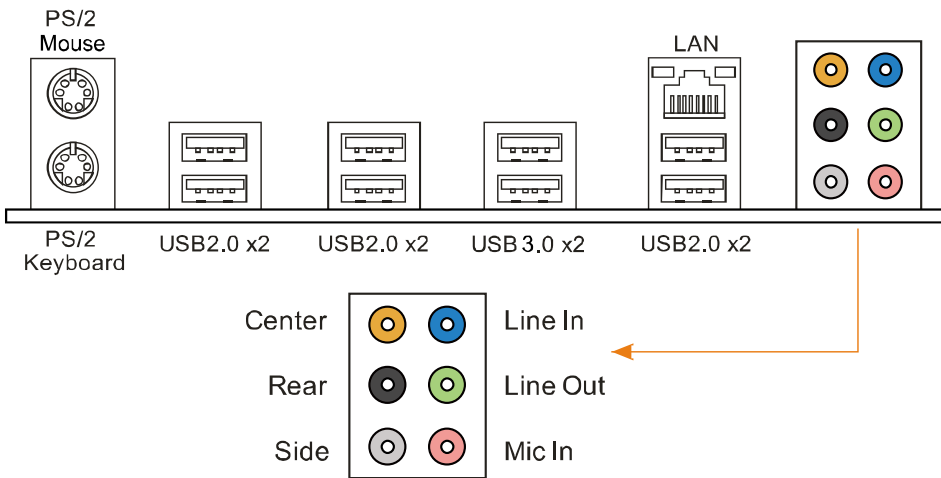

## 1.5 Motherboard Layout

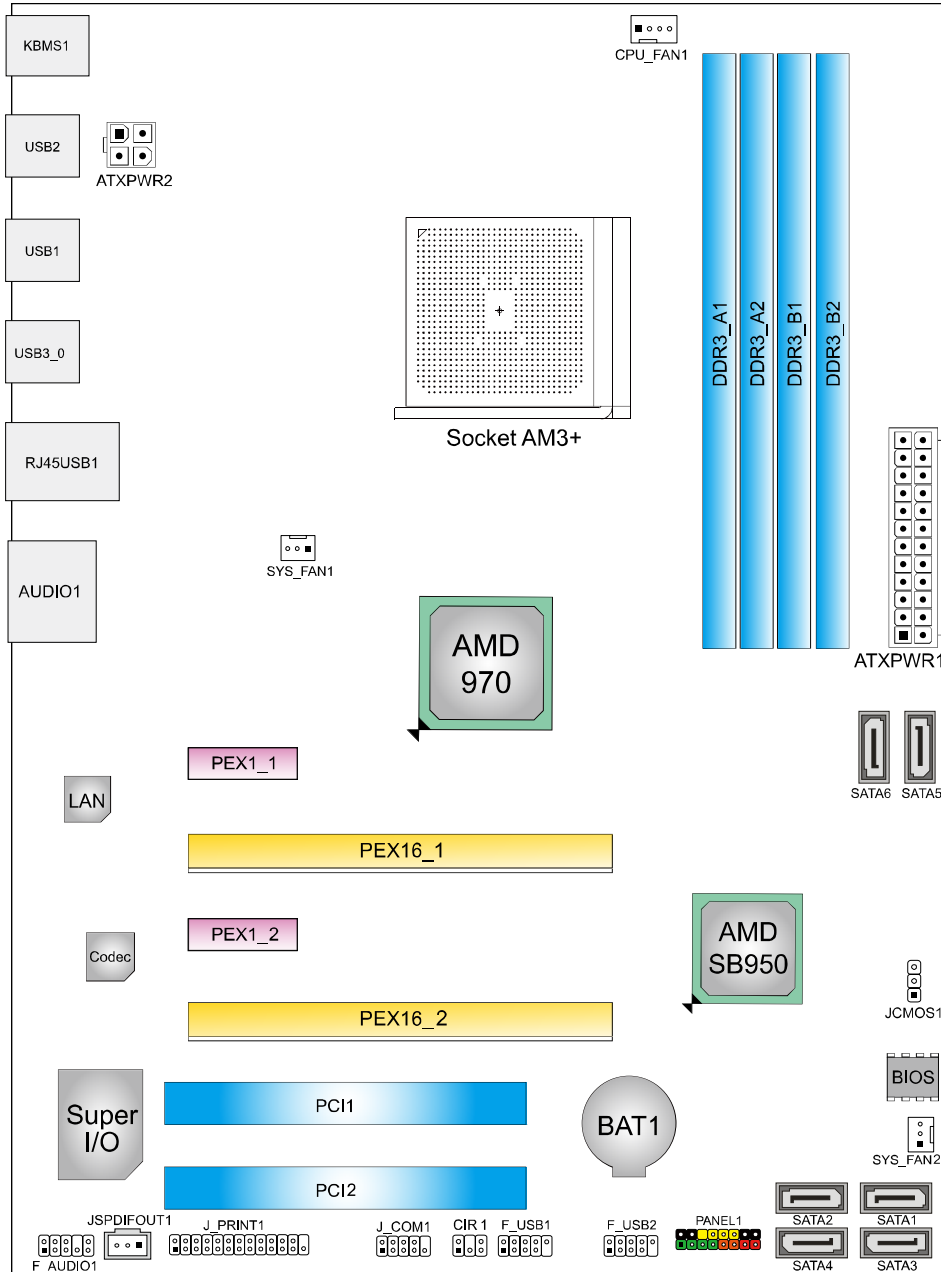

**Note1:** ■ represents the 1st pin.

## CHAPTER 2: HARDWARE INSTALLATION

### 2.1 Installing Central Processing Unit (CPU)

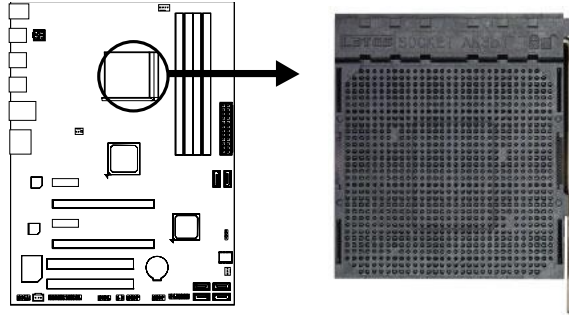

**Step 1:** Pull the lever toward direction A from the socket and then raise the lever up to a 90-degree angle.

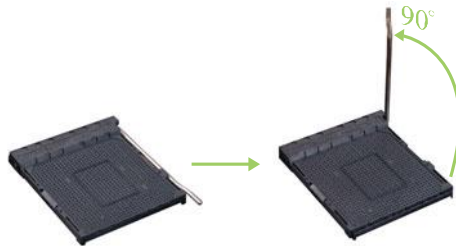

**Step 2:** Look for the white triangle on socket, and the gold triangle on CPU should point towards this white triangle. The CPU will fit only in the correct orientation.

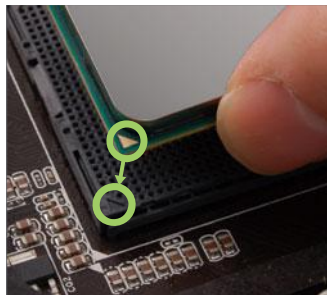

**Note:** The CPU fits only in one correct orientation. Do not force the CPU into the socket to prevent damaging the CPU.

**Step 3:** Hold the CPU down firmly, and then close the lever toward direct B to complete the installation.

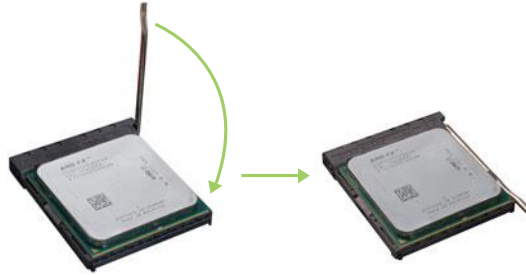

## 2.2 Install a Heatsink

**Step 1:** Place the heatsink and fan assembly onto the retention frame. Match the heatsink clip with the socket mounting-lug. Hook the spring clip to the mounting-lug.

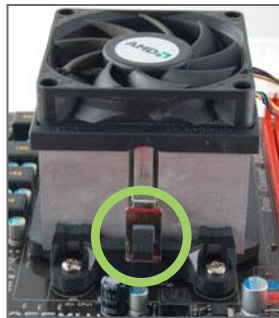

**Step 2:** On the other side, push the retention clip straight down to lock into the plastic lug on the retention frame, and then press down the locker until it stops.



**Note1:** Do not forget to connect the CPU fan connector.  
**Note2:** For proper installation, please kindly refer to the installation manual of your CPU heatsink.



## 2.3 Fan Headers

These fan headers support cooling-fans built in the computer. The fan cable and connector may be different according to the fan manufacturer. Connect the fan cable to the connector while matching the black wire to pin#1.

### CPU\_FAN1: CPU Fan Header

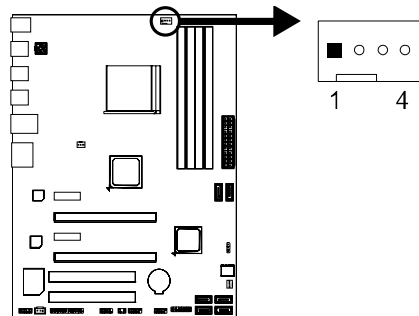

Pin	Assignment
1	Ground
2	+12V
3	FAN RPM rate sense
4	Smart Fan Control (By Fan)

### SYS\_FAN1/2: System Fan Header

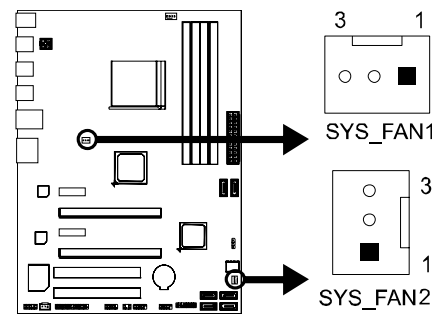

Pin	Assignment
1	Ground
2	+12V
3	FAN RPM rate sense

**Note:** CPU\_FAN1, SYS\_FAN1/2 support 4-pin and 3-pin head connectors. When connecting with wires onto connectors, please note that the red wire is the positive and should be connected to pin#2, and the black wire is Ground and should be connected to GND.

## 2.4 Installing System Memory

### A. DDR3 Modules

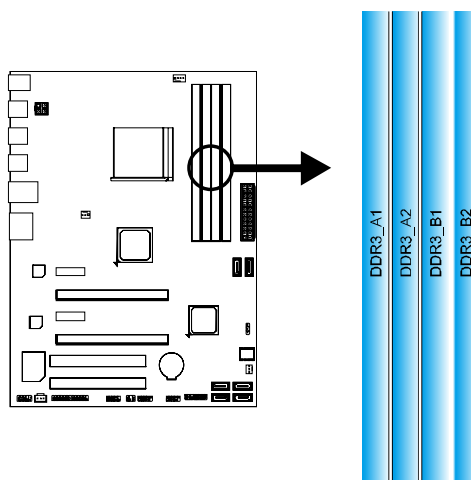

**Step 1:** Unlock a DIMM slot by pressing the retaining clips outward. Align a DIMM on the slot such that the notch on the DIMM matches the break on the slot.

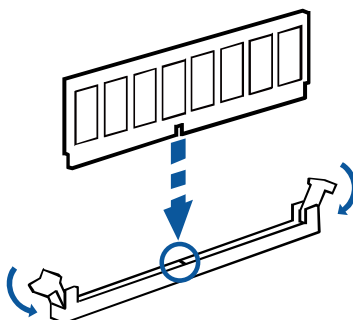

**Step 2:** Insert the DIMM vertically and firmly into the slot until the retaining chip snap back in place and the DIMM is properly seated.

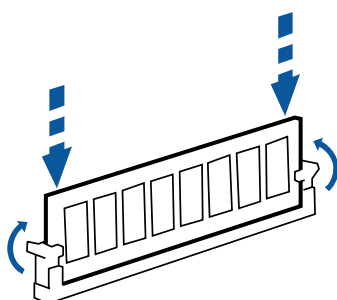

**Note:** If the DIMM does not go in smoothly, do not force it. Pull it all the way out and try again.

## B. Memory Capacity

DIMM Socket Location	DDR3 Module	Total Memory Size
DDR3_A1	512MB/1GB/2GB/4GB/8GB/16GB	Max is 64GB.
DDR3_A2	512MB/1GB/2GB/4GB/8GB/16GB	
DDR3_B1	512MB/1GB/2GB/4GB/8GB/16GB	
DDR3_B2	512MB/1GB/2GB/4GB/8GB/16GB	

## C. Dual Channel Memory Installation

Please refer to the following requirements to activate Dual Channel function:

Install memory module of the same density in pairs, shown in the table.

Dual Channel Status	DDR3_A1	DDR3_A2	DDR3_B1	DDR3_B2
Enabled	X	O	X	O
Enabled	O	O	O	O

(O means memory installed, X means memory not installed.)

**Note1:** The DRAM bus width of the memory module must be the same (x8 or x16)

**Note2:** Memory module must be installed in DDR3-A2 or DDR3-B2 to boot the system.

## D. DDR Speed Support

Please refer to the following table for DDR speed reference:

# of DIMM per Channel	DDR Speed (1.5V)		
	DDR3-1333	DDR3-1600	DDR3-1866
1 of 2 UDIMMs	O	O	O
2 of 2 UDIMMs	O	O	X

## 2.5 Connectors and Slots

### ATXPWR2: ATX Power Source Connector

This connector provides +12V to CPU power circuit.

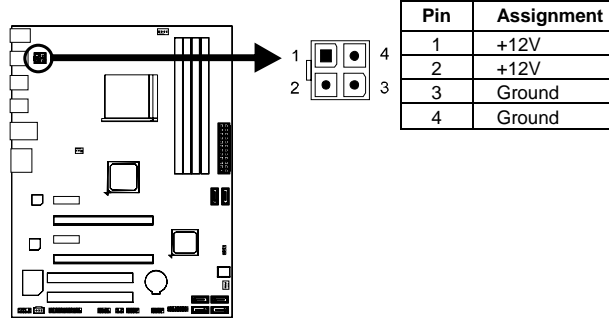

### ATXPWR1: ATX Power Source Connector

This connector allows user to connect 24-pin power connector on the ATX power supply.

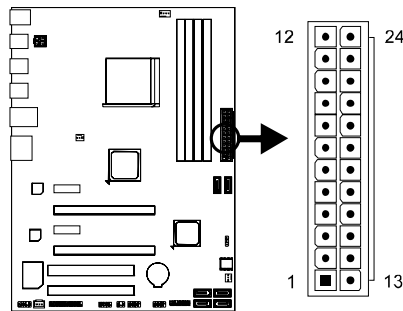

Pin	Assignment	Pin	Assignment
13	+3.3V	1	+3.3V
14	-12V	2	+3.3V
15	Ground	3	Ground
16	PS_ON	4	+5V
17	Ground	5	Ground
18	Ground	6	+5V
19	Ground	7	Ground
20	NC	8	PW_OK
21	+5V	9	Standby Voltage+5V
22	+5V	10	+12V
23	+5V	11	+12V
24	Ground	12	+3.3V

**Note1:** Before you power on the system, please make sure that both ATXPWR1 and ATXPWR2 connectors have been plugged-in.

**Note2:** Insufficient power supplied to the system may result in instability or the peripherals not functioning properly. Use of a PSU with a higher power output is recommended when configuring a system with more power-consuming devices.

**PEX16\_1: PCI-Express Gen2 x16 Slot**

- PCI-Express 2.0 compliant.
- Maximum theoretical realized bandwidth of 8GB/s simultaneously per direction, for an aggregate of 16GB/s totally.

**PEX16\_2: PCI-Express Gen2 x4 Slot**

- PCI-Express 2.0 compliant.
- Data transfer bandwidth up to 2GB/s per direction; 4GB/s in total.

**Note:** For more details about AMD CrossFireX, please access the website, respectively: <http://support.amd.com/us/Pages/AMDSupportHub.aspx> .

**PEX1\_1/PEX1\_2: PCI-Express Gen2 x1 Slot**

- PCI-Express 2.0 compliant.
- Data transfer bandwidth up to 500MB/s per direction; 1GB/s in total.

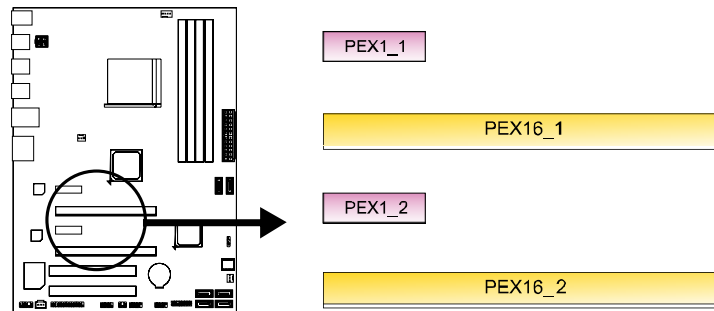
**PCI1/PCI2: Peripheral Component Interconnect Slots**

PCI stands for Peripheral Component Interconnect, and it is a bus standard for expansion cards. This PCI slot is designated as 32 bits.

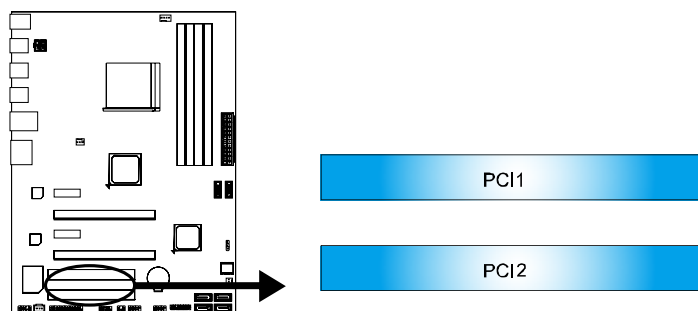

### Install an Expansion Card

You can install your expansion card by following steps:

1. Read the related expansion card's instruction document before install the expansion card into the computer.
2. Remove your computer's chassis cover, screws and slot bracket from the computer.
3. Place a card in the expansion slot and press down on the card until it is completely seated in the slot.
4. Secure the card's metal bracket to the chassis back panel with a screw.
5. Replace your computer's chassis cover.
6. Power on the computer, if necessary, change BIOS settings for the expansion card.
7. Install related driver for the expansion card.

### SATA1~SATA6: Serial ATA 6.0 Gb/s Connectors

These connectors connect to SATA hard disk drives via SATA cables.

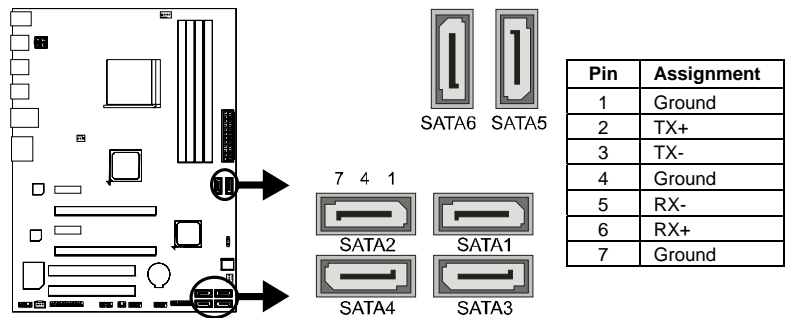

## CHAPTER 3: HEADERS & JUMPERS SETUP

### 3.1 How to Setup Jumpers

The illustration shows how to set up jumpers. When the jumper cap is placed on pins, the jumper is “close”, if not, that means the jumper is “open”.



### 3.2 Detail Settings

#### PANEL1: Front Panel Header

This 16-pin connector includes Power-on, Reset, HDD LED, Power LED, and speaker connection. It allows user to connect the PC case's front panel switch functions.

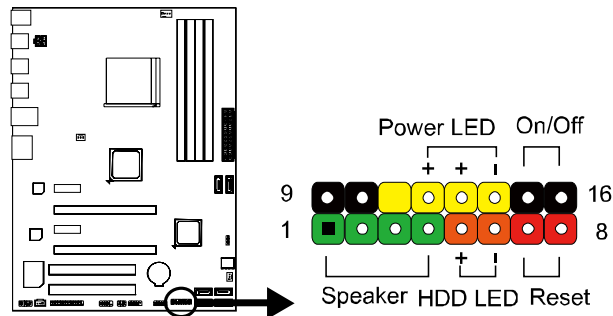

Pin	Assignment	Function	Pin	Assignment	Function
1	+5V	Speaker Connector	9	N/A	N/A
2	N/A		10	N/A	N/A
3	N/A		11	N/A	N/A
4	Speaker	Hard drive LED	12	Power LED (+)	Power LED
5	HDD LED (+)		13	Power LED (+)	
6	HDD LED (-)	Reset button	14	Power LED (-)	
7	Ground		15	Power button	Power-on button
8	Reset control	16	Ground		

### JCMOS1: Clear CMOS Header

Placing the jumper on pin2-3 allows user to restore the BIOS safe setting and the CMOS data. Please carefully follow the procedures to avoid damaging the motherboard.

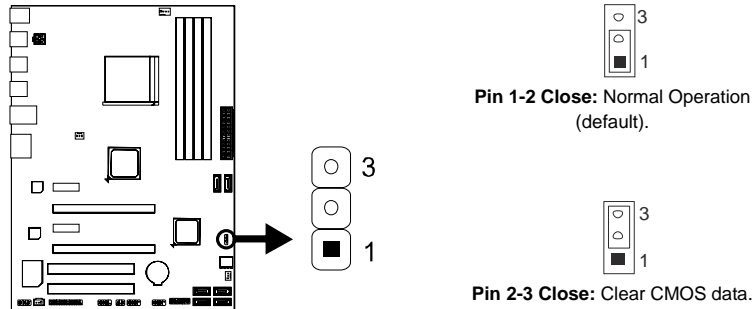

#### ※ Clear CMOS Procedures:

1. Remove AC power line.
2. Set the jumper to "Pin 2-3 close".
3. Wait for five seconds.
4. Set the jumper to "Pin 1-2 close".
5. Power on the AC.
6. Load Optimal Defaults and save settings in CMOS.

### J\_COM1: Serial port Connector

The motherboard has a Serial Port Connector for connecting RS-232 Port.

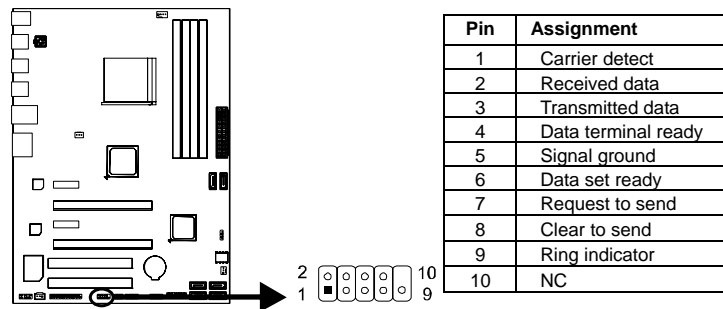



**F\_AUDIO1: Front Panel Audio Header**

This header allows user to connect the front audio output cable with the PC front panel. This header allows only HD audio front panel connector; AC'97 connector is not acceptable.

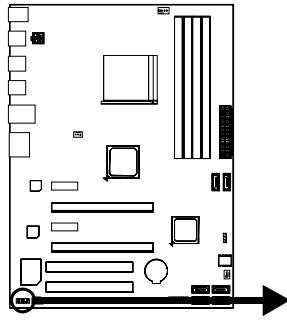

Pin	Assignment
1	Mic Left in
2	Ground
3	Mic Right in
4	GPIO
5	Right line in
6	Jack Sense
7	Front Sense
8	Key
9	Left line in
10	Jack Sense

**JSPDIFOUT1: Digital Audio-out Connector**

This connector allows user to connect the PCI bracket SPDIF output header.

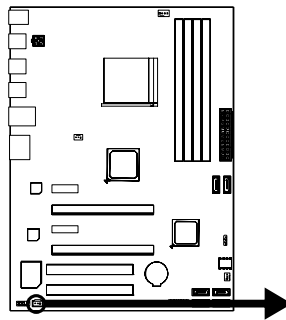

Pin	Assignment
1	+5V
2	SPDIF_OUT
3	Ground

**CIR1: Consumer IR Connector**

This header is for infrared remote control and communication.

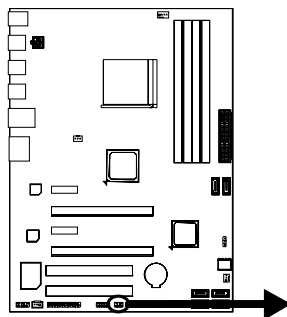

Pin	Assignment
1	IrDA serial input
2	Ground
3	Ground
4	Key
5	IrDA serial output
6	IR Power

### J\_PRINT1: Printer Port Connector

This header allows you to connector printer on the PC.

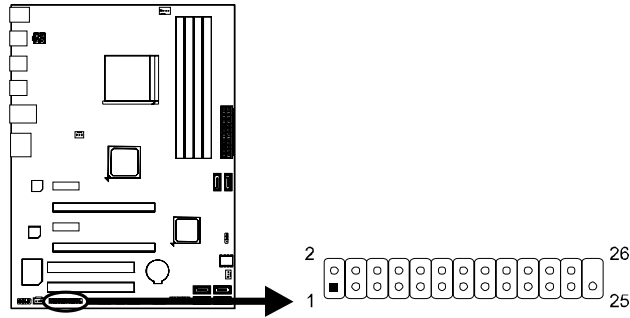

Pin	Assignment	Pin	Assignment
1	-Strobe	14	Ground
2	-ALF	15	Data 6
3	Data 0	16	Ground
4	-Error	17	Data 7
5	Data 1	18	Ground
6	-Init	19	-ACK
7	Data 2	20	Ground
8	-Scltin	21	Busy
9	Data 3	22	Ground
10	Ground	23	PE
11	Data 4	24	Ground
12	Ground	25	SCLT
13	Data 5	26	Key

### F\_USB1/F\_USB2: Headers for USB 2.0 Ports at Front Panel

These headers allow user to connect additional USB cable on the PC front panel, and also can be connected with internal USB devices, like USB card reader.

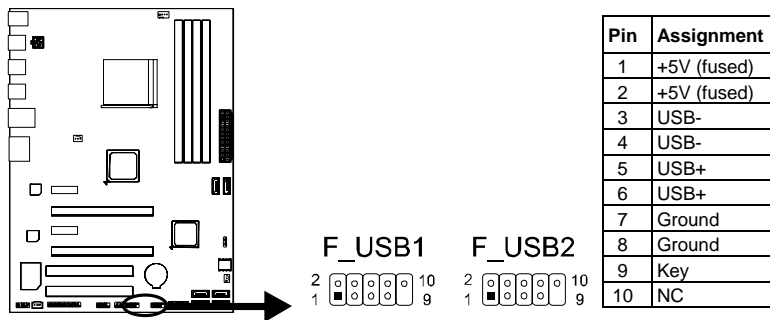

Pin	Assignment
1	+5V (fused)
2	+5V (fused)
3	USB-
4	USB-
5	USB+
6	USB+
7	Ground
8	Ground
9	Key
10	NC

## CHAPTER 4: UEFI BIOS & SOFTWARE

### 4.1 UEFI BIOS Setup

- For better system performance, the UEFI BIOS firmware is being continuously updated. The UEFI BIOS information described below in this manual is for your reference only and the actual UEFI BIOS information and settings on board may be different from this manual
- For further information of setting up the UEFI BIOS, please refer to the UEFI BIOS Manual in the Setup DVD.

### 4.2 BIOS Update

There are three ways to update the BIOS:  
BIOS Update Utility, BIOS Online Update Utility and BIOS Flasher.

#### 1. BIOS Update Utility

1. Installing BIOS Update Utility from the DVD Driver.
2. Download the proper BIOS from [www.biostar.com.tw](http://www.biostar.com.tw).

3. Open BIOS Update Utility and click the **Update BIOS** button on the main screen.



4. A warning message will show up to request your agreement to start the BIOS update. Click **OK** to start the update procedure.

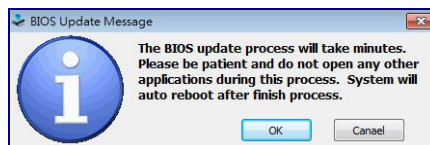

5. Choose the location for your BIOS file in the system. Please select the proper BIOS file, and then click on **Open**. It will take several minutes, please be patient.

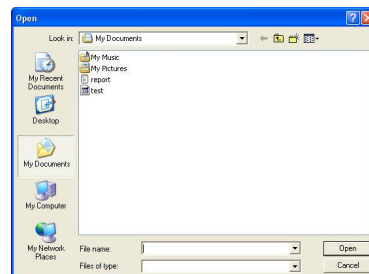

6. After the BIOS Update process is finished, click on **OK** to reboot the system.

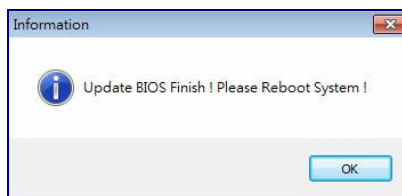

7. While the system boots up and the full screen logo shows up, please press the **Del** <Delete> key to enter BIOS setup.

After entering the BIOS setup, please go to the **Save & Exit**, using the **Restore Defaults** function to load Optimized Defaults, and select **Save Changes and Reset** to restart the computer. Then, the BIOS Update is completed.

### Backup BIOS

Click the Backup BIOS button on the main screen for the backup of BIOS, and select a proper location for your backup BIOS file in the system, and click **Save**.

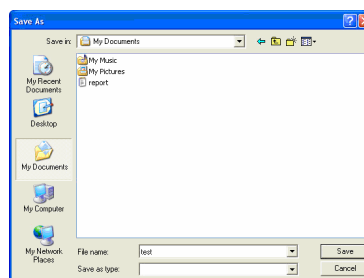

## 2. Online Update Utility

1. Installing BIOS Update Utility from the DVD Driver.
2. Please make sure the system is connected to the internet before using this function.

3. Open BIOS Update Utility and click the **Online Update** button on the main screen.



4. An open dialog will show up to request your agreement to start the BIOS update. Click **Yes** to start the online update procedure.

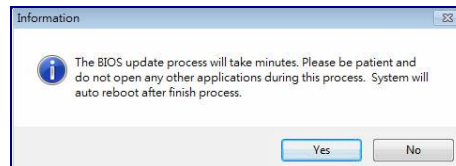

5. If there is a new BIOS version, the utility will ask you to download it. Click **Yes** to proceed.

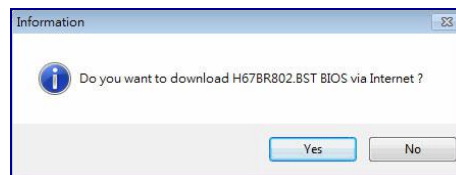

6. After the download is completed, you will be asked to program (update) the BIOS or not. Click **Yes** to proceed.

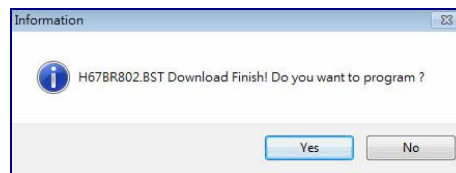

7. After the updating process is finished, you will be asked you to reboot the system. Click **OK** to reboot.

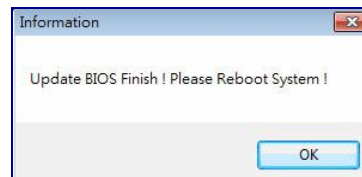

8. While the system boots up and the full screen logo shows up, press  <Delete> key to enter BIOS setup.

After entering the BIOS setup, please go to the **Save & Exit**, using the **Restore Defaults** function to load Optimized Defaults, and select **Save Changes and Reset** to restart the computer. Then, the BIOS Update is completed.

### 3. BIOSTAR BIOS Flasher

BIOSTAR BIOS Flasher is a BIOS flashing utility providing you an easy and simple way to update your BIOS via USB pen drive.

**Note1:** This utility only allows storage device with FAT32/16 format and single partition.

**Note2:** Shutting down or resetting the system while updating the BIOS will lead to system boot failure.

The BIOSTAR BIOS Flasher is built in the BIOS ROM. To enter the utility, **press <F12> during the Power-On Self Tests (POST)** procedure while booting up.

#### Updating BIOS with BIOSTAR BIOS Flasher

1. Go to the website to download the latest BIOS file for the motherboard.
2. Then, copy and save the BIOS file into a USB flash (pen) drive.
3. Insert the USB pen drive that contains the BIOS file to the USB port.
4. Power on or reset the computer and then press **<F12>** during the **POST** process.

5. After entering the POST screen, the BIOS-FLASHER utility pops out. Choose [fs0] to search for the BIOS file.



6. Select the proper BIOS file, and a message asking if you are sure to flash the BIOS file. Click Yes to start updating BIOS.

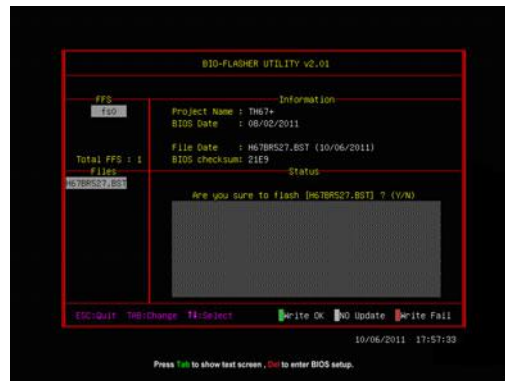

7. A dialog pops out after BIOS flash is completed, asking you to restart the system. Press the [Y] key to restart system.



8. While the system boots up and the full screen logo shows up, press  <Delete> to enter BIOS setup.

After entering the BIOS setup, please go to the **Save & Exit**, using the **Restore Defaults** function to load Optimized Defaults, and select **Save Changes and Reset** to restart the computer. Then, the BIOS Update is completed.

## 4.3 Software

### Installing Software

1. Insert the Setup DVD to the optical drive. The driver installation program would appear if the Autorun function has been enabled.
2. Select **Software Installation**, and then click on the respective software title.
3. Follow the on-screen instructions to complete the installation.

**Note1:** All the information and content about following software are subject to be changed without notice. For better performance, the software is being continuously updated.

**Note2:** The information and pictures described below are for your reference only. The actual information and settings on board may be slightly different from this manual.

### Launching Software

After the installation process is completed, you will see the software icon showing on the desktop. Double-click the icon to launch it.

### eHot-Line

eHot-Line is a convenient utility that helps you to contact with our Tech-Support system. This utility will collect the system information which is useful for analyzing the problem you may have encountered, and then send these information to our tech-support department to help you fix the problem.

**Note:** Before you use this utility, please set Outlook Express as your default e-mail client application program.

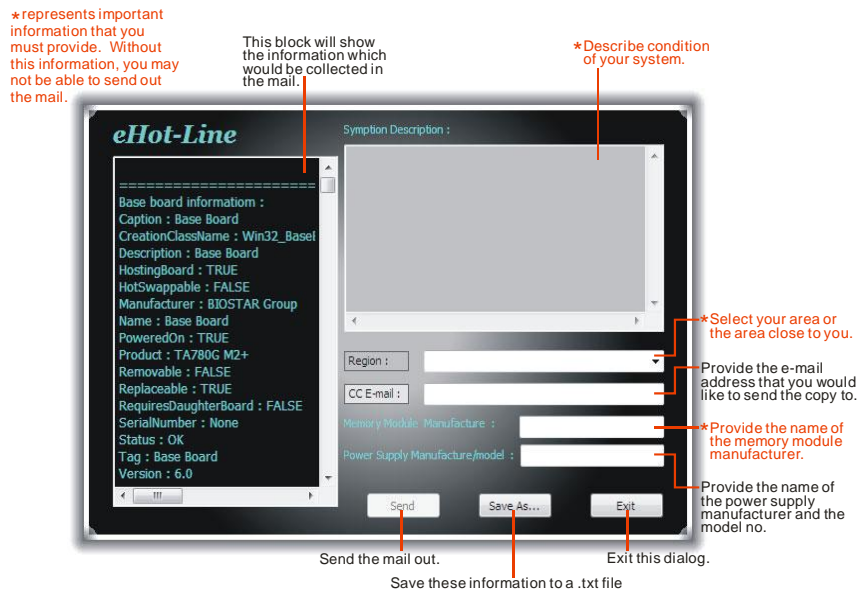



After filling up this information, click **"Send"** to send the mail out. A warning dialog would appear asking for your confirmation; click **"Send"** to confirm or **"Do Not Send"** to cancel.



If you want to save this information to a .txt file, click **"Save As..."** and then you will see a saving dialog appears asking you to enter file name.

Enter the file name and then click **"Save"**. Your system information will be saved to a .txt file.

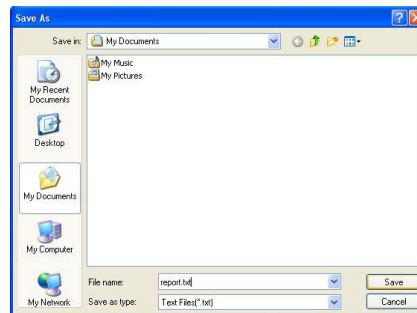

Open the saved .txt file, you will see your system information including motherboard/BIOS/CPU/video/device/OS information. This information is also concluded in the sent mail.

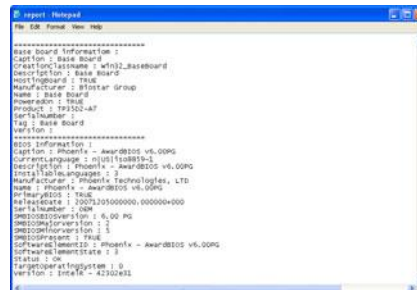

**Note1:** We will not share customer's data with any other third parties, so please feel free to provide your system information while using eHot-Line service.

**Note2:** If you are not using Outlook Express as your default e-mail client application, you may need to save the system information to a .txt file and send the file to our tech support with other e-mail application. Go to the following web <http://www.biostar.com.tw/app/en/about/contact.php> for getting our contact information.

## CHAPTER 5: USEFUL HELP

### 5.1 Driver Installation

After you installed your operating system, please insert the Fully Setup Driver DVD into your optical drive and install the driver for better system performance.

You will see the following window after you insert the DVD

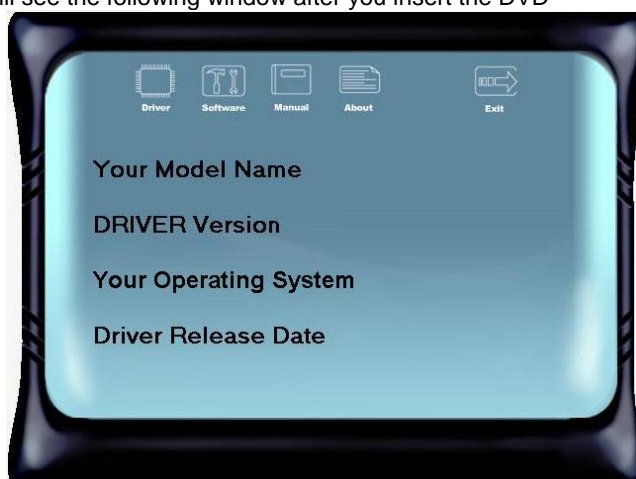

The setup guide will auto detect your motherboard and operating system.

**Note:** If this window didn't show up after you insert the Driver DVD, please use file browser to locate and execute the file SETUP.EXE under your optical drive.

#### A. Driver Installation

To install the driver, please click on the Driver icon. The setup guide will list the compatible driver for your motherboard and operating system. Click on each device driver to launch the installation program.

#### B. Software Installation

To install the software, please click on the Software icon. The setup guide will list the software available for your system, click on each software title to launch the installation program.

#### C. Manual

Aside from the paperback manual, we also provide manual in the Driver DVD. Click on the Manual icon to browse for available manual.

**Note:** You will need Acrobat Reader to open the manual file. Please download the latest version of Acrobat Reader software from <http://get.adobe.com/reader/>

## 5.2 AMI BIOS Beep Code

### Boot Block Beep Codes

Number of Beeps	Description
Continuing	Memory sizing error or Memory module not found

### POST BIOS Beep Codes

Number of Beeps	Description
1	Success booting.
8	Display memory error (system video adapter)

## 5.3 Troubleshooting

Probable	Solution
<ol style="list-style-type: none"> <li>There is no power in the system. Power LED does not shine; the fan of the power supply does not work</li> <li>Indicator light on keyboard does not shine.</li> </ol>	<ol style="list-style-type: none"> <li>Make sure power cable is securely plugged in.</li> <li>Replace cable.</li> <li>Contact technical support.</li> </ol>
System is inoperative. Keyboard lights are on, power indicator lights are lit, and hard drives are running.	Using even pressure on both ends of the DIMM, press down firmly until the module snaps into place.
System does not boot from a hard disk drive, but can be booted from optical drive.	<ol style="list-style-type: none"> <li>Check cable running from disk to disk controller board. Make sure both ends are securely plugged in; check the drive type in the standard CMOS setup.</li> <li>Backing up the hard drive is extremely important. All hard disks are capable of breaking down at any time.</li> </ol>
System only boots from an optical drive. Hard disks can be read, applications can be used, but system fails to boot from a hard disk.	<ol style="list-style-type: none"> <li>Back up data and applications files.</li> <li>Reformat the hard drive. Re-install applications and data using backup disks.</li> </ol>
Screen message shows "Invalid Configuration" or "CMOS Failure."	Review system's equipment. Make sure correct information is in setup.
System cannot boot after user installs a second hard drive.	<ol style="list-style-type: none"> <li>Set master/slave jumpers correctly.</li> <li>Run SETUP program and select correct drive types. Call the drive manufacturers for compatibility with other drives.</li> </ol>

### CPU Overheated

If the system shutdown automatically after power on system for seconds, that means the CPU protection function has been activated.

When the CPU is over heated, the motherboard will shutdown automatically to avoid a damage of the CPU, and the system may not power on again.

In this case, please double check:

1. The CPU cooler surface is placed evenly with the CPU surface.
2. CPU fan is rotated normally.
3. CPU fan speed is fulfilling with the CPU speed.

After confirmed, please follow steps below to relief the CPU protection function.

1. Remove the power cord from power supply for seconds.
2. Wait for seconds.
3. Plug in the power cord and boot up the system.

Or you can:

1. Clear the CMOS data.  
(See "Close CMOS Header: JCMOS1" section)
2. Wait for seconds.
3. Power on the system again.

## 5.4 RAID Functions

### Operating System

Supports Windows Vista , Windows 7 and Windows 8.

### Raid Arrays

RAID supports the following types of RAID arrays:

**RAID 0:** RAID 0 defines a disk striping scheme that improves disk read and write times for many applications.

**RAID 1:** RAID 1 defines techniques for mirroring data.

**RAID 10:** RAID 10 combines the techniques used in RAID 0 and RAID 1.

**RAID 5:** RAID 5 provides fault tolerance and better utilization of disk capacity.

### RAID Definitions

#### RAID 0:

The controller “stripes” data across multiple drives in a RAID 0 array system. It breaks up a large file into smaller blocks and performs disk reads and writes across multiple drives in parallel. The size of each block is determined by the stripe size parameter, which you set during the creation of the RAID set based on the system environment. This technique reduces overall disk access time and offers high bandwidth.

#### Features and Benefits

- **Drives:** Minimum 2, and maximum is up to 6 or 8. Depending on the platform.
- **Uses:** Intended for non-critical data requiring high data throughput, or any environment that does not require fault tolerance.
- **Benefits:** provides increased data throughput, especially for large files. No capacity loss penalty for parity.
- **Drawbacks:** Does not deliver any fault tolerance. If any drive in the array fails, all data is lost.
- **Fault Tolerance:** No.
- **Total Capacity:** (Minimal. HDD Capacity) x (Connected HDDs Amount)

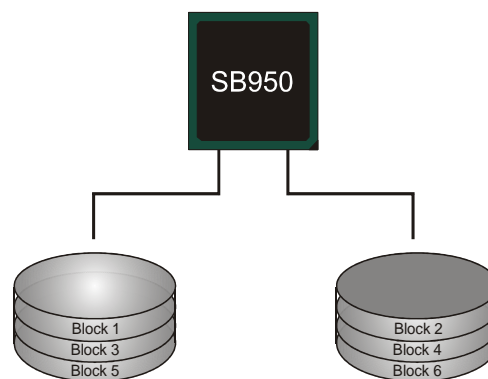

### RAID 1:

Every read and write is actually carried out in parallel across 2 disk drives in a RAID 1 array system. The mirrored (backup) copy of the data can reside on the same disk or on a second redundant drive in the array. RAID 1 provides a hot-standby copy of data if the active volume or drive is corrupted or becomes unavailable because of a hardware failure.

RAID techniques can be applied for high-availability solutions, or as a form of automatic backup that eliminates tedious manual backups to more expensive and less reliable media.

#### Features and Benefits

- **Drives:** Minimum 2, and maximum is 2.
- **Uses:** RAID 1 is ideal for small databases or any other application that requires fault tolerance and minimal capacity.
- **Benefits:** Provides 100% data redundancy. Should one drive fail, the controller switches to the other drive.
- **Drawbacks:** Requires 2 drives for the storage space of one drive. Performance is impaired during drive rebuilds.
- **Fault Tolerance:** Yes.

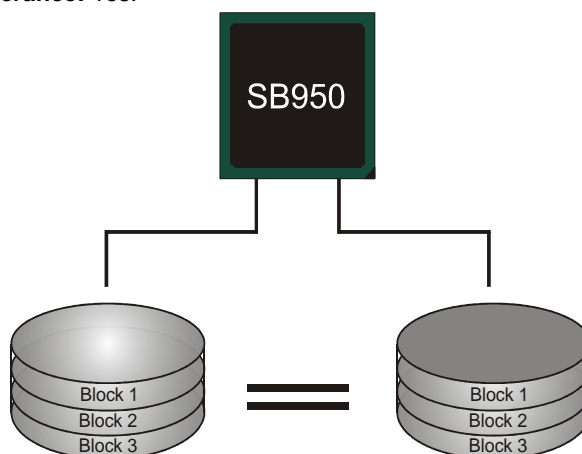

**RAID 10:**

RAID 1 drives can be striped using RAID 0 techniques. Resulting in a RAID 10 solution for improved resiliency, performance and rebuild performance.

**Features and Benefits**

- **Drives:** Minimum 4, and maximum is 6 or 8, depending on the platform.
- **Benefits:** Optimizes for both fault tolerance and performance, allowing for automatic redundancy. May be simultaneously used with other RAID levels in an array, and allows for spare disks.
- **Drawbacks:** Requires twice the available disk space for data redundancy, the same as RAID level 1.
- **Fault Tolerance:** Yes.

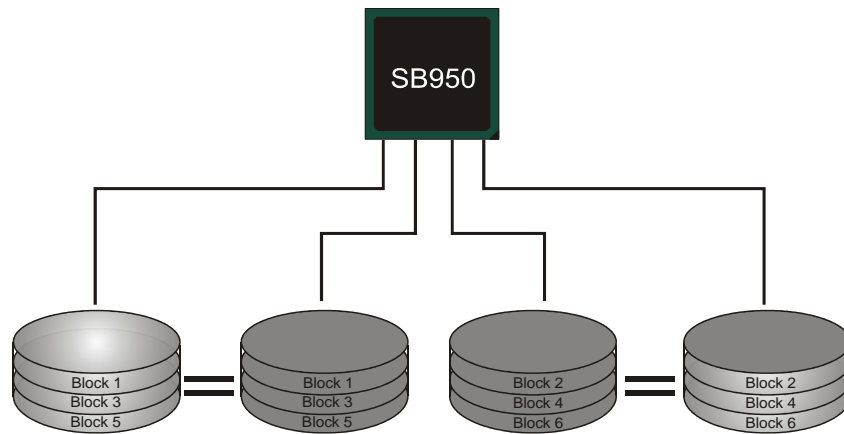

**RAID 5:**

RAID 5 stripes both data and parity information across three or more drives. It writes data and parity blocks across all the drives in the array. Fault tolerance is maintained by ensuring that the parity information for any given block of data is placed on a different drive from those used to store the data itself.

**Features and Benefits**

- **Drives:** Minimum 3.
- **Uses:** RAID 5 is recommended for transaction processing and general purpose service.
- **Benefits:** An ideal combination of good performance, good fault tolerance, and high capacity and storage efficiency.
- **Drawbacks:** Individual block data transfer rate same as a single disk. Write performance can be CPU intensive.
- **Fault Tolerance:** Yes.





This Page Intentionally Left Blank

## APPENDIX: SPEC IN OTHER LANGUAGES

### German

Spezifikationen		
CPU	Socket AM3+ AMD Sempron / Phenom II / Athlon II / FX Prozessoren (Maximales Watt: 140W)	Die AMD 64-Architektur unterstützt eine 32-Bit- und 64-Bit-Datenverarbeitung Unterstützt Hyper Transport 3.0
FSB	Unterstützt HyperTransport 3.0 mit einer Bandbreite von bis zu 4.8 GT/s	
Chipsatz	AMD 970 AMD SB950	
Super E/A	ITE 8728F-BX Bietet die häufig verwendeten alten Super E/A-Funktionen. Low Pin Count-Schnittstelle	Umgebungskontrolle, Hardware-Überwachung Lüfterdrehzahl-Controller "Smart Guardian"-Funktion von ITE
Arbeitsspeicher	DDR3 DIMM-Steckplätze x 4 Max. 64GB Arbeitsspeicher Jeder DIMM unterstützt 512MB/ 1GB/2GB/4GB/8GB/16GB DDR3.	Dual-Kanal DDR3 Speichermodul Unterstützt DDR3 800/1066/1333/1600/1866 Unterstützt DDR3 2000 (OC)
SATA III	Integrierter Serial ATA-Controller	Datenübertragungsraten bis zu 6 Gb/s Konform mit der SATA-Spezifikation Version 3.0 Unterstützt RAID 0,1,5,10
LAN	Realtek RTL 8111F	10 / 100 / 1000 Mb/s Auto-Negotiation Halb- / Vollduplex-Funktion
Audio-Codec	ALC892	7.1-Kanal-Audioausgabe Unterstützt High-Definition Audio
USB3.0	Asmedia ASM1042 A4	Datenübertragungsraten bis zu 600 MB / s
Steckplätze	PCI Steckplatz x2 PCI Express Gen2 x1 Steckplatz x2 PCI Express Gen2 x16 Steckplatz x2	unterstützt AMD CrossFireX™ (x16,x4)
Onboard-Anschluss	SATA-Anschluss x6 Fronttafelanschluss x1 Front-Audioanschluss x1 S/PDIF Ausgangsanschluss x1	Jeder Anschluss unterstützt 1 SATA-Laufwerk Unterstützt die Fronttafel-funktionen Unterstützt die Fronttafel-Audioanschlussfunktion Unterstützt die digitale Audioausgabefunktion

Spezifikationen			
	Verbraucher-IR Anschluss	x1	
	CPU-Lüfter-Sockel	x1	CPU-Lüfterstromversorgungsanschluss (mit Smart Fan-Funktion)
	System-Lüfter-Sockel	x2	System-Lüfter-Stromversorgungsanschluss
	"CMOS löschen"-Sockel	x1	
	USB2.0-Anschluss	x2	Jeder Anschluss unterstützt 2 Fronttafel-USB2.0-Anschlüsse
	Druckeranschluss Anschluss	x1	Jeder Anschluss unterstützt 1 Druckeranschluss
	Serieller Anschluss	x1	
	Stromanschluss (24-polig)	x1	
	Stromanschluss (4-polig)	x1	
Rückseiten-E/A	PS/2-Tastatur	x1	
	PS/2-Maus	x1	
	LAN-Anschluss	x1	
	USB2.0-Anschluss	x6	
	USB3.0-Anschluss	x2	
	Audioanschluss	x6	
Platinengröße	305 mm (B) X 225 mm (L)		
OS-Unterstützung	Windows XP / Vista / 7 / 8		Biostar behält sich das Recht vor, ohne Ankündigung die Unterstützung für ein Betriebssystem hinzuzufügen oder zu entfernen.

## French

SPEC		
UC	Socket AM3+ Processeurs AMD Sempron / Phenom II / Athlon II / FX (Watt maximum : 140W)	L'architecture AMD 64 permet le calcul 32 et 64 bits Prend en charge Hyper Transport 3.0
Bus frontal	Prend en charge Hyper Transport 3.0 jusqu'à une bande passante de 4.8 GT/s	
Chipset	AMD 970 AMD SB950	
Super E/S	ITE 8728F-BX Fournit la fonctionnalité de Super E/S patrimoniales la plus utilisée. Interface à faible compte de broches	Initiatives de contrôle environnementales, Moniteur de matériel Contrôleur de vitesse de ventilateur Fonction "Gardien intelligent" de l'ITE
Mémoire principale	Fentes DDR3 DIMM x 4 Capacité mémoire maximale de 64Go Chaque DIMM prend en charge des DDR3 de 512Mo/1Go/2Go/4Go/8Go/16Go	Module de mémoire DDR3 à mode à double voie Prend en charge la DDR3 800/1066/1333/1600/1866 Prend en charge la DDR3 2000 (OC)
SATA III	Contrôleur Serial ATA intégré	Taux de transfert jusqu'à 6 Go/s. Conforme à la spécification SATA Version 3.0 Prise en charge RAID 0,1,5,10
LAN	Realtek RTL8111F	10 / 100 / 1000 Mb/s négociation automatique Half / Full duplex capability
Codec audio	ALC892	Sortie audio à 7.1 voies Prise en charge de l'audio haute définition
USB3.0	Asmedia ASM1042 A4	Taux de transfert de données jusqu'à 600 Mo / s
Fentes	Fente PCI x2 Fente PCI Express Gen2 x1 x2 Fente PCI Express Gen2 x16 x2	supports AMD CrossFireX™ (x16,x4)
Connecteur embarqué	Connecteur SATA x6 Connecteur du panneau avant x1 Connecteur Audio du panneau avant x1 Connecteur de sortie S/PDIF x1 Connecteur de IR du consommateur x1	Chaque connecteur prend en charge 1 périphérique SATA Prend en charge les équipements du panneau avant Prend en charge la fonction audio du panneau avant Prend en charge la fonction de sortie audio numérique

SPEC			
	Embase de ventilateur UC	x1	Alimentation électrique du ventilateur UC (avec fonction de ventilateur intelligent)
	Embase de ventilateur système	x2	Alimentation électrique du ventilateur système
	Embase d'effacement CMOS	x1	
	Connecteur USB2.0	x2	Chaque connecteur prend en charge 2 ports USB2.0 de panneau avant
	Connecteur de Port d'imprimante	x1	Chaque connecteur prend en charge 1 Port d'imprimante
	Port série	x1	
	Connecteur d'alimentation (24 broches)	x1	
	Connecteur d'alimentation (4 broches)	x1	
E/S du panneau arrière	Clavier PS/2	x1	
	Souris PS/2	x1	
	Port LAN	x1	
	Port USB2.0	x6	
	Port USB3.0	x2	
	Fiche audio	x6	
Dimensions de la carte	305 mm (l) X 225 mm (H)		
Support SE	Windows XP / Vista / 7 / 8		Biostar se réserve le droit d'ajouter ou de supprimer le support de SE avec ou sans préavis.

## Italian

SPECIFICA		
CPU	Socket AM3+ Processori AMD Sempron / Phenom II / Athlon II / FX (Watt massimo: 140W)	L'architettura AMD 64 abilita la computazione 32 e 64 bit Supporto di Hyper Transport 3.0
FSB	Supporto di HyperTransport 3.0 fino a 4.8 GT/s di larghezza di banda	
Chipset	AMD 970 AMD SB950	
Super I/O	ITE 8728F-BX Fornisce le funzionalità legacy Super I/O usate più comunemente. Interfaccia LPC (Low Pin Count)	Funzioni di controllo dell'ambiente: Monitoraggio hardware Controller velocità ventolina Funzione "Smart Guardian" di ITE
Memoria principale	Alloggi DIMM DDR3 x 4 Capacità massima della memoria 64GB Ciascun DIMM supporta DDR3 512MB/1GB/2GB/4GB/8GB/16GB	Modulo di memoria DDR3 a canale doppio Supporto di DDR3 800/1066/1333/1600/1866 Supporto di DDR3 2000 (OC)
SATA III	Controller Serial ATA integrato	Velocità di trasferimento dei dati fino a 6 Gb/s. Compatibile specifiche SATA Versione 3.0 Supporto RAID 0,1,5,10
LAN	Realtek RTL 8111F	Negoziazione automatica 10 / 100 / 1000 Mb/s Capacità Half / Full Duplex
Codec audio	ALC892	Uscita audio 7.1 canali Supporto audio High-Definition (HD)
USB3.0	Asmedia ASM1042 A4	Velocità di trasferimento dati fino a 600 MB / s
Alloggi	Alloggio PCI x2 Alloggio PCI Express Gen2 x1 x2 Alloggio PCI Express Gen2 x16 x2	supporta AMD CrossFireX™ (x16, x4)
Connettori su scheda	Connettore SATA x6 Connettore pannello frontale x1 Connettore audio frontale x1 Connettore output S/PDIF x1 Connettore IR del consumatore x1	Ciascun connettore supporta 1 unità SATA Supporta i servizi del pannello frontale Supporta la funzione audio pannello frontale Supporta la funzione d'output audio digitale

SPECIFICA			
	Collettore ventolina CPU	x1	Alimentazione ventolina CPU (con funzione Smart Fan)
	Collettore ventolina sistema	x2	Alimentazione ventolina di sistema
	Collettore cancellazione CMOS	x1	
	Connettore USB2.0	x2	Ciascun connettore supporta 2 porte USB2.0 pannello frontale
	Connettore Porta stampante	x1	Ciascun connettore supporta 1 Porta stampante
	Porta seriale	x1	
	Connettore alimentazione (24 pin)	x1	
	Connettore alimentazione (4 pin)	x1	
I/O pannello posteriore	Tastiera PS/2	x1	
	Mouse PS/2	x1	
	Porta LAN	x1	
	Porta USB2.0	x6	
	Porta USB3.0	x2	
	Connettore audio	x6	
Dimensioni scheda	305 mm (larghezza) x 225 mm (altezza)		
Sistemi operativi supportati	Windows XP / Vista / 7 / 8		Biostar si riserva il diritto di aggiungere o rimuovere il supporto di qualsiasi sistema operativo senza preavviso.

## Spanish

<i>Especificación</i>		
CPU	Conector AM3+ Procesadores AMD Sempron / Phenom II / Athlon II / FX (Vatio máximo: 140W)	La arquitectura AMD 64 permite el procesamiento de 32 y 64 bits Soporta las tecnologías Hyper Transport 3.0
FSB	Admite HyperTransport 3.0 con un ancho de banda de hasta 4.8 GT/s	
Conjunto de chips	AMD 970 AMD SB950	
Súper E/S	ITE 8728F-BX Le ofrece las funcionalidades heredadas de uso más común Súper E/S. Interfaz de cuenta Low Pin	Iniciativas de control de entorno, Monitor hardware Controlador de velocidad de ventilador Función "Guardia inteligente" de ITE
Memoria principal	Ranuras DIMM DDR3 x 4 Capacidad máxima de memoria de 64GB Cada DIMM admite DDR de 512MB/1GB/2GB/4GB/8GB/16GB	Módulo de memoria DDR3 de canal Doble Admite DDR3 de 800/1066/1333/1600/1866 Admite DDR3 de 2000 (OC)
SATA III	Controlador ATA Serie Integrado	Tasas de transferencia de hasta 6 Gb/s. Compatible con la versión SATA 3.0 Admite RAID 0,1,5,10
Red Local	Realtek RTL 8111F	Negociación de 10 / 100 / 1000 Mb/s Funciones Half / Full dúplex
Códecs de sonido	ALC892	Salida de sonido de 7.1 canales Soporte de sonido de Alta Definición
USB3.0	Asmedia ASM1042 A4	Tasas de transferencia de datos hasta 600 MB / s
Ranuras	Ranura PCI X2 Ranura PCI express Gen2 x1 X2 Ranura PCI express Gen2 x16 X2	soporta AMD CrossFireX™ (x16, x4)
Conectores en placa	Conector SATA X6 Conector de panel frontal X1 Conector de sonido frontal X1 Conector de salida S/PDIF X1 Conector de IR del consumidor X1	Cada conector soporta 1 dispositivos SATA Soporta instalaciones en el panel frontal Soporta funciones de sonido en el panel frontal Soporta función de salida de sonido digital



<b>Especificación</b>			
	Cabecera de ventilador de CPU	X1	Fuente de alimentación de ventilador de CPU (con función Smart Fan)
	Cabecera de ventilador de sistema	X2	Fuente de alimentación de ventilador de sistema
	Cabecera de borrado de CMOS	X1	
	Conector USB2.0	X2	Cada conector soporta 2 puertos USB2.0 frontales
	Conector Puerto de impresora	X1	Cada conector soporta 1 Puerto de impresora
	Puerto serie	X1	
	Conector de alimentación (24 patillas)	X1	
	Conector de alimentación (4 patillas)	X1	
Panel trasero de E/S	Teclado PS/2	X1	
	Ratón PS/2	X1	
	Puerto de red local	X1	
	Puerto USB2.0	X6	
	Puerto USB3.0	X2	
	Conector de sonido	X6	
Tamaño de la placa	305 mm. (A) X 225 mm. (H)		
Soporte de sistema operativo	Windows XP / Vista / 7 / 8		Biostar se reserva el derecho de añadir o retirar el soporte de cualquier SO con o sin aviso previo.

## Portuguese

ESPECIFICAÇÕES		
CPU	Socket AM3+ Processadores AMD Sempron / Phenom II / Athlon II / FX (Watt máximo: 140W)	A arquitectura AMD 64 permite uma computação de 32 e 64 bits Suporta as tecnologias Hyper Transport 3.0
FSB	Suporta a tecnologia HyperTransport 3.0 com uma largura de banda até 4.8 GT/s	
Chipset	AMD 970 AMD SB950	
Especificação Super I/O	ITE 8728F-BX Proporciona as funcionalidades mais utilizadas em termos da especificação Super I/O. Interface LPC (Low Pin Count).	Iniciativas para controlo do ambiente Monitorização do hardware Controlador da velocidade da ventoinha Função "Smart Guardian" da ITE
Memória principal	Ranuras DIMM DDR3 x 4 Capacidade máxima de memória: 64GB Cada módulo DIMM suporta uma memória DDR3 de 512MB/ 1GB/2GB/4GB/8GB/16GB	Módulo de memória DDR3 de canal duplo Suporta módulos DDR3 800/1066/1333/1600/1866 Suporta módulos DDR3 2000 (OC)
SATA III	Controlador Serial ATA integrado	Velocidades de transmissão de dados até 6 Gb/s. Compatibilidade com a especificação SATA versão 3.0 Suporta as funções RAID 0,1,5,10
LAN	Realtek RTL 8111F	Auto negociação de 10 / 100 / 1000 Mb/s Capacidade semi/full-duplex
Codec de som	ALC892	Saída de áudio de 7.1 canais Suporta a especificação High-Definition Audio
USB3.0	Asmedia ASM1042 A4	Taxas de transferência de dados até 600 MB / s
Ranuras	Ranura PCI x2 Ranura PCI Express Gen2 x1 x2 Ranura PCI Express Gen2 x16 x2	suporta AMD CrossFireX™ (x16, x4)
Conectores na placa	Conector SATA x6 Conector do painel frontal x1 Conector de áudio frontal x1 Conector de saída S/PDIF x1 Conector de IR do consumidor x1	Cada conector suporta 1 dispositivo SATA Para suporte de várias funções no painel frontal Suporta a função de áudio no painel frontal Suporta a saída de áudio digital

<i>ESPECIFICAÇÕES</i>			
	Conector da ventoinha da CPU	x1	Alimentação da ventoinha da CPU (com a função Smart Fan)
	Conector da ventoinha do sistema	x2	Alimentação da ventoinha do sistema
	Conector para limpeza do CMOS	x1	
	Conector USB2.0	x2	Cada conector suporta 2 portas USB2.0 no painel frontal
	Conector da para impressora	x1	Cada conector suporta 1 Porta para impressora
	Porta série	x1	
	Conector de alimentação (24 pinos)	x1	
	Conector de alimentação (4 pinos)	x1	
Entradas/Saídas no painel traseiro	Teclado PS/2	x1	
	Rato PS/2	x1	
	Porta LAN	x1	
	Porta USB2.0	x6	
	Porta USB3.0	x2	
	Tomada de áudio	x6	
Tamanho da placa	305 mm (L) X 225 mm (A)		
Sistemas operativos suportados	Windows XP / Vista / 7 / 8		A Biostar reserva-se o direito de adicionar ou remover suporte para qualquer sistema operativo com ou sem aviso prévio.

## Polish

SPEC		
Procesor	Socket AM3+ AMD Sempron / Phenom II / Athlon II / FX Procesory (Maksymalny Watt: 140W)	Architektura AMD 64 umożliwia przetwarzanie 32 i 64 bitowe Obsługa Hyper Transport 3.0
FSB	Obsługa HyperTransport 3.0 o szerokości pasma do 4.8 GT/s	
Chipset	AMD 970 AMD SB950	
Pamięć główna	Gniazda DDR3 DIMM x 4 Maks. wielkość pamięci 64GB Każde gniazdo DIMM obsługuje moduły 512MB/1GB/2GB/4GB/8GB/16GB DDR3	Moduł pamięci DDR3 z trybem podwójnego kanału Obsługa DDR3 800/1066/1333/1600/1866 Obsługa DDR3 2000 (OC)
Super I/O	ITE 8728F-BX Zapewnia najbardziej powszechne funkcje Super I/O. Interfejs Low Pin Count	Funkcje kontroli warunków pracy, Monitor H/W Kontroler prędkości wentylatora Funkcja ITE "Smart Guardian"
SATA III	Zintegrowany kontroler Serial ATA	Transfer danych do 6 Gb/s. Zgodność ze specyfikacją SATA w wersji 3.0 Obsługa RAID 0,1,5,10
LAN	Realtek RTL 8111F	10 / 100 / 1000 Mb/s z automatyczną negocjacją szybkości Działanie w trybie połowicznego/pełnego duplexu
Kodek dźwiękowy	ALC892	7.1 kanałowe wyjście audio Obsługa High-Definition Audio
USB3.0	Asmedia ASM1042 A4	Cena transferu danych do 600 MB / s
Gniazda	Gniazdo PCI x2 Gniazdo PCI Express Gen2 x1 x2 Gniazdo PCI Express Gen2 x16 x2	obsługuje AMD CrossFireX™ (x16, x4)
Złącza wbudowane	Złącze SATA x6 Złącze panela przedniego x1 Przednie złącze audio x1 Złącze wyjścia S/PDIF x1 Złącze Konsument IR x1	Każde złącze obsługuje 1 urządzenie SATA Obsługa elementów panela przedniego Obsługa funkcji audio na panelu przednim Obsługa funkcji cyfrowego wyjścia audio

SPEC			
	Złącze główkowe wentylatora procesora	x1	Zasilanie wentylatora procesora (z funkcją Smart Fan)
	Złącze główkowe wentylatora systemowego.....		Zasilanie wentylatora systemowego
	Złącze główkowe kasowania CMOS	x1	
	Złącze USB2.0	x2	Każde złącze obsługuje 2 porty USB2.0 na panelu przednim
	Złącze Port drukarki	x1	Każde złącze obsługuje 1 Port drukarki
	Port szeregowy	x1	
	Złącze zasilania (24 pinowe)	x1	
	Złącze zasilania (4 pinowe)	x1	
Back Panel I/O	Klawiatura PS/2	x1	
	Mysz PS/2	x1	
	Port LAN	x1	
	Port USB2.0	x6	
	Port USB3.0	x2	
	Gniazdo audio	x6	
Wymiary płyty	305 mm (S) X 225 mm (W)		
Obsługa systemu operacyjnego	Windows XP / Vista / 7 / 8		Biostar zastrzega sobie prawo dodawania lub odwoływania obsługi dowolnego systemu operacyjnego bez powiadomienia.

## Russian

СПЕЦ		
CPU (центральный процессор)	Гнездо AM3+ Процессоры AMD Sempron / Phenom II / Athlon II / FX (Максимальный ватт: 140W)	Архитектура AMD 64 разрешать обработка данных на 32 и 64 бит Поддержка Hyper Transport 3.0
FSB	Поддержка HyperTransport 3.0 с пропускной способностью до 4.8 GT/s	
Набор микросхем	AMD 970 AMD SB950	
Основная память	Слоты DDR3 DIMM x 4 Максимальная ёмкость памяти 64ГБ Каждый модуль DIMM поддерживает 512МБ/1ГБ/2ГБ/4ГБ/8ГБ/16ГБ DDR3	Модуль памяти с двухканальным режимом DDR3 Поддержка DDR3 800/1066/1333/1600/1866 Поддержка DDR3 2000 (OC)
Super I/O	ITE 8728F-BX Обеспечивает наиболее используемые действующие функциональные возможности Super I/O. Интерфейс с низким количеством выводов	Инициативы по охране окружающей среды, Аппаратный монитор Регулятор скорости Функция ITE "Smart Guardian" (Интеллектуальная защита)
SATA III	Встроенное последовательное устройство управления ATA	скорость передачи данных до 6 гигабит/с. Соответствие спецификации SATA версия 3.0 Поддержка RAID 0,1,5,10
Локальная сеть	Realtek RTL 8111F	Автоматическое согласование 10 / 100 / 1000 Мб/с Частичная / полная дуплексная способность
Звуковой кодек	ALC892	Звуковая поддержка High-Definition 7.1канальный звуковой выход
USB3.0	Asmedia ASM1042 A4	скорости передачи данных до 600 МБ / с
Слоты	Слот PCI x2 Слот PCI Express Gen2 x1 x2 Слот PCI Express Gen2 x16 x2	поддерживает AMD CrossFireX™ (x16, x4)
Встроенный разъём	Разъём SATA x6 Разъём на лицевой панели x1 Входной звуковой разъём x1 Разъём вывода для S/PDIF x1 Разъём едока ИКБЫИ x1	Каждый разъём поддерживает 1 устройство SATA Поддержка устройств на лицевой панели Поддержка звуковых функций на лицевой панели Поддержка вывода цифровой звуковой функции

СПЕЦ		
	Контактирующее приспособление вентилятора центрального процессора x1	Источник питания для вентилятора центрального процессора (с функцией интеллектуального вентилятора)
	Контактирующее приспособление вентилятора системы x2	Источник питания для вентилятора системы
	Открытое контактирующее приспособление CMOS x1	
	USB2.0-разъём x2	Каждый разъём поддерживает 2 USB2.0-порта на лицевой панели
	Разъём Порт подключения принтера x1	Каждый разъём поддерживает 1 Порт подключения принтера
	Последовательный порт x1	
	Разъем питания (24 вывод) x1	
	Разъем питания (4 вывод) x1	
Задняя панель средств ввода-вывода	Клавиатура PS/2 x1	
	Мышь PS/2 x1	
	Порт LAN x1	
	USB2.0-порт x6	
	USB3.0-порт x2	
	Гнездо для подключения наушников x6	
Размер панели	305 мм (Ш) X 225 мм (В)	
Поддержка OS	Windows XP / Vista / 7 / 8	Biostar сохраняет за собой право добавлять или удалять средства обеспечения для OS с или без предварительного уведомления.

## Arabic

المواصفات		
وحدة المعالجة المركزية	AM3+ مقبس واطة) AMD Sempron / Phenom II / Athlon II معالجات (و) FX / (140 و) قصوى	إجراء العمليات الحاسوبية بسرعة 32 و 64 بت AMD 64 يمكن تقنية و 3.0 Hyper Transport تدعم تقنية
النقل الأممي الجانبي	4.8 GT/s يتردد يصل إلى 3.0 HyperTransport تدعم تقنية	
مجموعة الشرائح	AMD 970 AMD SB950	
الذاكرة الرئيسية	قناة DDR3 DIMM سعة ذاكرة قصوى 64 جيجا بايت سعة 512/2 DDR3 تدعم ذاكرة من نوع DIMM تدعم كل قناة ميجا بايت و 1/2 و 4/8 و 16 جيجا بايت	عدد 4 مزوجة القناة DDR3 وحدة ذاكرة سعات 1866/1600/1333/1066/800 ميجا DDR3 تدعم الذاكرة من نوع بايت 2000 (OC) ساعات DDR3 نوع من الذاكرة تدعم
Super I/O	ITE 8728F-BX الأكثر استخداماً Super I/O توفر وظيفة Low Pin Count Interface تدعم تقنية	وسائل التحكم في البيئة: مراقب لمعرفة حالة الأجهزة مراقب في سرعة المروحة ITE من "Smart Guardian" وظيفة
SATA III	متكامل Serial ATA متحكم	نقل البيانات بسرعة تصل إلى 6 جيجابت/ثانية. 3.0 الإصدار SATA مطابقة لمواصفات RAID 0,1,5,10 تدعم تقنية
شبكة داخلية	Realtek RTL 8111F	تفاوض تلقائي 100/10 ميجا بايت / ثانية و 1 جيجا بايت/ثانية إمكانية النقل المزدوج الكلي/النصفي
كوديك الصوت	ALC892	تدعم تقنية الصوت عالي التعريف من 7.1 قنوات لخرج الصوت
USB3.0	Asmedia ASM1042 A4	ثانوية / بايت ميغا 600 إلى تصل بيانات نقل معدلات
الفتحات	قناة PCI قناة PCI Express Gen2 x1 قناة PCI Express Gen2 x16	قاعدة إيه إم دي AMD كروس فير (AMD CrossFire™) (x16, x4)
المنفذ على سطح اللوحة	منفذ SATA منفذ اللوحة الأممية منفذ الصوت الأممي منفذ خرج S/PDIF منفذ الأحمر تحت مستهلكة	SATA يدعم كل منفذ واحد من أجهزة يدعم تجهيزات اللوحة الأممية يدعم وظيفة الصوت باللوحة الأممية يدعم وظيفة خرج الصوت الرقمي عدد 1



المواصفات		
وصلة مروحة وحدة المعالجة المركزية	عدد 1	Smart Fan لتوصيل الطاقة لمروحة وحدة المعالجة مع وظيفة
وصلة مروحة النظام	عدد 2	لتوصيل الطاقة لمروحة النظام
وصلة مسح CMOS	عدد 1	
منفذ USB2.0	عدد 2	بدعم كل منفذ قمتي USB2.0 باللوحة الأممية
منفذ طاقة	عدد 1	
منفذ تسلسلي	عدد 1	
منفذ توصيل الطاقة (24دبوس)	عدد 1	
منفذ توصيل الطاقة (4دبوس)	عدد 1	
لوحة مفاتيح PS/2	عدد 1	
ملوس PS/2	عدد 1	
منفذ شبكة اتصال محلية	عدد 1	منفذ دخل/خروج
منفذ USB2.0	عدد 6	اللوحة الخلفية
منفذ USB3.0	عدد 2	
مقيس صوت	عدد 6	
حجم اللوحة	305 مم (عرض) X 225 مم (ارتفاع)	
دعم أنظمة التشغيل	Windows XP / Vista / 7/8	
	بحقها في اضافة أو ازالة الدعم لأي نظام تشغيل باخطار أو بدون Biostar:حتفظ بخطار.	

## Japanese

仕様		
CPU	Socket AM3+ AMD Sempron / Phenom II / Athlon II / FX プロセッサ (最高のワット: 140W)	AMD 64アーキテクチャでは、32ビットと64ビット計算が可能です ハイパートランスポート3.0をサポートします
FSB	4.8 GT/sのバンド幅までハイパートランスポート3.0をサポートします	
チップセット	AMD 970 AMD SB950	
メインメモリ	DDR3 DIMMスロット x4 最大メモリ容量64GB 各DIMMは 512MB/1GB/2GB/4GB/8GB/16GB DDR3をサポート	デュアルチャンネルモードDDR3メモリモジュール DDR3 800/1066/1333/1600/1866 をサポート DDR3 2000 (OC) をサポート
Super I/O	ITE 8728F-BX もともと一般に使用されるレガシーSuper I/O機能を採用しています。 低ピンカウントインターフェイス	環境コントロールイニシアチブ、 HWモニター ファン速度コントローラ/ モニター ITEの「スマートガーディアン」機能
SATA III	統合シリアルATAコントローラ	最高6 Gb/秒のデータ転送速度 SATAバージョン3.0仕様に準拠。 RAID 0,1,5,10のサポート
LAN	Realtek RTL 8111F	10 / 100 / 1000 Mb/秒のオートネゴシエーション 半/全二重機能
サウンド Codec	ALC892	ハイデフィニションオーディオのサポート 7.1チャンネルオーディオアウト
USB3.0	Asmedia ASM1042 A4	データ転送速度最大600 MB /秒の
スロット	PCIスロット x2 PCI Express Gen2 x1スロット x2 PCI Express Gen2 x16スロット x2	AMD CrossFireX™ (x16, x4)
オンボードコネクタ	SATAコネクタ x6 フロントパネルコネクタ x1 フロントオーディオコネクタ x1 S/PDIFアウトコネクタ x1 消費者IRコネクタ x1	各コネクタは1つのSATAデバイスをサポートします フロントパネル機能をサポートします フロントパネルオーディオ機能をサポートします デジタルオーディオアウト機能をサポートします

仕様			
	CPUファンヘッダ	x1	CPUファン電源装置(スマートファン機能を搭載)
	システムファンヘッダ	x2	システムファン電源装置
	CMOSクリアヘッダ	x1	
	USB2.0コネクタ	x2	各コネクタは2つのフロントパネルUSB2.0ポートをサポートします
	プリンタポートコネクタ	x1	各コネクタは1つのプリンタポートをサポートします
	シリアルポート	x1	
	電源コネクタ(24ピン)	x1	
	電源コネクタ(4ピン)	x1	
背面パネル I/O	PS/2キーボード	x1	
	PS/2マウス	x1	
	LANポート	x1	
	USB2.0ポート	x6	
	USB3.0ポート	x2	
	オーディオジャック	x6	
ボードサイズ	305 mm (幅) X 225 mm (高さ)		
OSサポート	Windows XP / Vista / 7 / 8		BioStarは事前のサポートなしにOSサポートを追加または削除する権利を留保します。

2014/03/17