

## FCC Information and Copyright

This equipment has been tested and found to comply with the limits of a Class B digital device, pursuant to Part 15 of the FCC Rules. These limits are designed to provide reasonable protection against harmful interference in a residential installation. This equipment generates, uses, and can radiate radio frequency energy and, if not installed and used in accordance with the instructions, may cause harmful interference to radio communications. There is no guarantee that interference will not occur in a particular installation.

The vendor makes no representations or warranties with respect to the contents here and specially disclaims any implied warranties of merchantability or fitness for any purpose. Further the vendor reserves the right to revise this publication and to make changes to the contents here without obligation to notify any party beforehand.

Duplication of this publication, in part or in whole, is not allowed without first obtaining the vendor's approval in writing.

The content of this user's manual is subject to be changed without notice and we will not be responsible for any mistakes found in this user's manual. All the brand and product names are trademarks of their respective companies.



### **Dichiarazione di conformità sintetica**

Ai sensi dell'art. 2 comma 3 del D.M. 275 del 30/10/2002

Si dichiara che questo prodotto è conforme alle normative vigenti e soddisfa i requisiti essenziali richiesti dalle direttive

2004/108/CE, 2006/95/CE e 1999/05/CE

quando ad esso applicabili

### **Short Declaration of conformity**

We declare this product is complying with the laws in force and meeting all the essential requirements as specified by the directives

2004/108/CE, 2006/95/CE and 1999/05/CE

whenever these laws may be applied

---

---

## Table of Contents

---

---

<b>Chapter 1: Introduction .....</b>	<b>1</b>
<b>1.1 Before You Start.....</b>	<b>1</b>
<b>1.2 Package Checklist .....</b>	<b>1</b>
<b>1.3 Motherboard Features.....</b>	<b>2</b>
<b>1.4 Rear Panel Connectors.....</b>	<b>4</b>
<b>1.5 Motherboard Layout.....</b>	<b>5</b>
<b>Chapter 2: Hardware Installation .....</b>	<b>6</b>
<b>2.1 Installing Central Processing Unit (CPU) .....</b>	<b>6</b>
<b>2.2 FAN Headers .....</b>	<b>8</b>
<b>2.3 Installing System Memory .....</b>	<b>9</b>
<b>2.4 Connectors and Slots.....</b>	<b>11</b>
<b>Chapter 3: Headers &amp; Jumpers Setup .....</b>	<b>15</b>
<b>3.1 How to Setup Jumpers.....</b>	<b>15</b>
<b>3.2 Detail Settings .....</b>	<b>15</b>
<b>Chapter 4: RAID / AHCI Functions.....</b>	<b>20</b>
<b>4.1 Operating System .....</b>	<b>20</b>
<b>4.2 Raid Arrays.....</b>	<b>21</b>
<b>4.3 How RAID Works .....</b>	<b>22</b>
<b>4.4 Intel Smart Response Technology .....</b>	<b>26</b>
<b>Chapter 5: T-Series UEFI BIOS &amp; Software.....</b>	<b>27</b>
<b>5.1 T-Series UEFI BIOS .....</b>	<b>27</b>
<b>5.2 T-Series Software.....</b>	<b>30</b>
<b>Chapter 6: Useful Help .....</b>	<b>40</b>
<b>6.1 Driver Installation Note.....</b>	<b>40</b>
<b>6.2 Extra Information.....</b>	<b>41</b>
<b>6.3 AMI BIOS Post Code.....</b>	<b>42</b>
<b>6.4 Troubleshooting .....</b>	<b>44</b>
<b>Appendix: SPEC In Other Languages .....</b>	<b>46</b>
<b>German.....</b>	<b>46</b>
<b>French .....</b>	<b>48</b>
<b>Italian.....</b>	<b>50</b>
<b>Spanish .....</b>	<b>52</b>
<b>Portuguese .....</b>	<b>54</b>
<b>Polish.....</b>	<b>56</b>
<b>Russian .....</b>	<b>58</b>
<b>Arabic.....</b>	<b>60</b>
<b>Japanese .....</b>	<b>62</b>

## **CHAPTER 1: INTRODUCTION**

### **1.1 BEFORE YOU START**

Thank you for choosing our product. Before you start installing the motherboard, please make sure you follow the instructions below:

- Prepare a dry and stable working environment with sufficient lighting.
- Always disconnect the computer from power outlet before operation.
- Before you take the motherboard out from anti-static bag, ground yourself properly by touching any safely grounded appliance, or use grounded wrist strap to remove the static charge.
- Avoid touching the components on motherboard or the rear side of the board unless necessary. Hold the board on the edge, do not try to bend or flex the board.
- Do not leave any unfastened small parts inside the case after installation. Loose parts will cause short circuits which may damage the equipment.
- Keep the computer from dangerous area, such as heat source, humid air and water.
- The operating temperatures of the computer should be 0 to 45 degrees Celsius.

### **1.2 PACKAGE CHECKLIST**

- ✚ Serial ATA Cable X 4
- ✚ Rear I/O Panel for ATX Case X 1
- ✚ User's Manual X 1
- ✚ Fully Setup Driver DVD X 1

**Note:** The package contents may be different due to area or your motherboard version.

### 1.3 MOTHERBOARD FEATURES

SPEC			
CPU	Socket 1155 Intel Core i7 / i5 / i3 / Pentium / Celeron processor	Supports Execute Disable Bit / Enhanced Intel SpeedStep® / Intel Architecture-64 / Extended Memory 64 Technology / Virtualization Technology / Hyper Threading	
Chipset	Intel Z77 (TZ77B), Intel Z75 (TZ75B) Intel H77 (T77)		
Super I/O	IT8728 Provides the most commonly used legacy Super I/O functionality. Low Pin Count Interface	Environment Control initiatives, Hardware Monitor Controller Fan Speed Controller ITE's "Smart Guardian" function	
Main Memory	DDR3 DIMM Slots x 4 Max Memory Capacity 32GB Each DIMM supports 512MB/ 1GB/2GB/4GB/8GB DDR3	Dual Channel Mode DDR3 memory module Supports DDR3 1066/1333/1600 Supports DDR3(OC) 1800/2000/2200/2400 Supports DDR3(OC) 1866/2133 (for TZ77B, TZ75B) Registered DIMM and ECC DIMM is not supported	
SATA 2 & 3	Integrated Serial ATA Controller	Data transfer rates up to 3.0 Gb/s / 6.0 Gb/s. SATA Version 2.0 / 3.0 specification compliant RAID 0,1,5,10, SRT (TZ77B, T77) support	
LAN	Realtek RTL 8111E	10 / 100 Mb/s / 1Gb/s auto negotiation Half / Full duplex capability	
Sound Codec	ALC892	7.1 channels audio out High Definition Audio	
USB3.0	Z77 (TZ77B) / Z75 (TZ75B) / H77 (T77)	Data transfer rates up to 600 MB/s	
Slots	PCI slot	x2	Supports PCI expansion cards
	PCI Express Gen3 x 16 slot	x1	Supports PCI-E Gen3 x16 expansion card
	PCI Express Gen2 x 16 slot(x4)	x1	Supports PCI-E Gen2 x16 expansion card
	PCI Express Gen2 x 1 slot	x2	Supports PCI-E Gen2 x1 expansion cards
On Board Connectors	SATA3 Connector	x2	Each connector supports 1 SATA3 devices
	SATA2 Connector	x4	Each connector supports 1 SATA2 devices
	Front Panel Connector	x1	Supports front panel facilities
	Front Audio Connector	x1	Supports front panel audio function
	CPU Fan Header	x1	CPU Fan power supply (with Smart Fan function)

**TZ77B/TZ75B/T77**

<b>SPEC</b>			
	System Fan Header	x2	System Fan Power supply
	Clear CMOS Header	x1	Restore CMOS data to factory default
	USB2.0 Connector	x2	Each connector supports 2 front panel USB2.0 ports
	USB3.0 Connector	x1	Each connector supports 2 front panel USB3.0 ports
	Consumer IR Connector	x1	Supports infrared function
	Serial Port Connector	x1	Connects to RS-232 Port
	S/PDIF out Connector	x1	Supports digital audio out function
	Power Connector (24pin)	x1	Connects to Power supply
	Power Connector (8pin)	x1	Connects to Power supply
Back Panel I/O	PS/2 Keyboard	x1	Connects to PS/2 Keyboard
	HDMI Port	x1	Connects to HDMI cable
	VGA Port	x1	Connect to D-SUB monitor
	DVI Port	x1	Connect to DVI monitor
	LAN port	x1	Connect to RJ-45 ethernet cable
	USB2.0 Port	x4	Connect to USB2.0 devices
	USB3.0 Port	x2	Connect to USB3.0 devices
	Audio Jack	x6	Provide Audio-In/Out and Mic. connection
Board Size	220 (W) x 295 (L) mm		ATX
OS Support	Windows XP / Vista / 7		Biostar reserves the right to add or remove support for any OS with or without notice

## 1.4 REAR PANEL CONNECTORS

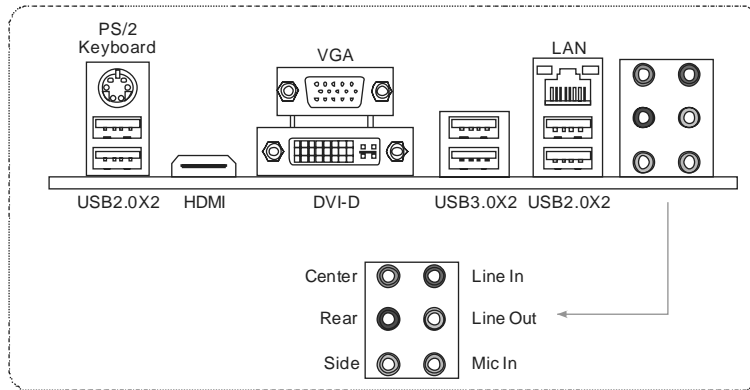

**NOTE:** USB3.0 ports (only supported by Windows 7) are backward compatible with USB2.0/USB1.X devices.

**NOTE:** Maximum resolution:  
 HDMI: 1920 x 1200 @60Hz, compliant with HDMI 1.4a  
 DVI: 1920 x 1200 @60Hz  
 VGA: 2048 x 1536 @75Hz

**NOTE:** This motherboard supports dual video output:

Display Devices	VGA	DVI-D	HDMI
<b>VGA</b>	X	A	A
<b>DVI-D</b>	A	X	S <sup>1</sup> , C, E
<b>HDMI</b>	A	S <sup>1</sup> , C, E	X

- A = Single Pipe Single Display, Intel® Dual Display Clone (Only 24-bpp), or Extended Desktop Mode
- C = Clone Mode
- E = Extended Desktop Mode
- S<sup>1</sup> = Single Pipe Single Display With One Display Device Disabled
- X = Unsupported / Note Applicable

### 1.5 MOTHERBOARD LAYOUT

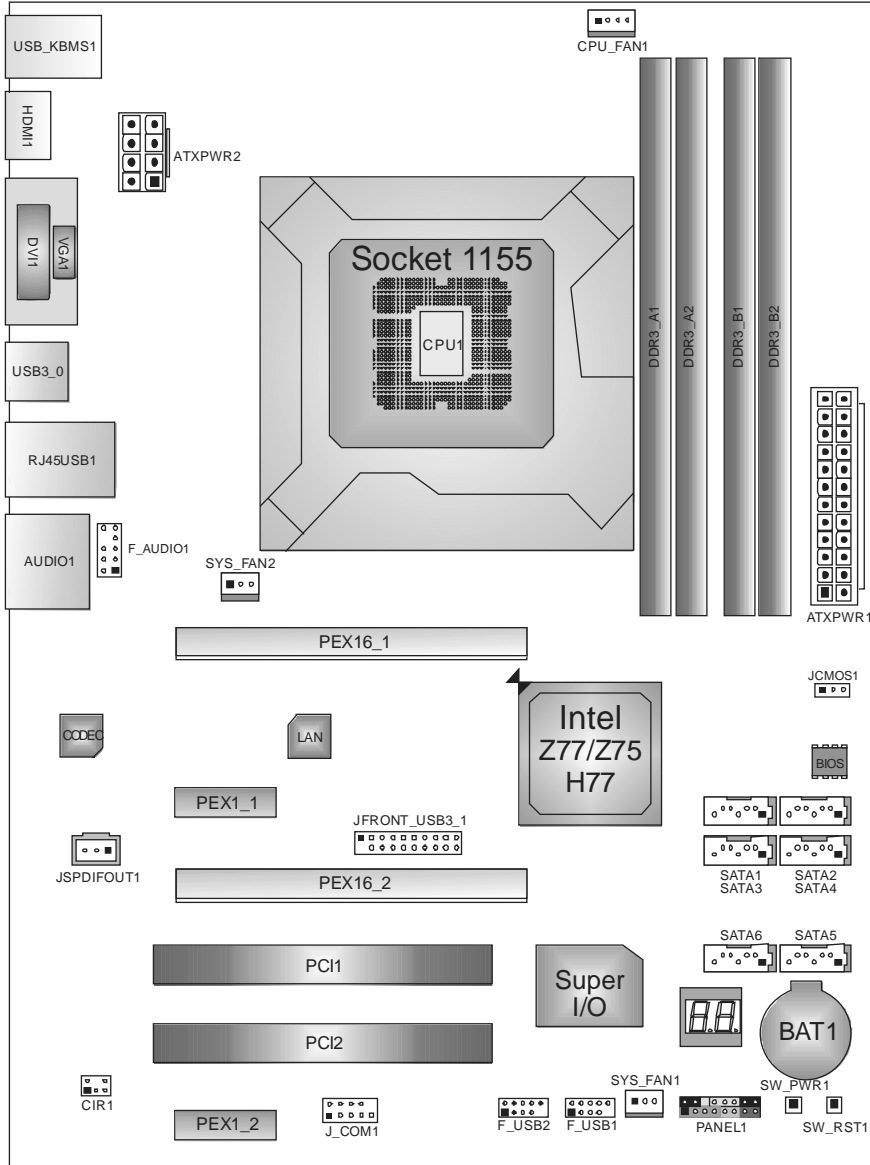

**Note:** ■ represents the 1<sup>st</sup> pin.

## CHAPTER 2: HARDWARE INSTALLATION

### 2.1 INSTALLING CENTRAL PROCESSING UNIT (CPU)

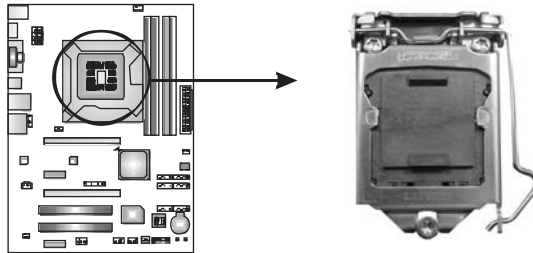

**Notice:**

1. Remove Pin Cap before installation, and make good preservation for future use. When the CPU is removed, cover the Pin Cap on the empty socket to ensure pin legs won't be damaged.
2. The motherboard might equip with two different types of pin cap. Please refer below instruction to remove the pin cap.

**Step 1:** Pull the socket locking lever out from the socket and then raise the lever up.

Type A

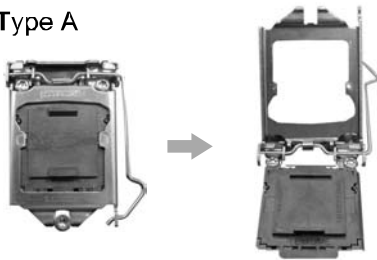

Type B

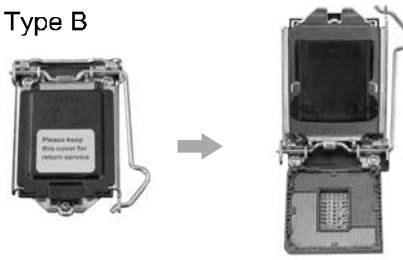

**Step 2:** Remove the Pin Cap.

Type A

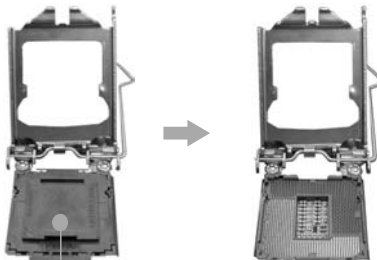

Pin Cap

Type B

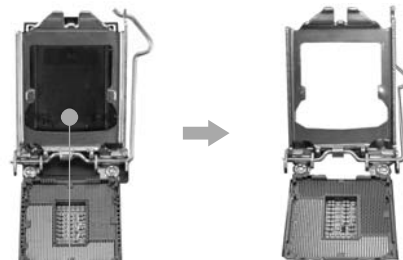

Pin Cap



---

---

### TZ77B/TZ75B/T77

**Step 3:** Hold processor with your thumb and index fingers, oriented as shown. Align the notches with the socket. Lower the processor straight down without tilting or sliding the processor in the socket.

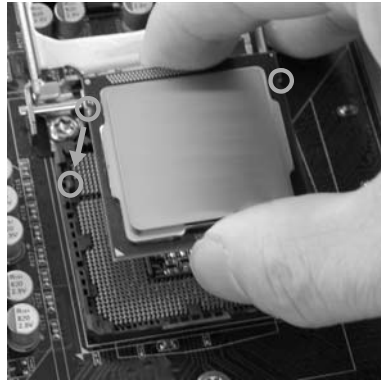

**Step 4:** Close the load plate. Pressing down on the load plate, close and engage the socket lever.



**Step 5:** Put the CPU Fan and heatsink assembly on the CPU and buckle it on the retention frame. Connect the CPU FAN power cable into the CPU\_FAN1 to complete the installation.

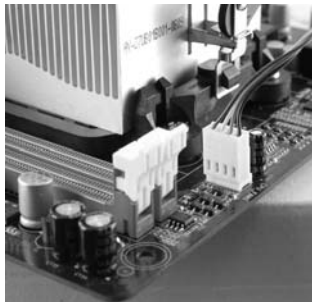

## 2.2 FAN HEADERS

These fan headers support cooling-fans built in the computer. The fan cable and connector may be different according to the fan manufacturer. Connect the fan cable to the connector while matching the black wire to pin#1.

### CPU\_FAN1: CPU Fan Header

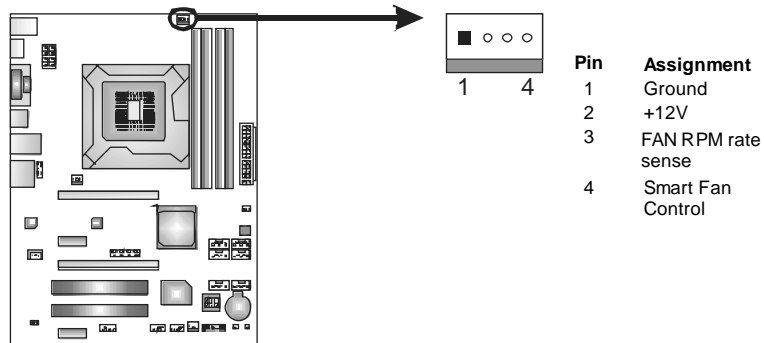

### SYS\_FAN1/SYS\_FAN2: System Fan Headers

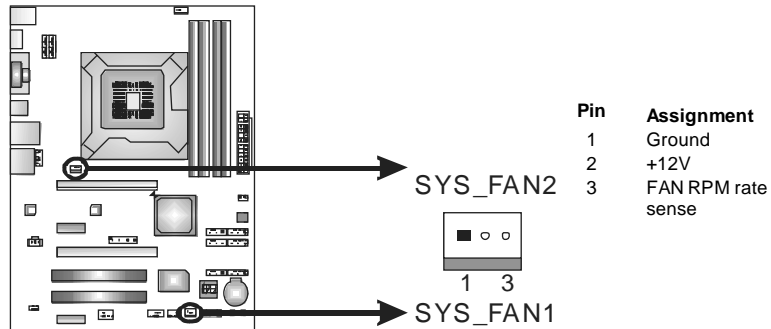

**Note:**

The SYS\_FAN1/SYS\_FAN2 support 3-pin head connectors; the CPU\_FAN1 supports 4-pin head connector. When connecting with wires onto connectors, please note that the red wire is the positive and should be connected to pin#2, and the black wire is Ground and should be connected to GND.

## 2.3 INSTALLING SYSTEM MEMORY

### A. Memory Modules

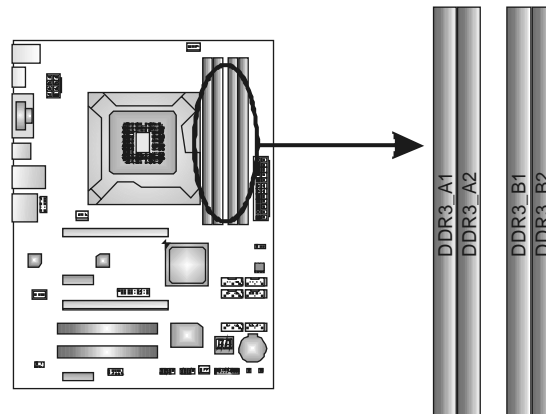

1. Unlock a DIMM slot by pressing the retaining clips outward. Align a DIMM on the slot such that the notch on the DIMM matches the

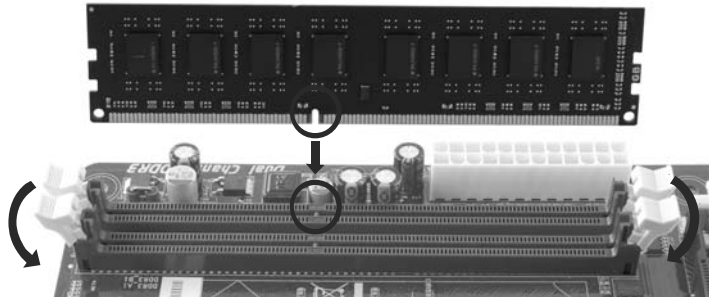

2. Insert the DIMM vertically and firmly into the slot until the retaining chip snap back in place and the DIMM is properly seated.

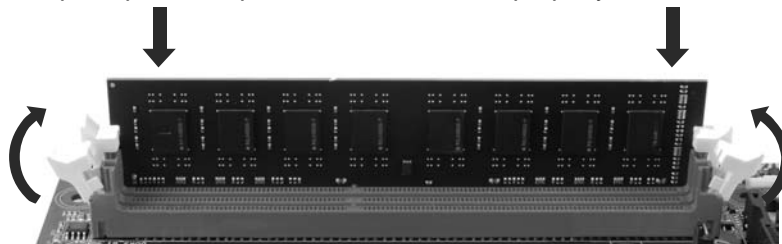

**Note:**

If the DIMM does not go in smoothly, do not force it. Pull it all the way out and try again.

### B. Memory Capacity

DIMM Socket Location	DDR3 Module	Total Memory Size
DDR3_A1	512MB/1GB/2GB/4GB/8GB	Max is 32GB.
DDR3_A2	512MB/1GB/2GB/4GB/8GB	
DDR3_B1	512MB/1GB/2GB/4GB/8GB	
DDR3_B2	512MB/1GB/2GB/4GB/8GB	

### C. Dual Channel Memory Installation

Please refer to the following requirements to activate Dual Channel function:

Install memory module of the same density in pairs, shown in the table.

Dual Channel Status	DDR3_A1	DDR3_A2	DDR3_B1	DDR3_B2
Enabled	O	X	O	X
Enabled	X	O	X	O
Enabled	O	O	O	O
Enabled	O	X	X	O
Enabled	X	O	O	X

(O means memory installed, X means memory not installed.)

The DRAM bus width of the memory module must be the same (x8 or x16)

## 2.4 CONNECTORS AND SLOTS

### SATA1/SATA2: Serial ATA3 Connectors

The motherboard has a PCI to SATA Controller with 2 channels SATA interface, it satisfies the SATA 3.0 spec and with transfer rate of 6.0Gb/s.

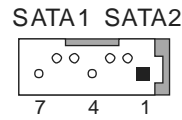
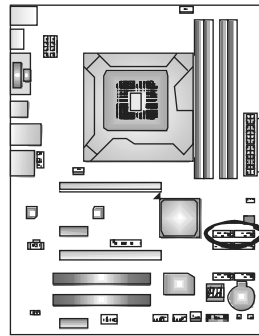

Pin	Assignment
1	Ground
2	TX+
3	TX-
4	Ground
5	RX-
6	RX+
7	Ground

### SATA3 ~ 6: Serial ATA2 Connectors

The motherboard has a PCI to SATA Controller with 4 channels SATA2 interface, it satisfies the SATA 2.0 spec and with transfer rate of 3.0Gb/s.

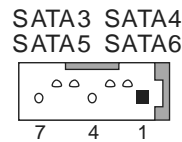
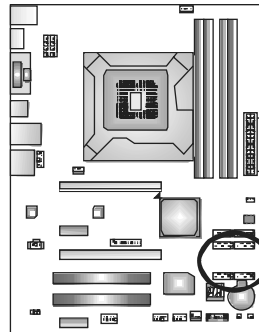

Pin	Assignment
1	Ground
2	TX+
3	TX-
4	Ground
5	RX-
6	RX+
7	Ground

**PEX16\_1: PCI-Express Gen3 x16 Slot**

- PCI-Express 3.0 compliant.
- Maximum theoretical realized bandwidth of 16GB/s simultaneously per direction, for an aggregate of 32GB/s totally.
- PCI-E 3.0 is supported by Core i7-3xxx / i5-3xxx CPU.

**PEX16\_2: PCI-Express Gen2 x4 Slot**

- PCI-Express 2.0 compliant.
- Maximum theoretical realized bandwidth of 2GB/s simultaneously per direction, for an aggregate of 4GB/s totally.

**PEX1\_1/PEX1\_2: PCI-Express Gen2 x1 Slot**

- PCI-Express 2.0 compliant.
- Data transfer bandwidth up to 500MB/s per direction; 1GB/s in total.

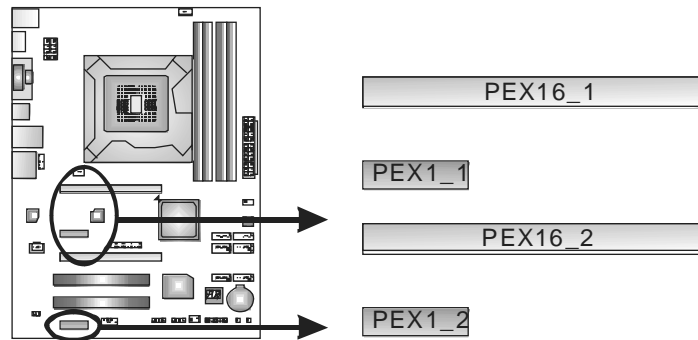

**PCI1/PCI2: Peripheral Component Interconnect Slots**

This motherboard is equipped with 2 standard PCI slots. PCI stands for Peripheral Component Interconnect, and it is a bus standard for expansion cards. This PCI slot is designated as 32 bits.

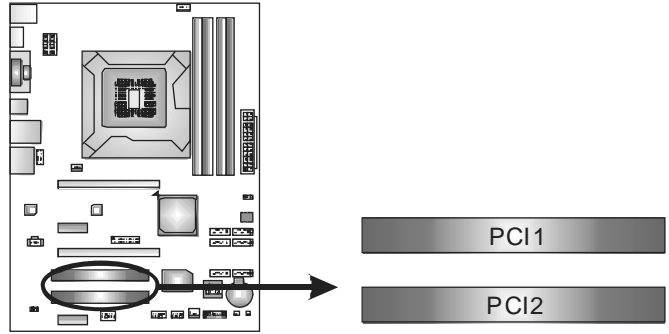

**ATXPWR2: ATX Power Source Connectors**

These connectors provide +12V to CPU power circuit. If the CPU power plug is 4-pin, please plug it into Pin 1-2-5-6 of ATXPWR2.

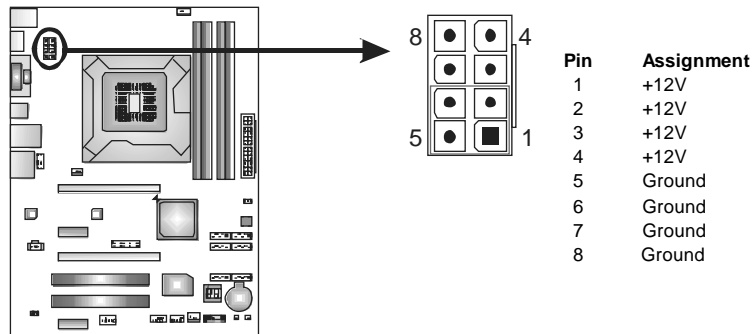

### ATXPWR1: ATX Power Source Connector

This connector allows user to connect 24-pin power connector on the ATX power supply.

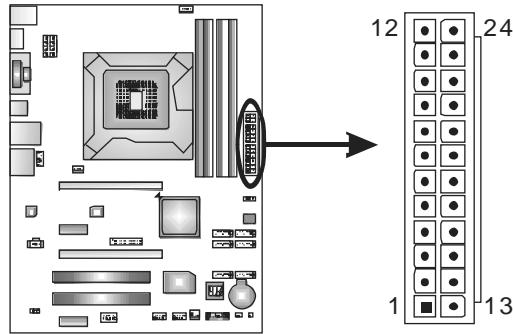

Pin	Assignment	Pin	Assignment
13	+3.3V	1	+3.3V
14	-12V	2	+3.3V
15	Ground	3	Ground
16	PS_ON	4	+5V
17	Ground	5	Ground
18	Ground	6	+5V
19	Ground	7	Ground
20	NC	8	PW_OK
21	+5V	9	Standby Voltage+5V
22	+5V	10	+12V
23	+5V	11	+12V
24	Ground	12	+3.3V

**Note:**

Before you power on the system, please make sure that ATXPWR1 and ATXPWR2 connectors have been well plugged-in.



## CHAPTER 3: HEADERS & JUMPERS SETUP

### 3.1 HOW TO SETUP JUMPERS

The illustration shows how to set up jumpers. When the jumper cap is placed on pins, the jumper is “close”, if not, that means the jumper is “open”.

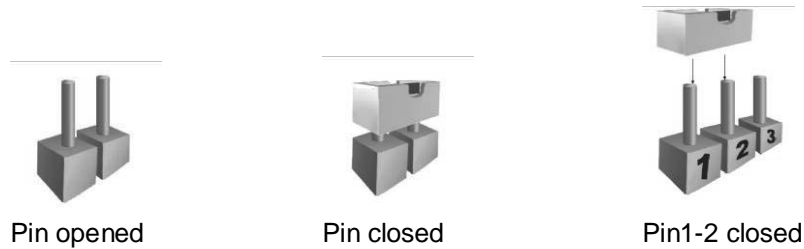

### 3.2 DETAIL SETTINGS

#### PANEL1: Front Panel Header

This 16-pin connector includes Power-on, Reset, HDD LED, Power LED, and speaker connection. It allows user to connect the PC case's front panel switch functions.

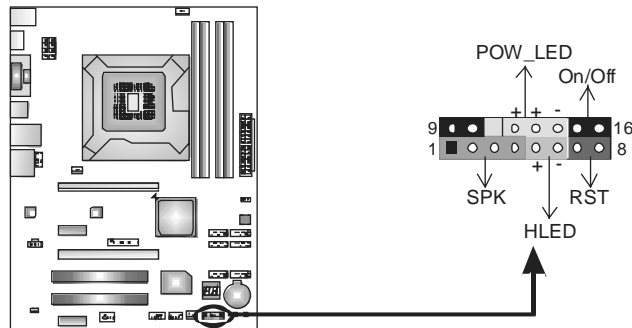

Pin	Assignment	Function	Pin	Assignment	Function
1	+5V	Speaker Connector	9	N/A	N/A
2	N/A		10	N/A	N/A
3	N/A		11	N/A	N/A
4	Speaker	Hard drive LED	12	Power LED (+)	Power LED
5	HDD LED (+)		13	Power LED (+)	
6	HDD LED (-)	Reset button	14	Power LED (-)	Power-on button
7	Ground		15	Power button	
8	Reset control		16	Ground	

### F\_USB1/F\_USB2: Headers for USB 2.0 Ports at Front Panel

These headers allow user to connect additional USB cable on the PC front panel, and also can be connected with internal USB devices, like USB card reader.

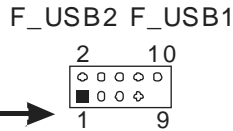
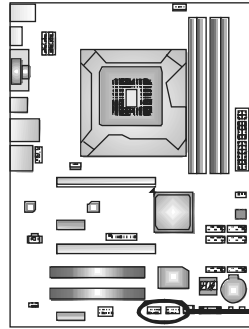

Pin	Assignment
1	+5V (fused)
2	+5V (fused)
3	USB-
4	USB-
5	USB+
6	USB+
7	Ground
8	Ground
9	Key
10	NC

### JFRONT\_USB3\_1: Header for USB 3.0 Ports at Front Panel

This header allows user to connect additional USB cable on the PC front panel, and also can be connected with internal USB devices, like USB card reader.

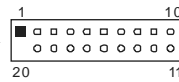
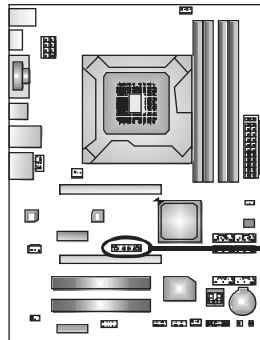

Pin	Assignment	Pin	Assignment
1	VBUS0	11	D2+
2	SSRX1-	12	D2-
3	SSRX1+	13	Ground
4	Ground	14	SSTX2+
5	SSTX1-	15	SSTX2-
6	SSTX1+	16	Ground
7	Ground	17	SSRX2+
8	D1-	18	SSRX2-
9	D1+	19	VBUS1
10	ID	20	Key

**NOTE:** USB3.0 is only supported by Windows 7.

**F\_AUDIO1: Front Panel Audio Header**

This header allows user to connect the front audio output cable with the PC front panel. This header supports HD and AC'97 audio front panel connector.

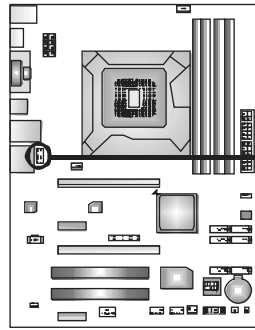

Pin	Assignment
1	Mic Left in
2	Ground
3	Mic Right in
4	GPIO
5	Right line in
6	Jack Sense
7	Front Sense
8	Key
9	Left line in
10	Jack Sense

**JSPDIFOUT1: Digital Audio-out Connector**

This connector allows user to connect the PCI bracket SPDIF output header.

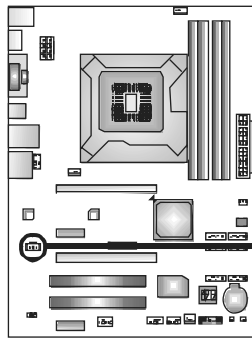

Pin	Assignment
1	+5V
2	SPDIF_OUT
3	Ground

**CIR1: Consumer IR Connector**

This header is for infrared remote control and communication.

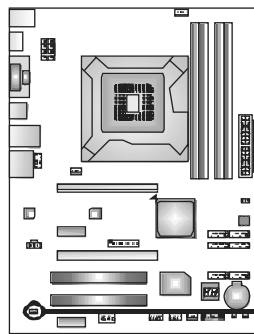

Pin	Assignment
1	IrDA serial input
2	Ground
3	Ground
4	Key
5	IrDA serial output
6	IR Power

### JCMOS1: Clear CMOS Header

Placing the jumper on pin2-3 allows user to restore the BIOS safe setting and the CMOS data. Please carefully follow the procedures to avoid damaging the motherboard.

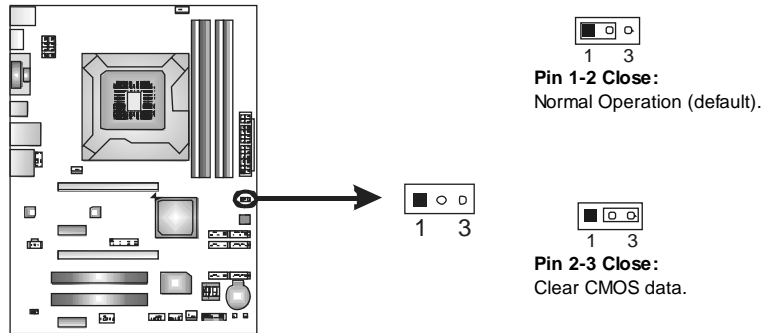

#### ※ Clear CMOS Procedures:

1. Remove AC power line.
2. Set the jumper to "Pin 2-3 close".
3. Wait for five seconds.
4. Set the jumper to "Pin 1-2 close".
5. Power on the AC.
6. Reset your desired password or clear the CMOS data.

### J\_COM1: Serial Port Connector

The motherboard has a Serial Port Connector for connecting RS-232 Port.

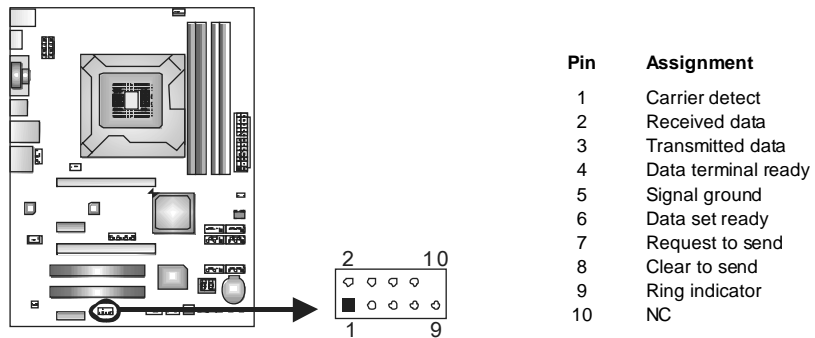

### BIOS POST Code/CPU Temperature Indicator

This indicator will show POST code while booting. After the booting sequence, it will show current CPU temperature through hexadecimal figure. Please refer to Chapter 6.3 for all the BIOS POST codes.

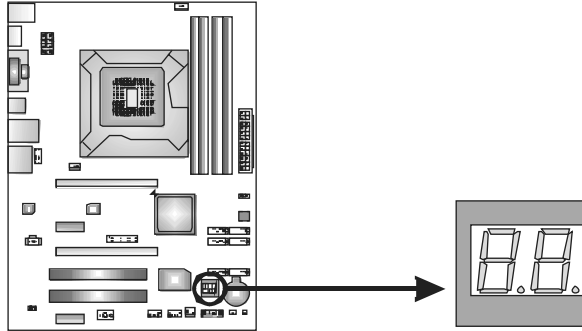

### On-Board Buttons

There are 2 on-board buttons.

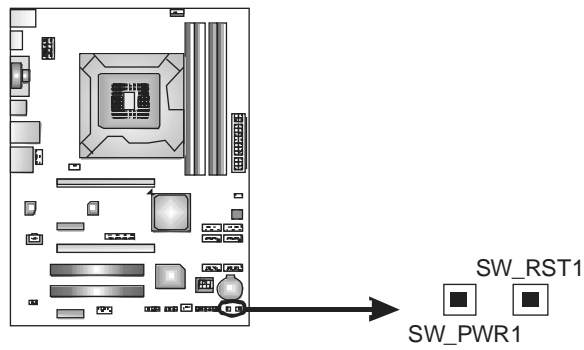

**SW\_RST1:** Reset button.

**SW\_PWR1:** Power Switch button.

## CHAPTER 4: RAID / AHCI FUNCTIONS

### 4.1 OPERATING SYSTEM

CHIP	SATA Controller Configuration	Supporting OS
Intel Z77/Z75/H77 SATA1/SATA2/ SATA3/SATA4/ SATA5/SATA6	AHCI	Windows XP SP2 (32 and 64 bit) Windows Vista SP2 (32 and 64 bit) Windows 7 (32 and 64 bit)
Intel Z77/Z75/H77 SATA1/SATA2/ SATA3/SATA4/ SATA5/SATA6	RAID	Windows XP SP2 (32 and 64 bit) Windows Vista SP2 (32 and 64 bit) Windows 7 (32 and 64 bit)

#### The 'F6 Method'+ to enable RAID / AHCI Driver when installing Windows XP

1. Before you start Windows installation, copy the proper files for the Windows version on USB floppy.

	Windows XP 32	Windows XP 64
SATA1/SATA2/ SATA3/SATA4/ SATA5/SATA6 AHCI/RAID Driver Path	x:\Driver\Chipset\Intel\SATA\7 \F6flpy32\Driver\	x:\Driver\Chipset\Intel\SATA\7 \F6flpy64\Driver\

2. When the operating system installation starts, follow Windows indication by pressing F6 to load the driver.

**Enable RAID / AHCI Driver when installing Windows 7/Vista**

1. Before you start Windows installation, copy the proper files for the Windows version to any USB storage.

	<b>Windows 7 32</b>	<b>Windows 7 64</b>	<b>Windows Vista 32</b>	<b>Windows Vista 64</b>
SATA1/SATA2/ SATA3/SATA4/ SATA5/SATA6 AHCI/RAID Driver Path	x:\Driver\Chipset\ Intel\SATA\7\F6flpy 32\Driver\	x:\Driver\Chipset\ Intel\SATA\7\F6flpy 64\Driver\	x:\Driver\Chipset\ Intel\SATA\7\F6flpy 32\Driver\	x:\Driver\Chipset\ Intel\SATA\7\F6flpy 64\Driver\

2. Follow Windows 7 / Vista indication to load the driver in the installation process.

## 4.2 RAID ARRAYS

<b>CONNECTOR</b>	<b>BY CHIP</b>	<b>SPEED</b>	<b>Support</b>
SATA1/SATA2	Intel Z77/Z75/H77	6 Gb/s.	RAID 0 / 1 / 5 / 10
SATA3/SATA4/SATA5/SATA6	Intel Z77/Z75/H77	3 Gb/s.	RAID 0 / 1 / 5 / 10

RAID supports the following types of RAID arrays:

**RAID 0:** RAID 0 defines a disk striping scheme that improves disk read and write times for many applications.

**RAID 1:** RAID 1 defines techniques for mirroring data.

**RAID 10:** RAID 10 combines the techniques used in RAID 0 and RAID 1.

**RAID 5:** RAID 5 provides fault tolerance and better utilization of disk capacity.

### 4.3 How RAID WORKS

#### **RAID 0:**

The controller “stripes” data across multiple drives in a RAID 0 array system. It breaks up a large file into smaller blocks and performs disk reads and writes across multiple drives in parallel. The size of each block is determined by the stripe size parameter, which you set during the creation of the RAID set based on the system environment. This technique reduces overall disk access time and offers high bandwidth.

#### **Features and Benefits**

- **Drives:** Minimum 2, and maximum is up to 6 or 8. Depending on the platform.
- **Uses:** Intended for non-critical data requiring high data throughput, or any environment that does not require fault tolerance.
- **Benefits:** provides increased data throughput, especially for large files. No capacity loss penalty for parity.
- **Drawbacks:** Does not deliver any fault tolerance. If any drive in the array fails, all data is lost.
- **Fault Tolerance:** No.

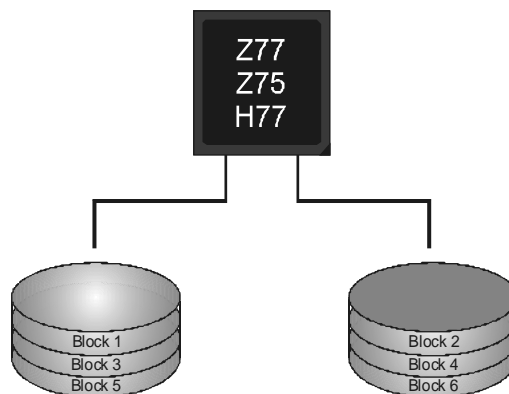



**RAID 1:**

Every read and write is actually carried out in parallel across 2 disk drives in a RAID 1 array system. The mirrored (backup) copy of the data can reside on the same disk or on a second redundant drive in the array. RAID 1 provides a hot-standby copy of data if the active volume or drive is corrupted or becomes unavailable because of a hardware failure. RAID techniques can be applied for high-availability solutions, or as a form of automatic backup that eliminates tedious manual backups to more expensive and less reliable media.

**Features and Benefits**

- **Drives:** Minimum 2, and maximum is 2.
- **Uses:** RAID 1 is ideal for small databases or any other application that requires fault tolerance and minimal capacity.
- **Benefits:** Provides 100% data redundancy. Should one drive fail, the controller switches to the other drive.
- **Drawbacks:** Requires 2 drives for the storage space of one drive. Performance is impaired during drive rebuilds.
- **Fault Tolerance:** Yes.

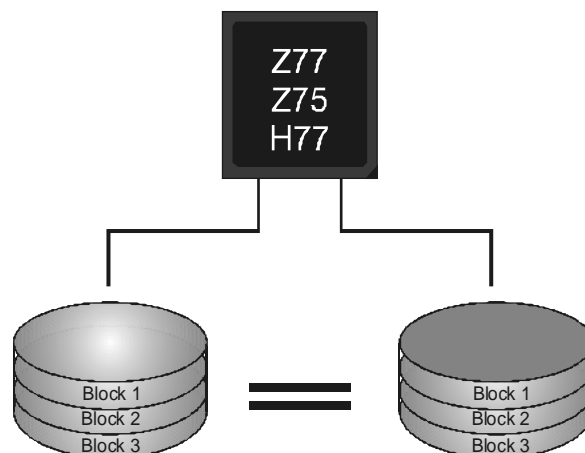

**RAID 10:**

RAID 1 drives can be striped using RAID 0 techniques. Resulting in a RAID 10 solution for improved resiliency, performance and rebuild performance.

**Features and Benefits**

- **Drives:** Minimum 4, and maximum is 6 or 8, depending on the platform.
- **Benefits:** Optimizes for both fault tolerance and performance, allowing for automatic redundancy. May be simultaneously used with other RAID levels in an array, and allows for spare disks.
- **Drawbacks:** Requires twice the available disk space for data redundancy, the same as RAID level 1.
- **Fault Tolerance:** Yes.

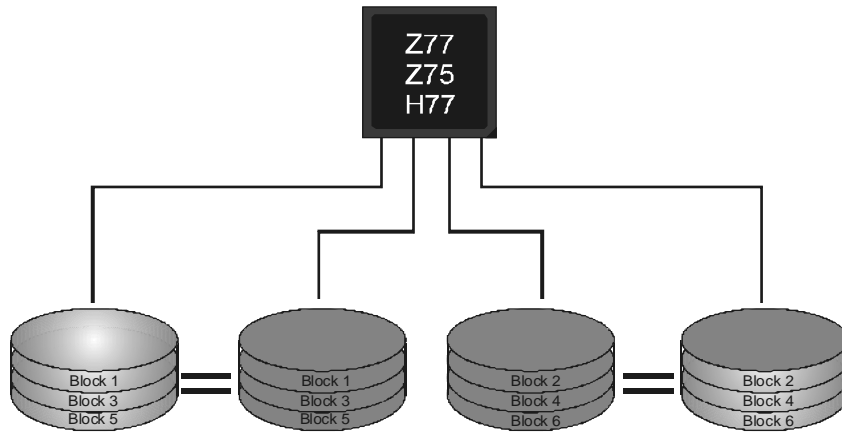

**RAID 5:**

RAID 5 stripes both data and parity information across three or more drives. It writes data and parity blocks across all the drives in the array. Fault tolerance is maintained by ensuring that the parity information for any given block of data is placed on a different drive from those used to store the data itself.

**Features and Benefits**

- **Drives:** Minimum 3.
- **Uses:** RAID 5 is recommended for transaction processing and general purpose service.
- **Benefits:** An ideal combination of good performance, good fault tolerance, and high capacity and storage efficiency.
- **Drawbacks:** Individual block data transfer rate same as a single disk. Write performance can be CPU intensive.
- **Fault Tolerance:** Yes.

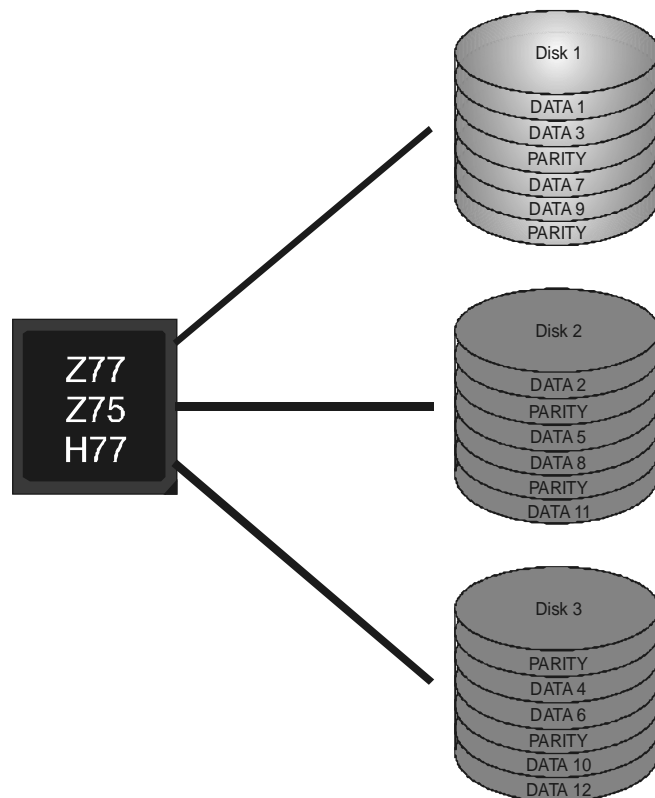

#### **4.4 INTEL SMART RESPONSE TECHNOLOGY**

With Intel(R) Smart Response Technology, the performance of RAID with an Intel SSD drive can be improved better. This function is only for TZ77B and T77.

##### ***Installing Smart Response Technology***

1. Install RAID drives (RAID 0, 1, 5) and an Intel SSD.
2. Activate RAID mode from BIOS, and install operating system.
3. Insert the Setup DVD to the optical drive, and Install all drivers (including Intel(R) Smart Response Technology Driver). After all processes finish, reboot the system.
4. Intel(R) SRT service icon will show in notification area. Double click it to open the main windows.
5. Select "Accelerate" page, and make sure the status of accelerated device has been enabled accelerated.

## CHAPTER 5: T-SERIES UEFI BIOS & SOFTWARE

### 5.1 T-SERIES UEFI BIOS

#### T-Series UEFI BIOS Features

- Overclocking Navigator Engine (O.N.E.)
- Self Recovery System (S.R.S)
- Smart Fan Function
- BIO-Flasher: Update UEFI BIOS file from USB Flash Drive

#### **!! WARNING !!**

For better system performance, the UEFI BIOS firmware is being continuously updated. The UEFI BIOS information described below in this manual is for your reference only and the actual UEFI BIOS information and settings on board may be different from this manual. For further information of setting up the UEFI BIOS, please refer to the UEFI BIOS Manual in the Setup DVD.

#### A. Overclocking Navigator Engine (O.N.E.)

O.N.E provides 4 systems allowing users to customize personal overclock settings: Manual CPU System, Manual Memory System, Manual PWM System, and Manual Voltage System.

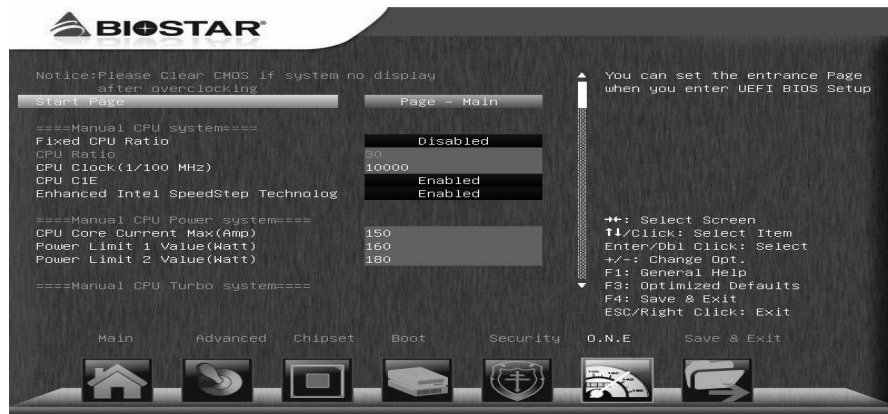

#### Notice:

Not all types of Intel CPU perform above overclock setting ideally; the difference will be based on the selected CPU model.

**NOTE**

Overclock is an optional process, but not a “must-do” process; it is not recommended for inexperienced users. Therefore, we will not be responsible for any hardware damage which may be caused by overclocking. We also would not guarantee any overclocking performance.

**B. Self Recovery System (S.R.S.)**

This function can't be seen under UEFI BIOS setup, and is always on whenever the system starts up.

However, it can prevent system hang-up due to inappropriate overclock actions.

When the system hangs up, S.R.S. will automatically log in the default UEFI BIOS setting, and all overclock settings will be re-configured.

**C. Smart Fan Function**

Smart Fan Function is under “Smart Fan Control” in “Advanced Menu”.

This is a brilliant feature to control CPU/System Temperature vs. Fan speed. When enabling Smart Fan function, Fan speed is controlled automatically by CPU/System temperature.

This function will protect CPU/System from overheat problem and maintain the system temperature at a safe level.





### CPU Smart FAN

This item allows you to control the CPU Smart Fan function.

### CPU FAN Calibrate

Press [ENTER] to calibrate CPU FAN.

### Control Mode

This item provides several operation modes of the fan.

### Fan Ctrl OFF(°C)

When CPU temperature is lower than this value, the CPU fan will keep lowest RPM. The range is from 0~127, with an interval of 1.

### Fan Ctrl On(°C)

When CPU temperature is higher than this value, the CPU fan controller will turn on. The range is from 0~127, with an interval of 1.

### Fan Ctrl Start Value

This item sets CPU FAN Start Speed Value. The range is from 0~127, with an interval of 1.

### Fan Ctrl Sensitive

The bigger the numeral is, the higher the FAN speed is. The range is from 0~127, with an interval of 1.

## 5.2 T-SERIES SOFTWARE

### Installing T-Series Software

1. Insert the Setup DVD to the optical drive. The driver installation program would appear if the Auto-run function has been enabled.
2. Select **Software Installation**, and then click on the respective software title.
3. Follow the on-screen instructions to complete the installation.

### Launching T-Series Software

After the installation process is completed, you will see the software icon showing on the desktop. Double-click the icon to launch it.



Due to the H77 chipset limitation, the most overclocking functions will not be available for T77 motherboard.

### TOverclocker

TOverclocker presents a simple Windows-based system performance enhancement and manageability utility. It features several powerful and easy to use tools such as Overclocking for enhancing system performance, also for special enhancement on CPU and Memory. Smart-Fan management and PC health are for monitoring system status. This utility also allows you to make overclocking profiles saving unlimitedly, and pre-set OC modes are for easy OC. (The illustration below is for reference only)

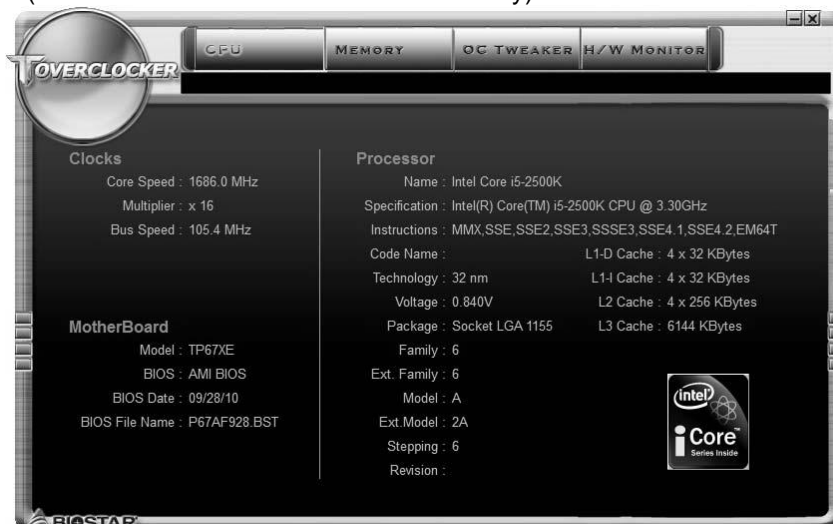





The **CPU** tab provides information on the CPU and motherboard.



The **Memory** tab provides information on the memory module(s).

You can select memory module on a specific slot to see its information.



The **OC Tweaker** tab allows you to change system clock settings and voltages settings. It also provides six pre-set modes for you:



**3 Pre-set Modes: V6, V12, AUTO** for different overclocking experience.

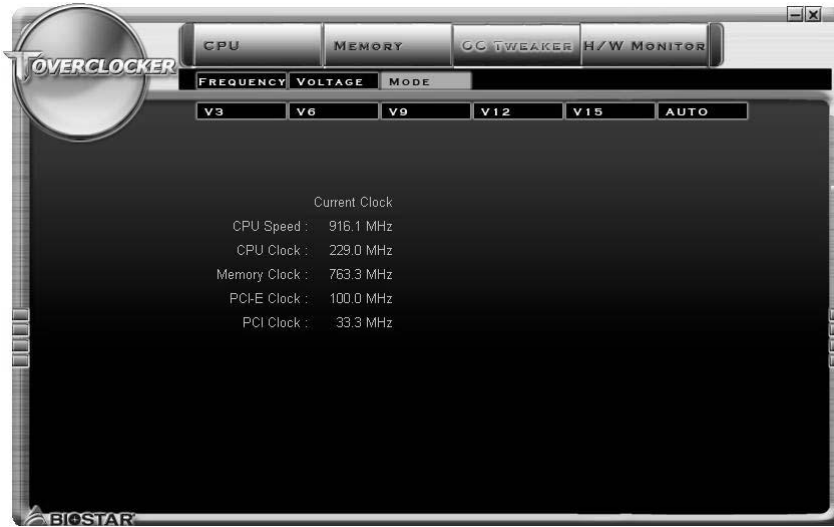

The **HW Monitor** tab allows you to monitor hardware voltage, fan speed, and temperature. Besides, you also can set related values for CPU Smart Fan.





Pressing **TOVERCLOCKER** logo displays information about manufacturer and software version. You can update current version by clicking the button "Live Update."



### Green Power II Utility

BIOSTAR G.P.U II (Green Power Utility) is a new function. The utility enhances energy efficiency by disabling extra phases while CPU is on light loading; it features 4+1 power phases, current power saving, and total power saving. This tool integrates a friendly GUI to monitor your CPU Usage, CPU Watt, and CPU Temperature. Moreover, it optimizes power saving and best power efficiency on your system. (The illustration below is for reference only)

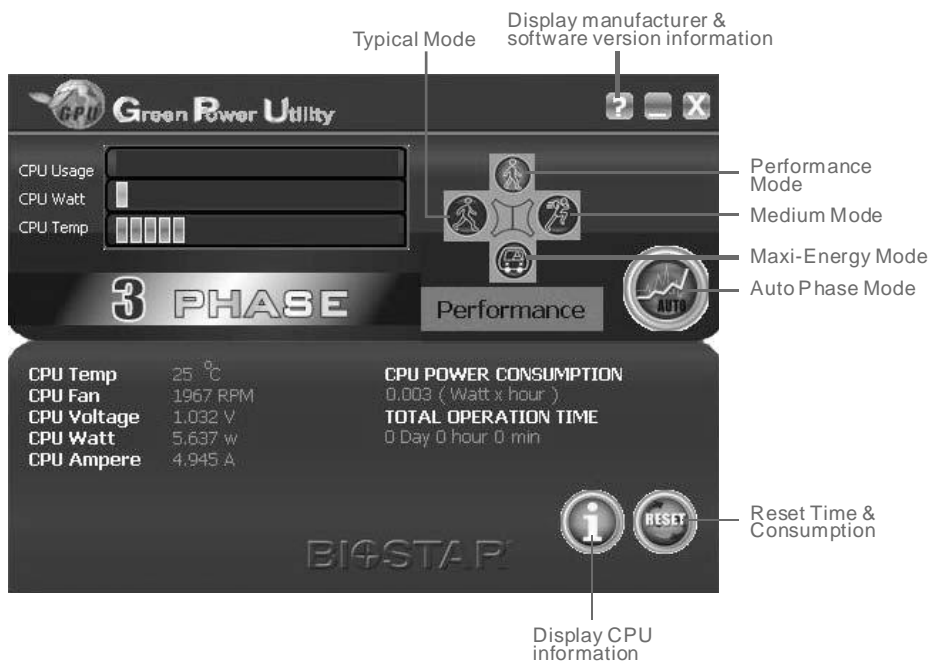

### **G.P.U Mode Setting**

This utility provides five modes, upon your requirements, to improve system performance or to save power consumption.

**Note:** Even if the modes saving more power consumption are chosen, the system still can keep excellent performance.

- **Auto Phase Mode**

System switches the mode automatically according to current system loading condition.

- **Performance Mode**

This is the mode saving power consumption most. Least energy will be used in the system.

- **Typical Mode**

Compared with that in Performance Mode, energy consumption in this mode is a little bit more.

- **Medium Mode**

This is the standard system power saving mode.

- **Maxi-Energy Mode**

This is the best system performance mode.

### eHot-Line (Optional)

eHot-Line is a convenient utility that helps you to contact with our Tech-Support system. This utility will collect the system information which is useful for analyzing the problem you may have encountered, and then send these information to our tech-support department to help you fix the problem.

 Before you use this utility, please set Outlook Express as your default e-mail client application program.

\* represents important information that you must provide. Without this information, you may not be able to send out the mail.

This block will show the information which would be collected in the mail.

\* Describe condition of your system.

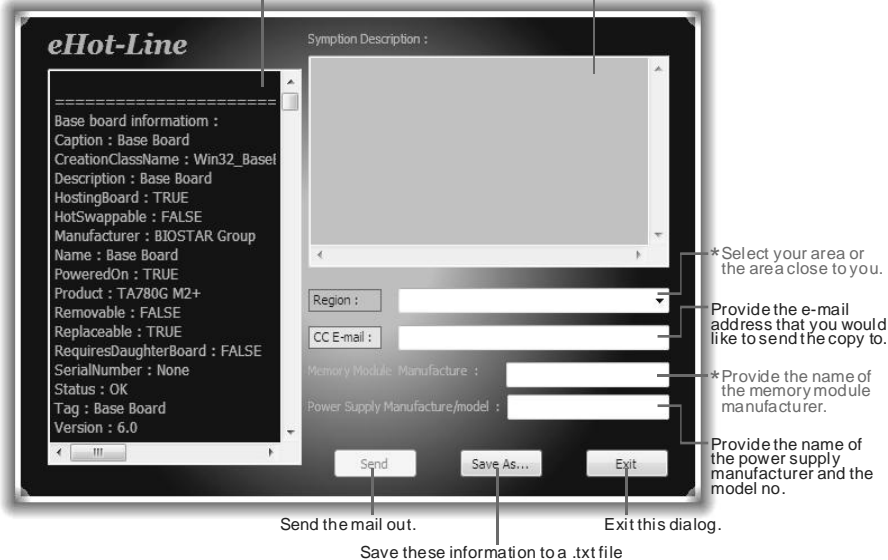

\* Select your area or the area close to you.

Provide the e-mail address that you would like to send the copy to.

\* Provide the name of the memory module manufacturer.

Provide the name of the power supply manufacturer and the model no.

Send the mail out.

Exit this dialog.

Save these information to a .txt file

After filling up this information, click **“Send”** to send the mail out. A warning dialog would appear asking for your confirmation; click **“Send”** to confirm or **“Do Not Send”** to cancel.



If you want to save this information to a .txt file, click **“Save As...”** and then you will see a saving dialog appears asking you to enter file name.

Enter the file name and then click “Save”. Your system information will be saved to a .txt file.

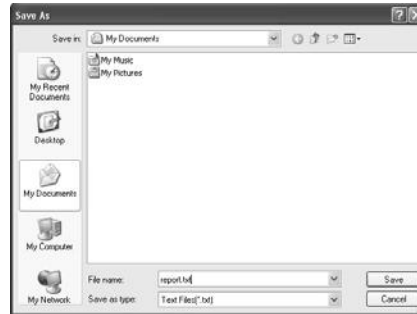

Open the saved .txt file, you will see your system information including motherboard/BIOS/CPU/video/device/OS information. This information is also included in the sent mail.



**We will not share customer’s data with any other third parties,** so please feel free to provide your system information while using eHot-Line service.



If you are not using Outlook Express as your default e-mail client application, you may need to save the system information to a .txt file and send the file to our tech support with other e-mail application.

## BIOS Update

BIOS Update is a convenient utility which allows you to update your motherboard BIOS under Windows system.

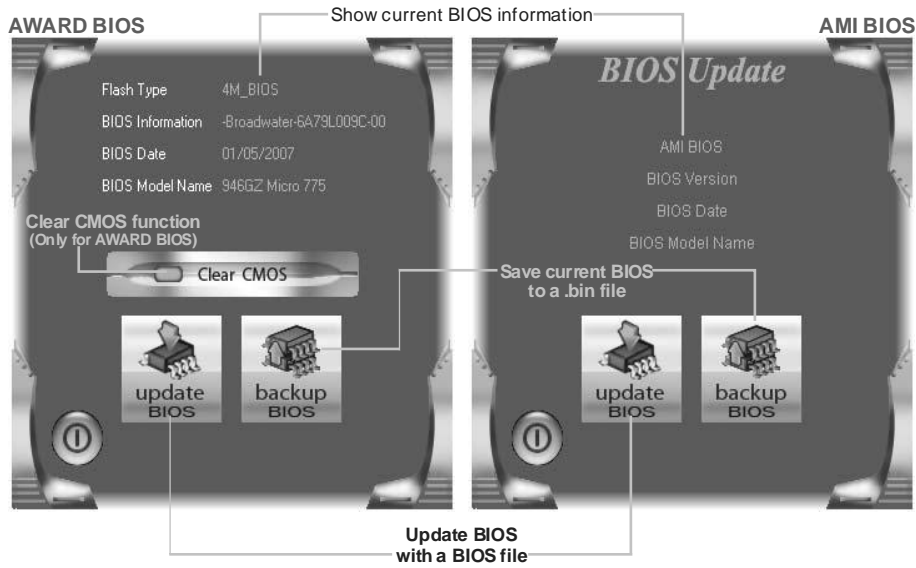

### <Backup BIOS>

Once click on this button, the saving dialog will show. Choose the position to save file and enter file name. (We recommend that the file name should be English/number and no longer than 7 characters.) Then click **Save**.

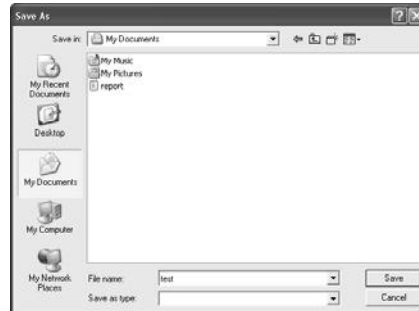

<Update BIOS>

Before doing this, please download the proper BIOS file from the website.

For AWARD BIOS, update BIOS procedure should be run with Clear CMOS function, so please check on Clear CMOS first.

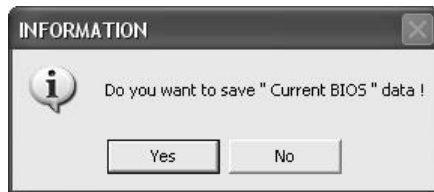
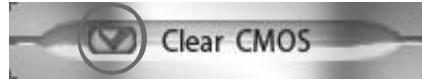

Then click Update BIOS button, a dialog will show for asking you backup current BIOS. Click **Yes** for BIOS backup and refer to the Backup BIOS procedure; or click **No** to skip this procedure.

After the BIOS Backup procedure, the open dialog will show for requesting the BIOS file which is going to be updated. Please choose the proper BIOS file for updating, then click on **Open**.

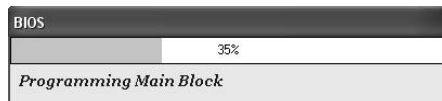
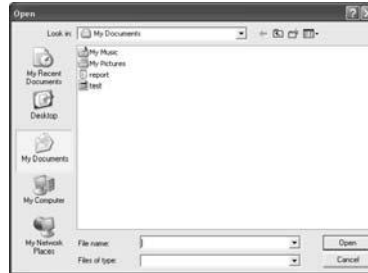

The utility will update BIOS with the proper BIOS file, and this process may take minutes. Please do not open any other applications during this process.

After the BIOS Update process, click on **OK** to restart the system.



While the system boots up and the full screen logo shows, press  <Delete> key to enter BIOS setup.

In the BIOS setup, use the **Load Optimized Defaults** function and then **Save and Exit Setup** to exit BIOS setup. BIOS Update is completed.



All the information and content above about the T-Series software are subject to be changed without notice. For better performance, the software is being continuously updated. The information and pictures described above are for your reference only. The actual information and settings on board may be slightly different from this manual.



### **BIOScreen Utility (Optional)**

This utility allows you to personalize your boot logo easily. You can choose JPG or BMP as your boot logo so as to customize your computer.



Please follow the following instructions to update boot logo:

1. **Load Image** : Choose the picture as the boot logo.
2. **Transform** : Transform the picture for BIOS and preview the result.
3. **Update Bios** : Write the picture to BIOS Memory to complete the update.

## CHAPTER 6: USEFUL HELP

### 6.1 DRIVER INSTALLATION NOTE

After you installed your operating system, please insert the Fully Setup Driver DVD into your optical drive and install the driver for better system performance.

You will see the following window after you insert the DVD

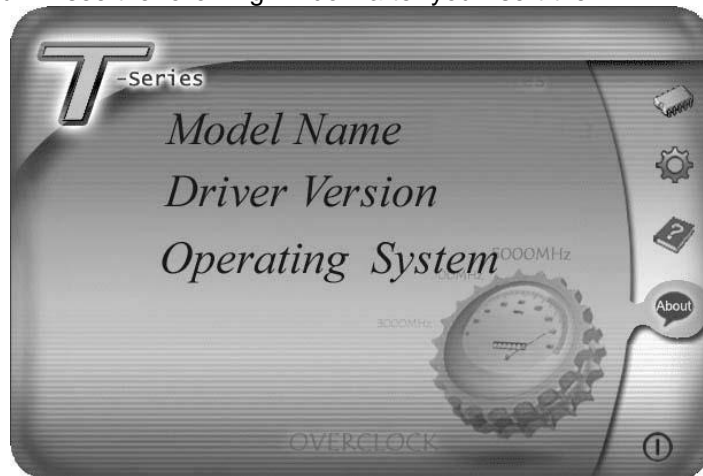

The setup guide will auto detect your motherboard and operating system.

**Note:**

If this window didn't show up after you insert the Driver DVD, please use file browser to locate and execute the file **SETUP.EXE** under your optical drive.

#### A. Driver Installation

To install the driver, please click on the Driver icon. The setup guide will list the compatible driver for your motherboard and operating system. Click on each device driver to launch the installation program.

#### B. Software Installation

To install the software, please click on the Software icon. The setup guide will list the software available for your system, click on each software title to launch the installation program.

#### C. Manual

Aside from the paperback manual, we also provide manual in the Driver DVD. Click on the Manual icon to browse for available manual.

**Note:**

You will need Acrobat Reader to open the manual file. Please download the latest version of Acrobat Reader software from <http://www.adobe.com/products/acrobat/readstep2.html>

## 6.2 EXTRA INFORMATION

### ***CPU Overheated***

If the system shutdown automatically after power on system for seconds, that means the CPU protection function has been activated.

When the CPU is over heated, the motherboard will shutdown automatically to avoid a damage of the CPU, and the system may not power on again.

In this case, please double check:

1. The CPU cooler surface is placed evenly with the CPU surface.
2. CPU fan is rotated normally.
3. CPU fan speed is fulfilling with the CPU speed.

After confirmed, please follow steps below to relief the CPU protection function.

1. Remove the power cord from power supply for seconds.
2. Wait for seconds.
3. Plug in the power cord and boot up the system.

Or you can:

1. Clear the CMOS data.  
(See "Close CMOS Header: JCMOS1" section)
2. Wait for seconds.
3. Power on the system again.

### 6.3 AMI BIOS Post Code

Checkpoint	Description
03	Disable NMI, Parity, video for EGA, and DMA controllers. Initialize BIOS, POST, Runtime data area. Also initialize BIOS modules on POST entry and GPNV area. Initialize CMOS as mentioned in the Kernel Variable "wCMOSFlags."
04	Check CMOS diagnostic byte to determine if battery power is OK and CMOS checksum is OK. Verify CMOS checksum manually by reading storage area. If the CMOS checksum is bad, update CMOS with power-on default values and clear passwords. Initialize status register A. Initializes data variables that are based on CMOS setup questions. Initializes both the 8259 compatible PICs in the system
05	Initializes the interrupt controlling hardware (generally PIC) and interrupt vector table.
06	Do RW test to CH-2 count reg. Initialize CH-0 as system timer. Install the POSTINT1Ch handler. Enable IRQ-0 in PIC for system timer interrupt. Traps INT1Ch vector to "POSTINT1ChHandlerBlock."
07	Fixes CPU POST interface calling pointer.
08	Initializes the CPU. The BAT test is being done on KBC. Program the keyboard controller command byte is being done after Auto detection of KB/MS using AMI KB-5.
C0	Early CPU Init Start -- Disable Cache – Init Local APIC.
C1	Set up boot strap processor Information.
C2	Set up boot strap processor for POST.
C5	Enumerate and set up application processors.
C6	Re-enable cache for boot strap processor.
C7	Early CPU Init Exit.
0A	Initializes the 8042 compatible Key Board Controller.
0B	Detects the presence of PS/2 mouse.
0C	Detects the presence of Keyboard in KBC port.
0E	Testing and initialization of different Input Devices. Also, update the Kernel Variables. Traps the INT09h vector, so that the POST INT09h handler gets control for IRQ1. Uncompress all available language, BIOS logo, and Silent logo modules.
13	Early POST initialization of chipset registers.
20	Relocate System Management Interrupt vector for all CPU in the system.
24	Uncompress and initialize any platform specific BIOS modules. GPNV is initialized at this checkpoint.
2A	Initializes different devices through DIM. See DIM Code Checkpoints section of document for more information.
2C	Initializes different devices. Detects and initializes the video adapter installed in the system that have optional ROMs.
2E	Initializes all the output devices.
31	Allocate memory for ADM module and uncompress it. Give control to ADM module for initialization. Initialize language and font modules for ADM. Activate ADM module.
33	Initializes the silent boot module. Set the window for displaying text information.

Checkpoint	Description
37	Displaying sign-on message, CPU information, setup key message, and any OEM specific information.
38	Initializes different devices through DIM. See DIM Code Checkpoints section of document for more information. USB controllers are initialized at this point.
39	Initializes DMAC-1 & DMAC-2.
3A	Initialize RTC date/time.
3B	Test for total memory installed in the system. Also, Check for DEL or ESC keys to limit memory test. Display total memory in the system.
3C	Mid POST initialization of chipset registers.
40	Detect different devices (Parallel ports, serial ports, and coprocessor in CPU, etc.) successfully installed in the system and update the BDA, EBDA...etc.
52	Updates CMOS memory size from memory found in memory test. Allocates memory for Extended BIOS Data Area from base memory. Programming the memory hole or any kind of implementation that needs an adjustment in system RAM size if needed.
60	Initializes NUM-LOCK status and programs the KBD typematic rate.
75	Initialize Int-13 and prepare for IPL detection.
78	Initializes IPL devices controlled by BIOS and option ROMs.
7C	Generate and write contents of ESCD in NVRam.
84	Log errors encountered during POST.
85	Display errors to the user and gets the user response for error.
87	Execute BIOS setup if needed / requested. Check boot password if installed.
8C	Late POST initialization of chipset registers.
8D	Build ACPI tables (if ACPI is supported).
8E	Program the peripheral parameters. Enable/Disable NMI as selected.
90	Initialization of system management interrupt by invoking all handlers. Please note this checkpoint comes right after checkpoint 20h.
A1	Clean-up work needed before booting to OS.
A2	Takes care of runtime image preparation for different BIOS modules. Fill the free area in F000h segment with 0FFh. Initializes the Microsoft IRQ Routing Table. Prepares the runtime language module. Disables the system configuration display if needed.
A4	Initialize runtime language module. Display boot option popup menu.
A7	Displays the system configuration screen if enabled. Initialize the CPU's before boot, which includes the programming of the MTRR's.
A9	Wait for user input at config display if needed.
AA	Uninstall POST INT1Ch vector and INT09h vector.
AB	Prepare BBS for Int 19 boot. Init MP tables.
AC	End of POST initialization of chipset registers. De-initializes the ADM module.
B1	Save system context for ACPI. Prepare CPU for OS boot including final MTRR values.
00	Passes control to OS Loader (typically INT19h).

## 6.4 TROUBLESHOOTING

Probable	Solution
<ol style="list-style-type: none"> <li>1. There is no power in the system. Power LED does not shine; the fan of the power supply does not work</li> <li>2. Indicator light on keyboard does not shine.</li> </ol>	<ol style="list-style-type: none"> <li>1. Make sure power cable is securely plugged in.</li> <li>2. Replace cable.</li> <li>3. Contact technical support.</li> </ol>
<p>System is inoperative. Keyboard lights are on, power indicator lights are lit, and hard drives are running.</p>	<p>Using even pressure on both ends of the DIMM, press down firmly until the module snaps into place.</p>
<p>System does not boot from a hard disk drive, but can be booted from optical drive.</p>	<ol style="list-style-type: none"> <li>1. Check cable running from disk to disk controller board. Make sure both ends are securely plugged in; check the drive type in the standard CMOS setup.</li> <li>2. Backing up the hard drive is extremely important. All hard disks are capable of breaking down at any time.</li> </ol>
<p>System only boots from an optical drive. Hard disks can be read, applications can be used, but system fails to boot from a hard disk.</p>	<ol style="list-style-type: none"> <li>1. Back up data and applications files.</li> <li>2. Reformat the hard drive. Re-install applications and data using backup disks.</li> </ol>
<p>Screen message shows "Invalid Configuration" or "CMOS Failure."</p>	<p>Review system's equipment. Make sure correct information is in setup.</p>
<p>System cannot boot after user installs a second hard drive.</p>	<ol style="list-style-type: none"> <li>1. Set master/slave jumpers correctly.</li> <li>2. Run SETUP program and select correct drive types. Call the drive manufacturers for compatibility with other drives.</li> </ol>

This page is intentionally left blank.

**APPENDIX: SPEC IN OTHER LANGUAGES****GERMAN**

<i>Spezifikationen</i>		
CPU	Socket 1155 Intel Core i7 / i5 / i3 / Pentium / Celeron Prozessoren	Unterstützt Execute Disable Bit / Enhanced Intel SpeedStep® / Intel Architecture-64 / Extended Memory 64 Technology / Virtualization Technology / Hyper Threading
Chipsatz	Intel Z77 (TZ77B), Intel Z75 (TZ75B) Intel H77 (T77)	
Super E/A	IT8728 Bietet die häufig verwendeten alten Super E/A-Funktionen. Low Pin Count-Schnittstelle	Umgebungskontrolle, Hardware-Überwachung Lüfterdrehzahl-Controller/-Überwachung "Smart Guardian"-Funktion von ITE
Arbeitsspeicher	DDR3 DIMM-Steckplätze x 4 Max. 32GB Arbeitsspeicher Jeder DIMM unterstützt 512MB/ 1GB/2GB/4GB/8GB DDR3.	Dual-Kanal DDR3 Speichermodul Unterstützt DDR3 1066/1333/1600 Unterstützt DDR3(OC) 1800/2000/2200/2400 Unterstützt DDR3(OC) 1866/2133 (TZ77B, TZ75B) registrierte DIMMs. ECC DIMMs werden nicht unterstützt.
SATA 2 & 3	Integrierter Serial ATA-Controller	Datentransfertrate bis zu 3.0Gb/s / 6.0Gb/s. Konform mit der SATA-Spezifikation Version 2.0 / 3.0 Unterstützt RAID 0,1,5,10, SRT (TZ77B)
LAN	Realtek RTL 8111E	10 / 100 / 1000 Mb/s Auto-Negotiation Halb-/ Vollduplex-Funktion
HD Audio-Unterstützung	ALC892	Unterstützt High-Definition Audio 7.1-Kanal-Audioausgabe
USB3.0	Z77 (TZ77B) / Z75 (TZ75B) / H77 (T77)	Datenübertragungsraten bis zu 600 MB / s
Steckplätze	PCI-Steckplatz x2 PCI Express Gen3 x16 Steckplatz x1 PCI Express Gen2 x16 Steckplatz(x4) x1 PCI Express Gen2 x 1-Steckplatz x2	
Onboard-Anschluss	SATA3-Anschluss x2 SATA2-Anschluss x4 Fronttafelanschluss x1	Jeder Anschluss unterstützt 1 SATA3-Laufwerk Jeder Anschluss unterstützt 1 SATA2-Laufwerk Unterstützt die Fronttafel-funktionen



<b>Spezifikationen</b>			
	Front-Audioanschluss	x1	Unterstützt die Fronttafel-Audioanschlussfunktion
	CPU-Lüfter-Sockel	x1	CPU-Lüfterstromversorgungsanschluss (mit Smart Fan-Funktion)
	System-Lüfter-Sockel	x2	System-Lüfter-Stromversorgungsanschluss
	"CMOS löschen"-Sockel	x1	
	USB2.0-Anschluss	x2	Jeder Anschluss unterstützt 2 Fronttafel-USB2.0-Anschlüsse
	USB3.0-Anschluss	x1	Jeder Anschluss unterstützt 2 Fronttafel-USB3.0-Anschlüsse
	Verbraucher-IR Anschluss	x1	
	Serieller Anschluss	x1	
	S/PDIF Ausgangsanschluss	x1	Unterstützt die digitale Audioausgabefunktion
	Stromanschluss (24-polig)	x1	
	Stromanschluss (8-polig)	x1	
Rückseiten-E/A	PS/2-Tastatur	x1	
	HDMI-Anschluss	x1	
	VGA-Anschluss	x1	
	DVI-Anschluss	x1	
	LAN-Anschluss	x1	
	USB2.0-Anschluss	x4	
	USB3.0-Anschluss	x2	
	Audioanschluss	x6	
Platinengröße	220 mm (B) X 295 mm (L)		ATX
OS-Unterstützung	Windows XP / Vista / 7		Biostar behält sich das Recht vor, ohne Ankündigung die Unterstützung für ein Betriebssystem hinzuzufügen oder zu entfernen.

**FRENCH**

SPEC		
UC	Socket 1155 Processeurs Intel Core i7 / i5 / i3 / Pentium / Celeron	Prend en charge les technologies d'exécution de bit de désactivation / Intel SpeedStep® optimisée/ d'architecture Intel 64 / de mémoire étendue 64 / de virtualisation / Hyper Threading
Chipset	Intel Z77 (TZ77B), Intel Z75 (TZ75B) Intel H77 (T77)	
Super E/S	IT8728 Fournit la fonctionnalité de Super E/S patrimoniales la plus utilisée. Interface à faible compte de broches	Initiatives de contrôle environnementales, Moniteur de matériel Contrôleur /moniteur de vitesse de ventilateur Fonction "Gardien intelligent" de l'ITE
Mémoire principale	Fentes DDR3 DIMM x 4 Capacité mémoire maximale de 32 Go Chaque DIMM prend en charge des DDR3 de 512Mo/1Go/2Go/4Go/8Go	Module de mémoire DDR3 à mode à double voie Prend en charge la DDR3 1066/1333/1600 Prend en charge la DDR3 (OC) 1800/ 2000/ 2200/ 2400 Prend en charge la DDR3 (OC) 1866/2133 (TZ77B, TZ75B) Les DIMM à registres et DIMM avec code correcteurs d'erreurs ne sont pas prises en charge
SATA 2 & 3	Contrôleur Serial ATA intégré :	Taux de transfert jusqu'à 3.0Go/s / 6.0Go/s. Conforme à la spécification SATA Version 2.0 / 3.0 Prise en charge RAID 0,1,5,10, SRT (TZ77B, T77)
LAN	Realtek RTL 8111E	10 / 100 / 1000 Mb/s négociation automatique Half / Full duplex capability
Prise en charge audio HD	ALC892	Prise en charge de l'audio haute définition Sortie audio à 7.1 voies
USB3.0	Z77 (TZ77B) / Z75 (TZ75B) / H77 (T77)	Taux de transfert de données jusqu'à 600 Mo / s
Fentes	Fente PCI x2 Fente PCI Express Gen3 x16 x1 Fente PCI Express Gen2 x16(x4) x1 Fente PCI Express Gen2 x1 x2	
Connecteur	Connecteur SATA3 x2	Chaque connecteur prend en charge 1 périphérique SATA3

**TZ77B/TZ75B/T77**

<b>SPEC</b>			
embarqué	Connecteur SATA2	x4	Chaque connecteur prend en charge 1 périphérique SATA2
	Connecteur du panneau avant	x1	Prend en charge les équipements du panneau avant
	Connecteur Audio du panneau avant	x1	Prend en charge la fonction audio du panneau avant
	Embase de ventilateur UC	x1	Alimentation électrique du ventilateur UC (avec fonction de ventilateur intelligent)
	Embase de ventilateur système	x2	Alimentation électrique du ventilateur système
	Embase d'effacement CMOS	x1	
	Connecteur USB2.0	x2	Chaque connecteur prend en charge 2 ports USB2.0 de panneau avant
	Connecteur USB3.0	x1	Chaque connecteur prend en charge 2 ports USB3.0 de panneau avant
	Connecteur de IR du consommateur	x1	
	Port série	x1	
	Connecteur de sortie S/PDIF	x1	Prend en charge la fonction de sortie audio numérique
	Connecteur d'alimentation (24 broches)	x1	
	Connecteur d'alimentation (8 broches)	x1	
	E/S du panneau arrière	Clavier PS/2	x1
Port HDMI		x1	
Port VGA		x1	
Port DVI		x1	
Port LAN		x1	
Port USB2.0		x4	
Port USB3.0		x2	
Fiche audio		x6	
Dimensions de la carte	220 mm (l) X 295 mm (H)	ATX	
Support SE	Windows XP / Vista / 7		Biostar se réserve le droit d'ajouter ou de supprimer le support de SE avec ou sans préavis

**ITALIAN**

<b>SPECIFICA</b>		
CPU	Socket 1155 Processore Intel Core i7 / i5 / i3 / Pentium / Celeron	Supporto di Execute Disable Bit / Enhanced Intel SpeedStep® / Architettura Intel 64 / Tecnologia Extended Memory 64 / Tecnologia Virtualization / Hyper Threading
Chipset	Intel Z77 (TZ77B), Intel Z75 (TZ75B) Intel H77 (T77)	
Super I/O	IT8728 Fornisce le funzionalità legacy Super I/O usate più comunemente. Interfaccia LPC (Low Pin Count)	Funzioni di controllo dell'ambiente: Monitoraggio hardware Controller / Monitoraggio velocità ventolina Funzione "Smart Guardian" di ITE
Memoria principale	Alloggi DIMM DDR3 x 4 Capacità massima della memoria 32GB Ciascun DIMM supporta DDR3 512MB/1GB/2GB/4GB/8GB	Modulo di memoria DDR3 a canale doppio Supporto di DDR3 1066/1333/1600 Supporto di DDR3(OC) 1800/2000/2200/2400 Supporto di DDR3(OC) 1866/2133 (TZ77B, TZ75B) DIMM registrati e DIMM ECC non sono supportati
SATA 2 & 3	Controller Serial ATA integrato	Velocità di trasferimento dei dati fino a 3.0Gb/s / 6.0Gb/s. Compatibile specifiche SATA Versione 2.0/3.0 Supporto RAID 0,1,5,10, SRT (TZ77B, T77)
LAN	Realtek RTL 8111E	Negoziazione automatica 10 / 100 / 1000 Mb/s Capacità Half / Full Duplex
Supporto audio HD	ALC892	Supporto audio High-Definition (HD) Uscita audio 7.1 canali
USB3.0	Z77 (TZ77B) / Z75 (TZ75B) / H77 (T77)	Velocità di trasferimento dati fino a 600 MB / s
Alloggi	Alloggio PCI x2 Alloggio PCI Express Gen3 x16 x1 Alloggio PCI Express Gen2 x16(x4) x1 Alloggio PCI Express Gen2 x1 x2	
Connettori su scheda	Connettore SATA3 x2 Connettore SATA2 x4 Connettore pannello frontale x1 Connettore audio frontale x1	Ciascun connettore supporta 1 unità SATA3 Ciascun connettore supporta 1 unità SATA2 Supporta i servizi del pannello frontale Supporta la funzione audio pannello frontale

## TZ77B/TZ75B/T77

<b>SPECIFICA</b>			
	Collettore ventolina CPU	x1	Alimentazione ventolina CPU (con funzione Smart Fan)
	Collettore ventolina sistema	x2	Alimentazione ventolina di sistema
	Collettore cancellazione CMOS	x1	
	Connettore USB2.0	x2	Ciascun connettore supporta 2 porte USB2.0 pannello frontale
	Connettore USB3.0	x1	Ciascun connettore supporta 2 porte USB3.0 pannello frontale
	Connettore IR del consumatore	x1	
	Porta seriale	x1	
	Connettore output S/PDIF	x1	Supporta la funzione d'output audio digitale
	Connettore alimentazione (24 pin)	x1	
	Connettore alimentazione (8 pin)	x1	
I/O pannello posteriore	Tastiera PS/2	x1	
	Porta HDMI	x1	
	Porta VGA	x1	
	Porta DVI	x1	
	Porta LAN	x1	
	Porta USB2.0	x4	
	Porta USB3.0	x2	
	Connettore audio	x6	
Dimensioni scheda	220 mm (larghezza) x 295 mm (altezza)		ATX
Sistemi operativi supportati	Windows XP / Vista / 7		Biostar si riserva il diritto di aggiungere o rimuovere il supporto di qualsiasi sistema operativo senza preavviso.

**SPANISH**

<b>Especificación</b>		
CPU	Socket 1155 Procesador Intel Core i7 / i5 / i3 / Pentium / Celeron	Admite Bit de deshabilitación de ejecución / Intel SpeedStep® Mejorado / Intel Architecture-64 / Tecnología Extended Memory 64 / Tecnología de virtualización / Hyper Threading
Conjunto de chips	Intel Z77 (TZ77B), Intel Z75 (TZ75B) Intel H77 (T77)	
Súper E/S	IT8728 Le ofrece las funcionalidades heredadas de uso más común Súper E/S. Interfaz de cuenta Low Pin	Iniciativas de control de entorno, Monitor hardware Controlador/monitor de velocidad de ventilador Función "Guardia inteligente" de ITE
Memoria principal	Ranuras DIMM DDR3 x 4 Capacidad máxima de memoria de 32GB Cada DIMM admite DDR de 512MB/1GB/2GB/4GB/8GB	Módulo de memoria DDR3 de canal Doble Admite DDR3 de 1066/1333/1600 Admite DDR3 de (OC) 1800/2000/2200/2400 Admite DDR3 de (OC) 1866/2133 (TZ77B, TZ75B) No admite DIMM registrados o DIMM compatibles con ECC
SATA 2 & 3	Controlador ATA Serie Integrado	Tasas de transferencia de hasta 3.0 Gb/s / 6.0 Gb/s. Compatible con la versión SATA 2.0 / 3.0. Admite RAID 0,1,5,10, SRT (TZ77B, T77)
Red Local	Realtek RTL 8111E	Negociación de 10 / 100 / 1000 Mb/s Funciones Half / Full dúplex
Soporte de sonido HD	ALC892	Soporte de sonido de Alta Definición Salida de sonido de 7.1 canales
USB3.0	Z77 (TZ77B) / Z75 (TZ75B) / H77 (T77)	Tasas de transferencia de datos hasta 600 MB / s
Ranuras	Ranura PCI X2 Ranura PCI Express Gen3 x16 X1 Ranura PCI Express Gen2 x16(x4) X1 Ranura PCI Express Gen2 x 1 X2	
Conectores en placa	Conector SATA3 X2 Conector SATA2 X4 Conector de panel frontal X1 Conector de sonido frontal X1 Cabecera de ventilador de CPU X1	Cada conector soporta 1 dispositivos SATA3 Cada conector soporta 1 dispositivos SATA2 Soporta instalaciones en el panel frontal Soporta funciones de sonido en el panel frontal Fuente de alimentación de ventilador de CPU (con función Smart Fan)

<b>Especificación</b>			
	Cabecera de ventilador de sistema	X2	Fuente de alimentación de ventilador de sistema
	Cabecera de borrado de CMOS	X1	
	Conector USB2.0	X2	Cada conector soporta 2 puertos USB2.0 frontales
	Conector USB3.0	X1	Cada conector soporta 2 puertos USB3.0 frontales
	Conector de IR del consumidor	X1	
	Puerto serie	X1	
	Conector de salida S/PDIF	X1	Soporta función de salida de sonido digital
	Conector de alimentación (24 patillas)	X1	
	Conector de alimentación (8 patillas)	X1	
Panel trasero de E/S	Teclado PS/2	X1	
	Puerto HDMI	x1	
	Puerto VGA	X1	
	Puerto DVI	X1	
	Puerto de red local	X1	
	Puerto USB2.0	X4	
	Puerto USB3.0	X2	
	Conector de sonido	X6	
Tamaño de la placa	220 mm. (A) X 295 Mm. (H)		ATX
Soporte de sistema operativo	Windows XP / Vista / 7		Biostar se reserva el derecho de añadir o retirar el soporte de cualquier SO con o sin aviso previo.

**PORTUGUESE**

<b>ESPECIFICAÇÕES</b>		
CPU	Socket 1155 Processador Intel Core i7 / i5 / i3 / Pentium / Celeron	Suporta as tecnologias Execute Disable Bit / Enhanced Intel SpeedStep® / Intel Architecture -64 / Extended Memory 64 / Virtualization / Hyper Threading
Chipset	Intel Z77 (TZ77B), Intel Z75 (TZ75B) Intel H77 (T77)	
Especificação do Super I/O	IT8728 Proporciona as funcionalidades mais utilizadas em termos da especificação Super I/O. Interface LPC (Low Pin Count).	Iniciativas para controlo do ambiente Monitorização do hardware Controlador/Monitor da velocidade da ventoinha Função "Smart Guardian" da ITE
Memória principal	Ranhuras DIMM DDR3 x 4 Capacidade máxima de memória: 32 GB Cada módulo DIMM suporta uma memória DDR3 de 512MB/ 1GB/2GB/4GB/8GB	Módulo de memória DDR3 de canal duplo Suporta módulos DDR3 1066/1333/1600 Suporta módulos DDR3 (OC) 1800/ 2000/ 2200/ 2400 Suporta módulos DDR3 (OC) 1866/2133 (TZ77B, TZ75B) Os módulos DIMM registados e os DIMM ECC não são suportados
SATA 2 & 3	Controlador Serial ATA integrado	Velocidades de transmissão de dados até 3.0 Gb/s / 6.0 Gb/s. Compatibilidade com a especificação SATA versão 2.0 / 3.0. Suporta as funções RAID 0,1,5,10, SRT (TZ77B, T77)
LAN	Realtek RTL 8111E	Auto negociação de 10 / 100 / 1000 Mb/s Capacidade semi/full-duplex
Suporte para áudio de alta definição	ALC892	Suporta a especificação High-Definition Audio Saída de áudio de 7.1 canais
USB3.0	Z77 (TZ77B) / Z75 (TZ75B) / H77 (T77)	Taxas de transferência de dados até 600 MB / s
Ranhuras	Ranhura PCI x2 Ranhura PCI Express Gen3 x16 x1 Ranhura PCI Express Gen2 x16(x4) x1 Ranhura PCI Express Gen2 x 1 x2	



<b>ESPECIFICAÇÕES</b>			
Conectores na placa	Conector SATA3	x2	Cada conector suporta 1 dispositivo SATA3
	Conector SATA2	x4	Cada conector suporta 1 dispositivo SATA2
	Conector do painel frontal	x1	Para suporte de várias funções no painel frontal
	Conector de áudio frontal	x1	Suporta a função de áudio no painel frontal
	Conector da ventoinha da CPU	x1	Alimentação da ventoinha da CPU (com a função Smart Fan)
	Conector da ventoinha do sistema	x2	Alimentação da ventoinha do sistema
	Conector para limpeza do CMOS	x1	
	Conector USB2.0	x2	Cada conector suporta 2 portas USB2.0 no painel frontal
	Conector USB3.0	x1	Cada conector suporta 2 portas USB3.0 no painel frontal
	Conector de IR do consumidor	x1	
	Porta série	x1	
	Conector de saída S/PDIF	x1	Suporta a saída de áudio digital
	Conector de alimentação (24 pinos)	x1	
Conector de alimentação (8 pinos)	x1		
Entradas/Saídas no painel traseiro	Teclado PS/2	x1	
	Porta HDMI	x1	
	Porta VGA	x1	
	Porta DVI	x1	
	Porta LAN	x1	
	Porta USB2.0	x4	
	Porta USB3.0	x2	
Tomada de áudio	x6		
Tamanho da placa	220 mm (L) X 295 mm (A)	ATX	
Sistemas operativos suportados	Windows XP / Vista / 7	A Biostar reserva-se o direito de adicionar ou remover suporte para qualquer sistema operativo com ou sem aviso prévio.	

**POLISH**

<i>SPEC</i>		
Procesor	Socket 1155 Procesor Intel Core i7 / i5 / i3 / Pentium / Celeron	Obsługa Execute Disable Bit / Enhanced Intel SpeedStep® / Intel Architecture-64 / Extended Memory 64 Technology / Virtualization Technology / Hyper Threading
Chipset	Intel Z77 (TZ77B), Intel Z75 (TZ75B) Intel H77 (T77)	
Pamięć główna	Gniazda DDR3 DIMM x 4 Maks. wielkość pamięci 32GB Każde gniazdo DIMM obsługuje moduły 512MB/1GB/2GB/4GB/8GB DDR3	Moduł pamięci DDR3 z trybem podwójnego kanału Obsługa DDR3 1066/1333/1600 Obsługa DDR3(OC) 1800/2000/2200/2400 Obsługa DDR3(OC) 1866/2133 (TZ77B, TZ75B) Brak obsługi Registered DIMM oraz ECC DIMM
Super I/O	IT8728 Zapewnia najbardziej powszechne funkcje Super I/O. Interfejs Low Pin Count	Funkcje kontroli warunków pracy, Monitor H/W Kontroler/Monitor prędkości wentylatora Funkcja ITE "Smart Guardian"
SATA 2 & 3	Zintegrowany kontroler Serial ATA	Transfer danych do 3.0 Gb/s / 6.0 Gb/s. Zgodność ze specyfikacją SATA w wersji 2.0 / 3.0. Obsługa RAID 0,1,5,10, SRT (TZ77B, T77)
LAN	Realtek RTL 8111E	10 / 100 / 1000 Mb/s z automatyczną negocjacją szybkości Działanie w trybie połowicznego / pełnego duplexu
Obsługa audio HD	ALC892	Obsługa High-Definition Audio 7.1 kanałowe wyjście audio
USB3.0	Z77 (TZ77B) / Z75 (TZ75B) / H77 (T77)	Cena transferu danych do 600 MB / s
Gniazda	Gniazdo PCI x2 Gniazdo PCI Express Gen3 x16 x1 Gniazdo PCI Express Gen2 x16(x4) x1 Gniazdo PCI Express Gen2 x 1 x2	
Złącza wbudowane	Złącze SATA3 x2 Złącze SATA2 x4 Złącze panela przedniego x1 Przednie złącze audio x1 Złącze główkowe wentylatora procesora x1	Każde złącze obsługuje 1 urządzenie SATA3 Każde złącze obsługuje 1 urządzenie SATA2 Obsługa elementów panela przedniego Obsługa funkcji audio na panelu przednim Zasilanie wentylatora procesora (z funkcją Smart Fan)

**TZ77B/TZ75B/T77**

<b>SPEC</b>		
	Złącze główkowe wentylatora systemowego x2	Zasilanie wentylatora systemowego
	Złącze główkowe kasowania CMOS x1	
	Złącze USB2.0 x2	Każde złącze obsługuje 2 porty USB2.0 na panelu przednim
	Złącze USB3.0 x1	Każde złącze obsługuje 2 porty USB3.0 na panelu przednim
	Złącze Konsument IR x1	
	Port szeregowy x1	
	Złącze wyjścia S/PDIF x1	Obsługa funkcji cyfrowego wyjścia audio
	Złącze zasilania (24 pinowe) x1	
	Złącze zasilania (8 pinowe) x1	
Back Panel I/O	Klawiatura PS/2 x1	
	Port HDMI x1	
	Port VGA x1	
	Port DVI x1	
	Port LAN x1	
	Port USB2.0 x4	
	Port USB3.0 x2	
	Gniazdo audio x6	
Wymiary płyty	220 mm (S) X 295 mm (W)	ATX
Obsługa systemu operacyjnego	Windows XP / Vista / 7	Biostar zastrzega sobie prawo dodawania lub odwoływania obsługi dowolnego systemu operacyjnego bez powiadomienia.

**RUSSIAN**

<b>СПЕЦ</b>		
CPU (центральный процессор)	Socket 1155 Процессор Intel Core i7 / i5 / i3 / Pentium / Celeron	Поддержка технологий Execute Disable Bit / Enhanced Intel SpeedStep® / Intel Architecture-64 / Extended Memory 64 Technology / технологии виртуализация / Hyper Threading
Набор микросхем	Intel Z77 (TZ77B), Intel Z75 (TZ75B) Intel H77 (T77)	
Основная память	Слоты DDR3 DIMM x 4 Максимальная ёмкость памяти 32 ГБ Каждый модуль DIMM поддерживает 512МБ/1ГБ/2ГБ/4ГБ/8 ГБ DDR3	Модуль памяти с двухканальным режимом DDR3 Поддержка DDR3 1066/1333/1600 Поддержка DDR3(OC) 1800/2000/2200/2400 Поддержка DDR3(OC) 1866/2133 (TZ77B, TZ75B) Не поддерживает зарегистрированные модули DIMM and ECC DIMM
Super I/O	IT8728 Обеспечивает наиболее используемые действующие функциональные возможности Super I/O. Интерфейс с низким количеством выводов	Инициативы по охране окружающей среды, Аппаратный монитор Регулятор скорости вентилятора/ монитор Функция ITE "Smart Guardian" (Интеллектуальная защита)
SATA 2 & 3	Встроенное последовательное устройство управления ATA	скорость передачи данных до 3.0 гигабит/с / 6.0 гигабит/с. Соответствие спецификации SATA версия 2.0/3.0 Поддержка RAID 0,1,5,10, SRT (TZ77B, T77)
Локальная сеть	Realtek RTL 8111E	Автоматическое согласование 10 / 100 / 1000 Мб/с Частичная / полная дуплексная способность
Звуковая поддержка жесткого диска	ALC892	Звуковая поддержка High-Definition 7.1канальный звуковой выход
USB3.0	Z77 (TZ77B) / Z75 (TZ75B) / H77 (T77)	скорости передачи данных до 600 МБ / с
Слоты	Слот PCI x2 Слот PCI Express Gen3 x16 x1 Слот PCI Express Gen2 x16(x4) x1 Слот PCI Express Gen2 x 1 x2	
Встроенный разъём	Разъём SATA3 x2 Разъём SATA2 x4 Разъём на лицевой панели x1	Каждый разъём поддерживает 1 устройство SATA3 Каждый разъём поддерживает 1 устройство SATA2 Поддержка устройств на лицевой панели

СПЕЦ			
	Входной звуковой разъём	x1	Поддержка звуковых функций на лицевой панели
	Контактирующее приспособление вентилятора центрального процессора	x1	Источник питания для вентилятора центрального процессора (с функцией интеллектуального вентилятора)
	Контактирующее приспособление вентилятора системы	x2	Источник питания для вентилятора системы
	Открытое контактирующее приспособление CMOS	x1	
	USB2.0-разъём	x2	Каждый разъём поддерживает 2 USB2.0-порта на лицевой панели
	USB3.0-разъём	x1	Каждый разъём поддерживает 2 USB3.0-порта на лицевой панели
	Разъём едока ИКЫЙ	x1	
	Последовательный порт	x1	
	Разъём вывода для S/PDIF	x1	Поддержка вывода цифровой звуковой функции
	Разъём питания (24 вывод)	x1	
	Разъём питания (8 вывод)	x1	
Задняя панель средств ввода-вывода	Клавиатура PS/2	x1	
	Порт HDMI	x1	
	Порт VGA	x1	
	Порт DVI	x1	
	Порт LAN	x1	
	USB2.0-порт	x4	
	USB3.0-порт	x2	
	Гнездо для подключения наушников	x6	
Размер панели	220 мм (Ш) X 295 мм (В)		ATX
Поддержка OS	Windows XP / Vista / 7		Biostar сохраняет за собой право добавлять или удалять средства обеспечения для OS с или без предварительного уведомления.

## ARABIC

للمواصفات		
Execute Disable Bit / Enhanced Intel SpeedStep® / Intel Architecture-64 / Extended Memory 64 Technology / Virtualization Technology / Hyper Threading	Socket 1155 Intel Core i7 / i5 / i3 / Pentium / Celeron يتردد يصل إلى	وحدة المعالجة المركزية
	Intel Z77 (TZ77B), Intel Z75 (TZ75B) Intel H77 (T77)	مجموعة الشرائح
عدد 4 قناة DDR3 DIMM سعة ذاكرة قصوى 32 جيجا بايت ميجا بايت و 1/512/1 سعة DDR3 تدعم ذاكرة من نوع DIMM تدعم كل قناة و 2/4 و 8 جيجا بايت	مزدوجة القناة DDR3 وحدة ذاكرة سعة 1600 / 1333 / 1066 DDR3 تدعم الذاكرة من نوع ميجا بايت سعة 1800 / 2000 / DDR3(OC) تدعم الذاكرة من نوع ميجا بايت 2400 / 2200 سعة 1866 / 2133 ميجا DDR3(OC) تدعم الذاكرة من نوع ميجا بايت ( TZ77B, TZ75B ) ECC وتلك التي لا تتوافق مع DIMM لا تدعم رقائق الذاكرة	الذاكرة الرئيسية
وسائل التحكم في البيئة: مراقب لمعرفة حالة الأجزاء مراقب في سرعة المروحة ITE من "Smart Guardian" وظيفة	IT8728 الأكثر استخداماً Super I/O يوفر وظيفة Low Pin Count Interface تدعم تقنية	Super I/O
ثانية/جيجابت 6.0 / ثمانية/جيجابت 3.0 إلى تصل بسرعات البيانات نقل الإصدار SATA مطابقة للمواصفات 2.0 / 3.0. RAID 0,1,5,10, SRT (TZ77B, T77) تدعم تقنية	متكامل Serial ATA متحكم	SATA 2 & 3
تفاوض تلقائي 100/10 ميجا بايت / ثمانية و 1 جيجا بايت/ثانية إمكانية النقل المزدوج الكامل/الصفى	Realtek RTL 8111E	شبكة داخلية
تدعم تقنية الصوت عالي التعريف من 7.1 قنوات لخرج الصوت	ALC892	دعم الصوت عالي التعريف
ثانية / بايت ميغا 600 إلى تصل بيانات نقل معدلات	Z77 (TZ77B) / Z75 (TZ75B) / H77 (T77)	USB3.0
	عدد 2 عدد 1 عدد 1 عدد 2	قناة PCI قناة PCI Express x16 Gen3 قناة PCI Express (x4)x16 Gen2 قناة PCI Express Gen2 x 1
يدعم كل منفذ واحد من أجهزة SATA3	عدد 2	المنفذ على سطح منفذ SATA3
يدعم كل منفذ واحد من أجهزة SATA2	عدد 4	منفذ SATA2

TZ77B/TZ75B/T77

المواصفات		
اللوحة	منفذ اللوحة الأممية	عدد 1
	منفذ الصوت الأممي	عدد 1
	وصلة مروحة وحدة المعالجة المركزية	عدد 1
	وصلة مروحة النظام	عدد 2
	وصلة مسح CMOS	عدد 1
	منفذ USB2.0	عدد 2
	منفذ USB3.0	عدد 1
	منفذ مستهلكة تحت الأحمر	عدد 1
	منفذ تنسلسي	عدد 1
	منفذ خرج S/PDIF	عدد 1
	منفذ توصيل الطاقة (24دبوس)	عدد 1
	منفذ توصيل الطاقة (8دبوس)	عدد 1
	لوحة مفاتيح PS/2	عدد 1
	منافذ HDMI	عدد 1
	منافذ VGA	عدد 1
	منافذ DVI	عدد 1
	منفذ دخل/مخرج	عدد 1
	اللوحة الخلفية	عدد 1
	منفذ شبكة اتصال محلية	عدد 1
	منافذ USB2.0	عدد 4
	منافذ USB3.0	عدد 2
	مقيس صوت	عدد 6
حجم اللوحة	295 مم (عرض) X 220 مم (ارتفاع)	ATX
دعم أنظمة التشغيل	Windows XP / Vista / 7	بحقها في إضافة أو إزالة الدعم لأي نظام تشغيل باخطار أو Biostar احتفظ بيون الخطار.

**JAPANESE**

仕様		
CPU	Socket 1155 Intel Core i7 / i5 / i3 / Pentium / Celeron プロセッサ	Execute Disable Bit / Enhanced Intel SpeedStep® / Intel Architecture-64 / Extended Memory 64 Technology / Virtualization Technology / Hyper Threadingをサポートします
チップセット	Intel Z77 (TZ77B), Intel Z75 (TZ75B) Intel H77 (T77)	
メインメモリ	DDR3 DIMMスロット x 4 最大メモリ容量32GB 各DIMMは 512MB/1GB/2GB/4GB/8GB DDR3をサポート	デュアルチャンネルモードDDR3メモリモジュール DDR3 1066 / 1333 /1600 をサポート DDR3(OC) 1800/2000/2200/2400 をサポート DDR3(OC) 1866/2133 (TZ77B, TZ75B) をサポート 登録済みDIMMとECC DIMMはサポートされません
Super I/O	IT8728 もっとも一般に使用されるレガシーSuper I/O機能を採用しています。 低ピンカウントインターフェイス	環境コントロールイニシアチブ、 H/Wモニター ファン速度コントローラ/ モニター ITEの「スマートガーディアン」機能
SATA 2 & 3	統合シリアルATAコントローラ	最高3.0 Gb/秒 / 6.0 Gb/秒のデータ転送速度 SATAバージョン2.0 / 3.0仕様に準拠。 RAID 0,1,5,10, SRT (TZ77B, T77)のサポート
LAN	Realtek RTL 8111E	10 / 100 / 1000 Mb/秒のオートネゴシエーション 半/全二重機能
HDオーディオのサポート	ALC892 ハイデフィニションオーディオのサポート 7.1チャンネルオーディオアウト	
USB3.0	Z77 (TZ77B) / Z75 (TZ75B) / H77 (T77)	データ転送速度最大600 MB /秒の
スロット	PCIスロット x2 PCI Express Gen3 x16スロット x1 PCI Express Gen2 x16スロット(x4) x1 PCI Express Gen2 x 1スロット x2	
オンボードコネクタ	SATA3コネクタ x2 SATA2コネクタ x4 フロントパネルコネクタ x1 フロントオーディオコネクタ x1	各コネクタは1つのSATA3デバイスをサポートします 各コネクタは1つのSATA2デバイスをサポートします フロントパネル機能をサポートします フロントパネルオーディオ機能をサポートします



TZ77B/TZ75B/T77

仕様			
	CPUファンヘッダ	x1	CPUファン電源装置(スマートファン機能を搭載)
	システムファンヘッダ	x2	システムファン電源装置
	CMOSクリアヘッダ	x1	
	USB2.0コネクタ	x2	各コネクタは2つのフロントパネルUSB2.0ポートをサポートします
	USB3.0コネクタ	x1	各コネクタは2つのフロントパネルUSB3.0ポートをサポートします
	消費者IRコネクタ	x1	
	シリアルポート	x1	
	S/PDIFアウトコネクタ	x1	デジタルオーディオアウト機能をサポートします
	電源コネクタ(24ピン)	x1	
	電源コネクタ(8ピン)	x1	
背面パネル I/O	PS/2キーボード	x1	
	HDMIポート	x1	
	VGAポート	x1	
	DVI-Dポート	x1	
	LANポート	x1	
	USB2.0ポート	x4	
	USB3.0ポート	x2	
	オーディオジャック	x6	
ボードサイズ	220 mm (幅) X 295 mm (高さ)		ATX
OSサポート	Windows XP / Vista / 7		Biostarは事前のサポートなしにOSサポートを追加または削除する権利を留保します。

2012/04/10