

*The Bose® Acoustimass® 6 Series III and Acoustimass 10 Series III
Home Theater Speaker Systems*

Owner's Guide

BOSE®

*August 13 , 2002
AM264887_00_V.pdf
Bose Corporation*

 **WARNING:** To reduce the risk of fire or electric shock, do not expose the Acoustimass® module to rain or moisture.

 **CAUTION:** To prevent electric shock, match wide blade of plug to wide slot, insert fully.

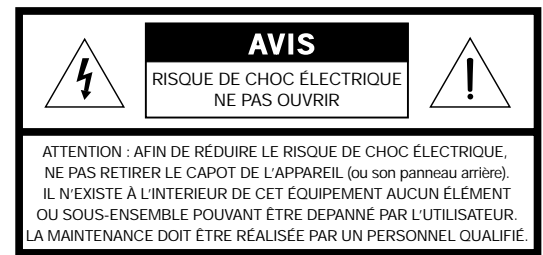
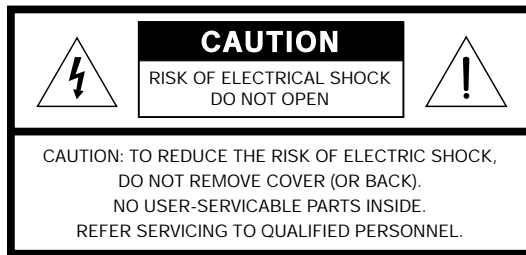

These CAUTION marks may be located on the Acoustimass module:



The lightning flash with arrowhead symbol, within an equilateral triangle, is intended to alert the user to the presence of uninsulated dangerous voltage within the system enclosure that may be of sufficient magnitude to constitute a risk of electric shock.



The exclamation point within an equilateral triangle, as marked on the system, is intended to alert the user to the presence of important operating and maintenance instructions in this owner's guide.

Additional safety information

See the additional safety information on the Important Safety Instructions page enclosed with your speaker system.

Please read this owner's guide

Please take the time to follow this owner's guide carefully. It will help you set up and operate your system properly, and enjoy all of its advanced features. Please save your owner's guide for future reference.

 **CAUTION:** No naked flame sources, such as lighted candles, should be placed on the apparatus.

For your records

The system serial number is located on the bottom of the Acoustimass module.

Serial number: _____

Dealer name: _____

Dealer phone: _____ Purchase date _____

Please keep your sales receipt and warranty card together with this owner's guide.

©2002 Bose Corporation. No part of this work may be reproduced, modified, distributed or otherwise used without prior written permission.

Manufactured under license from Dolby Laboratories. "Dolby" and the double-D symbol are trademarks of Dolby Laboratories. Confidential Unpublished Works. ©1992-1997 Dolby Laboratories. All rights reserved.

Where to find ...



Setting Up	4
Before you begin	4
Unpacking the carton	4
Placing your speakers to achieve realistic home theater sound	5
Front center cube speaker	6
Front left and right cube speakers	7
Rear cube speakers	7
Powered Acoustimass® module	7
Connecting the speakers	8
Connecting front cube speakers to the Acoustimass module	8
Connecting rear cube speakers to the Acoustimass module	9
Connecting the Acoustimass module to the receiver	10
Checking the connections	12
Connecting the Acoustimass module to power	12
Using your system	13
For realistic home theater sound	13
Adjusting the LFE level	13
Adjusting the bass/room compensation level	13
Setting your digital surround sound receiver	13
Be sure to get the digital audio signal	14
Setting your analog surround sound receiver	14
Reference	15
Troubleshooting	15
Customer service	15
Cleaning the speakers	16
Technical information	16
Warranty period	17
Accessories	17

Before you begin

We appreciate your choice of the Bose® Acoustimass® 6 Series III or Acoustimass 10 Series III home entertainment speaker system.

Bose Virtually Invisible® speaker technology allows you to enjoy lifelike home performances from the very latest surround-sound encoded movies, CDs, and television shows, without a room full of speakers. The cube speakers, along with the powered Acoustimass module, reproduce the full-spectrum of sound from multi-channel digital programming. Integrated Signal Processing assures full bass performance from all channels, at audible listening levels, regardless of your receiver settings.

Your stereo VCR, stereo television, or DVD player sends the encoded program material to the surround-sound receiver, which interprets and distributes the information to the powered Acoustimass module. The module delivers the bass for all channels and sends appropriate sounds to each cube speaker. The sound mix varies with different program types: dialogue is usually sent to the center cube speaker, a visual soundstage is created by the left and right front cube speakers, and you feel as if you are in the center of the action because sounds and special effects are directed to the rear cube speakers. At a given point in a surround-sound performance, you may hear sound from one, a few, or all of the cube speakers.

To select surround-encoded program material, look for the terms Surround, Dolby Surround, the double-D symbol , Dolby Digital , other digital formats, or the word "surround" preceding a TV broadcast. Your system is compatible with home theater receivers. You can also enjoy a wide variety of stereo programming that is not surround-encoded.

Unpacking the carton

 **WARNING:** The powered Acoustimass® 6 module weighs 27 pounds (12.3 kg). The powered Acoustimass 10 module weighs 35 pounds (15.9kg). Use good lifting practice to avoid injury.

 **WARNING:** To avoid danger of suffocation, keep the plastic bags that wrap these speakers out of the reach of children.

 **Note:** This product is not to be powered by any DC-to-AC inverters that may be found in automobiles, recreational vehicles, boats, ships, or other similar situations.

Carefully unpack the carton contents (Figure 1):

1. Remove the brown inner carton containing the cube speakers.
2. Gently roll the carton over onto its side.
3. Slowly pull the Acoustimass module from the carton.
4. Gently stand the module up.

 **Note:** Now is a good time to record the serial number of these speakers on your warranty card. Please save all packing materials for possible future use.

Figure 1

Carton contents

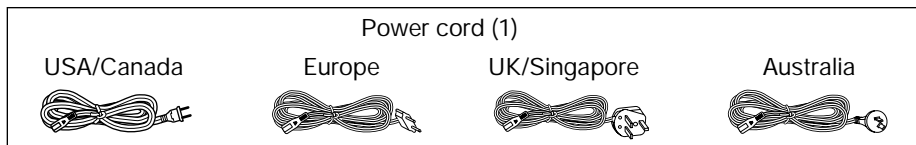
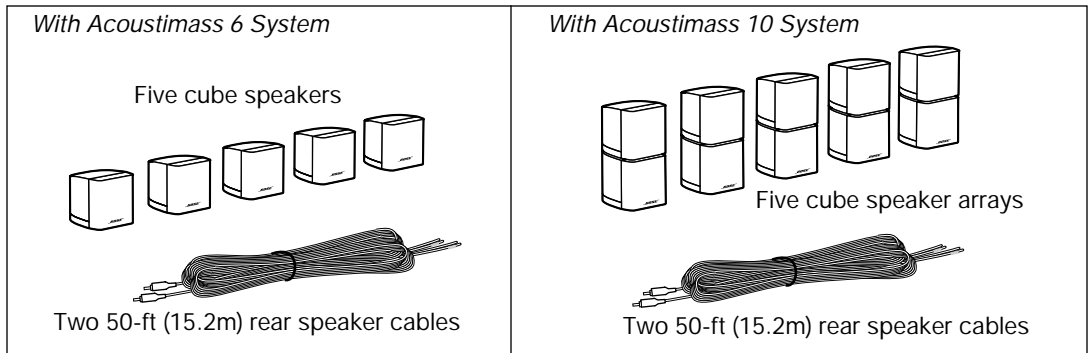
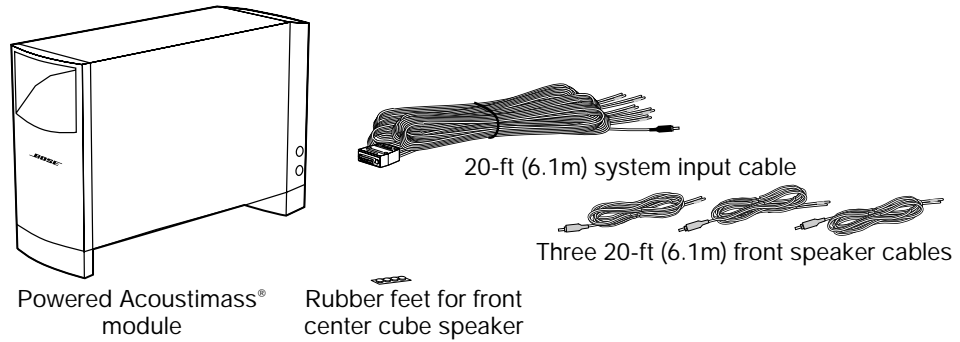

Placing your speakers to achieve realistic home theater sound

A suggested home theater layout is shown in Figure 2. You may want to place the speakers differently to take advantage of the sound characteristics of different rooms. Here are some suggested guidelines for placing your speaker system:

- The cube speakers are identical and can be used for any channel.
- Each of the Acoustimass cube speakers is magnetically shielded to prevent interference with a TV picture.
- In the Acoustimass 10 system, the top and bottom sections of the cube speaker arrays can be rotated to create room-filling sound patterns (Figure 3).
- Bose® wall brackets and floor stands can extend your placement options. See “Accessories” on page 17. Please follow wall bracket instructions carefully. Proper mounting will ensure optimum performance and safety from your system.

Setting Up

Figure 2

A suggested home theater layout

For Acoustimass® 6 Series III System

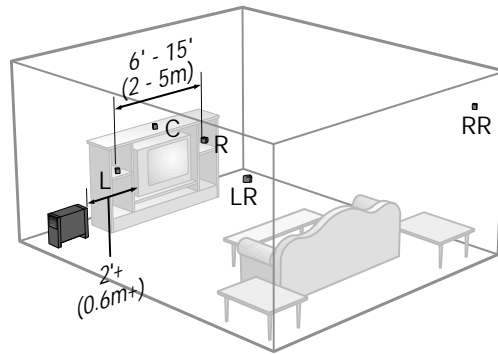

For Acoustimass 10 Series III System

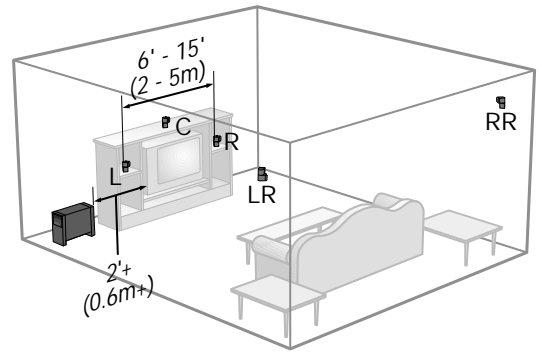

CAUTION: To prevent interference, keep the Acoustimass module at least 2 feet (.6 m) from your TV set.

Figure 3

Room reflection diagram

For Acoustimass 6 Series III

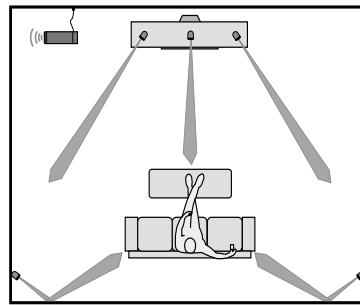

For Acoustimass 10 Series III

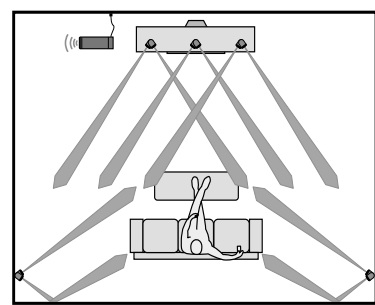

Front center cube speaker

The front center cube speaker localizes action and dialogue on your screen. Sound should seem to come from within the picture.

- Place the front center cube speaker above, below, or on top of your television. If below, be sure that it is not supporting the weight of the television in any way.
- Keep the front cube speaker as close to the vertical center of the screen as possible, for the most accurate dialogue reproduction.

CAUTION: Choose a stable and level surface for your cube speakers. Vibration can cause them to move, particularly on smooth surfaces like marble, glass, or highly polished wood. If you are placing the center cube speaker on top of your television, use the set of four rubber feet provided. You may obtain additional rubber feet (part number 178321-04), free of charge, by contacting Bose® Customer Service. See the list of phone numbers included with your system.

Front left and right cube speakers

The front left and right speaker arrays create a sound image wider than the screen that seems natural to viewers sitting anywhere in the room. You can place the speaker arrays near a TV screen with no picture interference. Place the front cube arrays on either side of your TV, at least 6 feet (2 m), or as much as 15 feet (5 m) apart (see Figure 2).

Rear cube speakers

The rear, or surround, cube speakers add discrete sounds and special effects that expand the visual image, bringing the viewer into the center of the action. The rear cube speakers may carry dialogue as well.

- Position the left and right rear cube speakers to allow the sound to reach the viewer from both sides, rather than from directly behind (see Figure 3).
- Place the rear cube speakers at ear height or higher, if possible.
- *For the Acoustimass® 10 system*, rotate the top and bottom sections of the rear cube speaker arrays to direct the sound to the front and back of the listener (see Figure 3).
- *For the Acoustimass 6 system*, aim the rear cube speakers slightly behind the listener or reflect the sound off the rear wall (see Figure 3).

Powered Acoustimass module

Bose® Acoustimass speaker technology takes advantage of the fact that the source of pure bass sound is difficult to locate, so you can hide the powered Acoustimass module conveniently out of sight. Place the module at the same end of the room as the television monitor.

- You may hide the module behind furniture, but do not block the opening. Be sure there are at least 2 inches (5 cm) between the opening and any surface.
- If the opening faces the wall it increases the bass; if it faces away it decreases the bass.

⚠ CAUTION: To prevent interference, keep the module at least 2 feet (.6 m) from your TV set.

Figure 4

Powered Acoustimass
module placement

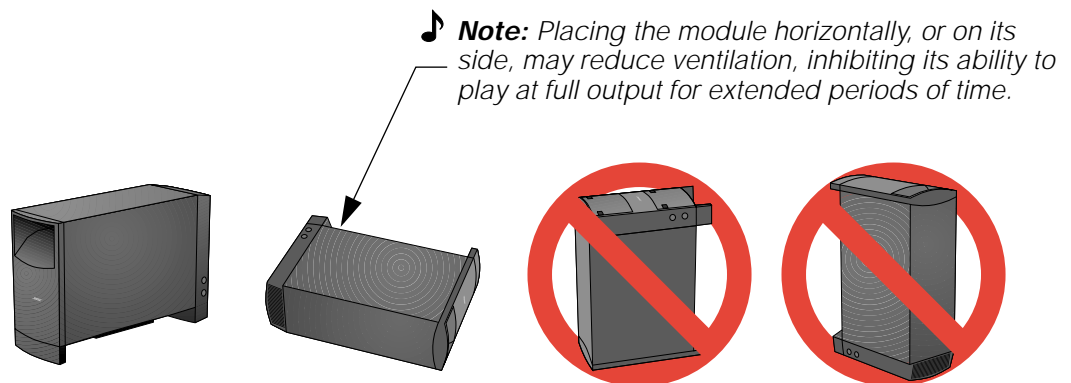

Connecting the speakers

- ⚠ **CAUTION:** Never connect the cube speakers directly to a receiver output. Always connect them to the powered Acoustimass® module, then connect the module to the receiver.
- ⚠ **CAUTION:** Never use broken or frayed wiring, which can result in electrical shock or damage to your system. The supplied cables are not intended for in-wall installation. Check local building codes or enlist a qualified installer.

Connecting front cube speakers to the Acoustimass module

Three individual 20-foot (6.1 m) speaker cables connect the center, right, and left front cube speakers to the Acoustimass module (Figure 5). Be sure to match the correct cable with the corresponding speaker location. Front speaker cables have blue RCA connectors at one end with **L** (left), **R** (right), or **C** (center) molded into the connectors. The other ends of the cables have two wires. The red collars on the + wire are labeled **LEFT**, **RIGHT**, or **CENTER**.

Figure 5

Cube speaker connections to Acoustimass module

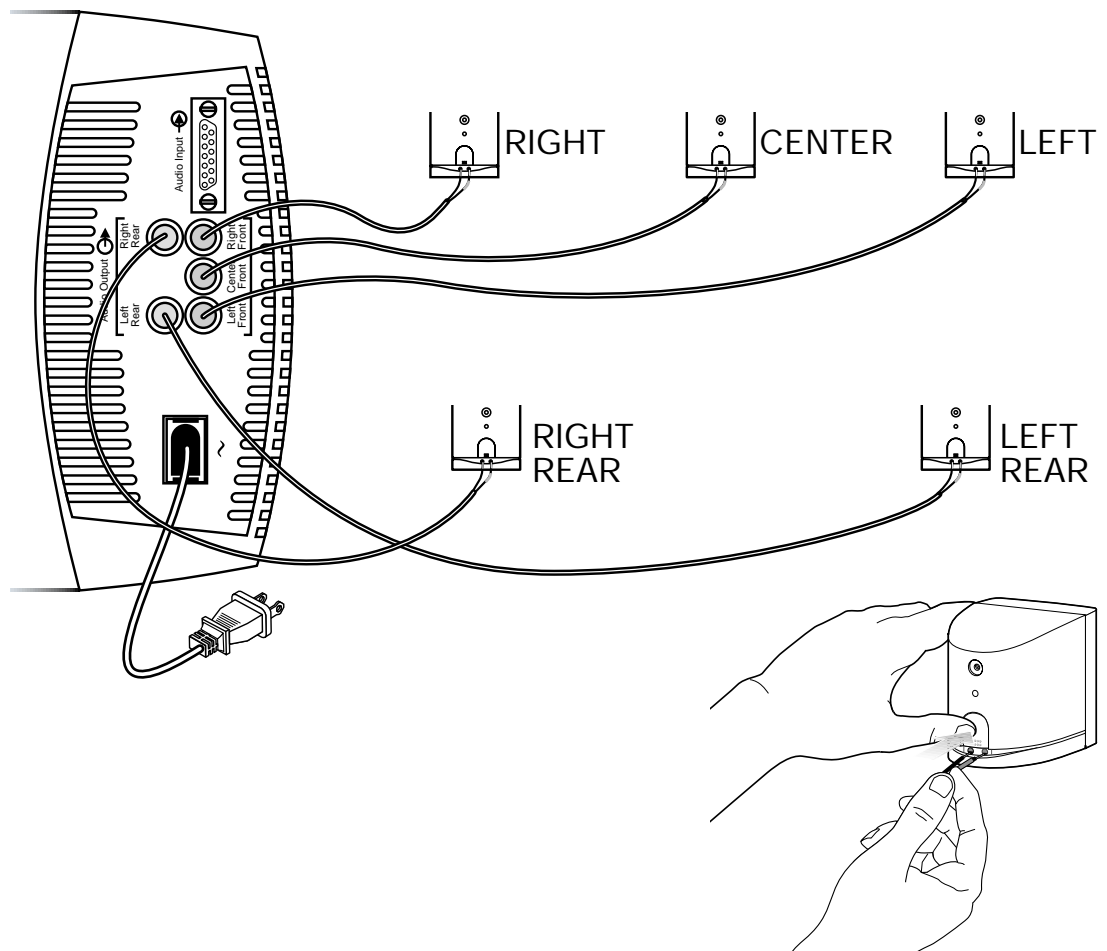

1. Connect the wire pair marked **CENTER** to the center cube speaker (Figure 5). Press the terminal tab on the back of the cube speaker. Insert the marked (+) wire into the red terminal and the plain (-) wire into the black terminal. Release the tab to secure the wires.
2. Connect the wire pair marked **RIGHT** to the right front cube speaker (to the right of the TV as you face it).
3. Connect the wire pair marked **LEFT** to the left front cube speaker.
4. Plug the other end of each cable into the **Center Front**, **Right Front**, and **Left Front** blue RCA jacks, respectively, on the Acoustimass® module.

Connecting rear cube speakers to the Acoustimass module

Each rear cube speaker is connected to the Acoustimass module with a 50-foot (15 m) speaker cable (Figure 5). Be sure to match the correct cable with the corresponding speaker location. Rear speaker cables have orange RCA connectors at one end with **LR** (left rear) and **RR** (right rear) molded into the connectors. The other ends of the cables have two wires. The red collars on the + wires are labeled **LEFT REAR** and **RIGHT REAR**.

1. Connect the wire pair marked **RIGHT REAR** to the right rear cube speaker (on your right as you face the TV). See Figure 5. Press the terminal tab on the back of the cube speaker. Insert the marked (+) wire into the red terminal and the plain (-) wire into the black terminal. Release the tab to secure the wires.
2. Connect the wire pair marked **LEFT REAR** to the left rear cube speaker.
3. Plug the other end of each cable into the **Right Rear** and **Left Rear** orange RCA jacks, respectively, on the Acoustimass module.

Connecting the Acoustimass® module to the receiver

The 20-foot (6.1 m) system input cable connects the module to your surround receiver (see Figure 6). The system input cable has a multi-pin connector on one end and several wire pairs on the other. The wire pairs of the cable may be separated or “unzipped” as much as needed to comfortably reach the surround receiver connections. Each wire pair is marked on the cable jacket with **RIGHT**, **LEFT**, **CENTER**, **RIGHT SURROUND** or **LEFT SURROUND** to indicate where each wire connects to the receiver.

- ⚠ **CAUTION:** Before making any connections turn off your receiver and unplug it from the AC (mains) outlet. Not doing so may result in damage to your system.
- ⚠ **CAUTION:** Do not connect the powered Acoustimass module directly to your TV unless the TV provides surround decoding circuitry and amplified outputs for all channels.
 1. Insert the multi-pin connector on the system input cable into the input jack on the Acoustimass module. Tighten the two thumbscrews to assure a secure connection.
 2. Connect each wire pair on the other end of the system input cable to your surround receiver. Carefully match the polarity of the connections (+ to + and – to –).
 - Attach each marked wire (+) to the appropriate + terminal.
 - Attach each plain wire (–) to the appropriate – terminal.
- 🎵 **Note:** The RCA plug of the system input cable comes with a cover installed. Remove this cover for connection to the LFE/SUBWOOFER OUT jack. If your receiver has no LFE/SUBWOOFER OUT jack, leave the plug cover in place.
 3. If applicable, connect the RCA plug on the system input cable to the LFE/SUBWOOFER OUT jack on your surround receiver.
- ⚠ **CAUTION:** Do not allow exposed wires to brush against each other; this could damage your receiver.

Figure 6

Acoustimass® module to receiver connections

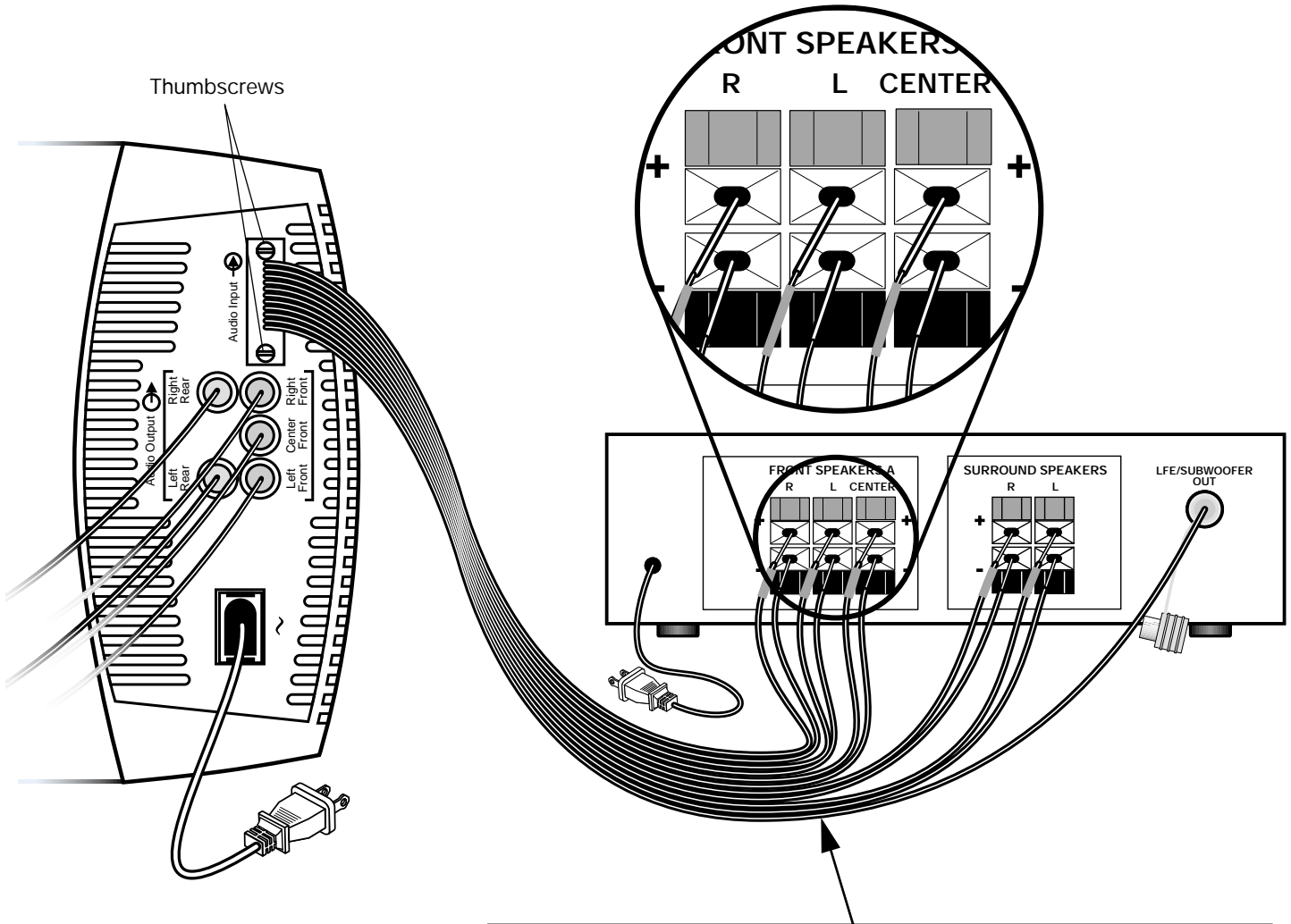

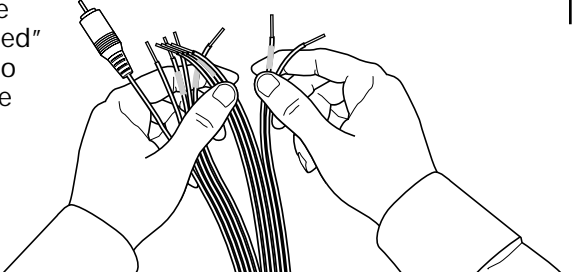

Note: Cables may be separated or “unzipped” as much as needed to comfortably reach the surround receiver connections.

Checking the connections

Check all connections from the receiver to the powered Acoustimass® module and from the module to the cube speakers (Figure 5 and Figure 6). Make sure the cube speakers are connected to the proper terminals according to their position in your room. Check that the wires are connected to your surround receiver in phase (+ to + and – to –). Correct wiring problems before you plug your receiver in and turn it on.

Connecting the Acoustimass module to power

♪ **Note:** *Bose® recommends using a quality surge suppressor on all electronics equipment. Voltage variations and spikes can damage electronic components in any system. A quality suppressor can eliminate the vast majority of failures attributed to surges and may be purchased at an electronics store.*

After you have checked all system connections, plug the power cord of the powered Acoustimass module into an AC (mains) receptacle. Your Acoustimass speaker system will turn on and off automatically as it receives a signal from your surround receiver.

For realistic home theater sound

⚠ CAUTION: The Acoustimass® 6 and Acoustimass 10 speaker systems incorporate an automatic protection circuit, which guards against most kinds of damage from electrical stress or overload. This circuit activates at high volume levels to reduce output, causing a slight decrease in volume. This is normal operation and indicates that power input may be exceeding safe levels. Sustained listening at these levels is not recommended.

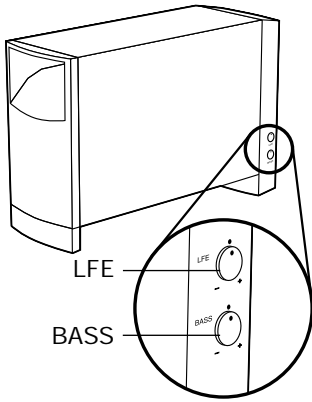

Adjusting the LFE level (low frequency effects)

The **LFE** level control on your powered Acoustimass module increases or decreases the relative level of low frequency effects on movie soundtracks. Use it to regulate the presence of these underlying deep bass sounds. Use the "test tones" feature in your digital surround sound receiver to match the volume levels for each of the cube speakers. Then use the **LFE** control on the Acoustimass module to match the volume of the LFE channel to the cube speaker channels.

Adjusting the bass/room compensation level

This feature will allow you to fine-tune your system after you have placed the Acoustimass module in your selected location. If the room sounds "thin" or lacks bass, turn the **BASS** control in a clockwise direction to increase the bass level of the module. If the room sounds "boomy" or has too much bass, turn the knob in a counter-clockwise rotation to reduce the bass level of the module. The factory or detent setting is appropriate for a majority of listening situations.

Setting your digital surround sound receiver

Your Acoustimass 6 or Acoustimass 10 speakers are compatible with the output from digital surround receivers. Integrated Signal Processing assures full bass reproduction for all channels regardless of receiver settings. However, the following table suggests a set of recommended receiver settings. The cube speaker arrays should be set to **LARGE** in the receiver's digital display menu. The **LFE**, or subwoofer, is set to **ON**. If applicable, the crossover value should be set to the lowest number possible, typically 80 Hz.

Speaker	Receiver setting
Front left and right	LARGE
Front center	LARGE
Rear left and right	LARGE
LFE/Subwoofer	ON

Be sure to get the digital audio signal

To be sure that the *digital audio* signal from your DVD player reaches your surround receiver, connect the *digital audio* output from your DVD player to the *digital audio* input on your receiver (Figure 7).

Before you play a DVD disc, be sure to select the digital output in the setup menu of your DVD Player. For additional setup and operating information, please refer to the owner's guide that came with your surround receiver.

Figure 7

Digital signal connections
on a surround receiver

🎵 **Note:** Use the **OPTICAL** or **COAXIAL**
digital input connections, but not both.

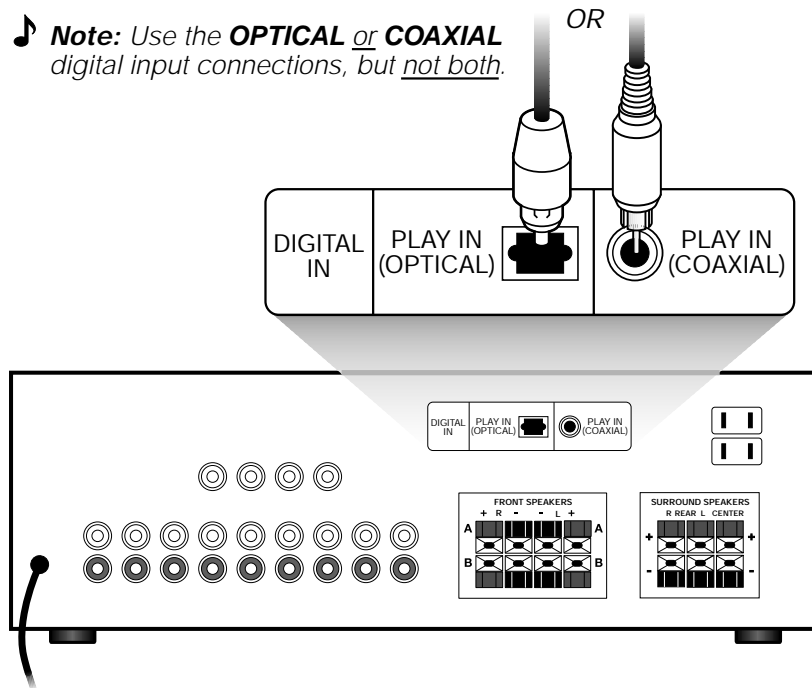

Setting your analog surround sound receiver

For analog surround sound (not digital) applications, we recommend that you set the surround-sound center mode of your receiver to **WIDE**. Instructions for this process vary, depending on the brand and model of your surround receiver. Follow your receiver owner's guide for testing and adjusting the balance of each speaker.

Troubleshooting

If you have a problem with your Acoustimass® speaker system, turn off your sound source and try the following solutions. If you still have a problem, contact your Bose® dealer to arrange for service. To contact Bose directly, refer to the list of service offices and phone numbers enclosed in the shipping carton.

Problem	What to do
System does not function at all	<ul style="list-style-type: none"> • Make sure the receiver and powered Acoustimass module are plugged into an operating AC wall outlet and that the receiver is turned on. • Be sure to select a source at the receiver (video, CD, DVD, tuner).
No sound	<ul style="list-style-type: none"> • Check the speaker connections. • Make sure that the powered Acoustimass module is plugged in. • For digital sound, be sure a coaxial or optical cable connects the digital output of the DVD player with the digital input on your receiver. • Be sure the audio source selected is correct. For example, select DVD audio on your receiver and player for DVD sound. • Disconnect any headphones. • Increase the volume.
No sound from cube speakers	<ul style="list-style-type: none"> • Be sure the powered Acoustimass module is plugged in and the receiver is turned on.
Sound is distorted	<ul style="list-style-type: none"> • Make sure speaker wire is not damaged. • Reduce the volume of external components connected to the receiver.
No bass	<ul style="list-style-type: none"> • Be sure the speaker connections at the receiver/amplifier are correct (+ to + and – to –).
Not enough or too much bass	<ul style="list-style-type: none"> • Move the powered Acoustimass module closer to a wall or corner to increase bass. Move it farther away from a wall or corner to decrease bass. • Adjust the LFE Level or Room Compensation control.
No surround sound	<ul style="list-style-type: none"> • Be sure your receiver is processing a signal from a Hi-Fi VCR, stereo TV, laserdisc, or DVD player, or other surround-sound source. • If you are using the Dolby Pro-Logic mode, check that surround-sound is turned ON. • If you are using digital programming, verify that the settings are correct at the receiver. • Be sure the source material (DVD, laser disc, or broadcast programming) is Dolby Digital encoded.

Customer service

For additional help in solving problems, contact Bose customer service. See the list of service offices and phone numbers enclosed in the shipping carton.

Cleaning the speakers

The cabinets of your Acoustimass® speaker system may be cleaned only with a soft dry cloth. Do not use any sprays near the system or allow liquids to spill into any openings. Also, do not use any solvents, chemicals, or cleaning solutions containing alcohol, ammonia, or abrasives.

The grille assemblies on the cube arrays may be carefully vacuumed, if necessary. Please note that the drivers are located directly behind the grille cloth, and are easily damaged if reasonable care is not taken.

Technical information

Features

- Direct/Reflecting® speaker technology (Acoustimass 10 Series III System)
- Virtually Invisible® speaker design
- Acoustimass speaker technology combined with Integrated Signal Processing
- Magnetically shielded cube speakers
- Automatic system protection circuitry
- Syncom® computer quality control

Finish

- Cube arrays: Black or Arctic White finish
- Acoustimass module: Scratch-resistant Black or Arctic White textured finish

	Acoustimass 6 Series III	Acoustimass 10 Series III
Acoustimass module power rating	USA/Canada: 100-127V ~ 50/60 Hz 135W Europe/Australia: 220-240V ~ 50/60 Hz 135W	USA/Canada: 100-127V ~ 50/60 Hz 270W Europe/Australia: 220-240V ~ 50/60 Hz 270W
Speaker driver complement	Cube speakers: One 2.5-inch (6.35 cm) Twiddler™ speaker Module: one 5.25-inch (13 cm) woofer	Cube speaker array: Two 2.5-inch (6.35 cm) Twiddler™ speakers Module: two 5.25-inch (13 cm) woofers
Connectivity	Compatible with A/V receivers and amplifiers rated from 10 to 150 watts per channel, rated from 4 to 8 ohms	Compatible with A/V receivers and amplifiers rated from 10 to 200 watts per channel, rated from 4 to 8 ohms
Size	Cube speaker: 3.1"H x 3.1"W x 4.0"D (7.9 cm x 7.9 cm x 10.2 cm) Module: 16.3"H x 8.1"W x 22.3"D (41.4 cm x 20.6 cm x 56.6 cm)	Cube speaker array: 6.2"H x 3.1"W x 4.0"D (15.7 cm x 7.9 cm x 10.2 cm) Module: 16.3"H x 8.1"W x 25.3"D (41.4 cm x 20.6 cm x 64.3 cm)
Weight	Cube speaker: 1.1 lb (0.5 kg) Module: 27 lb (12.2 kg)	Cube speaker: 2.4 lb (1.1 kg) Module: 35 lb (15.8 kg)

Warranty period

Your Acoustimass® speaker system is covered by a limited transferable warranty. Details of the warranty are provided on the warranty card that came with your system. Please fill out the information section on the card and mail it to Bose®.

Accessories

- Table stands: UTS-20B (black), UTS-20W (white)
- Floor stands: UFS-20B (black), UFS-20W (white)
- Wall brackets: UB-20B (black), UB-20W (white)
- Module input cable adapter for use with existing wiring:
PN 267138-001 (black)
PN 267138-002 (white)
- Module-to-cube speaker cable adapter for use with existing wiring:
PN 267139-001 (black)
PN 267139-002 (white)
- Module 20 ft (6.1 m) input extension cable:
PN198221-001 (black)
PN198221-002 (white)



BOSE[®]
Better sound through research[®]

©2002 Bose Corporation, The Mountain,
Framingham, MA 01701-9168 USA
264887 AM Rev.00 JN20952