



The Bose® Lifestyle® 12 Series II System

Owner's Guide

October 29, 2001

AM196573_05_V.pdf

 **WARNING:** To reduce the risk of fire or electric shock, do not expose the system to rain or moisture.

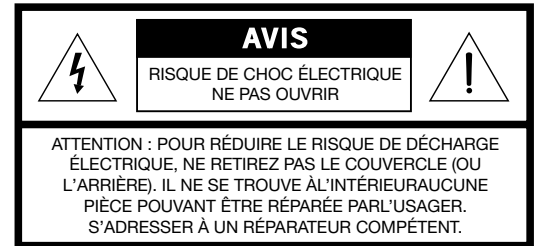
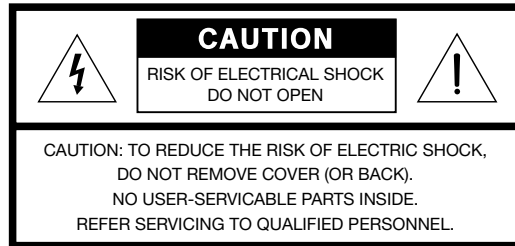

These CAUTION marks may be located on the back panel and bottom of your Lifestyle® music center and the bottom panel of your Acoustimass® module:



The lightning flash with arrowhead symbol, within an equilateral triangle, is intended to alert the user to the presence of uninsulated dangerous voltage within the system enclosure that may be of sufficient magnitude to constitute a risk of electric shock.





The exclamation point within an equilateral triangle, as marked on the system, is intended to alert the user to the presence of important operating and maintenance instructions in this owner's guide.

 **CAUTION:** To prevent electric shock, match wide blade of plug to wide slot, insert fully.

Class 1 laser product

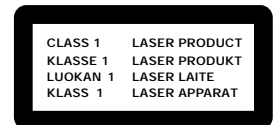
This compact disc player is classified as a CLASS 1 LASER PRODUCT. The CLASS 1 LASER PRODUCT label is located on the bottom of the unit.



 **CAUTION:** Use of controls or adjustments or performance of procedures other than those specified herein may result in hazardous radiation exposure. The compact disc player should not be adjusted or repaired by anyone except properly qualified service personnel.

Class B emissions limits

This Class B digital apparatus meets all requirements of the Canadian Interference-Causing Equipment Regulations.

Batteries

Please dispose of used batteries properly, following any local regulations. Do not incinerate.

Additional safety information

See the additional instructions on the *Important Safety Information* page enclosed with this owner's guide.

Please read this owner's guide

Please take the time to follow this owner's guide carefully. It will help you set up and operate your system properly, and enjoy all of its advanced features. Save your owner's guide for future reference.

Important Safety Instructions

1. **Read these instructions** – for all components before using this product.
2. **Keep these instructions** – for future reference.
3. **Heed all warnings** – on the product and in the owner's guide.
4. **Follow all instructions.**
5. **Do not use this apparatus near water or moisture** – Do not use this product near a bathtub, washbowl, kitchen sink, laundry tub, in a wet basement, near a swimming pool, or anywhere else that water or moisture are present.
6. **Clean only with a dry cloth** – and as directed by Bose® Corporation. Unplug this product from the wall outlet before cleaning.
7. **Do not block any ventilation openings. Install in accordance with the manufacturer's instructions** – To ensure reliable operation of the product and to protect it from overheating, put the product in a position and location that will not interfere with its proper ventilation. For example, do not place the product on a bed, sofa, or similar surface that may block the ventilation openings. Do not put it in a built-in system, such as a bookcase or a cabinet that may keep air from flowing through its ventilation openings.
8. **Do not install near any heat sources, such as radiators, heat registers, stoves or other apparatus (including amplifiers) that produce heat.**
9. **Do not defeat the safety purpose of the polarized or grounding-type plug. A polarized plug has two blades with one wider than the other. A grounding-type plug has two blades and a third grounding prong. The wider blade or third prong are provided for your safety. If the provided plug does not fit in your outlet, consult an electrician for replacement of the obsolete outlet.**
10. **Protect the power cord from being walked on or pinched, particularly at plugs, convenience receptacles, and the point where they exit from the apparatus.**
11. **Only use attachments/accessories specified by the manufacturer.**
12. **Use only with the cart, stand, tripod, bracket or table specified by the manufacturer or sold with the apparatus. When a cart is used, use caution when moving the cart/apparatus combination to avoid injury from tip-over.**
13. **Unplug this apparatus during lightning storms or when unused for long periods of time** – to prevent damage to this product.
14. **Refer all servicing to qualified service personnel. Servicing is required when the apparatus has been damaged in any way: such as power-supply cord or plug is damaged; liquid has been spilled or objects have fallen into the apparatus; the apparatus has been exposed to rain or moisture, does not operate normally, or has been dropped** – Do not attempt to service this product yourself. Opening or removing covers may expose you to dangerous voltages or other hazards. Please call Bose to be referred to an authorized service center near you.
15. **To prevent risk of fire or electric shock, avoid overloading wall outlets, extension cords, or integral convenience receptacles.**
16. **Do not let objects or liquids enter the product** – as they may touch dangerous voltage points or short-out parts that could result in a fire or electric shock.
17. **See product enclosure for safety related markings.**

Information about products that generate electrical noise

If applicable, this equipment has been tested and found to comply with the limits for a Class B digital device, pursuant to Part 15 of the FCC rules. These limits are designed to provide reasonable protection against harmful interference in a residential installation. This equipment generates, uses, and can radiate radio frequency energy and, if not installed and used in accordance with the instructions, may cause harmful interference to radio communications. However, this is no guarantee that interference will not occur in a particular installation. If this equipment does cause harmful interference to radio or television reception, which can be determined by turning the equipment off and on, you are encouraged to try to correct the interference by one or more of the following measures:

- Reorient or relocate the receiving antenna.
- Increase the separation between the equipment and receiver.
- Connect the equipment to an outlet on a different circuit than the one to which the receiver is connected.
- Consult the dealer or an experienced radio/TV technician for help.

Note: *Unauthorized modification of the receiver or radio remote control could void the user's authority to operate this equipment.*

This product complies with the Canadian ICES-003 Class B specifications.



Important Safety Instructions

18. **Use proper power sources** – Plug the product into a proper power source, as described in the operating instructions or as marked on the product.
19. **Avoid power lines** – Use extreme care when installing an outside antenna system to keep from touching power lines or circuits, as contact with them may be fatal. Do not install external antennas near overhead power lines or other electric light or power circuits, nor where an antenna can fall into such circuits or power lines.
20. **Ground all outdoor antennas** – If an external antenna or cable system is connected to this product, be sure the antenna or cable system is grounded. This will provide some protection against voltage surges and built-up static charges.

Section 810 of the National Electrical Code ANSI/NFPA No. 70 provides information with respect to proper grounding of the mast and supporting structure, grounding of the lead-in wire to an antenna discharge unit, size of grounding conductors, location of antenna-discharge unit, connection to grounding electrodes, and requirements for the ground electrode. Refer to the antenna grounding illustration on this page.

Antenna grounding

Example of antenna grounding as per National Electrical Code, ANSI/NFPA 70.

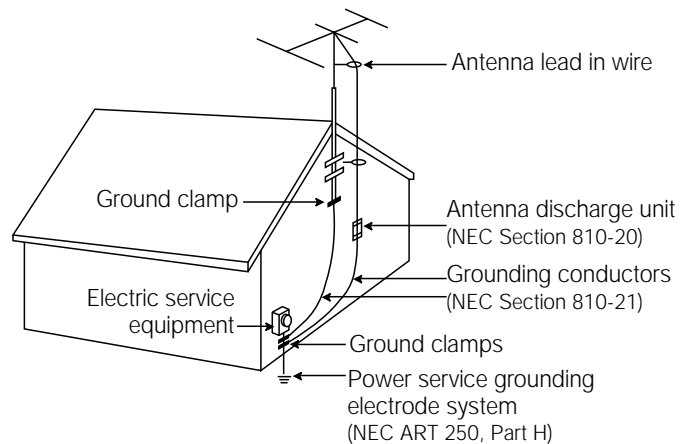

Note to CATV system installer

This reminder is provided to call the CATV system installer's attention to Article 820-40 of the NEC (of USA) that provides guidelines for proper grounding. In particular, it specifies that the cable ground shall be connected to the grounding system of the building, as close to the point of cable entry as is practical.

BOSE[®]
Better sound through research[®]

©2001 Bose Corporation,
The Mountain, Framingham, MA
01701-9168 USA
255805 AM Rev.00 JN10494

Where to find...

Setting Up

- Before you begin 4
- Unpacking the carton 5
- Selecting the locations for your Lifestyle® 12 system 6
- Connecting the speakers and Lifestyle® music center 9
- Connecting your home theater components to the Lifestyle® 12 system 12
- Connecting the antennas 16
- Attaching the wire cover 16
- Installing the batteries in the remote control 17
- Setting radio channel spacing for dual voltage and 120V systems 17

Operating Your Lifestyle® 12 System

- Turning on the music center 18
- The music center display 18
- The music center controls 19
- The Lifestyle® remote control 19
- The system controls 20
- Additional system controls 21
- Listening to your Lifestyle® 12 system 22
- Operating the special features 23
- Chimes 23
- Listening to digital sound 24
- Listening to compact discs 24
- Listening to the radio 25
- Using the system with external components 26

Maintaining Your Lifestyle® 12 System

- Fine-tuning your system 27
- Changing the house code settings 28
- Adding speakers 29
- Troubleshooting 30
- Warranty period 31
- Customer service 31
- Taking care of your Lifestyle® 12 system 32

Product Information

- Technical information 33
- Accessories 33

Index 34

Bose® Corporation inside back cover

For your records

Serial numbers are located on the bottom of the music center and the bottom panel of the Acoustimass® module.

Music center serial number: _____

Acoustimass module serial number: _____

Dealer name: _____

Dealer phone: _____ Purchase date: _____

We suggest you keep your sales slip and warranty card together with this owner's guide.

Before you begin

Thank you for purchasing the Bose® Lifestyle® 12 Series II system. This complete audio home entertainment system offers superb sound, elegance, technology, and simplicity for music and home theater. Your system is fully compatible with *digital* program material and includes:

- A Lifestyle® music center with built-in AM/FM radio and CD player
- Inputs for a video sound source, a digital sound source, and a tape deck (or other auxiliary source)
- Powered Acoustimass® speakers with a hideaway Acoustimass module and five cube speaker arrays
- An easy-to-use remote control

Realism and impact

Your Lifestyle® 12 Series II home theater system is equipped with an all new Videostage® decoder that uses digital signal processing. The result is increased surround sound realism and impact both for movie soundtracks and music recordings. Built-in Dolby Digital decoding of inputs from DVD, digital TV, next-generation cable boxes, and satellite receivers provides “5.1” capability – up to five discrete audio channels directed into five independent cube speaker arrays, plus rich bass sound from the Acoustimass module. The Videostage decoder processes analog formats, as well as two or even single-channel PCM and Dolby Digital bitstreams, and helps to deliver the acoustic experience of the movies right in your home.

Compatibility

Your system is fully compatible with:

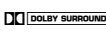
- **Digital-audio bitstreams.** Look for the symbol  or the terms Dolby Digital or PCM on DVD-Video discs. Your Lifestyle® 12 Series II system cannot process MPEG-2 or DTS digital bitstreams.
- **Surround-sound sources** such as VCRs, stereo TVs, cable boxes, and satellite receivers. Videostage decoding directs *stereo* information to the surround channels, so the sound of stereo broadcasts and rented or recorded tapes can approach that of your DVD discs.
- **Surround-encoded analog or digital audio signals.** Look for the terms Surround or Dolby Surround, or the symbol  on tapes and discs, or the word “surround” preceding a TV broadcast.
- **Stereo program material** from TV, FM, CD, and cassette. Videostage decoding delivers five channels, even when the original source contained only one or two.
- **Monoaural program material.** Videostage decoding can process a one-channel program into five-channel sound and direct the result to five independent speakers. Dialogue remains locked on-screen, while music and ambient effects fill the room.

Automatic sound level monitoring and control

Your enjoyment of movies at home is enhanced by Digital Dynamic Range® compression. This technology automatically monitors and adjusts the volume to allow you to hear soft sounds, particularly dialogue, and to prevent you from being overwhelmed by a loud special effect (e.g., a crash or explosion). This feature is especially useful for late night movie viewing – it eliminates the need for you to constantly adjust the volume settings. (See pages 22-23.)

Unpacking the carton

Carefully unpack your system. Save all packing materials for possible future use. The original packing materials provide the safest way to transport your Lifestyle® 12 system. If any part of the product appears damaged, do not attempt to use the system. Notify Bose® or your authorized Bose dealer immediately.

Check to be sure your Lifestyle® 12 system contains the parts identified in Figure 1.

Note: Find the serial numbers on the bottom panel of the Acoustimass® module and the bottom of the music center. Then write them on your warranty card and in the spaces provided on page 3.

WARNING: The Acoustimass module weighs 33 pounds (15 kg). Use good lifting practice to avoid injury.

WARNING: To avoid danger of suffocation, keep the plastic bags out of the reach of children.

Figure 1

What comes with your Lifestyle® 12 Series II system:

- Lifestyle® music center
- AC power (mains) pack*
- Wire cover
- FM antenna
- AM loop antenna
- Antenna base
- Remote control
- 3 AA batteries
- Acoustimass module
- 5 cube speaker arrays
- AC power (mains) cord*
- Audio input cable
- 5 speaker cables (3 front and 2 surround)
- 8 self-adhesive rubber feet
- Stereo cable
- Lifestyle® system CD
- Test CD

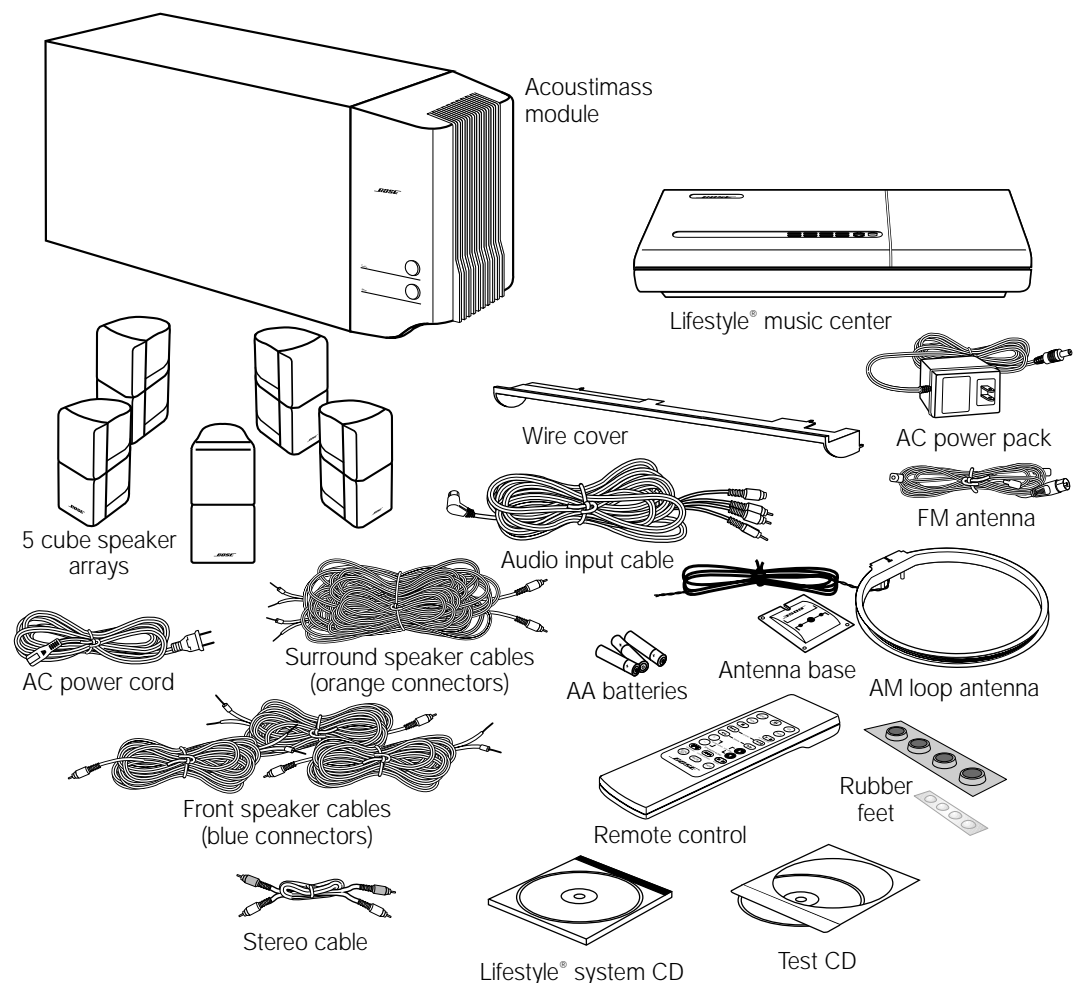

* Power cord and pack shown above are USA/Canada versions. Dual voltage systems include 1 power cord, 1 adapter, and 2 power packs. The power cords and packs for Europe, UK/Singapore, and Australia are shown below.

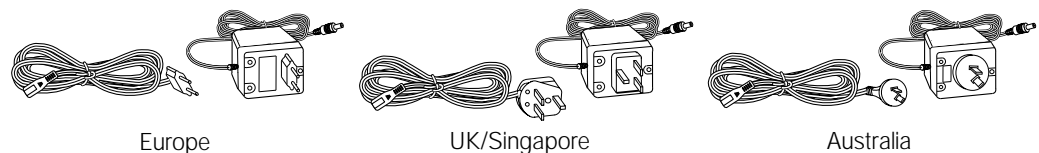

Selecting the locations for your Lifestyle® 12 system

When you place your speakers according to the guidelines below, a combination of reflected and direct sound provides the audio atmosphere of a home theater. You may experiment with the placement and orientation of the cubes to produce the sound most pleasing to you. For more discussion of speaker placement and room acoustics, see “Fine-tuning your system” on page 27.

Speaker locations

Follow these guidelines to select locations that provide the maximum home theater effect from your Lifestyle® 12 system (Figures 2 and 3).



CAUTION: Choose a stable and level surface for your speakers. Vibration can cause the speakers to move, particularly on smooth surfaces like marble, glass, or highly polished wood. If you are placing the center speaker on top of the television, use the smaller of the two sets of four rubber feet provided. You may obtain additional rubber feet (part no. 178321), free of charge, by contacting Bose® Customer Service (see listings on the inside back cover).

Left and right front speakers

The sound from the left and right front speakers should seem to appear at the edge of the picture, so that the acoustic image is close to the size of the visual image (Figure 2).

1. Place the cubes so that they line up with the center of the TV screen.
2. Place them up to 3 feet (1 m) from the edge of the TV screen.

We recommend a maximum distance of 3 feet (1 m) so that the sound does not become too separated from the picture. You may wish to vary this distance based on room conditions and personal preference. The front cables allow the cube speakers to be placed up to 20 feet (6.1 m) from the Acoustimass® module.

3. Direct one cube of each array forward. Direct the other cube toward the wall or in a different direction to create reflected sound. (See the illustration of reflected sound patterns in Figure 3.)



Note: The cube speakers are magnetically shielded so you can place them close to the TV without affecting picture quality.

Center speaker

The sound from the center speaker should appear to come directly from the center of the picture (Figure 2). The center speaker cable allows up to 20 feet (6.1 m) distance from the Acoustimass module.

1. Place the center speaker directly above or below the center of the TV screen, or at the closest convenient location.
2. Align the speaker with the front of the TV screen (not pushed to the back of the TV).
3. Direct each of the cubes slightly away from center, to create a wider area of direct sound (Figure 3).



Note: If you put the speakers in a bookcase unit, be sure to place each one at the front edge of the shelf. Placing speakers in an enclosed space can change the tonal quality of the sound. This effect is minimized if the shelves are filled with books.

Figure 2

Recommended front speaker locations

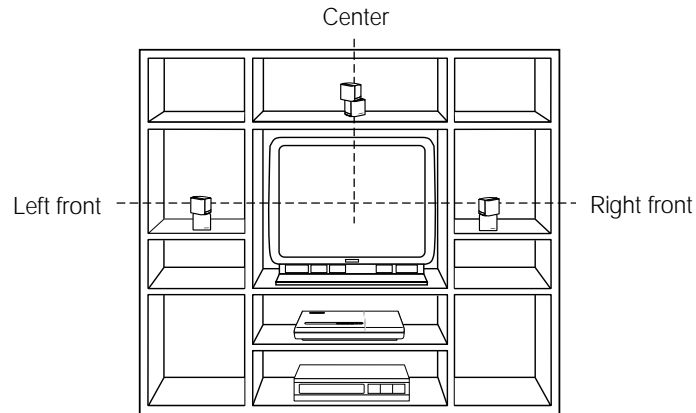

Surround speakers

The surround (rear) speakers create an area of sound around the listener. Place them in the back half of your room. Direct the cubes so that you cannot pinpoint the exact location of the sound source (Figure 3). The surround cables allow up to 50 feet (15.2 m) distance from the Acoustimass® module.

Figure 3

Speaker placement

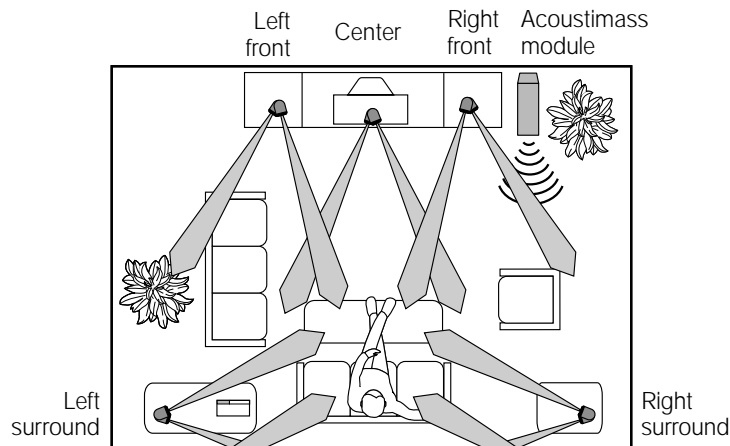

1. Place the speakers at ear height or higher, if possible.
2. Adjust the rear surround speakers to direct sound to the front and back of the listener.

Acoustimass® module

Follow these guidelines to select a location for the Acoustimass module.

Note: To avoid interference with the TV picture, place the Acoustimass module at least 18 inches (45 cm) from the TV.

1. Place the Acoustimass module along the same wall as the TV, or close to the same end of the room as the front speakers (see the example along the front wall in Figure 3).
2. Select a convenient location – under a table, behind a sofa. Do not allow furniture or drapes to block the ventilation openings of the module.
3. Place the Acoustimass module within reach of the audio input cable, speaker cables, and an AC power (mains) outlet.
4. Select a position for the Acoustimass module (Figure 4). For proper ventilation, place it on the long edge, with the connectors facing the floor. An alternate position is on its largest side, with the bass and treble controls facing up. Do not place the module on either end, as shown by the last two views in Figure 4.

Figure 4

Acoustimass module positions

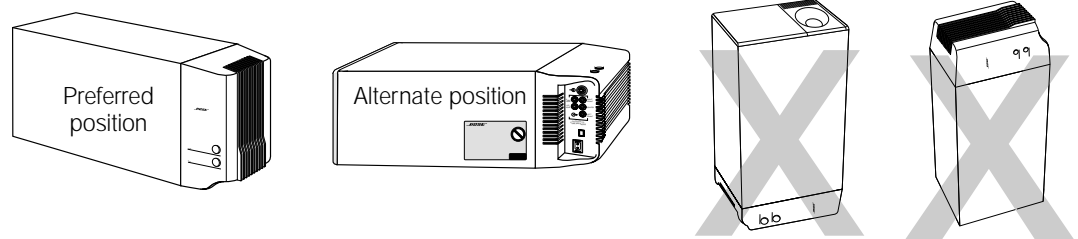

5. Once you have selected a position for the module, place the four self-adhesive rubber feet near the corners of the bottom surface. The rubber feet provide increased stability and protection from scratches.
6. Aim the port (the round opening) into the room or along the wall to avoid blocking the port or creating too much bass.
7. For best bass performance, do not place the port at equal distances from any two walls or from a wall and the ceiling.

CAUTION: Do not cover the ventilation openings of the Acoustimass module. The slots on the end provide ventilation for the built-in electronic circuitry, and should not be blocked.

CAUTION: The magnetic field from the Acoustimass module is not an immediate risk to your video tapes, audio tapes, and other magnetic media. However, you should not store tapes directly on or near the Acoustimass module.

Music center

Select a location for the music center.

1. Allow enough room to open the CD player cover.
2. Place the music center close enough to the sound sources (TV, VCR, DVD player, etc.) to allow for cable length. If you need additional audio and/or video cables to connect all of your components, see your dealer or call Bose®.
3. Place the music center within 30 feet (9.1 m) of the Acoustimass module (the length of the audio input cable).

Connecting the speakers and Lifestyle® music center

Once you have selected locations for your music system, connect the speakers.

⚠ CAUTION: Make sure all components are unplugged from the power outlet before you begin hooking up the system.

Connecting the cube speaker arrays to the Acoustimass® module

Each speaker cable contains two wires. The wire marked with a red collar is positive (+) and the plain one is negative (-). These wires match the positive (red) and negative (black) terminals on the back of each speaker. To lengthen the cable, use heavy-duty RCA extension cables or splice in 18-gauge or thicker cord (connecting + to + and - to -). To purchase cables, see your dealer or electronics store, or call Bose® customer service.

🎵 Note: The surround cables are joined together for your convenience, providing an easy-to-use cable for connecting the surround speakers. To run the cables in different directions from the Acoustimass module, simply pull apart the cables as needed.

1. Match the correct cable to the corresponding speaker location.
 - Front speaker cables have blue connectors at one end, with L, R, or C molded into the connectors. The red collars on the + wire are labeled LEFT, RIGHT, and CENTER.
 - Surround speaker cables have orange connectors at one end, with L or R molded into the connectors. The red collars on the + wire are labeled LEFT and RIGHT.
2. Connect the wire end of one speaker cable to the terminals on the rear of the matching cube speaker array.
 - a. Press the terminal tab on the back of the cube array to insert the marked wire into the red terminal and the plain wire into the black terminal. Release the tab to secure the wire.
 - b. Repeat this step for each of the five cube speaker arrays. (See Figure 5.

Figure 5

Speaker cable connections to the cube speaker array

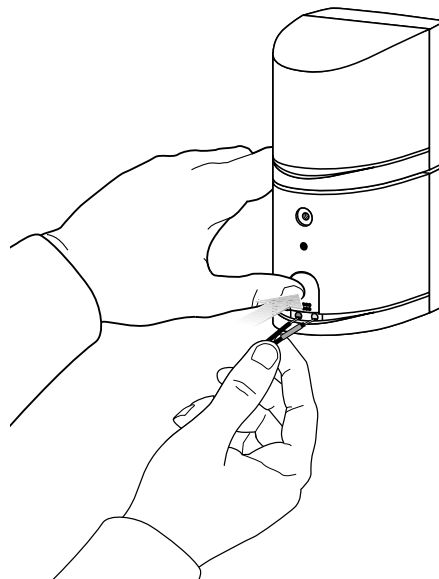

⚠ CAUTION: Make sure no strands of wire from any terminal touch any other terminal. Bridged wires create short circuits that affect proper operation of your system.

3. Connect each cable to the corresponding jack on the Acoustimass module.
 - a. Plug the blue connectors into the matching left front, center, and right front jacks.
 - b. Plug the orange connectors into the matching left surround and right surround jacks.

Connecting the Acoustimass® module to the Lifestyle® music center

Connect the Acoustimass module to the music center with the audio input cable (Figure 6).

1. Insert the three male connectors at one end of the audio input cable into the appropriate jacks on the rear panel of the music center:
 - Black connector into the SYSTEM CONTROL 1 jack
 - Red connector into the R (right) FIXED OUTPUT jack
 - White connector into the L (left) FIXED OUTPUT jack
2. Insert the single right-angle multi-pin connector on the other end of the audio input cable into the AUDIO INPUT jack on the Acoustimass module. Align the connector at the angle shown in Figure 6.
3. Extend the audio input cable as much as possible, since it includes an antenna for the remote control.

- 🎵 **Note:** Connect your digital signal source to the female RCA connector. See “Connecting your home theater components...” on page 12.
- 🎵 **Note:** Be sure the connectors are fully inserted into each of the jacks. If the black connector is not inserted fully into the SYSTEM CONTROL jack, you will hear no sound.
- 🎵 **Note:** Do **not** connect the audio input cable to the SPEAKERS A or SPEAKERS B outputs (Figure 6). The speakers in your Lifestyle® 12 system are designed to work properly with the fixed level audio output available from the FIXED OUTPUT jacks.

Figure 6

Music center and speaker connections

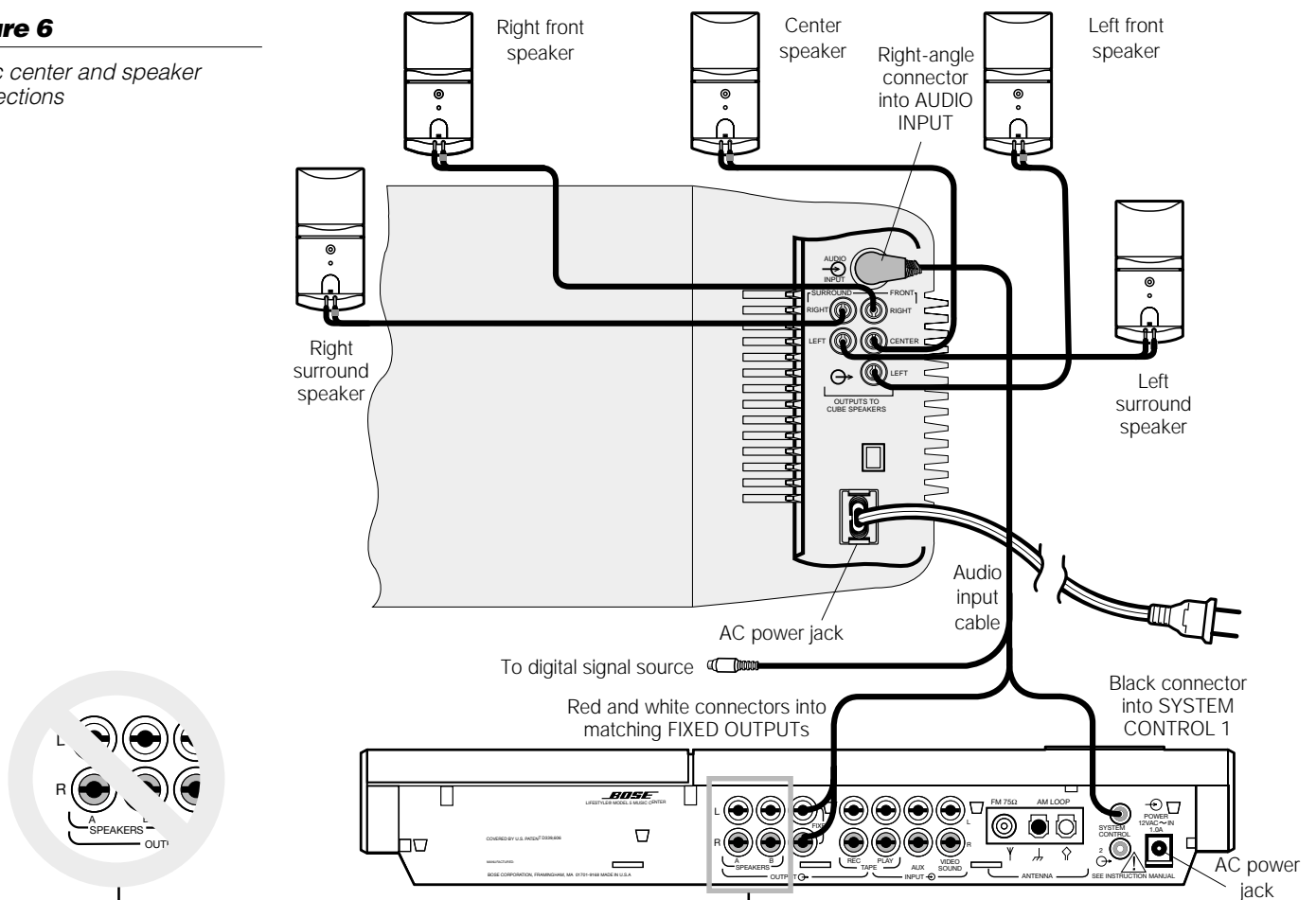

Connecting the Acoustimass® module power (mains) cord

1. On a dual voltage system, the voltage selector switch is preset at the factory to be correct for your area. Check to be sure it is set for the proper voltage (Figure 7). Use 115V for North America; 230V for Europe and Australia. In Europe, use the adapter plug provided. If you are in doubt, contact your local electric utility for the appropriate voltage setting.

Figure 7

Dual voltage Acoustimass module: voltage selector switch settings

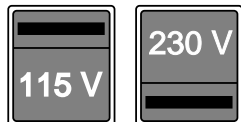

CAUTION: Make sure the voltage selector switch is set correctly.

2. Plug the small end of the power (mains) cord into the Acoustimass module AC power jack.



Note: Do **not** plug the AC power cord into a power outlet until all component connections are complete.

Connecting the music center AC (mains) power pack

The Lifestyle® music center comes with a 120V AC (mains) power pack for use in the USA and Canada or an appropriate 230V or 240V power pack for international use. (See Figures 1 and 8.) Dual voltage models include both 120V and 230V power packs.



CAUTION: Be sure to use the correct power pack for your area. Using the wrong one may damage your power pack or your music center.

- Model PS71, 120V in North America
- Model PS72, 230V in Europe
- Model PS74, 230V in UK or Singapore
- Model PS77, 240V in Australia

Figure 8

The AC power pack (model PS71 shown)

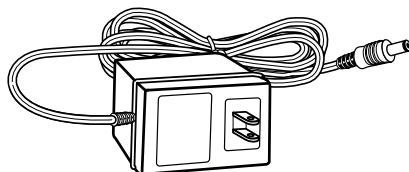

1. Firmly insert the small connector on the end of the AC (mains) power pack cable into the AC POWER jack on the back of the Lifestyle® music center.
2. Make sure that the power pack reaches an AC (mains) outlet.



Note: Do **not** plug the AC power pack into a power outlet until all component connections are complete.

Connecting your home theater components to the Lifestyle® 12 system

There are many possible variations of equipment in a home theater. In addition to the Lifestyle® 12 system, a home theater complement typically includes a stereo or mono TV and stereo VCR. In a digital home theater system, the primary source may be a DVD player. Your home theater can include many other combinations of equipment, including cable TV, laserdisc players, additional VCRs, and a satellite decoder.

♪ **Note:** A mono TV only serves as a display for the video, not as a source for the audio.

In order for the Lifestyle® 12 system to provide home theater effects, the program material must be in stereo or surround-encoded, and the device playing the material must be stereo. Look for the word “surround” on the tape, CD, or preceding the TV broadcast. To hear stereo or surround sound from encoded video tapes, you must have a stereo (HiFi) VCR. While not all VCRs deliver stereo, all CD, and DVD players and nearly all laserdisc players do.

♪ **Note:** Line level outputs from most VCRs or laserdisc players are fixed. If your VCR, laserdisc player, or other video sound source has fixed and variable outputs, use the fixed outputs.

Setting up a digital sound source

Connect a DTV or DVD player’s digital signal directly to the female RCA jack on the audio input cable. Connect the DVD player’s analog signal output to the AUX inputs. If your Lifestyle® system receives a valid digital signal (including PCM or Dolby Digital bitstreams), this digital sound is used. If no valid digital signal is received, then your system selects the analog signal being sent to AUX, which is then processed by the Videostage® decoder for excellent home theater sound. If your digital audio source has an optical connector, you will need an adapter with an RCA (coaxial) connector. Consult your dealer or contact Bose®.

♪ **Note:** Ensure the connection between the digital source and the Lifestyle® system is made using a 3 to 6 foot (1 to 2 m) standard audio cable or video cable. For longer lengths, use a 75 ohm cable.

Figure 9

Music center connectors

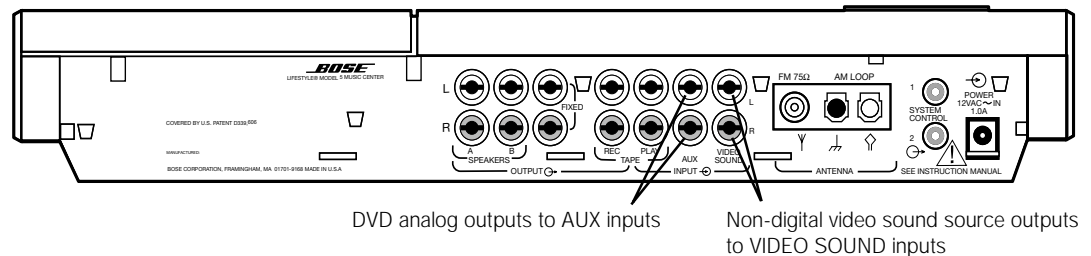

Setting up a video sound source

The Lifestyle® 12 system has one set of video sound inputs (Figure 9) for your non-digital video sound sources, such as your TV or VCR.

♪ **Note:** Your Lifestyle® 12 system includes one 6-foot (1.8 m) stereo cable to connect the right (R) and left (L) audio outputs from a component to the music center inputs. Cables may also be supplied with your components. If needed, audio cables are available at many electronics stores, or call Bose. Most audio cables are color coded. Match red connectors to right (R) jacks and black or white connectors to left (L) jacks.

How to set up your home theater

There are two basic methods for setting up your home theater. It is best to connect components directly to the Lifestyle® 12 music center, and select the source from its remote or control panel. A second option is to use a stereo TV as the switching center to select the sound source. In each example, the analog outputs from the DVD player (or other digital device) are connected to the AUX inputs. You may need extra long audio cables or extensions for some of these connections.

(1) To connect video sound sources directly to the Lifestyle® 12 system

You may connect up to three video sound sources directly to your system. For example, connect the analog outputs of your DVD player to AUX, the TV to VIDEO SOUND, and the VCR's fixed outputs to TAPE PLAY on the back of your music center. (See Figure 10.) Connect the coaxial digital audio output from your DVD player to the female RCA connection on the audio input cable (connecting the music center with the module) using a male-to-male RCA cable.

If a valid digital signal is received by the Lifestyle® 12 system through the audio input cable, the system plays that audio source. If no valid digital signal is received, it selects the backup analog signal being sent to AUX.

When connecting to your TV:

- Connect the TV fixed audio outputs to the VIDEO SOUND INPUTs on the music center.
- Turn the TV speakers off or the volume all the way down. (If there is an internal/external speakers switch, select external speakers. Do not connect any speakers to the TV.)
- Turn off any special TV settings such as expanded stereo, mega-bass, phantom, or SAP. They prevent proper surround processing through your Lifestyle® system.
- Set the TV balance control to the center of the dial or range.
- Set tone controls to flat or the middle position (neutral).
- Set TV to the stereo position.

Figure 10

Connecting components to the Lifestyle® 12 system inputs

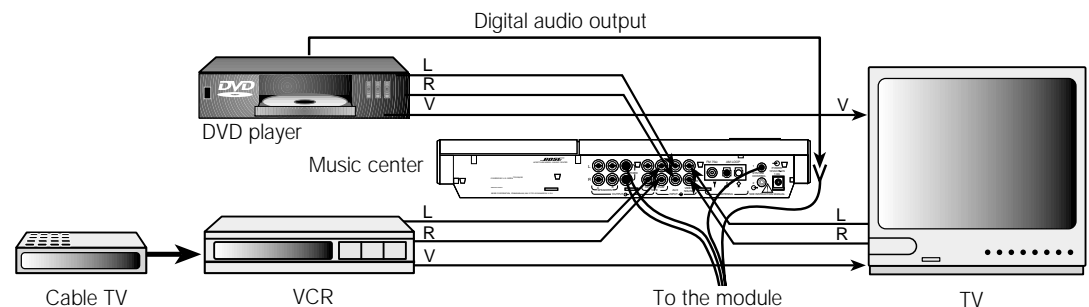

(2) To direct video sound sources through your TV

This is an alternative connection method. (See Figure 11.) If your stereo TV has fixed audio outputs (the audio signal level doesn't change) and it allows you to select the source of the signal (VCR, laserdisc, cable, etc.), then you can:

- Connect your DVD player L and R outputs to the music center AUX inputs.
- Connect the DVD video output to one of the video inputs on the TV.
- Connect the coaxial digital audio output from your DVD player to the female RCA connection on the audio input cable (connecting the music center with the module), using a male-to-male RCA cable.
- Connect your home theater components to the TV inputs.
- Connect the TV fixed audio outputs to the VIDEO SOUND INPUTS on the music center.
- Turn the TV speakers off or the volume all the way down. (If there is an internal/external speakers switch, select external speakers. Do not connect any speakers to the TV.)
- Turn off any special TV settings such as expanded stereo, mega-bass, phantom, or SAP. They prevent proper surround processing through your Lifestyle® system.
- Set the TV balance control to the center of the dial or range.
- Set tone controls to flat or the middle position (neutral).
- Set TV to the stereo position.

♪ **Note:** If necessary, as a second choice, you can use the variable audio outputs from your stereo TV. Turn off or disconnect the TV's speakers and leave the volume control up – close to the maximum setting.

♪ **Note:** If you connect your stereo VCR through your stereo TV, do not use coaxial cable. Instead, connect the VCR L and R audio outputs to the TV L and R audio inputs to ensure proper stereo and surround sound.

Figure 11

Connecting components through your TV

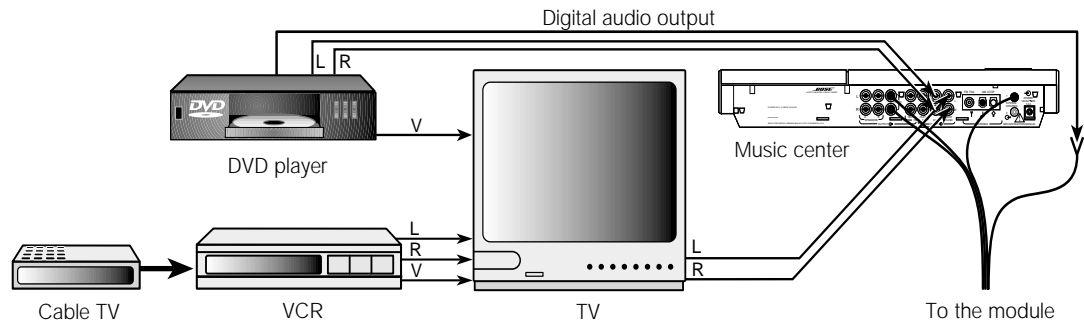

About the video source

Your TV is the display for the video (picture) signal. Thus, the video signal must be connected directly to the TV. Do not connect it to the Lifestyle® 12 system.

♪ **Note:** For assistance with video connections between your DVD player and/or VCR and TV, see your video components manuals.

♪ **Note:** There is no video signal input (usually a yellow-coded jack) on the music center. The VIDEO SOUND INPUT jacks are for audio from a video source.

Other connections

Use standard RCA audio cables to connect other components to your Lifestyle® music center, matching the red connector to R (right) and the white (or black) connector to L (left).

You can use a Y-adapter (available at electronics stores) to connect a mono source.

Tape deck

To use an external recorder (analog audio cassette, MD, or digital audio tape), connect the inputs (REC) of the recorder to the music center's TAPE REC jacks. Connect the outputs (PLAY) from the recorder to the music center's TAPE PLAY jacks.

CD changer or laserdisc player

To use one of these components, connect its audio outputs to the music center VIDEO SOUND INPUTS or AUX (if not used for a digital source) jacks, matching the red plug to R (right) and black or white plug to L (left).

Turntable

To connect a turntable, you need a phono preamplifier (with RIAA equalization). You can order the appropriate model from Bose® by calling 1-800-367-4008 and asking for part number 252603. Connect the audio outputs of the phono preamplifier to the music center's VIDEO or AUX (if not used for a digital source) jacks, matching the red plug to R (right) and black or white plug to L (left).

♪ **Note:** The Lifestyle® 12 system cannot turn on or turn off a connected component.

Connecting the antennas

The rear panel of your Lifestyle® music center provides connections for AM and FM antennas (Figure 12). Unwind each antenna's wires. Antennas provide better reception when their wires are not bundled.

Figure 12

The antenna connections

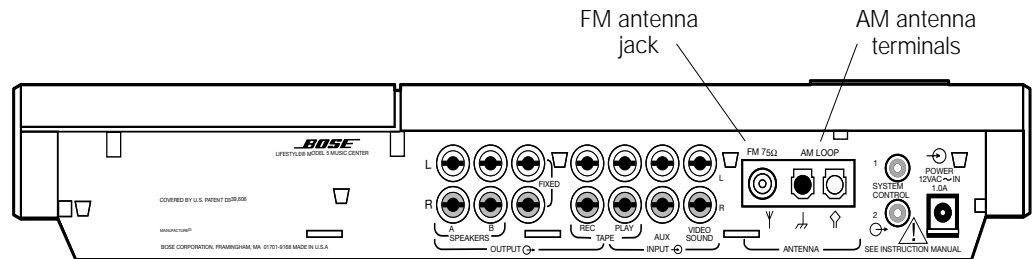

Figure 13

The FM dipole antenna



FM antenna connections

1. Plug the antenna connector into the FM ANTENNA jack on the back of the Lifestyle® music center.
2. Spread out the antenna arms. Experiment with both the placement and the angle of this antenna to provide optimum FM reception.

AM antenna connections



Note: To install the AM antenna on a wall, follow the instructions enclosed with the antenna.

1. Loosen the AM LOOP ANTENNA screw terminals on the back of the Lifestyle® music center.
2. Slide the wire connectors around the screw terminals. Tighten the screws over the connectors.
3. Stand the loop antenna on the base, following the instructions enclosed with the antenna.
4. Move the loop part of the antenna as far as possible but at least 20 inches (50 cm) from the music center and at least 4 feet (1.2 m) from the Acoustimass® module. Experiment with the orientation of the loop for optimum AM reception.



Note: Outdoor antennas may be used with the music center antenna connections. To install an outdoor antenna, consult a qualified installer. Follow all safety instructions.

Figure 14

The AM loop antenna

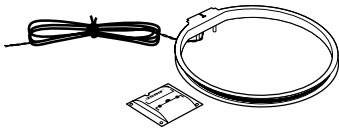

Connecting to a cable radio signal

To connect your system to the FM signal available from some cable TV companies, contact your cable provider for assistance. The connection is made to the FM 75Ω EXTERNAL antenna connector on the back of the system.



CAUTION: Be certain that the installation includes a signal splitter so that only the FM band, not the cable TV band, is transmitted to the system. It is necessary to use a splitter that filters the signal to prevent any re-emissions of the TV spectrum through the system.

Attaching the wire cover

After all the connections are completed, attach the wire cover to the music center to hide the wires and jacks from view. The five tabs on the wire cover snap into matching slots on the music center back panel.

Figure 15

The wire cover

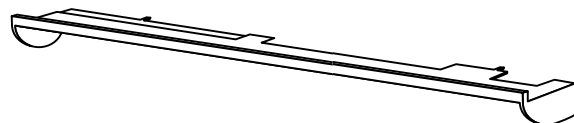

Installing the batteries in the remote control

1. Slide open the battery compartment on the back of the remote (Figure 16).
2. Insert 3 AA or IEC-R6 1.5V batteries, or the equivalent, as shown. Match the + and – symbols on the batteries with the + and – markings inside the compartment.
3. Slide the battery compartment cover back into place.

Replace the batteries when the remote control stops operating or its range seems reduced. Alkaline batteries are recommended.

Note: Do not change the settings of the factory-preset miniature switches. See “Changing the house code settings” on page 28 for information on how to prevent conflicts with other Lifestyle® music systems.

Figure 16

Installing the remote control batteries

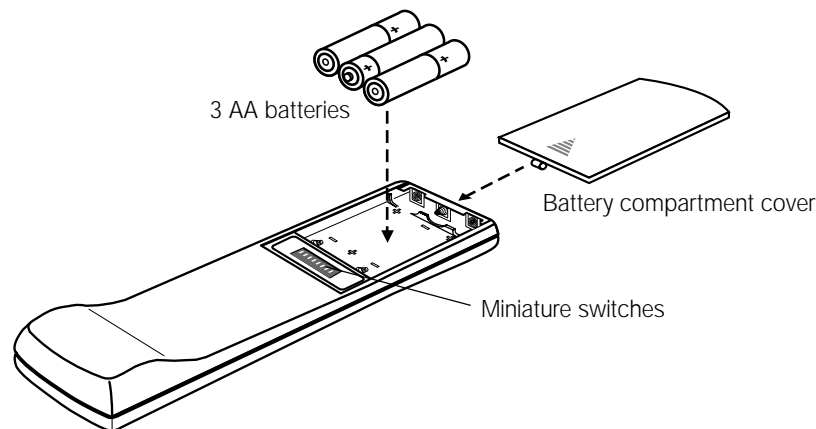

Setting radio channel spacing for dual voltage and 120V systems

Dual voltage music centers (which include both 120V and 230V power packs) and 120V music centers can be set for two types of AM and FM channel spacing.

- Channel spacing for North America is 10 kHz for AM and 200 kHz for FM.
- Channel spacing for Europe is 9 kHz for AM and 50 kHz for FM.

Your dual voltage or 120V music center is factory preset for North American spacing. Select the channel spacing most appropriate for your area.

To change AM and FM channel spacing:

1. Press OFF to turn off the music system.
2. Press and release the ERASE key under the CD cover. (See Figure 18 on page 19.)

The display indicates US for North American spacing and EU for European spacing.

Turning on the music center

Plug the Acoustimass® module power cord into an AC (mains) outlet. Then plug in the music center power pack.

- 🎵 **Note:** Your speakers will not operate unless all cable and power connections are completed before turning on the music center.

You are ready to enjoy your new Lifestyle® system. Refer to the pages that follow for information on operating the music center controls and the Lifestyle® remote control.

Play the Test CD, following the instructions on page 24. Listen to the instructions on the CD to verify your system setup.

- 🎵 **Note:** If your system will be unattended for a few days, you may want to unplug your music center to prevent a neighbor's Lifestyle® remote control or your pets from accidentally turning it on. Also see "Changing the house code settings" on page 28.

The music center display

This music center display (Figure 17) provides information on the music center functions.

Figure 17

The music center display

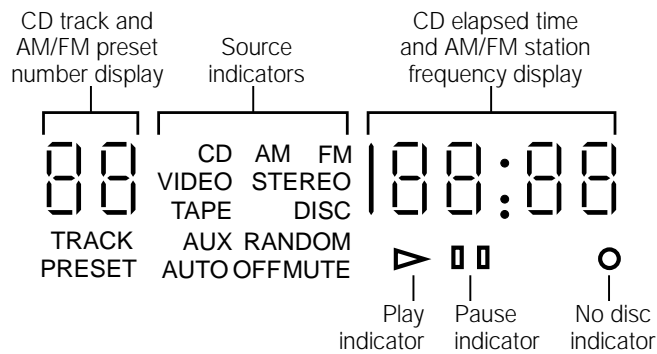

The music center controls

The music center function keys are described on pages 20-23. Use the following special music center keys to manually tune the radio and set station presets. The CD cover latch opens the CD cover for loading and unloading a CD (Figure 18).

SEEK/TUNE < / > - Lowers or raises the frequency setting of the radio (stations).

PRESET STORE/ERASE - Adds or removes radio station presets. For instructions, see page 25.

Figure 18

The music center controls

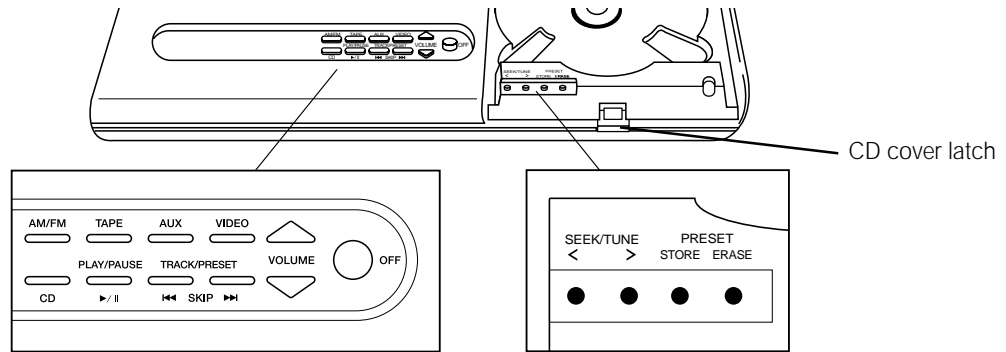

The Lifestyle® remote control

Figure 19

The remote control

The advanced radio-frequency remote control works from anywhere within most types of home construction; its radio wave signals pass through walls and floors to reach the music center. Simply press the desired button. You do not need to aim the remote at the music center.







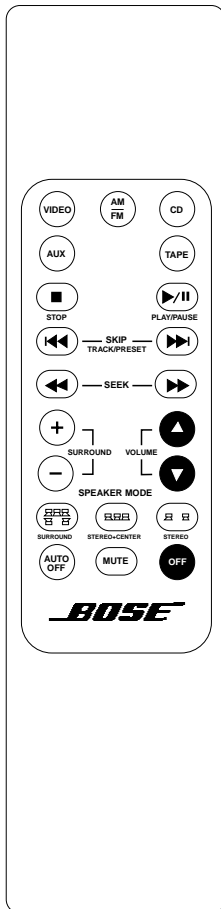















Note: Some types of buildings create “dead spots” where the remote will not operate. Simply move the remote a foot or two and try again. You can also move the music center a few feet to a location with better remote response.

Figure 19 shows the layout of the remote control.

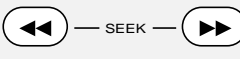

Special buttons on the remote control select the speaker mode (5, 3 or 2 speakers), and adjust the surround (rear) volume and the center speaker volume.





The system controls

Function	Remote Control	Music Center
VIDEO - Selects a video sound source connected to the VIDEO inputs, and turns the system on. (See page 22.)		
AM/FM - Selects the radio and turns the system on to the previously selected station. When the radio is on, switches between AM and FM.		
CD - Selects the built-in CD player and turns the system on.		
AUX - Selects the DVD player (or other component connected to the AUX inputs) and turns the system on. Selects digital audio, if present.		
TAPE - Selects a tape deck or other component connected to the TAPE inputs, and turns the system on.		
■ STOP - Stops the CD player.		
▶/ PLAY/PAUSE - Begins or pauses play of the CD. When held down for two seconds, stops play of a CD.		
◀◀▶▶ SKIP - Selects the previous or next CD track, or the previous or next preset radio station.		
◀◀▶▶ SKIP - Press and hold to scan a CD. When these two keys on the music center are pressed simultaneously, plays CD tracks in random order.		
◀◀▶▶ SEEK - Searches backward or forward through a CD. Seeks the previous or next strong AM or FM station.		
VOLUME ▲ \ ▼ - Raises or lowers the system volume.		
AUTO OFF - Sets a 15-minute delay before the system shuts off. Each additional key press increases the time until shutoff by 15 minutes (up to 75 minutes).		
MUTE - Silences the speakers. Also restores volume to muted speakers.		
OFF - Turns the system off.		

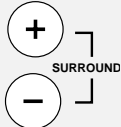
Additional system controls

Function	Remote control
<p>SURROUND</p> <ul style="list-style-type: none"> • Press and release to select SURROUND (5-speaker) mode for all sources. • Press and hold for 3 seconds to engage (1 chime) or disengage (2 chimes) simulated surround for monaural program sources. • Press and hold for 8 seconds to restore (3 chimes) factory settings for speaker mode and surround volume level. 	
<p>STEREO+CENTER</p> <ul style="list-style-type: none"> • Press and release to select STEREO+CENTER (3-speaker) mode for all sources. • Press and hold for 8 seconds to restore (3 chimes) factory settings for speaker mode and center volume level. 	
<p>STEREO</p> <ul style="list-style-type: none"> • Press and release to select STEREO (2-speaker) mode for all sources. • Press and hold to engage (1 chime) or disengage (2 chimes) Digital Dynamic Range® compression. 	
<p>SURROUND + / -</p> <ul style="list-style-type: none"> • In SURROUND (5-speaker) mode, raises or lowers volume of surround speakers. • In STEREO+CENTER (3-speaker) mode, raises or lowers volume of center speaker. • In STEREO (2-speaker) mode, + selects the SURROUND mode. <p>Note: <i>The adjustments made with SURROUND + and - will be remembered even if you select another speaker mode.</i></p>	

Note: *If you set the master volume level very high or very low, a built-in feature automatically resets it to a moderate threshold level the next time the system is turned on.*

Note: *To restore all factory default settings, turn power off then on, press and hold the SURROUND  (5-speaker) button until you hear the 3-chime confirmation tone, then press and hold the STEREO+CENTER  (3-speaker) button until you hear the 3-chime confirmation tone.*

Listening to your Lifestyle® 12 system

Your Lifestyle® 12 system uses digital signal processing to bring even greater realism and impact to both movies and music recordings. Built-in Dolby Digital decoding delivers up to 5.1 discrete audio channels (i.e., five for the independent cube speaker arrays and one for rich bass from the Acoustimass® module) from DVD, digital TV, next-generation cable boxes, and satellite receivers. With analog formats, as well as for two-channel PCM and Dolby Digital bitstreams, Videostage® decoding directs stereo information to the surround channels, so the sound of stereo broadcasts and rented or recorded tapes can approach that of your DVD discs.

In addition, Videostage decoding processes a one-channel program and directs five-channel sound to five independent speakers. Dialogue remains locked on-screen, while music and ambient effects fill the room to increase your listening enjoyment.

Your Lifestyle® 12 system offers the option of listening in 5, 3, or 2-speaker mode. The system turns on in SURROUND (5-speaker) mode. For most video material (mono, stereo, or surround), listening in 5 or 3-speaker mode helps anchor the dialogue to the picture while providing a fuller sound.

Using enhanced mode for movie soundtracks

Pressing VIDEO or AUX turns the system on in enhanced mode, with bass and treble settings specially designed for proper playback of movie soundtracks. Press the same button (VIDEO or AUX) again to alternate between enhanced mode for movies and standard mode for other listening. Pressing TAPE turns the system on in standard mode. Press TAPE again to alternate between enhanced mode for movies and standard mode for other listening.

♪ **Note:** *Enhanced mode provides more bass and less treble, as is specified for proper playback of movie sound.*

Digital Dynamic Range® compression

Digital Dynamic Range® compression automatically adjusts the volume to allow you to hear soft sounds (particularly dialogue) and to prevent you from being overwhelmed by a loud special effect (e.g., an explosion). This feature is engaged when you turn on the system but you may turn it on (one chime) or off (two chimes) using the STEREO  (2-speaker) button.

Using simulated surround for mono movie material

Bose® Videostage decoding can process a one-channel program into five-speaker sound – directing the signals so that dialogue remains locked on-screen, while music and ambient effects fill the room. You experience a surround sensation, providing extra enjoyment when you watch older (i.e., pre-stereo) movies. This feature can be used for mono TV, FM, and AM programs. Press the SURROUND  (5-speaker) button to turn it on (one chime) or off (two chimes). This feature is automatically engaged when a Dolby Digital bitstream indicates that it contains a mono program.

Operating the special features

Please see the previous page for a more detailed explanation of these special features.



Enhanced mode

When you select	The mode is	To change this
VIDEO or AUX	Enhanced	Press the same button again
TAPE	Standard	Press the same button again
CD or AM/FM	Standard	Not applicable: You cannot select enhanced mode for CD or AM/FM

Digital Dynamic Range® compression

When you select	DRC is	To change this
VIDEO or AUX	ON	Press and hold the STEREO  (2-speaker) button until two chimes are heard
CD, AM/FM, or TAPE	OFF	Press and hold the STEREO  (2-speaker) button until one chime is heard

Simulated surround (monaural into 5 speakers)

When your audio source is	Simulated surround is	To change this
Mono Dolby Digital	ON	Press and hold the SURROUND  (5-speaker) button until two chimes are heard (OFF)
Anything else	OFF	Press and hold the SURROUND  (5-speaker) button until one chime is heard (ON)

To return speaker levels to factory settings

To reset	Press
Center speaker level	STEREO+CENTER  (3-speaker) button until you hear a 3-note chime
Surround (rear) speakers level	SURROUND  (5-speaker) button until you hear a 3-note chime

Chimes

When you hear one or more chimes, it means that one of the system features has been turned on or off.

What the chimes mean

When you hear	This means
1 chime	Simulated surround (monaural into 5 speakers) <i>or</i> Digital Dynamic Range compression has been turned ON
2 chimes	Simulated surround (monaural into 5 speakers) <i>or</i> Digital Dynamic Range compression has been turned OFF
3 chimes	Surround speaker level or Center speaker level has been restored to factory default settings

Listening to digital sound

Turning on the digital audio source

Turn on the DVD player, DTV, or other digital audio source. Load the DVD disc.

Turning on the system and choosing digital sound

Press AUX to turn your system on to play digital sound. If your Lifestyle® system does not receive a valid PCM or Dolby Digital bitstream, it will automatically select the analog signal connected to the music center AUX jacks.

Selecting listening material

To select material with compatible digital-audio bitstreams, look for the terms PCM or Dolby Digital, or the symbol  on DVD-Video discs. Your Lifestyle® 12 system cannot process MPEG-2 or DTS digital bitstreams. Make sure a connection is made between your DVD player or digital TV digital audio output and your system's digital audio input.

To select surround-encoded analog or digital audio material, look for the terms Surround or Dolby Surround, the symbol  on tapes and discs, or the word "surround" preceding a TV broadcast. You can listen to any program material in SURROUND (5-speaker) mode, though you may not hear sound from all five speakers all the time. Some monaural and stereo materials will not cause sound to be directed to the surround speakers. Even with surround-encoded material there are times when no sounds are directed to the surround speakers.

Listening to compact discs

Loading a CD into the music center

Press the latch on the CD cover, and place a CD onto the spindle, label-side up. Close the CD cover.

Turning the system on and choosing the CD player

Press the CD key on the remote or the music center. If the music system is already on, pressing one of these keys selects the CD player and the CD indicator lights. The system turns on in SURROUND mode. Select another speaker mode, if desired.

If a CD has been loaded, it begins to play. If no CD is loaded, the No Disc  indicator lights.

Using the CD player

The following operations apply to keys on both the remote control and the music center, except where noted:

- To play a stopped or paused CD, press ►/|| PLAY/PAUSE.
- To pause a CD, press ►/||.
- To stop a CD, hold the ►/|| key on the music center for two seconds, press the ■ STOP key on the remote, or open the CD cover.
- To skip tracks, press SKIP ►► (forward) to go to the next track or SKIP ◄◄ (reverse) to go to the beginning of the current or previous track.
- To move through a track, on the remote control press SEEK ►► (forward) to move forward or SEEK ◄◄ (reverse) to move back, on the music center press and hold ►►SKIP or SKIP◄◄.
- To play tracks in random order, (using the music center controls only) press the SKIP ►► and ◄◄ keys simultaneously. To continue playing the tracks in their regular order, press these keys again.

Listening to the radio

Turning the system on and choosing the radio

Press the AM/FM key on the remote or the music center to turn your music system on to the most recently heard AM or FM station. The system turns on in SURROUND mode. Select another speaker mode, if desired.

 **Note:** If the system is on and the radio is already selected, this key switches between the AM and FM bands.

Tuning

Seeking the strongest stations

- Press and release the SEEK ►► (forward) or ◄◄ (reverse) key on the remote to seek and stop at the next strong signal. If you hold these keys down, the radio continues to seek without stopping at any station.
- Or, press SEEK/TUNE > or < (under the CD cover) on the music center.
- To stop seeking in one direction, briefly press the opposite direction key.

Switching between AM and FM

Press the AM/FM key to switch to the other band.

Manual tuning

If you want to tune the radio to a distant or weak station that the radio cannot seek, use the SEEK/TUNE keys, located under the CD cover.

1. Hold down the > or < key to scan through the stations.
2. Release the > or < key to stop at a selected station.
3. As soon as the scan stops, tap the > or < key to tune one channel at a time.

Setting a station preset

Your Lifestyle® music center can store up to 20 AM and FM stations in any combination.

1. Select a radio station you wish to store as a preset.
2. Press the STORE key (located under the CD cover). The station is stored in the lowest available preset location.
3. If you decide not to store the displayed station in the displayed preset location:
 - a. Press and hold the STORE key.
 - b. Press the SKIP ►► (forward) or ◄◄ (reverse) key to select a different preset number for this station.
 - c. Release the STORE key. The frequency of the preset station flashes.

 **Note:** You cannot store a station in an already-occupied preset location without erasing that preset station first (see "Erasing a preset station" below). If you attempt to store more than 20 stations, the preset display will flash '— —'.

Selecting a preset station

Once you have set station presets, press SKIP ►► (forward) or ◄◄ (reverse) to select the next or the previous preset station.

Erasing a preset station

1. Use the SKIP ►► (forward) or ◄◄ (reverse) keys to select the preset station you wish to erase.
2. Press the ERASE key (located under the CD cover). The preset number is no longer lit.

Using the system with external components



Follow the instructions on pages 12-15 for connecting components.

Turn on your component directly or by using its remote control. Use the VOLUME ▲ or ▼ button on the Lifestyle® remote control or music center to raise or lower the volume. Control all other functions at the source, referring to its owner's manual if necessary. To begin, make sure the component is turned on and a tape, CD, DVD, laserdisc, etc. is loaded.

♪ **Note:** *The Lifestyle® 12 system cannot turn a connected component on or off.*

Turning the system on and selecting the component

Press the TAPE, AUX, or VIDEO button on either the remote or the console to turn the system on and select the component connected to that input. If the system is already on, press one of these buttons to select the component.

♪ **Note:** *Selecting a source turns the system on in SURROUND (5-speaker) mode. Press STEREO+CENTER  (3-speaker) or STEREO  (2-speaker) to change the mode."/> The appropriate display indicator lights when the system is on and the component is selected.*

Using a video sound source

Press VIDEO on the remote or SOURCE SELECT on the music center until VIDEO appears on the display. This turns your system on in SURROUND (5-speaker) mode and selects the video sound source connected to the VIDEO jacks.

If your video component is connected to the music center TAPE jacks, press TAPE on the remote or SOURCE SELECT on the music center until TAPE appears on the display. This turns your system on in SURROUND (5-speaker) mode and selects the source connected to the TAPE jacks.

Using enhanced mode for movie soundtracks

When a movie soundtrack is played in a motion picture theater, its bass and treble are restored to the original levels intended by the movie's sound designer. To re-create the performance in your home, your Lifestyle® 12 system's enhanced mode restores the bass and treble to these levels when you select VIDEO or AUX.

When VIDEO or AUX is selected, you can also choose between standard and enhanced modes. The system turns on in enhanced mode for movies. Press the same button (VIDEO or AUX) again to change to standard mode. When TAPE is selected, the system turns on in standard mode. Press TAPE again to change to enhanced mode for movies.

♪ **Note:** *You may not hear a difference between enhanced and standard modes when listening to dialogue or other program material that does not have much bass or treble.*

Using a tape deck, CD changer, or other connected component

Turn on your component directly or by using its remote control. Use the VOLUME ▲ (up) or ▼ (down) key to raise or lower the volume. Control all other functions at the source, referring to its owner's manual if necessary. To record to a connected tape deck, play the source (AM/FM, CD, AUX, VIDEO) you wish to tape. Set the tape unit to record.

Using headphones

For headphone listening, use the stereo mini headphones  jack on the left side of the music center. While this jack accepts most headphone models, you can get an adapter at Bose® dealers and most electronics stores, if needed. Connecting headphones automatically shuts off speakers connected to the FIXED OUTPUTS and SPEAKERS A.

Fine-tuning your system

Figure 20

Bass and treble controls

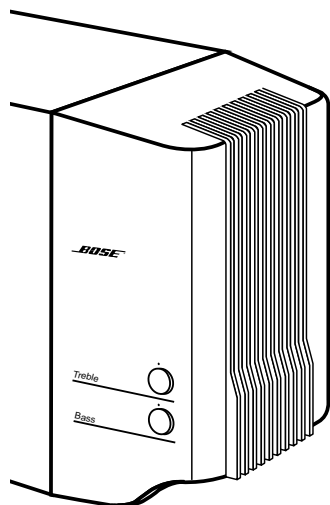

In most situations, following the speaker placement guidelines (see pages 6-8) provides excellent sound quality.

You do not need to adjust tone settings for changes in volume, since Bose® patented signal processing technology provides a natural tonal balance over the full range of volume settings. If desired, you can further fine-tune your system as described below.

Adjusting speaker controls

The Lifestyle® 12 system TREBLE and BASS controls are located on the Acoustimass® module (Figure 20). They allow you to adjust the treble (high frequencies) and bass (low frequencies). In the normal setting, the dots on each control are in the 12 o'clock position. You can also locate the normal setting by feeling when the control settles into the notch at this position. Turn the controls clockwise to increase, and counterclockwise to decrease, the amount of treble or bass.

Compensating for room acoustics

The acoustics (sound qualities) of your room can affect the overall sound quality of any speaker system. In general, you can reduce many problems with acoustics by the cautious use of the TREBLE and BASS controls.

Too much or too little treble

Rooms with too few sound-absorbing furnishings, especially those with bare floors and walls, may sound overly shrill or "bright." Turning down the treble control (toward -) decreases treble sound.

Rooms with a lot of sound-absorbing furnishings, such as upholstered furniture, wall-to-wall carpet, or heavy drapes, may reduce the treble sound of your system. Moving speakers further away from soft furnishings increases treble. You can increase treble sound by slightly turning up the treble control (toward +).

Too much or too little bass

You can decrease bass sound by turning down the bass control (toward -). To increase bass, turn up the bass control (toward +).

Acoustimass module placement affects the amount of bass you hear. Placing the module closer to the corner of the room increases bass. Moving the module away from the corner decreases bass.

Changing the house code settings

Each Lifestyle® remote control uses a system of matching house codes to communicate with its corresponding music center. If your remote's commands ever conflict with those of another nearby Lifestyle® system, you can easily set a new house code for your system and its remote control(s) by following the procedures below.

1. Open the remote control battery cover.
2. Locate the miniature switches (Figure 21). Change the position of switch 2, 3, or 4 by moving it in the opposite direction from its current setting.

♪ **Note:** Do not change any other switches at this time.

3. Replace the battery cover on the remote control.
4. Press the OFF key on the music center.
5. Open the CD cover.
6. Press the STORE key. The display will begin to flash '— —'.
7. Within two seconds while the display is flashing, press any key on the remote control.

The display stops flashing and momentarily shows '— —' to confirm recognition of the house code. The system will remain off.

8. If you have additional remote controls, open the battery cover of each one and change the switches to match those of the first remote control. It is not necessary to repeat steps 4–7.

Figure 21

Miniature switches for setting house codes and speakers

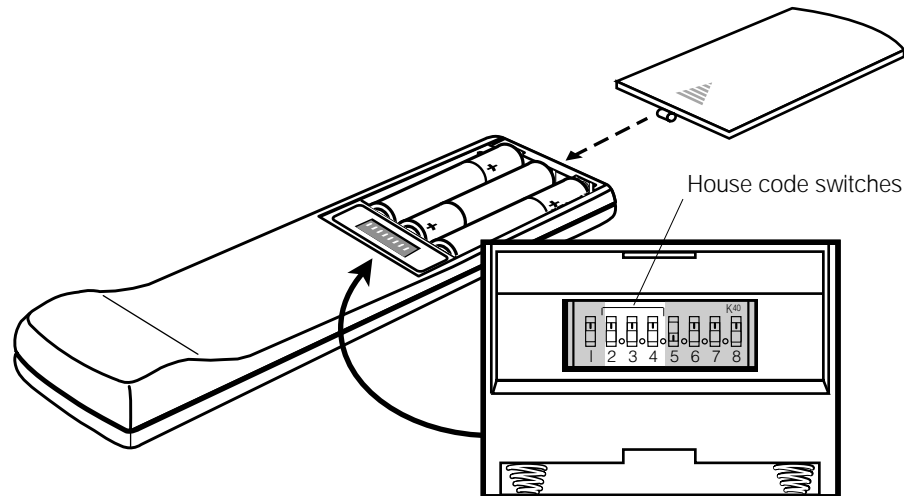

Adding speakers

Your Lifestyle® 12 system provides high quality audio for a single listening area. However, your music center also provides connections (SPEAKERS A or SPEAKERS B) for adding a pair of powered speakers in a second room. In the second room, you can listen to the sound source that is playing in the main room.

You can purchase an additional remote control to keep in the second room.

Keep the following considerations in mind if you choose to connect secondary speakers.

Using speakers connected to the B outputs:

- You must use a second remote control, set to B (see instructions below), to turn on the B speakers.
- Adjusting volume with this second remote adjusts volume for only the B speakers.
- Using the mute key on the second remote mutes or unmutes the second room speakers.

Using speakers connected to the A outputs:

- The music center controls operate speakers connected to FIXED and A outputs.
- Adjusting volume from the music center control panel or with the remote control that came with the system adjusts volume for speakers connected to FIXED and A outputs.
- Using the mute key on the main remote mutes or unmutes speakers connected to FIXED and A outputs.

Setting a second remote for additional speakers

You need a second remote control, set to B, to operate speakers connected to the SPEAKERS B outputs. When you purchase a second remote control, it is shipped set to A, to control your main speakers. It will also control secondary speakers connected to SPEAKERS A.

To set your second remote to control speakers connected to B, follow these steps:

1. Open the remote control battery cover.
2. Locate miniature switch 5. Slide the switch down (Figure 22).
3. Locate miniature switch 6. Slide the switch up (Figure 22).
4. Make sure that the house code switches match those on your first remote (see page 28).
5. Replace the battery cover on the remote control.

Note: Switches 7 and 8 are not for current system use.

Figure 22

Speaker code switch settings











Set to SPEAKERS A



Set to SPEAKERS B

Troubleshooting

Problem	What to do
System does not function at all	<ul style="list-style-type: none"> • Make sure the power connector is inserted securely into the music center, the power cord is inserted securely into the Acoustimass® module, and the power pack and power cord are plugged fully into operating AC wall outlets. • Be sure to select a source (CD, AM/FM, etc.). • Unplug the music center power pack for a minute, then reconnect it. This allows the unit to reset itself after a power surge or power interruption.
No sound	<ul style="list-style-type: none"> • Increase the volume. • Check to see if MUTE is lit on the display. If it is, press the MUTE button on the remote control to unmute the sound. • Make sure the audio input cable is connected to the music center FIXED outputs, the black connector is fully seated in the music center SYSTEM CONTROL 1 jack, and the multi-pin connector is firmly seated in the Acoustimass module jack. • Check speaker connections. • Make sure the digital audio input cable is firmly seated in the music center AUX jack and the other end of the cable is firmly seated in the connector at the digital source. • Turn the music center off for 10 seconds, then on again, to restore communication between the music center and the speakers. • Check the connections for any external components. Make sure to select the correct source for the desired input. • Be sure the CD is placed correctly, label-side up, in the music center, and the cover is closed. • Disconnect any headphones. • Connect the FM and AM antennas.
No sound from center speaker	<ul style="list-style-type: none"> • Make sure that the center cube cable is connected at both ends. • Select STEREO+CENTER  (3-speaker) or SURROUND  (5-speaker) mode.
Too much sound from center speaker	<ul style="list-style-type: none"> • In STEREO+CENTER (3-speaker) mode, press SURROUND  to decrease center speaker volume. • Press and hold the STEREO+CENTER  (3-speaker) button for 10 seconds to restore the factory preset center volume setting.
No sound from surround speakers	<ul style="list-style-type: none"> • Select SURROUND  (5-speaker) mode. • Press SURROUND . • Make sure the video sound source is stereo and surround-encoded, and the component used (TV, VCR, DVD, or laserdisc player) is stereo.
Surround speakers are too loud	<ul style="list-style-type: none"> • In SURROUND (5-speaker) mode, press SURROUND . • Make sure that the left and right front speakers are connected to the front speaker jacks (blue) and the left and right surround speakers are connected to the surround speaker jacks (orange). • Press and hold the SURROUND  (5-speaker) button for 10 seconds to restore the factory preset surround volume setting.
Remote control is inconsistent or does not work	<ul style="list-style-type: none"> • Check batteries and their polarity (+ and -). See page 17. • Operate the remote control closer to the music center. • Move the remote (or the music center) a few feet to avoid an area of “dead spots.” See note on page 19. • Make sure the audio input cable is firmly seated, uncoiled, and extended as much as possible. • Make sure the remote control and music center house codes match. Follow steps 4-7 on page 28 to match the house code settings.

Problem	What to do
Unit turns on and off by itself, or behaves erratically	<ul style="list-style-type: none"> • Change the house code setting to prevent signals from conflicting with another nearby Lifestyle® system. See page 28 for instructions on setting the house code.
CD does not play	<ul style="list-style-type: none"> • Make sure the music center CD cover is closed. • Check to see if the play symbol ► in the display is lit. • After pressing the CD key, wait a few seconds before pressing PLAY. • Check to see if there is a disc in the player, label-side up. • The disc may be damaged. Try another disc. • There may be dirt or dust on the laser pickup or on the CD. Clean the CD. See Figure 24 on page 32. Do not touch the laser pickup. • The music center cannot play a DVD disc.
Radio does not work	<ul style="list-style-type: none"> • Make sure antennas are connected properly. • Move AM antenna at least 20 inches (50 cm) from the music center. • Adjust antenna position to improve reception. • AM antenna must be upright. • Move antennas farther from TV or other electronic equipment. • You may be in an area of weak signal coverage.
FM sound is distorted	<ul style="list-style-type: none"> • Adjust antenna position to reduce interference.
FM sound is noisy in surround mode	<ul style="list-style-type: none"> • Weak FM stations will produce static in the surround speakers. Press the STEREO  (2-speaker) button to minimize noise.
Sound is distorted	<ul style="list-style-type: none"> • Make sure speaker cables are not damaged and the connections are secure. • Reduce the output level from any external components connected to the music center.
Volume control is too sensitive	<ul style="list-style-type: none"> • Check to be sure the audio input cable is connected to the music center FIXED OUTPUTs, not to SPEAKERS A or B.
No tape, CD, VCR, DVD or TV sound	<ul style="list-style-type: none"> • Check the connections. • Make sure the component is turned on. • Refer to the component owner's manual.

Warranty period

The Bose® Lifestyle® 12 system is covered by a limited 1-year transferable warranty. Details of the warranty are provided on the warranty card that came with your system. Please fill out the information section on the card and mail it to Bose.

Customer service

For additional help in solving problems, contact Bose Corporation customer service. See the inside back cover for Bose customer service offices and phone numbers.

Taking care of your Lifestyle® 12 system

The only maintenance needed is cleaning the system and your compact discs, and replacing remote control batteries.

For information on replacing the remote control batteries see “Installing the batteries in the remote control” on page 17.

Figure 23

Handling a CD

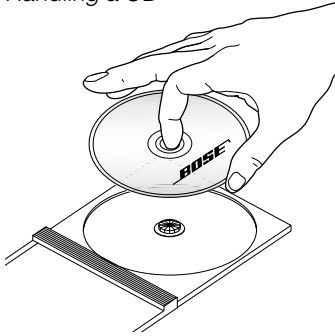

Handling CDs

Handle discs by their edges to prevent fingerprints and scratches (Figure 23).

To remove stains or fingerprints from the surface of a disc, use a soft, lint-free, dry cloth. Wipe in straight movements from the center of the disc to the outside (Figure 24). Do not use any chemical products; they can damage the disc.

Do not write on or attach labels to the surface of the disc.

To minimize exposure to dust and dirt, replace discs in their cases after use. Store each disc in its case, out of direct sunlight, high temperatures, and humidity.

Cleaning the music center

Use only a soft, dry cloth to clean the outside of the music center.

Do not use any solvents, chemicals, or cleaning solutions containing alcohol, ammonia, or abrasives. Do not allow liquids to spill into any openings. Do not use any sprays near the system.

Figure 24

Cleaning a CD

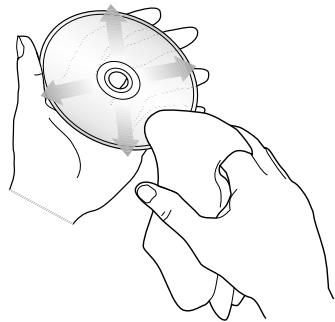

Cleaning the speakers

Clean the surface of your speakers with a soft, damp cloth. You can use an ammonia-free window cleaner on a soft cloth to maintain the finish.

Do not use any sprays near the system. Do not use any solvents, chemicals, or cleaning solutions containing alcohol, ammonia, or abrasives. Do not allow liquids to spill into any openings.

The speaker grille panels require no special care, although you may vacuum them carefully, if necessary.



CAUTION: If liquids get into the product, turn the system off and allow it to air dry. Then turn it on again. If you notice any problems with its functioning, turn it off and contact Bose® customer service.

Technical information

Powered Acoustimass® 25 speaker system

Power rating

USA/Canada: 120V~ 50/60 Hz 350W

Europe/Australia: 220-240V~ 50/60 Hz 350W

Dual Voltage: 115/230V~ 50/60 Hz 350W

Model 5 music center

Power pack power rating

USA/Canada: 120V~ 60 Hz 25VA

Europe: 230V~ 50 Hz 25VA

Australia: 240V~ 50 Hz 25VA

Dual Voltage: 120V~ 60 Hz 25VA and
230V~ 50 Hz 25VA

Inputs

TAPE: 3V maximum

AUX, VIDEO SOUND: 4V maximum

FM antenna: 75Ω

AM antenna: 12 μH

POWER: 12V~, 1.0 A

Outputs

Variable audio: SPEAKERS A and B

Fixed audio: FIXED, TAPE

Headphone: 32Ω minimum impedance

SYSTEM CONTROL: for use with Bose®
powered speakers and accessories

RC-9 remote control

Range: 65 feet (20 m)

Dimensions

Music center

15.0" W x 7.8" D x 2.5" H
(38.1 cm x 19.8 cm x 6.4 cm)

Cube speakers

3.1" W x 4.0" D x 6.2" H
(7.8 cm x 10.2 cm x 15.7 cm)

Acoustimass® module

23.3" W x 7.5" D x 14.0" H
(59.0 cm x 19.0 cm x 35.5 cm)

Weights

Music center

4.0 lb (1.7 kg)

Cube speakers

2.4 lb (1.1 kg)

Acoustimass module

33 lb (15.0 kg)

Total shipping weight

61 lb (27.7 kg)

Finish

Music center

Simulated aluminum, Polymer

Cube speakers

Polymer, painted

Acoustimass module

Vinyl veneer, Polymer

Accessories

To find out about mounting brackets, stands, additional remote controls, and connecting additional Bose powered loudspeakers, contact your Bose dealer. Or call Bose directly (see inside back cover for phone numbers).

A

AA 5, 17
 AC POWER 11
 AC power cord 5, 11
 AC power pack 5, 11
 accessories 33
 acoustic image 6
 acoustics 27
 Acoustimass® module 2-8, 10, 11, 16, 18, 22, 27, 30, 33
 AM 17, 20, 22, 25
 AM ANTENNA 16
 AM antenna 5, 16, 30, 31, 33
 AM/FM 4, 18, 20, 22-26, 30
 analog 12, 13, 15, 22, 24
 antenna 5, 10, 16, 30, 31, 33
 array 9
 audio cable 12, 13
 audio input cable 5, 8, 10, 12, 14, 30, 31
 audio tapes 8
 Australia 5, 11
 AUTO OFF 20
 AUX 12-14, 20, 22, 24, 26, 30, 33

B

BASS 27
 batteries 2, 5, 17, 30, 32
 battery cover 28, 29
 brackets 33

C

cable 5-12, 14, 30, 31
 cable box 4, 22
 cable radio 16
 cable TV 12, 16
 Canada 5, 11, 33
 CD 8, 12, 18-20, 23-26, 28, 30-32
 CD cover 8, 17, 25, 30
 CDI player 12
 center speaker 6, 10, 23, 30
 channel spacing 17, 19
 chime 21-23
 cleaning 32
 coaxial 12-14
 components 11-15, 20, 26, 30, 31
 connection 9-11, 13-16, 18, 29-31
 console 26
 controls 2, 8, 13, 14, 18-21, 24, 27, 33
 cube speakers 4-6, 9, 22, 33
 customer service 6, 9, 31

D

damage 5, 31
 dead spots 19, 30
 decoder 4, 12
 delay shutoff 20
 digital
 audio 13-15, 20, 24
 bitstream 4, 12, 22, 24
 signal 10, 12, 13
 signal processing 4, 22
 sound 4, 24
 TV 4, 22, 24
 display 12, 15, 18, 24-26, 28, 31
 distorted 31
 Dolby Digital 4, 12, 22, 24
 Dolby Surround 4, 24
 DTS 4, 24
 DTV 12, 24
 dual voltage 5, 11, 17, 33
 DVD 4, 12-14, 22, 24, 26, 31
 Digital Dynamic Range® compression 4, 21-23

E

elapsed time 18
 enhanced mode 22, 23, 26
 ERASE 17, 19, 25
 EU 17
 Europe 5, 11, 17, 33
 expanded stereo 13, 14
 external antenna 16

F

5.1 4, 22
 5-speaker 21-24, 26, 30
 factory default 21, 23
 factory preset 17, 30
 factory setting 23
 finish 32, 33
 five-channel 22
 FIXED 29, 31, 33
 fixed 10, 12-14, 26, 30
 FIXED OUTPUT 10
 FM 17, 20, 22, 25, 31
 FM 75Ω EXTERNAL antenna 16
 FM antenna 5, 16, 30, 33
 frequency 18
 front speaker 5-8, 10, 30

G

grille 32

H

handling CDs 32
 headphone 26, 30, 33
 home theater 4, 6, 12-14
 house code 18, 28-31

I

IEC-R6 17
 input 12, 13, 15
 interference 31
 internal/external 13, 14
 international use 11

L

laserdisc 12, 13, 26, 30
 Lifestyle® system CD 5
 liquids 32

M

magnetic shielding 6
 maintenance 32
 male-to-male RCA cable 13, 14
 manually tune 19
 mega-bass 13, 14
 moisture 2
 mono 4, 12, 15, 21, 22
 mounting brackets 33
 movie soundtracks 22, 26
 MPEG-2 4, 24
 multi-pin connector 10, 30
 music center 2-5, 8-21, 24-26, 28-33
 MUTE 20, 30
 mute 29

N

No disc 18, 24
 noise 31
 North America 11, 17

O

1 chime 21-23
 115/230V 33
 115V 11
 120V 11, 17, 33
 OFF 17, 20, 23, 28
 ON 23
 one chime 21-23
 one-channel 22
 optical connector 12
 orange 5, 9
 outdoor antenna 16
 outlet 8, 9, 11, 18, 30

P

Pause 18
 PCM 4, 12, 22, 24
 phantom 13, 14
 phone numbers 31, 33
 placement 6, 7, 16, 27
 PLAY 15, 31
 Play 18
 PLAY/PAUSE 20, 24
 polarity 30
 port 8
 power cord 5, 11, 18, 30
 power pack 5, 11, 17, 18, 30, 33
 power rating 33
 power surge 30
 powered speakers 29
 PRESET 19
 preset 18-20, 25
 preset radio station 20
 problems 27, 31
 purchase date 3

R

radio 4, 19, 20, 25, 31
 radio channel spacing 17
 random 20, 24
 RCA cable 14
 RCA connector 10
 RCA extension cables 9
 REC 15
 reception 16, 31
 red 9, 10, 12, 15
 reflected sound 6
 remote control 3-5, 10, 17-19, 21,
 24, 26, 28-30, 33
 room acoustics 27
 rubber feet 5, 6, 8

S

75 ohm cable 12
 safety 2
 SAP 13, 14
 satellite receiver 4, 22
 scan 20, 25
 screw terminals 16
 second remote 29
 SEEK 19, 20, 24, 25
 serial number 3, 5
 signal processing technology 27
 signal splitter 16
 simulated surround 21, 23

Singapore 11
 SKIP 20, 24, 25
 SOUND 13, 14
 sound level 4
 sound source 4, 12-14, 26, 30
 soundtrack 4, 22, 26
 SOURCE SELECT 26
 speaker cable 5, 6, 8, 9, 31
 speaker connections 10
 speaker mode 19, 21, 24, 25
 SPEAKERS A 10, 26, 29, 31, 33
 SPEAKERS B 10, 29, 31, 33
 special effect 4, 22
 special features 23
 spill 32
 splice 9
 sprays 32
 stability 6, 8
 standard mode 22, 26
 station preset 25
 STEREO 21, 22, 26
 stereo 4, 12-14, 22, 24, 30
 stereo cable 5
 stereo TV 4
 STEREO+CENTER 21, 23, 24, 26, 30
 STOP 20
 Stop 20
 STORE 25, 28
 STORE/ERASE 19
 SURROUND 21- 26, 30
 surround 4, 5, 7, 9-13, 14, 22, 24, 30
 surround cables 9
 surround sound 14
 surround speaker 5, 7, 9, 10, 23, 24,
 30, 31
 switches 17, 20, 28, 29
 SYSTEM CONTROL 10, 30, 33
 system shut off 20

T

2 chimes 21- 23
 2-speaker 21-23, 26, 31
 220V 33
 230V 11, 17, 33
 240V 11, 33
 3 chimes 21-23
 3-speaker 21-23, 26, 30
 TAPE 15, 20, 22, 23, 26, 33
 tape deck 4, 15, 20, 26
 TAPE PLAY 13
 TAPE REC 15

tapes 4, 8, 22
 Test CD 5, 18
 three chimes 21-23
 tone settings 27
 TREBLE 27
 treble control 27
 troubleshooting 30
 TUNE 19, 25
 tuning 6, 22, 25, 27
 turntable 15
 TV 4, 6, 8, 12-16, 22, 30, 31
 two chimes 21-23

U

UK/Singapore 5
 unpack 3, 5
 US 17
 USA 5, 11, 17, 33

V

variable 12, 14, 33
 VCR 4, 8, 12-14, 30, 31
 ventilation 8
 vibration 6
 VIDEO 15, 20, 22, 23, 26, 33
 video cable 12
 video signal 15
 VIDEO SOUND 13
 video sound 14, 26
 video tapes 8, 12
 Videostage® 4, 12, 22
 voltage 2, 5, 11, 33
 VOLUME 20, 26
 volume 4, 13, 14, 19- 22, 26,
 27, 29, 30

W

warranty 31
 warranty card 3, 5
 weak signal 31
 weak station 25
 weight 33
 white 10, 12, 15
 wire cover 5, 16
 wire size 9



USA

Bose Corporation, The Mountain
Framingham, MA 01701-9168
1-800-367-4008
Phone hours - ET (eastern time):
Weekdays 8:30 a.m. to 8 p.m.
Saturdays 9 a.m. to 3 p.m.

Canada

Bose Ltd., 1-35 East Beaver Creek Road
Richmond Hill, Ontario L4B 1B3
1-800-465-2673
Phone hours - ET (eastern time):
Weekdays 9 a.m. to 5 p.m.

European Office

Bose Products B.V., Nijverheidstraat 8
1135 GE Edam, Nederland
TEL 0299-390111 FAX 0299-390114

Australia

Australia Pty Limited, 1 Sorrell Street
Parramatta, NSW 2150
TEL 02 9204-6111 FAX 02 9204-6122

Belgique/België

Bose N.V., Limesweg 2, B-3700 Tongeren
TEL 012-390800 FAX 012-390840

Danmark

Bose A/S, Industrivej 7, 2605 Brøndby
TEL 4343-7777 FAX 4343-7818

Deutschland

Bose GmbH, Max-Planck-Straße 36d
D-61381 Friedrichsdorf
TEL 06172-71040 FAX 06172-710419

France

Bose S.A., 6, rue Saint Vincent
78100 Saint Germain en Laye
TEL 01-30616363 FAX 01-30614105

India

Bose Corporation India Private Limited
W-16, Greater Kailash-II
New Delhi 110 048
TEL (011) 648 4462 FAX (011) 648 4463

Ireland

Bose Corporation
Carrickmacross, Co Monaghan
TEL 042-9661988 FAX 042-9661998

Italia

Bose S.p.A., Via della Magliana 876
00148 Roma
TEL 06-65670802 FAX 06-65680167

Japan

Bose K.K., Shibuya YT Building
28-3 Maruyama-cho
Shibuya-ku, Tokyo 150
TEL 3-5489-0955 FAX 3-5489-0592

Nederland

Bose B.V., Nijverheidstraat 8
1135 GE Edam
TEL 0299-390111 FAX 0299-390109

Norge

Bose A/S, Solheimsgate 11
N-2001, Lillestrøm
TEL 63-817380 FAX 63-810819

Österreich

Bose Ges.m.b.H., Vienna Business Park
Wienerbergstrasse 7 (10.OG)
A-1100 Vienna
TEL 01-60404340 FAX 01-604043423

Schweiz

Bose AG, Rünenbergerstrasse 13
4460-Gelterkinden
TEL 061-9815544 FAX 061-9815502

Sverige

Bose A/S, JohanneFredsgatan 4
S-43153 Mölndal
TEL 31-878850 FAX 31-274891

United Kingdom

Bose Limited
1 Ambley Green
Gillingham Business Park
Gillingham, Kent ME8 0NJ
TEL 0870-741-4500 FAX 0870-741-4545

From other locations

Bose Customer Service, 1 New York Ave.
Framingham, MA 01701-9168 USA
TEL (508) 766-1900 FAX (508) 766-1919

World Wide Web

www.bose.com

BOSE[®]
Better sound through research[®]

©2001 Bose Corporation
The Mountain, Framingham, MA 01701-9168 USA
196573 AM Rev.05 JN20413