



The Bose® Lifestyle® 20 Music System

Owner's Guide

October 29, 2001

AM178934_09_V.pdf

Warning

To reduce the risk of fire or electric shock, do not expose this system to rain or moisture.

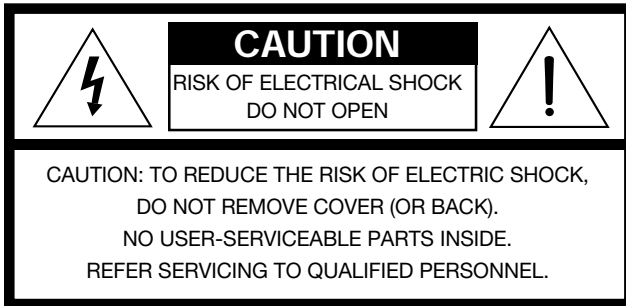

CAUTION:

For units with a polarized power plug, to prevent electric shock, match wide blade of plug to wide slot, insert fully.

These CAUTION marks may be located on the back panel and bottom of your Lifestyle® music center and the bottom panel of your Acoustimass® module:



The lightning flash with arrowhead symbol, within an equilateral triangle, is intended to alert the user to the presence of uninsulated dangerous voltage within the system enclosure that may be of sufficient magnitude to constitute a risk of electric shock.



The exclamation point within an equilateral triangle, as marked on the system, is intended to alert the user to the presence of important operating and maintenance instructions in this owner's guide.

Class 1 laser product

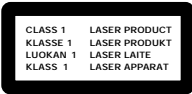

This compact disc player is classified as a CLASS 1 LASER product. The CLASS 1 LASER PRODUCT label is located on the bottom of the unit.

CAUTION: Use of controls or adjustments or performance of procedures other than those specified herein may result in hazardous radiation exposure. The compact disc player should not be adjusted or repaired by anyone except properly qualified service personnel.

Note: This music system is not intended for use in moving vehicles.

Class B emissions limits

This digital apparatus does not exceed the Class B limits for radio noise emissions from digital apparatus set out in the Radio Interference Regulations of the Canadian Department of Communications.

Batteries

Please dispose of used batteries properly, following any local regulations. Do not incinerate.

Additional safety information

See the additional information on the *Important Safety Instructions* page enclosed with this owner's guide.

Please read this owner's guide

Please take the time to follow this owner's guide carefully. It will help you set up and operate your system properly, and enjoy all of its advanced features. Save your owner's guide for future reference.

Important Safety Instructions

1. **Read these instructions** – for all components before using this product.
2. **Keep these instructions** – for future reference.
3. **Heed all warnings** – on the product and in the owner's guide.
4. **Follow all instructions.**
5. **Do not use this apparatus near water or moisture** – Do not use this product near a bathtub, washbowl, kitchen sink, laundry tub, in a wet basement, near a swimming pool, or anywhere else that water or moisture are present.
6. **Clean only with a dry cloth** – and as directed by Bose® Corporation. Unplug this product from the wall outlet before cleaning.
7. **Do not block any ventilation openings. Install in accordance with the manufacturer's instructions** – To ensure reliable operation of the product and to protect it from overheating, put the product in a position and location that will not interfere with its proper ventilation. For example, do not place the product on a bed, sofa, or similar surface that may block the ventilation openings. Do not put it in a built-in system, such as a bookcase or a cabinet that may keep air from flowing through its ventilation openings.
8. **Do not install near any heat sources, such as radiators, heat registers, stoves or other apparatus (including amplifiers) that produce heat.**
9. **Do not defeat the safety purpose of the polarized or grounding-type plug. A polarized plug has two blades with one wider than the other. A grounding-type plug has two blades and a third grounding prong. The wider blade or third prong are provided for your safety. If the provided plug does not fit in your outlet, consult an electrician for replacement of the obsolete outlet.**
10. **Protect the power cord from being walked on or pinched, particularly at plugs, convenience receptacles, and the point where they exit from the apparatus.**
11. **Only use attachments/accessories specified by the manufacturer.**
12. **Use only with the cart, stand, tripod, bracket or table specified by the manufacturer or sold with the apparatus. When a cart is used, use caution when moving the cart/apparatus combination to avoid injury from tip-over.**
13. **Unplug this apparatus during lightning storms or when unused for long periods of time** – to prevent damage to this product.
14. **Refer all servicing to qualified service personnel. Servicing is required when the apparatus has been damaged in any way: such as power-supply cord or plug is damaged; liquid has been spilled or objects have fallen into the apparatus; the apparatus has been exposed to rain or moisture, does not operate normally, or has been dropped** – Do not attempt to service this product yourself. Opening or removing covers may expose you to dangerous voltages or other hazards. Please call Bose to be referred to an authorized service center near you.
15. **To prevent risk of fire or electric shock, avoid overloading wall outlets, extension cords, or integral convenience receptacles.**
16. **Do not let objects or liquids enter the product** – as they may touch dangerous voltage points or short-out parts that could result in a fire or electric shock.
17. **See product enclosure for safety related markings.**

Information about products that generate electrical noise

If applicable, this equipment has been tested and found to comply with the limits for a Class B digital device, pursuant to Part 15 of the FCC rules. These limits are designed to provide reasonable protection against harmful interference in a residential installation. This equipment generates, uses, and can radiate radio frequency energy and, if not installed and used in accordance with the instructions, may cause harmful interference to radio communications. However, this is no guarantee that interference will not occur in a particular installation. If this equipment does cause harmful interference to radio or television reception, which can be determined by turning the equipment off and on, you are encouraged to try to correct the interference by one or more of the following measures:

- Reorient or relocate the receiving antenna.
- Increase the separation between the equipment and receiver.
- Connect the equipment to an outlet on a different circuit than the one to which the receiver is connected.
- Consult the dealer or an experienced radio/TV technician for help.

Note: *Unauthorized modification of the receiver or radio remote control could void the user's authority to operate this equipment.*

This product complies with the Canadian ICES-003 Class B specifications.



Important Safety Instructions

18. **Use proper power sources** – Plug the product into a proper power source, as described in the operating instructions or as marked on the product.
19. **Avoid power lines** – Use extreme care when installing an outside antenna system to keep from touching power lines or circuits, as contact with them may be fatal. Do not install external antennas near overhead power lines or other electric light or power circuits, nor where an antenna can fall into such circuits or power lines.
20. **Ground all outdoor antennas** – If an external antenna or cable system is connected to this product, be sure the antenna or cable system is grounded. This will provide some protection against voltage surges and built-up static charges. Section 810 of the National Electrical Code ANSI/NFPA No. 70 provides information with respect to proper grounding of the mast and supporting structure, grounding of the lead-in wire to an antenna discharge unit, size of grounding conductors, location of antenna-discharge unit, connection to grounding electrodes, and requirements for the ground electrode. Refer to the antenna grounding illustration on this page.

Antenna grounding

Example of antenna grounding as per National Electrical Code, ANSI/NFPA 70.

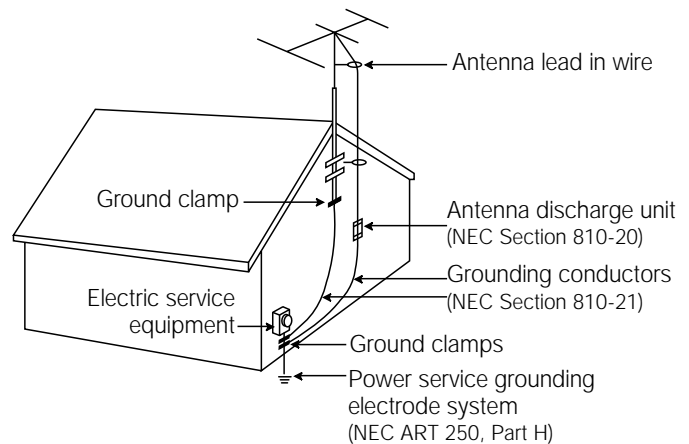

Note to CATV system installer

This reminder is provided to call the CATV system installer's attention to Article 820-40 of the NEC (of USA) that provides guidelines for proper grounding. In particular, it specifies that the cable ground shall be connected to the grounding system of the building, as close to the point of cable entry as is practical.

BOSE
Better sound through research®

©2001 Bose Corporation,
The Mountain, Framingham, MA
01701-9168 USA
255805 AM Rev.00 JN10494

Where to find...

Setting Up

- Before you begin 4
- Unpack the carton 5
- Select the locations for your Lifestyle® 20 music system 6
- Connect the speakers and Lifestyle® music center 7
- Other connections 8
- Connect the antennas 9
- Set up the remote control 10
- Set radio channel spacing on dual voltage systems 10

Operating Your Lifestyle® 20 Music System

- Listening to your Lifestyle® 20 music system 11
- The music center display 11
- The system controls 12
- Other music center controls 13
- The Lifestyle® 20 remote control 13
- Listening to compact discs 14
- Listening to the radio 16
- Using the system with external components 17
- Fine-tuning your system 18
- Using two listening zones 19

Maintaining Your Lifestyle® 20 Music System

- Changing the house code settings 21
- Troubleshooting 22
- Transporting your music center 23
- Warranty period 23
- Customer service 23
- Taking care of your Lifestyle® 20 music system 24

Product Information

- Technical information 25
- Accessories 25

Index 26

Bose® Corporation inside back cover

For your records

Serial numbers are located on the bottom of the music center and the bottom panel of the Acoustimass® module.

Lifestyle® music center serial number: _____

Acoustimass module serial number: _____

Dealer name: _____

Dealer phone: _____ Purchase date: _____

We suggest you keep your sales slip and warranty card together with this owner's guide.

Before you begin

Thank you for purchasing the Bose® Lifestyle® 20 music system. This remarkably compact system is a result of advanced technology developed by years of research. Technological innovations that make the Lifestyle® 20 music system possible include the smallest CD changer now available for home use and Jewel Cube™ speakers one-half the size of the previous Acoustimass® cube speakers.

To create speakers this small, the magnet inside is formed using the rare earth element neodymium and has ten times more energy (per unit volume) than conventional magnets. For high performance from such a small package, a port 3.8 inches (9.7 cm) long was designed in the shape of a nautilus shell and enclosed inside the tiny cube.

These, and numerous other innovations, bring you the Lifestyle® 20 music system, offering superb sound, elegance, technology, and simplicity for music and home entertainment.

Your system includes:

- A Lifestyle® music center with built-in AM/FM radio and six-disc CD changer
- Powered Acoustimass speakers consisting of two Jewel Cube speakers and a hide-away Acoustimass module
- An easy-to-use remote control
- Inputs for two video sound sources, an auxiliary source, and a tape deck
- Capability for operating two listening zones

Your Lifestyle® music system offers several ways to listen to superbly reproduced sound. You can use its built-in sound sources, connect additional equipment such as a tape deck, laserdisc player, VCR, or TV, and use two listening zones.

Please take the time to follow this owner's guide carefully. It will help you set up and operate your Lifestyle® music system, and enjoy all of its advanced features. Save your owner's guide for future reference.

CAUTION:

Remove and dispose of the three manufacturer's shipping screws from the bottom of the Lifestyle® music center before setting up your system.

The shipping screws are for use by the manufacturer only. They are not re-installable.

Unpack the carton

Carefully unpack your system. Save all packing materials for possible future use. The original packing materials provide the safest way to transport your Lifestyle® system. If any part of the product appears damaged, do not attempt to use the system. Notify Bose® or your authorized Bose dealer immediately.

Check to be sure your Lifestyle® 20 music system contains the parts identified in Figure 1.

Note: Find the serial numbers on the bottom panel of the Acoustimass® module and the bottom of the music center. Write them on your warranty card and in the spaces provided on page 3.

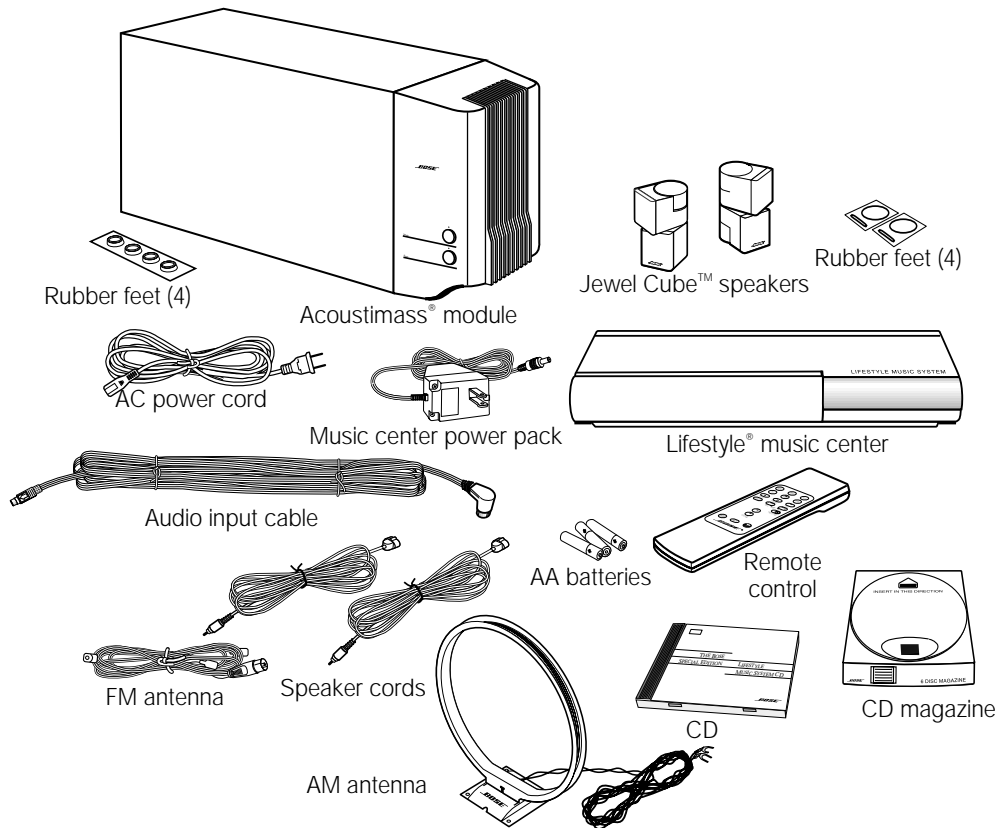



Figure 1

What comes with your Lifestyle® 20 system:

- Lifestyle® music center
- Music center power pack*
- 2 Jewel Cube speakers
- 2 speaker cords (20')
- Acoustimass module
- 8 self-adhesive rubber feet (4 for the module and 4 for the Jewel Cube speakers)
- AC power (mains) cord*
- Audio input cable (30')
- Remote control
- 3 AA batteries
- FM antenna
- AM antenna
- CD magazine
- CD

* Power cord and pack shown at left are USA/Canada/Japan versions.

Dual voltage systems include 1 power cord, 1 adapter , and 2 power packs.

The adapter and power cords and packs for Europe, UK/Singapore, and Australia are shown below.

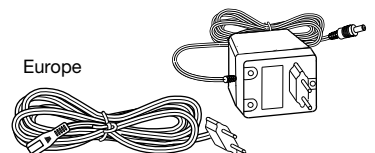

Europe

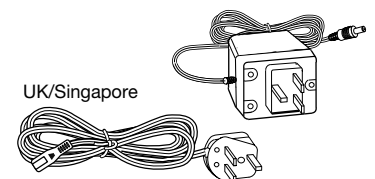

UK/Singapore

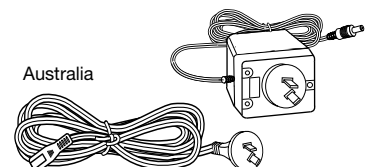

Australia

Select the locations for your Lifestyle® 20 music system

When you place your speakers according to the guidelines below, a combination of reflected and direct sound provides a good stereo image virtually everywhere in the room. You may experiment with the placement and orientation of the Jewel Cube™ speakers and Acoustimass® module to produce sound most pleasing to you.

To adjust your system for the characteristics of your listening room, see “Fine-tuning your system” on page 18.

Jewel Cube speakers

1. For the most lifelike sound, place the Jewel Cube speakers 6-12 feet (1.8-3.6 m) apart. They can be as close as 3 feet (1 m) or as far apart as 15 feet (4.6 m).
2. Place the Jewel Cube speakers 6-12 inches (15-30 cm) from the surface behind them.
3. Direct one cube of each speaker toward the center of the room (Figure 2). Direct the other cube toward a side wall to create reflected sound.

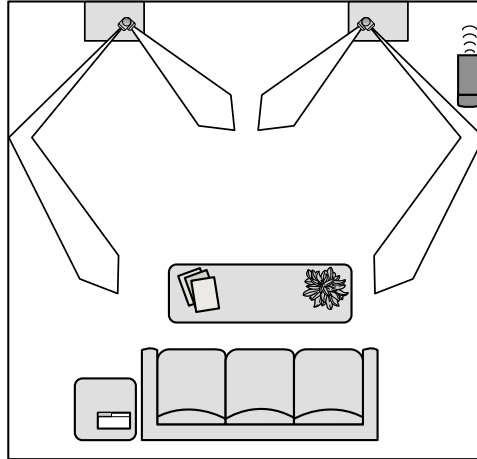

Note: The Jewel Cube speakers are magnetically shielded so you can place them close to a TV without affecting picture quality.

Acoustimass module

Follow these guidelines to select a location for the Acoustimass module.

1. Place the Acoustimass module along a side wall near the front of the room, if possible (Figure 2). You can place the module along the same wall as the speakers, if more convenient.
2. Aim the round opening (port) along the wall, 2 feet (.6 m) from a corner (Figure 2). Avoid blocking the port.
3. Select a convenient location – under a table, behind a sofa. Do not allow furniture or drapes to block the ventilation openings on the module.
4. Place the Acoustimass module within reach of the audio input cable, speaker cables, and an electric outlet.
5. For proper ventilation, place the Acoustimass module on its long side, with the connectors facing the floor (Figure 3). Or place it on its largest side, with the bass and treble controls facing up. Do not place the module on either end.
6. Once you have selected a position for the Acoustimass module, place the four self-adhesive rubber feet near the corners of the bottom surface. On a bare floor, the rubber feet provide increased stability and protection from scratches.
7. For best bass performance, do not place the module midway between any two walls.

Note: To avoid interference with the TV picture, keep the Acoustimass module at least 18 inches (45 cm) from any TV.

Music center

Select a location for the music center.

1. Place the music center on a level surface and allow enough room to lift the door.
2. Make sure it is close enough to any additional sound sources (TV, VCR, etc.) to allow for cable length.
3. Keep the music center within 30 feet (9.1 m) of the Acoustimass module (the length of the audio input cable).

Figure 2

Recommended speaker locations

CAUTION:

Choose a stable and level surface for your Jewel Cube speakers. Vibration can cause the speakers to move, particularly on very smooth surfaces. For stability, peel off the backing from the rubber feet and center them in the matching shapes on the bottom of each speaker.

Figure 3

Acoustimass module positions

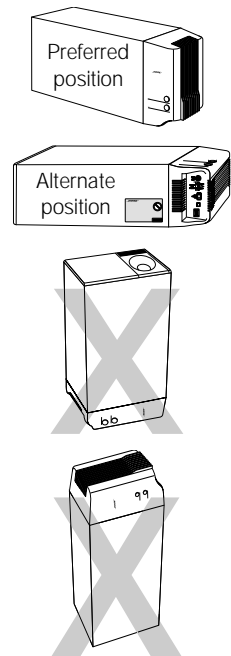

CAUTION:

Do not cover the ventilation openings of the Acoustimass module. The slots on the end provide ventilation for the built-in electronic circuitry, and should not be blocked.

Connect the speakers and Lifestyle® music center

Once you have selected locations for your speakers and music center, connect the system.

Connecting the Jewel Cube™ speakers to the Acoustimass® module

1. Insert the connector of each speaker cable fully into the jack on the rear of each speaker (Figure 4). Match the ridge of the connector to the notch at the top of the jack.
2. Connect each 20-foot (6.1 m) cable to the corresponding left or right green jack on the Acoustimass module. Speaker cables have green connectors at one end, with L (left) and R (right) molded into the connectors.

To lengthen the cable, connect speaker wire with male phono (RCA) plugs on each end to your supplied speaker cable. Use a female-to-female adapter (“barrel” connector). Or, splice in 18-gauge (.75 mm²) or thicker cord (connecting + to + and – to –). To purchase extension wire, see your dealer, electronics store, or call Bose® customer service.

Connecting the Acoustimass module to the Lifestyle® music center

Connect the Acoustimass module to the music center with the audio input cable (Figure 5).

1. Plug the small black multi-pin connector into the jack marked SPEAKER ZONE 1 on the back of the music center.
2. Insert the right-angle multi-pin connector on the other end of the audio input cable into the AUDIO INPUT jack on the Acoustimass module. Align the connector at the angle shown in Figure 5.

Note Be sure that each connector is inserted completely into each jack.

3. Extend the audio input cable as much as possible, since it includes an antenna for the remote control.

For information on connecting zone 2, see “Using two listening zones” on pages 19-20.

CAUTION:

Make sure all components of your system are unplugged from the AC power (mains) source before you begin connecting them.

Figure 4

Speaker cable connection to the Jewel Cube speaker

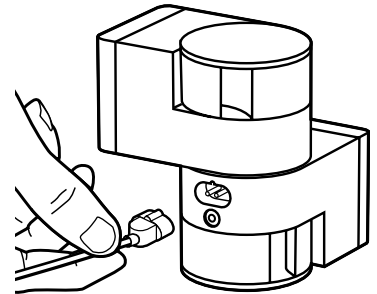
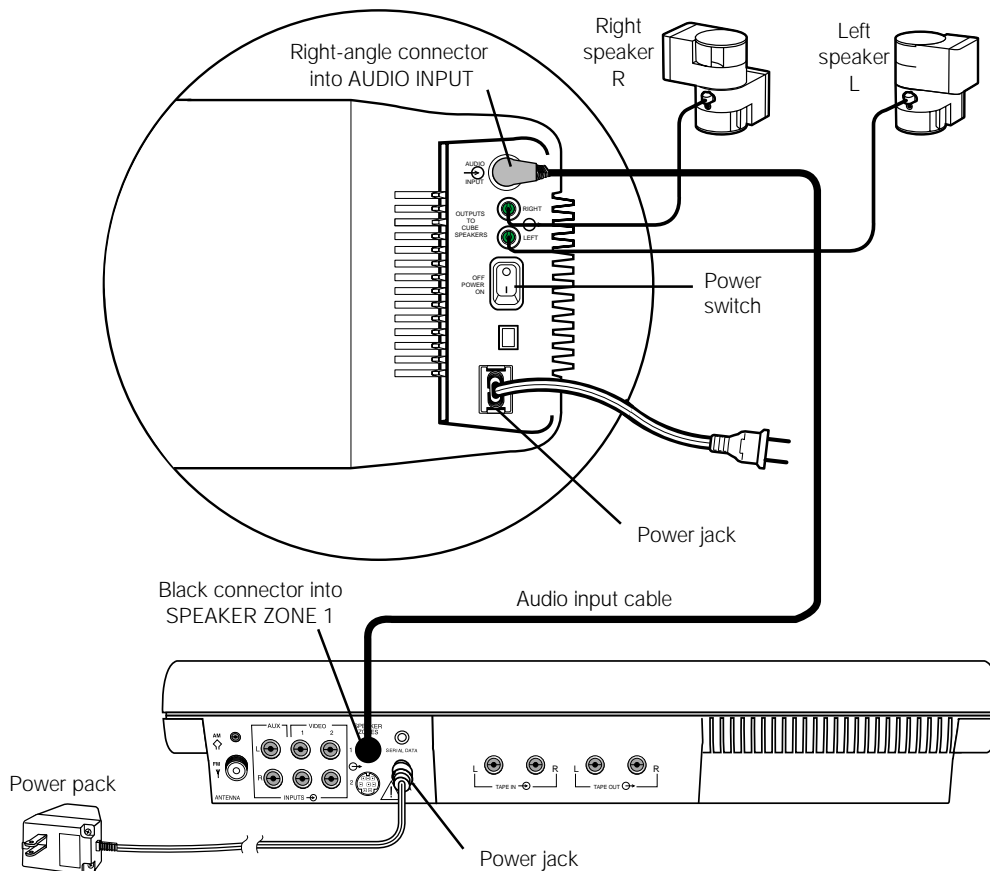

Figure 5

Connecting the speakers and the music center



Connecting the Acoustimass® module power cord

1. On a dual voltage Acoustimass module, the voltage selector switch is preset at the factory. Check to be sure it is set for the proper voltage (Figure 6). Use 115V for North America, and 230V for Europe and Australia. In Europe, use the adapter plug provided. If you are in doubt, contact your local electric utility for the appropriate voltage setting.
2. Plug the small end of the AC power (mains) cord into the module power jack.

Note: Do not plug the power cord into a power outlet until you complete all connections.

Connecting the music center power pack

The Lifestyle® music center comes with a 100V, 120V, 230V, or 240V power pack. See Figures 1 and 7. Dual voltage models include both the PS71 and PS72 power packs.

Use only the Bose® power pack model specified for your area:

- Model PS71, 120V in North America
- Model PS72, 230V in Europe
- Model PS73, 100V in Japan
- Model PS74, 230V in UK or Singapore
- Model PS77, 240V in Australia

1. Firmly insert the small connector on the end of the AC power (mains) pack cable into the AC POWER jack on the back of the Lifestyle® music center.
2. Make sure that the power pack reaches an AC power (mains) outlet.

Note: Do not plug the power pack into a power outlet until you complete all connections.

Other connections

Use standard audio cables to connect other components to your Lifestyle® music system, matching the red connector to R (right), white (or black) connector to L (left).

Video components

To play video sound through your Lifestyle® music system, connect the R and L fixed audio outputs of your stereo VCR, stereo TV, or laserdisc player to the music center VIDEO 1 or 2 jacks. See Figure 8. You can use a Y-adaptor (available at electronics stores) to connect a mono source. However, the left and right speakers then play the same monaural sound.

Tape deck

To use an external tape recorder (analog audio cassette, analog open reel, digital audio tape, Digital Compact Cassette, or MiniDisc), connect the inputs (REC) of the tape deck to the music center TAPE OUT jacks. Connect the outputs (PLAY) from the tape deck to the music center TAPE IN jacks. See Figure 8.

Additional CD player or changer

To use an external CD player or changer, connect the outputs from the component to the music center AUX INPUT jacks. See Figure 8.

Turntable

To connect a turntable, you need a phono preamplifier (with RIAA equalization). Consult your dealer for the appropriate model.

Note: The Lifestyle® 20 music system cannot turn a connected component on or off.

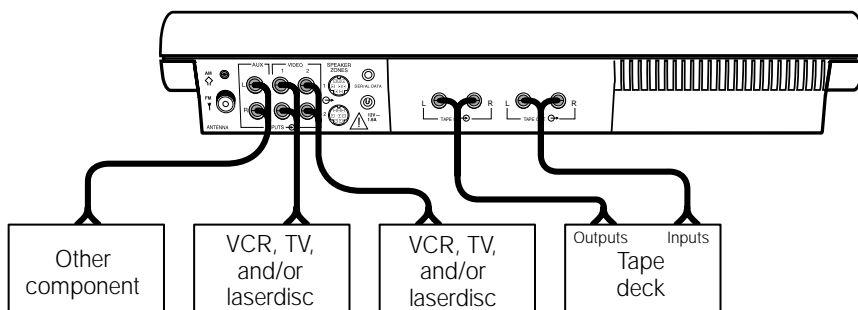
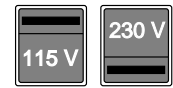

Figure 6

Dual voltage Acoustimass module: voltage selector switch settings



CAUTION:

Make sure the voltage selector switch is set correctly.

Figure 7

The AC power pack (model PS71 shown)

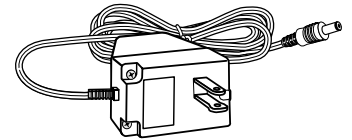

CAUTION:

Be sure to use the correct power pack for your area. Using the wrong one may damage your music center.

Figure 8

Connecting other components

Connect the antennas

The rear panel of your Lifestyle® music center provides connections for AM and FM antennas (Figure 9). Unwind each antenna. Antennas provide better reception when their wires are not bundled.

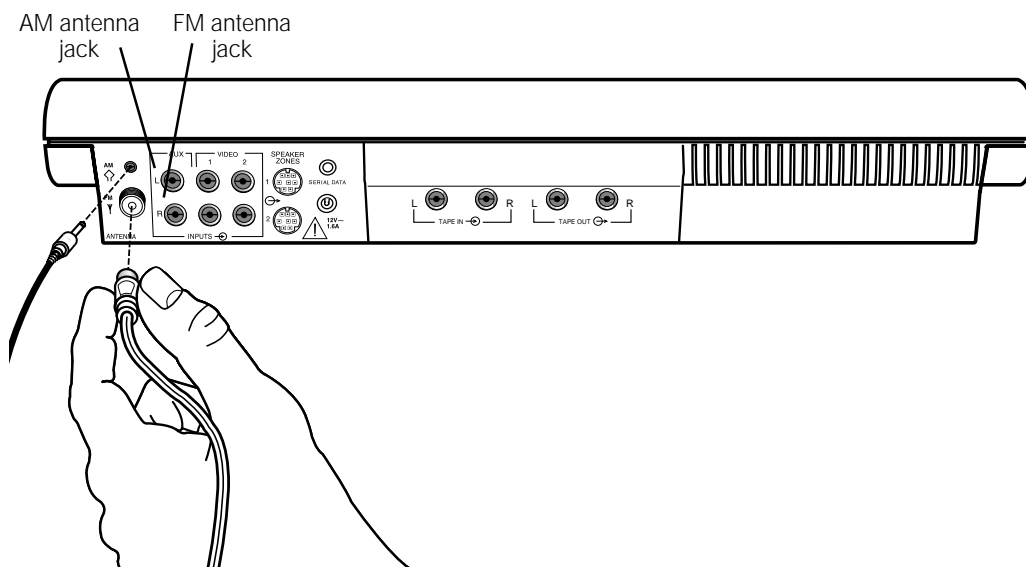

Figure 9

The antenna connections

FM antenna connections

1. Plug the FM antenna connector into the FM ANTENNA jack on the back of the Lifestyle® music center.
2. Spread out the antenna arms. Experiment with both the placement and the angle of this antenna to provide optimum FM reception.

Note: A central antenna or cable, or an outdoor FM antenna, may be used with the music center antenna connections. To install an outdoor antenna, consult a qualified installer. Follow all safety instructions.

AM antenna connections

1. Plug the AM antenna connector into the AM ANTENNA jack on the back of the Lifestyle® music center.
2. Move the antenna as far as possible from the music center and at least four feet (1.2 m) from the Acoustimass® module. This prevents interference with AM reception.
3. You may want to adjust the antenna location or orientation as needed to receive distant stations.

Figure 10

The FM antenna



Figure 11

The AM antenna

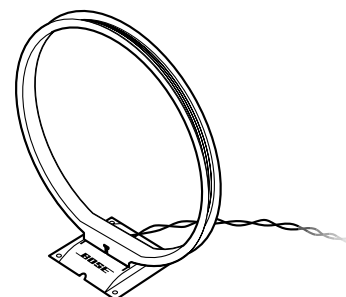

Set up the remote control

1. Slide open the battery compartment on the back of the remote (Figure 12).
2. Insert 3 AA or IEC-R6 1.5V batteries, or the equivalent, as shown. Match the + and – symbols on the batteries with the + and – markings inside the compartment.
3. Slide the battery compartment cover back into place.

Replace the batteries when the remote control stops operating or its range seems reduced. Alkaline batteries are recommended.

Note Do not change the settings of the factory-preset miniature switches. See “Changing the house code settings” on page 21 for information on how to prevent conflicts with other Lifestyle® music systems.

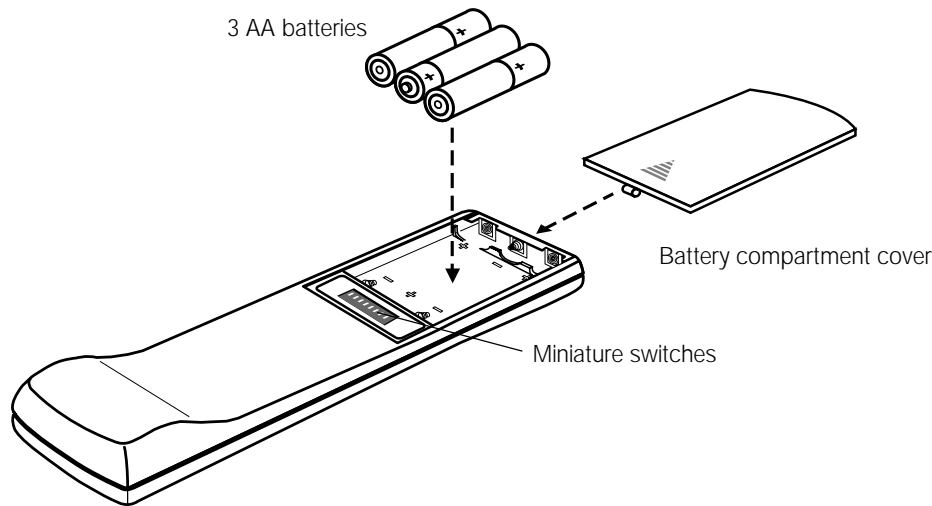

Figure 12

Installing the remote control batteries

Set radio channel spacing on dual voltage systems

Dual voltage music centers (which include both 120V and 230V power packs) can be set for two types of AM and FM channel spacing.

- 10 kHz for AM and 200 kHz for FM (common to North America)
- 9 kHz for AM and 50 kHz for FM (common to Europe)

Your dual voltage music center is preset for North American spacing. Select the channel spacing most appropriate for your area.

To change between North American and European channel spacing:

1. Turn the music center off.
2. Press and hold the ERASE key (on the music center control panel) for three seconds. The display flashes PROGRAM and indicates US for North American spacing or EURO for European spacing.
3. Press SOURCE SELECT (on the music center control panel) while holding the ERASE key. The display flashes PROGRAM and the setting changes from US to EURO . While holding ERASE, press SOURCE SELECT again to change from EURO to US .

Listening to your Lifestyle® 20 music system

Plug the Acoustimass® module power cord into an AC power (mains) outlet. Then plug in the music center power pack. Turn the power switch on the Acoustimass module connection panel to the ON (I) position. We recommend you leave this switch on. The module uses less than 2 watts of electricity in standby mode (less than an average night light).

You are ready to enjoy music from your new Lifestyle® music system.

Refer to the information below on the music center display, and to the following pages for information on the music center controls and the Lifestyle® remote control.

To open the music center, press up gently on the bottom of the door (Figure 13).

- To play compact discs, follow the instructions on pages 14 and 15.
- To listen to the radio, follow the instructions on page 16.
- To use other components with your Lifestyle® music system, see page 17.
- To use your system with two listening zones, see pages 19 and 20.

Turning the system on

- Press ON/OFF or any source key on the remote (CD, AM/FM, TAPE, VIDEO 1 or 2, AUX). Or, press ON/OFF or SOURCE SELECT on the music center.

Adjusting the volume

- Use the VOLUME ▲ (up) or ▼ (down) keys to raise or lower the volume.
- Use the MUTE key on the remote control to silence the speakers in the zone controlled by that remote. Press MUTE again to restore volume to the muted speakers.
- Use the MUTE ALL key on the remote control to silence speakers in both zones. Press MUTE ALL to restore volume to the muted speakers. Or, press MUTE, VOLUME ▲, PLAY, or a source key to resume sound in the selected zone.

Turning the system off

- Press the ON/OFF key on the remote or the music center.

The music center display

This music center display (Figure 14) provides information on the music center functions.

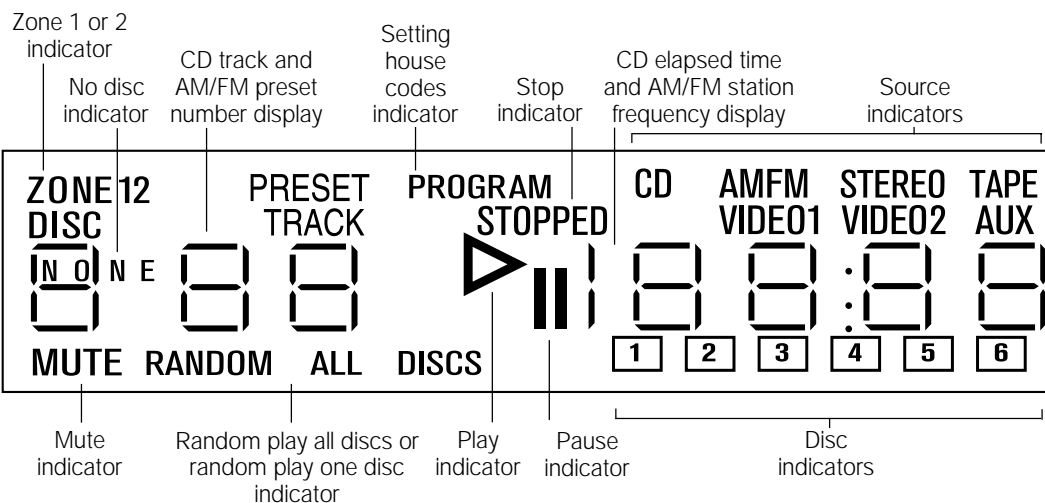

CAUTION:

Be sure to remove the three shipping screws on the bottom of the music center before turning on the system.

Figure 13

Opening the music center door

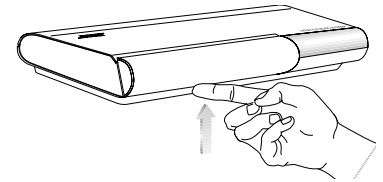





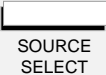

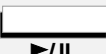



















Figure 14

The music center display

The system controls

Function	Remote control	Music center
VIDEO 1 - Selects a video sound source connected to the VIDEO 1 inputs, and turns the music system on.		
VIDEO 2 - Selects a video sound source connected to the VIDEO 2 inputs, and turns the music system on.		
AUX - Selects a component connected to the AUX inputs, and turns the music system on.		
CD - Selects the built-in CD changer and turns the music system on.		
AM/FM - Selects the radio and turns the system on to the previously selected station. When the radio is on, switches between AM and FM.		
TAPE - Selects a tape deck or component connected to the TAPE inputs, and turns the music system on.		
SOURCE SELECT - Turns the system on to the previously selected sound source. When on, changes the source in this sequence – CD, FM, AM, VIDEO 1, VIDEO 2, AUX, TAPE, CD. . .		
■ STOP - Stops the CD player. After 20 minutes, the music system shuts off.		
 PAUSE - Pauses play of the CD. After a 20-minute pause, changes to STOP.		
▶ PLAY - Begins play of the CD.		
RANDOM (or ◀◀ SKIP plus SKIP ▶▶) - In CD mode, begins random play of all tracks on all discs. Pressed again, begins random play of tracks on the current disc. Pressed again, cancels random play.		
◀◀ SKIP - Selects the previous CD track, or the previous preset radio station. Held down, initiates scan (CD) or seek (tuner) function.		
▶▶ SKIP - Selects the next CD track, or the next preset radio station. Held down, initiates scan (CD) or seek (tuner) function.		
NEXT DISC - Advances to play the next disc loaded in the CD magazine.		
VOLUME ▲ \ ▼ - Raises or lowers the system volume.	 	 
MUTE - Silences the speakers in the selected zone. Also restores volume to muted speakers in the selected zone.		
MUTE ALL - Silences all speakers currently playing. Also restores sound to speakers silenced by the MUTE ALL key.		
ON/OFF - Turns the system on and off.		

Note For information on controlling the music system from different listening zones, see "Using two listening zones" on pages 19-20.

Other music center controls

The music center function keys are described on the previous page. Use the following special music center keys to tune the radio, set station presets, and scan a CD (Figure 15).

TUNE ◀/▶ - Lowers or raises the frequency setting of the radio (stations). In CD mode, initiates a fast scan of the current CD.

STORE or **ERASE** - Adds or removes radio station presets. For instructions, see page 16. Also used for changing channel spacing (page 10) and house codes (page 21).

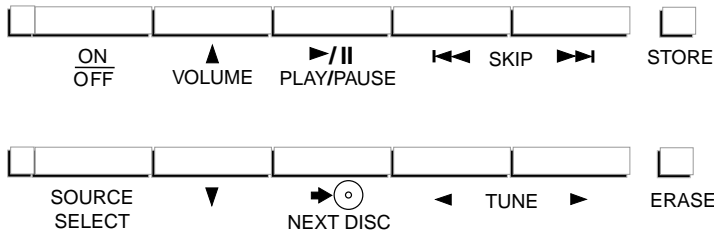

Figure 15

The music center controls

The Lifestyle® 20 remote control

For most types of home construction, your advanced radio-frequency remote control works from anywhere in your home. Its radio wave signals pass through walls and floors to reach the music center. To operate, simply press the desired key. You don't need to aim the remote at the music center.

Note Some types of buildings create "dead spots" where the remote will not operate. Simply move the remote a foot or two and try again. You can also move the music center a few feet to a location with better remote response.

Figure 16 shows the layout of the remote control keys.

Figure 16

The remote control keys

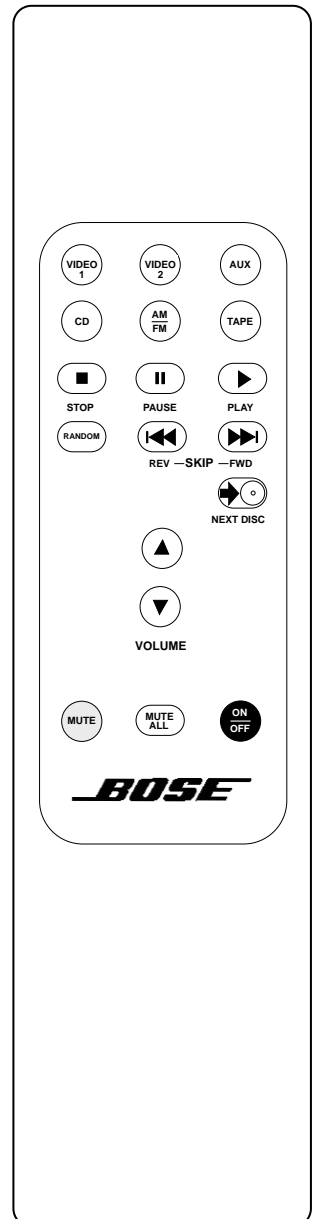

Listening to compact discs

Using the CD changer

You can load up to six compact discs at a time.

Loading discs into the CD magazine

Hold the magazine, looking at the side with the arrow. Insert up to six discs, label side up (Figure 17). Take care to place only one disc in each slot. Note the slot numbers 1 through 6, from bottom to top, on the front edge window. These numbers correspond to the CD numbers on the display.

Note: If a disc is upside-down, it does not play. The display shows the word "disc" and flashes the box representing that disc.

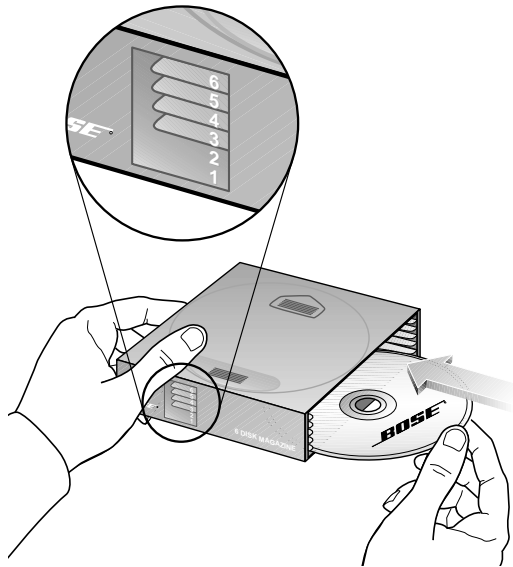

Figure 17

Loading a CD

CAUTION:

Do **not** insert more than one disc into any slot. Forcing two discs into one slot could cause them to become stuck, and could damage the discs, the CD magazine, or the music center.

Ejecting discs from the CD magazine

Press the white lever that corresponds to the disc you want to eject. This ejects the disc far enough for you to grasp the edge and remove it from the magazine (Figure 18).

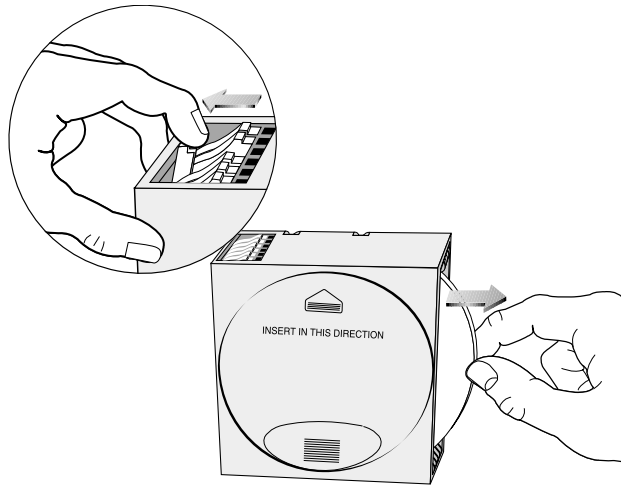

Figure 18

Ejecting a CD

Loading the CD magazine into the music center

Open the music center door. Insert the CD magazine fully into the music center, following the direction of the arrow on the magazine (Figure 19).

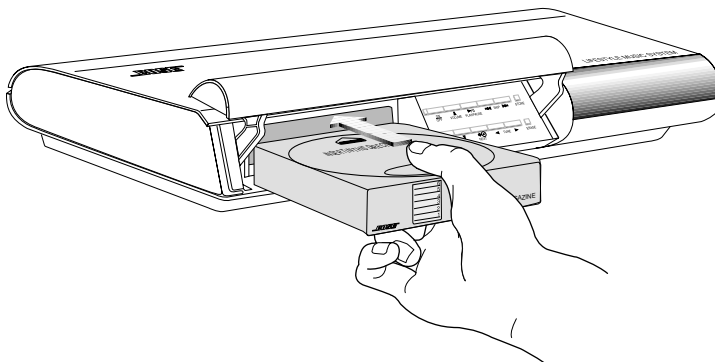

Figure 19

Loading the CD magazine

Ejecting the CD magazine from the music center

Press the EJECT button, at the lower left of the magazine slot, to remove the magazine (Figure 20).

If a CD is playing, pressing the EJECT button stops the CD, replaces it in the magazine, and ejects the magazine.

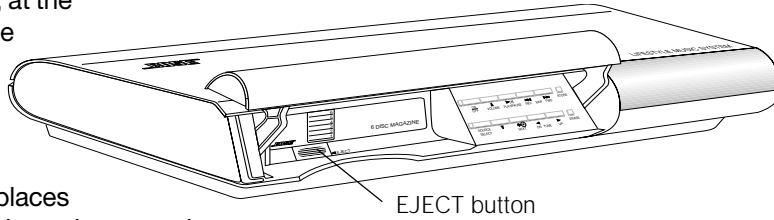

Figure 20

The CD magazine EJECT button

Turning the system on and choosing the CD player

Press the CD key on the remote or press SOURCE SELECT on the music center until CD is selected. If the music system is already on, use one of these keys to select the CD player. The CD indicator on the display lights. If a CD has been loaded, it begins to play.

CD operations

If you want to

- Play or resume play of a CD
- Pause a CD
- Stop a CD
- Go to next track
- Go to beginning of current track
- Go to previous track

Press

- ▶ PLAY, or ▶/|| PLAY/PAUSE
- || PAUSE, or ▶/|| PLAY/PAUSE
- STOP, or select another source
- SKIP ▶▶ (forward)
- SKIP ◀◀ (reverse) after 4 seconds of track play
- SKIP ◀◀ within the first four seconds of the track
- After four seconds, press SKIP ◀◀ twice to go to the previous track. In RANDOM mode, skips to previous track played.
- ▶⊙ NEXT DISC
- In PLAY mode, selects discs in order, 1 through 6, then back to 1; in RANDOM mode, randomly selects another disc. The music center skips empty disc slots.
- Press and hold SKIP ◀◀ or ▶▶, or TUNE ◀ or ▶
- RANDOM, or SKIP ◀◀ plus ▶▶ (on the music center)
- RANDOM, or SKIP ◀◀ plus ▶▶ (on the music center), a second time
- RANDOM, or SKIP ◀◀ plus ▶▶ (on the music center), a third time, press ■ STOP, or select another source

Play another disc

Scan a CD

Randomly play tracks on all discs

Randomly play tracks on one disc

Cancel random play

Note: To prevent excessive wear on the CD mechanism, unattended CD play or random play operations change to STOP after 24 hours. If you want to leave the music center playing unattended for longer than 24 hours, you can use the radio.

The music center display provides the following information about the CD changer functions (see sample display in Figure 21):

- Which CD is playing, paused, or stopped, or NONE if no disc is installed
- How much time the current CD has played
- Which track is playing
- If RANDOM ALL DISCS or RANDOM (one disc) is selected
- Which slots have been scanned and have discs loaded
 - Numbers in boxes represent discs in slots.
 - Empty boxes indicate disc slots that have not yet been scanned by the music center.
 - Blank spaces indicate empty slots (or discs that cannot be loaded).
 - A flashing box indicates the disc is upside down or cannot be read.

Figure 21

Display of CD playing in zone 1: Disc 3, track 8, 2 minutes and 45 seconds played, 6 CDs are loaded, and random play for all discs is selected



Listening to the radio

Turning the system on and choosing the radio

Press AM/FM (on the remote) or SOURCE SELECT (on the music center) to turn your system on to the most recently selected AM or FM station.

Note: If the system is on and the radio is already selected, the AM/FM key switches between AM and FM bands.

Tuning

Seeking the strongest stations

- Press and hold SKIP ►► (forward) or ◄◄ (reverse) to start seeking. Release the key to stop at the next strong signal.
- To stop seeking sooner, briefly press SKIP or ■ STOP.
- You can seek again without holding down the SKIP key. Right after the first seek operation stops, briefly press the SKIP ►► or ◄◄ key.

Note: If you hold a SKIP key down, the radio continues to seek without stopping at any station.

Switching between AM and FM

Press AM/FM to switch from one band to the other.

Manual tuning

To tune to a distant or weak station that the radio cannot seek, use TUNE ◀ or ▶ on the music center.

Setting a station preset

Your Lifestyle® music center can store up to 25 AM and 25 FM stations.

Note: To allow for different station preferences, you can reserve a group of preset numbers for each household member. Any station can be assigned to more than one preset number. Or, you can reserve different number groups for different types of stations. For easy reference, you may want to keep a written record of your presets.

1. Lift the music center door.
2. Select a radio station you want to store as a preset, either by tuning manually or by pressing and holding a SKIP key.
3. Press the STORE key. The lowest available preset number flashes for three seconds, then is set and displayed.
4. If you prefer a different preset number, while the number is flashing, press either SKIP key to select another available preset number. The preset number is displayed.

Note: You cannot store a station in an already-occupied preset location without erasing that preset station first (see "Erasing a preset station" below). If you attempt to store more than 25 AM or 25 FM stations, the preset display flashes "--."

Selecting a preset station

Once you have set station presets, press SKIP ►► or ◄◄ to select the next or the previous preset station. See Figure 22 for a sample display of a preset FM station.

Erasing a preset station

1. Lift the music center door.
2. Select the preset station you want to erase.
3. Press the ERASE key.

Figure 22

FM display showing a preset station

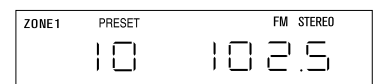

Using the system with external components

Follow the instructions on page 8 for connecting a component.

Turn on your component directly or by using its remote control. Use the VOLUME ▲ or ▼ key on the Lifestyle® remote control or music center to raise or lower the volume. Control all other functions at the source, referring to its owner's manual, if necessary. To begin, make sure the component is turned on and a tape, CD, laserdisc, etc. is loaded.

Note: The Lifestyle® 20 music system cannot turn a connected component on or off.

Turning the system on and selecting the component

Press the TAPE, AUX, VIDEO 1, or VIDEO 2 key on the remote or press SOURCE SELECT on the music center until the desired component is selected. This turns your music system on and selects the component connected to that input. If the music system is already on, this key selects the component.

The appropriate display indicator lights when the system is on and the component is selected.

Using a video sound source

Press VIDEO 1 or VIDEO 2 on the remote or SOURCE SELECT on the music center until VIDEO 1 or VIDEO 2 appears on the display. This turns your music system on and selects the video sound source connected to the VIDEO 1 or VIDEO 2 jacks. If the music system is already on, this key selects the component.

If your video component is connected to the music center AUX or TAPE jacks, press AUX or TAPE on the remote or use SOURCE SELECT on the music center to select the component.

Using a tape deck

To record to a connected tape deck, play the source (AM/FM, CD, AUX, VIDEO 1 or 2) you want to tape. In a 2-zone system, play the source in zone 1. Set the tape deck to record.

Using headphones

For headphone listening, use the stereo mini headphones jack on the right side of the music center (Figure 23). While this jack accepts most headphone models, you can get an adapter at Bose® dealers and most electronics stores, if needed.

Connecting headphones silences the speakers connected to SPEAKER ZONE 1.

CAUTION:

The magnetic field from the Acoustimass® module is not an immediate risk to your video tapes, audio tapes, and other magnetic media. However, you should not store tapes directly on or near the Acoustimass module.

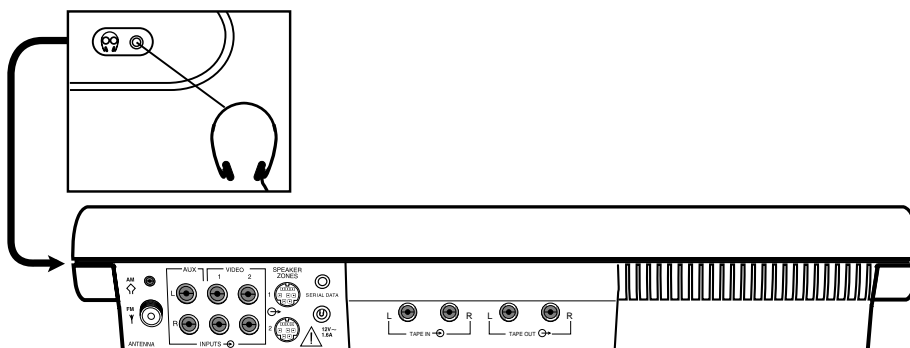

Figure 23

Connecting headphones

Fine-tuning your system

In most situations, following the speaker placement guidelines (see page 6) for your Lifestyle® 20 music system provides excellent sound quality.

You do not need to adjust tone settings for changes in volume, since Bose® patented signal processing technology provides a natural tonal balance over the full range of volume settings.

If desired, you can further fine-tune your system as described below.

Adjusting speaker controls

The Lifestyle® 20 music system TREBLE and BASS controls are located on the Acoustimass® module (Figure 24). They allow you to adjust the treble (high frequencies) and bass (low frequencies). In the normal setting, the dots on each control are in the 12 o'clock position. You can also locate the normal setting by feeling when the control settles into the notch at this position. Turn the controls clockwise to increase, and counterclockwise to decrease, the amount of treble or bass.

Compensating for room acoustics

The acoustics (sound qualities) of your room can affect the overall sound quality of any speaker system. In general, you can reduce many problems with acoustics by the cautious use of the TREBLE and BASS controls.

Too much or too little treble

Rooms with too few sound-absorbing furnishings, especially those with bare floors and walls, may sound overly shrill or "bright." Turning down the treble control (toward -) decreases treble sound.

Rooms with a lot of sound-absorbing furnishings, such as upholstered furniture, wall-to-wall carpet, or heavy drapes, may reduce the treble sound of your system. Moving speakers further away from soft furnishings increases treble. You can increase treble sound by slightly turning up the treble control (toward +).

Too much or too little bass

You can decrease bass sound by turning down the bass control (toward -). To increase bass, turn up the bass control (toward +).

Acoustimass module placement affects the amount of bass you hear. Placing the module closer to the corner of the room will increase bass. Moving the module away from the corner will decrease bass.

Figure 24

Bass and treble controls

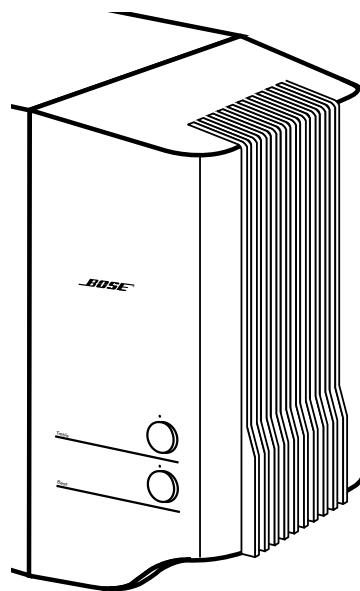

Using two listening zones

The Lifestyle® 20 music system can direct sound from one or two sound sources to two different listening areas at the same time. Each listening area, whether a room or a group of rooms (including outdoor areas), is referred to as a zone. By adding powered speakers and a second remote, you can establish two listening zones.

How zones work

- Zones 1 and 2 can play different sound sources at the same time – CD, AM/FM tuner, TAPE, VIDEO sound, or AUX.
- Both zones can listen to the same sound source at the same time.
- Only one radio station can be played at a time.

Setting up two zones

- The Lifestyle® 20 powered speakers are set up in zone 1.
- Any combination of rooms and floors in your home can be set up as zones.
- Use a Lifestyle® 20 system cable to connect a second Bose® powered speaker system to the SPEAKERS ZONE 2 jack on the back of the music center.
- You can also use special adapters to connect an existing stereo system.
- Use a second Lifestyle® system remote control to operate zone 2.

See your dealer or contact Bose for information on obtaining additional powered speakers, remote controls, and adapters for connecting additional equipment.

Setting a second remote for zone 2

You need a second remote control, set to ZONE 2, to operate speakers connected to the ZONE 2 output.

To set your second remote to control speakers in the second zone, follow these steps:

1. Open the remote control battery cover.
2. Locate miniature switch 8 (Figure 26). If it is set *down* for ZONE 1, slide it *up* for ZONE 2, using a paper clip, ballpoint pen, or similar object.
3. Make sure the house code switches (1, 2, 3, and 4) match those on your first remote. (See page 21 for more information on house codes.)
4. Replace the battery cover.

Figure 25

Example of two listening zones: the Lifestyle® 20 speakers in zone 1 (living room) and powered speaker system in zone 2 (bedroom)

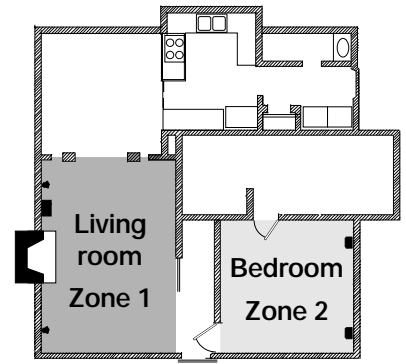
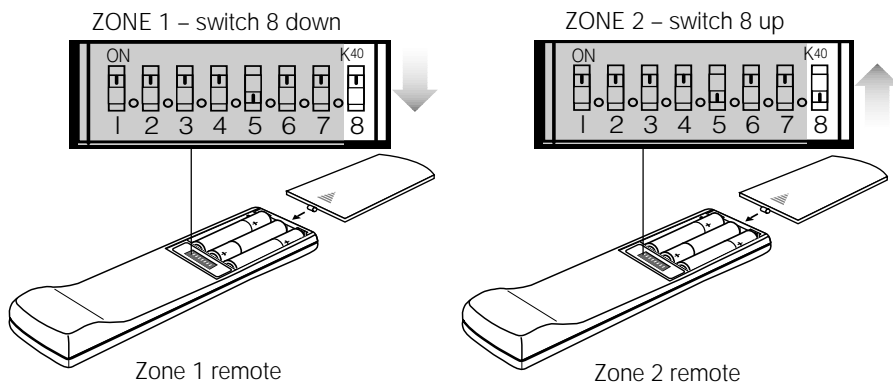

Figure 26

Speaker code switch settings



Operating two listening zones

Controlling the zones from the remote controls

To control two zones you need to have remotes set to each zone. See instructions on page 19 for setting a second remote to zone 2.

- You can select and control sources in each zone by commands from its remote control.
- You can control the volume in each zone directly from its remote control.
- You can turn each zone on and off directly from its remote control.
- You can listen to the same source in both zones.

Controlling the zones from the music center control panel

Turning two zones on and off from the music center involves a sequence of actions.

- To turn zone 2 on from the music center, press and hold the ON/OFF key. Watch the display to see which zone is on or off. Release the key to keep the option shown.

Holding the ON/OFF key causes this repeating sequence:

	zone 1	zone 2
First	ON	OFF
Second	ON	ON
Third	OFF	ON

- To turn the zones on or off from the music center when both zones are on, press the ON/OFF key for the following sequence:

	zone 1	zone 2
	ON	ON
First press	OFF	ON
Second press	OFF	OFF
Third press	ON	OFF
Fourth press	OFF	OFF
Additional presses	zone 1 repeats ON and OFF	

- When zone 1 is on (even if zone 2 is also on), the music center keys control zone 1 only.
- When zone 2 is the only zone on, the music center keys control zone 2.
- If you press SOURCE SELECT for FM or AM while zone 2 is playing the other radio band, the band selected in zone 2 flashes on the display. If you do not want to change the band playing in zone 2, use SOURCE SELECT to choose another source within two seconds.

The music center display of zone information

- When zone 1 or both zones are on, the display shows zone 1 information.
- When only zone 2 is on, the display shows zone 2 information.

Changing the house code settings

Each Lifestyle® remote control uses a system of matching house codes to communicate with its corresponding music center. If your remote's commands ever conflict with those of another nearby Lifestyle® system, you can easily set a new house code for your system and its remote control(s) by following the procedures below.

1. Open the remote control battery cover and locate the miniature switches (Figure 27).
2. To create a new code, change the position of any of switches 1, 2, 3, or 4 by moving them in the opposite direction from their current settings. Use a paper clip, ball point pen, or similar object.

Note: Do not change switches 5, 6, or 7 at this time. The manufacturer's standard setting is switch 5 up and switches 6 and 7 down.

3. Replace the battery cover.

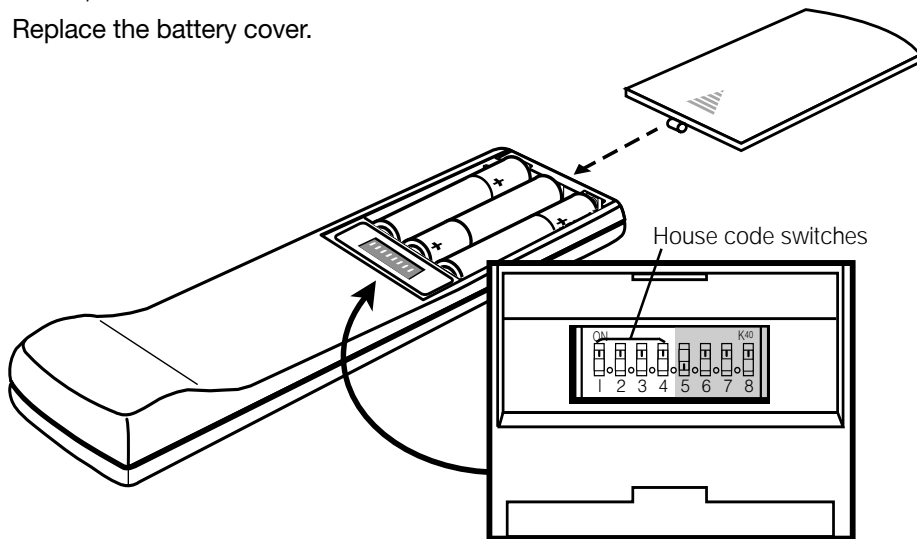

Figure 27

Miniature switches for setting house codes and zones

4. Lift the music center door.
5. Turn both zones off.
6. Press and hold the STORE key. The display will begin to flash PROGRAM.
7. While you hold the STORE key and the display is flashing, press any key on the remote control.
 - The display stops flashing and momentarily shows PROGRAM to confirm recognition of a new house code.
 - The display verifies the house code by lighting four rectangles corresponding to the four switch positions (up or down). See the example in Figure 28.
8. Release the STORE key. The system remains off.
9. If you have additional remote controls, change the switches to match those of the first remote control. It is not necessary to repeat steps 4-8.

Note: To verify your system's house code, press STORE while the system is off. The display confirms the settings of switches 1-4.

Figure 28

Display confirming an example of house code setting (switch 1 up, switches 2, 3, and 4 down)

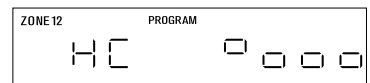

Troubleshooting

Problem	What to do
System does not function at all	<ul style="list-style-type: none"> • Make sure the power connector is plugged securely into the music center, the power cord is plugged securely into the Acoustimass® module, the power pack and power cord are plugged securely into operating AC wall outlets, and the module power switch is on. • Be sure to select a source (CD, AM/FM, etc.). • Unplug the music center power pack for a minute, then reconnect it. This allows the unit to reset itself after a power surge or power interruption. • If the system is not responding, press STORE, ERASE, and ON/OFF (on the music center) at the same time, to reset the system.
No sound	<ul style="list-style-type: none"> • Make sure the audio input cable is firmly seated in the music center SPEAKER ZONE 1 jack and the multi-pin connector on the other end is firmly seated in the Acoustimass module AUDIO INPUT jack. • Make sure the module power switch is in the ON position. • Check the cables connecting the Jewel Cube™ speakers to the Acoustimass module. • Turn the music center off for ten seconds, then on again, to restore communication between the music center and the speakers. • Check the connections for any external components. Make sure to select the correct source for the desired input. • Be sure the CD is placed correctly, label-side up, in the magazine, and the magazine is inserted properly in the music center. • Increase the volume. • Check to see if MUTE is lit on the display. If it is, press the MUTE button on the remote control to unmute the sound. • Disconnect any headphones. • Connect the FM and AM antennas.
Remote control is inconsistent or does not work	<ul style="list-style-type: none"> • Check batteries and their polarity (+ and -). See page 10. • Operate the remote control closer to the music center. • Move the remote (or the music center) a few feet to avoid an area of "dead spots." See note on page 13. • Make sure the remote control and music center house codes match. Follow steps 4-8 on page 21 to match the house code settings.
Unit turns on and off by itself, or behaves erratically	<ul style="list-style-type: none"> • Change the house code setting to prevent signals from conflicting with another nearby Lifestyle® system. See page 21 for instructions on setting the house code.
Radio does not work	<ul style="list-style-type: none"> • Make sure antennas are connected properly. • Adjust antenna position to improve reception. • AM antenna must be upright. • You may be in an area of weak signal coverage.

Problem	What to do
CD does not play	<ul style="list-style-type: none"> • Check to see if the play symbol ► in the display is lit. • After pressing the CD key, wait a few seconds before pressing PLAY. • Make sure the magazine is properly inserted. • Check to see if there is a disc in the magazine, label-side up. Display shows a flashing box for a disc that is label-side down or cannot be read. • The disc may be defective. Try another disc. • There may be dirt or dust on the CD. Clean the CD. • Eject the magazine and try loading the CD again. • A display message “E01” indicates a mechanical error. Unplug the music center. Reconnect power and try again. If “E01” reappears, call customer service.
FM sound is distorted	<ul style="list-style-type: none"> • Adjust antenna position to reduce interference.
Sound is distorted	<ul style="list-style-type: none"> • Make sure speaker cables are not damaged and the connections are secure. • Reduce the output level from any external components connected to the music center.
No tape, CD, VCR, or TV sound	<ul style="list-style-type: none"> • Check the connections. • Make sure the component is turned on. • Refer to the component owner’s manual.

Transporting your music center

To transport your music center, follow these steps to lock down the CD mechanism.

1. Eject the CD magazine.
2. Make sure the music center is off (all zones).
3. On the music center, press STORE, ERASE, and PLAY/PAUSE at the same time. Then release.
4. Press and hold the EJECT button for 10 seconds. The CD elevator moves into locked down position.
5. If you hear the elevator continue to move up and down, wait 10 seconds and then repeat steps 3 and 4.

The CD mechanism unlocks automatically the next time you select CD.

Warranty period

The Bose® Lifestyle® 20 music system is covered by a limited 1-year transferable warranty. Details of the warranty are provided on the warranty card that came with your system. Please fill out the information section on the card and mail it to Bose.

Customer service

For additional help in solving problems, contact Bose customer service. See the inside back cover for Bose Corporation customer service offices and phone numbers.

Taking care of your Lifestyle® 20 music system

The only maintenance needed is cleaning the system and your compact discs, and replacing remote control batteries.

For information on replacing the remote control batteries see “Set up the remote control” on page 10.

Handling CDs

Handle discs by their edges to prevent fingerprints and scratches (Figure 29).

To remove stains or fingerprints from the surface of a disc, use a lint-free, soft, dry cloth. Wipe in straight movements from the center of the disc to the outside (Figure 30). Do not use any chemical products; they can damage the disc.

Do not write on, or attach labels to the surface of the disc.

To minimize exposure to dust and dirt, replace discs in their cases after use. Store each disc in its case, out of direct sunlight, high temperatures, and humidity.

Cleaning the music center

Use only a soft, dry cloth to clean the outside of the Lifestyle® music center.

Do not use any solvents, chemicals, or cleaning solutions containing alcohol, ammonia, or abrasives. Do not allow liquids to spill into any openings. Do not use any sprays near the system.

Cleaning the speakers

Clean the surface of your speakers with a soft, damp cloth. You can use an ammonia-free window cleaner on a soft cloth to maintain the finish.

Do not use any sprays near the system. Do not use any solvents, chemicals, or cleaning solutions containing alcohol, ammonia, or abrasives. Do not allow liquids to spill into any openings.

The speaker grille panels require no special care, although you may vacuum them carefully, if necessary.

Figure 29

Handling a CD



Figure 30

Cleaning a CD

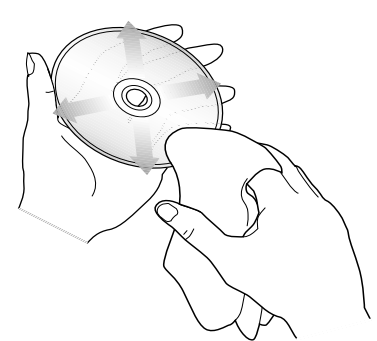

Technical information

Music center power pack power rating

USA/Canada: 120V~ 60 Hz 25VA

Europe: 230V~ 50 Hz 25VA

Australia: 240V~ 50 Hz 25VA

Dual voltage: 120V~ 60 Hz 25VA and
230V~ 50 Hz 25VA

Speaker system power rating

USA/Canada: 120V~ 50/60 Hz 350W

Europe/Australia: 220-240V~ 50/60 Hz 350W

Dual voltage: 115/230V~ 50/60 Hz 350W

Music center inputs

TAPE: 2Vrms, maximum

AUX, VIDEO SOUND: 2Vrms, maximum

FM antenna: 75Ω

AM antenna: 12μH

POWER: 12V~, 1.3A

Music center outputs

Variable audio: SPEAKER ZONES 1 and 2

Fixed audio: ZONE 1, ZONE 2, TAPE

Headphone: 32Ω minimum impedance

SERIAL DATA: for future use

Zone connector pinout:

1: variable left audio

2: variable right audio

3: fixed left audio

4: fixed right audio

5: audio ground

6: +10V control line

7: SMART SPEAKER data

8: control line ground (and remote antenna)

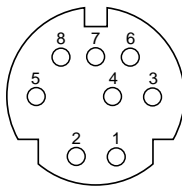

Remote control range

65 feet (20 m)

Dimensions

Music center

15.5" W x 8.0" D x 2.6" H
(39.4 cm x 20.3 cm x 6.6 cm)

Jewel Cube™ speaker

2.2" W x 3.2" D x 4.4" H
(5.6 cm x 8.1 cm x 11.2 cm)

Acoustimass® module

23.3" W x 7.5" D x 14.0" H
(59.0 cm x 19.0 cm x 35.5 cm)

Weights

Music center

5.9 lb (2.7 kg)

Jewel Cube speaker

1 lb (0.5 kg)

Acoustimass module

33 lb (15.0 kg)

Total shipping weight

52 lb (23.6 kg)

Finish

Music center

Aluminum

Jewel Cube speakers

Polymer, painted

Acoustimass module

Vinyl veneer, Polymer

Accessories

To find out about mounting brackets, stands, CD magazines, additional remote controls, and connecting additional Bose® powered loudspeakers, contact your Bose dealer. Or call Bose directly (see inside back cover for phone numbers).

A

accessories 25
Acoustimass® module 2-8, 11, 18, 22
adapter plug 8
AM antenna 5, 9, 22, 25
AM/FM 4, 11, 12, 16, 17, 22
antenna 5, 9, 22, 23, 25
audio input cable 5, 7, 22
AUX 12, 17, 19, 25
auxiliary 4

B

BASS control 18
batteries 5, 10, 22, 24

C

cable 2, 5-8, 22, 23
CD 5, 8, 9, 11-17, 19, 22-25
CD changer 4, 12, 14, 15
CD magazine 5, 14, 15
cleaning 24
compact disc 11, 14
connections 7-9, 22-24
controls 2, 6, 12, 13, 18, 21, 25
customer service 7, 23

D

display 10, 11, 14-17, 20-22
dual voltage 5, 7, 8, 10, 25

E

EJECT button 15
ERASE 10, 13, 16
error message 15, 22

F

FM antenna 5, 9, 25

H

headphones 17, 22
house codes 10, 21

J

Jewel Cube™ speakers 5, 6, 7, 22, 25

L

laserdisc player 4, 8, 17
listening zone 4, 7, 12, 16, 19, 20

M

magazine 5, 12, 14, 15, 22
music center 2-17, 12, 19-25
MUTE 11, 12, 22
MUTE ALL 11, 12

N

NEXT DISC 12, 15

O

ON/OFF 12, 20

P

PAUSE 12, 15
PHONES jack 17
placement 6, 18
PLAY 8, 11, 12, 14, 15, 22
port 6
power cord 5, 8, 11, 22
power pack 5, 8, 10, 11, 22, 25
preset radio station 11, 12, 13, 16

R

radio 2, 4, 11-13, 16, 22
radio channel spacing 10
radio station presets 13
RANDOM 12, 15
remote control 4, 5, 10, 12-17, 19-24, 25
room compensation controls 18
rubber feet 5, 6

S

safety information 2
serial number 3, 5
SKIP 12, 15, 16
SOURCE SELECT 12, 15-17
speaker cable 6, 7, 23
speaker placement 6, 18
station presets 13, 16
STOP 12, 15
STORE 13, 16, 21
switches 10, 19, 21

T

TAPE 8, 12, 17, 19, 25
tape deck 4, 8, 12, 17
TREBLE control 18
troubleshooting 22
TUNE 13, 15, 16
tuner 12, 19
tuning 16, 18
turntable 8
TV 4, 6, 8, 23

U

unpack 5

V

VCR 4, 8, 23
ventilation 6
VIDEO 12, 17, 19, 25
video sound 4, 8, 12, 17, 25
voltage 2, 5, 8, 10, 25
voltage selector switch 7
VOLUME 11, 12, 17
volume 11, 12, 17, 18, 22

W

warranty 3, 23

Z

zones 4, 7, 11, 12, 16, 17, 19-22, 25



USA

Bose Corporation, The Mountain
Framingham, MA 01701-9168
1-800-367-4008
Phone hours - ET (eastern time):
Weekdays 8:30 a.m. to 8 p.m.
Saturdays 9 a.m. to 3 p.m.

Canada

Bose Ltd., 1-35 East Beaver Creek Road
Richmond Hill, Ontario L4B 1B3
1-800-465-2673
Phone hours - ET (eastern time):
Weekdays 9 a.m. to 5 p.m.

European Office

Bose Products B.V., Nijverheidstraat 8
1135 GE Edam, Nederland
TEL 0299-390111 FAX 0299-390114

Australia

Bose Pty Limited, 1 Sorrell Street
Parramatta, NSW 2150
TEL 02 9204-6111 FAX 02 9204-6122

Belgique/België

Bose N.V., Limesweg 2, B-3700 Tongeren
TEL 012-390800 FAX 012-390840

Danmark

Bose A/S, Industrivej 7, 2605 Brøndby
TEL 4343-7777 FAX 4343-7818

Deutschland

Bose GmbH, Max-Planck-Straße 36d
D-61381 Friedrichsdorf
TEL 06172-71040 FAX 06172-710419

France

Bose S.A., 6, rue Saint Vincent
78100 Saint Germain en Laye
TEL 01-30616363 FAX 01-30614105

India

Bose Corporation India Private Limited
W-16, Greater Kailash-II
New Delhi 110 048
TEL (011) 648 4462 FAX (011) 648 4463

Ireland

Bose Corporation
Carrickmacross, Co Monaghan
TEL 042-961988 FAX 042-961998

Italia

Bose S.p.A., Via della Magliana 876
00148 Roma
www.bose.it
TEL 06-65670802 FAX 06-65680167

Japan

Bose K.K., Shibuya YT Building
28-3 Maruyama-cho
Shibuya-ku, Tokyo 150
TEL 3-5489-0955 FAX 3-5489-0592

Nederland

Bose B.V., Nijverheidstraat 8
1135 GE Edam
TEL 0299-390111 FAX 0299-390109

Norge

Bose A/S, Solheimsgate 11
N-2001, Lillestrøm
TEL 63-817380 FAX 63-810819

Österreich

Bose Ges.m.b.H., Vienna Business Park
Wienerbergstrasse 7 (10.OG)
A-1100 Vienna
TEL 01-60404340 FAX 01-604043423

Schweiz

Bose AG, Rünenbergerstrasse 13
4460-Gelterkinden
TEL 061-9815544 FAX 061-9815502

Sverige

Bose A/S, Johannefredsgatan 4
S-43153 Mölndal
TEL 31-878850 FAX 31-274891

United Kingdom

Bose Limited, 1 Ambley Green
Gillingham Business Park
Gillingham, Kent ME8 ONJ
TEL 0870-741-4500 FAX 0870-741-4545

From other locations

Bose Customer Service, 1 New York Ave.
Framingham, MA 01701-9168 USA
TEL (508) 766-1900 FAX (508) 766-1919

World Wide Web

www.bose.com



BOSE[®]
Better sound through research[®]

©2001 Bose Corporation
The Mountain, Framingham, MA 01701-9168 USA
178934 AM Rev.09 JN20413