

BOSE[®]



WAVE[®] MUSIC SYSTEM III

Owner's Guide

SAFETY INFORMATION

Please read this owner's guide

Please take the time to follow the instructions in this owner's guide carefully. It will help you set up and operate your system properly and enjoy its advanced features. Please save this owner's guide for future reference.

WARNING: To reduce the risk of fire or electrical shock, do not expose the product to rain or moisture.

WARNING: Do not expose this apparatus to dripping or splashing, and do not place objects filled with liquids, such as vases, on or near the apparatus. As with any electronic products, use care not to spill liquids into any part of the system. Liquids can cause a failure and/or a fire hazard.



CAUTION: To reduce the risk of electric shock, do not disassemble this product unless you are qualified. Refer servicing to qualified service personnel.

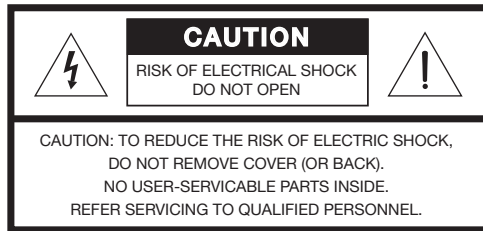

The lightning flash with arrowhead symbol within an equilateral triangle alerts the user to the presence of uninsulated dangerous voltage within the system enclosure that may be of sufficient magnitude to constitute a risk of electrical shock.



The exclamation point within an equilateral triangle, as marked on the system, is intended to alert the user to the presence of important operating and maintenance instructions in this owner's guide.

CAUTION: To prevent electric shock, match the wide blade of the line cord plug to the wide slot of the AC (mains) receptacle. Insert fully.

CAUTION: Use of controls or adjustments or performance of procedures other than those specified herein may result in hazardous radiation exposure from the internal laser component. The compact disc player should not be adjusted or repaired by anyone except properly qualified service personnel.

WARNING: Keep the remote control battery away from children. It may cause a fire or chemical burn if mishandled. Do not recharge, disassemble, heat above 100°C (212°F), or incinerate. Dispose of used batteries promptly. Replace only with a battery of the correct type and model number.

WARNING: Danger of explosion if battery is incorrectly replaced. Replace only with an agency-approved (e.g. UL) CR2032 or DL3032 3-volt lithium battery.



Please dispose of used batteries properly, following any local regulations. Do not incinerate.

WARNING: Do not place any naked flame sources, such as lighted candles, on or near the apparatus.

WARNING: Contains small parts which may be a choking hazard. Not suitable for children under age 3.



Note: The product label is located on the bottom of the product.

Note: The product must be used indoors. It is neither designed nor tested for use outdoors, in recreational vehicles, or on boats.

Note: Where the mains plug or appliance coupler is used as the disconnect device, such disconnect device shall remain readily operable.



This product conforms to all EU Directive requirements as applicable by law. The complete Declaration of Conformity can be found at www.Bose.com/compliance.

Class 1 laser product

This CD player is classified as a CLASS 1 LASER PRODUCT according to EN/IEC 60825. The CLASS 1 LASER PRODUCT label is located on the bottom of the unit.

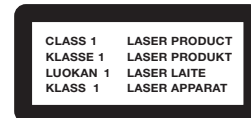

IMPORTANT SAFETY INSTRUCTIONS

- 1. Read these instructions** – for all components before using this product.
- 2. Keep these instructions** – for future reference.
- 3. Heed all warnings** – on the product and in the owner's guide.
- 4. Follow all instructions.**
- 5. Do not use this apparatus near water or moisture** – Do not use this product near a bathtub, washbowl, kitchen sink, laundry tub, in a wet basement, near a swimming pool, or anywhere else that water or moisture are present.
- 6. Clean only with a dry cloth** – and as directed by Bose Corporation. Unplug this product from the wall outlet before cleaning.
- 7. Do not block any ventilation openings. Install in accordance with the manufacturer's instructions** – To ensure reliable operation of the product and to protect it from overheating, put the product in a position and location that will not interfere with its proper ventilation. For example, do not place the product on a bed, sofa, or similar surface that may block the ventilation openings. Do not put it in a built-in system, such as a bookcase or a cabinet that may keep air from flowing through its ventilation openings.
- 8. Do not install near any heat sources, such as radiators, heat registers, stoves or other apparatus (including amplifiers) that produce heat.**
- 9. Do not defeat the safety purpose of the polarized or grounding-type plug. A polarized plug has two blades with one wider than the other. A grounding-type plug has two blades and a third grounding prong. The wider blade or third prong are provided for your safety. If the provided plug does not fit in your outlet, consult an electrician for replacement of the obsolete outlet.**
- 10. Protect the power cord from being walked on or pinched, particularly at plugs, convenience receptacles, and the point where they exit from the apparatus.**
- 11. Only use attachments/accessories specified by the manufacturer.**
- 12. Use only with the cart, stand, tripod, bracket or table specified by the manufacturer or sold with the apparatus. When a cart is used, use caution when moving the cart/apparatus combination to avoid injury from tip-over.**
- 13. Unplug this apparatus during lightning storms or when unused for long periods of time** – to prevent damage to this product.
- 14. Refer all servicing to qualified service personnel. Servicing is required when the apparatus has been damaged in any way: such as power-supply cord or plug is damaged; liquid has been spilled or objects have fallen into the apparatus; the apparatus has been exposed to rain or moisture, does not operate normally, or has been dropped** – Do not attempt to service this product yourself. Opening or removing covers may expose you to dangerous voltages or other hazards. Please call Bose to be referred to an authorized service center near you.
- 15. To prevent risk of fire or electric shock, avoid overloading wall outlets, extension cords, or integral convenience receptacles.**
- 16. Do not let objects or liquids enter the product** – as they may touch dangerous voltage points or short-out parts that could result in a fire or electric shock.
- 17. See product enclosure bottom for safety related markings.**
- 18. Use Proper Power Sources** – Plug the product into a proper power source, as described in the operating instructions or as marked on the product.
- 19. Avoid Power Lines** – Use extreme care when installing an outside antenna system to keep from touching power lines or circuits, as contact with them may be fatal. Do not install external antennas near overhead power lines or other electric light or power circuits, nor where an antenna can fall into such circuits or power lines.
- 20. Ground All Outdoor Antennas** – If an external antenna or cable system is connected to this product, be sure the antenna or cable system is grounded. This will provide some protection against voltage surges and built-up static charges. Section 810 of the National Electrical Code ANSI/NFPA No. 70 provides information with respect to proper grounding of the mast and supporting structure, grounding of the lead-in wire to an antenna discharge unit, size of grounding conductors, location of antenna-discharge unit, connection to grounding electrodes, and requirements for the ground electrode. Refer to the antenna grounding illustration on the next page.



Information about products that generate electrical noise

If applicable, this equipment has been tested and found to comply with the limits for a Class B digital device, pursuant to Part 15 of the FCC rules. These limits are designed to provide reasonable protection against harmful interference in a residential installation. This equipment generates, uses, and can radiate radio frequency energy and, if not installed and used in accordance with the instructions, may cause harmful interference to radio communications. However, this is no guarantee that interference will not occur in a particular installation. If this equipment does cause harmful interference to radio or television reception, which can be determined by turning the equipment off and on, you are encouraged to try to correct the interference by one or more of the following measures:

- Reorient or relocate the receiving antenna.
- Increase the separation between the equipment and receiver.
- Connect the equipment to an outlet on a different circuit than the one to which the receiver is connected.
- Consult the dealer or an experienced radio/TV technician for help.

Note: Unauthorized modification of the receiver or radio remote control could void the user's authority to operate this equipment.

This product complies with the Canadian ICES-003 Class B specifications.

Antenna grounding

Example of antenna grounding as per National Electrical Code, ANSI/NFPA 70.

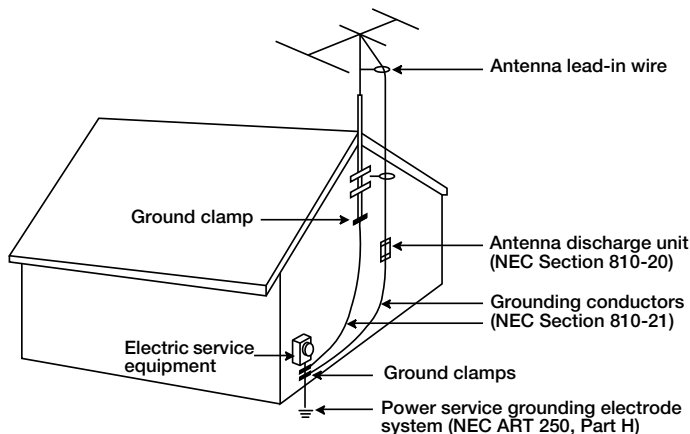

Product data logger

The Wave® music system III features a product data logger that is designed to help Bose better understand product usage and performance over time. The product data logger records certain technical data and usage history, including but not limited to volume levels, on/off data, user settings, source inputs, power output, and setup data. We may use this data to provide you with better service and support on your Wave® music system III and to improve product design in the future. Special equipment is required to read the data stored by the product data logger and such data can only be retrieved by Bose if your Wave® music system III is returned to Bose for service or as returned merchandise. The product data logger does not collect any personally identifiable information about you and does not record title, genre or other information about the media content you access while using your Wave® music system III.

For your records

Record the serial number of your new Wave® music system III in the space below. The serial number can be found on the bottom panel.

Serial number _____

Purchase date _____

We suggest you keep your receipt with this owner's guide.

©1994-2012 Bose Corporation. No part of this work may be reproduced, modified, distributed or otherwise used without prior written permission. All trademarks referenced herein are property of Bose Corporation. The distinctive design of the Wave music system is a registered trademark of Bose Corporation in the U.S. and other countries.

MPEG Layer-3 audio coding technology licensed from Fraunhofer IIS and Thompson.

SETTING UP YOUR WAVE® MUSIC SYSTEM III ...	6	CONNECTING OTHER EQUIPMENT	15
Unpacking	6	Rear panel input/outputs	15
Selecting a location	6	Using headphones	15
Connecting to power	6	Using the AUX IN connector	15
Setting the clock	6	Using an external antenna	16
Introduction	7	Connecting to a Lifestyle® system	16
The demonstration CD	7	PERSONALIZING YOUR	
The benefits of research	7	WAVE® MUSIC SYSTEM III	17
Special Features	7	The setup menu	17
OPERATING YOUR WAVE® MUSIC SYSTEM III	8	Adjusting the snooze time	18
Remote control	8	Turning RDS on or off	18
Touch pad	8	Selecting the continuous play source	18
Reading the display	9	Changing the time format	18
Turning the Wave® music system III on and off	9	Adjusting the display brightness	19
Controlling the volume	9	Setting the room code	19
Setting the Sleep timer	9	Turning the touch pad on or off	19
LISTENING TO RADIO	10	Changing the system standby timeout	19
Selecting the radio band	10	Performing a system reset	20
Listening to FM/AM radio	10	MAINTAINING YOUR	
Tuning to an FM/AM station	10	WAVE® MUSIC SYSTEM III	21
Storing FM/AM radio station presets	10	Troubleshooting	21
TALK RADIO mode	10	Replacing the remote control battery	22
PLAYING COMPACT DISCS	11	Cleaning	22
Playing audio compact discs (CDs)	11	Customer service	22
CD Play Modes	11	Limited warranty	22
Playing music file (MP3) CDs	11	Technical information	22
Navigating through music files	12	INDEX	23
Play modes for music file CDs	12	CONTACT INFORMATION	25
SETTING AND USING THE ALARMS	13		
Introduction	13		
Using the Alarm buttons	13		
Alarm status indicators	13		
Setting the alarms	13		
Using the alarms	14		
Turning an alarm on or off	14		
Snoozing an alarm	14		
Stopping a sounding alarm	14		

SETTING UP YOUR WAVE® MUSIC SYSTEM III

Unpacking

Please check the shipping carton for the following items:

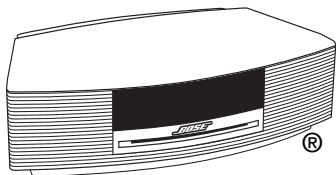

Wave® music system III



Remote control
(battery installed)

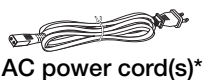

AC power cord(s)*



Demonstration CD

*The appropriate power cord(s) for your region is supplied.

Selecting a location

- Place your Wave® music system III on a table or other flat surface.
- To enjoy maximum audio performance, place your Wave® music system III across the room from where you will be listening.
- For best audio performance, place your Wave® music system III within two feet of a wall, and avoid placing directly in a corner.

Notes:

- Do not place your Wave® music system III on a metal surface. It could interfere with AM reception.
- Do not place your Wave® music system III on a heat-sensitive surface. Like all electrical equipment, it generates some heat.
- Do not use your Wave® music system III in a damp location or any other place where moisture can get inside.

Connecting to power

1. Insert the small end of the power cord into the connector labeled **AC POWER** on the rear panel of your Wave® music system III.
2. Plug the power cord into an electrical outlet.

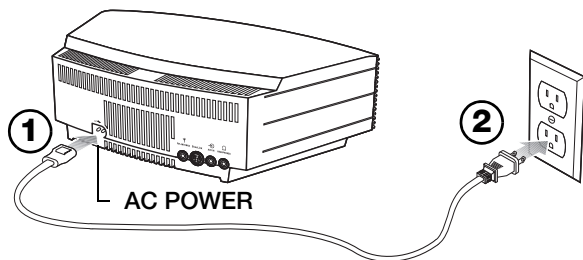

3. Unwind and straighten the power cord to ensure the best FM radio reception. The power cord is used as an antenna.

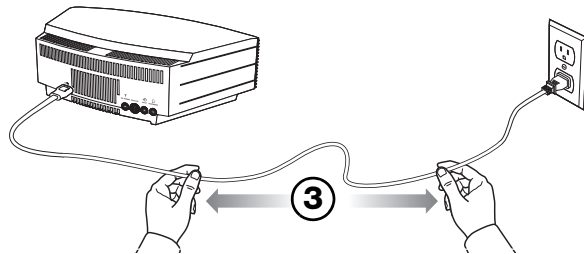

Setting the clock

After plugging in your Wave® music system III, set the clock using the remote. Your Wave® music system III is easily operated using the remote control. Just aim the remote at the front panel and press the necessary buttons.

1. Press and hold down either **Time** button for about 1 sec.



Note: Press-and-hold operations require holding the button down for about one second.



Initially, **HOLD TO SET** appears on the display and then quickly changes to **- CLOCK SET -** as the button is depressed.

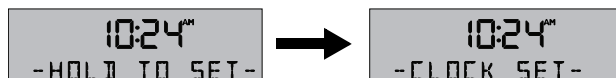

2. Release the selected **Time** button.
3. Press **Time -** to adjust the displayed time backward or press **Time +** to adjust the displayed time forward until it matches the current time. You can also press and hold for rapid adjustment.
4. Wait five seconds for the system to exit the clock setup mode automatically.

Notes:

- To change the clock display from 12-hour (AM/PM) time to 24-hour time, see "Changing the time format" on page 18.
- If the Wave® music system III loses power due to a power outage or unplugging the unit to move it, all system settings will be permanently retained. However, the clock time will only be temporarily stored in backup memory for up to 48 hours.

Introduction

Thank you for purchasing the Bose® Wave® music system III, an elegant way to bring high quality sound into any room.

The demonstration CD

We encourage you to begin by listening to the demonstration CD provided. Simply insert the demonstration disc and your Wave® music system III will play the CD automatically. For more details on playing CDs see “Playing audio compact discs (CDs)” on page 11.

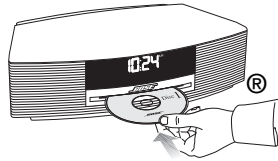

The benefits of research

Over fourteen years of research by Bose Corporation brings you the benefits of award-winning patented acoustic waveguide speaker technology. Using this technology, a tube efficiently transfers energy from a small speaker to the outside air over a wide range of low frequencies. And, long waveguides, folded into intricate patterns, fit into products small enough to be placed comfortably in your home. Your Wave® music system III features dual tapered waveguide speaker technology, connecting two speakers to two 26" tapered waveguides which combine to produce unprecedented instrument timbre from a system this size.

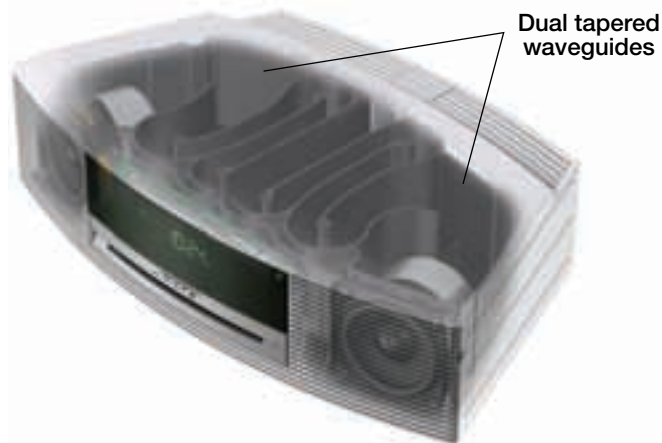

Special Features

Alarm settings let you wake to your favorite radio station or CD track



You can set your Wave® music system III to wake to your favorite radio station or CD track. For more details, see “Setting the alarms” on page 13.

You can listen to your favorite music file (MP3) CDs



Your Wave® music system III can play MP3 music files recorded on CD-R and CD-RW discs. You can use the remote control to easily navigate through your MP3 files and play your favorites. For details, see “Playing music file (MP3) CDs” on page 11.

The setup menu allows you to personalize system operation



System settings were selected at the factory to satisfy most owners of the Wave® music system III. If you wish to change the settings, see “Personalizing Your Wave® Music System III” on page 17.

The setup menu allows you to change the following system settings to your liking:

- Snooze time
- RDS information on or off
- Play a radio station automatically after a CD ends
- Clock time format (12- or 24-hour)
- Display brightness level
- Bose® link room code
- Touch pad on or off
- Disable the automatic off feature
- Reset to factory settings

OPERATING YOUR WAVE® MUSIC SYSTEM III

Remote control

Your Wave® music system III is easily operated using the remote control. Just aim the remote at the display and press the buttons. The remote normally works within 20 feet of the display.

Notes:

- Press-and-hold operations require holding the button down for about one second.
- Pressing **RADIO**, **CD**, or **AUX** automatically turns on the Wave® music system III to the source selected.

Radio

- Turns on the radio.
- Selects FM or AM radio (page 10).

Power On/Off (Stop Alarm)

- Turns the power on or off (page 9).
- Stops a sounding alarm (page 14).

Mute

- Press to silence audio (page 9).
- Press again to restore audio.

Volume

- Turns volume up or down (page 9).

Seek/Track

- Press: Finds the next radio station with a strong signal (page 10), or skips to next/previous CD track (page 11).
- Press and hold: Rapidly moves forward/backward through radio frequencies with a strong signal (page 10), or rapidly skips to next/previous CD tracks (page 11).

Tune/MP3

- Press: Skips to next/previous radio frequency (page 10), or navigates between folders when playing MP3 CDs (page 11).
- Press and hold: Rapidly moves forward/backward through radio frequencies (page 10), or scans forward/backward through a CD track (page 11).

Play Mode

- Selects shuffle and repeat CD play modes (page 11).
- Turns TALK RADIO mode on or off for AM or FM (page 10).

CD

- Turns on the CD player (page 11).

Sleep (Buzzer)

- Snoozes a sounding alarm (page 14).
- Sets unit to shut off automatically after 10-90 minutes (page 9).
- Selects Buzzer in Alarm Setup (page 13).

AUX

- Press to hear audio from an external source connected to the system (page 15).

Presets

- Press: Recalls a stored radio station (page 10).
- Press and hold: Stores a radio station for quick recall (page 10).

Play/Pause

- Plays a CD (page 11).
- Pauses a playing CD (page 11).

Stop/Eject

- Press once: Stops a CD (page 11).
- Press again: Ejects a CD (page 11).

Time

- Sets clock time (page 6).
- When setting alarms, sets the alarm time (page 13).

Alarms

- Sets and controls Alarms (page 13).

Alarm Setup (Menu)

- Press and hold: Enters the system setup menu (page 17).



Alarm 1

- Turns Alarm 1 on or off

Alarm 2

- Turns Alarm 2 on or off

Touch pad

Your Wave® music system III has a touch-sensitive control under the top, front, center area of the enclosure.

Momentarily placing your hand on the touch pad can turn your Wave® music system III on or off (page 9), snooze a sounding alarm, and reset it for the next day (page 14).

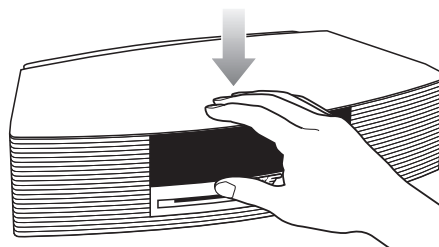

Reading the display

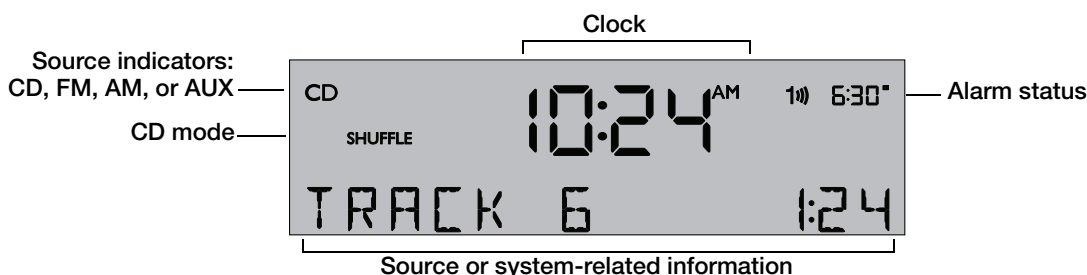

Turning the Wave® music system III on and off

To turn the system on or off (standby):

- Press the remote power button , or
- Touch the touch pad.

The last source you were listening to will be active.

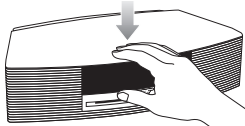

Alternatively:

Press any source button to turn the Wave® music system III on to that source.



Note: Pressing **AUX** does not turn on a device connected to AUX IN (such as your TV). Be sure to turn the device on first.

Note: After 24 hours of no button presses the system automatically switches to standby (off). If the 30-minute system standby timer (page 19) is enabled, the system automatically switches to standby if no audio is played and no buttons are pressed for 30 minutes.

Controlling the volume



Press and hold **Volume ▲** or **Volume ▼** to adjust the volume level. **VOLUME - 0** (silent) to **99** (loud) appears on the display to indicate the level.



Press **Mute** to silence the Wave® music system III. Press **Mute** again, or press **Volume ▲** to unmute.

To lower the volume before unmuting, press **Volume ▼** while muted.

Note: When the Wave® music system III is off, the volume can only be adjusted between 10 and 75.

Setting the Sleep timer



Press **Sleep** to set the Wave® music system III to shut off automatically after a selected period of time.

- After pressing **Sleep, SLEEP - 30 MIN** (or your last setting) appears on the display and the sleep timer begins counting down. If your Wave® music system III is off, press **Sleep** to turn it on and immediately set the sleep time. The last source selected will start playing as the sleep timer counts down.
- While the **SLEEP** setting is displayed, press **Sleep** again to set the sleep timer to 10-90 minutes (in 10-minute increments) or OFF.

Note: If more than 10 seconds elapses between button presses, the Wave® music system III automatically exits the sleep timer setup mode.

- To review the remaining sleep time, press **Sleep**.
- To cancel the sleep timer, press **On/Off**.

LISTENING TO RADIO

Selecting the radio band



Press **Radio** to turn on the radio to the station last selected. Press **Radio** as necessary to select FM or AM.

Listening to FM/AM radio

When you select FM radio, RDS information for the current station is displayed. This is controlled by the RADIO TEXT setting in the setup menu (page 18). To disable RDS and view only the station frequency, change the RADIO TEXT setting to OFF.

RDS information displayed (RADIO TEXT- ON):



RDS information

No RDS information displayed (RADIO TEXT- OFF):



Station frequency

Tuning to an FM/AM station

When you press **Radio**, **Seek/Track**, or **Tune/MP3** to tune to a radio station, the frequency appears in the center of the display while you are tuning.

Station frequency while tuning



- Press **Seek/Track** **◀◀** to find a lower frequency station with a strong signal; Press **Seek/Track** **▶▶** to find a higher frequency station with a strong signal.



- Press **Tune/MP3** **<** to manually tune to a lower frequency; press **Tune/MP3** **>** to manually tune to a higher frequency.



- Press and hold **Tune/MP3** **<** to rapidly lower the frequency; press and hold **Tune/MP3** **>** to rapidly increase the frequency.

Note: If AM reception is weak, rotate your Wave® music system **III** clockwise or counterclockwise to improve AM reception. If FM reception is weak, make sure the power cord is straightened as much as possible. To improve FM reception, you can install an external FM antenna. See "Using an external antenna" on page 16.

Storing FM/AM radio station presets

You can store up to six FM and six AM radio stations for quick recall using the **Presets** buttons.

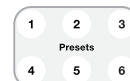

1. Tune to the station you want to save as a preset.
2. Press and hold one of the six **Presets** buttons until you hear a double beep and the preset number and station frequency appear on the display.
3. Press one of the **Presets** buttons to quickly tune to a previously stored FM or AM station.

Note: Storing a preset will replace any station previously stored to that preset number.

TALK RADIO mode

Talk radio broadcasts can be greatly affected by either the microphone selection or the boosting of low frequencies by some radio stations. They do so in an attempt to improve speech when heard through conventional radios. In high-quality audio products, this results in sound that is unnatural or bass heavy. By selecting the TALK RADIO mode, your Wave® music system **III** automatically adjusts to compensate for artificially boosted low frequencies.



When the radio is playing, press **Play Mode** twice to turn the TALK RADIO mode on or off.

When on, **TALK RADIO- ON** is displayed. When off, **TALK RADIO- OFF** is displayed.

Note: The TALK RADIO setting is automatically cancelled when you tune to another station, switch to another source, or turn your Wave® music system **III** off.

Playing audio compact discs (CDs)

Insert the disc, label side up, into the CD slot below the display. The disc player will automatically pull the disc in and begin playing.

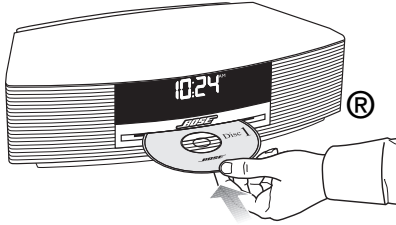

Press **CD** if the CD source is not selected.



- When an audio CD is playing, CD source information is displayed:

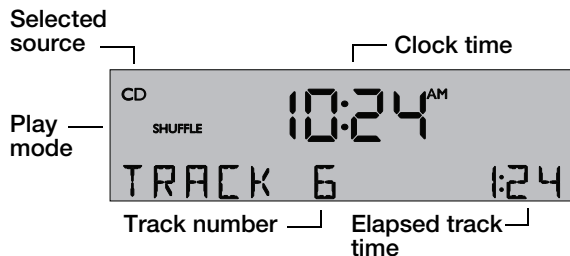

- Press **Play/Pause** to pause a playing CD. The elapsed time flashes while paused. Press **Play/Pause** again to resume play.
- Press **Seek/Track** **⏮** to skip to the beginning of the current track; Press **Seek/Track** **⏮** again to skip to the beginning of the previous track.
- Press **Seek/Track** **⏭** to skip to the next track.
- Press and hold **Tune/MP3** **<** to scan backward quickly through a track; press **Tune/MP3** **>** to scan forward quickly through a track.
- Press **Stop/Eject** to stop a CD. Press **Stop/Eject** again to eject a CD. If a CD is playing, press and hold **Stop/Eject** to stop a CD and eject it.

Play / Pause



Seek / Track



Tune / MP3



Stop / Eject



Note: When you play a stopped CD it will always resume from the place it was stopped.

Note: If you eject a CD but do not remove it from the CD player slot within 10 seconds, the CD player will pull the CD back into the player, reload it, and start playing.

CAUTION: DO NOT INSERT mini CDs or non-circular CDs into the disc player. These discs may not play properly and could interfere with the system's ability to eject them.

CD Play Modes

While a CD is playing, you can change the way it is played. Press **Play Mode** repeatedly until the play mode you want is displayed:

- **NORMAL PLAY** – Plays tracks once in sequential order.
- **SHUFFLE DISC** – Plays all tracks once in random order.
- **SHUFFLE RPT** – Repeats all tracks in a random order that changes each time the disc is repeated.
- **REPEAT DISC** – Repeats the disc from the beginning after the last track is played.
- **REPEAT TRACK** – Repeats the selected track continuously.

Note: The play mode will return to **NORMAL PLAY** whenever a CD is inserted.

Playing music file (MP3) CDs

Your Wave® music system III can play MP3 music files recorded on CD-R and CD-RW discs. You can easily navigate through your music files using the **Tune/MP3** and **Seek/Track** remote control buttons.

Note: MP3 is a music compression technology that reduces a song's file size without noticeable effect in the quality of the sound. Through compression algorithms, the MP3 format makes it easy for you to store many times the number of songs you would find on a conventional audio CD. In fact, an MP3 CD can contain as much music as ten standard audio CDs on just one disc, which can then be organized into folders on a PC before being stored on the disc.

Music files on an MP3 CD are played according to the folder structure on the disc.

For example:

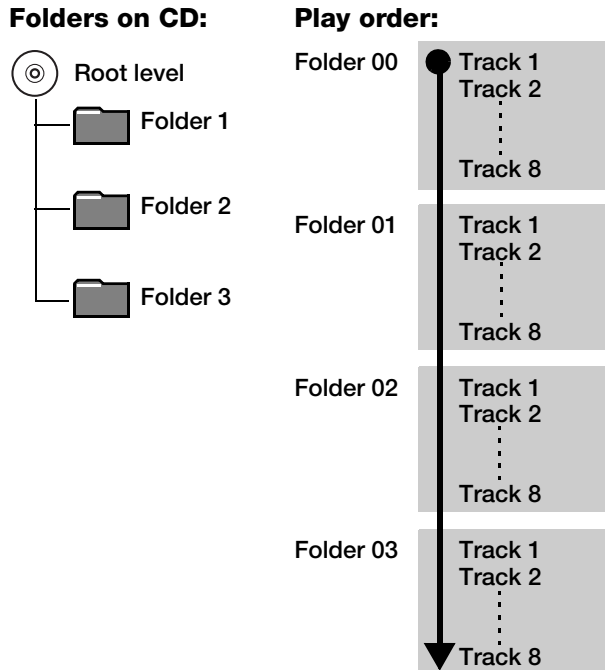

To play, pause, stop or eject an MP3 CD, use the same remote control buttons as for an audio CD. See “Playing audio compact discs (CDs)” on page 11.

The Wave® music system III will display artist name and song title information when available on music file CDs.

Note: The audio quality of MP3 CDs is dependent on factors such as the encoded bit rate, the sampling rate, and the type of encoder used. The Wave® music system III supports MP3 CDs encoded at bit rates of 64kbps or higher, and sampling rates of 32kHz or higher. It is recommended that a bit rate of at least 128kbps and a sampling rate of 44.1kHz or better be used.

Note: Playback quality of recorded CD-R and CD-RW discs is dependent on the CD recording process and software used to record the disc. An improperly recorded audio CD may cause the system to exhibit unexpected behavior.

Navigating through music files

- Press **Tune/MP3 <** to skip to the previous folder; press **Tune/MP3 >** to skip to the next folder.
- Press **Seek/Track <<** to skip to the beginning of the current track; Press **Seek/Track >>** again to skip to the beginning of the previous track.
- Press **Seek/Track >>>** to skip to the next track.



- When navigating an MP3 CD, folder number and track number are displayed:

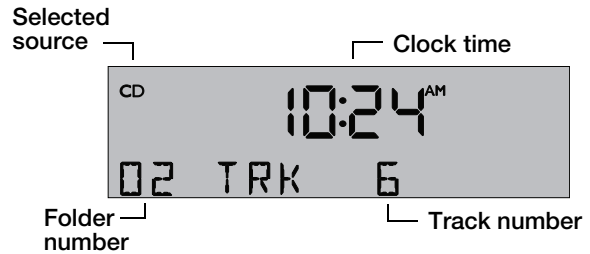

Note: The Root level is displayed as folder number 00.

Once the track begins playing, artist name, song title, and elapsed track time will return to the display:

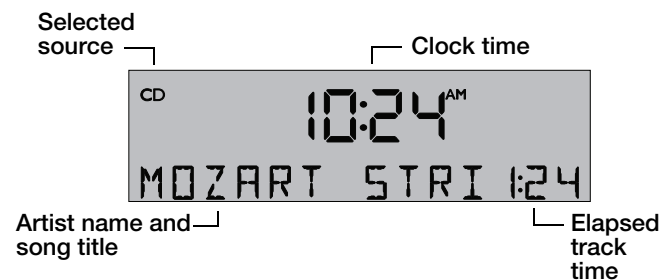

Play modes for music file CDs

Play Mode While a music file CD is playing, you can change the way it is played. Press **Play Mode** repeatedly until the play mode you want is displayed:

- **NORMAL PLAY** – Plays tracks once in sequential order.
- **SHUFFLE DISC** – Plays all tracks once in random order.
- **SHUFFLE FLDR** – Plays all tracks in the selected folder in random order (MP3 only).
- **SHUF RPT FDR** – Repeats all tracks in a folder in a random order that changes each time the folder is repeated (MP3 only).
- **SHUFF RPT CD** – Repeats all tracks on a disc in a random order that changes each time the disc is repeated.
- **REPEAT DISC** – Repeats all tracks on a disc in order.
- **REPEAT FOLDR** – Repeats all tracks in a folder in order (MP3 only).
- **REPEAT TRACK** – Repeats the selected track continuously.

Note: The play mode will return to **NORMAL PLAY** whenever a CD is inserted.

Introduction

The Wave® Music System III has two independent alarms, **Alarm 1** and **Alarm 2**.

Each alarm can be set for:

- Time
- Wake-up source: buzzer, radio, or CD
- Volume

Using the Alarm buttons

Using the **Alarm** buttons on the bottom of the remote you can setup and operate each alarm:

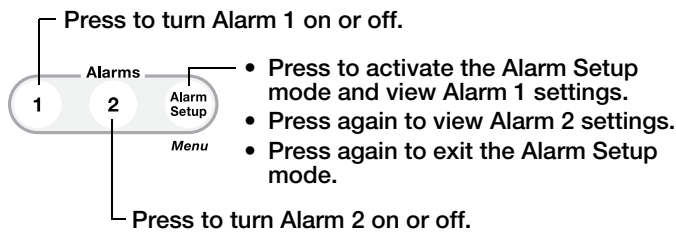

Alarm status indicators

The upper right-hand corner of the display shows the alarm status indicators if the alarm is set:

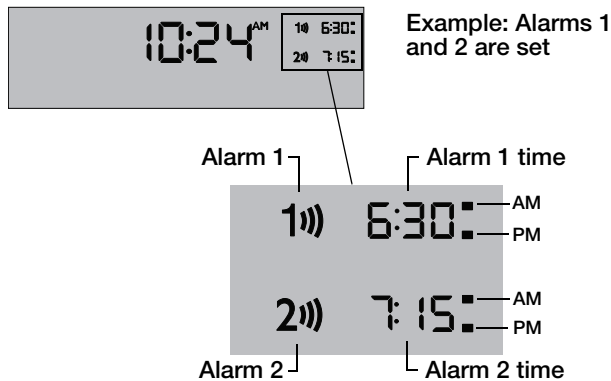

Setting the alarms

You can choose the settings for each alarm by activating the Alarm Setup mode and displaying the settings for the alarm you want to change.

To setup Alarm 1 or 2:

1. Press **Alarm Setup** to activate the Alarm Setup mode and display the settings for Alarm 1.



The alarm number and time start flashing.



Then the display shows you the current settings for Alarm 1.



2. Using the **Time** buttons, set the alarm time.

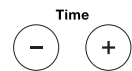

3. Select your wake-up source:

- BUZZER is the factory alarm setting.
- Press to choose a radio station.
- Press to choose a track.

4. Press **Volume** up or down to set the volume level of the selected wake-up source.



5. Press to enter the Alarm 2 setup mode. Repeat Steps 2-4 to set up Alarm 2.

6. Press again to exit the Alarm Setup mode.

The alarm you set is turned on and the alarm time appears on the display:



Using the alarms

Turning an alarm on or off

Press **1** or **2** to turn the selected alarm on or off.

When an alarm is turned on, the alarm number and time appear in the upper right corner of the display.

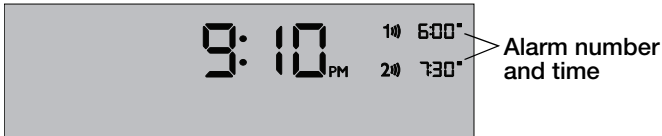

Snoozing an alarm

To snooze a sounding alarm:

Touch the touch pad,

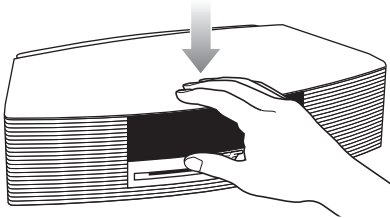

or press **Sleep**.

SNOOZE is displayed for the duration of the selected snooze time and then the alarm sounds again.

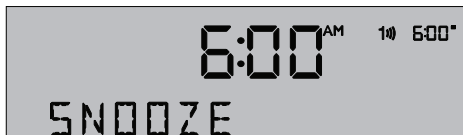

The snooze time is set at the factory to 10 minutes. To change the snooze time to 20, 30, 40, 50, or 60 minutes, see "Adjusting the snooze time" on page 18.

To reset a snoozed alarm for the next day:

After snoozing the alarm, place your hand on the touch pad again and hold it there for at least 2 seconds, or

press the power button  .
Stop Alarm

Stopping a sounding alarm

Press  to stop a sounding alarm.
Stop Alarm

This also resets the alarm for the next day.

Rear panel input/outputs

The rear panel of your Wave® music system III provides connections for external equipment.

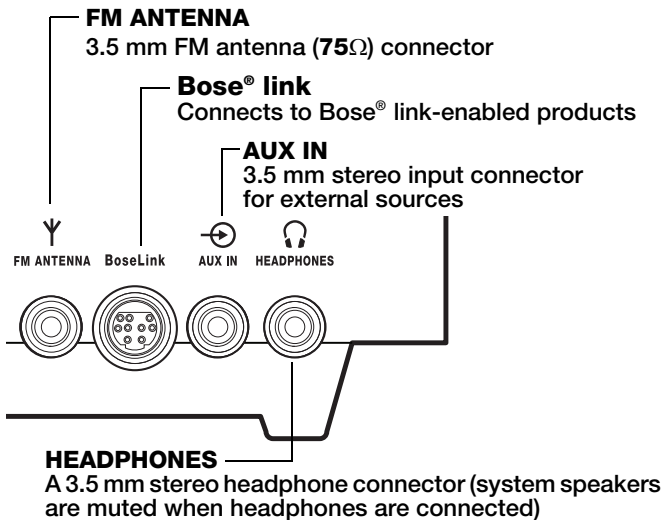

Using headphones

For private listening, connect headphones to the headphone connector on the rear panel of the Wave® music system III.

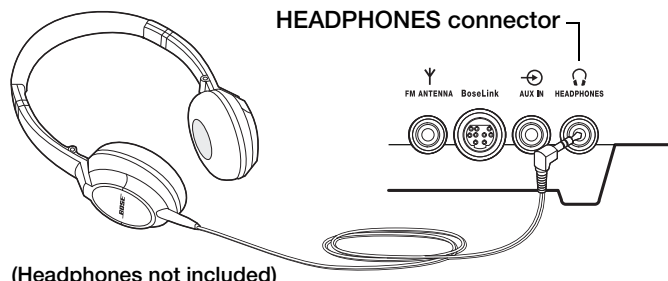

The speakers are automatically muted when you plug in your headphones.

CAUTION: Long-term exposure to loud music may cause hearing damage. It is best to avoid extreme volume when using headphones, especially for extended periods.

Note: The speakers will automatically unmute when headphones are disconnected from the Wave® music system. Because headphone volume levels may vary from speaker volume levels, be sure to lower the volume of the Wave® music system III before connecting or disconnecting headphones.

Note: If an alarm sounds while using headphones, it will sound through the Wave® music system III speakers.

To change the headphones volume:

Press **Volume ▲** or **▼** to adjust the listening level of your headphones.



Using the AUX IN connector

When using a TV, DVD player, computer, video game or other audio source, you can enhance your listening experience by playing the audio device through your Wave® music system III.

Connecting an audio device to your Wave® music system III requires one of the following cables:

- Male-to-male 3.5 mm stereo cable
- Dual RCA male to 3.5 mm male stereo cable



To obtain the correct cable, contact Bose® Customer Service or visit a local electronics store. See the contact information inside the back cover of this guide.

To connect an audio device, such as your TV, to your Wave® music system III:

1. Connect one end of the stereo cable to the output of the audio device.

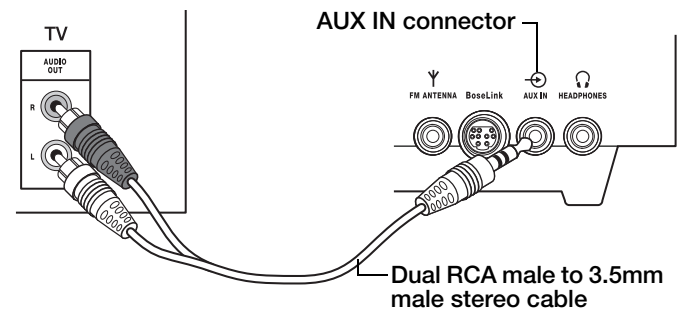

2. Connect the other end of the cable to the **AUX IN** connector on the rear panel of your Wave® music system III.
3. Press **AUX** to turn on the system and select the AUX input.

Note: If your Wave® music system III is connected to a Bose® link accessory, pressing AUX will toggle between the AUX device input and the Bose link input.

4. Press and hold **Volume ▲** or **▼** to adjust the listening level.



Note: If the volume level of your Wave® music system III cannot be adjusted high enough, increase the volume level of the connected audio device.

Using an external antenna

The Wave® music system III power cord is used as an antenna for FM radio. If, after adjusting the position of the power cord, you still experience poor reception, you may need to install an external antenna. An external FM dipole antenna can be ordered through Bose Customer Service. See the phone numbers listed inside the back cover of this guide.

1. Insert the 3.5 mm plug of the FM antenna into the **FM ANTENNA** connector.
2. Extend the ends of the antenna as far from the unit and other external equipment as possible to establish optimum reception.

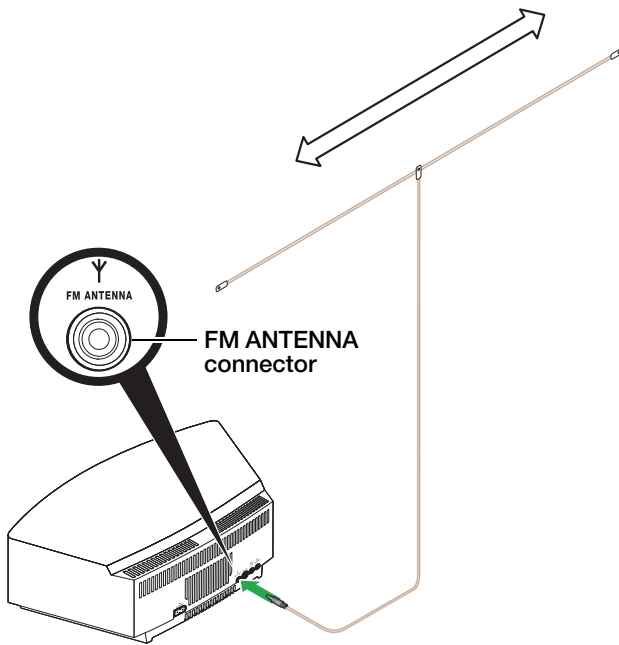

Note: Many FM radio stations transmit a vertically polarized signal as well as, or instead of, a horizontally polarized signal. If the horizontal antenna orientation does not provide good reception, try hanging the antenna in a vertical orientation.

Connecting to a Lifestyle® system

You can use your Wave® music system III as a multi-room expansion speaker system for a Bose® link-enabled Lifestyle® home entertainment system.

Contact Bose Customer Service to obtain the required cables and instructions. See the phone numbers listed inside the back cover of this guide.

PERSONALIZING YOUR WAVE® MUSIC SYSTEM III

System settings were selected at the factory to satisfy most owners of a Wave® music system III. However, if you wish to adjust the system settings see the instructions on the following pages.

The setup menu

The setup menu allows you to customize the operation of the Wave® music system III.

System Setting	Menu Item	Factory Setting	Choices	Description
Snooze Duration	SNOOZE-	10 MIN	10 MIN, 20 MIN, 30 MIN, 40 MIN, 50 MIN, 60 MIN, OFF	Determines the snooze time duration.
Radio Data System (RDS) Information	RADIO TEXT-	ON	ON, OFF	Enables (ON) or disables (OFF) the system to display RDS information.
Continuous Play	CONT PLAY-	NO	NO, AUX, FM, AM, DAB	Determines which source will automatically play after a CD ends.
Clock Time Format	TIME-	12 HOUR	12-HOUR, 24-HOUR	Sets the clock display for 12-hour (AM/PM) or 24-hour time.
Display High Brightness Level	BRIGHT HI-	10	8-15	Sets the display brightness level when the unit detects high ambient light conditions.
Display Low Brightness Level	BRIGHT LO-	4	1-8	Sets the display brightness level when the unit detects low ambient light conditions.
Room Code	ROOM-	B _ _ _ -	B _ _ _ -, C _ _ _ -, D _ _ _ -, E _ _ _ -, F _ _ _ -, G _ _ _ -, H _ _ _ -, I _ _ _ -, J _ _ _ -, K _ _ _ -, L _ _ _ -, M _ _ _ -, N _ _ _ -, O _ _ _ -	Sets the room code for your Wave® music system III when it is connected to your Lifestyle® system through a Bose® link network. The dashes following the room letter indicate how the microswitches should be set on the Lifestyle® remote control.
Capacitive touch control	TOUCH PAD-	ON	ON, OFF	Enables (ON) or disables (OFF) the touch pad.
30 min. system standby timer	AUTO OFF-	YES	YES, NO	Enables (YES) or disables (NO) the 30-minute system standby timeout. Refer to “Turning the Wave® music system III on and off” on page 9.
System Reset	RESET ALL-	NO	NO, YES	Restores the Wave® music system III to factory settings.

To change a system setting:

1. Press and hold **Alarm Setup (Menu)** until **-SETUP MENU-** is displayed.



2. Press **Tune/MP3 >** until the menu item you want to change is displayed.



3. Press **Time -** or **Time +** to change the value or selection.

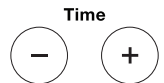





4. Press **Alarm Setup (Menu)** to exit the setup menu or wait 10 seconds for the setup menu to exit automatically.





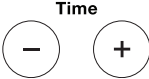

Adjusting the snooze time

This setting determines the duration of time the system remains silent when the snooze function is activated.

1. Press and hold **Alarm Setup (Menu)** until **-SETUP MENU-** is displayed. 
2. Press **Tune/MP3 >** once until **SNOOZE- 10 MIN** is displayed. 
3. Press **Time -** or **Time +** to change the snooze time to 10-60 minutes (in 10-minute increments). 
4. Press **Alarm Setup (Menu)** to exit the setup menu or wait 10 seconds for the setup menu to exit automatically. 



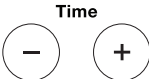

Turning RDS on or off

This setting enables or disables your system to display RDS information. The RDS is a system that transmits useful information, such as station name, program information and the current time. RDS is used only on FM and RDS information is displayed only if it is included in the FM broadcast signal.

1. Press and hold **Alarm Setup (Menu)** until **-SETUP MENU-** is displayed. 
2. Press **Tune/MP3 >** twice until **RADIO TEXT-** is displayed. 
3. Press **Time -** or **Time +** to select **OFF** or **ON**. 
4. Press **Alarm Setup (Menu)** to exit the setup menu or wait 10 seconds for the setup menu to exit automatically. 



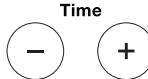

Selecting the continuous play source

Your Wave® music system III has a continuous play feature. When a CD stops playing, you can program another source to automatically start playing.

1. Press and hold **Alarm Setup (Menu)** until **-SETUP MENU-** is displayed. 
2. Press **Tune/MP3 >** three times until **CONT PLAY-** is displayed. 
3. Press **Time -** or **Time +** to select **AUX, FM, AM, DAB,** or **NO**. 
4. Press **Alarm Setup (Menu)** to exit the setup menu or wait 10 seconds for the setup menu to exit automatically. 







Changing the time format

You can choose to have the display show the time in 12-hour (AM/PM) or 24-hour time.

1. Press and hold **Alarm Setup (Menu)** until **-SETUP MENU-** is displayed. 
2. Press **Tune/MP3 >** four times until **TIME-** is displayed. 
3. Press **Time -** or **Time +** to select **12 HOUR** or **24 HOUR**. 
4. Press **Alarm Setup (Menu)** to exit the setup menu or wait 10 seconds for the setup menu to exit automatically. 

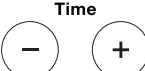
Adjusting the display brightness

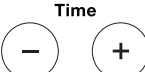

The brightness level of the display automatically adjusts itself for low and high ambient light conditions. This feature brightens the display for better visibility in high ambient light conditions and dims the display making it less intrusive in low ambient light conditions. High and low brightness settings can be set independently.



1. Press and hold **Alarm Setup (Menu)** until **-SETUP MENU-** is displayed. 
2. Press **Tune/MP3 >** five times until **BRIGHT HI-** is displayed. 
3. Press **Time -** or **Time +** to set the high display brightness level to a value from 8-15. 
4. Press **Tune/MP3 >** once until **BRIGHT LO-** is displayed. 
5. Press **Time -** or **Time +** to set the low display brightness level from 1-8. 
6. Press **Alarm Setup (Menu)** to exit the setup menu or wait 10 seconds for the setup menu to exit automatically. 

Setting the room code

Your Wave® music system III comes from the factory ready to operate as a second room (room code B) when connected to a Bose® link enabled Lifestyle® system. If you want to use your Wave® music system III with your Lifestyle® system beyond a second room you will need to change the room code to match that of the remote control you are using for that room.



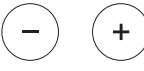

Refer to your Lifestyle® system owner's guide for more information on room codes.

1. Press and hold **Alarm Setup (Menu)** until **-SETUP MENU-** is displayed. 
2. Press **Tune/MP3 >** seven times until **ROOM- B _ _ _ -** is displayed. The dashes following the room letter indicate how the microswitches should be set on the Lifestyle® remote control. 



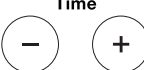

3. Press **Time -** or **Time +** to select a room code other than room B. 
4. Press **Alarm Setup (Menu)** to exit the setup menu or wait 10 seconds for the setup menu to exit automatically. 

Turning the touch pad on or off

If you do not wish to use the touch pad feature you can turn it off.

1. Press and hold **Alarm Setup (Menu)** until **-SETUP MENU-** is displayed. 
2. Press **Tune/MP3 >** eight times until **TOUCH PAD-** is displayed. 
3. Press **Time -** or **Time +** to select **OFF** or **ON**. 
4. Press **Alarm Setup (Menu)** to exit the setup menu or wait 10 seconds for the setup menu to exit automatically. 

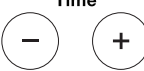
Changing the system standby timeout

1. Press and hold **Alarm Setup (Menu)** until **-SETUP MENU-** is displayed. 
2. Press **Tune/MP3 >** nine times until **AUTO OFF-** is displayed. 
3. Press **Time -** or **Time +** to select NO or YES. 
4. Press **Alarm Setup (Menu)** to exit the setup menu or wait 10 seconds for the setup menu to exit automatically. 

Performing a system reset

If you wish, you can restore your Wave® music system III to the original factory settings.

Note: A system reset erases all saved presets.

1. Press and hold **Alarm Setup (Menu)** until **-SETUP MENU-** is displayed.



2. Press **Tune/MP3 >** ten times until **RESET ALL- NO** is displayed.

Tune / MP3



3. Press **Time -** or **Time +** to change **RESET ALL- NO** to **RESET ALL- YES**.

Time



4. Press **Presets** button **3** when **PRESS PRESET 3 TO CONFIRM** appears on the display. When the reset is complete, **RESET COMPLETE** is displayed.



5. Press **Alarm Setup (Menu)** to exit the setup menu or wait 10 seconds for the setup menu to exit automatically.



Troubleshooting

Problem	What to do
System does not function	<ul style="list-style-type: none"> • Make sure the power cord is fully plugged into an operating electrical outlet. • Unplug the power cord from the AC wall outlet for 10 seconds and then reconnect it; this will reset the system. • Tap the touch pad on the top of the system to see if the system turns on (page 8).
No sound	<ul style="list-style-type: none"> • Turn the volume up. • Press Mute. • Eject the CD and reload it. • Press AUX to listen to an external source connected to the AUX IN input. • Make sure the external source is turned on and the volume on the external source is turned up. • Disconnect headphones from the system (connecting headphones mutes the speakers).
Poor sound quality	<ul style="list-style-type: none"> • If listening to an AM or FM source, try turning the Talk Radio mode on or off (page 10). • If listening to an AUX source, make sure you are using a stereo cable and that it is fully inserted.
Remote control is inconsistent or does not work	<ul style="list-style-type: none"> • Operate the remote control closer to the unit. • Check that the remote control battery is installed with positive (+) polarity facing up. • Replace the remote control battery. • Check for interference from fluorescent room lighting, sunlight, or dust or dirt on lens. • Try the unit in a different location.
AM reception is weak	<ul style="list-style-type: none"> • Adjust the internal antenna by rotating the unit slightly one way and then the other. • Move the unit farther from a TV, refrigerator, halogen lamps, dimmer switches, or other electronic equipment that generates electrical noise. • If neither suggestion works, you may be in an area of weak AM signal coverage.
FM reception is weak	<ul style="list-style-type: none"> • Extend the power cord as much as possible. The power cord acts as an FM antenna. See “Connecting to power” on page 6. • See “Using an external antenna” on page 16.
CD does not play	<ul style="list-style-type: none"> • Check that the CD source is selected or press CD. The CD icon should appear on the display. • Check that the CD was loaded label-side up. • Check that the disc surface is clean, if not, try cleaning it. • Check that an audio CD was loaded, not a DVD. • Try another disc.

Replacing the remote control battery

WARNING: Keep the remote control battery away from children. It may cause a fire or chemical burn if mishandled. Do not recharge, disassemble, heat above 212°F (100°C), or incinerate. Dispose of a used battery promptly. Replace only with a battery of the correct type and model number.

CAUTION: Danger of explosion if battery is incorrectly replaced. Replace only with an agency-approved (e.g. UL) CR2032 or DL3032 3-volt lithium battery.

1. Place the remote face down on a flat surface.
2. Using your finger, push the tab lock to the side as shown and hold. Slide the battery compartment open.

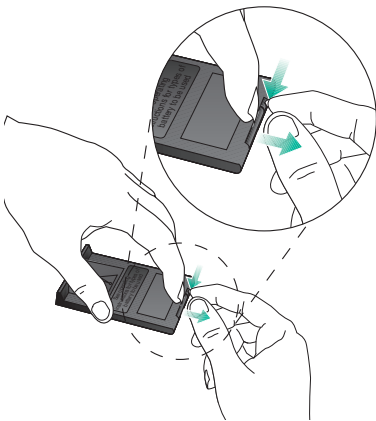

3. Remove the old battery and install the new one with the plus (+) symbol facing up.

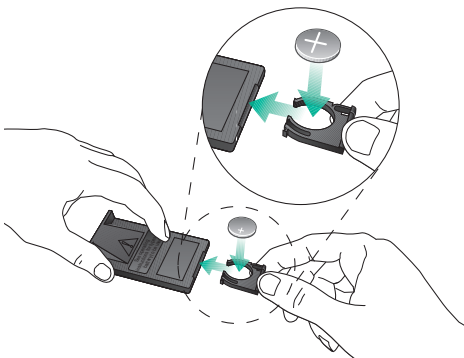

4. Gently slide the battery compartment closed. It locks automatically.

Cleaning

Use only a soft dry cloth to clean the enclosure of your Wave® music system III. If necessary, you may use a soft-bristled attachment to gently vacuum the front of the enclosure. Do not use any liquid cleaning solutions, solvents, chemicals, alcohol, ammonia, or abrasives.

CAUTION: Do not allow liquids to spill into any openings in the enclosure. If liquids get into the unit, unplug the product immediately. Call Bose® Customer Support as soon as possible to arrange for service. See the list of phone numbers inside the back cover.

Customer service

If you lose your remote, additional remotes are available from Bose® Customer Service. For additional help in solving problems, contact Bose Customer Service. See the phone numbers listed inside the back cover.

Limited warranty

Your Bose Wave® music system III is covered by a limited warranty. Details of the limited warranty are provided on the product registration card that is included in the carton. Please complete the information section on the card and mail it to Bose. Failure to do so will not affect your limited warranty rights.

What you must do to obtain Limited Warranty Service:

Return product, with proof of purchase from an authorized Bose dealer, using the following procedures:

1. Contact the Bose organization in your country or region (visit global.Bose.com for Bose contact information in your country/region) for specific return and shipping instructions;
2. Label and ship the product, freight prepaid, to the address provided by the Bose organization in your country; and
3. Place any necessary return authorization number prominently on the outside of the carton. Cartons not bearing a return authorization number, where required, will be refused.

Technical information

AC power rating

120V ~ 50/60Hz 60W

Dimensions

36.8 cm W x 21.9 cm D x 10.6 cm H (14.6" x 8.6" x 4.2")

Weight

3.9 kg (8.7 lb)

A

AC power 6
 AC power rating 22
 acoustic waveguide 7
 alarms, using the 14
 AM 10
 AM reception 21
 AM/PM (12-hour) time 6, 17, 18
 ambient light conditions 17, 19
 artist name 12
 audio CD 11
 audio device, connecting 15
 AUX IN connector 15
 auxiliary source 9

B

battery replacement 22
 Bose® link 15, 16, 17, 19
 brightness level 17, 19

C

carton 22
 CD 11
 CD play mode 11
 CD source 11, 21
 CD source information 11
 CD track 11
 CD-R 11
 CD-RW 11
 cleaning 22
 clock display 9
 clock setup mode 6
 clock time 6
 clock time format 6, 17, 18
 clock, setting the 6
 computer 15
 connecting other equipment 15
 continuous play 17
 continuous play source 18
 customer service 22
 customizing operation 17

D

demonstration CD 6, 7
 dimensions 22
 dimmer switches 21
 dipole antenna 16
 disc player 11
 display 9
 display brightness 17, 19
 DVD 21
 DVD player 15

E

electrical noise 21
 electrical outlet 21
 external equipment 15
 external FM antenna 10, 16
 external source 15, 21

F

factory settings 7, 17, 20
 factory snooze time setting 14
 FM 10
 FM antenna 6, 21
 FM reception 6, 10, 21
 frequency band 10

H

halogen lamps 21
 headphones 15, 21
 help in solving problems 22

I

internal antenna 21

L

Lifestyle® systems 15, 16, 17, 19
 listening level 15, 16
 listening to FM/AM radio 10
 location, selecting a 6

M

military (24-hour) time 17, 18
 MP3 CDs 7, 11, 12
 multi-room expansion 16
 music files, navigating 12

N

no sound 21

P

personalizing 17
 play mode 11, 12
 playing compact discs 11
 poor reception 16
 power 6
 power cord 6, 10, 16, 21
 power outage 6
 preset number 10
 presets 10
 press and hold operations 8

Q

quick recall 10

R

radio alarm 13
radio station 10
rapid adjustment 6
RDS 17, 18
rear panel 15
registration card 22
remote control 8
remote control battery 21, 22
remote control buttons 12
restore audio 8
room code, setting 17, 19

S

scan through a track 11
second room 19
setting alarm 13
setup menu 17, 19
shipping carton 6
shipping instructions 22
skip 11, 12
sleep timer setup mode 9
snooze control 14, 17
snooze time 18
song title information 12
sounding alarm 14
station frequency 10
stereo cable 15
stereo headphone connector 15
stereo input connector 15
stopping a sounding alarm 14
storing a radio station 10
system operation 7
system reset 17, 20
system settings 7, 17, 18, 19, 20
system setup mode 20
system standby timeout 17, 19

T

talk radio broadcasts 10
TALK RADIO mode 10
tapered waveguide 7
technical information 22
time increment 18
touch pad control 8, 17, 19
track number 11
troubleshooting 21
tuning the radio 10
turning alarm on and off 14
turning the radio on 10
TV 15, 21

U

unpacking 6

V

video game 15
volume level 9, 16, 21

W

warranty 22
waveguide speaker technology 7
weak AM reception 21
weak FM reception 21
weak reception 10
weight 22

CONTACT INFORMATION

USA Customer Support

Bose Corporation, The Mountain
Framingham, MA 01701-9168
1-800-367-4008

USA Customer Service

Bose Corporation, 1 New York Ave.
Framingham, MA 01701-9168
1-508-766-1900

Canada Customer Support

Bose Ltd., 1-35 East Beaver Creek Rd.
Richmond Hill, Ontario L4B 1B3
1-800-465-2673

European Office

Bose Products B.V., Nijverheidstraat 8
1135 GE Edam, Nederland
TEL 0299-390111 FAX 0299-390114

Australia

Bose Pty Limited,
Unit 3, 2 Holker Street,
Newington NSW, 2127
TEL +61 (0)2 8737 9999 FAX +61 (0)2 8737 9924

Deutschland

Postfach 1468
48504 Nordhorn
TEL 0130-2673555 FAX 05921-724250

France

Bose S.A.S.
12, rue de Témara
78100 Saint Germain en Laye
TEL 0969 320 546 FAX 01 30 61 33 11
www.Bose.fr

Japan

Bose K.K.
Shibuya YT Building
28-3 Maruyama-cho
Shibuya-ku, Tokyo 150-0044
TEL 0570-080-021 FAX 03-5489-1041
www.Bose.co.jp

Nederland

Bose B.V., Nijverheidstraat 8
1135 GE Edam, Nederland
TEL 0299-390111 FAX 0299-390114

United Kingdom

Freepost EX 151
Exeter EX1 1ZY
TEL 0800 614 293 FAX 0870 240 2013

World Wide Web

www.Bose.com



BOSE[®]
Better sound through research[®]

©2012 Bose Corporation, The Mountain,
Framingham, MA 01701-9168 USA
AM352154 Rev.00