

Canon EOS 10s



INSTRUCTIONS

Introduction

Thank you for selecting a Canon autofocus SLR camera.

This instruction book has been arranged with the most essential sections appearing in the beginning. *Read the pages marked with a black triangle (▲) at the top of each page if you just want to acquaint yourself with the information required for basic operation.*

The Canon EOS 10s' extensive built-in software programs include a bar-code reader* with a bar-code book* and Programmed Image Control which represent considerable effort to help you take the kind of pictures you thought required extensive camera knowledge.

An improved metering system now divides the picture into eight sections for more critical measurement. The fast, flexible autofocus gives you more capabilities and control for a variety of pictures.

A full line-up of EF lenses, Speedlite flash units, a remote controller, and other Canon brand accessories are available to equip you for a variety of shooting tasks.

- For bar-code program information, refer to the bar-code book.*

* Available optionally.

Attention



IMPORTANT INFORMATION

The Canon EOS 10s will give optimum performance together with specially designed Canon EF lenses, flash units and other Canon brand accessories. It is possible that the use of incompatible lenses or other accessories may result in unsatisfactory performance or damage to your Canon EOS 10s. We therefore suggest the use of Canon EF lenses and accessories. Damage to your Canon EOS 10s, as a result of malfunction or improper connections caused by the use of incompatible products may void its warranty.

Please read this instruction book carefully for a thorough understanding before using your EOS 10s.

While reading these instructions, unfold the front and back flaps for easy reference to the camera's parts.



Nomenclature

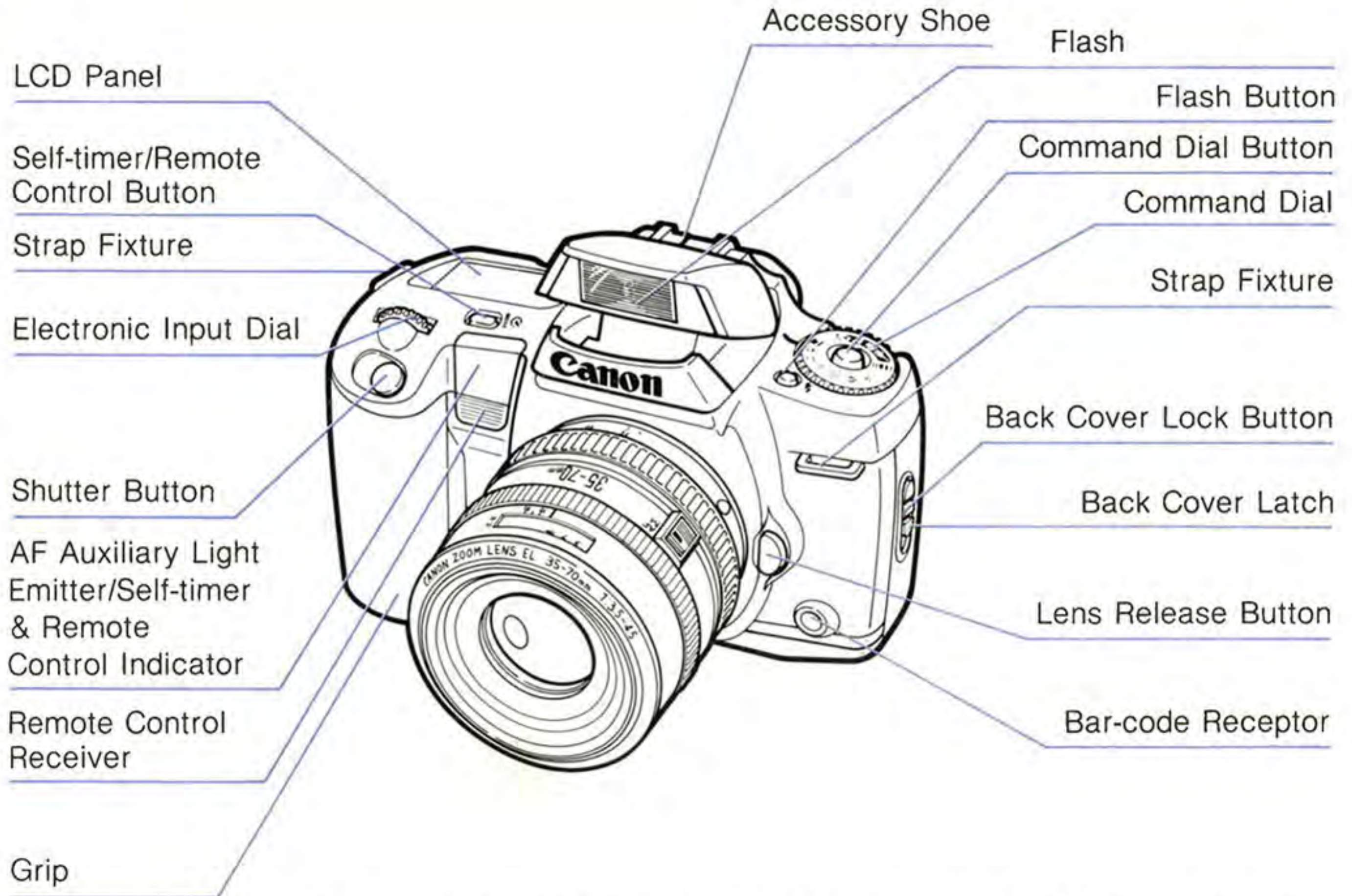

The camera illustration is shown with the optional EF 35-70 mm f/3.5-4.5 lens attached.

Table of Contents

A. Battery Load and Check	7	Q. Interval Timer	61
B. Lens Attachment	9	R. Multiple Exposures	63
C. Camera Handling	11	S. Custom Function Control	65
D. Command Dial	13	T. Liquid Crystal Display /	
E. Focusing	14	Battery Notes	69
- Difficult subjects for autofocus	15	U. Camera Care	71
[Manual Focusing]	15	- Attaching the strap	71
F. Green Zone	16	V. Reference	
G. Film Load	18	- LCD Panel Information	72
- Film Speed Setting	21	- Viewfinder Information	74
H. Programmed Image Control	23	- Infrared Film Use	75
I. Selecting the Focus Marks		- Battery Shooting Capacity	76
and AF Mode	27	- Comparisons Between AF Mode	
J. Film Wind Mode	32	and Film Wind Mode	77
K. Self-timer	33	- Program Line Characteristics	78
L. Setting the Shooting Mode:		W. Accessories	80
- Program AE	35	- Speedlite 430 EZ and 300 EZ	
- Built-in Flash	37	- Grip Extension GR 60	
- Shutter-Priority AE	40	- Remote Controller RC-1	
- Aperture-Priority AE	42	- Dioptic Adjustment Lenses	
- Depth-of-Field AE	45	X. Specifications	82
- Camera-shake Alert	50	Notice	87
- Manual Exposure	52		
M. Bulb	53		
N. Partial Metering (AE Lock)	55		
O. Exposure Compensation	57		
P. Auto Exposure Bracketing (AEB)	58		

Precautions



- 1) **This camera is not resistant to water** and should not be used outdoors in snow or rain. If accidentally dropped in water, contact an authorized Canon service facility. Keep the camera out of salt spray, and protect it from excessive humidity. If used at the beach, clean it thoroughly afterward with a dry cloth.
- 2) Do not attempt to disassemble the camera yourself. Always take it to an authorized Canon service facility for repair.
- 3) Remove the battery if you do not expect to use the camera for about three weeks or longer.
- 4) When storing the camera, wrap it in a clean, soft cloth and place in a cool, dry, dust-free place. Be sure to keep the camera out of direct sunlight, and away from "hot spots" such as the trunk or rear window shelf of a car. Avoid places where moth balls are used, and in extreme humidity, use a desiccant.
- 5) Carefully check the camera's operation after lengthy storage.
- 6) The battery may explode or cause burns if disassembled, recharged, shorted, exposed to high temperatures, or disposed in fire.
- 7) Film passing through X-ray examinations at airports may be exposed and ruined even if loaded in the camera. Request a hand-checked inspection to avoid damage.
- 8) Aerosol spray dust removers are not recommended for the shutter curtain.
- 9) Condensation is a problem when bringing cold equipment into a warm room. If the autofocus optics cloud over, accuracy may be seriously affected. Before entering a warm room, put equipment in a plastic bag so condensation forms on the outside of the bag.
 - * Please see p. 71 for camera care information.



BASIC OPERATION

EF 100-300 mm f/4.5-5.6

A. Battery Load and Check

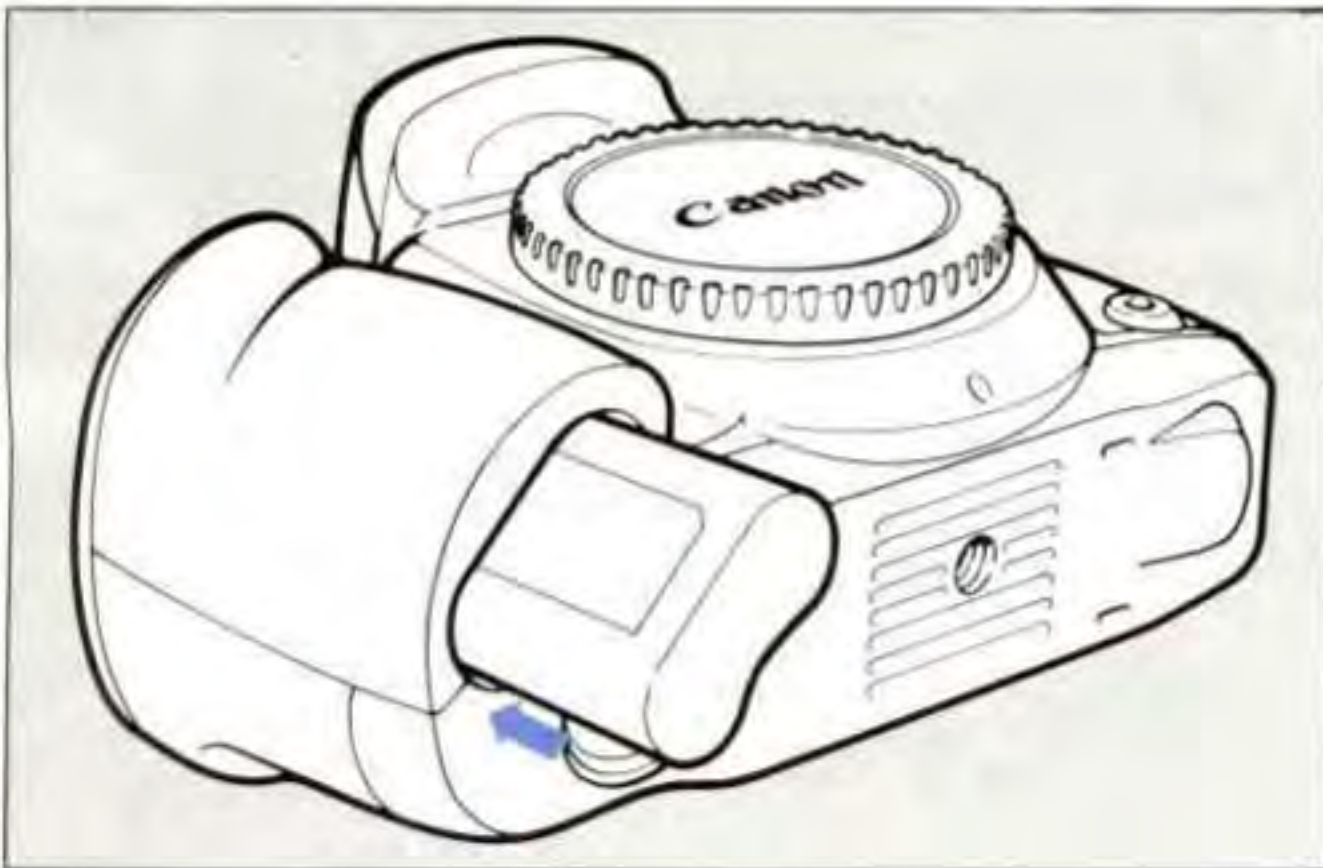
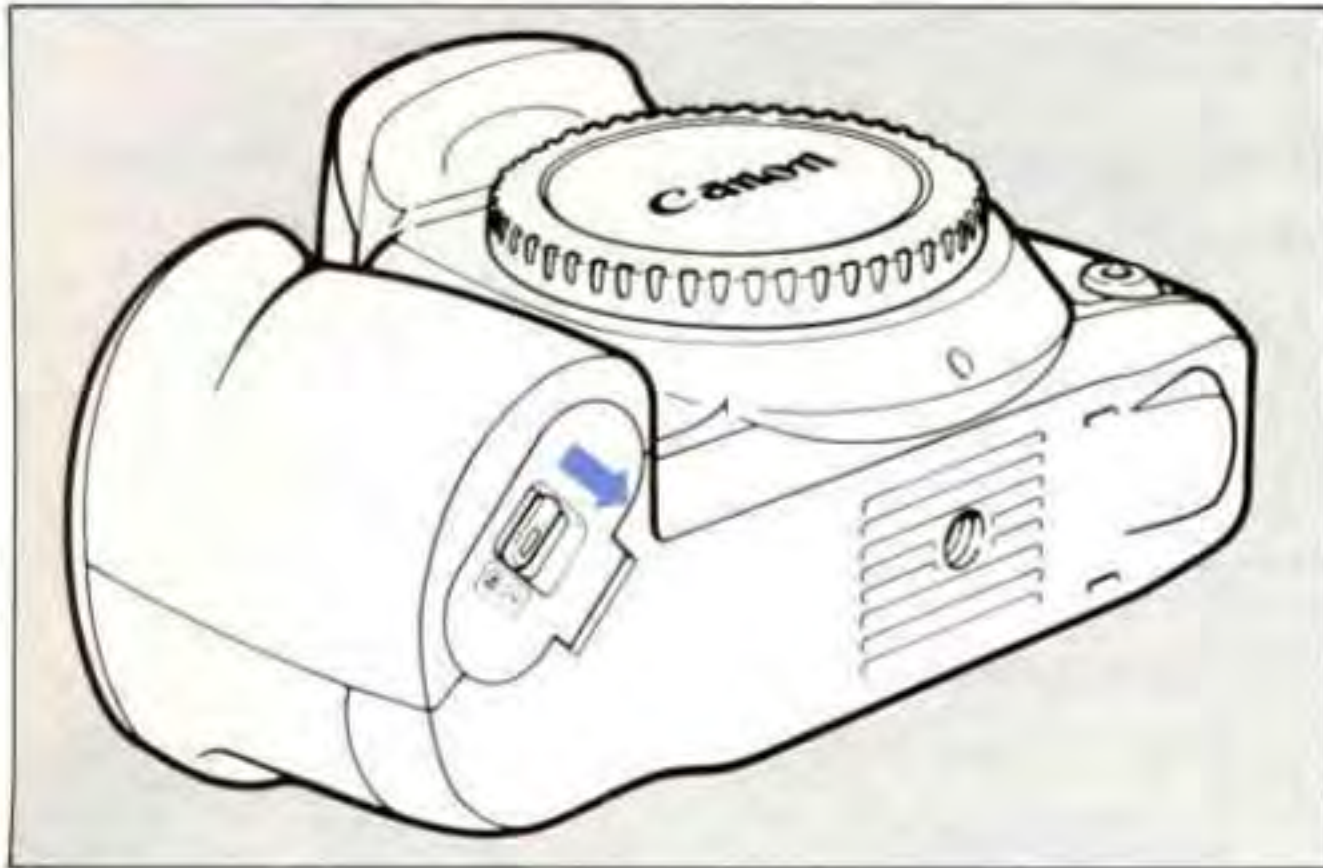

The camera operates on a 2CR5 lithium battery.

- 1) Slide the battery cover lock down to open. The cover cannot be removed from the camera.
- 2) Insert the battery as shown with the terminals facing toward the shutter button.
- 3) Close the cover and hold it down while sliding the lock to fasten it in place.
 - See pp. 69 and 70 for other important battery information.

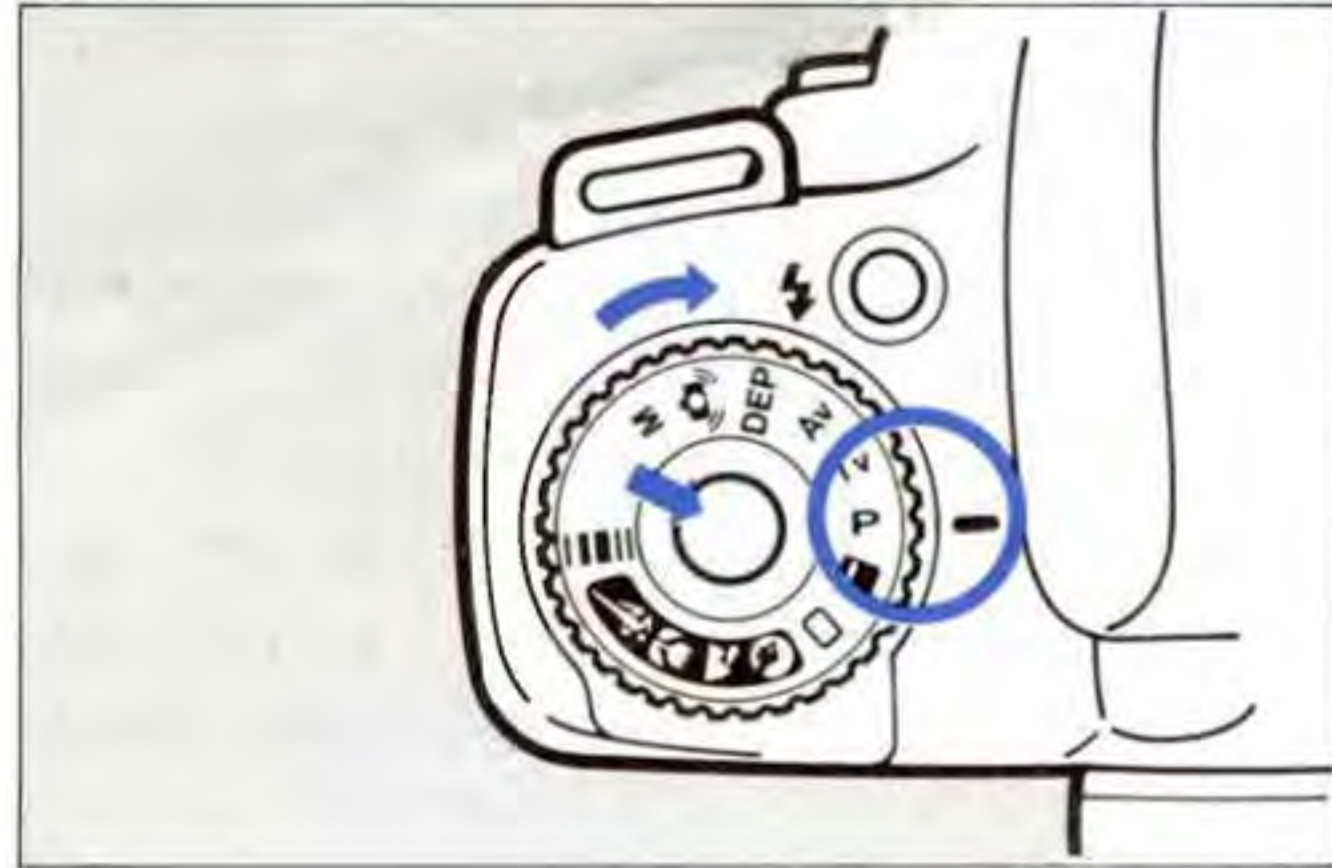

Battery Check

Take a minute to check the battery before shooting to ensure readiness.

- 1) Make sure the command dial is at the red **L** position.
- 2) Press the button in the middle of the dial and turn to P.
- 3) The battery check symbol  displays the remaining battery power in the LCD panel.
 - Refer to the symbols below for battery replacement conditions.

B. Lens Attachment

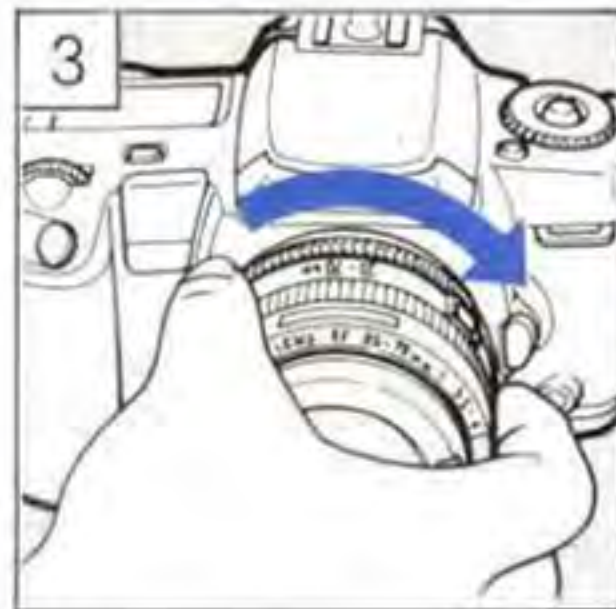
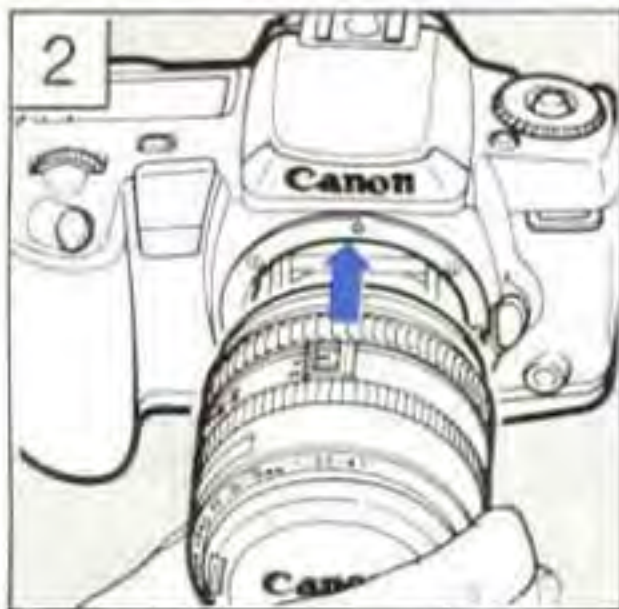
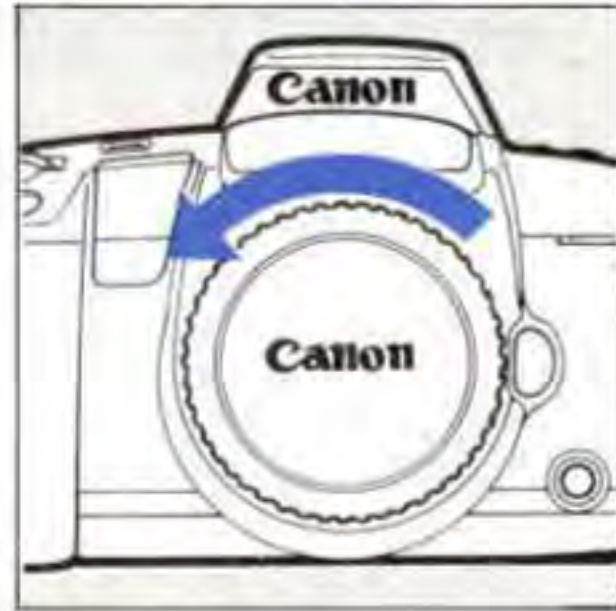
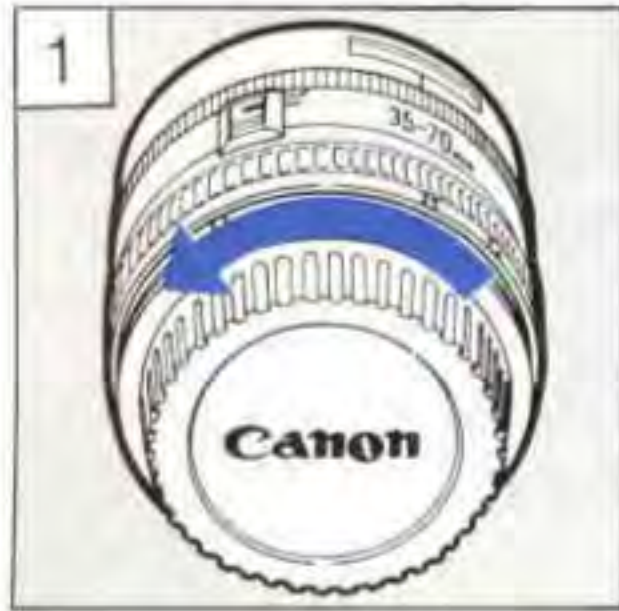

- 1) Remove the body and lens caps by turning them counterclockwise.
- 2) Align the lens' red dot to the camera's red dot.
- 3) With the camera facing you, turn the lens clockwise until it stops and locks with a click.
- 4) Remove the front lens cap.



Lens Information

- For automatic focusing, slide the lens' focus mode switch to AF. Set to M for manual operation. (See p. 15)
- **To remove the lens**, press the lens release button and turn counter-clockwise.

- The electronic contacts must be clean for proper connection. **Do not touch** these contacts.

Do not set the lens on its rear end without the lens cap attached to prevent damage to the electronic contacts.

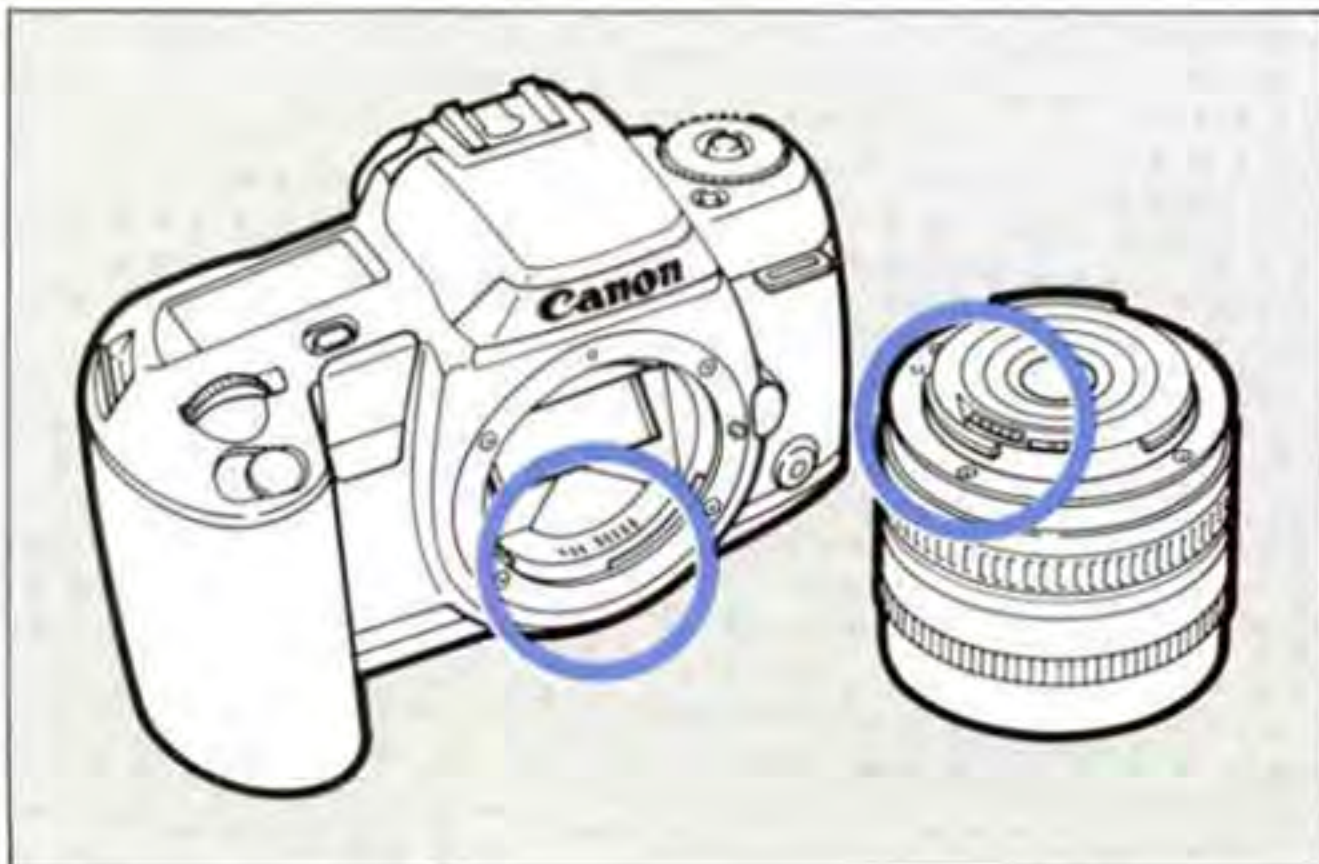

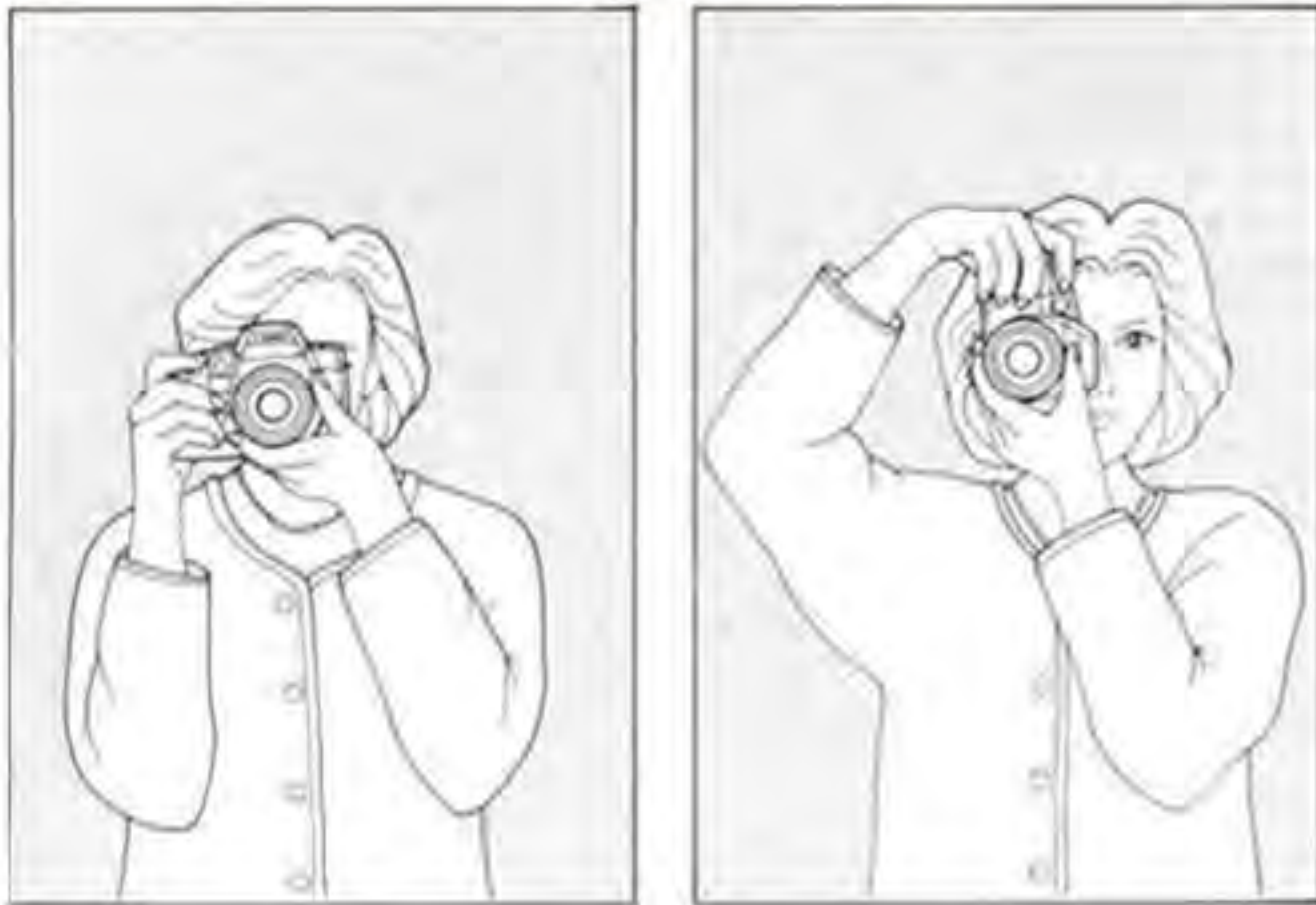

Sharp pictures require **that the camera be held still to prevent unnecessary movement called “camera shake” that can ruin your pictures.** Try the suggested tips below.

- 1) Hold the camera firmly in your right hand. Place the palm of your left hand on the bottom of the camera to support the lens.
- 2) Keep both elbows close to your body.
- 3) Spread your feet apart about shoulder width for a steady natural stance.
- 4) Lightly hold the camera against your nose and look into the viewfinder.

There is no one correct way to hold the camera. **Experiment to find the most comfortable position.** Whenever possible, lean against a steady support such as a tree, wall, or table to help you keep the camera still.

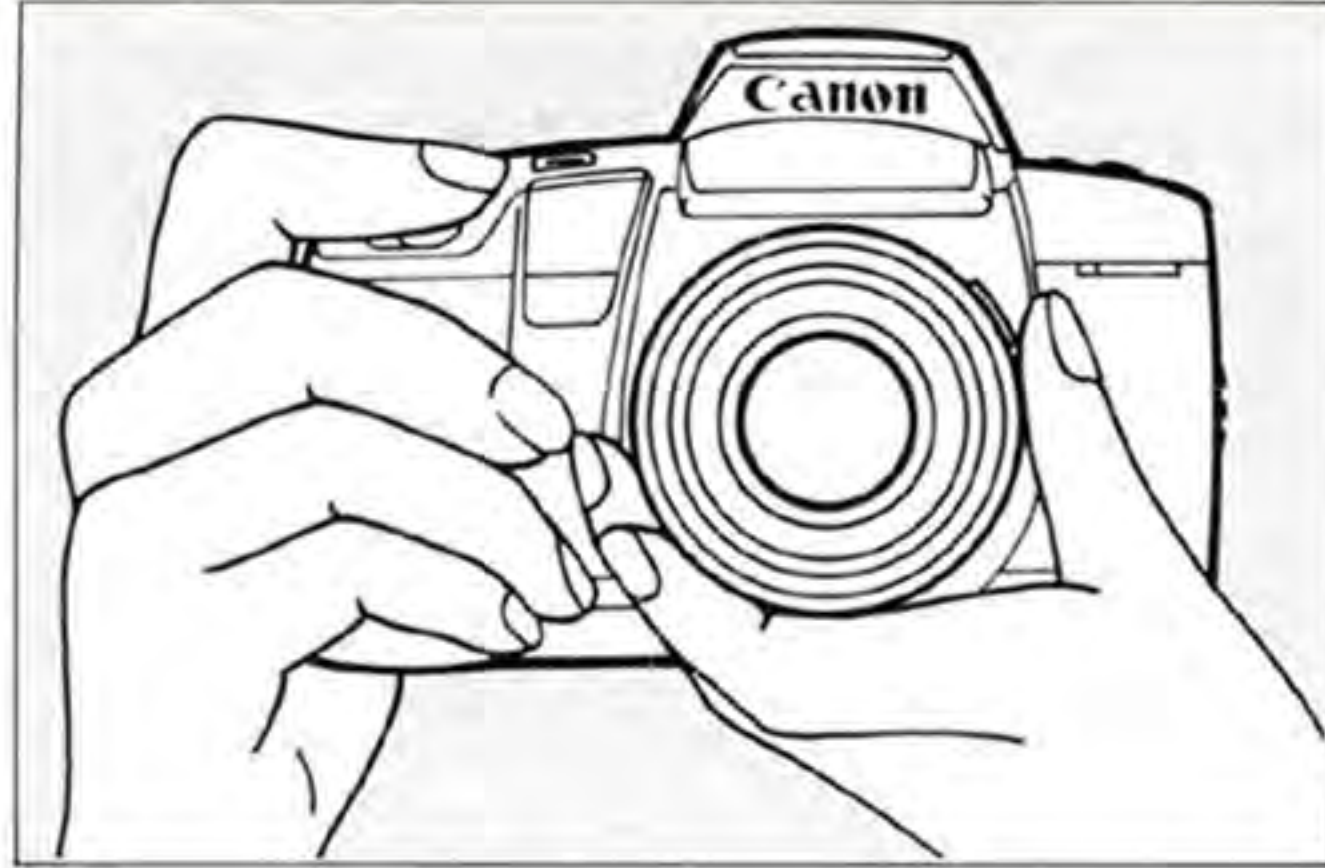

Shutter Button Action

Shutter button action also plays an important part in taking a picture. A quick stroke with the tip of your finger may cause "camera shake." **Always press the shutter button slowly and gently with the ball of your finger.**

D. Command Dial











The command dial has 13 positions for a variety of pictures and operations. The dial plays a key role in the setting of other functions. Please be aware of its position.

Before turning the dial from the  position, be sure to press the black button in the center of the dial first.



The dial positions are as follows:

-  : Green Zone (See page 16)
 -  : Portraits
 -  : Landscapes
 -  : Close-ups
 -  : Sports
 -  : Bar-Code Program*
 -  : Lock - Set here when the camera is not in use.
 - P** : Program (p.35)
 - Tv** : Shutter-Priority AE (p.40)
 - Av** : Aperture-Priority AE (p.42)
 - DEP** : Depth-of-Field AE (p. 45)
 -  : Camera-Shake Alert (p. 50)
 - M** : Manual Exposure (p. 52)
- Note: Landscapes, Close-ups, and Sports are grouped under Programmed Image Control (p. 23).*

For basic operation, set the dial to the green zone .

* Refer to the bar-code book (available optionally).

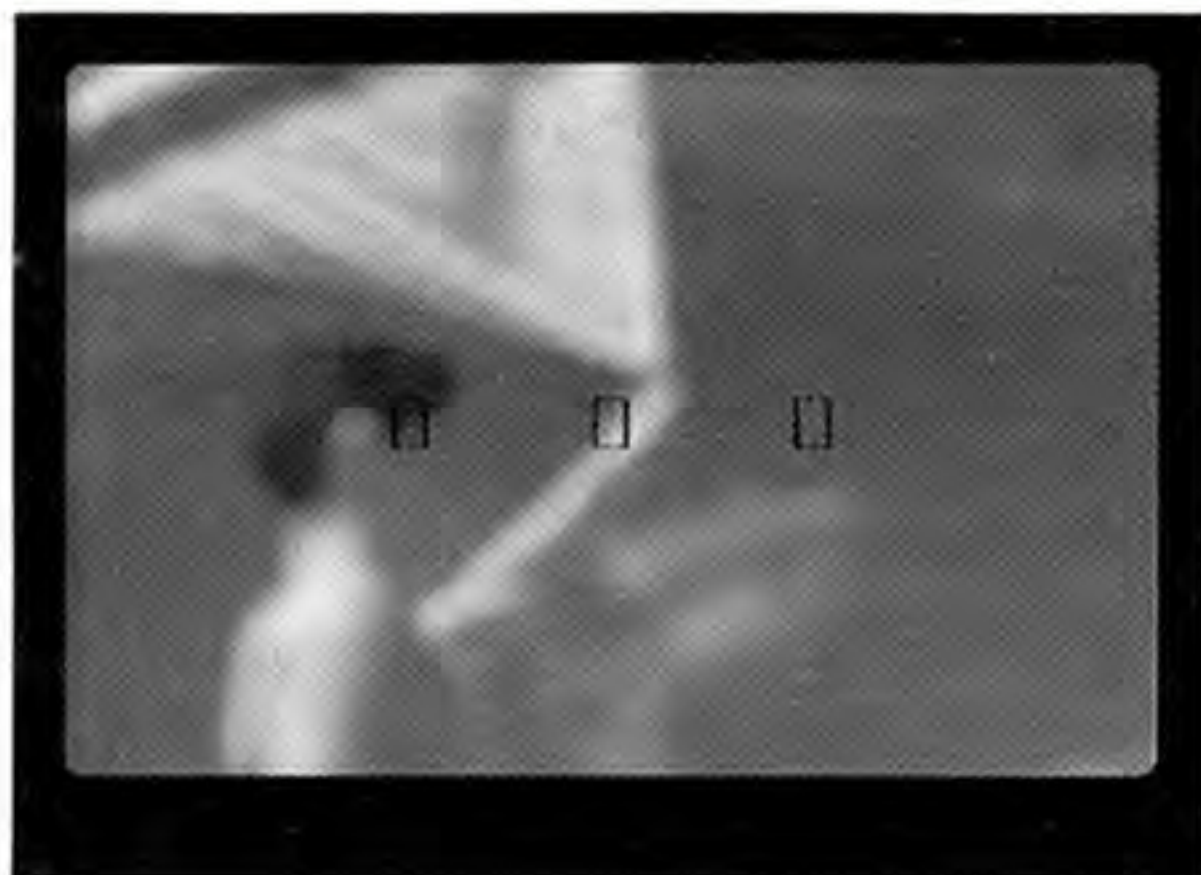

The camera will focus **only on a subject covered by one or all of the focus marks**. The flexibility of this camera's focus system allows you to decide whether to use all three marks or just one, see p. 27.

Press the shutter button halfway to start focus. When the subject is in focus, the green AF symbol ● lights up in the viewfinder.

- Be sure **not to touch** the front of the lens during focusing.
- When the subject cannot be focused, the green AF symbol ● starts blinking, and the shutter will not release, see p. 15.
- Focus can also be activated by pressing the partial metering button, see p. 67, Custom Function #4.
- Autofocus can also be done with a Canon Circular Polarizing Filter PL-C.

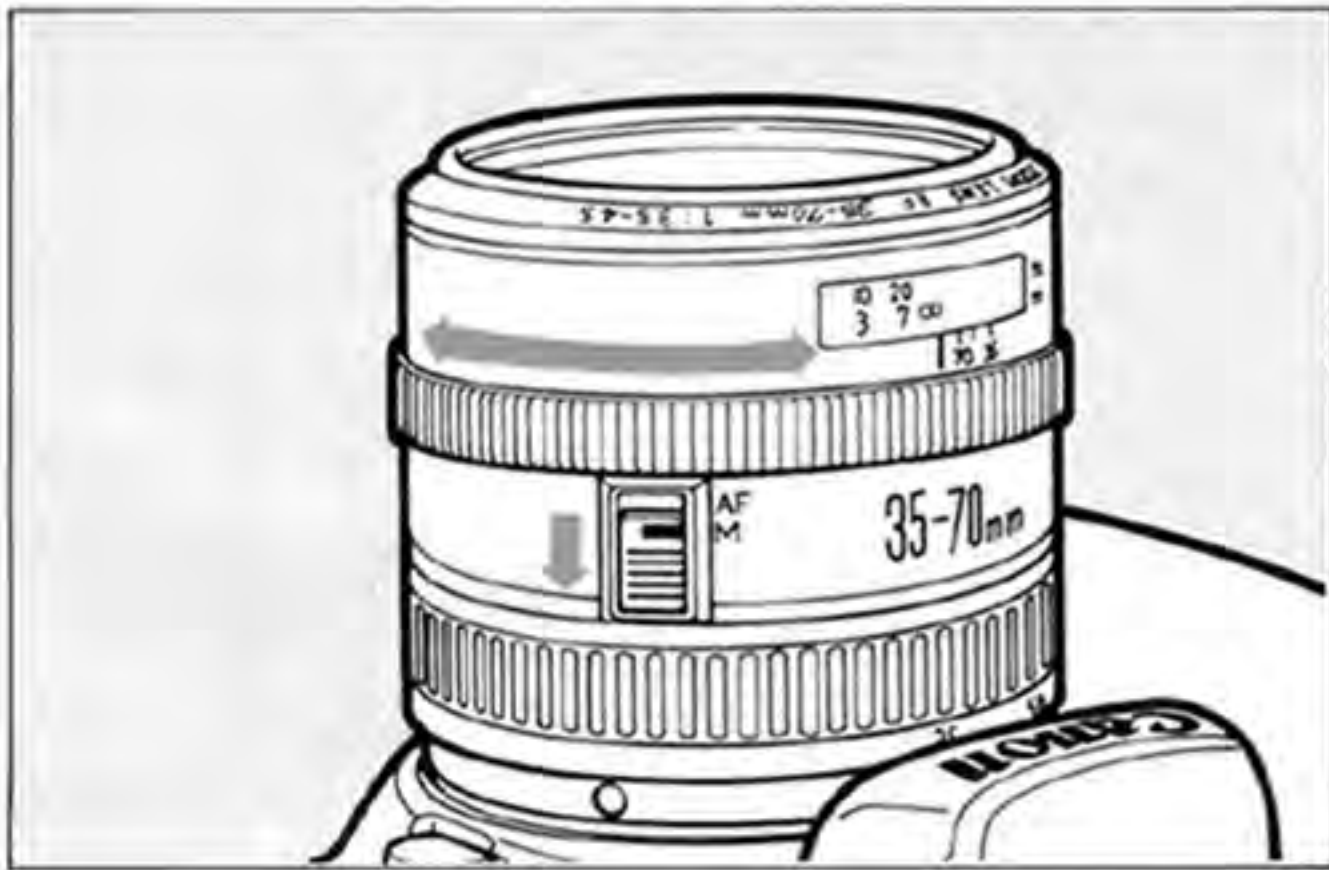

There are a few subjects that may be difficult for the camera to focus. The green AF symbol will blink in the viewfinder to warn you of this condition.

Subjects

- Extremely low-contrast subjects- misty scenes, light-colored or white objects.
- Subjects with an object in front of them- animals in a cage, subjects behind a wire fence.
- Strong, bright reflections- shiny metal, ice, surface of a lake.
- Fast-moving subjects- difficult to keep within the AF frame.

Focus these subjects by setting the lens' focus mode switch to "M" and turning the manual focusing ring until the image is sharp.



This setting for ***basic operation*** allows you to begin shooting immediately without making any settings before taking pictures.

- 1) Compose the picture and make sure **one of the focus marks covers the subject.**
 - 2) Press the shutter button halfway.
When the subject is in focus, the focus mark in use and the green AF symbol light up in the viewfinder. In low light or a backlit condition, the "⚡" mark blinks in the viewfinder. Press the flash button to pop up the flash and press again to retract it after exposure.*
 - 3) Press the shutter button all the way down.
- * See p. 36: "Fill-in Flash."
 - **For proper flash operation, do not attach an accessory shoe cover.**



The subject's eyes may appear red in flash photos due to the light reflected from the retina. To **minimize** this, have the subject avoid looking directly at the camera, and if indoors, turn on room lights.

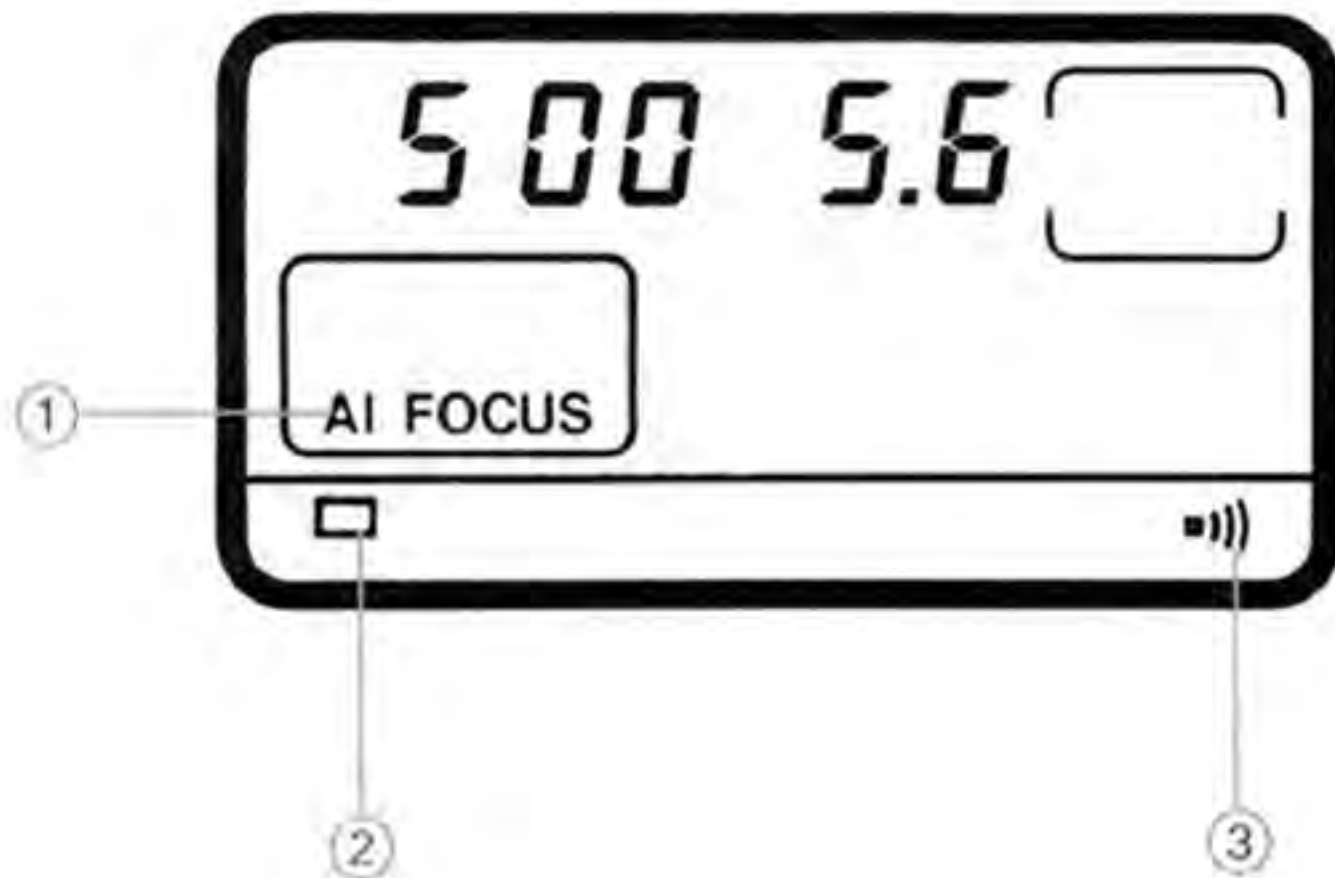

LCD Panel Information

When the command dial is set to , all controls are reset to the following condition which appears in the LCD panel.

- ① AI Focus mode (See p. 31)
- ② Single Frame Film Wind mode (See p. 32)
- ③ Camera Shake Warning Beeper Tone (See p. 39)
 - * All focus marks light up in the viewfinder indicating that three focus mark mode is set.
- See pp. 72 and 73 for a complete explanation of the LCD panel.

G. Film Load

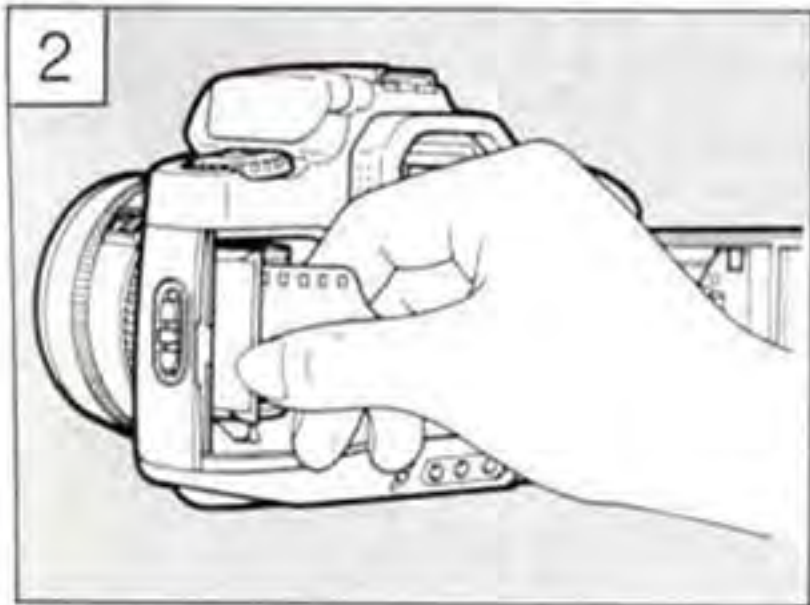
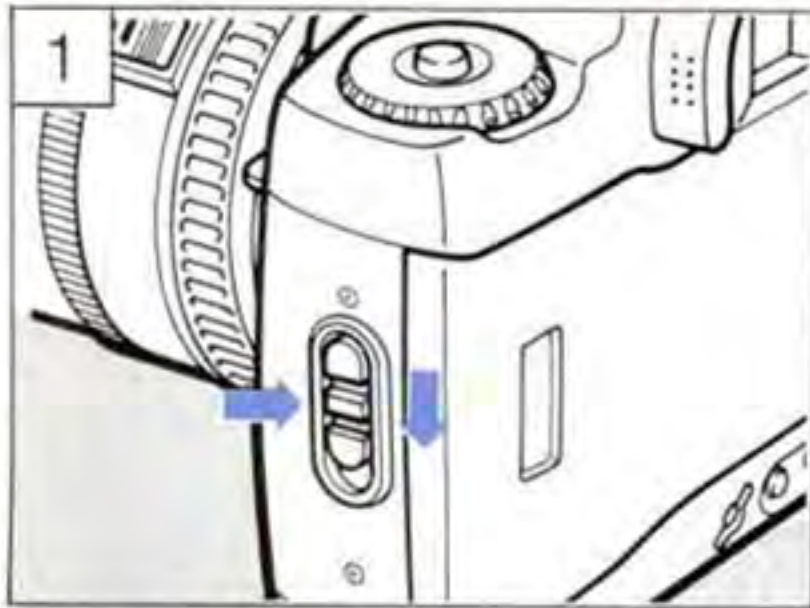

- Always load film **out of direct** sunlight.
- **Never touch the shutter curtain.** Its precision design makes it sensitive to pressure. When loading the film, be careful that the film tip does not touch the shutter curtain.

- 1) Open the back cover by pressing the back cover lock button and sliding the switch down.
- 2) Insert the film with the flat part of the cartridge on top. The film cartridge symbol will appear in the LCD panel.

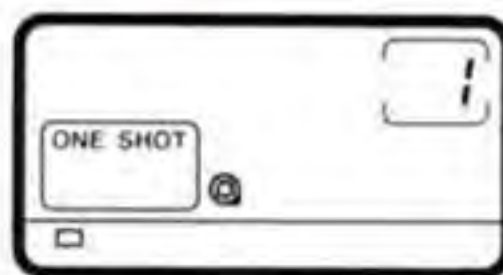
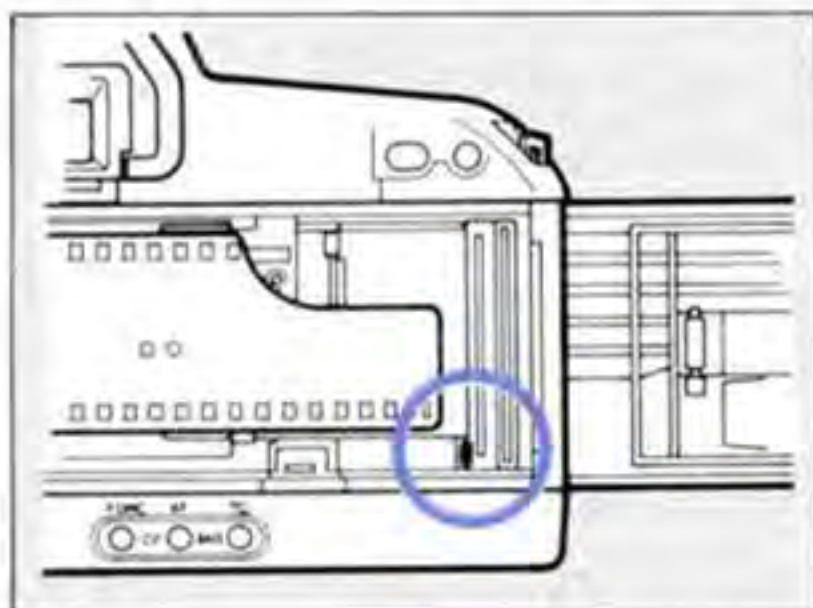
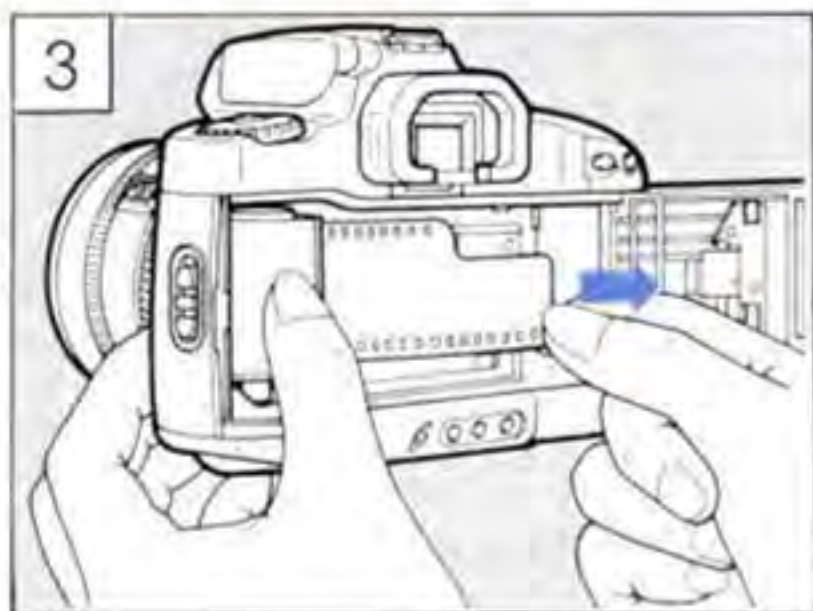

- 3) Carefully pull the film leader across until it reaches the orange mark.
 - 4) Make sure the film lies flat and close the back cover. The film automatically advances to the first usable frame and "1" appears in the frame counter.
- If the film cartridge symbol blinks, the film has not been loaded properly and the shutter will not release. Reload the film.
 - Film becomes soft and tears easily in high humidity. Keep it stored in its canister until loading.

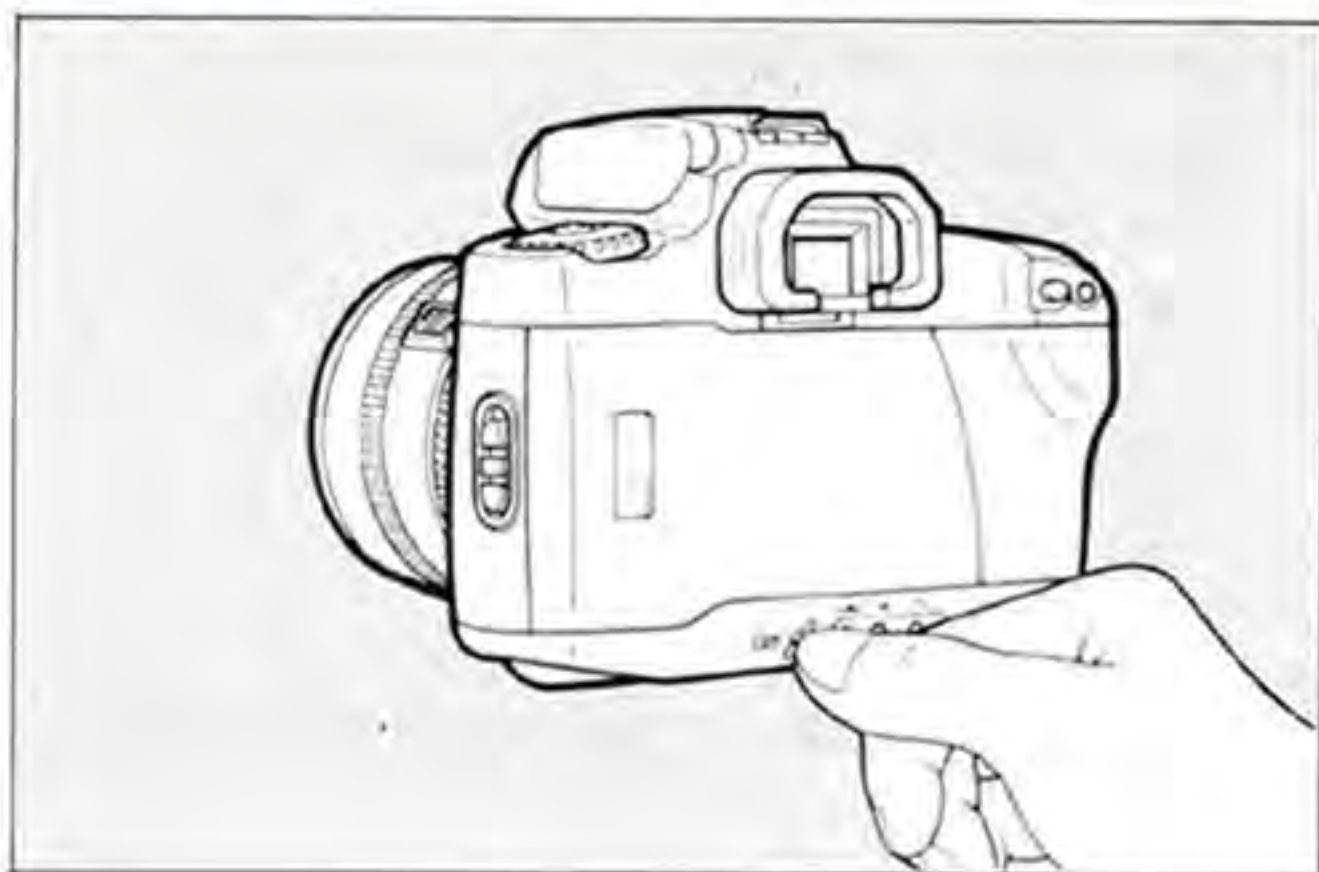

The film rewinds automatically at the end of the roll. The film leader is completely rewound into the cartridge in about eight seconds for 24-exp. film.

During rewind the frame counter counts back to "1" and the film cartridge symbol blinks when the process has finished. Remove the film only after the symbol starts blinking.

- Auto rewind may be canceled by setting Custom Function #1 on p. 67. In this case rewind is started by pressing the film rewind button.
- The film leader may be left out by setting Custom Function #2 on p. 67.

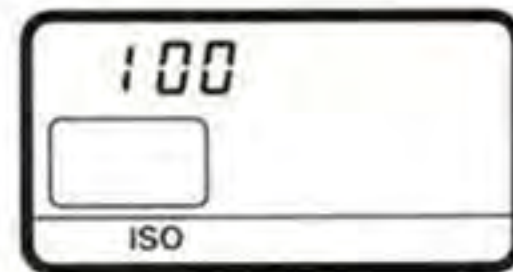
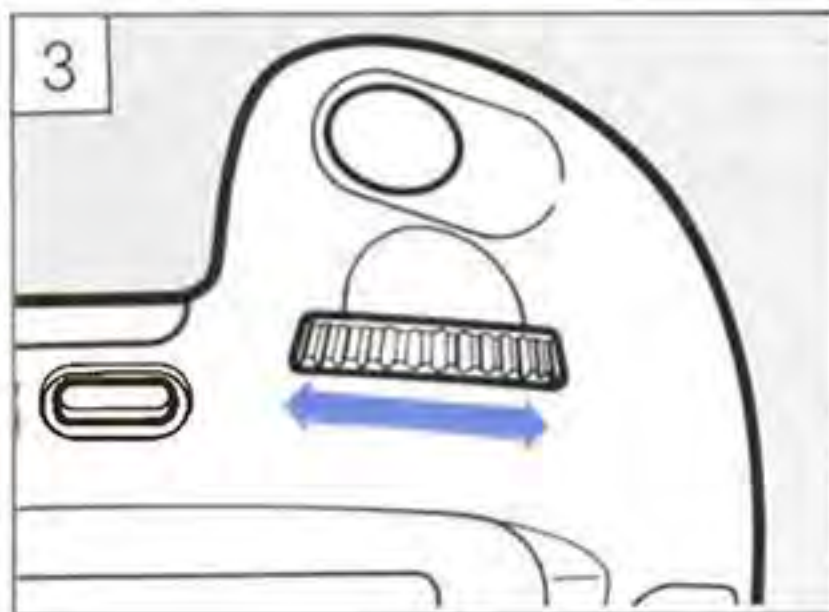
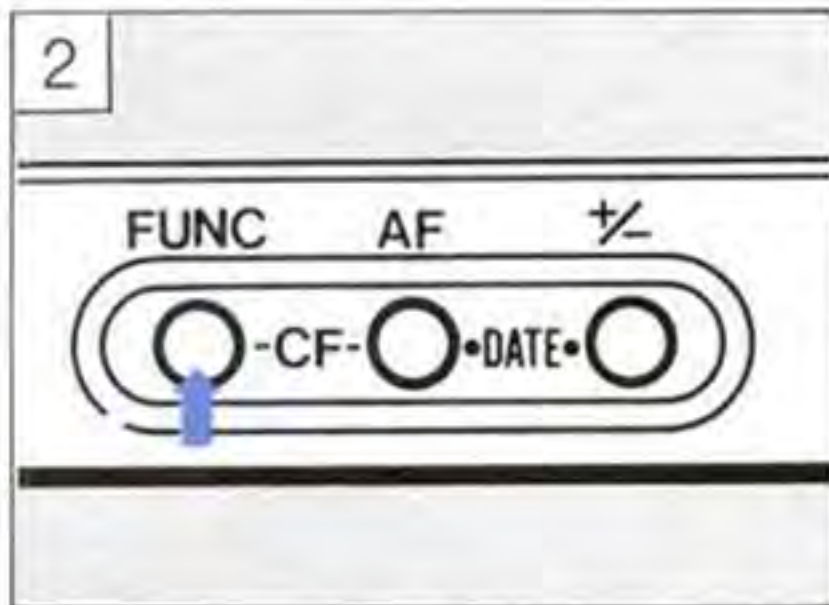
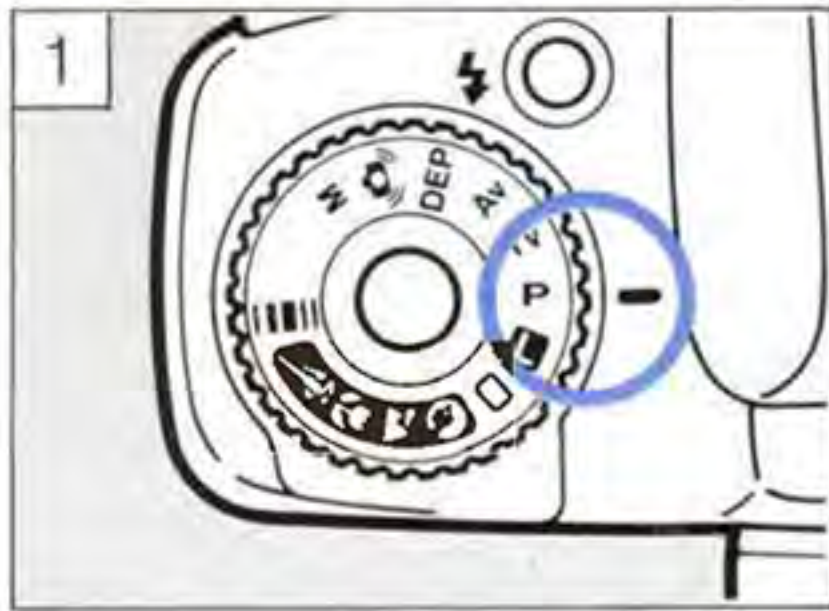

Film Speed Setting

The film speed for DX-coded film is automatically set according to the code on the cartridge from ISO 25-5000. The film speed appears in the LCD panel while the film advances to the first usable frame.

Non DX-coded Film Use

- 1) Set the command dial to P.
- 2) Press the function (blue) button to display **ISO**.
- 3) Turn the electronic input dial to set the desired speed from 6-6400. The display appears in the LCD panel for approximately six seconds.

To override the DX-code setting, set Custom Function #3 on p. 67. This will cancel the automatic setting for user input.



- When using *non-DX film* cartridges, the **ISO** mark blinks in the LCD panel. To change the ISO setting, follow the procedures explained for non DX-coded film use.

H. Programmed Image Control (P.I.C.)



With P.I.C., focus and film wind settings, as well as shutter speed and aperture value are made automatically for four types of pictures. These include portraits, landscapes, close-ups, and sports. This allows you to take pictures easily and concentrate on composition.

- **P.I.C. cannot be combined with an external flash.**



EF 28-80 mm f/2.8-4 L

- 👤 **Portraits** Settings: One Shot AF / Continuous wind / Evaluative metering

Narrow depth of field (see p.44) is generally used to emphasize the subject, therefore large apertures are set*. Fill the frame with the subject's upper body, and focus on the subject. Continuous film wind helps keep up with subtle changes in expression.



EF 35-70 mm f/3.5-4.5



EF 35-135 mm f/4-5.6

🏞️ **Landscapes** Settings: One shot AF / Single frame wind / Evaluative metering

Deep depth of field is usually the primary concern in landscape photography. This setting automatically sets small apertures for deep depth of field.

🌹 **Close-ups** Settings: One shot AF / Single frame wind / Partial metering

Depth of field is always a problem in macro photography. This setting selects small apertures *to insure a greater area of acceptable focus.



EF 70-210 mm f/3.5-4.5

-  **Sports** Settings: AI servo AF / Continuous wind / Evaluative metering
Faster shutter speeds are emphasized to help you keep up with all the action while AI servo tracks the subject's movement. Keep the autofocus marks on the subject.
- The central focus mark must be used for initial focusing operation.

* With portraits and close-ups, the new USM lenses (EF 35-135 mm f/4-5.6, EF 70-210 mm f/3.5-4.5 and 100-300 mm f/4.5-5.6) and the EF Macro 100 mm f/2.8 determine the background effect (blurred or sharp) based on the distance from camera to subject.

**TRY MORE CREATIVE PHOTOS WITH THE
POSITIONS ABOVE THE RED  MARK**

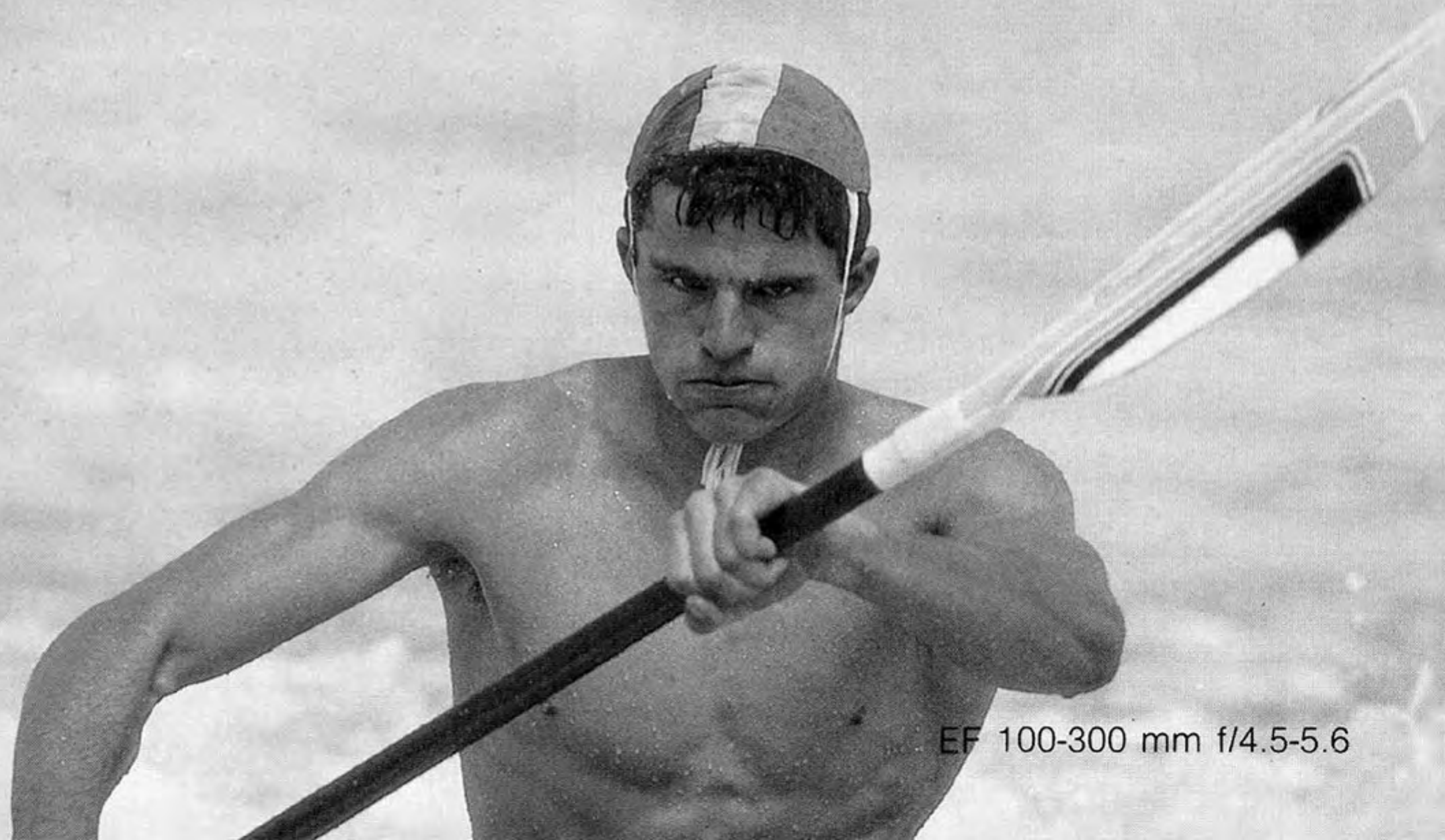

EF 100-300 mm f/4.5-5.6

I. Selecting the Focus Mark and AF Mode

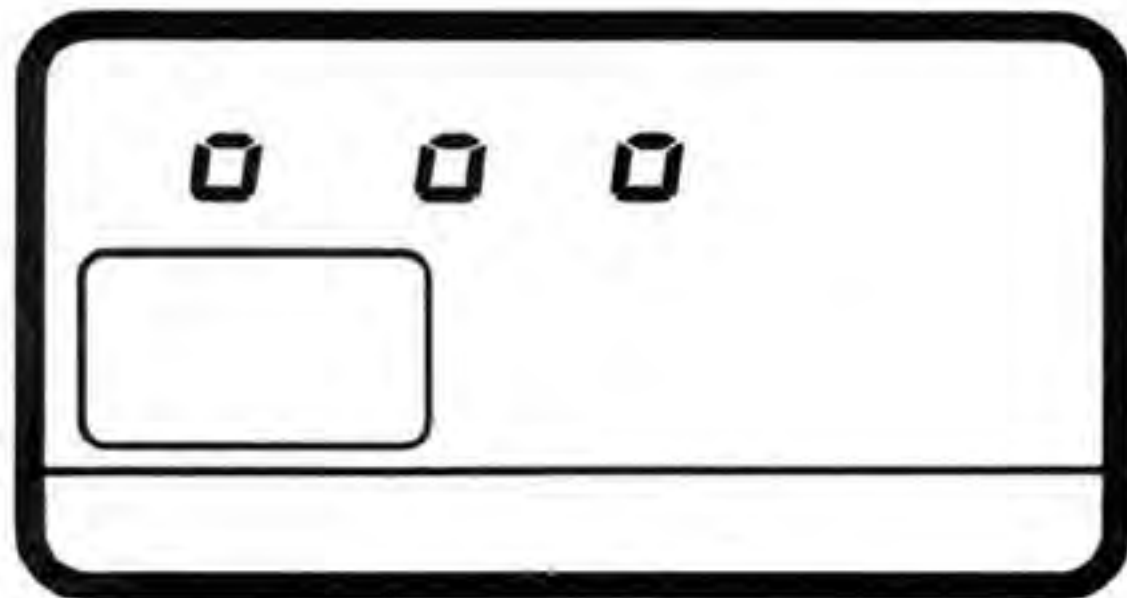
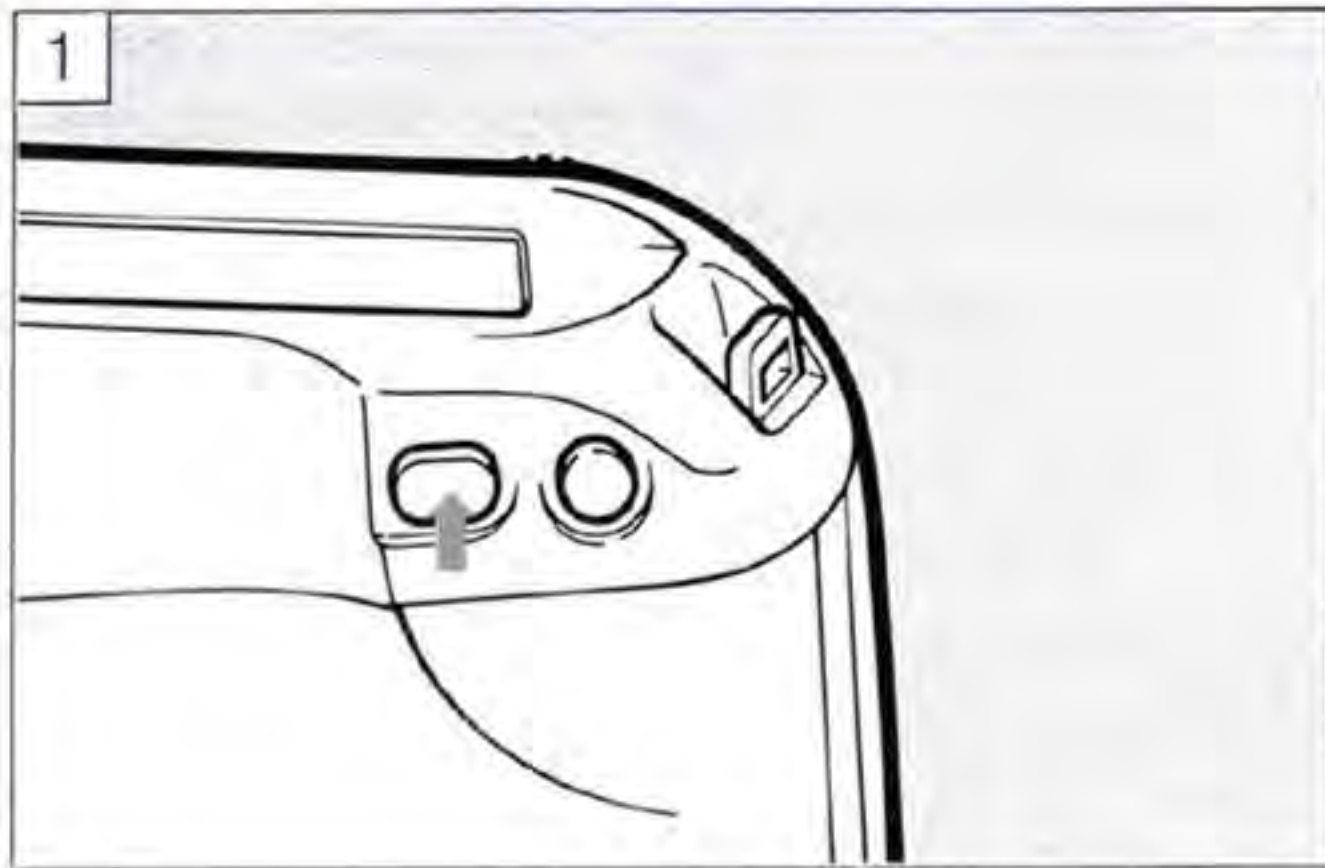





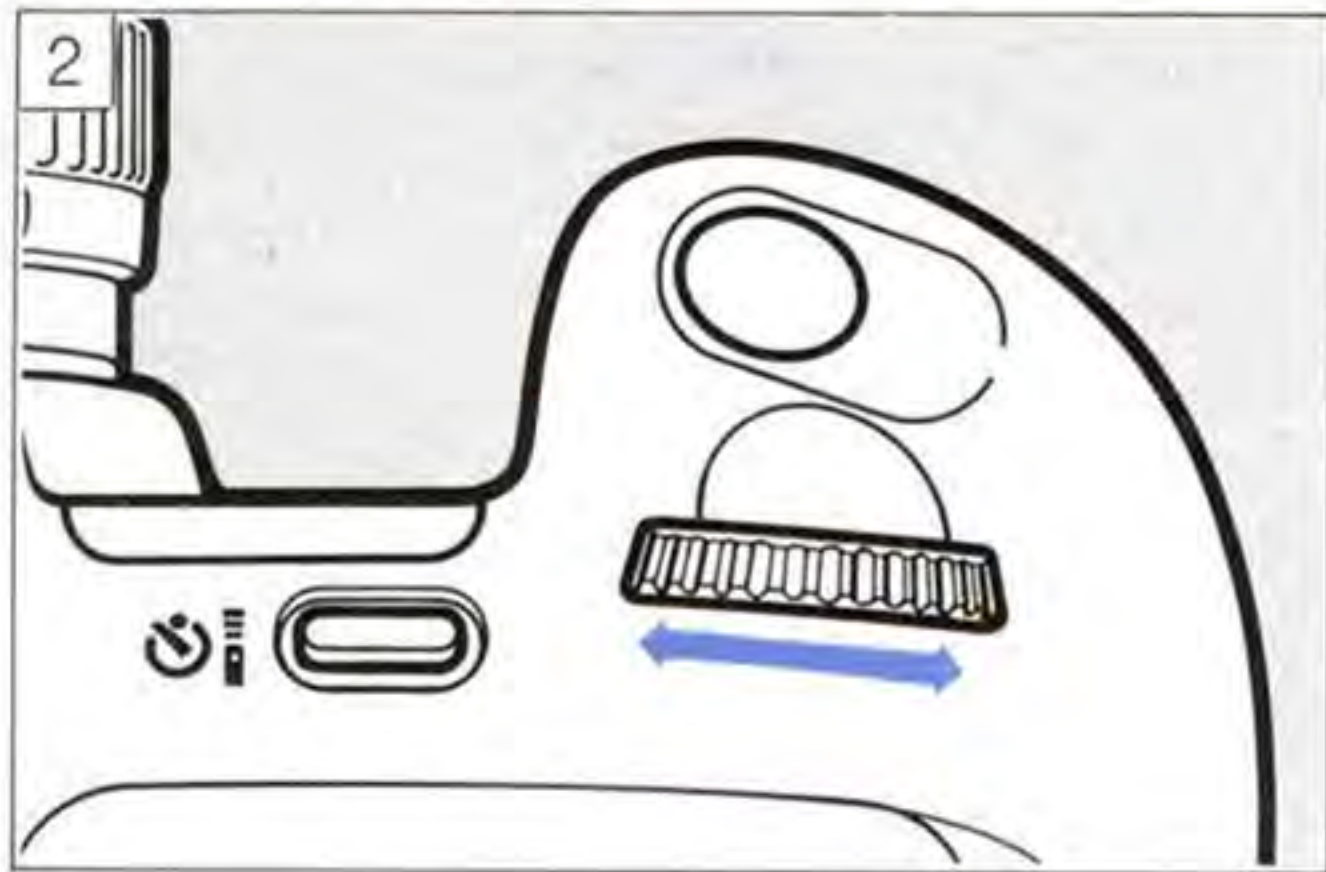

This camera's flexible focus system uses *three focus marks*. You decide which marks to use. The system evaluates the scene to decide where the main subject is, providing better accuracy for moving subjects.

However, when you want to take an extremely off-center subject without changing composition, etc., select one focus mark. **This cannot be set if the command dial is at the green zone, P.I.C., or bar-code setting.**

- 1) Press the focus mark (black oval) button to display **000** in the LCD panel and in the viewfinder.



- 2) Turn the electronic input dial to select the desired focus mark. **This operation can be done by looking through the viewfinder.** The selected focus mark lights up in the viewfinder and extinguishes during focusing, and lights up once again when the subject is in focus.
- Once the command dial is set at , , , ,  or , the focus mark is reset automatically to three focus mark mode.

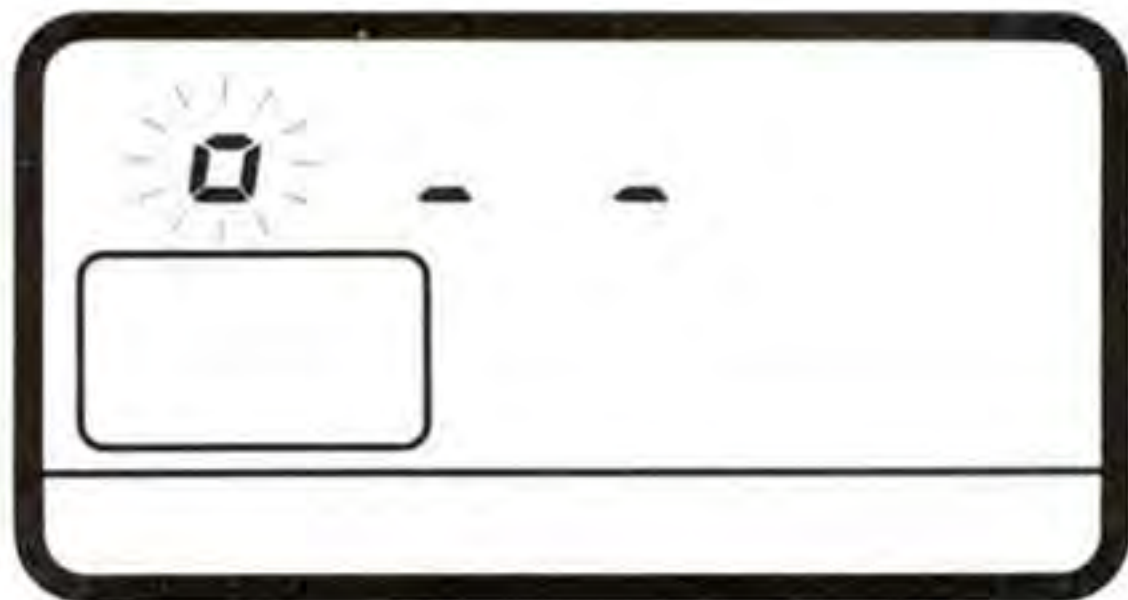

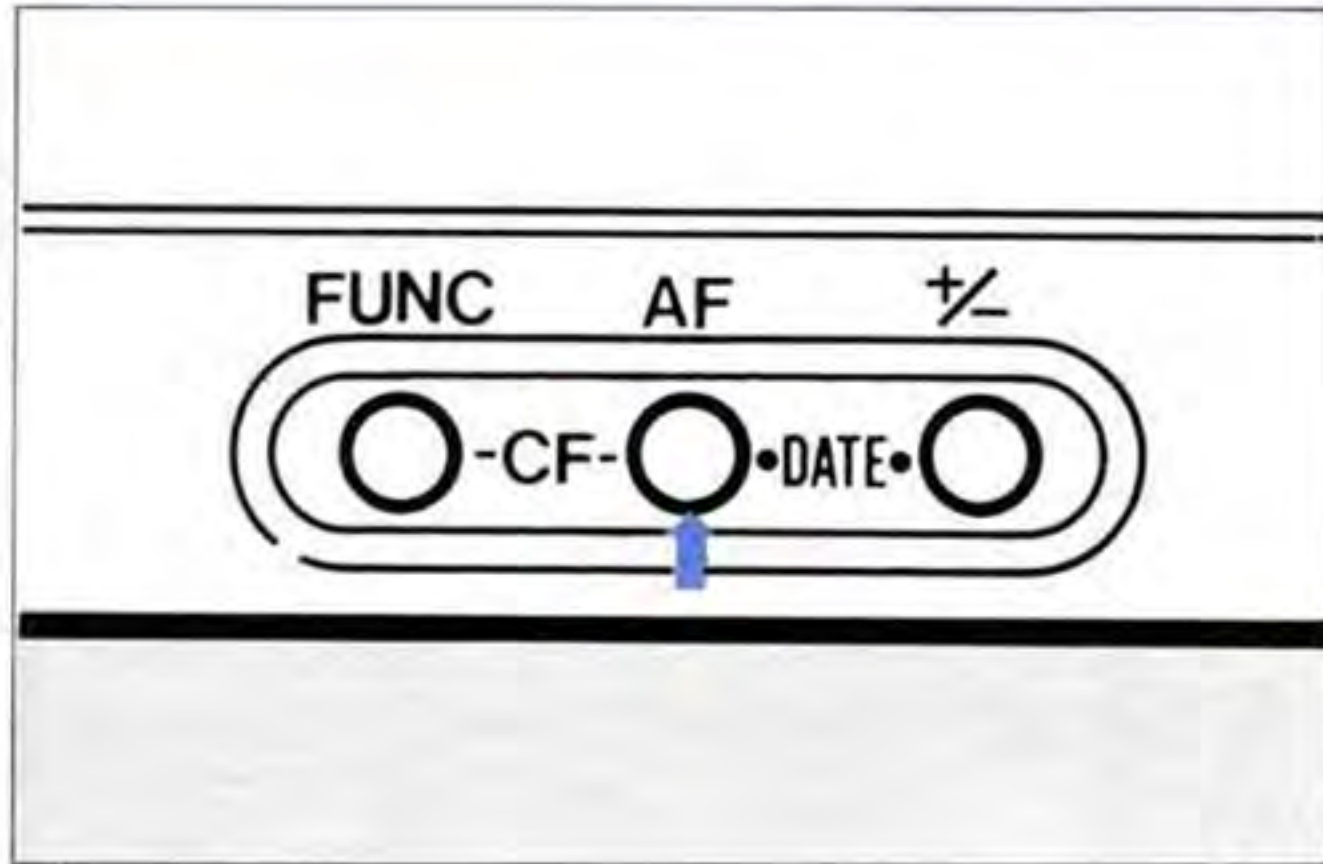

Setting the AF Mode

This camera has three AF modes. Set the AF mode by pressing the AF mode (yellow) button and turn the electronic input dial.

This cannot be set if the command dial is at the green zone, P.I.C., or bar-code setting.

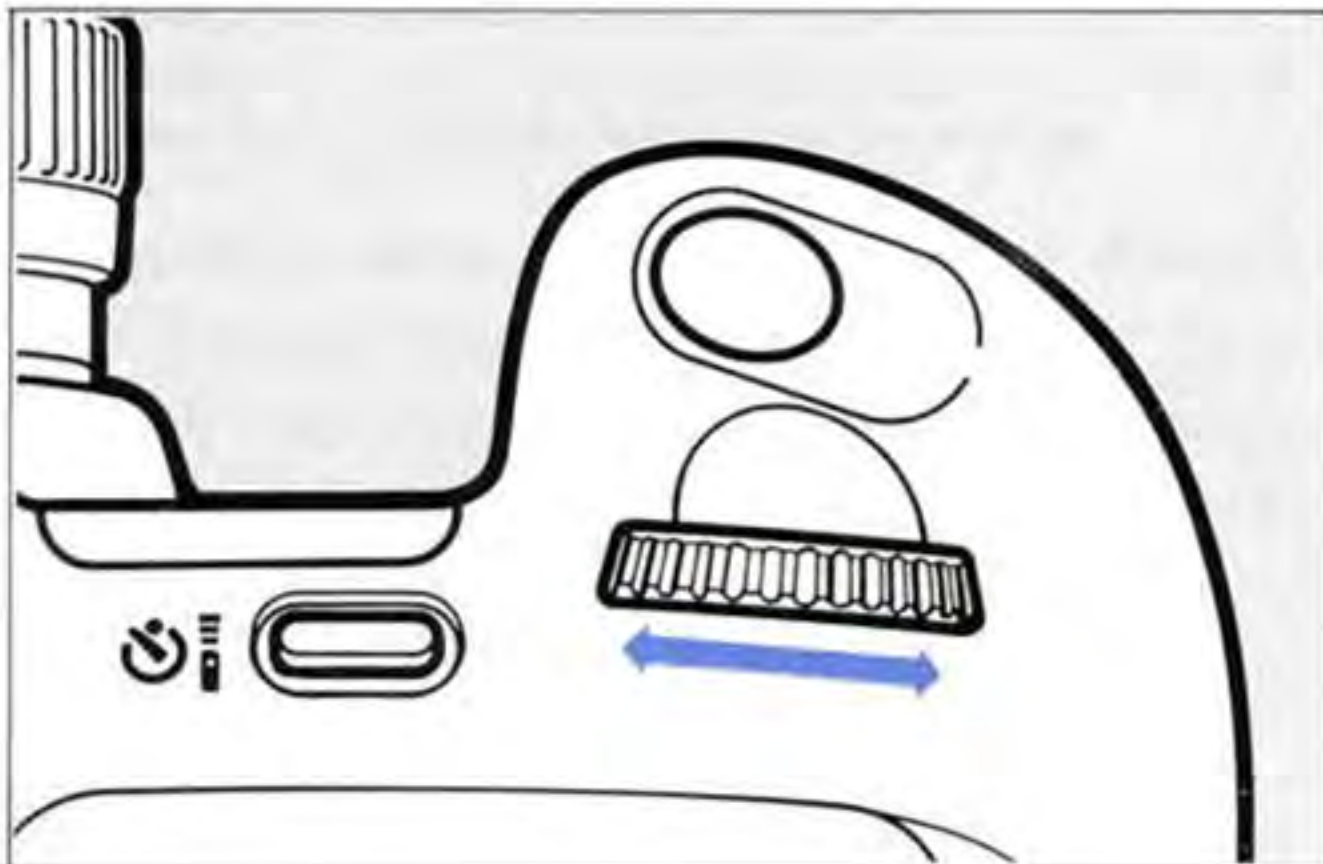

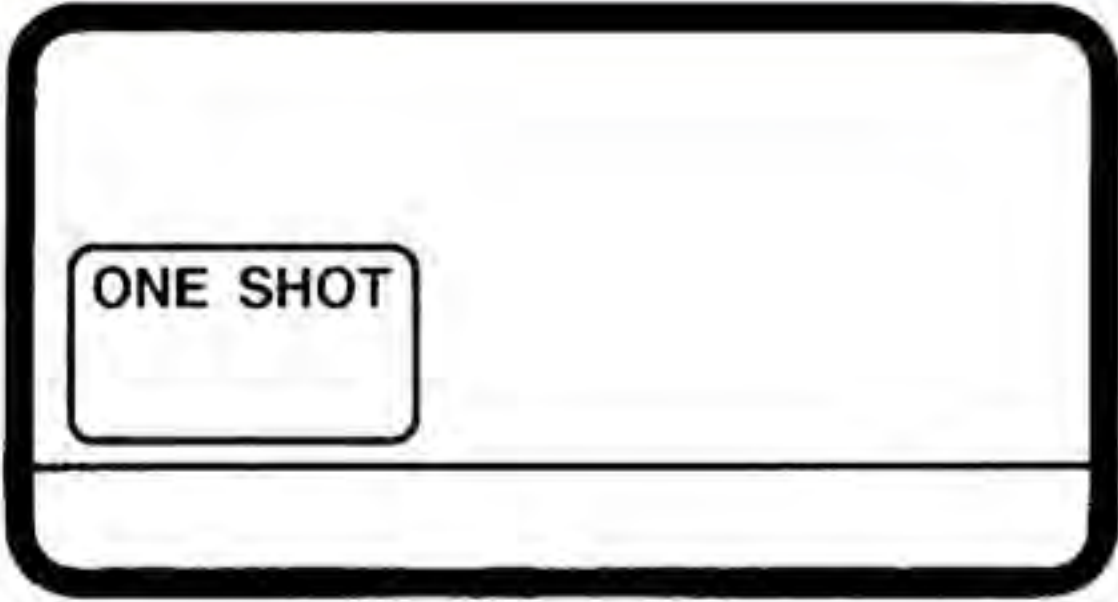
A diagram of a camera's mode selector dial. A small rectangular window on the left side of the dial is labeled "ONE SHOT". The rest of the dial is blank.

ONE SHOT

A diagram of a camera's mode selector dial. A small rectangular window on the left side of the dial is labeled "AI SERVO". The rest of the dial is blank.

AI SERVO

One Shot: The lens stops moving once the subject is in focus. As long as the shutter button is kept pressed halfway, the original focus and exposure remain locked.

- The shutter releases only after AF completion.

AI Servo: The lens continues to rotate, refocusing every time the focusing distance changes. Use this mode to freeze subject motion at a certain moment while following a moving subject. When the subject's speed increases, **Focus Prediction Control** activates automatically. Since it anticipates the subject's speed and distance, focus constantly adjusts from the moment the shutter button is pressed to the point of exposure.

Exposure is determined at the moment of shutter release. The AF in-focus symbol and beeper tone are cancelled.

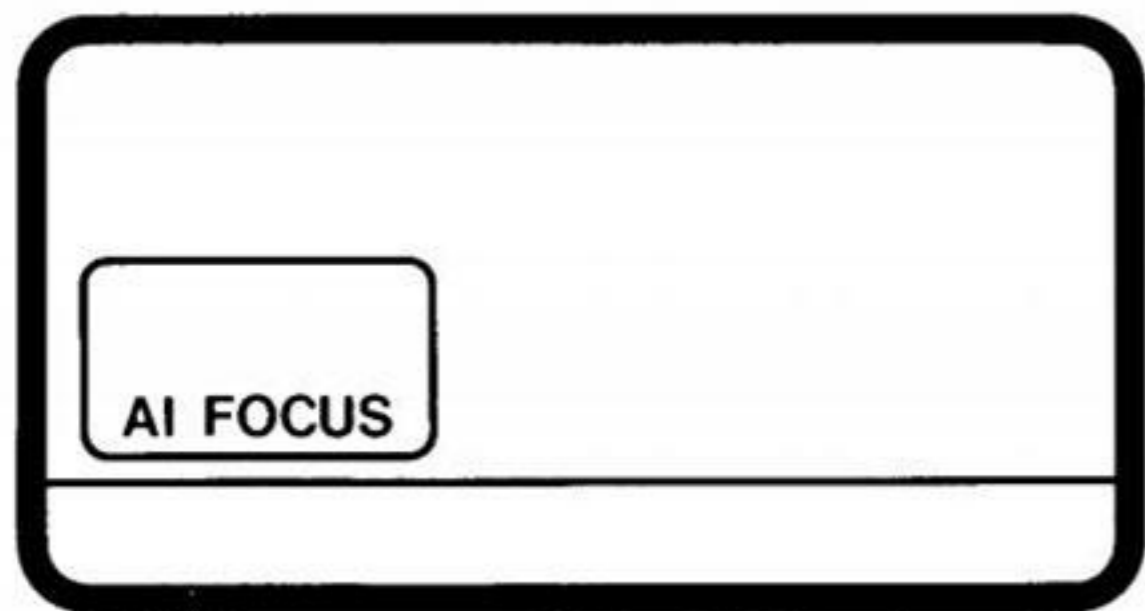

- When combined with three focus mark mode, the middle focus mark must be used for initial focusing operation.
- The shutter releases only after AF completion.

AI Focus: This mode is active only when the command dial is set at . The camera selects the appropriate focus mode based on the subject. **After AI servo is activated, the focus mode will not change.**

J. Film Wind Mode

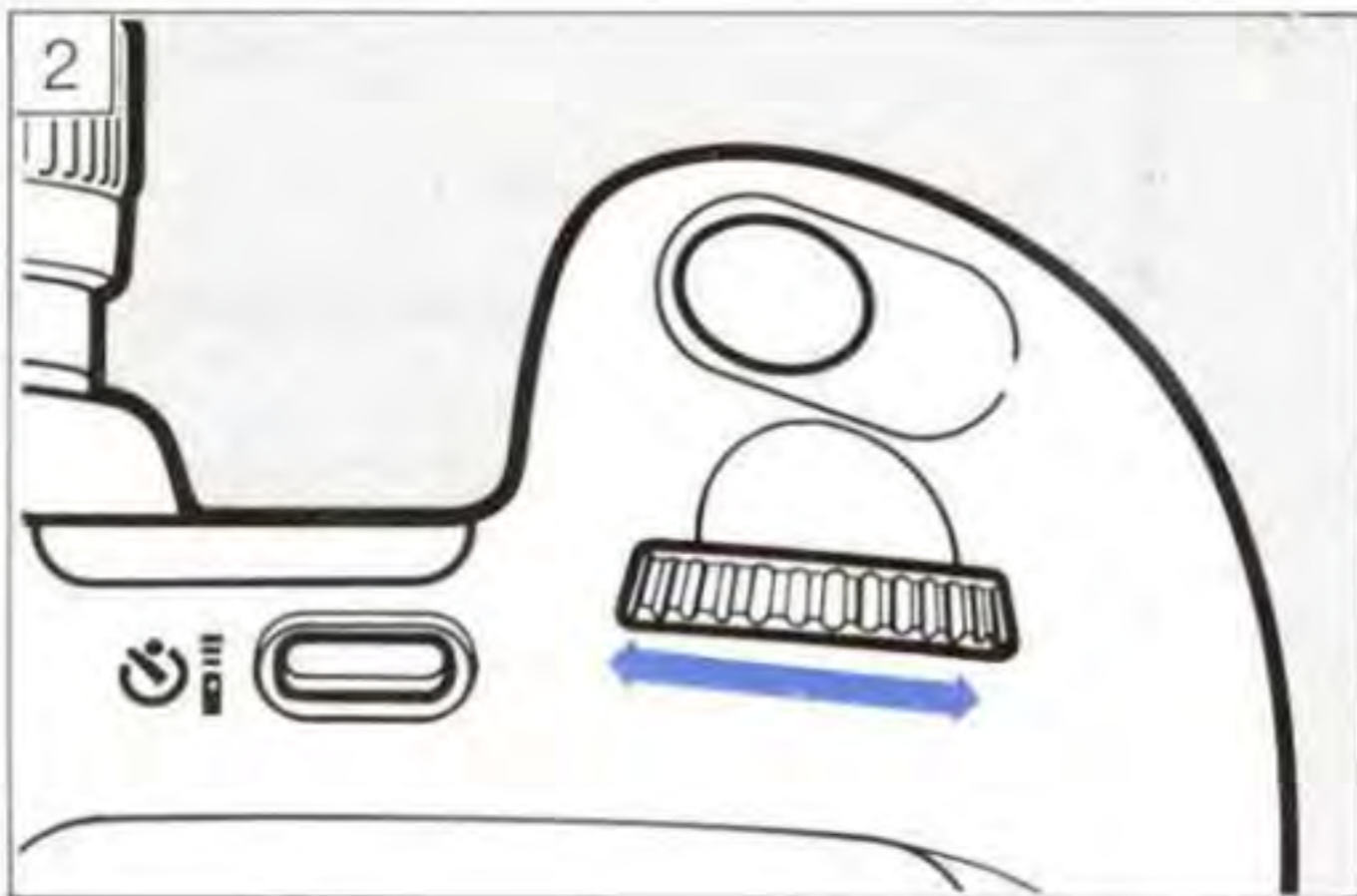
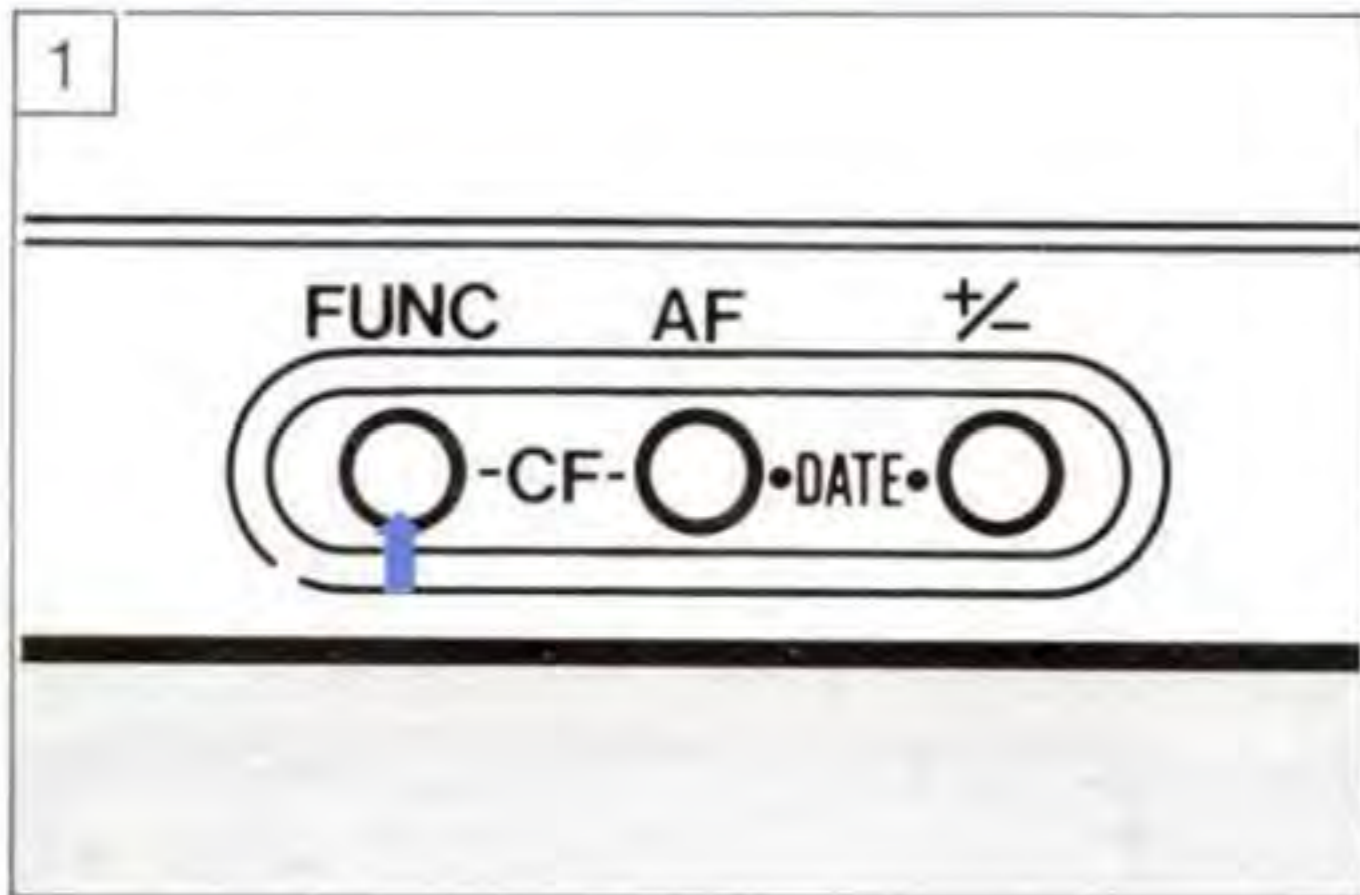

There are two film wind modes.

- : Single frame advance winds the film to the next frame after exposure.
- ☰ : Continuous frame advance winds the film at a maximum 5 fps in one-shot AF mode and 3 fps in AI servo AF mode when the shutter button is held.

- 1) Press the function button (blue) to display the film wind symbol.
- 2) Turn the electronic input dial to set the desired mode.
 - Once the command dial is set at □, ☰, ☹, ☼, 🏃, or 📷, the previous film wind mode setting is canceled.

K. Self-timer

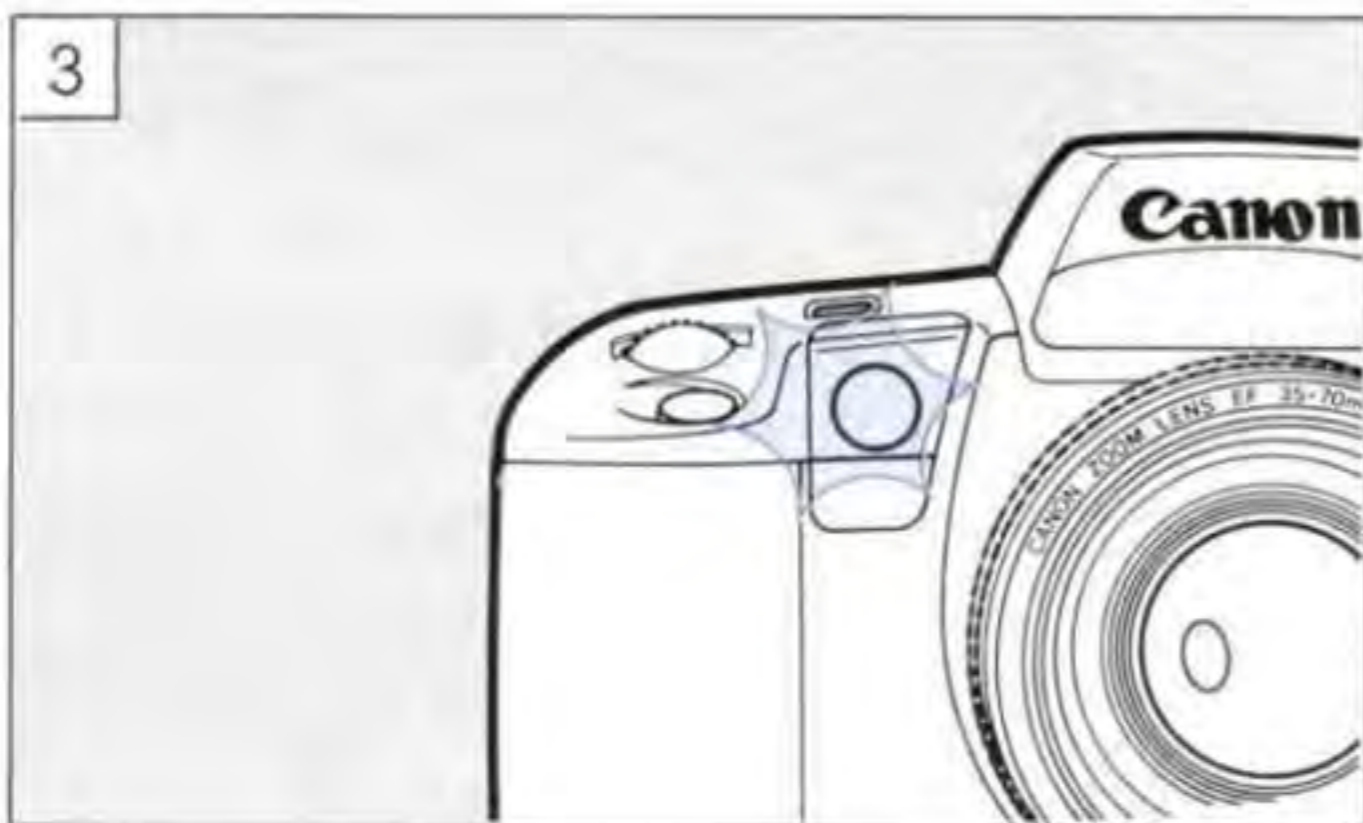
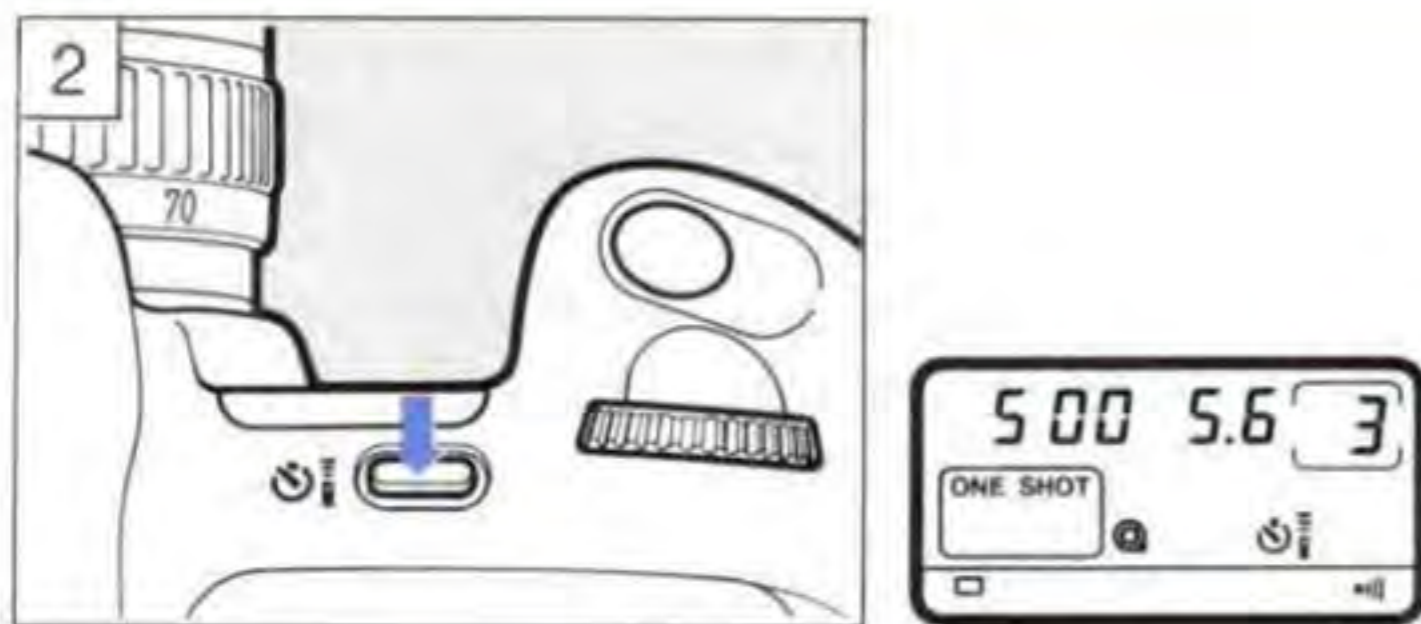

Use the self-timer function to delay shutter release for 10 seconds and include yourself in the picture. Place the camera on a tripod, table, or other steady surface.

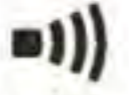
- 1) Focus the subject and compose the picture as desired.
- 2) Press the self-timer button.  appears in the LCD panel to confirm that the function is set.
- 3) Press the shutter button to start the timer. Two indicators monitor the countdown, the red LED starts blinking and the beeper tone sounds. Two seconds before the picture is taken, these indicators operate rapidly.
 - The beeper tone can be canceled. Press the function button (blue) to display  and Y and turn the electronic input dial to change Y to N.

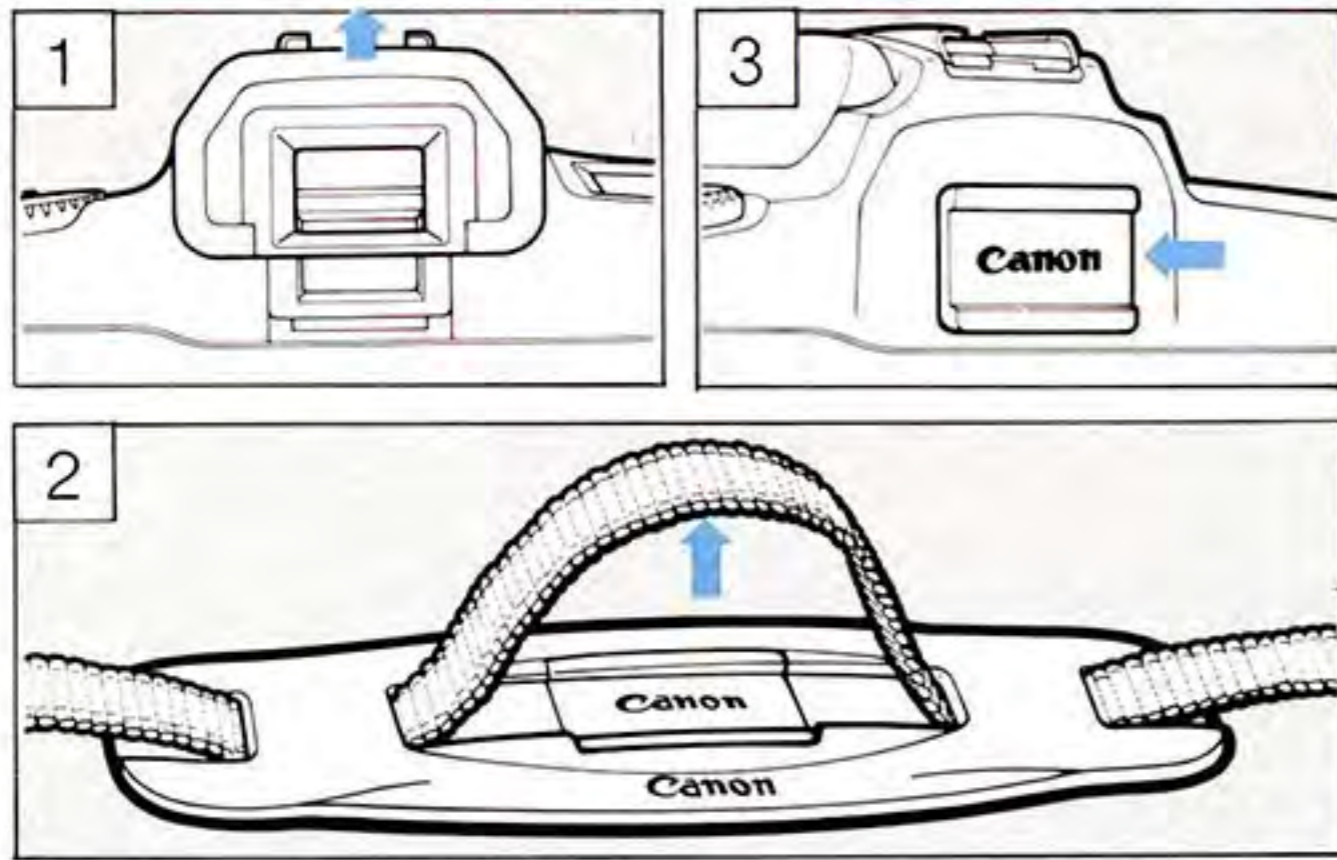

EF 35-105 mm f/3.5-4.5

When using the self-timer or the remote controller, and your eye will not be at the viewfinder when you press the shutter button completely, use the viewfinder cover to prevent stray light from entering.

- 1) Remove the eyecup frame by sliding it up.
- 2) Remove the viewfinder cover from the shoulder pad.
- 3) Attach the viewfinder cover.

The **Remote Controller RC-1**, optionally available, allows you to take pictures up to 16.4 ft / 5m away. There are two delay releases, immediate and two seconds. For convenient carrying, the controller attaches to the neckstrap.

- The two-second delay release on the remote controller can be combined with Custom Function # 13, mirror-up (see p. 68) for bulb, long exposure. See p. 53 for more information on bulb.

L. Setting the Shooting Mode

Turn the command dial to select the desired shooting mode



EF 50 mm f/1.8

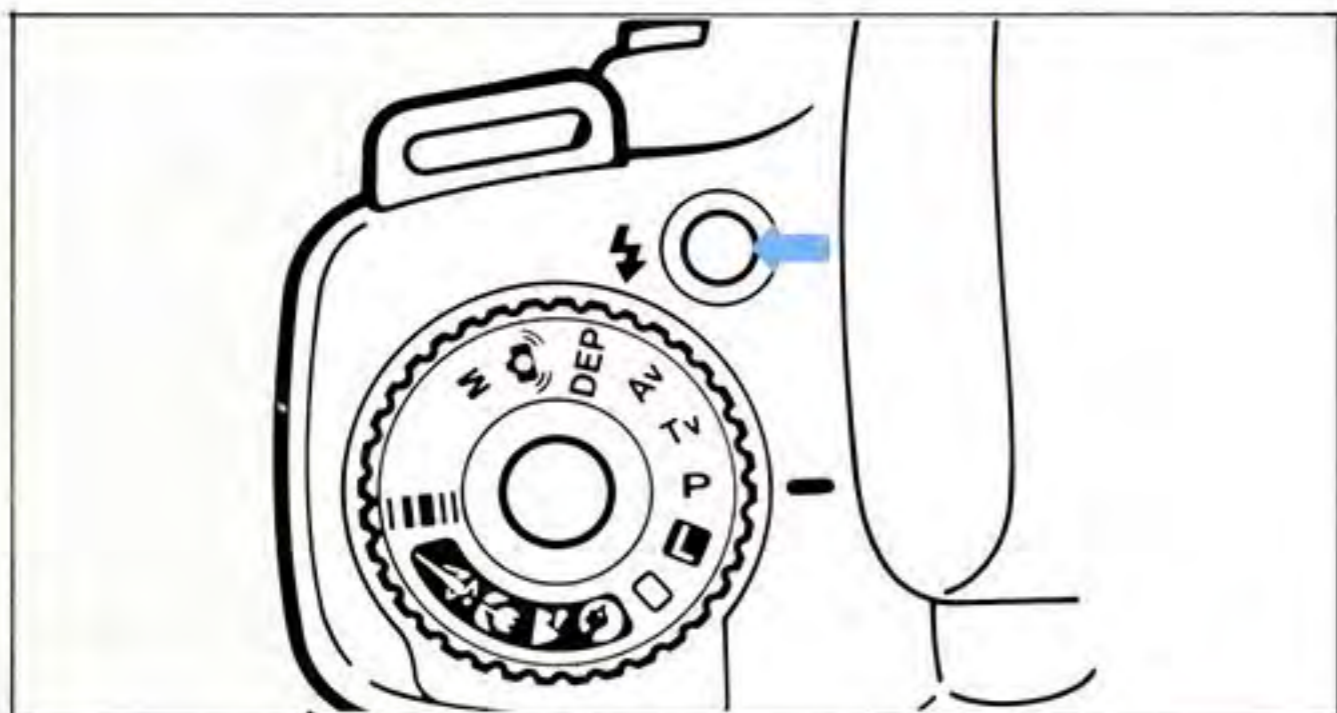
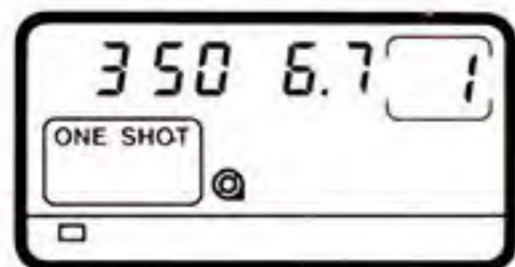

Program AE (P)

The camera sets both aperture and shutter speed automatically, taking into account the lens in use. For the program line, please see p. 78. The Program AE mode has the same characteristics as the green zone , however, AI Focus and single film winding are automatically set. Use the setting described on this page when you want to change the AF mode or use continuous film winding mode.

Viewfinder Information

If the shutter speed and aperture blink, exposure will be incorrect. Use a neutral density filter in bright settings or switch to flash photography in dark settings. **For flash operation, press the flash button, but wait until “” lights up before taking the picture.**



EF 50-200 mm f/3.5-4.5 L

- Using the following large-diameter lenses may cause shading at the lower part of flash photos:

EF 200 mm f/1.8L	EF 300 mm f/2.8L
EF 20-35 mm f/2.8L	EF 28-80 mm f/2.8-4L
EF 80-200 mm f/2.8L	EF 50-200 mm f/3.5-4.5
EF 50-200 mm f/3.5-4.5L	

- Using a lens of a focal length shorter than 35 mm may cause shading around the edges of flash photos.

Fill-in Flash:

The aim of fill-in flash is to provide just enough light to prevent the subject from being underexposed in backlit conditions. This lighting needs to be balanced to avoid unnatural effects. Fortunately with the built-in flash, this light is controlled to produce the best possible results.

Viewfinder Information

If the aperture value blinks, the subject will be exposed correctly, but the background overexposed.

- To prevent shading, do not use a lens hood when using the built-in flash.

A subject's eyes may appear red in flash photos due to the light reflected from the retina. To minimize this, have the subject avoid looking directly at the camera. If indoors, turn on additional room lighting.

Built-in Flash

The flash is designed to fire based on the focus mark covering the subject, therefore even if off-center, the subject will be correctly exposed. The flash guide number is 39.3 ft/12 m at ISO 100.

Flash Coupling Range

(When using color negative film)

[m/ft]

Aperture Value	ISO 100	ISO 400
2.8	1.0 ~ 6.0 / 3.3 ~ 19.7	2.0 ~ 12.0 / 6.6 ~ 39.4
4.0	1.0 ~ 4.2 / 3.3 ~ 13.8	1.4 ~ 8.4 / 4.6 ~ 27.6
5.6	1.0 ~ 3.0 / 3.3 ~ 9.8	1.0 ~ 6.0 / 3.3 ~ 19.7
8.0	1.0 ~ 2.1 / 3.3 ~ 6.9	1.0 ~ 4.2 / 3.3 ~ 13.8
11	1.0 ~ 1.5 / 3.3 ~ 4.9	1.0 ~ 3.0 / 3.3 ~ 9.8
16	—	1.0 ~ 2.1 / 3.3 ~ 6.9
22	—	1.0 ~ 1.5 / 3.3 ~ 4.9

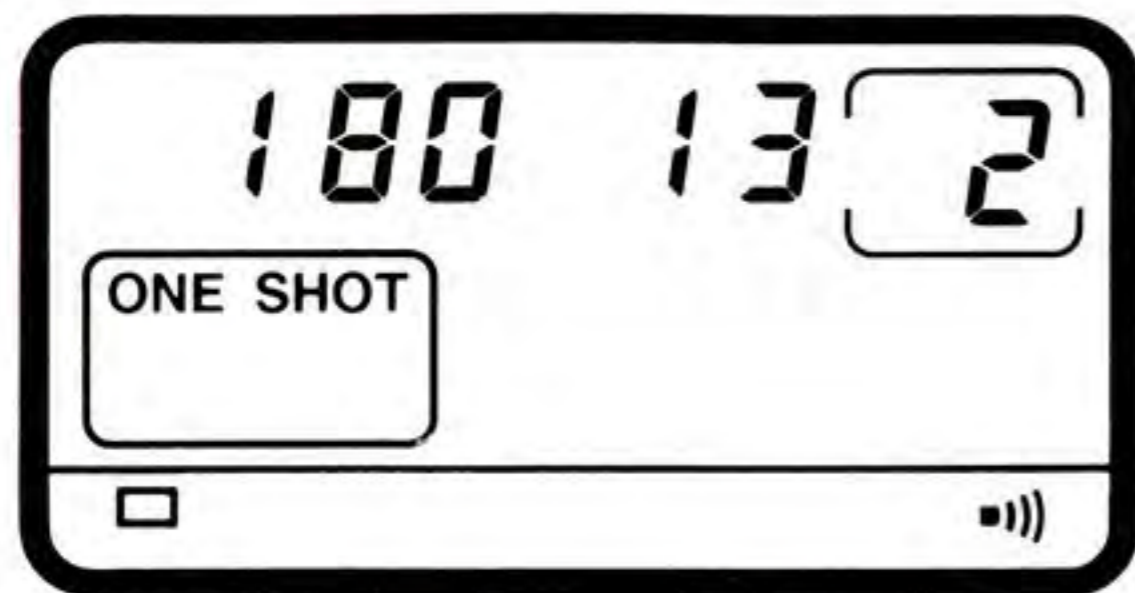

Program Shift

When you need a specific shutter speed or aperture value while shooting in program AE, turn the electronic input dial. This adjustment will clear after one exposure.

- **Program shift cannot be used with a flash.**
- See p. 79 for program shift characteristics.

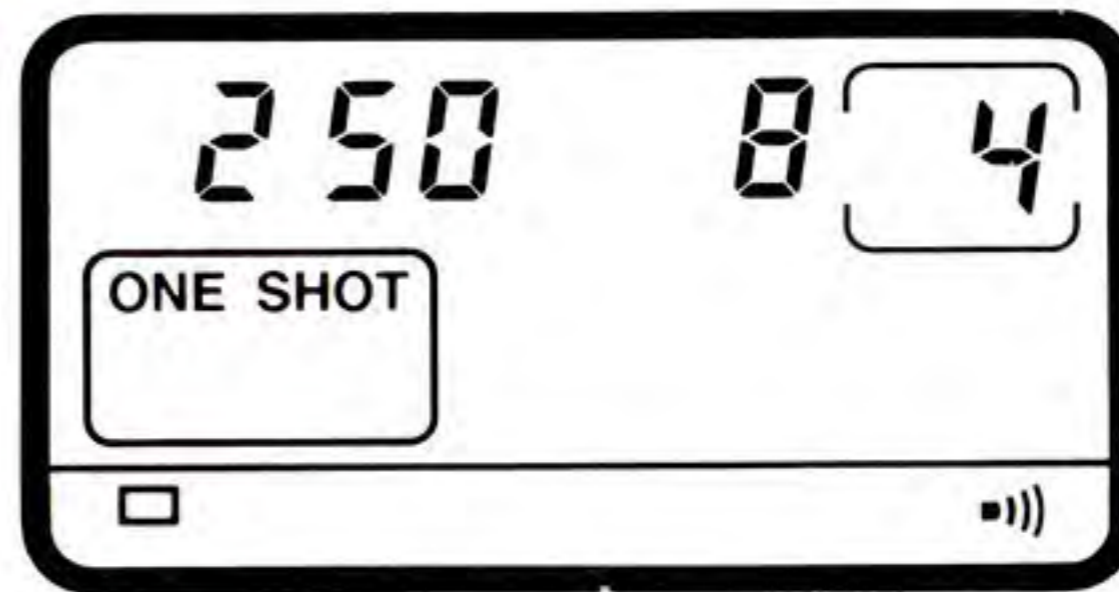
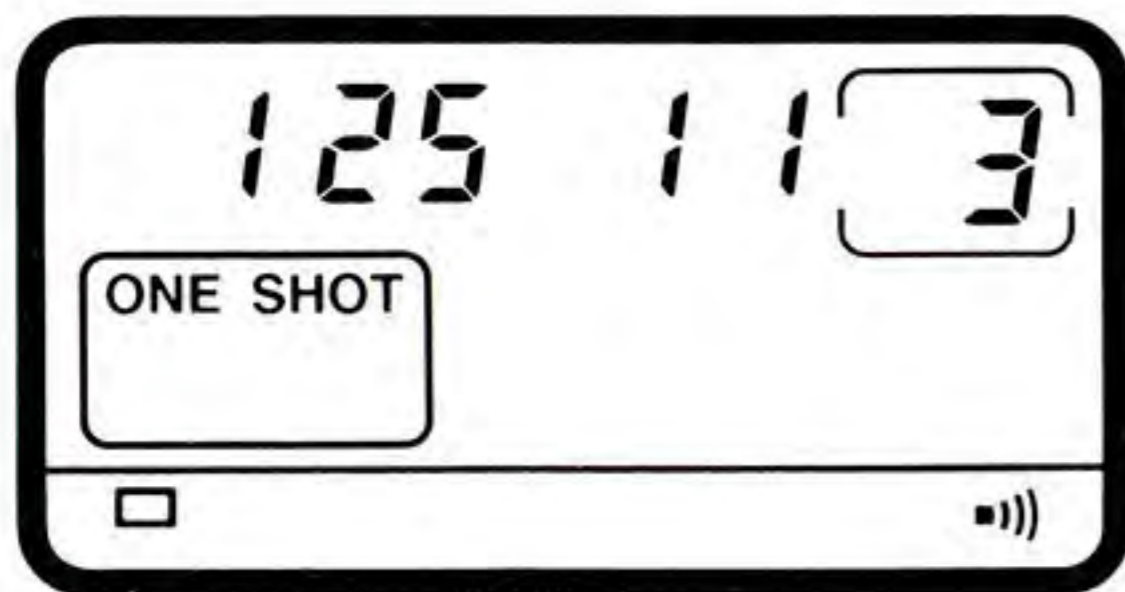

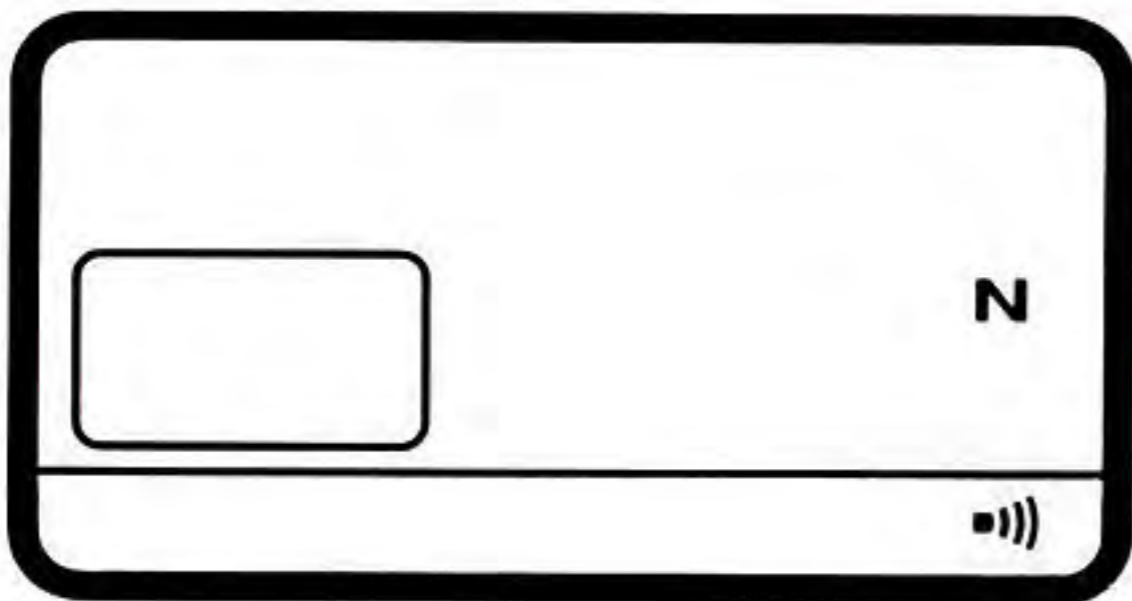
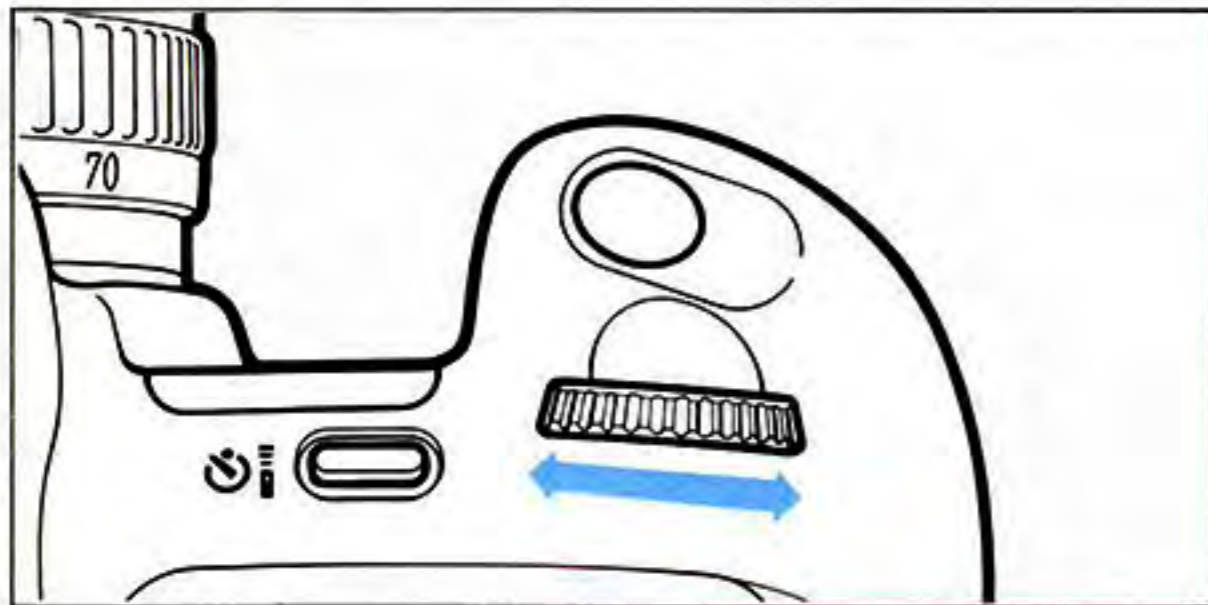
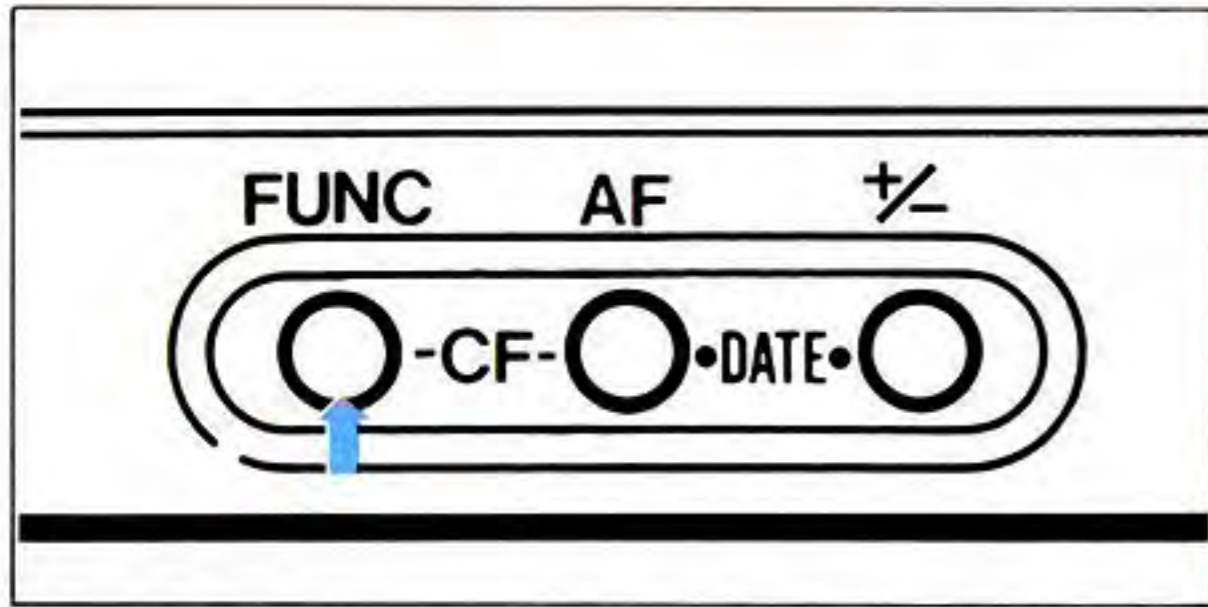

Camera Shake Warning Beeper Tone (■|||)

To prevent a blurred picture caused by camera shake, press the function (blue) button to display ■||| and turn the electronic input dial to display Y. For program AE (P), Aperture-priority AE (Av), Depth-of-field AE (Dep) and Camera-shake Alert (📷), a beeper tone sounds when the automatically-set shutter speed becomes **0 to 0.5 stops slower than “1/focal length of the lens in use”**. This is generally said to be **the limit for hand-held shooting**. However, if you want to cancel the warning, repeat the operation explained above to display ■||| and N.



EF 35-135 mm f/4-5.6



Shutter-Priority AE (Tv)

In this mode the user selects the shutter speed and the camera sets the aperture for the lighting conditions. This mode is best for taking pictures of moving subjects by controlling the shutter speed. Faster shutter speeds freeze subject motion while slower shutter speeds can produce artistic blur effects.

- The initial shutter speed setting is always 125 (1/125). Turn the electronic input dial for the desired shutter speed.

Shutter Speed Display

4000 3000 1000 750 500 350 250 180
125 90 60 45 30 20 15 10 8 6 4 3 2 0''7
1'' 1'' 5 2'' 3'' 4'' 6'' 8'' 10'' 15'' 20''
30''



EF 20-35 mm f/2.8 L

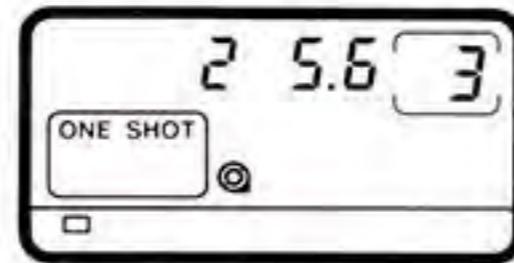

Viewfinder Information

Underexposure — the lens' maximum aperture starts blinking.

Set a slower shutter speed until it stops blinking.

Overexposure — the lens' minimum aperture starts blinking.

Set a faster shutter speed until it stops blinking.

Flash Use Information

If the lens' maximum aperture blinks, the main subject will be correctly exposed, but the background underexposed. The value may stop blinking if a slower shutter speed is set.

If the lens' minimum aperture blinks, the main subject will be correctly exposed, but the background overexposed. The value may stop blinking if a faster shutter speed is set.



EF 200 mm f/1.8 L

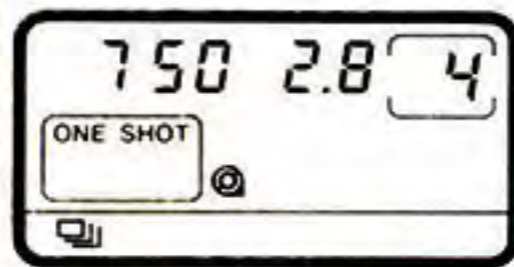

Aperture-Priority AE (Av)

In this mode, the user selects the aperture and the camera sets correct shutter speed for the lighting conditions.

Use this mode for portraits, landscapes, and still life photography where depth of field (see p. 47) is an important factor.

- The initial aperture value setting is always 5.6 (f/5.6). Turn the electronic input dial for the desired aperture value.

Viewfinder Information

Underexposure — the shutter speed of 30'' (30 sec.) blinks.

Set a larger aperture until the shutter speed stops blinking.

Overexposure — the shutter speed of 4000 (1/4000 sec.) blinks. Set a smaller aperture until the shutter speed stops blinking.



EF 35-105 mm f/3.5-4.5



Flash Use Information

If the slowest shutter speed “30” blinks, the main subject will be correctly exposed, but the background underexposed. The blinking value may stop by setting a larger aperture.

If the fastest possible x-sync. shutter speed “1/125” blinks, the main subject will be correctly exposed, but the background overexposed. The blinking value may stop by setting a smaller aperture.

- When the shutter speed is too slow to hand hold, we recommend using a tripod.



f/16



f/4

Depth of Field

What is “depth of field” ?

When your subject is in focus, there is a certain area in front of it and behind it which will also be in focus. This range of sharpness is called “**depth of field**”. Depth of Field has the following characteristics:

- 1) The smaller the aperture is, the deeper the depth of field and vice versa.
 - 2) The shorter the lens focal length is, the deeper the depth of field, provided that the aperture and shooting distance are the same.
 - 3) The farther the shooting distance is, the deeper the depth of field.
 - 4) Depth of field is generally greater in the background than the foreground.
- * To check the depth of field through the viewfinder, see p. 68: “Custom Function Control #11.”

Depth-of-Field AE (DEP)

The Depth-of-Field AE mode places everything between user set points (focus marks) in the foreground and background in focus. The points are set based on the focus mark in the viewfinder. Choose either single mark only, (left, right, or center) or all three marks **before** setting the focus points.

The camera sets the necessary aperture and shutter speed to obtain the best possible exposure under the existing lighting.

- **This mode cannot be used with flash.**



Three focus marks (□ □ □):

- 1) Set three focus mark selection mode (see p.27)

Compose the picture **so that the left or right focus mark covers the subject in the foreground, and that the center, right, or left mark covers the subject in the background.**



EF 35-135 mm f/4-5.6

- 2) Press the shutter button halfway. The correct aperture value and corresponding shutter speed are displayed both in the LCD panel and the viewfinder. Press the shutter button completely to take the picture.

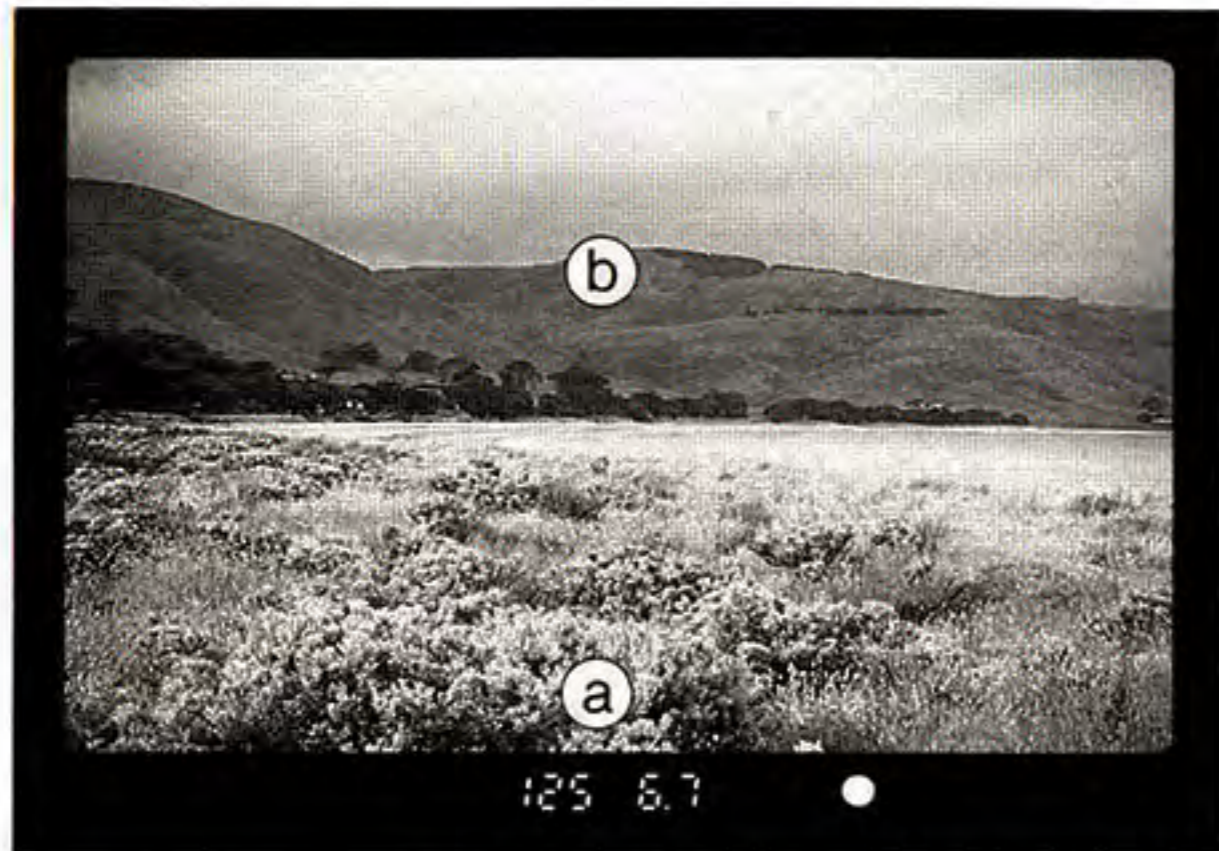

EF 28-70 mm f/3.5-4.5 II

Single focus mark (, , or):

- **DO NOT CHANGE THE FOCUS MARK DURING OPERATION.**

- 1) Select one desired focus mark. (See p. 27). Put the selected focus mark over the subject in the foreground (a) and press the shutter button halfway.
- 2) Remove your finger when the AF symbol and dEP 1 light up.
- 3) Repeat steps # 1 and 2 for the second point (b) dEP 2.

- 4) Reframe the picture and press the shutter button halfway. After the AF symbol and shooting values light up, press the shutter button completely.

Viewfinder Information

If the minimum aperture of the lens in use is blinking, you are too close. Clear the focus points by turning the command dial to another position and returning it to DEP. Move back from the subject and repeat steps # 1 through 4. When the aperture stops blinking, the distance range will be sharply focused and correct exposure will be obtained.

Additional Information

- A. If the minimum aperture continues to blink, the distance range is too deep for sharp focus. The exposure will produce the best possible results under the existing conditions.
- B. Wide-angle lenses are best used in this setting for maximum depth-of-field effect. Lenses longer than 200 mm are not recommended for deep depth of field.
- C. This mode can also be used to minimize depth of field by focusing on the same point both times. A telephoto lens gives portraits the best shallow depth of field effect.
- D. If both values blink, exposure is incorrect. Use a neutral density filter in bright settings.
- E. If the focus points are extremely near and far, the shutter speed may be very slow. Hold the camera steady, or use a tripod.
- F. Do not change the focal length after setting the first focus point on a zoom lens. Always set the focal length first.
- G. In this mode, exposure is determined at shutter release even with the combination of one shot AF mode and evaluative metering.

Camera-Shake Alert (📷)

Slow shutter speeds make the camera more vulnerable to the effects of camera shake, namely blurred pictures, particularly when using long focal length lenses. This mode sets a faster shutter speed to prevent camera shake based on the amount of camera movement and the lens. A speed limit function prevents setting a shutter speed slower than “1/focal length in use”.* Three marks appear in the viewfinder to indicate the camera’s condition.

* This function can be canceled with Custom Function Control # 14. (See p. 68)



EF 100-300 mm f/4.5-5.6

- 📷 lights up: Safe shutter speed is set.
- 📷 lights up and 📷 blinks: Shutter speed less than 2 steps slower than the safe shutter speed is set. Hold the camera firmly. See p. 11 “Camera Handling”.
- 📷 blinks: Shutter speed more than 2 steps slower than the safe shutter speed. We recommend turning on the flash or using a tripod.

- Manual focusing cannot be combined with this mode.
- AI Servo AF mode cannot be combined with this mode.
- The center focus mark (cross-type focusing sensor) is automatically selected with this mode to detect both the vertical and horizontal camera-shake amount.
- Due to the nature of “camera-shake”, please be aware that this mode cannot completely prevent blurred pictures.
- **When both the shutter speed and the aperture blink, the picture will be overexposed. Use a neutral density filter.**

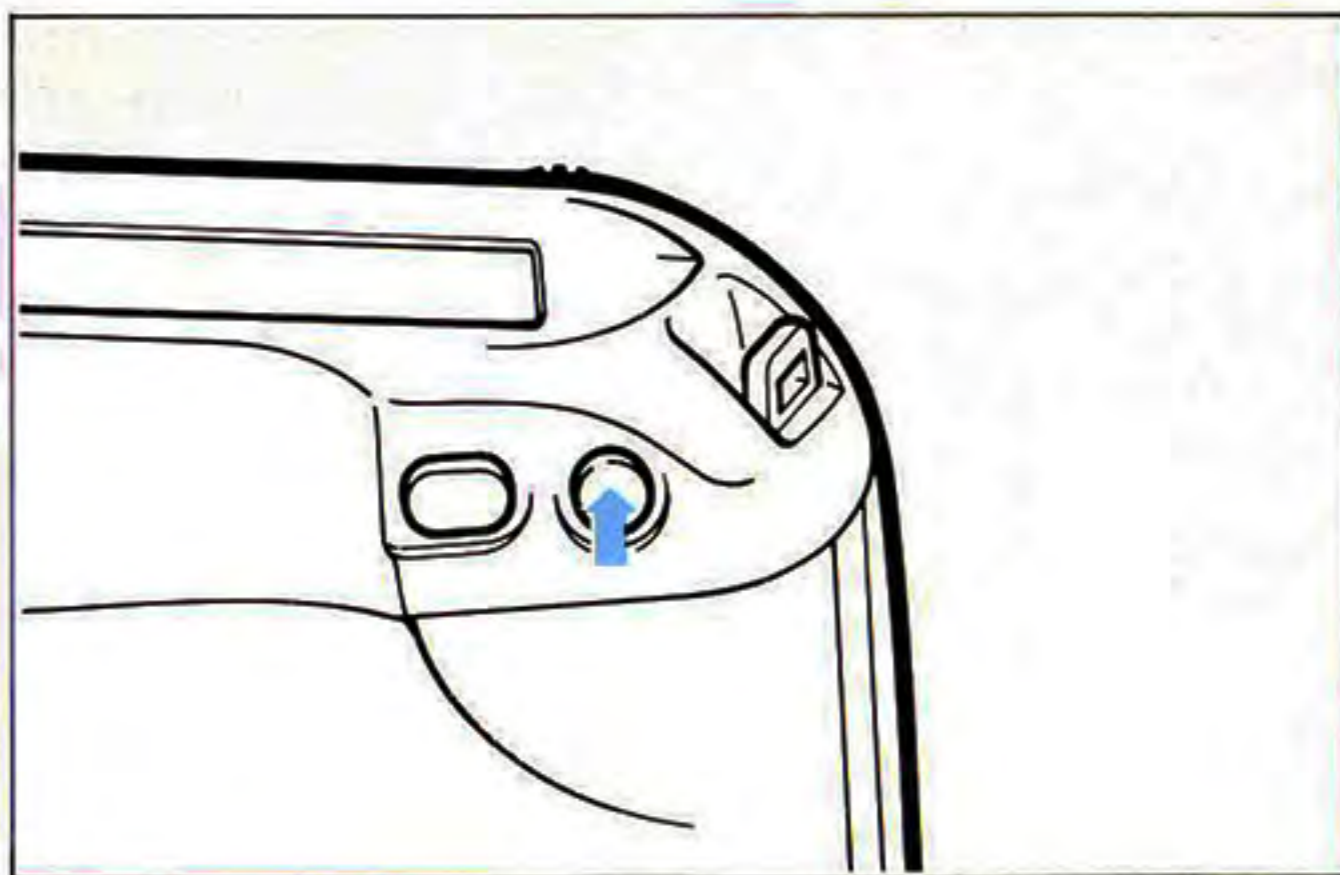
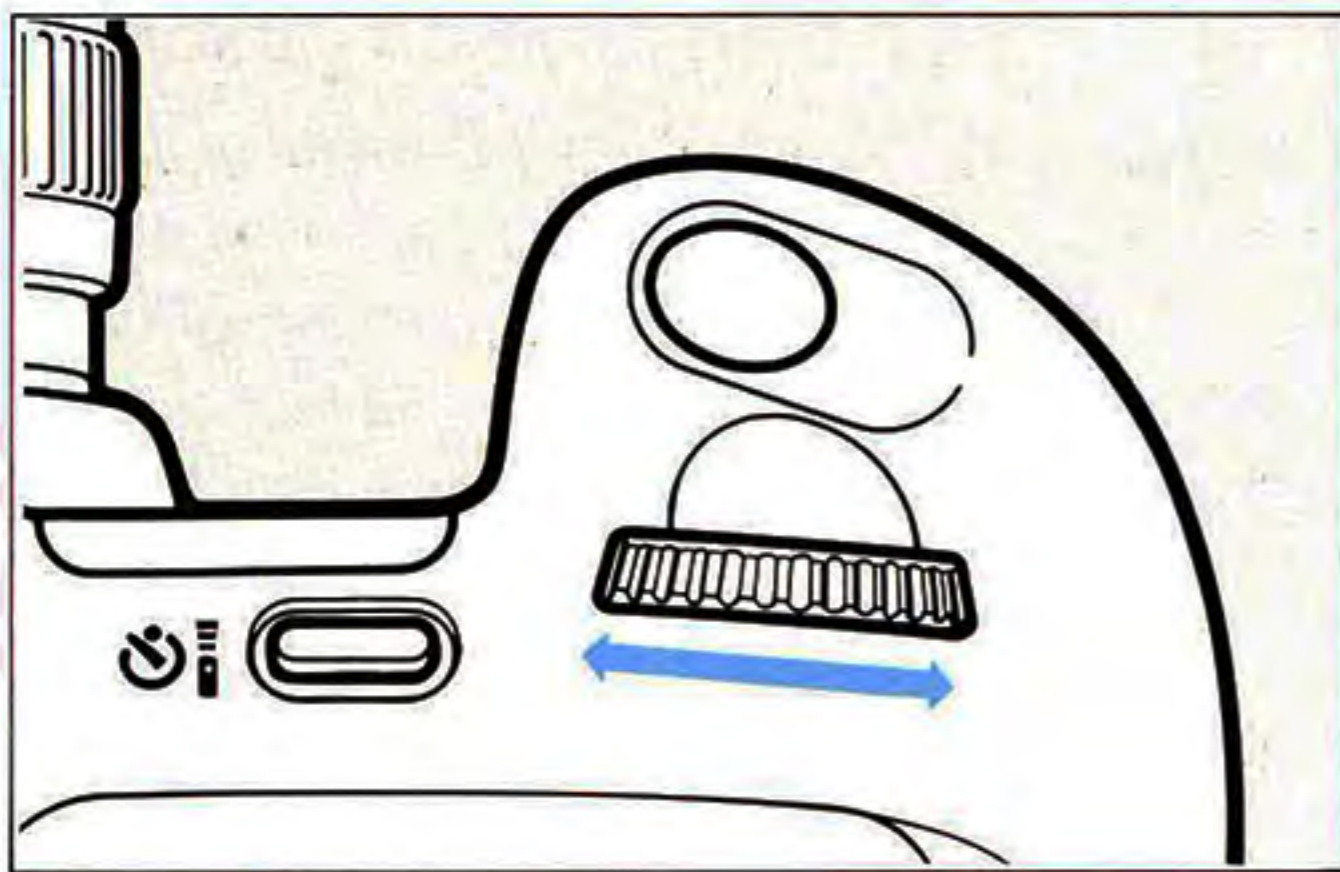

Manual Exposure (M)

This creative mode allows you to completely control exposure by setting both the shutter speed and aperture.

The initial setting is always 1/125 second at f/5.6.

- 1) Turn the electronic input dial to set the desired shutter speed.
- 2) Press the partial metering button. The shutter speed aperture value, and $-$, \pm or $+$ light up in the viewfinder. The meaning of each display is as follows:
 - $-$: Under exposure. Open the aperture or set a slower shutter speed.
 - \pm : Correct exposure.
 - $+$: Overexposure. Close the aperture or set a faster shutter speed.
- 3) While pressing the AE lock button, turn the electronic input dial until \pm displays in the viewfinder.

Determine the exposure referring to the shutter speed/aperture combination. Your technique will benefit greatly from practice.

M. Bulb (Long Exposure)

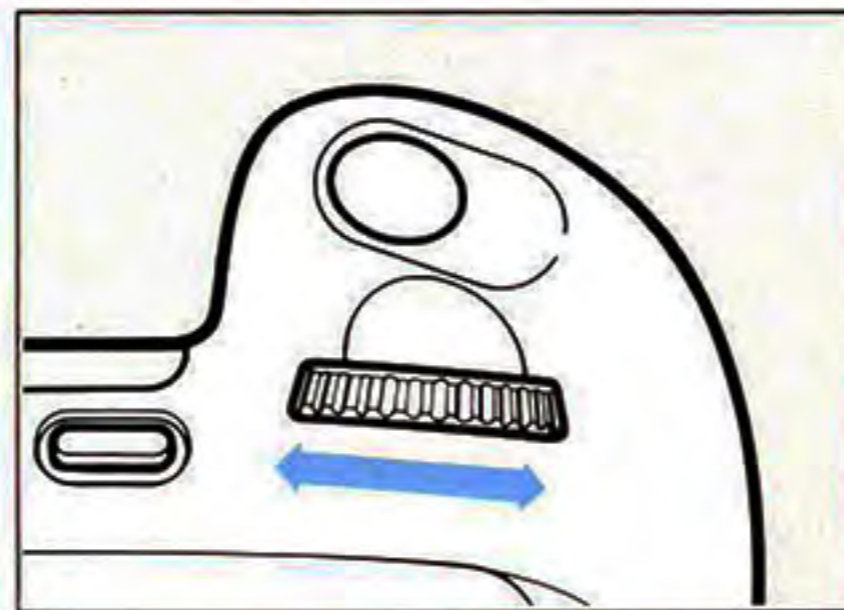
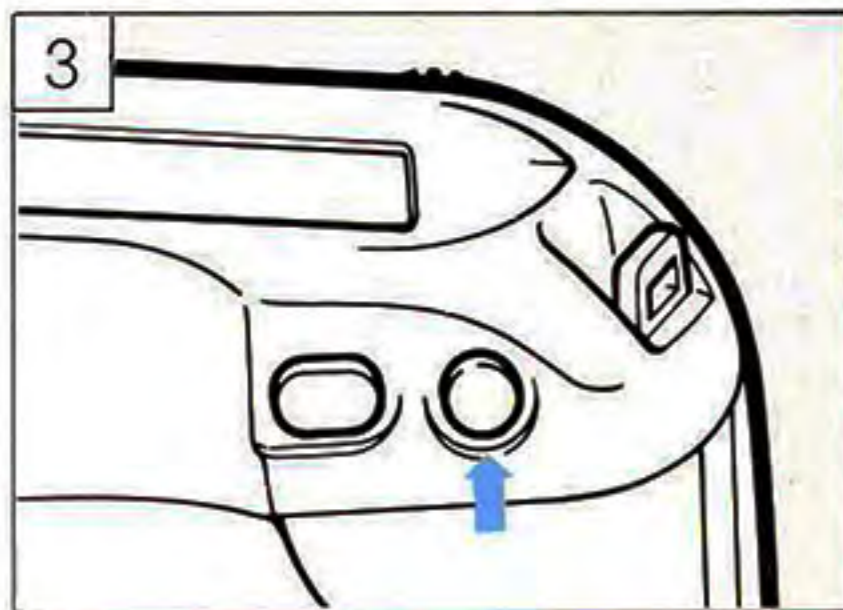
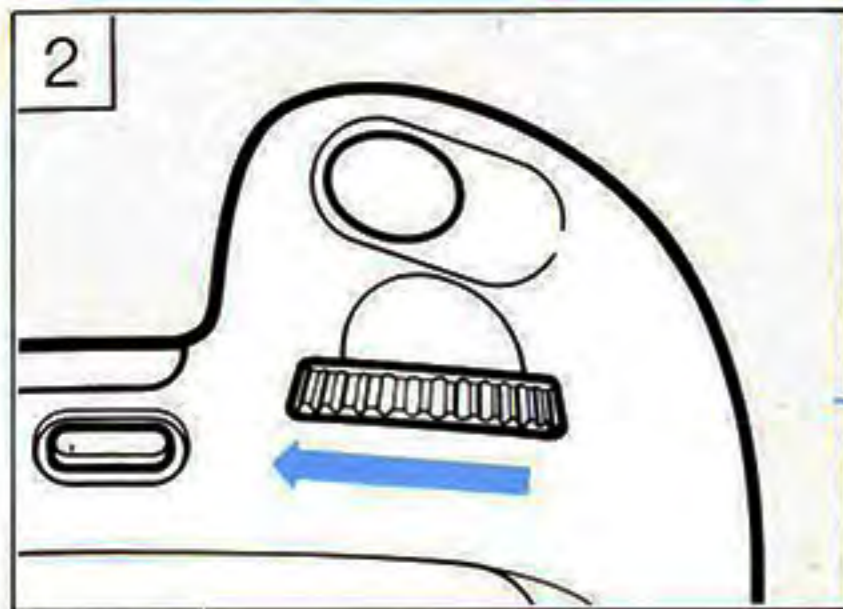
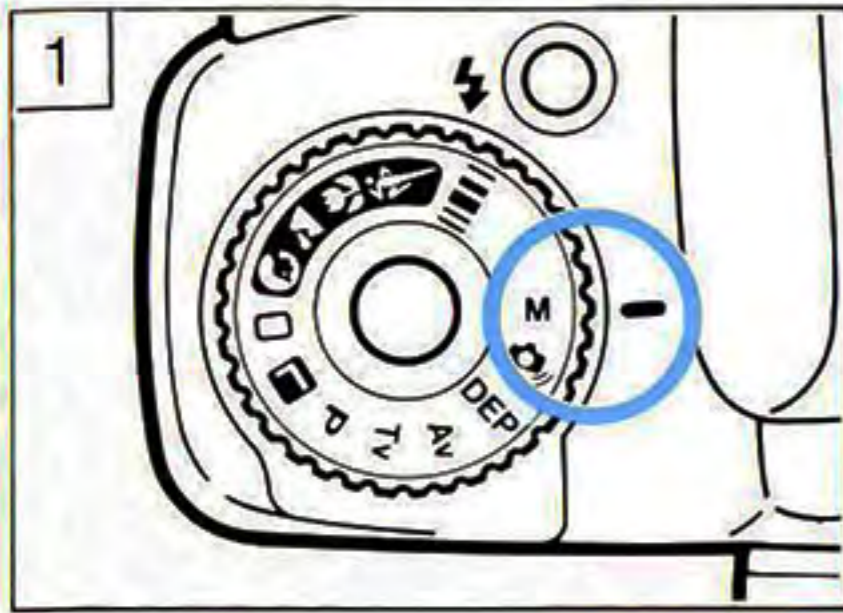

Use bulb for exposures longer than 30 seconds like astro or night photography. The exposure continues as long as the shutter button is held down.

- 1) Set the manual exposure mode by turning the command dial to **M**.
- 2) Turn the electronic input dial until **bulb** (after 30'') displays.
- 3) Set the aperture value by turning the electronic input dial while pressing the AE lock button.



- **Bulb cannot be used with a flash.**
- Bulb cannot be used with auto exposure bracketing.
- This mode requires very little power for minimal battery drain.
- Be sure to use a tripod and Remote Controller RC-1 (optionally available, see p.81). Press the control button once to start exposure and again to finish.
- Combination with the Custom Function Control #13 "mirror up" is helpful to preventing camera shake, see p. 68.

N. Partial Metering (AE Lock)



AE lock on the sky with the sun setting.

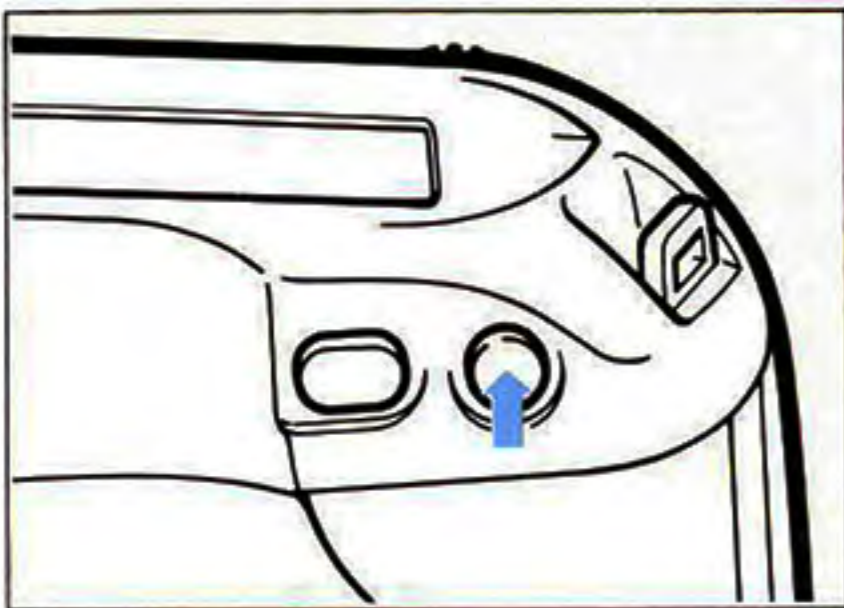

Partial metering reads 8.5% of the center of the picture area. This is particularly suited for photography in theaters and other situations when there is a *significant difference* in brightness between the main subject and background.

To set partial metering, press the black button behind of the camera. The partial metering Mark “ * ” appears in the viewfinder.

- The AE lock* function automatically works in the partial metering mode.
- Partial metering **cannot be set manually at the green zone, P.I.C., or barcode setting.**



* **AE Lock:**

The original exposure value remains locked as long as the shutter button is pressed halfway, so even if you recompose the picture, correct exposure on the main subject will not be affected by changes in lighting composition.

O. Exposure Compensation

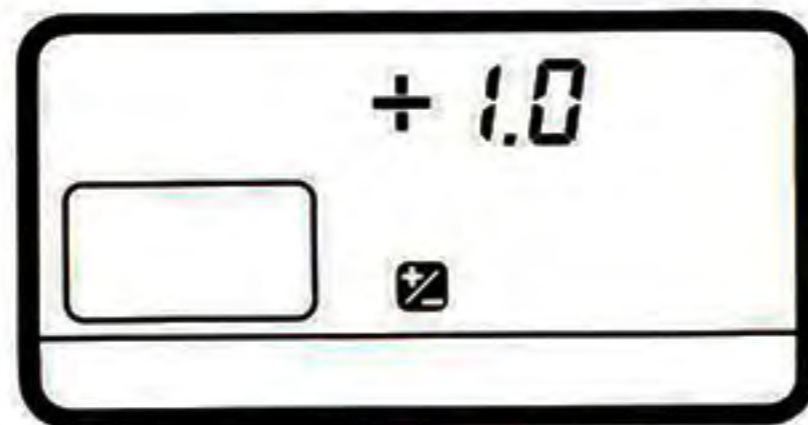
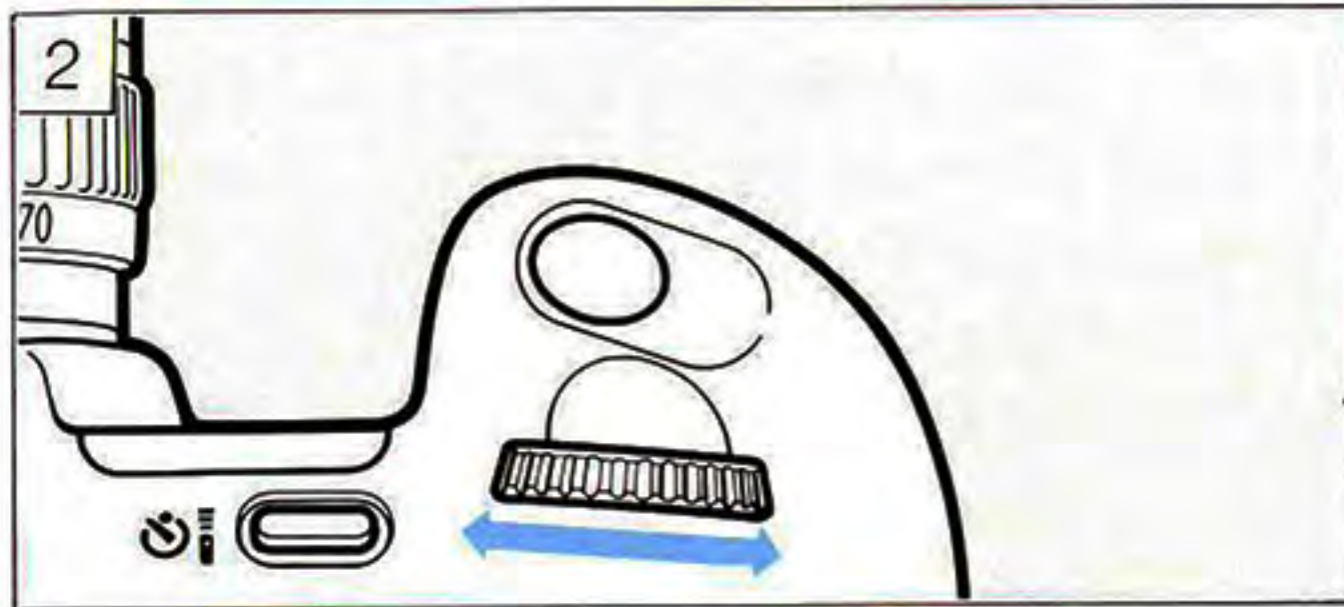
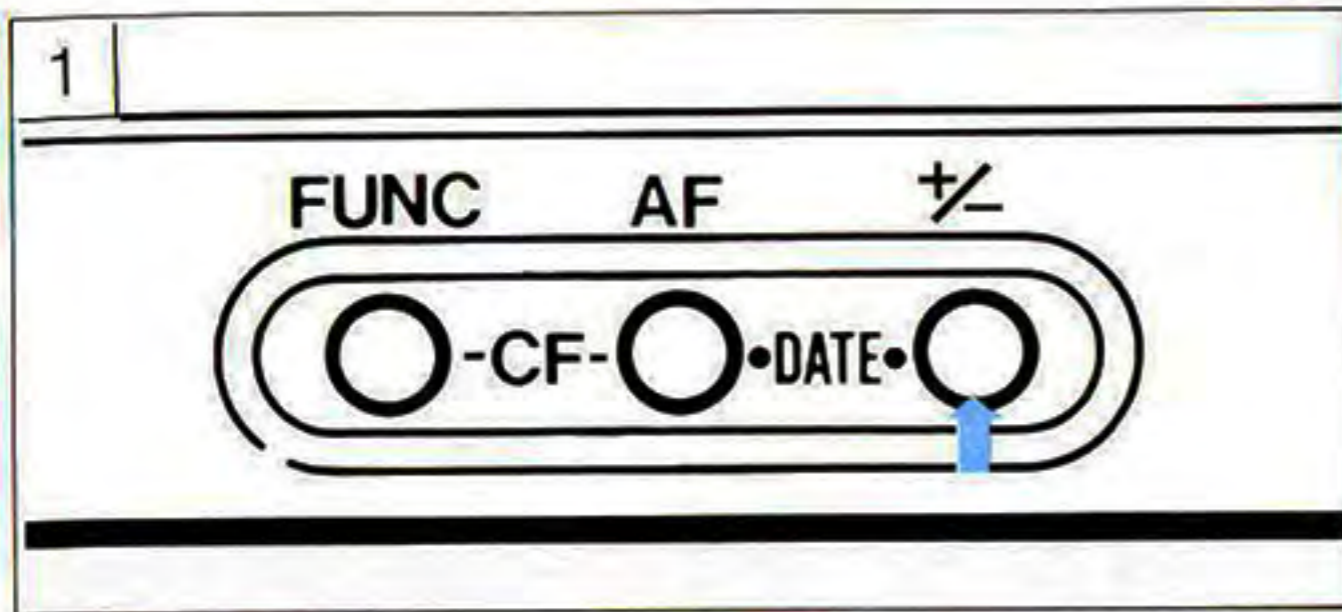

Use exposure compensation for intentionally underexposed or overexposed pictures. The compensation range is up to $+/-$ 5 stops in half-stop increments. **This cannot be set if the command dial is at the green zone, P.I.C., or bar-code setting.**

- 1) Press the $+/-$ (black) button to display the $+/-$ exposure compensation symbol in the LCD panel. The symbol appears for six seconds.
- 2) Turn the electronic input dial to set the desired value.
 - *Exposure compensation remains active until canceled.*
 - *To cancel exposure compensation, repeat steps #1 & 2 above and return the value to 0.0.*
 - The $+/-$ symbol indicating exposure compensation status appears only in the LCD panel. Press the $+/-$ button to display the value set.

P. Auto Exposure Bracketing (AEB)

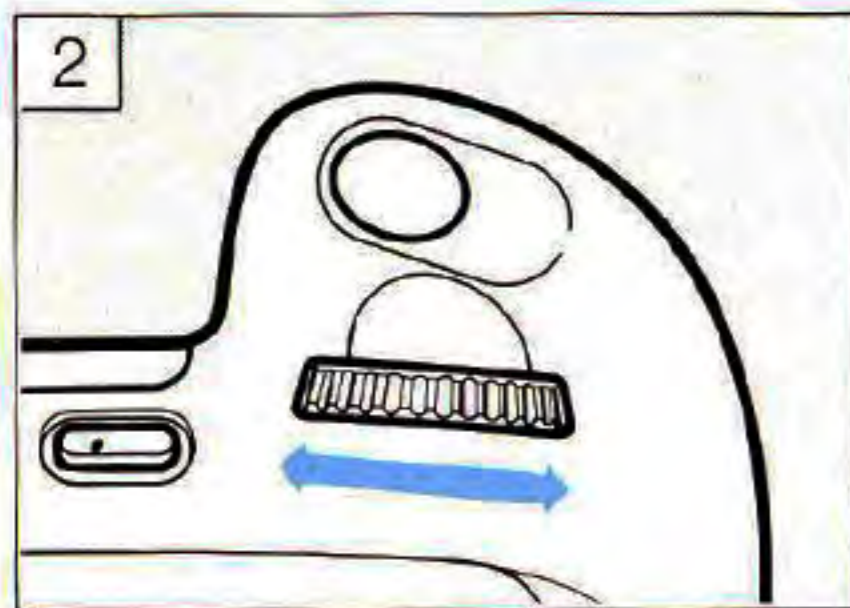
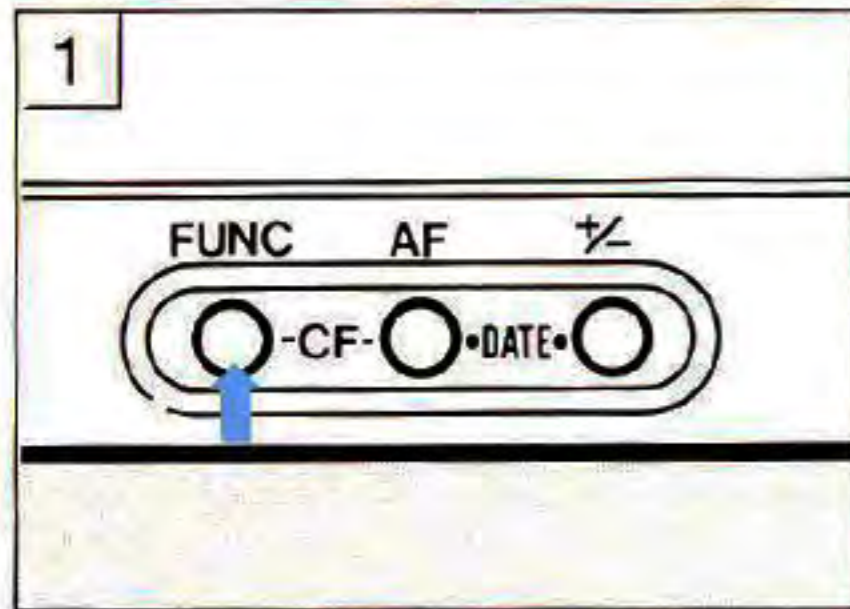

Use auto exposure bracketing to vary the rendition of the subject by changing the amount of exposure. *Three continuous exposures* are taken in the following order: under, normal, and over. The bracketing range is up to $+/-5$ stops in $1/2$ -stop increments. **This cannot be set if the command dial is at the green zone, P.I.C. setting or bar-code setting.**

- **AEB cannot be used with a flash.**
 - 1) Press the function (blue) button to display AEB in the LCD panel.
 - 2) Turn the electronic input dial to set the desired bracketing amount. If you set 1, the camera takes three exposures in the sequence of -1 stop, normal, and $+1$ stop over the normal exposure.
- *The AEB function remains active until canceled.* **To cancel AEB**, repeat steps #1 & 2 and set the value to 0.0.



EF 35-70 mm f/3.5-4.5

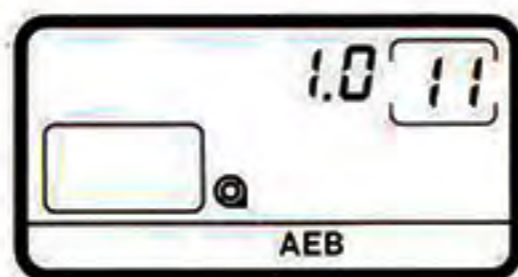

AEB Information

- The exposure value appears only in the LCD panel.
- Bulb cannot be used with AEB.
- *The camera controls the timing of each AEB exposure.*
- Do not set an amount that will exceed the maximum or minimum aperture value of the lens in use or that will exceed either 1/4000 second or 30 seconds shutter speed.

Helpful Hints

If you wish to shift your bracketed exposure value toward overexposure, you can combine exposure compensation with the auto exposure bracketing.

Example:

If you wish to bracket at 0.5 stop, 1.5 stop and 2.5 stop:

- 1) Set the auto exposure bracketing (AEB) value to 1.0; this will give - 1.0 stop, 0, + 1.0 stop.
- 2) Set the exposure compensation (EC) value to + 1.5. This will shift all exposures up 1.5 stop.

The bracketed value will be + 0.5 stop, + 1.5 stop, + 2.5 stop.*

$$\begin{aligned} * - 1.0 \text{ (AEB)} + 1.5 \text{ (EC)} &= + 0.5 \\ 0 \text{ (AEB)} + 1.5 \text{ (EC)} &= + 1.5 \\ + 1.0 \text{ (AEB)} + 1.5 \text{ (EC)} &= + 2.5 \end{aligned}$$

Q. Interval Timer

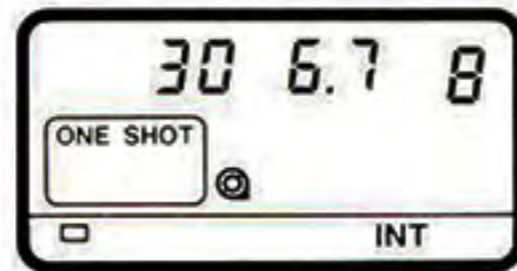

Use this function to take up to 36 pictures at any interval up to 23 hours, 59 minutes, and 59 seconds. The flexibility of the timer makes it perfect for sequences, flowers blooming, or group pictures that need more time than allowed with the self-timer. **This cannot be set if the command dial is at the green zone, P.I.C., or bar-code setting.**

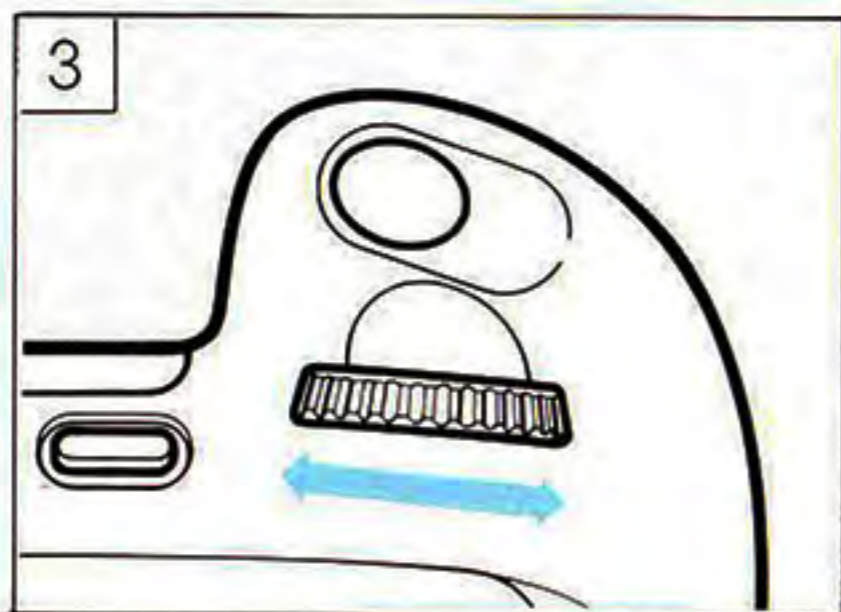
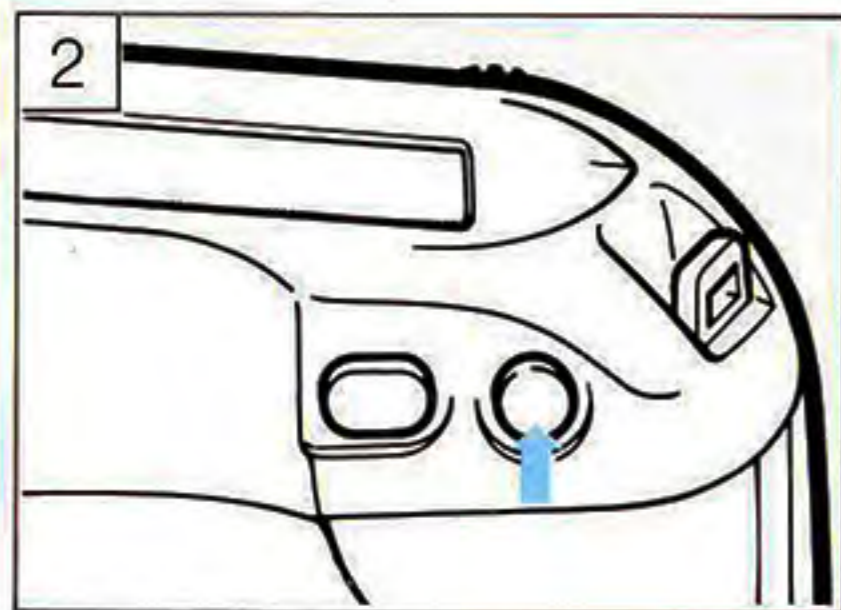
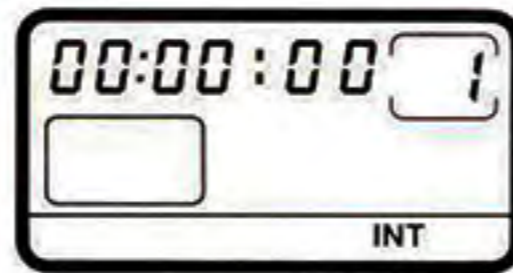
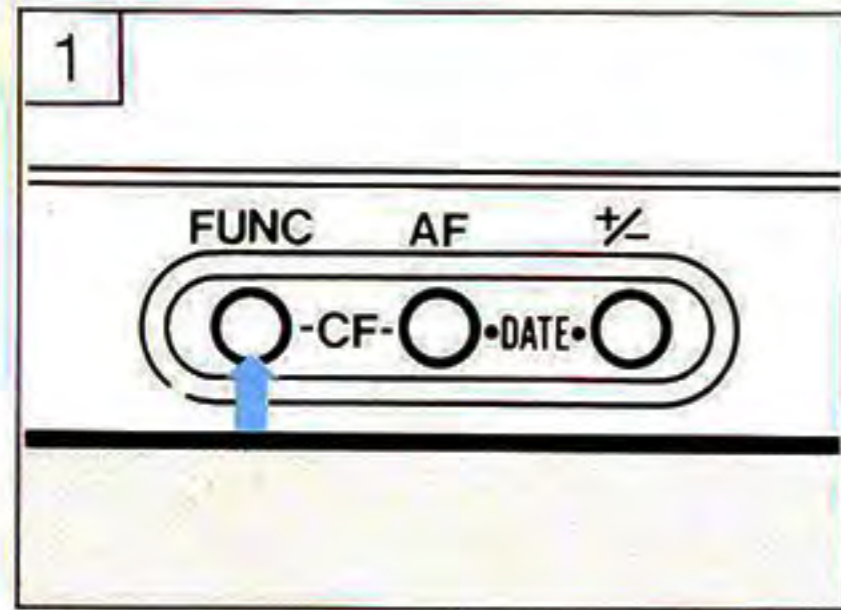

- 1) Press the function (blue) button to display **INT** in the LCD panel.
- 2) Press the partial metering (black) button to select the interval and the number of pictures to be set. Only a blinking number can be changed.
- 3) Turn the electronic input dial to set the desired number.
- 4) Repeat steps #2 and 3 to continue setting remaining numbers.
- 5) Press the shutter button to start the timer.

- To stop the timer in progress, turn the command dial to "L".
- For flash photography, press the flash button before starting the timer. In this case, set an interval longer than ten seconds for flash charging.

R. Multiple Exposures

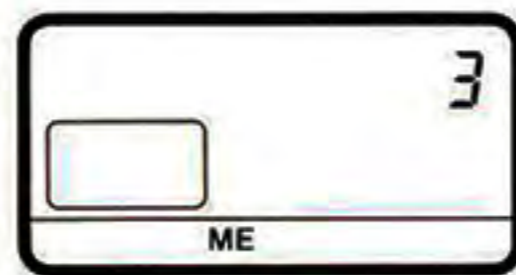
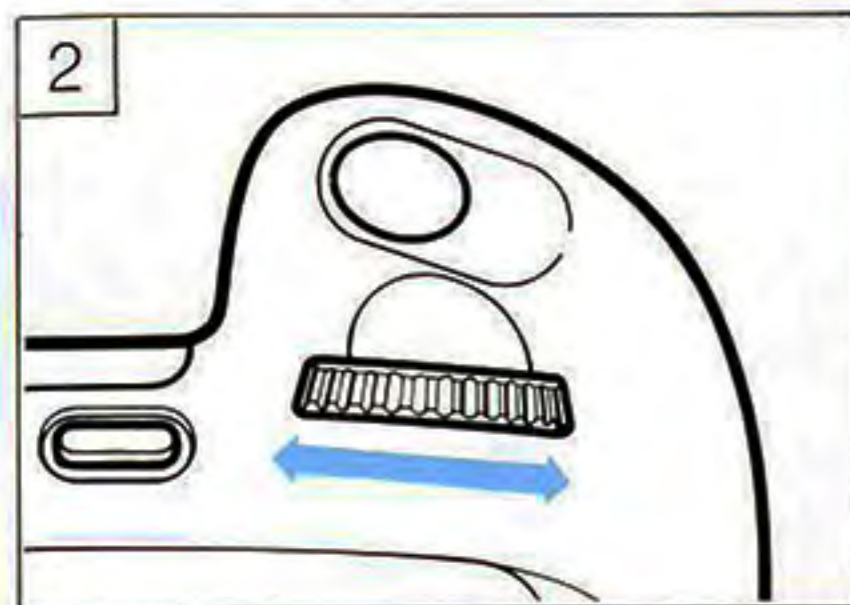
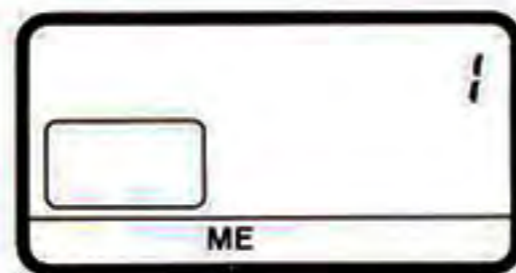
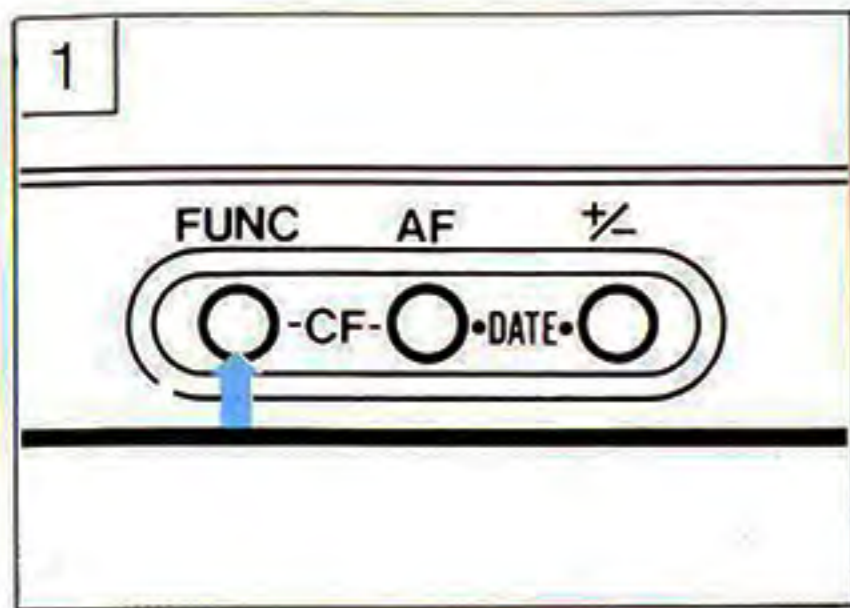

Try this function for creative and dramatic effects. Up to nine exposures can be made on the same frame with minimal operation.

This cannot be set if the command dial is at the green mark, P.I.C., or bar-code setting.

- 1) Press the function (blue) button to display ME in the LCD panel.
 - 2) Turn the electronic input dial to set the desired number of exposures.
 - 3) Press the shutter button to start.
- The film winds to the next frame after the exposures have been taken.

To clear preset exposures, repeat step #1 and turn the electronic input dial to return the number to one.

We recommend setting exposure compensation depending on the number of exposures for best results.

Number of exposures	Exposure compensation amount
Two	- 1.0
Three	- 1.5
Four	- 2.0

Multiple Exposure Information

1. The table at left is a **general guideline**. The actual amount varies according to the subject and desired effect. This kind of photo requires experimentation for best results.
2. Avoid taking exposures on the first and last several frames to minimize the risk of damage from film curl.
3. Generally, the first exposure should be a relatively dark subject so that the image in the next exposure will show up clearly.
4. When using print film, be sure to inform the developer that you have taken multiple exposures, otherwise pictures may be processed incorrectly.

S. Custom Function Control

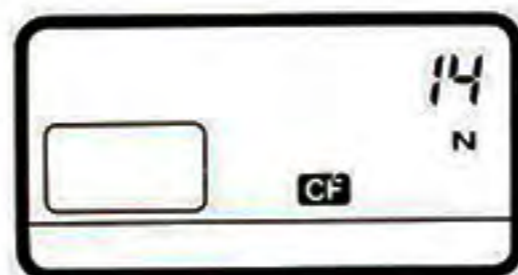
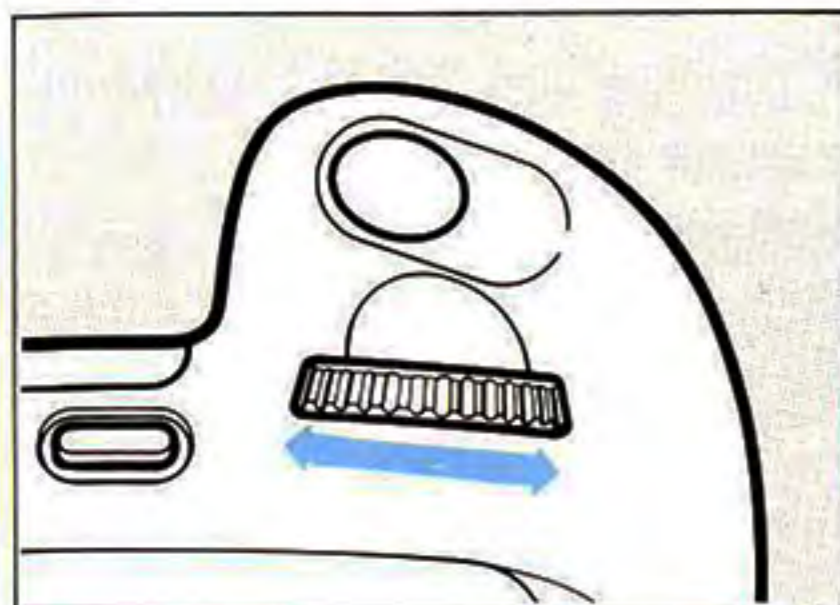
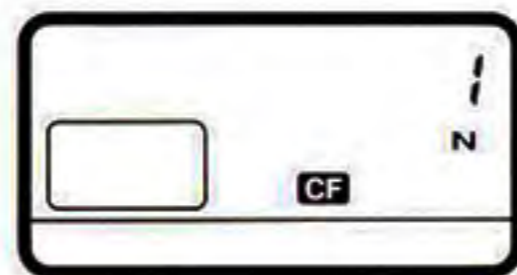
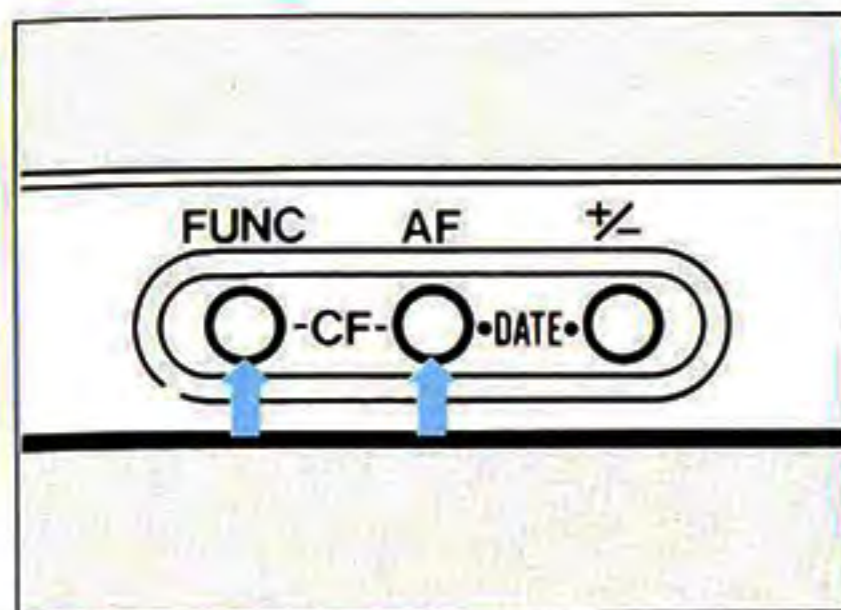

This versatile control lets you program fourteen functions* to your individual preference.

* Fifteen with the EOS-10 QD.

- 1) Press the function (blue) button and the AF mode (yellow) button to display the function number and CF symbol.
- 2) Turn the electronic input dial to the desired function number.

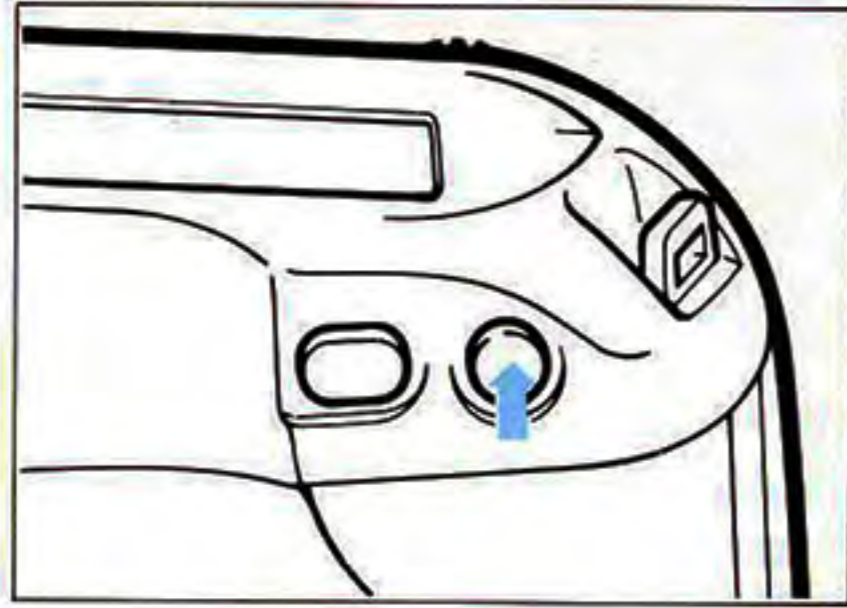







- 3) Press the partial metering button once to change the letter N (NO) to Y (YES) to set the desired function.
- The display appears for approximately six seconds. Press the shutter button halfway to return the LCD to its regular display.
 - **To cancel a function,** repeat steps #1 and 2 and press the partial metering button to change Y to N.
 - **To check which functions have been set, repeat steps #1 and 2 on p. 65. Y appears if the function is set.**

NOTE







Before using Custom Function Control, *please review their purpose carefully.* For example, Custom Function #3 cancels automatic film speed setting of your camera, Custom Function #4 cancels normal autofocus operations, etc.

CUSTOM FUNCTION CONTROL CHART

Control		User-selected Operation (Y)	Normal Operation (N)
1	Film Rewind Cancellation	Cancels automatic film rewind	Film rewind starts automatically at end of roll
2	Film Leader Out	Leaves the film leader outside the cartridge	Film leader completely rewound into cartridge
3	Film Speed Set	Allows manual film speed setting of DX-coded film	Film speed set by camera according to DX-code
4	Autofocus Start	Initiates autofocus by pressing partial metering button	Autofocus starts when shutter button pressed halfway
5	Manual Exposure	Aperture set by electronic input dial and shutter speed set by partial metering button + electronic input dial	Shutter speed set by electronic input dial and aperture set by AE lock button + electronic input dial
6	Camera-shake Warning	Turns off camera-shake warning tone	Tone sounds automatically with command dial set at  ,  ,  ,  ,  , or  .
7	Manual Focus Operation	Allows manual focus adjustment after autofocus with USM lenses* ¹ without prior setting	Manual focus adjustment possible by setting focus mode switch with USM lenses
8	AF Auxiliary Light	Does not emit	Automatically emitted when necessary

*¹ Only in one-shot AF mode.

Control		User-selected Operation (Y)	Normal Operation (N)
9	1/125 Shutter Speed Lock	Aperture-priority AE w/flash locks at 1/125 to prevent camera shake	Shutter speed set according to subject's peripheral brightness
10	Red Focus Marks Off	Focus marks do not flash in red* ²	Focus marks light up in red
11	Depth-of-Field Check	Possible by pressing the partial metering button * ³	Not possible
12	AE Lock	AE lock with evaluative metering	AE lock with partial metering
13	Mirror up	When using self-timer, the mirror is up when the shutter button is pressed	Not possible
14	Cancellation of speed limit function	Speed limit function is canceled.	In camera-shake alert mode, a speed limit function prevents setting a shutter speed slower than 1/focal length of the lens in use

*² Superimposed when the command dial is set at , , , , , and , or when selecting one focus mark.

*³ a) The aperture is stopped down after AF and AE lock.

b) When combined with Control #4, depth-of-field check is not possible in AI servo AF mode.

T. Liquid Crystal Display / Battery Notes

The LCD panel uses liquid crystal to show exposure information. After about five years, the display may become difficult to read. If this occurs, have it replaced at an authorized Canon service facility. Replacement is at the owner's expense.

Liquid crystal may also respond relatively slow in temperatures below 32°F / 0°C. It may also darken in temperatures around 140°F / 60°C. The LCD panel will return when the temperature returns to normal.

Battery Information

Lithium Battery Check

Always check the battery at the following times:

1. When loading a new battery
2. After lengthy storage
3. Before an important shooting assignment
4. In cold weather
5. If the shutter will not release

Battery Use Information

1. Wipe the battery terminals with a clean, dry cloth to ensure proper connection.
2. Remove the battery if you do not expect to use the camera for more than three weeks.
3. Battery performance deteriorates slightly in temperatures below 32°F/0°C. Keep the camera and especially a spare battery close to your

body or in an inside pocket to keep it warm until use.

4. The battery may explode or cause burns if disassembled, recharged, shorted, exposed to high temperatures, or disposed of in fire. Be sure to observe all precautions indicated on the battery package. *Always keep it out of the reach of children.*
5. If the battery check symbol blinks or does not appear in the LCD panel during battery check, exposure will be okay as long as the shutter releases. Film advance and rewind will be impaired by insufficient battery power. If wind or rewind stops due to the battery, the film cartridge symbol will blink. Film transport resumes after a new battery is loaded and the film rewind button pressed.

Blinking “bc” Display

There are two conditions when the blinking “bc” will appear in the LCD panel.

1. If the battery is nearly exhausted, the blinking “bc” will appear when the shutter button is pressed halfway or when the battery is checked.
 2. If the remaining battery power does not show a replacement condition, but the camera’s self-test process detects an internal malfunction, the blinking “bc” will appear when the shutter button is pressed halfway.*
- * In this case, remove the battery completely. Wipe the battery terminals and reload it. Check the battery again. If the blinking “bc” still appears, the camera needs to be examined by an authorized Canon service facility.

U. Camera Care

Keep your camera in top condition by following these suggestions for periodic cleaning. See the precautions on p. 5 for other important information.

1. Cleaning the lens surface-

Blow off dust with a blower brush and gently wipe the lens surface with a piece of lens cleaning paper moistened with lens cleaner. Clean in a **spiral** motion from the center outwards.

2. Cleaning the mirror and focusing screen-

Use a blower brush reserved for this use only. If more cleaning is necessary NEVER attempt to do it yourself. Take the camera to an authorized Canon service facility.

3. Cleaning the film chamber-

Use a blower brush to remove accumulated film dust particles that might scratch the film. Be careful not to touch the shutter curtain.

Attaching the strap

Thread the ends of the neckstrap through the fixtures as shown.

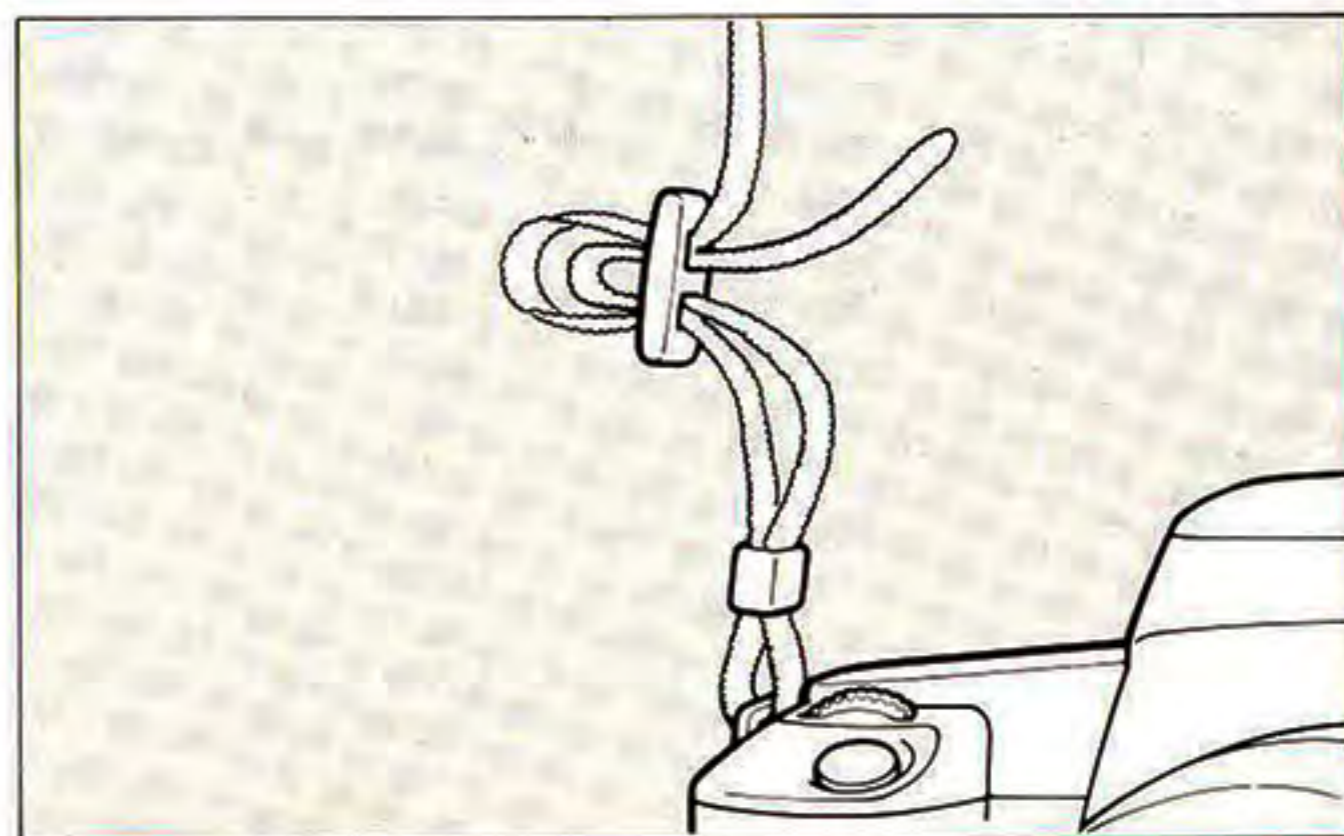

V. Reference

LCD Panel Information

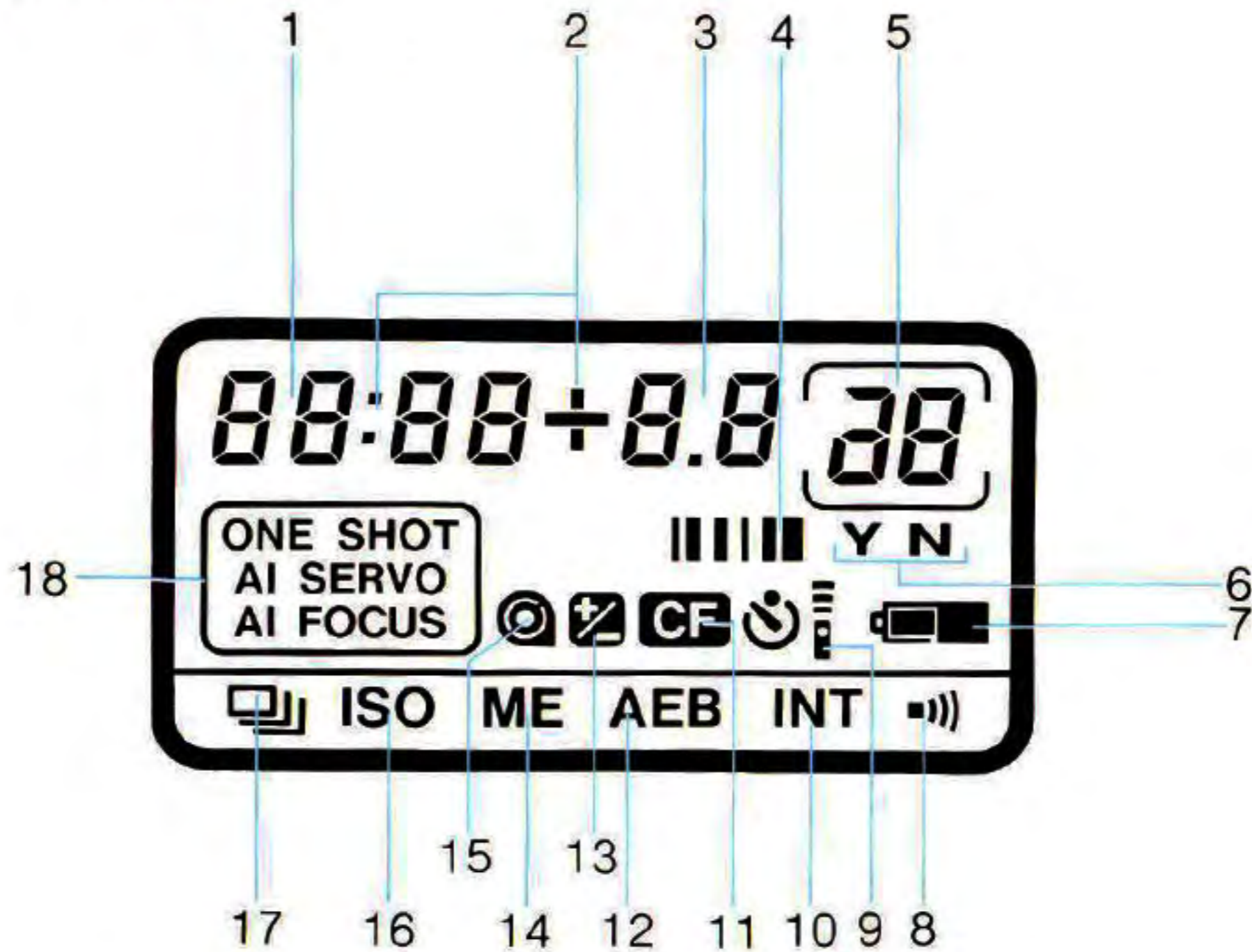

1.
 - a. Shutter Speed
 - b. Film Speed
 - c. Depth-of-Field
 - d. Interval Timer
2.
 - a. Exposure Compensation
 - b. Interval Timer
3.
 - a. Aperture Value
 - b. Exposure Compensation Value
 - c. AEB Value
 - d. Depth-of-Field AE
 - e. Interval Timer
 - f. Battery Check (bc)
 - g. Bar-code Program
4. Bar-code Program
5.
 - a. Frame Counter
 - b. Number of Multiple Exposures
 - c. Custom Function Control No.
 - d. Interval Timer Frame No.
6.
 - a. Camera-shake Beeper Tone Active
 - b. Camera-shake Beeper Tone Cancellation
7.
 - c. Regular Operation
 - d. Custom Function Active
7. Battery Check
8. Camera-shake Beeper Tone
9. Remote Controller
10. Interval Timer
11. Custom Function Control Set
12. Auto Exposure Bracketing
13. Exposure Compensation
14. Multiple Exposure
15. Film-Load Check/ Film Rewind Completion
16. Film Speed Setting
17. Film Winding Mode
18.
 - a. One-shot AF Mode
 - b. AI Servo AF Mode
 - c. AI Focus AF Mode

Viewfinder Information

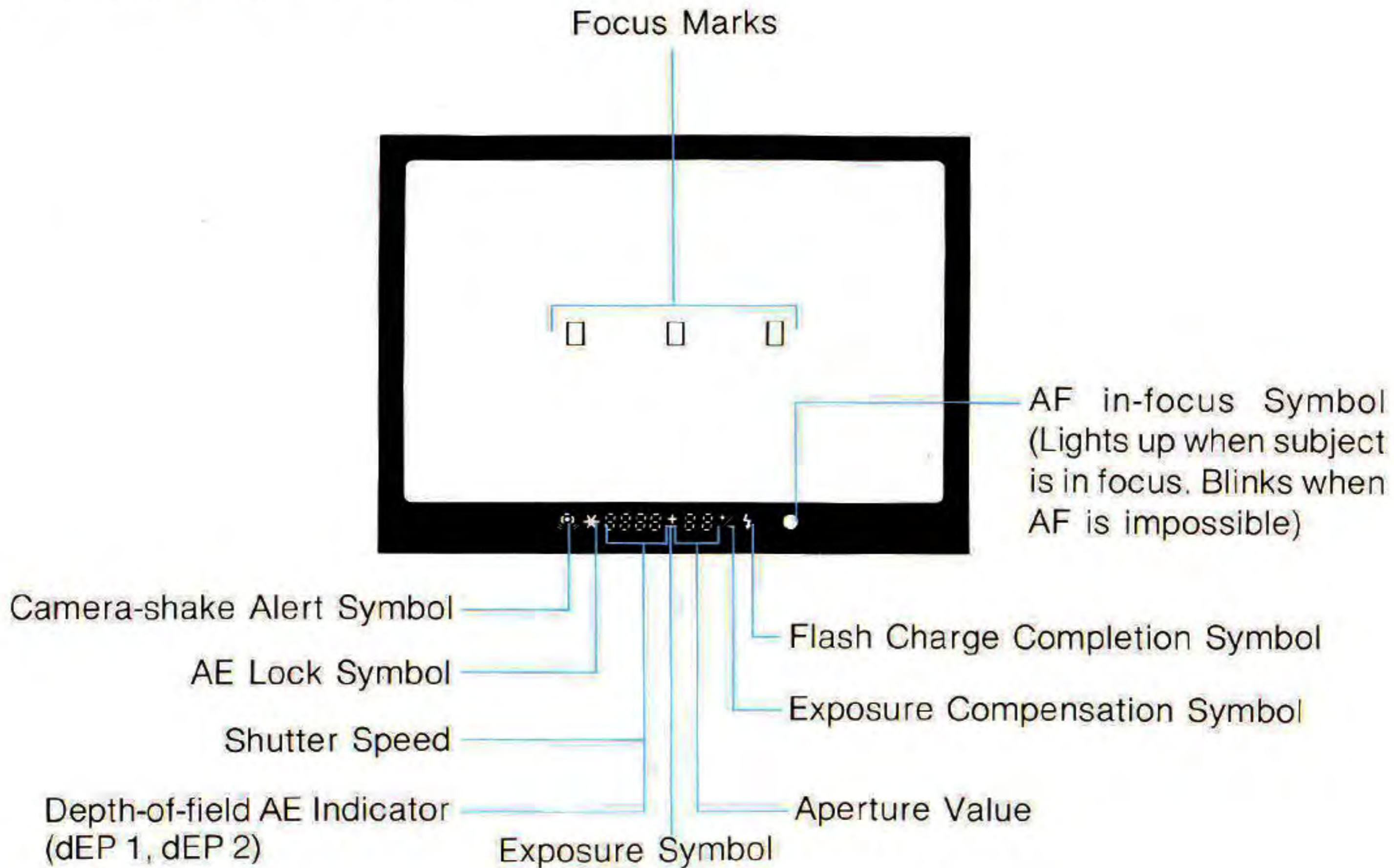

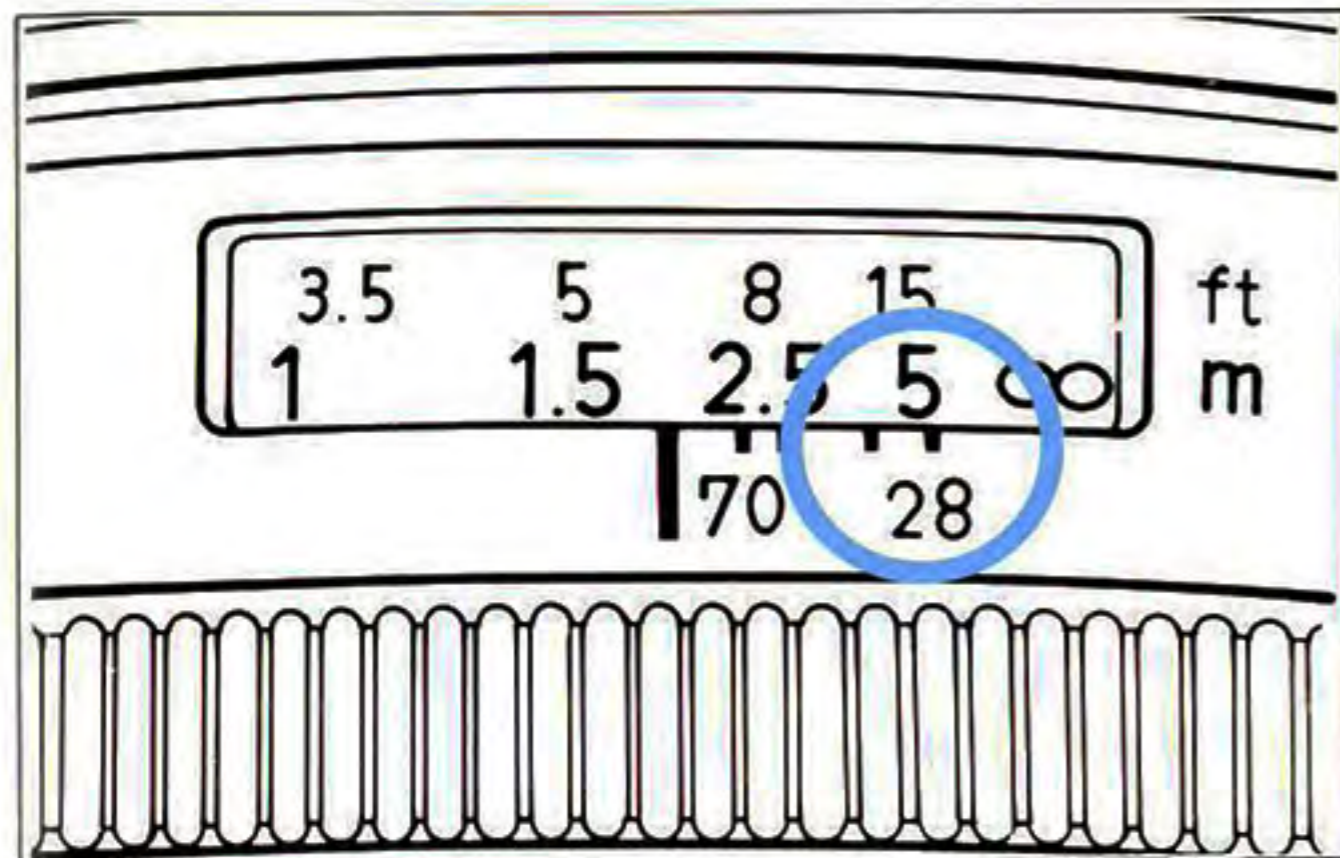
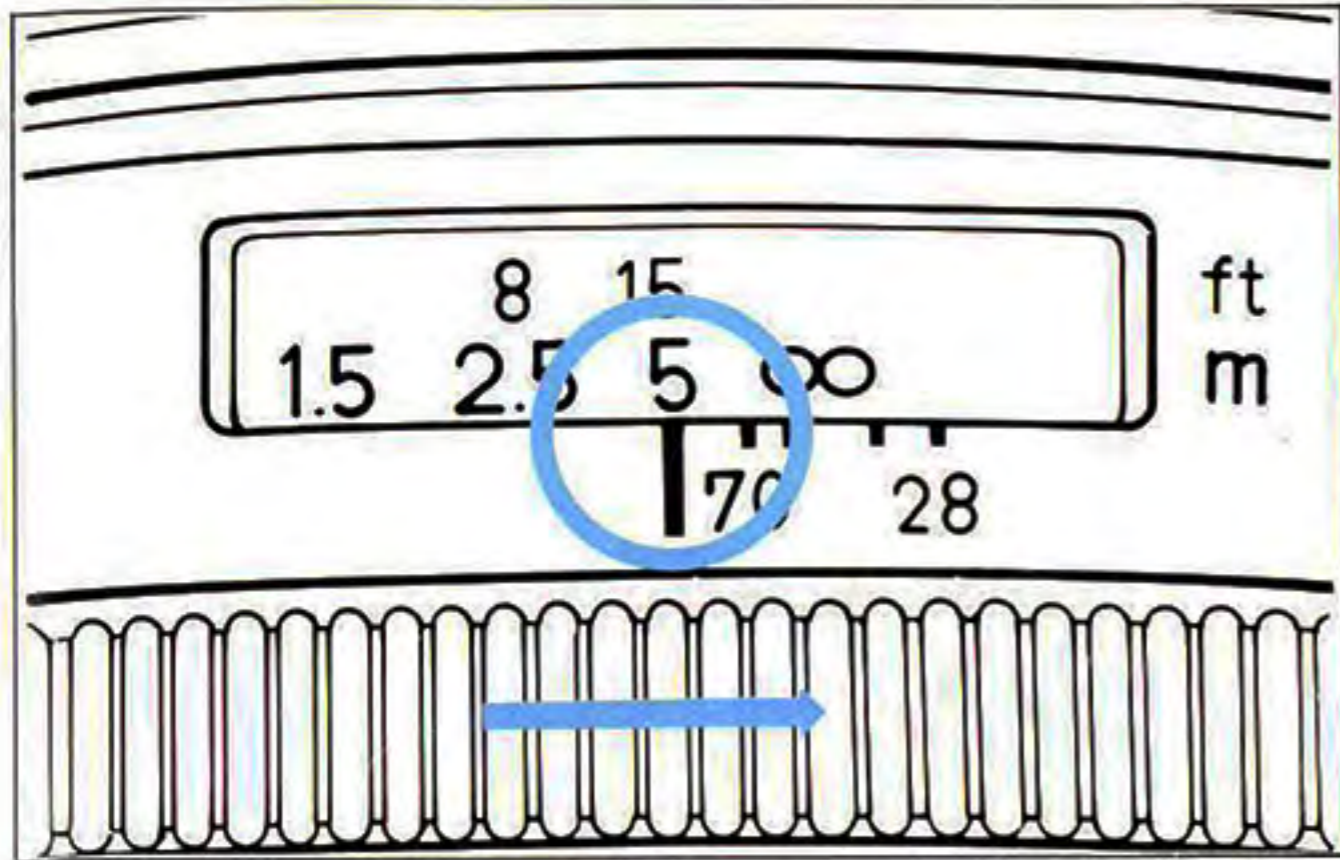

Infrared Film Use

When using black and white infrared film, make a slight adjustment in focus with the red infrared index. For example, focus the subject first, then, if the lens is focused at 5 m on the distance scale, turn the manual focusing ring to align the 5 m mark with the red dot and release the shutter. For zoom lenses, use the small red lines to align with the number as shown.

- Use a deep red filter as specified by the manufacturer.
- The infrared index mark position has been computed for infrared film usage with peak sensitivity at 800 nm.
- Follow the manufacturer's instructions when using color infrared film.

Battery Shooting Capacity

Based on a new 2CR5 lithium battery using the EF 35-135 mm f/4-5.6 and 24-exp. film

- 1) Without flash
- 2) With 50% flash
- 3) With 100% flash

Temperature	Capacity
Normal (20°C/68°F)	1) 60 rolls 2) 25 rolls 3) 13 rolls
Low (-20°C/-4°F)	1) 15 rolls 2) 8 rolls 3) 4 rolls

- The data is the same for the EF 50 mm f/1.8.
- Stated values reduced 50 % with USM lenses (excluding EF 35-135 mm f/4-5.6, EF 70-210 mm f/3.5-4.5 and EF 100-300 mm f/4.5-5.6)

The data are based on Canon's Standard Test Method.

Comparisons between AF Mode and Film Winding Mode

AF mode Film Wind- ing Mode	ONE-SHOT	AI SERVO
☐: Single	AF lock and AE lock in the evaluative metering mode take place simultaneously on AF completion. The shutter releases only after AF completion.	AF follows a subject and the exposure is determined at the moment of shutter release. The shutter releases only after AF completion.
☐☐: Con- tinuous	AF lock and AE lock in the evaluative metering mode take place simultaneously on AF completion, then continuous exposure is activated. (Approx. 5 fps maximum).	AF follows a subject and the exposure is determined at the moment of shutter release. AF is adjusted to follow the subject during exposure. (Approx. 3 fps maximum). The shutter releases only after AF completion.

Program Line (Program Characteristics)

This camera is equipped with advanced “Intelligent Program AE” which chooses the best shutter speed/aperture combinations, taking the lens’ focal length into account.

The camera-shake warning sounds when the automatically-set shutter speed becomes **0 to 0.5 steps slower than**

“1/focal length of the lens in use”. This shutter speed (1/focal length of the lens in use) is generally said to be **the limit for hand-held shooting**.

Blue: When using the EF 50 mm f/1.8
Black: When using the EF 35-105 mm f/3.5-4.5

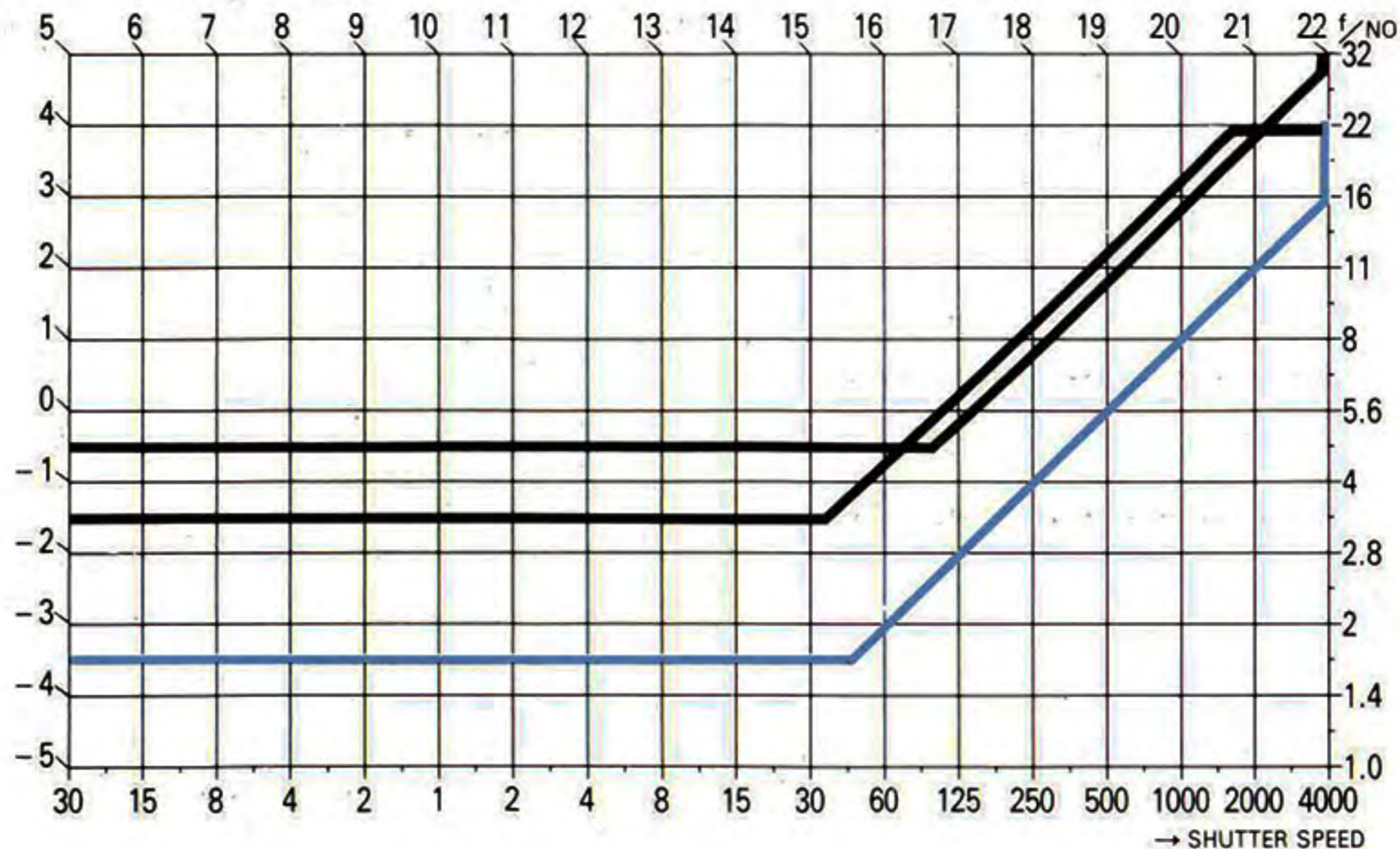

Program Shift Characteristics

(EF 50 mm f/1.8 - example with shift at EV 13)

- indicates the shutter speed/aperture combinations with program shift.

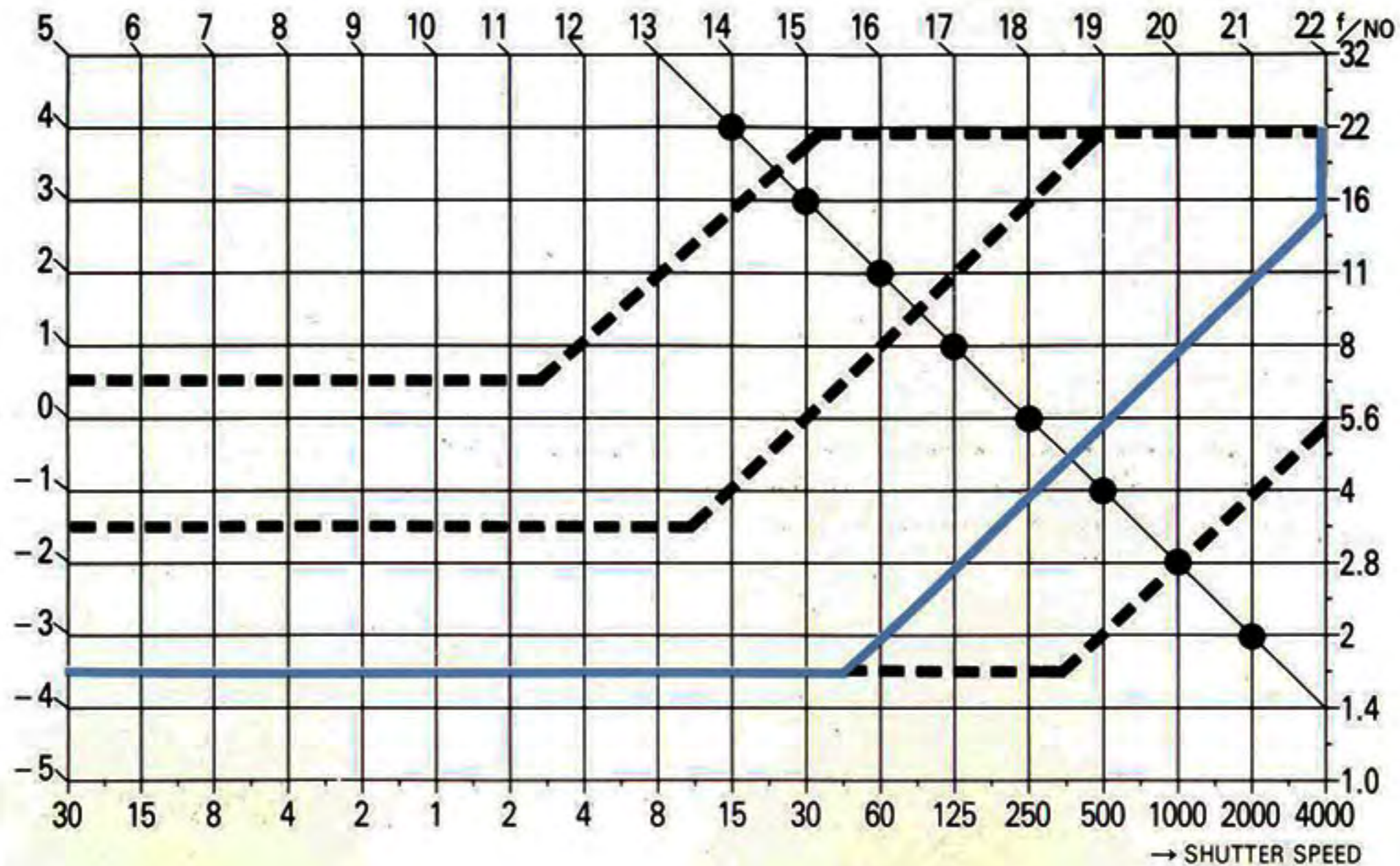



Speedlite 430 EZ/300 EZ

The **430 EZ** provides plenty of coverage for a variety of situations including fill-in flash with a guide no. of 141 ft/43 m (ISO 100) and a 1/125 second sync. speed. A-TTL and TTL output help you achieve the best possible results. Flash level compensation, bounce flash, slow synchronization, second curtain flash and an external battery pack round out the list of features.

The **300 EZ** has an auto internal zoom function to vary the flash output via A-TTL or TTL control. A guide no. of 93 ft/28 m (ISO 100) and a 1/125 second sync. speed for high performance. A fast recycling time of one second keeps you prepared for any situation. Slow synchronization and second-curtain flash features expand the unit's capabilities.

* When attached to EOS10, the speedlite's AF auxiliary light is not emitted.



Grip Extension GR-60

The grip extension increases the size of the grip to provide a more comfortable and secure hold for large hands. An adjustable padded strap is included for easier handling. Fastens into the tripod socket with a lock nut screw.

Remote Controller RC-1

Offering two release times, immediate and 2 seconds, this tiny controller works up to 16.4 ft/5 m away. It attaches to the camera strap for convenient carrying. A must for candids, family photos, and special occasions.

Dioptric Adjustment Lenses

For eyeglass wearers, there are 10 correction lenses available from +3 to -4. Conduct a test before purchase for the best match to your prescription and make viewing more comfortable.

X. SPECIFICATIONS

TYPE AND MAJOR COMPONENTS

Type: 35 mm focal plane shutter SLR (single-lens reflex) camera with autofocus, auto exposure, and built-in motor drive.

Lens Mount: Canon EF Mount (electronic signal transfer system)

Usable Lenses: Canon EF lenses

Viewfinder: Fixed eye-level pentaprism. Gives 92% vertical and horizontal coverage of actual picture area and 0.74X magnification with 50 mm lens at infinity. Eyepoint: 19 mm

Dioptric Adjustment: Built-in eyepiece is adjusted to standard -1 diopter.



Focusing Screen: New laser-matte screen with three focus marks.

Mirror: Quick-return half-mirror

Shutter: Vertical-travel, focal plane shutter with soft touch electromagnetic release and all speeds electronically controlled.

Shutter Speed: 1/4000 - 30 sec. and bulb. X-sync is 1/125 sec. Set in 1/2-stop increments.

Viewfinder Information: Displayed at the bottom of the viewing area.

1. Three focus marks
2. 7-segment LCD digit and character display
 - (1) Shutter speed: blinks at 2Hz for out-of-coupling range warning.
 - (2) Aperture value: blinks at 2 Hz for out-of-coupling range warning.
 - (3) Depth-of-Field AE: dEP 1, dEP 2
 - (4) Camera-shake Alert indicator: 
 - (5) Metered manual exposure level: -, ±, +
 - (6) AF in-focus indicator: • (Blinks at 8 Hz when AF is not possible)
 - (7) Flash-charge completion indicator: 
 - (8) AE lock indicator: ✖
 - (9) Exposure compensation indicator: 

AUTOFOCUS

AF Control System: TTL-SIR (Secondary Image Registration) phase detection type using Multi-BASIS (Base-Stored Image Sensor). Three modes available: One-shot, AI servo with Focus Prediction and AI Focus that automatically switches to One-shot or AI servo according to the subject. Manual focusing also possible.

X. SPECIFICATIONS

Focusing Point: Set by camera or user.

AF Working Range: EV 0 - 18 at ISO 100.

AF Auxiliary Light: Automatically projected when necessary.

Light through an LED (peak sensitivity: 695 nm) coupled to the focusing point. Effective focal length: from 35 mm to 135 mm. Effective distance range: 1 - 7 m/ 3.3 - 23 ft for the central area, 1 - 4 m/3.3 - 13.1 ft for the peripheral areas.

EXPOSURE CONTROL

Light Metering: TTL full-aperture metering using SPC (Silicon Photocell). Two metering patterns available: 8-Zone New Evaluative Metering, partial metering approx. 8.5% of the central picture area.

Metering Range: EV -1 to 20 at normal temperature (conversion with 50 mm f/1.4 at ISO 100)

Shooting Modes:

1. **Green Zone (□)** (Intelligent Program AE)

2. **Programmed Image Control**

- 1) Portraits
- 2) Landscapes
- 3) Close-ups
- 4) Sports

3. **Bar-code Program** (according to the program input)

4. **Intelligent Program AE with variable program shift function**

5. **Shutter-Priority AE**

6. **Aperture-Priority AE**

7. **Depth-of-Field AE**

8. **Camera-shake Alert**

9. **Manual**

10. **Flash AE** (A-TTL or TTL program flash AE with built-in flash)

Camera Shake Warning: Operates For program AE (P), aperture priority AE (Av), Depth-of-field AE (Dep) and Camera-shake Alert (📷). The camera shake warning beeper tone sounds when the automatically-set shutter speed becomes **0 to 0.5 steps slower than "1/focal length of the lens in use"**.

Beeper can be canceled with Custom Function #6.

Multiple Exposures: Up to nine exposures can be preset. Automatically clears upon completion.

Exposure Compensation: + / - 5 stops in 1/2 stop increments.

Automatic Exposure Bracketing: \pm 5 stops in 1/2 stop increments. Three continuous exposures are taken in sequence: one under, one at the standard metered value, and one over.

Depth-of-Field Check: With Custom Function #11 by pressing the partial metering button.

FILM TRANSPORT

Film Speed Setting: ISO 6—6400; automatically set in 1/3 - stop increments according to DX code or set by user.

Film Loading: Automatic

Film Wind: Automatic. Two modes available:
 (Single Frame) and  (Continuous at up to 5 fps.)

Film Rewind: Automatic (approx. 8 sec. with 24-exp film at normal temperature). Mid-roll rewind also possible.

FLASH

Type: Built-in, retractable type TTL automatic flash.

The flash cannot be combined with an external flash.

Guide Number: 12 m/39.3 ft at ISO 100

Recycling Time: Approx. 2 sec

Flash Coverage Angle: Equivalent to the coverage angle of a 35 mm lens

Flash Coupling Range: 1 - 4.3 m/3.3 - 14.1 ft at ISO 100

Flash Duration: 1.0 ms or less

Color Temperature: Equivalent to daylight

Power Source: Same as the body

POWER SOURCE

Battery: One, six-volt lithium battery (2CR5).

Battery Check: Automatic by turning the camera on. Indicated by a 4-step display on the LCD panel.

Notice

This equipment has been tested and found to comply with the limits for a Class B computing device in accordance with the specifications set forth in Subpart J of Part 15 of the FCC Rules. If this equipment does cause interference to radio or television reception which can be determined by turning the equipment on and off, use the equipment in another location. If necessary, the user should consult the dealer or an experienced radio/television technician for additional suggestions. The user may find the following booklet prepared by the Federal Communications Commission helpful:

“INTERFERENCE HANDBOOK”

This booklet is available from the U.S. Government Printing Office, Washington, D.C., 20402, Stock No. 044-000-00450-7.

This digital apparatus does not exceed the Class B limits for radio noise emissions from digital apparatus set out in the Radio Interference Regulations of the Canadian Department of Communications.

Please copy this page and keep in your camera bag for handy reference.

CUSTOM FUNCTION CONTROL LIST

1. Film Rewind Cancellation
2. Film Leader Out
3. Film Speed Set
4. Autofocus Start
5. Manual Exposure
6. Camera-shake Beeper Off
7. Manual Focus Operation
8. AF Auxiliary Light
9. 1/125 Shutter Speed Lock
10. Red Focus Marks Off
11. Depth-of-Field Check
12. AE Lock
13. Mirror Up
14. Cancel Safety Limitation

Shooting Capacity (with 24-exp. film):

Temperature	Without flash	With 50 % flash use	With 100 % flash use
Normal (68°F/20°C)	60 rolls	25 rolls	13 rolls
Low (-4°F/-20°C)	15 rolls	8 rolls	4 rolls

OTHER

Remote Control: Possible by using optional remote control unit.

Self-timer: Electronically controlled with a 10-sec. delay

Data Display: In the viewfinder and LCD panel.

DIMENSIONS

Size: 6-1/4" (W) × 4-3/16" (H) × 2-3/4" (D)
(158 × 106 × 70 mm)

Weight: 20.3 oz. (580 g) without battery.
21.7 oz. (620 g) with battery.

All data are based on Canon's Standard Test Method.

Subject to change without notice.

Nomenclature

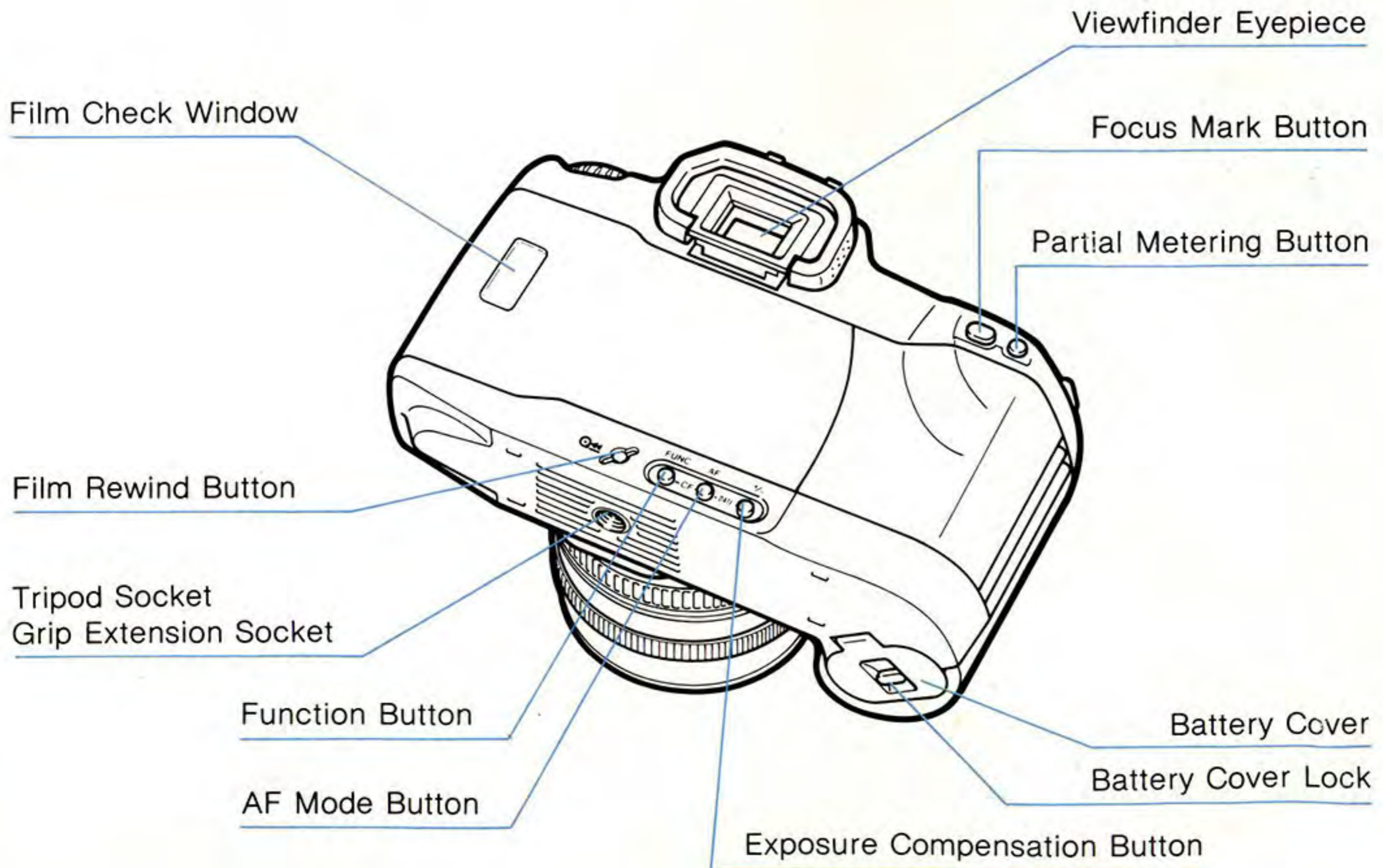

Canon

CANON INC. 7-1, Nishi-Shinjuku 2-Chome, Shinjuku-ku, Tokyo 163, Japan
Mailing address: P.O. Box 5050, Dai-ichi Seimei Building, Tokyo 163, Japan

U.S.A. **CANON U.S.A., INC. HEADQUARTERS**
One Canon Plaza, Lake Success, N.Y. 11042, U.S.A.
CANON U.S.A., INC. NEW JERSEY OFFICE
P.O. Box 1000, 100 Jamesburg Road Jamesburg, New Jersey 08831
CANON U.S.A., INC. WASHINGTON D.C. BRANCH
5701 General Washington Drive Alexandria, Va. 22312, U.S.A.
CANON U.S.A., INC. CHICAGO OFFICE
100 Park Blvd. Itasca, Il. 60143-2693, U.S.A.
CANON U.S.A., INC. ATLANTA OFFICE
5625 Oakbrook Parkway Norcross, Ga. 30093, U.S.A.
CANON U.S.A., INC. DALLAS OFFICE
3200, Regent Blvd. Irving, Tex. 75063-3145, U.S.A.
CANON U.S.A., INC. LOS ANGELES OFFICE
123 Paularino Avenue East, Costa Mesa, Cal. 92626, U.S.A.
CANON U.S.A., INC. SANTA CLARA BRANCH
4000 Burton Drive, Santa, Clara, Cal. 95054, U.S.A.
CANON U.S.A., INC. HONOLULU BRANCH
1020 Auahi St., Bldg. #8, Honolulu, Hawaii 96814, U.S.A.

CANADA **CANON CANADA INC. HEADQUARTERS**
6390 Dixie Road, Mississauga, Ontario L5T 1P7, Canada
CANON CANADA INC. MONTREAL SERVICE CENTRE
10652 Côte de Liesse, Lachine, Québec H8T 1A5, Canada
CANON CANADA INC. CALGARY OFFICE
2828, 16th Street, N.E. Calgary, Alberta T2E 7K7, Canada

EUROPE, AFRICA & MIDDLE EAST **CANON EUROPA N.V.**
Bovenkerkerweg 59-61, P.O. Box 2262, 1180 EG Amstelveen, The Netherlands
CANON PHOTO VIDEO FRANCE S.A.
"Le Doubleton" 11, Avenue Dubonnet 92407 Courbevoie Cedex, France
CANON UK LTD.
Units 4 & 5, Brent Trading Centre, North Circular Road, London NW10 0JF, United Kingdom
CANON EURO-PHOTO G.m.b.H
Siemensring 90-92, D-4156 Willich 1, Germany

CENTRAL & SOUTH AMERICA **CANON LATIN AMERICA, INC. DEPTO. DE VENTAS**
Apartado 7022, Panamá 5, República de Panamá
CANON LATIN AMERICA, INC. CENTRO DE SERVICIO Y REPARACION
Apartado 2019, Zona Libre de Colón, República de Panamá

SOUTHEAST ASIA **CANON HONGKONG TRADING CO., LTD.**
10/F., Mirror Tower, 61 Mody Road, Tsimshatsui East, Kowloon, Hong Kong
CANON SINGAPORE PTE. LTD.
95 South Bridge Road #13-01/15, Pidemco Centre, Singapore 0105

OCEANIA **CANON AUSTRALIA PTY. LTD.**
1 Thomas Holt Drive, North Ryde, N.S.W. 2113, Australia
CANON NEW ZEALAND LTD.
Fred Thomas Drive, P.O. Box 33-336, Takapuna, Auckland, New Zealand

JAPAN **CANON SALES CO., INC.**
11-28, Mita, 3-Chome, Minato-ku, Tokyo 108, Japan