

Canon

# EOS 5D

## Mark III



- This manual is for the EOS 5D Mark III installed with firmware version 1.2.0 or later.
- The "Software Start Guide" is included at the end of this manual.

Canon EOS 5D Mark III

INSTRUCTION MANUAL



E

INSTRUCTION  
MANUAL

# Introduction

The EOS 5D Mark III is a digital single-lens reflex camera featuring a fine-detail, full-frame (approx. 36 x 24 mm) CMOS sensor with approx. 22.3 effective megapixels, DIGIC 5+, approx. 100% viewfinder coverage, high-precision and high-speed 61-point AF, approx. 6 fps continuous shooting, Live View shooting, and Full High-Definition (Full HD) movie shooting.

## **Before Starting to Shoot, Be Sure to Read the Following**

To avoid botched pictures and accidents, first read the “Safety Precautions” (p.389-391) and “Handling Precautions” (p.14-15). Also, read this manual carefully to ensure that you use the camera correctly.

## **Refer to This Manual while Using the Camera to Further Familiarize Yourself with the Camera**

While reading this manual, take a few test shots and see how they come out. You can then better understand the camera. Be sure to store this manual safely, too, so that you can refer to it again when necessary.

## **Testing the Camera Before Use and Liability**

After shooting, play images back and check whether they have been properly recorded. If the camera or memory card is faulty and the images cannot be recorded or downloaded to a computer, Canon cannot be held liable for any loss or inconvenience caused.

## **Copyrights**

Copyright laws in your country may prohibit the use of your recorded images of people and certain subjects for anything but private enjoyment. Also be aware that certain public performances, exhibitions, etc., may prohibit photography even for private enjoyment.

## **Memory Cards**

In this manual, “CF card” refers to CompactFlash cards and “SD card” refers to SD/SDHC/SDXC cards. “Card” refers to all memory cards used to record images or movies. **The camera does not come with a card for recording images/movies.** Please purchase it separately.

# Item Check List

Before starting, check that all the following items have been included with your camera. If anything is missing, contact your dealer.

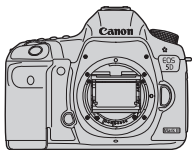

**Camera**  
(with body cap)



**Eyecup Eg**



**Battery Pack  
LP-E6**  
(with protective cover)



**Battery Charger  
LC-E6/LC-E6E\***

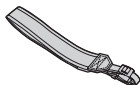

**Wide Strap**



**Interface Cable  
IFC-200U**

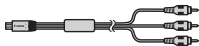

**Stereo AV Cable  
AVC-DC400ST**



**Camera Instruction Manual**  
(this booklet)



**EOS DIGITAL Solution Disk**  
(Software/Software Instruction Manuals)

- \* Battery Charger LC-E6 or LC-E6E is provided. (The LC-E6E comes with a power cord.)
- Attach Eyecup Eg to the viewfinder eyepiece.
- If you purchased a Lens Kit, check that the lens is included.
- Depending on the Lens Kit type, a lens instruction manual may also be included.
- Be careful not to lose any of the above items.

## Software Instruction Manuals

The Software Instruction Manuals are included on the EOS DIGITAL Solution Disk as PDF files. See page 396 for instructions to look up information in the Software Instruction Manuals.



# Conventions Used in this Manual

## Icons in this Manual



: Indicates the Main Dial.



: Indicates the Quick Control Dial.



: Indicates the Multi-controller.



: Indicates the Setting button.

4, 6, 10, 16 : Indicates that the corresponding function remains active for 4 sec., 6 sec., 10 sec., or 16 sec. respectively after you let go of the button.

\* In this manual, the icons and markings indicating the camera's buttons, dials, and settings correspond to the icons and markings on the camera and on the LCD monitor.

**MENU** : Indicates a function that can be changed by pressing the <MENU> button and changing the setting.

☆ : When shown at the upper right of a page, it indicates that the function is available only when the Mode Dial is set to **P**, **Tv**, **Av**, **M**, or **B**.

\* The respective function cannot be used in the <A+> (Scene Intelligent Auto) mode.

(p.\*\*): Reference page numbers for more information.



: Warning to prevent shooting problems.



: Supplemental information.



: Tips or advice for better shooting.



: Problem-solving advice.

## Basic Assumptions

- All operations explained in this manual assume that the power switch has been set to <ON> and the <LOCK▶> switch has been set to the left (Multi function lock released) (p.34, 47).
- It is assumed that all the menu settings and Custom Functions are set to their defaults.
- The illustrations in this manual show the camera attached with the EF50mm f/1.4 USM or EF24-105mm f/4L IS USM lens as an example.

# Chapters

For first-time DSLR users, Chapters 1 and 2 explain the camera's basic operations and shooting procedures.

	<b>Introduction</b>	2
<b>1</b>	<b>Getting Started</b>	27
<b>2</b>	<b>Basic Shooting</b>	63
<b>3</b>	<b>Setting the AF and Drive Modes</b>	69
<b>4</b>	<b>Image Settings</b>	117
<b>5</b>	<b>Advanced Operations</b>	161
<b>6</b>	<b>Flash Photography</b>	189
<b>7</b>	<b>Shooting with the LCD Monitor (Live View Shooting)</b>	199
<b>8</b>	<b>Shooting Movies</b>	219
<b>9</b>	<b>Image Playback</b>	249
<b>10</b>	<b>Post-Processing Images</b>	287
<b>11</b>	<b>Sensor Cleaning</b>	295
<b>12</b>	<b>Printing Images and Transferring Images to a Computer</b>	301
<b>13</b>	<b>Customizing the Camera</b>	319
<b>14</b>	<b>Reference</b>	341
<b>15</b>	<b>Software Start Guide</b>	393

# Contents



## Introduction 2

Item Check List.....	3
Conventions Used in this Manual.....	4
Chapters.....	5
Index to Features .....	12
Handling Precautions .....	14
Quick Start Guide .....	16
Nomenclature .....	18



## 1 Getting Started 27

Charging the Battery .....	28
Installing and Removing the Battery.....	30
Installing and Removing the Card .....	31
Turning on the Power .....	34
Setting the Date, Time, and Zone .....	36
Selecting the Interface Language.....	38
Attaching and Detaching a Lens .....	39
About the Lens Image Stabilizer .....	42
Basic Operation.....	43
<b>[Q]</b> Quick Control for Shooting Functions .....	49
<b>[MENU]</b> Menu Operations.....	51
Before You Start.....	53
Formatting the Card.....	53
Setting the Power-off Time/Auto Power Off .....	55
Setting the Image Review Time .....	55
Reverting the Camera to the Default Settings .....	56
Displaying the Grid and Electronic Level.....	59
<b>[?]</b> Feature Guide.....	61







## 2 Basic Shooting 63

-  Fully Automatic Shooting (Scene Intelligent Auto) ..... 64
-  Full Auto Techniques (Scene Intelligent Auto) ..... 67

## 3 Setting the AF and Drive Modes 69







- AF: Selecting the AF Mode ..... 70
-  Selecting the AF Area ..... 72
- AF Area Selection Modes ..... 75
- About the AF Sensor ..... 78
- Lenses and Usable AF Points ..... 79
- Selecting AI Servo AF Characteristics (For a Subject) ..... 87
- Customizing AF Functions ..... 96
- Fine Adjustment of AF's Point of Focus (AF Microadjustment) .... 106
- When Autofocus Fails ..... 112
  - MF: Manual Focusing ..... 113
-  Selecting the Drive Mode ..... 114
-  Using the Self-timer ..... 115

## 4 Image Settings 117

- Selecting the Card for Recording and Playback ..... 118
- Setting the Image-Recording Quality ..... 121
- ISO: Setting the ISO Speed ..... 126
-  Selecting a Picture Style ..... 131
-  Customizing a Picture Style ..... 134
-  Registering a Picture Style ..... 137
- WB: Setting the White Balance ..... 139
  -  Custom White Balance ..... 140
  -  Setting the Color Temperature ..... 141
-  White Balance Correction ..... 142
- Correcting the Brightness and Contrast Automatically (Auto Lighting Optimizer) .. 144

Noise Reduction Settings .....	145
Highlight Tone Priority .....	148
Lens Peripheral Illumination / Chromatic Aberration Correction.....	149
Creating and Selecting a Folder .....	152
Changing the File Name.....	154
File Numbering Methods .....	156
Setting Copyright Information.....	158
Setting the Color Space .....	160

## 5 Advanced Operations 161

<b>P</b> : Program AE .....	162
<b>Tv</b> : Shutter-Priority AE.....	164
<b>Av</b> : Aperture-Priority AE .....	166
Depth of Field Preview.....	167
<b>M</b> : Manual Exposure .....	168
 Selecting the Metering Mode.....	169
Setting Exposure Compensation.....	171
 Auto Exposure Bracketing (AEB).....	172
 AE Lock.....	173
<b>B</b> : Bulb Exposures.....	174
<b>HDR</b> : HDR (High Dynamic Range) Shooting .....	175
 Multiple Exposures .....	179
 Mirror Lockup .....	186
Using the Eyepiece Cover .....	187
 Using a Remote Switch .....	187
 Remote Control Shooting .....	188

## 6 Flash Photography 189

 Flash Photography .....	190
Setting the Flash .....	193









**7 Shooting with the LCD Monitor (Live View Shooting) 199**













 Shooting with the LCD Monitor .....	200
Shooting Function Settings .....	204
Menu Function Settings .....	205
Using AF to Focus .....	209
Focusing Manually .....	216

**8 Shooting Movies 219**

 Shooting Movies .....	220
Autoexposure Shooting .....	220
Shutter-priority AE .....	221
Aperture-priority AE .....	222
Manual Exposure Shooting .....	225
Shooting Still Photos .....	230
Shooting Function Settings .....	232
Setting the Movie-Recording Size .....	233
Setting the Sound Recording .....	236
Silent Control .....	238
Setting the Time Code .....	239
Menu Function Settings .....	243

**9 Image Playback 249**

 Image Playback .....	250
<b>INFO.:</b> Shooting Information Display .....	252
  Searching for Images Quickly .....	255
 Magnified View .....	257
 Comparing Images (Two-image Display) .....	259
 Rotating the Image .....	260
Setting Ratings .....	261
 Quick Control During Playback .....	263

 Enjoying Movies .....	265
 Playing Movies .....	267
 Editing the Movie's First and Last Scenes .....	269
Slide Show (Auto Playback) .....	271
Viewing the Images on TV .....	274
 Protecting Images.....	278
 Copying Images .....	280
 Erasing Images.....	283
Changing Image Playback Settings .....	285
Adjusting the LCD Monitor Brightness.....	285
Auto Rotation of Vertical Images .....	286
<b>10 Post-Processing Images</b> .....	<b>287</b>
 Processing RAW Images with the Camera .....	288
 Resize.....	293
<b>11 Sensor Cleaning</b> .....	<b>295</b>
 Automatic Sensor Cleaning .....	296
Appending Dust Delete Data .....	297
Manual Sensor Cleaning .....	299
<b>12 Printing Images and Transferring Images to a Computer</b> .....	<b>301</b>
Preparing to Print .....	302
 Printing.....	304
Trimming the Image.....	309
 Digital Print Order Format (DPOF) .....	311
 Direct Printing with DPOF.....	314
 Transferring Images to a Personal Computer.....	315

**13 Customizing the Camera 319**

Custom Functions .....	320
Custom Function Settings .....	321
C.Fn1: Exposure .....	321
C.Fn2: Disp./Operation .....	324
C.Fn3: Others .....	326
C.Fn2: Custom Controls .....	327
Registering My Menu .....	337
 Register Custom Shooting Modes .....	338

**14 Reference 341**

<b>INFO.</b> Button Functions .....	342
Checking the Battery Information .....	344
Using a Household Power Outlet .....	348
Replacing the Date/Time Battery .....	349
Using Eye-Fi Cards .....	350
Function Availability Table According to Shooting Mode .....	352
Menu Settings .....	354
System Map .....	362
Troubleshooting Guide .....	364
Error Codes .....	377
Specifications .....	378
Safety Precautions .....	389

**15 Software Start Guide 393**

Software Start Guide .....	394
Index .....	397

# Index to Features

## Power

- Charging the battery → p.28
- Battery check → p.35
- Battery information check → p.344
- Power outlet → p.348
- Auto power off → p.55

## Card

- Format → p.53
- Select card → p.118
- Release shutter without card → p.32

## Lens

- Attaching/Detaching → p.39
- Zoom → p.40
- Image Stabilizer → p.42

## Basic Settings

- Language → p.38
- Date/Time/Zone → p.36
- Beeper → p.354
- Copyright information → p.158
- Clear all camera settings → p.56

## Viewfinder

- Diopter adjustment → p.43
- Eyepiece cover → p.187
- Grid display → p.59
- Electronic level → p.59

## LCD Monitor

- Brightness adjustment → p.285
- Electronic level → p.60
- Feature guide → p.61

## AF

- AF mode → p.70
- AF area selection mode → p.72
- AF point selection → p.74
- AI Servo AF characteristics → p.87
- AF Custom Functions → p.96
- AF Microadjustment → p.106
- Manual focusing → p.113

## Metering

- Metering mode → p.169

## Drive

- Drive mode → p.114
- Self-timer → p.115
- Maximum burst → p.125

## Recording Images

- Record func. → p.118
- Create/select a folder → p.152
- File name → p.154
- File No. → p.156

## Image Quality

- Image-recording quality → p.121
- ISO speed → p.126
- Picture Style → p.131
- White balance → p.139
- Auto Lighting Optimizer → p.144
- Noise reduction for high ISO speeds → p.145
- Noise reduction for long exposures → p.146
- Highlight tone priority → p.148
- Peripheral illumination correction → p.149

- Chromatic aberration correction → p.150
- Color space → p.160

## Shooting

- Shooting mode → p.24
- HDR → p.175
- Multiple exposures → p.179
- Mirror lockup → p.186
- Depth-of-field preview → p.167
- Remote control → p.188
- Quick Control → p.49

## Exposure Adjustment

- Exposure compensation → p.171
- AEB → p.172
- AE lock → p.173
- Safety shift → p.323

## Flash

- External flash → p.189
- External flash function settings → p.193
- External Speedlite Custom Functions → p.198

## Live View Shooting

- Live View shooting → p.199
- Focusing → p.209
- Aspect ratio → p.206

## Movie Shooting

- Movie shooting → p.219
- Movie recording size → p.233
- Sound recording → p.236
- Time code → p.239
- HDMI output → p.245
- Still photo shooting → p.230

## Playback

- Image review time → p.55
- Single image display → p.250
- Shooting information display → p.252
- Index display → p.255
- Image browsing (Jump display) → p.256
- Magnified view → p.257
- Two-image display → p.259
- Image rotate → p.260
- Rating → p.261
- Movie playback → p.267
- Slide show → p.271
- Viewing images on TV → p.274
- Protect → p.278
- Copying → p.280
- Erase → p.283

## Image Editing

- RAW image processing → p.288
- Resize → p.293

## Printing and Transferring Images

- PictBridge → p.302
- Print Order (DPOF) → p.311
- Image transfer → p.315

## Customization

- Custom Functions (C.Fn) → p.320
- Custom Controls → p.327
- My Menu → p.337
- Custom shooting mode → p.338

## Sensor Cleaning and Dust Reduction

- Sensor cleaning → p.296
- Append Dust Delete Data → p.297

# Handling Precautions

## Camera Care

- This camera is a precision instrument. Do not drop it or subject it to physical shock.
- The camera is not waterproof and cannot be used underwater. If you accidentally drop the camera into water, promptly consult your nearest Canon Service Center. Wipe off any water droplets with a dry cloth. If the camera has been exposed to salty air, wipe it with a well-wrung wet cloth.
- Never leave the camera near anything having a strong magnetic field such as a magnet or electric motor. Also avoid using or leaving the camera near anything emitting strong radio waves such as a large antenna. Strong magnetic fields can cause camera misoperation or destroy image data.
- Do not leave the camera in excessive heat such as in a car in direct sunlight. High temperatures can cause the camera to malfunction.
- The camera contains precision electronic circuitry. Never attempt to disassemble the camera yourself.
- Do not block the mirror operation with your finger, etc. Doing so may cause a malfunction.
- Use a blower to blow away dust on the lens, viewfinder, reflex mirror, and focusing screen. Do not use cleaners that contain organic solvents to clean the camera body or lens. For stubborn dirt, take the camera to the nearest Canon Service Center.
- Do not touch the camera's electrical contacts with your fingers. This is to prevent the contacts from corroding. Corroded contacts can cause camera misoperation.
- If the camera is suddenly brought in from the cold into a warm room, condensation may form on the camera and internal parts. To prevent condensation, first put the camera in a sealed plastic bag and let it adjust to the warmer temperature before taking it out of the bag.
- If condensation forms on the camera, do not use the camera. This is to avoid damaging the camera. If there is condensation, remove the lens, card and battery from the camera, and wait until the condensation has evaporated before using the camera.
- If the camera will not be used for an extended period, remove the battery and store the camera in a cool, dry, well-ventilated location. Even while the camera is in storage, press the shutter button a few times once in a while to check that the camera is still working.
- Avoid storing the camera where there are corrosive chemicals such as a darkroom or chemical lab.
- If the camera has not been used for an extended period, test all its functions before using it. If you have not used the camera for some time or if there is an important shoot coming up, have the camera checked by your Canon dealer or check the camera yourself and make sure it is working properly.

## LCD Panel and LCD Monitor

- Although the LCD monitor is manufactured with very high precision technology with over 99.99% effective pixels, there may be a few dead pixels among the remaining 0.01% or less pixels. Dead pixels displaying only black or red, etc., are not a malfunction. They do not affect the images recorded.
- If the LCD monitor is left on for a prolonged period, screen burn-in may occur where you see remnants of what was displayed. However, this is only temporary and will disappear when the camera is left unused for a few days.
- In low or high temperatures, the LCD monitor display may seem slow or it may look black. It will return to normal at room temperature.

## Cards

To protect the card and its recorded data, note the following:

- Do not drop, bend, or wet the card. Do not subject it to excessive force, physical shock, or vibration.
- Do not touch the card's electronic contacts with your fingers or anything metallic.
- Do not store or use the card near anything having a strong magnetic field such as a TV set, speakers, or magnet. Also avoid places prone to having static electricity.
- Do not leave the card in direct sunlight or near a heat source.
- Store the card in a case.
- Do not store the card in hot, dusty, or humid locations.

## Lens

After detaching the lens from the camera, attach the lens caps and put down the lens with the rear end up to avoid scratching the lens surface and electrical contacts.

Contacts



## Cautions During Prolonged Use

If you use continuous shooting, Live View shooting, or movie shooting for a prolonged period, the camera may become hot. Although this is not a malfunction, holding the hot camera for a long period can cause slight skin burns.

# Quick Start Guide

1

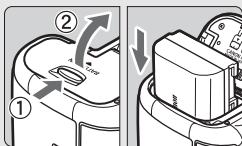

**Insert the battery** (p.30).

- To charge the battery, see page 28.

2

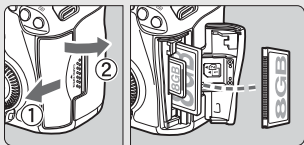

**Insert a card** (p.31).

- The camera-front side slot is for a CF card, and the camera-back side slot is for an SD card.

3



**Attach the lens** (p.39).

- Align it with the red dot.

4



**Set the lens focus mode switch to <AF>** (p.39).

5

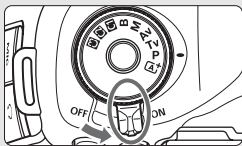

**Set the power switch to <ON>** (p.34).



6



While holding down the center of the Mode Dial, set it to  $\langle \text{AI}^+ \rangle$  (Scene Intelligent Auto) (p.64).

- All the necessary camera settings will be set automatically.

7



**Focus the subject** (p.44).

- Look through the viewfinder and aim the viewfinder center over the subject.
- Press the shutter button halfway, and the camera will focus the subject.

8

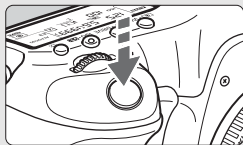

**Take the picture** (p.44).

- Press the shutter button completely to take the picture.

9



**Review the picture** (p.55).

- The captured image will be displayed for 2 sec. on the LCD monitor.
- To display the image again, press the  $\langle \text{▶} \rangle$  button (p.250).

- To shoot while looking at the LCD monitor, see “Live View Shooting” (p.199).
- To view the images captured so far, see “Image Playback” (p.250).
- To delete an image, see “Erasing Images” (p.283).

# Nomenclature

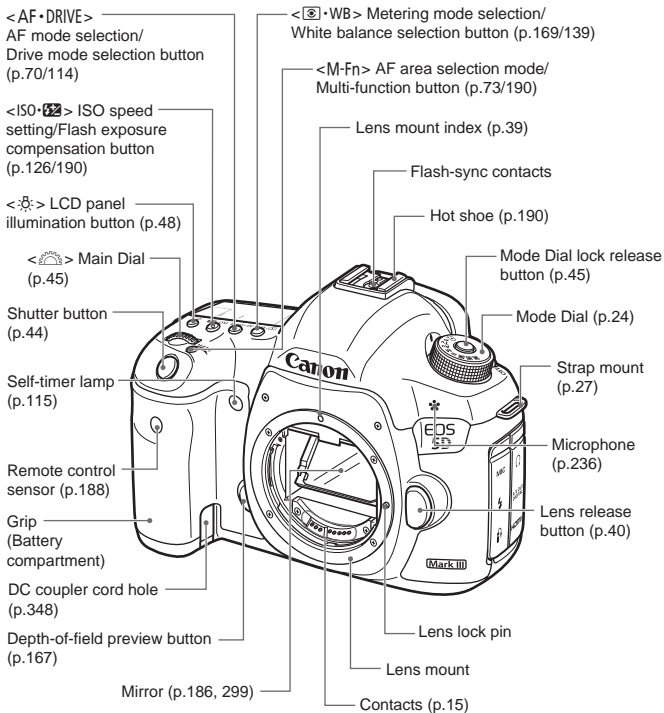

Body cap (p.39)

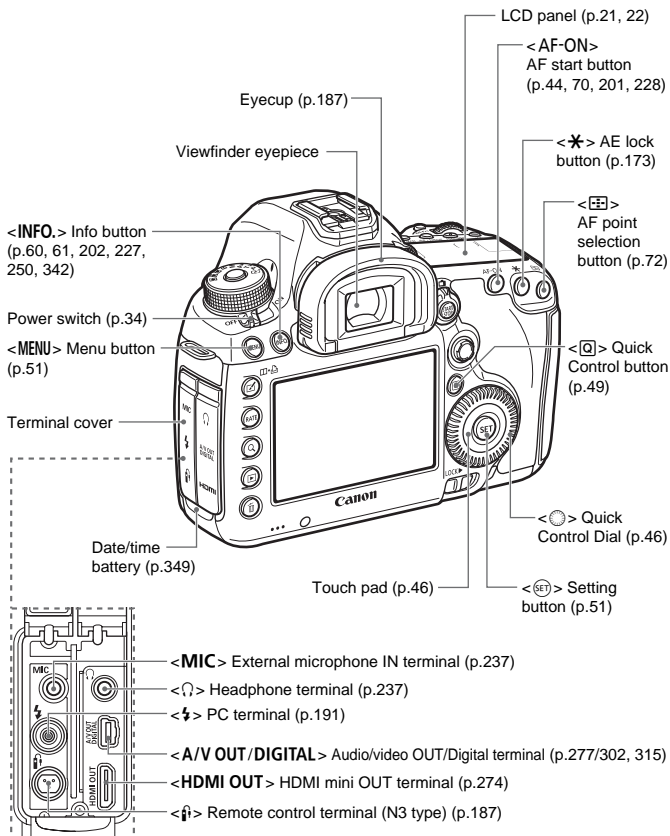

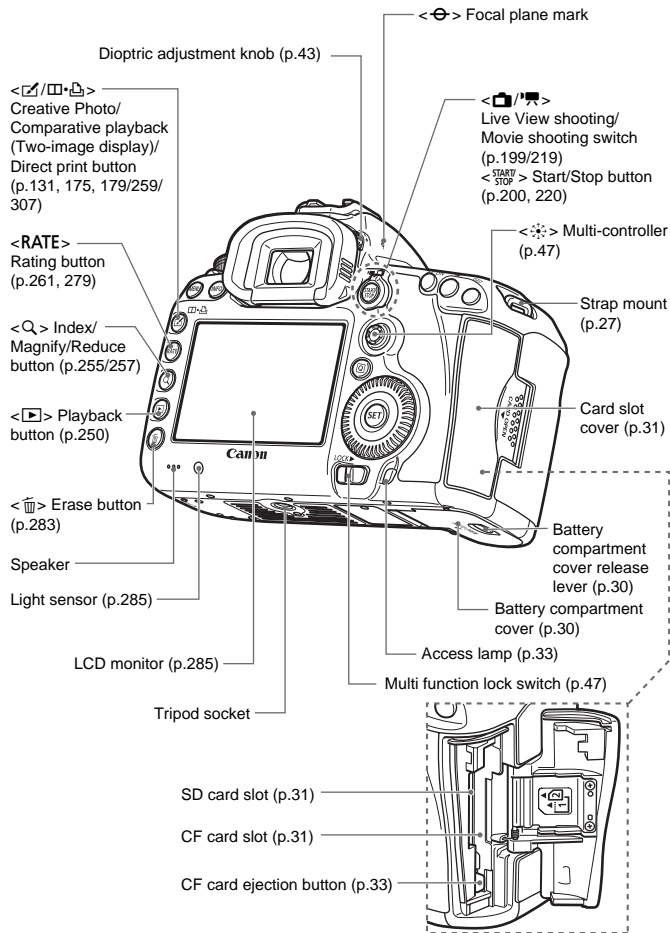

## LCD Panel

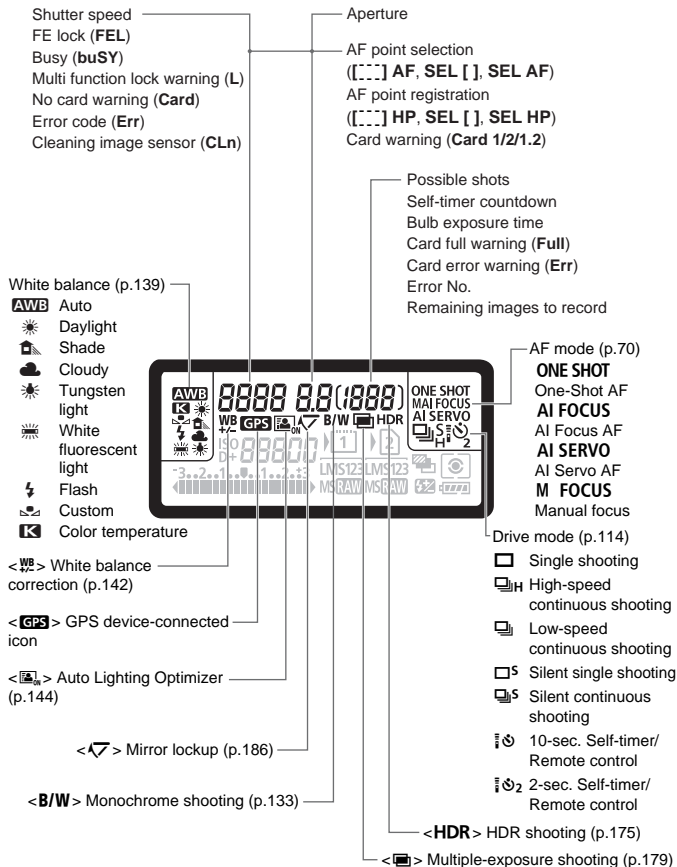

The display will show only the settings currently applied.

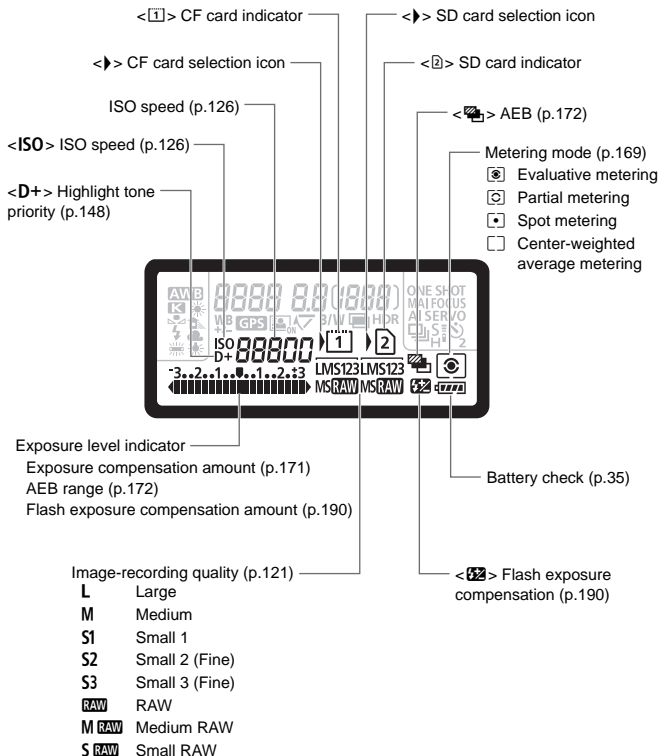

## Viewfinder Information

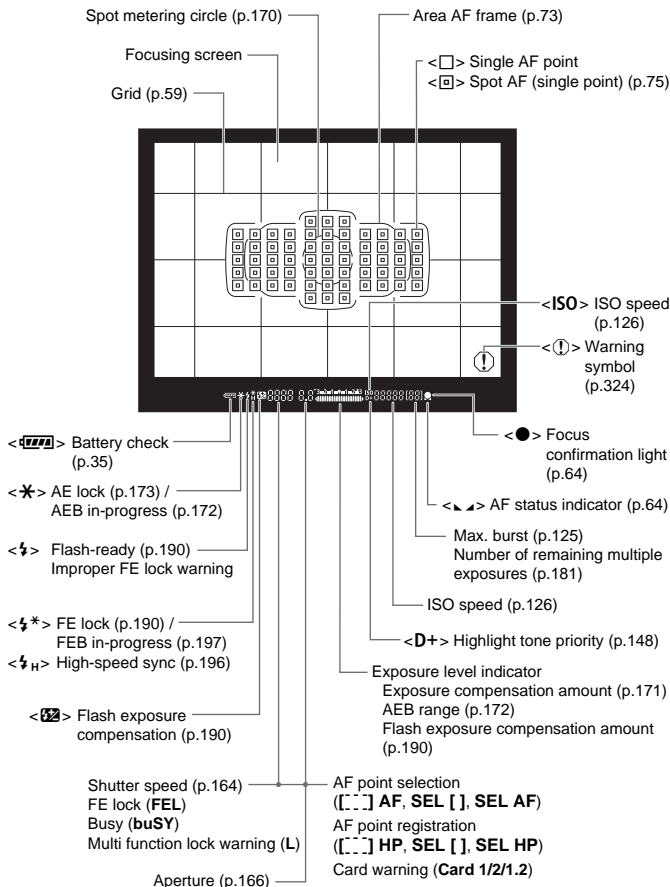

The display will show only the settings currently applied.

## Mode Dial

Turn the Mode Dial while holding down the Mode Dial center (Mode Dial lock release button).

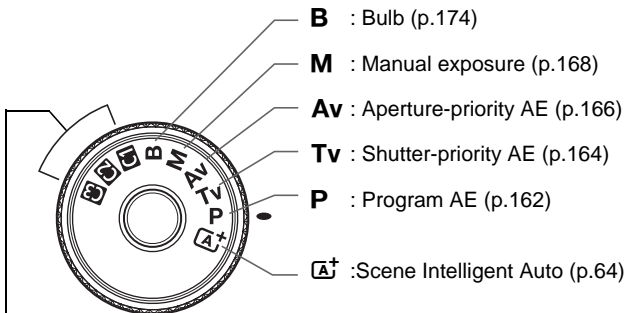

## Custom shooting modes

You can register the shooting mode (**P/Tv/Av/M/B**), AF mode, menu settings, etc., to **C1**, **C2**, **C3** Mode Dial settings and shoot (p.338).

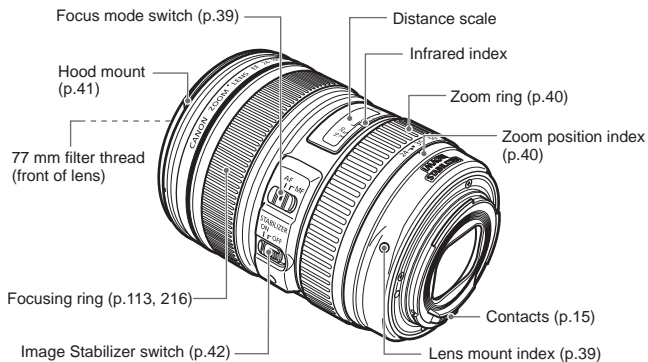

**EF24-105mm f/4L IS USM lens**

## Battery Charger LC-E6

Charger for Battery Pack LP-E6/LP-E6N (p.28).

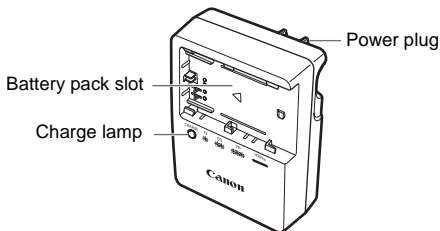

**IMPORTANT SAFETY INSTRUCTIONS-SAVE THESE INSTRUCTIONS.  
DANGER-TO REDUCE THE RISK OF FIRE OR ELECTRIC SHOCK,  
CAREFULLY FOLLOW THESE INSTRUCTIONS.**

For connection to a supply not in the U.S.A., use an attachment plug adapter of the proper configuration for the power outlet, if needed.

## Battery Charger LC-E6E

Charger for Battery Pack LP-E6/LP-E6N (p.28).

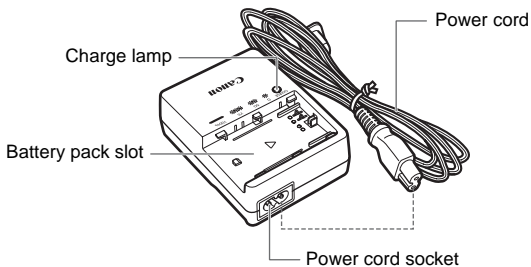

# 1

## Getting Started

This chapter explains preparatory steps before you start shooting and basic camera operations.

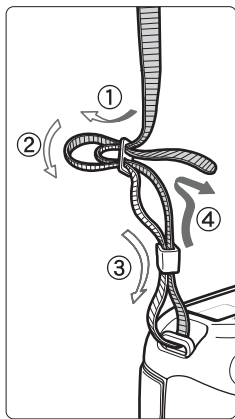

### Attaching the Strap

Pass the end of the strap through the camera's strap mount eyelet from the bottom. Then pass it through the strap's buckle as shown in the illustration. Pull the strap to take up any slack and make sure the strap will not loosen from the buckle.

- The eyepiece cover is also attached to the strap (p.187).

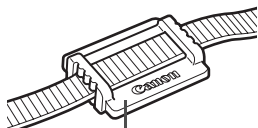

Eyepiece cover

# Charging the Battery

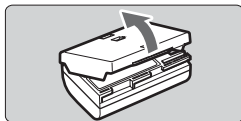

## 1 Remove the protective cover.

- Detach the protective cover provided with the battery.

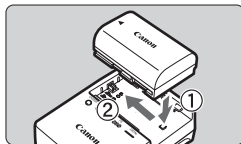

## 2 Attach the battery.

- As shown in the illustration, attach the battery securely to the charger.
- To detach the battery, follow the above procedure in reverse.

### LC-E6

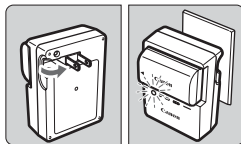

## 3 Recharge the battery.

### For LC-E6

- As shown by the arrow, flip out the battery charger's prongs and insert the prongs into a power outlet.

### LC-E6E

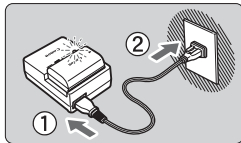

### For LC-E6E

- Connect the power cord to the charger and insert the plug into the power outlet.
- ▶ Recharging starts automatically and the charge lamp blinks in orange.

Charge Level	Charge Lamp	
	Color	Indicator
0 - 49%	Orange	Blinks once per second
50 - 74%		Blinks twice per second
75% or higher		Blinks three times per second
Fully charged	Green	Lights up

- It takes approx. 2.5 hours to fully recharge a completely exhausted battery at 23°C / 73°F. The time required to recharge the battery depends on the ambient temperature and the battery's charge level.
- For safety reasons, recharging in low temperatures (5°C - 10°C / 41°F - 50°F) will take longer (up to 4 hours).

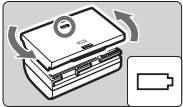

## Tips for Using the Battery and Charger

- **Upon purchase, the battery is not fully charged.**  
Recharge the battery before using.
  - **Recharge the battery on the day before or on the day it is to be used.**  
Even during storage, a charged battery will gradually drain and lose its capacity.
  - **After recharging the battery, detach it and disconnect the charger from the power outlet.**
  - **You can attach the cover in a different orientation to indicate whether the battery has been recharged or not.**  
If the battery has been recharged, attach the cover so that the battery-shaped hole <img alt="Battery-shaped hole icon" data-bbox="398 398 428 418"/> is aligned over the blue sticker on the battery. If the battery is exhausted, attach the cover in the opposite orientation.
 
  - **When not using the camera, remove the battery.**  
If the battery is left in the camera for a prolonged period, a small amount of power current is released, resulting in excess discharge and shorter battery life. Store the battery with the protective cover attached. Storing the battery after it is fully charged can lower the battery's performance.
  - **The battery charger can also be used in foreign countries.**  
The battery charger is compatible with a 100 V AC to 240 V AC 50/60 Hz power source. If necessary, attach a commercially-available plug adapter for the respective country or region. Do not attach any portable voltage transformer to the battery charger. Doing so can damage the battery charger.
  - **If the battery becomes exhausted quickly even after being fully charged, the battery has reached the end of its service life.**  
Check the battery's recharge performance (p.344) and purchase a new battery.
- After disconnecting the charger's power plug, do not touch the prongs for at least 10 sec.
  - If the battery's remaining capacity (p.344) is 94% or higher, the battery will not be recharged.
  - The charger cannot charge any battery other than Battery Pack LP-E6/LP-E6N.

# Installing and Removing the Battery

Load a fully-charged Battery Pack LP-E6 (or LP-E6N) into the camera. The camera's viewfinder becomes bright when a battery is installed, and darkens when the battery is removed.

## Installing the Battery

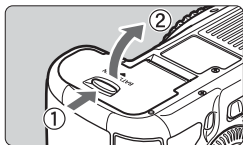

### 1 Open the cover.

- Slide the lever as shown by the arrows and open the cover.

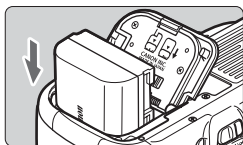

### 2 Insert the battery.

- Insert the end with the battery contacts.
- Insert the battery until it locks in place.

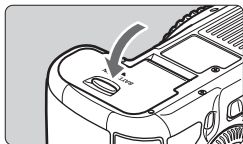

### 3 Close the cover.

- Press the cover until it snaps shut.

 Only Battery Pack LP-E6/LP-E6N can be used.

## Removing the Battery

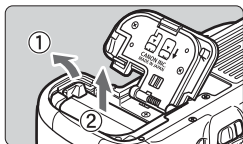

### Open the cover and remove the battery.

- Press the battery release lever as shown by the arrow and remove the battery.
- To prevent short circuiting of the battery contacts, be sure to attach the protective cover (provided, p.29) to the battery.

# Installing and Removing the Card

The camera can use a CF card and SD card. **Images can be recorded when at least one card is installed in the camera.**

If a card is inserted in both slots, you can select which card to record images to or record the same images simultaneously on both cards (p.118, 120).

**ⓘ If you use an SD card, be sure the card's write-protect switch is set upward to enable writing/erasing.**

## Installing the Card

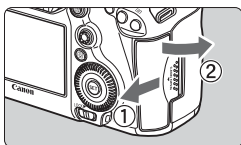

### 1 Open the cover.

- Slide the cover as shown by the arrow to open it.

#### CF card

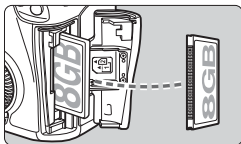

### 2 Insert the card.

- The camera-front side slot is for a CF card, and the camera-back side slot is for an SD card.
- **Face the CF card's label side toward you and insert the end with the small holes into the camera.**
- **If the card is inserted in the wrong way, it may damage the camera.**

#### SD card

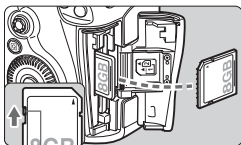

Write-protect switch

- ▶ The CF card eject button will stick out.
- **With the SD card's label facing you, push in the card until it clicks in place.**

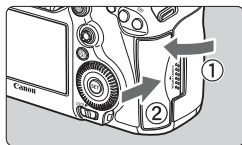

### 3 Close the cover.

- Close the cover and slide it in the direction shown by the arrows until it snaps shut.
- ▶ When you set the power switch to <ON> (p.34), the number of possible shots and the loaded card(s) will be displayed on the LCD panel.

**The images will be recorded to the card with the <▶> icon next to the respective card's indicator.**

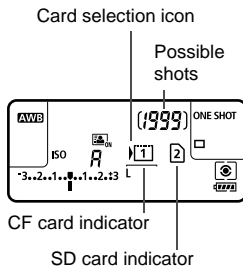

- The camera cannot use Type II CF cards or hard disk cards.
- Although the camera does not comply with the UHS (Ultra-High Speed) speed class standard, UHS SDHC/SDXC cards can be used.



- SDHC/SDXC memory cards can be used with the camera.
- Ultra DMA (UDMA) CF cards can also be used with the camera. UDMA CF cards enable faster data writing.
- The number of possible shots depends on the remaining capacity of the card, image-recording quality, ISO speed, etc.
- Setting [ 1: Release shutter without card ] to [Disable] will prevent you from forgetting to insert a card (p.354).





## Removing the Card

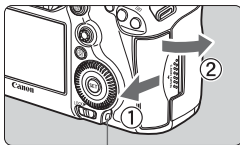

Access lamp

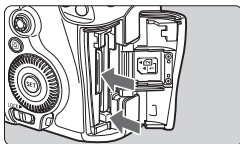

### 1 Open the cover.

- Set the power switch to <OFF>.
- **Make sure the access lamp is off, then open the cover.**
- If [Recording ...] is displayed, close the cover.

### 2 Remove the card.

- To remove the CF card, push the eject button.
- To remove the SD card, push it in gently and release it. Then pull it out.
- Pull the card straight out, then close the cover.



- **When the access lamp is lit or blinking, it indicates that images are being written to or read by the card, being erased, or data is being transferred. Do not open the card slot cover during this time. Also, never do any of the following while the access lamp is lit or blinking. Otherwise, it can damage the image data, card, or camera.**
  - Removing the card.
  - Removing the battery.
  - Shaking or banging the camera around.
- If the card already contains recorded images, the image number may not start from 0001 (p.156).
- If a card-related error message is displayed on the LCD monitor, remove and reinsert the card. If the error persists, use a different card. If you can transfer all the images on the card to a computer, transfer all the images and then format the card with the camera (p.53). The card may then return to normal.
- Do not touch the SD card's contacts with your fingers or metal objects.

## Turning on the Power

If you turn on the power switch and the Date/Time/Zone setting screen appears, see page 36 to set the Date/Time/Zone.

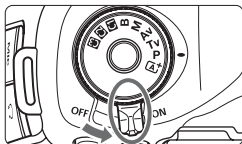

- <ON> : The camera turns on.
- <OFF> : The camera is turned off and does not operate. Set to this position when not using the camera.

## About the Automatic Self-Cleaning Sensor

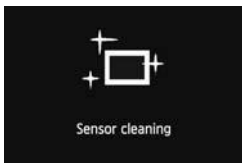

- Whenever you set the power switch to <ON> or <OFF>, sensor cleaning will be executed automatically. (A small sound may be heard.) During the sensor cleaning, the LCD monitor will display <+□+>.
- You can still shoot during sensor cleaning by pressing the shutter button halfway (p.44) to stop the sensor cleaning and take a picture.
- If you repeatedly turn the power switch <ON>/<OFF> at a short interval, the <+□+> icon may not be displayed. This is normal and not a problem.

## **MENU** About Auto Power Off





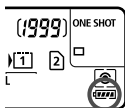

- To save battery power, the camera turns off automatically after 1 minute of non-operation. To turn on the camera again, just press the shutter button halfway (p.44).
- You can change the auto power-off time with [**F2: Auto power off**] (p.55).

 If you set the power switch to <OFF> while an image is being recorded to the card, [**Recording ...**] will be displayed and the power will turn off after the card finishes recording the image.

## Checking the Battery Level

When the power switch is set to <ON>, the battery level will be indicated in one of six levels. A blinking battery icon () indicates that the battery will be exhausted soon.



Icon						
Level (%)	100 - 70	69 - 50	49 - 20	19 - 10	9 - 1	0



## Battery Life

[Approx. number of shots]

Temperature	At 23°C / 73°F	At 0°C / 32°F
Possible shots	950	850

- The figures above are based on a fully-charged Battery Pack LP-E6, no Live View shooting, and CIPA (Camera & Imaging Products Association) testing standards.
- Possible shots with Battery Grip BG-E11
  - With LP-E6 x 2: approx. twice the shots without the battery grip.
  - With size-AA/LR6 alkaline batteries (at 23°C / 73°F): approx. 270 shots.



- The number of possible shots will decrease with any of the following operations:
  - Pressing the shutter button halfway for a prolonged period.
  - Activating the AF frequently without taking a picture.
  - Using the lens Image Stabilizer.
  - Using the LCD monitor often.
- The number of possible shots may decrease depending on the actual shooting conditions.
- The lens operation is powered by the camera's battery. Depending on the lens used, the number of possible shots may be lower.
- For the number of possible shots with Live View shooting, see page 201.
- See [**3: Battery info.**] to check the battery's condition in detail (p.344).
- If size-AA/LR6 batteries are used in Battery Grip BG-E11, a four-level indicator will be displayed. (/ ) will not be displayed.)

## **MENU** Setting the Date, Time, and Zone

When you turn on the power for the first time or if the date/time has been reset, the Date/Time/Zone setting screen will appear. Follow steps 3 to 6 to set the current date, time, and time zone.

**Note that the date/time appended to recorded images will be based on this date/time setting. Be sure to set the correct date/time.**

You can also set the time zone of your current address. Then if you travel to another time zone, you can simply set your destination's time zone so that the correct date/time will be recorded.



### **1** Display the menu screen.

- Press the <MENU> button to display the menu screen.

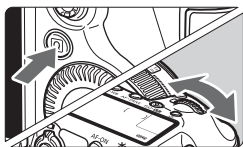

### **2** Under the [Q] tab, select [Date/Time/Zone].

- Press the <Q> button and select the [Q] tab.
- Turn the <G> dial to select the [Q2] tab.
- Turn the <DIAL> dial to select [Date/Time/Zone], then press <SET>.

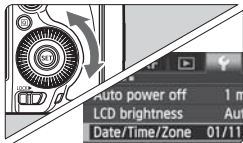

### **3** Set the time zone.

- [London] is set by default.
- Turn the <DIAL> dial to select [Time zone].
- Press <SET> so <DIAL> is displayed.
- Turn the <DIAL> dial to select the time zone, then press <SET>.

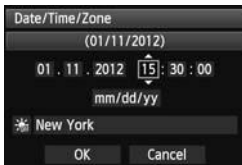

## 4 Set the date and time.

- Turn the <☉> dial to select the number.
- Press <SET> so <☐> is displayed.
- Turn the <☉> dial to select the desired setting, then press <SET> (Returns to <☐>).

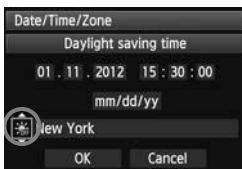

## 5 Set the daylight saving time.

- Set if necessary.
- Turn the <☉> dial to select [☐].
- Press <SET> so <☐> is displayed.
- Turn the <☉> dial to select [☀], then press <SET>.
- When the daylight saving time is set to [☀], the time set in step 4 will advance by 1 hour. If [☐] is set, the daylight saving time will be canceled and the time will go back by 1 hour.

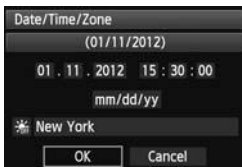

## 6 Exit the setting.

- Turn the <☉> dial to select [OK], then press <SET>.
- ▶ The Date/Time/Zone will be set and the menu will reappear.



- The menu setting procedure is explained on pages 51-52.
- The date/time that was set will start from when you press <SET> in step 6.
- In step 3, the time displayed on the upper right is the time difference compared with Coordinated Universal Time (UTC). If you do not see your time zone, set the time zone while referring to the difference with UTC.

## MENU Selecting the Interface Language

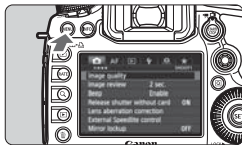

### 1 Display the menu screen.

- Press the <MENU> button to display the menu screen.

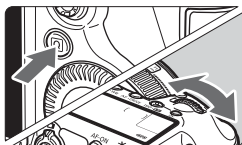

### 2 Under the [Q] tab, select [Language].

- Press the <Q> button and select the [Q] tab.
- Turn the <Sun> dial to select the [2] tab.
- Turn the <Dial> to select [Language] (the fourth item from the top), then press <SET>.

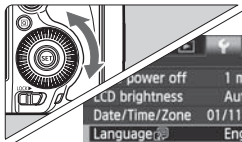

### 3 Set the desired language.

- Turn the <Dial> to select the language, then press <SET>.
- ▶ The interface language will change.

English	Norsk	Română
Deutsch	Svenska	Türkçe
Français	Español	العربية
Nederlands	Ελληνικά	ελληνικά
Dansk	Русский	简体中文
Português	Polski	繁體中文
Suomi	Čeština	한국어
Italiano	Magyar	日本語
Українська		

# Attaching and Detaching a Lens

The camera is compatible with all Canon EF lenses. **The camera cannot be used with EF-S or EF-M lenses.**

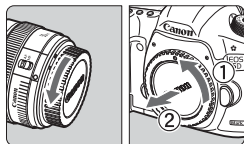

## 1 Remove the caps.

- Remove the rear lens cap and the body cap by turning them as shown by the arrows.

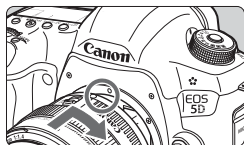

## 2 Attach the lens.

- Align the red dots on the lens and camera and turn the lens as shown by the arrow until it clicks in place.

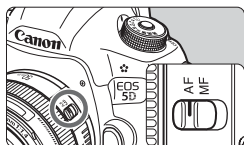

## 3 Set the lens focus mode switch to <AF>.

- <AF> stands for Autofocus.
- If it is set to <MF> (manual focus), autofocus will not operate.

## 4 Remove the front lens cap.



- Do not look at the sun directly through any lens. Doing so may cause loss of vision.
- If the front part (focusing ring) of the lens rotates during autofocus, do not touch the rotating part.

### Minimizing Dust

- When changing lenses, do it quickly in a place with minimal dust.
- When storing the camera without a lens attached, be sure to attach the body cap to the camera.
- Remove dust on the body cap before attaching it.

### About Zooming

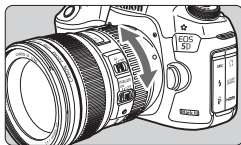

To zoom, turn the zoom ring on the lens with your fingers.

**If you want to zoom, do it before focusing. Turning the zoom ring after achieving focus may throw off the focus slightly.**

### Detaching the Lens

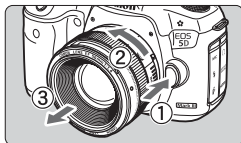

**While pressing the lens release button, turn the lens as shown by the arrow.**

- Turn the lens until it stops, then detach it.
- Attach the rear lens cap to the detached lens.



## Attaching a Lens Hood

When the dedicated EW-83H hood is attached to the EF24-105mm f/4L IS USM lens, it blocks stray light and protects the front of the lens from snow, rain, dust, etc. Before storing the lens in a bag, etc., you can attach the hood in reverse.

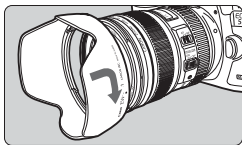

- 1 **Align the red dots on the hood and lens edges.**

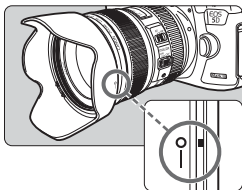

- 2 **Turn the hood as shown in the illustration.**

- Turn the lens hood clockwise until it attaches securely.



- If the hood is not properly attached, it may obstruct the image's periphery, making it look dark.
- When attaching or detaching the lens hood, grasp the base of the hood when turning it. Grasping the hood's edges when turning it may deform the hood.

## About the Lens Image Stabilizer

When you use the IS lens' built-in Image Stabilizer, camera shake is corrected to obtain a sharper shot. The procedure explained here is based on the EF24-105mm f/4L IS USM lens as an example.

\* IS stands for Image Stabilizer.

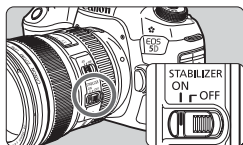

- 1 Set the IS switch to <ON>.**
  - Also set the camera's power switch to <ON>.
- 2 Press the shutter button halfway.**
  - ▶ The Image Stabilizer will operate.
- 3 Take the picture.**
  - When the picture looks steady in the viewfinder, press the shutter button completely to take the picture.

- The Image Stabilizer cannot correct "subject blur", when the subject moves at the time of exposure.
- For bulb exposures, set the IS switch to <OFF>. If <ON> is set instead, Image Stabilizer misoperation may occur.
- The Image Stabilizer may not be effective for excessive shaking such as on a rocking boat.
- The Image Stabilizer may not be effective when you use the EF24-105mm f/4L IS USM lens for panned shots.



- The Image Stabilizer can operate with the lens focus mode switch set to either <AF> or <MF>.
- When using a tripod, you can still shoot with the IS switch set to <ON> with no problem. However, to save battery power, setting the IS switch to <OFF> is recommended.
- The Image Stabilizer is effective even when the camera is mounted on a monopod.

# Basic Operation

## Adjusting the Viewfinder Clarity

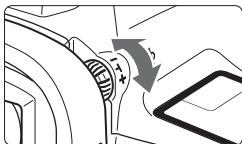

### Turn the dioptic adjustment knob.

- Turn the knob left or right so that the AF points in the viewfinder look sharp.
- If the knob is difficult to turn, remove the eyecup (p.187).



If the camera's dioptic adjustment still cannot provide a sharp viewfinder image, using Dioptic Adjustment Lens Eg (sold separately) is recommended.

## Holding the Camera

To obtain sharp images, hold the camera still to minimize camera shake.

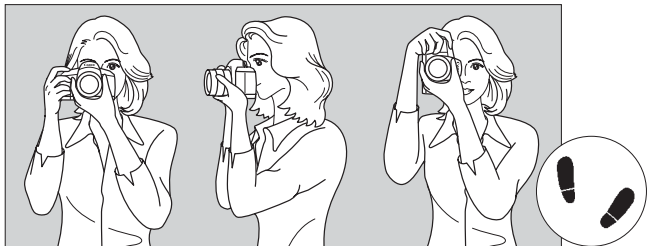

Horizontal shooting

Vertical shooting

1. Wrap your right hand around the camera grip firmly.
2. Hold the lens bottom with your left hand.
3. Rest your hand's right index finger lightly on the shutter button.
4. Press your arms and elbows lightly against the front of your body.
5. To maintain a stable stance, place one foot slightly ahead of the other.
6. Press the camera against your face and look through the viewfinder.



To shoot while looking at the LCD monitor, see page 68.

## Shutter Button

The shutter button has two steps. You can press the shutter button halfway. Then you can further press the shutter button completely.



### Pressing halfway

This activates autofocus and the automatic exposure system that sets the shutter speed and aperture.

The exposure setting (shutter speed and aperture) is displayed in the viewfinder and on the LCD panel (☺4).

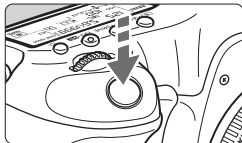

### Pressing completely

This releases the shutter and takes the picture.

## Preventing Camera Shake

Hand-held camera movement during the moment of exposure is called camera shake. It can cause blurred pictures. To prevent camera shake, note the following:

- Hold and steady the camera as shown on the preceding page.
- Press the shutter button halfway to autofocus, then slowly press the shutter button completely.



- In the **P/Tv/Av/M/B** modes, pressing the <AF-ON> button will execute the same operation as pressing the shutter button halfway.
- If you press the shutter button completely without pressing it halfway first or if you press the shutter button halfway and then press it completely immediately, the camera will take a moment before it takes the picture.
- Even during menu display, image playback, or image recording, you can instantly go back to shooting-ready by pressing the shutter button halfway.

## Mode Dial

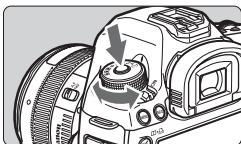



Turn the dial while holding down the lock release button at the center of the dial.

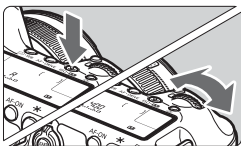

## Main Dial



- (1) After pressing a button, turn the  dial.

When you press a button such as  $\langle \text{WB} \rangle$   $\langle \text{AF} \cdot \text{DRIVE} \rangle$   $\langle \text{ISO} \cdot \text{[ISO icon]} \rangle$ , the respective function remains selected for 6 seconds (6). During this time, you can turn the  dial to set the desired setting.

When the function selection ends or if you press the shutter button halfway, the camera will be ready to shoot.

- Use this dial to select or set the metering mode, AF mode, ISO speed, AF point, etc.

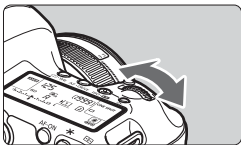

- (2) Turn the  dial only.

While looking at the viewfinder or LCD panel, turn the  dial to set the desired setting.

- Use this dial to set the shutter speed, aperture, etc.





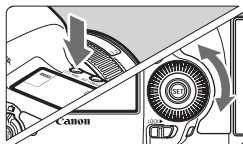

The operations in (1) are also possible while the  $\langle \text{LOCK} \blacktriangleright \rangle$  switch is set to the right (Multi function lock, p.47).

## Quick Control Dial



### (1) After pressing a button, turn the dial.

When you press a button such as  •WB > <AF •DRIVE> <ISO • >, the respective function remains selected for 6 seconds (). During this time, you can turn the  dial to set the desired setting. When the function selection ends or if you press the shutter button halfway, the camera will be ready to shoot.

- Use this dial to select or set the white balance, drive mode, flash exposure compensation, AF point, etc.

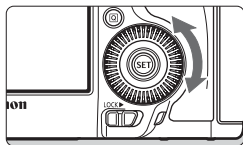



### (2) Turn the dial only.

While looking at the viewfinder or LCD panel, turn the  dial to set the desired setting.



- Use this dial to set the exposure compensation amount, the aperture setting for manual exposures, etc.

 The operations in (1) are also possible while the <LOCK▶> switch is set to the right (Multi function lock, p.47).

## Touch Pad

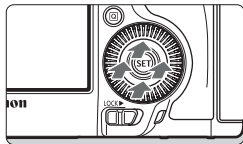
During movie shooting, the touch pad provides a quiet way to adjust the shutter speed, aperture, ISO speed, exposure compensation, sound recording level, and headphone volume (p.238). This function works when [ 5: Silent Control] is set to [Enable ].





After pressing the  button, tap the  dial's inner ring at the top, bottom, left, or right.

## Multi-controller

The  consists of an eight-direction key and a button at the center.



- Use it to select the AF point, correct the white balance, move the AF point or magnifying frame during Live View shooting, scroll around magnified images during playback, operate the Quick Control screen, etc.
- You can also use it to select or set menu options (except [ 1: Erase images] and [ 1: Format card]).
- For menus and the Quick Control screen, the Multi-controller works only in the vertical and horizontal directions. It does not work in diagonal directions.

## LOCK▶ Multi function Lock

With [ 2: Multi function lock] set (p.325) and the <LOCK▶> switch set to the right, it prevents the Main Dial, Quick Control Dial, and Multi-controller from moving and changing a setting inadvertently.

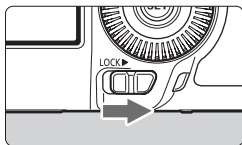

<LOCK▶> switch set to the left:

Lock released

<LOCK▶> switch set to the right:



Lock engaged

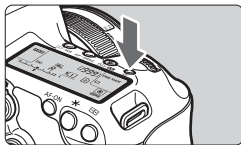

If the <LOCK▶> switch is set to the right and you try to use one of the locked camera controls, <L> will be displayed in the viewfinder and on the LCD panel. On the shooting settings display (p.48), [LOCK] will be displayed.

## LCD Panel Illumination



Turn on ()off the LCD panel illumination by pressing the < > button. During a bulb exposure, pressing the shutter button completely will turn off the LCD panel illumination.

## Displaying Shooting Settings



After you press the <**INFO.**> button a number of times, the shooting settings will be displayed.

With the shooting settings displayed, you can turn the Mode Dial to see the settings for each shooting mode (p.343). Pressing the < > button enables Quick Control of the shooting settings (p.49). Press the <**INFO.**> button again to turn off the display.



## Q Quick Control for Shooting Functions

You can directly select and set the shooting functions displayed on the LCD monitor. This is called the Quick Control screen.

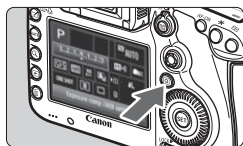

### 1 Press the <Q> button.

- ▶ The Quick Control screen will appear (10).

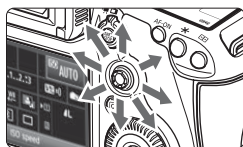

### 2 Set the desired function.

- Use <Q> to select a function.
- ▶ The setting of the selected function is displayed at the bottom.
- Turn the <Q> or <Q> dial to change the setting.

#### ● A+ mode



#### ● P/Tv/Av/M/B modes



### 3 Take the picture.

- Press the shutter button completely to take the picture.
- ▶ The captured image will be displayed.



In the <A+> mode, you can only select or set the recording function, card, image-recording quality, and drive mode.

## Settable Functions on Quick Control Screen

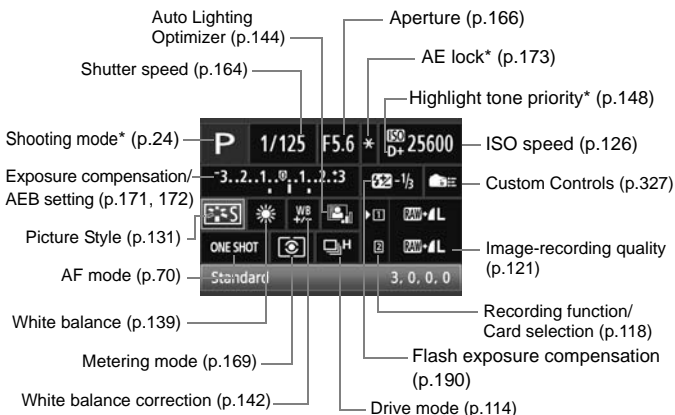

Asterisked functions cannot be set with the Quick Control screen.

## Function Setting Screen

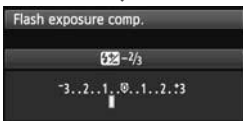

- Select the desired function and press <SET>. The function's setting screen will appear.
- Turn the <DIAL> or <DIAL> dial to change the setting. There are also functions that are set by pressing the <INFO.> button.
- Press <SET> to finalize the setting and return to the Quick Control screen.
- When you select <CUSTOM> (Custom Controls, p.327) and press the <MENU> button, the shooting settings display will reappear.

## MENU Menu Operations

With menus, you can set various functions such as the image-recording quality, date/time, etc. While looking at the LCD monitor, use the <MENU> and <Q> buttons on the camera back and the <MAIN DIAL> <Q> dials.

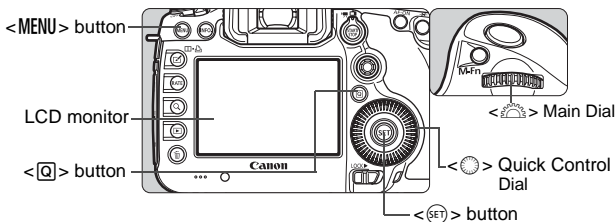

### **A<sup>+</sup>** Mode Menu Screen

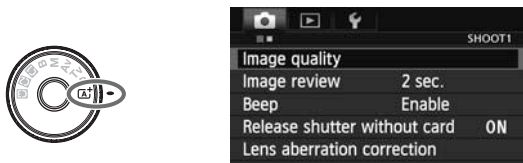

\* Some menu tabs and menu items are not displayed in the <A<sup>+</sup>> mode.

### **P/Tv/Av/M/B** Mode Menu Screen

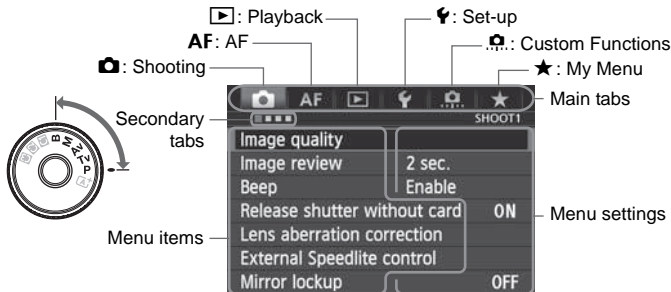

## Menu Setting Procedure

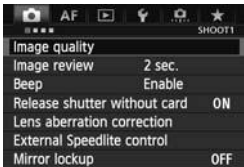

### 1 Display the menu screen.

- Press the <MENU> button to display the menu screen.

### 2 Select a tab.

- Each time you press the <Q> button, the main tab will switch.
- Turn the <DIAL> dial to select a secondary tab.
- For example, the [CAMERA 4] tab refers to the screen displayed when the CAMERA (Shooting) tab's fourth dot ■ from the left is selected.

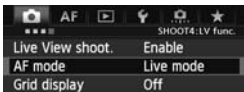

### 3 Select the desired item.

- Turn the <DIAL> dial to select the item, then press <SET>.

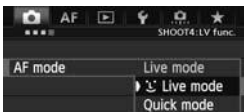

### 4 Select the setting.

- Turn the <DIAL> dial to select the desired setting.
- The current setting is indicated in blue.

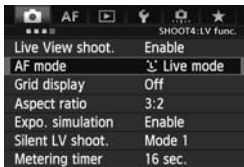

### 5 Set the desired setting.

- Press <SET> to set it.

### 6 Exit the setting.

- Press the <MENU> button to exit the menu and return to shooting-ready.

- The explanation of menu functions hereinafter assumes that you have pressed the <MENU> button to display the menu screen.
- You can also use <DIAL> to set menu settings. (Except for [CAMERA 1: Erase images] and [CAMERA 1: Format card].)
- To cancel, press the <MENU> button.
- For details about each menu item, see page 354.

# Before You Start

## MENU Formatting the Card

If the card is new or was previously formatted by another camera or computer, format the card with the camera.

- ⚠ **When the card is formatted, all images and data in the card will be erased. As even protected images will be erased, make sure there is nothing you need to keep. If necessary, transfer the images to a personal computer, etc., before formatting the card.**

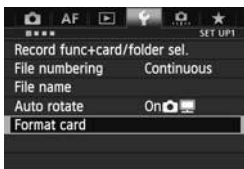

### 1 Select [Format card].

- Under the [1] tab, select [Format card], then press <[SET]>.



### 2 Select the card.

- [1] is the CF card, and [2] is the SD card.
- Turn the <[DIAL]> dial to select the card, then press <[SET]>.



### 3 Select [OK].

- Select [OK], then press <[SET]>.
- ▶ The card will be formatted.
- ▶ When the formatting is completed, the menu will reappear.



- When [2] is selected, low-level formatting is possible (p.54). For low-level formatting, press the <[MENU]> button to append [Low level format] with a <[CHECK]> checkmark, then select [OK].



## Format the card in the following cases:

- The card is new.
- The card was formatted by a different camera or a computer.
- The card is full with images or data.
- A card-related error is displayed (p.377).

### About Low-level Formatting

- Do low-level formatting if the SD card's recording or reading speed seems slow or if you want to totally erase all data in the card.
- Since low-level formatting will erase all recordable sectors in the SD card, the formatting will take slightly longer than normal formatting.
- You can stop the low-level formatting by selecting **[Cancel]**. Even in this case, normal formatting will be completed and you can use the SD card as usual.



- Cards with 128 GB or lower capacity will be formatted in FAT format. Cards with a capacity higher than 128 GB will be formatted in exFAT format. If you format a card with a capacity over 128 GB with this camera and then insert it into another camera, an error may be displayed and the card may become impossible to use. Depending on the personal computer's OS or card reader, it may not recognize a card formatted in exFAT format.
- When the card is formatted or data is erased, only the file management information is changed. The actual data is not completely erased. Be aware of this when selling or discarding the card. When discarding the card, execute low-level formatting or destroy the card physically to prevent the data from being leaked.
- **Before using a new Eye-Fi card, the software in the card must be installed in your computer. Then format the card with the camera.**



- The card capacity displayed on the card format screen may be smaller than the capacity indicated on the card.
- This device incorporates exFAT technology licensed from Microsoft.

## MENU Setting the Power-off Time/Auto Power Off

To save battery power, the camera turns off automatically after a set time of idle operation elapses. If you do not want the camera to turn off automatically, set this to **[Disable]**. After the power turns off, you can turn on the camera again by pressing the shutter button or other buttons.

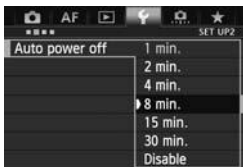

- 1 **Select [Auto power off].**
  - Under the [**2**] tab, select **[Auto power off]**, then press <SET>.
- 2 **Set the desired time.**
  - Select the desired setting, then press <SET>.

 Even if **[Disable]** is set, the LCD monitor will turn off automatically after 30 min. to save power. (The camera's power does not turn off.)

## MENU Setting the Image Review Time

You can set how long the image is displayed on the LCD monitor immediately after capture. To keep the image displayed, set **[Hold]**. To not have the image displayed, set **[Off]**.

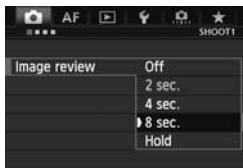

- 1 **Select [Image review].**
  - Under the [**1**] tab, select **[Image review]**, then press <SET>.
- 2 **Set the desired time.**
  - Select the desired setting, then press <SET>.

 If **[Hold]** is set, the image will be displayed until the auto power off time elapses.

**MENU** Reverting the Camera to the Default Settings ☆

The camera's shooting settings and menu settings can be reverted to their defaults.

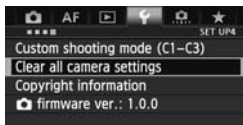
**1** Select [Clear all camera settings].

- Under the [F4] tab, select [Clear all camera settings], then press <SET>.

**2** Select [OK].

- Select [OK], then press <SET>.
- ▶ Setting [Clear all camera settings] will reset the camera to the following default settings:

**Shooting Settings**

AF mode	One-Shot AF
AF area selection mode	Single-point AF (Manual selection)
AF point selection	Center
Registered AF point	Canceled
Metering mode	 (Evaluative metering)
ISO speed	Auto
ISO speed range	Minimum limit: 100 Maximum limit: 25600
Auto ISO range	Minimum limit: 100 Maximum limit: 12800
ISO Auto minimum shutter speed	Auto

Drive mode	<input type="checkbox"/> (Single shooting)
Exposure compensation/AEB	Canceled
Flash exposure compensation	0 (Zero)
Multiple exposure	Disable
HDR Mode	Disable HDR
Mirror lockup	Disable
Custom Functions	Unchanged
Flash function settings	Unchanged



## Image-recording Settings





Image quality	L
Picture Style	Standard
Auto Lighting Optimizer	Standard
Peripheral illumination correction	Enable/ Correction data retained
Chromatic aberration correction	Enable/ Correction data retained
White balance	(Auto)
Custom White Balance	Canceled
White balance correction	Canceled
White balance bracketing	Canceled
Color space	sRGB
Long exposure noise reduction	Disable
High ISO speed noise reduction	Standard
Highlight tone priority	Disable
Record function	Standard
File numbering	Continuous
File name	Preset code
Auto cleaning	Enable
Dust Delete Data	Erased

## AF Settings

Case 1 - 6*	Case1/Parameter settings of all cases cleared
AI Servo 1st image priority	Equal priority
AI Servo 2nd image priority	Equal priority
USM lens electronic MF	Enable after One-Shot AF
AF-assist beam firing	Enable
One-Shot AF release priority	Focus priority
Lens drive when AF impossible	Continue focus search
Selectable AF point	61 points
Select AF area selection mode	All modes selected
AF area selection method	M-Fn button
Orientation linked AF point	Same for both vertical/horizontal
Manual AF point selection pattern	Stops at AF area edges
AF point display during focus	Selected (constant)
VF display illumination	Auto
AF Microadjustment	Disable

\* The default settings are shown on pages 88 to 91.

## Camera Settings

Auto power off	1 min.
Beep	Enable
Release shutter without card	Enable
Image review	2 sec.
Highlight alert	Disable
AF point display	Disable
Histogram display	Brightness
Playback grid	Off
Magnification (Approx.)	2x
Image jump w/ 	 (10 images)
Auto rotate	On  
Movie playback count	Unchanged
LCD brightness	Auto
Date/Time/Zone	Unchanged
Language	Unchanged
Video system	Unchanged
<b>INFO</b> button display options	All items selected
VF grid display	Disable
<b>RATE</b> button function	Rating
Custom shooting modes	Unchanged
Copyright information	Unchanged
Control over HDMI	Disable
Eye-Fi transmission	Disable
My Menu settings	Unchanged
Display from My Menu	Disable

## Live View Shooting Settings

Live View shooting	Enable
AF mode	Live mode
Grid display	Off
Aspect ratio	3:2
Exposure simulation	Enable
Silent LV shooting	Mode 1
Metering timer	16 sec.

## Movie Shooting Settings

AF mode	Live mode
Grid display	Off
Movie recording size	1920x1080/IPB
Sound recording	Auto
Silent LV shooting	Mode 1
Metering timer	16 sec.
Time code	
Count up	Unchanged
Start time setting	Unchanged
Movie recording count	Unchanged
Movie playback count	Unchanged
HDMI	Off
Drop frame	Unchanged
Silent Control	Disable
Movie shooting button	
HDMI output + LCD	No mirroring
HDMI frame rate	Auto

 For WFT and GPS settings, refer to the respective device's instruction manual.

# Displaying the Grid and Electronic Level

You can display a grid and electronic level in the viewfinder and on the LCD monitor to help correct camera tilt.

## Displaying the Grid in the Viewfinder



- 1 Select [VF grid display].**
  - Under the [**2**] tab, select [**VF grid display**], then press <SET>.
- 2 Select [Enable].**
  - Turn the <DIAL> dial to select [**Enable**], then press <SET>.
  - The grid will be displayed in the viewfinder.

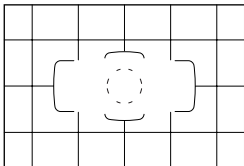

## Displaying the Electronic Level in the Viewfinder

The viewfinder can display an electronic level using the AF points. For details, see Custom Controls (p.327).



A grid can also be displayed on the LCD monitor during Live View shooting and movie shooting (p.205, 243).

## Displaying the Electronic Level on the LCD Monitor

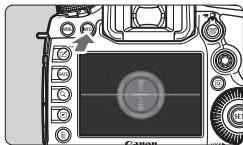

### 1 Press the <INFO.> button.

- Each time you press the <INFO.> button, the screen display will change.
- Display the electronic level.
- If the electronic level does not appear, set [**F3: INFO button display options**] so that the electronic level can be displayed (p.342).



### 2 Check the camera's tilt.

- The horizontal and vertical tilt are displayed in 1° increments.
- When the red line turns green, it indicates that the tilt is corrected.



Vertical level

Horizontal level



- Even when the tilt is corrected, there may be a margin of error of  $\pm 1^\circ$ .
- If the camera is very tilted, the electronic level's margin of error will be bigger.

With this same procedure, you can display the electronic level during Live View shooting and before shooting a movie (p.202, 227). Note that the electronic level cannot be displayed during movie shooting. (The electronic level will disappear when you start shooting a movie.)

## ? Feature Guide

When [INFO Help] is displayed at the bottom of the menu screen, the Feature guide can be displayed. The Feature guide is displayed while you hold down the <INFO.> button. If the Feature guide fills two or more screens, a scroll bar will appear on the right edge. To scroll, hold down the <INFO.> button and turn the <◉> dial.

- Example: [AF1] tab [Case 2]

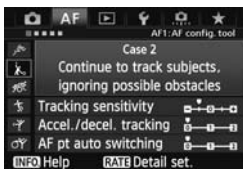

INFO.  
➔

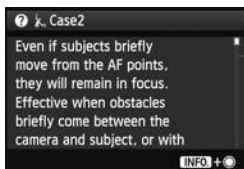

Scroll bar

- Example: [AF3] tab [AF-assist beam firing]

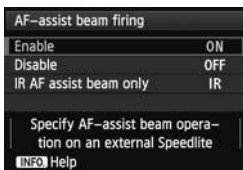

INFO.  
➔

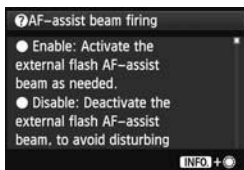

- Example: [◉.2] tab [Multi function lock]



INFO.  
➔

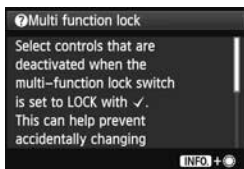



# 2

## Basic Shooting

This chapter explains how to use the Mode Dial's **<A+>** (Scene Intelligent Auto) mode for easy picture taking.

In the **<A+>** mode, all you do is point and shoot and the camera sets everything automatically (p.352). Also, to prevent botched pictures due to mistaken operations, major shooting settings cannot be changed.

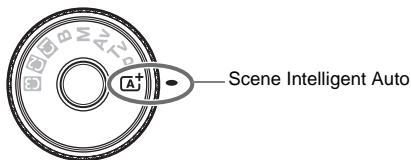

### About the Auto Lighting Optimizer

In the **<A+>** mode, the Auto Lighting Optimizer (p.144) will adjust the image automatically to obtain the optimum brightness and contrast. It is also enabled by default in the **P/Tv/Av/B** modes.

## **[A<sup>+</sup>]** Fully Automatic Shooting (Scene Intelligent Auto) ■

**<[A<sup>+</sup>>** is a fully-automatic mode. The camera analyzes the scene and sets the optimum settings automatically. Detecting whether the subject is still or moving, it also adjusts focus automatically.



Area AF frame

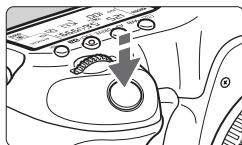
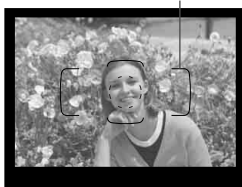

Focus confirmation light

### **1 Set the Mode Dial to <[A<sup>+</sup>>.**

- Turn the Mode Dial while holding down the lock release button at the center.

### **2 Aim the Area AF frame over the target subject.**

- All the AF points will be used to focus, and generally the closest object will be focused.
- Aiming the center of the Area AF frame over the subject will make focusing easier.

### **3 Focus the subject.**

- Press the shutter button halfway. The lens elements will shift to focus.
  - ▶ During the autofocus operation, <[AF]> will be displayed.
  - ▶ The AF point(s) that achieve(s) focus will be displayed. At the same time, the beeper will sound and the focus confirmation light <●> in the viewfinder will light up.
  - ▶ In low light, the AF point(s) will light up briefly in red.



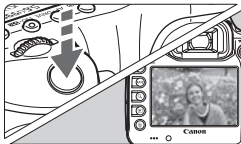

## 4 Take the picture.

- Press the shutter button completely to take the picture.
- ▶ The captured image will be displayed for 2 sec. on the LCD monitor.



The **A<sup>+</sup>** mode makes the colors look more impressive in nature, outdoor, and sunset scenes. If you did not obtain the desired color tones, change the shooting mode to **<P/Tv/Av/M>**, set a Picture Style other than **<A>**, then shoot again.



## FAQ

- **The focus confirmation light **<●>** blinks and focus is not achieved.**

Aim the center of the Area AF frame over a zone with good contrast, then press the shutter button halfway (p.44). If you are too close to the subject, move away and try again. If focus cannot be achieved, the AF status indicator **<▲>** will also blink.

- **Multiple AF points light up simultaneously.**

All those AF points have achieved focus. As long as the AF point covering the desired subject lights up, you can take the picture.

- **The beeper continues to beep softly. (The focus confirmation light **<●>** does not light up.)**

It indicates that the camera is focusing continuously on a moving subject. (The AF status indicator **<▲>** is displayed, but the focus confirmation light **<●>** does not light up.) You can take sharp pictures of a moving subject.

Note that focus lock (p.67) will not work in this case.

- **Pressing the shutter button halfway does not focus the subject.**

If the focus mode switch on the lens is set to **<MF>** (Manual Focus), set it to **<AF>** (Autofocus).

- **The shutter speed display is blinking.**

Since it is too dark, taking the picture may result in a blurred subject due to camera shake. Using a tripod or a Canon EX-series Speedlite (p.190) (sold separately) is recommended.

- **When flash was used, the bottom part of the picture came out unnaturally dark.**

If a hood is attached to the lens, it can obstruct the flash coverage. If the subject is close, detach the hood before taking the picture with flash.

## Full Auto Techniques (Scene Intelligent Auto) ■

### Recomposing the Shot



Depending on the scene, position the subject toward the left or right to create a balanced background and good perspective.

In the  mode, while you press the shutter button halfway to focus a still subject, the focus will be locked. You can then recompose the shot and press the shutter button completely to take the picture. This is called “focus lock”.

### Shooting a Moving Subject



In the  mode, if the subject moves (distance to camera changes) while or after you focus, AI Servo AF will take effect to focus the subject continuously. As long as the Area AF frame covers the subject while you press the shutter button halfway, the focusing will be continuous. When you want to take the picture, press the shutter button completely.

## Live View Shooting

You can shoot while viewing the image on the LCD monitor. This is called “Live View shooting”. For details, see page 199.

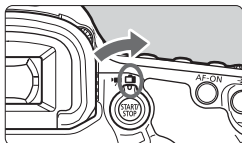

- 1 Set the Live View shooting/Movie shooting switch to <img alt="Camera icon" data-bbox="715 215 755 235"/>.**

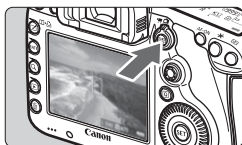

- 2 Display the Live View image on the LCD monitor.**

- Press the <img alt="Start/Stop button" data-bbox="595 385 635 405"/> button.
- ▶ The Live View image will appear on the LCD monitor.



- 3 Focus the subject.**

- Aim the center AF point <img alt="AF point icon" data-bbox="295 500 315 520"/> on the subject.
- Press the shutter button halfway to focus.
- ▶ When focus is achieved, the AF point will turn green and the beeper will sound.

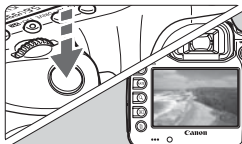

- 4 Take the picture.**

- Press the shutter button completely.
- ▶ The picture will be taken and the captured image is displayed on the LCD monitor.
- ▶ After the image review ends, the camera will return to Live View shooting automatically.
- Press the <img alt="Start/Stop button" data-bbox="595 870 635 890"/> button to end the Live View shooting.

# 3

## Setting the AF and Drive Modes

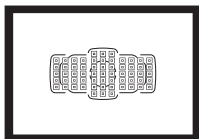

The 61 AF points in the viewfinder make AF shooting suitable for a wide variety of subjects and scenes.

You can also select the AF mode and drive mode that best match the shooting conditions and subject.

- A ☆ icon at the upper right of a page title indicates that the function can be used when the Mode Dial is set to <P/Tv/Av/M/B>.
- In the <A+> mode, the AF mode and AF point (AF area selection mode) will be set automatically.



<AF> stands for autofocus. <MF> stands for manual focus.

# AF: Selecting the AF Mode ☆

You can select the AF mode to suit the shooting conditions or subject. In the  $\langle \text{AF}^+ \rangle$  mode, "AI Focus AF" is set automatically.



- 1 On the lens, set the focus mode switch to  $\langle \text{AF} \rangle$ .



- 2 Press the  $\langle \text{AF} \cdot \text{DRIVE} \rangle$  button. (⓪6)

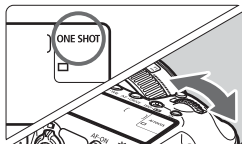

- 3 Select the AF mode.

- While looking at the LCD panel, turn the  $\langle \text{☀} \rangle$  dial.

**ONE SHOT**: One-Shot AF

**AI FOCUS**: AI Focus AF

**AI SERVO**: AI Servo AF

In the **P/Tv/Av/M/B** shooting modes, AF is also possible by pressing the  $\langle \text{AF-ON} \rangle$  button.

## One-Shot AF for Still Subjects

**Suited for still subjects. When you press the shutter button halfway, the camera will focus only once.**

- When focus is achieved, the AF point that achieved focus will be displayed, and the focus confirmation light  $\langle \bullet \rangle$  in the viewfinder will also light up.
- With evaluative metering, the exposure setting will be set at the same time focus is achieved.
- While you hold down the shutter button halfway, the focus will be locked. You can then recompose the shot if desired.



- If focus cannot be achieved, the focus confirmation light <●> and AF status indicator <▲> in the viewfinder will blink. If this occurs, the picture cannot be taken even if the shutter button is pressed completely. Recompose the picture and try to focus again. Or see “When Autofocus Fails” (p.112).
- If [AF1: Beep] is set to [Disable], the beeper will not sound when focus is achieved.
- After achieving focus with One-Shot AF, you can lock the focus on a subject and recompose the shot. This is called “focus lock”. This is convenient when you want to focus a subject not covered by the Area AF frame.

## AI Servo AF for Moving Subjects

**This AF mode is suited for moving subjects when the focusing distance keeps changing. While you hold down the shutter button halfway, the subject will be focused continuously.**

- The exposure is set at the moment the picture is taken.
- When the AF area selection mode is set to 61-point automatic selection (p.72), the camera first uses the manually-selected AF point to focus. During autofocusing, if the subject moves away from the manually-selected AF point, focus tracking continues as long as the subject is covered by the Area AF frame.



With AI Servo AF, the beeper will not sound even when focus is achieved. Also, the focus confirmation light <●> in the viewfinder will not light up.

## AI Focus AF for Automatic Switching of AF Mode

**AI Focus AF switches the AF mode from One-Shot AF to AI Servo AF automatically if a still subject starts moving.**

- After the subject is focused in One-Shot AF mode, if the subject starts moving, the camera will detect the movement and change the AF mode automatically to AI Servo AF.



When focus is achieved in the AI Focus AF mode with the Servo mode active, the beeper will sound softly. However, the focus confirmation light <●> in the viewfinder will not light up. Note that focus will not be locked in this case.

## **Selecting the AF Area** ☆

61 AF points are provided for AF. You can select the AF point(s) suiting the scene or subject.

 **Depending on the lens attached to the camera, the number of usable AF points and AF point patterns will differ. For details, see “Lenses and Usable AF Points” on page 79.**

---

### **AF Area Selection Mode**

You can select one of six AF area selection modes. See the next page for the selection procedure.

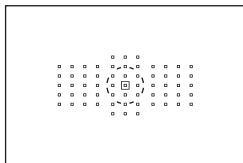

#### **Single-point Spot AF (Manual selection)**

For pinpoint focusing.

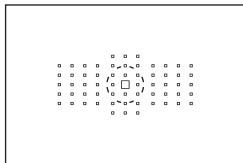

#### **Single-point AF (Manual selection)**

Select one AF point to focus.

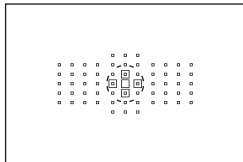

#### **AF point expansion (Manual selection )**

The manually-selected AF point <□> and four surrounding AF points <□> (above, below, on the left and on the right) are used to focus.



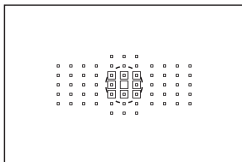

### AF point expansion (Manual selection, surrounding points)

The manually-selected AF point <☐> and the surrounding AF points <◻> are used to focus.

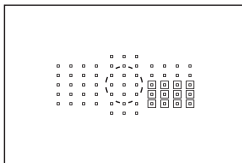

### Zone AF (Manual selection of zone)

The 61 AF points are divided into nine zones for focusing.

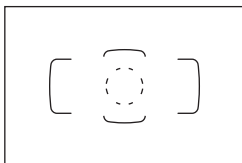

### 61-point automatic selection AF

All the AF points are used to focus. This mode is set automatically in the <[A+]> mode.

## Select the AF Area Selection Mode

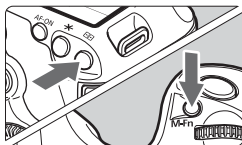

### Select the AF area selection mode.

- Press the <☐> button.
- Look through the viewfinder and press the <M-Fn> button.
- ▶ Press the <M-Fn> button to switch the AF area selection mode.



- With [AF4: Select AF area selec. mode], you can limit the selectable AF area selection modes (p.101).
- If you set [AF4: AF area selection method] to [☐→Main Dial], you can select the AF area selection mode by pressing the <☐> button, then turning the <☺> dial (p.102).

## Selecting the AF Point Manually

You can manually select the AF point or zone. With 61-point automatic selection AF, you can set the starting AF point for AI Servo AF.

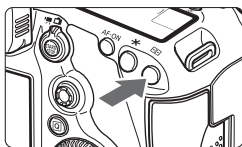

### 1 Press the <☰> button.

- ▶ The AF points will be displayed in the viewfinder.
- In AF point expansion modes, effective adjacent AF points will also be displayed.
- In the Zone AF mode, the selected zone will be displayed.

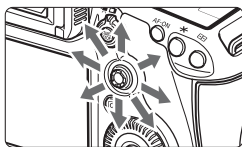

### 2 Select an AF point.

- The AF point selection will change in the direction you tilt the <☰>. If you press <☰> straight down, the center AF point (or center Zone) will be selected.
- The <☰> dial selects an AF point in the horizontal direction, and the <☰> dial selects an AF point in the vertical direction.
- In the Zone AF mode, turning the <☰> or <☰> dial will change the Zone in a looping sequence.

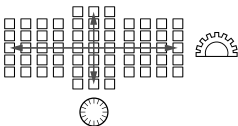

## AF Point Display Indications

Pressing the <☰> button lights up the AF points that are cross-type AF points for high-precision autofocusing. The blinking AF points are horizontal-line sensitive. For details, see page 78.

- When you press the <☰> button, the LCD panel displays the following:
  - 61-point automatic selection AF and Zone AF (manual selection of zone): [☰] AF
  - Single-point Spot AF and Single-point AF: SEL [ ] (Center)/SEL AF (Off-center)
- With [AF5: Manual AF pt. selec. pattern], you can set either [Stops at AF area edges] or [Continuous] (p.104).

# AF Area Selection Modes ☆

## Single-point Spot AF (Manual selection)



Although this is the same as single-point AF, the selected AF point <□> covers a smaller area to focus. Effective for pinpoint focusing of overlapping subjects such as an animal in a cage. Since Spot AF covers a very small area, focusing may be difficult during hand-held shooting or for a moving subject.

## Single-point AF (Manual selection)

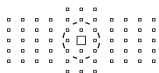

Select one AF point <□> to be used for focusing.

## AF point expansion (Manual selection □□□)

The manually-selected AF point <□> and adjacent AF points <□> (above, below, on the left and on the right) are used to focus. Effective when it is difficult to track a moving subject with just one AF point. With AI Servo AF, the manually-selected AF point <□> must focus-track the subject first. However, it is easier to focus the target subject than with Zone AF. With One-Shot AF, when focus is achieved with an expanded AF point, the expanded AF point <□> will also be displayed along with the manually-selected AF point <□>.



## AF point expansion (Manual selection, surrounding points)

The manually-selected AF point <□> and adjacent AF points <▷> are used to focus. The AF point expansion is larger than with AF point expansion (Manual selection "□"), so the focusing is executed over a wider area. Effective when it is difficult to track a moving subject with just one AF point.

AI Servo AF and One-Shot AF work in the same way as with AF point expansion (Manual selection "□") mode (p.75).



## Zone AF (Manual selection of zone)

The 61 AF points are divided into nine zones for focusing. All the AF points in the selected zone are used for the automatic selection of the point of focus. It makes achieving focus easier than with single-point AF or AF point expansion and it is effective for moving subjects.

However, since it is inclined to focus the nearest subject, focusing a specific target is harder than with single-point AF or AF point expansion. The AF point(s) achieving focus is displayed as <□>.



## 61-point automatic selection AF

All the AF points are used to focus. This mode is set automatically in the **<A+>** mode.



With One-Shot AF, pressing the shutter button halfway will display the AF point(s) **<□>** that achieved focus. If multiple AF points are displayed, it means they all have achieved focus. This mode tends to focus the nearest subject.

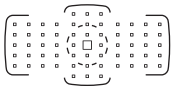

With AI Servo AF, the manually-selected (p.74) AF point **<□>** is used first to achieve focus. The AF point(s) achieving focus is displayed as **<□>**.

- With 61-point automatic selection AF or Zone AF, the active AF point **<□>** will keep switching to track the subject in AI Servo AF mode. However, under certain shooting conditions (such as when the subject is small), it may not be able to track the subject. Also, in low temperatures, the tracking response is slower.
- With Single-point Spot AF, focusing with the Speedlite's AF-assist beam may be difficult.
- If you are using a peripheral AF point or a wide-angle lens, achieving focus with the EOS-dedicated Speedlite's AF-assist beam may be difficult. In such a case, select an AF point close to the center.
- When the AF point(s) light up, part or all of the viewfinder may light up in red. This is a characteristic of AF point display (using liquid crystal).
- In low temperatures, the AF point's blinking (p.74) may be difficult to see. This is a characteristic of AF point display (using liquid crystal).

- If you set [**AF4: Orientation linked AF point**] to [**□□ Select separate AF points**], you can set the AF area selection mode and manually-selected AF point (or Zone) separately for vertical and horizontal shooting (p.103).
- With [**AF4: Selectable AF point**], you can change the number of manually selectable AF points (p.100).



## About the AF Sensor

The camera's AF sensor has 61 AF points. The illustration below shows the AF sensor pattern corresponding to each AF point. With  $f/2.8$  or larger maximum aperture lenses, high-precision AF is possible at the viewfinder center.

**Depending on the lens attached to the camera, the number of usable AF points and AF pattern will differ. For details, see pages 79 to 85.**

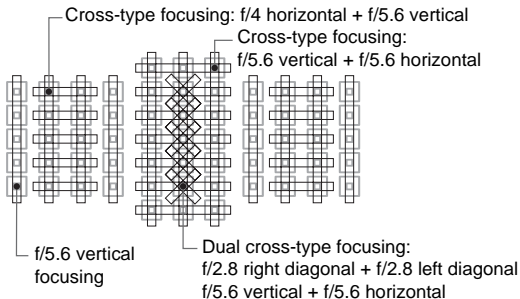
### Diagram

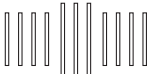

	<p>These focusing sensors are geared to obtain higher precision focusing with <math>f/2.8</math> or larger maximum aperture lenses. A diagonal cross pattern makes it easier to focus subjects that may be difficult to focus. They cover the five vertical AF points at the center.</p>
	<p>These focusing sensors are geared to obtain high-precision focusing with <math>f/4</math> or larger maximum aperture lenses. Since they have a horizontal pattern, they can detect vertical lines.</p>
	<p>These focusing sensors are geared for <math>f/5.6</math> or larger maximum aperture lenses. Since they have a horizontal pattern, it can detect vertical lines. They cover the three columns of AF points at the viewfinder's center. The center AF point, and the AF points above and under the center AF point are geared for <math>f/8</math> or larger maximum aperture.</p>
	<p>These focusing sensors are geared for <math>f/5.6</math> or larger maximum aperture lenses. They can detect horizontal lines and cover all 61 AF points in a vertical pattern. The center AF point, and the AF points on the left and right of the center AF point are geared for <math>f/8</math> or larger maximum aperture.</p>

# Lenses and Usable AF Points



- Although the camera has 61 AF points, the number of usable AF points and focusing patterns will differ depending on the lens. The lenses are thereby classified into nine groups from A to I. Check which group your lens belongs to.
- When using a lens in Groups F to H, fewer AF points will be usable.



- When you press the button, the AF points indicated by the mark will blink. (The // AF points will stay lit.)
- When using a lens marked with “\*\*”, see page 86.
- Regarding new lenses marketed after the EOS 5D Mark III, check Canon's Web site to see which group they belong to.
- Some lenses may not be available in certain countries or regions.

## Group A

Autofocusing with 61 points is possible. All of the AF area selection modes are selectable.

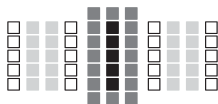

- : Dual cross-type AF point. Subject tracking is superior and the focusing precision is higher than with other AF points.
- : Cross-type AF point. Subject tracking is superior and high-precision focusing is achieved.
- : AF points sensitive to horizontal lines.

EF24mm f/1.4L USM	EF50mm f/1.8	EF200mm f/1.8L USM
EF24mm f/1.4L II USM	EF50mm f/1.8 II	EF200mm f/1.8L USM + Extender EF1.4x*
EF28mm f/1.8 USM	EF85mm f/1.2L USM	EF200mm f/2L IS USM
EF35mm f/1.4L USM	EF85mm f/1.2L II USM	EF200mm f/2L IS USM + Extender EF1.4x
EF35mm f/2	EF85mm f/1.8 USM	EF200mm f/2.8L USM
EF35mm f/2 IS USM	EF100mm f/2 USM	EF200mm f/2.8L II USM
EF50mm f/1.0L USM	EF135mm f/2L USM	EF300mm f/2.8L USM
EF50mm f/1.2L USM	EF135mm f/2L USM + Extender EF1.4x	EF300mm f/2.8L IS USM
EF50mm f/1.4 USM	EF135mm f/2.8 (Softfocus)	EF300mm f/2.8L IS II USM

EF400mm f/2.8L USM	EF16-35mm f/2.8L USM	EF70-200mm f/2.8L USM
EF400mm f/2.8L II USM	EF16-35mm f/2.8L II USM	EF70-200mm f/2.8L IS USM
EF400mm f/2.8L IS USM	EF17-35mm f/2.8L USM	EF70-200mm f/2.8L IS II USM
EF400mm f/2.8L IS II USM	EF20-35mm f/2.8L	EF80-200mm f/2.8L
TS-E45mm f/2.8	EF24-70mm f/2.8L II USM	
TS-E90mm f/2.8	EF28-70mm f/2.8L USM	

- With a TS-E lens, when focusing manually without tilt/shift.

## Group B

Autofocusing with 61 points is possible. All of the AF area selection modes are selectable.

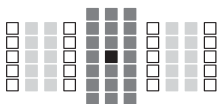

- : Dual cross-type AF point. Subject tracking is superior and the focusing precision is higher than with other AF points.
- : Cross-type AF point. Subject tracking is superior and high-precision focusing is achieved.
- : AF points sensitive to horizontal lines.

EF14mm f/2.8L USM	EF20mm f/2.8 USM	EF28mm f/2.8 IS USM
EF14mm f/2.8L II USM	EF24mm f/2.8	EF24-70mm f/2.8L USM
EF15mm f/2.8 Fisheye	EF24mm f/2.8 IS USM	

## Group C

Autofocusing with 61 points is possible. All of the AF area selection modes are selectable.

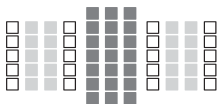

- : Cross-type AF point. Subject tracking is superior and high-precision focusing is achieved.
- : AF points sensitive to horizontal lines.



EF50mm f/2.5 Compact Macro	TS-E24mm f/3.5L	EF200mm f/2L IS USM + Extender EF2x
EF100mm f/2.8 Macro	TS-E24mm f/3.5L II	EF8-15mm f/4L Fisheye USM
EF100mm f/2.8L Macro IS USM	EF200mm f/2.8L USM + Extender EF1.4x	EF16-35mm f/4L IS USM
EF300mm f/4L USM	EF200mm f/2.8L II USM + Extender EF1.4x	EF17-40mm f/4L USM
EF300mm f/4L IS USM	EF300mm f/2.8L USM + Extender EF1.4x*	EF24-70mm f/4L IS USM
EF400mm f/4 DO IS USM	EF300mm f/2.8L IS USM + Extender EF1.4x	EF24-105mm f/4L IS USM
EF400mm f/4 DO IS II USM	EF300mm f/2.8L IS II USM + Extender EF1.4x	EF28-80mm f/2.8-4L USM
EF500mm f/4L IS USM	EF400mm f/2.8L USM + Extender EF1.4x*	EF70-210mm f/4
EF500mm f/4L IS II USM	EF400mm f/2.8L II USM + Extender EF1.4x*	EF70-200mm f/4L USM
EF600mm f/4L USM	EF400mm f/2.8L IS USM + Extender EF1.4x	EF70-200mm f/4L IS USM
EF600mm f/4L IS USM	EF400mm f/2.8L IS II USM + Extender EF1.4x	EF70-200mm f/2.8L USM + Extender EF1.4x*
EF600mm f/4L IS II USM	EF135mm f/2L USM + Extender EF2x	EF70-200mm f/2.8L IS USM + Extender EF1.4x
TS-E17mm f/4L	EF200mm f/1.8L USM + Extender EF2x*	EF70-200mm f/2.8L IS II USM + Extender EF1.4x

- With a TS-E lens, when focusing manually without tilt/shift.

## Group D

Autofocusing with 61 points is possible. All of the AF area selection modes are selectable.

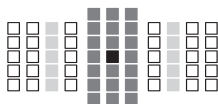

- : Dual cross-type AF point. Subject tracking is superior and the focusing precision is higher than with other AF points.
- : Cross-type AF point. Subject tracking is superior and high-precision focusing is achieved.
- : AF points sensitive to horizontal lines.

EF28mm f/2.8	EF40mm f/2.8 STM
--------------	------------------

## Group E

Autofocusing with 61 points is possible. All of the AF area selection modes are selectable.

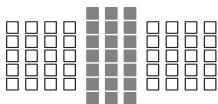

- : Cross-type AF point. Subject tracking is superior and high-precision focusing is achieved.
- : AF points sensitive to horizontal lines.

EF50mm f/2.5 Compact Macro + LIFE SIZE Converter	EF300mm f/2.8L IS USM + Extender EF2x	EF28-105mm f/3.5-4.5 II USM
EF100mm f/2.8 Macro USM	EF300mm f/2.8L IS II USM + Extender EF2x	EF28-135mm f/3.5-5.6 IS USM
EF400mm f/5.6L USM	EF400mm f/2.8L USM + Extender EF2x*	EF28-200mm f/3.5-5.6
EF500mm f/4.5L USM	EF400mm f/2.8L II USM + Extender EF2x*	EF28-200mm f/3.5-5.6 USM
EF300mm f/4L USM + Extender EF1.4x	EF400mm f/2.8L IS USM + Extender EF2x	EF28-300mm f/3.5-5.6L IS USM
EF300mm f/4L IS USM + Extender EF1.4x	EF400mm f/2.8L IS II USM + Extender EF2x	EF35-105mm f/3.5-4.5
EF400mm f/4 DO IS USM + Extender EF1.4x	EF20-35mm f/3.5-4.5 USM	EF35-135mm f/3.5-4.5
EF400mm f/4 DO IS II USM + Extender EF1.4x	EF24-85mm f/3.5-4.5 USM	EF35-135mm f/4-5.6 USM
EF500mm f/4L IS USM + Extender EF1.4x	EF24-105mm f/3.5-5.6 IS STM	EF38-76mm f/4.5-5.6
EF500mm f/4L IS II USM + Extender EF1.4x	EF28-90mm f/4-5.6	EF50-200mm f/3.5-4.5
EF600mm f/4L USM + Extender EF1.4x*	EF28-90mm f/4-5.6 USM	EF50-200mm f/3.5-4.5L
EF600mm f/4L IS USM + Extender EF1.4x	EF28-90mm f/4-5.6 II	EF55-200mm f/4.5-5.6 USM
EF600mm f/4L IS II USM + Extender EF1.4x	EF28-90mm f/4-5.6 II USM	EF55-200mm f/4.5-5.6 II USM
EF200mm f/2.8L USM + Extender EF2x	EF28-90mm f/4-5.6 III	EF200-400mm f/4L IS USM Extender 1.4x: With built-in Ext. 1.4x
EF200mm f/2.8L II USM + Extender EF2x	EF28-105mm f/3.5-4.5 USM	EF200-400mm f/4L IS USM Extender 1.4x + Extender EF1.4x
EF300mm f/2.8L USM + Extender EF2x*		

EF70-200mm f/2.8L USM + Extender EF2x*	EF70-300mm f/4.5-5.6 DO IS USM	EF80-200mm f/4.5-5.6
EF70-200mm f/2.8L IS USM + Extender EF2x	EF75-300mm f/4-5.6	EF90-300mm f/4.5-5.6
EF70-200mm f/2.8L IS II USM + Extender EF2x	EF75-300mm f/4-5.6 USM	EF90-300mm f/4.5-5.6 USM
EF70-200mm f/4L USM + Extender EF1.4x	EF75-300mm f/4-5.6 II	EF100-200mm f/4.5A
EF70-200mm f/4L IS USM + Extender EF1.4x	EF75-300mm f/4-5.6 II USM	EF100-300mm f/4.5-5.6 USM
EF70-210mm f/3.5-4.5 USM	EF75-300mm f/4-5.6 III	EF100-300mm f/5.6
EF70-300mm f/4-5.6 IS USM	EF75-300mm f/4-5.6 III USM	EF100-300mm f/5.6L
EF70-300mm f/4-5.6L IS USM	EF75-300mm f/4-5.6 IS USM	EF100-400mm f/4.5-5.6L IS USM

## Group F

Autofocusing with only 47 points is possible. (Not possible with all 61 AF points.) All of the AF area selection modes are selectable. During automatic AF point selection, the outer frame marking the AF area (Area AF frame) will be different from 61-point automatic selection AF.

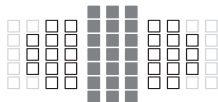

- : Cross-type AF point. Subject tracking is superior and high-precision focusing is achieved.
- : AF points sensitive to horizontal lines.
- : Disabled AF points (not displayed).

EF800mm f/5.6L IS USM	EF28-80mm f/3.5-5.6 III USM	EF35-80mm f/4-5.6 II
EF22-55mm f/4-5.6 USM	EF28-80mm f/3.5-5.6 IV USM	EF35-80mm f/4-5.6 III
EF28-70mm f/3.5-4.5	EF28-80mm f/3.5-5.6 V USM	EF35-80mm f/4-5.6 PZ
EF28-70mm f/3.5-4.5 II	EF28-105mm f/4-5.6	EF35-80mm f/4-5.6 USM
EF28-80mm f/3.5-5.6	EF28-105mm f/4-5.6 USM	EF35-350mm f/3.5-5.6L USM
EF28-80mm f/3.5-5.6 USM	EF35-70mm f/3.5-4.5	EF80-200mm f/4.5-5.6 II
EF28-80mm f/3.5-5.6 II	EF35-70mm f/3.5-4.5A	EF80-200mm f/4.5-5.6 USM
EF28-80mm f/3.5-5.6 II USM	EF35-80mm f/4-5.6	

## Group G

Autofocusing with only 33 points is possible. (Not possible with all 61 AF points.) All of the AF area selection modes are selectable. During automatic AF point selection, the outer frame marking the AF area (Area AF frame) will be different from 61-point automatic selection AF.

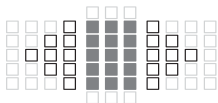

- : Cross-type AF point. Subject tracking is superior and high-precision focusing is achieved.
- : AF points sensitive to horizontal lines.
- : Disabled AF points (not displayed).

EF180mm f/3.5L Macro USM	EF180mm f/3.5L Macro USM + Extender EF1.4x	EF1200mm f/5.6L USM
--------------------------	--	---------------------

## Group H

Only the AF point at the center of the viewfinder, and the surrounding AF points (above, below, on the right and on the left) can be used for autofocusing. Only the following AF area selection modes are selectable: Single-point AF (Manual selection), Single-point Spot AF (Manual selection), and AF point expansion (Manual selection  $\text{⦿}$ ).

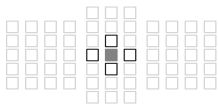

- : Cross-type AF point. Subject tracking is superior and high-precision focusing is achieved.
- : AF points sensitive to horizontal lines (on the right and on the left of the center AF point) or vertical lines (above and under the center AF point). Manual selection is not possible. Only available when “AF point expansion (Manual selection  $\text{⦿}$ )” is selected.
- : Disabled AF points (not displayed).

EF35-105mm f/4.5-5.6	EF35-105mm f/4.5-5.6 USM
----------------------	--------------------------

● **AF when the maximum aperture is f/8**

When an extender is attached to the lens, AF is possible even when the maximum aperture value is larger than f/5.6 up to f/8. Selectable AF area selection modes are the same as that of group H (p.84).

EF400mm f/5.6L USM + Extender EF1.4x	EF400mm f/4 DO IS II USM + Extender EF2x	EF70-200mm f/4L USM + Extender EF2x
EF500mm f/4.5L USM + Extender EF1.4x*	EF500mm f/4L IS USM + Extender EF2x	EF70-200mm f/4L IS USM + Extender EF2x
EF800mm f/5.6L IS USM + Extender EF1.4x	EF500mm f/4L IS II USM + Extender EF2x	EF100-400mm f/4.5-5.6L IS USM + Extender EF1.4x
EF1200mm f/5.6L USM + Extender EF1.4x*	EF600mm f/4L USM + Extender EF2x*	EF200-400mm f/4L IS USM Extender 1.4x: With built-in Ext. 1.4x + Ext. EF1.4x
EF300mm f/4L USM + Extender EF2x	EF600mm f/4L IS USM + Extender EF2x	
EF300mm f/4L IS USM + Extender EF2x	EF600mm f/4L IS II USM + Extender EF2x	EF200-400mm f/4L IS USM Extender 1.4x + Extender EF2x
EF400mm f/4 DO IS USM + Extender EF2x		



- If the maximum aperture is smaller than f/5.6 (the maximum aperture value is larger than f/5.6 up to f/8), focus may not be achieved with AF when shooting low-contrast or low-light subjects.
- When Extender EF2x is attached to the EF180mm f/3.5L Macro USM lens, AF is not possible.
- If the maximum aperture is smaller than f/8 (the maximum aperture value exceeds f/8), AF is not possible during viewfinder shooting. Also, AF is not possible with AF-ON during Live View shooting and movie shooting.

## Group I

Autofocusing with 61 points is possible. All of the AF area selection modes are selectable.

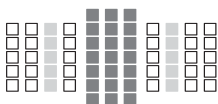

- : Cross-type AF point. Subject tracking is superior and high-precision focusing is achieved.
- : AF points sensitive to horizontal lines.
- : AF points sensitive to horizontal lines.

EF200-400mm f/4L IS USM Extender 1.4x

 When using a lens and an Extender in the combination marked with \*, precise focus may not be achieved with AF. In such a case, refer to the instruction manual of the lens or Extender used.

 Both “Extender EF1.4x” and “Extender EF2x” apply to all the I/II/III models (under this grouping).

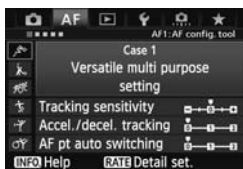

## **MENU** Selecting AI Servo AF Characteristics (For a Subject) ☆

You can easily fine-tune AI Servo AF to suit a particular subject or scene just by selecting between case 1 to case 6. This feature is called the “AF Configuration Tool.”









**1** Select the [AF1] tab.

**2** Select a case.

- Turn the <  > dial to select a case icon, then press <  >.
- ▶ The selected case will be set. The selected case is indicated in blue.

### About Case 1 to 6

As explained on pages 92 to 94, case 1 to 6 are six setting combinations of subject-tracking sensitivity, acceleration/deceleration tracking, and AF point auto switching. Refer to the table below to select the case applicable to the subject or scene.

Case	Icon	Description	Applicable Subjects	Page
Case 1		Versatile multi purpose setting	For any moving subject.	88
Case 2		Continue to track the subject, ignoring possible obstacles	Tennis players, butterfly swimmers, freestyle skiers, etc.	88
Case 3		Instantly focus on subjects suddenly entering AF points	Starting line of a bicycle race, alpine downhill skiers, etc.	89
Case 4		For subjects that accelerate or decelerate quickly	Soccer, motor sports, basketball, etc.	89
Case 5		For erratic subjects moving quickly in any direction	Figure skaters, etc.	90
Case 6		For subjects that change speed and move erratically	Rhythm gymnastics, etc.	91

## Case 1: Versatile multi purpose setting

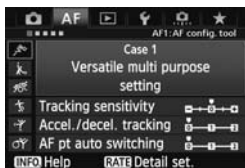

Standard setting suited for any moving subject. Works with many subjects and scenes.

Select [Case 2] to [Case 6] in the following cases: when obstacles enter AF points, when the subject tends to stray from AF points, when you want to focus a subject that suddenly appears, or when the subject moves dramatically up, down, left, or right.

### Default settings

- Tracking sensitivity: [0]
- Accel./decel. tracking: [0]
- AF pt auto switching: [0]

## Case 2: Continue to track subject, ignoring possible obstacles

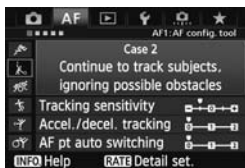

The camera will try to continue focusing the subject even if an obstacle enters the AF points or if the subject strays from the AF points. Effective when there may be an obstacle blocking the subject or when you do not want to focus the background.

### Default settings

- Tracking sensitivity:  
[Locked on: -1]
- Accel./decel. tracking: [0]
- AF pt auto switching: [0]

If an obstacle gets in the way or if the subject moves away from the AF points for a prolonged period and the default setting is unable to track the target subject, setting [Tracking sensitivity] to [Locked on: -2] may give better results (p.92).



### Case 3: Instantly focus on subjects suddenly entering AF points

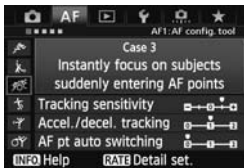

Once an AF point starts tracking the subject, this setting enables the camera to focus consecutive subjects at different distances. If a new subject appears in front of the target subject, the camera will start focusing the new subject. Also effective when you want to always focus on the closest subject.

#### Default settings

- Tracking sensitivity:  
[Responsive: +1]
- Accel./decel. tracking: [+1]
- AF pt auto switching: [0]

 If you want to quickly focus a subject appearing suddenly, setting [Tracking sensitivity] to [+2] may give better results (p.92).

### Case 4: For subjects that accelerate or decelerate quickly

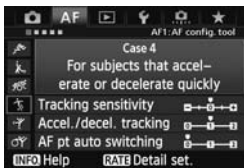

Geared for tracking moving subjects whose speed can change dramatically and suddenly.  
Effective for subjects having sudden movements, sudden acceleration/ deceleration, or sudden stops.

#### Default settings

- Tracking sensitivity: [0]
- Accel./decel. tracking: [+1]
- AF pt auto switching: [0]

 If the moving subject suddenly and greatly changes speed, setting [Accel./decel. tracking] to [+2] may give better results (p.93).

## Case 5: For erratic subjects moving quickly in any direction

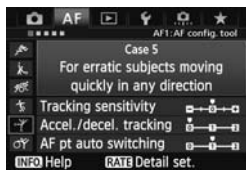

### Default settings

- Tracking sensitivity: [0]
- Accel./decel. tracking: [0]
- AF pt auto switching: [+1]

Even if the target subject moves dramatically up, down, left, or right, the AF point will switch automatically to focus-track the subject. Effective for shooting subjects that move dramatically up, down, left, or right. This setting takes effect when the following AF area selection modes are set: AF point expansion (Manual selection  $\text{AF} \cdot \text{EXP}$ ), AF point expansion (Manual selection, surrounding points), Zone AF (Manual selection), 61-point automatic selection AF.

**This setting is not available with the Single-point Spot AF (Manual selection) and Single-point AF (Manual selection) modes.**

 If the subject moves erratically up, down, left, or right, setting [AF pt auto switching] to [+2] may give better results (p.94).

## Case 6: For subjects that change speed and move erratically

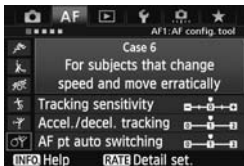

### Default settings

- Tracking sensitivity: [0]
- Accel./decel. tracking: [+1]
- AF pt auto switching: [+1]

Geared for tracking moving subjects whose speed can change dramatically and suddenly. Also, if the target subject moves dramatically up, down, left or right and it is difficult to focus, the AF point switches automatically to track the subject.

This setting takes effect when the following AF area selection modes are set: AF point expansion (Manual selection  $\square \square \square$ ), AF point expansion (Manual selection, surrounding points), Zone AF (Manual selection), 61-point automatic selection AF.

**This setting is not available with the Single-point Spot AF (Manual selection) and Single-point AF (Manual selection) modes.**



- If the moving subject suddenly and greatly changes speed, setting [**Accel./decel. tracking**] to [+2] may give better results (p.93).
- If the subject moves erratically up, down, left, or right, setting [**AF pt auto switching**] to [+2] may give better results (p.94).

## About the Parameters

### ● Tracking sensitivity

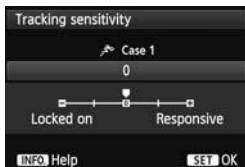

Sets the subject-tracking sensitivity during AI Servo AF when an obstacle enters the AF points or when the AF points stray from the subject.

[0]

Standard setting suited for most moving subjects.

[Locked on: -2 / Locked on: -1]

The camera will try to continue focusing the subject even if an obstacle enters the AF points or if the subject strays from the AF points. The -2 setting makes the camera track the target subject longer than with the -1 setting.

However, if the camera focuses the wrong subject, it may take slightly longer to switch and focus the target subject.

[Responsive: +2 / Responsive: +1]

Once an AF point tracks a subject, the camera can focus consecutive subjects at different distances. Also effective when you want to always focus on the closest subject. The +2 setting makes it quicker to focus the next consecutive subject than with +1.

However, the camera will be more prone to focus on the wrong subject.

 [Tracking sensitivity] is the feature named [AI Servo tracking sensitivity] in the EOS-1D Mark III/IV, EOS-1Ds Mark III, and EOS 7D.

● **Accel./decel. tracking**

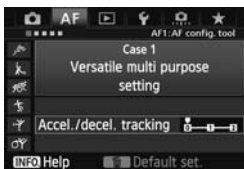

This sets the tracking sensitivity for moving subjects whose speed can suddenly change dramatically by starting or stopping suddenly, etc.

[0]

Suited for subjects that move at a fixed speed.

[+2 / +1]

Effective for subjects having sudden movements, sudden acceleration/deceleration, or sudden stops. Even if the moving subject's speed suddenly changes dramatically, the camera continues to focus the target subject. For example, for an approaching subject, the camera becomes less prone to focus behind it, which would result in a blurred subject. For a subject stopping suddenly, the camera becomes less prone to focus in front of it. Setting +2 can track dramatic changes in the moving subject's speed better than with +1.

However, since the camera will be sensitive to even slight movements of the subject, the focusing may be unstable momentarily.

● **AF pt auto switching**

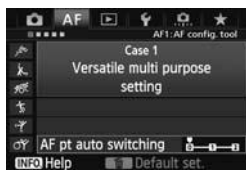

This sets the switching sensitivity of the AF points as they track the subject moving dramatically up, down, left, or right.

This setting takes effect in the following AF area selection modes: AF point expansion (Manual selection  $\square \square \square$ ), AF point expansion (Manual selection, surrounding points), Zone AF (Manual selection), 61-point automatic selection AF.

**[0]**

Standard setting for gradual AF point switching.

**[+2 / +1]**

Even if the target subject moves dramatically up, down, left, or right and moves away from the AF point, the AF point switches to another one to continue focusing the subject. The camera switches to the AF point deemed most likely to focus the subject based on the subject's continual movement, contrast, etc. Setting +2 makes the camera more prone to switch the AF point than with +1.

However, with a wide-angle lens having a wide depth of field or if the subject is too small in the frame, the camera may focus with the wrong AF point.

## Changing Cases' Parameter Settings

You can adjust each case's three parameters (1. Tracking sensitivity, 2. Accel./decel. tracking, and 3. AF pt auto switching) as desired.

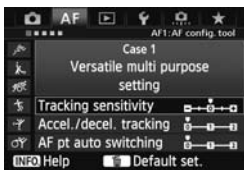

### 1 Select a case.

- Turn the <⦿> dial to select the icon of the case you want to adjust.

### 2 Press the <RATE> button.

- The selected case will have a purple frame.

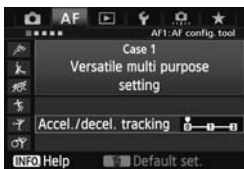

### 3 Select the desired item.

- Turn the <⦿> dial to select a parameter, then press <SET>.
- When Tracking sensitivity is selected, the setting screen will appear.

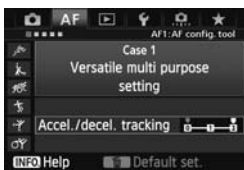

### 4 Make the adjustment.

- Turn the <⦿> dial to adjust as desired, then press <SET>.
- ▶ The adjustment is saved.
- The default setting is indicated by the light gray [▼] mark.

### 5 Exit the setting.

- To return to the screen in step 1, press the <RATE> button.



- In step 2, pressing the <⏮> button will reset the respective case's three parameters to their default settings.
- You can also register the 1, 2, and 3 parameter settings to My Menu (p.337). Doing so will change the selected case's settings.
- When shooting with a case whose parameters you adjusted, select the adjusted case and then take the picture.

## MENU Customizing AF Functions ☆

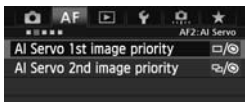

With the [ **AF2** ] to [ **AF5** ] menu tabs, you can set the AF functions to suit your shooting style or subject.

### AF2: AI Servo

#### AI Servo 1st image priority

You can set the AF operation characteristics and shutter-release timing for the first shot during continuous shooting with AI Servo AF.

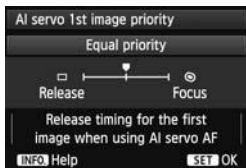

#### □/⊕: Equal priority

Equal priority is given to focusing and shutter release.

#### □: Release priority

Pressing the shutter button takes the picture immediately even if focus has not been achieved. This gives priority to getting the shot rather than achieving correct focus.

#### ⊕: Focus priority

Pressing the shutter button does not take the picture until focus has been achieved. Effective when you want to achieve focus before capturing the shot.



## AI Servo 2nd image priority

You can set the AF operation characteristics and shutter-release timing during continuous shooting after the first shot with AI Servo AF.

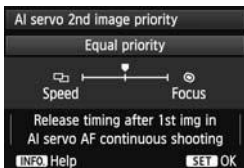

### /🎯: Equal priority

Equal priority is given to focusing and continuous shooting speed. In low light or with low-contrast subjects, shooting speed may slow down.

### : Shooting speed priority

Priority is given to the continuous shooting speed instead of achieving focus. The continuous shooting speed does not slow down. Convenient when you want to maintain the continuous shooting speed.

### 🎯: Focus priority

Priority is given to achieving focus instead of the continuous shooting speed. The picture is not taken until focus is achieved. Effective when you want to achieve focus before capturing the shot.

## AF3: One Shot

### USM lens electronic MF

For the lenses below, which have an electronic focusing ring, you can set whether to use the electronic focusing ring.

EF50mm f/1.0L USM	EF300mm f/2.8L USM	EF600mm f/4L USM
EF85mm f/1.2L USM	EF400mm f/2.8L USM	EF1200mm f/5.6L USM
EF85mm f/1.2L II USM	EF400mm f/2.8L II USM	EF28-80mm f/2.8-4L USM
EF200mm f/1.8L USM	EF500mm f/4.5L USM	

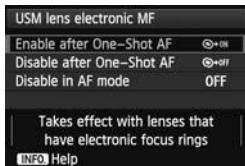

#### ☉+ON: Enable after One-Shot AF

After AF operates, if you keep pressing the shutter button, you can focus manually.

#### ☉+OFF: Disable after One-Shot AF

After AF operates, manual focusing is disabled.

#### OFF: Disable in AF mode

When the lens' focus mode switch is set to [AF], manual focusing is disabled.

## AF-assist beam firing

Enables or disables the EOS-dedicated Speedlite's AF-assist beam.

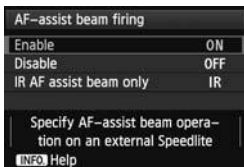

### ON: Enable

The external Speedlite emits the AF-assist beam when necessary.

### OFF: Disable

The external Speedlite will not emit the AF-assist beam. This prevents the AF-assist beam from disturbing others.

### IR: IR AF assist beam only

Among external Speedlites, only models with an infrared AF-assist beam will be able to emit the beam. Set this if you do not want the AF assist to be emitted as small flashes.



If the external Speedlite's Custom Function [**AF-assist beam firing**] is set to [**Disable**], this function's setting will be overridden and the AF-assist beam will not be emitted.

## One-Shot AF release priority

You can set the AF operation characteristics and shutter-release timing for One-Shot AF.

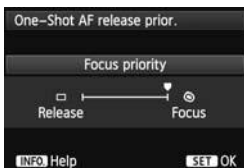

### ⦿: Focus priority

The picture is not taken until focus is achieved. Effective when you want to achieve focus before capturing the shot.

### □: Release priority

Priority is given to taking the picture instead of achieving focus. This gives priority to getting the shot rather than achieving correct focus.

**Note that the picture will be taken even if focus has not been achieved.**

## AF4

## Lens drive when AF impossible

If focus cannot be achieved with autofocus, you can have the camera keep searching for the correct focus or have it stop searching.

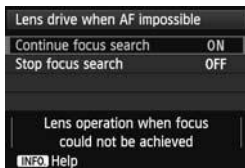
**ON: Continue focus search**

If focus cannot be achieved with autofocus, the lens is driven to search for the correct focus.

**OFF: Stop focus search**

If autofocus starts and the focus is far off or if focus cannot be achieved, the lens drive stops. This prevents the lens from becoming grossly out of focus due to focus searching.



Super telephoto lenses can become grossly out of focus during continuous focus search, taking more time to achieve focus the next time. Therefore, setting [Stop focus search] is recommended for super telephoto lenses.

## Selectable AF point

You can change the number of manually selectable AF points. In the case of automatic AF point selection, all 61 AF points will remain active regardless of this setting.

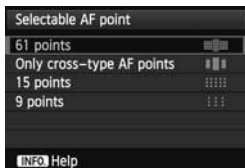
**||||| : 61 points**

All 61 AF points will be manually selectable.

**||| : Only cross-type AF points**

Only cross-type AF points will be manually selectable. The number of selectable cross-type AF points will differ depending on the lens.



### ⋮⋮⋮⋮ : 15 points

Fifteen major AF points will be manually selectable.



### ⋮⋮⋮ : 9 points

Nine major AF points will be manually selectable.

 With a lens from groups F to H (p.83-85), the number of manually selectable AF points will be fewer.

-  ● Even with settings other than **[61 points]**, AF point expansion (Manual selection ) , AF point expansion (Manual selection, surrounding points), and Zone AF (manual selection of Zone) are still possible.
- When you press the  button, the AF points that are not manually selectable will not be displayed.

## Select AF area selection mode

You can limit the selectable AF area selection modes to suit your shooting preferences. Turn the  dial to select a selection mode, then press  to append a  checkmark. Then select **[OK]** to register the setting.

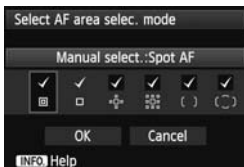

### : **Manual select.:Spot AF**

For pinpoint focusing with a narrower AF point than single-point AF.

### : **Manual selection:1 pt AF**

One of the AF points set by **[Selectable AF point]** setting can be selected.

### : **Expand AF area:**

The camera will focus with the manually-selected AF point and the adjacent AF points (above, below, left and right).

### : **Expand AF area:Surround**

The camera will focus with the manually-selected AF point and the surrounding AF points.

## ( ) : **Manual select.:Zone AF**

The 61 AF points are divided into nine zones for focusing.

## (○) : **Auto selection: 61 pt AF**

All of the AF points are used for focusing.

- The <√> mark cannot be deleted from **[Manual selection:1 pt AF]**.
- If the attached lens belongs to group H (p.84, 85), you can only select **[Manual select.:Spot AF]**, **[Manual selection:1 pt AF]**, and **[Expand AF area:☉]**.

## AF area selection method

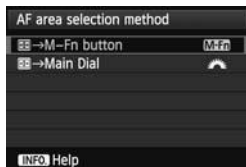

You can set the method for changing the AF area selection mode.





### **M-Fn** : → **M-Fn button**

After you press the <> button, each time you press the <M-Fn> button, the AF area selection mode changes.

### : → **Main Dial**

After you press the <> button, turning the <> dial changes the AF area selection mode.

 When  → **Main Dial** is set, use the <> to move the AF point horizontally.

## Orientation linked AF point

You can set the AF area selection mode and manually-selected AF point separately for vertical shooting and horizontal shooting.

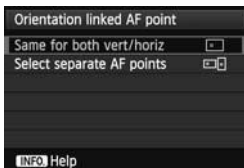

### : Same for both vert/horiz

The same AF area selection mode and manually-selected AF point (or Zone) are used for both vertical shooting and horizontal shooting.

### : Select separate AF points

The AF area selection mode and manually-selected AF point (or Zone) can be set separately for each camera orientation (1. Horizontal, 2. Vertical with the camera grip at the top, 3. Vertical with the camera grip at the bottom). Convenient when, for instance, you want to keep using the right AF point during all camera orientations.

When you manually select the AF area selection mode and AF point (or Zone with Zone AF) for each of the three camera orientations, they will be set for the respective orientation. Whenever you change the camera orientation, the camera will switch to the AF area selection mode and manually-selected AF point (or Zone) set for that orientation.



- If you clear the camera settings to their defaults (p.56), the setting will be **[Same for both vert/horiz]**. Also, your settings for the three camera orientations will be cleared and all three will revert to Single-point AF (Manual selection) with the center AF point selected.
- If you set this and later attach a lens from a different AF group (p.79-85, especially Group H), the setting may be cleared.

## AF5

## Manual AF point selection pattern

During manual AF point selection, the selection can either stop at the outer edge or it can move to the opposite AF point. This function works in AF area selection modes other than 61-point automatic selection AF and Zone AF. (It works in 61-point automatic selection AF only with AI Servo AF.)

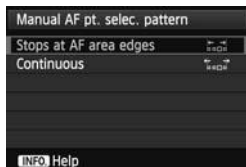

**Stops at AF area edges**

Convenient if you often use an AF point along the edge.

**Continuous**

Instead of stopping at the outer edge, the selected AF point continues to the opposite side.

## AF point display during focus

You can set whether or not to display the AF point(s) in the following cases: 1. When selecting the AF point(s), 2. When the camera is ready to shoot (before AF operation), 3. During AF operation, and 4. When focus is achieved.

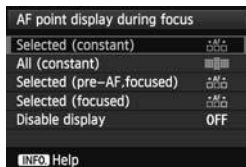

**Selected (constant)**

The selected AF point(s) is always displayed.

**All (constant)**

All 61 AF points are always displayed.

**Selected (pre-AF, focused)**

The selected AF point(s) is displayed for 1, 2, and 4.

**Selected (focused)**

The selected AF point(s) is displayed for 1 and 4.

**OFF: Disable display**

For 2, 3, and 4, the selected AF point(s) will not be displayed.





If **[Selected (pre-AF, focused)]** or **[Selected (focused)]** is set, the AF point will not be displayed even when focus is achieved with AI Servo AF.

## VF display illumination

The AF points and grid in the viewfinder can be illuminated in red when focus is achieved.

VF display illumination	
Auto	AUTO
Enable	ON
Disable	OFF
INFO Help	

### **AUTO: Auto**

The AF points and grid are automatically illuminated in red under low light.

### **ON: Enable**

The AF points and grid are illuminated in red regardless of the ambient light level.

### **OFF: Disable**

The AF points and grid are not illuminated in red.



The setting here is not applied to the electronic level display (p.59) in the viewfinder.



When you press the **<AF-ON>** button, the AF points and grid will be illuminated in red regardless of this setting.

## AF Microadjustment

You can make fine adjustments for the AF's point of focus. For details, see "Fine Adjustment of AF's Point of Focus" on page 106.

## **MENU** Fine Adjustment of AF's Point of Focus ☆

Fine adjustment of the AF's point of focus is possible for viewfinder shooting and Live View shooting in the Quick mode. This is called "AF Microadjustment". Before making the adjustment, read "Notes for AF Microadjustment" on page 111.

- !** Normally, this adjustment is not required. Do this adjustment only if necessary. Note that doing this adjustment may prevent correct focusing from being achieved.

### **Adjust All by Same Amount**

Set the adjustment manually by adjusting, shooting, and checking the result. Repeat this until the desired adjustment is made. During AF, regardless of the lens used, the point of focus will always be shifted by the adjustment amount.

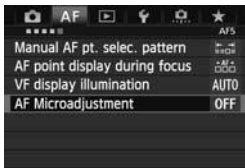

#### **1 Select [AF Microadjustment].**

- Under the [AF5] tab, select [AF Microadjustment], then press <SET>.

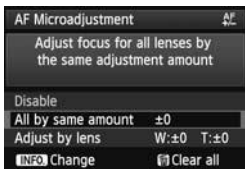

#### **2 Select [All by same amount].**

- Turn the <DISP> dial to select [All by same amount].

#### **3 Press the <INFO.> button.**

- ▶ The [All by same amount] screen will appear.

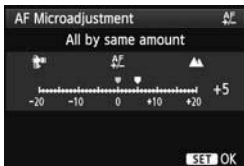

## 4 Make the adjustment.

- Turn the <⊙> dial to make the adjustment. The adjustable range is  $\pm 20$  steps.
- Setting it toward “-: 📷 ” will shift the point of focus in front of the standard point of focus.
- Setting it toward “+: ▲ ” will shift the point of focus to the rear of the standard point of focus.
- After making the adjustment, press <SET>.
- Turn the <⊙> dial to select [**All by same amount**], then press <SET>. The menu will reappear.

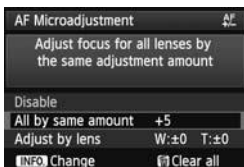

## 5 Check the result of the adjustment.

- Take a picture and play back the image (p.250) to check the adjustment result.
- When the resulting picture is focused in front of the targeted point, adjust toward the “+: ▲ ” side. When the resulting picture is focused behind the targeted point, adjust toward the “-: 📷 ” side.
- If necessary, do the adjustment again.

🔊 If [**All by same amount**] is selected, AF adjustment will not be possible for the wide-angle and telephoto ends of zoom lenses.

## Adjust by Lens

You can make the adjustment for each lens and register the adjustment in the camera. You can register the adjustment for up to 40 lenses. When you autofocus with a lens whose adjustment has been registered, the point of focus will always be shifted by the adjustment amount. Set the adjustment manually by adjusting, shooting, and checking the result. Repeat this until the desired adjustment is made. If you use a zoom lens, make the adjustment for the wide-angle (W) and telephoto (T) ends.

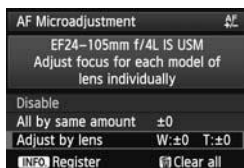

### 1 Select [Adjust by lens].

- Turn the <◉> dial to select [Adjust by lens].

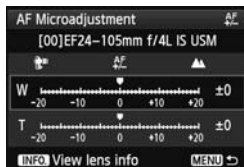

### 2 Press the <INFO.> button.

- ▶ The [Adjust by lens] screen will appear.



### 3 Check and change the lens information.

#### Check the lens information.

- Press the <INFO.> button.
- ▶ The screen will show the lens name and a 10-digit serial number. When the serial number is displayed, select [OK] and go to step 4.
- If the lens' serial number cannot be confirmed, "0000000000" will be displayed. Enter the number as indicated below. See the next page about the asterisk "\*" displayed in front of the lens serial number.



### Enter the serial number.

- Turn the <⊙> dial to select the digit, then press <SET> to display <⊙>.
- Turn the <⊙> dial to enter the number, then press <SET>.
- After entering all the digits, turn the <⊙> dial to select [OK], then press <SET>.

### About the Lens Serial Number

- In step 3, if “\*” appears in front of the 10-digit lens serial number, you cannot register several copies of the same lens model. Even if you enter the serial number, “\*” will remain displayed.
- The lens serial number on the lens may differ from the serial number displayed on the screen in step 3. This is not a defect.
- If the lens serial number is eleven digits or longer, enter only the last ten digits.
- If the lens serial number includes letters, enter only the numbers in step 3.
- The location of the serial number differs depending on the lens.
- Some lenses may not have a serial number inscribed. To register a lens that has no serial number inscribed, enter any serial number in step 3.



- If [Adjust by lens] is selected and an Extender is used, the adjustment will be registered for the lens and Extender combination.
- If 40 lenses have already been registered, a message will appear. After you select a lens whose registration is to be erased (overwritten), you can register another lens.

### Single focal length lens

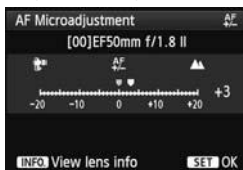

### Zoom lens

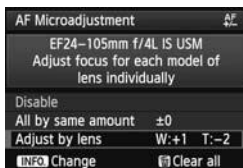
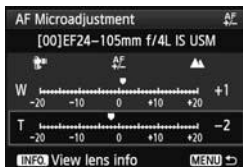

## 4 Make the adjustment.

- For a zoom lens, turn the  $\langle \odot \rangle$  dial and select the wide-angle (W) or telephoto (T) end. Pressing  $\langle \text{SET} \rangle$  will turn off the purple frame and make the adjustment possible.
- Turn the  $\langle \odot \rangle$  dial to adjust as desired, then press  $\langle \text{SET} \rangle$ . The adjustable range is  $\pm 20$  steps.
- Setting it toward “-:  $\text{■}$ ” will shift the point of focus in front of the standard point of focus.
- Setting it toward “+:  $\blacktriangle$ ” will shift the point of focus to the rear of the standard point of focus.
- For a zoom lens, repeat step 4 and adjust it for the wide-angle (W) and telephoto (T) ends.
- After completing the adjustment, press the  $\langle \text{MENU} \rangle$  button to return to the screen in step 1.
- Turn the  $\langle \odot \rangle$  dial to select [**Adjust by lens**], then press  $\langle \text{SET} \rangle$ . The menu will reappear.

## 5 Check the result of the adjustment.





- Take a picture and play back the image (p.250) to check the adjustment result.
- When the resulting picture is focused in front of the targeted point, adjust toward the “+:  $\blacktriangle$ ” side. When the resulting picture is focused behind the targeted point, adjust toward the “-:  $\text{■}$ ” side.
- If necessary, do the adjustment again.

 When shooting with the intermediate range (focal length) of a zoom lens, the AF's point of focus is corrected relative to the adjustments made for the wide-angle and telephoto ends. Even if only the wide-angle or telephoto end has been adjusted, a correction will be made automatically for the intermediate range.

## Clearing All AF Microadjustments

When [🗑️ Clear all] appears at the bottom of the screen, pressing the <🗑️> button will clear all the adjustments made for [All by same amount] and [Adjust by lens].

### Notes for AF Microadjustment

- 
  - The AF's point of focus will vary slightly depending on the subject conditions, brightness, zoom position, and other shooting conditions. Therefore, even if you perform AF Microadjustment, focus may still not be achieved at the suitable position.
  - The adjustments will be retained even if you clear all the camera settings (p.56). However, the setting itself will be [Disable].
- 
  - It is best to make the adjustment at the actual location where you will shoot. This will make the adjustment more precise.
  - Using a tripod when making the adjustment is recommended.
  - For checking the adjustment result, shooting at the  L image-recording quality is recommended.
  - The adjustment amount of one step varies depending on the maximum aperture of the lens. Keep adjusting, shooting, and checking the focus repeatedly to adjust the AF's point of focus.
  - AF adjustment is not possible for the Live mode and  Live mode (contrast AF).

## When Autofocus Fails



Autofocus can fail to achieve focus (viewfinder's focus confirmation light <●> blinks) with certain subjects such as the following:

### Subjects difficult to focus

- Very low-contrast subjects  
(Example: Blue sky, solid-color walls, etc.)
- Subjects in very low light
- Extremely backlit or reflective subjects  
(Example: Car with a highly reflective body, etc.)
- Near and far subjects covered by an AF point  
(Example: Animal in a cage, etc.)
- Repetitive patterns  
(Example: Skyscraper windows, computer keyboards, etc.)

In such cases, do either of the following:

- (1) With One-Shot AF, focus on an object at the same distance as the subject and lock the focus before recomposing (p.67).
- (2) Set the lens focus mode switch to <MF> and focus manually (p.113).

 For conditions where AF can fail to achieve focus with [Live mode]/[ Live mode] during Live View shooting, see page 213.



## MF: Manual Focusing

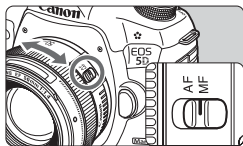

Focusing ring

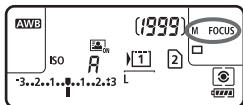

**1 Set the lens focus mode switch to <MF>.**

- ▶ <M FOCUS> will be displayed on the LCD panel.

**2 Focus the subject.**

- Focus by turning the lens focusing ring until the subject looks sharp in the viewfinder.



- When you press the shutter button halfway while focusing manually, the focus confirmation light <●> will light up when focus is achieved.
- With 61-point automatic selection, when the center AF point achieves focus, the focus confirmation light <●> will light up.

## Selecting the Drive Mode

Single and continuous drive modes are provided.

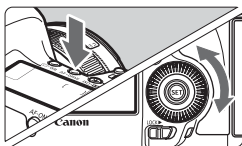

1 Press the <AF•DRIVE> button. (06)

2 Select the drive mode.

- While looking at the LCD panel, turn the <Q> dial.

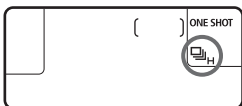

 : **Single shooting**

When you press the shutter button completely, only one shot will be taken.

H: **High-speed continuous shooting** (Max. approx. 6 shots/sec.)

 : **Low-speed continuous shooting** (Max. approx. 3 shots/sec.)

While you hold down the shutter button completely, shots will be taken continuously.

S : **Silent single shooting**

The shooting sound for single shooting is quieter than <□>.

S : **Silent continuous shooting** (Max. approx. 3 shots/sec.)

The shooting sound for continuous shooting is quieter than <□H>.

 : **10-sec. self-timer/Remote control**

2 : **2-sec. self-timer/Remote control**

For self-timer shooting, see the next page. For remote control shooting, see page 188.

 If the image-recording quality settings of card 1 and card 2 are different when [1: Record func.] is set to [Rec. separately] (p.118), the maximum burst for continuous shooting will decrease greatly (p.123). When internal memory becomes full during continuous shooting, the continuous shooting speed may drop during shooting since shooting will be temporarily disabled (p.125).



- If  $\langle \square S \rangle$  or  $\langle \square S \rangle$  is set, the time lag from when you press the shutter button completely until the picture is taken will be longer than normal.
  - When the battery level is low, the continuous shooting speed may become slightly slower.
  - $\langle \square H \rangle$ : The maximum continuous shooting speed of approx. 6 shots/sec. is attained under the following conditions\*: At 1/500 sec. or faster shutter speed, and at the maximum aperture (varies depending on the lens). The continuous shooting speed may be slower depending on the shutter speed, aperture, subject conditions, brightness, lens type, flash use, etc.
- \* With the AF mode set to One-Shot AF and the Image Stabilizer turned off when using the following lenses: EF300mm f/4L IS USM, EF28-135mm f/3.5-5.6 IS USM, EF75-300mm f/4-5.6 IS USM, EF100-400mm f/4.5-5.6L IS USM.

## Using the Self-timer

Use the self-timer when you want to be in the picture.

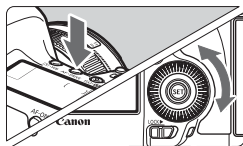

1 Press the  $\langle \text{AF} \cdot \text{DRIVE} \rangle$  button. ( )

2 Select the self-timer.

- While looking at the LCD panel, turn the  $\langle \odot \rangle$  dial to select the self-timer.

: 10-sec. self-timer

: 2-sec. self-timer



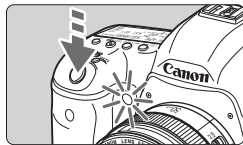

3 Take the picture.

- Look through the viewfinder, focus the subject, then press the shutter button completely.
- ▶ You can check the self-timer operation with the self-timer lamp, beeper, and countdown display (in seconds) on the LCD panel.
- ▶ Two seconds before the picture is taken, the self-timer lamp will stay on and the beeper will sound faster.



 If you will not look through the viewfinder when you press the shutter button, attach the eyepiece cover (p.187). If stray light enters the viewfinder when the picture is taken, it may throw off the exposure.

- 
- The <2> enables you to shoot while not touching the camera mounted on a tripod. This prevents camera shake while you shoot still lifes or bulb exposures.
  - After taking self-timer shots, playing back the image (p.250) to check focus and exposure is recommended.
  - When using the self-timer to shoot only yourself, use focus lock (p.67) on an object at about the same distance as where you will stand.
  - To cancel the self-timer after it starts, press the <AF•DRIVE> button.

# 4

## Image Settings

This chapter explains image-related function settings: Image-recording quality, ISO speed, Picture Style, white balance, Auto Lighting Optimizer, lens peripheral illumination correction, chromatic aberration correction, and other functions.

- A ☆ icon at the upper right of a page title indicates that the function can be used when the Mode Dial is set to <P/Tv/**Av/M/B**>.

\* The function cannot be used in the <A<sup>+</sup>> mode.

## **MENU** Selecting the Card for Recording and Playback

If either a CF card or SD card is already inserted, you can start shooting. When only one card is inserted, the procedures described on pages 118 to 120 are not necessary.

If you insert both a CF card and SD card, you can select the recording method and select which card to use for recording and playing back images.

### Recording Method with Two Cards Inserted

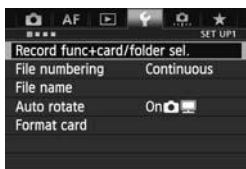

#### 1 Select [Record func+card/folder sel.].

- Under the [**1**] tab, select [**Record func+card/folder sel.**], then press <SET>.



#### 2 Select [Record func.].

- Turn the <DIAL> dial to select [**Record func.**], then press <SET>.

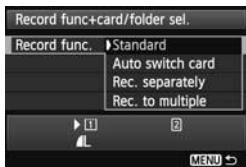

#### 3 Select the recording method.

- Turn the <DIAL> dial to select the recording method, then press <SET>.

- **Standard**

Images will be recorded to the card selected with [**Record/play**].

- **Auto switch card**

Same as with the [**Standard**] setting, but if the card becomes full, the camera will automatically switch to the other card to record images. When the camera switches to the other card, a new folder will be created automatically.

- **Rec. separately**

You can set the image-recording quality for each card (p.121). Each image is recorded to both the CF and SD cards at the image-recording quality you have set. You can freely set the image-recording quality to **L** and **RAW**, **S3** and **M RAW**, etc.

- **Rec. to multiple**

Each image is recorded to both the CF and SD cards simultaneously at the same image size. You can also select RAW+JPEG.



If the image-recording quality settings of card ① and card ② are different when [**Rec. separately**] is set, the maximum burst will decrease greatly (p.123).



When [**Rec. separately**] or [**Rec. to multiple**] is set, the image will be recorded under the same file number to both the CF and SD cards. Also, the LCD panel will display the number of possible shots of the card having the lower number. If one of the cards becomes full, [**Card\* full**] will be displayed and shooting will be disabled. If this happens, either replace the card or set the recording method to [**Standard**] or [**Auto switch card**] and select the card with space remaining to continue shooting.

## Selecting the CF or SD Card for Recording and Playback



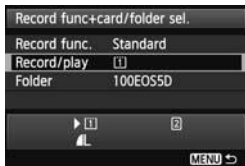

If **[Record func.]** is set to **[Standard]** or **[Auto switch card]**, select the card for recording and playing images.

If **[Record func.]** is set to **[Rec. separately]** or **[Rec. to multiple]**, select the card for playing images.

If **[Standard]** or **[Auto switch card]** is set:





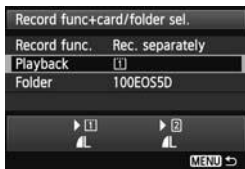

### Select **[Record/play]**.

- Turn the <  > dial to select **[Record/play]**, then press <  >.
  - 1 : Record images to and play images back from the CF card.
  - 2 : Record images to and play images back from the SD card.
- Turn the <  > dial to select the card, then press <  >.

If **[Rec. separately]** or **[Rec. to multiple]** is set:



### Select **[Playback]**.

- Turn the <  > dial to select **[Playback]**, then press <  >.
  - 1 : Play back the CF card's images.
  - 2 : Play back the SD card's images.
- Turn the <  > dial to select the card, then press <  >.



## MENU Setting the Image-Recording Quality

You can select the pixel count and the image quality. There are eight JPEG image-recording quality settings: **L**, **L**, **M**, **M**, **S1**, **S1**, **S2**, **S3**. There are three RAW image quality settings: **RAW**, **M RAW**, **S RAW** (p.124).

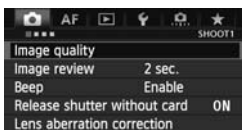

### 1 Select [Image quality].

- Under the [**1**] tab, select [**Image quality**], then press <SET>.

With [Standard / Auto switch card / Rec. to multiple] set:

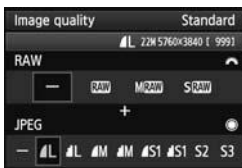

### 2 Select the image-recording quality.

- To select a RAW setting, turn the <DIAL> dial. To select a JPEG setting, turn the <DIAL> dial.
- On the upper right, the “\*\*M (megapixels) \*\*\*\* x \*\*\*\*” number indicates the recorded pixel count, and [\*\*\*] is the number of possible shots (displayed up to 9999).
- Press <SET> to set it.

With [Rec. separately] set:

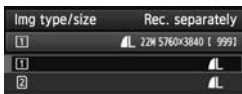

- Under [**1**: Record func+card/ folder sel.], if [**Record func.**] is set to [**Rec. separately**], turn the <DIAL> dial to select <1> or <2>, then press <SET>.

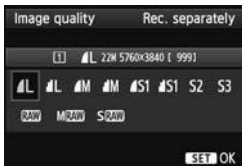

On the screen that appears, turn the <DIAL> dial to select the image-recording quality, then press <SET>.

## Image-recording Quality Setting Examples

**L** only

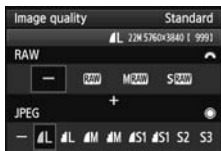

**RAW** only

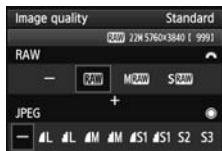

**RAW** + **L**

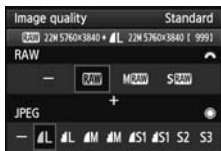

**S RAW** + **M**

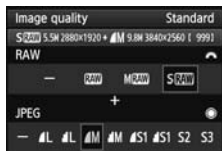

- If [-] is set for both RAW and JPEG, **L** will be set.
- The number of possible shots will be displayed up to 9999 on the LCD panel.

## Guide to Image-Recording Quality Settings (Approx.)

Image Quality		Pixels Recorded (megapixels)	Printing Size	File Size (MB)	Possible Shots	Maximum Burst
JPEG	L	22M	A2 or larger	7.0	1010	65 (16270)
	L			3.7	1930	1930 (30990)
	M	9.8M	A3 or larger	3.8	1860	1860 (29800)
	M			2.0	3430	3430 (55000)
	S1	5.5M	A4 or larger	2.5	2810	2810 (45140)
	S1			1.3	5240	5240 (83980)
	S2*1	2.5M	Around 9x13 cm	1.4	5030	5030 (80520)
S3*2	0.3M	—	0.3	19520	19520 (312420)	
RAW	RAW	22M	A2 or larger	27.1	260	13 (18)
	M RAW	10M	A3 or larger	19.1	370	10 (11)
	S RAW	5.5M	A4 or larger	15.1	480	12 (15)
RAW + JPEG	RAW L	22M 22M	A2 or larger A2 or larger	27.1+7.0	210	7 (7)
	M RAW L	10M 22M	A3 or larger A2 or larger	19.1+7.0	270	7 (7)
	S RAW L	5.5M 22M	A4 or larger A2 or larger	15.1+7.0	320	7 (7)

\*1: **S2** is suitable for playing the images on a digital photo frame.

\*2: **S3** is suitable for emailing the image or using it on a Web site.

- **S2** and **S3** will be in (Fine) quality.
- The file size, possible shots, and maximum burst during continuous shooting are based on Canon's testing standards (3:2 aspect ratio, ISO 100 and Standard Picture Style) using an 8 GB CF card. **These figures will vary depending on the subject, card brand, aspect ratio, ISO speed, Picture Style, Custom Functions, and other settings.**
- The maximum burst applies to high-speed continuous shooting. Figures in parentheses apply to an Ultra DMA (UDMA) mode 7, 128 GB card based on Canon's testing standards.



- If you select both RAW and JPEG, the same image will be recorded simultaneously to the card in both RAW and JPEG at the image-recording quality that was set. The two images will be recorded with the same file numbers (file extension .JPG for JPEG and .CR2 for RAW).
- The image-recording quality icons are as follows: **RAW** (RAW), **M RAW** (Medium RAW), **S RAW** (Small RAW), JPEG, **▲** (Fine), **■** (Normal), **L** (Large), **M** (Medium), and **S** (Small).

## About RAW

A RAW image is raw data output by the image sensor converted to digital data. It is recorded to the card as is, and you can select the quality as follows: **RAW**, **M RAW**, or **S RAW**.

A **RAW** image can be processed with [**▶** 1: **RAW image processing**] (p.288) and saved as a JPEG image. (**M RAW** and **S RAW** images cannot be processed with the camera.) While the RAW image itself does not change, you can process the RAW image according to different conditions to create any number of JPEG images from it.

With all RAW images, you can use Digital Photo Professional (provided software, p.394) to make various adjustments and then generate a JPEG, TIFF, etc., image incorporating those adjustments.



Commercially-available software may not be able to display RAW images. Using the provided software is recommended.

## One-touch Image Quality Setting

With Custom Controls, you can assign the image-recording quality to the <M-Fn> button or depth-of-field preview button so you can switch to it momentarily. If you assign [**One-touch image quality setting**] to the <M-Fn> button or depth-of-field preview button, you can quickly switch to the desired image-recording quality and shoot.

For details, see Custom Controls (p.327).

 If [**1: Record func+card/folder sel.**] is set to [**Rec. separately**], you cannot switch to the One-touch image quality setting.

## Maximum Burst During Continuous Shooting



The maximum burst is displayed on the bottom right in the viewfinder.

If the maximum burst for continuous shooting is 99 or higher, "99" will be displayed.

 The maximum burst is displayed even when a card is not inserted in the camera. Make sure that a card is inserted before taking a picture.

-  ● If the viewfinder displays "99" for the maximum burst, it means the maximum burst is 99 or higher. If the maximum burst decreases to 98 or lower and the internal buffer memory becomes full, "buSY" will be displayed in the viewfinder and on the LCD panel. Shooting will then be disabled temporarily. If you stop continuous shooting, the maximum burst will increase. After all the captured images are written to the card, the maximum burst will be as listed on page 123.
- The maximum burst indicator in the viewfinder will not change even when you use a UDMA CF card. However, the maximum burst shown in parentheses on page 123 will apply.

# ISO: Setting the ISO Speed <sup>☆</sup>

Set the ISO speed (image sensor's sensitivity to light) to suit the ambient light level. With the  $\langle \text{A}^+ \rangle$  mode selected, the ISO speed will be set automatically (p.127).

Regarding the ISO speed during movie shooting, see pages 223 and 226.

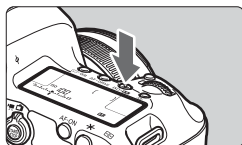

1 Press the  $\langle \text{ISO} \cdot \text{ISO} \rangle$  button. (ⓘ6)

2 Set the ISO speed.

- While looking at the LCD panel or viewfinder, turn the  $\langle \text{ISO} \text{ dial} \rangle$  dial.
- ISO speed can be set within ISO 100 - 25600 in 1/3-stop increments.
- "A" indicates ISO Auto. The ISO speed will be set automatically (p.127).

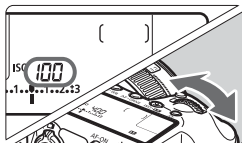

## ISO Speed Guide

ISO Speed	Shooting Situation (No flash)	Flash Range
L, 100 - 400	Sunny outdoors	The higher the ISO speed, the farther the flash range will extend.
400 - 1600	Overcast skies or evening time	
1600 - 25600, H1, H2	Dark indoors or night	

\* Higher ISO speeds will result in grainier images.

- If [**3: Highlight tone priority**] has been set to [Enable], you cannot select "L" (ISO 50), ISO 100/125/160, "H1" (ISO 51200), and "H2" (ISO 102400) (p.148).
- Shooting in high temperatures may result in images that look grainier. Long exposures can also cause irregular colors in the image.
- When you shoot at high ISO speeds, noise (dots of light, banding, etc.) may become noticeable.
- When shooting in conditions that produce an extreme amount of noise, such as a combination of high ISO speed, high temperature and long exposure, images may not be recorded properly.



- As H1 (equivalent to ISO 51200) and H2 (equivalent to 102400) are expanded ISO speed settings, noise (dots of light, banding, etc.) and irregular colors will be more noticeable, and the resolution lower than usual.
- If you use a high ISO speed and flash to shoot a close subject, overexposure may result.
- If you shoot a movie when [Maximum: 25600] is set with [ISO speed range] and ISO speed is set to ISO 16000/20000/25600, the ISO speed will switch to ISO12800 (during movie shooting with manual exposure). Even if you switch back to still photo shooting, the ISO speed will not revert to the original setting.
- If you shoot a movie when 1. L (50) or 2. H1 (51200)/H2 (102400) is set, the ISO speed setting will switch to 1. ISO 100 or 2. H (25600) respectively (during movie shooting with manual exposure). Even if you switch back to still photo shooting, the ISO speed will not revert to the original setting.



- Under [📷2: ISO speed settings], you can use [ISO speed range] to expand the settable ISO speed range from ISO 50 (L) to ISO 102400 (H2) (p.128).
- <ⓘ> can be displayed in the viewfinder when you set an expanded ISO speed (L, H1, or H2) (p.324).

## ISO Auto

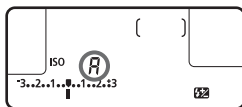

If the ISO speed is set to “A” (Auto), the actual ISO speed to be set will be displayed when you press the shutter button halfway. As indicated below, the ISO speed will be set automatically to suit the shooting mode.

Shooting Mode	ISO Speed Setting
[A <sup>+</sup> ]	Automatically set within ISO 100 - 12800
<b>P</b> / Tv / Av / M	Automatically set within ISO 100 - 25600*1
<b>B</b>	Fixed at ISO 400*1
With flash	Fixed at ISO 400*1*2*3

\*1: The actual ISO speed range depends on the [Minimum] and [Maximum] settings set in [Auto ISO range].

\*2: If fill flash will result in overexposure, ISO 100 or a higher ISO will be set.

\*3: When using bounce flash with an external Speedlite in the <[A<sup>+</sup>> and <P> modes, the ISO speed will be set automatically within ISO 400 - 1600.

**MENU** Setting the ISO Speed Range

You can set the manually-settable ISO speed range (minimum and maximum limits). You can set the minimum limit within L (ISO 50) to H1 (ISO 51200), and the maximum limit within ISO 100 to H2 (ISO 102400).

**1** Select [ISO speed settings].

- Under the [ 2] tab, select [ISO speed settings], then press <SET>.

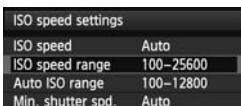
**2** Select [ISO speed range].

- Select [ISO speed range], then press <SET>.

**3** Set the minimum limit.

- Select the minimum limit box, then press <SET>.
- Turn the < > dial to select the minimum limit ISO speed, then press <SET>.

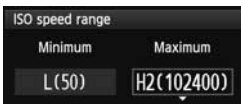
**4** Set the maximum limit.

- Select the maximum limit box, then press <SET>.
- Turn the < > dial to select the maximum limit ISO speed, then press <SET>.

**5** Exit the setting.

- Turn the < > dial to select [OK], then press <SET>.
- ▶ The menu reappears.



**MENU** Setting the ISO Speed Range for Auto ISO

You can set the automatic ISO speed range for Auto ISO within ISO 100 - 25600. You can set the minimum limit within ISO 100 - 12800, and the maximum limit within ISO 200 - 25600 in whole-stop increments.

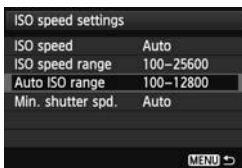
**1** Select **[Auto ISO range]**.

- Select **[Auto ISO range]**, then press **<SET>**.

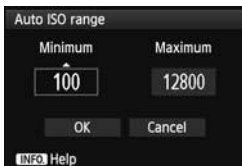
**2** Set the minimum limit.

- Select the minimum limit box, then press **<SET>**.
- Turn the **<DISP>** dial to select the minimum limit ISO speed, then press **<SET>**.

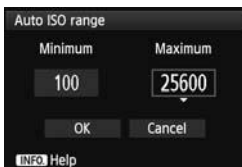
**3** Set the maximum limit.

- Select the maximum limit box, then press **<SET>**.
- Turn the **<DISP>** dial to select the maximum limit ISO speed, then press **<SET>**.

**4** Exit the setting.

- Turn the **<DISP>** dial to select **[OK]**, then press **<SET>**.
- ▶ The menu reappears.

 The **[Minimum]** and **[Maximum]** settings will also apply to the ISO speed safety shift's minimum and maximum ISO speed (p.323).

**MENU** Setting the Minimum Shutter Speed for Auto ISO

When Auto ISO is set, you can set the minimum shutter speed (1/250 sec. to 1 sec.) so that the automatically-set shutter speed is not too slow.

This is convenient in the <P> and <Av> modes when you use a wide-angle lens to shoot a moving subject. You can minimize both camera shake and subject blur.

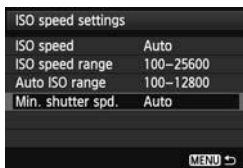
**1** Select [Min. shutter spd.].

- Select [Min. shutter spd.], then press <SET>.



**2** Set the desired minimum shutter speed.

- Turn the <DISP> dial to select the shutter speed, then press <SET>.
- ▶ The menu reappears.

- ❗ ● If a correct exposure cannot be obtained with the maximum ISO speed limit set with [Auto ISO range], a shutter speed slower than the [Min. shutter spd.] will be set to obtain a standard exposure.
- With flash photography, [Min. shutter spd.] will not be applied.

## Selecting a Picture Style <sup>☆</sup>

By selecting a Picture Style, you can obtain image characteristics matching your photographic expression or the subject.



The Picture Style is set automatically to  (Auto) in the  mode.



**1** Press the  button.





**2** Select [].

- Turn the  dial to select [, then press .
- ▶ The Picture Style selection screen will appear.



**3** Select a Picture Style.

- Turn the  dial to select the desired Picture Style, then press .
- ▶ The Picture Style will be set and the camera will be ready to shoot.



You can also select the Picture Style with [ 3: Picture Style].

## Picture Style Characteristics

### **Auto**

The color tone will be adjusted automatically to suit the scene. The colors will look vivid, especially for blue skies, greenery, and sunsets in nature, outdoor, and sunset scenes.

### **Standard**

The image looks vivid, sharp, and crisp. This is a general-purpose Picture Style suitable for most scenes.

### **Portrait**

For nice skin tones. The image looks softer. Suited for close-up portraits.

By changing the [**Color tone**] (p.134), you can adjust the skin tone.

### **Landscape**

For vivid blues and greens, and very sharp and crisp images. Effective for impressive landscapes.

### **Neutral**

This Picture Style is for users who prefer to process images with their computer. For natural colors and subdued images.

### **Faithful**

This Picture Style is for users who prefer to process images with their computer. When the subject is captured under a daylight color temperature of 5200K, the color is adjusted colorimetrically to match the subject's color. Images will appear dull and subdued.

 If the desired color tone is not obtained with [**Auto**], use another Picture Style.

## Monochrome

Creates black-and-white images.



Black-and-white images shot in JPEG cannot be reverted to color. If you want to later shoot pictures in color, make sure the **[Monochrome]** setting has been canceled. When **[Monochrome]** is selected, **<B/W>** will appear on the LCD panel.



**<(!)>** can be displayed in the viewfinder when **[Monochrome]** is set (p.324).

## User Def. 1-3





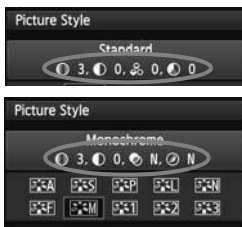

You can register a basic style such as **[Portrait]**, **[Landscape]**, a Picture Style file, etc., and adjust it as desired (p.137). Any User Defined Picture Style that has not been set will have the same settings as the **[Standard]** Picture Style.

## About the Symbols

The symbols of the Picture Style selection screen refer to parameters such as **[Sharpness]** and **[Contrast]**. The numerals indicate the parameter settings, such as for **[Sharpness]** and **[Contrast]**, for each Picture Style.



## Symbols



	Sharpness
	Contrast
	Saturation
	Color tone
	Filter effect (Monochrome)
	Toning effect (Monochrome)

## Customizing a Picture Style ☆

You can customize a Picture Style by adjusting individual parameters such as **[Sharpness]** and **[Contrast]**. To see the resulting effects, take test shots. To customize **[Monochrome]**, see page 136.

**1** Press the  > button.

**2** Select .



- Turn the  dial to select , then press .
- ▶ The Picture Style selection screen will appear.

**3** Select a Picture Style.

- Turn the  dial to select the desired Picture Style, then press <INFO.>.



**4** Select a parameter.

- Turn the  dial to select a parameter such as **[Sharpness]**, then press .

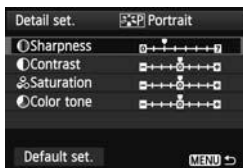

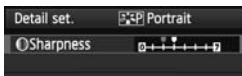

## 5 Set the parameter.

- Turn the <DIAL> dial to set the parameter as desired, then press <SET>.
- Press the <MENU> button to save the adjusted parameters. The Picture Style selection screen will reappear.
- ▶ Any settings different from the default will be displayed in blue.



### Parameter Settings and Effects

Sharpness	0: Less sharp outline	+7: Sharp outline
Contrast	-4: Low contrast	+4: High contrast
Saturation	-4: Low saturation	+4: High saturation
Color tone	-4: Reddish skin tone	+4: Yellowish skin tone



- By selecting [**Default set.**] in step 4, you can revert the respective Picture Style to its default parameter settings.
- To use the adjusted Picture Style, first select the adjusted Picture Style, then shoot.

## Monochrome Adjustment

For Monochrome, you can also set **[Filter effect]** and **[Toning effect]** in addition to **[Sharpness]** and **[Contrast]** explained on the preceding page.

### Filter Effect

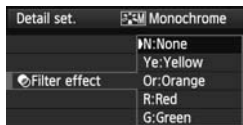

With a filter effect applied to a monochrome image, you can make white clouds or green trees stand out more.

Filter	Sample Effects
N : None	Normal black-and-white image with no filter effects.
Ye: Yellow	The blue sky will look more natural, and the white clouds will look crisper.
Or: Orange	The blue sky will look slightly darker. The sunset will look more brilliant.
R : Red	The blue sky will look quite dark. Fall leaves will look crisper and brighter.
G : Green	Skin tones and lips will appear muted. Tree leaves will look crisper and brighter.

Increasing the **[Contrast]** will make the filter effect more pronounced.

### Toning Effect

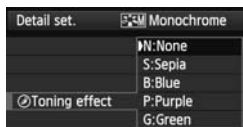

By applying a toning effect, you can create a monochrome image in that color. It can make the image look more impressive.

The following can be selected: **[N:None]**, **[S:Sepia]**, **[B:Blue]**, **[P:Purple]** or **[G:Green]**.



## Registering a Picture Style ☆



You can select a base Picture Style such as [Portrait] or [Landscape], adjust its parameters as desired and register it under [User Def. 1], [User Def. 2], or [User Def. 3].

You can create Picture Styles whose parameter settings such as sharpness and contrast are different.

You can also adjust the parameters of a Picture Style that has been registered to the camera with EOS Utility (provided software, p.394).



### 1 Press the button.

### 2 Select [].

- Turn the  dial to select [, then press .
- ▶ The Picture Style selection screen will appear.



### 3 Select [User Def.].

- Turn the  dial to select [User Def. \*], then press .



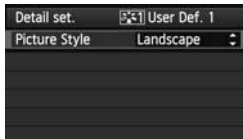

### 4 Press .

- With [Picture Style] selected, press .



### 5 Select the base Picture Style.

- Turn the  dial to select the base Picture Style, then press .
- To adjust the parameters of a Picture Style that has been registered to the camera with EOS Utility (provided software), select the Picture Style here.

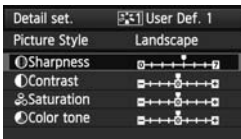

## 6 Select a parameter.

- Turn the <☉> dial to select a parameter such as [**Sharpness**], then press <☉>.

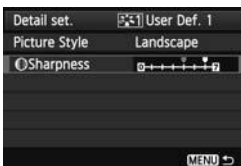

## 7 Set the parameter.

- Turn the <☉> dial to set the parameter as desired, then press <☉>.

For details, see “Customizing a Picture Style” on pages 134-136.

- Press the <MENU> button to register the modified Picture Style. The Picture Style selection screen will then reappear.
- ▶ The base Picture Style will be indicated on the right of [**User Def. \***].



- If a Picture Style has already been registered under [**User Def. \***], changing the base Picture Style in step 5 will nullify the parameter settings of the registered Picture Style.
- If you execute [**Clear all camera settings**] (p.56), all the [**User Def. \***] settings will revert to their defaults. Any Picture Style registered via EOS Utility (provided software) will have only its modified parameters reverted to their default settings.

- To use the adjusted Picture Style, select the registered [**User Def. \***], then shoot.
- For the procedure to register a Picture Style file to the camera, refer to the EOS Utility Instructions (p.396).

# WB: Setting the White Balance ☆

White balance (WB) is for making the white areas look white. Normally, the <AWB> (Auto) setting will obtain the correct white balance. If natural-looking colors cannot be obtained with <AWB>, you can select the white balance to match the light source or set it manually by shooting a white object.

<AWB> is automatically set in the <A+> mode.

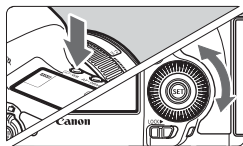

1 Press the <WB> button. (6)

2 Select the white balance.

- While looking at the LCD panel, turn the <DIAL> dial.

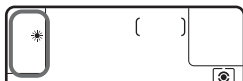

Display	Mode	Color Temperature (Approx. K: Kelvins)
AWB	Auto	3000 - 7000
☀	Daylight	5200
🏠	Shade	7000
☁	Cloudy, twilight, sunset	6000
💡	Tungsten light	3200
💡	White fluorescent light	4000
⚡	Flash use	Automatically set*
👤	Custom (p.140)	2000 - 10000
K	Color temperature (p.141)	2500 - 10000

\* Applicable with Speedlites having a color temperature transmission function. Otherwise, it will be fixed to approx. 6000K.

## About White Balance

To the human eye, a white object looks white regardless of the type of lighting. With a digital camera, the color temperature is adjusted with software to make the white areas look white. This adjustment serves as the basis for the color correction. The result is natural-looking colors in the pictures.

You can also set this with [2: White balance].

## Custom White Balance

Custom white balance enables you to manually set the white balance for a specific light source for better accuracy. Do this procedure under the actual light source to be used.

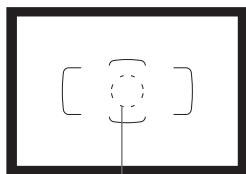

Spot metering circle

### 1 Photograph a white object.

- The plain, white object should fill the spot metering circle.
- Focus manually and set the standard exposure for the white object.
- You can set any white balance.

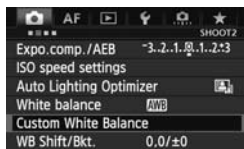

### 2 Select [Custom White Balance].

- Under the [CAMERA] tab, select [Custom White Balance], then press <SET>.
- ▶ The custom white balance selection screen will appear.



### 3 Import the white balance data.

- Turn the <DISP> dial to select the image captured in step 1, then press <SET>.
- ▶ On the dialog screen that appears, select [OK] and the data will be imported.
- When the menu reappears, press the <MENU> button to exit the menu.

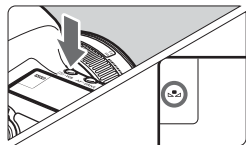

### 4 Press the <WB> button. (6)

### 5 Select the custom white balance.

- Look at the LCD panel and turn the <DISP> dial to select <WB>.



- If the exposure obtained in step 1 differs greatly from the standard exposure, a correct white balance may not be obtained.
- In step 3, the following images cannot be selected: images captured while the Picture Style was set to **[Monochrome]**, multiple-exposure images, and images taken with another camera.



- Instead of a white object, an 18% gray card (commercially available) can produce a more accurate white balance.
- The personal white balance registered with the provided software will be registered under <[WB]>. If you execute step 3, the data for the registered personal white balance will be erased.

## Setting the Color Temperature

You can set the white balance's color temperature numerically in kelvins. This is for advanced users.

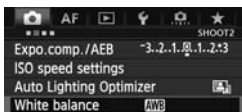

1

### Select [White balance].

- Under the [2] tab, select **[White balance]**, then press <[SET]>.

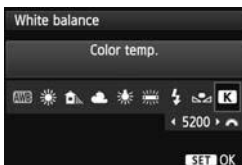

2

### Set the color temperature.

- Turn the <[]> dial to select [].
- Turn the <[]> dial to set the color temperature, then press <[SET]>.
- The color temperature can be set from approx. 2500K to 10000K in 100K increments.



- When setting the color temperature for an artificial light source, set white balance correction (magenta or green) as necessary.
- If you set <[]> to the reading taken with a commercially-available color temperature meter, take test shots and adjust the setting to compensate for the difference between the color temperature meter's reading and the camera's color temperature reading.

# WB $\pm$ White Balance Correction ☆

You can correct the white balance that has been set. This adjustment will have the same effect as using a commercially-available color temperature conversion filter or color compensating filter. Each color can be corrected to one of nine levels.

This function is for advanced users who are familiar with using color temperature conversion or color compensating filters.

## White Balance Correction



### 1 Select [WB Shift/Bkt.].

- Under the [ 2 ] tab, select [WB Shift/Bkt.], then press <SET>.

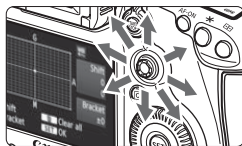

### 2 Set the white balance correction.

- Use < > to move the “■” mark to the desired position.
- B is for blue, A is amber, M is magenta, and G is green. The color in the respective direction will be corrected.
- On the upper right, “Shift” indicates the direction and correction amount.
- Pressing the < > button will cancel all the [WB Shift/Bkt.] settings.
- Press <SET> to exit the setting and return to the menu.

Sample setting: A2, G1

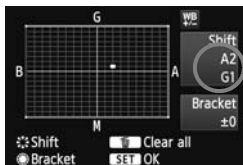

- During the white balance correction, <WB  $\pm$ > will be displayed on the LCD panel.
- <(!)> can be displayed in the viewfinder when white balance correction is set (p.324).
- One level of the blue/amber correction is equivalent to approx. 5 mireds of a color temperature conversion filter. (Mired: Measuring unit indicating the density of a color temperature conversion filter.)

## White Balance Auto Bracketing

With just one shot, three images having a different color balance can be recorded simultaneously. Based on the color temperature of the current white balance setting, the image will be bracketed with a blue/amber bias or magenta/green bias. This is called white balance bracketing (WB-BKT). White balance bracketing is possible up to  $\pm 3$  levels in single-level increments.

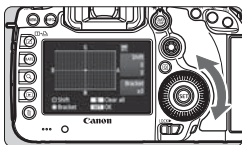

B/A bias  $\pm 3$  levels

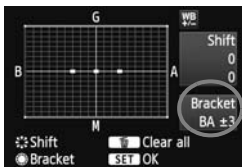

### Set the white balance bracketing amount.

- In step 2 for white balance correction, when you turn the  $\langle \odot \rangle$  dial, the “■” mark on the screen will change to “■■■” (3 points). Turning the dial to the right sets the B/A bracketing, and turning it to the left sets the M/G bracketing.
- ▶ On the right, “Bracket” indicates the bracketing direction and correction amount.
- Pressing the  $\langle \text{cancel} \rangle$  button will cancel all the [WB Shift/Bkt.] settings.
- Press  $\langle \text{SET} \rangle$  to exit the setting and return to the menu.

### Bracketing Sequence

The images will be bracketed in the following sequence: 1. Standard white balance, 2. Blue (B) bias, and 3. Amber (A) bias, or 1. Standard white balance, 2. Magenta (M) bias, and 3. Green (G) bias.



- During WB bracketing, the maximum burst for continuous shooting will be lower and the number of possible shots will also decrease to approx. one-third the normal number.
- You can also set white balance correction and AEB together with white balance bracketing. If you set AEB in combination with white balance bracketing, a total of nine images will be recorded for a single shot.
- Since three images are recorded for one shot, the card will take longer to record the shot.
- When white balance bracketing is set, the white balance icon will blink.
- You can change the number of shots for white balance bracketing (p.322).
- “BKT” stands for bracketing.

## **MENU** Correcting the Brightness and Contrast Automatically ☆

If the image comes out dark or the contrast is low, the brightness and contrast can be corrected automatically. This function is called Auto Lighting Optimizer. The default setting is **[Standard]**. With JPEG images, the correction is applied when the image is captured.

**[Standard]** is automatically set in the <A+> mode.



### 1 Select **[Auto Lighting Optimizer]**.

- Under the [**2**] tab, select **[Auto Lighting Optimizer]**, then press <SET>.



### 2 Select the setting.

- Turn the <DIAL> dial to select the desired setting, then press <SET>.

### 3 Take the picture.

- The image will be recorded with the brightness and contrast corrected if necessary.

- !**
- If [**3: Highlight tone priority**] is set to **[Enable]**, the Auto Lighting Optimizer will be set automatically to **[Disable]** and the setting cannot be changed.
  - Depending on the shooting conditions, noise may increase.
  - If a setting other than **[Disable]** is set and you use exposure compensation or flash exposure compensation to darken the exposure, the image may still come out bright. If you want a darker exposure, set this to **[Disable]**.
  - If the HDR mode (p.175) or multiple exposure shooting (p.179) is set, the Auto Lighting Optimizer will be set automatically to **[Disable]**. When the HDR mode or multiple exposure shooting is canceled, the Auto Lighting Optimizer will revert to the original setting.

**i** In step 2, if you press the <INFO.> button and uncheck <✓> the **[Disable during man expo]** setting, the Auto Lighting Optimizer can be set in the <M> mode.



# MENU Noise Reduction Settings ☆

## High ISO Speed Noise Reduction

This function reduces the noise generated in the image. Although noise reduction is applied at all ISO speeds, it is particularly effective at high ISO speeds. At low ISO speeds, the noise in the shadow areas is further reduced.



### 1 Select [High ISO speed NR].

- Under the [CAMERA 3] tab, select [High ISO speed NR], then press <SET>.

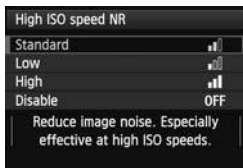

### 2 Set the desired setting.

- Turn the <DIAL> to select the desired noise reduction setting, then press <SET>.
- ▶ The setting screen closes and the menu will reappear.

### 3 Take the picture.

- The image will be recorded with noise reduction applied.



If you play back a **RAW** image with the camera, the effect of the high ISO speed noise reduction may look minimal. Check the noise reduction effect with Digital Photo Professional (provided software, p.394).

## Long Exposure Noise Reduction

Noise reduction is possible with images exposed for 1 sec. or longer.

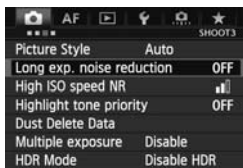

### 1 Select [Long exp. noise reduction].

- Under the [ 3] tab, select [**Long exp. noise reduction**], then press < >.

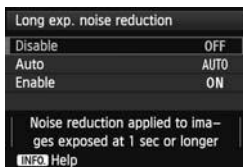

### 2 Set the desired setting.

- Turn the < > dial to select the desired setting, then press < >.
- ▶ The setting screen closes and the menu will reappear.

#### ● [Auto]

For 1 sec. or longer exposures, noise reduction is performed automatically if noise typical of long exposures is detected. This [**Auto**] setting is effective in most cases.

#### ● [Enable]

Noise reduction is performed for all exposures of 1 sec. or longer. The [**Enable**] setting may be able to reduce noise that otherwise cannot be detected with the [**Auto**] setting.

### 3 Take the picture.

- The image will be recorded with noise reduction applied.



- With **[Auto]** and **[Enable]**, after the picture is taken, the noise reduction process may take the same amount of time as the exposure. During noise reduction, shooting is still possible as long as the maximum burst indicator in the viewfinder shows “1” or higher.
- Images taken at ISO 1600 or higher may look grainier with the **[Enable]** setting than with the **[Disable]** and **[Auto]** settings.
- With **[Enable]**, if a long exposure is shot with the Live View image displayed, “**BUSY**” will be displayed during the noise reduction process. The Live View display will not appear until the noise reduction is completed. (You cannot take another picture.)

# MENU Highlight Tone Priority ☆

You can minimize overexposed highlight areas.

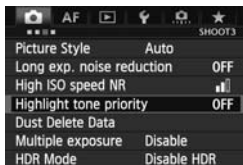

## 1 Select [Highlight tone priority].

- Under the [3] tab, select **[Highlight tone priority]**, then press < >.



## 2 Select [Enable].

- Turn the < > dial to select **[Enable]**, then press < >.
- Highlight details are improved. The dynamic range is expanded from the standard 18% gray to bright highlights. The gradation between the grays and highlights becomes smoother.

## 3 Take the picture.

- The image will be recorded with highlight tone priority applied.

- With **[Enable]**, the Auto Lighting Optimizer (p.144) is automatically set to **[Disable]** and the setting cannot be changed. When **[Highlight tone priority]** is set to **[Disable]**, the Auto Lighting Optimizer will revert to its original setting.
- With **[Enable]**, image noise may increase slightly more than with **[Disable]**.

- With **[Enable]**, the settable range will be ISO 200 - 25600 (ISO 200 - 12800 for movie shooting). Also, the < **D+** > icon will be displayed in the viewfinder and on the LCD panel when highlight tone priority is enabled.

## MENU Lens Peripheral Illumination / Chromatic Aberration Correction

Peripheral light fall-off occurs in lenses whose characteristics make the image corners look darker. Color fringing along subject outlines also is a chromatic aberration. Light fall-off and color fringing can be corrected. The default setting is **[Enable]** for both corrections.

### Peripheral Illumination Correction

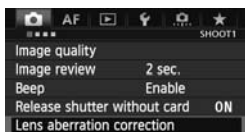

#### 1 Select **[Lens aberration correction]**.

- Under the [**1**] tab, select **[Lens aberration correction]**, then press **<SET>**.

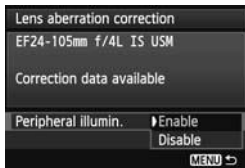

#### 2 Select the setting.

- Check that **[Correction data available]** is displayed for the attached lens.
- Turn the **<DISP>** dial to select **[Peripheral illumin.]**, then press **<SET>**.
- Select **[Enable]**, then press **<SET>**.
- If **[Correction data not available]** is displayed, see “About the Lens Correction Data” on page 151.

#### 3 Take the picture.

- The image will be recorded with the peripheral illumination corrected.



Depending on shooting conditions, noise may appear on the image periphery.



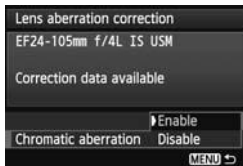

- The correction amount applied will be slightly lower than the maximum correction amount settable with Digital Photo Professional (provided software).
- The higher the ISO speed, the lower the correction amount will be.

## Chromatic Aberration Correction



### 1 Select the setting.

- Check that [**Correction data available**] is displayed for the attached lens.
- Turn the <  > dial to select [**Chromatic aberration**], then press <  >.
- Select [**Enable**], then press <  >.
- If [**Correction data not available**] is displayed, see “About the Lens Correction Data” on the next page.

### 2 Take the picture.

- The image will be recorded with the chromatic aberration corrected.

 If you play back a **RAW** image shot with the chromatic aberration corrected, the image will be displayed on the camera without the chromatic aberration correction applied. Check the chromatic aberration correction with Digital Photo Professional (provided software, p.394).

## About the Lens Correction Data

The camera already contains lens peripheral illumination correction data and chromatic aberration correction data for approx. 25 lenses. If you select **[Enable]**, the peripheral illumination correction and chromatic aberration correction will be applied automatically for any lens whose correction data has been registered in the camera.

With EOS Utility (provided software), you can check which lenses have their correction data registered in the camera. You can also register the correction data for unregistered lenses. For details, refer to the EOS Utility Instruction Manual (p.396).

## Notes for peripheral illumination correction and chromatic aberration correction



- Corrections cannot be applied to JPEG images captured when **[Disable]** was set.
- When using a non-Canon lens, setting the corrections to **[Disable]** is recommended, even if **[Correction data available]** is displayed.
- If you use the magnified view during Live View shooting, the peripheral illumination correction and chromatic aberration correction will not be reflected in the image.



- If the effect of the correction is not so visible magnify the image and check it.
- The corrections are also applied when an Extender is attached.
- If the correction data for the attached lens is not registered to the camera, the result will be the same as when the correction is set to **[Disable]**.
- If the lens does not have distance information, the correction amount will be lower.

## **MENU** Creating and Selecting a Folder

You can freely create and select the folder where the captured images are to be saved.

This is optional since a folder will be created automatically for saving captured images.

### Creating a Folder

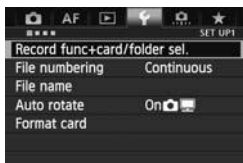

#### 1 Select [Record func+card/folder sel.].

- Under the [1] tab, select [Record func+card/folder sel.], then press <SET>.



#### 2 Select [Folder].

- Turn the <DIAL> dial to select [Folder], then press <SET>.

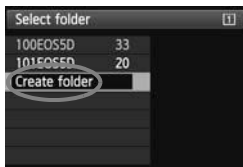

#### 3 Select [Create folder].

- Turn the <DIAL> dial to select [Create folder], then press <SET>.

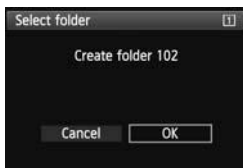

#### 4 Create a new folder.

- Turn the <DIAL> dial to select [OK], then press <SET>.
- ▶ A new folder with the folder number increased by one is created.



## Selecting a Folder



- With the folder selection screen displayed, turn the <◂> dial to select the desired folder, then press <SET>.
- ▶ The folder where the captured images will be saved is selected.
- Subsequent captured images will be recorded into the selected folder.

## About Folders

As with “100EOS5D” for example, the folder name starts with three digits (the folder number) followed by five alphanumeric characters. A folder can contain up to 9999 images (file number 0001 - 9999). When a folder becomes full, a new folder with the folder number increased by one is created automatically. Also, if manual reset (p.157) is executed, a new folder will be created automatically. Folders numbered from 100 to 999 can be created.

## Creating Folders with a Personal Computer

With the card open on the screen, create a new folder named “DCIM”. Open the DCIM folder and create as many folders as necessary to save and organize your images. The folder name must follow the format “100ABC\_D”. The first three digits are the folder number, from 100 to 999. The final five characters can be any combination of upper- and lower-case letters from A to Z, numerals, and the underscore “\_”. The space cannot be used. Also note that two folder names cannot share the same three-digit folder number (for example, “100ABC\_D” and “100W\_XYZ”), even if the other five characters in each name are different.

## MENU Changing the File Name

The file name has four alphanumeric characters followed by a four-digit image number (p.156) and extension. The first four alphanumeric characters are set upon factory shipment and unique to the camera. However, you can change them.

(Ex.) BE3B0001.JPG

With “User setting1”, you can change and register the four characters as desired. With “User setting2”, if you register three characters, the fourth character from the left will be appended automatically to indicate the image size.

### Registering or Changing the File Name

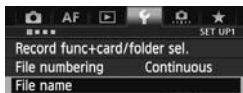

#### 1 Select [File name].

- Under the [**F1**] tab, select [**File name**], then press <SET>.

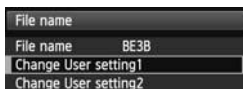

#### 2 Select [Change User setting\*].

- Turn the <DIAL> to select [**Change User setting\***], then press <SET>.



#### 3 Enter any alphanumeric characters.

- For User setting1, enter four characters. For User setting2, enter three characters.
- Press the <DELETE> button to delete any unnecessary characters.
- Press the <Q> button, and the text palette will be highlighted in a color frame. Text can be entered.
- Operate the <DIAL> or <DIAL> to move the  and select the desired character. Then press <SET> to enter it.



## 4 Exit the setting.

- Enter the required number of alphanumeric characters, then press the <MENU> button.
- ▶ The new file name will be registered and the screen in step 2 will reappear.

## 5 Select the registered file name.

- Turn the <DIAL> dial to select [File name], then press <SET>.
- Turn the <DIAL> dial to select the registered file name, then press <SET>.
- If User setting2 has been registered, select "\*\*\*\*" (the 3 characters registered) + image size".



Settings



### About User setting2

When you select the "\*\*\*\* + image size" registered with User setting2 and take pictures, the image-recording quality character will be automatically appended as the file name's fourth character from the left. The meaning of the image-recording quality characters is as follows:

"\*\*\*L" = L, L, RAW

"\*\*\*M" = M, M, M RAW

"\*\*\*S" = S1, S1, S RAW

"\*\*\*T" = S2

"\*\*\*U" = S3

When the image is transferred to a personal computer, the automatically appended fourth character will be included. You can then see the image size without having to open the image. RAW or JPEG images can be distinguished with the extension.



The first character cannot be an underscore "\_".



- The extension will be ".JPG" for JPEG images, ".CR2" for RAW images, and ".MOV" for movies.
- When you shoot a movie with User setting2, the file name's fourth character will be an underscore "\_".

## MENU File Numbering Methods

The four-digit file number is like the frame number on a roll of film. The captured images are assigned a sequential file number from 0001 to 9999 and saved in one folder. You can change how the file number is assigned. (Ex.) BE3B0001.JPG

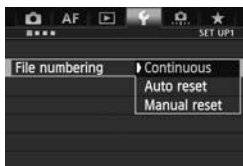

- 1 Select [File numbering].**
  - Under the [**F1**] tab, select [**File numbering**], then press <[SET]>.
- 2 Select the file numbering method.**
  - Turn the <[DIAL]> dial to select the desired setting, then press <[SET]>.

### Continuous

**Continues the file numbering sequence even after the card is replaced or a new folder is created.**

Even after you replace the card, create a folder, or switch the target card (such as [1] → [2]), the file numbering continues in sequence up to 9999 for the images saved. This is convenient when you want to save images numbered anywhere between 0001 to 9999 in multiple cards or folders into one folder in your personal computer.

If the replacement card or existing folder already contains images recorded previously, the file numbering of the new images may continue from the file numbering of the existing images in the card or folder. If you want to use continuous file numbering, you should use a newly-formatted card each time.

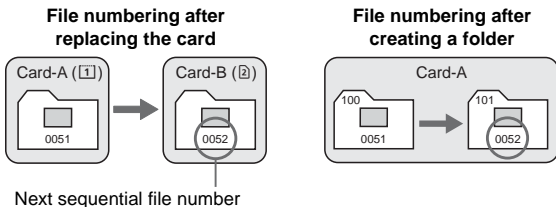

## Auto Reset

The file numbering restarts from 0001 each time the card is replaced or a new folder is created.

When you replace the card, create a folder, or switch the target card (such as ① → ②), the file numbering continues in sequence from 0001 for the images saved. This is convenient if you want to organize images according to cards or folders.

If the replacement card or existing folder already contains images recorded previously, the file numbering of the new images may continue from the file numbering of the existing images in the card or folder. If you want to save images with the file numbering starting from 0001, use a newly formatted card each time.

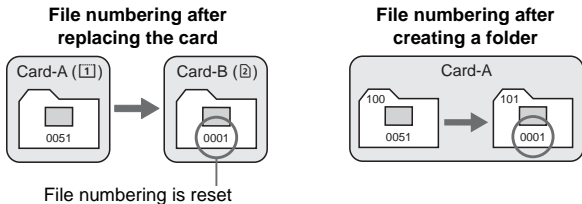

## Manual Reset

To reset the file numbering to 0001 or to start from file number 0001 in a new folder.

When you reset the file numbering manually, a new folder is created automatically and the file numbering of images saved to that folder starts from 0001.

This is convenient if you want to use different folders for the images taken yesterday and the ones taken today, for example. After the manual reset, the file numbering returns to continuous or auto reset. (There will be no Manual reset confirmation screen.)

 If the file number in folder 999 reaches 9999, shooting will not be possible even if the card still has storage capacity. The LCD monitor will display a message telling you to replace the card. Replace it with a new card.

## MENU Setting Copyright Information ☆

When you set the copyright information, it will be recorded to the image as Exif information.

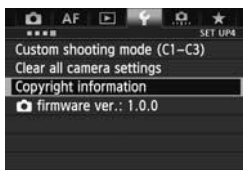

### 1 Select [Copyright information].

- Under the [**4**] tab, select [**Copyright information**], then press <SET>.



### 2 Select the option to be set.

- Turn the <DIAL> dial, select either [**Enter author's name**] or [**Enter copyright details**], then press <SET>.



### 3 Enter text.

- Press the <Q> button, and the text palette will be highlighted in a color frame. Text can be entered.
- Operate the <DIAL/ROTARY> dial or <DIAL> dial to move the cursor and select the desired character. Then press <SET> to enter it.
- You can enter up to 63 characters.
- To delete a character, press the <DELETE> button.

### 4 Exit the setting.

- After entering the text, press the <MENU> button.
- ▶ The information will be saved and the screen will return to step 2.

## Checking the Copyright Information



When you select [**Display copyright info.**] in step 2 on the preceding page, you can check the [**Author**] and [**Copyright**] information that you entered.

## Deleting the Copyright Information

When you select [**Delete copyright information**] in step 2 on the preceding page, you can delete the [**Author**] and [**Copyright**] information.



You can also set or check the copyright information with EOS Utility (provided software, p.394).

## MENU Setting the Color Space ☆

The range of reproducible colors is called the color space. With this camera, you can set the color space for captured images to sRGB or Adobe RGB. For normal shooting, sRGB is recommended.

The color space is set automatically to sRGB in the <[A]<sup>+</sup>> mode.

### 1 Select [Color space].

- Under the [CAMERA 2] tab, select [Color space], then press <[SET]>.

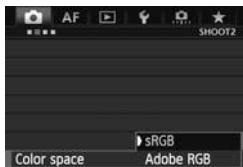

### 2 Set the desired color space.

- Select [sRGB] or [Adobe RGB], then press <[SET]>.

## About Adobe RGB

This color space is mainly used for commercial printing and other industrial uses. This setting is not recommended if you do not know about image processing, Adobe RGB, and Design rule for Camera File System 2.0 (Exif 2.21 or higher). The image will look very subdued in a sRGB personal computer environment and with printers not compatible with Design rule for Camera File System 2.0 (Exif 2.21 or higher). Post-processing of the image with software will therefore be required.



- If the captured still photo was shot in the Adobe RGB color space, the first character in the file name will be an underscore “\_”.
- The ICC profile is not appended. Refer to explanations about the ICC profile in the Digital Photo Professional Instruction Manual (p.396).



# 5

## Advanced Operations

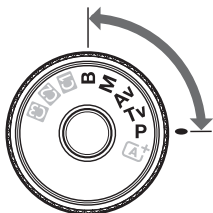

In the **P/Tv/Av/M/B** shooting modes, you can select the shutter speed, aperture, and other camera settings to change the exposure and obtain the desired result.

- A ☆ icon at the upper right of a page title indicates that the function can be used when the Mode Dial is set to <**P/Tv/Av/M/B**>.
- \* The function cannot be used in the <**A<sup>+</sup>**> mode.
- After you press the shutter button halfway and let go, the exposure values will remain displayed in the viewfinder and on the LCD panel for 4 sec. (Ⓔ4).
- For the functions settable in each shooting mode, see page 352.



Set the <LOCK▶> switch to the left.

## P: Program AE

The camera automatically sets the shutter speed and aperture to suit the subject's brightness. This is called Program AE.

\* <P> stands for Program.

\* AE stands for autoexposure.



### 1 Set the Mode Dial to <P>.

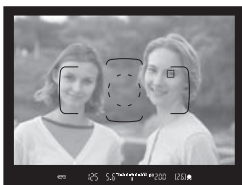

### 2 Focus the subject.

- Look through the viewfinder and aim the AF point over the subject. Then press the shutter button halfway.
- ▶ When focus is achieved, the focus confirmation light <●> on the viewfinder's bottom right will light up. (In One-Shot AF mode.)
- ▶ The shutter speed and aperture will be set automatically and displayed in the viewfinder and on the LCD panel.



### 3 Check the display.

- A standard exposure will be obtained as long as the shutter speed and aperture display do not blink.

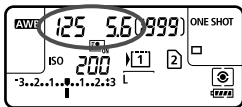

### 4 Take the picture.

- Compose the shot and press the shutter button completely.



- If the "30" shutter speed and the maximum aperture blink, it indicates underexposure. Increase the ISO speed or use flash.



- If the "8000" shutter speed and the minimum aperture blink, it indicates overexposure. Lower the ISO speed or use an ND filter (sold separately) to reduce the amount of light entering the lens.



### Differences Between <P> and <A+> Modes

In the <A+> mode, many functions such as the AF mode and metering mode are set automatically to prevent spoiled shots. The functions you can set are limited. With <P> mode, only the shutter speed and aperture are set automatically. You can freely set the AF mode, metering mode, and other functions (p.352).

### About Program Shift

- In the Program AE mode, you can freely change the shutter speed and aperture combination (Program) set automatically by the camera while maintaining the same exposure. This is called Program shift.
- To shift the program, press the shutter button down halfway, then turn the <A+> dial until the desired shutter speed or aperture is displayed.
- Program shift is canceled automatically after the picture is taken.
- Program shift cannot be used with flash.

## Tv: Shutter-Priority AE

In this mode, you set the shutter speed and the camera automatically sets the aperture to obtain the standard exposure suiting the brightness of the subject. This is called shutter-priority AE. A faster shutter speed can freeze the action or a moving subject. A slower shutter speed can create a blurred effect, giving the impression of motion.

\* <Tv> stands for Time value.



Blurred motion  
(Slow shutter speed: 1/30 sec.)



Frozen action  
(Fast shutter speed: 1/2000 sec.)



### 1 Set the Mode Dial to <Tv>.

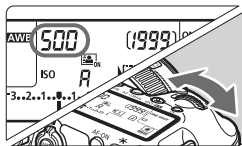

### 2 Set the desired shutter speed.

- While looking at the LCD panel, turn the <  > dial.

### 3 Focus the subject.

- Press the shutter button halfway.
- ▶ The aperture is set automatically.



### 4 Check the viewfinder display and shoot.

- As long as the aperture is not blinking, a standard exposure will be obtained.



- If the maximum aperture blinks, it indicates underexposure. Turn the <  > dial to set a slower shutter speed until the aperture stops blinking or set a higher ISO speed.



- If the minimum aperture blinks, it indicates overexposure. Turn the <  > dial to set a faster shutter speed until the aperture stops blinking or set a lower ISO speed.



### Shutter Speed Display

The shutter speeds from “8000” to “4” indicate the denominator of the fractional shutter speed. For example, “125” indicates 1/125 sec. Also, “0”5” indicates 0.5 sec. and “15”” is 15 sec.

# Av: Aperture-Priority AE

In this mode, you set the desired aperture and the camera sets the shutter speed automatically to obtain the standard exposure suiting the subject brightness. This is called aperture-priority AE. A higher f/number (smaller aperture hole) will make more of the foreground and background fall within acceptable focus. On the other hand, a lower f/number (larger aperture hole) will make less of the foreground and background fall within acceptable focus.

\* <Av> stands for Aperture value (aperture opening).



Blurred background  
(With a low aperture f/number: f/5.6)



Sharp foreground and background  
(With a high aperture f/number: f/32)



## 1 Set the Mode Dial to <Av>.

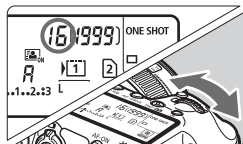

## 2 Set the desired aperture.

- While looking at the LCD panel, turn the <gear> dial.

## 3 Focus the subject.

- Press the shutter button halfway.
- ▶ The shutter speed is set automatically.



## 4 Check the viewfinder display and shoot.

- As long as the shutter speed is not blinking, a standard exposure will be obtained.



- If the “30” shutter speed blinks, it indicates underexposure. Turn the  dial to set a larger aperture (lower f/number) until the shutter speed blinking stops or set a higher ISO speed.



- If the “8000” shutter speed blinks, it indicates overexposure. Turn the  dial to set a smaller aperture (higher aperture f/number) until the shutter speed blinking stops or set a lower ISO speed.



### Aperture Display

The higher the f/number, the smaller the aperture opening will be. The apertures displayed will differ depending on the lens. If no lens is attached to the camera, “00” will be displayed for the aperture.

## Depth of Field Preview <sup>☆</sup>

The aperture opening (diaphragm) changes only at the moment when the picture is taken. Otherwise, the aperture remains fully open. Therefore, when you look at the scene through the viewfinder or on the LCD monitor, the depth of field will look narrow.

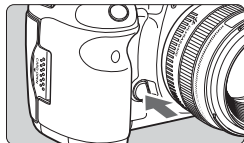

Press the depth-of-field preview button to stop down the lens to the current aperture setting and check the depth of field (range of acceptable focus).



- A higher f/number will make more of the foreground and background fall within acceptable focus. However, the viewfinder will look darker.
- The depth-of-field effect can be clearly seen on the Live View image as you change the aperture and press the depth-of-field preview button (p.200).
- The exposure will be locked (AE lock) while the depth-of-field preview button is pressed.

# M: Manual Exposure

In this mode, you set both the shutter speed and aperture as desired. To determine the exposure, refer to the exposure level indicator in the viewfinder or use a commercially-available exposure meter. This method is called manual exposure.

\* <M> stands for Manual.



1 Set the Mode Dial to <M>.

2 Set the ISO speed (p.126).

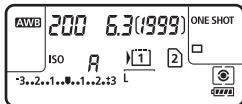

3 Set the shutter speed and aperture.

- To set the shutter speed, turn the <☀> dial.
- To set the aperture, turn the <☉> dial.
- If it cannot be set, set the <LOCK▶> switch to the left, then turn the <☀> or <☉> dial.

Standard exposure index



Exposure level mark

4 Focus the subject.

- Press the shutter button halfway.
- ▶ The exposure setting will be displayed in the viewfinder and on the LCD panel.
- The exposure level mark <▲> indicates how far the current exposure level is from the standard exposure level.

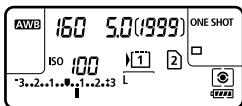

5 Set the exposure and take the picture.

- Check the exposure level and set the desired shutter speed and aperture.
- If the exposure compensation amount exceeds  $\pm 3$  stops, the end of the exposure level indicator will display <◀> or <▶>.

ⓘ If ISO Auto is set, the ISO speed setting will change to suit the shutter speed and aperture to obtain a standard exposure. Therefore, you may not obtain the desired exposure effect.





- In [**Q2: Auto Lighting Optimizer**], if the checkmark <✓> for [**Disable during man expo**] is removed, it can be set in the <M> mode (p.144).
- When ISO Auto is set, you can press the <✳> button to lock the ISO speed.
- After recomposing the picture, you can see the exposure level difference on the exposure level indicator (p.22, 23) compared to when you pressed the <✳> button.

## Selecting the Metering Mode <sup>★</sup>

You can select one of four methods to measure the subject brightness. The metering mode is set automatically to evaluative metering in the <A+> mode.

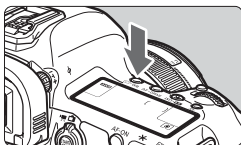

**1** Press the <WB> button. (⊗)

**2** Select the metering mode.

- While looking at the LCD panel, turn the <mode> dial.

 **Evaluative metering**

 **Partial metering**

 **Spot metering**

 **Center-weighted average metering**

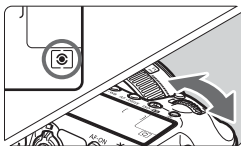

 **Evaluative metering**

This is a general-purpose metering mode suited even for backlit subjects. The camera sets the exposure automatically to suit the scene.

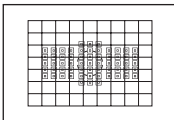

 **Partial metering**

Effective when the background is much brighter than the subject due to backlighting, etc. Partial metering covers approx. 6.2% of the viewfinder area at the center.

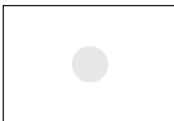

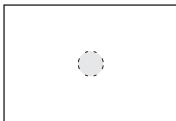

**Spot metering**

This is for metering a specific spot of the subject or scene. The metering is weighted at the center covering approx. 1.5% of the viewfinder area.



**Center-weighted average metering**

The metering is weighted at the center and then averaged for the entire scene.

# Setting Exposure Compensation <sup>☆</sup>

Exposure compensation can brighten (increased exposure) or darken (decreased exposure) the standard exposure set by the camera. Exposure compensation can be set in the **P/Tv/Av** shooting modes. Although you can set the exposure compensation up to  $\pm 5$  stops in 1/3-stop increments, the exposure compensation indicator in the viewfinder and on the LCD panel can only display the setting up to  $\pm 3$  stops. If you want to set the exposure compensation setting beyond  $\pm 3$  stops, you should use the Quick Control (p.49) or follow the instructions for [ 2: Expo.comp./AEB ] on the next page.

## 1 Check the exposure level indicator.

- Press the shutter button halfway ( ) and check the exposure level indicator.

Increased exposure for a brighter image



## 2 Set the exposure compensation amount.

- While looking at the viewfinder or LCD panel, turn the dial.
- If it cannot be set, set the switch to the left, then turn the dial.

Decreased exposure for a darker image



## 3 Take the picture.

- To cancel the exposure compensation, set the exposure compensation amount back to .

If [ 2: Auto Lighting Optimizer ] (p.144) is not set to [ **Disable** ], the image may still look bright even if a darker exposure compensation amount has been set.



- The exposure compensation amount will remain in effect even after you set the power switch to **<OFF>**.
- After setting the exposure compensation amount, you can set the switch to the right to prevent the exposure compensation amount from changing accidentally.
- If the exposure compensation amount exceeds  $\pm 3$  stops, the end of the exposure level indicator will display or .

# Auto Exposure Bracketing (AEB) <sup>☆</sup>

By changing the shutter speed or aperture automatically, the camera brackets the exposure up to  $\pm 3$  stops in 1/3-stop increments for three successive shots. This is called AEB. \* AEB stands for Auto Exposure Bracketing.

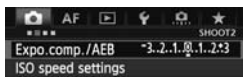

## 1 Select [Expo.comp./AEB].

- Under the [2] tab, select [Expo.comp./AEB], then press  $\langle \text{SET} \rangle$ .

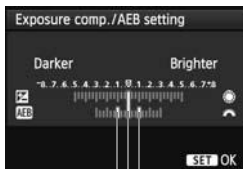

## 2 Set the AEB range.

- Turn the  $\langle \text{DIAL} \rangle$  dial to set the AEB range. If you turn  $\langle \text{DIAL} \rangle$ , you can set the exposure compensation.
- Press  $\langle \text{SET} \rangle$  to set it.
- ▶ When you exit the menu,  $\langle \text{MENU} \rangle$  and the AEB range will be displayed on the LCD panel.

AEB range

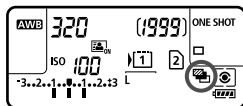

## 3 Take the picture.

- The three bracketed shots will be taken according to the drive mode set in this sequence: Standard exposure, decreased exposure, and increased exposure.
- AEB will not be automatically canceled. To cancel AEB, follow step 2 to turn off the AEB range display.



- During AEB shooting,  $\langle * \rangle$  and  $\langle \text{MENU} \rangle$  will blink respectively in the viewfinder and on the LCD panel.
- If the drive mode is set to  $\langle \text{S} \rangle$  or  $\langle \text{S} \rangle$ , press the shutter button three times for each shot. When  $\langle \text{H} \rangle$ ,  $\langle \text{S} \rangle$ , or  $\langle \text{S} \rangle$  is set and you hold down the shutter button completely, the three bracketed shots will be taken continuously and the camera will automatically stop shooting. When  $\langle \text{S} \rangle$  or  $\langle \text{S} \rangle$  is set, the three bracketed shots will be taken continuously after a 10-sec. or 2-sec. delay.
- You can set AEB in combination with exposure compensation.
- If the AEB range exceeds  $\pm 3$  stops, the end of the exposure level indicator will display  $\langle \blacktriangleleft \rangle$  or  $\langle \blacktriangleright \rangle$ .
- AEB cannot be set for bulb exposures or used with flash.
- AEB will be canceled automatically when you set the power switch to  $\langle \text{OFF} \rangle$  or when the flash is ready to fire.

## ✳ AE Lock ☆

Use AE lock when the area of focus is to be different from the exposure metering area or when you want to take multiple shots at the same exposure setting. Press the <✳> button to lock the exposure, then recompose and take the shot. This is called AE lock. It is effective for backlit subjects.

### 1 Focus the subject.

- Press the shutter button halfway.
- ▶ The exposure setting will be displayed.

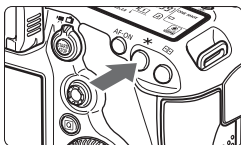

### 2 Press the <✳> button. (ⓘ4)



- ▶ The <✳> icon lights up in the viewfinder to indicate that the exposure setting is locked (AE lock).
- Each time you press the <✳> button, it locks the current autoexposure setting.



### 3 Recompose and take the picture.

- If you want to maintain the AE lock while taking more shots, hold down the <✳> button and press the shutter button to take another shot.

## AE Lock Effects

Metering Mode (p.169)	AF Point Selection Method (p.74)	
	Automatic Selection	Manual Selection
 *	AE lock is applied at the AF point that achieved focus.	AE lock is applied at the selected AF point.
	AE lock is applied at the center AF point.	

\* When the lens' focus mode switch is set to <MF>, AE lock is applied at the center AF point.



AE lock is not possible with bulb exposures.

## B: Bulb Exposures

When bulb is set, the shutter stays open as long as you hold down the shutter button completely, and closes when you let go of the shutter button. This is called bulb exposure. Use bulb exposures for night scenes, fireworks, the heavens, and other subjects requiring long exposures.



### 1 Set the Mode Dial to <B>.

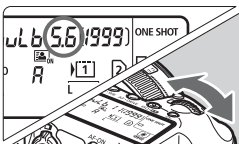

### 2 Set the desired aperture.

- While looking at the LCD panel, turn the <☀> or <☾> dial.

### 3 Take the picture.

- While you hold down the shutter button, the exposure will continue.
- ▶ The elapsed exposure time will be displayed on the LCD panel.

Elapsed exposure time

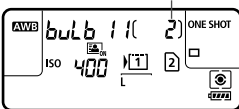

- Do not point the camera toward an intense light source, such as the sun on a sunny day or an intense artificial light source. Doing so may damage the image sensor or the camera's internal components.
- Long exposures produce more noise than usual.
- If ISO Auto is set, the ISO speed will be fixed at ISO 400 (p.127).



- When [**3: Long exp. noise reduction**] is set to [Auto] or [Enable], noise generated by the long exposure can be reduced (p.146).
- For bulb exposures, using a tripod and Remote Switch RS-80N3 (sold separately) or Timer Remote Controller TC-80N3 (sold separately) is recommended (p.187).
- You can also use a remote controller (sold separately, p.188) for bulb exposures. When you press the remote controller's transmit button, the bulb exposure will start immediately or 2 sec. later. Press the button again to stop the bulb exposure.

# HDR: HDR (High Dynamic Range) Shooting ★

You can take artistic photos having a high dynamic range and preserving detail in highlight and shadow areas. HDR shooting is effective for landscape and still-life shots.

**With HDR shooting, three images of different exposures (standard exposure, underexposure, and overexposure) are captured for each shot and then merged together automatically. The HDR image is recorded as a JPEG image.**

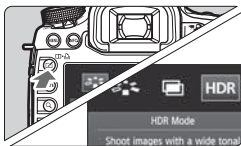

\* HDR stands for High Dynamic Range.

## HDR Shooting



**1 Press the  button.**

**2 Select the HDR mode.**

- Turn the  dial to select [HDR], then press .
- ▶ The HDR mode screen will appear.

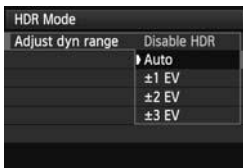

**3 Set [Adjust dyn range].**

- Select the desired dynamic range setting, then press .
- Selecting [Auto] will have the dynamic range set automatically the image's overall tonal range.
- The higher the number, the wider the dynamic range will be.
- To disable HDR shooting, select [Disable HDR].

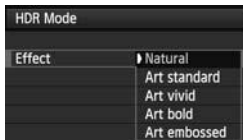

**4 Set [Effect].**

- Select the desired effect, then press .



- The HDR mode cannot be set if you use any of the following: AEB, white balance bracketing, multiple exposures, bulb exposure, or movie shooting.
- Flash will not fire during HDR shooting.

## About Effects

- **Natural**

For images preserving a wide tonal range where the highlight and shadow detail would otherwise be lost.

- **Art standard**

While the highlight and shadow detail will be better preserved than with [**Natural**], the contrast will be lower and the gradation flatter to have the picture look like a painting. The subject outlines will have bright (or dark) edges.

- **Art vivid**

The colors are more saturated than with [**Art standard**] and the low contrast and flat gradation create a graphic art effect.

- **Art bold**

The colors are the most saturated, making the subject pop out and the picture look like an oil painting.

- **Art embossed**

The color saturation, brightness, contrast and gradation are decreased to make the picture look flat. The picture looks faded and old. The subject outlines will have bright (or dark) edges.

	<b>Art standard</b>	<b>Art vivid</b>	<b>Art bold</b>	<b>Art embossed</b>
<b>Saturation</b>	Standard	High	Higher	Low
<b>Bold outline</b>	Standard	Weak	Strong	Stronger
<b>Brightness</b>	Standard	Standard	Standard	Dark
<b>Tone</b>	Flat	Flat	Flat	Flatter

 Each effect will be applied while based on the characteristics of the Picture Style currently set.



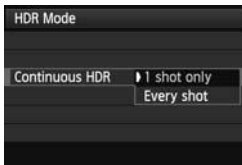

## 5 Set [Continuous HDR].

- Select either [**1 shot only**] or [**Every shot**], then press <SET>.
- With [**1 shot only**], HDR shooting will be canceled automatically after the shooting ends.
- With [**Every shot**], HDR shooting continues until the setting in step 3 is set to [**Disable HDR**].

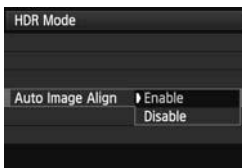

## 6 Set [Auto Image Align].

- For handheld shooting, select [**Enable**]. When using a tripod, select [**Disable**]. Then, press <SET>.

## 7 Set the images to be saved.

- To save all three images and the merged HDR image, select [**All images**], then press <SET>.
- To save only the HDR image, select [**HDR img only**], then press <SET>.

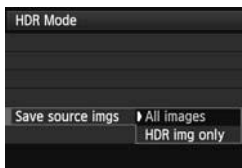

## 8 Take the picture.

- HDR shooting is possible with viewfinder shooting and Live View shooting.
- ▶ <HDR> will be displayed on the LCD panel.
- When you press the shutter button completely, three consecutive images will be captured, and the HDR image will be recorded to the card.



- HDR shooting is not possible with ISO expansion. (HDR shooting is possible within the range of ISO 100 - 25600.)
- When shooting HDR images with [**Auto Image Align**] set to [**Enable**], AF point display information (p.253) and Dust Delete data (p.297) will not be appended to the image.

- Using a tripod is recommended. For handheld shooting, using a fast shutter speed is recommended.
- HDR shooting of a moving subject is not recommended because the movement of the subject will appear as afterimages in the merged image. HDR shooting is suited for still subjects.
- In HDR shooting, 3 images are captured with different shutter speeds set automatically. Therefore, even in **Tv** and **M** shooting modes, the shutter speed will be shifted based on the shutter speed you set.
- To prevent camera shake, the ISO speed may be set higher than usual.
- If **[Auto Image Align]** is set to **[Enable]** and the HDR picture is shot handheld, the edges of the photos will be cropped, lowering the resolution slightly. Also, if the images cannot be aligned properly due to camera shake, etc., auto image alignment may not take effect. Note that when shooting with excessively bright or dark exposure settings, auto image alignment may not work properly.
- If you perform handheld HDR shooting while **[Auto Image Align]** is set to **[Disable]**, the 3 images may not be properly aligned and the HDR effect may be minimal.
- Auto image alignment may not work properly with repetitive patterns (lattice, stripes, etc.) or flat, single-tone images.
- The color gradation of the sky or white walls may not be reproduced correctly. Irregular colors or noise may appear.
- HDR shooting under fluorescent or LED lighting may result in unnatural color reproduction of the illuminated areas.
- With HDR shooting, the three images will be merged after you take a picture. Therefore, it will take a longer time to record the HDR image to the card than with normal shooting. During the merging of the images, **"BUSY"** will be displayed and you cannot take another picture until the merging is completed.
- In HDR mode, the options dimmed in the camera menu cannot be set. When you set HDR mode, the Auto Lighting Optimizer will be set automatically to **[Disable]**. It will revert to the original setting when you cancel the HDR mode.

- If the image-recording quality is set to RAW, the HDR image will be recorded in **HL** quality. If the image-recording quality is set to RAW+JPEG, the HDR image will be recorded in the JPEG quality set.
- You can also set HDR shooting with **[Q3: HDR Mode]**.

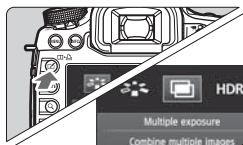

## Multiple Exposures ☆

You can shoot two to nine exposures to be merged into one image. If you shoot multiple-exposure images with Live View shooting (p.199), you can see how the single exposures merge while shooting.



1 Press the  button.

2 Select multiple exposure.

- Turn the  dial to select [, then press .
- ▶ The multiple exposure setting screen will appear.



3 Set [Multiple exposure].

- Select [On:Func/Ctrl] or [On:ContShtng], then press .
  - To quit shooting multiple exposures, select [Disable].
- **On: Func/Ctrl (Function and control priority)**  
Convenient when you want to shoot multiple exposures while checking the result as you proceed. During continuous shooting, the continuous shooting speed will decrease greatly.
  - **On: ContShtng (Continuous shooting priority)**  
Geared for continuous multiple-exposure shooting of a moving subject. Continuous shooting is possible, but the following operations are disabled during shooting: menu viewing, Live View display, image review after image capture, image playback, and undo last image (p.184).  
Also, only the multiple-exposure image will be saved. (The single exposures merged in the multiple-exposure image will not be saved.)



- If you set white balance bracketing, the HDR mode or if you shoot a movie, multiple exposure shooting cannot be set.
- If you perform Live View shooting while [On:ContShtng] is set, the Live View function will stop automatically after the first shot is taken. From the second shot onward, shoot while looking through the viewfinder.



## 4 Set [Multi-expos ctrl].

- Select the desired multiple-exposure control method, then press < (SET) >.

### ● Additive

The exposure of each single exposure is added cumulatively. Based on the [No. of exposures], set a negative exposure compensation. Refer to the basic guide below to set a negative exposure compensation.

#### Exposure Compensation Setting Guide for Multiple Exposures

Two exposures: -1 stop, three exposures: -1.5 stop, four exposures: -2 stops



If [On:Func/Ctrl] and [Additive] are both set, the image displayed during shooting may look noisy. However, when you finish shooting the set number of exposures, noise reduction will be applied and the final multiple-exposure image will look less noisy.

### ● Average

Based on the [No. of exposures], negative exposure compensation is set automatically as you shoot multiple exposures. If you shoot multiple exposures of the same scene, the exposure of the subject's background will be automatically controlled to obtain a standard exposure. If you want to change the exposure of each single exposure, select [Additive].

### ● Bright/Dark

The brightness (or darkness) of the base image and the images to be added are compared at the same position, and then the bright (or dark) part will be left in the picture. Depending on the overlapping colors, the colors may be mixed depending on the brightness (or darkness) ratio of the compared images.

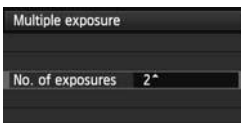

## 5 Set the [No. of exposures].

- Turn the < (DIAL) > dial to select the number of exposures, then press < (SET) >.
- You can set it from 2 to 9 exposures.

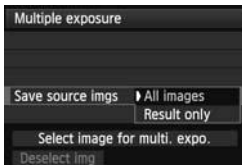

## 6 Set the images to be saved.

- To save all the single exposures and the merged multiple-exposure image, select **[All images]**, then press <SET>.
- To save only the merged multiple-exposure image, select **[Result only]**, then press <SET>.

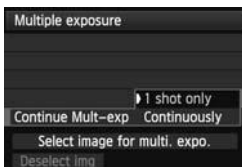

## 7 Set [Continue Multi-exp].

- Select either **[1 shot only]** or **[Continuously]**, then press <SET>.
- With **[1 shot only]**, the setting in step 3 will be set automatically to **[Disable]**. Multiple-exposure shooting will be canceled automatically after the shooting ends.
- With **[Continuously]**, multiple-exposure shooting continues until the setting in step 3 is set to **[Disable]**.



Remaining number of exposures

## 8 Take the first exposure.

- ▶ When **[On:Func/Ctrl]** is set, the captured image will be displayed.
- ▶ The <[ ]> icon will blink.
- The number of remaining exposures is displayed in brackets [ ] in the viewfinder or on the screen.
- Pressing the <[ ]> button enables you to view the captured image (p.184).



- During multiple-exposure shooting, Auto Lighting Optimizer, highlight tone priority, peripheral illumination correction and chromatic aberration correction will be disabled.
- The image-recording quality, ISO speed, Picture Style, high ISO speed noise reduction and color space, etc. set for the first single exposure will also be set for the subsequent exposures.
- If the Picture Style is **[Auto]**, the **[Standard]** Picture Style will be set for shooting.

## 9 Shoot subsequent exposures.

- ▶ When [**On:Func/Ctrl**] is set, the merged multiple-exposure image will be displayed.
- With Live View shooting, the multiple-exposure images merged so far will be displayed. By pressing the <**INFO.**> button, you can display only the Live View image.
- After you shoot the set number of exposures, multiple-exposure shooting will be canceled. With continuous shooting, after you finish shooting the set number of exposures while holding down the shutter button, the shooting will stop.

- With multiple exposures, the more exposures there are, the more noticeable the noise, irregular colors, and banding will be. Also, as noise increases with higher ISO speeds, shooting at low ISO speeds is recommended.
- If [**Additive**] is set, the image processing after taking the multiple exposures will take time. (The access lamp will light up for longer than usual.)
- If you perform Live View shooting while [**On:Func/Ctrl**] and [**Additive**] are both set, the Live View function will stop automatically when the multiple exposure shooting ends.
- In step 9, the brightness and noise of the multiple-exposure image displayed during Live View shooting will be different from the final multiple-exposure image recorded.
- If [**On:ContShtng**] is set, let go of the shutter button after shooting the set number of exposures.
- If the power switch is set to <**OFF**> or the battery is replaced after you set multiple exposure settings, multiple-exposure shooting will be canceled.
- If you switch the shooting mode to <**A<sup>+</sup>**> <**1**/**2**/**3**> while shooting, multiple-exposure shooting will end.
- When multiple exposure is set or during multiple-exposure shooting, you cannot use the functions dimmed in the camera menu.
- If you connect the camera to a personal computer or printer, multiple-exposure shooting is not possible.

- When [**On:Func/ctrl**] is set, you can press the <**▶**> button to view the multiple exposures taken so far or delete the last single exposure (p.184).
- You can also set multiple exposure with [**3: Multiple exposure**].

## Merging multiple exposures with an image recorded in the card

You can select an image recorded in the card as the first single exposure. The original of the selected image will remain intact.

**You can only select RAW images.** You cannot select M RAW/S RAW or JPEG images.



### 1 Select [Select image for multi. expo.].

- Select [**Select image for multi. expo.**], then press <SET>.
- ▶ The images in the card will be displayed.

### 2 Select an image.

- Turn the <DISP> dial to select the image to be used as the first single exposure, then press <SET>.
- Turn the <DISP> dial to select [OK].
- ▶ The file No. of the selected image will be displayed at the bottom of the screen.

### 3 Take the picture.

- When you select the first image, the number of remaining exposures as set with [**No. of exposures**] will decrease by 1. For example, if [**No. of exposures**] is 3, you can shoot two exposures.



- Images shot with highlight tone priority set to [**Enable**], images of which the aspect ratio is other than 3:2 (p.206), or those with cropping information appended (p.326) cannot be selected as the first single exposure.
- Auto Lighting Optimizer, peripheral illumination correction and chromatic aberration correction will be disabled, regardless of the settings of the RAW image selected as the first single exposure.
- The ISO speed, Picture Style, high ISO speed noise reduction, and color space, etc. set for the first RAW image will also be set for the subsequent images.
- If the first RAW image's Picture Style is [**Auto**], the [**Standard**] Picture Style will be set for the subsequent images.
- You cannot select an image taken with another camera.

- You can also select a **RAW** multiple-exposure image as the first single exposure.
- If you select [**Deselect img**], the selected image will be canceled.

## Checking and Deleting Multiple Exposures During Shooting



When [**On:Func/ctrl**] is set and you have not finished shooting the set number of exposures, you can press the <▶> button to view the merged multiple-exposure image so far. You can check how it looks and the exposure. (Not possible when [**On:ContShtng**] is set.)

If you press the <⏏> button, the operations possible during multiple-exposure shooting will be displayed.

Operation	Description
↶ Return to previous screen	The operations will disappear and the screen before you pressed the <⏏> button will reappear.
🗑 Undo last image	Deletes the last image you shot (shoot another image). The number of remaining exposures will increase by 1.
📁 Save and exit	If [ <b>Save source imgs: All images</b> ] is set, all of the single exposures and the merged multiple-exposure image will be saved before exiting. If [ <b>Save source imgs: Result only</b> ] is set, only the merged multiple-exposure image will be saved before exiting.
🚪 Exit without saving	None of the images will be saved before exiting.

ⓘ During multiple-exposure shooting, you can only play back multiple-exposure images.



## FAQ

### ● Are there any restrictions on the image-recording quality?

All JPEG image-recording quality settings can be selected. If **M RAW** or **S RAW** is set, the merged multiple-exposure will be a **RAW** image.

Image-Recording Quality Setting	Single Exposures	Merged Multiple-Exposure
JPEG	JPEG	JPEG
<b>RAW</b>	<b>RAW</b>	<b>RAW</b>
<b>M RAW/S RAW</b>	<b>M RAW/S RAW</b>	<b>RAW</b>
<b>RAW+JPEG</b>	<b>RAW+JPEG</b>	<b>RAW+JPEG</b>
<b>M RAW/S RAW+JPEG</b>	<b>M RAW/S RAW+JPEG</b>	<b>RAW+JPEG</b>

### ● Can I merge images recorded in the card?

With **[Select image for multi. expo.]**, you can select the first single exposure from the images recorded on the card (p.183). Note that you cannot merge multiple images already recorded on the card.

### ● Are multiple exposures possible with Live View shooting?

With **[On:Func/Ctrl]** set, you can shoot multiple exposures with Live View shooting (p.199). Note that **[4: Aspect ratio]** will be fixed at **[3:2]**.

### ● What file numbers are used for saving merged multiple-exposures?

If all images are set to be saved, the merged multiple-exposure image file number will be the serial number coming after the file number of the final single exposure used to create the merged multiple-exposure image.

### ● Will auto power off take effect during multiple-exposure shooting?

As long as **[2: Auto power off]** is not set to **[Disable]**, the power will turn off automatically after 30 min. of non-operation. If the auto power off takes effect, multiple-exposure shooting will end, and multiple-exposure settings will be canceled. Before starting the multiple-exposure shooting, the auto power off will take effect as set with the camera, and multiple-exposure settings will be canceled.

# Mirror Lockup <sup>☆</sup>

Although using the self-timer or Remote Switch can prevent camera shake, using mirror lockup to prevent camera vibrations (mirror shock) can also help when you use a super telephoto lens or shoot close ups (macro photography).

## 1 Set [Mirror lockup] to [Enable].

- Under the [📷1] tab, select [Mirror lockup], then press <ⓈET>.
- Select [Enable], then press <ⓈET>.

## 2 Focus the subject, then press the shutter button completely.

- ▶ The mirror will swing up, and the <📷> icon will blink on the LCD panel.

## 3 Press the shutter button completely again.

- ▶ The picture is taken and the mirror goes back down.

- In very bright light such as at the beach or a ski slope on a sunny day, take the picture promptly after mirror lockup.
- Do not point the camera toward an intense light source, such as the sun on a sunny day or an intense artificial light source. Doing so may damage the image sensor or the camera's internal components.
- If you use the self-timer and mirror lockup in combination with a bulb exposure, keep pressing the shutter button completely (self-timer delay time + bulb exposure time). If you let go of the shutter button during the self-timer countdown, there will be a shutter-release sound, but no picture will be taken.
- During mirror lockup, shooting function settings and menu operations, etc. are disabled.

- Even if the drive mode is set to continuous shooting, only one shot can be taken.
- You can also use the self-timer with mirror lockup.
- If 30 seconds elapse after the mirror has locked up, it will go back down automatically. Pressing the shutter button completely again locks up the mirror again.
- For mirror lockup, using a tripod and Remote Switch RS-80N3 (sold separately) or Timer Remote Controller TC-80N3 (sold separately) is recommended (p.187).
- You can also use a remote controller (sold separately, p.188). Setting the remote controller to a 2-sec. delay is recommended.

## Using the Eyepiece Cover

When you use the self-timer or shoot bulb exposures and do not look through the viewfinder, stray light entering the viewfinder can cause the image to come out dark. To prevent this, use the eyepiece cover (p.27) attached to the camera strap.

During Live View shooting and movie shooting, attaching the eyepiece cover is not necessary.

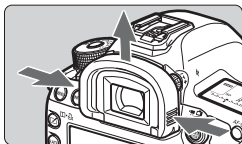

### 1 Remove the eyecup.

- While grasping both sides of the eyecup, slide it upward to remove.

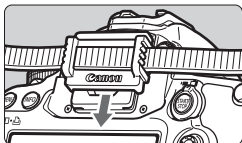

### 2 Attach the eyepiece cover.

- Slide the eyepiece cover down into the eyepiece groove to attach it.

## Using a Remote Switch

You can connect the Remote Switch RS-80N3 or Timer Remote Controller TC-80N3 (both sold separately) or any EOS accessory equipped with an N3-type terminal to the camera for shooting (p.362). To operate the accessory, refer to its instruction manual.

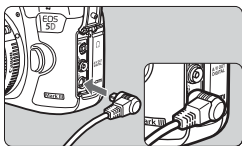

### 1 Open the terminal cover.

### 2 Connect the plug to the remote control terminal.

- Connect the plug as shown in the illustration.
- To disconnect the plug, grasp the silver part and pull.

## Remote Control Shooting



With Remote Controller RC-6 (sold separately), you can shoot remotely up to approx. 5 meters/16.4 feet from the camera. You can either shoot immediately or use a 2-sec. delay.

You can also use Remote Controller RC-1 and RC-5.

### 1 Focus the subject.

### 2 Set the lens focus mode switch to <MF>.

- You can also shoot with <AF>.

### 3 Press the <AF•DRIVE> button. (⊙6)

### 4 Select the self-timer.

- Look at the LCD panel and turn the <⊙> dial to select <⊙1> or <⊙2>.

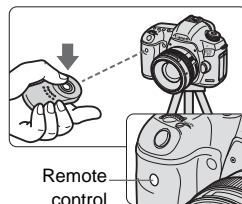
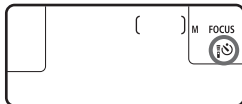
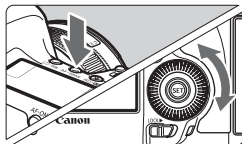

Remote control sensor

### 5 Press the remote controller's transmit button.

- Point the remote controller toward the camera's remote control sensor and press the transmit button.
- ▶ The self-timer lamp lights and the picture is taken.

Fluorescent or LED lighting may cause camera misoperation by triggering the shutter inadvertently. Try to keep the camera away from such light sources.

# 6

## Flash Photography

---

This chapter explains how to shoot with an EOS-dedicated, EX-series Speedlite (sold separately) or non-Canon flash unit and how to set flash functions on the camera's menu screen.

# ⚡ Flash Photography

## EOS-dedicated, EX-series Speedlites

An EX-series Speedlite (sold separately) makes flash photography as easy as normal shooting.

**For detailed instructions, refer to the EX-series Speedlite's instruction manual.** This camera is a Type-A camera that can use all the features of EX-series Speedlites.

To set the flash functions and flash Custom Functions with the camera's menu, see pages 193-198.



- **FE lock**

This enables you to attain a proper flash exposure for a specific part of the subject. Aim the viewfinder center over the subject, then press the camera's <M-Fn> button and take the picture.

- **Flash exposure compensation**

In the same way as normal exposure compensation, flash exposure compensation can be set. You can set flash exposure compensation up to  $\pm 3$  stops in 1/3-stop increments.

Press the camera's <ISO> button, then turn the <Q> dial while looking in the viewfinder or at the LCD panel.

⚠ If [CAMERA 2: Auto Lighting Optimizer] (p.144) is not set to [Disable], the image may still look bright even if a darker flash exposure compensation amount has been set.

📷 When it is difficult to achieve focus with autofocus, the EOS-dedicated, external Speedlite may automatically emit the AF-assist beam.

## Using Non-EX-series Canon Speedlites

- With an EZ/E/EG/ML/TL-series Speedlite set to A-TTL or TTL autoflash mode, the flash can be fired at full output only. Set the camera's shooting mode to <M> (manual exposure) or <Av> (aperture-priority AE) and adjust the aperture setting before shooting.
- When using a Speedlite that has manual flash mode, shoot in the manual flash mode.

## Using Non-Canon Flash Units

### Sync Speed

The camera can synchronize with non-Canon compact flash units at 1/200 sec. and slower speeds. With large studio flash units, since the flash duration is longer than compact flash units, set the sync speed within 1/60 sec. to 1/30 sec. Be sure to test the flash synchronization before shooting.

### PC Terminal

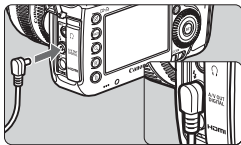

- The camera's PC terminal can be used with flash units having a sync cord. The PC terminal is threaded to prevent inadvertent disconnection.
- The camera's PC terminal has no polarity. You can connect any sync cord regardless of its polarity.

### Cautions for Live View shooting

If you use a non-Canon flash unit with Live View shooting, set [**4**: Silent LV shoot.] to [Disable] (p.208). The flash will not fire if it is set to [Mode 1] or [Mode 2].

- ⚠ ● If the camera is used with a flash unit or flash accessory dedicated to another camera brand, the camera may not operate properly and malfunction may result.
- Do not connect to the camera's PC terminal any flash unit requiring 250 V or more.
- Do not attach a high-voltage flash unit on the camera's hot shoe. It may not fire.

 A flash unit attached to the camera's hot shoe and a flash unit connected to the PC terminal can both be used at the same time.



## MENU Setting the Flash ☆

With an EX-series Speedlite having compatible flash function settings, you can use the camera's menu screen to set the Speedlite's functions and Custom Functions. **Attach the Speedlite to the camera and turn on the Speedlite.**

For details on the Speedlite's functions, refer to the Speedlite's instruction manual.

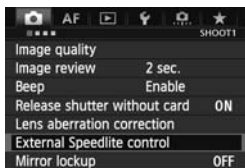

### 1 Select [External Speedlite control].

- Under the [ 1] tab, select [**External Speedlite control**], then press < >.
- ▶ The external Speedlite control screen will appear.

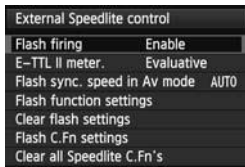

### 2 Select the desired item.

- Select the menu option to be set, then press < >.

#### [Flash firing]



To enable flash photography, set [**Enable**]. To enable only the AF-assist beam to be emitted, set [**Disable**].

#### [E-TTL II meter.]



For normal flash exposures, set it to [**Evaluative**]. If [**Average**] is set, the flash exposure will be averaged for the entire metered scene. Flash exposure compensation may be necessary. This setting is for advanced users.

**[Flash sync. speed in Av mode]**

Flash sync. speed in Av mode	
Auto	AUTO
1/200-1/60sec. auto	1/200 -1/60 A
1/200 sec. (fixed)	1/200
INFO Help	

You can set the flash-sync speed for flash photography in the aperture-priority AE (**Av**) mode.

- **AUTO: Auto**

The flash sync speed is set automatically within a range of 1/200 sec. to 30 sec. to suit the scene's brightness. High-speed sync is also possible.

- <sup>1/200</sup>/<sub>-1/60</sub> **A: 1/200-1/60 sec. auto**

Prevents a slow shutter speed from being set in low-light conditions. It is effective for preventing subject blur and camera shake.

However, while the subject will be properly exposed with the flash, the background may come out dark.

- **1/200: 1/200 sec. (fixed)**

The flash-sync speed is fixed at 1/200 sec. This more effectively prevents subject blur and camera shake than with **[1/200-1/60 sec. auto]**. However, in low light, the subject's background will come out darker than with **[1/200-1/60 sec. auto]**.

 If **[1/200-1/60 sec. auto]** or **[1/200 sec. (fixed)]** has been set, high-speed sync is not possible in the **<Av>** mode.

## [Flash function settings]

On the screen, the settable functions and the display will differ depending on the Speedlite, current flash mode, flash Custom Function settings, etc.

For details on your Speedlite's flash functions, refer to the Speedlite's instruction manual.

### Sample display

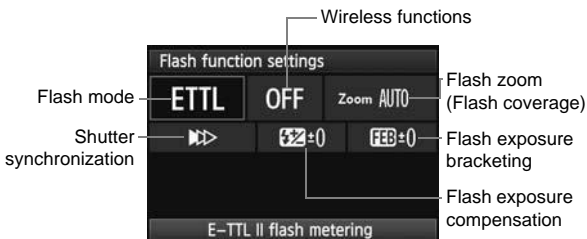

### ● Flash mode

You can select the flash mode to suit your desired flash shooting.

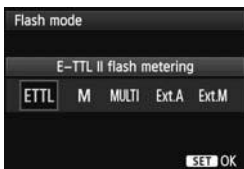

**[E-TTL II flash metering]** is the standard mode of EX-series Speedlites for automatic flash shooting.

The **[Manual flash]** mode is for setting the Speedlite's **[Flash output level]** yourself.

For other flash modes, refer to the Speedlite's instruction manual.

● **Wireless functions**



Wireless (multiple) flash shooting is possible with radio or optical transmission. For details on wireless flash, refer to the Speedlite's instruction manual.

● **Flash zoom (Flash coverage)**

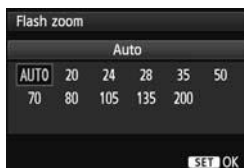

With Speedlites having a zooming flash head, you can set the flash coverage. Normally, set this to **[AUTO]** so that the camera will automatically set the flash coverage to match the lens focal length.

● **Shutter synchronization**

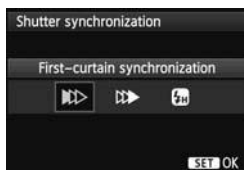

Normally, set this to **[First-curtain synchronization]** so that the flash fires immediately after the exposure starts.

If **[Second-curtain synchronization]** is set, the flash will fire right before the shutter closes. When this is combined with a slow shutter speed, you can create a trail of light such as from car headlights at night. With Second-curtain synchronization, two flashes will be fired: Once when you press the shutter button completely, and once immediately before the exposure ends.

If **[High-speed synchronization]** is set, the flash can be used at all shutter speeds. This is especially effective for portraits using fill flash when you want to give priority to the aperture setting.

## ● Flash exposure compensation

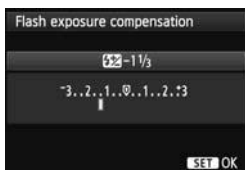



The same setting as “Flash exposure compensation” on page 190 can be set. For details, refer to the Speedlite’s instruction manual.

## ● Flash exposure bracketing



While the flash output is changed automatically, three shots are taken. For details on FEB (Flash Exposure Bracketing), refer to the Speedlite’s instruction manual.

 When using second-curtain synchronization, set the shutter speed to 1/25 sec. or slower. If the shutter speed is 1/30 sec. or faster, first-curtain synchronization will be applied even if **[Second-curtain synchronization]** is set.

- 
- By selecting **[Clear flash settings]**, you can revert the flash settings to their defaults.
  - With an EX-series Speedlite not compatible with flash function settings, you can only set the following: **[Flash firing]**, **[E-TTL II meter.]**, and **[Flash exposure compensation]** under **[Flash function settings]**. (**[Shutter synchronization]** can also be set with certain EX-series Speedlites.)
  - If flash exposure compensation is set with the Speedlite, you cannot set the flash exposure compensation on the camera (with the <ISO> > button or flash function settings). If it is set with both the camera and Speedlite, the Speedlite’s setting overrides the camera’s.

## Flash Custom Function Settings

For details on the Speedlite's Custom Functions, refer to the Speedlite's instruction manual.

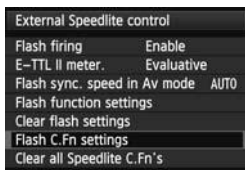



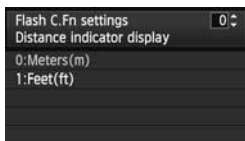

### 1 Select [Flash C.Fn settings].

- Select [**Flash C.Fn settings**], then press <  >.





### 2 Set the functions.

- Turn the <  > dial to select the number, then press <  >.
- Turn the <  > dial to select the menu option, then press <  >.

## Clearing Flash Custom Function Settings

Selecting [**Clear all Speedlite C.Fn's**] will clear all the Speedlite's Custom Function settings (except [**C.Fn-00: Distance indicator display**]).

 With an EX-series Speedlite, if the [**Flash metering mode**] Custom Function is set to [**TTL**] (autoflash), the Speedlite will always fire at full output.

 The Speedlite's Personal Functions (P.Fn) cannot be set or canceled with the camera's [**External Speedlite control**] screen. Set it with the Speedlite.

# 7

## Shooting with the LCD Monitor (Live View Shooting)



You can shoot while viewing the picture on the camera's LCD monitor. This is called "Live View shooting".

Live View shooting is enabled by setting the Live View shooting/Movie shooting switch to <img alt="camera icon" data-bbox="755 590 785 610"/>.

**Live View shooting is effective for photos of still subjects. If you handhold the camera and shoot while viewing the LCD monitor, camera shake can cause blurred images. Using a tripod is recommended.**



### About Remote Live View Shooting

With EOS Utility (provided software, p.394) installed in your computer, you can connect the camera to the computer and shoot remotely while viewing the computer screen. For details, refer to the EOS Utility Instruction Manual (p.396).

## Shooting with the LCD Monitor

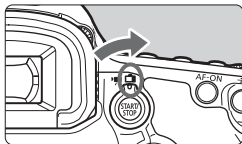

- 1** Set the Live View shooting/Movie shooting switch to .

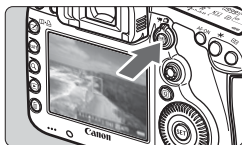

- 2** Display the Live View image.

- Press the  button.
- ▶ The Live View image will appear on the LCD monitor.
- The Live View image will closely reflect the brightness level of the actual image you capture.



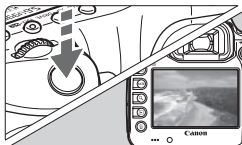

- 3** Focus the subject.

- When you press the shutter button halfway, the camera will focus with the current AF mode (p.209).



- 4** Take the picture.

- Press the shutter button completely.
- ▶ The picture will be taken and the captured image is displayed on the LCD monitor.
- ▶ After the image review ends, the camera will return to Live View shooting automatically.
- Press the  button to end the Live View shooting.

- 
- The image's field of view is approx. 100% (when the image-recording quality is set to JPEG .
  - The metering mode will be fixed to evaluative metering for Live View shooting.
  - In the **<P/Tv/Av/M/B>** shooting modes, you can check the depth of field by pressing the depth-of-field preview button.
  - During continuous shooting, the exposure set for the first shot will also be applied to subsequent shots.
  - You can also use a remote controller (sold separately, p.188) for Live View shooting.



## Enabling Live View Shooting

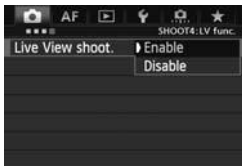

Set [**4: Live View shoot.**] to [**Enable**]. In the <**A+**> mode, it is displayed under [**2**].

## Battery Life with Live View Shooting [Approx. number of shots]

Temperature	At 23°C / 73°F	At 0°C / 32°F
Possible shots	200	180

- The figures above are based on a fully-charged Battery Pack LP-E6 and CIPA (Camera & Imaging Products Association) testing standards.
- With a fully-charged Battery Pack LP-E6, continuous Live View shooting is possible for approx. 1 hr. 30 min. at 23°C / 73°F.



- Do not point the camera toward an intense light source, such as the sun on a sunny day or an intense artificial light source. Doing so may damage the image sensor or the camera's internal components.
- **Cautions for using Live View shooting are on pages 217-218.**



- You can also focus by pressing the <AF-ON> button.
- When flash is used, there will be two shutter sounds, but only one shot will be taken.
- If the camera is not operated for a prolonged period, the power will turn off automatically as set with [**2: Auto power off**] (p.55). If [**2: Auto power off**] is set to [**Disable**], Live View shooting will end automatically after 30 min. (camera power remains on).
- With the stereo AV cable (provided) or HDMI cable (sold separately), you can display the Live View image on a TV (p.274, 277).

## About the Information Display

- Each time you press the <INFO.> button, the information display will change.

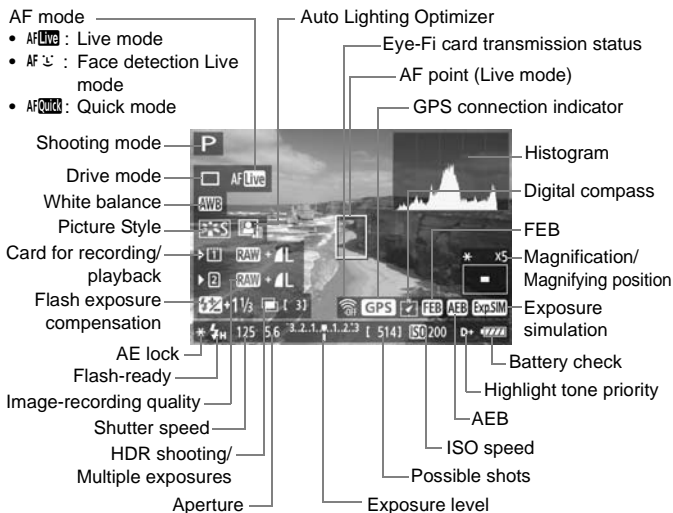

- The histogram can be displayed when [**Expo. simulation: Enable**] is set (p.207).
- You can display the electronic level by pressing the <INFO.> button (p.60). Note that if the AF mode is set to [**Live mode**] or the camera is connected to a TV set with an HDMI cable, the electronic level cannot be displayed.
- When <Exp.SIM> is displayed in white, it indicates that the Live View image brightness is close to what the captured image will look like.
- If <Exp.SIM> is blinking, it indicates that the Live View image is not being displayed at the suitable brightness due to low- or bright-light conditions. However, the actual image recorded will reflect the exposure setting.
- If flash is used or bulb is set, the <Exp.SIM> icon and histogram will be grayed out (for your reference). The histogram may not be properly displayed in low- or bright-light conditions.

## Final Image Simulation

The final image simulation reflects the effects of the Picture Style, white balance, etc., in the Live View image so you can see what the captured image will look like.







During shooting, the Live View image will automatically reflect the function settings listed below.



### Final image simulation during Live View shooting

- Picture Style
  - \* All parameters such as sharpness, contrast, color saturation, and color tone are reflected.
- White balance
- White balance correction
- Exposure (with [**Expo. simulation: Enable**])
- Depth of field (with depth-of-field preview button ON)
- Auto Lighting Optimizer
- Peripheral illumination correction
- Highlight tone priority
- Aspect ratio (image area confirmation)

# Shooting Function Settings

ISO /  / AF / DRIVE / WB /  /  Settings

While the Live View image is displayed, if you press the <ISO->, <AF•DRIVE>, <•WB>, <>, or <> button, the setting screen will appear on the LCD monitor and you can turn the <> or <> dial to set the respective shooting function.

When AFQuick is set, you can press the <> button to select the AF area selection mode and AF point. The procedure is the same as with viewfinder shooting. Note that the <> metering mode cannot be set.

## Quick Control







While the Live View image is displayed, you can press the <> button to set the Auto Lighting Optimizer, card selection, recording function, and image-recording quality.



### 1 Press the <> button.

- ▶ The settable functions will be displayed.

### 2 Select a function and set it.

- Use <> to select a function.
- ▶ The setting of the selected function is displayed at the bottom.
- Turn the <> or <> dial to set it.
- To set the recording function, press <>, then turn the <> or <> dial to set it.

## MENU Menu Function Settings



The screenshot shows the camera's menu interface. At the top, there are icons for camera, AF, video, a hand, a star, and a battery level indicator. Below these icons, the text 'SHOOT4: LV func.' is displayed. The main menu items are listed in a table:

Live View shoot.	Enable
AF mode	Live mode
Grid display	Off
Aspect ratio	3:2
Expo. simulation	Enable
Silent LV shoot.	Mode 1
Metering timer	16 sec.

Function settings particular to Live View shooting are explained here. The menu options under the [CAMERA 4] tab are explained on pages 205-208. In the <A+> mode, it is displayed under [CAMERA 2]. **The functions settable on this menu screen only apply during Live View shooting. These functions do not take effect during viewfinder shooting.**

---

### ● Live View shooting

You can set Live View shooting to [Enable] or [Disable].

### ● AF mode

You can select [Live mode] (p.209), [Live mode] (p.210), or [Quick mode] (p.214).

### ● Grid display

By displaying a [3x3] grid or [6x4] grid, you can check for any picture tilting. Also, with [3x3+diag], the grid is displayed together with diagonal lines to help you align the intersections over the subject for better balance in the composition.

- **Aspect ratio** ☆

The image's aspect ratio can be set to [3:2], [4:3], [16:9], or [1:1].

The area surrounding the Live View image is masked in black when the following aspect ratios are set: [4:3] [16:9] [1:1].

JPEG images will be saved with the set aspect ratio. RAW images will always be saved with the [3:2] aspect ratio. Since the aspect ratio information is appended to the RAW image, the image can be generated in the respective aspect ratio when you process the RAW image with the provided software.

When [. 3: Add cropping information] is not set to [Off], the aspect ratio will be 3:2. (The aspect ratio cannot be changed.)

Image Quality	Aspect Ratio and Pixel Count (approx.)			
	3:2	4:3	16:9	1:1
<b>L</b> <b>RAW</b>	5760x3840 (22.1 megapixels)	5120x3840 (19.7 megapixels)	5760x3240 (18.7 megapixels)	3840x3840 (14.7 megapixels)
<b>M</b>	3840x2560 (9.8 megapixels)	3408x2560* (8.7 megapixels)	3840x2160 (8.3 megapixels)	2560x2560 (6.6 megapixels)
<b>M</b> <b>RAW</b>	3960x2640 (10.5 megapixels)	3520x2640 (9.3 megapixels)	3960x2228* (8.8 megapixels)	2640x2640 (7.0 megapixels)
<b>S1</b>	2880x1920 (5.5 megapixels)	2560x1920 (4.9 megapixels)	2880x1624* (4.7 megapixels)	1920x1920 (3.7 megapixels)
<b>S</b> <b>RAW</b>	2880x1920 (5.5 megapixels)	2560x1920 (4.9 megapixels)	2880x1620 (4.7 megapixels)	1920x1920 (3.7 megapixels)
<b>S2</b>	1920x1280 (2.5 megapixels)	1696x1280* (2.2 megapixels)	1920x1080 (2.1 megapixels)	1280x1280 (1.6 megapixels)
<b>S3</b>	720x480 (350,000 pixels)	640x480 (310,000 pixels)	720x400* (290,000 pixels)	480x480 (230,000 pixels)



- For asterisked image-recording quality, the pixel count does not exactly match the set aspect ratio.
- The image area displayed for the asterisked aspect ratio is slightly larger than the recorded area. Check the captured images on the LCD monitor when shooting.
- If you use a different camera to directly print images shot with this camera in the 1:1 aspect ratio, the images may not be correctly printed.



With [**2: LV shooting area display**], you can set the display method for the shooting area (p.324).

### ● Exposure simulation <sup>★</sup>

Exposure simulation displays and simulates how the brightness of the actual image (exposure) will look.

#### ● Enable (Exp.SIM)

The displayed image brightness will be close to the actual brightness (exposure) of the resulting image. If you set exposure compensation, the image brightness will change accordingly.

#### ● During

Normally, the image is displayed at the standard brightness to make the Live View image easy to see. The image will be displayed close to the actual brightness (exposure) of the resulting image only while you hold down the depth-of-field preview button.

#### ● Disable (DISP)

The image is displayed at the standard brightness to make the Live View image easy to see. Even if you set exposure compensation, image is displayed at the standard brightness.



- If you set an expanded ISO speed setting as [**Maximum**] in [**ISO speed range**], Live View shooting will be possible under darker conditions.
- Even if a low ISO speed is set, noise may be noticeable in the displayed Live View image under low light. However, when you shoot, the image recorded will have minimal noise. (The image quality of the Live View image is different from that of the recorded image.)

- **Silent LV shooting** <sup>★</sup>

- **Mode 1**

The shooting operation noise is quieter than with normal shooting. Continuous shooting is also possible. If <[H]> is set, you can shoot at a maximum continuous shooting speed of approx. 6 fps.

- **Mode 2**

When the shutter button is pressed completely, only one shot will be taken. While you keep holding down the shutter button, the camera operation will be suspended. Then when you return to the shutter button's halfway position, the camera operation will resume. The shooting noise is thereby minimized. Even if continuous shooting is set, only a single shot will be taken.

- **Disable**

Be sure to set it to [**Disable**] if you use a TS-E lens (other than those listed in [] below) for **shifting or tilting the lens** or if you use an Extension tube. Setting it to [**Mode 1**] or [**Mode 2**] will result in incorrect or irregular exposures.

- If you use flash, silent shooting will not be possible regardless of the [**Silent LV shoot.**] setting.
  - When using a non-Canon flash unit, set it to [**Disable**]. The flash will not fire if it is set to [**Mode 1**] or [**Mode 2**].
  - If [**Mode 2**] is set and you use remote control shooting (p.188), the operation will be the same as with [**Mode 1**].

[] With the TS-E17mm f/4L or TS-E24mm f/3.5L II lens, you can use [**Mode 1**] or [**Mode 2**].

- **Metering timer** <sup>★</sup>

You can change how long the exposure setting is displayed (AE lock time).

[] If you select [**3: Dust Delete Data**], [**3: Sensor cleaning**], [**4: Clear all camera settings**], or [**4: Firmware Ver.**], the Live View shooting will be terminated.



# Using AF to Focus

## Selecting the AF Mode

The AF modes available are [**Live mode**], [**Live mode**] (face detection, p.210), and [**Quick mode**] (p.214).

If you want to achieve precise focus, set the lens focus mode switch to <MF>, magnify the image, and focus manually (p.216).

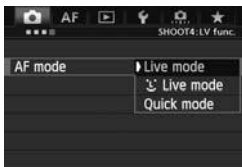

## Select the AF mode.

- Under the [**4**] tab, select [**AF mode**]. In the <[A+]> mode, it is displayed under [**2**].
- While the Live View image is displayed, you can press the <AF•DRIVE> button to select the AF mode on the setting screen displayed.

## Live Mode: AF Live

The image sensor is used to focus. Although AF is possible with the Live View image displayed, **the AF operation will take longer than with the Quick mode**. Also, achieving focus may be more difficult than with the Quick mode.



## 1 Display the Live View image.

- Press the <START/STOP> button.
- ▶ The Live View image will appear on the LCD monitor.
- ▶ The AF point <□> will appear.

## 2 Move the AF point.

- You can use <⬇️> to move the AF point to where you want to focus. (It cannot go to the edges of the picture.)
- Pressing <⬇️> straight down will return the AF point to the image center.

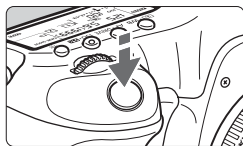

### 3 Focus the subject.

- Aim the AF point over the subject and press the shutter button halfway.
- ▶ When focus is achieved, the AF point will turn green and the beeper will sound.
- ▶ If focus is not achieved, the AF point will turn orange.



### 4 Take the picture.

- Check the focus and exposure, then press the shutter button completely to take the picture (p.200).

## ☺ (Face detection) Live Mode: AF ☺

With the same AF method as the Live mode, human faces are detected and focused. Have the target person face the camera.



### 1 Display the Live View image.

- Press the <  $\frac{\text{START}}{\text{STOP}}$  > button.
- ▶ The Live View image will appear on the LCD monitor.
- When a face is detected, the < [ ] > frame will appear over the face to be focused.
- If multiple faces are detected, < [ ] > will be displayed. Use <  $\frac{\text{START}}{\text{STOP}}$  > to move the < [ ] > frame over the target face.

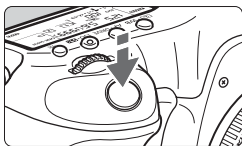

## 2 Focus the subject.

- Press the shutter button halfway and the camera will focus the face covered by the <□> frame.
- ▶ When focus is achieved, the AF point will turn green and the beeper will sound.
- ▶ If focus is not achieved, the AF point will turn orange.
- If a face cannot be detected, the AF point <□> will be displayed and AF will be executed at the center.



## 3 Take the picture.

- Check the focus and exposure, then press the shutter button completely to take the picture (p.200).





- If the focus is far off, face detection will not be possible. If the lens enables manual focusing even while the lens focus mode switch is set to <AF>, turn the focusing ring to attain rough focus. The face will then be detected and <□> will be displayed.
- An object other than a human face may be detected as a face.
- Face detection will not work if the face is very small or large in the picture, too bright or too dark, tilted horizontally or diagonally, or partially hidden.
- The <□> focusing frame may cover only part of the face.





- When you press <⊕> straight down or press <SET>, the AF mode will switch to the Live mode (p.209). You can tilt <⊕> to move the AF point. Press <⊕> straight down again or press <SET> to return to the 'L' (face detection) Live mode.
- Since AF is not possible with a face detected near the edge of the picture, the <□> will be grayed out. Then if you press the shutter button halfway, the center AF point <□> will be used to focus.

## Live Mode and (Face Detection) Live Mode Notes

### AF operation

- Focusing will take slightly longer.
- Even when focus has been achieved, pressing the shutter button halfway will focus again.
- The image brightness may change during and after the AF operation.
- If the light source changes while the Live View image is displayed, the screen may flicker and focusing may be difficult. If this happens, stop the Live View shooting and autofocus under the actual light source.
- If you press the  button in the Live mode, the image will be magnified at the AF point. If focusing is difficult in the magnified view, return to the normal view and autofocus. Note that the AF speed may differ between the normal and magnified views.
- If you autofocus in the Live mode's normal view and then magnify the image, the focus may no longer be correct.
- In the  Live mode, pressing the  button will not magnify the image.



- In the Live mode or  (face detection) Live mode, if you shoot a peripheral subject and it is slightly out of focus, aim the center AF point over the subject to focus, then take the picture.
- The external Speedlite will not emit the AF-assist beam. However, if an EX-series Speedlite (sold separately) equipped with a LED light is used, the LED light will turn on automatically for AF-assist when necessary in the Live mode and  (face detection) Live mode.

## Shooting conditions that can make focusing difficult

- Low-contrast subjects such as the blue sky and solid-color, flat surfaces.
- Subjects in low light.
- Stripes and other patterns where there is contrast only in the horizontal direction.
- Under a light source whose brightness, color, or pattern keeps changing.
- Night scenes or points of light.
- Under fluorescent or LED light sources or when the image flickers.
- Extremely small subjects.
- Subjects at the edge of the picture.
- Subjects strongly reflecting light.
- The AF point covers both a near and faraway subject (such as an animal in a cage).
- Subjects that keep moving within the AF point and cannot keep still due to camera shake or subject blur.
- A subject approaching or moving away from the camera.
- Autofocusing while the subject is way out of focus.
- Soft focus effect is applied with a soft focus lens.
- A special effects filter is used.

 If you use AF with any of the following lenses, using **[Quick mode]** is recommended. If you use the **[Live mode]** or **[Live mode]** for AF, it may take a longer time to achieve focus or the camera may not be able to achieve correct focus.

EF50mm f/1.4 USM, EF50mm f/1.8 II, EF50mm f/2.5 Compact Macro,  
EF75-300mm f/4-5.6 III, EF75-300mm f/4-5.6 III USM

For information on discontinued lenses, refer to your local Canon Web site.

**Quick Mode: AFQuick**

The dedicated AF sensor is used to focus in One-Shot AF mode (p.70), using the same AF method as with viewfinder shooting.

Although you can focus the target area quickly, **the Live View image will be interrupted momentarily during the AF operation.**

In AF area selection modes other than 61-point automatic selection AF, you can manually select the AF point or zone. In the  $\langle \text{AF}^+ \rangle$  mode, “61-point automatic selection AF” is set automatically.

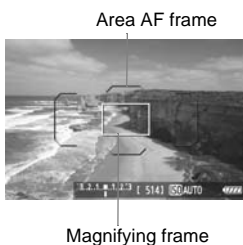
**1 Display the Live View image.**

- Press the  $\langle \text{START/STOP} \rangle$  button.
- ▶ The Live View image will appear on the LCD monitor.
- If the AF area selection mode is set to “61-point automatic selection AF”, the Area AF frame will be displayed.
- In other modes, the AF point will be displayed as a small frame.
- The larger rectangular frame is the magnifying frame.

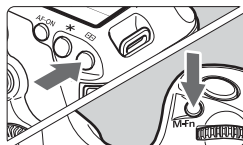
**2 Select the AF area selection mode.**

- Press the  $\langle \text{AF}^+ \rangle$  button.
- Each time you press the  $\langle \text{M-Fn} \rangle$  button, the AF area selection mode changes.

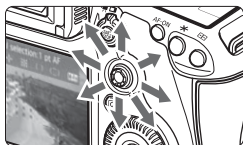

### 3 Select the AF point.

- The AF point selection will change in the direction you tilt the . If you press straight down, the center AF point (or center Zone) will be selected.
- You can also use the and dials to select the AF point. The dial selects an AF point in the horizontal direction, and the dial selects an AF point in the vertical direction.

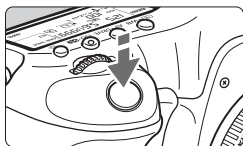
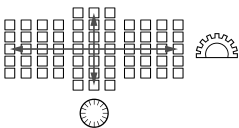

### 4 Focus the subject.

- Aim the AF point over the subject and press the shutter button halfway.
  - ▶ The Live View image will turn off, the reflex mirror will go back down, and AF will be executed. (No picture is taken.)
  - ▶ When focus is achieved, the beeper will sound and the Live View image will reappear.
  - ▶ The AF point used to focus will light up in green.
  - ▶ If focus is not achieved, the AF point will blink in orange.



### 5 Take the picture.

- Check the focus and exposure, then press the shutter button completely to take the picture (p.200).



You cannot take a picture during autofocusing. Take the picture while the Live View image is displayed.

# Focusing Manually

You can magnify the image and focus precisely with manual focus.

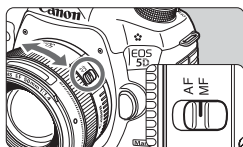

## 1 Set the lens focus mode switch to <MF>.

- Turn the lens focusing ring to focus roughly.



## 2 Move the magnifying frame.

- Use <⬤> to move the magnifying frame to the position where you want to focus.
- Pressing <⬤> straight down will return the magnifying frame to the image center.

Magnifying frame

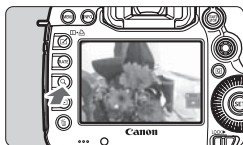

## 3 Magnify the image.

- Press the <Q> button.
- ▶ The area within the magnifying frame will be magnified.
- Each time you press the <Q> button, the view will change as follows:

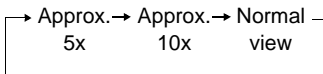

AE lock

Magnified area position

Magnification

## 4 Focus manually.

- While looking at the magnified image, turn the lens focusing ring to focus.
- After achieving focus, press the <Q> button to return to the normal view.

## 5 Take the picture.

- Check the focus and exposure, then press the shutter button completely to take the picture (p.200).









## Live View Shooting Cautions

### Image Quality

- When you shoot at high ISO speeds, noise (dots of light, banding, etc.) may become noticeable.
- Shooting in high temperatures may cause noise and irregular colors in the image.
- If Live View shooting is used continuously for a long period, the camera's internal temperature may rise, degrading image quality. Stop Live View shooting when not shooting images.
- If you shoot a long exposure while the camera's internal temperature is high, image quality may be degraded. Stop Live View shooting and wait a few minutes before shooting again.

### White and Red Internal Temperature Warning

- If the camera's internal temperature increases due to prolonged Live View shooting or a high ambient temperature, a white icon  will appear. If you continue shooting while this icon is displayed, the image quality may degrade. You should stop the Live View shooting and allow the camera to cool down before shooting again.
- If the camera's internal temperature further increases while the white icon  is displayed, a red icon  will start blinking. This blinking icon is a warning that the Live View shooting will soon end automatically. If this happens, you will not be able to shoot again until the camera's internal temperature decreases. Turn off the power and let the camera rest for a while.
- Using Live View shooting at a high temperature for a prolonged period will cause the  and  icons to appear earlier. When you are not shooting, turn off the camera.
- If the camera's internal temperature is high, the image quality of high ISO speed images or long exposures may be degraded even before the white icon  is displayed.

### Shooting Result

- If you take the picture in magnified view, the exposure may not come out as desired. Return to the normal view before taking the picture. In magnified view, the shutter speed and aperture will be displayed in orange. Even if you take the picture in magnified view, the image will be captured in the normal view.
- If [**2: Auto Lighting Optimizer**] (p.144) is not set to [**Disable**], the image may look bright even if a decreased exposure compensation or decreased flash exposure compensation has been set.

## Live View Shooting Cautions

### Live View Image

- Under low- or bright-light conditions, the Live View image may not reflect the brightness of the captured image.
- If the light source within the image changes, the screen may flicker. If this happens, stop the Live View shooting and resume shooting under the actual light source to be used.
- If you point the camera in a different direction, it may throw off the Live View image's correct brightness momentarily. Wait until the brightness level stabilizes before shooting.
- If there is a very bright light source in the picture, the bright area may appear black on the LCD monitor. However, the actual captured image will correctly show the bright area.
- In low light, if you set the [**42: LCD brightness**] to a bright setting, noise or irregular colors may appear in the Live View image. However, the noise or irregular colors will not be recorded in the captured image.
- When you magnify the image, the image sharpness may look more pronounced than it really is.

### Custom Functions

- During Live View shooting, certain Custom Function settings will not take effect (p.320).

### Lens and Flash

- The focus preset function is possible during Live View shooting only when using a (super) telephoto lens equipped with the focus preset mode marketed since the second half of 2011.
- FE lock and modeling flash will not work if an external Speedlite is used.

# 8

## Shooting Movies



Movie shooting is enabled by setting the Live View shooting/Movie shooting switch to <img alt="Movie icon" data-bbox="765 475 785 495"/>. The movie recording format will be MOV.

### Cards that can record movies

- When shooting movies, use a large-capacity card with a fast writing/reading speed as shown in the table.

Compression Method (p.233)	CF Card	SD Card
IPB	10 MB/sec. or faster	6 MB/sec. or faster
ALL-I (I-only)	30 MB/sec. or faster	20 MB/sec. or faster

- If you use a slow-writing card when shooting movies, the movie may not be recorded properly. Also, if you play back a movie on a card with a slow reading speed, the movie may not play back properly.
- If you want to shoot still photos while shooting a movie, you will need an even faster card.
- To check the card's reading/writing speed, refer to the card manufacturer's Web site.

# Shooting Movies

## Autoexposure Shooting

When the shooting mode is set to  $\langle \text{A}^+ \rangle$ ,  $\langle \text{P} \rangle$ , or  $\langle \text{B} \rangle$ , autoexposure control will take effect to suit the scene's current brightness. Exposure control will be the same for the three shooting modes.

**1 Set the Mode Dial to  $\langle \text{A}^+ \rangle$ ,  $\langle \text{P} \rangle$ , or  $\langle \text{B} \rangle$ .**

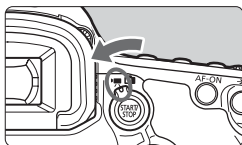

**2 Set the Live View shooting/Movie shooting switch to  $\langle \text{Movie} \rangle$ .**

- ▶ The reflex mirror will make a sound, then the image will appear on the LCD monitor.

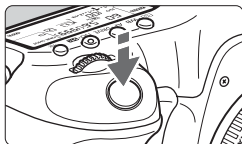

**3 Focus the subject.**

- Before shooting, focus with AF or manual focus (p.209-216).
- When you press the shutter button halfway, the camera will focus with the current AF mode.

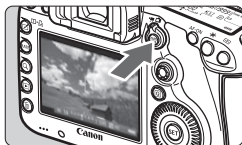

**4 Shoot the movie.**

- Press the  $\langle \text{START/STOP} \rangle$  button to start shooting a movie.
- ▶ While the movie is being shot, the "●" mark will be displayed on the upper right of the screen.
- To stop shooting the movie, press the  $\langle \text{START/STOP} \rangle$  button again.

Recording movie

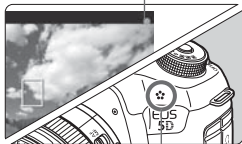

Microphone

 Regarding the cautions for movie shooting, see page 228.

## Shutter-priority AE

When the shooting mode is <Tv>, you can manually set the shutter speed for movie shooting. The ISO speed and aperture will be set automatically to suit the brightness and obtain a standard exposure.



### 1 Set the Mode Dial to <Tv>.

### 2 Set the Live View shooting/Movie shooting switch to <Movie>.



Shutter speed

### 3 Set the desired shutter speed.

- While looking at the LCD monitor, turn the <Sun> dial. The settable shutter speeds depend on the frame rate <Frame Rate>.
  - |      |      |      |                           |
|------|------|------|---------------------------|
| 1/30 | 1/25 | 1/24 | : 1/4000 sec. - 1/30 sec. |
| 1/60 | 1/50 |      | : 1/4000 sec. - 1/60 sec. |



### 4 Focus and shoot the movie.

- The procedure is the same as steps 3 and 4 for “Autoexposure Shooting” (p.220).



- Changing the shutter speed during movie shooting is not recommended since the changes in the exposure will be recorded.
- When shooting a movie of a moving subject, a shutter speed of 1/30 sec. to 1/125 sec. is recommended. The faster the shutter speed, the less smooth the subject's movement will look.
- If you change the shutter speed while shooting under fluorescent or LED lighting, image flicker may be recorded.

## Aperture-priority AE

When the shooting mode is <Av>, you can manually set the aperture for movie shooting. The ISO speed and shutter speed will be set automatically to suit the brightness and obtain a standard exposure.



**1 Set the Mode Dial to <Av>.**

**2 Set the Live View shooting/Movie shooting switch to <Movie>.**



Aperture

**3 Set the desired aperture.**

- While looking at the LCD monitor, turn the <Aperture> dial.



**4 Focus and shoot the movie.**

- The procedure is the same as steps 3 and 4 for “Autoexposure Shooting” (p.220).

**!** Changing the aperture during movie shooting is not recommended since variations in the exposure, due to the drive of the lens aperture, will be recorded.

### ISO speed in the **A<sup>+</sup>** mode

- In the **A<sup>+</sup>** mode, the ISO speed will be set automatically within ISO 100 - 12800.

### ISO speed in the **P**, **Tv**, **Av**, and **B** modes

- The ISO speed will be set automatically within ISO 100 - 12800.
- Under [**2: ISO speed settings**] (p.128), if you set the [**ISO speed range**]'s [**Maximum**] setting to [**25600/H**] in the **P**, **Av**, or **B** mode, the automatic ISO range will be expanded to H (equivalent to ISO 25600). Be aware that when you set [**Maximum**] to [**25600**], the maximum ISO speed will not be expanded and remains ISO 12800.
- If [**3: Highlight tone priority**] is set to [**Enable**] (p.148), the ISO speed will be ISO 200 - 12800.
- Under [**2: ISO speed settings**], [**Auto ISO range**] and [**Min. shutter spd.**] cannot be set (p.129, 130) for movie shooting. Also, [**ISO speed range**] cannot be set in the **Tv** mode.

ⓘ If [**Minimum**] is set to [**L(50)**] and [**Maximum**] to [**H1(51200)**] or [**H2(102400)**] in [**ISO speed range**], and you switch from still photo shooting to movie shooting, the minimum setting for automatic ISO range will be ISO 100 and the maximum will be H (ISO 25600, except in **A<sup>+</sup>** and **Tv** shooting modes). The ISO speed cannot be expanded to ISO 50 or ISO 51200/102400.

## Notes for Autoexposure, Shutter-priority AE, and Aperture-priority AE

- You can lock the exposure (AE lock) by pressing the <★> button (except in the **A<sup>+</sup>** mode, p.173). After applying AE lock during movie shooting, you can cancel it by pressing the <☐> button. (AE lock setting is retained until you press <☐>)
- You can set exposure compensation by setting the <LOCK▶> switch to the left and turning the <○> dial (except in the <A<sup>+</sup>> mode).
- Pressing the shutter button halfway displays the ISO speed and shutter speed at the screen bottom. This is the exposure setting for taking a still photo (p.227). The exposure setting for movie shooting is not displayed. Note that the exposure setting for movie shooting may differ from that for still photo shooting.

### Using an EX-series Speedlite (Sold Separately) Equipped with an LED Light

During movie shooting in the **A<sup>+</sup>**, **P**, **Tv**, **Av** or **B** mode, this camera supports the function that turns the Speedlite's LED light automatically in low-light conditions. **For details, refer to the Speedlite's instruction manual.**



## Manual Exposure Shooting

You can manually set the shutter speed, aperture, and ISO speed for movie shooting. Using manual exposure to shoot movies is for advanced users.



**1 Set the Mode Dial to <M>.**

**2 Set the Live View shooting/Movie shooting switch to <Movie>.**



**3 Set the ISO speed.**

- Press the <ISO> button.
- ▶ The ISO speed setting screen will appear on the LCD monitor.
- Turn the <ISO> dial to set the ISO speed.
- For details on the ISO speed, see the next page.



Shutter speed

**4 Set the shutter speed and aperture.**

- Press the shutter button halfway and check the exposure level indicator.
- To set the shutter speed, turn the <Shutter> dial. The settable shutter speeds depend on the frame rate <FR>.
- $\frac{1}{30}$   $\frac{1}{25}$   $\frac{1}{24}$  : 1/4000 sec. - 1/30 sec.
- $\frac{1}{60}$   $\frac{1}{50}$  : 1/4000 sec. - 1/60 sec.
- To set the aperture, turn the <Aperture> dial.
- If it cannot be set, set the <LOCK> switch to the left, then turn the <Shutter> or <Aperture> dial.





Aperture

**5 Focus and shoot the movie.**

- The procedure is the same as steps 3 and 4 for “Autoexposure Shooting” (p.220).

## ISO speed during manual-exposure shooting

- With **[Auto] (A)**, the ISO speed will be set automatically within ISO 100 - 12800.
- You can set the ISO speed manually within ISO 100 - 12800 in 1/3-stop increments. Under **[ 2: ISO speed settings]**, if you set **[ISO speed range]**'s **[Maximum]** setting to **[25600/H]**, the maximum ISO speed for manual ISO speed setting will be expanded to H (equivalent to 25600). Be aware that when you set **[Maximum]** to **[25600]**, the maximum ISO speed will not be expanded and remains ISO 12800.
- If **[ 3: Highlight tone priority]** is set to **[Enable]** (p.148), you can set the ISO speed within ISO 200 - 12800 (depending on the **[ISO speed range]** setting).
- Under **[ 2: ISO speed settings]**, **[Auto ISO range]** and **[Min. shutter spd.]** cannot be set (p.129, 130) for movie shooting.

- Since shooting a movie at ISO 16000/20000/25600 may result in much noise, it is designated as an expanded ISO speed (displayed as **[H]**).
- If **[Minimum]** is set to **[L(50)]** and **[Maximum]** to **[H1(51200)]** or **[H2(102400)]** in **[ISO speed range]**, and you switch from still photo shooting to movie shooting, the minimum setting for manual ISO range will be ISO 100 and the maximum will be H (ISO 25600). The ISO speed cannot be expanded to ISO 50 or ISO 51200/102400.
- Changing the shutter speed or aperture during movie shooting is not recommended since the changes in the exposure will be recorded.
- When shooting a movie of a moving subject, a shutter speed of 1/30 sec. to 1/125 sec. is recommended. The faster the shutter speed, the less smooth the subject's movement will look.
- If you change the shutter speed while shooting under fluorescent or LED lighting, image flicker may be recorded.

- If ISO Auto is set, you can press the **< \* >** button to lock the ISO speed.
- When you press the **< \* >** button and then recompose the picture, you can see the exposure level difference on the exposure level indicator (p.22, 227) compared to when you first press the **< \* >** button.
- By pressing the **< INFO >** button, you can display the histogram.

## Information Display

- Each time you press the <INFO.> button, the information display will change.

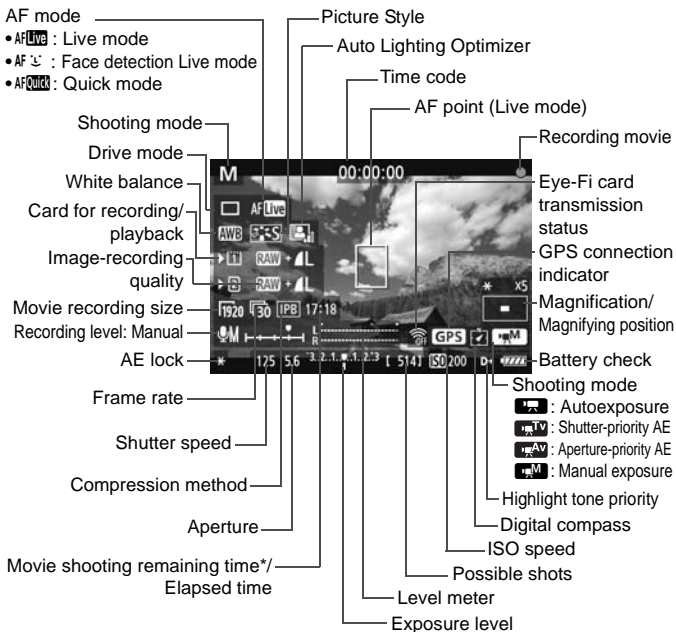

\* Applies to a single movie clip.



- You can display the electronic level by pressing the <INFO.> button (p.60).
- Note that if the AF mode is set to [<sup>Face</sup> Live mode] or the camera is connected to a TV set with an HDMI cable (p.274), the electronic level cannot be displayed.
- If there is no card in the camera, the movie shooting remaining time will be displayed in red.
- When movie shooting starts, the movie shooting remaining time will change to the elapsed time.

## Notes on Movie Shooting

- 🔊 ● The camera cannot autofocus continuously like a camcorder.
- Autofocusing during movie shooting may momentarily throw the focus far off or change the exposure.
- During movie shooting, do not point the lens toward the sun. The sun's heat can damage the camera's internal components.
- Under [**1: Record func+card/folder sel.**], even if [**Record func.**] is set to [**Rec. to multiple**] (p.118), the movie cannot be recorded to both the CF card <[1]> and SD card <[2]>. If [**Rec. separately**] or [**Rec. to multiple**] is set, the movie will be recorded to the card which has been set for [**Playback**].
- If <[AWB]> is set and the ISO speed or aperture changes during movie shooting, the white balance may also change.
- If you shoot a movie under fluorescent or LED lighting, the movie may flicker.
- Shooting a few test movies is recommended where you will perform zooming during movie shooting. Zooming during movie shooting may result in recording of changes in exposure or mechanical sound of the lens, or images may be out of focus.
- **Cautions for movie shooting are on pages 247 and 248.**
- **If necessary, also read the Live View shooting cautions on pages 217 and 218.**

- 📄 ● Movie-related settings are under the [**4**] and [**5**] tabs (p.243). In the <[A+]> mode, they are under the [**2**] and [**3**] tabs.
- A movie file is recorded each time you shoot a movie. If the file size exceeds 4 GB, a new file will be created.
- The movie image's field of view is approx. 100% (with movie recording size set to [F20]).
- You can also focus the image by pressing the <AF-ON> button.
- To focus during movie shooting, press the <AF-ON> button. You cannot focus by pressing the shutter button.
- Under [**5: Movie shoot. btn**], if [**👁️/AF-ON**] is selected, you can press the shutter button completely to start or stop the movie shooting (p.244).
- Monaural sound is recorded by the camera's built-in microphone (p.220).
- Stereo sound recording is also possible by connecting the Directional Stereo Microphone DM-E1 (sold separately) to the camera's external microphone IN terminal (p.19) as the external microphone is given the priority.

## Notes on Movie Shooting



- By connecting stereo headphones (commercially available) equipped with a 3.5 mm mini plug to the camera's headphone terminal (p.19), you can listen to the sound during movie shooting.
- You can use Remote Controller RC-6 (sold separately, p.188) to start and stop the movie shooting if the drive mode is  $\langle \text{M} \text{ } \text{M} \rangle$  or  $\langle \text{M} \text{ } \text{M}_2 \rangle$ . Set the shooting timing switch to  $\langle 2 \rangle$  (2-sec. delay), then press the transmit button. If the switch is set to  $\langle \bullet \rangle$  (immediate shooting), still photo shooting will take effect.
- With a fully-charged Battery Pack LP-E6, the total movie shooting time will be as follows: approx. 1 hr. 30 min. at room temperature (23°C/73°F), and approx. 1 hr. 20 min. at low temperatures (0°C/32°F).
- The focus preset function is possible for movie shooting when using a (super) telephoto lens equipped with the focus preset mode marketed since the second half of 2011.

## Final Image Simulation

The final image simulation is a function that allows you to see the effects of the Picture Style, white balance, etc., on the image. During movie shooting, the image displayed will automatically reflect the effects of the settings listed below.

### Final image simulation for movies

- Picture Style
  - \* All settings such as sharpness, contrast, color saturation, and color tone will be reflected.
- White balance
- White balance correction
- Exposure
- Depth of field
- Auto Lighting Optimizer
- Peripheral illumination correction
- Chromatic aberration correction
- Highlight tone priority

## Shooting Still Photos

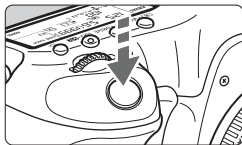

While shooting a movie, you can also take a still photo by pressing the shutter button completely.

### Taking still photos during movie shooting

- If you take a still photo during movie shooting, the movie will record a still moment lasting approx. 1 sec.
- The captured still photo will be recorded to the card, and the movie shooting will resume automatically when the Live View image is displayed.
- The movie and still photo will be recorded as separate files on the card.
- If [**Record func.**] (p.118) is set to [**Standard**] or [**Auto switch card**], the movies and still photos will be recorded to the same card. If [**Rec. separately**] or [**Rec. to multiple**] is set, the movies will be recorded to the card set for [**Playback**]. The still photos will be recorded at the image-recording quality set for the respective card.
- Functions particular to still photo shooting are shown below. Other functions will be the same as for movie shooting.

Function	Settings
Image-Recording Quality	As set in [ <b>1: Image quality</b> ]. When the movie recording size is [ <b>1920x1080</b> ] or [ <b>1280x720</b> ], the aspect ratio will be 16:9. When the size is [ <b>640x480</b> ], the aspect ratio will be 4:3.
ISO Speed*	<ul style="list-style-type: none"> <li>• &lt; <b>A<sup>+</sup>/P/Tv/Av/B</b> &gt;: 100 - 12800</li> <li>• &lt; <b>M</b> &gt;: See "ISO speed during manual-exposure shooting" on page 226.</li> </ul>
Exposure Setting	<ul style="list-style-type: none"> <li>• &lt; <b>A<sup>+</sup>/P/B</b> &gt;: Automatically-set shutter speed and aperture.</li> <li>• &lt; <b>Tv</b> &gt; : Manually set shutter speed and automatically set aperture.</li> <li>• &lt; <b>Av</b> &gt; : Manually set aperture and automatically set shutter speed.</li> <li>• &lt; <b>M</b> &gt; : Manually set shutter speed and aperture.</li> </ul>

\* If highlight tone priority is set, the ISO speed range will start from ISO 200.









- AEB cannot be used.
- Even if an external Speedlite is used, it will not fire.
- Continuous still photo shooting is possible during movie shooting. However, the captured images will not be displayed on the screen. Depending on the still photo's image-recording quality, number of shots during continuous shooting, card performance, etc., movie shooting may stop automatically.
- If [**5: Movie shoot. btn**] is set to [/], you cannot take still photos.







- If you want to shoot still photos continuously during movie shooting, using a high-speed card is recommended. Setting a smaller image-recording quality for still photos and shooting fewer continuous still photos are also recommended.
- You can shoot still photos in all drive modes.
- The self-timer can be used before you start shooting a movie. If used during movie shooting, the self-timer will switch to single-image shooting.

# Shooting Function Settings

## AF / DRIVE / WB / ISO / / Settings

If you press the <AF•DRIVE>, <•WB>, <ISO•>, <>, or <> button while the image is displayed on the LCD monitor, the setting screen will appear on the LCD monitor and you can turn the <> or <> dial to set the respective function.

When **AFQuick** is set, you can press the <> button to select the AF area selection mode and AF point. The procedure is the same as with viewfinder shooting. During manual-exposure shooting (p.225), you can press the <ISO•> button to set the ISO speed.

Note that the following cannot be set: <> Metering mode, <> Flash exposure compensation, <**HDR**> HDR mode, and <> Multiple exposures.







## Quick Control

While the image is displayed on the LCD monitor, you can press the <> button and set the following: Auto Lighting Optimizer, card selection, recording function, image-recording quality (still photos), movie-recording size, and sound-recording level (with [**Sound recording: Manual**] set).

### 1 Press the <> button.

- ▶ The settable functions will be displayed.

### 2 Select a function and set it.

- Use <> to select a function.
- ▶ The setting of the selected function is displayed at the bottom.
- Turn the <> or <> dial to set it.
- To set the card selection or recording function, press <>, then turn the <> or <> dial to set it.

 During movie shooting, you can set the following: Shutter speed, aperture, ISO speed, exposure compensation, and sound-recording level. (Settable functions may differ depending on the shooting mode and [**Sound recording**] setting.)



## MENU Setting the Movie-Recording Size



With [**4**: **Movie rec. size**], you can set the movie's image size, frame rate per second, and compression method. The frame rate switches automatically depending on the [**3**: **Video system**] setting.

In the <**A**> mode, these menu options are displayed under [**2**].

### ● Image size

- 1920 [1920x1080]** : Full High-Definition (Full HD) recording quality. The aspect ratio will be 16:9.
- 1280 [1280x720]** : High-Definition (HD) recording quality. The aspect ratio will be 16:9.
- 640 [640x480]** : Standard-definition recording quality. The aspect ratio will be 4:3.

### ● Frame rate (fps: frames per second)

- 30 / 60** : For areas where the TV format is NTSC (North America, Japan, Korea, Mexico, etc.).
- 25 / 50** : For areas where the TV format is PAL (Europe, Russia, China, Australia, etc.).
- 24** : Mainly for motion pictures.

### ● Compression method

- IPB** IPB : Compresses multiple frames at a time efficiently for recording. Since the file size will be smaller than with ALL-I, you can shoot longer.
- ALL-I** ALL-I (I-only) : Compresses one frame at a time for recording. Although the file size will be bigger than with IPB, the movie will be more suited for editing.

## Total Movie Recording Time and File Size Per Minute

Movie-Recording Size			Total Recording Time (approx.)			File Size (approx.)
			4 GB Card	8 GB Card	16 GB Card	
F1920	30 25 24	IPB	16 min.	32 min.	1 hr. 4 min.	235 MB/min.
	30 25 24	ALL-I	5 min.	11 min.	22 min.	685 MB/min.
F1280	60 50	IPB	18 min.	37 min.	1 hr. 14 min.	205 MB/min.
	60 50	ALL-I	6 min.	12 min.	25 min.	610 MB/min.
F640	30 25	IPB	48 min.	1 hr. 37 min.	3 hr. 14 min.	78 MB/min.

### ● About Movies Exceeding 4 GB

Even if you shoot a movie exceeding 4 GB, you can keep shooting without interruption.

Approx. 30 sec. before the movie reaches the 4 GB file size, the elapsed shooting time or time code displayed in the movie-shooting image will start blinking. If you keep shooting the movie and the file size exceeds 4 GB, a new movie file will be created automatically and the elapsed shooting time or time code will stop blinking.

When you play back the movie, you will have to play the individual movie files. Movie files cannot play back consecutively automatically. After the movie playback ends, select the next movie to play.

### ● Movie Shooting Time Limit

The maximum recording time of one movie clip is 29 min. 59 sec. If the movie shooting time reaches 29 min. 59 sec., the movie shooting will stop automatically. You can start shooting a movie again by pressing the  $\langle \overset{\text{START}}{\text{STOP}} \rangle$  button. (A new movie file starts being recorded.)



- An increase of the camera's internal temperature may cause movie shooting to stop before the maximum recording time shown in the preceding page (p.247).
- Even if **[Record func.]** is set to **[Auto switch card]**, the card cannot be switched automatically during movie shooting.



### About Full HD 1080

Full HD 1080 indicates compatibility with High-Definition featuring 1080 vertical pixels (scanning lines).



## MENU Setting the Sound Recording

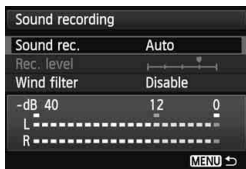

You can shoot movies while recording sound with the built-in monaural microphone or the Directional Stereo Microphone DM-E1 (sold separately). You can also freely adjust the sound-recording level.

Set the sound recording with [**4**: **Sound recording**]. In the <[**A**+> mode, this setting is displayed in [**2**].

### Sound Recording/Sound-Recording Level

- [Auto]** : The sound-recording level is adjusted automatically. Auto level control will operate automatically in response to the sound level.
- [Manual]** : For advanced users. You can adjust the sound recording level to one of 64 levels. Select [**Rec. level**] and look at the level meter while turning the <[**0**]> dial to adjust the sound-recording level. While looking at the peak hold indicator (3 sec.), adjust so that the level meter sometimes lights up the "12" (-12 dB) mark on the right for the loudest sounds. If it exceeds "0", the sound will be distorted.
- [Disable]** : Sound will not be recorded.

### Wind Filter

When set to [**Enable**], it reduces wind noise when there is wind outdoors. This works only with the built-in microphone.

Note that [**Enable**] will also reduce low bass sounds, so set it to [**Disable**] when there is no wind. It will make sound more natural than with [**Enable**].

### ● Using the microphone

The built-in microphone records monaural sound. Stereo sound recording is also possible by connecting the Directional Stereo Microphone DM-E1 (sold separately) to the camera's external microphone IN terminal (p.19) as the external microphone is given the priority. When an external microphone is connected, sound recording will switch automatically to the external microphone.

### ● Using headphones

By connecting stereo headphones (commercially available) equipped with a 3.5 mm mini plug to the camera's headphone terminal (p.19), you can listen to the sound during movie shooting. If you are using an external stereo microphone, you can listen to the sound in stereo.

You can also use headphones during movie playback.



The audio output to the headphones will not have noise reduction applied. It will therefore be different from the sound recorded with the movie.



- In the <[A]<sup>+</sup>> shooting mode, [Sound recording] settings will be [On/Off]. If [On] is set, the sound-recording level will be adjusted automatically (same as with [Auto]), but the wind filter function will not take effect.
- To adjust the headphones' volume, press the <[Q]> button, then tilt the multi-controller up or down while pressing the <RATE> button. Note that the headphone's volume will not be displayed on the screen. Adjust it while listening to the sound.
- The sound volume balance between L (left) and R (right) cannot be adjusted.
- The 48 kHz sampling frequency will be 16-bit recordings for both L and R.
- If [☑5: Silent Control] is set to [Enable Ⓢ] (p.238), you can adjust the sound-recording level with the <[Ⓢ]> touch pad to reduce the operation noise during movie shooting.

## MENU Silent Control

This function is convenient when you want to change the ISO speed, sound-recording level, etc., silently while shooting a movie.



When [**5: Silent Control**] is set to [**Enable** ], you can use the touch pad < > on the inner ring of the Quick Control Dial.

In the < > mode, this function is displayed in [**3**].

You can just touch the top, bottom, left, or right of < > for silent operation. During movie shooting, you can press the < > to display the Quick Control screen and change the settings below with < >.

Settable Functions	Shooting Mode			
	P/B	Tv	Av	M
1. Shutter speed	–	○	–	○
2. Aperture	–	–	○	○
3. ISO speed	–	–	–	○
4. Exposure compensation	○	○	○	–
5. Sound-recording level	○	○	○	○



- If [**5: Silent Control**] is set to [**Enable** ], you cannot adjust the sound-recording level with the < > Quick Control dial during movie shooting.
- Even if you change the aperture silently with < >, the movie will still record the lens aperture-driving sound.
- If there is water or dirt on the < >, the touch operation may not work. In such a case, use a clean cloth to clean the < >. If it still does not work, wait a while and try again.

Before shooting a movie, use the < > to adjust the sound-recording level in the Quick Control and [**Rec. level**] screens.

## MENU Setting the Time Code

Time code	
Count up	Rec run
Start time setting	
Movie rec count	Rec time
Movie play count	Rec time
HDMI	
Drop frame	Enable
MENU 	

The time code is a time reference recorded automatically to synchronize the video and audio during movie shooting. It is recorded at all times in the following units: hours, minutes, seconds, and frames. It is mainly used during movie editing.

Set the time code with [5: Time code]. In the <[A+]> mode, this function is displayed in [3].

### Count Up

- [Rec run] : The time code counts up only while you are shooting a movie. The time code will be continuous across sequential movie files.
- [Free run] : The time code counts up whether you are shooting or not.

### Start Time Setting

You can set the time code's start time.

- [Manual input setting]: You can freely set the hour, minute, second, and frames.
- [Reset] : The time set with [Manual input setting] and [Set to camera time] is reset to 00:00:00:00.
- [Set to camera time] : Sets hours, minutes, and seconds to match the camera's internal clock. "Frames" will be set to 00.

 If [Free run] is set and you change the time, zone, or daylight saving time (p.36), the time code will be affected.

## Movie Recording Count

You can select what to display on the movie-shooting screen.

**[Rec time]** : Indicates the elapsed time from the start of the movie shooting.

**[Time code]** : Indicates the time code during movie shooting.

 Shooting still photos during movie shooting will cause a discrepancy between the actual time and time code.

 Regardless of the **[Movie rec count]** setting, the time code will always be recorded to the movie file.

## Movie Playback Count

You can select what to display on the movie playback screen.

**[Rec time]** : Displays the recording time and playback time during movie playback.

**[Time code]** : Displays the time code during movie playback.

With **[Time code]** set:



During movie shooting



During movie playback

- 
- If you change the setting for either **[Movie play count]** in **[CAMERA 5 (movie): Time code]** or for **[CAMERA 3: Movie play count]**, the other setting will also change automatically.
  - "Frames" are not displayed during movie shooting and movie playback.



## HDMI

- **Time code**

You can append the time code to a movie that was output from HDMI (p.246).

[On]: Time code is appended to the HDMI output image.

[Off]: Time code is not appended to the HDMI output image.

- **Recording command**

When you record a movie that is output from HDMI to an external recording device, you can synchronize the camera's movie shooting start/stop with the external recording device's recording operation.

[On]: Synchronize external recording device's recording start/stop with camera's movie shooting start/stop.

[Off]: Control external device's recording start/stop from external recording device.



If the movie-recording quality's frame rate (p.233) and HDMI output frame rate are set manually to NTSC and PAL frame rates in a combination that does not function properly, the time code will not be appended to the HDMI output image.

## Drop Frame

If the frame rate setting is  $\overline{30}$  (29.97fps) or  $\overline{60}$  (59.94fps), the time code's frame count causes a discrepancy between the actual time and time code. This discrepancy can be corrected automatically. This correction function is called drop frame.

**[Enable]** : The discrepancy is corrected automatically by skipping time code numbers (DF: Drop frame).

**[Disable]** : The discrepancy is not corrected (NDF: Non-drop frame).

 When the frame rate is set to  $\overline{24}$  (23.976fps),  $\overline{25}$  (25.00fps), or  $\overline{50}$  (50.00fps), the drop frame function does not take effect. (If  $\overline{24}$  is set or [**3**: Video system] is set to [PAL], [Drop frame] option will not be displayed.)

## MENU Menu Function Settings

### [CAMERA 4] Menu



When the Live View shooting/Movie shooting switch is set to <CAMERA 4>, the [CAMERA 4] and [CAMERA 5] tabs dedicated to movie shooting will be displayed. The menu options are as follows. In the <CAMERA 4+> mode, [CAMERA 2] and [CAMERA 3] will be displayed.

- **AF mode**

The AF modes will be the same as described on pages 209-215. You can select [**Live mode**], [**Live mode**], or [**Quick mode**]. Note that continuous focusing of a moving subject is not possible. Even if the AF mode is set to [**Quick mode**], it will switch to [**Live mode**] during movie shooting.

- **Grid display**

With [**3x3** 3x3] or [**6x4** 6x4], you can display grid lines. It can help you level the camera vertically or horizontally. Also, with [**3x3+diag** 3x3+diag], the grid is displayed together with diagonal lines to help you align the intersections over the subject for better balance in the composition.

- **Movie recording size**

You can set the movie recording size (image size, frame rate, and compression method). For details, see pages 233 to 235.

- **Sound recording**

You can set sound recording settings. For details, see pages 236 and 237.

- **Silent LV shooting** ☆

This function applies to still photo shooting. For details, see page 208.

- **Metering timer** ☆

You can change how long the exposure setting is displayed (AE lock time).

## [CAMERA 5] Menu

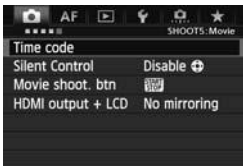

- **Time code**

You can set the time code. For details, see pages 239-242.

- **Silent Control**

When [**Enable** Ⓢ] is set, you can use the touch pad <Ⓢ> and Quick Control screen to change settings silently during movie shooting. For details, see page 238.

- **Movie shooting button**

When [**START/STOP** Ⓢ] is set, besides pressing the <START/STOP> button, you can also press the shutter button completely or use Remote Switch RS-80N3 (sold separately) or Timer Remote Controller TC-80N3 (sold separately) to start/stop the movie shooting (p.187). However, when [**START/STOP** Ⓢ] is set, still photo shooting is not possible (p.230).

## ● HDMI output + LCD

This is for recording the HDMI output image to an external recording device. [**No mirroring**] is set by default.

If you set [**Mirroring**], the movie displayed on the LCD monitor as it is being recorded can also be displayed from the HDMI output. Note that the video from the HDMI output will be displayed without the shooting information or masking for indicating image area (output without information overlay: through display).

If [**No mirroring**] is set, the movie will be displayed on the LCD monitor, but if there is HDMI output, the LCD monitor will turn off. With this setting, the movie from the HDMI output will show the shooting information and masking for indicating image area. However, by pressing the <**INFO.**> button, you can eliminate the information from the output.



- If the HDMI movie is output without information, the card's remaining capacity, battery level, internal temperature increase (p.247) and other indicators will not appear on the HDMI output screen. Be aware of this if [**No mirroring**] is set. If [**Mirroring**] is set, you can check these indicators on the LCD monitor.
- When you are not shooting movies, the power will turn off automatically in accordance with the auto power off time. If you are recording the HDMI output image to an external recording device, setting [**2: Auto power off**] to [**Disable**] (p.55) is recommended.
- Audio is not output during HDMI output.
- Even if [**Mirroring**] is set, no image will be displayed through the HDMI output when a movie is played back or menu is displayed.
- When you stop movie shooting, the HDMI output image will pause (frame stop) while the movie is being recorded to the card. After the recording is completed, the image will be displayed normally.
- Simultaneous output from both HDMI and A/V OUT is not possible. The movie will be output to the cable that was connected to the terminal last. During A/V OUT output, nothing will be displayed on the LCD monitor.
- The brightness of a movie shot by the camera and that of a recorded HDMI output image on the external recording device may differ depending on the viewing environment.

- By pressing the <INFO.> button, you can change the information displayed on the screen.
- You can append a time code to the HDMI output image (p.241).

## [F2] Menu







### ● HDMI frame rate

You can set the HDMI output frame rate to **[Auto]**, **[24p]**, or **[60i/50i]**. When you record movie from the HDMI output to a commercially-available external recording device, set the frame rate to match the external recording device's frame rate.

- If the frame rate set manually is not compatible with the external recording device, the frame rate will be set automatically.
- If **[Movie recording size]** is set to frame rate  when **[HDMI frame rate: 60i]** is set, "2-3 pulldown" will be performed.

## Movie Shooting Cautions

### White and Red Internal Temperature Warning Icons

- If the camera's internal temperature increases due to prolonged movie shooting or a high ambient temperature, a white icon  will appear. Even if you shoot a movie while this icon is displayed, the movie's image quality will hardly be affected. However, if you shoot still photos, the image quality of the still photos may degrade. You should stop shooting still photos for a while and allow the camera to cool down.
- If the camera's internal temperature further increases while the white icon  is displayed, a red icon  may start blinking. This blinking icon is a warning that movie shooting will soon end automatically. If this happens, you will not be able to shoot again until the camera's internal temperature decreases. Turn off the power and let the camera rest for a while.
- Shooting a movie at a high temperature for a prolonged period will cause the  and  icons to appear earlier. When you are not shooting, turn off the camera.

### Recording and Image Quality

- If the attached lens has an Image Stabilizer, the Image Stabilizer will operate at all times even if you do not press the shutter button halfway. The Image Stabilizer consumes battery power and may shorten the total movie shooting time or decrease the number of possible shots. If you use a tripod or if the Image Stabilizer is not necessary, you should set the IS switch to **<OFF>**.
- The camera's built-in microphone will also pick up the operation sound and mechanical sound of the camera during shooting. Use the Directional Stereo Microphone DM-E1 (sold separately) to reduce these sounds in the movie.
- Do not connect anything other than an external microphone to the camera's external microphone IN terminal.
- If there is a very bright light source in the picture, the bright area may appear black on the LCD monitor. In movies, the bright areas will be recorded in almost the same way you see it on the LCD monitor.
- In low light, noise or irregular colors may appear in the image. In movies, the bright areas will be recorded in almost the same way you see it on the LCD monitor.

## Movie Shooting Cautions

### Recording and Image Quality

- If you use a card having a slow writing speed, a five-level indicator may appear on the right of the screen during movie shooting. It indicates how much data has not yet been written to the card (remaining capacity of the internal buffer memory). The slower the card, the faster the indicator will climb upward. If the indicator becomes full, movie shooting will stop automatically.

If the card has a fast writing speed, the indicator will either not appear or the level (if displayed) will hardly go upward.

First, shoot a few test movies to see if the card can write fast enough.



Indicator

### Still Photo Shooting During Movie Shooting

- Regarding the image quality of still photos, see “Image Quality” on page 217.

### Playback and TV connection

- In autoexposure shooting, shutter-priority AE, or aperture-priority AE modes, if the brightness changes during movie shooting, the movie may freeze temporarily. In such cases, shoot movies with manual exposure.
- If you connect the camera to a TV set (p.274, 277) and shoot a movie, the TV will not output any sound during the shooting. However, the sound will be properly recorded.



# 9

## Image Playback

This chapter explains how to play back and erase photos and movies, how to display them on a TV screen, and other playback-related functions.

### **About images taken with another camera**

The camera may not be able to properly display images captured with a different camera or edited with a computer or whose file name was changed.

# ▶ Image Playback

## Single-Image Display



### 1 Play back the image.

- Press the <▶> button.
- ▶ The last captured image or last image viewed will appear.

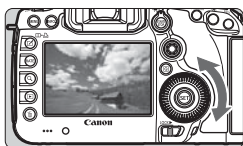

### 2 Select an image.

- To play back images starting with the last image, turn the <◂> dial counterclockwise. To play back images starting with the first captured image, turn the dial clockwise.
- Each time you press the <INFO.> button, the display format will change.



No information



With basic information

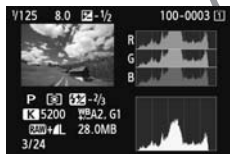

Histogram



Shooting information display

### 3 Exit the image playback.

- Press the <▶> button to exit the image playback and return to shooting-ready state.

#### MENU Grid Display

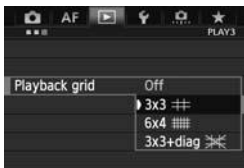

In single-image display and two-image display (p.259) display, you can overlay the grid on the image playback.

With [**▶3: Playback grid**], you can select [**3x3** 3x3], [**6x4** 6x4], or [**3x3+diag** 3x3+diag].

This function is convenient for checking the image's tilt and composition.

# INFO.: Shooting Information Display

## Sample Information for Still Photos

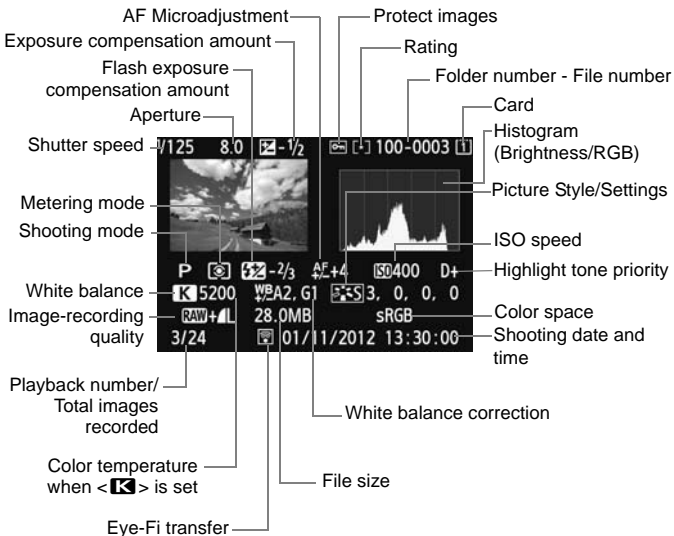

- \* When you shoot in RAW+JPEG image quality, the RAW image file size will be displayed.
- \* During flash photography without flash exposure compensation, <f> will be displayed.
- \* <HDR> and the dynamic range adjustment amount will be displayed for images taken in the HDR mode.
- \* <M> will be displayed for multiple-exposure photos.
- \* For still photos taken during movie shooting, <M> will be displayed.
- \* For JPEG images developed with the camera's RAW processing function or resized, and then saved, <M> will be displayed.

## Sample Information for Movies

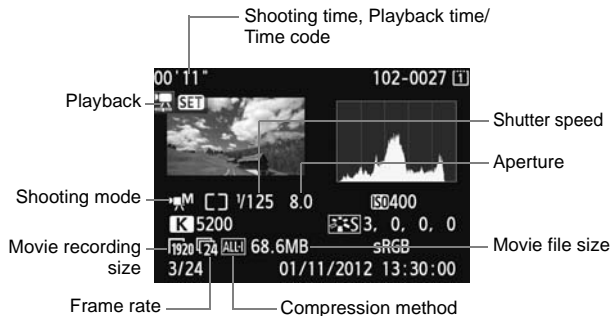

### ● About the Highlight Alert

When [ 3: Highlight alert ] is set to [Enable], overexposed highlight areas will blink. To obtain more image detail in the overexposed areas, set the exposure compensation to a negative amount and shoot again.

### ● About the AF Point Display

When [ 3: AF point disp. ] is set to [Enable], the AF point that achieved focus will be displayed in red. If automatic AF point selection was used, multiple AF points may be displayed in red.

## ● About the Histogram

The brightness histogram shows the exposure level distribution and overall brightness. The RGB histogram is for checking the color saturation and gradation. The display can be switched with [  3: Histogram disp].

### [Brightness] Display

This histogram is a graph showing the distribution of the image's brightness level. The horizontal axis indicates the brightness level (darker on the left and brighter on the right), while the vertical axis indicates how many pixels exist for each brightness level. The more pixels there are toward the left, the darker the image. And the more pixels there are toward the right, the brighter the image. If there are too many pixels on the left, the shadow detail will be lost. And if there are too many pixels on the right, the highlight detail will be lost. The gradation in-between will be reproduced. By checking the image and its brightness histogram, you can see the exposure level inclination and the overall gradation.

#### Sample Histograms



Dark image



Normal brightness



Bright image

### [RGB] Display

This histogram is a graph showing the distribution of each primary color's brightness level in the image (RGB or red, green, and blue). The horizontal axis indicates the color's brightness level (darker on the left and brighter on the right), while the vertical axis indicates how many pixels exist for each color brightness level. The more pixels there are toward the left, the darker and less prominent the color. And the more pixels there are toward the right, the brighter and denser the color. If there are too many pixels on the left, the respective color information will be lacking. And if there are too many pixels on the right, the color will be too saturated with no gradation. By checking the image's RGB histogram, you can see the color's saturation and gradation condition and white balance inclination.

## ▶ Searching for Images Quickly

### ❑ Display Multiple Images on One Screen (Index Display)

You can search for images quickly with the index display showing four or nine images on one screen.

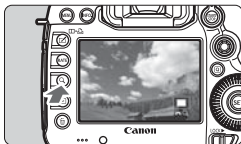



#### 1 Press the <Q> button.

- During image playback, press the <Q> button.
- ▶ [  Q ] will be displayed on the lower right of the screen.





#### 2 Switch to the index display.

- Turn the < > dial counterclockwise.
- ▶ The 4-image index display will appear. The currently-selected image will be highlighted in a blue frame.
- If you turn the < > dial further counterclockwise, the 9-image index display will appear. Turning the < > dial clockwise will switch the display from 9 images, 4 images and to one image.



#### 3 Select an image.



- Turn the < > dial to move the blue frame and select the image.
- Press the <Q> button to turn off the [  Q ] icon, then turn the < > dial to go to the next or preceding screen.
- Press <SET> in the index display, and the selected image will be displayed as a single image.

## Jump through Images (Jump Display)

With the single image display, you can turn the < > dial to jump through the images forward or back according to the jump method set.



### 1 Select [Image jump w/ ].

- Under the [ 2] tab, select [Image jump w/ ], then press <SET>.

### 2 Select the jump method.

- Turn the < > dial to select the jump method, then press <SET>.

: Display images one by one

: Jump 10 images

: Jump 100 images

: Display by date

: Display by folder

: Display movies only

: Display stills only

: Display by image rating (p.261)

Turn the < > dial to select the rating.



Jump method

Playback position

### 3 Browse by jumping.

- Press the < > button to play back images.
- On the single-image display, turn the < > dial.

- To search images according to the shooting date, select [Date].
- To search images according to folder, select [Folder].
- If the card contains both movies and still photos, select [Movies] or [Stills] to display only either ones.
- If no images match the selected [Rating], you cannot browse through the images with the < > dial.



## Q Magnified View

You can magnify a captured image by approx. 1.5x to 10x on the LCD monitor.

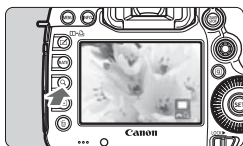

Magnified area position

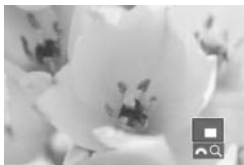
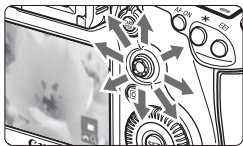

### 1 Magnify the image.

- The image can be magnified during image playback (single-image display), during image review after image capture, and from shooting-ready state.
- Press the **<Q>** button.
- ▶ The magnified view will appear. The magnified area and [ **Q**] will be displayed on the lower right of the screen.
- The image magnification increases as you turn the **< >** dial clockwise. You can magnify the image up to 10x.
- The image magnification decreases as you turn the **< >** dial counterclockwise. Turning the dial further will display the index display (p.255).

### 2 Scroll around the image.

- Use **< >** to scroll around the magnified image.
- To exit the magnified view, press the **<Q>** button or **< >** button and the single image display will return.



- In magnified view, you can turn the **< >** dial to view another image at the same magnification.
- The image can be magnified also during the image review immediately after shooting.
- A movie cannot be magnified.

**MENU Magnification Settings**

Magnificatn (apx)
1x (no magnification)
2x (magnify from center)
4x (magnify from center)
8x (magnify from center)
10x (magnify from center)
Actual size (from selected pt)
Same as last magnif. (from ctr)

Under the [ 3] tab, when you select [**Magnificatn (apx)**], you can set the starting magnification and initial position for the magnified view.

- **1x (no magnification)**

The image will not be magnified. The magnified view will start with the single-image display.

- **2x, 4x, 8x, 10x (magnify from center)**



The magnified view will start at the image center at the selected magnification.

- **Actual size (from selected point)**

The recorded image's pixels will be displayed at approx. 100%. The magnified view will start at the AF point that achieved focus. If the photo was taken with manual focus, the magnified view will start at the image center.

- **Same as last magnification (from center)**

The magnification will be the same as the last time you exited the magnified view with the < > or <Q> button. The magnified view starts from the image center.

 With images taken with [**Live mode**] or [ **Live mode**] (p.209), the magnified view starts from the image center.

## ☐ Comparing Images (Two-Image Display) ■

You can compare two images side by side on the LCD monitor.

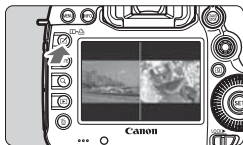

### 1 Set the two-image display.

- During image playback, press the  $\langle \square \cdot \square \rangle$  button.
- ▶ Two images will be displayed. The currently-selected image will be highlighted in a blue frame.



### 2 Select the images to be compared.

- Pressing  $\langle \text{SET} \rangle$  switches the blue frame between the two images.
- Turn the  $\langle \odot \rangle$  dial to select an image.
- Repeat step 2 to select the other image to be compared.
- By pressing the  $\langle \square \rangle$  button, you can set the same magnification and magnified area for both images. (The magnification settings will match those of the image not highlighted in blue.)
- By holding the  $\langle \triangleright \rangle$  button, you can display the image highlighted in blue as a single image.
- To return to the single-image display, press the  $\langle \square \cdot \square \rangle$  button.



- Magnified view, jump display, setting ratings, protecting the image, and deleting the image are possible.
- By pressing the  $\langle \text{INFO.} \rangle$  button, you can change the shooting information display.
- You cannot play back movies in the two-image display.

## Rotating the Image

You can rotate the displayed image to the desired orientation.

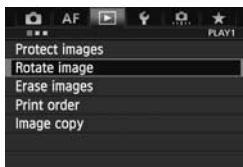

### 1 Select [Rotate image].

- Under the [▶1] tab, select [Rotate image], then press <Ⓢ>.







### 2 Select an image.

- Turn the <⦿> dial to select the image to be rotated.
- You can also select an image on the index display (p.255).



### 3 Rotate the image.

- Each time you press <Ⓢ>, the image will rotate clockwise as follows: 90° → 270° → 0°
- To rotate another image, repeat steps 2 and 3.
- Press the <MENU> button to return to the menu.

- If you have set [**1: Auto rotate**] to [On  ] (p.286) before taking vertical shots, you need not rotate the image as described above.
- If the rotated image is not displayed in the rotated orientation during image playback, set [**1: Auto rotate**] to [On  ].
- A movie cannot be rotated.

# Setting Ratings

You can rate images and movies with one of five rating marks: [★]/[★★]/[★★★]/[★★★★]/[★★★★★]. This function is called rating.

## Set ratings with the <RATE> Button



### 1 Select an image or movie.

- During image playback, turn the <DISP> dial to select an image or movie to be rated.
- You can also select an image or movie on the index display (p.255).



### 2 Rate the image or movie.

- Each time you press the <RATE> button, the rating mark will change: [★]/[★★]/[★★★]/[★★★★]/[★★★★★]/None.
- To rate another image or movie, repeat steps 1 and 2.



- If [4: RATE btn function] is set to [Protect], change it to [Rating].
- If you press the <Q> button when [Rating] is selected in [4: RATE btn function], you can set the rating marks that can be selected when you press the <RATE> button.

## MENU Set ratings with the menu





### 1 Select [Rating].

- Under the [2] tab, select [Rating], then press <GET>.





## 2 Select an image or movie.

- Turn the <  > dial to select the image or movie to be rated.
- If you press the < Q > button and turn the <  > dial counterclockwise, you can select an image or movie from a three-image display. To return to the single-image display, turn the <  > dial clockwise.





## 3 Rate the image or movie.

- Pressing <  > will turn off the [SET] icon.
- Turn the <  > dial to select a rating.
- ▶ The total number of images and movies rated will be counted for each rating.
- To rate another image or movie, repeat steps 2 and 3.
- Press the < MENU > button to return to the menu.

 The total number of images with a given rating can be displayed up to 999. If there are more than 999 images with a given rating, [###] will be displayed for that rating.

### Taking advantage of ratings

- With [  2: Image jump w/  ], you can display only rated images and movies.
- With [  2: Slide show ], you can play back only rated images and movies.
- With Digital Photo Professional (provided software, p.394), you can select only rated images and movies.
- With Windows 8.1, Windows 8, or Windows 7 etc., you can see each file's rating as part of the file information display or in the provided image viewer.

## **Q** Quick Control During Playback

During playback, you can press the **<Q>** button to set the following: **[On]**: **Protect images**, **[Q]**: Rotate image, **★**: **Rating**, **RAW/JPEG**: RAW image processing (RAW images only), **[Q]**: Resize (JPEG image only), **[On]**: **Highlight alert**, **[On]**: **AF point display**, **[Q]**: **Image jump w/ [Sun]**.  
For movies, only the functions in bold above can be set.



### **1** Press the **<Q>** button.

- During image playback, press the **<Q>** button.
- ▶ The Quick Control screen will appear.









### **2** Select a function and set it.

- Tilt **<[Sun]>** up or down to select a function.
- ▶ The setting of the selected function is displayed at the bottom.
- Turn the **<[Sun]>** dial to set the function.
- For RAW image processing and Resize, press **<[SET]>** and set the function. For details, see page 288 for RAW image processing and page 293 for Resize. To cancel, press the **<[MENU]>** button.

### **3** Exit the setting.

- Press the **<Q>** button and the Quick Control screen will turn off.

 To rotate an image, set [**1: Auto rotate**] to [**On**  ]. If [**1: Auto rotate**] is set to [**On** ] or [**Off**], the [**Rotate image**] setting will be recorded to the image, but the camera will not rotate the image for display.

- 
- Pressing the <> button during the index display will switch to the single-image display and the Quick Control screen will appear. Pressing the <> button again will return to the index display.
  - For images taken with another camera, selectable functions may be limited.



## Enjoying Movies

You can play back movies in the following three ways:

### Playback on a TV set (p.274, 277)



Use the provided AV cable or an HDMI Cable HTC-100 (sold separately) to connect the camera to a TV set. Then you can play back captured movies and still photos on the TV.

If you have a High-Definition TV set and connect your camera with an HDMI cable, you can watch Full High-Definition (Full HD: 1920x1080) and High-Definition (HD: 1280x720) movies with higher image quality.



- Movies on a card can be played only by devices compatible with MOV files.
- Since hard disk recorders do not have an HDMI IN terminal, the camera cannot be connected to a hard disk recorder with an HDMI cable.
- Even if the camera is connected to a hard disk recorder with a USB cable, movies and still photos cannot be played nor saved.

### Playback on the Camera's LCD Monitor (p.267-273)

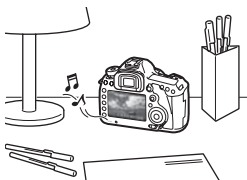

You can play back movies on the camera's LCD monitor. You can also edit out the movie's first and last scenes, and play back the still photos and movies on the card in an automatic slide show.



- A movie edited with a personal computer cannot be rewritten to the card and played back with the camera.

## Playback and Editing with a Personal Computer (p.394)

The movie files recorded on the card can be transferred to a personal computer and played with ImageBrowser EX.



- To have the movie play back smoothly on a personal computer, use a high-performance personal computer. Regarding the computer hardware requirements for ImageBrowser EX, refer to the PDF file ImageBrowser EX User Guide.
- If you want to use commercially-available software to play back or edit the movies, be sure it is compatible with MOV files. For details on commercially-available software, contact the software maker.

## ▶ Playing Movies



### 1 Play back the image.

- Press the <▶> button to display images.



### 2 Select a movie.

- Turn the <☉> dial to select the movie to be played.
- With the single-image display, the <▶ SET> icon displayed on the upper left indicates a movie.
- On the index display, the perforations on the left edge of the image indicates a movie. **As movies cannot be played on the index display, press <SET> to switch to the single-image display.**



### 3 On the single-image display, press <SET>.

- ▶ The movie playback panel will appear on the bottom.



### 4 Play back the movie.



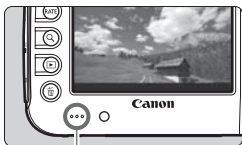







- Turn the <☉> dial to select [▶] (Play), then press <SET>.
- ▶ The movie will start playing.
- You can pause the movie playback by pressing <SET>.
- During movie playback, you can adjust the sound volume by turning the <☉> dial.
- For more details on the playback procedure, see the next page.



Speaker



Before listening to a movie through headphones, tone down the volume to prevent hurting your ears.

Function	Playback Description
 Exit	Returns to the single-image display.
 Play	Pressing <SET> toggles between play and stop.
 Slow motion	Adjust the slow motion speed by turning the <DIAL> dial. The slow-motion speed is indicated on the upper right.
 First frame	Displays the movie's first frame.
 Previous frame	Each time you press <SET>, the previous frame is displayed. If you hold down <SET>, it will rewind the movie.
 Next frame	Each time you press <SET>, the movie will play frame-by-frame. If you hold down <SET>, it will fast forward the movie.
 Last frame	Displays the movie's last frame.
 Edit	Displays the editing screen (p.269).
	Playback position
mm' ss"	Playback time (minutes:seconds with [Movie play count: Rec time] set)
hh:mm:ss:ff	Time code (hours:minutes:seconds:frames with [Movie play count: Time code] set)
 Volume	You can adjust the built-in speaker's (p.267) volume by turning the <DIAL> dial.



- With a fully-charged Battery Pack LP-E6, the continuous playback time at 23°C/73°F will be as follows: approx. 3 hr. 30 min.
- By connecting commercially-available headphones equipped with a 3.5 mm stereo mini plug to the camera's headphone terminal (p.19), you can listen to the movie's sound (p.237).
- If you connect the camera to a TV set (p.274, 277) to play back a movie, adjust the sound volume with the TV set. (Turning the <DIAL> dial will not adjust the sound volume.)
- If you took a still photo while you shot the movie, the movie image displayed will look still for approx. 1 sec..

## ✂ Editing the Movie's First and Last Scenes ■

You can edit out the first and last scenes of a movie in 1-sec. increments.



### 1 On the movie playback screen, select [✂].

- ▶ The movie editing panel will be displayed at the bottom of the screen.



### 2 Specify the part to be edited out.

- Select either [✂] (Cut beginning) or [✂] (Cut end), then press <SET>.
- Tilt <⬅➡> to the left or right to see the previous or next frames. Holding it down will fast forward the frames. Turn the <⌚> dial for frame-by-frame playback.
- After deciding which part to edit out, press <SET>. The portion highlighted in blue on the top of the screen is what will remain.



### 3 Check the edited movie.

- Select [▶] and press <SET> to play back the portion highlighted in blue.
- To change the editing, go back to step 2.
- To cancel the editing, select [↶] and press <SET>.



## 4 Save the movie.

- Select [**⏏**], then press < **Ⓢ** >.
- ▶ The save screen will appear.
- To save it as a new movie, select [**New file**]. To save it and overwrite the original movie file, select [**Overwrite**]. Then press < **Ⓢ** >.
- On the confirmation screen, select [**OK**], then press < **Ⓢ** > to save the edited movie and return to the movie playback screen.

- Since the editing is performed in 1-sec. increments (position indicated by [**⏏**]), the exact position where the movie is edited may differ slightly from the position you specified.
- If the card does not have enough free space, [**New file**] will not be available.

## MENU Slide Show (Auto Playback)

You can play back the images on the card as an automatic slide show.

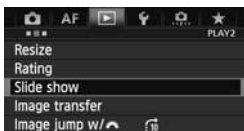

### 1 Select [Slide show].

- Under the [PLAY2] tab, select [Slide show], then press <SET>.

Number of images to be played

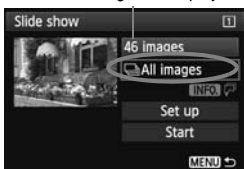

### 2 Select the images to be played.

- Turn the <DIAL> to select the desired option, then press <SET>.

#### [All images/Movies/Stills]

- Turn the <DIAL> to select one of the following: [All images/Movies/Stills]. Then press <SET>.

#### [Date/Folder/Rating]

- Turn the <DIAL> to select one of the following: [Date/Folder/Rating].
- When <INFO> is highlighted, press the <INFO> button.
- Turn the <DIAL> to select the desired setting, then press <SET>.

[Date]



[Folder]



[Rating]



Item	Playback Description
<b>All images</b>	All the still photos and movies on the card will be played back.
<b>Date</b>	Still photos and movies taken on the selected shooting date will be played back.
<b>Folder</b>	Still photos and movies in the selected folder will be played back.
<b>Movies</b>	Only the movies on the card will be played back.
<b>Stills</b>	Only the still photos on the card will be played back.
<b>Rating</b>	Only the still photos and movies with the selected rating will be played back.



### 3 Set the play time and repeat option.

- Turn the < > dial to select **[Set up]**, then press < >.
- For still photos, set the **[Display time]** and **[Repeat]** options, then press the < **MENU** > button.

**[Display time]**



**[Repeat]**







#### 4 Start the slide show.

- Turn the <⦿> dial to select [**Start**], then press <ⓈET>.
- ▶ After [**Loading image...**] is displayed, the slide show will start.

#### 5 Quit the slide show.

- To quit the slide show and return to the setting screen, press the <MENU> button.



- To pause the slide show, press <ⓈET>. During pause, [||] will be displayed on the upper left of the image. Press <ⓈET> again to resume the slide show.
- During auto playback, you can press the <INFO.> button to change the still photo display format (p.250).
- During movie playback, you can adjust the sound volume by turning the <⦿> dial.
- During auto playback or pause, you can turn the <⦿> dial to view another image.
- During auto playback, auto power off will not work.
- The display time may vary depending on the image.
- To view the slide show on a TV set, see pages 274 and 277.

## Viewing the Images on TV

You can view the still photos and movies on a TV set.

- Adjust the movie's sound volume with the TV set. The sound volume cannot be adjusted with the camera.
- Before connecting or disconnecting the cable between the camera and television, turn off the camera and TV set.
- Depending on the TV set, part of the image displayed may be cut off.

### Viewing on High-Definition (HD) TV Sets

HDMI Cable HTC-100 (sold separately) is required.

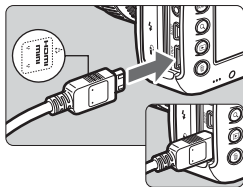

#### 1 Connect the HDMI cable to the camera.

- With the plug's <▲HDMI MINI> logo facing the front of the camera, insert it into the <HDMI OUT> terminal.

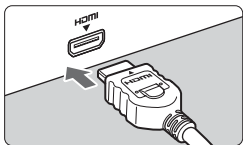

#### 2 Connect the HDMI cable to the TV set.

- Connect the HDMI cable to the TV's HDMI IN port.

#### 3 Turn on the TV and switch the TV's video input to select the connected port.

#### 4 Set the camera's power switch to <ON>.

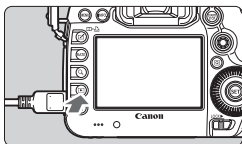

## 5 Press the **<▶>** button.

- ▶ The image will appear on the TV screen. (Nothing will be displayed on the camera's LCD monitor.)
- The images will automatically be displayed at the TV's optimum resolution.
- By pressing the **<INFO.>** button, you can change the display format.
- To play back movies, see page 267.



The movie cannot be output at the same time from both the **<HDMI OUT>** and **<A/V OUT>** terminals.



- Do not connect any other device's output to the camera's **<HDMI OUT>** terminal. Doing so may cause a malfunction.
- Certain TVs may not be able to play back the captured images. In such a case, use the provided AV cable to connect to the TV.

## Using HDMI CEC TV Sets

If the TV set connected to the camera with an HDMI cable is compatible with HDMI CEC\*, you can use the TV set's remote control for playback operations.

\* An HDMI-standard function enabling HDMI devices to control each other so that you can control them with one remote control unit.

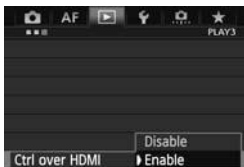

## 1 Set **[Ctrl over HDMI]** to **[Enable]**.

- Under the **[▶3]** tab, select **[Ctrl over HDMI]**, then press **<SET>**.
- Select **[Enable]**, then press **<SET>**.

**2 Connect the camera to a TV set.**

- Use an HDMI cable to connect the camera to the TV.
- ▶ The TV's input will switch automatically to the HDMI port connected to the camera.

**3 Press the camera's <▶> button.**

- ▶ An image will appear on the TV screen and you can use the TV's remote control to play back images.

**4 Select an image or movie.**

- Point the remote control toward the TV set and press the ←/→ button to select an image.

**Still photo playback menu****Movie playback menu**

- ↶ : Return
- ☰ : 9-image index
- ▶ : Play movie
- ⤴ : Slide show
- INFO. : Disp. shooting info
- 🔄 : Rotate

**5 Press the remote control's Enter button.**

- ▶ The menu appears and you can perform the playback operations shown on the left.
- Press the ←/→ button to select the desired option, then press the Enter button. For a slide show, press the remote control's ↑/↓ button to select an option, then press the Enter button.
- If you select [**Return**] and press the Enter button, the menu will disappear and you can use the ←/→ button to select an image.

 During the two-image display (p.259), playback with the TV's remote control is not possible. To use the TV's remote control for playback, first press the <☐•▶> button to return to the single-image display.

- Some TV sets require you to first enable the HDMI CEC connection. For details, refer to the TV set's instruction manual.
- Certain TV sets, even those compatible with HDMI CEC, may not operate properly. In such a case, set [**▶3: Ctrl over HDMI**] to [**Disable**], and use the camera to control the playback operation.

## Viewing on Non High-Definition (HD) TV Sets

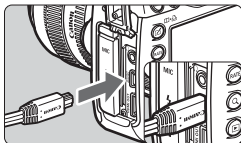

### 1 Connect the provided AV cable to the camera.

- With the plug's <Canon> logo facing the back of the camera, insert it into the <A/V OUT> terminal.

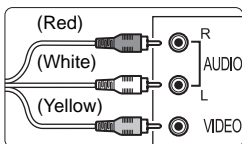

### 2 Connect the AV cable to the TV set.

- Connect the AV cable to the TV's video IN terminal and audio IN terminal.

### 3 Turn on the TV and switch the TV's video input to select the connected port.

### 4 Set the camera's power switch to <ON>.

### 5 Press the <▶> button.

- ▶ The image will appear on the TV screen. (Nothing will be displayed on the camera's LCD monitor.)
- To play back movies, see page 267.

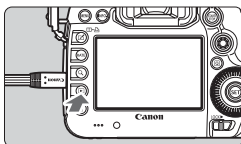

- Do not use any AV cable other than the one provided. Images may not be displayed if you use a different cable.
- If the video system format does not match the TV's, the images will not be displayed properly. Set the proper video system format with [**3**: Video system].



# Protecting Images

Protecting an image prevents it from being erased accidentally.

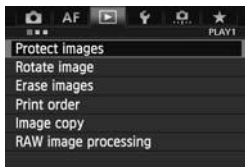
## **MENU** Protecting a Single Image



### 1 Select [Protect images].

- Under the [ 1] tab, select [Protect images], then press < >.



### 2 Select [Select images].







- Select [Select images], then press < >.
- ▶ The images will be displayed.

Image protect icon



### 3 Protect the image.

- Turn the < > dial to select the image to be protected, then press < >.
- ▶ The image will be protected, and the < > icon will appear at the top of the screen.
- To cancel the image protection, press < > again. The < > icon will disappear.
- To protect another image, repeat step 3.
- Press the <MENU> button to return to the menu.

## **MENU** Protecting All Images in a Folder or Card

You can protect all the images in a folder or on a card at one time.



Under [**▶**1: **Protect images**], when you select [**All images in folder**] or [**All images on card**], all the images in the folder or on a card will be protected.

To cancel the image protection, select [**Unprotect all images in folder**] or [**Unprotect all images on card**].

## **Set with the <RATE> Button**

During image playback, you can use the <RATE> button to protect an image.



- Set [**4**3: **RATE** btn function] to [**Protect**].
- Play back the images and select the image to be protected.
- When you press the <RATE> button, the image will be protected and the < > icon will appear at the top of the screen.
- To cancel the image protection, press the <RATE> button again. The < > icon will disappear.

**!** If you format the card (p.53), the protected images will also be erased.



- Movies can also be protected.
- Once an image is protected, it cannot be erased by the camera's erase function. To erase a protected image, you must first cancel the protection.
- If you erase all the images (p.284), only the protected images will remain. This is convenient when you want to erase unnecessary images all at once.



## Copying Images

The images recorded on one card can be copied to the other card.

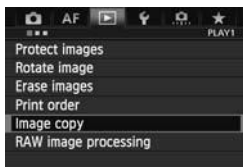
### **MENU** Copying Individual Images



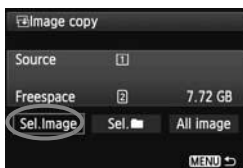

#### 1 Select [Image copy].

- Under the [] 1 tab, select [Image copy], then press <  >.







#### 2 Select [Sel. Image].

- Check the copy source and target card's capacity.
- Turn the <  > dial to select [Sel. Image], then press <  >.



#### 3 Select the folder.

- Turn the <  > dial to select the folder containing the image to be copied, then press <  >.
- Refer to the images displayed on the right to select the desired folder.
- ▶ The images in the selected folder will be displayed.

 The copy source is the card selected in the [ 1: Record func+card/folder sel.] menu's [Record/play] ([Playback]) setting.



Total images selected



## 4 Select the images to be copied.

- Turn the <⦿> dial to select an image to be copied, then press <SET>.
- ▶ The <✓> icon will appear on the upper left of the screen.
- If you press the <Q> button and turn the <⦿> dial counterclockwise, you can select an image from a three-image display. To return to the single-image display, turn the <⦿> dial clockwise.
- To select other images to be copied, repeat step 4.

## 5 Press the <RATE> button.

- After selecting all the images to be copied, press the <RATE> button.



## 6 Select [OK].

- Check the target card and press <SET>.

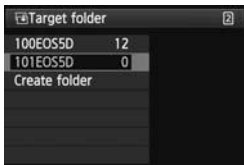

## 7 Select the target folder.

- Turn the <⦿> dial to select the folder to copy the images to, then press <SET>.
- To create a new folder, select [Create folder].

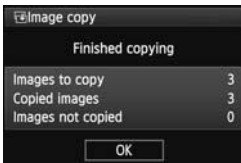
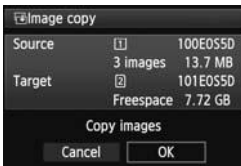

## 8 Select [OK].

- Check the copy source and target card's information.
- Turn the < [OK] > dial to select [OK], then press < [SET] >.
- ▶ The copying will start and the progress will be displayed.
- When the copying is completed, the result will be displayed.
- Select [OK] to return to the screen in step 2.

### MENU Copying All Images in a Folder or Card

You can copy all the images in a folder or on a card at one time. Under [▶ 1: Image copy], when you select [Sel. █] or [All image], you can copy all the images in the folder or on a card.

- The file name of the copied image will be the same as the source image's file name.
- If [Sel. Image] is set, you cannot copy images in multiple folders at one time. Select images in each folder to copy them folder by folder.
- If an image is being copied to a target folder/card which has an image with the same file number, the following will be displayed: [Skip image and continue] [Replace existing image] [Cancel copy]. Select the copying method, then press < [SET] >.
  - [Skip image and continue]: Any images in the source folder having the same file number as images in the target folder will be skipped and not copied.
  - [Replace existing image]: Any images in the target folder having the same file number as the source images (including protected images) will be overwritten. If an image with a print order (p.311) is overwritten, you will have to set the print order again.
- The image's print order information and image transfer information will not be retained when the image is copied.
- Shooting is not possible during the copying operation. Select [Cancel] before shooting.

## Erasing Images

You can either select and erase images one by one or erase them in one batch. Protected images (p.278) will not be erased.

- 1 **Once an image is erased, it cannot be recovered. Make sure you no longer need the image before erasing it. To prevent important images from being erased accidentally, protect them. Erasing a RAW+JPEG image will erase both the RAW and JPEG images.**

### Erasing a Single Image





- 1 **Play back the image to be erased.**

- 2 **Press the  button.**

- ▶ The Erase menu will appear at the bottom of the screen.



- 3 **Erase the image.**

- Turn the  dial to select [Erase], then press . The image displayed will be erased.



-  When you set [:3: Default Erase option] to [[Erase] selected], you can erase images quicker (p.326).

### **MENU** Checkmarking Images to be Erased in a Batch

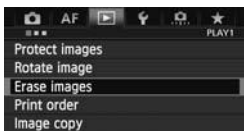
By appending  checkmarks to the images to be erased, you can erase multiple images at one time.



- 1 **Select [Erase images].**

- Under the [ 1] tab, select [Erase images], then press .

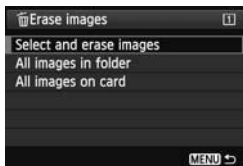

## 2 Select [Select and erase images].

- Select [**Select and erase images**], then press <SET>.
- ▶ The images will be displayed.
- If you press the <Q> button and turn the <⚙> dial counterclockwise, you can select an image from a three-image display. To return to the single-image display, turn the <⚙> dial clockwise.



## 3 Select the images to be erased.

- Turn the <⦿> dial to select the image to be erased, then press <SET>.
- ▶ A <✓> checkmark will be displayed on the upper left.
- To select other images to be erased, repeat step 3.

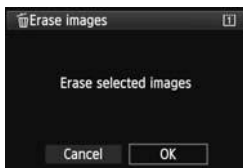

## 4 Erase the images.

- Press the <🗑> button.
- Select [**OK**], then press <SET>.
- ▶ The selected images will be erased.

### **MENU** Erasing All Images in a Folder or Card

You can erase all the images in a folder or on a card at one time. When [**▶ 1: Erase images**] is set to [**All images in folder**] or [**All images on card**], all the images in the folder or card will be erased.

- To also erase protected images, format the card (p.53).
- When [**All images on card**] is selected, the images will be erased on the card selected under [**⚡ 1: Record func+card/folder sel.**] with [**Record/play**] ([**Playback**]).

# Changing Image Playback Settings

## MENU Adjusting the LCD Monitor Brightness

The LCD monitor's brightness is adjusted automatically for optimum viewing. You can set the automatic adjustment's brightness level (brighter or darker) or adjust the brightness manually.

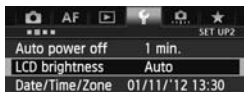

### 1 Select [LCD brightness].

- Under the [**F2**] tab, select [**LCD brightness**], then press <SET>.

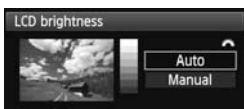

### 2 Select [Auto] or [Manual].

- Turn the <DIAL> to make the selection.

### 3 Adjust the brightness.

- While referring to the gray chart, turn the <DIAL> dial, then press <SET>.
- You can adjust [**Auto**] to one of three levels, and [**Manual**] to one of seven levels.



Automatic adjustment



Manual adjustment

While [**Auto**] is set, be careful not to obstruct the round, external light sensor (p.20) on the right of the LCD monitor with your finger, etc.

To check the image's exposure, looking at the histogram is recommended (p.254).

## MENU Auto Rotation of Vertical Images



Vertical images are rotated automatically so they are displayed vertically on the camera's LCD monitor and on the personal computer instead of horizontally. The setting of this feature can be changed.

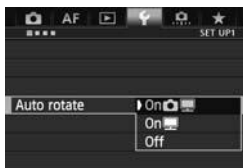

### 1 Select [Auto rotate].

- Under the [**1**] tab, select [**Auto rotate**], then press <SET>.

### 2 Set the auto rotation.

- Select the desired option, then press <SET>.

- **On**  

The vertical image is automatically rotated during playback on both the camera's LCD monitor and on the computer.

- **On** 

The vertical image is automatically rotated only on the computer.

- **Off**

The vertical image is not automatically rotated.

 Auto rotation will not work with vertical images captured while auto rotation was [**Off**]. They will not rotate even if you later switch it to [**On**] for playback.

-  Immediately after image capture, the vertical image will not be automatically rotated for the image review.
- If the vertical image is taken while the camera is pointed up or down, the image may not be rotated automatically for playback.
- If the vertical image is not automatically rotated on the personal computer screen, it means the software you are using is unable to rotate the image. Using the provided software is recommended.

# 10

## Post-Processing Images

You can process RAW images with the camera or resize (shrink) JPEG images.

- A ☆ icon at the upper right of a page title indicates that the function can be used when the Mode Dial is set to <P/Tv/Av/M/B>.

\* The function cannot be used in the <A<sup>+</sup>> mode.

- The camera may not be able to process images taken with another camera.
- Post-processing images as described in this chapter is not possible if the camera is set for HDR shooting or multiple exposures, or while it is connected to a personal computer via the <DIGITAL> terminal.

# RAW/JPEG ↓ Processing RAW Images with the Camera ☆

You can process **RAW** images with the camera and save them as JPEG images. While the RAW image itself does not change, you can process the RAW image according to different conditions to create any number of JPEG images from it.

Note that **M RAW** and **S RAW** images cannot be processed with the camera. Use Digital Photo Professional (provided software, p.394) to process those images.

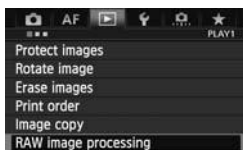

## 1 Select [RAW image processing].

- Under the [▶1] tab, select [**RAW image processing**], then press <SET>.
- ▶ **RAW** images will be displayed.



## 2 Select an image.

- Turn the <◉> dial to select the image you want to process.
- If you press the <Q> button and turn the <☀> dial counterclockwise, you can select an image from the index display.



## 3 Process the image.

- Press <SET> and the RAW-processing options will appear (p.290-292).
- Use <⊗> to select an option, then turn the <◉> dial to set it.
- ▶ The displayed image will reflect “Brightness adjustment”, “White balance”, and the other setting adjustments.
- To return to the image settings at the time of shooting, press the <INFO.> button.





## Displaying the setting screen

- Press <SET> to display the setting screen. Turn the <☉> or <☽> dial to change the setting. To return to the screen in step 3, press <SET>.



## 4 Save the image.

- Select [L] (Save), then press <SET>.
- Select [OK] to save the image.
- Check the destination folder and image file number, then select [OK].
- To process another image, repeat steps 2 to 4.
- Press the <MENU> button to return to the menu.

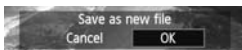

## About the Magnified View















You can magnify the image by pressing the <Q> button in step 3. The magnification will differ depending on the pixel count of **[Image quality]** set in **[RAW image processing]**. With <☼>, you can scroll around the magnified image.

To cancel the magnified view, press the <Q> button again.

## Images with Aspect Ratio Setting

Images shot in a Live View shooting aspect ratio (**[4:3]** **[16:9]** **[1:1]**) will be displayed in the respective aspect ratio. JPEG images will also be saved in the set aspect ratio.

## RAW Image-processing Options

-  **Brightness adjustment**  
You can adjust the image brightness up to  $\pm 1$  stop in 1/3-stop increments. The displayed image will reflect the setting's effect.
-  **White balance** (p.139)  
You can select the white balance. If you select [**K**], turn the  dial to set the color temperature on the setting screen. The displayed image will reflect the setting's effect.
-  **Picture Style** (p.131)  
You can select the Picture Style. To set the parameters such as Sharpness, press  to display the setting screen. Turn the  dial to select the Picture Style. Turn the  dial to select a parameter to be adjusted, then turn the  dial to set it. To return to the screen in step 3, press . The displayed image will reflect the setting's effect.
-  **Auto Lighting Optimizer** (p.144)  
You can set the Auto Lighting Optimizer. The displayed image will reflect the setting's effect.
-  **High ISO speed noise reduction** (p.145)  
You can set the noise reduction for high ISO speeds. The displayed image will reflect the setting's effect. If the effect is difficult to discern, press the  button to magnify the image. (Press the  button to return to the normal view.)
-  **Image quality** (p.121)  
You can set the image quality of the JPEG image to be saved when converting the RAW image. The image size displayed, such as [**\*\*\*M\*\*\*x\*\*\***], has a 3:2 aspect ratio. The pixel count of each aspect ratio is indicated on page 294.

- sRGB **Color space** (p.160)

You can select either sRGB or Adobe RGB. Since the camera's LCD monitor is not compatible with Adobe RGB, the image will not look very different when either color space is set.

- OFF **Peripheral illumination correction** (p.149)

If [**Enable**] is set, the corrected image will be displayed. If the effect is difficult to discern, press the <Q> button to magnify the image and check the corners. (Press the <Q> button to return to the normal view.) The peripheral illumination correction applied with the camera will be less pronounced than with Digital Photo Professional (provided software) and may be less apparent. In such a case, use Digital Photo Professional to apply the peripheral illumination correction.

- OFF **Distortion correction**

When [**Enable**] is set, image distortion due to the lens characteristics is corrected. If [**Enable**] is set, the corrected image will be displayed. The image periphery will be cropped in the corrected image.

Since the image resolution may look slightly lower, use the Picture Style's Sharpness parameter to make adjustments as necessary.



When processing images with [**Distortion correction**] set to [**Enable**], AF point display information (p.253) and Dust Delete data (p.297) will not be appended to the image.

●  **Chromatic aberration correction**

When [**Enable**] is set, the lens' chromatic aberrations (color fringing along the subject's outline) can be corrected. If [**Enable**] is set, the corrected image will be displayed. If the effect is difficult to discern, press the <Q> button to magnify the image. (Press the <Q> button to return to the normal view.)

 **About peripheral illumination correction, distortion correction, and chromatic aberration correction**

To execute peripheral illumination correction, distortion correction, and chromatic aberration correction with the camera, the data of the lens used for the shot must be registered in the camera. If the lens data has not been registered in the camera, use EOS Utility (provided software, p.394) to register the lens data.

 Processing RAW images in the camera will not produce the same results as processing RAW images with Digital Photo Professional.

## **Resize**

You can resize an image to make the pixel count lower and save it as a new image. Resizing an image is possible only with JPEG **L/M/S1/S2** images. **JPEG S3 and RAW images cannot be resized.**



### 1 **Select [Resize].**

- Under the [**2**] tab, select [**Resize**], then press <SET>.
- ▶ The images will be displayed.



### 2 **Select an image.**

- Turn the <DISP> dial to select the image you want to resize.
- If you press the <Q> button and turn the <DISP> dial counterclockwise, you can select an image from the index display.



Target sizes

### 3 **Select the desired image size.**

- Press <SET> to display the image sizes.
- Turn the <DISP> dial to select the desired image size, then press <SET>.



### 4 **Save the image.**

- Select [**OK**] to save the resized image.
- Check the destination folder and image file number, then select [**OK**].
- To resize another image, repeat steps 2 to 4.
- Press the <MENU> button to return to the menu.

## Resize Options According to Original Image Size

Original Image Size	Available Resize Settings			
	M	S1	S2	S3
L	<input type="radio"/>	<input type="radio"/>	<input type="radio"/>	<input type="radio"/>
M		<input type="radio"/>	<input type="radio"/>	<input type="radio"/>
S1			<input type="radio"/>	<input type="radio"/>
S2				<input type="radio"/>

### About Image Sizes

The image size displayed in step 3 on the preceding page, such as **[\*\*M\*\*\*\*x\*\*\*\*]**, has a 3:2 aspect ratio. The image size according to aspect ratios is shown in the table below.

The asterisked image-recording quality figures do not exactly match the aspect ratio. The image will be cropped slightly.

Image Quality	Aspect Ratio and Pixel Count			
	3:2	4:3	16:9	1:1
M	3840x2560 (9.8 megapixels)	3408x2560* (8.7 megapixels)	3840x2160 (8.3 megapixels)	2560x2560 (6.6 megapixels)
S1	2880x1920 (5.5 megapixels)	2560x1920 (4.9 megapixels)	2880x1624* (4.7 megapixels)	1920x1920 (3.7 megapixels)
S2	1920x1280 (2.5 megapixels)	1696x1280* (2.2 megapixels)	1920x1080 (2.1 megapixels)	1280x1280 (1.6 megapixels)
S3	720x480 (350,000 pixels)	640x480 (310,000 pixels)	720x400* (290,000 pixels)	480x480 (230,000 pixels)

# 11

## Sensor Cleaning

The camera has a Self Cleaning Sensor Unit attached to the image sensor's front layer (low-pass filter) to shake off dust automatically.

The Dust Delete Data can also be appended to the image so that the dust spots remaining can be erased automatically by Digital Photo Professional (provided software, p.394).

### **About smudges adhering to the front of the sensor**

Besides dust entering the camera from outside, in rare cases lubricant from the camera's internal parts may adhere to the front of the sensor. If visible spots still remain after the automatic sensor cleaning, having the sensor cleaned by a Canon Service Center is recommended.



Even while the Self Cleaning Sensor Unit is operating, you can press the shutter button halfway to interrupt the cleaning and start shooting immediately.

## Automatic Sensor Cleaning

Whenever you set the power switch to <ON> or <OFF>, the Self Cleaning Sensor Unit operates to automatically shake off the dust on the front of the sensor. Normally, you need not pay attention to this operation. However, you can choose to perform sensor cleaning at any time, or disable it.

### Cleaning the Sensor Now

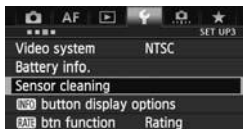

#### 1 Select [Sensor cleaning].

- Under the [3] tab, select [**Sensor cleaning**], then press <SET>.

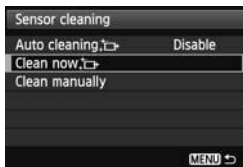

#### 2 Select [Clean now ].

- Select [**Clean now** ], then press <SET>.
- Select [**OK**] on the dialog screen, then press <SET>.
- ▶ The screen will indicate that the sensor is being cleaned. Although there will be a shutter sound during the cleaning, a picture is not taken.



- For best results, perform the sensor cleaning while the camera bottom is placed on a table or other flat surface.
- Even if you repeat the sensor cleaning, the result will not improve much. Immediately after the sensor cleaning is finished, the [**Clean now** ] option will remain disabled temporarily.

### Disabling Automatic Sensor Cleaning

- In step 2, select [**Auto cleaning** ] and set it to [**Disable**].
- ▶ The sensor cleaning will no longer be executed when you set the power switch to <ON> or <OFF>.



## MENU Appending Dust Delete Data ☆

Normally, the Self Cleaning Sensor Unit will eliminate most of the dust that may be visible on captured images. However, in case visible dust still remains, you can append the Dust Delete Data to the image for erasing the dust spots later. The Dust Delete Data is used by Digital Photo Professional (provided software, p.394) to erase the dust spots automatically.

### Preparation

- Prepare a solid white object such as a sheet of paper.
- Set the lens focal length to 50 mm or longer.
- Set the lens focus mode switch to <MF> and set the focus to infinity ( $\infty$ ). If the lens has no distance scale, look at the front of the lens and turn the focusing ring clockwise all the way.

### Obtain the Dust Delete Data

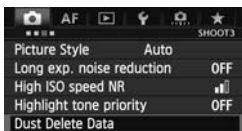

#### 1 Select [Dust Delete Data].

- Under the [**3**] tab, select [**Dust Delete Data**], then press <SET>.

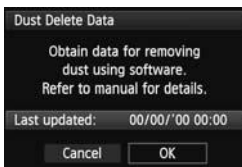

#### 2 Select [OK].

- Select [**OK**] and press <SET>. After the automatic self-cleaning of the sensor is performed, a message will appear. Although there will be a shutter sound during the cleaning, no picture is taken.

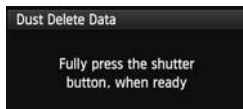
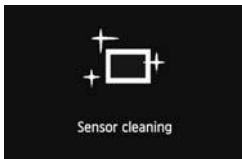



### 3 Photograph a solid-white object.

- At a distance of 20 cm - 30 cm (0.7 ft. - 1.0 ft.), fill the viewfinder with a patternless, solid-white object and take a picture.
- ▶ The picture will be taken in aperture-priority AE mode at an aperture of f/22.
- Since the image will not be saved, the data can still be obtained even if there is no card in the camera.
- ▶ When the picture is taken, the camera will start collecting the Dust Delete Data. When the Dust Delete Data is obtained, a message will appear. Select [OK], and the menu will reappear.
- If the data was not obtained successfully, a message to that effect will appear. Follow the “Preparation” procedure on the preceding page, then select [OK]. Take the picture again.

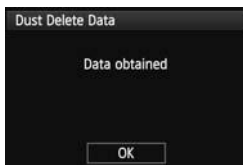

## About the Dust Delete Data

After the Dust Delete Data is obtained, it is appended to all the JPEG and RAW images captured thereafter. Before an important shoot, you should update the Dust Delete Data by obtaining it again.

For details about using Digital Photo Professional (provided software, p.394) to erase dust spots, refer to the Digital Photo Professional Instruction Manual (p.396).

The Dust Delete Data appended to the image is so small that it hardly affects the image file size.

**!** Be sure to use a solid-white object such as a new sheet of white paper. If the paper has any pattern or design, it may be recognized as dust data and affect the accuracy of the dust deletion with the software.

## MENU Manual Sensor Cleaning<sup>☆</sup>

Dust that could not be removed by the automatic sensor cleaning can be removed manually with a blower, etc. Before cleaning the sensor, detach the lens from the camera.

**The surface of the image sensor is extremely delicate. If the sensor needs to be cleaned directly, having it done by a Canon Service Center is recommended.**

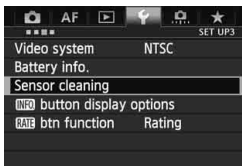

### 1 Select [Sensor cleaning].

- Under the [**4**3] tab, select [**Sensor cleaning**], then press <SET>.



### 2 Select [Clean manually].

- Select [**Clean manually**], then press <SET>.



### 3 Select [OK].

- Select [**OK**], then press <SET>.
- ▶ In a moment, the reflex mirror will lockup and the shutter will open.
- “CLn” will blink on the LCD panel.

### 4 Clean the sensor.

### 5 End the cleaning.

- Set the power switch to <OFF>.



If you use a battery, make sure it is fully charged. If the battery grip with size-AA/LR6 batteries is attached, manual sensor cleaning will not be possible.



For the power source, using the DC Coupler DR-E6 (sold separately) and AC Adapter AC-E6N (sold separately) is recommended.

- **While cleaning the sensor, never do any of the following. Doing any of the following will cut off the power and close the shutter. The shutter curtains and image sensor may then get damaged.**
  - **Setting the power switch to <OFF>.**
  - **Removing or inserting the battery.**
- The surface of the image sensor is extremely delicate. Clean the sensor with care.
- Use a plain blower without any brush attached. A brush can scratch the sensor.
- Do not insert the blower tip inside the camera beyond the lens mount. If the power is cut off, the shutter will close and the shutter curtains or reflex mirror may get damaged.
- Never use canned air or gas to clean the sensor. The blowing force can damage the sensor or the spray gas can freeze on the sensor.
- If the battery level becomes low while you clean the sensor, the beeper will sound as a warning. Stop cleaning the sensor.
- If a smudge that cannot be removed with a blower remains, having the sensor cleaned by a Canon Service Center is recommended.

# 12

## Printing Images and Transferring Images to a Computer

- **Printing** (p.304)  
You can connect the camera directly to a printer and print out the images on the card. The camera is compatible with “PictBridge” which is the standard for direct printing.
- **Digital Print Order Format (DPOF)** (p.311)  
DPOF (Digital Print Order Format) enables you to print images recorded on the card according to your printing instructions such as the image selection, quantity to print, etc. You can print multiple images in one batch or give the print order to a photofinisher.
- **Transferring Images to a Personal Computer** (p.315)  
You can connect the camera to a personal computer and operate the camera to transfer images recorded on the card to the personal computer.

## Preparing to Print

The direct printing procedure can be performed entirely with the camera while you look at the LCD monitor.

### Connecting the Camera to a Printer

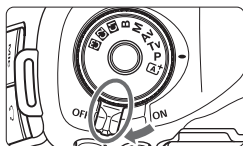

- 1 Set the camera's power switch to **<OFF>**.

- 2 Set up the printer.

- For details, refer to the printer's instruction manual.

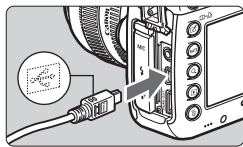

- 3 Connecting the camera to the printer.

- Use the interface cable provided with the camera.
- Connect the cable to the camera's **<DIGITAL>** terminal with the cable plug's **<↔>** icon facing the front of the camera.
- To connect to the printer, refer to the printer's instruction manual.

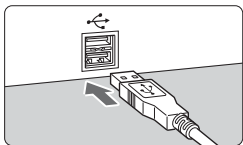

- 4 Turn on the printer.

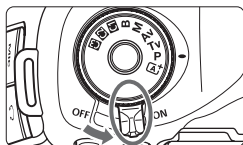

- 5 Set the camera's power switch to **<ON>**.

- ▶ Some printers may make a beeping sound.

## PictBridge



## 6 Play back the image.

- Press the <▶> button.
- ▶ The image will appear, and the <PictBridge icon> will appear on the upper left to indicate that the camera is connected to a printer.



- Movies cannot be printed.
- The camera cannot be used with printers compatible only with CP Direct or Bubble Jet Direct.
- Do not use any interface cable other than the one provided.
- If there is a long beeping sound in step 5, it indicates a problem with the printer. Resolve the problem displayed by the error message (p.310).
- Printing is not possible in the HDR mode.



- You can also print RAW images taken with this camera.
- If you use a battery pack to power the camera, make sure it is fully charged. With a fully-charged battery, printing up to approx. 4 hours is possible.
- Before disconnecting the cable, first turn off the camera and printer. Hold the plug (not the cord) to pull out the cable.
- For direct printing, using the DC Coupler DR-E6 (sold separately) and AC Adapter AC-E6N (sold separately) to power the camera is recommended.

# ☑ Printing

The screen display and setting options will differ depending on the printer. Some settings may not be available. For details, refer to the printer's instruction manual.

Printer-connected icon



## 1 Select the image to be printed.

- Check that the <☑> icon is displayed on the upper left of the LCD monitor.
- Turn the <☉> dial to select the image to be printed.

## 2 Press <SET>.

- ▶ The print settings screen will appear.

### Print setting screen

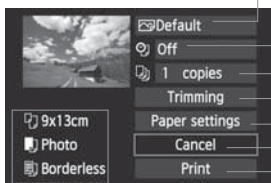

Sets the printing effects (p.306).

Sets the date or file number imprinting to on or off.

Sets the quantity to be printed.

Sets the trimming (cropping) (p.309).

Sets the paper size, type, and layout.

Returns to the screen in step 1.

Starts the printing.

The paper size, type, and layout you have set are displayed.

\* Depending on the printer, certain settings such as the date and file number imprinting and trimming may not be selectable.

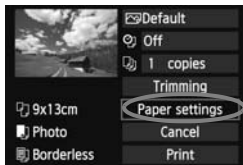

## 3 Select [Paper settings].

- Select [Paper settings], then press <SET>.
- ▶ The paper settings screen will appear.



## Setting the Paper Size



- Select the size of the paper loaded in the printer, then press **<SET>**.
- ▶ The paper type screen will appear.

## Setting the Paper Type

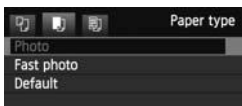

- Select the type of the paper loaded in the printer, then press **<SET>**.
- ▶ The page layout screen will appear.

## Setting the Page Layout

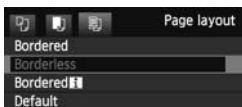

- Select the page layout, then press **<SET>**.
- ▶ The print settings screen will reappear.

<b>Bordered</b>	The print will have white borders along the edges.
<b>Borderless</b>	The print will have no borders. If your printer cannot print borderless prints, the print will have borders.
<b>Bordered [i]</b>	The shooting information* <sup>1</sup> will be imprinted on the border on 9x13 cm and larger prints.
<b>xx-up</b>	Option to print 2, 4, 8, 9, 16, or 20 images on one sheet.
<b>20-up [i]</b> <b>35-up [i]</b>	Twenty or 35 images will be printed as thumbnails on A4 or Letter size paper* <sup>2</sup> . • <b>[20-up [i]]</b> will have the shooting information* <sup>1</sup> imprinted.
<b>Default</b>	The page layout will vary depending on the printer model or its settings.

\*1: From the Exif data, the camera name, lens name, shooting mode, shutter speed, aperture, exposure compensation amount, ISO speed, white balance, etc., will be imprinted.

\*2: After ordering the prints with "Digital Print Order Format (DPOF)" (p.311), you should print by following "Direct Printing with DPOF" (p.314).

If the image's aspect ratio is different from the printing paper's aspect ratio, the image may be cropped significantly if you print it as a borderless print. If the image is cropped, it may look more grainy on the paper due to the fewer number of pixels.

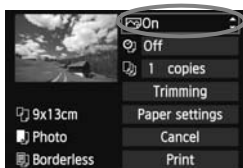

## 4 Set the printing effects.

- Set if necessary. If you do not need to set any printing effects, go to step 5.
- **What is displayed on the screen differs depending on the printer.**
- Select the option, then press <SET>.
- Select the desired printing effect, then press <SET>.
- If the <INFO> icon is displayed brightly next to <INFO>, you can also adjust the printing effect (p.308).

Printing Effect	Description
On	The image will be printed according to the printer's standard colors. The image's Exif data is used to make automatic corrections.
Off	No automatic correction will be applied.
VIVID	The image will be printed with higher saturation to produce more vivid blues and greens.
NR	Image noise is reduced before printing.
<b>B/W B/W</b>	Prints in black-and-white with true blacks.
<b>B/W Cool tone</b>	Prints in black-and-white with cool, bluish blacks.
<b>B/W Warm tone</b>	Prints in black-and-white with warm, yellowish blacks.
Natural	Prints the image in the actual colors and contrast. No automatic color adjustments are applied.
Natural M	The printing characteristics are the same as the "Natural" setting. However, this setting enables finer printing adjustments than with "Natural."
Default	The printing will differ depending on the printer. For details, refer to the printer's instruction manual.

\* When you change the printing effects, it is reflected in the image displayed on the upper left. Note that the printed image may look slightly different from the displayed image which is only an approximation. This also applies to [Brightness] and [Adjust levels] on page 308.

If the shooting information of an image shot at the H1 or H2 ISO speed is imprinted, the correct ISO speed may not be imprinted.



## 5 Set the date and file number imprinting.

- Set if necessary.
- Select <Ⓞ>, then press <SET>.
- Set as desired, then press <SET>.



## 6 Set the number of copies.

- Set if necessary.
- Select <Ⓞ>, then press <SET>.
- Set the number of copies, then press <SET>.

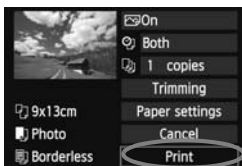

## 7 Start printing.

- Select [Print], then press <SET>.



- With Easy printing, you can print another image using the same settings. Just select the image and press the <□•□> button. With Easy printing, the number of copies will always be 1. (You cannot set the number of copies.) Also, any trimming (p.309) will not be applied.
- The **[Default]** setting for printing effects and other options are the printer's own default settings as set by the printer's manufacturer. Refer to the printer's instruction manual to find out what the **[Default]** settings are.
- Depending on the image's file size and image-recording quality, it may take some time for the printing to start after you select **[Print]**.
- If image tilt correction (p.309) is applied, it may take longer to print the image.
- To stop the printing, press <SET> while **[Stop]** is displayed, then select **[OK]**.
- If you execute **[F4: Clear all camera settings]** (p.56), all the settings will revert to their defaults.

## Adjustment of Printing Effects

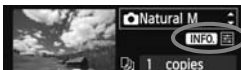

In step 4 on page 306, select the printing effect. When the  icon is displayed brightly next to **<INFO.>**, you can press the **<INFO.>** button. You can then adjust the printing effect. What can be adjusted or what is displayed will depend on the selection made in step 4.



### ● Brightness

The image brightness can be adjusted.

### ● Adjust levels

When you select **[Manual]**, you can change the histogram's distribution and adjust the image's brightness and contrast.

With the Adjust levels screen displayed, press the **<INFO.>** button to change the position of the **<↑>**. Turn the **<⦿>** dial to freely adjust the shadow level (0 - 127) or highlight level (128 - 255).

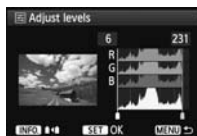

### ● Brightener

Effective in backlit conditions that can make the subject's face look dark. When **[On]** is set, the face will be brightened for printing.

### ● Red-eye corr.

Effective in flash images where the subject has red eye. When **[On]** is set, the red eye will be corrected for printing.



- The **[ Brightener]** and **[Red-eye corr.]** effects will not show on the screen.
- When **[Detail set.]** is selected, you can adjust the **[Contrast]**, **[Saturation]**, **[Color tone]**, and **[Color balance]**. To adjust the **[Color balance]**, use **<◀>**. B is for blue, A is amber, M is magenta, and G is green. The color in the respective direction will be corrected.
- If you select **[Clear all]**, all the printing effect settings will be reverted to their defaults.

## Trimming the Image



You can crop the image and print only the trimmed portion as if the image was recomposed.

### **Set the trimming right before printing.**

If you set the trimming and then set the print settings, you may have to set the trimming again before printing.

**1 On the print settings screen, select [Trimming].**

**2 Set the trimming frame size, position, and aspect ratio.**

- The image area within the trimming frame will be printed. The trimming frame's aspect ratio can be changed with **[Paper settings]**.

### **Changing the trimming frame size**

Turn the  dial to change the trimming frame size. The smaller the trimming frame, the larger the image magnification will be for printing.



### **Moving the trimming frame**

Use  to move the frame over the image vertically or horizontally. Move the trimming frame until it covers the desired image area.

### **Rotating the frame**

Pressing the **<INFO.>** button will toggle the trimming frame between the vertical and horizontal orientations. This enables you to create a vertically oriented print from a horizontal image.

### **Image tilt correction**

By turning the  dial, you can adjust the image tilt angle up to  $\pm 10$  degrees in 0.5-degree increments. When you adjust the image tilt, the  icon on the screen will turn blue.

**3 Press  to exit the trimming.**

- ▶ The print settings screen will reappear.
- You can check the trimmed image area on the upper left of the print settings screen.

- Depending on the printer, the trimmed image area may not be printed as you specified.
- The smaller you make the trimming frame, the grainier the picture will look in the print.
- While trimming the image, look at the camera's LCD monitor. If you look at the image on a TV screen, the trimming frame may not be displayed accurately.



## Handling Printer Errors

If you resolve a printer error (no ink, no paper, etc.) and select [**Continue**] to resume printing but it does not resume, operate the buttons on the printer to resume printing. For details on resuming the printing, refer to the printer's instruction manual.

### Error Messages

If a problem occurs during printing, an error message will appear on the camera's LCD monitor. Press <ⓈET> to stop printing. After fixing the problem, resume printing. For details on how to fix a printing problem, refer to the printer's instruction manual.

#### Paper Error

Check whether the paper is properly loaded in the printer.

#### Ink Error

Check the printer's ink level, and check the waste ink tank.

#### Hardware Error

Check for any printer problems other than paper and ink problems.

#### File Error

The selected image cannot be printed via PictBridge. Images taken with a different camera or images edited with a computer may not be printable.

# Digital Print Order Format (DPOF)

You can set the print type, date imprinting, and file number imprinting. The print settings will be applied to all print-ordered images. (They cannot be set individually for each image.)

## Setting the Printing Options

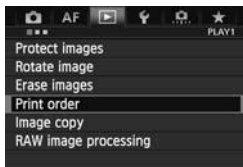

### 1 Select [Print order].

- Under the [▶1] tab, select [Print order], then press <SET>.

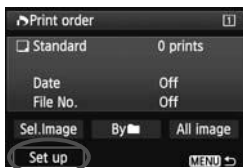

### 2 Select [Set up].

- Select [Set up], then press <SET>.

### 3 Set the option as desired.

- Set the [Print type], [Date], and [File No.].
- Select the option to be set, then press <SET>. Select the desired setting, then press <SET>.

[Print type]





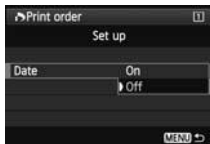

[Date]

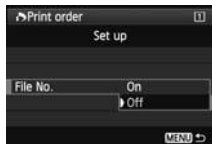



[File No.]



Print type		Standard	Prints one image on one sheet.
		Index	Multiple thumbnail images are printed on one sheet.
	 	Both	Prints both the standard and index prints.
Date	On	[On] imprints the recorded date on the print.	
	Off		
File number	On	[On] imprints the file number on the print.	
	Off		

## 4 Exit the setting.

- Press the <MENU> button.
- ▶ The print order screen will reappear.
- Next, select [**Sel.Image**], [**By** ], or [**All image**] to order the images to be printed.

- 
- Even if [**Date**] and [**File No.**] are set to [**On**], the date or file number may not be imprinted depending on the print type setting and printer model.
  - With [**Index**] prints, both the [**Date**] and [**File No.**] cannot be set to [**On**] at the same time.
  - When printing with DPOF, you must use the card whose print order specifications have been set. It will not work if you just extract images from the card and try to print them.
  - Certain DPOF-compatible printers and photofinishers may not be able to print the images as you specified. If this happens with your printer, refer to the printer's instruction manual. Or check with your photofinisher about compatibility when ordering prints.
  - Do not insert into the camera a card whose print order was set by a different camera and then try to specify a print order. The print order may not work or may be overwritten. Also, depending on the image type, the print order may not be possible.

 RAW images and movies cannot be print ordered. You can print RAW images with PictBridge (p.302).



## Print Ordering

### ● Sel.Image

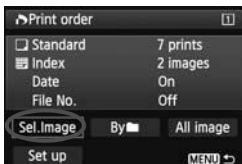

Select and order images one by one. If you press the <Q> button and turn the <☀> dial counterclockwise, you can select an image from a three-image display. To return to the single-image display, turn the <☀> dial clockwise. Press the <MENU> button to save the print order to the card.



### [Standard] [Both]

Press <SET> and a print order for one copy of the displayed image will be placed. By turning the <☀> dial, you can set the quantity up to 99.



### [Index]

Press <SET> to include images with a checkmark <✓> in the index print.

### ● By [Folder Icon]

Select **[Mark all in folder]** and select the folder. A print order for one copy of all the images in the folder will be placed. If you select **[Clear all in folder]** and select the folder, the print order for that folder will all be canceled.

### ● All image

If you select **[Mark all on card]**, one copy of all the images on the card will be set for printing. If you select **[Clear all on card]**, the print order will be cleared for all the images on the card.



- Note that RAW images and movies will not be included in the print order even if you set "By [Folder Icon]" or "All image."
- When using a PictBridge printer, print no more than 400 images for one print order. If you specify more than this, all the images may not be printed.

## Direct Printing with DPOF

With a PictBridge printer, you can easily print images with DPOF.

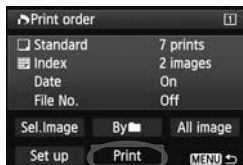

### 1 Prepare to print.

- See page 302. Follow the “Connecting the Camera to a Printer” procedure up to step 5.

### 2 Under the [ ] tab, select [Print order].

### 3 Select [Print].

- [Print] will be displayed only if the camera is connected to a printer and printing is possible.

### 4 Set the [Paper settings] (p.304).

- Set the printing effects (p.306) if necessary.

### 5 Select [OK].

- Before printing, be sure to set the paper size.
- Certain printers cannot imprint the file number.
- If [Bordered] is set, certain printers may imprint the date on the border.
- Depending on the printer, the date may appear faint if it is imprinted on a bright background or on the border.

- Under [Adjust levels], [Manual] cannot be selected.
- If you stopped the printing and want to resume printing the remaining images, select [Resume]. Note that printing will not resume if you stop the printing and any of the following occurs:
  - Before resuming the printing, you changed the print order or deleted print-ordered images.
  - When you set the index, you changed the paper setting before resuming the printing.
  - When you paused the printing, the card's remaining capacity was low.
- If a problem occurs during printing, see page 310.

## Transferring Images to a Personal Computer ■

You can connect the camera to a personal computer and operate the camera to transfer images on the card to the personal computer. This is called direct image transfer.

**The direct image transfer can be performed with the camera while you look at the LCD monitor.**

The images transferred to the personal computer will be saved in the [Pictures] or [My Pictures] folder and organized in folders by shooting date.

**ⓘ Before connecting the camera to the personal computer, be sure to install the provided software (EOS DIGITAL Solution Disk on CD-ROM) on the personal computer.**

For the procedure to install the provided software, see page 395.

### Preparation for Image Transfer

**1 Set the camera's power switch to <OFF>.**

**2 Connect the camera to a personal computer.**

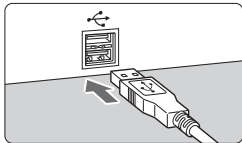
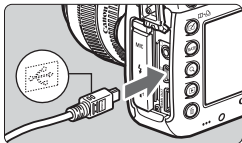

- Use the interface cable provided with the camera.
- Connect the cable to the camera's <DIGITAL> terminal with the cable plug's <↔> icon facing the front of the camera.
- Connect the cord's plug to the personal computer's USB terminal.

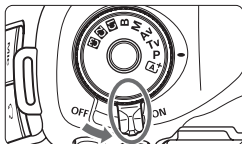

### 3 Set the camera's power switch to <ON>.

- When the personal computer displays a screen to select the program, select **[EOS Utility]**.
- ▶ The EOS Utility screen will appear on the personal computer.

⚠ **After the EOS Utility screen appears, do not operate EOS Utility.** If any screen other than EOS Utility's main window is displayed, **[Direct transfer]** in step 5 on page 318 will not be displayed. (The image transfer function will not be available.)

- If the EOS Utility screen does not appear, refer to the EOS Utility Instruction Manual (p.396).
- Before disconnecting the cable, turn off the camera. Hold the plug (not the cord) to pull out the cable.

## **MENU** Transferring RAW+JPEG Images



For RAW+JPEG images, you can specify which image to transfer. On the next page in step 2, select **[RAW+JPEG transfer]**, and select the image to be transferred: **[JPEG only]**, **[RAW only]**, or **[RAW+JPEG]**.

## MENU Select the Images to be Transferred

### ● Sel.Image



#### 1 Select [Image transfer].

- Under the [▶2] tab, select [Image transfer], then press <SET>.



#### 2 Select [Image sel./transfer].

- Select [Image sel./transfer], then press <SET>.

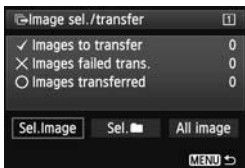

#### 3 Select [Sel.Image].

- Select [Sel.Image], then press <SET>.

#### 4 Select the images to be transferred.

- Turn the <Q> dial to select the image to be transferred, then press <SET>.
- Turn the <Q> dial to display the <✓> on the screen's upper left, then press <SET>.
- If you press the <Q> button and turn the <Q> dial counterclockwise, you can select an image from a three-image display. To return to the single-image display, turn the <Q> dial clockwise.
- To select other images to be transferred, repeat step 4.
- To return to the screen in step 3, press the <MENU> button.



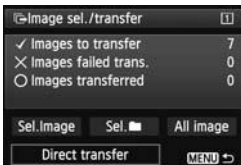

- When [Sel.Image] is selected, you can check the image's transfer status on the upper left of the screen: No mark: Not selected. ✓: Selected for transfer. X: Transfer failed. ○: Transfer succeeded.
- On page 316, the procedures for [RAW+JPEG transfer] and steps 1 to 4 can also be performed while the camera is not connected to a personal computer.



## 5 Transfer the image.

- On the computer screen, check that EOS Utility's main window is displayed.
  - Select [**Direct transfer**], then press < (SET) >.
  - On the confirmation screen, select [OK] and the images will be transferred to the personal computer.
  - Images selected with [Sel. [Folder]] and [All image] can also be transferred in this way.
- **Sel. [Folder]**  
 Select [Sel. [Folder]] and select [**Folder images not transfer'd**]. When you select a folder, all the images in that folder not yet transferred to the personal computer will be selected.  
 Selecting [**Folder images failed transf.**] will select the selected folder's images that failed to transfer.  
 Selecting [**Clear folder transf. history**] will clear the transfer history of the images in the selected folder. After clearing the transfer history, you can select [**Folder images not transfer'd**] and again transfer all the images in the folder.
  - **All image**  
 If [**All image**] is selected and you select [**Card images not transferred**], all the images on the card not yet transferred to a personal computer will be selected.  
 For a description of [**Card images failed transfer**] and [**Clear card's transf. history**], see "Sel. [Folder]" above.

-  ● If any screen other than EOS Utility's main window is displayed on the personal computer, [**Direct transfer**] is not displayed.
- During the image transfer, certain menu options cannot be used.

-  ● You can also transfer movies.
- Up to 9,999 images can be transferred in one batch.
  - Shooting is possible during the image transfer.

# 13

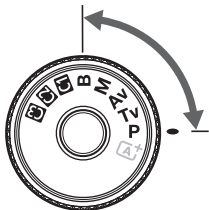

## Customizing the Camera

You can customize various camera features to suit your picture-taking preferences with Custom Functions. Also, the current camera settings can be saved under the Mode Dial's <C1>, <C2>, and <C3> positions. The features explained in this chapter can be set and used in the following shooting modes: **P/Tv/Av/M/B**.



# MENU Custom Functions ☆

## ☛ 1: Exposure

		 LV Shooting	 Movie Shooting
Exposure level increments	p.321	<input type="radio"/>	<input type="radio"/>
ISO speed setting increments		<input type="radio"/>	In <b>M</b>
Bracketing auto cancel		<input type="radio"/>	(Still photo, with WB bracketing set)
Bracketing sequence	<input type="radio"/>		
Number of bracketed shots	p.322	<input type="radio"/>	
Safety shift	p.323	<input type="radio"/>	

## ☛ 2: Display/Operation

Warnings  in viewfinder	p.324		
LV shooting area display		<input type="radio"/>	
Dial direction during Tv/Av	p.325	<input type="radio"/>	<input type="radio"/>
Multi function lock		<input type="radio"/>	<input type="radio"/>
Custom Controls		Depends on setting	

## ☛ 3: Others

Add cropping information	p.326	<input type="radio"/>	
Default Erase option		(During playback)	

## ☛ 4: Clear

Selecting [**☛ 4: Clear all Custom Func. (C.Fn)**] will clear all the Custom Function settings.

- The shaded Custom Functions do not function during Live View (LV shooting) nor movie shooting. (Settings are disabled.)
- Even if all the Custom Functions are cleared, the settings for [**☛ 2: Custom Controls**] will remain unchanged.



## MENU Custom Function Settings ☆

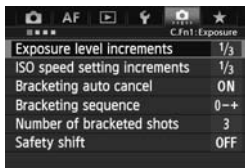

Under the [] tab, you can customize various camera features to suit your picture-taking preferences. Any settings different from the default will be displayed in blue.

### C.Fn1: Exposure

#### Exposure level increments

**1/3: 1/3-stop**

**1/2: 1/2-stop**

Sets 1/2-stop increments for the shutter speed, aperture, exposure compensation, AEB, flash exposure compensation, etc. Effective when you prefer to control the exposure in less fine increments than 1/3-stop increments.



With [**1/2-stop**] set, the exposure level will be displayed in the viewfinder and on the LCD panel as shown below.



#### ISO speed setting increments

**1/3: 1/3-stop**

**1/1: 1-stop**

#### Bracketing auto cancel

**ON: Enable**

When you set the power switch to <**OFF**>, the AEB and white balance bracketing settings will be canceled. AEB will also be canceled when the flash is ready to fire or if you switch to movie shooting.

**OFF: Disable**

The AEB and white balance bracketing settings will not be canceled even if you set the power switch to <**OFF**>. (If the flash is ready to fire or if you switch to movie shooting, AEB will be canceled temporarily, but the AEB range will be retained.)

## Bracketing sequence

The AEB shooting sequence and white balance bracketing sequence can be changed.

**0-+:** 0, -, +

**-0+:** -, 0, +

**+0-:** +, 0, -

AEB	White Balance Bracketing	
	B/A Direction	M/G Direction
0 : Standard exposure	0 : Standard white balance	0 : Standard white balance
- : Decreased exposure	- : Blue bias	- : Magenta bias
+ : Increased exposure	+ : Amber bias	+ : Green bias

## Number of bracketed shots

The number of shots taken with AEB and white balance bracketing can be changed from the usual 3 shots to 2, 5, or 7 shots.

When [**Bracketing sequence: 0, -, +**] is set, the bracketed shots will be taken as shown in the table below.

**3: 3 shots**

**2: 2 shots**

**5: 5 shots**

**7: 7 shots**

(1-stop increments)

	1st Shot	2nd Shot	3rd Shot	4th Shot	5th Shot	6th Shot	7th Shot
3: 3 shots	Standard (0)	-1	+1				
2: 2 shots	Standard (0)	±1					
5: 5 shots	Standard (0)	-2	-1	+1	+2		
7: 7 shots	Standard (0)	-3	-2	-1	+1	+2	+3

 If [**2 shots**] is set, you can select the + or - side when setting the AEB range.

## Safety shift

### OFF: Disable

#### Tv/Av: Shutter speed/Aperture

This takes effect in the shutter-priority AE (**Tv**) and aperture-priority AE (**Av**) modes. If the subject brightness changes and the standard exposure cannot be obtained within the autoexposure range, the camera will automatically change the manually-selected setting to obtain a standard exposure.

#### ISO: ISO speed

This works in the Program AE (**P**), shutter-priority AE (**Tv**), and aperture-priority AE (**Av**) modes. If the subject brightness changes and the standard exposure cannot be obtained within the autoexposure range, the camera will automatically change the manually set ISO speed to obtain a standard exposure.





- Under [**2: ISO speed settings**], even if [**ISO speed range**] or [**Min. shutter spd.**] is changed from the default setting, safety shift will override it if a standard exposure cannot be obtained.
- The minimum and maximum ISO speeds of the safety shift using the ISO speed will be determined by the [**Auto ISO range**] setting (p.129). However, if the manually set ISO speed exceeds the [**Auto ISO range**], the safety shift will take effect up to the manually set ISO speed.
- If [**Shutter speed/Aperture**] or [**ISO speed**] is set, safety shift will take effect if necessary even when flash is used.

## C.Fn2: Disp./Operation

### Warnings in viewfinder

When any of the following functions are set, the  icon can be displayed on the viewfinder's bottom right (p.23).

Select the function for which you want the warning icon to appear, press  to append a , then select [OK].

#### When monochrome is set

If the Picture Style is set to [Monochrome] (p.133), the warning icon will appear.

#### When WB is corrected

If white balance correction (p.142) is set, the warning icon will appear.

#### When one-touch image quality is set

If you change the image-recording quality with the one-touch image quality function (p.334), the warning icon will appear.

#### When ISO expansion is used

If the ISO speed is set manually to L (50), H1 (51200), or H2 (102400) (p.127), the warning icon will appear.

#### When spot metering is set

If the metering mode is set to [Spot metering] (p.170), the warning icon will appear.

### LV shooting area display

When the aspect ratio for Live View shooting is set to [4:3], [16:9], or [1:1] (p.206), you can set the display method for the shooting area.

Masked





Outlined

## Dial direction during Tv/Av



 **Normal**

 **Reverse direction**

The dial's turning direction for setting the shutter speed and aperture can be reversed.

In the <M> shooting mode, the turning direction of the  and  dial will be reversed. In the other shooting modes, the turning direction of only the  dial will be reversed. The  dial's turning direction will be the same for the <M> mode and for setting the exposure compensation.

## Multi function lock

When the <LOCK▶> switch is set to the right, it will prevent the , , and  from accidentally changing a setting.



Select the camera control you want to lock, then press <SET> to append a checkmark <✓> and select [OK].

 **Main Dial**

 **Quick Control Dial**

 **Multi-controller**



- If the <LOCK▶> switch is set and you try to use one of the locked camera controls, <L> will be displayed in the viewfinder and on the LCD panel. Also, on the shooting settings display (p.48), [LOCK] will be displayed.
- By default, when the <LOCK▶> switch is set to the right, the  dial will be locked.
- Even if the  dial is appended with a <✓> checkmark, you can still use the touch pad .

## Custom Controls

You can assign often-used functions to camera buttons or dials according to your preferences. For details, see page 327.

## C.Fn3: Others

### Add cropping information

If you set cropping information, vertical lines for the aspect ratio you have set will appear on the Live View image. You can then compose the shot as if you were shooting with a medium- or large-format camera (6x6 cm, 4x5 inch, etc.).

When you take a picture, the aspect ratio information for cropping the image with the provided software will be appended to the image. (The image is recorded to the card without being cropped.)

After the image is transferred to a personal computer, you can use Digital Photo Professional (provided software, p.394) to easily crop the image to the aspect ratio that was set.

**OFF : Off**

**6:7 : Aspect ratio 6:7**

**6:6 : Aspect ratio 6:6**

**5:6 : Aspect ratio 10:12**

**3:4 : Aspect ratio 3:4**

**5:7 : Aspect ratio 5:7**

**4:5 : Aspect ratio 4:5**

- If [**4: Aspect ratio**] is not set to [**3:2**], you cannot add cropping information to the image.
- If cropping information has been added to a **RAW** image, the image cannot be cropped with the camera's RAW image processing.

### Default Erase option

During image playback and image review after image capture, when you press the <  > button, the erase menu appears (p.283). You can set which option, [**Cancel**] or [**Erase**], is to be preselected on this screen.

If [**Erase**] is set, you can just press <  > to quickly erase the image.

 [**Cancel**] selected

 [**Erase**] selected

- If [**Erase**] is set, be careful not to erase an image accidentally.

## 2: Custom Controls

You can assign frequently-used functions to camera buttons or dials according to your preferences.

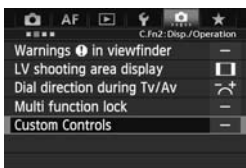

### 1 Select [2: Custom Controls].

- Under the [2] tab, select [Custom Controls], then press <SET>.
- ▶ The Custom Controls screen will appear.



### 2 Select a camera button or dial.

- Turn the <DISP> dial to select a button or dial, then press <SET>.
- ▶ The name of the camera control and the assignable functions will be displayed.



### 3 Assign a function.

- Turn the <DISP> dial to select the desired function, then press <SET>.
- If the [INFO] icon appears on the bottom left, you can press the <INFO.> button and set other related options (p.330-336). Select the desired option on the screen displayed, then press <SET>.

### 4 Exit the setting.





- When you press <SET> to exit the setting, the screen in step 2 will reappear.
- Press the <MENU> button to exit.

With the screen in step 2 displayed, you can press the <DISP> button to cancel the Custom Control settings. Note that the [2: Custom Controls] settings will not be canceled even if you select [4: Clear all Custom Func. (C.Fn)].

## Assignable Functions to Camera Controls

Function		Page		AF-ON	
AF	AF	Metering and AF start	330	<input type="radio"/>	<input type="radio"/> *1
	AF-OFF	AF stop	331	<input type="radio"/>	<input type="radio"/>
	AF↔	Switch to registered AF function			
		ONE SHOT ↔ AI SERVO			
		Switch to registered AF point	332		
		AF point direct selection			
Exposure		Metering start	332	<input type="radio"/>	
		AE lock		<input type="radio"/>	<input type="radio"/>
		AE lock (while button pressed)		<input type="radio"/>	
		AE lock (hold)	333	<input type="radio"/>	<input type="radio"/>
	FEL	FE lock		<input type="radio"/>	<input type="radio"/>
	ISO	Set ISO speed (hold button, turn )			
	ISO	Set ISO speed ( during metering)			
	Tv	Shutter speed setting in M mode			
Av	Aperture setting in M mode				
Image		One-touch image quality setting	334		
		One-touch image quality (hold)			
		Image quality			
		Picture Style			
Operation		Depth-of-field preview	335		
		IS start			
		VF electronic level			
	MENU	Menu display	336		
		Image playback			
		Magnify/Reduce (press SET, turn )			
OFF	No function (disabled)		<input type="radio"/>	<input type="radio"/>	



	LENS*	M-Fn	SET			
	<input type="radio"/>					
<input type="radio"/>	<input type="radio"/>					
<input type="radio"/> *2	<input type="radio"/> *2					
<input type="radio"/>	<input type="radio"/>					
<input type="radio"/> *3	<input type="radio"/> *3					
					<input type="radio"/>	<input type="radio"/> *4
<input type="radio"/>	<input type="radio"/>	<input type="radio"/>				
<input type="radio"/>	<input type="radio"/>	<input type="radio"/>				
<input type="radio"/>		<input type="radio"/>				
			<input type="radio"/>			
					<input type="radio"/>	
				<input type="radio"/>	<input type="radio"/>	
				<input type="radio"/>	<input type="radio"/>	
<input type="radio"/> *5		<input type="radio"/> *5				
<input type="radio"/> *5		<input type="radio"/> *5				
			<input type="radio"/>			
			<input type="radio"/>			
<input type="radio"/>						
<input type="radio"/>	<input type="radio"/>					
<input type="radio"/>		<input type="radio"/>				
			<input type="radio"/>			
			<input type="radio"/>			
			<input type="radio"/>			
<input type="radio"/>			<input type="radio"/>			<input type="radio"/>

\* The AF stop button (**LENS**) is provided only on super telephoto IS lenses.

## AF: Metering and AF start

When you press the button assigned to this function, metering and AF are executed.

\*1: If you assign the [Metering and AF start] function to the <AF-ON> and <✳> buttons and add the function to switch to the registered AF point, you can instantly switch to the registered AF point. To enable this function, press the <INFO.> button in step 3 on page 327. On the [AF start point] selection screen, select [Registered AF point].

### ● Registering and using an AF point

1. Set the AF area selection mode to one of the following: Single-point Spot AF, Single-point AF, AF point expansion (manual selection, surrounding points), or 61-point automatic selection AF. (Zone AF cannot be registered.)
2. Select an AF point manually (p.74).
3. Hold down the <☑> button and press the <⦿> button. A beep will sound and the AF point will be registered. If the AF area selection mode is not set to 61-point automatic selection AF, the registered AF point will blink.

If [AF4: Orientation linked AF point] is set to [Select separate AF points], you can register the AF point separately for the vertical (camera grip at top or bottom) and horizontal orientations.

4. When you press the <AF-ON> button assigned to this function or press the <✳> button, the camera will switch to the manually-selected AF point when you registered.

To cancel the registered AF point, hold down the <☑> button and press the <ISO•> button. The registered AF point will also be canceled if you select [4: Clear all camera settings].

- When an AF point is registered, the following will be displayed:
  - 61-point automatic selection AF: [ ] HP
  - Single-point Spot AF, Single-point AF, AF point expansion: SEL [ ](Center)/SEL HP (Off-center)
- When registered with SEL [ ] or SEL HP, the registered AF point will blink.

**AF-OFF: AF stop**

The AF will stop while you hold down the button assigned to this function. Convenient when you want to lock the focus during AI Servo AF.

**AF↔: Switch to registered AF function**

After setting AF area selection mode (p.72), Tracking sensitivity (p.92), Acceleration/deceleration tracking (p.93), AF point auto switching (p.94), AI Servo 1st image priority (p.96), and AI Servo 2nd image priority (p.97) and assigning this function to a button, you can apply these settings while you hold down the assigned button for AF.

Convenient when you want to change the AF characteristics during AI Servo AF.

\*2: In step 3 on page 327, if you press the <INFO.> button, the “Switch to registered AF func.” setting screen will appear. Turn the <◀▶> or <☀> dial to select the parameter to be registered, then press <SET> to append a checkmark <✓>. When you select a parameter and press <SET>, you can set the parameter.

By pressing the <⏪> button, you can revert the settings to their defaults.

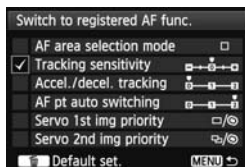
**ONE SHOT ↔ AI SERVO**





You can switch the AF mode. In One-Shot AF mode, when you hold down the button to which this function is assigned, the camera switches to AI Servo AF mode. In the AI Servo AF mode, the camera switches to One-Shot AF mode only while you hold down the button. Convenient when you need to keep switching between One-Shot AF and AI Servo AF for a subject that keeps moving and stopping.



 : **Switch to registered AF point**

During metering, when you press the button assigned to this function, the camera will switch to the AF point registered on page 330.

\*3: In step 3 on page 327, when you press the <INFO.> button, you can select [**Switch only when btn is held**] or [**Switch each time btn is pressed**].

 : **AF point direct selection**

During metering, you can select an AF point directly with the <> dial or <> without pressing the <> button. With the <> dial, you can select a left or right AF point. (With Zone AF, the selected zone will change in a loop.)

\*4: If you use <> and press the <INFO.> button in step 3 on page 327, you can press <> straight down to select [**Switch to center AF point**] or [**Switch to registered AF point**].

 : **Metering start**

When you press the shutter button halfway, only exposure metering is performed.



 : **AE lock**

When you press the button assigned to this function, you can lock the exposure (AE lock) during the metering. Convenient when you want to focus and meter the shot at different areas or when you want to take multiple shots at the same exposure setting.

 : **AE lock (while button pressed)**

The exposure will be locked (AE lock) while you press the shutter button.

 If you assign [**AE lock (while button pressed)**] to the shutter button, any buttons assigned to [**AE lock**] or [**AE lock (hold)**] will also work as [**AE lock (while button pressed)**].



 If you change the aperture in <M> mode when [**AF point direct selection**] is set, turn the <> dial while holding down the <> button.



**\*H: AE lock (hold)**



When you press the button assigned to this function, you can lock the exposure (AE lock). The AE lock will be maintained until you press the button again. Convenient when you want to focus and meter the shot at different areas or when you want to take multiple shots at the same exposure setting.

**FEL: FE lock**

During flash photography, pressing the button assigned to this function will fire a preflash and record the required flash output (FE lock).



**ISO : Set ISO speed (hold button, turn )**

You can set the ISO speed by holding down  and turning the  dial. If Auto ISO is set, manual ISO speed setting will take effect. Auto ISO cannot be set. If you use this function in the **<M>** mode, you can adjust the exposure with the ISO speed while maintaining the current shutter speed and aperture.



**ISO : Set ISO speed ( during metering)**

During metering, you can set the ISO speed by turning the  dial. If Auto ISO is set, manual ISO speed setting will take effect. Auto ISO cannot be set. If you use this function in the **<M>** mode, you can adjust the exposure with the ISO speed while maintaining the current shutter speed and aperture.

**Tv: Shutter speed setting in M mode**

In manual exposure **<M>**, you can set the shutter speed with the  or  dial.

**Av: Aperture setting in M mode**

In manual exposure **<M>**, you can set the aperture with the  or  dial.

: **One-touch image quality setting**

When you press the button assigned to this function, you can switch to the image-recording quality set here. While the camera switches the image-recording quality, the image-recording quality will blink on the LCD panel. After the shooting ends, the One-touch image quality setting will be canceled and the camera will switch back to the previous image-recording quality.

\*5: In step 3 on page 327, if you press the <INFO.> button, you can select the image-recording quality for this function to switch to.

: **One-touch image quality (hold)**

When you press the button assigned to this function, you can switch to the image-recording quality set here. While the camera switches the image-recording quality, the image-recording quality will blink on the LCD panel. Even after shooting, the One-touch image quality setting will not be canceled. To revert to the previous image-recording quality setting, press the button assigned to this function again.

\*5: In step 3 on page 327, if you press the <INFO.> button, you can select the image-recording quality for this function to switch to.

: **Image quality**

Press <SET> to display the image-recording quality setting screen (p.121) on the LCD monitor.

: **Picture Style**

Press <SET> to display the Picture Style selection setting screen (p.131) on the LCD monitor.

 During the switch to the One-touch image quality setting, <(!)> can be displayed in the viewfinder (p.324).

: **Depth-of-field preview**

When you press the depth-of-field preview button, the aperture will stop down and you can check the depth of field (p.167).

: **IS start**

With the lens' IS switch set to <ON>, the lens' Image Stabilizer operates when you press the button assigned to this function.

: **VF electronic level**

When you press the button assigned to this function, the viewfinder will display a grid and an electronic level using the AF points.

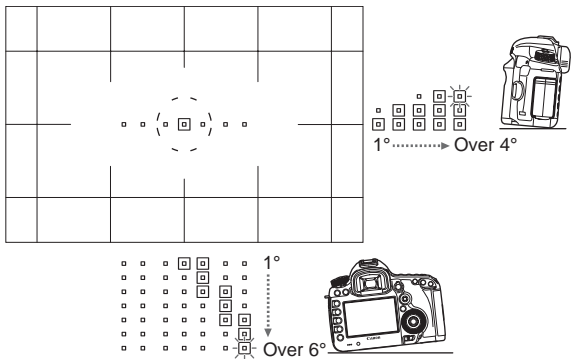



**MENU: Menu display**

Pressing <> will display the menu on the LCD monitor.

**: Image playback**

Pressing <> will play back images.

**: Magnify/Reduce (press SET, turn )**

Press <> to magnify the images recorded on the card. See p.257 for the operation procedure. You can also magnify the Live View image during Live View shooting and movie shooting when focusing with Live Mode, Quick Mode, and manual focus (p.212, 216).

**OFF: No function (disabled)**

Use this setting when you do not want to assign any function to the button.



## MENU Registering My Menu ☆

Under the My Menu tab, you can register up to six menu options and Custom Functions whose settings you change frequently.

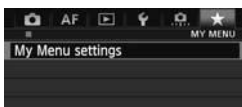

### 1 Select [My Menu settings].

- Under the [★] tab, select [My Menu settings], then press <SET>.

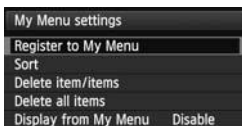

### 2 Select [Register to My Menu].

- Select [Register to My Menu], then press <SET>.

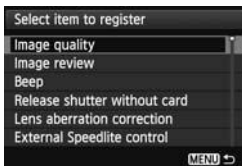

### 3 Register the desired items.

- Select an item to register, then press <SET>.
- On the confirmation dialog, select [OK] and press <SET> to register the item.
- You can register up to six items.
- To return to the screen in step 2, press the <MENU> button.

## About My Menu Settings

### ● Sort

You can change the order of the registered items in My Menu. Select [Sort] and select the item whose order you want to change. Then press <SET>. With [↕] displayed, turn the <DISP> dial to change the order, then press <SET>.



### ● Delete item/items and Delete all items

You can delete any of the registered items. [Delete item/items] deletes one item at a time, and [Delete all items] deletes all registered items.

### ● Display from My Menu



When [Enable] is set, the [★] tab will be displayed first when you display the menu screen.

# Register Custom Shooting Modes <sup>☆</sup>

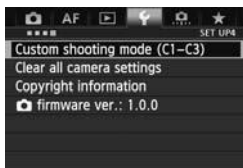
You can register current camera settings, such as the shooting mode, menu functions, and Custom Function settings, as Custom shooting modes under the Mode Dial's <>, <>, and <> positions.





## 1 Select [Custom shooting mode (C1-C3)].

- Under the [4] tab, select [**Custom shooting mode (C1-C3)**], then press <>.





## 2 Select [Register settings].

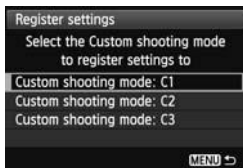

- Turn the <> dial to select [**Register settings**], then press <>.



## 3 Register the Custom shooting mode.

- Turn the <> dial to select the Custom shooting mode to be registered, then press <>.
- On the confirmation dialog, select [**OK**] and press <>.
- ▶ The current camera settings (p.339, 340) will be registered under the Mode Dial's C\* position.

## Automatic Updating

If you change a setting while you shoot in the <>, <>, or <> mode, the Custom shooting mode can be automatically updated to reflect the changed setting(s). To enable this automatic update, in step 2, set [**Auto update set.**] to [**Enable**]. The settings that can be automatically updated are listed on pages 339 and 340.

## Canceling Registered Custom Shooting Modes

In step 2, if you select [**Clear settings**], the respective Mode Dial position will revert to the default setting effective before you registered the camera settings. The procedure is the same as step 3.

## Settings Registered

- **Shooting functions**

Shooting mode + exposure setting, ISO speed, AF mode, AF area selection mode, AF point, Metering mode, Drive mode, Exposure compensation amount, Flash exposure compensation amount

- **Menu functions**

[1] Image quality, Image review, Beep, Release shutter without card, Lens aberration correction (Peripheral illumination correction, Chromatic aberration correction), External Speedlite control, Mirror lockup

[2] Exposure compensation/AEB, ISO speed settings, Auto Lighting Optimizer, White balance, Custom White Balance, White balance Shift/Bracketing, Color space

[3] Picture Style, Long exp. noise reduction, High ISO speed NR, Highlight tone priority, Multiple exposure (settings), HDR Mode (settings)

[4 (Live View shooting)]

Live View shooting, AF mode, Grid display, Aspect ratio, Exposure simulation, Silent LV shooting, Metering timer

[4 (Movie)]

AF mode, Grid display, Movie recording size, Sound recording, Silent LV shooting, Metering timer

[5 (Movie)]

Movie recording count, Movie play count, Silent Control, Movie shooting button, HDMI output + LCD

[AF1] Case 1, Case 2, Case 3, Case 4, Case 5, Case 6

[AF2] AI Servo 1st image priority, AI Servo 2nd image priority

[AF3] USM lens electronic MF, AF-assist beam firing, One-Shot AF release priority

[AF4] Lens drive when AF impossible, Selectable AF point, Select AF area selec. mode, AF area selection method, Orientation linked AF point

[AF5] Manual AF point selection pattern, AF point display during focus, VF display illumination

- [▶2] Slide show, Image jump with 
- [▶3] Highlight alert, AF point disp., Playback grid, Histogram display, Movie play count, Magnificatn (approx.)
- [⚡1] File numbering, Auto rotate, Eye-Fi settings
- [⚡2] Auto power off, LCD brightness, VF grid display, HDMI frame rate
- [⚡3] Sensor cleaning (Auto cleaning), **INFO** button display options, **RATE** button function
- [.☼.1] Exposure level increments, ISO speed setting increments, Bracketing auto cancel, Bracketing sequence, Number of bracketed shots, Safety shift
- [.☼.2] LV shooting area display, Dial direction during Tv/Av, Multi function lock, Custom Controls
- [.☼.3] Add cropping information, Default Erase option

-  ● My Menu settings will not be registered.
- When the Mode Dial is set to <C1>, <C2>, or <C3>, you cannot select [**⚡4: Clear all camera settings**] and [**.☼.4: Clear all Custom Func. (C.Fn)**].

-  ● Even when the Mode Dial is set to <C1>, <C2>, or <C3>, you can still change shooting function settings and menu settings.
- By pressing the <INFO.> button, you can check which shooting mode is registered under <C1>, <C2>, and <C3> (p.342, 343).

# 14

## Reference

---

This chapter provides reference information for camera features, system accessories, etc.

# INFO. Button Functions

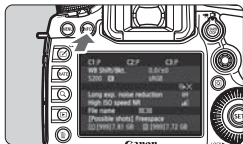

When you press the <INFO.> button while the camera is ready to shoot, you can display [**Displays camera settings**], [**Electronic level**] (p.60), and [**Displays shooting functions**] (p.343).

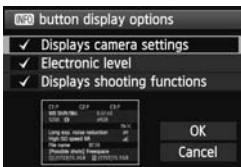

Under the [**3**] tab, [**INFO button display options**] enables you to select the options displayed when the <INFO.> button is pressed.

- Select the desired display option and press <SET> to append a checkmark <✓>.
- After making the selection, select [OK], then press <SET>.

- Note that you cannot remove the <✓> for all three display options.
- The [**Displays camera settings**] sample screen is displayed in English for all languages.
- Even if you uncheck the [**Electronic level**] so it does not appear, it will still appear for Live View shooting and movie shooting when you press the <INFO.> button.

## Camera Settings

Shooting mode registered under the Mode Dial's **C1**, **C2**, and **C3**

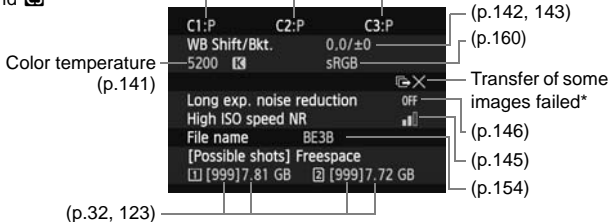

\* This icon is displayed when the transfer of some images failed.

## Shooting Settings

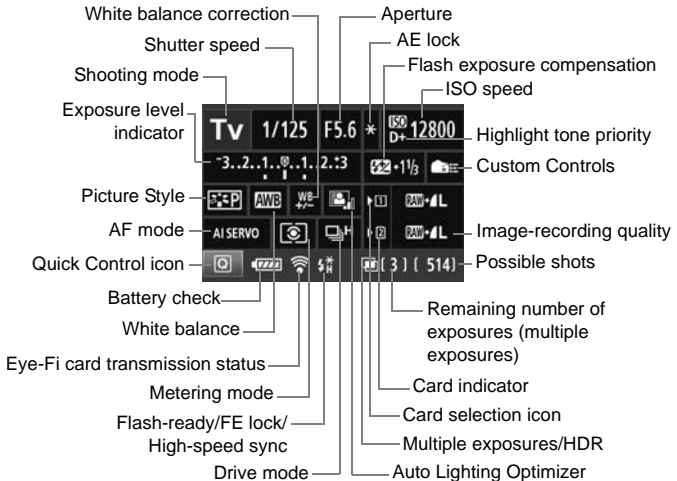

- Pressing the **<Q>** button enables Quick Control of the shooting settings (p.49).
- If you press the **<ISO>**, **<AF·DRIVE>**, **<WB>**, or **<METERING>** button, the respective setting screen will appear on the LCD monitor and you can turn the **<DIAL>** or **<DISK>** dial to set the function. You can also select the AF point with **<AF POINT>**.



If you turn off the power while the “Shooting settings display” screen is displayed, the same screen will be displayed when you turn on the power again. To cancel this, press the **<INFO.>** button to turn off the screen, then turn off the power switch.

## MENU Checking the Battery Information

You can check the battery's condition on the LCD monitor. Each Battery Pack LP-E6/LP-E6N has a unique serial number, and you can register multiple battery packs to the camera. When you use this feature, you can check the registered battery pack's remaining capacity and operation history.

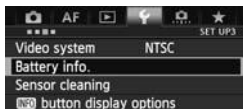

Battery position

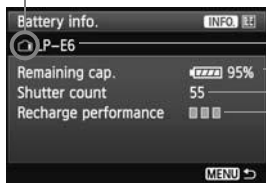

### Select [Battery info.].

- Under the [**F3**] tab, select [**Battery info.**], then press <[**SET**]>.
- ▶ The battery info screen will appear.

Battery model or household power source being used.

The battery level icon (p.35) is displayed together with the remaining battery capacity shown in 1% increments.

Shots taken with the current battery. The number is reset when the battery is recharged.

Battery's recharge performance level is displayed in one of three levels.

■■■■ (Green): Battery's recharge performance is fine.

■■■ (Green): Battery's recharge performance is slightly degraded.

■■ (Red): Purchasing a new battery is recommended.

**!** The use of a genuine Canon Battery Pack LP-E6/LP-E6N is recommended. If you use any battery other than the Battery Pack LP-E6/LP-E6N, the camera's full performance may not be attained or malfunction may result.



- The shutter count is the number of still photos taken. (Movies are not counted.)
- The battery information will also be displayed when a LP-E6/LP-E6N battery pack is in the Battery Grip BG-E11. If you use size-AA/LR6 batteries, only the battery level indicator will be displayed.
- If for some reason, communication with the battery is not possible or irregular, [**Use this battery?**] will be displayed. If you select [**OK**], you can continue shooting. However, depending on the battery, the battery info screen may not be displayed or may not display battery info correctly.



## Registering the Battery to the Camera

You can register up to six LP-E6/LP-E6N battery packs to the camera. To register multiple battery packs to the camera, do the procedure below for each battery pack.

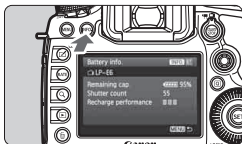

### 1 Press the **<INFO.>** button.

- With the battery info. screen displayed, press the **<INFO.>** button.
- ▶ The battery history screen will appear.
- ▶ If the battery has not been registered, it will be grayed out.

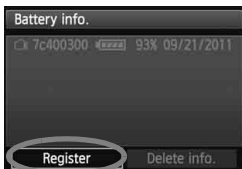

### 2 Select **[Register]**.

- Select **[Register]**, then press **<(SET)>**.
- ▶ The confirmation dialog will appear.



### 3 Select **[OK]**.

- Select **[OK]**, then press **<(SET)>**.
- ▶ The battery pack will be registered, and the battery history screen will reappear.
- ▶ The grayed-out battery number will now be displayed in white letters.
- Press the **<MENU>** button. The battery info. screen will reappear.



- The battery cannot be registered if Battery Grip BG-E11 (sold separately) using AA/R6 batteries is attached or the camera is powered by the DC Coupler DR-E6 (sold separately) and AC Adapter AC-E6N (sold separately).
- If six battery packs have already been registered, **[Register]** cannot be selected. To delete unnecessary battery information, see page 347.

## Labeling the Serial No. on the Battery

Affixing a serial number label onto all the registered Battery Pack LP-E6/LP-E6N's makes it convenient.

Serial No.

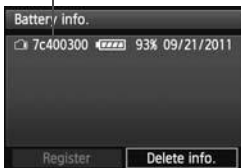

### 1 Write the serial number on a label.

- Write the serial number displayed on the battery history screen on a commercially-available label approx. 25 mm x 15 mm / 1.0 in. x 0.6 in. in size.

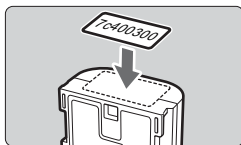

### 2 Take out the battery and affix the label.

- Set the power switch to <OFF>.
- Open the battery compartment cover and remove the battery.
- Affix the label as shown (side with no electrical contacts) in the illustration.
- Repeat this procedure for all of your battery packs so you can easily see the serial number.

- Do not affix the label on any part other than as shown in the illustration in step 2. Otherwise, the misplaced label may make it difficult to insert the battery or impossible to turn on the camera.
- If you use Battery Grip BG-E11, the label may peel off as you repeatedly insert and remove the battery pack. If it peels off, affix a new label.

## Checking the Remaining Capacity of a Registered Battery Pack

You can check the remaining capacity of any battery pack (even when not installed) and also when it was last used.

Serial No.      Date last used



Remaining capacity

### Look for the serial number.

- Refer to the battery's serial number label and look for the battery's serial number on the battery history screen.
- ▶ You can check the respective battery pack's remaining capacity and the date when it was last used.

## Deleting the Registered Battery Pack Information

### 1 Select [Delete info.].

- Follow step 2 on page 345 to select [Delete info.], then press <SET>.

### 2 Select the battery pack information to be deleted.

- Select the battery pack information to be deleted, then press <SET>.
- ▶ <✓> will appear.
- To delete information for another battery pack, repeat this procedure.

### 3 Press the <🗑️> button.

- ▶ The confirmation dialog will appear.

### 4 Select [OK].

- Select [OK], then press <SET>.
- ▶ The battery pack information will be deleted, and the screen in step 1 will reappear.

## Using a Household Power Outlet

You can power the camera with a household power outlet by using the DC Coupler DR-E6 and AC Adapter AC-E6N (both sold separately).

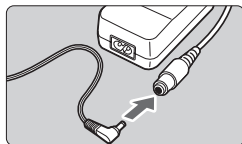

### 1 Connect the DC Coupler's plug.

- Connect the DC Coupler's plug to the AC Adapter's socket.

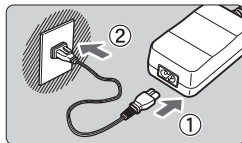

### 2 Connect the power cord.

- Connect the power cord as shown in the illustration.
- After using the camera, unplug the power plug from the power outlet.

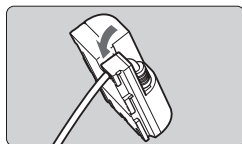

### 3 Place the cord in the groove.

- Insert the DC Coupler's cord carefully without damaging the cord.

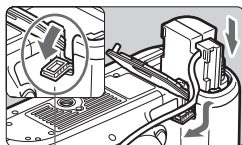

### 4 Insert the DC Coupler.

- Open the battery compartment cover and open the DC Coupler cord hole cover.
- Insert the DC Coupler securely until it locks and put the cord through the hole.
- Close the cover.

DC Coupler cord hole

**!** Do not connect or disconnect the power cord or DC Coupler while the camera's power switch is set to **<ON>**.

## Replacing the Date/Time Battery

The date/time (backup) battery maintains the camera's date and time. Its service life is approx. 5 years. If the date/time is reset when camera is turned on, follow the procedure below to replace the backup battery with a new CR1616 lithium battery.

**The date/time/zone setting will also be reset, so be sure to set the correct date/time/zone (p.36).**

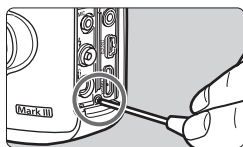

**1 Set the power switch to <OFF>.**

**2 Unscrew the battery holder screw.**

- Use a small Phillips screwdriver.
- Be careful not to lose the screw.

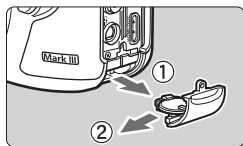

**3 Take off the battery holder.**

- Push out the battery as shown by arrow 2.

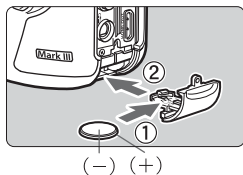

**4 Replace the battery in the battery holder.**

- Make sure the new battery is in the proper + - orientation.

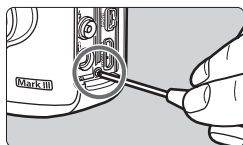

**5 Tighten the battery holder's screw.**

 For the date/time battery, be sure to use a CR1616 lithium battery.

# Using Eye-Fi Cards

With a commercially-available Eye-Fi card already set up, you can automatically transfer captured images to a personal computer or upload them to an online service via a wireless LAN.

The image transfer is a function of the Eye-Fi card. For instructions on how to set up and use the Eye-Fi card or to troubleshoot any image transfer problems, refer to the Eye-Fi card's instruction manual or contact the card's manufacturer.

**ⓘ The camera is not guaranteed to support Eye-Fi card functions (including wireless transfer). In case of an issue with an Eye-Fi card, please check with the card manufacturer. Also note that approval is required to use Eye-Fi cards in many countries or regions. Without approval, use of the card is not permitted. If it is unclear whether the card has been approved for use in your area, please check with the card manufacturer.**

## 1 Insert an Eye-Fi card. (p.31)



## 2 Select [Eye-Fi settings].

- Under the [**1**] tab, select [**Eye-Fi settings**], then press <SET>.
- This menu is displayed only when an Eye-Fi card is inserted into the camera.



## 3 Enable Eye-Fi transmission.

- Press <SET>, set [**Eye-Fi trans.**] to [**Enable**], then press <SET>.
- If you set [**Disable**], automatic transmission will not occur even with the Eye-Fi card inserted (Transmission status icon )

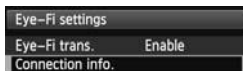

## 4 Display the connection information.

- Select [**Connection info.**], then press <SET>.



## 5 Check the [Access point SSID:].





- Check that an access point is displayed for [Access point SSID:].
- You can also check the Eye-Fi card's MAC address and firmware version.
- Press the <MENU> button to exit the menu.

## 6 Take the picture.



Transmission status icon

- ▶ The picture is transferred and the <Wi-Fi> icon switches from gray (Not connected) to one of the icons below.
- For transferred images,  is displayed in the shooting information display (p.252).

-  (Gray) **Not connected** : No connection with access point.
-  (Blinking) **Connecting** : Connection with access point.
-  (Displayed) **Connected** : Connection to access point established.
-  ( ↑ ) **Transferring** : Image transfer to access point in progress.

## ⚠ Cautions for Using Eye-Fi Cards

- If "⚠" is displayed, an error occurred while retrieving the card information. Turn the camera's power switch off and on again.
- Even if [Eye-Fi trans.] is set to [Disable], it may still transmit a signal. In hospitals, airports, and other places where wireless transmissions are prohibited, remove the Eye-Fi card from the camera.
- If the image transfer does not function, check the Eye-Fi card and personal computer settings. For details, refer to the card's instruction manual.
- Depending on the wireless LAN's connection conditions, the image transfer may take longer or it may be interrupted.
- Because of the transmission function, the Eye-Fi card may become hot.
- The battery power will be consumed faster.
- During the image transfer, auto power off will not take effect.

# Function Availability Table According to Shooting Mode





● : Set automatically ○ : User selectable □ : Not selectable/Disabled

Function		Still Photos						Movies	
			P	Tv	Av	M	B		
All image quality settings selectable		○	○	○	○	○	○		○
ISO speed	Automatically set/Auto ISO	●	○	○	○	○	○	● Except M ○ In M	
	Manual		○	○	○	○	○	○ In M	
Picture Style	Automatic selection							mode:	
	Manual selection		○	○	○	○	○	○	
White balance	Auto	●	○	○	○	○	○	○	
	Preset		○	○	○	○	○	○	
	Custom		○	○	○	○	○	○	
	Color temperature setting		○	○	○	○	○	○	
	Correction/Bracketing		○	○	○	○	○		○
Auto Lighting Optimizer		●	○	○	○	○	○	○	
Lens aberration correction	Peripheral illumination correction	○	○	○	○	○	○	○	
	Chromatic aberration correction	○	○	○	○	○	○	○	
Long exposure noise reduction			○	○	○	○	○		
High ISO speed noise reduction		●	○	○	○	○	○	○	
Highlight tone priority			○	○	○	○	○	○	
Multiple exposures			○	○	○	○	○		
HDR shooting			○	○	○	○			
Color space	sRGB	●	○	○	○	○	○	●	○
	Adobe RGB		○	○	○	○	○		○
AF	AF mode	One-Shot AF		○	○	○	○	AFLive AF AFQuick	
		AI Servo AF		○	○	○	○		
		AI Focus AF	●	○	○	○	○		
	AF area selection mode			○	○	○	○	○	With AFQuick (except )

\*1: The icon indicates still photo shooting in the movie shooting mode.

\*2: If used during movie shooting, it will switch to AFLive.



Function			Still Photos						Movies	
				<b>P</b>	<b>Tv</b>	<b>Av</b>	<b>M</b>	<b>B</b>		 *1
<b>AF</b>	AF point selection	Auto	●	○	○	○	○	○	With AF-ON (except  )	
		Manual		○	○	○	○	○		
	AF-assist beam		●	○	○	○	○	○		
	Manual focusing (MF)		○	○	○	○	○	○	○	
	AF Configuration Tool			○	○	○	○	○		
	AF Microadjustment			○	○	○	○	○	With AF-ON (except  )	
<b>Metering mode</b>	Evaluative metering		●	○	○	○	○	○		
	Metering mode selection			○	○	○	○	○		
<b>Exposure</b>	Program shift			○						
	AE lock <sup>*3</sup>			○	○	○			In <b>P, Tv, Av, B</b>	
	Exposure compensation			○	○	○				
	AEB			○	○	○	○			
	Depth-of-field preview			○	○	○	○	○		
<b>Drive</b>	Single shooting		○	○	○	○	○	○		○
	High-speed continuous shooting		○	○	○	○	○	○		○
	Low-speed continuous shooting		○	○	○	○	○	○		○
	Silent single shooting		○	○	○	○	○	○		○
	Silent continuous shooting		○	○	○	○	○	○		○
	 (10 sec.)		○	○	○	○	○	○		○ <sup>*4</sup>
	 (2 sec.)		○	○	○	○	○	○		○ <sup>*4</sup>
<b>External Speedlite</b>	FE lock			○	○	○	○	○		
	Flash exposure compensation			○	○	○	○	○		
<b>Live View shooting</b>			○	○	○	○	○	○		
<b>Aspect ratio<sup>*5</sup></b>				○	○	○	○	○		
<b>Quick Control</b>			○	○	○	○	○	○	○	

\*3: In the <M> mode with Auto ISO, you can set a fixed ISO speed.

\*4: Works only before the start of movie shooting.







\*5: Settable only for Live View shooting.

# Menu Settings

## For Viewfinder Shooting and Live View Shooting

### Shooting 1 (Red)









Page

Image quality	RAW / M RAW / S RAW	121
	 L /  L /  M /  M /  S1 /  S1 / S2 / S3	
Image review	Off / 2 sec. / 4 sec. / 8 sec. / Hold	55
Beep	Enable / Disable	-
Release shutter without card	Enable / Disable	32
Lens aberration correction	Peripheral illumination: Enable / Disable Chromatic aberration: Enable / Disable	149
External Speedlite control	Flash firing / E-TTL II metering / Flash sync. speed in Av mode / Flash function settings / Clear flash settings / Flash C.Fn settings / Clear all Speedlite C.Fn's	193
Mirror lockup	Disable / Enable	186

-  Shaded menu options are not displayed in the <[A+]> mode.
- What is displayed under [ 1: Image quality] depends on the [Record func.] (p.118) setting under [ 1: Record func+card/folder sel.]. If [Rec. separately] is set, set the image quality for each card.









 Shooting 2 (Red)

Page

<b>Exposure compensation/AEB</b>	1/3-stop increments, $\pm 5$ stops (AEB $\pm 3$ stops)	171 172
<b>ISO speed settings</b>	ISO speed / ISO speed range / Auto ISO range / Minimum shutter speed	126 to 130
<b>Auto Lighting Optimizer</b>	Disable / Low / Standard / High Disable during manual exposure	144
<b>White balance</b>	 /  /  /  /  /  /  /  /  (Approx. 2500 - 10000)	139
<b>Custom White Balance</b>	Manual setting of white balance	140
<b>White balance shift/bracketing</b>	White balance correction: B/A/M/G bias, 9 levels each White balance bracketing: B/A and M/G bias, single-level increments, $\pm 3$ levels	142 143
<b>Color space</b>	sRGB / Adobe RGB	160

\* During movie shooting, [Expo.comp./AEB] will be [Exposure comp.].





 Shooting 3 (Red)



<b>Picture Style</b>	 Auto /  Standard /  Portrait /  Landscape /  Neutral /  Faithful /  Monochrome /  User Def. 1, 2, 3	131 to 138
<b>Long exposure noise reduction</b>	Disable / Auto / Enable	146
<b>High ISO speed noise reduction</b>	Standard / Low / High / Disable	145
<b>Highlight tone priority</b>	Disable / Enable	148
<b>Dust Delete Data</b>	Obtain data to be used by provided software to delete dust spots	297
<b>Multiple exposure</b>	Multiple exposure / Multiple exposure control / No. of exposures / Save source images / Continue multiple exposure	179
<b>HDR Mode</b>	Adjust dynamic range / Effect / Continuous HDR / Auto Image Align / Save source images	175

\* For movie shooting, [Multiple exposure] and [HDR Mode] cannot be selected (grayed out).

**📷: Shooting 4\* (Red)**

Page

<b>Live View shooting</b>	Enable / Disable	205
<b>AF mode</b>	Live mode /  Live mode / Quick mode	209
<b>Grid display</b>	Off / 3x3  / 6x4  / 3x3+diag 	205
<b>Aspect ratio</b>	3:2 / 4:3 / 16:9 / 1:1	206
<b>Exposure simulation</b>	Enable / During  / Disable	207
<b>Silent LV shooting</b>	Mode 1 / Mode 2 / Disable	208
<b>Metering timer</b>	4 sec. / 16 sec. / 30 sec. / 1 min. / 10 min. / 30 min.	208

\* In the <+> mode, these menu options are displayed under [2].

**AF: AF1 (Purple)**

<b>Case 1</b>	Versatile multi purpose setting	88
<b>Case 2</b>	Continue to track subjects, ignoring possible obstacles	88
<b>Case 3</b>	Instantly focus on subjects suddenly entering AF points	89
<b>Case 4</b>	For subjects that accelerate or decelerate quickly	89
<b>Case 5</b>	For erratic subjects moving quickly in any direction (disabled in Single-point AF mode)	90
<b>Case 6</b>	For subjects that change speed and move erratically (disabled in Single-point AF mode)	91

**AF: AF2 (Purple)**



<b>AI Servo 1st image priority</b>	Release priority / Equal priority / Focus priority	96
<b>AI Servo 2nd image priority</b>	Shooting speed priority / Equal priority / Focus priority	97

**AF: AF3 (Purple)**

Page

<b>USM lens electronic MF</b>	Enable after One-Shot AF / Disable after One-Shot AF / Disable in AF mode	98
<b>AF-assist beam firing</b>	Enable / Disable / IR AF assist beam only	99
<b>One-Shot AF release priority</b>	Release priority / Focus priority	99

**AF: AF4 (Purple)**

<b>Lens drive when AF impossible</b>	Continue focus search / Stop focus search	100
<b>Selectable AF point</b>	61 points / Only cross-type AF points / 15 points / 9 points	100
<b>Select AF area selection mode</b>	Manual selection: Spot AF / Manual selection: 1 point AF / Expand AF area:  / Expand AF area: Surround / Manual selection: Zone AF / Auto selection: 61 point AF	101
<b>AF area selection method</b>	 → M-Fn button /  → Main Dial	102
<b>Orientation linked AF point</b>	Same for both vertical/horizontal / Select separate AF points	103

**AF: AF5 (Purple)**

<b>Manual AF point selection pattern</b>	Stops at AF area edges / Continuous	104
<b>AF point display during focus</b>	Selected (constant) / All (constant) / Selected (pre-AF, focused) / Selected (focused) / Disable display	104
<b>VF display illumination</b>	Auto / Enable / Disable	105
<b>AF Microadjustment</b>	Disable / All by same amount / Adjust by lens	106

## ▶: Playback 1 (Blue)



Page

<b>Protect images</b>	Erase-protect images	278
<b>Rotate image</b>	Rotate vertical images	260
<b>Erase images</b>	Erase images	283
<b>Print order</b>	Specify images to be printed (DPOF)	311
<b>Image copy</b>	Copy images between cards	280
<b>RAW image processing</b>	Process <b>RAW</b> images	288

## ▶: Playback 2 (Blue)

<b>Resize</b>	Downsize the image's pixel count	293
<b>Rating</b>	[OFF] / [-.] / [-.] / [-.] / [-.] / [-.]	261
<b>Slide show</b>	Playback description, Display time, and Repeat for auto playback	271
<b>Image transfer</b>	Select images to be transferred to a personal computer	315
<b>Image jump w/ </b>	1 image / 10 images / 100 images / Date / Folder / Movies / Stills / Rating	256

## ▶: Playback 3 (Blue)

<b>Highlight alert</b>	Disable / Enable	253
<b>AF point display</b>	Disable / Enable	253
<b>Playback grid</b>	Off / 3x3  / 6x4  / 3x3+diag 	251
<b>Histogram display</b>	Brightness / RGB	254
<b>Movie play count*</b>	Rec time / Time code	240
<b>Magnification (Approx.)</b>	1x (no magnification) / 2x (magnify from center) / 4x (magnify from center) / 8x (magnify from center) / 10x (magnify from center) / Actual size (from selected point) / Same as last magnification (from center)	258
<b>Control over HDMI</b>	Disable / Enable	275

\* The setting is linked to the [Time code]'s [Movie play count] under the  5 (Movie) tab.

## ☛: Set-up 1 (Yellow)

Page

<b>Record function+card/ folder selection</b>	[Record func.] Standard / Auto switch card / Record separately / Record to multiple	118
	[Record/play] [Playback] [1] / [2]	120
	[Folder] Creating and selecting a folder	152
<b>File numbering</b>	Continuous / Auto reset / Manual reset	156
<b>File name</b>	Preset code / User setting 1 / User setting 2	154
<b>Auto rotate</b>	On   / On  / Off	286
<b>Format card</b>	Initialize and erase data on the card	53
<b>Eye-Fi settings</b>	Displayed when a commercially-available Eye-Fi card is inserted	350

## ☛: Set-up 2 (Yellow)



<b>Auto power off</b>	1 min. / 2 min. / 4 min. / 8 min. / 15 min. / 30 min. / Disable	55
<b>LCD brightness</b>	Auto: Adjustable to one of three brightness levels Manual: Adjustable to one of seven brightness levels	285
<b>Date/Time/Zone</b>	Date (year, month, day) / Time (hour, min., sec.) / Daylight saving time / Time zone	36
<b>Language</b>	Select the interface language	38
<b>VF grid display</b>	Disable / Enable	59
<b>GPS device settings</b>	Settings available when the GPS Receiver GP-E2 (sold separately) is attached	-
<b>HDMI frame rate</b>	Auto / 24p / 60i/50i	246





When using a GPS device or a Wireless File Transmitter, be sure to check the countries and areas of use, and use the device in accordance with the laws and regulations of the country or region.

### : Set-up 3 (Yellow)

Page

<b>Video system</b>	NTSC / PAL	233 277
<b>Battery info.</b>	Power / Remaining capacity / Shutter count / Recharge performance / Battery registration / Battery history	344 to 347
<b>Sensor cleaning</b>	Auto cleaning: Enable / Disable	296
	Clean now	
	Clean manually	299
<b> button display options</b>	Displays camera settings / Electronic level / Displays shooting functions	342
<b> button function</b>	Rating / Protect	261 279
<b>Communication settings</b>	Displayed when WFT-E7 (sold separately) is attached	-

### : Set-up 4 (Yellow)

<b>Custom shooting mode (C1-C3)</b>	Register current camera settings to the Mode Dial's  ,  , and  positions	338
<b>Clear all camera settings</b>	Resets the camera to the default settings	56
<b>Copyright information</b>	Display copyright information / Enter author's name / Enter copyright details / Delete copyright information	158
<b>Firmware Ver.</b>	For updating the firmware	-

### : Custom Functions (Orange)

<b>C.Fn1: Exposure</b>	Customize camera functions as desired	321
<b>C.Fn2: Display/Operation</b>		324
<b>C.Fn3: Others</b>		326
<b>C.Fn4: Clear</b>	Clears all Custom Function settings	320

### : My Menu (Green)

















<b>My Menu settings</b>	Register frequently-used menu options and Custom Functions	337
-------------------------	--	-----





## For Movie Shooting

### Shooting 4\*1 (Movie) (Red)





Page



<b>AF mode</b>	Live mode /  Live mode / Quick mode	243
<b>Grid display</b>	Off / 3x3  / 6x4  / 3x3+diag 	243
<b>Movie recording size</b>	1920x1080 (  /  /  ) (  /  ) 1280x720 (  /  ) (  /  ) 640x480 (  /  ) (  )	233
<b>Sound recording*2</b>	Sound recording: Auto / Manual / Disable	236
	Recording level	
	Wind filter: Disable / Enable	
<b>Silent LV shooting</b>	Mode 1 / Mode 2 / Disable	244
<b>Metering timer</b>	4 sec. / 16 sec. / 30 sec. / 1 min. / 10 min. / 30 min.	244

\*1: In the < > mode, these menu options are displayed under [ 2].

\*2: In the < > mode, it will be [**Sound recording**]: [**On/Off**].

### Shooting 5\*1 (Movie) (Red)

<b>Time code</b>	Count up / Start time setting / Movie rec count / Movie play count*2 / HDMI / Drop frame	239
<b>Silent Control</b>	Enable  / Disable 	238
<b>Movie shooting button</b>	 / 	244
<b>HDMI output + LCD</b>	No mirroring / Mirroring	245

\*1: In the < > mode, these menu options are displayed under [ 3].

\*2: The setting is linked to [**Movie play count**] under the [ 3] tab.

# System Map

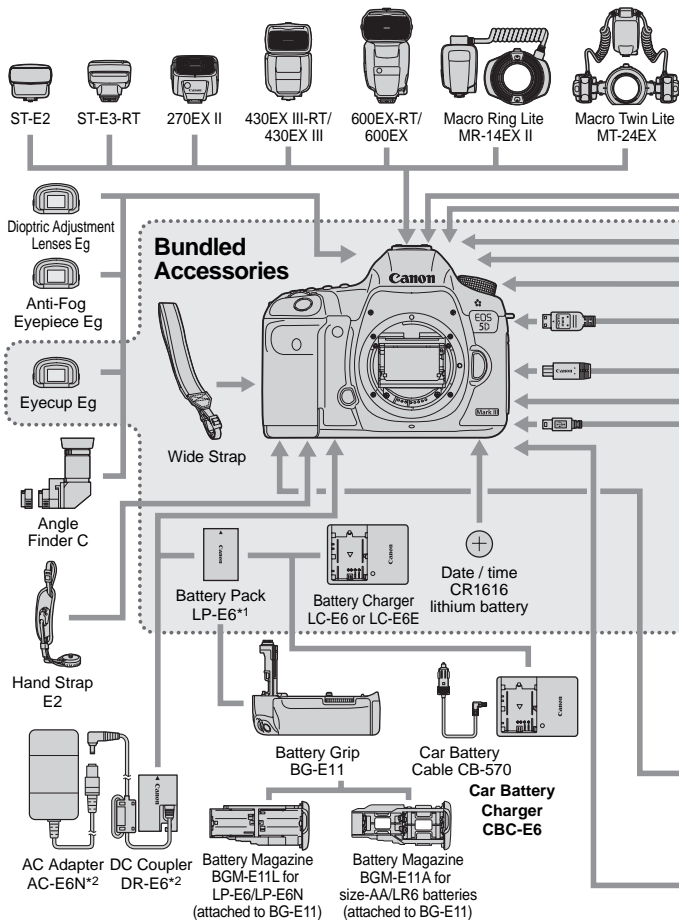

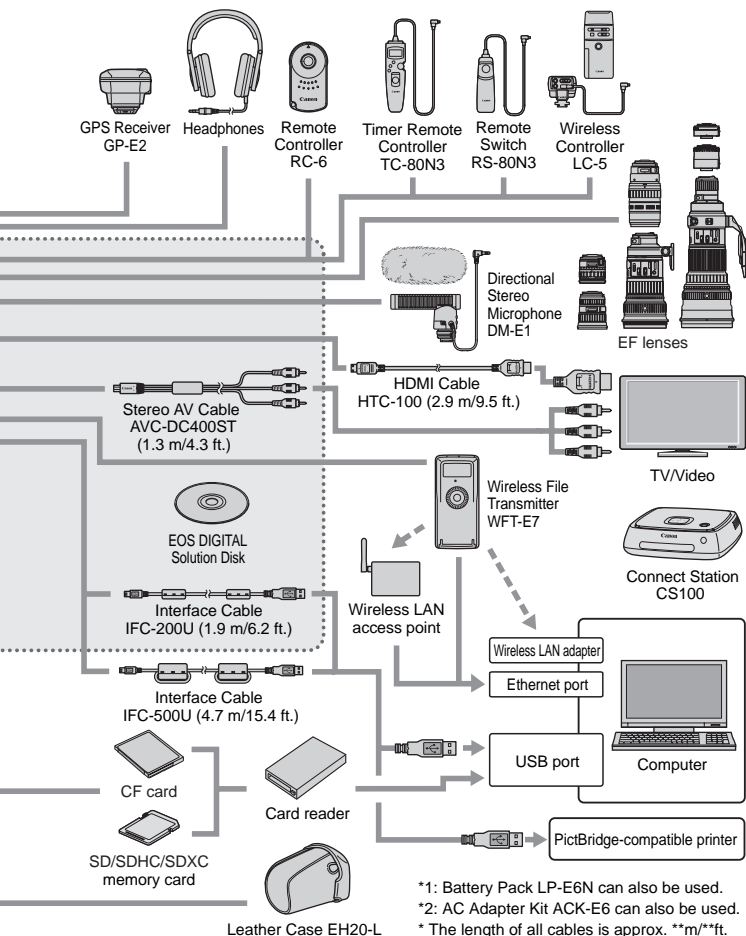

# Troubleshooting Guide

If a problem occurs with the camera, first refer to this Troubleshooting Guide. If this Troubleshooting Guide does not resolve the problem, contact your dealer or nearest Canon Service Center.

## Power-Related Problems

### The battery pack does not recharge.

- If the battery's remaining capacity (p.344) is 94% or higher, the battery will not be recharged.
- Do not recharge any battery pack other than genuine Canon Battery Pack LP-E6/LP-E6N.

### The charger's lamp blinks at high speed.

- If there is a problem with the battery charger or battery pack or if communication with the battery pack (non-Canon battery packs) is not possible, the protective circuit will terminate the charging and the orange lamp will blink quickly at a regular interval. If there is a problem with the battery charger or battery pack, unplug the charger's power plug from the power outlet. Detach and reattach the battery pack to the charger. Wait 2 to 3 minutes, then reconnect the power plug to the power outlet. If the problem persists, contact your dealer or nearest Canon Service Center.

### The charger's lamp does not blink.

- If the internal temperature of the battery pack attached to the charger is high, the charger will not charge the battery for safety reasons (lamp off). During the charging, if the battery's temperature becomes high for any reason, the charging will stop automatically (lamp blinks). When the battery temperature goes down, the charging will resume automatically.

### The camera does not operate even when the power switch is set to <ON>.

- The battery is not properly installed in the camera (p.30).
- Make sure the battery compartment cover is closed (p.30).
- Make sure the card slot cover is closed (p.31).
- Recharge the battery (p.28).

### The access lamp still blinks even when the power switch is set to <OFF>.

- If the power is turned off while an image is being recorded to the card, the access lamp will remain on/continue to blink for a few seconds. When the image recording is completed, the power will turn off automatically.

### The battery becomes exhausted quickly.

- Use a fully-charged battery pack (p.28).
- The battery performance may have degraded. See [**⚡3: Battery info.**] to check the battery's recharge performance level (p.344). If the battery performance is poor, replace the battery pack with a new one.
- The number of possible shots will decrease with any of the following operations:
  - Pressing the shutter button halfway for a prolonged period.
  - Often activating only the AF without taking a picture.
  - Using the lens' Image Stabilizer.
  - Using the LCD monitor often.
  - Continuing Live View shooting or movie shooting for a prolonged period.

### The camera turns off by itself.

- Auto power off is in effect. If you do not want auto power off to take effect, set [**⚡2: Auto power off**] to [**Disable**] (p.55).
- Even if [**⚡2: Auto power off**] is set to [**Disable**], the LCD monitor will still turn off after the camera is left idle for 30 min. (The camera's power does not turn off.)

## Shooting-Related Problems

### The lens cannot be attached.

- The camera cannot be used with EF-S or EF-M lenses (p.39).

### The viewfinder is dark.

- Install a recharged battery pack in the camera (p.28).

### No images can be shot or recorded.

- The card is not properly inserted (p.31).
- If you are using an SD card, slide the card's write-protect switch to the Write/Erase setting (p.31).
- If the card is full, replace the card or delete unnecessary images to make room (p.31, 283).
- If you try to focus in the One-Shot AF mode while the focus confirmation light <●> in the viewfinder blinks, a picture cannot be taken. Press the shutter button halfway again to refocus automatically, or focus manually (p.44, 113).

### The card cannot be used.

- If a card error message is displayed, see page 33 or 377.

### An error message is displayed when the card is inserted in another camera.

- Cards with capacities greater than 128 GB are formatted in exFAT. This means that if you format a card with a capacity over 128 GB with this camera and then insert it into another camera, an error may be displayed and it may not be possible to use the card.

### The image is out of focus.

- Set the lens focus mode switch to <AF> (p.39).
- To prevent camera shake, press the shutter button gently (p.43, 44).
- If the lens has an Image Stabilizer, set the IS switch to <ON> (p.42).
- In low light, the shutter speed may become slow. Use a faster shutter speed (p.164), set a higher ISO speed (p.126), use flash (p.190), or use a tripod.

### There are fewer AF points.

- Depending on the attached lens, the number of usable AF points and patterns will differ. The lenses are categorized into eight groups from A to H. Check which group your lens belongs to. Using a lens in Groups F to H will have fewer usable AF points (p.79).

### The AF point is blinking.

- When you press the <AF-ON> button, the blinking AF points are those that are not cross-type AF points and are only horizontal line-sensitive. The AF points that light up are cross-type AF points (p.74).
- The AF point at the registered area is blinking (p.330).

### I cannot lock the focus and recompose the shot.

- Set the AF mode to One-Shot AF. Focus lock is not possible in the AI Servo AF and AI Focus AF modes (p.70).

### The continuous shooting speed is slow.

- Depending on the shutter speed, aperture, subject conditions, brightness, etc., the continuous shooting speed may become slower.

### The maximum burst during continuous shooting is lower.

- If you shoot something that has fine detail (such as a field of grass), the file size will be larger and the actual maximum burst may be lower than the number mentioned on page 123.

### ISO 100 cannot be set. ISO speed expansion cannot be selected.

- If [**3: Highlight tone priority**] is set to [**Enable**], the settable ISO speed range will be ISO 200-25600 (or up to 12800 for movie shooting). Even if you expand the settable ISO speed range in [**ISO speed range**], you cannot set expanded ISO speeds (L, H, H1, H2). When [**3: Highlight tone priority**] is set to [**Disable**], ISO 100/125/160 can be set (p.148).

### The Auto Lighting Optimizer cannot be set.

- If [**☑3: Highlight tone priority**] is set to [**Enable**], the Auto Lighting Optimizer cannot be set. When [**☑3: Highlight tone priority**] is set to [**Disable**], then the Auto Lighting Optimizer can be set (p.148).

### Even though I set a decreased exposure compensation, the image comes out bright.

- Set [**☑2: Auto Lighting Optimizer**] to [**Disable**]. When [**Standard/Low/High**] is set, even if you set a decreased exposure compensation or flash exposure compensation, the image may come out bright (p.171).

### The Live View image or movie shooting image is not displayed during multiple-exposure shooting.

- If [**On:ContShtng**] is set, Live View display, image review after image capture, and image playback are not possible during shooting (p.179).

### The multiple-exposure image is shot in **RAW** quality.

- When the image-recording quality is set to **M RAW** or **S RAW**, the multiple-exposure image will be recorded in **RAW** quality (p.185).

### When I use the <Av> mode with flash, the shutter speed becomes slow.

- If you shoot at night when the background is dark, the shutter speed becomes slow automatically (slow-sync shooting) so that both the subject and background are properly exposed. To prevent a slow shutter speed, under [**☑1: External Speedlite control**], set [**Flash sync. speed in Av mode**] to [**1/200-1/60 sec. auto**] or [**1/200 sec. (fixed)**] (p.194).

### The flash does not fire.

- Make sure the flash (or PC sync cord) is securely attached to the camera.
- If you use a non-Canon flash unit with Live View shooting, set [**☑4: Silent LV shoot.**] to [**Disable**] (p.208).



### The flash always fires at full output.

- If you use a flash unit other than an EX-series Speedlite, the flash will always be fired at full output (p.191).
- When the [**Flash metering mode**] flash Custom Function is set to [**TTL (autoflash)**], the flash will always be fired at full output (p.198).

### Flash exposure compensation cannot be set.

- If flash exposure compensation has already been set with the Speedlite, flash exposure compensation cannot be set with the camera. When the Speedlite's flash exposure compensation is canceled (set to 0), flash exposure compensation can be set with the camera.



### High-speed sync cannot be set in the <Av> mode.

- Under [**1: External Speedlite control**], set [**Flash sync. speed in Av mode**] to [**Auto**] (p.194).

### The shutter makes two shooting sounds during Live View shooting.

- If you use flash, the shutter will make two sounds each time you shoot (p.201).

### During Live View and movie shooting, a white or red icon is displayed.

- It indicates that the camera's internal temperature is high. If the white < > icon displayed, the still photo's image quality may deteriorate. If the red < > icon is displayed, it indicates that the Live View or movie shooting will soon be terminated automatically (p.217, 247).

### Movie shooting terminates by itself.

- If the card's writing speed is slow, movie shooting may stop automatically. When the compression method is set to **[IPB]**, use a CF card with a reading/writing speed of at least 10 MB per sec., and a SD card with a reading/writing speed of at least 6 MB per sec. When the compression method is set to **[ALL-I (I-only)]**, use a CF card with a reading/writing speed of at least 30 MB per sec., and a SD card with a reading/writing speed of at least 20 MB per sec. To find out the card's reading/writing speed, refer to the card manufacturer's Web site (p.219).
- If the movie shooting time reaches 29 min. 59 sec., the movie shooting will stop automatically.

### The ISO speed cannot be set for movie shooting.

- If the shooting mode is **<[A<sup>+</sup>/P/Tv/Av/B>**, the ISO speed will be set automatically. In the **<M>** mode, you can freely set the ISO speed (p.226).

### ISO 16000/20000/25600 cannot be set for movie shooting.

- Under **[Q2: ISO speed range]**, if you set the **[ISO speed range]**'s **[Maximum]** setting to **[25600/H]**, the maximum ISO speed for manual ISO speed setting will be expanded and then ISO 16000/20000/25600 can be set. However, since shooting a movie at ISO 16000/20000/25600 may result in much noise, it is designated as an expanded ISO speed (displayed as **[H]**).

### The manually set ISO speed changes when switching to movie shooting.

- If you shoot a movie when **[Maximum: 25600]** is set with **[ISO speed range]** and ISO speed is set to ISO 16000/20000/25600, the ISO speed will switch to ISO12800 (during movie shooting with manual exposure). Even if you switch back to still photo shooting, the ISO speed will not revert to the original setting.
- If you shoot a movie when 1. L (50) or 2. H1 (51200)/H2 (102400) is set, the ISO speed setting will switch to 1. ISO 100 or 2. H (25600) respectively (during movie shooting with manual exposure). Even if you switch back to still photo shooting, the ISO speed will not revert to the original setting.

**The exposure changes during movie shooting.**

- If you change the shutter speed or aperture during movie shooting, the changes in the exposure may be recorded.
- Zooming the lens during movie shooting can cause changes in the exposure regardless of whether the lens' maximum aperture changes or not. Changes in the exposure may be recorded as a result.

**The subject looks distorted during movie shooting.**

- If you move the camera to the left or right quickly (high-speed panning) or shoot a moving subject, the image may look distorted.

**The image flickers or horizontal stripes appear during movie shooting.**

- Flickering, horizontal stripes (noise), or irregular exposures can be caused by fluorescent light, LED bulbs, or other light sources during movie shooting. Also, changes in the exposure (brightness) or color tone may also be recorded. In the <M> mode, a slow shutter speed may solve the problem.

**When I shoot still photos during movie shooting, the movie shooting stops.**

- To shoot still photos during movie shooting, using a CF card compatible with UDMA transfer rates is recommended.
- Setting a lower image quality for still photos and shooting fewer continuous still photos can also resolve the problem.

**Time code is off.**

- Shooting still photos during movie shooting will cause a discrepancy between the actual time and time code. When you want to edit a movie using time code, it is recommended not to shoot still photos during movie shooting.

### The time code cannot be appended during HDMI output.

- If the movie-recording quality's frame rate setting is set to a value that does not function properly in combination with the NTSC/PAL frame rate, the time code will not be appended to the HDMI output image.

### The HDMI output image has a temporary frame stop.

- When the movie shooting ends, the HDMI output image pauses (frame stop). When writing to the card is completed, the movie is output normally.

### Movie shooting stops if I connect or disconnect the HDMI cable.

- If you connect or disconnect the HDMI cable during movie shooting, the movie shooting will stop.

## Operation Problems

### I cannot change the setting with <>, <>, or <>.

- Set the <LOCK▶> switch to the left (lock release, p.47).
- Check the [ 2: Multi function lock] setting (p.325).

### The camera button/dial's function has changed.

- Check the [ 2: Custom Controls] setting (p.327).

## Display Problems

### The menu screen shows few tabs and options.

- In the <> mode, only certain menu tabs and options are displayed. Set the shooting mode to <P/Tv/Av/M/B> (p.51).

**The file name's first character is an underscore (“\_”).**

- Set the color space to sRGB. If Adobe RGB is set, the first character will be an underscore (p.160).

**The fourth character in the file name changes.**

- With [**1: File name**], select the camera's unique file name or the file name registered under User setting 1 (p.154).

**The file numbering does not start from 0001.**

- If the card already contains recorded images, the image number may not start from 0001 (p.156).

**The shooting date and time displayed is incorrect.**

- The correct date and time has not been set (p.36).
- Check the time zone and daylight savings time (p.37).

**The date and time is not in the picture.**

- The shooting date and time does not appear in the picture. The date and time is instead recorded in the image data as shooting information. When printing, you can imprint the date and time in the picture by using the date and time recorded in the shooting information (p.307, 311).

**[###] is displayed.**

- If the card has recorded a number of images greater than the camera can display, [###] will be displayed (p.262).

**In the viewfinder, the AF point display speed is slow.**

- In low temperatures, the display speed of the AF points may become slower due to the AF point display device's (liquid crystal) characteristics. The display speed will return to normal at room temperature.

### **The LCD monitor does not display a clear image.**

- If the LCD monitor is dirty, use a soft cloth to clean it.
- In low or high temperatures, the LCD monitor display may seem slow or may look black. It will return to normal at room temperature.

### **[Eye-Fi settings] does not appear.**

- **[Eye-Fi settings]** will appear only when an Eye-Fi card is inserted into the camera. If the Eye-Fi card has a write-protect switch set to the LOCK position, you will not be able to check the card's connection status or disable Eye-Fi card transmission (p.350).

## **Playback Problems**

### **Part of the image blinks in black.**

- [**▶**3: Highlight alert] is set to **[Enable]** (p.253).

### **A red box is displayed on the image.**

- [**▶**3: AF point disp.] is set to **[Enable]** (p.253).

### **The image cannot be erased.**

- If the image is protected, it cannot be erased (p.278).

### **The movie cannot play.**

- Movies edited with a personal computer cannot be played with the camera.

### **When the movie is played, camera operation noise can be heard.**

- If you operate the camera's dials or lens during movie shooting, the operation noise will also be recorded. Using the Directional Stereo Microphone DM-E1 (sold separately) is recommended (p.237).

### The movie has still moments.

- During autoexposure movie shooting, if there is a drastic change in the exposure level, the recording will stop momentarily until the brightness stabilizes. If this happens, shoot with <M> shooting mode (p.225).

### No image appears on the TV screen.

- Use the stereo AV cable that came with the camera (p.277).
- Make sure the stereo AV cable or HDMI cable's plug is inserted all the way in (p.274, 277).
- Set the video OUT system (NTSC/PAL) to the same video system as the TV set (p.277).
- Even if you play back an image when [5: HDMI output + LCD] is set to [Mirroring], the image will not appear on the TV specified as HDMI output.

### There are multiple movie files for a single movie shoot.

- If the movie file size reaches 4 GB, another movie file will be created automatically (p.234).

### My card reader does not recognize the card.

- If you format a card of 128 GB or higher with this camera, it will be formatted in exFAT. This means that some card readers and computer operating systems might not recognize the card properly. In such a case, connect your camera to the computer with the provided interface cable, then transfer the images to your computer using EOS Utility (provided software, p.394).

### I cannot process the RAW image.

- **M RAW** and **S RAW** images cannot be processed with the camera. Use the provided software Digital Photo Professional to process the image (p.394).

### **I cannot resize the image.**

- **S3** JPEG images and **RAW/M RAW/S RAW** images cannot be resized with the camera (p.293).

## **Sensor Cleaning Problems**

### **The shutter makes a noise during sensor cleaning.**

- If you selected [**Clean now** ], the shutter will make a noise, but no picture is taken (p.296).

### **Automatic sensor cleaning does not work.**

- If you repeatedly turn the power switch **<ON>** and **<OFF>** at a short interval, the **< >** icon may not be displayed (p.34).

## **Printing-Related Problems**

### **There are fewer printing effects than listed in the instruction manual.**

- What is displayed on the screen differs depending on the printer. This instruction manual lists all the printing effects available (p.306).

## **Image Transfer Problems**

### **I cannot transfer images to a personal computer.**

- Install the provided software (EOS DIGITAL Solution Disk CD-ROM) on the personal computer (p.395).
- Check that EOS Utility's main window is displayed.



# Error Codes

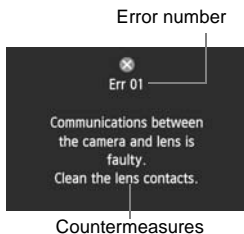

If there is a problem with the camera, an error message will appear. Follow the on-screen instructions.

No.	Error Message & Solution
01	<p><b>Communications between the camera and lens is faulty. Clean the lens contacts.</b></p> <p>→ Clean the electrical contacts on the camera and lens or use a Canon lens (p.15, 18).</p>
02	<p><b>Card * cannot be accessed. Reinsert/change card * or format card * with camera.</b></p> <p>→ Remove and insert the card again, replace the card, or format the card (p.31, 53).</p>
04	<p><b>Cannot save images because card * is full. Replace card *.</b></p> <p>→ Replace the card, erase unnecessary images, or format the card (p.31, 53, 283).</p>
06	<p><b>Sensor cleaning is not possible. Turn the camera off and on again.</b></p> <p>→ Operate the power switch (p.34).</p>
10, 20, 30, 40, 50, 60, 70, 80, 99	<p><b>Shooting is not possible due to an error. Turn the camera off and on again or re-install the battery.</b></p> <p>→ Operate the power switch, remove and install the battery pack again, or use a Canon lens (p.30, 34).</p>

\* If the error still persists, write down the error number and contact your nearest Canon Service Center.

# Specifications

## • Type

Type:	Digital, single-lens reflex, AF/AE camera
Recording media:	CF card (Type I, UDMA mode 7-compatible), SD memory card, SDHC memory card, SDXC memory card
Image sensor size:	Approx. 36 x 24 mm
Compatible lenses:	Canon EF lenses (except EF-S and EF-M lenses) (35 mm-equivalent lens focal length will be as indicated on the lens)
Lens mount:	Canon EF mount

## • Image Sensor

Type:	CMOS sensor
Effective pixels:	Approx. 22.30 megapixels
Aspect ratio:	3:2
Dust delete feature:	Auto, Manual, Dust Delete Data appending

## • Recording System

Recording format:	Design rule for Camera File System 2.0
Image type:	JPEG, RAW (14-bit Canon original), RAW+JPEG simultaneous recording enabled
Recorded pixels:	L (Large) : Approx. 22.10 megapixels (5760 x 3840) M (Medium) : Approx. 9.80 megapixels (3840 x 2560) S1 (Small 1) : Approx. 5.50 megapixels (2880 x 1920) S2 (Small 2) : Approx. 2.50 megapixels (1920 x 1280) S3 (Small 3) : Approx. 350,000 pixels (720 x 480) RAW : Approx. 22.10 megapixels (5760 x 3840) M-RAW : Approx. 10.50 megapixels (3960 x 2640) S-RAW : Approx. 5.50 megapixels (2880 x 1920)
Recording function:	Standard, Auto switch card, Rec. separately, Rec. to multiple
Create/select a folder:	Possible
File name:	Preset code, User setting 1, User setting 2
File numbering:	Continuous, auto reset, manual reset

## • Image Processing During Shooting

Picture Style:	Auto, Standard, Portrait, Landscape, Neutral, Faithful, Monochrome, User Def. 1 - 3
White balance:	Auto, Preset (Daylight, Shade, Cloudy, Tungsten light, White fluorescent light, Flash), Custom, Color temperature setting (Approx. 2500-10000K), White balance correction, and White balance bracketing possible * Flash color temperature information transmission enabled

Noise reduction:	Applicable to long exposures and high ISO speed shots
Automatic image brightness correction:	Auto Lighting Optimizer
Highlight tone priority:	Provided
Lens aberration correction:	Peripheral illumination correction, Chromatic aberration correction

### •Viewfinder

Type:	Eye-level pentaprism
Coverage:	Vertical/Horizontal approx. 100% (with Eye point approx. 21 mm)
Magnification:	Approx. 0.71x (-1 m <sup>-1</sup> with 50 mm lens at infinity)
Eye point:	Approx. 21 mm (from eyepiece lens center at -1 m <sup>-1</sup> )
Built-in dioptic adjustment:	Approx. -3.0 - +1.0 m <sup>-1</sup> (dpt)
Focusing screen:	Fixed
AF status indicator:	Provided
Grid display:	Provided
Electronic level:	Horizontal: 1° increments, ±6° Vertical: 1° increments, ±4° * During horizontal shooting
Mirror:	Quick-return type
Depth-of-field preview:	Provided

### •Autofocus

Type:	TTL secondary image-registration, phase detection
AF points:	61 points (Up to 41 cross-type points) * Number of available AF points and cross-type points vary depending on the lens.
Focusing brightness range:	EV -2 - 18 (with center f/2.8 AF point, 23°C/73°F, ISO 100)
Focus modes:	One-Shot AF, AI Servo AF, AI Focus AF, Manual focusing (MF)
AF area selection modes:	Single-point Spot AF (manual selection), Single-point AF (manual selection), AF point expansion (manual selection; up, down, left, and right), AF point expansion (manual selection; surround), Zone AF (manual selection), Auto selection of 61 AF points
AF Configuration tool:	Case 1 - 6
AI Servo characteristics:	Tracking sensitivity, Acceleration/deceleration tracking, AF point auto switching

AF fine adjustment: AF Microadjustment (All lenses by same amount or Adjust by lens)

AF-assist beam: Emitted by the EOS-dedicated external Speedlite

### • Exposure Control

Metering modes: 63-zone TTL full-aperture metering  
Evaluative metering (linked to all AF points)  
Partial metering (approx. 6.2% of viewfinder at center)  
Spot metering (approx. 1.5% of viewfinder at center)  
Center-weighted average metering

Metering range: EV 1 - 20 (at 23°C/73°F with EF50mm f/1.4 USM lens, ISO 100)

Exposure control: Program AE (Scene Intelligent Auto, Program), Shutter-priority AE, Aperture-priority AE, Manual exposure, Bulb exposure

ISO speed: Scene Intelligent Auto: ISO 100 - 12800 set automatically  
(Recommended exposure index) P, Tv, Av, M, B: Auto ISO, ISO 100 - 25600 (in 1/3- or whole-stop increments), or ISO expansion to L (50), H1 (equivalent to ISO 51200), H2 (equivalent to ISO 102400)

ISO speed settings: ISO speed range, Auto ISO range, and Auto ISO minimum shutter speed settable

Exposure compensation: Manual:  $\pm 5$  stops in 1/3- or 1/2-stop increments  
AEB:  $\pm 3$  stops in 1/3- or 1/2-stop increments (Can be combined with manual exposure compensation)

AE lock: Auto: Applied in One-Shot AF mode with evaluative metering when focus is achieved  
Manual: By AE lock button

### • HDR Shooting

Dynamic range adjustment: Auto,  $\pm 1$  EV,  $\pm 2$  EV,  $\pm 3$  EV  
Effect: Natural, Art standard, Art vivid, Art bold, Art embossed  
Auto image align: Possible

### • Multiple Exposures

Shooting method: Function/control priority, Continuous shooting priority  
No. of multiple exposures: 2 to 9 exposures  
Multiple-exposure control: Additive, Average, Bright, Dark

## • Shutter

Type:	Electronically-controlled, focal-plane shutter
Shutter speeds:	1/8000 sec. to 30 sec., bulb (Total shutter speed range. Available range varies by shooting mode.), X-sync at 1/200 sec.

## • Drive System

Drive modes:	Single shooting, High-speed continuous shooting, Low-speed continuous shooting, Silent single shooting, Silent continuous shooting, 10-sec. self-timer/remote control, 2-sec. self-timer/remote control
--------------	---

Continuous shooting speed:

High-speed continuous shooting:

Max. approx. 6 shots/sec.

Low-speed continuous shooting:

Max. approx. 3 shots/sec.

Silent continuous shooting: Max. approx. 3 shots/sec.

Max. burst:

JPEG Large/Fine: Approx. 65 shots (approx. 16270 shots)

RAW: Approx. 13 shots (approx. 18 shots)

RAW+JPEG Large/Fine: Approx. 7 shots (approx. 7 shots)

\* Figures are based on Canon's testing standards (ISO 100 and Standard Picture Style) and a 8 GB card.

\* Figures in parentheses apply to an UDMA mode 7, 128 GB card based on Canon's testing standards.

## • External Speedlite

Compatible Speedlites:	EX-series Speedlites
Flash metering:	E-TTL II autoflash
Flash exposure compensation:	±3 stops in 1/3- or 1/2-stop increments
FE lock:	Provided
PC terminal:	Provided
External Speedlite control:	Provided

\* Compatible with radio wireless flash photography.

## • Live View Shooting

Aspect ratio settings:	3:2, 4:3, 16:9, 1:1
Focus modes:	Live mode, Face detection Live mode (contrast detection), Quick mode (phase-difference detection), Manual focusing (Approx. 5x / 10x magnification possible)
Focusing brightness range:	EV 1 - 18 (with contrast detection, at 23°C/73°F, ISO 100)
Metering modes:	Evaluative metering with the image sensor
Metering range:	EV 0 - 20 (at 23°C/73°F with EF50mm f/1.4 USM lens, ISO 100)
Silent shooting:	Provided (Mode 1 and 2)
Grid display:	Three types

## • Movie Shooting

Movie recording compression:	MPEG-4 AVC/H.264 Variable (average) bit rate
Audio recording format:	Linear PCM
Recording format:	MOV
Recording size and frame rate:	1920x1080 (Full HD): 30p/25p/24p 1280x720 (HD) : 60p/50p 640x480 (SD) : 30p/25p * 30p: 29.97 fps, 25p: 25.00 fps, 24p: 23.976 fps, 60p: 59.94 fps, 50p: 50.00 fps
Compression method:	ALL-I (I-only), IPB
File size:	1920x1080 (30p/25p/24p) / IPB : Approx. 235 MB/min. 1920x1080 (30p/25p/24p) / ALL-I : Approx. 685 MB/min. 1280x720 (60p/50p) / IPB : Approx. 205 MB/min. 1280x720 (60p/50p) / ALL-I : Approx. 610 MB/min. 640x480 (30p/25p) / IPB : Approx. 78 MB/min. * Card reading/writing speed necessary for movie shooting: CF card: IPB: at least 10 MB per sec./ALL-I: at least 30 MB per sec. SD card: IPB: at least 6 MB per sec./ALL-I: at least 20 MB per sec.
Focus modes:	Same as focusing with Live View shooting
Metering modes:	Center-weighted average and Evaluative metering with the image sensor * Automatically set by the focusing mode.

Metering range:	EV 0 - 20 (at 23°C/73°F with EF50mm f/1.4 USM lens, ISO 100)
Exposure control:	1. Autoexposure, 2. Shutter-priority AE, 3. Aperture-priority AE, 4. Manual exposure * With 1, 2, and 3, exposure compensation and AE lock are possible (except in Scene Intelligent Auto mode).
Exposure compensation:	±3 stops in 1/3-stop increments (±5 stops for still photos)
ISO speed:	Scene Intelligent Auto and Tv: Automatically set within ISO 100 - 12800
(Recommended exposure index)	P, Av, and B: Automatically set within ISO 100 - 12800, expandable to H (equivalent to ISO 25600) M: Auto ISO (automatically set within ISO 100 - 12800), ISO 100 - 12800 set manually (in 1/3- or whole-stop increments), expandable to H (equivalent to ISO 16000/20000/25600)
Time code:	Supported
Drop frames:	Compatible with 60p/30p
Sound recording:	Built-in monaural microphone, external stereo microphone terminal provided Sound recording level adjustable, wind filter provided
Headphones:	Headphone terminal provided
Grid display:	Three types
Still photos:	Possible
Two-screen display:	Simultaneous display of LCD monitor and HDMI output image is possible.
HDMI output:	Image without information display can be output. * Selectable from Auto, 24p, 60i, and 50i.

### •LCD Monitor

Type:	TFT color, liquid-crystal monitor
Monitor size and dots:	Wide, 8.1 cm (3.2-in.) (3:2) with approx. 1.04 million dots
Brightness adjustment:	Auto (Dark, Standard, Bright), Manual (7 levels)
Electronic level:	Provided
Interface languages:	25
Feature guide:	Displayable

### •Playback

Image display formats:	Single image display, Single image + Info display (Basic info, shooting info, histogram), 4-image index, 9-image index, 2-image display
Highlight alert:	Overexposed highlights blink
AF point display:	Possible

Grid display:	Three types
Zoom magnification:	Approx. 1.5x - 10x, starting magnification and position settable
Image browsing methods:	Single image, jump by 10 or 100 images, by shooting date, by folder, by movies, by stills, by rating
Image rotate:	Possible
Ratings:	Provided
Movie playback:	Enabled (LCD monitor, video/audio OUT, HDMI OUT), built-in speaker
Slide show:	All images, by date, by folder, movies, stills, or by rating
Image protect:	Possible
Copying images:	Possible

### • Post-Processing of Images

In-camera RAW image processing:	Brightness correction, White balance, Picture Style, Auto Lighting Optimizer, High ISO speed noise reduction, JPEG image-recording quality, Color space, Peripheral illumination correction, Distortion correction, and Chromatic aberration correction
Resize:	Possible

### • Direct Printing

Compatible printers:	PictBridge-compatible printers
Printable images:	JPEG and RAW images
Print ordering:	DPOF Version 1.1 compatible

### • Image Transfer

Transferrable images:	Still photos (JPEG, RAW, RAW+JPEG images), Movies
-----------------------	---

### • Custom Functions

Custom Functions:	13
My Menu registration:	Possible
Custom shooting modes:	Register under Mode Dial's C1/C2/C3
Copyright information:	Entry and inclusion enabled

### • Interface

Audio/video OUT/ Digital terminal:	Analog video (Compatible with NTSC/PAL)/stereo audio output Personal computer communication, Direct printing (Hi-Speed USB or equivalent), Wireless File Transmitter WFT-E7, GPS Receiver GP-E2 connection
HDMI mini OUT terminal:	Type C (Auto switching of resolution), CEC-compatible



**External microphone IN**

terminal:	3.5 mm stereo mini-jack
Headphone terminal:	3.5 mm stereo mini-jack
Remote control terminal:	Compatible with N3-type remote controller
Wireless remote control:	Remote Controller RC-6
Eye-Fi card:	Compatible

**• Power**

Battery:	Battery Pack LP-E6/LP-E6N (Quantity 1) * AC power usable with household power outlet accessories. * With Battery Grip BG-E11 attached, size-AA/LR6 batteries can be used.
Battery information:	Remaining capacity, Shutter count, Recharge performance, and Battery registration possible
Battery life: (Based on CIPA testing standards)	With viewfinder shooting: Approx. 950 shots at 23°C/73°F, approx. 850 shots at 0°C/32°F With Live View shooting: Approx. 200 shots at 23°C/73°F, approx. 180 shots at 0°C/32°F
Movie shooting time:	Approx. 1 hr. 30 min. at 23°C/73°F Approx. 1 hr. 20 min. at 0°C/32°F * With fully-charged Battery Pack LP-E6
Date/Time battery:	CR1616 lithium battery (Quantity 1)

**• Dimensions and Weight**

Dimensions (W x H x D):	Approx. 152.0 x 116.4 x 76.4 mm / 6.0 x 4.6 x 3.0 in.
Weight:	Approx. 950 g / 33.5 oz. (Including battery, CF card, SD memory card), Approx. 860 g / 30.3 oz. (Body only)

**• Operation Environment**

Working temperature range:	0°C - 40°C / 32°F - 104°F
Working humidity:	85% or less

**• Battery Pack LP-E6**

Type:	Rechargeable lithium-ion battery
Rated voltage:	7.2 V DC
Battery capacity:	1800 mAh
Dimensions (W x H x D):	Approx. 38.4 x 21.0 x 56.8 mm / 1.5 x 0.8 x 2.2 in.
Weight:	Approx. 80 g / 2.8 oz.

• **Battery Charger LC-E6**

Compatible battery:	Battery Pack LP-E6/LP-E6N
Recharging time:	Approx. 2 hr. 30 min.
Rated input:	100 - 240 V AC (50/60 Hz)
Rated output:	8.4 V DC / 1.2 A
Working temperature range:	5°C - 40°C / 41°F - 104°F
Working humidity:	85% or less
Dimensions (W x H x D):	Approx. 69.0 x 33.0 x 93.0 mm / 2.7 x 1.3 x 3.7 in.
Weight:	Approx. 115 g / 4.1 oz.

• **Battery Charger LC-E6E**

Compatible battery:	Battery Pack LP-E6/LP-E6N
Power cord length:	Approx. 1 m / 3.3 ft.
Recharging time:	Approx. 2 hours 30 min.
Rated input:	100 - 240 V AC (50/60 Hz)
Rated output:	8.4 V DC/1.2A
Working temperature range:	5°C - 40°C / 41°F - 104°F
Working humidity:	85% or less
Dimensions (W x H x D):	Approx. 69.0 x 33.0 x 93.0 mm / 2.7 x 1.3 x 3.7 in.
Weight:	Approx. 110 g / 3.9 oz. (excluding power cord)

• **EF24-105mm f/4L IS USM**

Angle of view:	Diagonal extent: 84° - 23°20'
	Horizontal extent: 74° - 19°20'
	Vertical extent: 53° - 13°
Lens construction:	18 elements in 13 groups
Minimum aperture:	f/22
Closest focusing distance:	0.45 m / 1.48 ft. (from image sensor plane)
Max. magnification:	0.23x (at 105 mm)
Field of view:	535 x 345 - 158 x 106 mm / 21.1 x 13.6 - 6.2 x 4.2 in. (at 0.45 m)
Image Stabilizer:	Lens shift type
Filter size:	77 mm
Lens cap:	E-77U/E-77 II
Max. diameter x length:	83.5 x 107 mm / 3.3 x 4.2 in.
Weight:	Approx. 670 g / 23.6 oz.
Hood	EW-83H
Case	LP1219

- All the data above is based on Canon's testing standards and CIPA (Camera & Imaging Products Association) testing standards and guidelines.
- Dimensions, maximum diameter, length and weight listed above are based on CIPA Guidelines (except weight for camera body only).
- Product specifications and the exterior are subject to change without notice.
- If a problem occurs with a non-Canon lens attached to the camera, consult the respective lens maker.

## Trademarks

- Adobe is a trademark of Adobe Systems Incorporated.
- Microsoft and Windows are trademarks or registered trademarks of Microsoft Corporation in the United States and/or other countries.
- Macintosh and Mac OS are trademarks of Apple Inc., registered in the U.S. and other countries.
- CompactFlash is a trademark of SanDisk Corporation.
- SDXC logo is a trademark of SD-3C, LLC.
- HDMI, HDMI logo, and High-Definition Multimedia Interface are trademarks or registered trademarks of HDMI Licensing LLC.
- All other trademarks are the property of their respective owners.

## About MPEG-4 Licensing

"This product is licensed under AT&T patents for the MPEG-4 standard and may be used for encoding MPEG-4 compliant video and/or decoding MPEG-4 compliant video that was encoded only (1) for a personal and non-commercial purpose or (2) by a video provider licensed under the AT&T patents to provide MPEG-4 compliant video. No license is granted or implied for any other use for MPEG-4 standard."

\* Notice displayed in English as required.

### **Use of genuine Canon accessories is recommended**

This product is designed to achieve excellent performance when used with genuine Canon accessories. Canon shall not be liable for any damage to this product and/or accidents such as fire, etc., caused by the malfunction of non-genuine Canon accessories (e.g., a leakage and/or explosion of a battery pack). Please note that this warranty does not apply to repairs arising out of the malfunction of non-genuine Canon accessories, although you may request such repairs on a chargeable basis.

 Battery Pack LP-E6/LP-E6N is dedicated to Canon products only. Using it with an incompatible battery charger or product may result in malfunction or accidents for which Canon cannot be held liable.

## Safety Precautions

The following precautions are provided to prevent harm or injury to yourself and others. Make sure to thoroughly understand and follow these precautions before using the product.

**If you experience any malfunctions, problems, or damage to the product, contact the nearest Canon Service Center or the dealer from whom you purchased the product.**



**Warnings:** Follow the warnings below. Otherwise, death or serious injuries may result.

- To prevent fire, excessive heat, chemical leakage, explosions, and electrical shock, follow the safeguards below:
  - Do not use any batteries, power sources, or accessories not specified in the Instruction Manual. Do not use any home-made or modified batteries.
  - Do not short-circuit, disassemble, or modify the battery. Do not apply heat or solder to the battery. Do not expose the battery to fire or water. Do not subject the battery to strong physical shock.
  - Do not insert the battery's plus and minus ends incorrectly.
  - Do not recharge the battery in temperatures outside the allowable ambient temperature range. Also, do not exceed the recharging time indicated in the Instruction Manual.
  - Do not insert any foreign metallic objects into the electrical contacts of the camera, accessories, connecting cables, etc.
- When disposing of a battery, insulate the electrical contacts with tape to prevent contact with other metallic objects or batteries. This is to prevent a fire or an explosion.
- If excessive heat, smoke, or fumes are emitted when recharging the battery, immediately unplug the battery charger from the power outlet to stop recharging. Otherwise, it may cause a fire, heat damage or electrical shock.
- If the battery leaks, changes color, deforms, or emits smoke or fumes, remove it immediately. Be careful not to get burned in the process. It may cause a fire, electrical shock or skin burn if you keep using it.
- Prevent any battery leakage from contacting your eyes, skin, and clothing. It can cause blindness or skin problems. If the battery leakage contacts your eyes, skin, or clothing, flush the affected area with lots of clean water without rubbing it. See a physician immediately.
- Do not leave any cords near a heat source. It can deform the cord or melt the insulation and cause a fire or electrical shock.
- Do not hold the camera in the same position for long periods of time. Even if the camera does not feel too hot, prolonged contact with the same body part may cause skin redness, blistering or low-temperature contact burns. Using a tripod is recommended for people with circulation problems or very sensitive skin, or when using the camera in very hot places.
- Do not fire the flash at anyone driving a car or other vehicle. It may cause an accident.

- When the camera or accessories are not in use, make sure to remove the battery and disconnect the power plug from the equipment before storing. This is to prevent electrical shock, excessive heat, fire, or corrosion.
- Do not use the equipment where there is flammable gas. This is to prevent an explosion or a fire.
- If you drop the equipment and the casing breaks open to expose the internal parts, do not touch the internal parts. There is a possibility of an electrical shock.
- Do not disassemble or modify the equipment. High-voltage internal parts can cause electrical shock.
- Do not look at the sun or an extremely bright light source through the camera or lens. Doing so may damage your vision.
- Keep equipment out of the reach of children and infants, including when in use. Straps or cords may accidentally cause choking, electrical shock, or injury. Choking or injury may also occur if a child or infant accidentally swallows a camera part or accessory. If a child or infant swallows a part or accessory, consult a physician immediately.
- Do not store the equipment in dusty or humid places. Likewise, store the battery with its protective cover attached to prevent short-circuit. This is to prevent a fire, excessive heat, electrical shock, or burn.
- Before using the camera inside an airplane or hospital, check if it is allowed. Electromagnetic waves emitted by the camera may interfere with the plane's instruments or the hospital's medical equipment.
- To prevent a fire and electrical shock, follow the safeguards below:
  - Always insert the power plug all the way in.
  - Do not handle a power plug with wet hands.
  - When unplugging a power plug, grasp and pull the plug instead of the cord.
  - Do not scratch, cut, or excessively bend the cord or put a heavy object on the cord. Also do not twist or tie the cords.
  - Do not connect too many power plugs to the same power outlet.
  - Do not use a cord whose wire is broken or insulation is damaged.
- Unplug the power plug periodically and clean off the dust around the power outlet with a dry cloth. If the surrounding is dusty, humid, or oily, the dust on the power outlet may become moist and short-circuit the outlet, causing a fire.
- Do not connect the battery directly to an electrical outlet or a car's cigarette lighter outlet. The battery may leak, generate excessive heat or explode, causing a fire, burns or injuries.
- A thorough explanation of how to use the product by an adult is required when the product is used by children. Supervise children while they are using the product. Incorrect usage may result in electrical shock or injury.
- Do not leave a lens or lens-attached camera in the sun without the lens cap attached. Otherwise, the lens may concentrate the sun's rays and cause a fire.
- Do not cover or wrap the product with a cloth. Doing so may trap heat within and cause the casing to deform or catch fire.
- Be careful not to get the camera wet. If you drop the product in the water or if water or metal get inside the product, promptly remove the battery. This is to prevent a fire and an electrical shock.
- Do not use paint thinner, benzene, or other organic solvents to clean the product. Doing so may cause fire or a health hazard.



**Cautions:** Follow the cautions below. Otherwise physical injury or property damage may result.

- Do not use or store the product inside a car under the hot sun or near a heat source. The product may become hot and cause skin burns. Doing so may also cause battery leakage or explosion, which will degrade the performance or shorten the life of the product.
- Do not carry the camera around when it is attached to a tripod. Doing so may cause injury. Also make sure the tripod is sturdy enough to support the camera and lens.
- Do not leave the product in a low-temperature environment for an extended period of time. The product will become cold and may cause injury when touched.
- Do not fire the flash near the eyes. It may hurt the eyes.
- Never play the provided CD-ROM in a drive that is not compatible with the CD-ROM. If you use it in a music CD player, you may damage the speakers and other components. When using headphones, there is also a risk of injury to your ears from excessively loud volume.

CAN ICES-3 (B) / NMB-3 (B)



USA and Canada only:

The Lithium ion/polymer battery that powers the product is recyclable. Please call 1-800-8-BATTERY for information on how to recycle this battery.

For CA, USA only

Included lithium battery contains Perchlorate Material – special handling may apply. See [www.dtsc.ca.gov/hazardouswaste/perchlorate/](http://www.dtsc.ca.gov/hazardouswaste/perchlorate/) for details.

## CAUTION

RISK OF EXPLOSION IF BATTERY IS REPLACED BY AN INCORRECT TYPE.  
DISPOSE OF USED BATTERIES ACCORDING TO LOCAL REGULATION.

## Digital Camera Model DS126321 Systems

This device complies with Part 15 of the FCC Rules. Operation is subject to the following two conditions: (1) This device may not cause harmful interference, and (2) this device must accept any interference received, including interference that may cause undesired operation.

**Note:** This equipment has been tested and found to comply with the limits for class B digital devices, pursuant to Part 15 of the FCC Rules. These limits are designed to provide reasonable protection against harmful interference in a residential installation. This equipment generates, uses and can radiate radio frequency energy and, if not installed and used in accordance with the instructions, may cause harmful interference to radio communications. However, there is no guarantee that interference will not occur in a particular installation. If this equipment does cause harmful interference to radio or television reception, which can be determined by turning the equipment off and on, the user is encouraged to try to correct the interference by one or more of the following measures:

- Reorient or relocate the receiving antenna.
- Increase the separation between the equipment and receiver.
- Connect the equipment into an outlet on a circuit different from that to which the receiver is connected.
- Consult the dealer or an experienced radio/TV technician for help.

The cable with the ferrite core provided with the digital camera must be used with this equipment in order to comply with Class B limits in Subpart B of Part 15 of the FCC rules.

Do not make any changes or modifications to the equipment unless otherwise specified in the manual. If such changes or modifications should be made, you could be required to stop operation of the equipment.

Canon U.S.A. Inc.  
One Canon Park, Melville, NY 11747, U.S.A.  
Tel No. 1-800-OK-CANON (1-800-652-2666)



# 15

## Software Start Guide

---

This chapter gives an overview of the software in the EOS DIGITAL Solution Disk (CD-ROM) provided with the camera and explains how to install the software on a personal computer. It also explains how to view the Software Instruction Manuals.



**EOS DIGITAL Solution Disk**  
(Software/Software Instruction Manuals)

# Software Start Guide



## EOS DIGITAL Solution Disk

Various software for EOS DIGITAL cameras are contained on the EOS DIGITAL Solution Disk.

### EOS Utility

With the camera connected to a personal computer, EOS Utility enables you to transfer still photos and movies shot with the camera to the computer. You can also use the personal computer to set various camera settings and shoot remotely with the computer connected to the camera.

### Digital Photo Professional

This software is recommended for users who mainly shoot RAW images. You can view, edit, process, and print RAW images at high speed. You can also edit JPEG images while retaining the original images.

### Picture Style Editor

You can edit Picture Styles and create and save original Picture Style files. This software is aimed at advanced users who are experienced in processing images.

### ImageBrowser EX

Connect to the Internet to download and install the software\*. This software is recommended for users who mainly shoot JPEG images. You can easily view and play back still photos and MOV movies, and also print JPEG images.

\* EOS DIGITAL Solution Disk is necessary for downloading and installing ImageBrowser EX.

 Note that the software ZoomBrowser EX/ImageBrowser provided with previous cameras does not support still photos and movie files shot with this camera (not compatible). Use ImageBrowser EX.

## Installing the Software



- **Do not connect the camera to your computer before you install the software. The software will not be installed correctly.**
- When downloading and installing ImageBrowser EX, follow the steps below as with other EOS software included on the EOS DIGITAL Solution Disk. Note that Internet connection is necessary. Downloading or installing software is not possible in environments with no Internet connection.
- Even if your computer already has ImageBrowser EX installed, follow the steps below to reinstall ImageBrowser EX. It will be updated to the latest version with features optimized for your camera. Also, the latest functions may be added with the auto update feature.
- For software other than ImageBrowser EX, if a previous version is installed, follow the steps below to reinstall the software. (The newer version will overwrite the previous version.)

### 1 Insert the EOS DIGITAL Solution Disk into your computer.

- For Macintosh, double-click to open the CD-ROM icon displayed on the desktop, then double-click on [setup].

### 2 Click [Easy Installation] and follow the on-screen instructions to install.

- If the install screen for “Microsoft Silverlight” is displayed during installation, install “Microsoft Silverlight”.

### 3 Click [Restart] and remove the CD-ROM after the computer restarts.

- When the computer has restarted, the installation is complete.



## Software Instruction Manual

Software Instruction Manuals are contained on the EOS DIGITAL Solution Disk. Instructions for copying and viewing the Software Instruction Manual PDFs are as follows.

### 1 Insert the EOS DIGITAL Solution Disk into your computer.

### 2 Close the install screen.

- When the EOS DIGITAL Solution Disk install screen appears, close the install screen.

### 3 Open the CD-ROM.

### 4 Open the [Manual] folder.

### 5 Copy the [English] folder to your computer.

- Instruction Manual PDFs with the names below are copied.

	Windows	Macintosh
EOS Utility	EUx.xW_E_xx	EUx.xM_E_xx
Digital Photo Professional	DPPx.xW_E_xx	DPPx.xM_E_xx
Picture Style Editor	PSEx.xW_E_xx	PSEx.xM_E_xx

- Instruction manual for ImageBrowser EX (ImageBrowser EX User Guide) is included in the software.

### 6 Double-click the copied PDF file.

- Adobe Reader (latest version recommended) must be installed in your computer.
- Adobe Reader can be downloaded free from the Internet.

# Index

- 10-sec. or 2-sec. delay..... 115  
1280x720 ..... 233  
1920x1080 ..... 233  
4- or 9-image index display..... 255  
61-point automatic  
selection AF ..... 73, 77  
640x480 ..... 233
- A**
- A+** ..... 64, 220  
AC Adapter ..... 348  
Access lamp..... 33  
Adobe RGB..... 160  
AE lock..... 173  
AEB..... 172, 321  
AF  
    AF area selection mode..... 72, 75  
    AF group..... 79  
    AF Microadjustment..... 106  
    AF mode ..... 70  
    AF point ..... 72, 75  
    AF point selection ..... 74, 332  
    AF status indicator ..... 64  
    AF-assist beam..... 99  
    Beeper ..... 354  
    Customization..... 96  
    Difficult-to-focus subjects.. 112, 213  
    f/8..... 85  
    Manual focusing ..... 113, 216  
    Out of focus ..... 42, 43, 112, 213  
    Recompose ..... 67  
AF area selection mode..... 72, 75  
AF Configuration Tool ..... 87  
AF point expansion ..... 72, 75  
AF-ON (AF start) button..... 44  
AI FOCUS (AI Focus AF)..... 71  
AI SERVO (AI Servo AF)..... 71  
    Accel./decel. tracking ..... 93  
    AF pt auto switching..... 94  
    Tracking sensitivity..... 92  
AI Servo AF ..... 67, 71  
ALL-I (I-only)..... 233  
Ambient light sensor..... 20  
Aperture-priority AE ..... 166, 222  
Area AF frame ..... 23, 72, 77  
Aspect ratio ..... 206  
Audio/video OUT ..... 265, 274  
Auto Lighting Optimizer..... 63, 144  
Auto playback..... 271  
Auto power off ..... 34, 55  
Auto reset ..... 157  
Auto rotate of vertical images..... 286  
Auto switch card ..... 119  
Autofocus → AF  
Automatic selection (AF) ..... 73, 77  
Automatic selection of AF  
point..... 73, 77  
Av (Aperture-priority AE) ..... 166, 222  
A/V OUT ..... 265, 277
- B**
- B (Bulb) ..... 174, 220  
B/W..... 133, 136  
Battery ..... 28, 30, 35  
Battery Grip ..... 35, 362  
Beeper..... 354  
Black-and-white image..... 133, 136  
Bracketing ..... 143, 172  
Bulb exposures..... 174

- C**
- C** (Custom shooting)..... 338
  - Cable ..... 3, 274, 277, 362
  - Camera
    - Camera shake ..... 186
    - Clear camera settings ..... 56
    - Holding the camera ..... 43
    - Settings display ..... 342
  - Camera shake ..... 42, 43
  - Card ..... 15, 31, 53
    - Card reminder ..... 32
    - Format ..... 53
    - Low-level format ..... 54
    - Problem ..... 33, 54
  - Center-weighted average  
metering ..... 170
  - CF card → Card
  - Charger ..... 26, 28
  - Chromatic aberration correction ... 150
  - Cleaning ..... 295
  - Clear camera settings ..... 56
  - Color space ..... 160
  - Color temperature ..... 139, 141
  - Color tone ..... 135
  - Continuous ..... 156
  - Continuous shooting ..... 114
  - Contrast ..... 135
  - Copyright information ..... 158
  - Creative Photo ..... 131, 175, 179
    - ★ icon ..... 4
  - Cropping information ..... 326
  - Cross-type focusing ..... 74, 78
  - Custom Controls ..... 50, 327
  - Custom Functions ..... 320
  - Custom shooting mode ..... 338
  - Custom WB ..... 140
- D**
- Date/Time ..... 36
    - Date/time battery  
replacement ..... 349
  - Daylight saving time ..... 37
  - DC coupler ..... 348
  - Depth-of-field preview .. 167, 200, 203
  - Dial
    - Main Dial ..... 45
    - Quick Control Dial ..... 46
  - Digital terminal ..... 302, 315
  - Dioptic adjustment ..... 43
  - Direct printing ..... 314
  - Direct selection (AF point) ..... 332
  - DPOF ..... 311
  - Drive mode ..... 114
  - Dust Delete Data ..... 297
- E**
- Electronic level ..... 60, 335
  - Erase (image) ..... 283
  - Error codes ..... 377
  - Evaluative metering ..... 169
  - exFAT ..... 54
  - Exposure compensation ..... 171
  - Exposure level increments ..... 321
  - Exposure level indicator ... 22, 23, 343
  - Exposure simulation ..... 207
  - Extension ..... 155
  - External Speedlite → Flash
  - Eyecup ..... 187
  - Eye-Fi card ..... 350
  - Eyepiece cover ..... 27, 187

- F**
- FE lock ..... 190
  - Feature guide ..... 61
  - File name ..... 154, 156
  - File size ..... 123, 234, 252
  - Filter effect ..... 136
  - Final image simulation ..... 203, 229
  - Fine (Image-recording quality) ..... 121
  - Firmware Ver. .... 360
  - First-curtain synchronization ..... 196
  - Flash (Speedlite)
    - Custom Functions ..... 198
    - External Speedlite ..... 190
    - FE lock ..... 190
    - Flash control ..... 193
    - Flash exposure compensation .. 190
    - Flash-sync speed ..... 191
    - Manual flash ..... 195
    - Shutter synchronization  
(1st/2nd curtain) ..... 196
    - Wireless ..... 196
  - Flash exposure bracketing ..... 197
  - Flash exposure compensation ..... 190, 197
  - Flash mode ..... 195
  - Flash-sync contacts ..... 18
  - Focus confirmation light ..... 64
  - Focus lock ..... 67
  - Focus mode switch ..... 39, 113, 216
  - Focusing → AF
  - Folder Create/Select ..... 152
  - Format (card initialization) ..... 53
  - Frame rate ..... 233, 246
  - Full Auto (Scene Intelligent Auto) ... 64
  - Full HD ..... 233, 235
  - Full High-Definition  
(Full HD) ..... 233, 265, 274
- G**
- Grid display ..... 59, 205, 243, 251
- H**
- HD ..... 233, 274
  - HDMI ..... 241, 245, 246, 265, 274
  - HDMI CEC ..... 275
  - HDR ..... 175
  - Headphones ..... 237
  - High ISO speed noise reduction... 145
  - High-Definition (HD) ..... 233, 265, 274
  - Highlight alert ..... 253
  - Highlight detail loss ..... 253
  - Highlight tone priority ..... 148
  - Histogram (Brightness/RGB) ..... 254
  - Hot shoe ..... 190
  - Household power ..... 348
- I**
- ICC profile ..... 160
  - Illumination (LCD panel) ..... 48
  - Image
    - AF point display ..... 253
    - Auto playback ..... 271
    - Auto rotate ..... 286
    - Copying ..... 280
    - Erase ..... 283
    - Highlight alert ..... 253
    - Histogram ..... 254
    - Index ..... 255
    - Jump display  
(Image browsing) ..... 256
    - Magnified view ..... 257
    - Manual rotate ..... 260

- No..... 156
  - Playback..... 249
  - Protect..... 278
  - Rating..... 261
  - Shooting information ..... 252
  - Slide show ..... 271
  - Transfer ..... 315
  - Two-image display..... 259
  - View on TV ..... 265, 274
  - Image dust prevention ..... 295
  - Image review ..... 55
  - Image Stabilizer (lens) ..... 42
  - Image-recording quality ..... 121
  - Index display..... 255
  - INFO. button ..... 202, 227, 250, 342
  - IPB..... 233
  - ISO speed..... 126, 223, 226
    - Automatic setting (Auto) ..... 127
    - Automatic setting range..... 129
    - ISO expansion..... 128
    - Manual Setting range ..... 128
    - Minimum shutter speed ..... 130
    - Setting increments..... 321
- J**
- JPEG ..... 121
  - Jump display..... 256
- L**
- Language..... 38
  - Large (Image-recording quality).... 123
  - LCD monitor..... 15
    - Brightness adjustment..... 285
    - Electronic level ..... 60
    - Image playback ..... 249
    - Menu screen..... 51, 354
    - Shooting settings display.... 48, 343
  - LCD panel..... 21
  - Lens ..... 25, 39
    - Chromatic aberration  
correction ..... 150
    - Lock release ..... 40
    - Peripheral illumination  
correction ..... 149
  - Lens hood ..... 41
  - Live View shooting ..... 68, 199
    - Exposure simulation ..... 207
    - Face detection Live mode  
(AF)..... 210
    - Grid display..... 205
    - Information display..... 202
    - Live mode (AF) ..... 209
    - Manual focusing..... 216
    - Metering timer..... 208
    - Possible shots..... 201
    - Quick Control ..... 204
    - Quick mode (AF)..... 214
    - Silent shooting ..... 208
  - LOCK ..... 47
  - Long exposure noise reduction .... 146
  - Long exposures..... 174
- M**
- M (Manual exposure) ..... 168, 225
  - Magnification/Start position ..... 258
  - Magnified view ..... 216, 257
  - Main Dial ..... 45
  - Malfunction ..... 364
  - Manual exposure..... 168, 225
  - Manual focusing ..... 113, 216
  - Manual reset ..... 157
  - Manual selection (AF) ..... 72, 75
  - Maximum aperture ..... 85
  - Maximum burst..... 123, 125



- Medium  
(Image-recording quality) ..... 123, 293
  - Memory card → Card
  - Menu ..... 51
    - My Menu ..... 337
    - Setting procedure ..... 52
    - Settings ..... 354
  - MENU** icon ..... 4
  - Metering mode ..... 169
  - Metering timer ..... 208, 244
  - MF (Manual focusing) ..... 113, 216
  - M-Fn ..... 73, 329
  - Microadjustment ..... 106
  - Microphone ..... 220, 237
  - Mirror lockup ..... 186
  - Mode Dial ..... 24, 45
  - Monochrome image ..... 133, 136
  - Movie ..... 219
    - AE lock ..... 224
    - AF mode ..... 232, 243
    - Aperture-priority AE ..... 222
    - Autoexposure shooting ..... 220
    - Compression method ..... 233
    - Count ..... 240
    - Drop frame ..... 242
    - Edit ..... 269
    - Editing out first and last scenes ..... 269
    - Enjoying ..... 265
    - External microphone ..... 237
    - File size ..... 234
    - Frame rate ..... 233
    - Grid display ..... 243
    - Headphones ..... 237
    - Information display ..... 227
    - Manual exposure shooting ..... 225
    - Metering timer ..... 244
    - Microphone ..... 220, 237
    - Movie recording size ..... 233
    - Movie shooting button ..... 244
    - Playback ..... 267
    - Quick Control ..... 232
    - Recording command ..... 241
    - Recording time ..... 234
    - Shutter-priority AE ..... 221
    - Silent control ..... 238
    - Silent shooting ..... 244
    - Sound recording ..... 236
    - Still photos ..... 230
    - Time code ..... 239
    - View on TV ..... 265, 274
    - Wind filter ..... 236
  - M-RAW (Medium RAW) ..... 121, 124
  - Multi function ..... 73, 190, 329
  - Multi-controller ..... 47
  - Multi-function lock ..... 47
  - Multiple exposures ..... 179
  - My Menu ..... 337
- N**
- Noise reduction
    - High ISO speed ..... 145
    - Long exposures ..... 146
  - Nomenclature ..... 18
  - Non-Canon flash units ..... 191
  - Normal  
(Image-recording quality) ..... 121
  - NTSC ..... 233, 360
- O**
- ONE SHOT (One-Shot AF) ..... 70
  - One-Shot AF ..... 70
  - One-touch image quality setting... 125
- P**
- P (Program AE) ..... 162, 220

PAL .....	233, 360
Partial metering.....	169
PC terminal.....	191
Peripheral illumination correction .....	149
Personal white balance.....	141
PictBridge .....	301
Picture Style.....	131, 134, 137
Pixels .....	121
Playback.....	249
Possible shots.....	35, 123, 201
Power	
Auto power off .....	55
Battery check.....	35, 344
Battery info .....	344
Household power .....	348
Possible shots .....	35, 123, 201
Recharge.....	28
Recharge performance.....	344
Pressing completely.....	44
Pressing halfway.....	44
Printing.....	301
Layout.....	305
Paper settings .....	305
Print Order (DPOF) .....	311
Printing effects.....	306
Tilt correction .....	309
Trimming.....	309
Program AE .....	162, 220
Program shift.....	163
Protect (image erase-protection) ..	278

**Q**

 .....	49, 204, 232, 263
Quick Control .....	49, 204, 232, 263
Quick Control Dial.....	46
Quick mode (AF).....	214

**R**

Rating mark.....	261
RAW .....	121, 124
RAW image processing.....	288
RAW+JPEG .....	121
Rec. separately .....	119
Rec. to multiple .....	119
Recharge.....	28
Record func.....	118
Recording level .....	236
Reduced display.....	255, 257
Registering and using an AF point.....	330
Release shutter without card.....	32
Remote control shooting .....	188
Remote switch shooting .....	187
Resize .....	293
Rotate (image) .....	260, 286, 309

**S**

Safety precautions .....	389
Safety shift .....	323
Saturation.....	135
SD, SDHC, SDXC card → Card	
Second-curtain synchronization ...	196
Self-timer.....	115, 188
Sensor cleaning .....	295
Sepia (Monochrome).....	136
Sharpness.....	135
Shooting information display .....	252
Shooting mode .....	24
Av (Aperture-priority AE).....	166
B (Bulb).....	174
 (Custom shooting).....	338

- M (Manual exposure)..... 168
  - P (Program AE) ..... 162
  - Tv (Shutter-priority AE)..... 164
  - A+** (Scene Intelligent Auto) ..... 64
  - Shooting mode's settable functions..... 352
  - Shooting orientation registration ... 103
  - Shooting settings display ..... 48, 343
  - Shutter button ..... 44
  - Shutter synchronization ..... 196
  - Shutter-priority AE..... 164, 221
  - Silent shooting
    - Continuous shooting..... 114
    - Silent LV shooting..... 208, 244
    - Single shooting ..... 114
  - Single image display ..... 250
  - Single shooting ..... 114
  - Single-point AF ..... 72, 75
  - Single-point Spot AF ..... 72, 75
  - Slide show..... 271
  - Small (Image-recording quality) ..... 123, 293
  - Software..... 393
  - Speaker..... 267
  - Spot AF point ..... 23
  - Spot metering..... 170
  - S-RAW (Small RAW) ..... 121, 124
  - sRGB ..... 160
  - Stopped-down aperture..... 167, 200, 203
  - Strap ..... 27
  - System map ..... 362
- T**
- Temperature warning ..... 217, 247
  - Time code..... 239, 241
  - Tone priority..... 148
  - Toning effect (Monochrome)..... 136
  - Touch pad..... 46, 238
  - Trimming (printing) ..... 309
  - Tripod socket..... 20
  - Tv (Shutter-priority AE)..... 164, 221
  - Two-image display..... 259
- U**
- Ultra DMA (UDMA)..... 32
  - USB (Digital) terminal..... 302, 315
- V**
- Video system..... 233, 277, 360
  - View on TV ..... 265, 274
  - Viewfinder..... 23
    - Dioptric adjustment ..... 43
    - Electronic level..... 59, 335
    - Grid display ..... 59
  - Volume (Movie playback) ..... 268
- W**
- Warning icon ..... 324
  - WB (White balance) ..... 139
  - White balance..... 139
    - Bracketing ..... 143
    - Color temperature setting ..... 141
    - Correction ..... 142
    - Custom..... 140
    - Personal..... 141
  - Wind filter ..... 236
- Z**
- Zone ..... 36
  - Zone AF..... 73

# Canon

The descriptions in this Instruction Manual are current as of June 2016. For information on the compatibility with any products introduced after this date, contact any Canon Service Center. For the latest version Instruction Manual, refer to the Canon Web site.