

Canon EOS

620·650



Introduction

Thank you for purchasing the Canon EOS 620/650. Designed with the most advanced and innovative technology available, this high-performance AF/AE SLR camera with a built-in motor drive offers you genuine, creative freedom and picture-taking ease.

Enjoy Taking Photos More Comfortably

This is EOS' design theme. The EOS 620/650 has brilliantly made it come true thanks to the high speed, precise autofocus system and the built-in motor drive capable of winding film up to three frames per second which maximizes your potential.

Needless to say film speed setting and film transportation have been completely automated. A few of the many features of the EOS 620/650 are the evaluative metering function (Factor 6 light analysis system) in which the camera automatically recognizes subject pattern and its size so correct exposure can be obtained in backlit situations, and the intelligent program AE mode which selects the ideal program line according to the characteristics of the lens in use.

In addition, your photographic options are further expanded by exclusive accessories such as the Speedlites 420EZ and 300EZ that respond to a wide range of illuminations from dark surroundings to fill-in flash, the Quartz Date Back E that imprints data, and the Technical Back E that memorizes exposure control data.

For a full understanding of the EOS 620/650, please read this instruction booklet carefully before using the camera.

While reading these instructions unfold the front and back flaps of this booklet for easy reference to the camera's parts.

"EOS" is derived from "Electro-Optical System" originating from the completely electronic data communication between the camera and lens. Further, "EOS" is the Goddess of Dawn in Greek mythology — heralding the new, genuine AF system generation.

"EF" lens stands for "Electro-Focus" and adopts the lens-integral autofocus system which uses special motors to make precise and high-speed autofocusing possible whatever the lens focal length.

NOMENCLATURE



Table of Contents

Preliminary Preparations

1. Attaching the Lens	6
2. Loading the Battery	8
3. Checking the Battery	9
4. Loading the Film	10
[Automatic Film Speed Setting]	12

Basic Steps

1. Setting the Main Switch to the "Full Auto" Position	14
2. Holding the Camera	15
3. AF Focusing	16
4. Exposure	17
[Display Panel Illumination]	18
5. Automatic Film Rewind	19
[Rewinding Mid-Roll]	20

Making the Most of Your EOS 620/650

1. Main Switch Functions	22
2. Setting the AF Mode	24
3. Setting the Film Winding Mode	26
4. Setting the Shooting Mode	27
(1) Program AE	28
(2) Program Shift Function	30
(3) Shutter-Priority AE	32
(4) Aperture-Priority AE	34
[Depth of Field]	36
(5) Depth of Field AE	38
(6) Manual	42

5. Partial Metering	44
6. Exposure Compensation	46
7. Auto Exposure Bracketing	48
8. Multiple Exposures	52
9. Difficult Subjects for Autofocus	54
10. Manual Focusing	56

Other Shooting

1. Self-timer Photography	58
2. Dedicated Flash Photography	60
3. Bulb [Long Exposure]	63
4. Shooting with Infrared Film	64

Accessories

Caring for Your Camera

Other Notes

Appendix

Specifications

Carrying the Camera

Preliminary Preparations

1. Attaching the Lens



- 1) Turn the rear lens cap in the direction of the arrow until it stops and remove it from the lens.
 - To attach the rear lens cap, align its "O" mark with the red dot on the lens. Then lightly push it in and turn it clockwise until it stops.



- 2) Turn the body cap counter-clockwise and remove it.
 - To attach the body cap, align its "O" mark with the camera's red dot, then turn the cap clockwise.



- 3) To mount the lens, align the lens mount positioning point with the camera's red dot.



4) Then turn the lens clockwise until it stops and the lens is locked with a click.

- To remove the lens, turn it counterclockwise while pressing the lens release button.



5) Remove the front lens cap.

CAUTION

- Be sure to keep the electronic contacts of the lens and the camera clean to ensure proper connection.
- Be sure to place the lens' front end down to avoid damaging the electronic contacts.



2. Loading the Battery

This camera uses one, six-volt lithium battery pack (2CR5).



- 1) Remove the grip with a coin or similar object.



- 2) As shown in the photo, load the battery so that its terminals face in the direction of the camera. Make sure the battery is pushed in all the way until it is locked by the orange lever.
- 3) Replace the grip securely.

- When replacing the battery, first push the orange lever upward to remove the dead battery.
- When using a tripod, dismount the camera before replacing the battery.



3. Checking the Battery



1) Set the main switch to the green “□”, “A” or “(•)” mark. The display will come on at this time. If the display does not appear, confirm that the battery is loaded correctly.

(example)

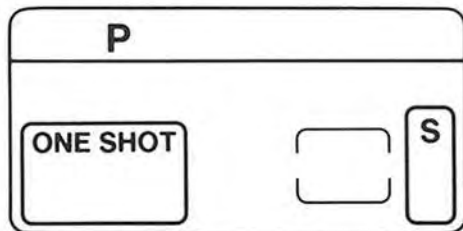

2) Open the switch cover on the back of the camera and press the battery check button (). Battery power shows in the display panel.

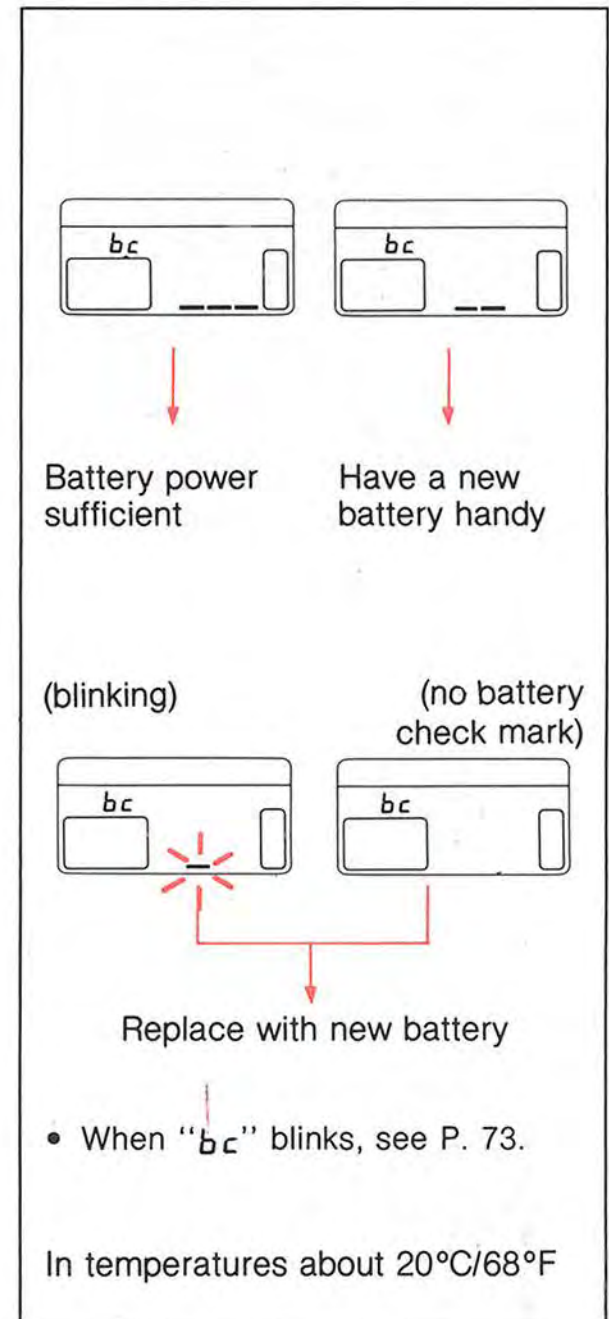

4. Loading the Film



1) To open the back cover, push the back cover latch down while pressing the back cover lock button.



2) Insert the upper-flat end of the film cartridge into the film chamber first. The film-load check mark (Ⓢ) appears in the display panel.



3) Pull the film leader across the shutter curtain until its tip is aligned with the orange index.

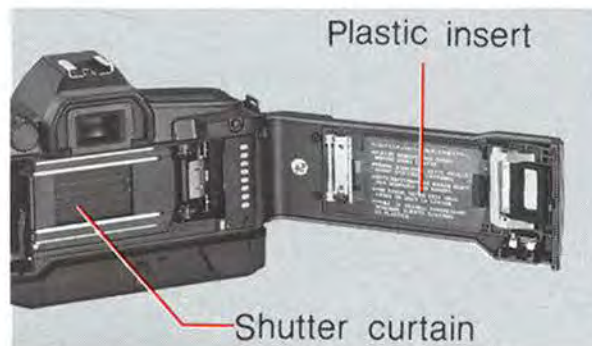

CAUTION

- Before loading the first roll of film, remove the plastic insert.
- NEVER touch the shutter curtain. Its high-precision design makes it sensitive to pressure. Also, when loading the film be careful that the film leader does not touch the shutter curtain.

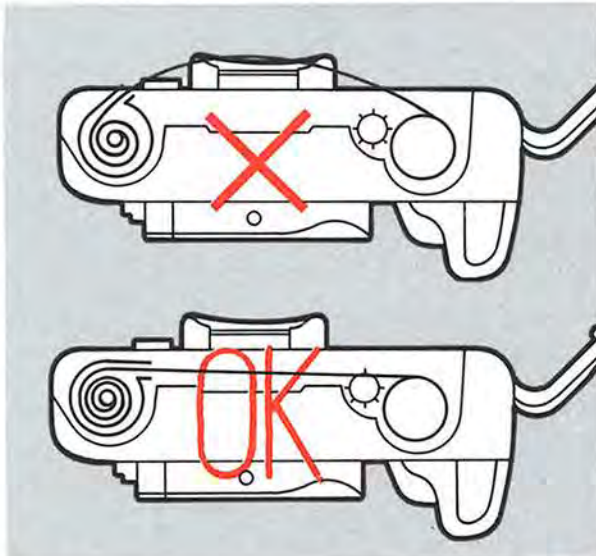

4) Make sure that the film has no slack and that its perforations are properly engaged with the sprocket teeth.

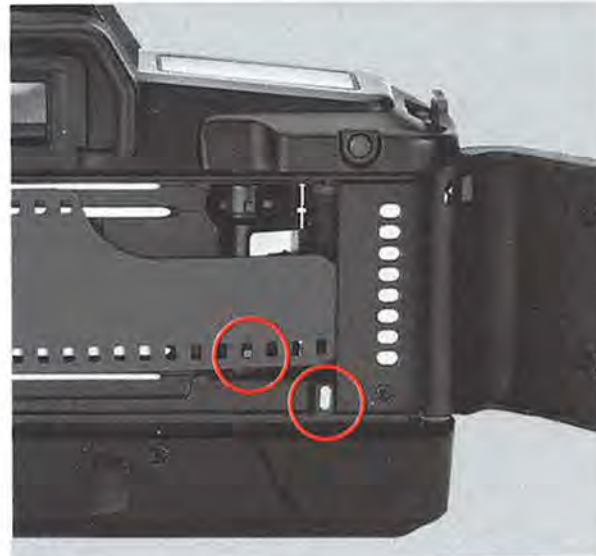

5) Close the back cover. The camera advances the film automatically and stops when "1" appears in the frame counter in the display panel.

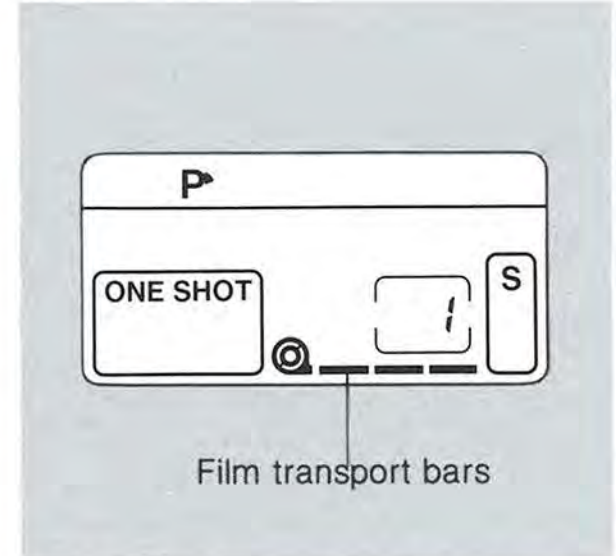

6) During film advance, the film transport bars will appear at the bottom of the display panel moving in sequence from left to right. However, if the film does not advance correctly, the bars blink after the camera has stopped and the shutter will not release. Reload the film.

If the film leader extends past the orange index, take out the film cartridge and manually rewind the excess film back into the cartridge.

Film becomes soft and tears easily in high humidity. Keep it stored in its canister until loading.

Automatic Film Speed Setting



The camera automatically sets film speed by sensing the DX code marked on the film cartridge. (ISO 25–5000 according to DX code standard)

1. The automatically-set film speed will appear in the display panel while the film advances to the first usable frame.



2. When using film without a DX code, set the speed manually by following these steps: (ISO 6–6400).

- 1) Set the main switch to either “A” or “(••) ”.
- 2) Open the switch cover, and press both the blue and yellow buttons at the same time to display the ISO film speed number.
- 3) Turn the electronic input dial until your film speed displays.



- Once the buttons are depressed, you can remove your fingers because the ISO display is held on for approximately eight seconds. To clear this status within eight seconds, press the shooting mode selector.
- The previously set film speed appears and blinks in the display panel to warn you if the film speed has not been set. Always be sure to set the correct film speed, because the warning stops after film speed setting.

Basic Steps

1. Setting the Main Switch to the “Full Auto” Position



1) Slide the lens focus mode switch to “AF.”



2) Set the camera's main switch to the “Full Auto” position (the green “□” mark).

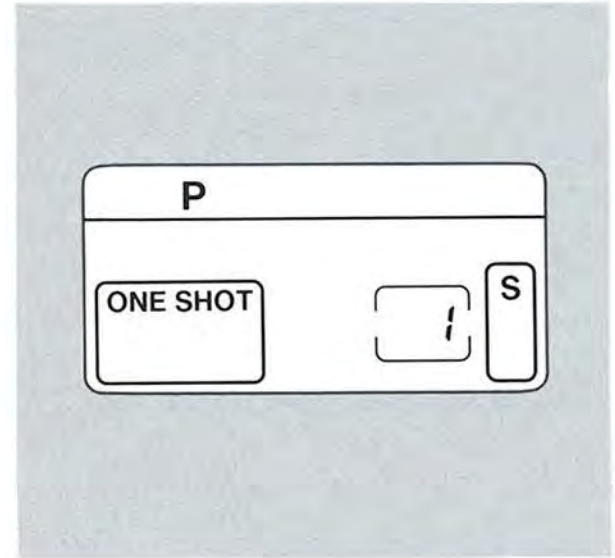

The following displays will appear:

ONE SHOT: One of the AF modes.

P (Program): One of the AE modes.

S (Single): One of the film winding modes.

For further details on the above displays, please refer to pp. 24, 26 and 27.

2. Holding the Camera



Your pictures will not be sharp if the camera moves as the shutter is pressed. This movement is called “camera-shake.” To avoid this, try the following camera-holding technique:

- 1) Hold the camera firmly, with your left hand supporting the camera and lens.
- 2) Press your left elbow close to your body.

- 3) Lightly hold the camera against your cheek or forehead and look into the viewfinder.
- 4) Spread your feet slightly apart, one foot ahead of the other, and relax.

There is no one correct way to hold the camera, so experiment to find the most comfortable way. If possible, lean against a steady support such as a tree, wall, or table to help you keep the camera still.

3. AF Focusing

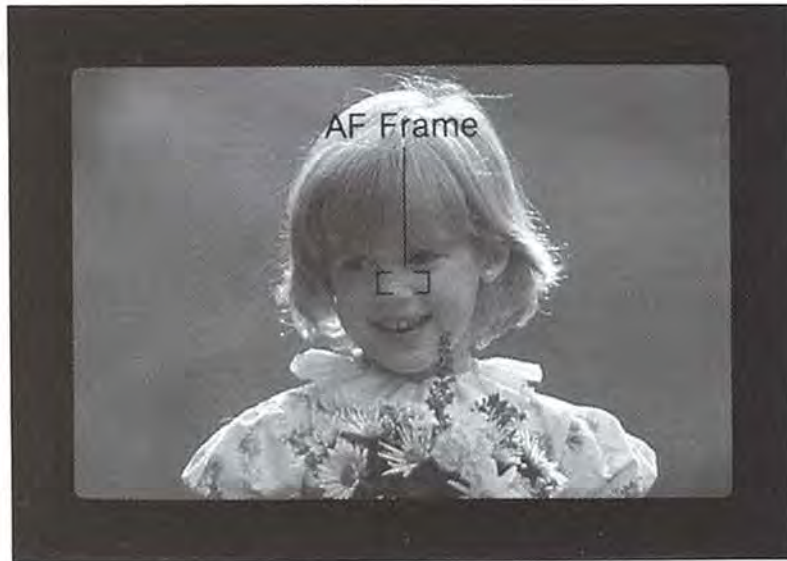

- 1) Center the AF frame (“[]” mark) over the main subject.



- 2) Press the shutter button halfway and automatic focus (AF) starts. When correct focus is obtained, the green AF in-focus indicator lights up in the viewfinder and the AF focus signal (short electronic beeper tone) sounds.
 - Original focus remains locked, even if the subject or focusing distance changes as long as the shutter button is held halfway.
 - When AF is impossible, the green AF in-focus indicator will start blinking and the shutter will not release. (see pp. 54 to 56.)

Do not touch the lens' moving parts during AF focusing.

4. Exposure

- 1) Gently press the shutter button halfway to check the exposure.
 - Once the shutter button is pressed halfway, the display is held on for approximately eight seconds.
 - When the automatically-set shutter speed is too slow to hand-hold, the camera-shake warning sounds (long electronic beeper tone). We recommend using a tripod or a flash.

Correct exposure display

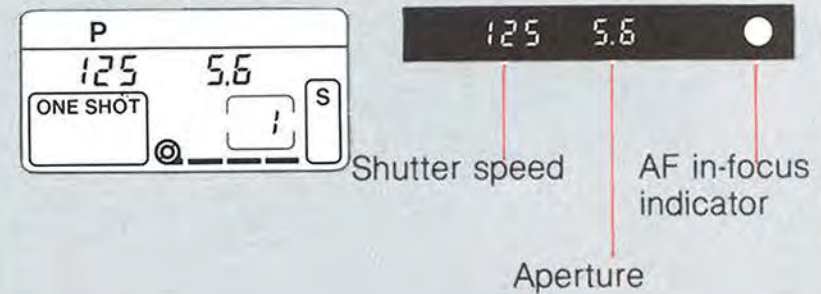

Display Panel Illumination (EOS 620 Only)



- 2) Compose the picture and while continuing to hold down the shutter button gently press the shutter button completely to take the picture.
- The camera automatically advances the film to the next frame.
 - Set the main switch to “L” to turn off the camera.



- Press the display panel illumination button to illuminate the display panel for approximately eight seconds.
- To turn off the illumination within eight seconds press the display panel illumination button again.

This camera is equipped with advanced “evaluative metering” so it automatically recognizes lighting conditions, subject pattern, and even subject size in the picture area. Even when there is a difference in brightness between the main subject and the background (e.g. backlit photography), correct exposure can be obtained without exposure compensation.

5. Automatic Film Rewind

The film automatically rewinds at the end of the roll.

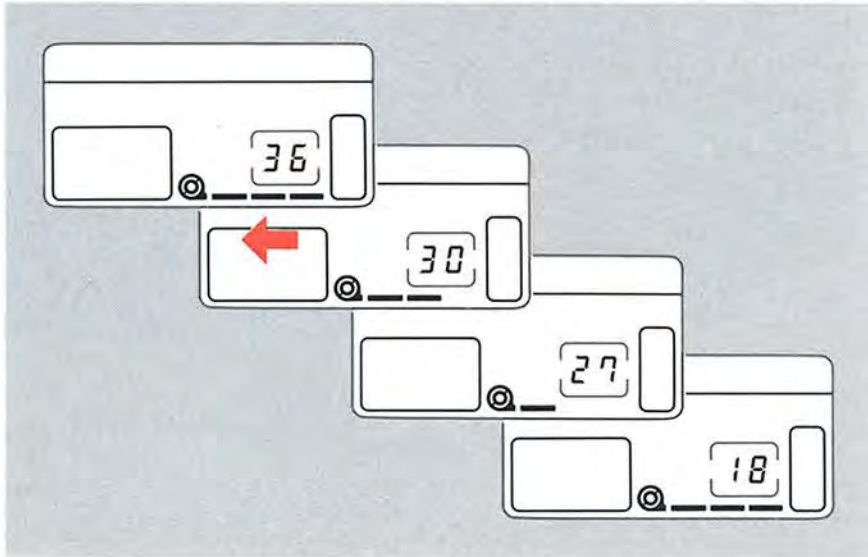

- 1) During rewind the film transport bars move in sequence from right to left to indicate the function in progress while the frame counter counts in descending order.

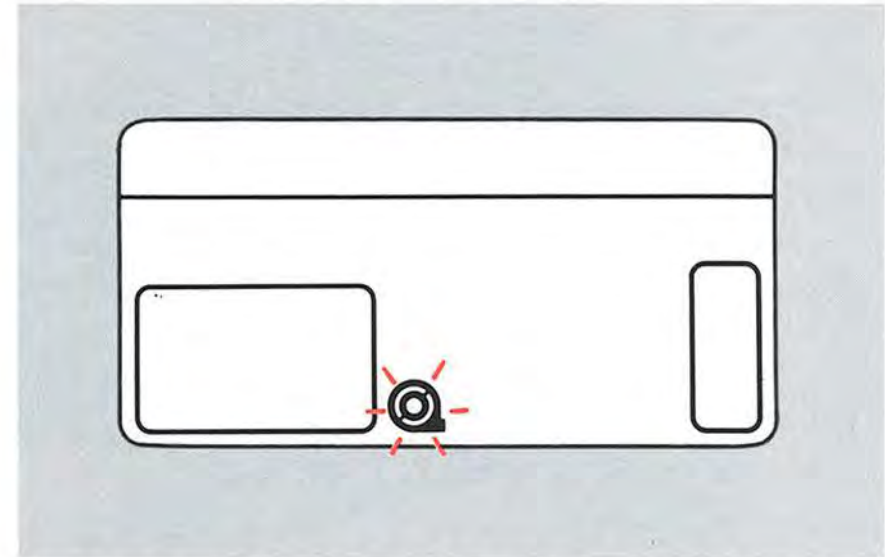

- 2) Film rewind stops automatically when the film has been completely rewound. Open the back cover when the film-load check mark (⊙) blinks.

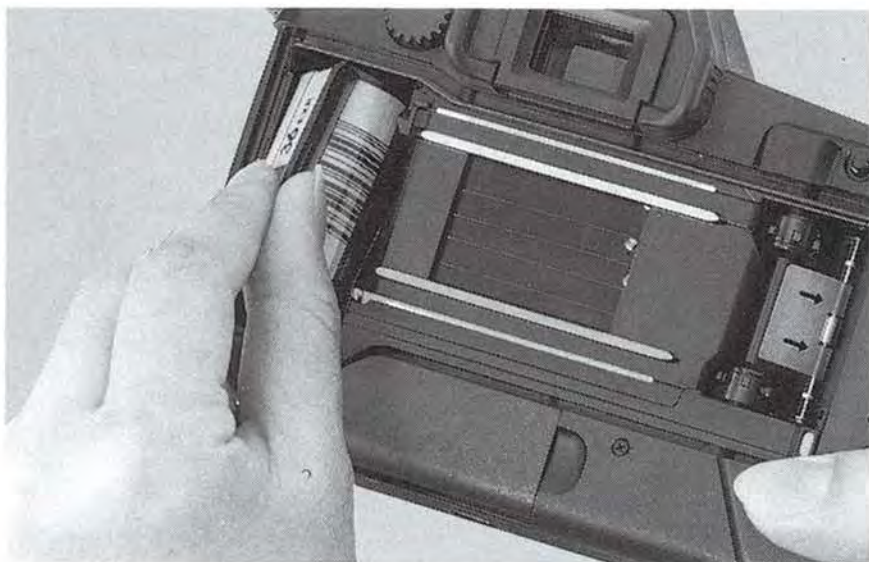

3) Remove the film cartridge.

Rewinding Mid-Roll

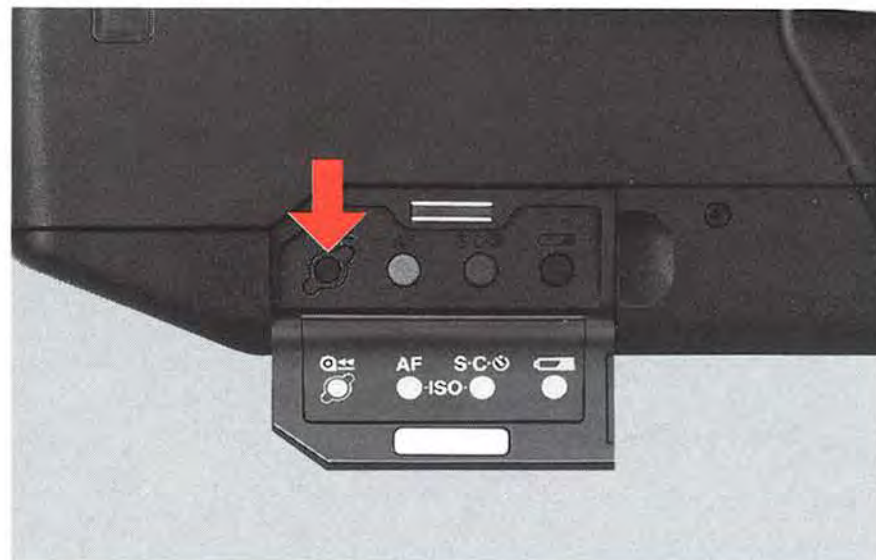

Press the film rewind button (🔄) to rewind before the roll ends. The function begins immediately.

Making the Most of Your EOS 620/650

Detailed explanation of other modes to make picture-taking fun.

1. Main Switch Functions

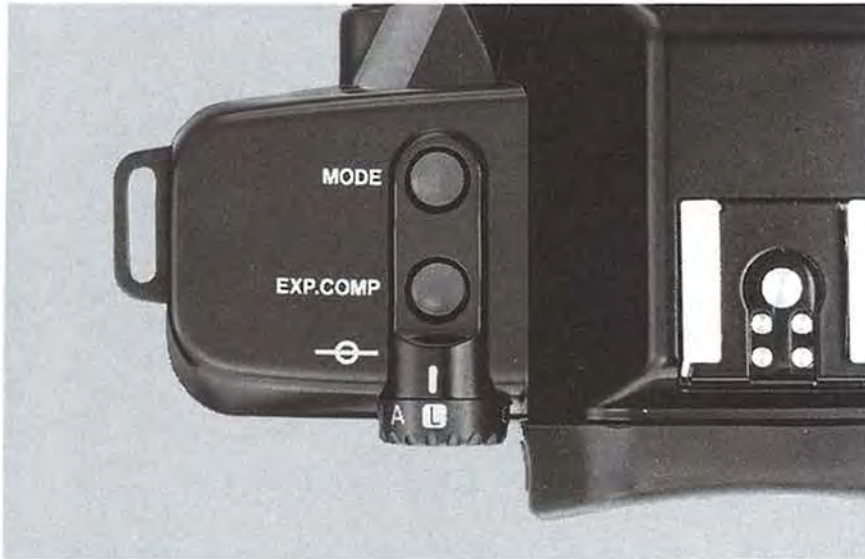

The main switch has four positions.

L(OFF): Turns off the camera. Be sure to set at this position to prevent accidental shutter release when not in use.



A(ON): Activates the camera. (The electronic beeper tone does not sound at this position.)



((••)) (ON): In addition to being the same ON position as “A”, the electronic beeper tone sounds in the following cases;

- 1) When correct focus is obtained. – AF focus signal (short beeper tone)
- 2) When the automatically-set shutter speed is too slow to hand-hold. – Camera-shake warning (long beeper tone)



□ (ON): Full auto position. The setting will be as follows automatically regardless of the mode.

- 1) AF mode – ONE SHOT
- 2) AE mode – P (Program)
- 3) Film winding mode – S (Single)
- 4) Electronic beeper tone
 - short; AF focus signal
 - long; camera-shake warning

Various AE and AF modes described in “Making the Most of Your EOS 620/650” cannot be set when the main switch is at the “□” position. Make sure the main switch is set to “A” or “((••))” position.

2. Setting the AF mode

This camera has two AF modes and the manual focus mode.

ONE SHOT: Normal set position. The lens stops moving once focus has been obtained. As long as the shutter button is kept pressed halfway, the original focus and exposure remain locked. This mode is useful when you want your subject to be off-center.

- The shutter releases only after AF completion.

SERVO: The lens continues to rotate, refocusing every time the focusing distance changes. Use this mode to freeze subject motion at a certain moment while following a moving subject. Exposure is determined at the moment of shutter release.

- The shutter releases whether or not AF has been completed.

MANUAL: Refer to p. 56.



To set the AF mode, follow these steps:

- 1) Set the lens focus mode switch to “AF.”

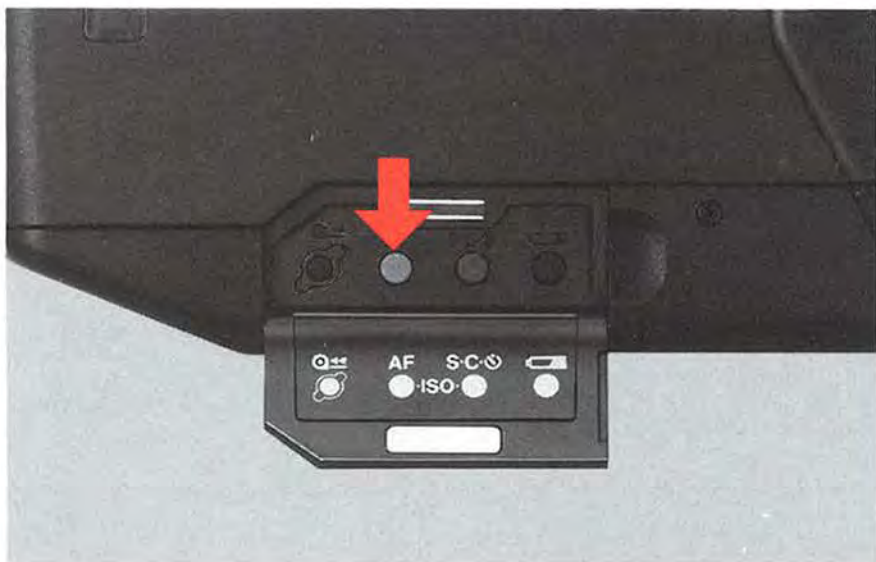

2) Open the switch cover and press the yellow AF mode selector.

- The display will be held on for approximately eight seconds so you can remove your finger. To clear this status within eight seconds, press the shooting mode selector.

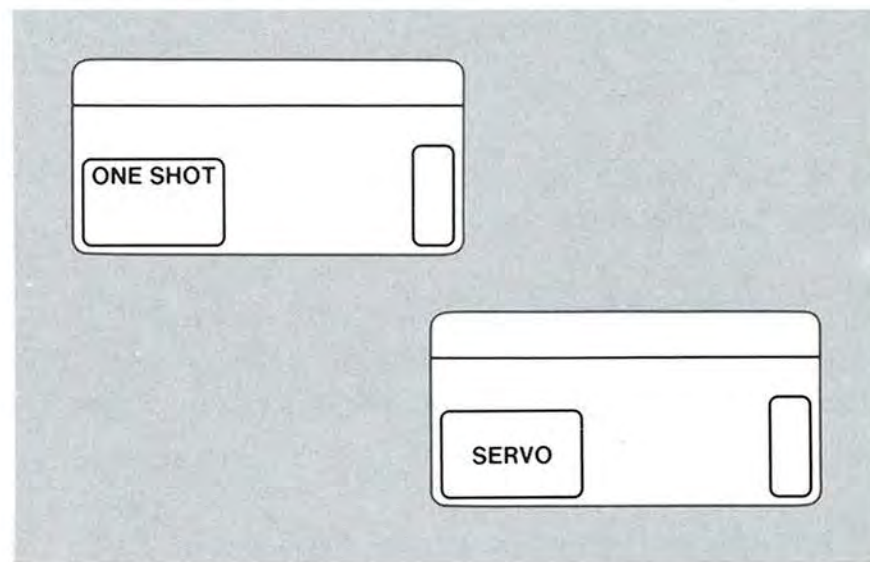

3) Turn the electronic input dial to select either "ONE SHOT" or "SERVO"

3. Setting the Film Winding Mode

This camera has two automatic film winding modes.

S: Single exposure. The film automatically advances to the next frame upon shutter release.

C: Continuous exposure. Keep pressing the shutter button and the film winds continuously at the maximum speed of approximately three frames per second.

: Self-timer position. (see p. 58)

To set the film winding mode, follow these steps:

- 1) Open the switch cover and press the blue film winding mode selector.
 - The display will be held on for approximately eight seconds so you can remove your finger. To clear this status within eight seconds, press the shooting mode selector.

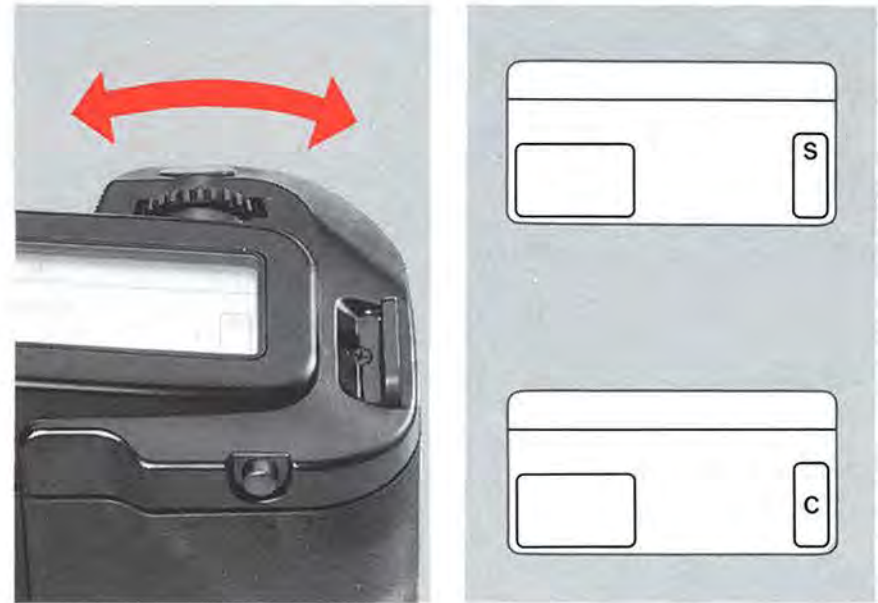

- 2) Turn the electronic input dial to set either “S” or “C” in the display panel.



4. Setting the Shooting Mode

To set the shooting mode, press the shooting mode selector while turning the electronic input dial until the desired mode appears. (The display moves in the following cycle.)

- Once the shutter button is pressed halfway, the display will be held on for approximately eight seconds. To clear this status within eight seconds, press the shooting mode selector.

AF can be done with the Canon Circular Polarizing Filter PL-C. When using a linear polarizing filter, use manual focusing. (see p. 56)

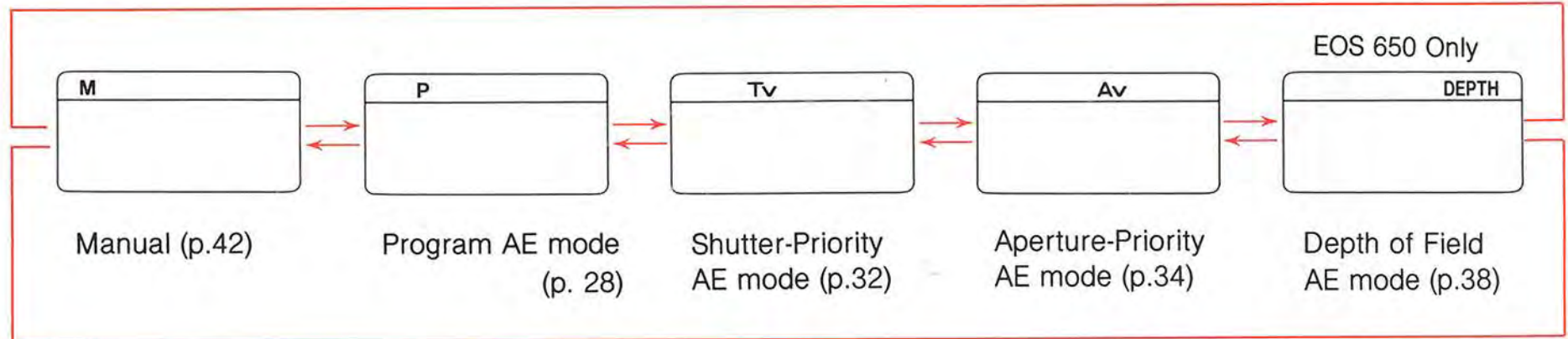

(1) Program AE

[PURPOSE]

The camera automatically sets shutter speed/aperture combinations according to subject brightness. This mode particularly suits first-time SLR users or those who prefer to concentrate on picture composition or candid snapshots.

[SETTING]

While pressing the shooting mode selector, turn the electronic input dial until "P" appears in the display panel.

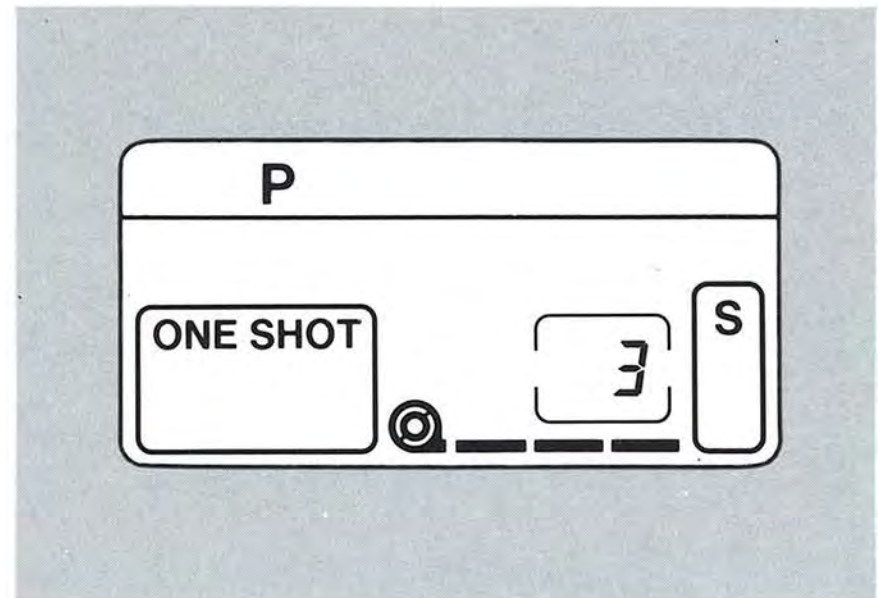

[VIEWFINDER INFORMATION]

Make sure that both values remain continuously lit.



When both values blink, exposure is incorrect. Use an ND filter in bright settings and switch to flash photography in dark settings.

When the automatically-set shutter speed is too slow to hand-hold, the camera will sound a long beeper tone to warn you. We recommend using a tripod or flash.

The camera selects the ideal program line according to the characteristics of the lens in use, i.e., the maximum or minimum aperture and lens focal length. This is referred to as “Intelligent Program AE.” For further information on the program line, please see pp. 79 and 80.

This program AE mode has the same characteristics as the one selected when the main switch is set to the green “” mark (see p.14). However, the “ONE SHOT” AF and “S” film winding modes are automatically set so use the setting described on this page when you want to use the “SERVO” AF mode or “C” film winding mode.

(2) Program Shift Function (EOS 620 Only)

[PURPOSE]

With the EOS 620, you can change the automatically-set shutter speed/aperture combinations of the program AE mode. This function is particularly useful when you need a specific shutter speed or aperture while shooting in the program AE mode.



[SETTING]

Simply turn the electronic input dial until the desired shutter speed or aperture value appears after pressing the shutter button halfway to meter the subject. For example, when you need a fast shutter speed suddenly to freeze a fast-moving subject while shooting in the program AE mode, turn the electronic input dial to set a fast shutter speed such as 1/500 second.

- Once the shutter button is pressed halfway, you can remove your finger because the display will be held on for approximately eight seconds.

Be sure to set the main switch to the “A” or “(•)” position. (At the green “□” position, the program shift function cannot be used.)

Example:

Displays when the shutter button is pressed halfway

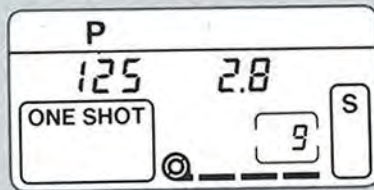

Turn the electronic input dial.

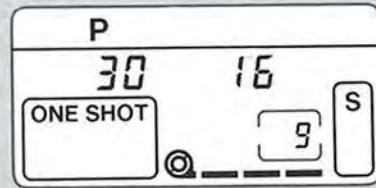
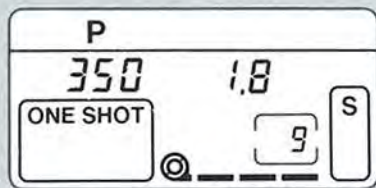

- After shutter release, the program shift function automatically clears.
- The program shift function cannot be used in flash photography.
- For further information on the program shift characteristics, please see p.81

(3) Shutter-Priority AE

[PURPOSE]

In this mode the shutter speed is manually set and the camera automatically chooses the correct aperture for the lighting conditions. This mode is best for taking pictures of moving subjects by controlling the shutter speed. Faster shutter speeds freeze subject motion while slower shutter speeds can produce artistic blur effects.

[SETTING]

- 1) While pressing the shooting mode selector, turn the electronic input dial until "Tv" appears in the display panel.
- 2) Remove your finger from the shooting mode selector. At this point, the initial shutter speed setting is always 125 (1/125 sec).
- 3) Turn the electronic input dial until the desired shutter speed appears.

Shutter speed display

4000	3000	2000	1500	1000	750	500	350				
250	180	125	90	60	45	30	20	15	10	8	6
4	3	2	0"7	1"	1"5	2"	3"	4"	6"	8"	
10"	15"	20"	30"								

Note

4000 and 3000 EOS 620 only

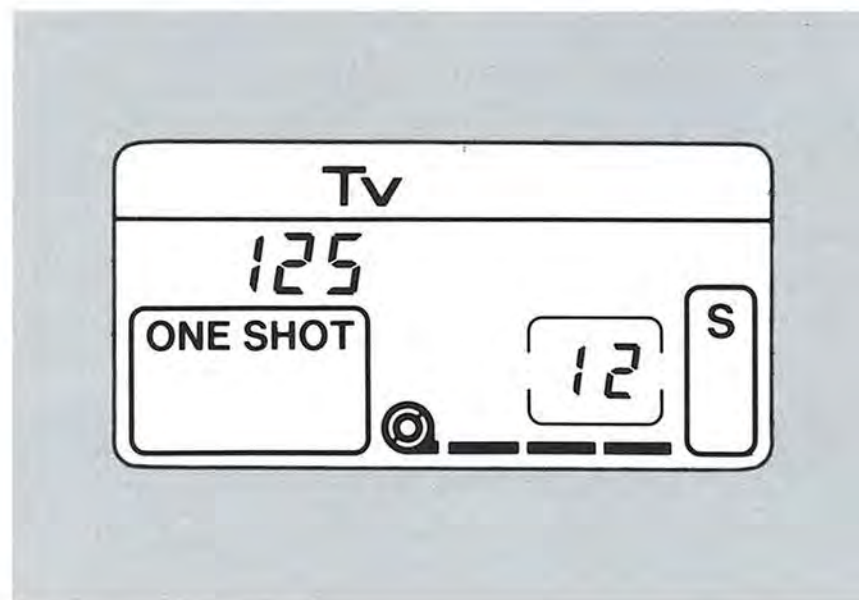

[VIEWFINDER INFORMATION]

Make sure that both values remain continuously lit.

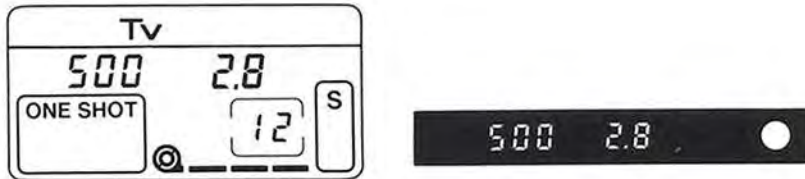

Underexposure — The lens maximum aperture starts blinking. Turn the electronic input dial and set a slower shutter speed until the maximum aperture stops blinking.

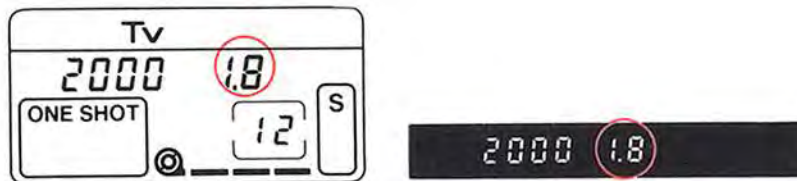

Overexposure — The lens minimum aperture starts blinking. Turn the electronic input dial and set a faster shutter speed until the minimum aperture stops blinking.

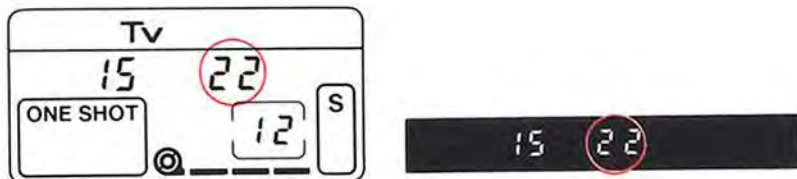

The “camera-shake” warning does not sound in shutter-priority AE.

(4) Aperture-Priority AE

[PURPOSE]

In this mode, the aperture is set manually and the camera chooses correct shutter speed for the lighting conditions (the opposite of shutter-priority AE). Use this mode for portraits, landscapes and still-life photography where depth of field is an important factor. (see p. 36)

[SETTING]

- 1) While pressing the shooting mode selector, turn the electronic input dial until "Av" appears in the display panel.
- 2) Remove your finger from the shooting mode selector. At this point, the initial aperture setting is always 5.6 (f/5.6).
- 3) Turn the electronic input dial until the desired aperture value appears.

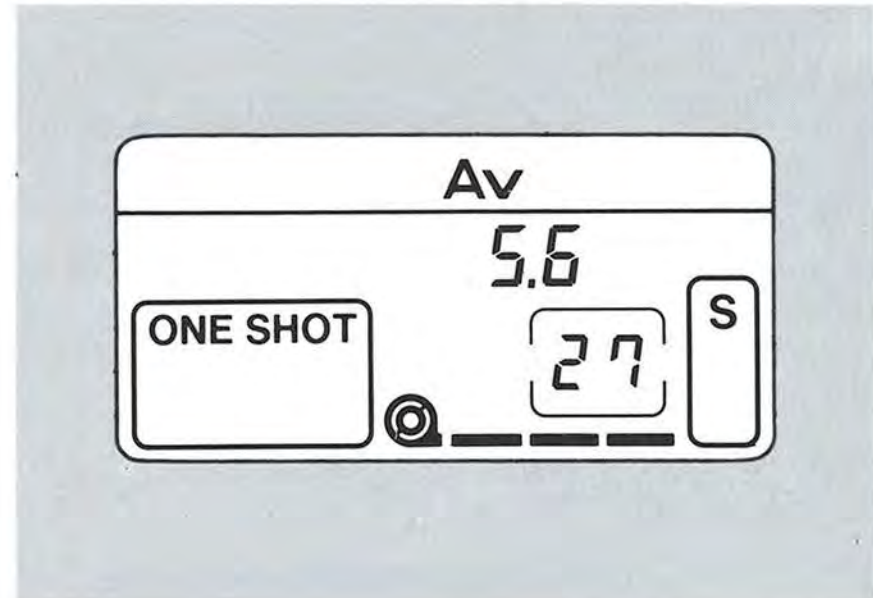

[VIEWFINDER INFORMATION]

Make sure that both values remain continuously lit.

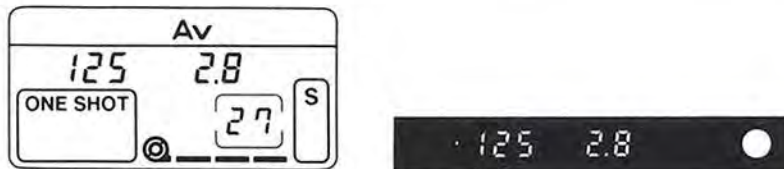

Underexposure — The shutter speed of 30" starts blinking. Turn the electronic input dial and set a larger aperture until 30" stops blinking.

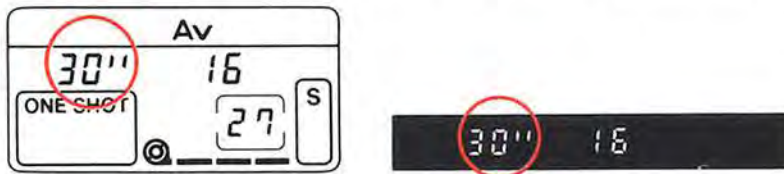

Overexposure—The shutter speed of 2000 with the EOS 650 or 4000 with the EOS 620 starts blinking. Turn the electronic input dial and set a smaller aperture until the shutter speed stops blinking.



When the automatically-set shutter speed is too slow to hand-hold, the camera-shake warning sounds. We recommend using a tripod.

Depth of Field

When your subject is in focus, there is a certain area in front of it and behind it which will also be in focus. This range of sharpness is called “depth of field”.

Depth of field has the following characteristics:

- 1) The smaller the aperture, the wider the depth of field and vice versa.
- 2) The shorter the lens focal length is, the greater the depth of field, provided that aperture and shooting distance are the same.
- 3) The farther the shooting distance, the greater the depth of field.
- 4) Depth of field is generally greater in the background than the foreground by a ratio of two to one.



f/16



f/1.8



To check the depth of field (1)
Push the depth-of-field check button and the camera will stop-down the aperture to either the automatically-calculated value (e.g. shutter-priority AE), or the one set manually (e.g. aperture-priority AE). As you look through the viewfinder with the button pushed in, you can see the range of sharpness, i.e. the depth of field.

It is impossible to check depth of field when the main switch is set at the green "  " mark.



To check the depth of field (2)
Press the shutter button halfway and note the aperture value. Find the two aperture values on the depth-of-field scale on the lens which correspond to that value. Then draw imaginary lines from those two values to the distance scale. The effective depth of field lies between those two distances. For example, using a standard 50mm lens focused at 5m with the aperture set at f/11, depth of field extends from approx. 2.7m to 10m (approx. 8.8ft to 32.8ft) away. Any subject from 2.7m to 10m away will be in reasonably sharp focus.

There are some lenses which have no depth-of-field scale so follow step (1).

(5) Depth of Field AE (EOS 650 Only)

[PURPOSE]

This mode makes everything from a certain point in the foreground to the background in focus, using both the AF function and the depth of field. The camera automatically sets the correct aperture value and corresponding shutter speed for the lighting conditions. Use this mode for landscapes and large-group commemorative shots.

[SETTING]

- 1) While pressing the shooting mode selector, turn the electronic input dial until "DEPTH" appears in the display panel.

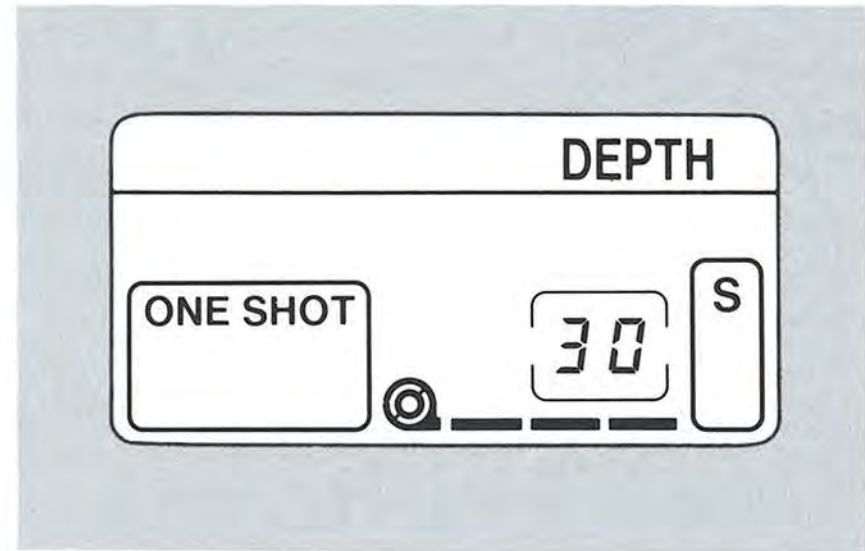
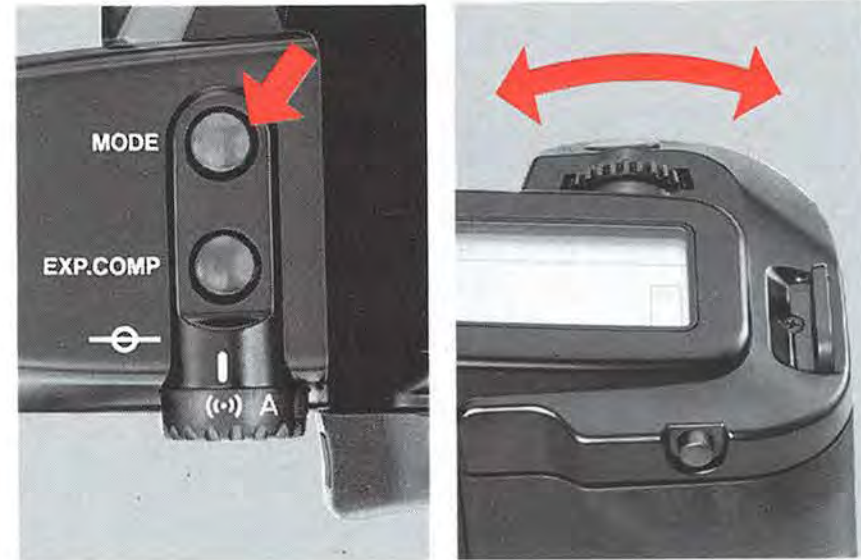



- 2) Compose the picture first.
- 3) Focus the subject in either the ONE SHOT or SERVO mode.
- 4) Center the AF frame (“[]”) over the first point in the foreground (see illus. A).
- 5) Press the shutter button halfway to focus the “A” point and remove your finger from the shutter button when the AF in-focus indicator lights up.



The display after the first “A” point is focused.

- 6) Focus the second “B” point of the background (see illus. B as you would for step 4).

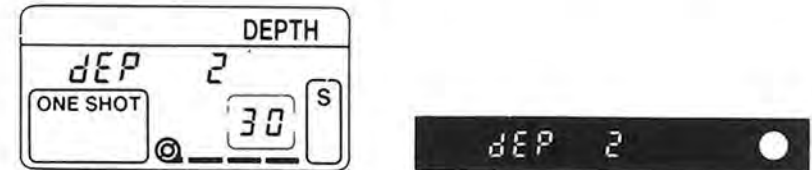

The display after the second “B” point is focused.

- 7) Press the shutter button halfway once again. At this time, the correct aperture value and corresponding shutter speed are displayed.

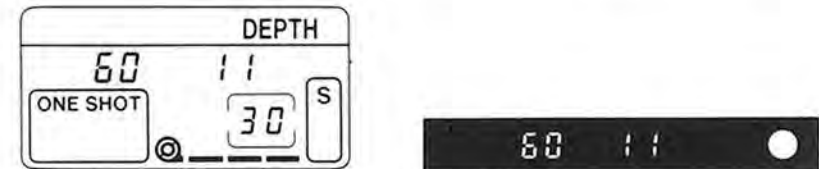

- 8) Gently press the shutter button completely to take the picture.

When shooting continuously, it is not necessary to focus the same subject again provided you keep pressing the shutter button halfway after exposure. (To clear, press the shooting mode selector after you remove your finger from the shutter button.)

[VIEWFINDER INFORMATION]

If it is impossible to get the distance range in focus, the lens minimum aperture value will start blinking. Exposure, however, will still be correct and you will get the best results under the existing shooting conditions. (see helpful hints 41)



[Helpful Hints]

1. Move back from the subject and follow steps 2 through 7 again. If the minimum aperture stops blinking, the distance range will be in sharp focus and the exposure will be correct.
2. Use a wide-angle lens (or wide-angle side when using a zoom lens) and follow steps 2 through 7 again. If the minimum aperture stops blinking, the distance range will be in sharp focus and the exposure will be correct.



Make sure that both values remain continuously lit.

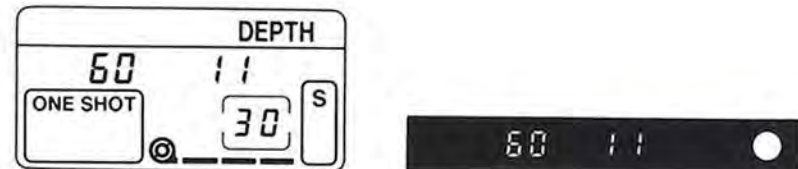

When both values blink, exposure is incorrect. Use an ND filter in bright settings and switch to flash photography in dark settings.

- When you try to focus extremely near and far points the automatically-set shutter speed will be comparatively slower and the long beeper tone will sound to warn you of camera-shake. Hold the camera steady or use a tripod.
- When using a zoom lens, do not change the lens focal length after focusing the first point. Always be sure to compose the picture first.
- It is advisable to use a wide-angle lens to obtain maximum depth-of-field effect. (A lens focal length of more than 200mm is not recommended when you want maximum depth of field.)
- Depth of field will be shallow if two points are focused at the same shooting distance. When you want to take a portrait, a telephoto lens is recommended to strengthen the shallow effect.
- In depth of field AE, exposure is determined at the moment of shutter release even if the AF mode is set at ONE SHOT. (see p.24)
- Depth of field AE cannot be used in flash photography.
- Press the shooting mode selector to clear the depth of field AE while operating.

(5) Manual Override

[PURPOSE]

This creative mode allows you to control exposure by setting both the shutter speed and aperture.

[SETTING]

- 1) While pressing the shooting mode selector, turn the electronic input dial until "M" appears in the display panel.
- 2) Remove your finger from the shooting mode selector.
 - At this point, the initial setting is always 1/125 sec. at f/5.6.

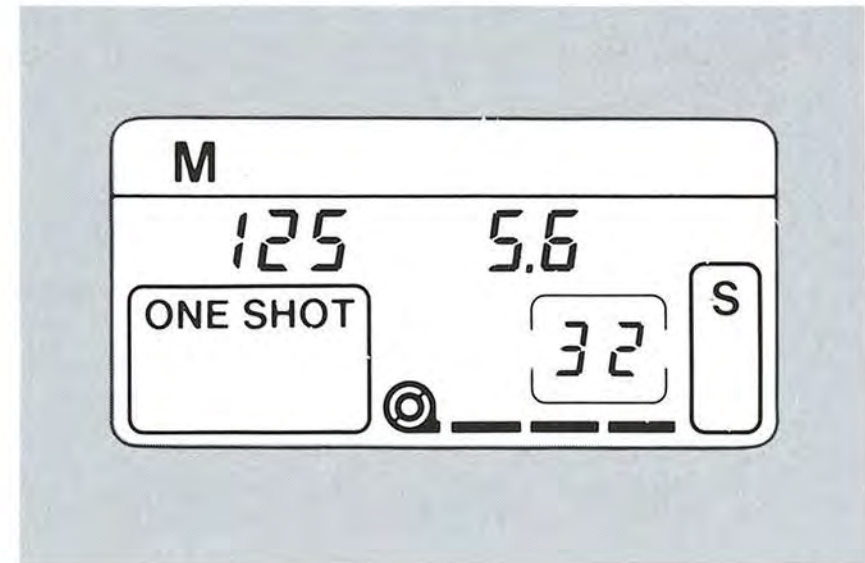

- 3) Turn the electronic input dial to set the desired shutter speed.
- 4) Press the manual aperture set button.
 - At this point, “ OP ”, “ oo ”, or “ CL ” lights up instead of the shutter speed. (The aperture value remains unchanged.) The meaning of each display follows:

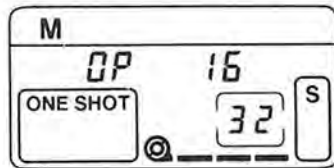

OP : underexposure
(OPen the aperture)

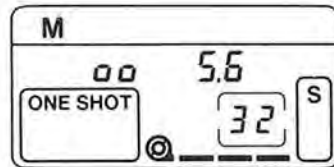

OO : correct exposure

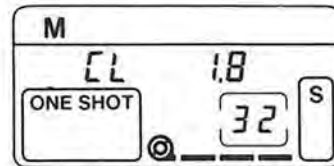

CL : overexposure
(CLose the aperture.)



- 5) While pressing the manual aperture set button, turn the electronic input dial until “ oo ” displays. The corresponding aperture value displays.
- 6) Remove your finger from the manual aperture set button.
- 7) Determine the exposure referring to the shutter speed/aperture combination. You must rely on your own experience for setting the exposure.
 - Set a slower shutter speed if “ OP ” remains lit when the electronic input dial is turned to the lens maximum aperture.
 - Set a faster shutter speed if “ CL ” remains lit when the electronic input dial is turned to the lens minimum aperture.
 - The camera-shake warning does not sound in the manual mode.

5. Partial Metering

This camera has an evaluative metering function which allows you to obtain the correct exposure without exposure compensation in normal backlit photography (see p. 18). Use the partial metering mode, however, for stage photography where there is a big difference in brightness between the main subject and the background, and when you want to control the exposure.

- The partial metering mode can be used regardless of the camera's mode, except when the main switch is set to the full auto position ().
- The partial metering area is approximately 6.5% of the picture area.
- The AE lock mechanism automatically works in the partial metering mode.

AE lock:

The original exposure value remains locked as long as the shutter button is pressed halfway, so even if you recompose the picture, correct exposure on the main subject will not be affected by changes in lighting conditions.

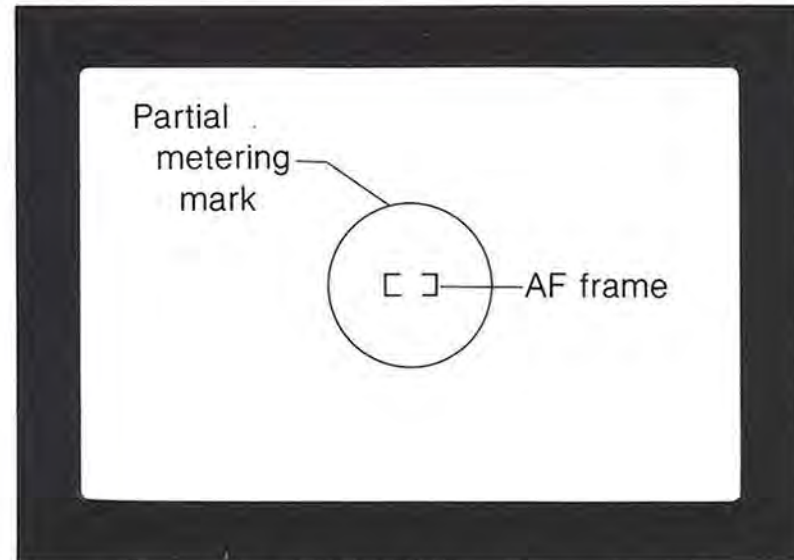

- 1) Put the main subject in the center and cover with the partial metering mark.
- 2) Press the shutter button halfway.



3) While pressing the shutter button halfway, press the partial metering button. (In the manual override, however, press the partial metering button while pressing the manual aperture set button.)

- A green asterisk (“✱”) indicating that the partial metering mode and the AE lock are on appears in the viewfinder.
- You can remove your finger from the partial metering button if you keep pressing the shutter button halfway.



4) Compose the picture while continuing to hold down the shutter button, then press the shutter button completely to take the picture.

Sequential AE lock photography

When shooting continuously with AE lock in the same lighting conditions, it is not necessary to meter the subject for each shot provided you keep pressing the shutter button halfway after each exposure.

6. Exposure Compensation

Use exposure compensation for high-key (intentionally overexposed) or low-key (intentionally underexposed) shots. The range of exposure compensation is up to ± 5 steps in 1/2-step increments.

- “+” means increasing exposure while “-” means decreasing exposure.
- Exposure compensation can be used regardless of the metering or shooting mode, except when the main switch is set to the full auto position ().

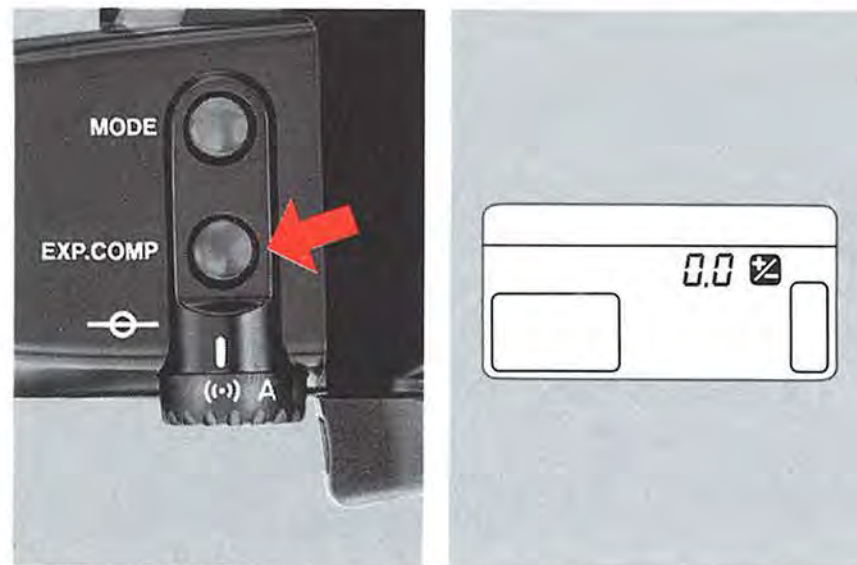

- 1) Press the exposure compensation button and “0.0±” appears in the display panel.

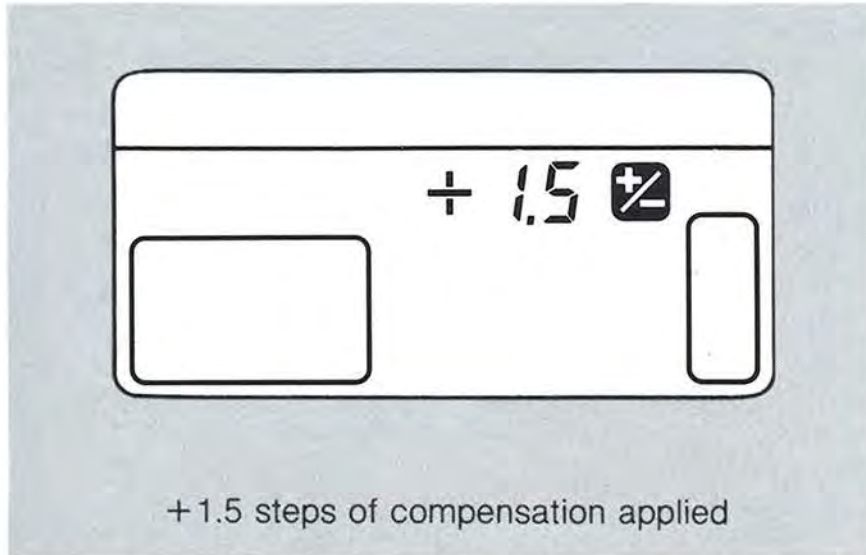

- 2) While pressing the exposure compensation button, turn the electronic input dial to the desired exposure compensation value.
- 3) Remove your finger from the exposure compensation button.

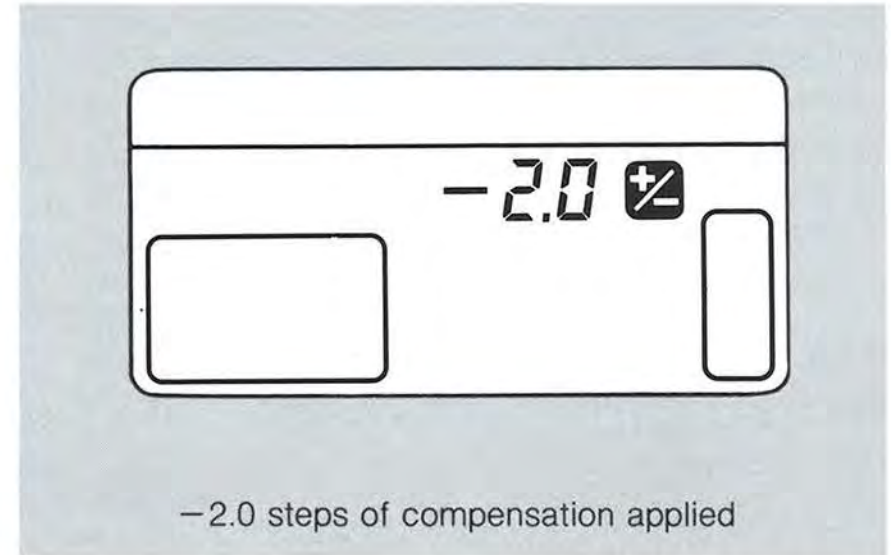

- The "+/-" mark indicating exposure compensation status appears in the viewfinder and in the display panel.
- Reset the amount of compensation to "0.0±" otherwise, subsequent frames will be incorrectly exposed.

7. Auto Exposure Bracketing (EOS 620 Only)

Use auto exposure bracketing when you want to choose the best exposure by changing the amount of exposure on film intentionally. The range of bracketing is up to ± 5 steps in 1/2-step increments.

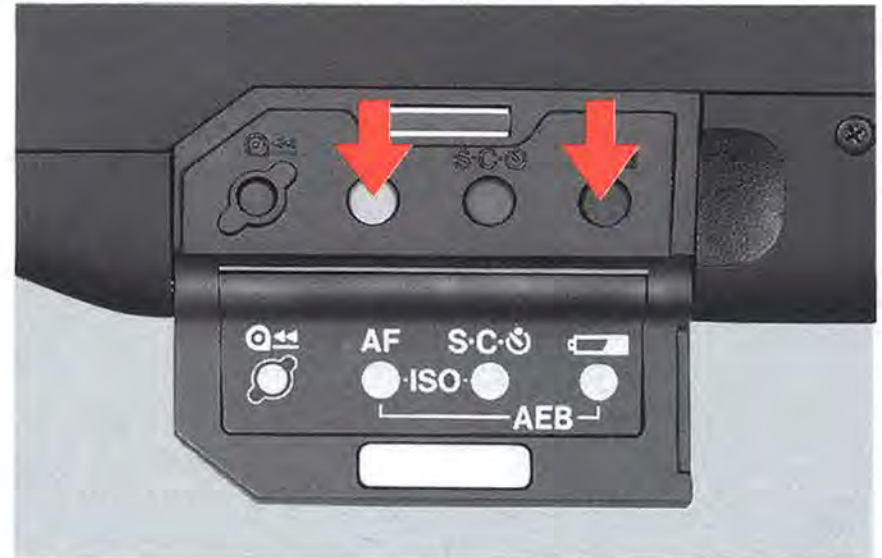

- 1) Open the switch cover and press both the AF mode selector and battery check button simultaneously to display the 0.0 and "AEB" indicating auto exposure bracketing.
 - Once the buttons are depressed, you can remove your fingers because the "AEB" display is held on for approximately eight seconds. To clear this status within eight seconds, press the shooting mode selector.



- 2) Turn the electronic input dial to the desired bracketing value.
 - If you set 1.5 in the display panel, for example, the camera automatically makes three continuous exposures in sequence of -1.5 step of underexposure, correct exposure according to the camera's meter and $+1.5$ step of overexposure. Then the auto exposure bracketing status automatically clears.

Notes

1. Three continuous exposures are automatically made regardless of the film winding mode.

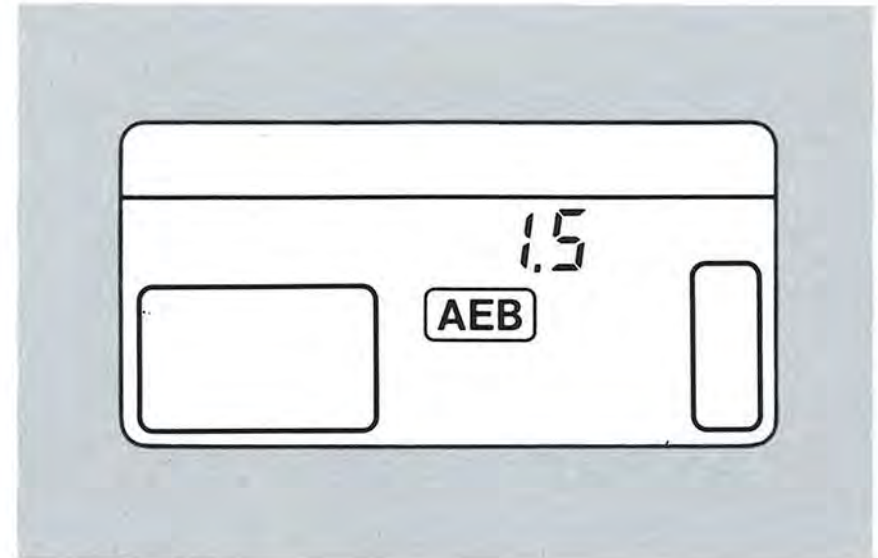

2. The original focus remains locked during three continuous exposures regardless of the AF mode.
3. To clear auto exposure bracketing before shooting, display the "AEB" and preset bracket value again by following step 1) above, then turn the electronic input dial until the bracket value returns to 0.0. (Clearing auto exposure bracketing is impossible while shooting.)
4. Bulb cannot be used with auto exposure bracketing.
5. Auto exposure bracketing is impossible with a flash.

(Auto Exposure Bracketing Continued)



- 1.5 step of
compensation applied



±0 step of
compensation applied



+ 1.5 step of
compensation applied

Helpful Hints

1. Use the exposure compensation function if, for example, you want particular overexposing-bracket exposures such as ± 0.5 , $+1.5$ and $+2.5$.

Example:

- 1) Set auto exposure bracketing value to 1.0 — (-1.0 , ± 0 , $+1.0$).
- 2) Set the exposure compensation value to $+1.5$.

The result will be three continuous exposures in sequence of $+0.5$, $+1.5$ and $+2.5$.

2. With the Technical Back E, auto exposure bracketing can be done up to nine exposures in 1/4-step increments.

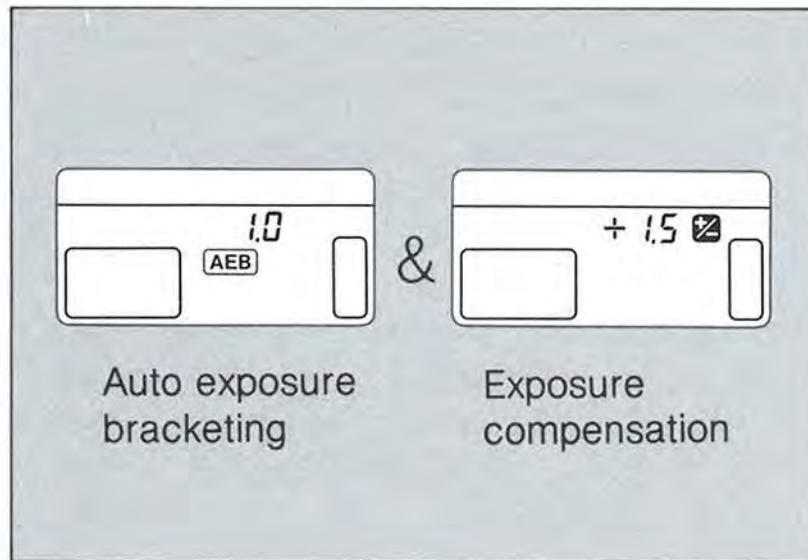

8. Multiple Exposures (EOS 620 Only)

The EOS 620's provision for multiple exposures allows you to take two or more exposures on the same frame for a creative effect. Preset multiple exposures up to nine frames with the single operation of the electronic input dial are possible.



- 1) Press both the shooting mode selector and the exposure compensation button simultaneously. The "ME" mark indicating multiple exposure status will then appear in the display panel and the frame counter will become "1".
- 2) While pressing both turn the electronic input dial to the desired number of exposures. For example, set "3" on the frame counter if you want to make three exposures on the same frame.



- While shooting, the “ME” mark will blink to indicate the camera is in the multiple exposure status.
- After the preset number of exposures have been completed, the film automatically advances to the next frame.

[Clearing Preset Exposures]

1. Before shooting
Follow steps 1) and 2) on p. 52 and turn the electronic input dial to return the frame counter to “1”.
2. While shooting
The operating procedures are basically the same as mentioned above, but turn the electronic input dial until the frame counter is blank.

[Exposure Compensation]

It is necessary to correct the exposure depending on the situation because the same frame is exposed several times. Use the exposure compensation function referring to pp.46—47.

Number of exposures	Exposure Compensation Setting
Double	– 1.0
Triple	– 1.5
Quadruple	– 2.0

Notes

1. The preceding table is a general guideline. The actual amount of exposure compensation varies according to the situation. Your technique will benefit greatly from practice.
2. It is not advisable to make multiple exposures on the first or last several frames due to possible film curl which may adversely affect image registration.
3. Generally, the first exposure of a series should be a relatively dark subject so that the image in the next exposure will show up clearly.
4. When using a negative film, please inform the developer that you have taken multiple exposures with the negative film, or your picture taken in multiple exposure may not be printed.

9. Difficult Subjects for Autofocus

Although the AF system of the camera is very accurate, it is not perfect. The following subjects are difficult for autofocus. When AF is impossible, the green AF in-focus indicator will blink in the viewfinder.

Subjects
• Low contrast subjects (misty scenes, light-colored or white objects)(A)
• Subjects in extremely low-light situations (a dark room, night scenes)(B)
• Subjects having generally horizontal patterns (window blinds)(C)
• Subjects in extremely strong backlight with strong reflections(D)
• Subjects with an object in front of them (caged zoo animals)(E)
• Fast-moving subjects (difficult to keep within the AF frame)(F)

(A)

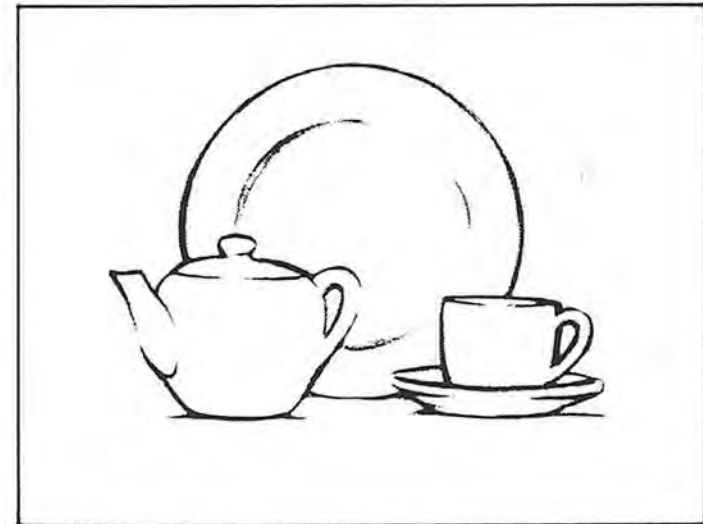

(C)

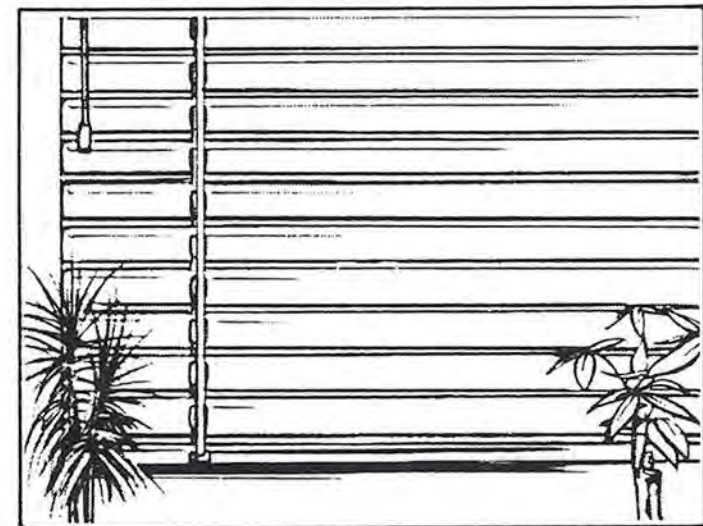

(B)



Focus these subjects as follows:

1. Autofocus a substitute subject at the same distance from the camera as your main subject, and then recompose the picture (A)
2. Hold the camera vertically and focus the subject using autofocus then recompose the picture (C)
3. Manually focus the subject following the steps on the next page.

(E)

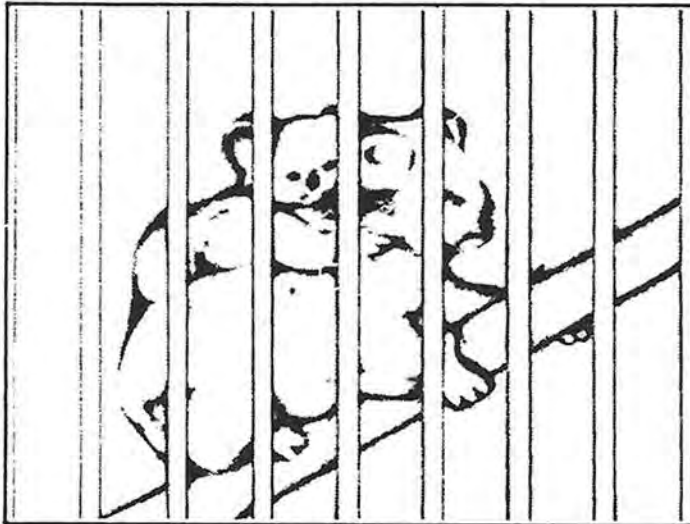

10. Manual Focusing

- 1) Slide the lens focus mode switch to "M".
 - The panel display automatically changes to "M. FOCUS" and the AF mode cannot be set.
- 2) Turn the lens manual focusing ring and focus your subject using the matte-surface.
 - The subject is in focus when the image is not fuzzy.

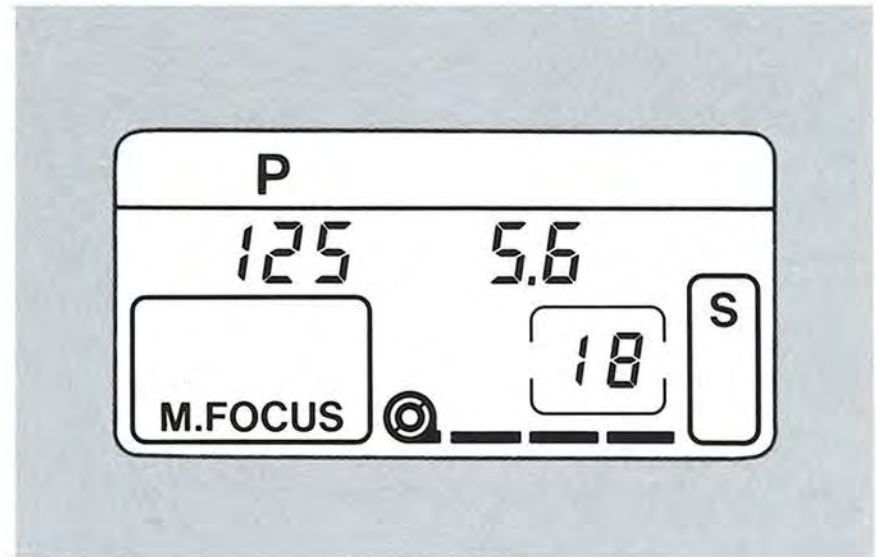

Other Shooting

1. Self-timer Photography

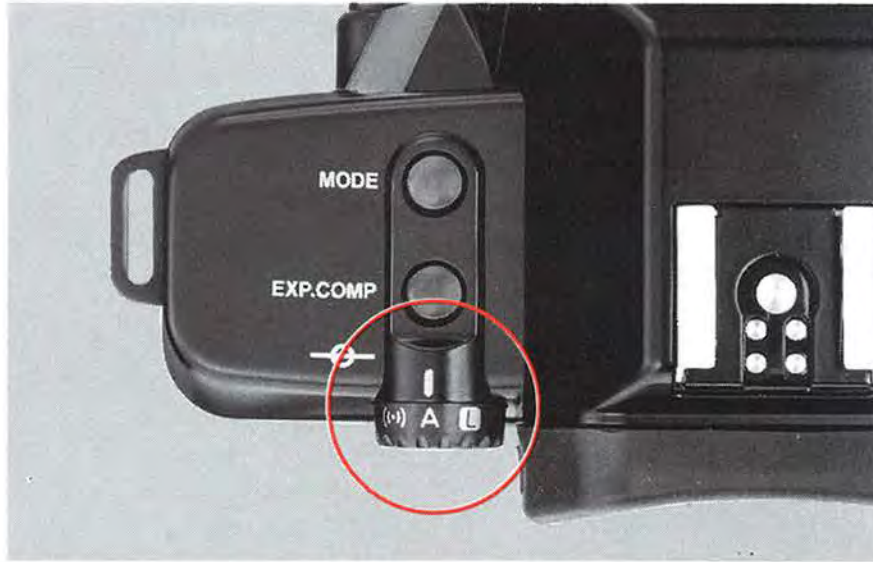

The self-timer allows you to delay shutter release for ten seconds.

To set:

- 1) Put the camera on a table, tripod, or other flat surface.
- 2) Set the main switch to either "A" or "(••)."

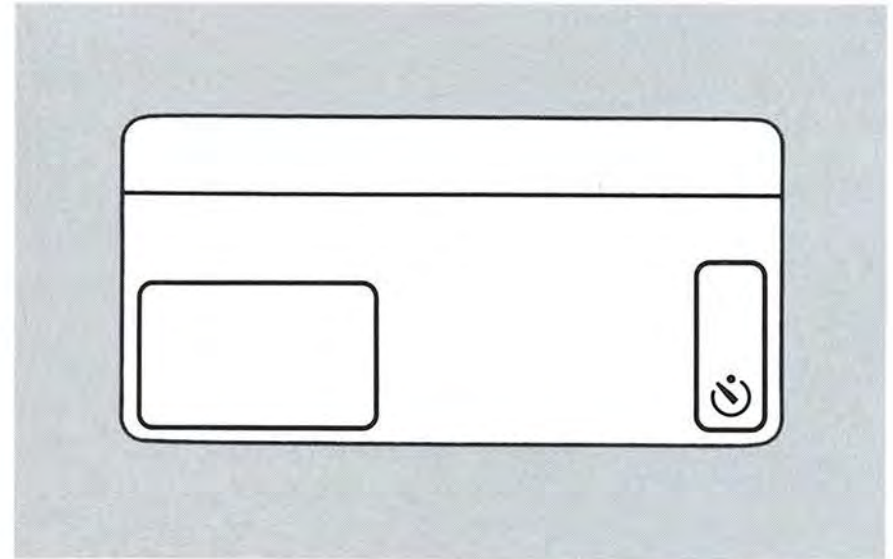

- 3) Open the switch cover and press the blue film winding mode selector (see p. 26).
- 4) Turn the electronic input dial until "⌚" mark appears in the display panel.

- 5) Focus the subject in either the ONE SHOT or SERVO mode.
 - 6) Make sure the exposure is correct and then press the shutter button. The self-timer operation indicator will start blinking and the frame counter displays the countdown.
- The shutter automatically releases ten seconds after being pressed. Two seconds before shutter release, the indicator starts blinking faster.
 - To cancel the self-timer before shutter release, press the battery check button.
 - Do not stand in front of the camera when you press the shutter button.



If your eye will not be at the viewfinder when you press the shutter button, cover the viewfinder as shown to prevent stray light from entering at the rear, using the viewfinder cover attached to the neckstrap shoulder pad.



2. Dedicated Flash Photography

- (1) Use the Canon Speedlites 420EZ and 300EZ as fill-in flash in outdoor settings as well as for normal flash when shooting at night or in a dimly-lit room. These units feature a built-in AF auxiliary light function for dark situations, so you can perform AF flash photography.



Speedlite 420EZ

Speedlite 300EZ

Fill-in flash:

This technique utilizes a flash unit as an auxiliary light to prevent subject underexposure in backlit situations. Generally, the exposure level between the main subject illuminated by the flash and the background in ambient light must be balanced to avoid unnatural effects. With the Canon Speedlites 420EZ and 300EZ there is no need to balance this exposure level because it is automatically controlled.

Upon flash charge completion in the Program AE mode, the aperture value and the X-sync shutter speed are automatically set. X-sync shutter speed is set between 1/60 and 1/125 sec with the EOS 650 and between 1/60 and 1/250 sec with the EOS 620.

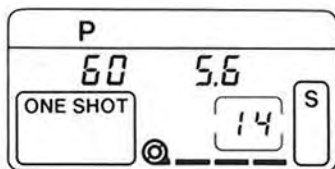

X-sync shutter speed

Flash-charge completion mark

Aperture value

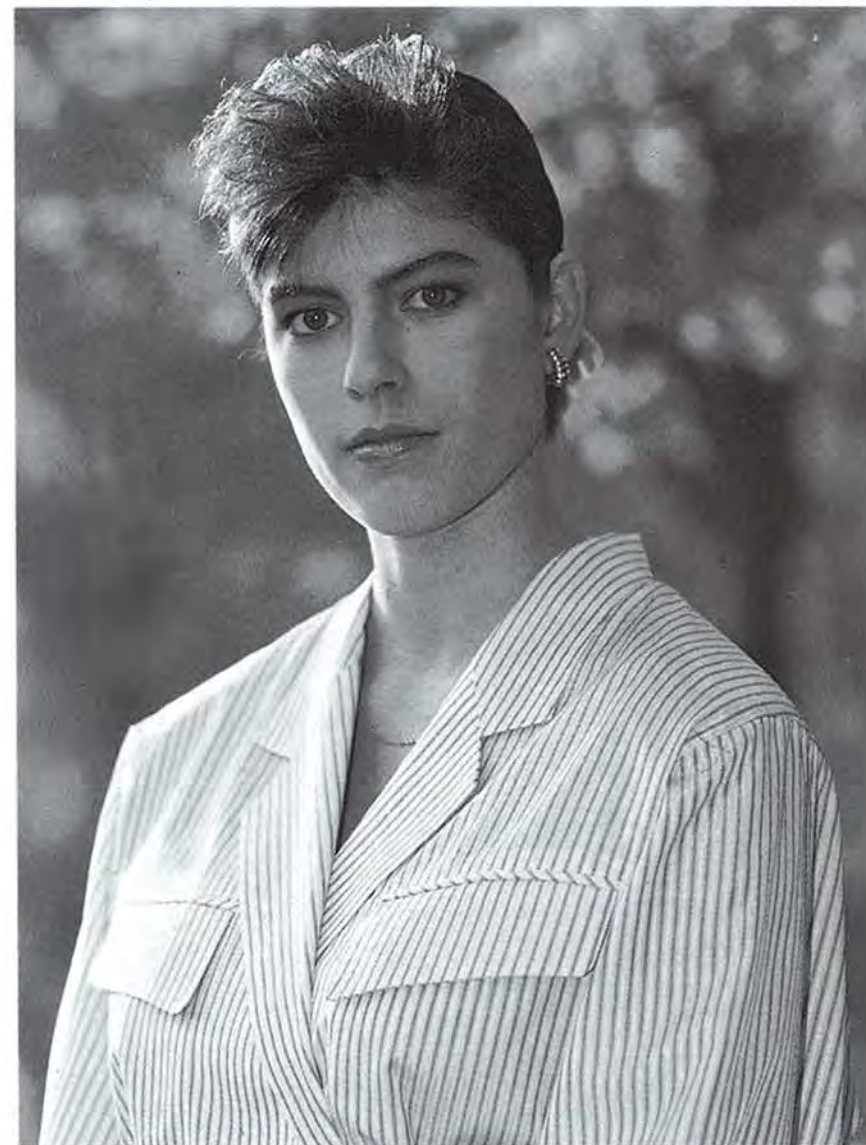

Please consult the Speedlite's instruction book for further details.

(2) Other Canon Speedlites

Follow the steps below for automatic flash photography:

- 1) Set the camera's shooting mode to "M".
- 2) Set the desired X-sync shutter speed between 30 and 1/125 sec with the EOS 650 and between 30 and 1/250 sec with the EOS 620.
 - If the shutter speed is faster than 1/125 sec (EOS 650) or 1/250 sec (EOS 620), it is automatically set to 1/125 sec (EOS 650) or 1/250 sec (EOS 620).
- 3) Set the aperture on the flash.
- 4) Set the same flash aperture on the camera.
 - When using the 300TL, set the flash mode set button to A-TTL or FEL for TTL automatic flash photography.
 - Do not use the 277T and 299T in the "PROGRAM" mode. Be sure to set the flash to "F. NO. SET" mode.
 - The 244T and the multiple flash accessories for the T90 cannot be used.

(3) Other Manufacturers' Flashes

The X-sync speed can be set to 1/125 or slower with the EOS 650 and 1/250 sec or slower with the EOS 620. (1/60 sec or slower with the EOS 650 and 1/125 sec or slower with the EOS 620 with a large, studio-type flash), but please confirm correct synchronization before use (due to their flash duration).

Use a Canon Speedlite with this camera. Using a flash (usually with more than two contacts) or flash accessory of another manufacturer may cause the camera to work improperly or even damage the camera itself.

When a large, studio-type flash or general cable connection type flash is used with this camera, the Canon Hot Shoe Adapter is required to connect the flash with the camera.

3. Bulb (Long Exposure)

Use the bulb mode for exposures longer than 30 seconds like astro or night photography.

- 1) Set the shooting mode to "M".
- 2) Turn the electronic input dial until "buLb" (next to 30") displays.
- 3) Set the aperture value by turning the electronic input dial while pressing the manual aperture set button.
 - The camera requires relatively little power in the bulb mode saving battery usage.
 - Bulb operation time displays by a series of three bars and numbers from 1 to 30. Each bar mark indicates 30 seconds. Maximum exposure time display is 120 seconds. (three bars and 30).

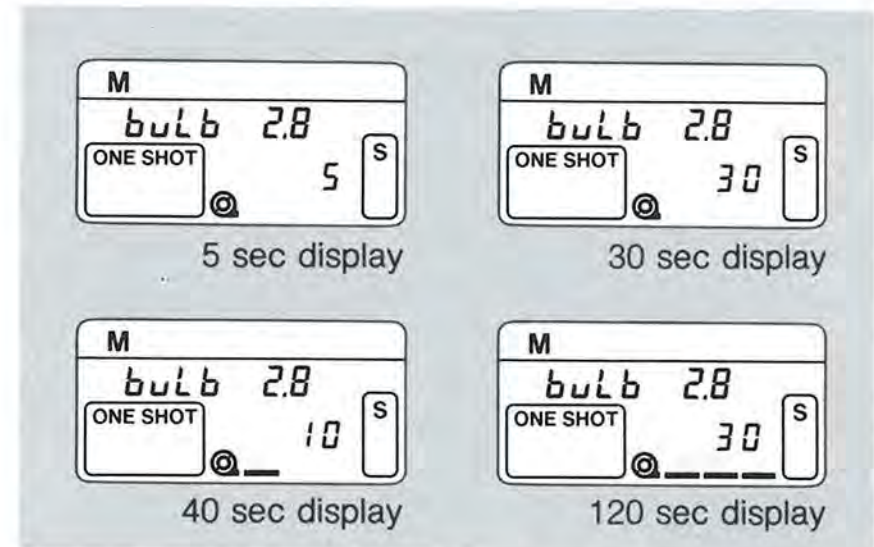

- Use the Technical Back E to control the exposure time within a period of 23 hrs. 59 mins. 59 secs. (available optionally)
- Use a tripod, Remote Switch 60T3 and Grip GR20 (standard with the EOS 620) when taking long exposures (available optionally).
- There is no exposure warning in the bulb mode.

4. Shooting with Infrared Film



When using black-and-white infrared film make a slight adjustment in focus with the red infrared index.

For example, focus the subject first, then if the lens is focused at 5m on the distance scale, turn the manual focusing ring to align the 5m mark with the red dot and release the shutter.

- When using infrared film, use a deep red filter as specified by the manufacturer.
- The infrared index mark position has been computed for infrared film usage with peak sensitivity at 800nm.
- Read the manufacturer's instructions when using color infrared film.

Speedlites 420EZ/300EZ

These are high-performance, electronic flash units featuring A (Advanced)-TTL automatic flash output control, which respond to a wide range of illumination from dark surroundings to bright (fill-in flash). They have a built-in auto internal zoom mechanism in the flash head which automatically adjusts the flash coverage angle to use flash energy more effectively. In addition, the rapid-fire flash system enables you to take a flash picture in no less than 1 second with the 300EZ or 1.5 seconds with the 420EZ. The guide numbers are 35 (ISO 100•m) or 116 (ISO 100•ft.) with the 420EZ, and 28 (ISO 100•m) or 93 (ISO 100•ft.) with the 300EZ.

- The above figures show the guide numbers when the flash head is set at the 50mm position at full charge.





EF Lenses

The greatest feature of SLR cameras is that they accept a variety of interchangeable lenses ranging from fish-eye to telephoto. Canon provides the following 13 different interchangeable lenses plus an extender exclusively for the EF 300mm f/2.8L for just as many applications. Canon EF lenses succeed the FD lens' established reputation for high resolution, superb color balance and easy handling.

Helpful Hint:

The most important point in lens selection is identifying a clear idea of the kind of subjects you want to photograph. For example, a short telephoto is indispensable for a portrait, while a wide-angle and a telephoto are necessary for landscape photography. Most people, however, want enough flexibility to take shots of the family, travel scenery, sports events, and other subjects. That's why Canon's lens system offers various types of zoom lenses.



EF Lens Lineup

Lens	Angle of View	Construction	Minimum Aperture	Closest Focusing Distance		Filter Size (mm)	Length		Weight	
				(m)	(ft)		(mm)	(in.)	(gr.)	(ozs.)
Fish-eye EF 15mm f / 2.8	180°	7-8	22	0.2	0.7	Filter Holder	62.2	2- 7 / 16	360	12-11 / 16
EF 28mm f / 2.8	75°	5-5	22	0.3	1	52	42.5	1- 5 / 8	185	6- 1 / 2
★ EF 50mm f / 1.0 L (Ultrasonic)	46°	9-11	16	0.6	2	72	80.0	3- 1 / 8	960	33- 7 / 8
EF 50mm f / 1.8	46°	5-6	22	0.45	1.5	52	42.5	1- 5 / 8	190	6-11 / 16
★ Softfocus EF 135mm f / 2.8	18°	6-7	32	1.3	4.5	52	98.7	3- 7 / 8	410	14- 7 / 16
★ EF 300mm f / 2.8 L (Ultrasonic)	8°15'	7-9	32	3	10	48	243.0	9- 9 / 16	2,850	100- 9 / 16
★ EF 28-70mm f / 3.5-4.5	75°-34°	9-10	22-29	0.5	1.75	52	74.8	2-15 / 16	300	10- 9 / 16
★ EF 28-80mm f/2.8-4L (Ultrasonic)	75°-30°	12-16	22-32	0.75	2.5	72	122.0	4-13 / 16	940	33- 3 / 16
EF 35-70mm f / 3.5-4.5	63°-34°	8-9	22-29	0.5	1.75	52	63.0	2- 1 / 2	245	8- 5 / 8
EF 35-105mm f / 3.5-4.5	63°-23°30'	11-14	22-29	1.2	4	58	81.9	3- 1 / 4	400	14- 1 / 8
EF 70-210mm f/4	34°-11°45'	8-11	32	1.5	5	58	137.6	5- 7 / 16	650	23
★ EF 100-300mm f / 5.6	24°- 8°15'	9-15	32	2	7	58	166.8	6- 9 / 16	720	25- 3 / 8
★ EF 100-300mm f / 5.6 L	24°- 8°15'	10-15	32	2	7	58	166.6	6- 9 / 16	720	25- 3 / 8
★ Extender EF 2X	-	5-7	-	-	-	-	50.5	2	290	10- 1 / 4

1. The Extender EF 2X is for exclusive use with EF 300mm f / 2.8L.
2. All EF zoom lenses have a built-in macro mechanism.
3. ★ indicates these lenses will be available soon.

Interchangeable Focusing Screens

The Overall New Laser-Matte/AF Frame screen comes with your camera. You can change the focusing screen according to specific focusing

needs with six different focusing screens available optionally.

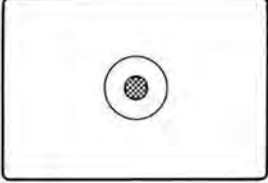
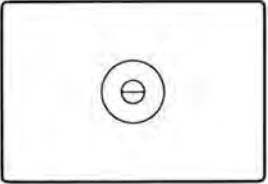
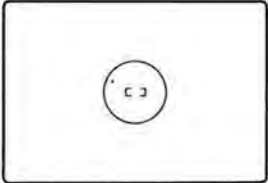
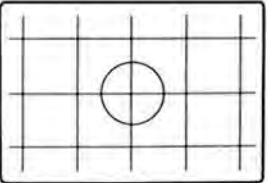
Type	Application
<p>A. Microprism</p> 	<p>Matte field with microprism rangefinder spot in the center of the screen. Usable with all lenses. Especially suited for general photography using an aperture of f/5.6 or larger.</p>
<p>B. New Split</p> 	<p>Matte field with split-image rangefinder spot in the center of the screen. Suitable for all lenses.</p>
<p>C. Overall New Laser Matte/AF Frame</p> 	<p>Matte field with AF frame in the center of the screen. This screen enables the entire field of view to be seen without distraction. Usable with all lenses.</p>
<p>D. Laser Matte/Section</p> 	<p>Matte field with vertical and horizontal reference lines. It is best for architectural photography, etc. where accurate image placement is essential.</p>

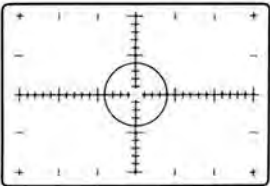
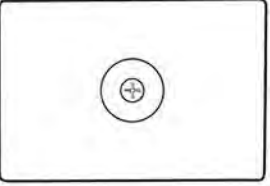
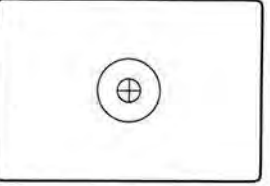
<p>H. Laser Matte/Scale</p> 	<p>Matte field with vertical and horizontal scale in millimeters. Recommended for close-ups, etc. where it is useful to know the size of the subject or the magnification involved.</p>
<p>I. Laser Matte/Double Cross-hair Reticle</p> 	<p>Matte field with clear center spot containing double cross-hair reticle. While focusing, move your eye from left to right. If cross-hairs stay in the same position on the subject, the subject is in focus. Recommended for astrophotography or other high magnification.</p>
<p>L. Cross Split-image</p> 	<p>Matte field with cross split-image in the center of the screen which divides the subject in half both vertically and horizontally. The subject is in focus when the four quarters merge to become one unbroken image. Suitable for general photography using an aperture of f/5.6 or larger.</p>

NEVER change the focusing screen with your fingers. A specially-provided tool accompanies each screen to facilitate replacement.

These focusing screens are exclusively designed for EOS cameras. Do not use them in any other cameras.

Quartz Date Back E



The Quartz Date Back E is a fully automatic data back which imprints data on the film.

1. Auto date up through the year 2029. (automatic compensation for leap years and long/short months)
2. Auto digital clock mode (Day/Hour/Minutes) with 24-hour display.
3. Arbitrary 6-digit numbers
4. Frame counter number from Fc 0001 through 9999.

Technical Back E / Interface Unit TB / Keyboard Unit E



As the name "Technical" suggests, the Technical Back E not only imprints the data and arbitrary comments (up to 30 digits) on film but memorizes shooting data such as shutter speed, aperture value, lens focal length and film speed.

- The technical Back E, Keyboard Unit E, and the Interface Unit TB will be available soon.

- When the Technical Back E is connected to a personal computer through the Interface Unit TB, it is also possible to command the camera from a computer, etc. (The Interface Unit TB is sold in both MSX and IBM computer models, but product availability may vary from area to area.)
- With the Keyboard Unit E, comments can be imprinted in English, French, German and Spanish.

Dioptric Adjustment Lenses



Ten eyesight correction lenses are available in powers of +3, +2, +1.5, +1, +0.5, 0, -0.5, -2, -3 and -4 diopters. They make viewing and focusing easier if you are near or far-sighted. Choose the one which is closest to your eyeglass prescription, and make a practical test if possible.

- The dioptic adjustment lens consists of a correction lens and removable rubber frame (eyecup). With the frame removed, the correction lens can be attached to the A-series and T-series cameras.

Circular Polarizing Filters PL-C



AF photography is possible with the Canon Circular Polarizing Filters PL-C. These are screw-in types available in three thread diameters: 52mm, 58mm and 72mm.

Interchangeable Grips



You can replace the palm grip according to your hand size.

Three types are available:

1. Grip GR30: Standard with the EOS 650. Has no remote control terminal.
2. Grip GR20: Standard with the EOS 620. The same size as Grip GR30 but equipped with a remote control terminal.
3. Grip GR10 (Grip L): The large-size grip for bigger hands. Has no remote control terminal.

Caring for Your Camera

As with any precision instrument proper care and maintenance involve a few simple rules and good common sense. Observing them will keep your camera in top condition at all times. We recommend cleaning your camera periodically.

Cleaning tools: blower brush, lens cleaning fluid, lens cleaning tissue, silicone-treated cloth

- 1) To clean the lens surface and the viewfinder eyepiece:

Blow off dust with the blower brush and gently wipe the lens surface with a lens cleaning tissue slightly moistened with lens cleaner.

- 2) To clean the reflecting mirror and the focusing screen:

Only use a blower brush. If more cleaning is necessary NEVER attempt to do it yourself, take it to an authorized Canon Service Facility.

- 3) To clean the film chamber:

Use a blower brush to occasionally remove accumulated film dust particles that might scratch the film.

- 4) To clean the film pressure plate and the film guide rails:

Lightly wipe the surface with a lens cleaning tissue moistened with lens cleaning fluid.

PRECAUTIONS

- Be careful NEVER to touch the shutter curtain.
- After using the camera at the beach, clean it thoroughly. Salt and sand are the camera's worst enemies.
- Aerosol spray dust removers are not recommended for the shutter curtain area. If used, hold the can at least 20cm (8 inches) away from the curtain.

STORAGE

The best thing you can do for your camera is to use it regularly. If you must store it for awhile remove the battery. Then wrap the camera in a clean, soft cloth and place it in a cool, dry, dust-free place. If you store the camera body and lens separately, attach the body and rear lens caps.

AVOID STORING YOUR CAMERA IN THE FOLLOWING PLACES:

- "Hot spots" such as a car trunk, rear window shelf or glove compartment.
- Laboratories or other areas where chemicals may cause corrosion.
- In direct sunlight.

Carefully check the operation of each part after prolonged storage before shooting important events.

1. Liquid Crystal Display

The display panel uses a liquid crystal to display exposure information. After about five years, the display may become hard to read.

The liquid crystal may respond relatively slow in low temperatures about 0°C/32°F and the display may become dark in high temperatures about 60°C/140°F. Regular functioning resumes in temperatures about 20°C/68°F.

Take your camera to the nearest Canon Service Facility for the replacement of the liquid crystal. (Replacement will be at owner's expense.)

2. Blinking "bc" Display

A "bc" appearing with battery check bar marks may blink in the display panel to warn you of battery replacement or camera malfunction. Perform the following operations:

- 1) Check the battery first.
- 2) If battery voltage is insufficient, replace the battery.
- 3) If battery voltage is sufficient, remove the battery from the battery chamber and reinstall it.
- 4) Release the shutter once.

If the blinking "bc" disappears, the camera has returned to normal condition and you can keep shooting. If it does not disappear after repeating these operations several times, there has been a camera malfunction and the camera needs repair. Take the camera to the nearest Canon Service Facility.

3. Lithium Battery Pack (1)

This camera uses one, six-volt lithium battery pack (2CR5). Try to make a habit of checking the battery at the following times:

- After loading a new battery
 - After prolonged storage
 - If the shutter will not release
 - Shooting in low temperatures
 - Before shooting important events
- 1) Wipe the battery terminals and the camera contacts with a clean, dry cloth before loading to ensure proper contact.
 - 2) Remove the battery if you do not expect to use the camera for about three weeks or longer.
 - 3) Battery performance deteriorates slightly in temperatures below 0°C/32°F. Keep the camera and a spare battery pack close to your body or in a pocket to keep them warm until you are ready.

Battery may explode or cause burns if disassembled, recharged, shorted or exposed to high temperature or disposed in fire.

4. Lithium Battery Pack (2)

Even if one blinking bar mark or no bar mark appears in the display panel during battery check, exposure will be correct as long as the shutter releases. Automatic wind and rewind, however, may not be possible because of insufficient battery power.

Also, if the camera stops during wind or rewind all the film transport bars start blinking to warn you. Automatic rewind re-starts after new battery pack replacement and pressing the film rewind button.

5. X-ray Examinations at Airports

Film passing through X-ray examinations at airports may be exposed and ruined even when loaded. To avoid accidental exposure, tell the inspector to hand-check your camera and film.

Appendix

1. LCD Panel Display

This camera uses a liquid crystal display panel to indicate shooting information. The diagram below shows all the information for explanation. How-

ever, the display never actually looks like this. Normally, the panel displays only the information required at the time.

EOS 650

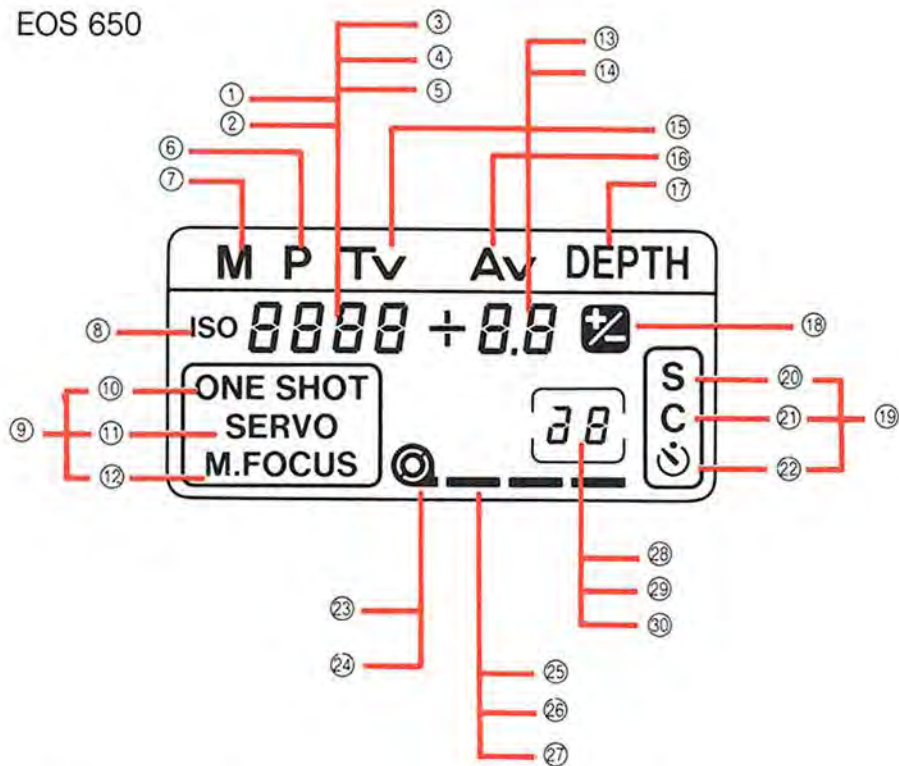

EOS 620

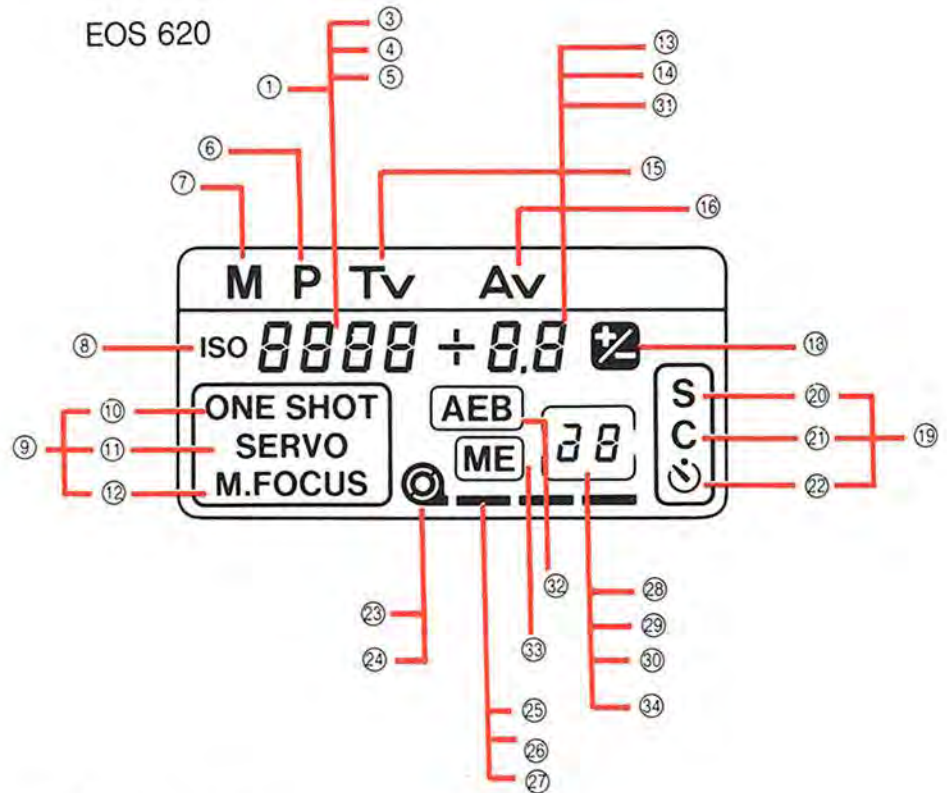

- ① Battery check
- ② Depth of field AE
- ③ ISO film speed
- ④ Shutter speed
- ⑤ Metered manual exposure level
- ⑥ Program AE
- ⑦ Manual
- ⑧ ISO indicator
- ⑨ AF mode
- ⑩ One-shot AF
- ⑪ Servo AF
- ⑫ Manual focusing
- ⑬ Aperture value
- ⑭ Exposure compensation value
- ⑮ Shutter-priority AE
- ⑯ Aperture-priority AE
- ⑰ Depth of field AE
- ⑱ Exposure compensation

- ⑲ Film winding mode
- ⑳ Single exposure
- ㉑ Continuous exposure
- ㉒ Self-timer
- ㉓ Film-load check
- ㉔ Film rewind completion
- ㉕ Film transport (wind/rewind)
- ㉖ Film wind completion
- ㉗ Battery check
- ㉘ Frame counter
- ㉙ Self-timer countdown
- ㉚ Bulb exposure time
- ㉛ Auto exposure bracketing value
- ㉜ Auto exposure bracketing
- ㉝ Multiple exposures
- ㉞ Number of multiple exposures

2. Viewfinder Information Display

The bright and easy-to-read viewfinder displays only necessary information outside the field of view.

The diagram here shows all the information at the same time for explanation.

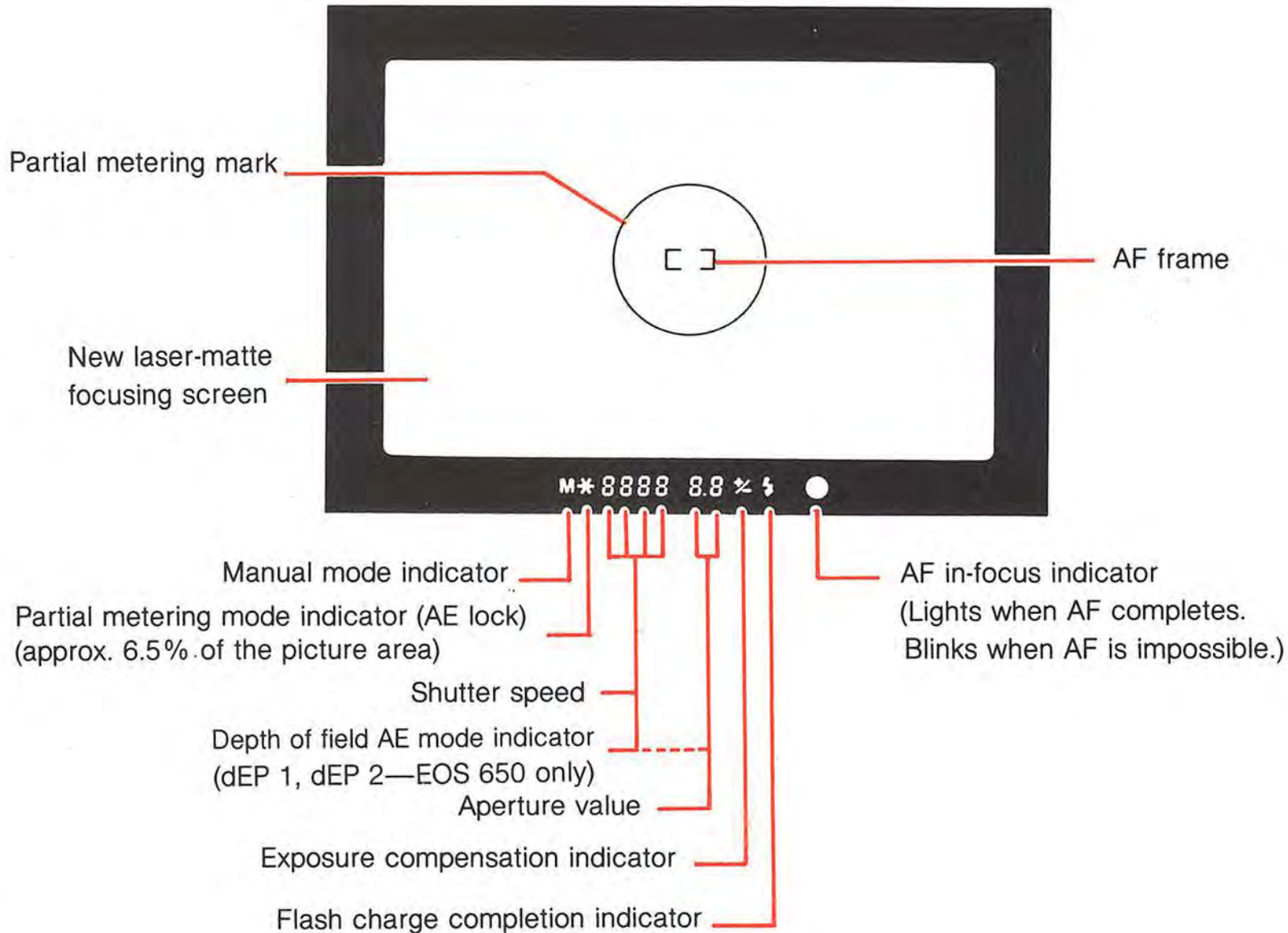

3. Shooting Capacity

For one, new 2CR5 lithium battery pack in the continuous film winding mode.

Temperature	24-exp. rolls	36-exp. rolls
Normal (20°C/68°F)	150	100
Low (-20°C/-4°F)	15	10

(Based on Canon's Standard Test Method)

4. Evaluative Metering Characteristics

As shown below, the evaluative metering system automatically measures light in six different zones, analyzing lighting conditions, subject pattern and subject size while putting an emphasis on the main subject.

- The metering system automatically switches to the partial metering mode when the partial metering button is pressed.

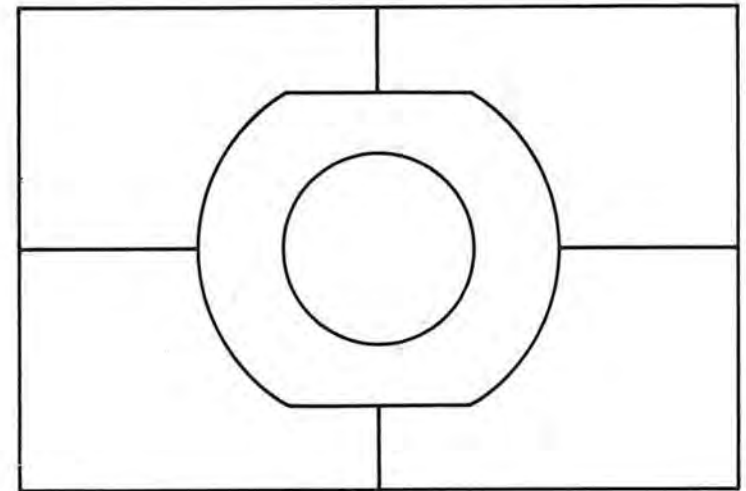

5. Comparisons between AF Mode and Film Winding Mode (in the evaluative metering mode)

AF mode Film winding mode	ONE SHOT AF	SERVO AF
S: single	AF lock and AE lock in the evaluative metering mode take place simultaneously when AF completes.	AF follows a subject and the exposure is determined at the moment of shutter release.
C: continuous	AF lock and AE lock in the evaluative metering mode take place simultaneously when AF completes, then continuous exposure is made.	AF follows a subject and the exposure is determined at the moment of shutter release. AF is adjusted to follow the subject during exposure.

- The partial metering mode can be used regardless of the camera's shooting mode, except when the main switch is set to the full auto position.
- The exposure compensation can be used regardless of the camera's metering or shooting mode, except when the main switch is set to the full auto position.

6. Program Line (program characteristics)

This camera is equipped with the advanced "Intelligent Program AE" which chooses the best shutter speed/aperture combinations, taking the lens focal length into account. When the automatically-set shutter speed becomes 0 to 0.5 steps

below $1/\text{focal length}$ of the lens in use, the camera-shake warning sounds. The shutter speed of $1/\text{focal length}$ of the lens is generally said to be the limit for hand-held shooting.

EOS 650

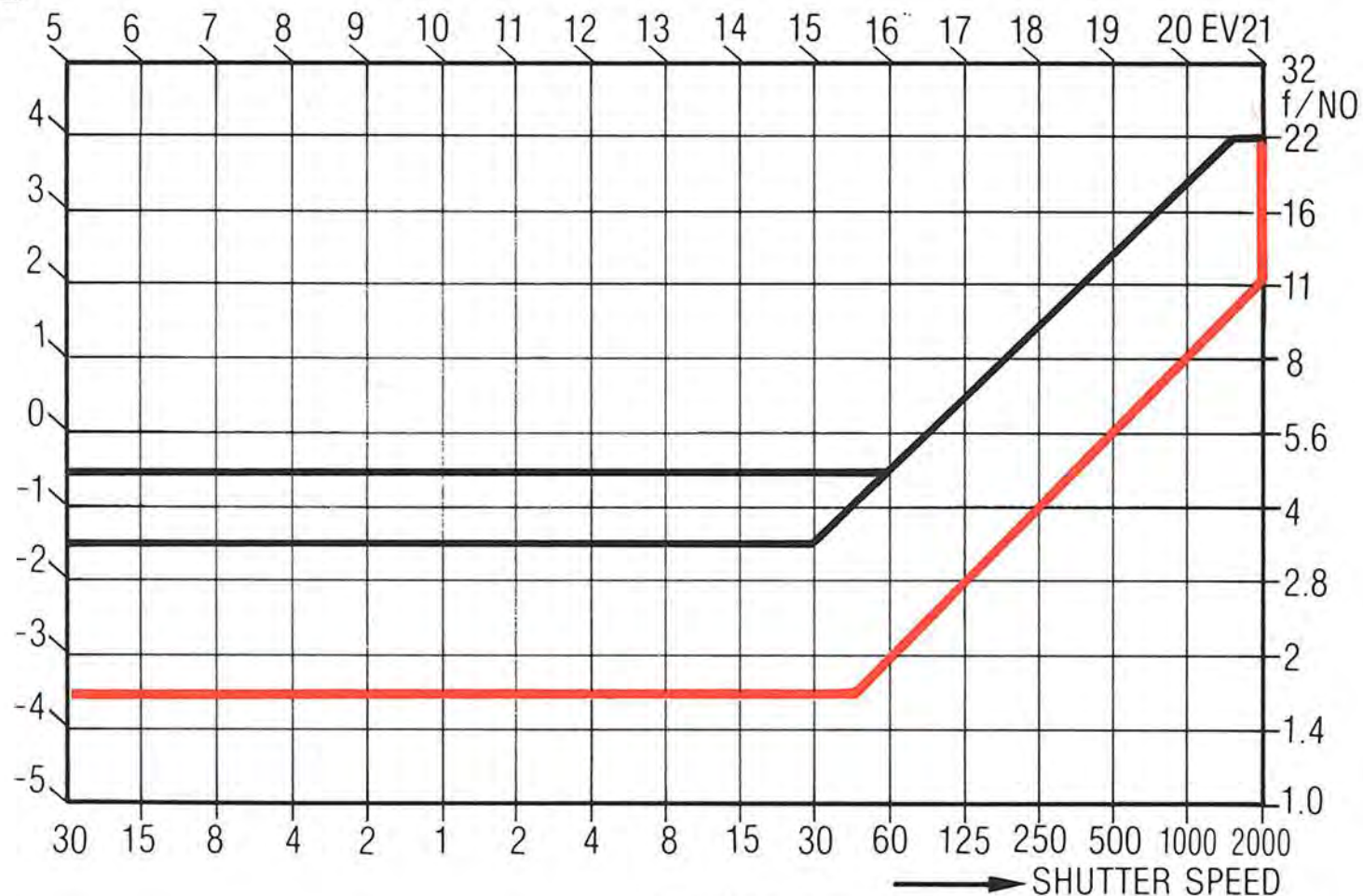

Red: When using the EF 50mm f/1.8

Black: When using the EF 35-70mm f/3.5-4.5

EOS 620

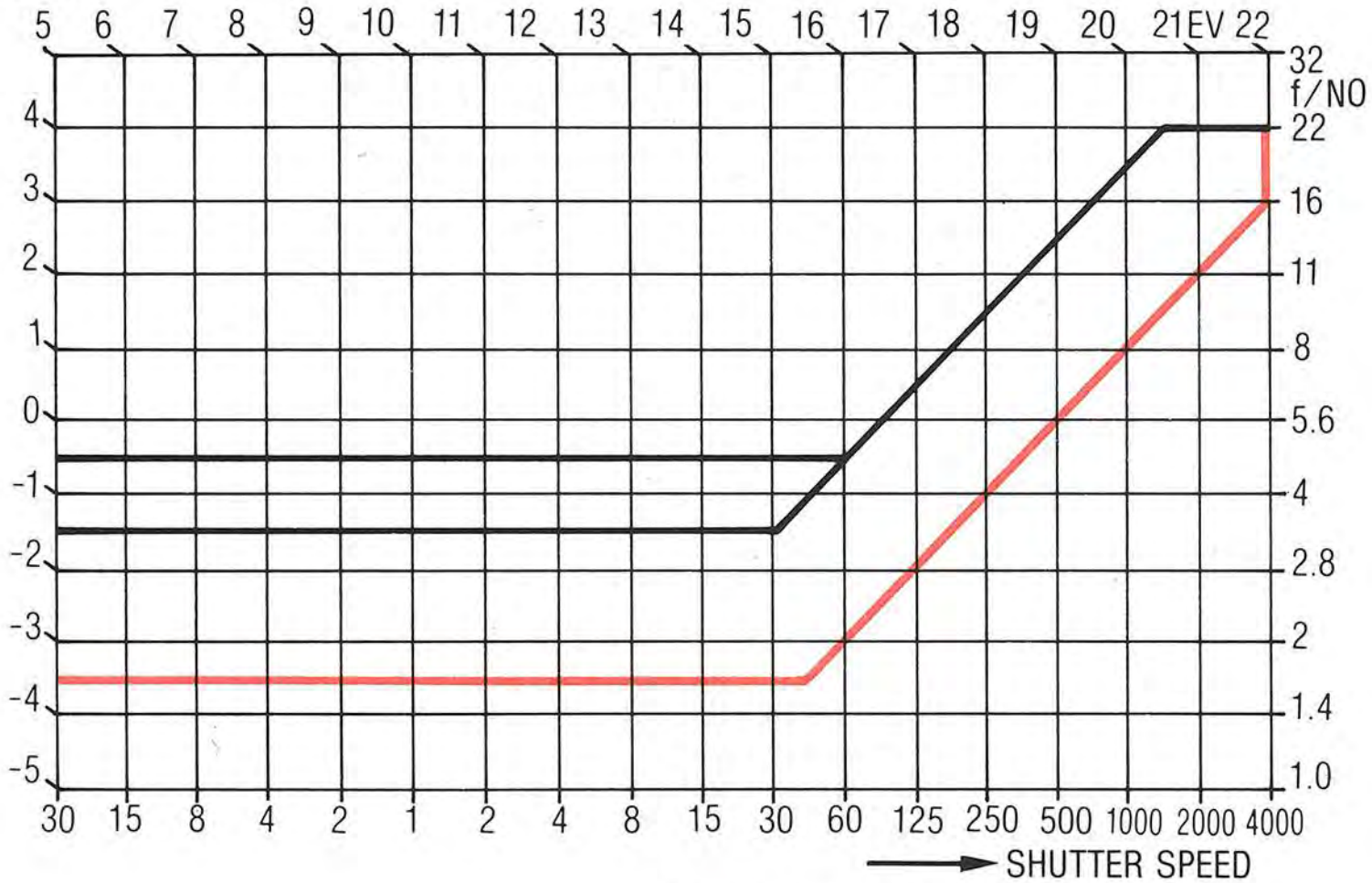

Red: When using the EF 50mm f/1.8

Black: When using the EF 35-70mm f/3.5-4.5

Program shift characteristics (EOS 620 only)

(EF 50mm f/1.8, — example with shift at EV13)

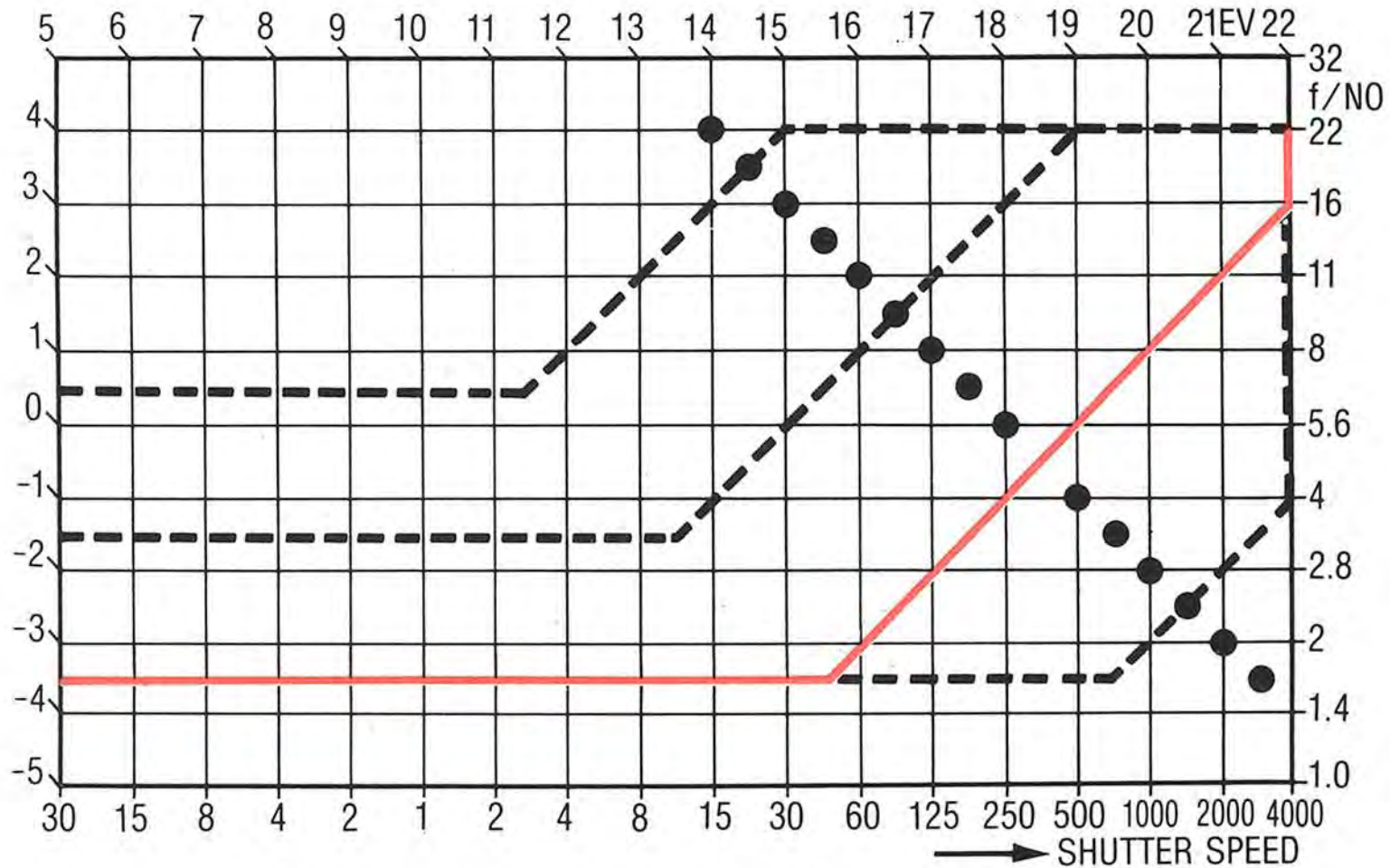

● indicates the shutter/aperture combinations in program shift function.

Specifications

Type:

35mm autofocus, single-lens reflex camera with electronically-controlled automatic exposure, focal plane shutter, and built-in motor drive.

Format: 24x36mm

Usable Lenses:

Canon EF lenses (full aperture metering only)

Standard Lens: EF 50 mm f/1.8

Lens Mount:

Canon EF Mount (electronic signal transfer system)

Viewfinder:

Fixed eye-level pentaprism. Gives 94% vertical and horizontal coverage of actual picture area, and 0.8X magnification at infinity with a standard 50mm lens.

Dioptric Adjustment:

Built-in eyepiece is adjusted to standard -1 diopter. (eyepoint: 19.3mm)

Focusing Screen:

Overall new laser-matte/AF frame. Six types of interchangeable screens are available optionally.

Mirror:

Quick-return half-mirror with shock and noise absorber.

Viewfinder Information:

Displayed at the bottom of the viewing area.

(1) 7-segment LCD digit and character display

1. Shutter speed – flashes at 2Hz to give out-of-metering range warning.
2. Aperture value – flashes at 2Hz to give out-of-metering range warning.
3. Metered manual exposure level—OP, oo, CL
4. Depth of field AE (EÖS 650 only)—dEP 1, dEP 2

(2) LCD mask character display

1. ✖ – AE lock indicator in partial metering mode.
2. M – Manual exposure indicator
3. ⚡ – flash charge completion indicator
4. +/- – exposure compensation indicator
5. ● – AF in-focus indicator (flashes at 8Hz when AF is not possible.)

Light Metering System:

TTL full aperture metering using SPC. Two selectable metering patterns: evaluative metering and partial metering (approx. 6.5% of the picture area). Stopped-down metering is not possible.

Exposure Modes:

1. Shutter-Priority AE
2. Aperture-Priority AE
3. Intelligent Program AE
4. Program Shift Function (EOS 620 only)
5. Depth of Field AE (EOS 650 only)
6. Manual
7. Flash AE (A-TTL program flash AE and TTL program flash AE with specified Canon Speedlites)

Camera-shake Warning:

Operates for program AE, aperture-priority AE, and the EOS 650's depth of field AE modes. When automatically set shutter speed falls 0 to 0.5 steps below 1/focal length of the lens in use, the electronic beeper sounds. Beeper can also be turned on and off.

Metering Coupling Range:

EV 1–20 (EV –1 to 20 in normal temperature) with 50mm f/1.4 at ISO 100 or equivalent.

Film Speed:

ISO 25–5000 is automatically set by 1/3 step according to DX code standard. ISO 6–6400 can also be set manually.

Exposure Compensation:

±5 steps by 1/2-step increment

Auto Exposure Bracketing (EOS 620 Only):

±5 steps in 1/2-step increments. Three con-

tinuous exposures are taken in sequence of underexposure, correct exposure according to camera's meter and overexposure.

Multiple Exposures (EOS 620 Only):

Presetting up to nine exposures is possible. Automatically cleared upon completion.

AF Control System:

TTL-SIR (TTL secondary imaged registration) phase-detection type using BASIS(base-stored image sensor). AF operation starts when the shutter button is pressed halfway. AF in-focus indicator lights upon ranging completion. Audible indicator (electronic beeper) can be turned on and off.

Three selectable modes:

1. ONE SHOT: AF operation ends and focus is locked once ranging is completed. Shutter does not release until ranging is completed.
2. SERVO: Focus continuously adjusts to follow the subject movement. Shutter can be released at any time regardless of ranging completion.
3. Manual: By rotating the manual focusing ring after focus mode switch is set to "M".

AF Working Range: EV 1–18 at ISO 100

AF Auxiliary Light:

The ultra-bright red LED (peak sensitivity: 700 nm) is automatically projected with specified Canon Speedlites.

Shutter:

Vertical-travel focal plane shutter with soft-touch electromagnetic release. All speeds electronically controlled.

Shutter Speed:

EOS 650—1/2000—30 secs and bulb. X-sync is 1/125 sec. Can be set in 1/2-step increments.

EOS 620—1/4000—30 secs and bulb. X-sync is 1/250 sec. Can be set in 1/2-step increments.

Self-timer:

Electronically controlled with a delay of approx. 10 secs indicated by blinking LED operation confirmation lamp.

Film Loading:

After film positioning and back cover closure, the film automatically advances to the first usable frame and then stops (approx. 1.5 secs)

Film Wind:

Automatic using the built-in miniature motor. Confirmation by the film transport bar marks in the display panel.

Film Winding Mode:

Two selectable modes; S (single exposure) and C (continuous exposure at the maximum speed of approx. three frames per second).

Film Rewind:

Automatic using the built-in miniature motor. Starts when the film end is reached and then stops (with 24-exp. film, approx. 10 secs with the EOS 650 and approx. 7 secs with the EOS 620). Mid-roll rewind performed by pressing the film rewind button.

Flash Contact:

Coupled directly to the camera by X-sync contact on the accessory shoe.

Automatic Flash (using the Speedlite 420EZ/300EZ with the camera set to "P"):

A-TTL flash auto—Using the camera's A-TTL program and the flash's near-infrared preflash, the correct aperture value is automatically set. X-sync speed is also automatically set between 1/60 and 1/125 sec with the EOS 650 and between 1/60 and 1/250 sec with the EOS 620 upon flash charge completion. TTL control system which meters the light reflected from the film surface. Automatic fill-in flash is possible.

Grip:

Interchangeable.

The GR30 (without remote control terminal) is standard with the EOS 650.

The GR20 (with remote control terminal) is standard with the EOS 620.

The large-size, Grip GR10 is available optionally.

Depth-of-Field Check:

By pressing the depth-of-field check button.

LCD Display Panel:

Displays only the information required at the time, e.g. shooting mode, film winding mode, AF mode, shutter speed, aperture value, film speed, or battery check. Timer function for eight secs is provided; the display is held on for eight secs after the switch i.e., shutter button is pressed. The EOS 620's display panel can be illuminated by electroluminescence.

Power Source:

One, six-volt lithium battery pack (2CR5). Battery is replaced by removing grip.

Battery Check:

By pressing the battery check button. Three energy levels are shown by the battery check bar marks in the display panel.

Back Cover:

Interchangeable. Opened by sliding the latch with safety lock. Quartz Date Back E and Technical Back E can be attached.

Dimensions: 148(W) × 108.3(H) × 67.5(D) mm
(5-13/16" × 4-1/4" × 2-5/8")

Weight: EOS 650—660g (23-5/16 oz.) body only
EOS 620—700g (24-11/16 oz.) body only

(All data are based on Canon's Standard Test Method.)

Subject to change without notice.

This equipment has been tested and found to comply with the limits for a Class B computing device in accordance with the specifications set forth in Subpart J of Part 15 of the FCC Rules. If this equipment does cause interference to radio or television reception which can be determined by turning the equipment on and off, use the equipment in another location. If necessary, the user should consult the dealer or an experienced radio/television technician for additional suggestions. The user may find the following booklet prepared by the Federal Communications Commission helpful:

"How to Identify and Resolve Radio-TV interference Problems"

This booklet is available from the US Government Printing Office, Washington, D.C., 20402, Stock No. 004-000-00345-4."

Viewfinder Eyepiece

Film-load Check Window

Back Cover

Switch Cover

Tripod Socket

Display Panel Illumination Button (EOS 620 Only)

Partial Metering Button

Grip Attachment Screw



Inside the Switch Cover

EOS 620

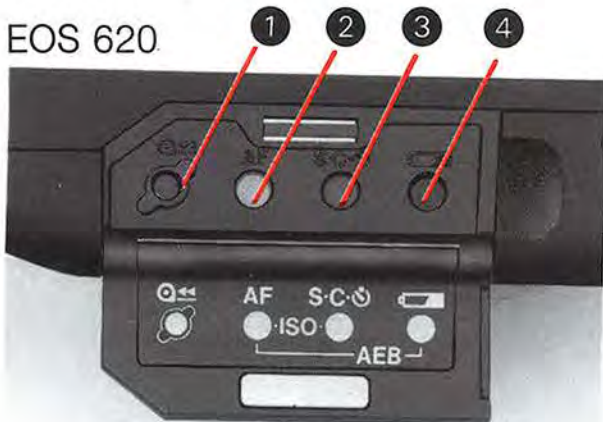

EOS 650

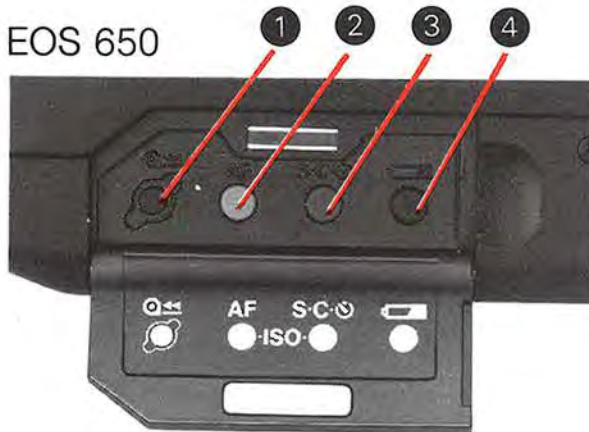

- ① Film Rewind Button
- ② AF Mode Selector
- ③ Film Winding Mode Selector
- ④ Battery Check Button

Carrying the Camera



- 1) Thread the ends of the neckstrap through the rings on the camera as shown.



- 2) Keep the camera in its case to protect it while carrying.



Camera Cases

Canon offers three semi-hard cases.

1. Semi-hard case S stores the camera with the EF 50mm f/1.8 lens.
2. Semi-hard case L stores the camera with the EF 35-70mm f/3.5-4.5 lens.
3. Semi-hard case LL stores the camera with the EF 35-105mm f/3.5-4.5 lens.

Canon

CANON INC. 7-1, Nishi-Shinjuku 2-Chome, Shinjuku-ku, Tokyo 163, Japan
Mailing address: P.O. Box 5050, Dai-ichi Seimei Building, Tokyo 163, Japan

- U.S.A. _____ **CANON U.S.A., INC. HEADQUARTERS**
One Canon Plaza, Lake Success, N.Y. 11042, U.S.A.
CANON U.S.A., INC. ATLANTA OFFICE
5625 Oakbrook Parkway Norcross, Ga. 30093, U.S.A.
CANON U.S.A., INC. CHICAGO OFFICE
100 Park Blvd. Itasca, Il. 60143-2693, U.S.A.
CANON U.S.A., INC. LOS ANGELES OFFICE
123 Paularino Avenue East, Costa Mesa, Cal. 92626, U.S.A.
CANON U.S.A., INC. SANTA CLARA BRANCH
4000 Burton Drive, Santa Clara, Cal. 95054, U.S.A.
CANON U.S.A., INC. DALLAS OFFICE
3200, Regent Blvd., Irving, Tex. 75063-3145, U.S.A.
CANON U.S.A., INC. HONOLULU BRANCH
Bldg. B-2, 1050 Ala Moana Blvd., Honolulu, Hawaii 96814, U.S.A.
CANON U.S.A., INC. WASHINGTON D.C. BRANCH
5701 General Washington Drive Alexandria, Va. 22312, U.S.A.
- CANADA _____ **CANON CANADA INC. HEADQUARTERS**
6390 Dixie Road, Mississauga, Ontario L5T 1P7, Canada
CANON CANADA INC. MONTREAL SERVICE CENTRE
10652 Côte de Liesse, Lachine, Quebec H8T 1A5, Canada
CANON CANADA INC. CALGARY OFFICE
2828, 16th Street, N.E. Calgary, Alberta T2E 7K7, Canada
- EUROPE, AFRICA
& MIDDLE EAST _____ **CANON EUROPA N.V.**
P.O. Box 7907, 1008 AC Amsterdam, The Netherlands
CANON FRANCE-PHOTO CINEMA S.A.
30, boulevard Vital-Bouhot, Ile de la Jatte, 92521 Neuilly-sur-Seine, France
CANON UK LTD.
Units 4 & 5, Brent Trading Centre, North Circular Road, London NW10 0JF, United Kingdom
CANON EURO-PHOTO G.m.b.H
Linsellesstraße 142-156, D-4156 Willich 3, West Germany
- CENTRAL &
SOUTH AMERICA _____ **CANON LATIN AMERICA, INC. DEPTO. DE VENTAS**
Apartado 7022, Panamá 5, República de Panamá
CANON LATIN AMERICA, INC. CENTRO DE SERVICIO Y REPARACION
Apartado 2019, Zona Libre de Colón, República de Panamá
- SOUTHEAST ASIA _____ **CANON HONG KONG TRADING CO., LTD.**
Room 1101-3 & 1121-2, Peninsula Centre, 67 Mody Road, Tsimshatsui East, Kowloon,
Hong Kong
CANON SINGAPORE PTE. LTD.
95 South Bridge Road #13-01/15, South Bridge Centre, Singapore 0105
- OCEANIA _____ **CANON AUSTRALIA PTY. LTD.**
Unit 1/37, Waterloo Road, North Ryde (Macquarie Park), N.S.W. 2113, Australia
- JAPAN _____ **CANON SALES CO., INC.**
11-28, Mita, 3-Chome, Minato-ku, Tokyo 108, Japan