

Canon

EOS

ELAN 7 / *ELAN 7*

DATE

30 / 33 DATE

Eos 7



E

English Edition

INSTRUCTIONS

The image was removed due
to copyright restrictions

Thank you for purchasing a Canon product.

The EOS 33/ELAN 7 is a high-performance, AF single-lens reflex camera with seven focusing points.

Its many features can suit a wide variety of subjects and shooting conditions. Camera operation can be fully automatic or you can use the semi-automatic or manual modes to obtain the desired effects.

Before using your new camera, read this instruction booklet to familiarize yourself with the camera.

Symbols



The Caution symbol alerts you to actions to prevent picture-taking problems.



The Note symbol gives supplemental information for basic camera operation.



The Light bulb symbol offers helpful tips for operating your camera or taking pictures.

Also read "Handling Cautions" on page 6 to prevent camera malfunction and damage.

Keep this instruction booklet handy for easy reference.



Before Using Your Camera

- Before shooting an important event, be sure to take test shots to make sure the camera operates properly.
- EOS cameras have a lens mount for dedicated operation (autofocusing, exposure control, etc.) with Canon EF lenses. Using a non-Canon EF lens with an EOS camera may not result in proper camera or lens operation.

Note that the warranty does not cover any camera malfunction or damage occurring with the use of non-Canon products.

Contents

Handling Cautions	6
Quick Start Guide	8
Nomenclature	10
Conventions Used in this Instruction Booklet	16
1 Before You Start	17
Installing the Batteries and Checking the Battery Level	18
Mounting and Detaching a Lens	20
Dioptic Adjustment	21
How the Shutter Button Works	22
Ⓜ Loading and Unloading Film	23
Holding the Camera	26
2 Fully Automatic Shooting	27
☐ Full Auto Mode	28
👤 Portrait Mode	32
🏞 Landscape Mode	33
🌿 Closeup Mode	34
🏃 Sports Mode	35
🌃 Night Scene Mode	36
⌚ Using the Self-timer	37
Imprinting the Date or Time (QD Model only)	39
3 AF Modes and Metering Modes	41
Selecting the AF Mode	42
📍 Selecting a Focusing Point	45
Focusing Off-Center Subjects	47
When Autofocus Fails	48
📊 Metering Modes	49
4 Creative Zone Modes	51
P Program AE	52
Tv Shutter-Speed Priority AE	54
Av Aperture-Priority AE	56

Depth-of-field Preview	57
M Manual Exposure	58
DEP Depth-of-Field AE	60
* AE Lock	63
Exposure Compensation	64
 Auto Exposure Bracketing (AEB)	65
Bulb Exposures	67
 Multiple Exposures	68
••) Silencing the Beeper	69
Mirror Lockup	70
ISO Setting the ISO Film Speed	71
Selecting the Film Advance Mode	71
 Wireless Remote Control	72
Using the Remote Switch	72
5 Flash Photography	73
Using the Built-in Flash	74
Flash Photography with an EX-Series Speedlite	77
Using Other EOS-Dedicated Speedlites	84
6 Custom Functions	85
Setting a Custom Function	86
Canceling a Custom Function	87
Custom Function List	88
Reference	90
Basic Photography Terms	90
Feature Availability Table	92
Program Line	94
Exposure Warning List	95
Troubleshooting Guide	96
Major Accessories	97
Major Specifications	99
Index	102

1

2

3

4

5

6

Reference

Handling Cautions

Camera Care and Storage

- (1) The camera is a precision instrument. Do not drop it or subject it to physical shock.
- (2) This camera is not waterproof and cannot be used underwater. If the camera gets really wet, promptly consult your nearest Canon Service Center. Wipe off any water droplets with a dry cloth. If the camera has been exposed to salty air, wipe with a well-wrung damp cloth.
- (3) Do not leave the camera in places prone to excessive heat such as in a car on a sunny day. Excessive heat can cause the camera to malfunction.
- (4) The camera contains precision electronic circuitry. Never attempt to disassemble the camera.
- (5) Use only a blower brush to blow away dust on the lens, eyepiece, mirror, focusing screen, and film compartment. Do not clean the camera body or lens with a cleaner containing an organic solvent. For stubborn dirt, consult your nearest Canon Service Center.
- (6) The shutter curtains are extremely thin. Use only a blower to clean them. Be careful not to blow air too forcefully on the shutter curtains. The shutter curtains can be easily deformed or damaged. Also, when loading and unloading film, be careful not to touch the shutter curtains.
- (7) Do not touch the electrical contacts with your fingers. Otherwise corrosion may develop on the contacts, resulting in improper camera operation.
- (8) If the camera is not to be used for an extended period, remove the battery. Store the camera in a well-ventilated, cool, dry place. During the storage period, press the shutter button to release the shutter a few times once in a while.
- (9) Avoid storing the camera in a laboratory, cabinet, etc., where corrosive chemicals are present.
- (10) If the camera has not been used for an extended period or if the camera is to be used for an important event, check the operation of all the camera controls or take it to your nearest Canon Service Center for inspection.
- (11) After detaching the lens from the camera, put on the lens caps or put down the lens with the rear end up to avoid scratching the lens surface and electrical contacts.
- (12) Even when the Main Switch is set to <OFF>, a small amount of power is still supplied to the camera's LCD panel. However, this does not affect the number of film rolls which can be taken with the battery.

LCD Displays

In time, the camera's LCD panel display and the LCD display in the viewfinder may fade and become difficult to read. If this happens, have it replaced (at cost) by a Canon Service Center.

At low temperatures, the LCD display response may become slower. And at 60°C or higher temperatures, the display may blacken. In either case, the display will return to normal at room temperature.

Lithium Batteries

- (1) The camera operates on two CR123A lithium batteries. Check the battery level in the following cases (→page 18):
 - After replacing the batteries.
 - After not using the camera for an extended period.
 - The shutter stops working.
 - The camera is being used in a low-temperature environment.
 - You will be shooting an important event.
- (2) Before installing the batteries, wipe the battery contacts to remove any fingerprints and smudges. This is to prevent faulty connections and corrosion.
- (3) Never disassemble or recharge the batteries. Also, never store a battery in high-temperature places or short circuit the battery contacts or toss a battery into a fire.
- (4) Although the batteries work well even at low temperatures, battery performance may decline slightly at freezing temperatures. In such a case, keep spare batteries warm in a pocket, etc., and use and warm the batteries alternately.

How Low Battery Levels Affect Camera Operation

On the LCD panel, if the $\langle \text{B} \rangle$ icon blinks or it is not displayed, a proper exposure can still be obtained as long as the shutter releases. However, when the battery level is low, film advance and auto rewind might stop midway or not work at all and $\langle \text{B} \rangle$ may blink on the LCD panel. After the batteries are replaced with new ones, film advance will be possible and film rewind can resume by pressing the $\langle \text{Q} \rangle$ button.

Lens Electrical Contacts

After detaching the lens from the camera, put on the lens caps or put down the lens with the rear end up to avoid scratching the lens surface and electrical contacts.

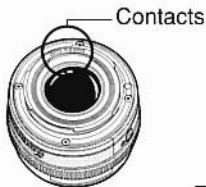

Quick Start Guide

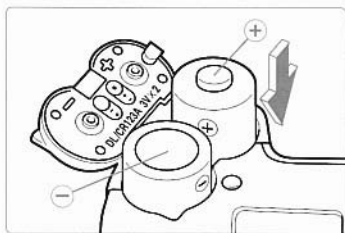

- 1 Install the batteries.**
Refer to the battery orientation diagram on the battery chamber cover, and insert two CR123A lithium batteries as shown. (→page 18)

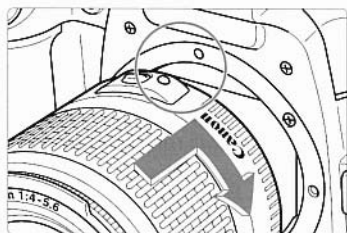

- 2 Attach a lens.**
Align the red dots on the lens and camera and turn the lens as shown by the arrow until it snaps in place. (→page 20)

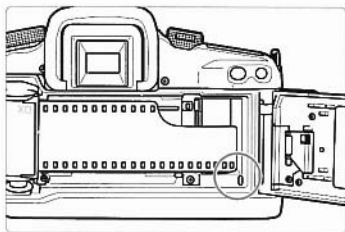

- 5 Load the film.**
Align the edge of the film leader with the orange mark on the camera and close the camera back until it snaps shut. (→page 23)
- The film will then advance to the first frame automatically.



- 6 Focus the subject.**
Aim the focusing points on the main subject and press the shutter button halfway to autofocus. (→page 22)
- Under low-light or backlit conditions, the built-in flash will pop-up and fire automatically. (→page 74)

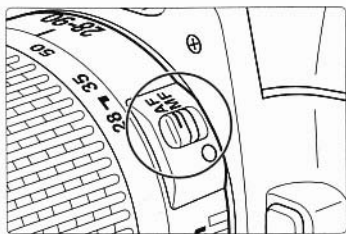

- 3** On the lens, set the focus mode switch to **<AF>**.
(→page 20)

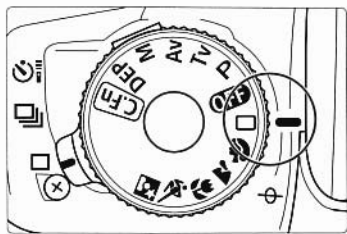

- 4** Turn the Command Dial to **<□>** (Full Auto). Keep pressing the Command Dial's lock button while turning the dial. (→page 28)

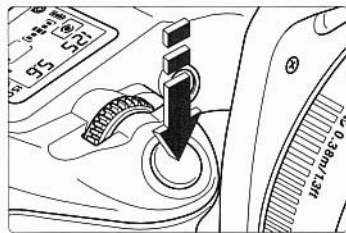

- 7** Take the picture. Press the shutter button completely to take the picture. (→page 22)

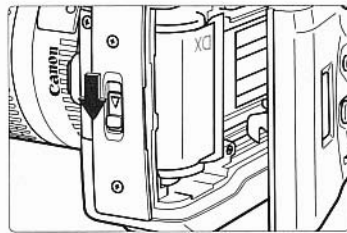

- 8** Unload the film. At the end of the roll, the film rewinds automatically. Open the camera back to remove the film cartridge. (→page 25)

Nomenclature

- The reference page is indicated in parentheses.
- The camera controls are indicated as icons in brackets < >.

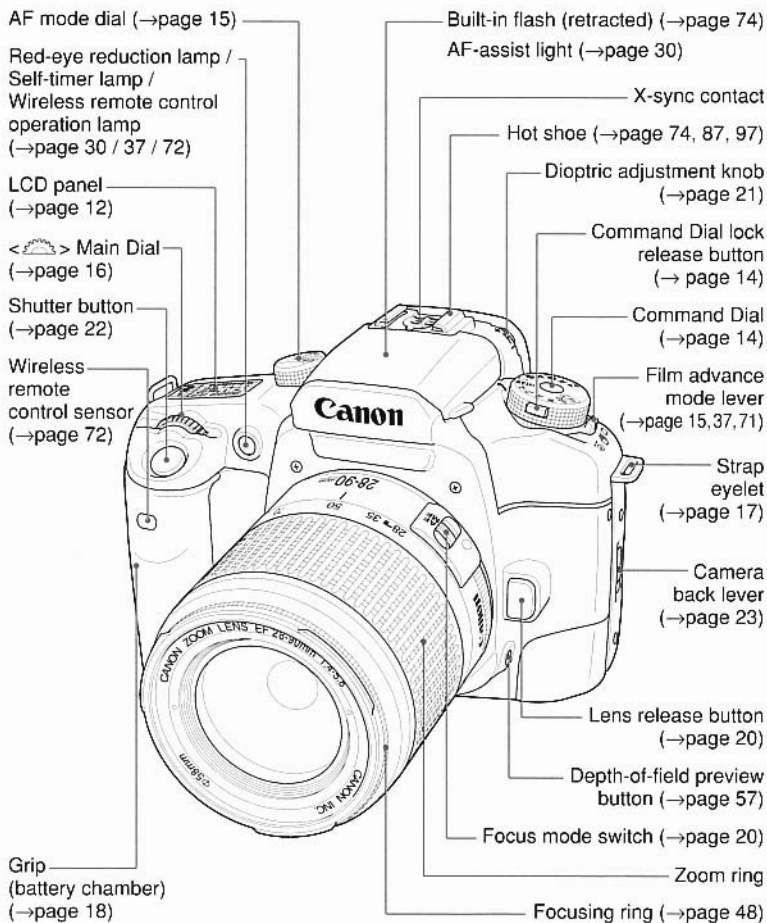

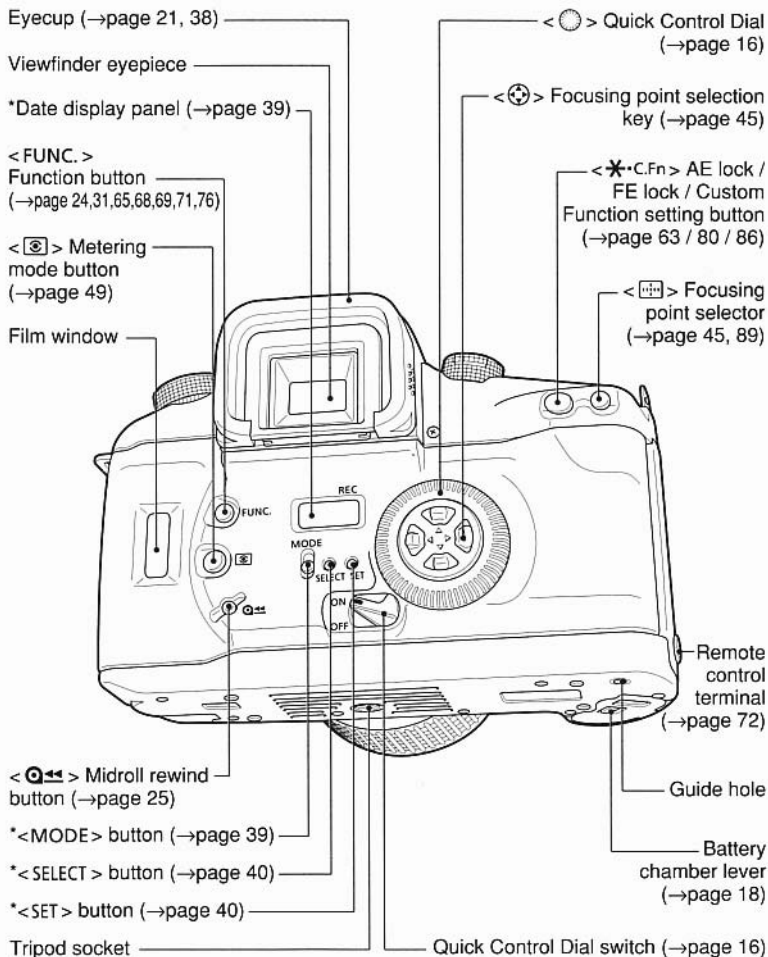

* QD Model only

LCD Panel

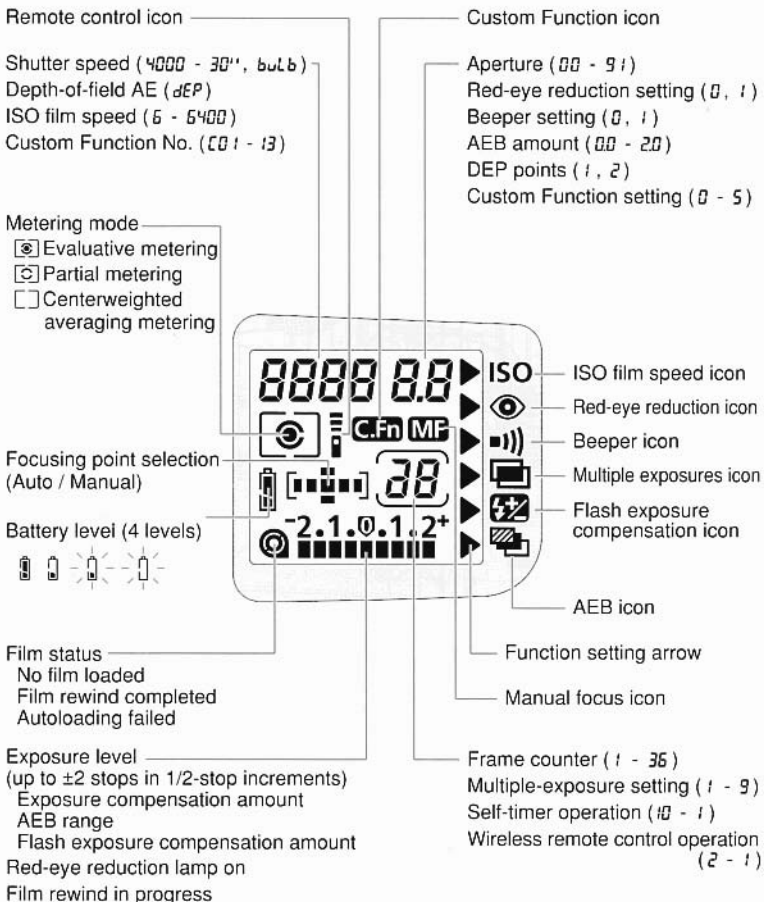

• The <▶> arrow is displayed next to the function being set.

Viewfinder Information

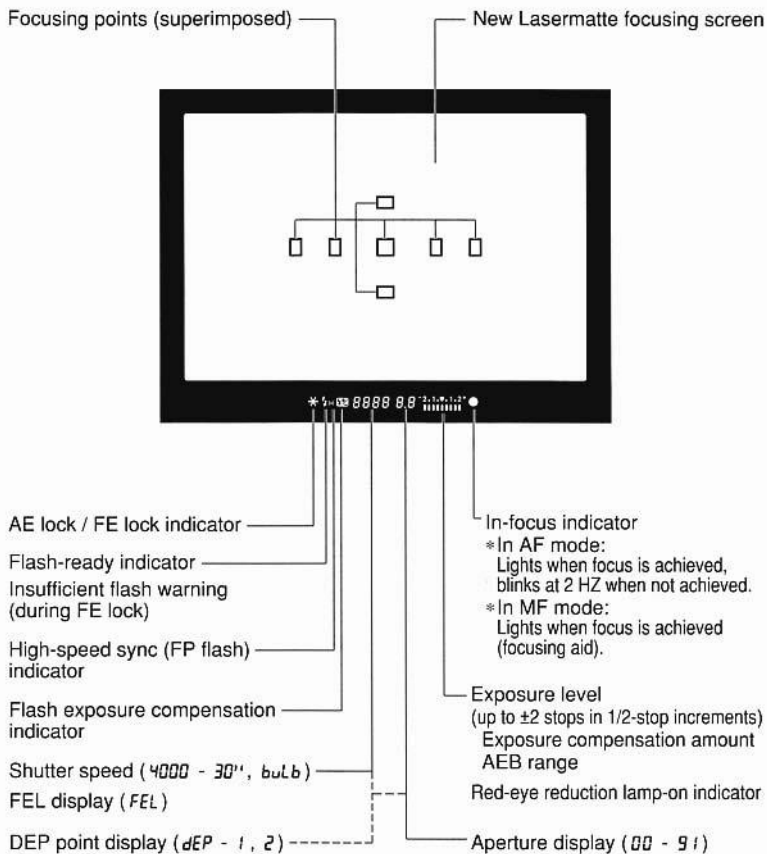

- On pages 12 and 13, all the display items are shown for explanatory purposes. During actual operation, only some of the items are displayed.

Command Dial

- The dial is divided into four zones.
- The dial is locked when it is set to <OFF>. To release the lock, hold down the Command Dial lock release button and turn the dial.

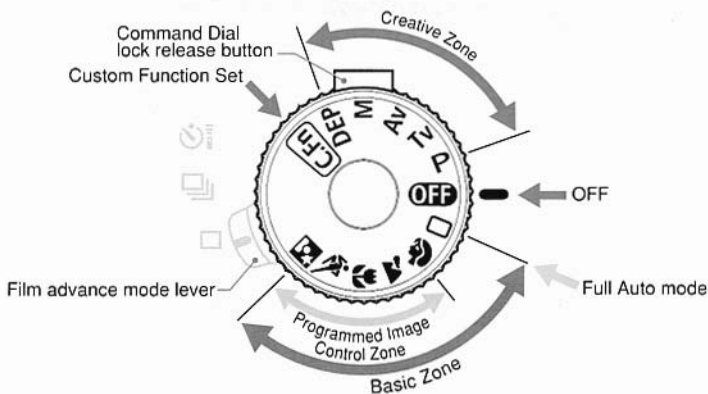

① Basic Zone

Basically, all you do is point and press the shutter button.

 : **Full Auto** (→page 28)

Fully automatic mode where the camera takes care of everything.

Programmed Image Control Zone

Fully automatic modes for a particular subject.

 : Portrait mode (→page 32)

 : Landscape mode (→page 33)

 : Close-up mode (→page 34)

 : Sports mode (→page 35)

 : Night Scene mode (→page 36)

② Creative Zone

Semi-automatic and manual modes enable you to take control of the camera to obtain the desired result.

P : Program AE (→page 52)

Tv : Shutter speed-priority AE (→page 54)

Av : Aperture-priority AE (→page 56)

M : Manual exposure (→page 58)

DEP : Depth-of-field AE (→page 60)

③ Custom Function Set

C.Fn : Custom Function (→page 85)

④ OFF : Off

AF Mode Dial

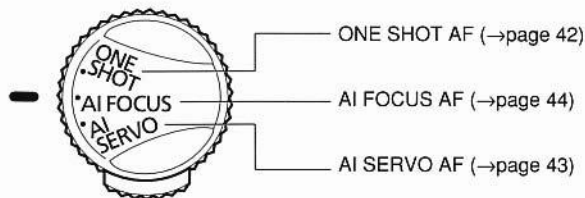

Film Advance Mode Lever

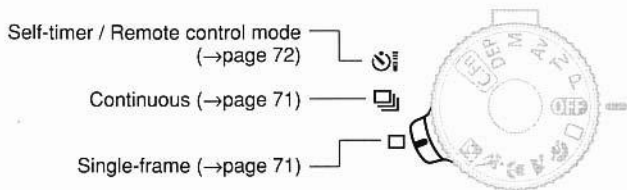

Conventions Used in this Instruction Booklet



- In this booklet, the <  > icon indicates the Main Dial.





- The <  > icon is the Quick Control Dial. Turn the Quick Control Dial switch to < ON > before using the Quick Control Dial.

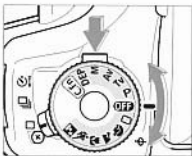

- This symbol indicates that there is a related Custom Function that is described briefly. Detailed descriptions are provided in “Custom Functions” on page 85.



- All the operations described in this booklet assume that the Command Dial is not set to < OFF >. Before proceeding with any operation, turn the Command Dial to a picture-taking mode by pressing the lock button and turning the dial.

- Page numbers in parentheses (→page ■) indicate where you can find more relevant information.
- The camera control icons and markings used in this booklet correspond to the actual icons and markings found on the camera. See “Nomenclature” on page 10.
- In this instruction booklet, a Canon EF 28-90mm f/4-5.6 lens is used for explaining the procedures.
- The procedures explained in this booklet assume that the Custom Functions are set to the default settings.
- The (), (), and () icons indicate that the respective function remains in effect for 4, 6, and 16 sec. respectively after the button is released.

This chapter explains the things you need to know and do before you use your camera for the first time.

Before You Start

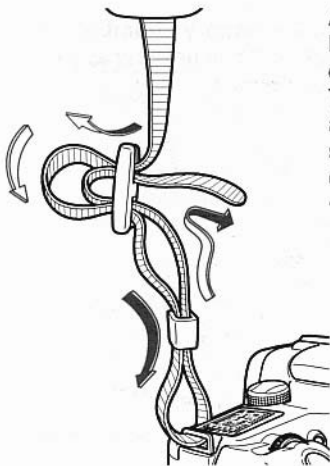

Attaching the Strap

Pass the end of the strap through the camera's strap eyelet from the bottom. Then pass it through the strap's clasps as shown in the illustration. Pull the strap to make sure it does not slip out of the clasp.

- The eyepiece cover is also attached to the strap. (→page 38)

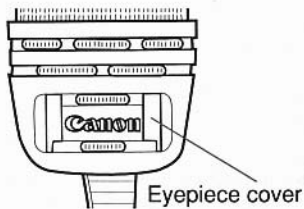

Installing the Batteries and Checking the Battery Level

Installing the Batteries

The camera uses two lithium CR123A (or DL123A) batteries.

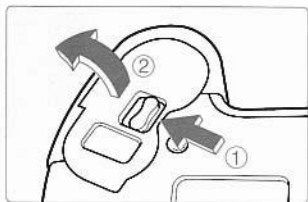

- 1 Open the battery chamber cover.**
- Slide cover release lever as shown by the arrow and open the battery chamber cover.

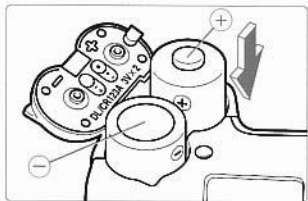

- 2 Insert the batteries.**
- Make sure the battery contacts (+ and -) are oriented as shown on the battery chamber cover.
 - Do not mix old and new batteries.

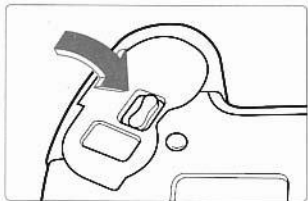

- 3 Close the battery chamber cover.**
- Press the cover until it snaps shut.

 For places where CR123A batteries may not be easily available, take spare batteries with you. Also carry spare batteries for extended shooting sessions.

Checking the Battery Level

Check the battery level after replacing the batteries and before using the camera.

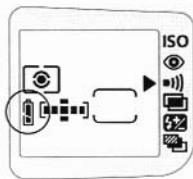
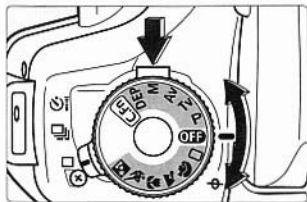

Turn the Command Dial to a picture-taking mode.

- Keep pressing the dial's lock release button while turning the dial.
- The camera will then turn on and the LCD panel will display one of the following battery level icons:



: Battery level OK.



: The battery level is low. Keep spare batteries handy.



: The batteries will soon be completely exhausted.



: Replace the batteries.
(→page 7)

Battery Service Life

(With 24-ex. rolls)

Ambient Temperature	0% Flash Use	50% Flash Use	100% Flash Use
At 20°C	125 rolls	38 rolls	19 rolls
At -20°C	70 rolls	20 rolls	10 rolls

- The Battery Service Life table above is based on Canon's testing conditions using an EF 50mm f/1.4 USM lens and new batteries.

- ❗ If nothing is displayed on the LCD panel, the batteries may have been installed incorrectly. Take out the batteries and install correctly. (→page 18)
- Pressing the shutter button halfway for a prolonged period or operating only the autofocus without taking a picture will still consume battery power. It will reduce the number of rolls that can be taken with the batteries.

📄 When not using the camera, set the Command Dial to < **OFF** >.

Mounting and Detaching a Lens

Mounting a Lens

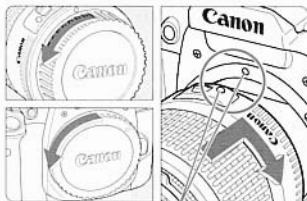

Red dots

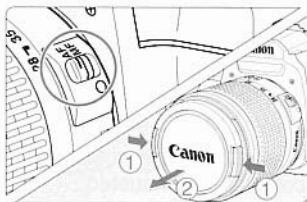

1 Remove the caps.

- Remove the rear lens cap and the camera body cap.

2 Mount the lens.

- Align the red dots on the lens and camera and turn the lens as shown by the arrow until it snaps in place.

3 On the lens, set the focus mode switch to <AF>.

- If the focus mode switch is set to <MF> (or <M> on older lenses), autofocus will not operate and <MF> will be displayed on the LCD panel.

4 Remove the front lens cap.

Detaching the Lens

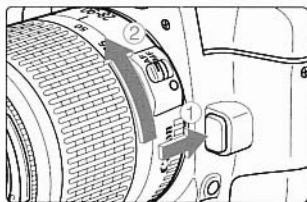

While pressing the lens release button, turn the lens as shown by the arrow.

- When the red dot on the lens is at the top, remove the lens.



- Keep the removed caps where you will not lose them.
- "AF" stands for Autofocus.
- "MF" (or "M") stands for Manual Focus.

Dioptric Adjustment

By adjusting the diopter, eyeglass wearers will not need their eyeglasses to see a sharp viewfinder image. The camera's adjustable dioptic range is -2.5 to $+0.5$ dpt.

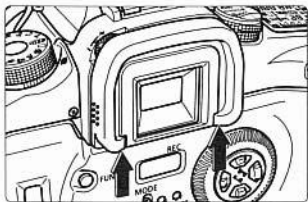

1

Remove the eyecup.

- While grasping both sides toward the bottom of the eyecup, slide it upward to remove.

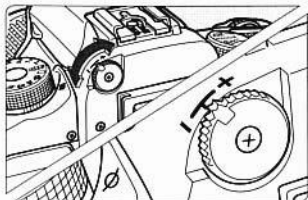

2

Turn the dioptic adjustment knob.

- Turn the knob to the right or left until the focusing points look sharp in the viewfinder.
- The diagram shows the knob set at the standard diopter (-1 dpt).

3

Reattach the eyecup.



If the viewfinder still does not look sharp after you turn the dioptic adjustment knob, use one of the Ed-series dioptic adjustment lenses (sold separately).

How the Shutter Button Works

The EOS camera's shutter button can be depressed halfway or all the way. There is a click stop at the halfway point.

Pressing the Shutter Button Halfway or Completely

The shutter button works as described below.

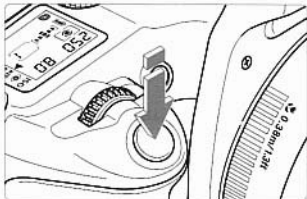

When it is pressed halfway:

- Autofocusing is activated, and when focus is achieved, the focusing point flashes and the beeper sounds. The in-focus indicator <●> on the viewfinder's lower right also lights.
- Also, the shutter speed and aperture are set and displayed on the LCD panel and in the viewfinder.

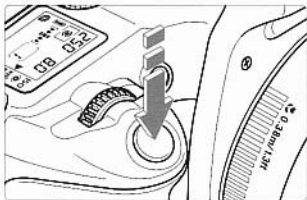

When it is pressed completely:

- The shutter is released to take the picture and the film advances by one frame.



- Camera movement during the moment of exposure is called camera shake. Camera shake can cause blurred pictures. To prevent blurred pictures due to camera shake:
 - Hold the camera steady (see page 26).
 - Use the center of your finger to touch the shutter button, grasp the camera with your entire right hand, then press the shutter button gently.
- If the AF Mode Dial has been set to <AI SERVO>, the in-focus indicator <●> will not light.
- If the AF Mode Dial has been set to <AI SERVO> and automatic focusing point selection is set (→page 45), the focusing point will not flash in red.

Ⓞ Loading and Unloading Film

Loading Film

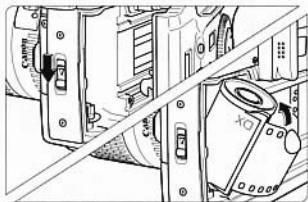

- 1 Open the camera back.**
- Slide the camera back lever down as shown by the arrow.

- 2 Insert the film cartridge at an angle as shown in the illustration.**
- Set the Command Dial to any setting except **<OFF>**.

Right

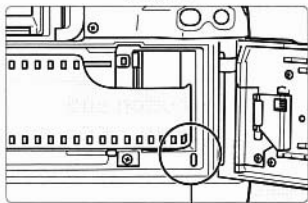

Orange mark

- 3 Pull the edge of the film leader to the orange mark on the camera.**
- Hold down the film cartridge while pulling out the film leader.
 - If the edge of the film leader goes beyond the orange mark, rewind some of the film back into the cartridge.

Wrong

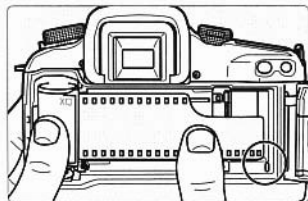
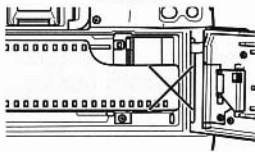

- 4 Close the camera back.**
- After checking that the film leader edge is correctly aligned with the orange mark, close the camera back.
 - The film will advance to frame 1 automatically.
 - When the initial film advance ends, the **<@>** icon and frame counter of "1" are displayed on the LCD panel.

🔊 In hot and humid environments, do not remove the film packaging until you are ready to load the film

- 📄
- If the film is not loaded properly, the <Ⓜ> icon will blink on the LCD panel and the shutter will not work. Reload the film cartridge properly.
 - Infrared film cannot be used with this camera.

Checking the Film Speed

The camera reads the film cartridge's DX code and sets the film speed automatically within ISO 25 - 5000.

- Set the Command Dial to a Creative Zone mode.

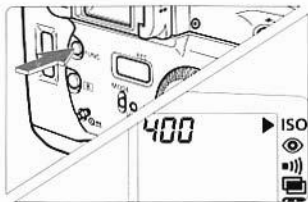

Press the <FUNC.> button and move the <▶> arrow to <ISO> on the LCD panel.

- The film speed will appear on the LCD panel.

📄 If you want to set a film speed different from the DX-coded film speed or if the film cartridge is not DX-coded, see "Setting the ISO Film Speed" on page 71.

📄 C.Fn-3-1 can prevent the film speed from being set automatically with the DX code. (→page 88)

Unloading Film

After the film's last frame is exposed, the camera rewinds the film automatically.

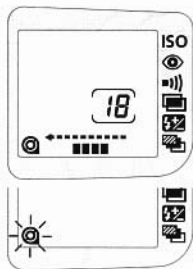

- ▶ When the film starts to rewind, the film rewind indicator on the LCD panel will flow from right to left to indicate that the film is rewinding. The frame counter also counts down.
- ▶ The film rewind stops automatically. Check that the <Ⓞ> icon on the LCD panel is blinking, then remove the film cartridge.

Ⓞ Midroll Rewind

To rewind the film in midroll, follow the procedure below.

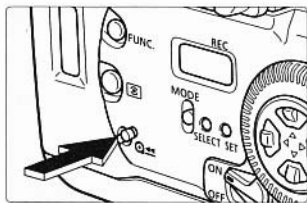

1 Press the <Q<=> button.

- ▶ The film will start rewinding. The subsequent operation will then be the same as normal film rewind.

2 Take out the film cartridge.

- ▶ Check that the <Ⓞ> icon on the LCD panel is blinking, then remove the film cartridge.

💡 During film rewind, pressing the <Q<=> button toggles between high-speed and low-speed (silent) rewind.

C.Fn Custom Function C.Fn-1 can alter the rewind speed. (→page 88)

C.Fn Normally, the entire film leader is rewound inside the film cartridge. Custom Function C.Fn-2-1 can leave out the film leader after film rewind. (→page 88)

Holding the Camera

To avoid taking blurred pictures, hold the camera steady to minimize camera shake.

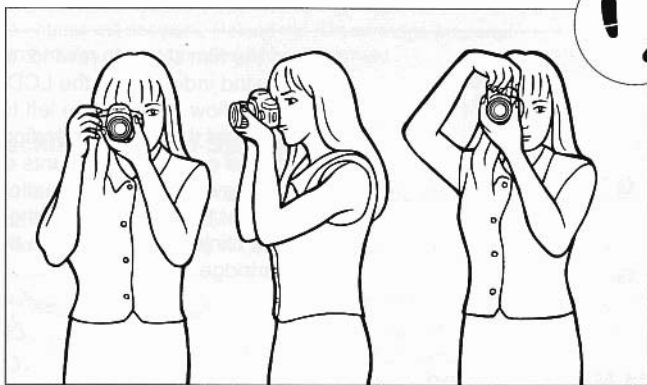

Horizontal shooting

Vertical shooting

- Firmly grasp the camera grip with your right hand, and press your right elbow lightly against your body.
- Hold the lens at the bottom with your left hand.
- Press the camera against your face and look through the viewfinder.
- To maintain a stable stance, place one foot in front of the other instead of lining up both feet.



The camera automatically senses whether it is in the horizontal or vertical position. When you switch between the horizontal and vertical orientations, the detection mechanism inside the camera will make a small sound.



For quick and easy picture-taking, this section describes the Command Dial's Basic Zone modes: <□>, <📷>, <📷>, <📷>, <📷>, and <📷>. These modes set all the camera settings automatically. All you do is point the camera and press the shutter button.

Also, these modes override the camera's <☀>, <○>, and AF Mode dials, film advance mode lever (except <🔄>), and buttons (except <FUNC.>, <🔍>, and the shutter button). This is to prevent spoiled shots caused by accidental operation of camera controls.

Fully Automatic Shooting

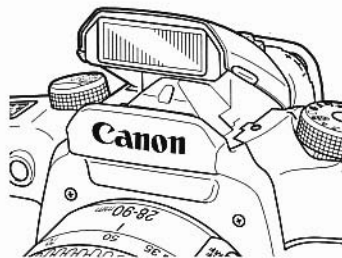

- In the Basic Zone modes except <📷> and <📷>, the built-in flash pops up and fires automatically under low-light or backlit conditions. (→page 74)
- The settings automatically set by the Basic Zone modes are shown in the "Feature Availability Table" on page 92.

Full Auto Mode

All you do is point the camera and press the shutter button. Everything is automatic so it is easy to photograph any subject. With seven focusing points to focus the subject, anyone can just point and shoot.

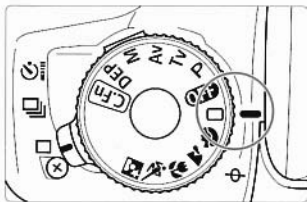

- 1 Turn the Command Dial to <AF>.**
- This automatically sets the AF mode to <AIFOCUS>, the film advance mode to <S> (single-frame shooting), and the metering mode to <E>.



AF Frame

- 2 Aim the focusing points on the subject.**
- The main subject, as determined by the camera, will be focused by one of the focusing points.
 - To focus a subject not covered by any of the focusing points, see "Focusing Off-Center Subjects" on page 47.

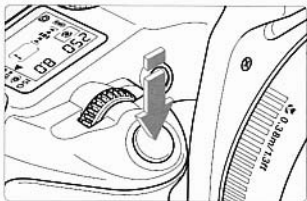

- 3 Press the shutter button halfway to focus.**
- When focus is achieved, the focusing point which achieved focus will flash in red, the beeper will sound, and the in-focus indicator <●> in the viewfinder's lower right will light.



4 Check the exposure setting.

- The shutter speed and aperture will be set automatically and displayed in the viewfinder and on the LCD panel.





5 Take the picture.

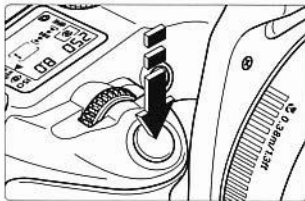

- Compose the shot and press the shutter button completely.





- When focus is achieved, the autofocus and auto exposure setting will also be locked.
- If the in-focus indicator <●> blinks, the picture cannot be taken. (→pages 48)
- Out of the seven focusing points, the one covering the closest subject is selected automatically to achieve focus.
- Multiple focusing points may light simultaneously. This indicates that these focusing points have all achieved focus.

Automatic Firing of the Built-in Flash

In the Basic Zone modes (except <  > and <  >), the built-in flash pops up and fires automatically under low-light or backlit conditions. (To retract the flash head, push it down by hand.)



 If the built-in flash's automatic pop-up action is obstructed accidentally, the  icon will blink on the LCD panel as a warning. If this happens, press the shutter button halfway to return the camera to normal operation.

 Also read the cautions for using the built-in flash on pages 74.

 If you do not want the built-in flash to fire, use the < **P** > (Program AE) mode. (→page 52)



AF-Assist with the Built-in Flash

Under low-light conditions, the built-in flash fires a brief burst of flashes when you press the shutter button halfway. This is to illuminate the subject (AF assist light) to enable easier autofocusing.

-  • The AF-assist light does not function in the <  > and <  > modes.
- The built-in flash's AF-assist light is effective up to about 4 meters.
 - In a Creative Zone mode, lift up the flash head and the AF-assist light will be emitted when necessary.
 - When an EOS-dedicated Speedlite is attached to the camera, the Speedlite's built-in AF-assist lamp will light.

Using Red-eye Reduction

When flash is used in a low-light environment, the subject's eyes may come out red in the photograph. "Red eye" happens when the light from the flash reflects off the retina of the eyes.

The camera's red-eye reduction feature turns on the red-eye reduction lamp to shine a gentle light into the subject's eyes to narrow the pupil diameter or iris. A smaller pupil reduces the chances of red eye from occurring. Red-eye reduction can be set in any picture-taking mode except <  > and <  >.

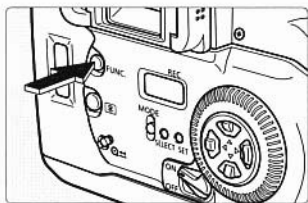

1 Move the <▶> arrow to the <👁> icon on the LCD panel.

- Look at the LCD panel and press the <FUNC.> button to move the arrow. (Ⓜ6)



2 Turn the <🌞> dial to set "!" on the LCD panel.

- To cancel red-eye reduction, set "□" on the LCD panel.
- Press the shutter button halfway to return to normal camera operation.
- When red-eye reduction is enabled, the red-eye reduction lamp-on indicator will be displayed in the viewfinder and on the LCD panel when you press the shutter button halfway and the lamp lights.



↓
Red-eye reduction lamp-on indicator

- Red-eye reduction will not work unless the subject looks at the red-eye reduction lamp. Tell the subject to look at the lamp.
- For maximum effectiveness, take the picture after the red-eye reduction lamp turns off (after 1.5 sec.).
- You can take a picture even while the red-eye reduction lamp is lit.
- The effectiveness of red-eye reduction varies depending on the subject.

💡 To further increase the effectiveness of red-eye reduction, go to a brighter environment or move closer to the subject.

Portrait Mode



This mode blurs the background to make the human subject stand out.

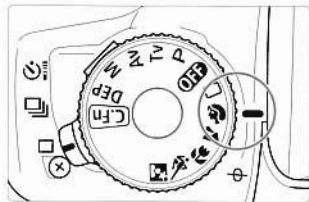

Turn the Command Dial to <P>.

- The picture-taking procedure is the same as with the <A> Full Auto mode on page 28.
- This automatically sets the AF mode to <ONE SHOT>, the film advance mode to <A>, and the metering mode to <M>.



- Background blur is most effective when the subject fills the frame from the waist up. Also, the further away the subject is from the background, the more blurred the background will become.
- Using a telephoto lens also increases background blur. If you have a zoom lens, use the longest focal length. (For example, a 28-90 mm zoom lens set to 90 mm.)



Landscape Mode

The image was removed due to copyright restrictions

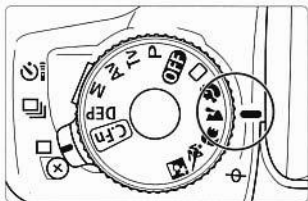
This is for sweeping scenery, night scenes, etc.



Turn the Command Dial to < >.

- The picture-taking procedure is the same as with the <  > Full Auto mode on page 28.
- This automatically sets the AF mode to < ^{ONE}SHOT >, the film advance mode to <  > (single-frame shooting), and the metering mode to <  >.

 If the shutter speed display blinks, the shutter speed may be too slow and a blurred picture may result due to camera shake. Using a tripod is recommended. (The shutter speed will still blink even while a tripod is used.)

 The built-in flash will not fire in this mode even while it is popped up.

 Using a wide-angle lens will further enhance the depth and breadth of the picture. If you have a zoom lens, use the shortest focal length. (For example, a 28-90 mm zoom lens set to 28 mm.)

Close-up Mode

The image was removed due to copyright restrictions

Use this mode to take close-up shots of flowers, insects, etc.

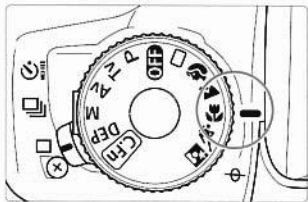

Turn the Command Dial to <🌸>.

- The picture-taking procedure is the same as with the <□> Full Auto mode on page 28.
- This automatically sets the AF mode to <ONE SHOT>, the film advance mode to <□> (single-frame shooting), and the metering mode to <☉>.

-  • As much as possible, focus the subject at the lens' closest focusing distance.
- If you have a zoom lens, use the maximum focal length to obtain a larger magnification.
- For better close-ups, an EOS-dedicated macro lens and Macro Ring Lite MR-14EX (both sold separately) are recommended.



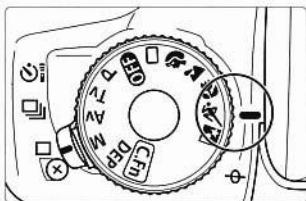

Sports Mode

The image was removed due to copyright restrictions

This is for sports and fast-moving subjects when you want to freeze the action on film.



Turn the Command Dial to >.

- The picture-taking procedure is the same as with the  Full Auto mode on page 28.
- This automatically sets the AF mode to  ^{AI}SERVO>, the film advance mode to  >, and the metering mode to  >.
- The in-focus indicator will not light even when focus is achieved.

 If the shutter speed display blinks, the shutter speed may be too slow and a blurred picture may result due to camera shake. Using a tripod is recommended. (The shutter speed will still blink even while a tripod is used.)

 The built-in flash will not fire in this mode even while it is popped up.

-  Using ISO 400 or faster film is recommended.
- For sports photography, a lens with a focal length of 200 mm or 300 mm is recommended.



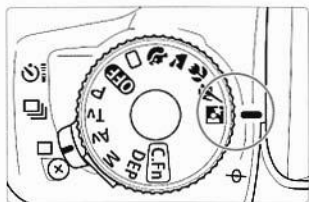

Night Scene Mode

The image was removed due to copyright restrictions





This mode is for taking pictures of people at twilight or at night. The flash illuminates the subject while a slow sync speed obtains a natural-looking exposure of the background.



Turn the Command Dial to .

- The picture-taking procedure is the same as with the  Full Auto mode on page 28.
- This automatically sets the AF mode to , the film advance mode to , and the metering mode to .

 To prevent camera shake, using a tripod is recommended.

-  If you want to photograph only a night scene (without people), use the  mode instead.
- Tell the subject to keep still even after the flash fires.
- If you use the self-timer in this mode, the red-eye reduction lamp will flash when the exposure is completed.
- The  mode can be used even while an EOS-dedicated Speedlite is attached to the camera.
- If the  mode is set in daylight, it will function in the same way as the  mode.

 Using ISO 400 or faster film is recommended.

Using the Self-timer

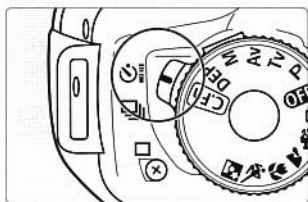

The self-timer is for when you want to be in the picture. It can be used in Basic Zone and Creative Zone modes. You should also use a tripod.



1 Set the film advance mode lever to .

- The  icon will be displayed on the LCD panel.

2 Take the picture.

- The picture-taking procedure is the same as with the  Full Auto mode on page 28.
- When you press the shutter button completely, the beeper will sound, the red-eye reduction lamp will flash, and the shutter will be released 10 sec. later.
During the first 8 seconds, the beeper beeps slowly and the red-eye reduction lamp flashes.
During the final 2 seconds, the beeper beeps faster and the red-eye reduction lamp stays lit.
- During the self-timer operation, the self-timer display on the LCD panel counts down in seconds until the picture is taken.
- To cancel the self-timer after it starts, set the film advance mode lever to  (single-frame shooting) or .

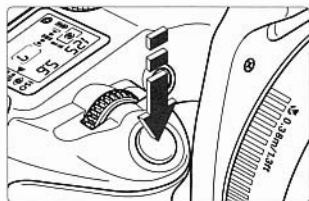

- Do not stand right in front of the camera when you press the shutter button to start the self-timer. Doing so will throw off the focus.

- The self-timer beeper can be silenced. See page 69.
- If you start the self-timer without looking through the viewfinder, stray light may enter the eyepiece and affect the exposure. To prevent this, attach the eyepiece cover on the eyepiece before pressing the shutter button.
- When using the self-timer to take a picture of only yourself, first lock the focus (→page 47) on an object at the same distance where you will be in the picture.
- With Remote Controller RC-1 or Remote Switch RS-60E3 (both sold separately), you can press the shutter button at a remote distance. (→page 72)

Using the Eyepiece Cover

When taking a picture while your eye is not covering the eyepiece (during self-timer or remote-control operation), cover the eyepiece with the eyepiece cover. This is to prevent stray light from entering the eyepiece and affecting the exposure.

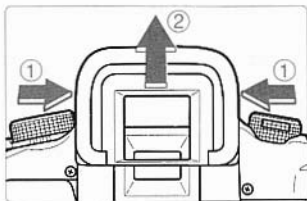

1 Remove the eyecup from the eyepiece.

- Grasp both sides of the eyecup and slide it up to remove.

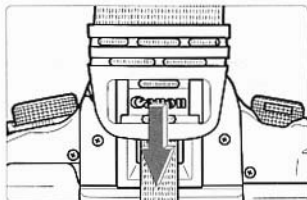

2 Slip the eyepiece cover onto the eyepiece.

- The eyepiece cover can be found on the camera strap.

Imprinting the Date or Time (QD Model only)

The image was removed due to copyright restrictions

The camera has a quartz date feature which maintains an automatic calendar up to the year 2019. It can imprint the date or time on the photograph as shown in the left photo. The imprinting can also be disabled so nothing is imprinted. The date or time can be imprinted in any picture-taking mode.

The date or time is imprinted on the lower right corner of the photograph.

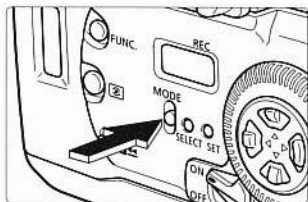

Press the <MODE> button.

- Each time the button is pressed, the imprinting format changes in the following sequence as shown on the quartz date display panel:

Year, month, day	'00 M 24	(2000 Dec. 24)
↓		
Day, hour, minute	24 16:45	(24th 16:45)
↓		
Hyphens	-- -- --	(Blank)
↓		
Month, day, year	M 12 24 00	(Dec. 24, 2000)
↓		
Day, month, year	24 M 12 00	(24 Dec. 2000)

- <M> is displayed above the month.
- The <—> bar above the last two digits is the imprint indicator. It blinks to indicate that the date or time is being imprinted when the picture is taken.

Setting the Date and Time

To set the date or time, follow the procedure below.



- 1 Select the date or time display.**
- Press the <MODE> button.

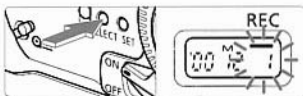

- 2 Select the digit to be set.**
- Press the <SELECT> button until the digit blinks.



- 3 Set the correct number.**
- Keep pressing the <SET> button until the correct number appears.



- 4 Finalize the setting.**
- Keep pressing the <SELECT> button until no digits blink.

Replacing the Quartz Date Back's Battery

When the date/time on the imprinted photograph looks faded, replace the CR2025 lithium battery as follows. Battery life is about 3 years.

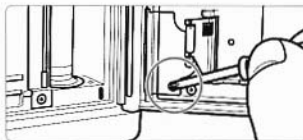

- 1 Remove the battery chamber cover.**
- Open the camera back and loosen the screw as shown in the illustration.

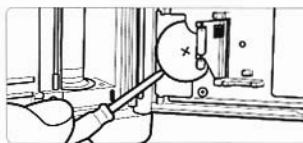

- 2 Take out the battery.**
- 3 Insert a new battery.**
- The battery's positive contact (+) must face up.
- 4 Reattach the battery chamber cover.**
- Set the correct date and time.

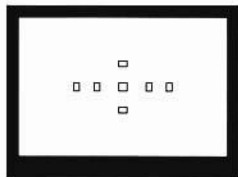

The viewfinder has seven focusing points. You can select the focusing point closest to the subject to make it easier and faster to compose the picture. You can also select the AF mode to suit the subject or shooting conditions.



The evaluative, partial, and centerweighted averaging metering modes are provided. Set the metering mode to suit shooting conditions and obtain the desired exposure.

AF Modes and Metering Modes

Selecting the AF Mode

Different AF modes have different AF operation characteristics. The camera provides three AF modes: One-Shot AF for still subjects, AI Servo AF for moving subjects, and AI Focus AF for still and moving subjects. Select the AF mode that suits the subject.

- The AF mode can be set only in the Creative Zone modes.

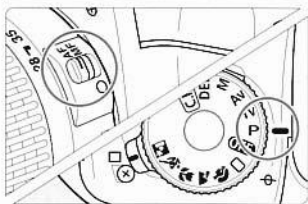

1 Set the lens focus mode switch to **<AF>**.

2 Set the camera to a **Creative Zone mode**.

- Turn the Command Dial to select the desired Creative Zone mode.



3 Turn the AF mode dial to select the AF mode.

One-Shot AF for Still Subjects



In-focus indicator

Focusing points



Press the shutter button halfway to start the AF operation. Focus will then be achieved once.

- The focusing point which achieves focus flashes briefly and the in-focus indicator <●> lights.
- When focus is achieved, the exposure setting (shutter speed and aperture) is set at the same time. The exposure setting and focus are locked while you keep pressing the shutter button halfway. You can then recompose the shot while maintaining the lock. (→page 47)

 If focus cannot be achieved, the in-focus indicator <●> in the viewfinder will blink. In this condition, you cannot take a picture even when you press the shutter button completely. Recompose the shot and focus again. See also “When Autofocus Fails” on page 48.

AI Servo AF for Moving Subjects

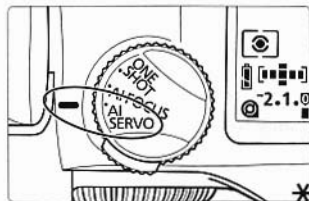

The camera focuses continuously while you keep pressing the shutter button halfway.

- This AF mode suits moving subjects when the focusing distance keeps changing.
- With predictive AF (→page 44), the camera can also focus track a subject which steadily approaches or retreats from the camera.
- The exposure setting is set when the picture is taken.

 In this mode, the in-focus indicator does not light and the beeper does not sound even when focus is achieved.

- If the in-focus indicator blinks, it means that focus has not been achieved.
- The focus cannot be locked. (→page 47)

* About Predictive AF

If the subject approaches or retreats from the camera at a constant rate, the camera tracks the subject and predicts the focusing distance immediately before the picture is taken. It thus predicts the distance where the subject will be at the moment of exposure. This is for obtaining a more accurate focus.

- In the automatic focusing point selection mode (→page 45), the camera first uses the center focusing point to focus. If the subject later moves away from the center focusing point, focus tracking continues as long as the subject is covered by another focusing point. The active focusing point does not flash.
- In the manual focusing point selection mode (→page 45), the focusing point that flashes in red is used for predictive AF.

C.Fn With C.Fn-4-2, you can lock the focus momentarily by pressing the **< * > C.Fn >** button even while AI Servo AF is in effect. (→page 88)

AI Focus AF for Still and Moving Subjects

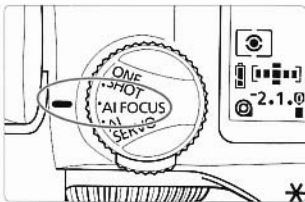

The AF mode changes automatically to suit the subject.

- If the subject focused in the One-Shot AF mode starts to move, the camera detects the subject movement and switches automatically to AI Servo AF to continue tracking the subject.



Selecting a Focusing Point

The focusing point achieves focus over the part it covers. You can select the focusing point in one of two ways: Automatic selection or manual selection.

- In Creative Zone modes, you can switch between automatic and manual focusing point selection.

Automatic Focusing Point Selection

The camera selects one of the seven focusing points automatically.

Manual Focusing Point Selection

Select one of the seven focusing points manually.

Focusing Point Selection Method

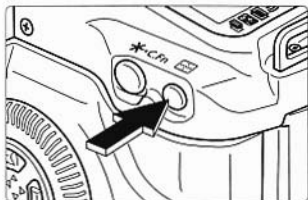

1

Press the <AF-ON> button. (06)

- The focusing point currently selected lights in red.

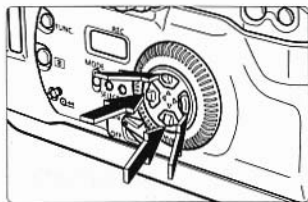

2

Select the desired focusing point.

- Look at the viewfinder or LCD panel and press the <OK> key.
- Press the <Left>, <Right>, <Up>, or <Down> keys on the left, right, top, or bottom to select the left, right, top, or bottom focusing point respectively.
- Press the shutter button halfway to focus with the selected focusing point.

Automatic Focusing Point Selection

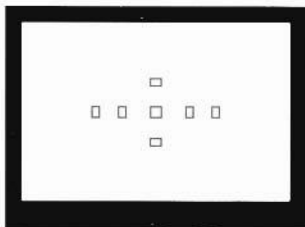

Light up all the focusing points in red.

- Press the key until the focusing point selection goes beyond the outer-most focusing point.

Manual Focusing Point Selection

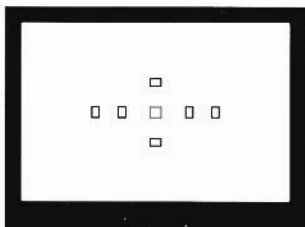

The center focusing point is selected.



Light up the desired focusing point in red.

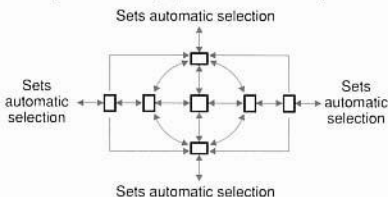

- The illustration below shows the  key's focusing point selection path.



- When you press the  button to switch from automatic focusing point selection to manual focusing point selection, the selection will start with the center focusing point.

C.Fn C.Fn-10-1 can disable the in-focus flashing of the focusing point. (→page 89)

C.Fn C.Fn-11-1 enables you to select a focusing point directly with the  keys without having to press the  button first. (→page 89)

C.Fn C.Fn-11-2 enables you to select a focusing point with the  and  dials instead of the  keys. (→page 89)

C.Fn C.Fn-12-1 enables you to switch to the center focusing point with the  button. (→page 89)

Focusing Off-Center Subjects

If you want to focus an off-center subject not covered by any of the focusing points, use focus lock as described below.

- Focus lock works only in the < ^{ONE}SHOT > AF mode. (→page 42)

1 Select the desired focusing point.
(→page 45)







2 Focus the subject.
• Aim the focusing point on the subject, then press the shutter button halfway.



3 Keep pressing the shutter button halfway and recompose the picture as desired.

4 Take the picture.

 Focus lock also works in the Basic Zone modes (except <  >). Just skip step 2 above.

 When focus is achieved, AE lock will also take effect at the active focusing point. Using the < ^{ONE}SHOT > and <  > (evaluative metering) modes are recommended.

When Autofocus Fails

The camera has a high-precision AF system which can focus almost all subjects. However, it can fail to achieve focus (the in-focus indicator blinks) the subjects listed below.

Difficult Subjects for Autofocusing

- Low-contrast subjects. Example: Blue sky, flat surface with a solid color.
- Subjects in very low light.
- Extremely backlit or reflective subjects. Example: Automobile with a highly reflective finish.
- Overlapping near and far objects. Example: Animal behind bars in a cage.

In such cases, use one of the following methods to focus:

- (1) Focus lock an object at the same distance as the subject and recompose.
- (2) Set the lens focus mode switch to **<MF>** or **<M>** and focus manually as explained below.

 If focus cannot be achieved even with the EOS-dedicated Speedlite's AF-assist light, select the center focusing point instead of an off-center focusing point.

MF Manual Focusing

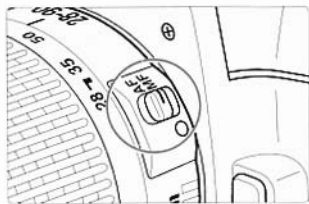

1 Set the lens focus mode switch to **<MF>** (or **<M>** on older lenses).

- The **<MF>** icon will be displayed on the LCD panel.

2 Focus the subject.

- Turn the lens focusing ring until the subject is in focus in the viewfinder.

 If you focus manually while you hold down the shutter button halfway, the focusing point(s) achieving focus will flash in the viewfinder and the in-focus indicator **<●>** will also light.

Metering Mode

The camera has three metering modes: Evaluative, partial, and centerweighted averaging metering. Use the metering mode most suited for the subject or situation.

- The metering mode can be selected in the Creative Zone modes.

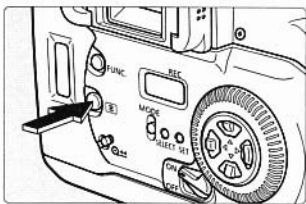

1 Press the  button. (ⓘ6)

2 Select the metering mode.

- Look at the LCD panel and turn the  dial until the desired metering mode's icon appears.

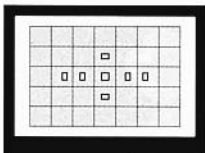

Evaluative metering

This is suited for most picture-taking conditions including backlit subjects. The viewfinder coverage is divided into 35 metering zones and evaluative metering is linked to the seven focusing points. The camera senses the subject's position and brightness, the background, the existing light, backlighting, and other lighting conditions to set a suitable exposure for the subject.

- During manual focusing, evaluative metering is linked only to the center focusing point.

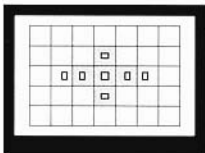

Partial metering

This is effective for backlit subjects. An area covering about 10% of the viewfinder screen at the center is used for metering.

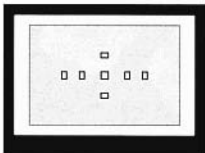

Centerweighted averaging metering

The metering is weighted at the center and then averaged for the entire scene.

C.Fn Partial metering and FE lock can be linked to the active focusing point. (See page 89 for C.Fn-8-1.)

The image was removed due
to copyright restrictions

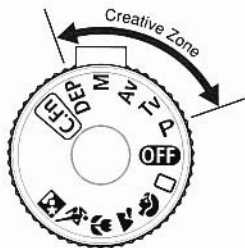

The Command Dial's Creative Zone modes give you more control over the camera. You can set the shutter speed and/or aperture to obtain the result you want. This chapter explains the effective uses of these Creative Zone modes: <P>, <Tv>, <Av>, <M>, and <DEP>.

Creative Zone Modes

- In the text, the <☀> icon indicates the Main Dial, and the <○> icon indicates the Quick Control Dial.
- Before starting, set the Quick Control Dial switch to <ON>.
- When you press the shutter button halfway and let go of the button, the shutter speed and aperture will remain displayed on the LCD panel and in the viewfinder for about 4 sec.
- The following features work in the Creative Zone modes: AE lock, exposure compensation, AEB, bulb exposures, multiple exposures, depth-of-field preview, mirror lockup, manual setting of film speed, and film advance mode selection.

P Program AE

The image was removed due to copyright restrictions

Like the <□> (Full Auto) mode, this is a general-purpose mode to make picture-taking easy. It sets the shutter speed and aperture automatically to suit the subject's brightness.

* "P" stands for Program.

* "AE" stands for auto exposure.

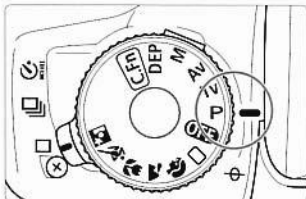

1 Turn the Command Dial to <P>.

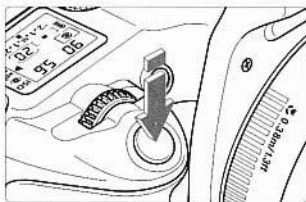

2 Press the shutter button halfway to focus.



3 Check the display.

- The shutter speed and aperture are set automatically and displayed in the viewfinder and on the LCD panel.
- If the shutter speed and aperture do not blink, a correct exposure will be obtained.
- If the shutter speed and aperture blink, see "Exposure Warnings" on page 95.

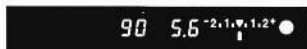

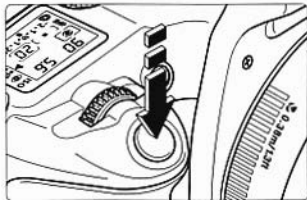

- 4 Take the picture.**
- Compose the shot and press the shutter button completely.

The Difference Between <P> and <□>

- The <P> and <□> modes set the same shutter speed and aperture settings automatically for picture-taking.
- The following features can be used with <P>, but not with <□>:
 - Manual focusing point selection
 - Metering mode selection
 - Film advance mode selection
 - Program shift
 - AE lock with the <∗> button
 - Exposure compensation
 - AEB
 - Depth-of-field preview
 - Multiple exposures
 - Custom Functions
 - Built-in flash ON
 - Flash exposure compensation
 - EX-series Speedlite compatibility
 - High-speed sync
 - FE lock
 - Flash ratio control
 - FEB
 - 2nd-curtain sync
 - Modeling flash

About Program Shift

In the Program AE mode, you can freely change the shutter speed and aperture combination (program) set by the camera while retaining the same exposure. This is called program shift.

To shift the program, press the shutter button halfway and turn the <☀> dial until the desired shutter speed or aperture is displayed.

- After the picture is taken with the shifted program, the shifted program is canceled automatically and the original program is restored.
- Program shift cannot be set when the built-in flash is used.

Tv Shutter-Speed Priority AE

In this mode, you set the shutter speed and the camera sets the aperture automatically to suit the brightness of the scene.

A fast shutter speed can freeze the motion of a fast-moving subject. Or, a slow shutter speed can blur the subject to give the impression of motion.

※ "Tv" stands for Time value which is the shutter speed.

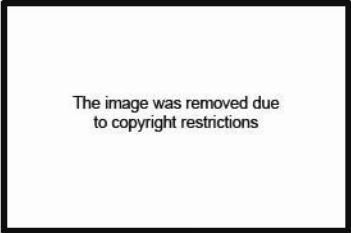

The image was removed due to copyright restrictions

Taken with a fast shutter speed.

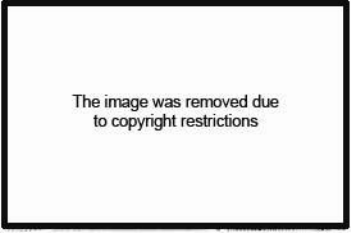

The image was removed due to copyright restrictions

Taken with a slow shutter speed.

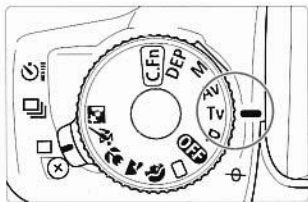

1 Turn the Command Dial to <Tv>.

2 Select the desired shutter speed.

- Look at the LCD panel and turn the <shutter speed icon> dial to set the desired shutter speed.

3 Press the shutter button halfway to focus the subject.

- The aperture is set automatically.



1000 4.0^{-2,1,1,2*}

4 Check the viewfinder display and take the picture.

- If the aperture display is not blinking, a correct exposure will be obtained.



- If the maximum aperture (the smallest f-number) blinks, it indicates underexposure. In such a case, turn the  dial to set a slower shutter speed until the aperture display stops blinking.



- If the minimum aperture (the largest f-number) blinks, it indicates overexposure. In such a case, turn the  dial to set a faster shutter speed until the aperture display stops blinking.



Shutter Speed Display

The shutter speed can be set and displayed in full and half stops. Shutter speeds from "2" to "4000" indicate the denominator of the fractional shutter speed. For example, "125" is 1/125 second. For slower shutter speeds, the numeral is appended with the seconds mark (""). For example, "0.7" is 0.7 second and "15" is 15 seconds.

4000	3000	2000	1500	1000	750	500	350	250	180				
125	90	60	45	30	20	15	10	8	6	4	3	2	0.7
1"	1.5"	2"	3"	4"	6"	8"	10"	15"	20"	30"			

-  To photograph a scene on a TV screen, mount the camera on a tripod and use a shutter speed of 1/15 sec.

Av Aperture-Priority AE

In this mode, you set the aperture and the camera sets the shutter speed automatically to suit the brightness of the subject.

A large aperture (small f-number) will blur the background and make the subject stand out. The larger the aperture, the more blurred the background will look.

Or, a small aperture (large f-number) will increase the depth of field to make both the foreground and background look sharp. The smaller the aperture, the sharper the background will look.

* "Av" stands for aperture value.



The image was removed due to copyright restrictions

Taken with a large aperture.



The image was removed due to copyright restrictions

Taken with a small aperture.

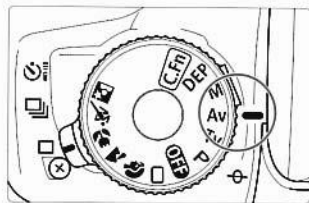

1 Turn the Command Dial to < Av >.

2 Select the desired aperture.

- Look at the LCD panel and turn the <  > dial to set the desired aperture.

3 Press the shutter button halfway to focus the subject.

- The shutter speed is set automatically.





30 11^{-2,1,1,2*} ●

4 Check the viewfinder display and take the picture.

- If the shutter speed display does not blink, a correct exposure will be obtained.

30'' 11^{-2,1,1,2*} ●4000 4.0^{-2,1,1,2*} ●

- If the slowest shutter speed blinks, it indicates underexposure. In such a case, turn the <  > dial to set a larger aperture (smaller f-number) until the shutter speed display stops blinking.
- If the maximum shutter speed blinks, it indicates overexposure. In such a case, turn the <  > dial to set a smaller aperture (larger f-number) until the shutter speed display stops blinking.



Aperture Display

The aperture can be set and displayed in full and half stops as shown below. The larger the number, the smaller the aperture opening will be. The displayable range of apertures depends on the lens mounted on the camera.

1.0	1.2	1.4	1.8	2.0	2.5	2.8	3.5	4.0	4.5	5.6	6.7	8.0	9.5
11	13	16	19	22	27	32	38	45	54	64	76	91	

If no lens is mounted on the camera, "00" will be displayed for the aperture setting.

Depth-of-field Preview

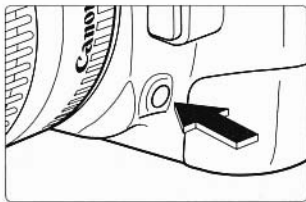

To check the depth of field, press the depth-of-field preview button. The camera will stop down the aperture and you can check the depth of field in the viewfinder.



- Depth-of-field preview can be used only in Creative Zone modes.
- When you press the depth-of-field preview button, AE lock also takes effect.

M Manual Exposure

In this mode, you set both the shutter speed and the aperture for total exposure control. The exposure level of the shutter speed and aperture you set is indicated on the exposure level scale. You can thereby check how suitable the exposure will be.

* "M" stands for Manual.

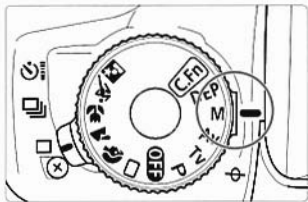

1 Turn the Command Dial to <M>.

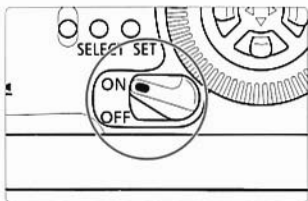

2 Turn the Quick Control Dial switch to <ON>.

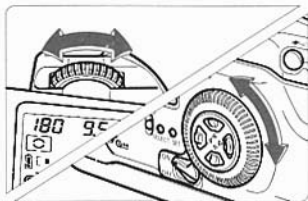

3 Turn the <☀> dial to set the shutter speed, and the <○> dial to set the aperture.

- Look at the LCD panel while turning the dial.

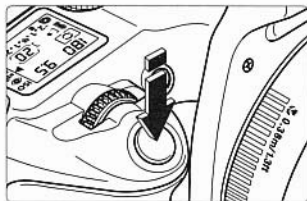

4 Press the shutter button halfway to focus the subject.

- The exposure level is displayed in the viewfinder.
- The exposure level indicator < ■ > indicates how close the exposure level is to the correct exposure.



5 Set the exposure setting.

- Look at the exposure level indicator and set the shutter speed and aperture as desired.



Correct exposure **-2.1.0.1.2+** : This is the standard level for a correct exposure.

Underexposure **-2.1.0.1.2+** : To achieve the correct exposure, set a slower shutter speed or a larger aperture.

Overexposure **-2.1.0.1.2+** : To achieve the correct exposure, set a faster shutter speed or a smaller aperture.

- If the exposure level indicator < ■ > blinks at < 2+ > or < -2 >, it indicates that the exposure is respectively overexposed or underexposed by 2 stops or more.

6 Take the picture.



4

Focus farthest subject.

- Aim the selected focusing point on the farthest subject, then press the shutter button. This is DEP point 2. (⊙4)
- The in-focus indicator lights and <●> is displayed.
- Steps 3 and 4 can also be done in reverse order.



5

Compose the picture and press the shutter button halfway. (⊙4)

- The point of focus is set between the DEP 1 and DEP 2 points. The aperture required to achieve the desired depth of field and a suitable shutter speed are set automatically.
- If you release the shutter button, "dEP" and the aperture will be displayed.
- The exposure setting is set when the picture is taken.



6

Take the picture.

- If the aperture display does not blink, the desired depth of field will be obtained.
- If the shutter speed and aperture displays do not blink, a correct exposure will be obtained.

- If the aperture display blinks, the desired depth of field will not be obtained. (However, you can still take the picture and obtain a correct exposure.) Either use a wide-angle lens or move away from the subject and repeat from step 3.



- If the "30''" shutter speed and the lens' maximum aperture (smallest f-number) blink, the scene is too dark for using depth-of-field AE.
- If the "4000" shutter speed and the lens' minimum aperture (largest f-number) blink, the scene is too bright. Use a neutral density (ND) filter to reduce the amount of light entering the camera.

- When using a zoom lens, do not change the zoom focal length while using the depth-of-field AE mode.
- After setting one or two DEP points, do not change the focusing point. Doing so will cancel the DEP point(s) that you have set and you will have to start over with the newly selected focusing point.
- Depth-of-field AE cannot be used if the lens focus switch is set to **<MF>** or **<M>**. The result will be the same as using Program AE.
- Depth-of-field AE cannot be used with flash. If flash is used, the result will be the same as using Program AE with flash.
- If depth-of-field AE is used with a lens having a focusing limiting switch (like the EF 300mm f/2.8L IS USM), set the switch to the maximum focusing distance range.

- To cancel the depth-of-field AE mode before taking the picture, turn the Command Dial to any setting except **<DEP>**.
- To check the depth of field (→page 57) while using depth-of-field AE, set DEP points 1 and 2 and press the shutter button halfway. Then press the depth-of-field preview button.
- If a slow shutter speed is set, use a tripod to prevent camera shake.

- To further increase the depth of field, use a wide-angle lens.
- Setting DEP points 1 and 2 at the same point on the subject will make the depth of field shallow. The foreground and background will then be blurred, making the subject stand out. Using a telephoto lens enhances this effect.

✳ AE Lock

With the same focusing point, you can obtain and lock the auto exposure setting on one part of the picture and then recompose to focus a different part of the picture. AE lock enables you to maintain the same exposure setting even after recomposing the shot. This is effective for backlit subjects.

- Also see "AE Lock Effect" on page 92 to see how AE lock works depending on the focusing point selection method and metering mode.



1 Focus the subject where you want to lock the exposure.

- Press the shutter button halfway to focus. (☺4)
- The exposure setting is displayed in the viewfinder.

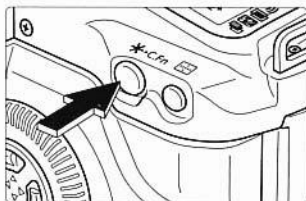

2 Press the <✳> button. (☺4)

- The <✳> indicator lights in the viewfinder and the exposure setting locks (AE lock).
- Each time you press the <✳> button, the auto exposure locks over the area covered by the selected focusing point.



3 Compose the shot and take the picture.



In the One-Shot AF or AI Focus AF (except AI Servo AF) modes, AE lock is set automatically when you press the shutter button halfway and focus is achieved.



C.Fn-4-1 enables AE lock with the shutter button (pressed halfway) and focusing with the <✳> button. (→page 88)

Exposure Compensation

Changing the standard exposure level set by the camera during picture-taking is called exposure compensation. Just turn the <○> dial and look at the viewfinder. You can set the exposure compensation up to ± 2 stops in half-stop increments.

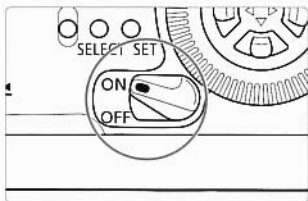

1 Turn on the Quick Control Dial switch to <ON>.

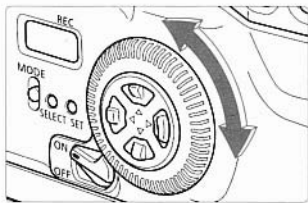

2 Press the shutter button halfway to focus the subject. (⊙4)

3 Check the exposure level.

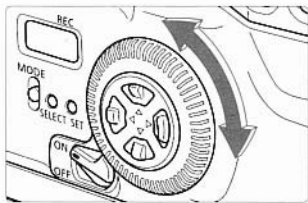

4 Set the exposure compensation amount.

- Turn the <○> dial to set the desired amount.
- Turn the <○> dial while pressing the shutter button halfway or within 4 sec. after pressing the shutter button halfway and letting go.
- You can also refer to the LCD panel while setting the exposure compensation amount.
- The <+> side indicates an overexposed amount, and the <-> side indicates an underexposed amount.

Overexposed amount

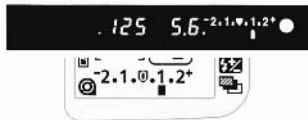

Underexposed amount



Underexposed amount ←.....■.....▶ Overexposed amount

- The exposure compensation amount set is retained even after the Command Dial is set to <OFF>.
- To cancel the exposure compensation, set the exposure level indicator back to <0>.

 After setting the exposure compensation amount, turn the Quick Control Dial switch to <OFF> to prevent inadvertent turning of the Quick Control Dial (thereby throwing off the exposure compensation amount set).

Auto Exposure Bracketing (AEB)

With AEB, the camera automatically changes the exposure within the set range (up to ± 2 stops in 1/2-stop increments) for three successive frames. The three bracketed shots are exposed in the following sequence (\rightarrow page 71): Correct exposure, underexposure, and overexposure.



The image was removed due to copyright restrictions

Correct exposure (0)



The image was removed due to copyright restrictions

Underexposure (-0.5 stop)

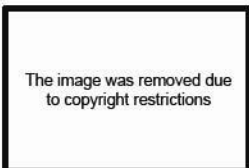

The image was removed due to copyright restrictions

Overexposure ($+0.5$ stop)

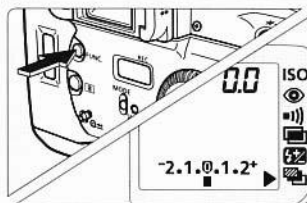

1 Move the $\langle \triangleright \rangle$ arrow to the icon.

- Look at the LCD panel and press the $\langle \text{FUNC.} \rangle$ button. ($\odot 6$)

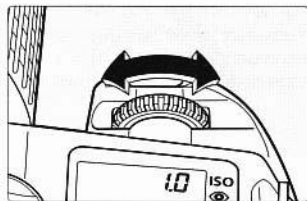

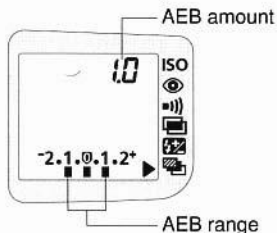

2 Set the desired AEB amount.

- Turn the  dial.
- The AEB amount and AEB range $\langle \blacksquare \rangle$ are displayed on the LCD panel.
- The sample illustration below shows an AEB amount of 1 stop with respect to the correct exposure level.



-2.1.0.1.2⁺ Correct exposure



-2.1.0.1.2⁺ Underexposure

-2.1.0.1.2⁺ Overexposure

3 Take the pictures.

- The bracketed pictures will be taken in the current film advance mode.
- The respective AEB amount is displayed on the LCD panel and in the viewfinder for each bracketed shot.
- After the three AEB shots are taken, the AEB will not be canceled automatically. To cancel AEB, set the AEB amount back to "0.0".

 AEB cannot be used with flash or bulb exposures.

-  In the continuous shooting mode, holding down the shutter button will take all three bracketed shots continuously. However, the viewfinder will not display the respective AEB information.
- If the self-timer or remote control is used, the three AEB shots will be taken in continuous succession automatically.
 - If C.Fn-5-1 is set (mirror lockup), single-frame film advance will take effect during AEB shooting even if the continuous film advance mode has been set.
 - AEB can be used in combination with exposure compensation. If the AEB + exposure compensation range you set exceeds the displayable range, it will be displayed as shown below.

In the <P>, <Tv>, <Av>, and <DEP> modes:

-2.1.0.1.2⁺ : ±1 stop AEB.



-2.1.0.1.2⁺ : ±1 stop AEB with -1-stop exposure compensation.



-2.1.0.1.2⁺ : ±1 stop AEB with -1.5-stop exposure compensation.

-2.1.0.1.2⁺ : ±1 stop AEB with -2-stop exposure compensation.

In the <M> mode:

-2.1.0.1.2⁺ : ±1 stop AEB with -2-stop exposure compensation.

-2.1.0.1.2⁺ : ±1 stop AEB with over -2-stop exposure compensation.

-2.1.0.1.2⁺

Bulb Exposures

A bulb exposure starts when you press the shutter button completely and ends when you release the shutter button. Bulb exposures are useful when long exposures are required for night scenes, fireworks, heavenly bodies, etc.

- Remote Switch RS-60E3 (sold separately) is convenient for bulb exposures.

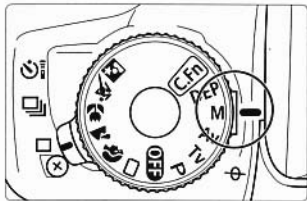

1 Turn the Command Dial to <M>.

2 Set the shutter speed to "bulb".

- Turn the <shutter speed> dial until "bulb" is displayed on the LCD panel.
- "bulb" follows "30''".

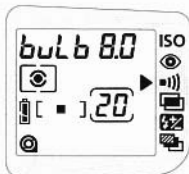

3 Set the aperture.

- Turn the <aperture> dial.

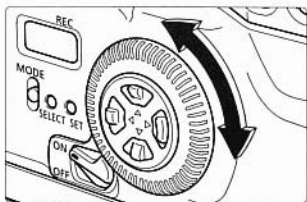

4 Start the bulb exposure.

- Press and hold down the shutter button.
- During the bulb exposure, "bulb" blinks on the LCD panel.
- The bulb exposure continues as long as you hold down the shutter button.

Multiple Exposures

By not advancing the film after taking a picture, a single frame can be shot multiple times. Up to nine multiple exposures can be taken on one frame.

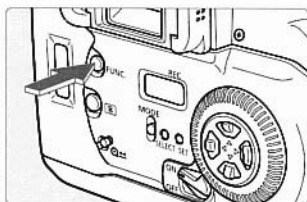

1 Move the <▶> arrow to the icon.

- Look at the LCD panel and press the <FUNC.> button. (ⓘ6)
- The frame counter will show "1".

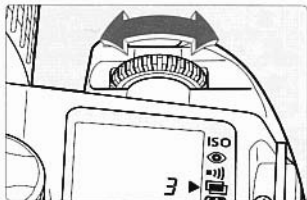

2 Set the desired number of multiple exposures.

- Turn the dial.



Three multiple exposures have been set above.

3 Select the picture-taking mode and take the multiple exposures.

- After you take all the multiple exposures, the film advances to the next frame automatically and the multiple-exposure setting is canceled.

If you shoot multiple exposures on the first few or last few frames of roll, the multiple exposures might not be precisely aligned due to the film advance mechanism's characteristics.

- During multiple-exposure shooting, the <▶> arrow next to the <M> icon on the LCD panel will blink.
- To cancel multiple exposures before shooting, set the number of multiple exposures to 1.
- To cancel multiple exposures after shooting, follow steps 1 and 2 to set the number of multiple exposures to blank.

Since shooting multiple exposures will expose the same frame multiple times, negative exposure compensation (→page 64) must first be set to avoid overexposure.

General Guide for Exposure Compensation

Multiple Exposures	2 exposures	3 exposures	4 exposures
Exposure Compensation Amount	-1.0 stop	-1.5 stop	-2.0 stop

These are only suggested exposure compensation amounts. The optimum amount depends on the scene. Experiment to find the optimum compensation amount.

Silencing the Beeper

The beeper can be silenced in all of the picture-taking modes.



1 Move the <▶> arrow to the <M> icon.

- Look at the LCD panel and press the <FUNC.> button. (Ⓞ6)



2 Set the setting to “0”.

- Turn the <DIAL> dial.
- To enable the beeper to sound, set to “1”.
- Press the shutter button halfway to return to normal camera operation.

Mirror Lockup

Mirror lockup is enabled with C.Fn-5-1 (→page 88). Keeping the reflex mirror in the up position prevents mirror-caused vibrations that can blur the image during close-up or telephoto shooting.

- When using mirror lockup, Remote Switch RS-60E3 (sold separately) is recommended.

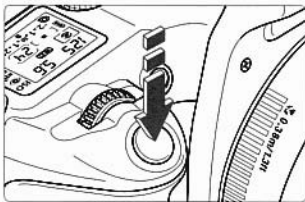

1 Press the shutter button completely.

- The reflex mirror locks up.
- The reflex mirror will go back down automatically after 30 seconds (if no picture is taken).

2 Press the shutter button completely again to take the picture.

- After the picture is taken, the reflex mirror goes back down.

- In bright light such as at the beach or ski slope on a sunny day, take the picture promptly after mirror lockup.
- During mirror lockup, do not point the camera lens at the sun. The sun's heat can scorch and damage the shutter curtains.
- If you use mirror lockup with the self-timer for a bulb exposure, there will be a shutter release sound when you let go of the shutter button during self-timer operation. This is not the sound of the shutter release.

- During mirror lockup, the film advance mode (→page 71) will be single-frame shooting regardless of the current film advance mode.
- If mirror lockup is used with the self-timer, pressing the shutter button completely the first time will lock up the mirror and release the shutter 10 seconds later.

ISO Setting the ISO Film Speed

If the film is not DX-coded or if you want to set a different film speed, you can set the film speed manually after loading the film into the camera. The settable film speed range is ISO 6 to 6400.

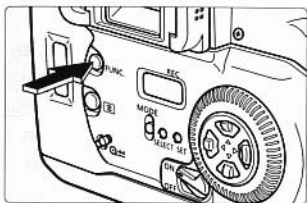

1 Move the <▶> arrow to the <ISO> icon.

- Look at the LCD panel and press the <FUNC.> button to move the arrow. ()
- The current film speed is displayed.

2 Set the desired film speed.

- Turn the <  > dial to set the film speed.
- Press the shutter button halfway to return to normal camera operation.

 The manually-set film speed will be canceled if the film is taken out and DX-coded film is loaded.

C.Fn With C.Fn-3-1, you can retain the manually-set film speed even after taking out the film and loading another DX-coded roll of film. (→page 88)

Selecting the Film Advance Mode

There are two film advance modes: Single-frame shooting and continuous shooting.

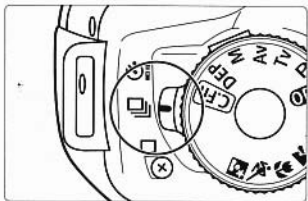

Single-frame Shooting

After a picture is taken, the film advances by one frame automatically.

Continuous Shooting

Holding down the shutter button advances the film continuously.

ONE SHOT : Approx. 4 frames per second.

AI SERVO : Approx. 3.5 frames per second.

Wireless Remote Control

Remote Controller RC-1 (sold separately) enables wireless remote control operation in all the picture-taking modes.

1 Turn the film advance mode lever to $\langle \text{☺} \rangle$.

- The $\langle \text{☺} \rangle$ icon appears on the LCD panel.

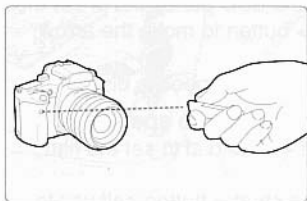

2 Take the picture via remote control.

- Point the Remote Controller RC-1's signal emitter toward the camera's remote control sensor and press the Send button. Wireless remote control works within 5 meters from the camera.
- Remote shutter release is indicated as follows:
2-sec. delay: The red-eye reduction lamp lights for 2 sec., then the picture is taken.
Immediate shutter release: When the picture is taken, the red-eye reduction lamp flashes.

⚠ Certain types of fluorescent lights might cause the remote control operation to work improperly. Place the camera away from any fluorescent lights as much as possible.

📄 If you set the film advance mode lever to $\langle \text{☺} \rangle$ and do nothing for four minutes, the wireless remote control mode will be canceled automatically to save battery power. To set it again, press the shutter button halfway. The $\langle \text{☺} \rangle$ icon displayed on the LCD panel indicates that the wireless remote control mode can be used.

Using the Remote Switch

The Remote Switch RS-60E3 (sold separately) can be used in all the picture-taking modes.

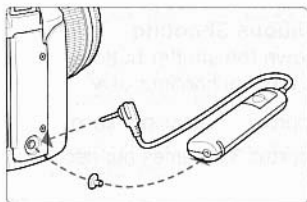

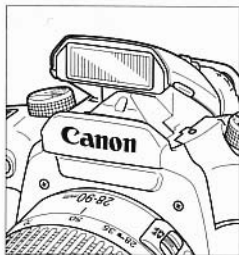

Connect the Remote Switch's plug to the camera's remote control terminal. Press the release button to take the picture.



About the Built-in Flash

Using the built-in flash is as easy as normal picture-taking.

In the Basic Zone modes (except <  > and <  >), the built-in flash is fully automatic. In Creative Zone modes, it can be used at any time.

Flash Photography





Using an External EOS-Dedicated Speedlite

- An external, EOS-dedicated Speedlite attached to the camera makes flash photography as easy as any AE mode. An EX-series Speedlite enables E-TTL autofocus as well as E-TTL wireless autofocus with multiple Speedlites.
- This chapter describes the features available with Speedlite 420EX. For detailed instructions for the 420EX, refer to its instruction booklet.

Using the Built-in Flash

In a Basic Zone Mode

In a Basic Zone mode (except <  > and <  >), the built-in flash pops up and fires automatically when necessary in low-light or backlit conditions.

In a Creative Zone Mode

In a Creative Zone mode, you can use the built-in flash at anytime regardless of the existing light level. Just pull up the built-in flash head before taking the picture.



- P** : Use this mode for automatic flash photography. The flash sync speed and flash aperture are set automatically as with the <  > (Full Auto) mode.
- Tv** : Use this mode if you want to set a flash sync speed slower than 1/125 sec. The camera will set the flash aperture automatically to obtain a correct flash exposure.
- Av** : Use this mode if you want to set the flash aperture. In this mode, you can obtain a balanced exposure between the subject and a dark background (night scene, etc.) with a slow sync speed set automatically by the camera. The flash illuminates the subject while the background is exposed with a long shutter speed.
- Be sure to use a tripod when a slow sync speed is set.
- M** : This mode enables you to set both the flash sync speed and flash aperture. The subject is properly exposed with the flash and the background is exposed with the flash sync speed and aperture you have set.
- DEP** : This mode gives the same flash result as the < **P** > mode.

Effective Range of the Built-in Flash (With EF 28-90mm f/4-5.6 lens)

ISO		28mm		90mm	
		Negative Film	Reversal Film	Negative Film	Reversal Film
100	m	1 - 4.6	1 - 3.2	1 - 3.2	1 - 2.3
	ft	3.3 - 15.1	3.3 - 10.5	3.3 - 10.5	3.3 - 7.5
200	m	1 - 6.5	1 - 4.6	1 - 4.6	1 - 3.2
	ft	3.3 - 21.3	3.3 - 15.1	3.3 - 15.1	3.3 - 10.5
400	m	1 - 9.2	1.2 - 6.5	1 - 6.5	1 - 4.6
	ft	3.3 - 30.2	3.9 - 21.3	3.3 - 21.3	3.3 - 15.1

Flash Sync Speeds and Flash Apertures

Mode	Sync Speed	Flash Aperture
P	The sync speed is set automatically within 1/60 - 1/125 sec.	The flash aperture is set automatically according to the TTL program.
Tv	Any sync speed 1/125 sec. or slower can be set manually.	The flash aperture is set automatically to match the sync speed you have set and the subject brightness.
Av	The sync speed is set automatically within a range of 30" to 1/125 sec. to match the flash aperture you have set and the subject brightness.	You set the flash aperture manually.
M	Any sync speed 1/125 sec. or slower can be set manually.	

-  Before attaching an EOS-dedicated Speedlite to the camera, push down the built-in flash if it is popped up.
 - When using the built-in flash, stay at least 1 meter away from the subject. Otherwise, part of the photo will look dark.
 - When using the built-in flash, detach any hood attached to the lens. A lens hood will partially obstruct the flash coverage.
 - If any of the following lenses is attached to the camera, the flash coverage of the built-in flash might be obstructed. Use an external, EOS-dedicated Speedlite with these lenses.
 - Fast lenses such as the EF 17-35mm f/2.8L USM and EF 28-70mm f/2.8L USM.
 - Super telephoto lenses such as the EF 300mm f/2.8L IS USM and EF 600mm f/4L IS USM.
 - The built-in flash's flash coverage is effective for lenses with a focal length of 28mm or longer. At focal lengths shorter than 28mm, the periphery of the photograph will look dark.
-
-  To retract the built-in flash, push it down.
 - If you set a sync speed faster than 1/125 sec. in the < **Tv** > or < **M** > mode, the sync speed will be set automatically to 1/125 sec.
 - When it is difficult to focus, the AF-assist light will be fired automatically. (→page 30)
 - The built-in flash and an external, EOS-dedicated Speedlite attached to the camera cannot be used at the same time.

Flash Exposure Compensation

You can set flash exposure compensation with the built-in flash or an external, EOS-dedicated Speedlite as easily as normal exposure compensation. The settable range is ± 2 stops in 1/2-stop increments.

- Flash exposure compensation works in the Creative Zone modes.

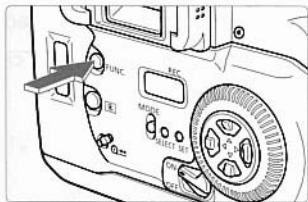

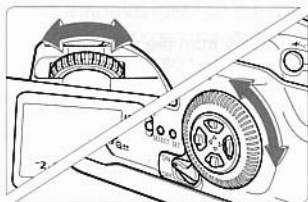
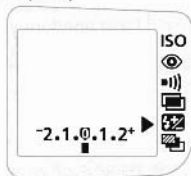

1 Move the arrow to the icon on the LCD panel.

- Press the <FUNC.> button to move the arrow. (ⓘ6)



2 Set the flash exposure compensation amount.

- Turn the  or  dial to set the amount.
- On the LCD panel, the plus side of the scale indicates overexposure and the minus side indicates underexposure.
- To check the flash exposure compensation amount that has been set, press the <FUNC.> button to display it on the LCD panel.
- The flash exposure compensation amount remains in effect even after the Command Dial is set to <OFF>.
- To cancel flash exposure compensation, set the amount back to .
- Press the shutter button halfway to return to normal camera operation.

Positive compensation

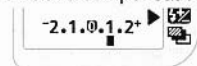

Negative compensation

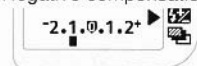

Flash Photography with an EX-Series Speedlite

With a Canon EX-Series Speedlite, flash photography is easy as using the built-in flash. You can also use the advanced features below.

- This section applies when Speedlite 420EX is attached to the camera.

• E-TTL Autoflash

With E-TTL autoflash (preflash evaluative metering), an optimum flash exposure is obtained for the subject in focus. In the aperture-priority AE mode, a slow sync speed is set automatically in low-light conditions to obtain a natural-looking, balanced exposure between the subject and background.

The image was removed due to copyright restrictions

• High-Speed Sync (FP Flash)

High-speed sync (FP or focal-plane flash) enables flash synchronization with all of the camera's shutter speeds from 30 sec. to 1/4000 sec.

• FE (Flash Exposure) Lock

FE lock obtains and locks the correct flash exposure for any part of the subject. This is the flash equivalent of AE lock.

• Flash exposure compensation

Like normal exposure compensation, flash exposure compensation can be used to set the flash output up to ± 2 stops in 1/2-stop increments.

• FEB (Flash Exposure Bracketing) (with 550EX or MR-14EX)

As with AEB (auto exposure bracketing), flash exposures can be bracketed up to ± 3 stops in 1/2-stop increments.

• E-TTL wireless autoflash with multiple Speedlites

With a master Speedlite (550EX, ST-E2, or MR-14EX) and the 420EX set as the slave unit(s), all the features listed above can be used for E-TTL wireless autoflash. Since no connecting cords are required, flexible and sophisticated lighting effects can be obtained.

• E-TTL is an abbreviation for Evaluative-Through-The-Lens.

- With autofocus, the flash exposure is always based on the aperture, and E-TTL autoflash metering is weighted at the active focusing point assumed to be covering the main subject.
- When it is difficult to autofocus, the Speedlite's AF-assist beam is emitted automatically.

Full Auto Flash

Full Auto E-TTL autoflash used in the <P> Program AE mode is explained below. For more details on using Speedlite 420EX, see the Speedlite 420EX instruction booklet.

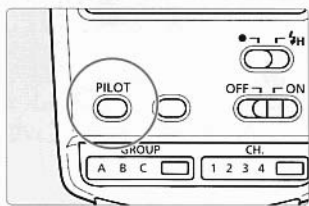

1 Set the Command Dial to <P>.

2 Check that the 420EX's pilot lamp is lit.

3 Focus the subject.



4 Take the picture.

- Make sure the flash-ready indicator <⚡> is lit, and check the shutter speed and aperture displays before taking the picture.

E-TTL Autoflash in Other Shooting Modes

Even in the <Tv>, <Av>, and <M> modes, E-TTL autoflash is as easy as normal picture-taking without flash.

(1) When you press the shutter button halfway, the camera sets the shutter speed and aperture.

Mode	Shutter Speed Setting	Flash Aperture Setting
Tv (Shutter speed-priority AE)	Manual (30 sec. - 1/125 sec.)	Auto
Av (Aperture-priority AE)	Auto (30 sec. - 1/125 sec.)	Manual
M (Manual)	Manual (30 sec. - 1/125 sec.)	Manual

(2) When you press the shutter button completely, preflash evaluative metering based on the aperture set in (1) is used for the E-TTL autoflash exposure.

(3) The background exposure is set by the shutter speed and aperture combination.



- About automatic reduction of flash output
If an EOS-dedicated Speedlite is used for a subject backlit by an overhead light, the flash output is reduced automatically to avoid having an unnatural-looking exposure. This is called automatic reduction of flash output.
- In the Basic Zone modes, flash photography is as easy as with the built-in flash.
- Using the <DEP> mode with flash gives the same result as the <P> mode.

High-Speed Sync (FP Flash)

When Speedlite 420EX is set to the high-speed sync mode <H>, it can synchronize at all shutter speeds, even those faster than 1/125 sec. When high-speed sync is enabled, <H> is displayed in the viewfinder.

High-speed sync is useful in the cases listed below.

- High-speed sync works in Creative Zone modes.

- (1) When you want to use fill flash for a portrait and maintain background blur with a large aperture.
- (2) When you want to create a catchlight in the subject's eyes.
- (3) When you want to use fill flash to eliminate shadows.



The image was removed due to copyright restrictions

With conventional flash.



The image was removed due to copyright restrictions

With FP flash.

* FE Lock

FE (flash exposure) lock obtains and locks the correct flash exposure reading for any part of the scene.

- FE lock works in Creative Zone modes.

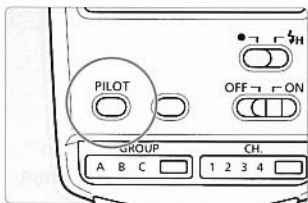

1 Check that the 420EX's pilot lamp is lit.

- The flash mode can be either normal or high-speed sync. FE lock works with either mode.

2 Focus the subject.

- Focus at the point where you want to lock the flash exposure.

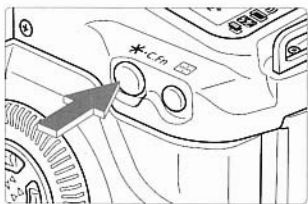

3 Aim the center focusing point where you want to lock the flash exposure, then press the < * > button. ($\phi 16$)

- The < * > icon lights in the viewfinder.
- The Speedlite fires a preflash and stores and locks the flash exposure reading in memory.
- In the viewfinder, the focusing point achieving FE lock flashes in red.
- Below the viewfinder, the display shown in ① appears for 0.5 sec. followed by the display shown by ②.
- Each time you press the < * > button, a preflash fires and the flash exposure reading is locked.

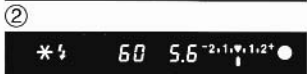



4 Take the picture.

- Compose the shot and take the picture.
- Normally, use the center focusing point for FE lock.

For this picture, the flash exposure was locked on the face and then the picture was recomposed. The subject was exposed correctly without being affected by the background reflection.

- ⓘ If the subject is too far away to obtain a correct flash exposure, the $\langle \frac{1}{2} \rangle$ icon will blink. Get closer to the subject and follow steps 2 and 3 again.

C.Fn C.Fn-8-1 enables FE lock with the user-selected focusing point. (→page 89)

Flash Exposure Compensation

Setting flash exposure compensation with the camera is described in “Flash Exposure Compensation” on page 76.

Flash exposure compensation can also be set with the following Speedlites: 550EX, 540EZ, 430EZ, and Macro Ring Lite MR-14EX.

- Flash exposure compensation can be set in the Creative Zone modes.

- ⓘ If flash exposure compensation is set with both the camera and external, EOS-dedicated Speedlite, the Speedlite's setting will override the camera's.

FEB (With 550EX or MR-14EX)

With Canon Speedlite 550EX or MR-14EX, three successive flash shots can be bracketed automatically up to ± 3 stops in 1/2-stop increments. The flash output changes for the three shots while the background exposure remains the same. This technique is called flash exposure bracketing.

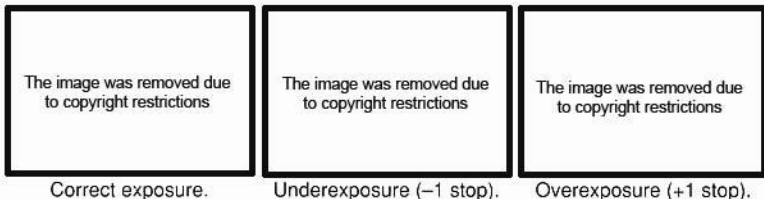

- Flash exposure bracketing is set with the Speedlite. For details, see the Speedlite's instruction booklet.
- Single-frame shooting $\langle \square \rangle$ is recommended with FEB.

Modeling Flash (With 550EX, 420EX or MR-14EX)

By firing a modeling flash, you can see the shadows and other flash lighting effects produced by multiple Speedlites in a wireless system.

- The modeling flash can be fired in the Creative Zone modes.

1 Make sure the camera and Speedlite are properly set for flash photography.

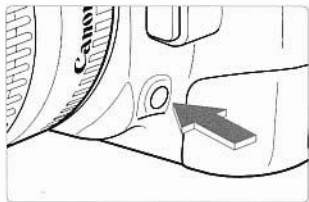

2 Press the camera's depth-of-field preview button.

- The Speedlite fires at 70 Hz for 1 second.

Wireless, Multi-Speedlite System

You can set up an E-TTL wireless autoflash system with a master unit (550EX, ST-E2, or MR-14EX) and slave units (420EX).

Set the 420EX's wireless selector to <SLAVE> to set it as a slave unit. Use the master unit as the main flash and the slave unit(s) as fill flash.

- For details, refer to the master and slave unit's instruction booklets.

Sample Setup for Wireless Flash

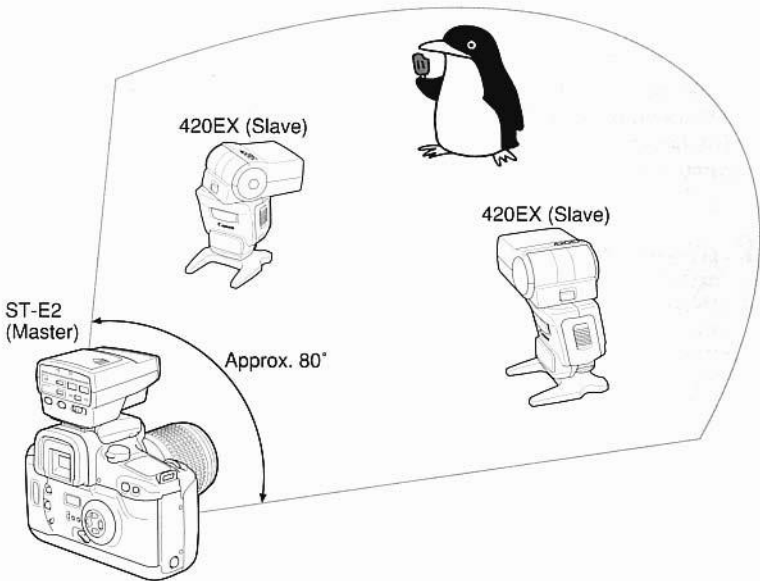

Using Other EOS-Dedicated Speedlites

With an EOS-dedicated Speedlite other than the EX series, TTL autoflash can be easily used like any AE mode.

The flash exposure is controlled by real-time, off-the-film flash metering linked to the focusing point.

- (1) When you press the shutter button halfway, the shutter speed and aperture are set automatically by the camera just like normal picture-taking without flash.

Mode	Shutter Speed Setting	Flash Aperture Setting
P (Program AE)	Auto (1/60 sec. - 1/125 sec.)	Auto
Tv (Shutter speed-priority AE)	Manual (30 sec. - 1/125 sec.)	Auto
Av (Aperture-priority AE)	Auto (30 sec. - 1/125 sec.)	Manual
M (Manual)	Manual (30 sec. - 1/125 sec.)	Manual

- (2) When you press the shutter button completely, TTL autoflash based on the aperture set in (1) is executed.
- (3) The background exposure is set by the shutter speed and aperture combination.



- In the Basic Zone modes, flash photography is as easy as with the built-in flash.
- Using the <DEP> mode with flash gives the same result as the <P> mode.
- Flash exposure compensation can also be set with the camera.
- If the multi-Speedlite system is wired with flash cords, TTL autoflash takes effect.
- When it is difficult to focus, the Speedlite's built-in AF-assist light will be emitted automatically.
- About automatic reduction of flash output

If an EOS-dedicated Speedlite is used for a subject backlit by an overhead light, the flash output is reduced automatically to avoid having an unnatural-looking exposure. This is called automatic reduction of flash output.



Custom Function Set

Custom Functions enable you to customize various camera features to suit your picture-taking preferences.

The **C.Fn** symbol in this booklet introduced the relevant Custom Function that is listed in this chapter.

Custom Functions

Custom Function settings are applied in the Creative Zone modes. They are not applied in the Basic Zone modes.

Setting a Custom Function

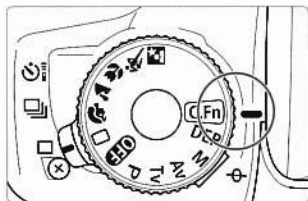

- 1 Turn the Command Dial to <C.Fn>.**
- The <C.Fn> icon and Custom Function No. are displayed on the LCD panel.

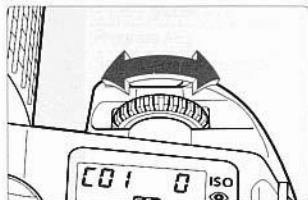

- 2 Select the Custom Function No.**
- Turn the <Fn> dial to select the Custom Function No.

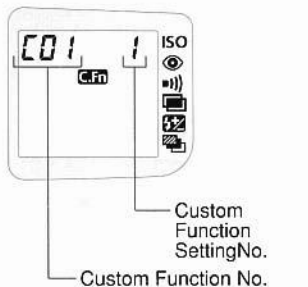

- 3 Set the Custom Function setting.**
- Press the <C.Fn> button.
 - The Custom Function setting changes each time you press the <C.Fn> button.

- 4 Turn the Command Dial to a setting other than <C.Fn>.**
- The <C.Fn> icon remains displayed on the LCD panel and the Custom Function setting is set.



"C.Fn" stands for Custom Function.

Canceling a Custom Function

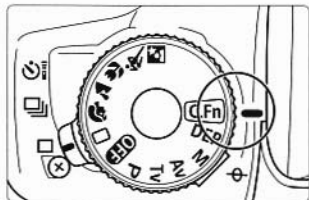

- 1 Turn the Command Dial to <C.Fn>.**
- The <C.Fn> icon and Custom Function No. are displayed on the LCD panel.

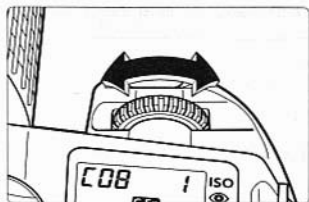

- 2 Select the Custom Function No. you want to cancel.**
- Turn the <C.Fn> dial to select the Custom Function No.

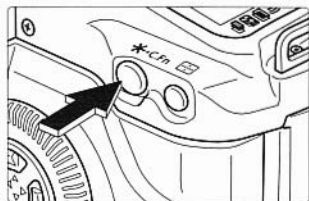









- 3 Set the setting to "0".**
- The Custom Function setting changes each time you press the <C.Fn> button.

- 4 Turn the Command Dial to a setting other than <C.Fn>.**
- The <C.Fn> icon turns off on the LCD panel and the Custom Function setting is canceled.
 - The <C.Fn> icon remains displayed on the LCD panel if another Custom Function has been set.

Custom Function List

C.Fn	Function	No.	
C.Fn-1	Film rewind speed	0	Low speed (silent)
		1	High speed
C.Fn-2	Film leader position after film rewind	0	Rewinds film leader into the cartridge.
		1	Leaves film leader outside the cartridge.
C.Fn-3	DX-coded film speed setting method	0	Enabled.
		1	Disabled.
C.Fn-4	Shutter button and < * > functions	0	AF start with shutter button pressed halfway and AE lock with < * > button.
		1	AF start with < * > button and AE lock with shutter button pressed halfway.
		2	AF start with shutter button pressed halfway and AF operation stopped with < * > button.
C.Fn-5	Mirror lockup	0	Disabled (Normal operation).
		1	Enabled.
C.Fn-6	Shutter curtain synchronization (with built-in and external flash)	0	1st-curtain sync (Normal operation)
		1	2nd-curtain sync
C.Fn-7	AF-assist light emission / Main flash firing	0	Built-in/external flash: Emits AF-assist/Fires main flash.
		1	Built-in/external flash: No AF-assist/Fires main flash.
		2	Built-in flash: No AF-assist/Fires main flash. External flash: AF-assist emitted/Fires main flash.
		3	Built-in/external flash: Emits AF-assist/No main flash.

C.Fn	Function	No.	
C.Fn-8	Partial metering linkage with focusing point/FE lock	0	Disabled (Partial metering and FE lock at center focusing point).
		1	Enabled.
C.Fn-9	Flash sync speed in aperture-priority AE mode	0	Set automatically.
		1	Set to 1/125 sec.
C.Fn-10	In-focus focusing point flashing	0	Enabled (superimposed).
		1	Disabled.
C.Fn-11	Focusing point selection method	0	<  > button + <  >
		1	<  > only. (Automatic selection with the <  > button.)
		2	<  > button + <  > <  >
C.Fn-12	Switch to center focusing point with the <  > button	0	Disabled.
		1	Enabled.
C.Fn-13	Lens AF stop button function	0	AF stop.
		1	AF start.
		2	AE lock during metering.
		3	Focusing point selection method switching (between automatic and manual).
		4	AF mode switching (between One-Shot AF and AI Servo AF)
		5	Start Image Stabilizer.

Basic Photography Terms

Exposure

Exposure occurs when the film is exposed to light. Correct exposure is obtained when the film is exposed to a proper amount of light in accordance with the film's sensitivity to light. The correct exposure is adjusted with the camera's shutter speed and aperture.

Shutter speed

The shutter speed is the length of time the camera's shutter opens to expose the film to the light coming through the lens. The shutter speed is displayed on the camera's LCD panel and in the viewfinder. It ranges from 30 sec. to 1/4000 sec. and bulb.

Aperture

The aperture setting (f-number) indicates the size of the aperture opening in the lens. It is used to adjust the amount of light striking the film. The aperture setting is displayed on the camera's LCD panel and in the viewfinder. It can range anywhere from 1.0 to 91, depending on the lens attached to the camera.

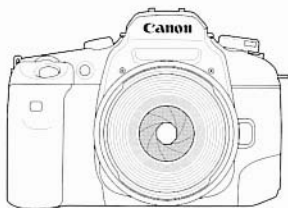

ISO film speed

The ISO film speed indicates the film's sensitivity to light. The higher the film speed, the more sensitive the film is. Therefore, ISO 400 and higher-speed films are suited for low-light conditions. The ISO film speed is set in accordance with standards set by the International Standardization Organization (ISO).

A film speed from 6 to 6400 can be set with the camera. The film speed is displayed on the LCD panel and in the viewfinder.

Depth of field

This is the range where acceptable focus can be achieved in front of and behind the point of optimum focus. The smaller the aperture (the larger the f-number), the deeper the depth of field. And the larger the aperture (the smaller the f-number), the shallower the depth of field.

The depth of field is affected as described below:

- (1) A smaller aperture (a larger f-number) increases the depth of field.
- (2) A longer distance between the camera and subject increases the depth of field.
- (3) When subject distance remains the same, a lens with a shorter focal length increases the depth of field.
- (4) The depth of field behind the point of optimum focus is longer than the depth of field in front of the point of optimum focus.

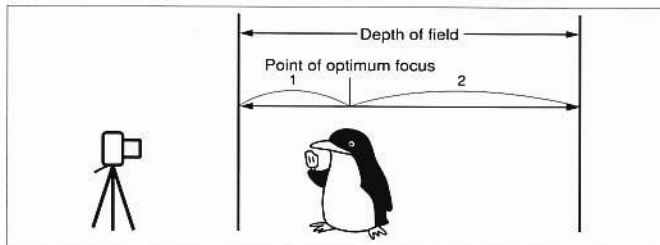

The image was removed due to copyright restrictions

Aperture set to $f/2$.

The image was removed due to copyright restrictions

Aperture set to $f/22$.

Feature Availability Table

Command Dial Mode	AF					Film Advance			Metering Mode		
	One-Shot	AI Servo	AI Focus	Focusing Point Selection		Single	Continuous	Self-timer	Evaluative	Partial	Centerweighted avg.
				Auto	Manual						
			●	●		●		○	●		
	●			●			●	○	●		
	●			●		●		○	●		
	●			●		●		○	●		
		●		●			●	○	●		
	●			●		●		○	●		
P	○	○	○	○	○	○	○	○	○	○	○
Tv	○	○	○	○	○	○	○	○	○	○	○
Av	○	○	○	○	○	○	○	○	○	○	○
DEP	●			○	○	○	○	○	○	○	○
M	○	○	○	○	○	○	○	○	○	○	○

- : Set automatically. ○ : User-selectable/settable.
- C.Fn can disable the AF-assist light.

AE Lock Effect (In Creative Zone modes)

Metering Mode		Focusing Point Selection Method	Manual Focusing Point Selection	Automatic Focusing Point Selection
Evaluative			AE lock is set at the selected focusing point.	AE lock is set at the focusing point which achieved focus.
Partial	With C.Fn-8-0		AE lock is set at the center focusing point.	AE lock is set at the center focusing point.
	With C.Fn-8-1		AE lock is set at the selected focusing point.*	
Centerweighted averaging			AE lock is set at the center focusing point.	

Built-in Flash			Exposure Compensation	AE Lock	FE Lock	Functions						Midroll Rewind	Custom Functions
Auto Firing	Manual Firing	AF-Assist				ISO Speed	Red-eye Reduction	Beeper	Multiple Exposures	Flash Exposure Compensation	AEB		
●		●					○	○				○	
●		●					○	○				○	
								○				○	
●		●					○	○				○	
								○				○	
●		●					○	○				○	
	○	●	○	○	○	○	○	○	○	○	○	○	○
	○	●	○	○	○	○	○	○	○	○	○	○	○
	○	●	○	○	○	○	○	○	○	○	○	○	○
	○	●	○	○	○	○	○	○	○	○	○	○	○

AF Mode and Film Advance Mode Combination

Film Advance Mode	One-Shot AF	AI Servo AF
<input type="checkbox"/> (Single)	The picture cannot be taken until focus is achieved. When focus is achieved, AF lock (focus lock) and AE lock (at the exposure setting obtained before the exposure) are applied.	Autofocus tracks the moving subject, and the exposure is set when the shutter is released.
<input type="checkbox"/> (Continuous)	The same conditions above apply during continuous shooting.	The same conditions above apply during continuous shooting.

- In the AI Focus AF mode, One-Shot AF or AI Servo AF is set automatically depending on the subject.

Reference

Program Line

The program line below applies when the camera is used in the <P> Program AE mode with an EF 28-90mm f/4-5.6 lens.

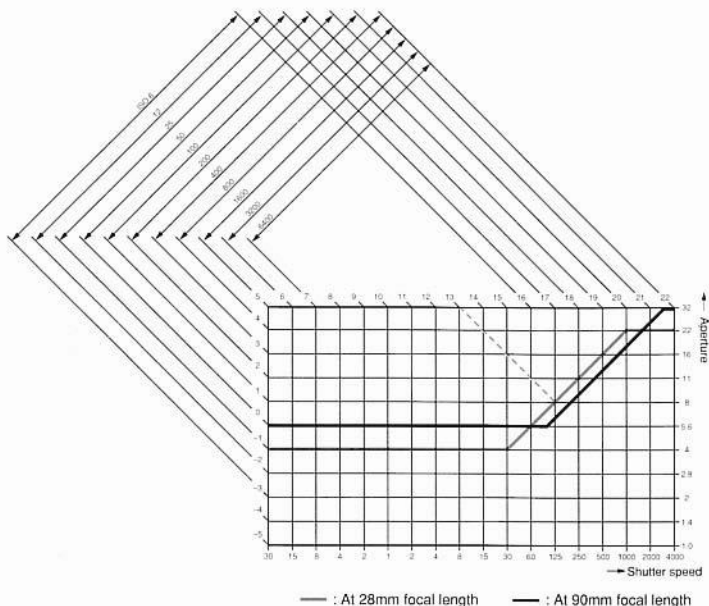

Program Line Description

The bottom horizontal axis represents the shutter speed and the right vertical axis represents the aperture. On the left edge and top edge of the graph, the Exposure Value (EV) is indicated for the respective shutter speed and aperture combination set by the Program AE mode and denoted by the program line.

Example: When the 28mm focal length is used and the subject brightness is EV 13, the point where the diagonal line from EV 13 (on the top edge of the graph) intersects the program line indicates the corresponding shutter speed (1/125 sec.) and aperture (f/8) which the program sets automatically. The arrowhead lines above the graph indicate the metering range for the respective film speed.

Exposure Warning List

Mode	Blinking Warning	Indication	Countermeasures
P		The subject is too dark.	Use flash.
		The subject is too bright.	Attach a neutral density filter to the lens.
Tv		The picture will be underexposed.	Turn the to set a slower shutter speed.
		The picture will be overexposed.	Turn the to set a faster shutter speed.
Av		The picture will be underexposed.	Turn the to set a larger aperture (smaller f-number).
		The picture will be overexposed.	Turn the to set a smaller aperture (larger f-number).
DEP		The desired depth of field cannot be obtained.	1) Move away from the subject and try again. 2) If a zoom lens is used, use the shortest focal length.
		The subject is too dark.	Use flash. The result will be the same as using the <P> mode.
		The subject is too bright.	Attach a neutral density (ND) filter to the lens.

 The sample warnings above apply when the lens used has a maximum aperture of f/4.0 and minimum aperture of f/22. The maximum and minimum aperture warning displays will differ depending on the lens attached to the camera.

Troubleshooting Guide

If there is a problem, try to resolve it by referring to this Troubleshooting Guide. If the problem still persists, take the camera to your nearest Canon Service Center.

<p>Nothing is displayed on the LCD panel.</p>	<p>The batteries are exhausted.</p> <ul style="list-style-type: none">▶ Replace the batteries with new ones. (→page 18, 19) <p>The batteries have been installed incorrectly.</p> <ul style="list-style-type: none">▶ Install the batteries correctly. (→page 18)
<p>The picture looks blurred.</p>	<p>The lens focus mode is set to <MF> (or <M>).</p> <ul style="list-style-type: none">▶ Set the lens focus mode to <AF> (or <A>). (→page 20) <p>There was camera shake when the picture was taken.</p> <ul style="list-style-type: none">▶ Hold the camera steady or use a faster shutter speed. (→page 22)
<p>The shutter does not work.</p>	<p>The <@> icon blinks on the LCD panel.</p> <ul style="list-style-type: none">▶ Take out the film and load it correctly. (→page 23) <p>The <⏏> icon blinks on the LCD panel.</p> <ul style="list-style-type: none">▶ Replace the batteries with new ones. (→page 18) <p>The <@> icon blinks while the rewind film is still in the camera.</p> <ul style="list-style-type: none">▶ Replace with a new roll of film. (→page 23) <p>The in-focus indicator in the viewfinder blinks and focus cannot be achieved.</p> <ul style="list-style-type: none">▶ Select another focusing point. (→page 45) If focus still cannot be achieved, focus manually. (→page 48)
<p>The <⏏> icon blinks on the LCD panel.</p>	<p>The battery level is very low.</p> <ul style="list-style-type: none">▶ Replace the batteries with new ones. (→page 18) <p>A misoperation has occurred.</p> <ul style="list-style-type: none">▶ Press the shutter button halfway. (→page 22)▶ Remove and reload the batteries. (→page 19) If the <⏏> icon stops blinking, picture-taking is possible. <p>If it is still blinking, consult your nearest Canon Service Center.</p>

Major Accessories



- **Battery Pack BP-300**

The vertical grip has its own shutter button and AE/FE lock button. It houses four size-AA batteries (alkaline, Ni-Cd, or nickel hydride). Two CR123A batteries to power the camera can also be used.



- **EX-series Speedlites 550EX, 420EX, and 220EX**

Three EOS-dedicated, E-TTL autofocus Speedlites are available. The 550EX with an autozoom head can provide a large flash output, the 420EX for affordable high performance, and the 220EX for compactness. The respective maximum Guide No. (at ISO 100 in meters) are 55, 42, and 22. All three Speedlites also enable high-speed sync (FP flash), and FE lock. With the 550EX and 420EX, E-TTL wireless autofocus with multiple Speedlites is possible.



- **Macro Ring Lite MR-14EX**

EOS-dedicated macro ring flash featuring Guide No. 14 (at ISO 100 in meters), twin flash tubes, and E-TTL autofocus. You can fire only one or both flash tubes and control the flash ratio between the two flash tubes. High-speed sync (FP flash) and FE lock are also possible. Sophisticated macro lighting effects can be obtained and operation is simple. The MR-14EX can also be used as the master unit in a wireless, multi-Speedlite system (with the 550EX or 420EX as slave units).



- **Remote Switch RS-60E3**

Wired remote switch for pressing the shutter button. It connects to the camera's remote control terminal and prevents camera shake during close-up shots, bulb exposures, etc.



- **Remote Controller RC-1**

Wireless remote controller for pressing the shutter button. Convenient for self-timer shots, close-up shots, bulb exposures, etc.



- **Camera Case EH14-L**

Dedicated, semi-hard case which can accommodate the camera attached with the EF 28-90mm f/4-5.6 (USM) lens.

Major Specifications

• Type

Type 35mm AF/AE single-lens reflex camera with focal-plane shutter and built-in motor drive, flash, and auto date back.

Picture size 24 mm x 36 mm

Compatible lenses Canon EF lenses

Lens mount Canon EF mount (electronic control)

• Viewfinder

Type Eye-level pentaprism

Picture coverage 90% vertical and 92% horizontal coverage

Eye Relief 19.5 mm

Magnification 0.70x (-1 diopter with 50mm lens at infinity)

Standard diopter -1 diopter

Dioptric Adjustment Built-in range of -2.5 - +0.5 dpt

Focusing screen Fixed, New Laser-matte focusing screen with focusing points

Mirror Quick-return half mirror (Transmission:reflection ratio of 40:60).
(No vignetting with EF 600mm f/4L IS USM or shorter lens.)

Viewfinder information (1) On the screen: Focusing points
(2) Below the screen: Shutter speed, aperture (FEL, DEP, END), AE/FE lock, exposure level (AE exposure compensation amount, flash exposure compensation amount, manual exposure level, AEB range, red-eye reduction lamp ON indicator), flash-ready indicator, FE lock underexposure warning, high-speed sync (FP flash), flash exposure compensation icon, AF/MF in-focus indicator

Depth-of-field Preview Depth-of-field preview button provided.

• Exposure Control

Metering modes TTL max. aperture metering with a 35-zone silicon photocell.

(1) Evaluative metering (linked to all focusing points)

(2) Partial metering (approx. 10% of viewfinder area at center)

(3) Centerweighted averaging metering

Exposure Control Methods (1) Program AE (shiftable)

(2) Shutter speed-priority AE

(3) Aperture-priority AE

(4) Depth-of-field AE (non-shiftable)

(5) Full Auto (non-shiftable)

(6) Programmed Image Control modes

Portrait, Landscape, Closeup, Sports, Night Scene

(7) E-TTL program flash AE

(8) A-TTL program flash AE

(9) TTL program flash AE

(10) Manual exposure

(11) Bulb

Metering range EV 1-20 (at 20°C with 50mm f/1.4 lens, at ISO 100)

Film speed range ISO 6-6400 (Set automatically with DX-coded film at ISO 25-5000.)

Exposure compensation (1) Manual exposure compensation: ± 2 stops in 1/2-stop increments.

(2) AEB: ± 2 stops in 1/2-stop increments (Correct exposure, underexposure, and overexposure sequence).

Reference

- AE lock(1) Auto AE lock
In One-Shot AF mode, AE lock applied when focus is achieved.
(2) Manual AE lock
Enabled in all metering modes with AE lock button.
- Multiple exposuresMax. 9 multiple exposures (cancelable and resettable anytime).
Cancels automatically after all multiple exposures are taken.
- Camera shake warningIn the Basic Zone modes, if the shutter speed set automatically is slower than the reciprocal of the lens focal length, the shutter speed display blinks at 2 Hz.

• Autofocus

- TypeTTL-SIR with a CMOS sensor
- Focusing points7
- AF working rangeEV 1-18 (at ISO 100)
- Focusing modes(1) One-Shot AF
Autofocus stops and locks when focus is achieved.
(2) AI Servo AF
Focuses the moving subject continuously up to the start of exposure. When focus is achieved, the in-focus indicator does not light (blinks at 2 Hz only if AF fails) and the beeper does not sound.
(3) AI Focus AF
Switches automatically between One-Shot AF and AI Servo AF to suit the subject.
(4) Manual focusing
Enabled with the focusing ring when the lens focus mode is set to MF (or M).
- In-focus indicator(1) Flashing (disabled with C.Fn-10-1) focusing point superimposed in viewfinder.
(2) In-focus indicator in viewfinder.
(3) Beeper sounds (can be disabled).
- Focusing point selection(1) Automatic selection: Camera-selected.
(2) Manual selection: One of 7 focusing points user-selected with focusing point selector and focusing point selection keys. (Selection operation modifiable with C.Fn-11-1/2.)
- Selected focusing point indicator..Superimposed in viewfinder and displayed on LCD panel.
- AF-assist lightBuilt-in flash fires intermittent burst automatically (disabled with C.Fn-7).
Effective range: Approx. 4.5 meters at center, Approx. 4 meters at periphery.

• Shutter

- TypeVertical-travel, focal-plane shutter with all speeds electronically controlled.
- Shutter speeds30 sec. to 1/4000 sec. in 1/2-stops, bulb, X-sync at 1/125 sec.
- Shutter releaseSoft-touch electromagnetic release.
- Self-timerElectronically-controlled with 10-sec. delay.

• Film Transport

Film loading	Automatic advance to frame 1.
Film advance	Automatic film advance with built-in motor. (1) Single (2) Continuous (approx. 4 fps max.).
Film rewind	Automatic at the end of the roll. (Silent or high-speed rewind enabled with C.Fn-1.) (Rewind speed switchable with midroll rewind button during rewind.)
Film rewind time and noise with 24-ex. film (36-ex. film)	Silent mode: Approx. 13 (18) sec. / Approx. 48 dB High-speed mode: Approx. 5 (8) sec. / Approx. 55 dB

• Built-in Flash

Type	Retractable TTL automatic flash (serially controlled) on pentaprism with auto pop-up and focusing point-linked, 3-zone autofocus metering.
Guide No.	Guide No. 13 (at ISO 100 in meters)
Recycling time	Approx. 2 sec.
Flash coverage	28mm lens focal length.
Firing preconditions	(1) Automatic pop-up and firing in low-light or backlit conditions in the Full Auto, Portrait, Closeup, and Night Scene. (2) In Creative Zone modes Manual pop-up and firing.
Flash exposure compensation	±2 stops in 1/2-stop increments.

• Date and Time Imprinting (QD Model only)

Type	Quartz clock with built-in auto calendar and liquid-crystal display.
Time span	Jan. 1, 1994 to Dec. 31, 2019, 0:00 to 23:59
Imprinting format	(1) Month, day, year (2) Day, month, year (3) Year, month, day (4) Day, hour, minute (5) Blank
Power source	One CR2025 lithium battery

• Other Specifications

Flash contacts	X-sync on hot shoe.
Speedlite compatibility	Compatible with E-TTL/A-TTL/TTL autofocus.
Custom Functions	13 Custom Functions (C.Fn-1 to C.Fn-13) with 34 settings
Remote control	(1) Wired remote control with RS-60E3. (2) Wireless remote control with RC-1.
Power source	Two CR123A (or DL123A) lithium batteries
Battery service life	(→page 19)
Battery check	One of four battery levels is displayed when the Command Dial is released from OFF.
Dimensions	146.7 (W) x 103 (H) x 69 (D) mm 5.78 (W) x 4.06 (H) x 2.72 (D) in.
Weight	575 g / 20.3 oz (body only, excluding batteries) Non-QD model: 570 g / 20.1 oz (body only, excluding batteries)

- All performance specifications are based on Canon's standard tests and measurements.
- All specifications are subject to change without notice.



A

Accessories	97
<  > AEB	65
AE lock	63
- effects of	92
- with < * >	63
AF	
- when AF fails	48
automatic focusing point selection	45
manual focusing point selection	45
AF modes	
- AF mode dial	15
- and film advance modes	93
- selection procedure	42
AI Focus AF	44
AI Servo AF	43
aperture	90
< Av > Aperture-priority AE	56
automatic focusing point selection	45

B

Basic Zone modes	14
batteries	
- installing	18
- level check	19
replacing quartz date battery	40
built-in flash	74
- automatic firing	30
- effective range	74
- firing AF-assist light	30
- using	74
bulb exposure	67



C

<  > Centerweighted averaging	49
<  > Closeup mode	34
Command Dial	14
<  > continuous shooting	71
conventions used in the instructions	16
Creative Zone modes	14
Custom Functions	85
- setting procedure	86
- canceling	87
- list	88



D

date and time	
- imprinting	39
- setting	40
<  > Depth-of-field AE	60
depth of field	91
- preview	57
dioptric adjustment	21

E

E-TTL autoflash	78
<  > Evaluative metering	49
exposure	90
- warnings	95
< * > AE lock	63
<  > auto exposure bracketing	65
<  > multiple exposures	68
< M > manual exposure	58
exposure compensation	64
eyecup	21
eyepiece cover	38

F

Feature Availability Table	92
FEB	82
< * > FE lock	80
film	
- checking	24
- < ISO > setting the ISO speed manually	71
- ISO speed	90
- loading	23
- <  > Midroll rewind	25
- unloading	25
battery service life	19
film advance mode	
- lever	15
- selecting	71
flash	
- sync speeds and aperture	75
- using flash	73
<  > Flash exposure compensation	76,81
flash and Full Auto mode	78
flash and picture-taking modes	78

- focusing
- < DEP > Depth-of-field AE60
 - off-center subjects47
 - < AF > Manual focusing48
- focusing points
- selection procedure45
 - selecting with < AF >45
- FP flash79
- < □ > Full Auto mode28
- H**
- < 1/8 > High-speed sync (FP flash)79
- Holding the Camera26
- I**
- < ISO > setting the film speed manually71
- L**
- < L > Landscape mode33
- LCD panel12
- lens
- detaching20
 - mounting20
- lock, Command Dial14
- M**
- < M > Manual exposure58
- < MF > Manual focus48
- manual focusing48
- manual focusing point selection45
- metering modes
- < □ > Centerweighted averaging49
 - < [] > Evaluative49
 - < [] > Partial49
 - < [] > selection of49
- mirror lockup70
- modeling flash82
- < [] > Multiple exposures68
- N**
- < [] > Night Scene mode36
- Nomenclature10
- O**
- One-Shot AF42
- P**
- < P > Program AE52
- < P > and < □ > (Full Auto) differences53
- < [] > Partial metering49
- < [] > Portrait mode32
- predictive AF44
- program line94
- program shift53
- Programmed Image Control Zone14
- R**
- < [] > Red-eye reduction30
- Remote Switch72
- S**
- shutter button22
- complete pressing22
 - halfway pressing22
- shutter speed90
- < Tv > Shutter speed-priority AE54
- < [] > silencing the beeper69
- < □ > Single-frame shooting71
- strap, attaching17
- T**
- < [] > Self-timer37
- < Tv > Shutter speed-priority AE54
- specifications99
- < [] > Sports mode35
- V**
- viewfinder
- information13
 - dioptric adjustment21
- W**
- wireless, multi-Speedlite flash83
- < [] > wireless remote control72

This device complies with Part 15 of the FCC Rules. Operation is subject to the following two conditions: (1) This device may not cause harmful interference, and (2) this device must accept any interference received, including interference that may cause undesired operation.

Do not make any changes or modifications to the equipment unless otherwise specified in the instructions. If such changes or modifications should be made, you could be required to stop operation of the equipment.

This equipment has been tested and found to comply with the limits for a class B digital device, pursuant to part 15 of the FCC Rules. These limits are designed to provide reasonable protection against harmful interference in a residential installation. This equipment generates, uses and can radiate radio frequency energy and, if not installed and used in accordance with the instructions, may cause harmful interference to radio communications.

However, there is no guarantee that interference will not occur in a particular installation. If this equipment does cause harmful interference to radio or television reception, which can be determined by turning the equipment off and on, the user is encouraged to try to correct the interference by one or more of the following measures:

- Reorient or relocate the receiving antenna.
- Increase the separation between the equipment and receiver.
- Consult the dealer or an experienced radio/TV technician for help.

This digital apparatus does not exceed the Class B limits for radio noise emissions from digital apparatus as set out in the interference-causing equipment standard entitled "Digital Apparatus", ICES-003 of the Industry Canada.



The CE Mark is a Directive conformity mark of the European Community (EC)

Canon

Company information that is no longer current has been removed. If you have any questions regarding this model and are calling from the USA, please call 1 800 OK CANON.