

Canon EOS *ELAN*



E

English Edition

INSTRUCTIONS

Introduction

Thank you for selecting a Canon EOS camera. The EOS ELAN is an autofocus SLR camera incorporating advanced functions designed for ease of use, and features a silent drive mechanism to make it the quietest camera in EOS series. Moreover, the EOS ELAN allows input of up to five bar-code programs from the Bar Code Book containing sample photographs and corresponding bar codes for setting optimum shooting data. Incorporating the latest EOS technology, the EOS ELAN is packed with features including a built-in auto zoom flash with automatic flash coverage for 28mm wide-angle lenses and twin electronic input dials for superior operability. Particularly beneficial is the EOS ELAN's silent operation which allows you to take pictures in situations normally avoided with other cameras due to their distracting operation noise.

- * The explanations in this instruction book assume use of the camera with the EF 28-80mm f/3.5-5.6 USM zoom lens attached. However, operation is basically the same for any EF lens.

Features

1. Silent drive mechanism provides quiet film winding and rewinding.
2. Bar-code system allows input of up to five bar-code programs for setting optimum shooting data.
3. Auto zoom flash automatically adjusts the flash coverage angle according to the lens focal length (28mm, 50mm, 80mm).
4. Twin electronic input dials for quick, efficient camera operation.

5. Cross-type BASIS AF sensor and AF auxiliary light for sure focusing even with low-contrast subjects.
6. Command dial "image zone" provides simple, fully automatic operation.

Attention

IMPORTANT INFORMATION

The Canon EOS ELAN will give optimum performance together with specially designed Canon EF lenses, flash units and other Canon brand accessories. It is possible that the use of incompatible lenses or other accessories may result in unsatisfactory performance or damage to your camera. We therefore suggest the use of Canon EF lenses and accessories. Damage to your Canon camera as a result of malfunction or improper connections caused by the use of incompatible products may void its warranty.

Please read these instructions carefully for a thorough understanding before taking pictures.

Nomenclature

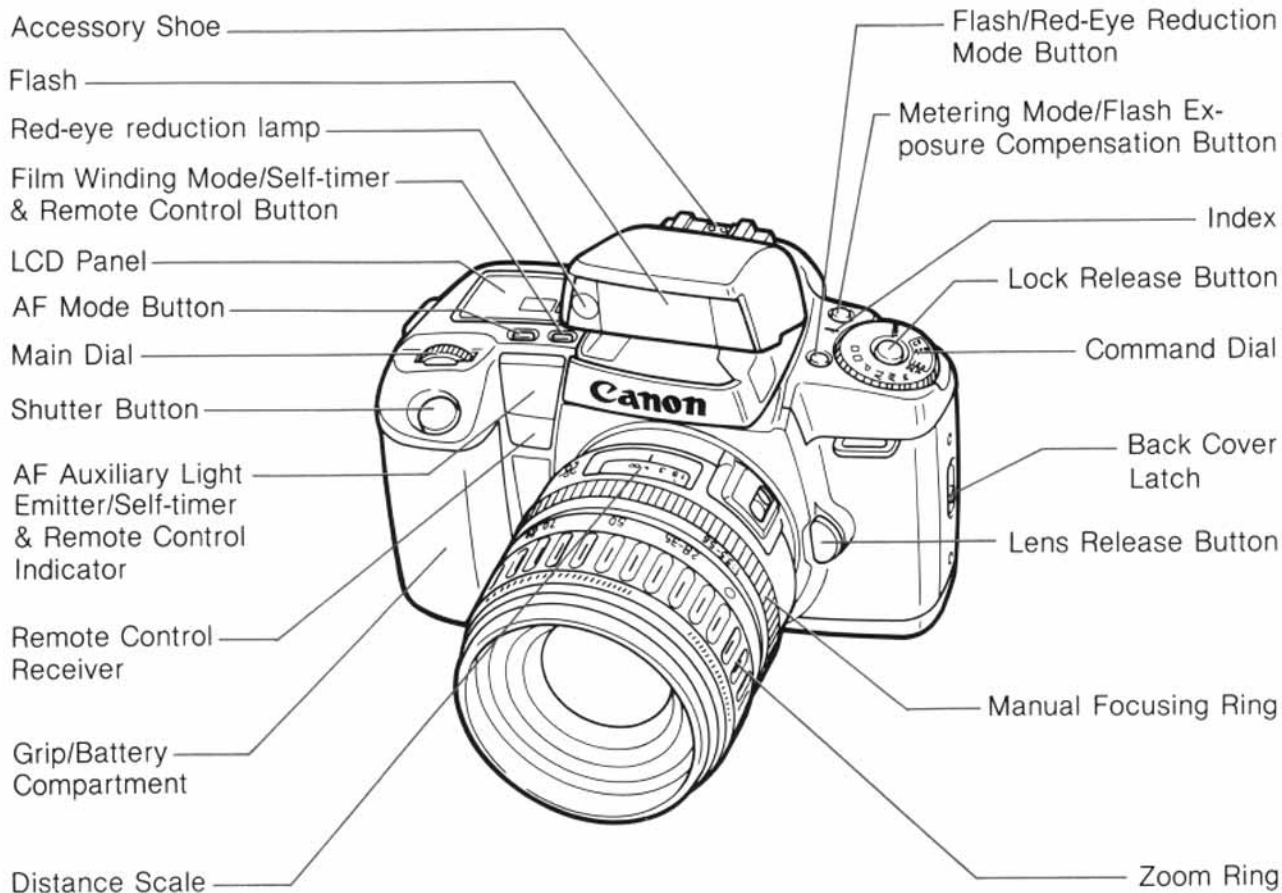

Nomenclature

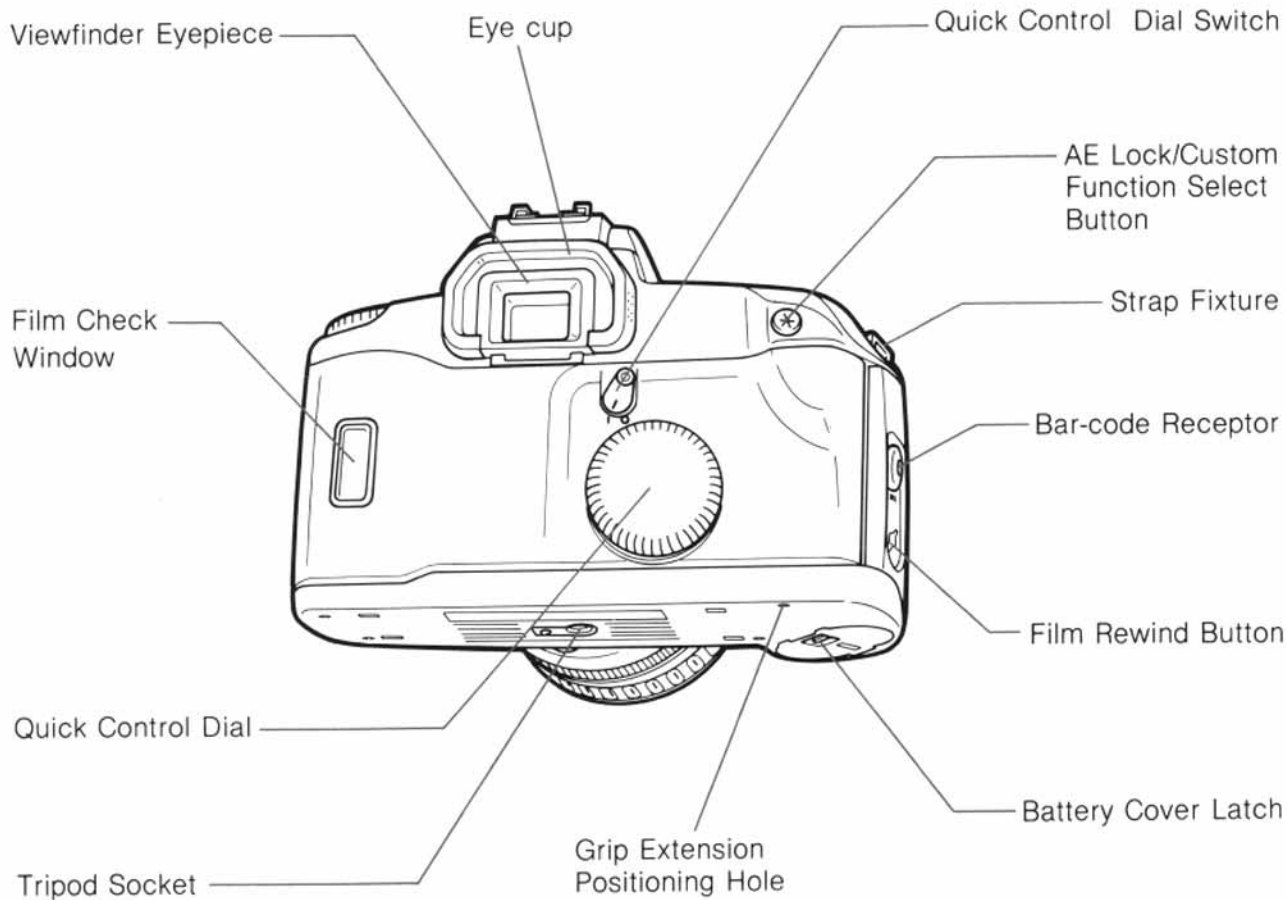

Command Dial

Creative Zone

- P : Program AE
- Tv : Shutter-priority AE
- Av : Aperture-priority AE
- M : Manual Exposure
- DEP: Depth-of-Field AE
- ISO : Film Speed Setting
-  : Multiple Exposures
- AEB: Auto Exposure Bracketing
- CF : Custom Function Setting

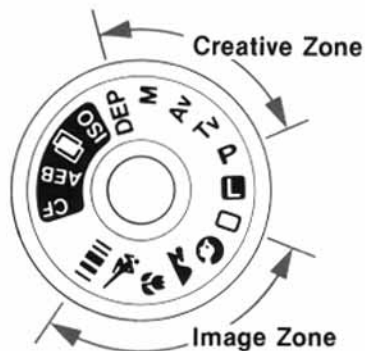

Image Zone

-  : Full Auto
-  : Portrait
-  : Landscape
-  : Close-up
-  : Sports
-  : Bar-code program

Display Panel

The EOS ELAN uses a large liquid crystal display panel to display shooting information. The diagram below shows all the information displayed simultaneously for explanation only. The LCD panel never actually appears like this.

- Shutter speed
- ISO film speed value
- dEP (Depth-of-field AE) indicator
- Bar-code Program No.
- Custom Function No.

- ISO indicator
- Bar-code mode indicator

- Film winding mode indicator
 - Single exposure
 - Continuous exposure
 - Self-timer/remote control

- Battery check indicator

- Metering mode indicator
 - Evaluative metering
 - Partial metering
 - Center-weighted average metering

- Film condition indicator
- Film-load check
- Film rewind completion

- Aperture value
- AEB step amount
- dEP point number
- Custom function setting

- Frame counter
- No. of preset multiple exposures
- No. of completed multiple exposures



- Custom function mode indicator
- Multiple exposure mode indicator
- Red-eye reduction mode indicator
- Auto exposure bracketing mode indicator
- Flash exposure compensation mode indicator
- Beeper mode indicator

- Exposure indicator
- Exposure compensation amount
- AEB step amount
- Flash exposure compensation amount
- Red-eye reduction lamp operation

- Manual exposure display

- Focus mode indicator
 - One-shot AF
 - AI Servo AF
 - Manual focus (all AF indicators extinguished)

- A minute amount of battery power is used for the display even when the command dial is set to L.

Viewfinder Information

The illustration shows all indicators lit for explanation purposes only. Only necessary information is displayed during actual use.

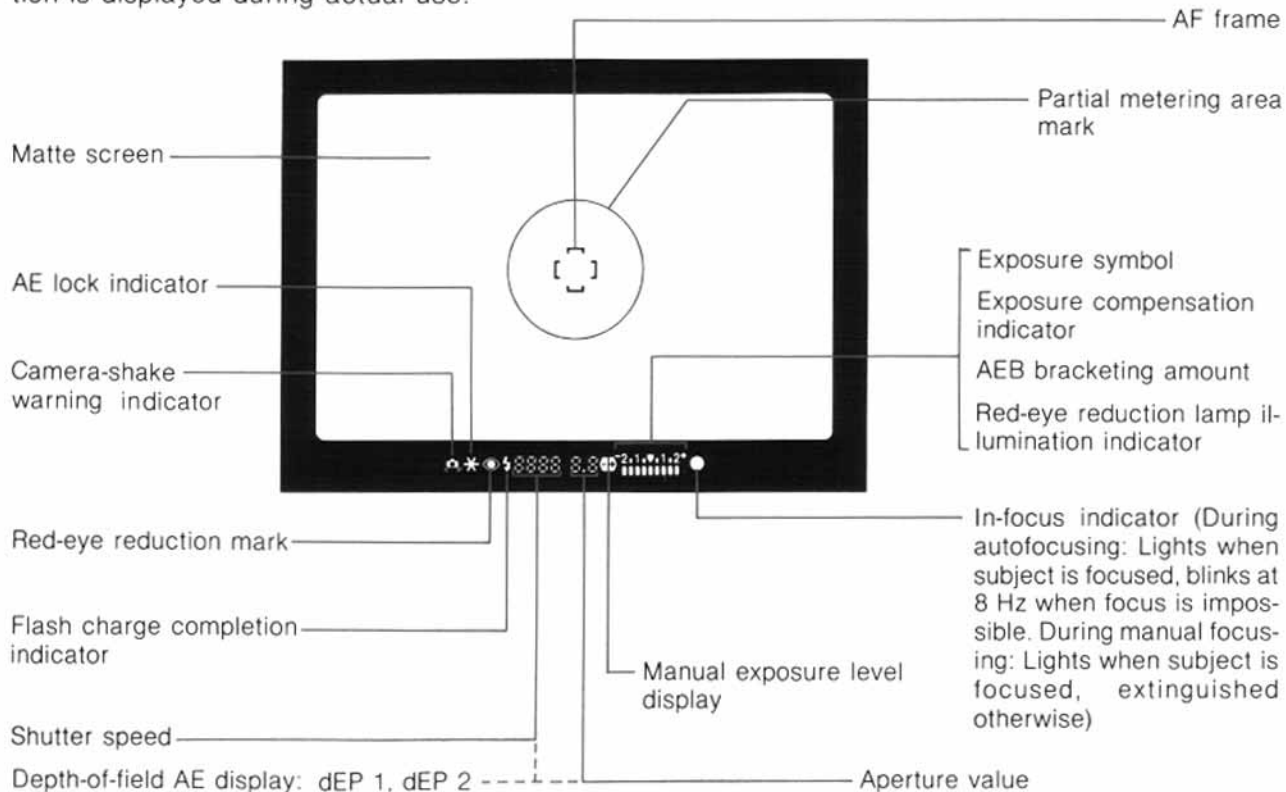







Table of Contents



Precautions	8
-------------------	---

I Basic Operation

[1] Preparations	10
1. Battery Loading and Check	10
2. Lens Attachment	12
3. Shutter Button Action and Focusing	14
4. Film Loading and Rewind	17
[2] Taking Pictures Using Image Zone	
Shooting Modes	20
1.  (Full Auto)	20
2.  (Portrait)	22
3.  (Landscape)	22
4.  (Close-up)	23
5.  (Sports)	23
6.  (Bar-code program)	24

II Advanced Operation

[1] Changing the Basic Functions	28
1. Selecting the Focusing Mode	28
1) One-shot AF	28
2) AI Servo AF	29
3) Manual Focusing	30

2. Selecting the Film Winding Mode	31
1)  (Single exposure)	31
2)  (Continuous exposure)	31
3)  (Self-timer/Remote control)	31
3. Selecting the Metering Mode	32
4. Using the Built-in Flash	33
5. Self-timer Function	36
Use of the Eyepiece Cover	37
[2] Taking Pictures Using Creative Zone	
Shooting Modes	38
1. P (Program AE)	38
2. Tv (Shutter-priority AE)	40
3. Av (Aperture-priority AE)	42
4. M (Manual exposure)	44
5. DEP (Depth-of-field AE)	46

III Useful Functions

1. AE Lock	50
2. Exposure Compensation	51
3. Built-in Flash Exposure Compensation	52
4. AEB (Auto Exposure Bracketing)	53
5.  (Multiple Exposure)	56
6. Bulb (Long Exposure) Operation	58
7. Manual Film Speed Setting	60
8. Custom Function Control	61

IV Reference

1. Exposure Warnings	64
2. Program Line Characteristics	66
3. Function Combination Charts	68
1) Programmed Image Control Functions	68
2) AF and Film Winding Modes	68
4. Accessories	69
■ Dedicated Canon Speedlites	69
■ Remote Controller RC-1	70
■ Grip Extension GR-70	70
■ Lens Hoods and Filters	70

■ Dioptic Adjustment Lenses	71
■ Cases	71

CAMERA CARE	72
■ Cleaning	72
■ Liquid Crystal Display/Battery Notes	72

Specifications	74
----------------	----

Precautions

- 1) **This camera is not resistant to water** and should not be used outdoors in snow or rain. If accidentally dropped in water, contact an authorized Canon service facility. Keep the camera out of salt spray, and protect it from excessive humidity. If used at the beach, clean it thoroughly afterward with a dry cloth.
 - 2) Do not attempt to disassemble the camera yourself. Always take it to an authorized Canon service facility for repair.
 - 3) Remove the battery if you do not expect to use the camera for about three weeks or longer.
 - 4) When storing the camera, wrap it in a clean, soft cloth and place in a cool, dry, dust-free place. Be sure to keep the camera out of direct sunlight, and away from "hot spots" such as the trunk or rear window shelf of a car. Avoid places where moth balls are used, and in extreme humidity, use a desiccant.
 - 5) Carefully check the camera's operation after lengthy storage.
 - 6) The battery may explode or cause burns if disassembled, recharged, shorted, exposed to high temperatures, or disposed of in fire.
 - 7) Film passing through X-ray examinations at airports may be exposed and ruined even if loaded in the camera. Request a hand-checked inspection to avoid damage.
 - 8) Aerosol spray dust removers are not recommended for the shutter curtain.
 - 9) Condensation is a problem when bringing cold equipment into a warm room. If the autofocus optics cloud over, accuracy may be seriously affected. Before entering a warm room, put equipment in a plastic bag so condensation forms on the outside of the bag.
 - 10) Color reproduction may be adversely affected if the film is left in the camera for a long time. **Always develop exposed film promptly.**
- * Please see page 72 for camera care information.

I Basic Operation

This section explains basic shooting preparations such as battery and film loading as well as simple picture taking operation using fully automatic shooting modes.

Attaching the Neckstrap

Thread the strap through the fixtures as shown in the illustration.

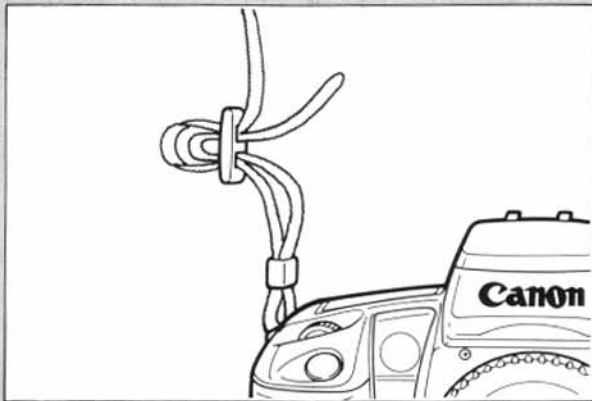

Command Dial

Release the command dial lock (L position) by turning the dial while pressing the center lock release button.

"L" is the lock (off) position, the positions from □ to ■■■■ are image zone modes, and the positions from "P" to "DEP" are creative zone modes. Turn the dial until the desired mode matches up with the index mark.

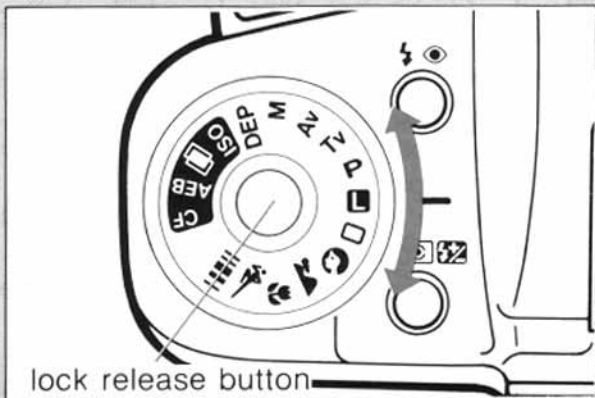

[1] Preparations

1. Battery Loading and Check

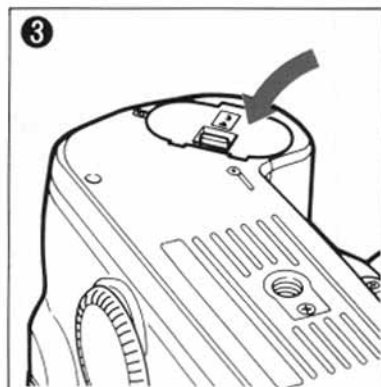
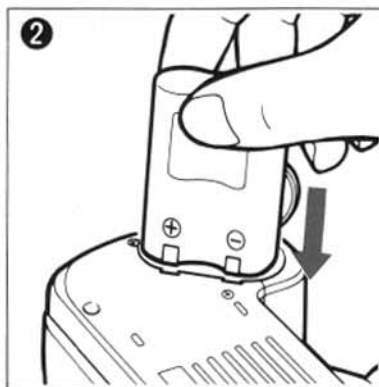
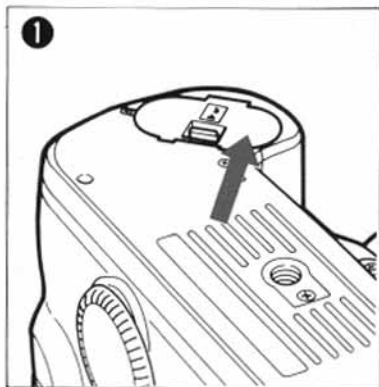

This camera uses a single 6V lithium battery (2CR5). Load the battery as follows.

- 1) Slide the battery cover latch to open the battery compartment.
- 2) Insert the battery so that its terminals enter the camera first.
- 3) Close the battery compartment until the battery cover latch locks.

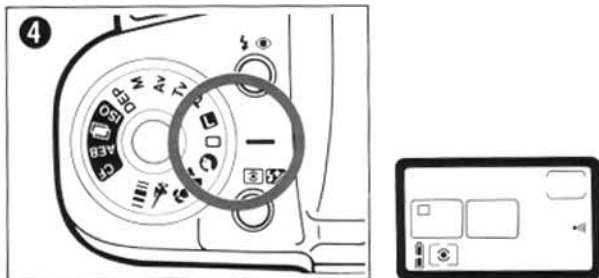

4) Press the lock release button and turn the command dial to □. Check the battery indicator displayed in the LCD panel.

If the entire battery indicator () is displayed, the battery is in good condition.

- * If nothing at all is displayed in the LCD panel, the battery may be inserted backwards. Remove the battery and reinsert it correctly.
- * When not using the camera, set the command dial to "L" to prevent unnecessary battery depletion or accidental picture taking.



When the battery indicator is only half full, have a new battery handy.



When the battery indicator is empty, replace the battery with a new one.



If the empty battery indicator is blinking, refer to page 73.

• Battery Life (Number of film rolls)

Temperature	Flash not used	50% flash use	100% flash use
Normal (+ 20°C/68°F)	100 rolls	30 rolls	15 rolls
Low (- 20°C/- 4°F)	28 rolls	13 rolls	7 rolls

- * Using a new battery, EF 28-80mm f/3.5-5.6 USM lens and 24-exposure film.
- * Stated values include camera operation when no film is loaded.
- * Data based on Canon's Standard Test Method.

2. Lens Attachment

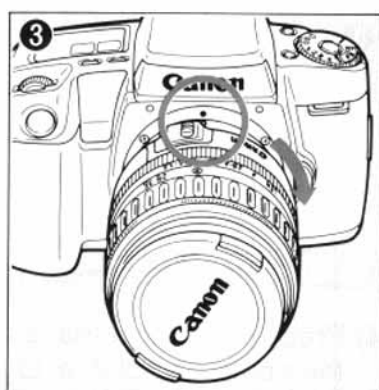
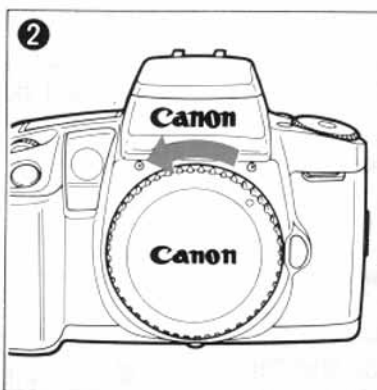
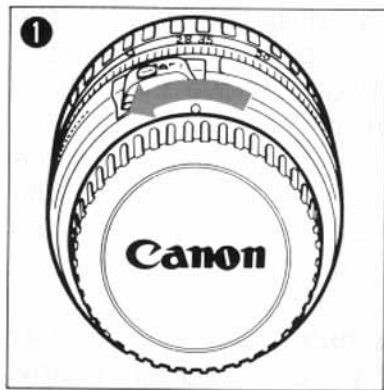

- 1) Remove the rear lens cap by turning counterclockwise.
- 2) Remove the camera body cap by turning counterclockwise.

The lens may already be mounted on the camera when purchased.

- 3) Align the red dots on the lens and camera body, then rotate the lens clockwise until it locks in place with a click.
* To remove the lens, press the lens release button while turning the lens counterclockwise.

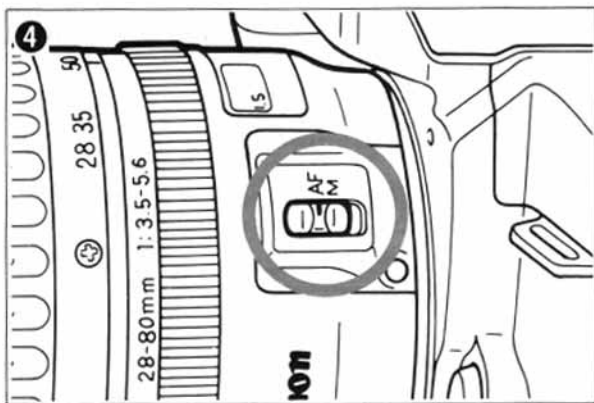

- 4) Set the lens' focus mode switch to AF.
- * Autofocusing is impossible when the switch is set to M.
 - * Do not touch the rotating part of the lens during autofocusing.

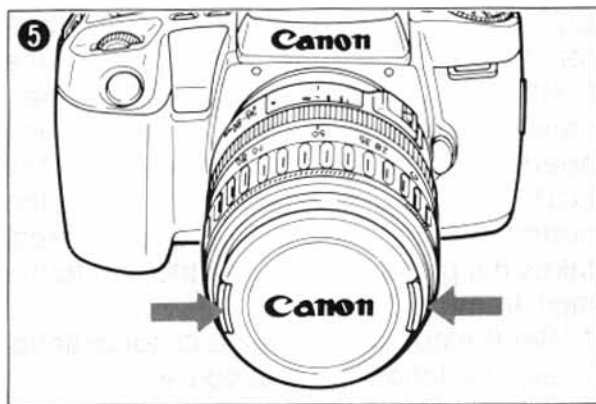

- 5) Remove the lens cap.
- * When the lens is removed from the camera, place it face down on a stable surface to prevent damage to the lens surface and electronic contacts.

3. Shutter Button Action and Focusing

EOS cameras use a two-step shutter button. Pressing the button "halfway" (to the first step) focuses the subject and determines the exposure (shutter speed and aperture value), which is displayed in the LCD panel and viewfinder. Pressing the button "completely" (to the second step) takes the picture and winds the film to the next frame.

* Set the command dial to \square for practicing the following procedure.

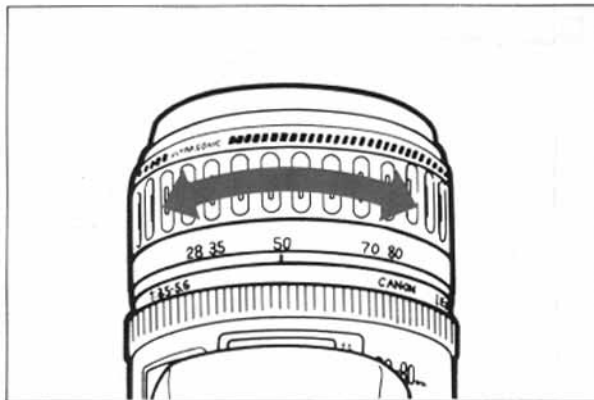
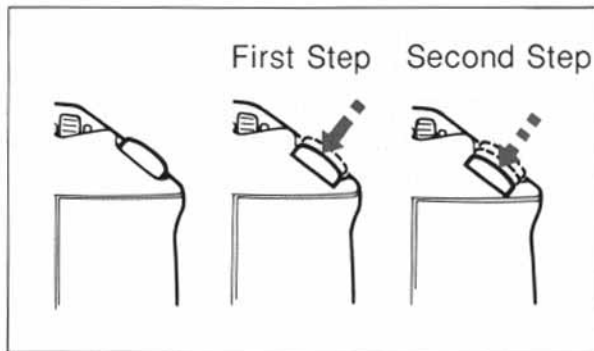

- 1) Look through the viewfinder and turn the zoom ring to set the desired subject size.

Focus lock

By keeping the shutter button pressed halfway after the subject is focused, the focus and exposure settings remain locked allowing you to recompose the scene as desired.



- 2) Cover the main subject with the AF frame ().



- 3) Press the shutter button halfway. The in-focus indicator lights when the subject is focused. Press the shutter button completely to take the picture.

6-second timer

If you remove your finger from the shutter button after pressing it halfway, the viewfinder and LCD panel displays will stay lit for approx. 6 seconds.

Viewfinder display

When you press the shutter button half-way and focus the subject, the in-focus indicator, shutter speed and aperture value light in the viewfinder. The shutter speed and aperture value also appear in the LCD panel.

- * The shutter will not release when the in-focus indicator blinks. See page 28.

(Camera-shake warning) indicator

 blinks in the viewfinder when the shutter speed is slow enough to cause blur due to camera shake. When this occurs, avoid sudden camera movement by holding the camera securely and pressing the shutter button gently or mounting the camera on a tripod.

- *  does not blink in Tv (shutter-priority AE) or M (manual exposure) mode.

4. Film Loading and Rewind

The shutter curtain operates with extremely high precision and can be easily damaged if touched. When loading or unloading film, be careful not to touch the shutter curtain accidentally with your finger or the tip of the film.

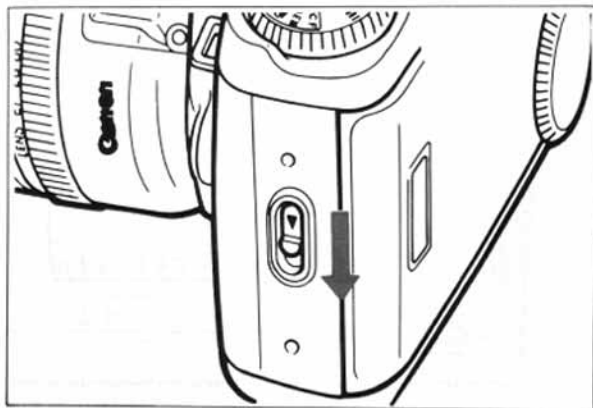
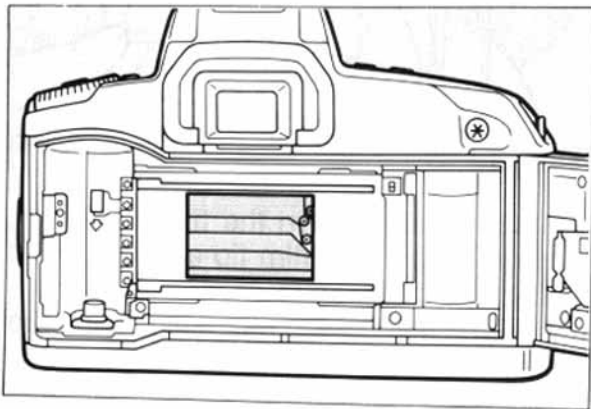

The film speed is set automatically according to the DX code on the film cartridge.

- 1) Open the back cover by sliding the back cover latch down.

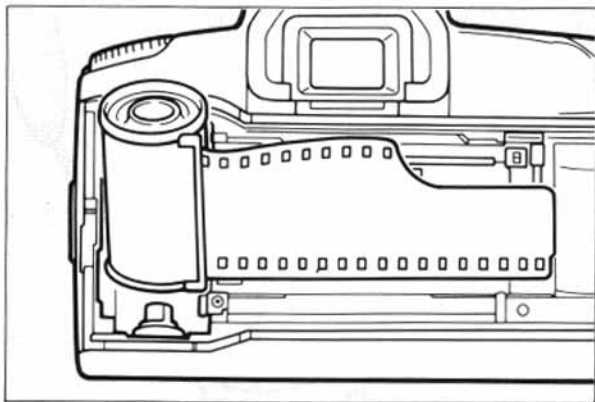

2) With the film leader facing outward, insert the film cartridge so that the flat end enters the top of the film chamber.

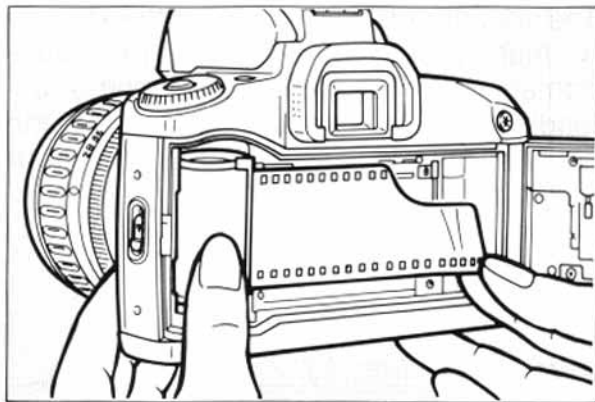

3) While holding down the film cartridge, carefully pull the film tip across until it reaches the orange mark.

* If you pull out too much film, wind the slack back into the cartridge.

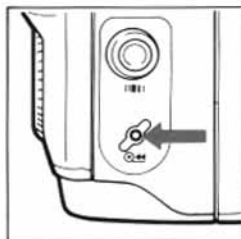

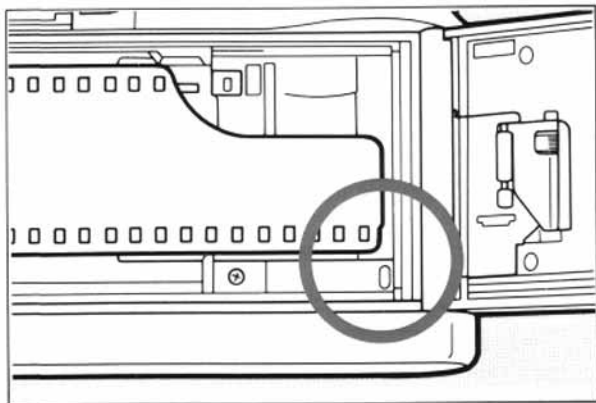

Rewinding film in mid-roll

Press the mid-roll rewind button to re-wind the film. After the film is wound completely into the film cartridge,  blinks in the LCD panel.



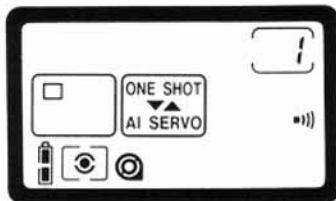

- 4) After checking that the film lies flat and that the tip is aligned with the orange mark, close the back cover.



- * The film automatically advances to the first frame, the frame counter shows "1" and  is displayed in the LCD panel.
- * If the film cartridge symbol blinks, the film is not loaded correctly. Reload the film. If the film is not loaded correctly, the shutter will not release when the shutter button is pressed.

Film rewind

The film automatically rewinds after the last frame is shot. When rewinding is completed,  blinks in the LCD panel. After confirming that  is blinking, open the back cover and remove the film.

* Infrared film cannot be used with this camera.

[2] Taking Pictures Using Image Zone Shooting Modes

Image zone shooting modes automatically set all camera functions such as metering and AF mode to the optimum settings appropriate for the selected mode.

- * When using an external flash unit in an image zone mode, the picture may not turn out as expected. Do not use an external flash unit with image zone modes. (Expect Full Auto Mode)
- * Refer to page 68 for the function settings in each mode.

1. (Full Auto)

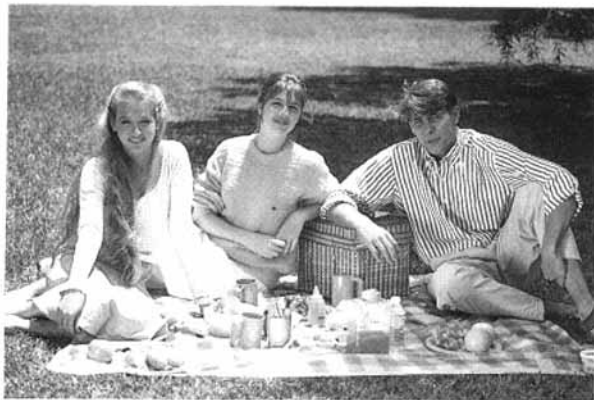

This setting allows you to begin taking pictures immediately without selecting a subject type. Focusing, exposure and film winding are all set automatically.

- * When One-shot AF mode is set, the camera automatically sets a faster shutter speed when camera shake is detected.

AF mode automatic switching function

In Full Auto mode, the camera senses the subject movement and automatically sets One-shot AF if the subject is stationary or AI Servo AF (→ page 29) if the subject is moving.

2. (Portrait)



Set this mode to create a sharply focused subject against a blurred background for flattering portraits.

- * Hold the shutter button down to take pictures continuously.

3. (Landscape)



Set this mode for vivid landscape pictures with everything sharply focused from near to far. When using a zoom lens, set the lens to a wide-angle position for best effect.

4. (Close-up)



Set this mode to use the lens' built-in macro function and take striking close-ups of small objects such as flowers and insects. When using a zoom lens, set the lens to telephoto for greatest magnification.

- * The built-in flash may be partially blocked by the lens at distances closer than 1 m/3.3 ft.
- * For high magnification close-ups we recommend use of a macro lens.

5. (Sports)



Use this setting for taking pictures of sporting events or other situations with fast-moving subjects. To bring your subject closer we recommend use of a telephoto lens such as the EF 70-210mm f/3.5-4.5USM. The camera continuously focuses as you follow the subject with the shutter button pressed halfway.

- * Pictures can be taken continuously by holding the shutter button pressed.

6. ||||| (Bar-code program)

In this mode camera settings are made automatically according to bar-code data read from the Bar Code book and input to the camera using a separately sold bar-code reader. The bar codes in the Bar Code book contain shooting data for setting the camera to take pictures similar to the accompanying sample photograph.

- * Refer to the Bar Code book for further information.
- 1) Read the desired bar code from the Bar Code book using the bar-code reader.
 - * For details on how to use the Bar Code book and bar-code reader, read the instructions provided in the Bar Code book.

The bar-code reader and Bar Code book are sold separately.

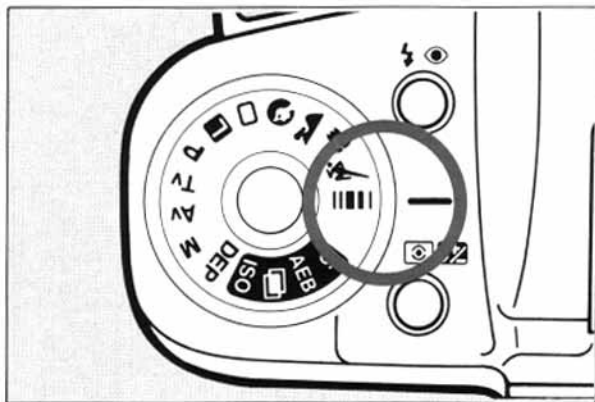

- 2) Set the command dial to ||||| .

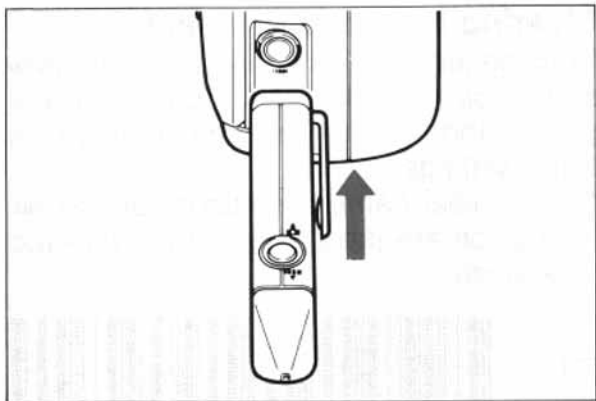



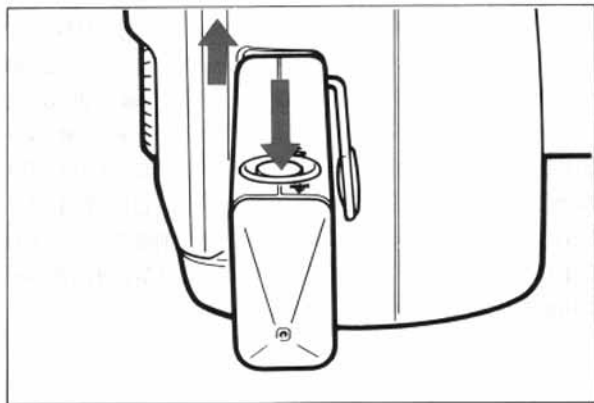

- 3) Press the end of the bar-code reader against the camera's bar-code receptor.
- * ■■■■ blinks in the LCD panel and the program number is displayed. If no bar-code program has been input, the displayed program number is *P00*.



- 4) While pressing the bar-code reader against the bar-code receptor, press the bar-code reader's transmission button to transmit the program.
- * When the program is input, a beep sound is heard, ■■■■ stops blinking in the LCD panel and the input bar-code program number is displayed.

Inputting five bar-code programs

Bar code programs from the Bar Code book can be input into the    and  positions as well as the dedicated  position. Just turn the command dial to the desired position and input the program. Input bar-code programs remain in the camera until erased or replaced by another program.

Clearing bar-code programs

By using the Bar Code book's "Clear" program, you can erase input bar-code programs and restore each position to its initial settings.

- * The initial camera settings for the  position are the same as the Full Auto position.



CLEAR

This section explains operations such as changing the camera's basic functions, taking pictures using creative zone shooting modes and using the built-in flash.

[1] Changing the Basic Functions

1. Selecting the Focusing Mode

Two types of autofocusing are available: One-shot AF and AI Servo AF. You can switch between One-shot and AI Servo by pressing the AF mode select button. The current AF mode is displayed in the LCD panel.

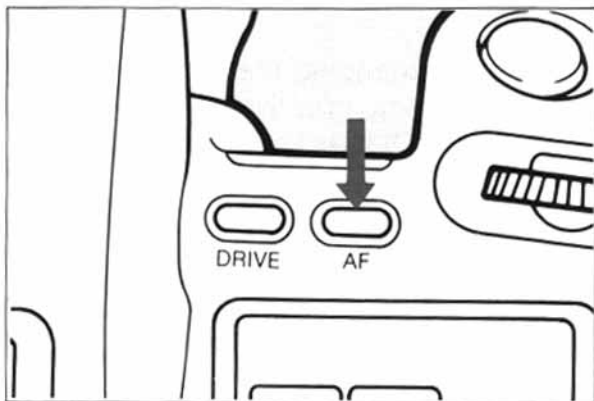

(1) One-shot AF

Use this mode with stationary subjects. The shutter will not release until the subject is focused. Exposure is determined when the subject is focused.



Some subjects may be difficult to focus causing the viewfinder's in-focus indicator to blink. If this occurs, use the focus lock function (→ page 14) or focus the subject manually.

* If the subject in the AF frame is too dark or low in contrast for normal autofocusing, the camera will automatically emit an AF auxiliary light to make focusing easier.

(2) AI Servo AF

Use this mode when taking pictures of moving subjects. The lens focuses the subject continuously while the shutter button is pressed halfway. AI Servo's predictive focus function* can track subjects moving toward or away from the camera. Exposure is determined immediately before the shutter is released.

* Focus lock cannot be used in this mode.



* Predictive focus function

Predictive focus detects the distance and speed of the subject then predicts the subject position so that the subject will be sharply focused the instant the exposure occurs.

(3) Manual Focusing

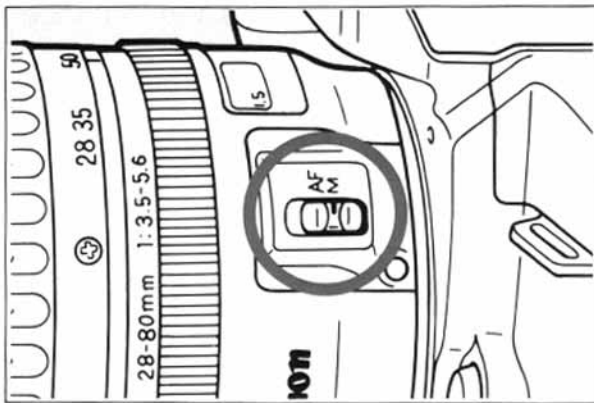

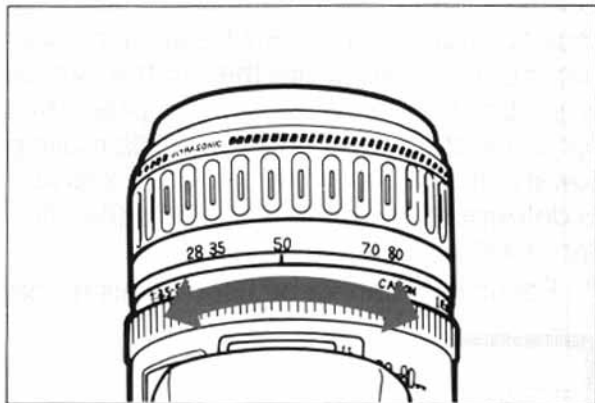

- 1) Set the lens' focus mode switch to M.
* The focus mode indicators in the LCD panel go out.



- 2) Turn the lens' manual focusing ring until the subject appears sharp.

When using an USM lens with distance scale, it is possible to adjust the focus manually, without having to change the focus mode from AF to Manual. Do not operate the focusing ring when manual focusing is not required.

2. Selecting the Film Winding Mode

Two film winding modes are provided — single exposure mode and continuous exposure mode. Each press of the film winding mode/self-timer & remote control button changes the LCD panel's film winding mode display in the following sequence: □ (single exposure) →  (continuous exposure) →  (self-timer/remote control).

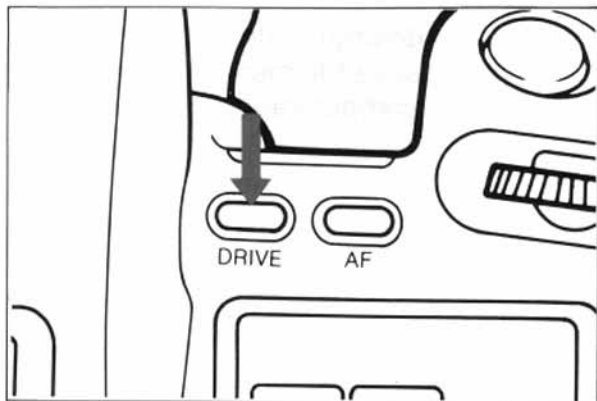

(1) □ (Single exposure)

The film advances one frame after each picture is taken. This mode is usually combined with One-shot AF mode.

(2) (Continuous exposure)

Pictures are taken continuously at up to 3 frames per second for as long as the shutter button is pressed. This mode makes best use of the features of AI Servo AF mode.

(3) (Self-timer/Remote control)



Set to this position when using the self-timer or remote control function.

3. Selecting the Metering Mode

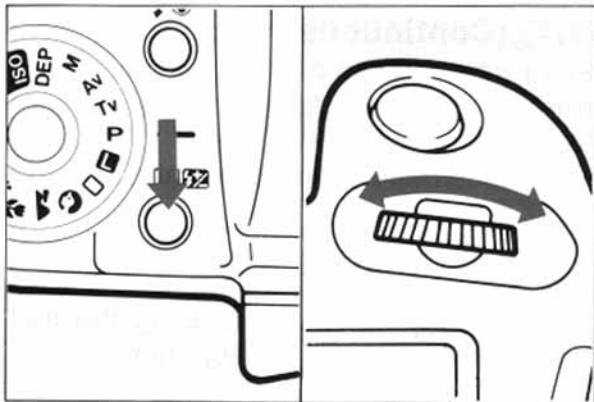
You can freely select any of three metering modes — evaluative metering, partial metering and center-weighted average metering.



1) Press the metering mode/flash exposure compensation button while operating the main dial.

* The LCD panel's metering mode indicator changes as follows:  (evaluative metering) →  (partial metering) →  (center-weighted average metering).

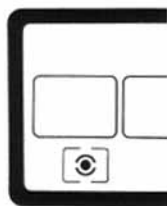

evaluative
metering

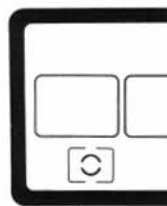

partial
metering

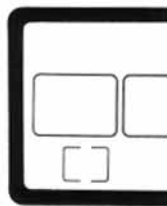

center
weighted
average
metering

2) When the desired metering mode is displayed, release the metering mode/flash exposure compensation button.

4. Using the Built-in Flash





The  indicator blinks in the viewfinder when the camera determines that flash use is necessary in low-light conditions or when the subject is backed by a strong light. To use the flash, press the flash button to pop it up. To retract the flash, push it down gently with your hand.

The built-in flash zooms automatically to adjust the flash illumination angle according to the lens focal length (28mm, 50mm or 80mm).

Use the built-in flash not only in dark situations but also during the day to fill in harsh shadows or to create a catch-light effect in the subject's eyes. Use of the built-in flash can provide a natural balance between the subject and background. Light from the built-in flash may be blocked when using the following lenses. When using such a lens we recommend using a dedicated external flash unit.

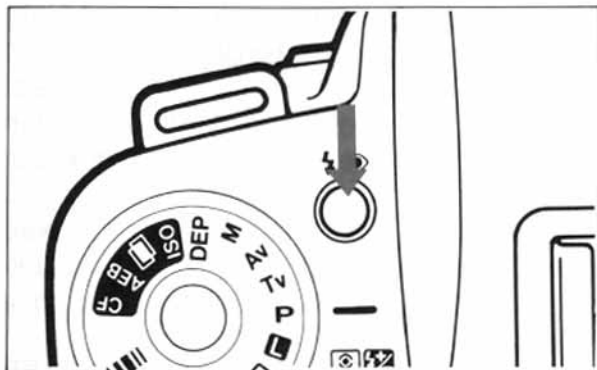
- Large aperture lenses such as the EF 20-35mm f/2.8L and EF 28-80mm f/2.8-4L.
- Long focal length zoom lenses such as the EF 80-200mm f/2.8L and EF 50-200mm f/3.5-4.5L.
- Super-telephoto lenses such as the EF 300mm f/2.8L and EF 600mm f/4L.



- 1) Press the flash button to pop up the flash.
- 2) When the shutter button is pressed halfway the  indicator is displayed along with the exposure settings in the viewfinder.



- 3) The flash fires whenever a picture is taken.

• X-sync Shutter Speed and Aperture Settings

Shooting mode	X-sync shutter speed	Aperture value
P (Program AE)	Automatically set to 1/60-1/125 sec.	Flash aperture automatically set according to TTL program (for built-in flash).
Tv (Shutter-priority AE)	Manually set to any shutter speed of 1/125 sec or slower.*	Automatically set according to ambient light level and shutter speed.
Av (Aperture-priority AE)	Automatically set between 30 sec and 1/125 sec according to ambient light level and set aperture value.	Manually set to desired aperture.
M (Manual exposure)	Manually set to any shutter speed of 1/125 sec or slower.*	Manually set to desired aperture.

* If a shutter speed faster than 1/125 sec is set, the camera automatically sets the shutter speed to 1/125 sec.

* For second-curtain sync operation, see "8. Custom Function Control" (CF2) on page 62.

- * To retract the flash, gently push it down with your hand until it locks shut.
- * A lens hood attached to the lens will block the light from the built-in flash. Always remove the lens hood when using the built-in flash.
- * The built-in flash and an external flash unit cannot be used together.
- * The built-in flash will not operate when an external flash unit or cover is attached to the accessory shoe.
- * If the built-in flash is held down while the flash button is pressed,  will blink in the LCD panel and the camera will stop operating. This is not a malfunction. Press the shutter button halfway to resume normal operation.

• **Flash Shooting Distance Range**
(meters, using the EF 28-80mm f/3.5-5.6 USM)

ISO	28mm		80mm	
	Negative film	Slide film	Negative film	Slide film
100	1.0 ~ 4.8	1.0 ~ 3.4	1.0 ~ 4.3	1.0 ~ 3.0
400	1.1 ~ 9.6	1.5 ~ 6.8	1.0 ~ 8.6	1.0 ~ 6.0

Red-eye reduction function

Pressing the flash button again after the flash is popped up activates the red-eye reduction function. In this mode,  lights in the LCD panel and viewfinder and the red-eye reduction lamp lights momentarily before the flash fires to minimize red eye.

When the red-eye reduction function is set and the shutter button is pressed halfway, the bar indicators in the LCD panel and viewfinder light up for about 1.5 seconds. When these indicators go out, press the shutter button completely to take the picture.

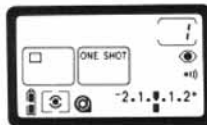

- * For best effect, have the subject look at the red-eye reduction lamp while it is lit.
- * To cancel red-eye reduction mode, press the flash button again.

5. Self-timer Function

When using the self-timer place the camera on a tripod or a steady surface. The picture is taken approximately 10 seconds after you press the shutter button.

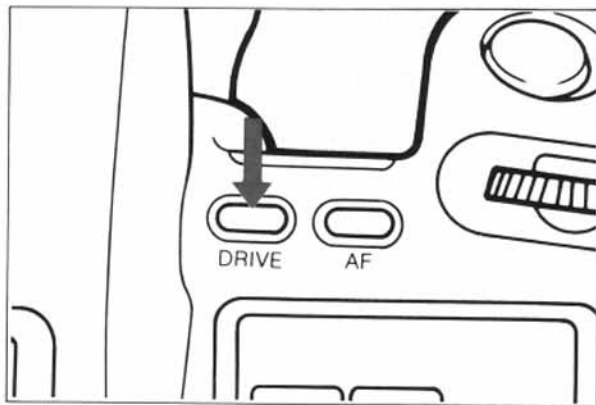

- 1) Press the film winding mode/self-timer & remote control button so that  appears in the LCD panel.
- 2) Compose the picture and press the shutter button halfway to focus the subject and set the exposure.

- 3) Press the shutter button completely.
 - * The picture is taken after a 10-second delay. The self-timer lamp lights two seconds before the picture is taken.
- 4) When finished using the self-timer, press the film winding mode/self-timer & remote control button to cancel the self-timer mode.
 - * Pressing the film winding mode/self-timer & remote control button before the picture is taken will cancel self-timer/remote control mode and stop the countdown.

If the camera is placed near an inverter-type fluorescent lamp while in self-timer/remote control mode, the effect of the light may accidentally trigger the camera. If this occurs, move the camera away from the fluorescent lamp.

Pressing the shutter button with your eye away from the viewfinder may allow light to enter the viewfinder and trick the metering system into setting a wrong exposure.

To prevent this from happening, remove the eye cup from the eyepiece and cover the eyepiece with the cover provided on the strap before pressing the shutter button.

Use of the Eyepiece Cover

The eyepiece cover is attached to the plastic part of the strap on the side bearing the EOS mark.

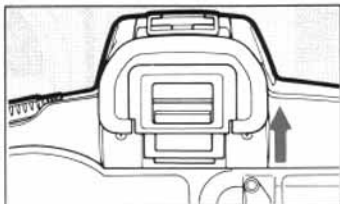
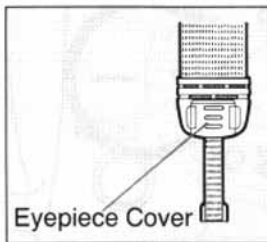

1 Remove eyecup.

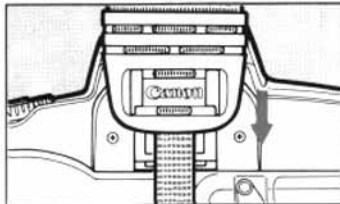

2 Insert eyepiece cover on viewfinder.

[2] Taking Pictures Using Creative Zone Shooting Modes

The command dial's creative zone contains five shooting modes selectable according to your subject or shooting objectives.

1. P (Program AE)

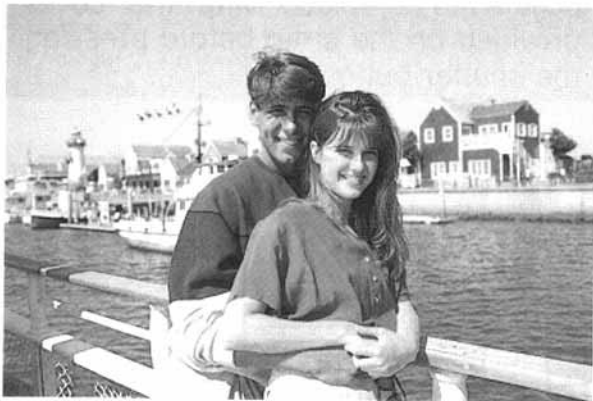

Set this mode for simple, fully-automatic operation similar to Full Auto mode. Unlike Full Auto, however, Program AE gives you the freedom to select the AF mode, film winding mode and metering mode as well

as use the AE lock, auto exposure bracketing and multiple exposure functions. The camera automatically sets the shutter speed and aperture according to the subject brightness.

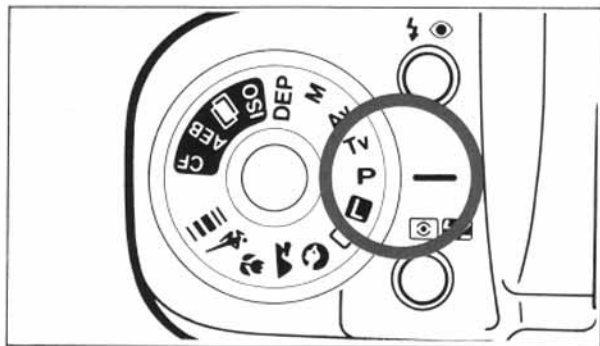

1) Set the command dial to P.

- 2) Press the shutter button halfway to focus the subject and confirm the exposure.

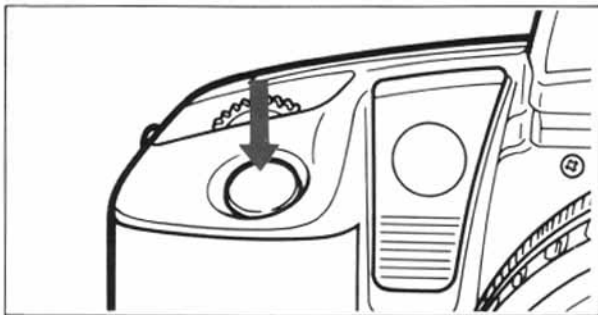

- 3) Press the shutter button completely to take the picture.

Exposure confirmation



- * If the shutter speed 4000 and the lens' minimum aperture value blink in the display, the subject will be overexposed. Use an ND filter.



- * If the shutter speed 30 and the lens' maximum aperture value blink in the display, the subject will be underexposed. Use flash.

Program shift function

When taking pictures in Program AE or Depth-of-field AE mode, you can change the set shutter speed and aperture value combination (program) while maintaining the same exposure. This operation is called "shifting the program."

After pressing the shutter button halfway, turn the main dial until the desired shutter speed/aperture combination is displayed.

- * The adjustment clears after one exposure.
- * Program shift cannot be used with the built-in flash.

2. Tv (Shutter-priority AE)



This mode is best for taking pictures of moving subjects by controlling the shutter speed. You set the shutter speed and the camera automatically sets the aperture according to the lighting conditions. Faster shutter speeds freeze subject motion while slower shutter speeds can produce artistic blur effects.

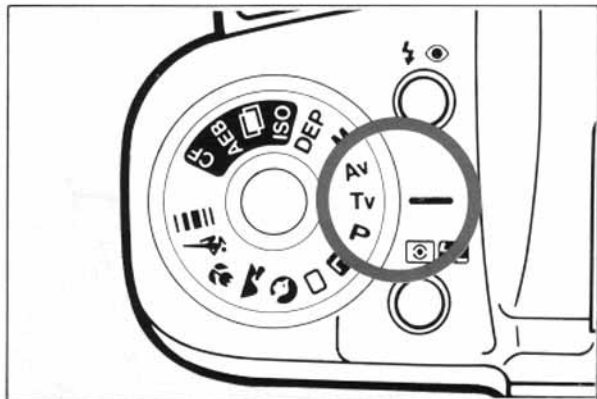

- 1) Set the command dial to Tv.

Exposure confirmation



- * If the maximum aperture value of the lens blinks in the display, the subject will be underexposed. Set a slower shutter speed until the display stops blinking.



- * If the minimum aperture value of the lens blinks in the display, the subject will be overexposed. Set a faster shutter speed until the display stops blinking.

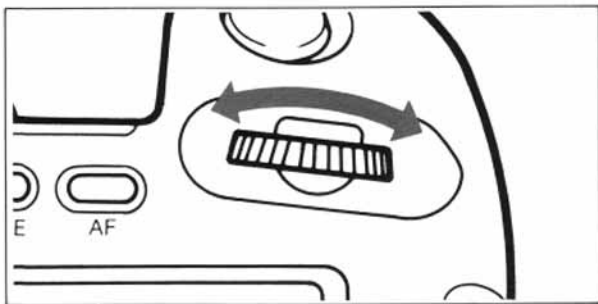

- 2) Turn the main dial to the desired shutter speed.
- 3) Focus the subject and confirm the exposure.

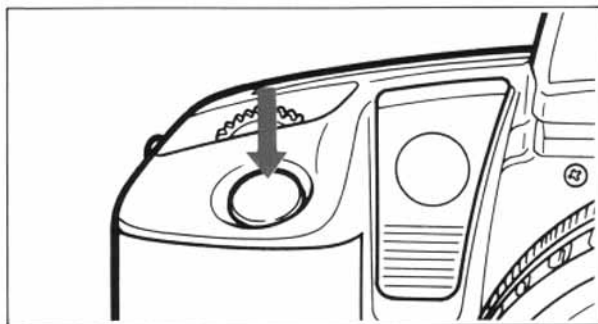

- 4) Press the shutter button completely to take the picture.

3. Av (Aperture-priority AE)



Use this mode for controlling background blur and depth of field by controlling the aperture. You set the aperture and the camera automatically sets the shutter speed according to the lighting conditions. Larger apertures (smaller numbers) blur the background for flattering portraits while smaller apertures (larger numbers) are best for landscapes to keep everything sharp from near to far.

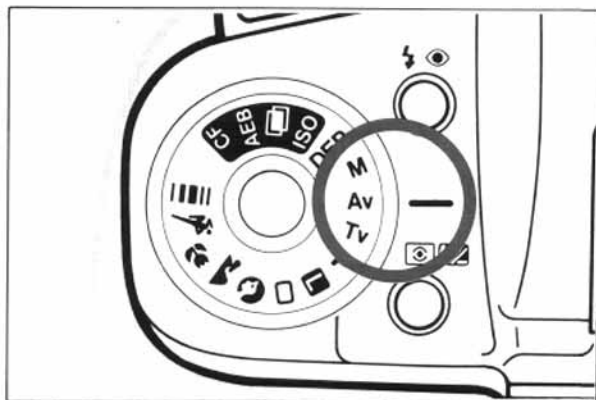

- 1) Set the command dial to Av.

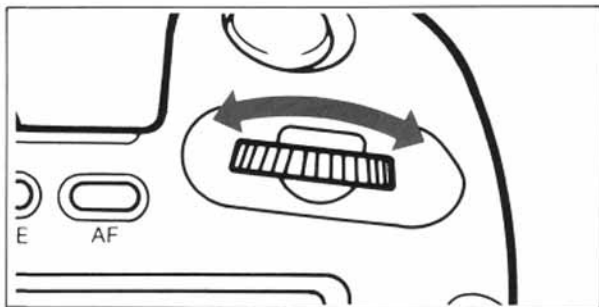

- 2) Turn the main dial to the desired aperture.
- 3) Focus the subject and confirm the exposure.

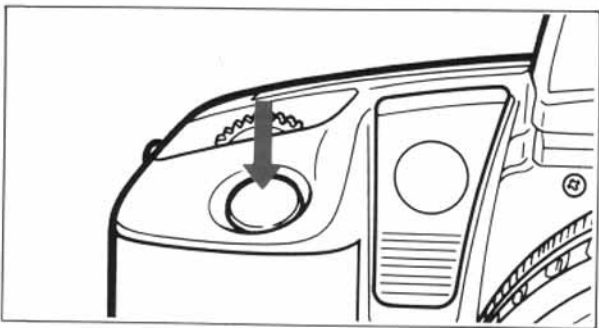

- 4) Press the shutter button completely to take the picture.

Exposure confirmation



- * If 30'' blinks in the shutter speed display, the picture will be underexposed. Set a larger aperture until the shutter speed stops blinking.



- * If 4000 blinks in the shutter speed display, the picture will be overexposed. Set a smaller aperture until the shutter speed stops blinking.

4. M (Manual exposure)



This creative mode lets you completely control exposure by setting both the shutter speed and aperture. The main dial sets the shutter speed and the quick control dial sets the aperture.

* We recommend using partial metering (→ page 32) when using manual exposure mode.

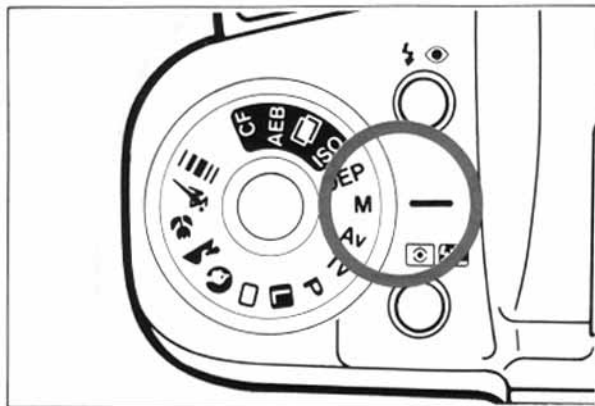

1) Set the command dial to M.

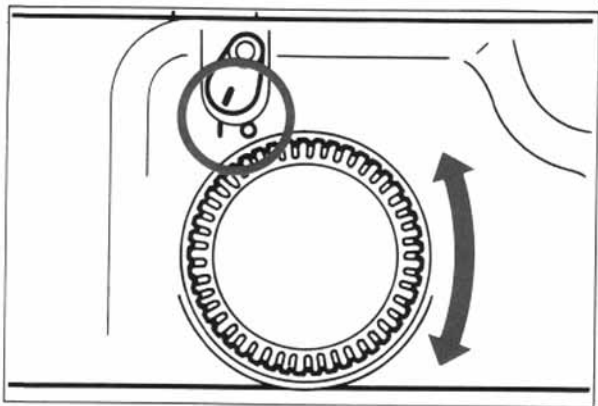

- 2) Set the quick control dial switch to **I**.
- 3) Turn the main dial to set the desired shutter speed.
- 4) Turn the quick control dial to set the desired aperture.
- 5) Focus the subject and determine the correct exposure using the exposure display.
- 6) Press the shutter button completely to take the picture.

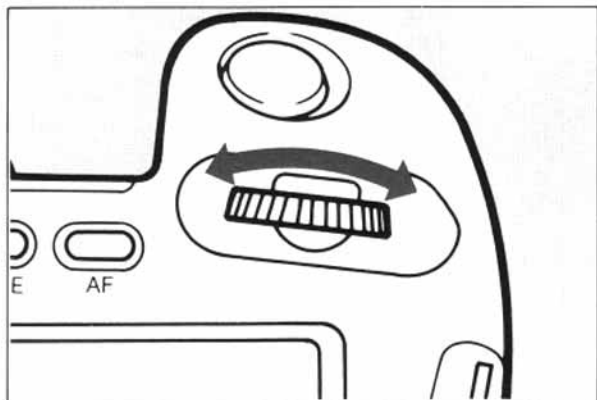

Exposure confirmation

- ☞ : Overexposure. Turn the main dial or quick control dial until ☞☞ is displayed.
- ☞☞ : Correct exposure. Use this position as the reference point when determining exposure.
- ☞ : Underexposure. Turn the main dial or quick control dial until ☞☞ is displayed.

5. DEP (Depth-of-field AE)



This mode places everything between two freely set points in the foreground and background in focus. Useful when taking pictures of landscapes or large groups of people.

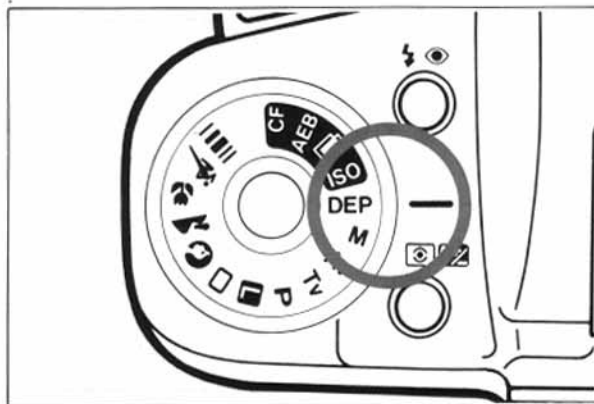

- 1) Set the command dial to DEP.

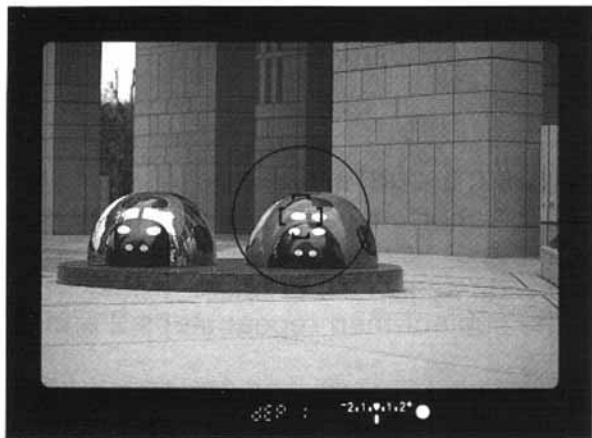

2) Place the AF frame on the nearest point you want in focus, then press the shutter button.

* When "dEP 1" is displayed in the viewfinder, remove your finger from the shutter button.

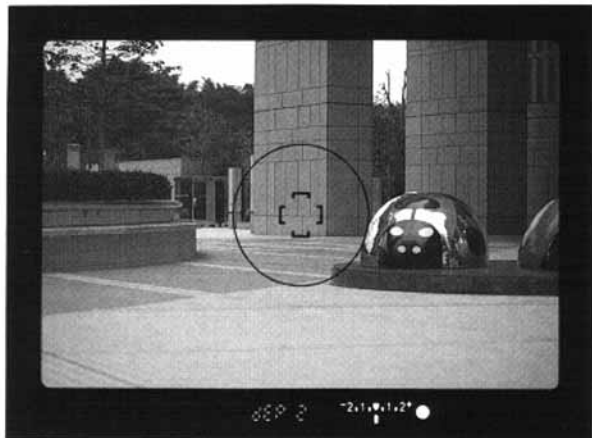

3) Place the AF frame on the farthest point you want in focus, then press the shutter button again.

* When "dEP 2" is displayed in the viewfinder, remove your finger from the shutter button.



4) Compose the picture and press the shutter button halfway to confirm the exposure.

- * The correct aperture value for the designated depth of field and the corresponding shutter speed are displayed in both the viewfinder and LCD panel.
- * If desired you can change the aperture/shutter speed combination by turning the main dial. (→ page 39)

5) Press the shutter button completely to take the picture.

Exposure confirmation

- * If the aperture value blinks, the desired depth of field cannot be obtained. Use a wide-angle lens or move farther from the subject then repeat steps 2 and 3.
- * To cancel depth-of-field AE in mid-operation, turn the command dial to another position.
- * When using a zoom lens, do not zoom the lens after setting the first focus point.
- * Flash cannot be used effectively in depth-of-field AE mode. Use of flash will provide the same result as using flash in Program AE mode.



III Useful Functions

This section explains various functions you can use to make fine adjustments to match your shooting objectives or the situation at hand.

- * Functions explained in this section cannot be used with image zone shooting modes.

1. AE Lock

Use AE lock in situations when there is extremely strong contrast between the subject and background or when a bright light source or highly reflective object is located in the picture.

When you press the AE lock button, * lights in the viewfinder to indicate that AE lock is set. Once * appears the exposure remains locked even if you release the AE lock button.

* Remove your finger from the shutter button when setting AE lock.

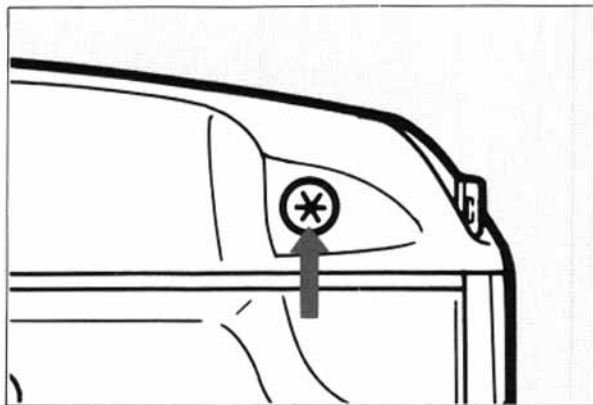

2. Exposure Compensation

When taking pictures in an AE shooting mode, you can use the quick control dial to vary the exposure according to the subject conditions. Exposure can be compensated up to ± 2 stops in $1/2$ -stop increments.

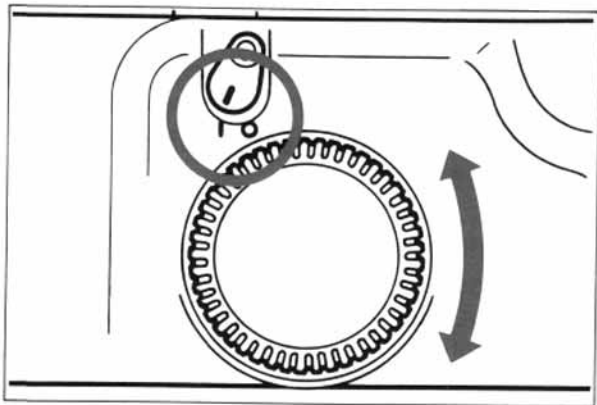

- 1) Set the quick control dial switch to **I**.
- 2) Focus the subject and confirm the exposure.



- 3) Turn the quick control dial to set the desired exposure compensation amount.

* The compensation amount is displayed in the LCD panel and viewfinder. “+” compensation overexposes the subject and “-” compensation underexposes it.



- 4) Press the shutter button completely to take the picture.
* To cancel exposure compensation, repeat step 3 to return the compensation amount to 0 (then set the quick control dial to **0**).

3. Built-in Flash Exposure Compensation

This function lets you vary the automatic flash exposure level of the built-in flash. The flash exposure can be compensated up to $+/-$ 2 stops in $1/2$ -stop increments. This function does not affect external flash units even if the flash exposure compensation display is lit.

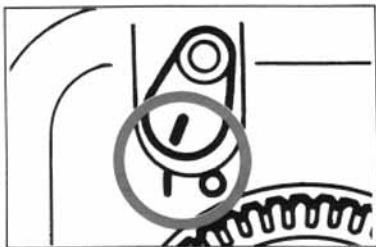

1) Set the quick control dial switch to **I**.

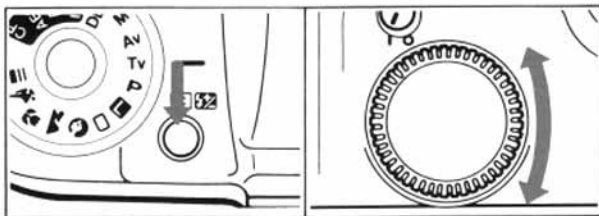

2) Press the flash exposure compensation button while turning the quick control dial to set the compensation amount.

- *  lights in the LCD panel.
- * The flash exposure compensation amount is displayed in the LCD panel.



"+" indicates overexposure compensation and "-" indicates underexposure compensation.

3) Release the flash exposure compensation button to lock in the compensation amount shown in the display. The flash exposure compensation display extinguishes.

- * To check the flash exposure compensation amount, press the flash exposure compensation button again.

4) Take a picture using the built-in flash.

- * Flash exposure compensation remains set until manually canceled. To cancel, carry out the operation in step 2 to reset the flash exposure compensation amount to 0.

- * Flash compensation can be used together with AE exposure compensation.

4. AEB (Auto Exposure Bracketing)

Use auto exposure bracketing in AE and manual exposure modes to take a sequence of pictures at different exposures. When this function is set, one press of the shutter button automatically takes three pictures in sequence while shifting the exposure for each picture. The bracketing amount can be set in 1/2-stop increments up to $+/- 2$ stops from the correct exposure value.

Auto exposure bracketing is particularly effective when using slide film, which produces noticeably different results with even small exposure variations.

* Three successive frames are exposed automatically even when single exposure mode is set.

(-1.0)



(+/-0)



(+1.0)



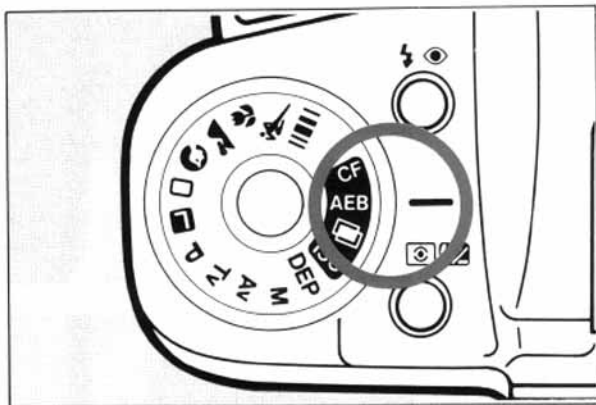

- 1) Set the command dial to AEB.
 - * "AEB" lights in the LCD panel.

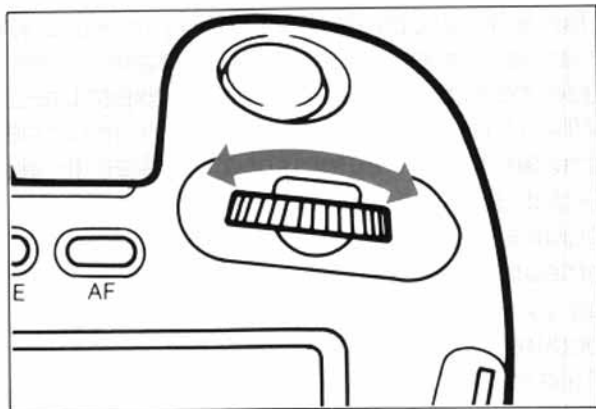

- 2) Turn the main dial to set the desired bracketing amount.
 - * The bracketing amount is shown in the LCD panel as both a dot display and a numerical value. If "1.0" is set, for instance, three pictures are taken in the following sequence: underexposure (-1.0 stop), correct exposure ($+/- 0$ stop) and overexposure ($+1.0$ stop).

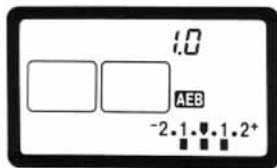

- * The compensation level is also displayed in the viewfinder.
- 3) Set the command dial to the desired shooting mode and take pictures.
- * To cancel auto exposure bracketing, repeat steps 1 and 2 to reset the bracketing amount to 0.

- * Auto exposure bracketing cannot be used in bulb mode or when using flash.
- * Auto exposure bracketing is automatically canceled when film is removed.
- * If you wish to shift the bracketed exposure values toward over- or underexposure, you can add exposure compensation using the quick control dial. In this case the LCD panel will not display the correct values, but exposures will be made correctly.

Auto exposure bracketing is carried out in each mode as follows:

(1) Program AE

Both the shutter speed and aperture value are shifted.

(2) Aperture-priority AE, Depth-of-Field AE, Manual Exposure

Only the shutter speed is shifted.



(3) Shutter-priority AE

Only the aperture value is shifted.

5. (Multiple Exposure)

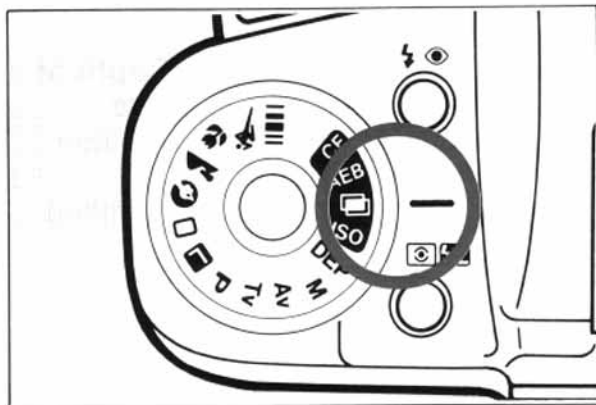
Up to nine exposures can be made on one frame by presetting the number of multiple exposures with the main dial.



- 1) Set the command dial to .
*  lights in the LCD panel.

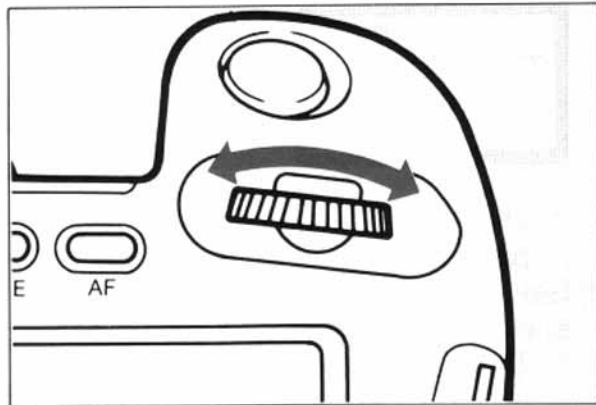

- 2) Turn the main dial to set the desired number of exposures in the frame counter display area.

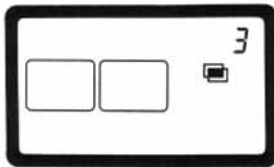

3) Set the command dial to the desired shooting mode and take pictures.

- *  blinks in the LCD panel while multiple exposures are being taken.
- * To cancel multiple exposure mode in mid-operation, repeat steps 1 and 2 to set the frame counter to a blank display.
- * When the preset number of multiple exposures is completed, the film automatically advances to the next frame and multiple exposure mode is canceled.

Helpful Hints

When taking multiple exposures on a single frame, you should decrease the exposure value for each exposure using exposure compensation. (→ page 51)

Number of multiple exposures	Compensation amount
2 exposures	-1.0
3 exposures	-1.5
4 exposures	-2.0

The above values should be used only as a guide. The actual compensation amount required depends on the shooting conditions and should be determined by prior testing.

6. Bulb (Long Exposure) Operation



Use this mode when long exposures are required, such as for pictures of night scenes and fireworks displays. The shutter stays open for as long as you press the shutter button.

Mount the camera on a tripod to prevent camera movement during exposure.

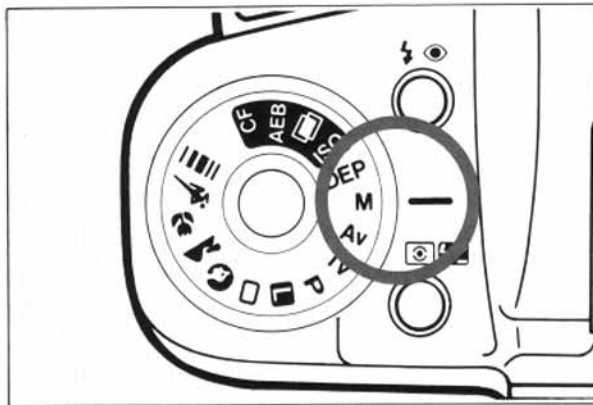

- 1) Set the command dial to M.

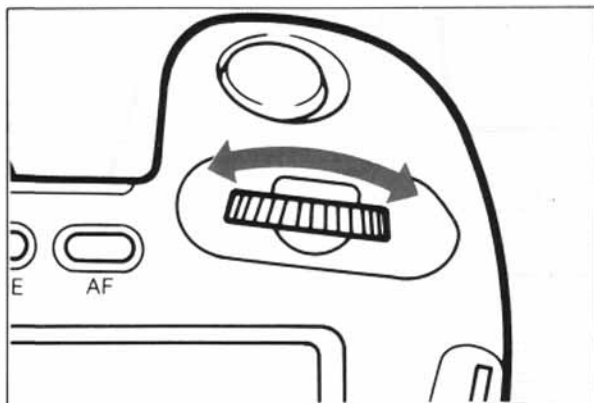

- 2) Turn the main dial to change the shutter speed until "buLb" appears in the LCD panel. "buLb" is the next position after 30"

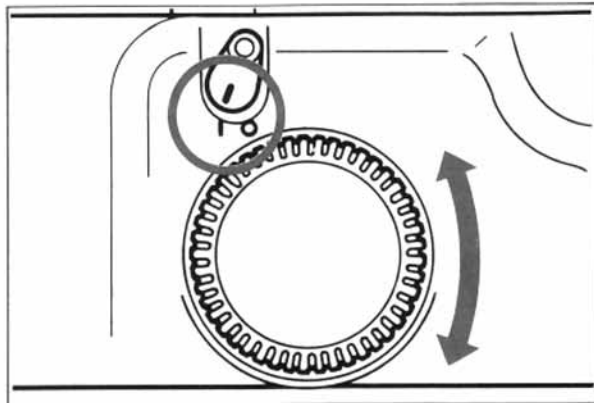

- 3) Set the quick control dial switch to **I**.
 4) Turn the quick control dial to the desired aperture.
 5) Press the shutter button for the desired length of time.
- * The viewfinder display extinguishes during the exposure.
 - * Remote controller RC-1 can be used to start and stop the bulb exposure. For details, read the instructions supplied with the RC-1.

7. Manual Film Speed Setting

The film speed can be set manually when using non-DX film or when you wish to set a film speed other than the DX-coded film speed. The setting range is ISO 6-6400.

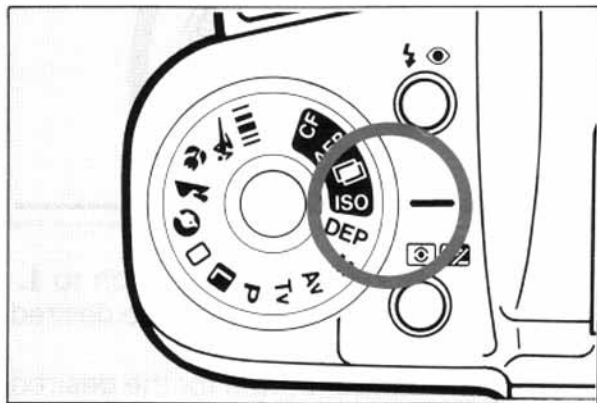

- 1) Set the command dial to ISO.
 - * "ISO" is displayed in the LCD panel.

* When using *non-DX* film cartridges, the **ISO** mark blinks in the LCD panel. To change the ISO setting, follow the procedures explained for non DX-coded film use.

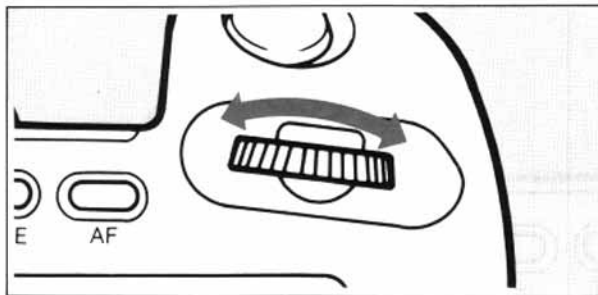

- 2) Turn the main dial to the desired film speed.
 - * The film speed is displayed in the LCD panel.



- 3) Set the command dial to a position other than ISO to complete the setting.

* If DX-coded film is loaded after manually setting the film speed, the DX-coded film speed is set.

8. Custom Function Control

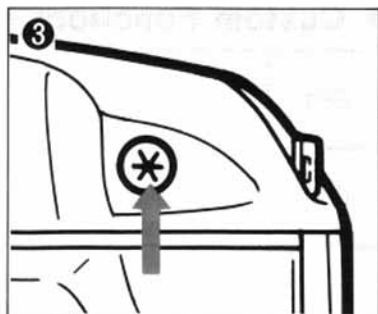
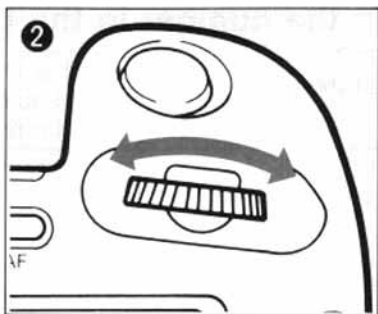
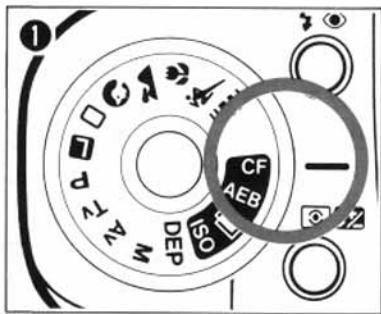

Seven types of custom functions are provided to let you customize the camera according to your personal shooting style. Set the custom functions as follows.

- 1) Set the command dial to CF.
 - * "CF" lights in the LCD panel.
- 2) Turn the main dial to select the desired custom function number.

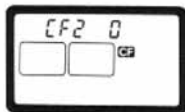

- 3) Press the AE lock/custom function select button to change the setting in the LCD panel to "1".

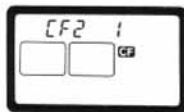









- * The number in the LCD panel switches between 0 and 1 each time the AE lock/custom function select button is pressed.
 - 1 : Sets the custom function to the custom setting.
 - 0 : Resets the custom function to the standard setting.
- 4) Turn the command dial to a position other than CF.

• Custom Functions (when the number in the LCD panel is 1)



CF1	Cancels automatic rewind at the end of film.	When the end of film is reached, the film does not start rewinding automatically. Film is rewound by pressing the film rewind button.
CF2	Changes the sync timing of the built-in flash from first curtain sync to second curtain sync.	Flash firing syncs with the travel of the second shutter curtain, providing a more natural effect when using slow shutter speeds.
CF3	Cancels automatic film speed setting with DX-coded film.	Use this function when you wish to compensate the film speed or manually set effective film speeds obtained from independent testing.
CF4	Prohibits firing of the AF auxiliary light during autofocusing.	This function is useful to keep the AF auxiliary light from appearing in other people's pictures in situations where many people are taking pictures of the same scene.
CF5	Changes the AE lock/custom function select button to a depth-of-field preview function.	Setting this function lets you use the AE lock/custom function select button to check the depth of field after the subject is focused and exposure is set.
CF6	Turns off the beeper tone.	When this function is set, the beeper tone will not sound during self-timer operation.
CF7	Locks the mirror up when the self-timer or remote control is activated.	When the shutter button is pressed completely in self-timer/remote control mode, the mirror moves up immediately and the picture is taken 10 seconds later.

IV Reference

1. Exposure Warnings

Shooting mode	Blinking display warning	Meaning	Corrective action	
P (Program AE)		Shutter speed 30" and maximum aperture of the lens in use.	Subject is too dark.	Use flash.
		Shutter speed 4000 and minimum aperture of the lens in use.	Subject is too bright.	Use an ND filter.
Tv (Shutter-priority AE)		Maximum aperture of the lens in use.	Subject will be underexposed.	Turn the main dial to a slower shutter speed.
		Minimum aperture of the lens in use.	Subject will be overexposed.	Turn the main dial to a faster shutter speed.
Av (Aperture-priority AE)		Shutter speed 30" .	Subject will be underexposed.	Turn the main dial to a larger aperture.
		Shutter speed 4000.	Subject will be overexposed.	Turn the main dial to a smaller aperture.
DEP (Depth-of-field AE)		Set aperture value.	Desired depth of field cannot be obtained.	1) Move farther from the subject and set the near and far points again. 2) When using a zoom lens, set to the wide-angle position.
		Shutter speed 30" and maximum aperture of the lens in use.	Subject is too dark.	Use flash. (Same result as using Program AE.)
		Shutter speed 4000 and minimum aperture of the lens in use.	Subject is too bright.	Use an ND filter.

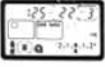
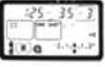
Exposure Warnings When Using Flash

Shooting mode	Blinking display warning	Meaning	Corrective action
P (Program AE)	 <p>When using daylight fill-in flash, shutter speed 125 and minimum aperture of the lens in use.</p>	Overall image will be overexposed.	Do not use flash.
Tv (Shutter-priority AE)	 <p>Minimum aperture of the lens in use.</p>	Overall image will be overexposed.	Do not use flash.
	 <p>Maximum aperture of the lens in use.</p>	Background will be underexposed.	Subject will be properly exposed.
Av (Aperture-priority AE)	 <p>Shutter speed 125.</p>	Overall image will be overexposed.	Turn the main dial to a smaller aperture.
	 <p>Shutter speed 30".</p>	Background will be underexposed.	Turn the main dial to a larger aperture.

2. Program Line Characteristics

This camera is equipped with advanced "Intelligent Program AE" which chooses the best shutter speed/aperture combinations taking the lens' focal length and minimum and maximum apertures into account.

The camera-shake warning indicator (📷) is displayed in the viewfinder when the

automatically-set shutter speed becomes 0 to 0.5 stops slower than "1/focal length of the lens in use". This shutter speed (1/focal length of the lens in use) is generally said to be the limit for hand-held shooting. The following graphs show the program lines for common lenses.

Program Characteristics

Pink: When using the EF 50 mm f/1.8

Black: When using the EF 28-80 mm f/3.5-5.6

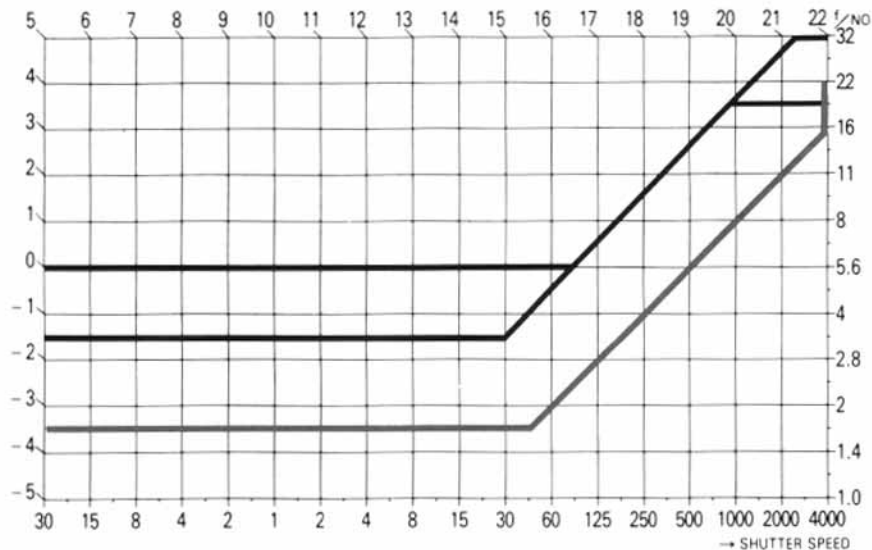

Program Shift Characteristics

* ● indicates the shutter speed/aperture combinations with program shift.

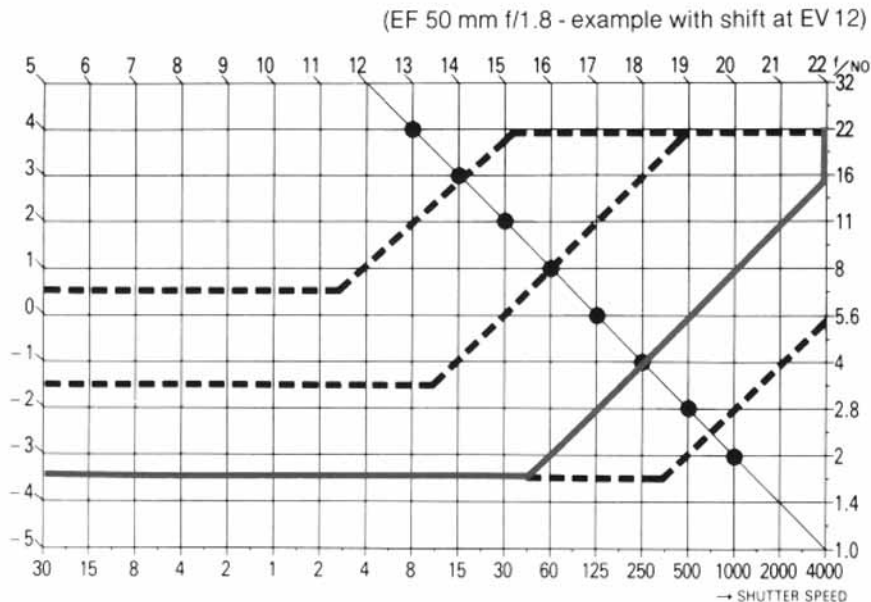



3. Function Combination Charts

(1) Programmed Image Control Mode Function Combinations

Shooting mode	AF mode		Film winding mode		Metering mode	
	ONE SHOT	AI SERVO	Single	Continuous	Evaluative	Partial
 (Full Auto)	(automatic switching)		•		•	
 (Portrait)	•			•	•	
 (Landscape)	•		•		•	
 (Close-up)	•		•			•
 (Sports)		•		•	•	

(2) AF and Film Winding Modes

Film winding mode / AF mode	ONE-SHOT	AI SERVO
 (Single)	AF lock and AE lock in the evaluative metering mode take place simultaneously on AF completion. The shutter releases only after AF completion.	AF follows the subject and the exposure is determined at the instant of shutter release.
 (Continuous)	AF lock and AE lock in the evaluative metering mode take place simultaneously on AF completion, then continuous exposure is activated. (Approx. 3 fps maximum.)	AF follows the subject and the exposure is determined at the instant of shutter release. AF is adjusted during exposure to follow the subject. (Approx. 2.5 fps maximum.)

■ Dedicated Canon Speedlites

Dedicated Speedlites you can use with the EOS ELAN include the powerful 430EZ zoom flash with a maximum guide number of 141 ft/43 m, and the 300EZ with a maximum guide number of 93 ft/28 m. With the 430EZ in particular, high-level flash functions such as automatic or manual flash output level compensation, stroboscopic flash, second-curtain sync, bounce flash, and slow synchronization are possible in addition to providing large output.

The ML-3 ring flash is useful for close-up photography with macro lenses.

When using any of these flashes with the camera in Full Auto mode, the camera automatically sets a 1/60-1/125 sec X-sync shutter speed as well as the flash control aperture value.

* For details refer to the instruction book supplied with the flash unit.



■ Remote Controller RC-1

The Remote Controller RC-1 lets you take pictures while standing away from the camera, and is especially useful for self-timer and bulb shooting as well as close-up photography and copying. It attaches to the camera strap for convenient carrying.

- * To prevent camera shake caused by mirror movement during close-up or long-exposure photography, set custom function No.7 to move the mirror up at the beginning of the self-timer/remote control shutter release delay countdown. (→ page 62)



■ Grip Extension GR-70

This dedicated grip extension with padded hand-strap provides a larger camera grip for improved holding comfort and security.



■ Lens Hoods and Filters

Use lens hoods and filters to keep unwanted light from entering the lens and provide special effects. Select the right hood size to match your lens and select filters according to your photographic objectives.

■ Dioptic Adjustment Lenses

Attaching a Dioptic Adjustment Lens E to the viewfinder eyepiece makes viewing and focusing easier without glasses for near- and far-sighted users. The built-in viewfinder eyepiece has a power of -1 diopter, and ten eyesight correction lenses are available for adjustment from $+3$ to -4 diopters. Choose the one which is closest to your eyeglass prescription. We recommend that you actually try the lens before purchasing to make sure you get the one which is best for your eyesight.

* The numerical value printed on a dioptic adjustment lens indicates the diopter value obtained when the dioptic adjustment lens is attached to the camera. This number does not indicate the diopter value of the dioptic adjustment lens itself.



■ Cases

Keep the camera in its case to protect it while carrying.

Canon offers two special semi-hard cases designed for use with this camera.

- Semi-hard Case L (EH-6L): For camera body and EF 35-80mm f/4-5.6 or EF 35-105mm f/4.5-5.6 zoom lens.
- Semi-hard Case LL (EH-6LL): For camera body and EF 28-80mm f/3.5-5.6 USM, EF35-135mm f/4.0-5.6 USM zoom lens.

EH-6LL



EH-6L



■ Cleaning

Keep your camera in top condition by following these suggestions for periodic cleaning. See the precautions on page 8 for other important information.

1. Cleaning the lens surface—
Blow off dust with a blower brush and gently wipe the lens surface with a piece of lens cleaning paper moistened with lens cleaner. Clean in a spiral motion from the center outwards.
2. Cleaning the mirror and focusing screen—
Use a blower brush reserved for this purpose only. If more cleaning is necessary NEVER attempt to do it yourself. Take the camera to an authorized Canon service facility.
3. Cleaning the film chamber—
Use a blower brush to remove accumulated film dust particles that might scratch the film. Be careful not to touch the shutter curtain.

4. Cleaning the film pressure plate and film guide rails—
Lightly wipe the surface with a piece of lens cleaning paper moistened with lens cleaning fluid. Be careful not to touch the shutter curtain.
* Use of aerosol spray dust removers is not recommended.

■ Liquid Crystal Display/Battery Notes

1) LCD Information

The LCD panel uses liquid crystal to show exposure information. After about five years, the display may become difficult to read. If this occurs, have it replaced at an authorized Canon service facility. Replacement is at the owner's expense.

Liquid crystal may also respond relatively slowly in temperatures below 32°F/0°C. It may also darken in temperatures of around 140°F/60°C. The LCD panel will return when the temperature returns to normal.

2) Blinking Empty Battery Indicator

There are two situations in which the blinking empty battery indicator will appear in the LCD panel: (1) when the battery is nearly exhausted or (2) when the camera's self-test process detects an internal malfunction. If the blinking empty battery indicator appears, perform the following operations:

1. Remove the battery, wipe the battery terminals and reload it. Check the battery again. If the blinking still appears, replace the battery with a new one.
2. Release the shutter once.

If the battery indicator stops blinking, the problem is corrected and you can continue using the camera normally. If the blinking does not stop, the camera needs to be examined by an authorized Canon service facility.

3) Lithium Battery Information

Always check the battery at the following times:

1. When loading a new battery
2. After lengthy storage
3. If the shutter will not release
4. In cold weather
5. Before an important shooting assignment

Battery Use Information

- * Wipe the battery terminals with a clean, dry cloth to ensure proper contact.
- * The battery may explode or cause burns if disassembled, recharged, shorted, exposed to high temperatures, or disposed of in fire. Be sure to observe all precautions indicated on the battery package. Always keep it out of the reach of children.
- * Battery performance deteriorates slightly in temperatures below 32°F/0°C. Keep the camera and especially a spare battery close to your body or in an inside pocket to keep it warm until use.
- * Remove the battery if you do not expect to use the camera for more than three weeks.

4) Camera Operation with a Low Battery

Even if the battery indicator blinks or does not appear in the LCD panel during battery check, exposure will be okay as long as the shutter releases. Film advance and rewind will be impaired by insufficient battery power. If wind or rewind stops due to the battery, the film cartridge symbol will blink. Film transport resumes after a new battery is loaded and the film rewind button pressed.

TYPE AND MAJOR COMPONENTS

Type: 35mm focal plane shutter SLR (single-lens reflex) camera with autofocus, auto exposure, built-in flash and built-in motor drive.

Lens Mount: Canon EF mount (electronic signal transfer system)

Usable Lenses: Canon EF lenses

Viewfinder: Fixed eye-level pentaprism. Gives 90% vertical and horizontal coverage of actual picture area and 0.75x magnification with 50mm lens at infinity.

Dioptic Adjustment: Built-in eyepiece is adjusted to -1 diopter (eyepoint: 20 mm).

Focusing Screen: Fixed, overall matte screen with AF frame and partial metering mark.

Shutter: Vertical-travel, focal plane shutter with all speeds electronically controlled.

Shutter Speed: 1/4000 - 30 sec. and bulb. X-sync is 1/125 sec. Set in 1/2-stop increments.

AUTOFOCUS

AF Control System: TTL-SIR (Secondary Image Registration) phase detection type using Cross-type BASIS (Base-Stored Image Sensor). Two autofocus modes available: One-shot AF and AI Servo AF. Manual focusing also possible.

AF Working Range: EV 0 - 18 at ISO 100.

AF Auxiliary Light: Automatically projected when necessary.

EXPOSURE CONTROL

Light Metering: TTL full-aperture metering using a 6-zone SPC (silicon photocell). Three metering modes available: evaluative metering, partial metering (covers approx. 6.5% of the central picture area) and center-weighted average metering.

Metering Range: EV -1 to 20 (with 50mm f/1.4 lens) at ISO 100 (normal temperature).

Shooting Modes:

1. Program AE
2. Shutter-priority AE
3. Aperture-priority AE
4. Depth-of-field AE
5. Full Auto
6. Bar-code program mode
7. Programmed Image Control (Portrait, Landscape, Close-up, Sports)
8. Flash AE (A-TTL or TTL program flash AE with built-in flash or dedicated speedlite)
9. Manual exposure

Camera Shake Warning: Operates in Full Auto, Program AE, Aperture-priority AE, Depth-of-field AE, Programmed Image Control, and bar-code program modes. Camera-shake indicator blinks in viewfinder when automatically-set shutter speed becomes 0 to 0.5 stops slower than "1/focal length of the lens in use."

Multiple Exposures: Up to nine exposures can be preset. Automatically clears upon completion.

Exposure Compensation: +/– 2 stops in 1/2-stop increments.

Auto Exposure Bracketing: +/– 2 stops in 1/2-stop increments. Three continuous exposures are taken in sequence: one under, one at the standard metered value, and one over.

FILM TRANSPORT

Film Speed Setting: Automatically set according to DX code (ISO 25-5000) or set by user (ISO 6-6400).

Film Loading: Automatic. Film automatically advances to first frame when back cover is closed.

Film Wind: Automatic using dedicated miniature motor. Two modes are available: single exposure and continuous exposure (3 fps maximum).

Film Rewind: Automatic rewind at end of roll.

OTHER

Self-timer: Electronically controlled with a 10-sec. delay.

Remote Control: Possible using optional remote control unit.

Custom Function Control: Seven built-in custom functions selectable by user.

POWER SOURCE

Battery: One six-volt lithium battery (2CR5).

Battery Check: Battery automatically checked when command dial moved to position other than "L". Battery condition indicator displayed on LCD panel.

SIZE

Dimensions: 154.2 (W) × 105.0 (H) × 69.1 (D) mm/
6-1/16" × 4-1/8" × 2-3/4"

Weight: 575 g/20.3 oz without battery (body only)

BUILT-IN FLASH

Type: Retractable type TTL automatic zoom flash housed in pentaprism. Series control system.

Guide Number (ISO 100, m/ft): 12/40 (28mm) to 17/60 (80mm)

Flash Coverage Angle: Automatically zooms to cover the field of view of 28mm, 50mm and 80mm focal lengths.

Recycling Time: Approx. 2 sec.

Flash Contacts: X-sync contact. Directly coupled contacts provided on accessory shoe. Red-eye reduction, 2nd. curtain sync, flash output compensation.

EF 28-80mm f/3.5-5.6 USM ZOOM LENS

Field of View	Diagonal	75° - 30°
	Vertical	46° - 17°
	Horizontal	65° - 25°
Optical Construction	10 elements in 9 groups	
Minimum Aperture	22 - 38	
Shooting Distance	0.8 m (macro: 0.5 m) to infinity	
Maximum Magnification and Field of View	28mm: 0.04 (macro: 0.069) 612 × 940 mm (macro: 357 × 550 mm)	
	80mm: 0.106 (macro: 0.182) 225 × 337 mm (macro: 131 × 196 mm)	
Filter Size	58 mm	
Hood	EW-68A	
Length × Max. Diameter	77.5 × 72 mm	
Weight	330 gr	
Case (hard case)	LH-B12	

When attaching a lens cap or filter to the EF 28-80mm f/3.5-5.6 USM, turn the zoom ring to either the WIDE (28mm) or TELE (80mm) position before attaching the cap or filter.

A polarizing filter can only be used at the WIDE and TELE positions.

All data based on Canon's Standard Test Method. Subject to change without notice.