

MX490 series Online Manual

Read Me First
Useful Functions Available on the Machine
Overview of the Machine
Printing
Copying
Scanning
Faxing
Troubleshooting

Contents

Read Me First.	18
How to Use the Online Manual.	19
Trademarks and Licenses.	20
Search Tips.	24
Notes on Operation Explanations.	26
Useful Functions Available on the Machine.	27
Connect Wirelessly with Ease in "Access Point Mode".	28
Print Photos Easily Using My Image Garden.	29
Download a Variety of Content Materials.	31
Print Items with Easy-PhotoPrint+ (Web Application).	32
Connection Methods Available on the Machine.	33
Connection without Using a Wireless Router (Windows XP).	35
Restrictions.	38
Notice for Web Service Printing.	40
Using PIXMA Cloud Link.	42
Using PIXMA Cloud Link from Your Smartphone, Tablet, or Computer.	43
Before Using Canon Inkjet Cloud Printing Center.	44
Requirements for Canon Inkjet Cloud Printing Center operation.	45
Preparations Before Using Canon Inkjet Cloud Printing Center.	46
Printing Your Printer registration ID.	53
Canon Inkjet Cloud Printing Center window.	54
Using Canon Inkjet Cloud Printing Center.	70
Adding a Printer.	74
Adding a PIXMA Cloud Link User.	76
Troubleshooting Canon Inkjet Cloud Printing Center.	81
Printing with Google Cloud Print.	83
Preparations for Printing with Google Cloud Print.	84
Printing from Computer or Smartphone with Google Cloud Print.	88
Printing from AirPrint Compliant Device.	90
Checking Printer Information.	95
Online Storage Integration Function.	97
Print Easily from a Smartphone or Tablet with PIXMA Printing Solutions.	98

Printing with Windows RT.	99
Overview of the Machine.	100
Safety Guide.	101
Safety Precautions.	102
Regulatory and Safety Information.	103
Main Components and Basic Operations.	109
Main Components.	110
Front View.	111
Rear View.	113
Inside View.	114
Operation Panel.	115
About the Power Supply of the Machine.	117
Confirming that the Power Is On.	118
Turning the Machine On and Off.	119
Notice for the Power Plug/Power Cord.	120
Notice for Unplugging the Power Cord.	121
LCD and Operation Panel.	122
Entering Numbers, Letters, and Symbols.	124
Loading Paper / Originals.	126
Loading Paper.	127
Loading Plain Paper / Photo Paper.	128
Loading Envelopes.	133
Media Types You Can Use.	138
Paper Load Limit.	140
Media Types You Cannot Use.	142
Printing Area.	143
Printing Area.	144
Other Sizes than Letter, Legal, Envelopes.	145
Letter, Legal.	146
Envelopes.	147
Loading Originals.	148
Position to Load Originals.	149
Loading Originals on the Platen Glass.	150
Loading Documents in the ADF (Auto Document Feeder).	151
How to Load Originals for Each Function.	152
Originals You Can Load.	154

Replacing a FINE Cartridge.	156
Replacing a FINE Cartridge.	157
Checking the Ink Status.	163
Checking the Ink Status with the LCD on the Machine.	164
Maintenance.	165
When Printing Becomes Faint or Colors Are Incorrect.	166
Maintenance Procedure.	167
Printing the Nozzle Check Pattern.	169
Examining the Nozzle Check Pattern.	170
Cleaning the Print Head.	171
Cleaning the Print Head Deeply.	172
Aligning the Print Head.	173
Performing Maintenance from a Computer.	176
Cleaning the Print Heads from Your Computer.	177
Aligning the Print Head.	179
Aligning the Print Head Position from Your Computer.	180
Aligning the Print Head Position Automatically from Your Computer.	184
Use Your Computer to Print a Nozzle Check Pattern.	186
Cleaning the Machine.	187
Cleaning the Exterior of the Machine.	188
Cleaning the Platen Glass and Document Cover.	189
Cleaning the ADF (Auto Document Feeder).	190
Cleaning the Paper Feed Roller.	192
Cleaning the Inside of the Machine (Bottom Plate Cleaning).	193
Changing the Machine Settings.	195
Changing Machine Settings from Your Computer.	196
Changing the Print Options.	197
Registering a Frequently Used Printing Profile.	198
Setting the Ink Cartridge to be Used.	200
Managing the Printer Power.	201
Reducing the Printer Noise.	203
Changing the Printer Operation Mode.	204
Changing the Machine Settings on the LCD.	206
Changing the Machine Settings on the LCD.	207
Fax settings.	208
Output settings.	212
LAN settings.	213

Dev. user settings.	215
Firmware update.	217
Cassette settings.	218
Reset setting.	219
About Quiet setting.	220
Using the Machine with the Access Point Mode.	221
Information about Network Connection.	224
Useful Information about Network Connection.	225
Default Values Set at Factory (Network).	226
Connecting the Machine to the Computer Using a USB Cable.	227
When Detecting the Printers Have the Same Name during Setup.	228
Connecting to Other Computer with LAN/Changing the Connection Method from USB to LAN.	229
Printing Out Network Setting Information.	230
About Network Communication.	232
Changing and Confirming Network Settings.	233
IJ Network Tool.	234
Changing the Settings in the Wireless LAN Sheet.	235
Changing the WEP Detailed Settings.	237
Changing the WPA/WPA2 Detailed Settings.	239
Changing the Settings in the Wired LAN Sheet.	242
Changing the Settings in the Admin Password Sheet.	243
Monitoring Wireless Network Status.	244
Initializing the Network Settings of the Machine.	247
Viewing the Modified Settings.	248
Screens for Network Connection of IJ Network Tool.	249
Canon IJ Network Tool Screen.	250
Configuration Screen.	254
Wireless LAN Sheet.	255
Search Screen.	257
WEP Details Screen.	259
WPA/WPA2 Details Screen.	260
Authentication Type Confirmation Screen.	261
PSK:Passphrase and Dynamic Encryption Setup Screen.	262
Setup Information Confirmation Screen.	263
Wired LAN Sheet.	264
Admin Password Sheet.	265
Network Information Screen.	266
Access Control Sheet.	267

Edit Accessible MAC Address Screen/Add Accessible MAC Address Screen.	271
Edit Accessible IP Address Screen/Add Accessible IP Address Screen.	272
Other Screens of IJ Network Tool.	273
Canon IJ Network Tool Screen.	274
Status Screen.	278
Connection Performance Measurement Screen.	279
Maintenance Screen.	281
Network Setup of the Card Slot Screen.	282
Associate Port Screen.	284
Network Information Screen.	285
Appendix for Network Communication.	286
Using the Card Slot over a Network.	287
When the Printer Driver Is Not Associated with a Port.	289
About Technical Terms.	290
Restrictions.	296
About Firewall.	297
Tips for Ensuring Optimal Printing Quality.	298
Useful Information about Ink.	299
Key Points to Successful Printing.	300
Be Sure to Check Paper Settings before Printing.	301
Be Sure to Set Cassette Paper Information after Loading Paper.	302
Canceling a Print Job.	303
Storing Printed Images.	304
Key to Enjoying Consistent Printing Quality.	305
Precautions for Safe Transport of the Machine.	306
Legal Limitations on Use of Your Product and Use of Images.	308
Specifications.	309
About the Administrator Password.	314
List of Function for Each Model.	315
Printing.	318
Printing from a Computer.	319
Printing with Application Software that You are Using (Printer Driver).	320
Printing with Easy Setup.	321
Paper Settings on the Printer Driver and the Printer (Media Type).	324
Paper Settings on the Printer Driver and the Printer (Paper Size).	325
Various Printing Methods.	326

Setting a Page Size and Orientation.	327
Setting the Number of Copies and Printing Order.	328
Setting the Stapling Margin.	330
Execute Borderless Printing.	332
Fit-to-Page Printing.	335
Scaled Printing.	337
Page Layout Printing.	340
Tiling/Poster Printing.	342
Booklet Printing.	345
Duplex Printing.	347
Stamp/Background Printing.	349
Registering a Stamp.	352
Registering Image Data to be Used as a Background.	355
Setting Up Envelope Printing.	358
Displaying the Print Results before Printing.	360
Setting Paper Dimensions (Custom Size).	361
Editing the Print Document or Reprinting from the Print History.	363
Changing the Print Quality and Correcting Image Data.	366
Setting the Print Quality Level (Custom).	367
Printing a Color Document in Monochrome.	369
Specifying Color Correction.	370
Optimal Photo Printing of Image Data.	372
Adjusting Colors with the Printer Driver.	373
Printing with ICC Profiles.	375
Adjusting Color Balance.	378
Adjusting Color Balance Using Sample Patterns (Printer Driver).	380
Adjusting Brightness.	384
Adjusting Intensity.	386
Adjusting Contrast.	388
Adjusting Intensity/Contrast Using Sample Patterns (Printer Driver).	390
Overview of the Printer Driver.	394
Canon IJ Printer Driver.	395
How to Open the Printer Driver Setup Window.	396
Canon IJ Status Monitor.	397
Checking the Ink Status from Your Computer.	398
Canon IJ Preview.	399
Deleting the Undesired Print Job.	400
Instructions for Use (Printer Driver).	401
Printer Driver Description.	403

Quick Setup tab Description.	404
Main tab Description.	410
Page Setup tab Description.	416
Maintenance tab Description.	428
Canon IJ Preview Description.	435
Canon IJ XPS Preview Description.	438
Canon IJ Status Monitor Description.	446
Updating the MP Drivers.	448
Obtaining the Latest MP Drivers.	449
Deleting the Unnecessary MP Drivers.	450
Before Installing the MP Drivers.	451
Installing the MP Drivers.	452
Printing Using the Operation Panel of the Machine.	453
Printing Template Forms Such As Lined Paper or Graph Paper.	454
Paper setting for Printing.	457
Copying.	460
Making Copies.	461
Setting Items for Copying.	463
Reducing or Enlarging a Copy.	465
About Special copy Menu.	466
Copying Two Pages to Fit onto a Single Page.	467
Copying Four Pages to Fit onto a Single Page.	469
Copying Thick Originals Such as Books.	471
Copying without Borders.	472
Collated Copying.	474
Scanning.	475
Scanning from a Computer.	476
Scanning with IJ Scan Utility.	477
What Is IJ Scan Utility (Scanner Software)?.	478
Starting IJ Scan Utility.	480
Easy Scanning with Auto Scan.	481
Scanning Documents.	482
Scanning Photos.	483
Scanning with Favorite Settings.	484
Scanning Items Larger than the Platen (Image Stitch).	485

Scanning Multiple Items at One Time.	489
Scanning Multiple Documents at One Time from the ADF (Auto Document Feeder).	492
Saving after Checking Scan Results.	496
Sending Scanned Images via E-mail.	499
Extracting Text from Scanned Images (OCR).	502
IJ Scan Utility Screens.	505
IJ Scan Utility Main Screen.	506
Settings Dialog Box.	508
Save Settings Dialog Box.	552
Image Stitch Window.	555
Scanning with Application Software that You are Using (ScanGear).	559
What Is ScanGear (Scanner Driver)?.	560
Scanning with Advanced Settings Using ScanGear (Scanner Driver).	562
Starting ScanGear (Scanner Driver).	563
Scanning in Basic Mode.	564
Scanning in Advanced Mode.	567
Scanning Multiple Documents from the ADF (Auto Document Feeder) in Advanced Mode.	569
Scanning Multiple Documents at One Time with ScanGear (Scanner Driver).	571
Correcting Images and Adjusting Colors with ScanGear (Scanner Driver).	575
Correcting Images (Unsharp Mask, Reduce Dust and Scratches, Fading Correction, etc.).	576
Adjusting Colors Using a Color Pattern.	580
Adjusting Saturation and Color Balance.	582
Adjusting Brightness and Contrast.	584
Adjusting Histogram.	586
Adjusting Tone Curve.	590
Setting Threshold.	593
ScanGear (Scanner Driver) Screens.	594
Basic Mode Tab.	595
Advanced Mode Tab.	602
Input Settings.	608
Output Settings.	611
Image Settings.	614
Color Adjustment Buttons.	619
Preferences Dialog Box.	622
Scanner Tab.	623
Preview Tab.	626
Scan Tab.	628
Color Settings Tab.	629

Placing Items (When Scanning from a Computer)	631
Adjusting Cropping Frames (ScanGear)	634
General Notes (Scanner Driver)	638
Useful Information on Scanning	640
Adjusting Cropping Frames in the Image Stitch Window	641
Resolution	642
Data Formats	644
Color Matching	645
IJ Network Scanner Selector EX Menu and Setting Screen	646
Uninstalling IJ Network Scanner Selector EX	649
Other Scanning Methods	650
Scanning with WIA Driver	651
Scanning Using the Control Panel (Windows XP Only)	655
Placing Items (When Scanning from a Computer)	657
Scanning from the Operation Panel of the Machine	660
Forwarding Scanned Data to the Computer Using the Operation Panel of the Machine	661
Setting Items for Scanning Using the Operation Panel of the Machine	665
Network Scan Settings	667
Selecting a Response to Commands from the Operation Panel Using IJ Scan Utility	671
Faxing	675
Preparing for Faxing	676
Connecting the Telephone Line	677
Setting the Telephone Line Type	680
Setting the Receive Mode	682
Setting the Sender Information	686
Sending Faxes Using the Operation Panel of the Machine	690
Sending Faxes by Entering Fax/Telephone Number	691
Resending Faxes (Redialing a Busy Number)	693
Setting Items for Sending Faxes	695
Sending Faxes Using Useful Functions	697
Sending a Fax after Speaking on Telephone	698
Sending a Fax to the Registered Recipient	700
Sending the Same Document to Several Recipients (Sequential Broadcasting)	702
Preventing Mistransmission of Faxes	704
Using the On Hook Dial Function	706
Registering Recipients	708

Registering Recipients Using the Operation Panel of the Machine.	709
Registering the Fax/Telephone Number of Recipients.	710
Registering Recipients in Group Dial.	713
Changing Registered Information.	715
Deleting Registered Information.	717
Printing a List of the Registered Destinations.	718
Registering Recipients Using Speed Dial Utility.	719
Starting Up Speed Dial Utility.	720
Speed Dial Utility Dialog box.	721
Saving Registered Information on the Machine to Your Computer.	723
Registering a Fax/telephone Number Using Speed Dial Utility.	724
Changing a Fax/telephone Number Using Speed Dial Utility.	726
Deleting a Fax/telephone Number Using Speed Dial Utility.	728
Changing Sender Information Using Speed Dial Utility.	729
Registering/Changing Rejected Number Using Speed Dial Utility.	730
Calling the Registered Information Up from Your Computer and Registering the Information to the Machine.	731
Uninstalling Speed Dial Utility.	732
Receiving Faxes.	733
Receiving Faxes.	734
Changing the Paper Settings.	738
Memory Reception.	740
Receiving Faxes Using Useful Functions.	742
Remote Reception.	743
Rejecting Fax Reception.	744
Using the Caller ID Service to Reject Calls.	747
Other Useful Fax Functions.	748
Using the Information Services.	749
Transmission/Reception of Faxes Using ECM.	751
Document Stored in Machine's Memory.	752
Printing a Document in Machine's Memory.	753
Deleting a Document in Machine's Memory.	755
Summary of Reports and Lists.	757
Sending Faxes from a Computer.	762
Sending a FAX (Fax Driver).	763
Creating an Address Book (Fax Driver).	766
Setup when Opening the Address Book for the First Time (Windows XP).	770

How to Open the Setting Screen of the Fax Driver.	771
Edit or Remove a Recipient from an Address Book (Fax Driver).	773
Search for a Recipient in an Address Book (Fax Driver).	776
Troubleshooting Problems Sending Faxes (Fax Driver).	778
General Notes (Fax Driver).	780
Troubleshooting.	781
Problems with Network Communication.	782
Cannot Detect a Machine on a Network.	783
Cannot Detect the Machine when Setting Up Network Communication.	784
Cannot Detect the Machine during Wireless LAN Setup: Check 1.	785
Cannot Detect the Machine during Wireless LAN Setup: Check 2.	786
Cannot Detect the Machine during Wireless LAN Setup: Check 3.	787
Cannot Detect the Machine during Wireless LAN Setup: Check 4.	788
Cannot Detect the Machine during Wireless LAN Setup: Check 5.	789
Cannot Detect the Machine during Wireless LAN Setup: Check 6.	790
The Machine Cannot Be Detected in the Wireless LAN.	791
Problems with the Machine while Using with Network.	793
The Machine Stopped Working Suddenly.	794
Forgot a Wireless Router Name, SSID, or a Network Key.	798
The Administrator Password Set to the Machine Was Forgotten.	800
Cannot Use the Machine on Replacing a Wireless Router or Changing Its Settings.	801
Printing Speed Is Slow.	803
Ink Remaining Level Is Not Displayed on Printer Status Monitor of the Machine.	804
Other Problems with Network.	805
The Message Is Displayed on the Computer Screen during Setup.	806
Packets Are Sent Steadily.	808
Checking Information about the Network.	809
How to Restore the Machine's Network Settings to Factory Default.	811
Problems while Printing/Scanning from Smartphone/Tablet.	812
Cannot Print/Scan from Smartphone/Tablet.	813
Problems with Printing.	816
Printing Does Not Start.	817
Paper Jams.	820
Print Results Not Satisfactory.	821
Cannot Print to End of Job.	823
No Printing Results/Printing Is Blurred/Colors Are Wrong/White Streaks.	824

Colors Are Unclear.	827
Lines Are Misaligned.	828
Line Does Not Print or Prints Partially.	829
Image Does Not Print or Prints Partially.	830
Printed Paper Curls or Has Ink Blots.	831
Paper Is Smudged/Printed Surface Is Scratched.	832
Back of the Paper Is Smudged.	836
Vertical Lines Are Printed on the Sides of the Printout.	837
Colors Are Uneven or Streaked.	838
Ink Is Not Ejected.	840
Paper Does Not Feed Properly/"No Paper" Error Occurs.	841
Copying/Printing Stops Before It Is Completed.	843
Problems with Scanning.	844
Problems with Scanning.	845
Scanner Does Not Work.	846
ScanGear (Scanner Driver) Does Not Start.	847
Error Message Appears and the ScanGear (Scanner Driver) Screen Does Not Appear.	848
Cannot Scan Multiple Items at One Time.	849
Cannot Scan Properly with Auto Scan.	850
Slow Scanning Speed.	851
"There is not enough memory." Message Is Displayed.	852
Computer Stops Operating during Scanning.	853
Scanner Does Not Work after Upgrading Windows.	854
Scanned Image Does Not Open.	856
Scan Results Not Satisfactory.	857
Scan Quality (Image Displayed on the Monitor) Is Poor.	858
Scanned Image Is Surrounded by Extra White Areas.	860
Cannot Scan at the Correct Size.	861
Position or Size of the Image Cannot be Detected Correctly When Scanning from the Operation Panel.	862
Item Is Placed Correctly, but the Scanned Image Is Slanted.	863
Scanned Image Is Enlarged (Reduced) on the Computer Monitor.	864
Software Problems.	865
The E-mail Client You Want to Use Does Not Appear in the Screen for Selecting an E-mail Client.	866
Problems with Faxing.	867
Problems Sending Faxes.	868
Cannot Send a Fax.	869

Cannot Perform Sequential Broadcasting by Redialing, or Cannot Dial by Entering the Numbers	871
Errors Often Occur When You Send a Fax.	872
Problems Receiving Faxes.	873
Cannot Receive a Fax, Cannot Print a Fax.	874
Machine Does Not Switch Automatically between Voice and Fax Calls.	876
Quality of Received Fax is Poor.	877
Cannot Receive a Color Fax.	878
Errors Often Occur When You Receive a Fax.	879
Cannot Send a Fax Clearly.	880
Telephone Problems.	881
Cannot Dial.	882
Telephone Disconnects During a Call.	883
Problems with the Machine.	884
The Machine Cannot Be Powered On.	885
The Machine Turns Off Unintentionally.	886
Cannot Connect to Computer with a USB Cable Properly.	887
Cannot Communicate with the Machine with USB Connection.	888
LCD Cannot Be Seen At All.	889
An Unintended Language Is Displayed on the LCD.	890
FINE Cartridge Holder Does Not Move to the Position for Replacing.	891
Printer Status Monitor Is Not Displayed.	892
Problems with Installation/Downloading.	893
Cannot Install the MP Drivers.	894
Easy-WebPrint EX Does Not Start Up or Easy-WebPrint EX Menu Does Not Appear.	897
How to Update MP Drivers in Network Environment.	898
Uninstalling IJ Network Tool.	899
About Errors/Messages Displayed.	900
If an Error Occurs.	901
A Message for Faxing Is Displayed on the Fax Standby Screen.	902
A Message Is Displayed.	905
If You Cannot Resolve the Problem.	911
List of Support Code for Error.	912
List of Support Code for Error (When Paper Is Jammed).	914
1300.	915
1303.	917
2801.	919

Paper Is Jammed inside the Machine.	922
In Other Cases.	925
1003.	926
1200.	927
1203.	928
1250.	929
1401.	930
1403.	931
1485.	932
1682.	933
1684.	934
1686.	935
1688.	936
168A.	937
1702.	938
1703.	939
1704.	940
1705.	941
1712.	942
1713.	943
1714.	944
1715.	945
1871.	946
1890.	947
2110.	948
2120.	951
2700.	952
2802.	953
2803.	954
2900.	957
2901.	958
4100.	959
4103.	960
5011.	961
5012.	962

5040.	963
5100.	964
5200.	965
5400.	966
5B02.	967
5B03.	968
5B04.	969
5B05.	970
5B12.	971
5B13.	972
5B14.	973
5B15.	974
6000.	975
6500.	976
6800.	977
6801.	978
6900.	979
6901.	980
6902.	981
6910.	982
6911.	983
6930.	984
6931.	985
6932.	986
6933.	987
6936.	988
6937.	989
6938.	990
6939.	991
693A.	992
6940.	993
6941.	994
6942.	995
6943.	996

6944.....	997
6945.....	998
6946.....	999
9500.....	1000
B201.....	1001
B202.....	1002
B203.....	1003
B204.....	1004

Read Me First

■ [Notes on Online Manual Usage](#)

■ [How to Print](#)

Notes on Online Manual Usage

- Reproduction, diversion or copying of any text, photo or image published in the *Online Manual* (hereinafter referred to as "this guide"), in whole or in part, is prohibited.
- In principle, Canon shall change or delete the contents of this guide without prior notice to customers. In addition, Canon may suspend or stop the disclosure of this guide due to unavoidable reasons. Canon shall not be liable for any damage suffered by customers as a result of changes in or deletion of information in this guide, or suspension/stoppage of disclosure of this guide.
- Although the contents of this guide have been prepared with utmost care, please contact the service center if you find any incorrect or missing information.
- In principle, the descriptions in this guide are based on the product at the time of its initial sale.
- This guide does not disclose the manuals of all the products sold by Canon. See the manual supplied with the product when using a product that is not described in this guide.

How to Print

Use the print function of your Web browser to print this guide.

To set to print background colors and images, follow the steps below.

▶▶ Note

- In Windows 8, print in the desktop version.

- **In Internet Explorer 9, 10, or 11**

1. Select  (Tools) > **Print** > **Page setup...**
2. Select the **Print Background Colors and Images** checkbox.

- **In Internet Explorer 8**

1. Press the Alt key to display the menus.
Alternatively, from **Tools**, select **Toolbars** > **Menu Bar** to display the menus.
2. Select **Page Setup...** from the **File** menu.
3. Select the **Print Background Colors and Images** checkbox.

- **In Mozilla Firefox**

1. Press the Alt key to display the menus.
Alternatively, click **Firefox**, then select **Menu Bar** from the right arrow of **Options** to display the menus.
2. Select **Page Setup...** from the **File** menu.
3. Select the **Print Background (colors & images)** checkbox in **Format & Options**.

- **In Google Chrome**

1. Select  (Chrome Menu) > **Print...**
2. Select the **Background colors & images** checkbox in **Options**.

How to Use the Online Manual

Symbols Used in This Document

Warning

Instructions that, if ignored, could result in death or serious personal injury caused by incorrect operation of the equipment. These must be observed for safe operation.

Caution

Instructions that, if ignored, could result in personal injury or material damage caused by incorrect operation of the equipment. These must be observed for safe operation.

Important

Instructions including important information. To avoid damage and injury or improper use of the product, be sure to read these indications.

Note

Instructions including notes for operation and additional explanations.

Basic

Instructions explaining basic operations of your product.

Note

- Icons may vary depending on your product.

Touch-enabled Device Users

For touch actions, you need to replace "right-click" in this document with the action set on the operating system. For example, if the action is set to "press and hold" on your operating system, replace "right-click" with "press and hold."

Trademarks and Licenses

- Microsoft is a registered trademark of Microsoft Corporation.
- Windows is a trademark or registered trademark of Microsoft Corporation in the U.S. and/or other countries.
- Windows Vista is a trademark or registered trademark of Microsoft Corporation in the U.S. and/or other countries.
- Internet Explorer is a trademark or registered trademark of Microsoft Corporation in the U.S. and/or other countries.
- Mac, Mac OS, AirPort, Safari, Bonjour, iPad, iPhone and iPod touch are trademarks of Apple Inc., registered in the U.S. and other countries. AirPrint and the AirPrint logo are trademarks of Apple Inc.
- IOS is a trademark or registered trademark of Cisco in the U.S. and other countries and is used under license.
- Google Cloud Print, Google Chrome, Android, Google Play and Picasa are either registered trademarks or trademarks of Google Inc.
- Adobe, Photoshop, Photoshop Elements, Lightroom, Adobe RGB and Adobe RGB (1998) are either registered trademarks or trademarks of Adobe Systems Incorporated in the United States and/or other countries.
- Photo Rag is a trademark of Hahnemühle FineArt GmbH.
- Bluetooth is a trademark of Bluetooth SIG, Inc., U.S.A. and licensed to Canon Inc.

Note

- The formal name of Windows Vista is Microsoft Windows Vista operating system.

Copyright (c) 2003-2004, Apple Computer, Inc. All rights reserved.

Redistribution and use in source and binary forms, with or without modification, are permitted provided that the following conditions are met:

1. Redistributions of source code must retain the above copyright notice, this list of conditions and the following disclaimer.
2. Redistributions in binary form must reproduce the above copyright notice, this list of conditions and the following disclaimer in the documentation and/or other materials provided with the distribution.
3. Neither the name of Apple Computer, Inc. ("Apple") nor the names of its contributors may be used to endorse or promote products derived from this software without specific prior written permission.

THIS SOFTWARE IS PROVIDED BY APPLE AND ITS CONTRIBUTORS "AS IS" AND ANY EXPRESS OR IMPLIED WARRANTIES, INCLUDING, BUT NOT LIMITED TO, THE IMPLIED WARRANTIES OF MERCHANTABILITY AND FITNESS FOR A PARTICULAR PURPOSE ARE DISCLAIMED. IN NO EVENT SHALL APPLE OR ITS CONTRIBUTORS BE LIABLE FOR ANY DIRECT, INDIRECT, INCIDENTAL, SPECIAL, EXEMPLARY, OR CONSEQUENTIAL DAMAGES (INCLUDING, BUT NOT LIMITED TO, PROCUREMENT OF SUBSTITUTE GOODS OR SERVICES; LOSS OF USE, DATA, OR PROFITS; OR BUSINESS INTERRUPTION) HOWEVER CAUSED AND ON ANY THEORY OF LIABILITY, WHETHER IN CONTRACT, STRICT LIABILITY, OR TORT INCLUDING NEGLIGENCE OR OTHERWISE) ARISING IN ANY WAY OUT OF THE USE OF THIS SOFTWARE, EVEN IF ADVISED OF THE POSSIBILITY OF SUCH DAMAGE.

Apache License

Version 2.0, January 2004

<http://www.apache.org/licenses/>

TERMS AND CONDITIONS FOR USE, REPRODUCTION, AND DISTRIBUTION

1. Definitions.

"License" shall mean the terms and conditions for use, reproduction, and distribution as defined by Sections 1 through 9 of this document.

"Licensor" shall mean the copyright owner or entity authorized by the copyright owner that is granting the License.

"Legal Entity" shall mean the union of the acting entity and all other entities that control, are controlled by, or are under common control with that entity. For the purposes of this definition, "control" means (i) the power, direct or indirect, to cause the direction or management of such entity, whether by contract or otherwise, or (ii) ownership of fifty percent (50%) or more of the outstanding shares, or (iii) beneficial ownership of such entity.

"You" (or "Your") shall mean an individual or Legal Entity exercising permissions granted by this License.

"Source" form shall mean the preferred form for making modifications, including but not limited to software source code, documentation source, and configuration files.

"Object" form shall mean any form resulting from mechanical transformation or translation of a Source form, including but not limited to compiled object code, generated documentation, and conversions to other media types.

"Work" shall mean the work of authorship, whether in Source or Object form, made available under the License, as indicated by a copyright notice that is included in or attached to the work (an example is provided in the Appendix below).

"Derivative Works" shall mean any work, whether in Source or Object form, that is based on (or derived from) the Work and for which the editorial revisions, annotations, elaborations, or other modifications represent, as a whole, an original work of authorship. For the purposes of this License, Derivative Works shall not include works that remain separable from, or merely link (or bind by name) to the interfaces of, the Work and Derivative Works thereof.

"Contribution" shall mean any work of authorship, including the original version of the Work and any modifications or additions to that Work or Derivative Works thereof, that is intentionally submitted to Licensor for inclusion in the Work by the copyright owner or by an individual or Legal Entity authorized to submit on behalf of the copyright owner. For the purposes of this definition, "submitted" means any form of electronic, verbal, or written communication sent to the Licensor or its representatives, including but not limited to communication on electronic mailing lists, source code control systems, and issue tracking systems that are managed by, or on behalf of, the Licensor for the purpose of discussing and improving the Work, but excluding communication that is conspicuously marked or otherwise designated in writing by the copyright owner as "Not a Contribution."

"Contributor" shall mean Licensor and any individual or Legal Entity on behalf of whom a Contribution has been received by Licensor and subsequently incorporated within the Work.

2. Grant of Copyright License. Subject to the terms and conditions of this License, each Contributor hereby grants to You a perpetual, worldwide, non-exclusive, no-charge, royalty-free, irrevocable copyright license to reproduce, prepare Derivative Works of, publicly display, publicly perform, sublicense, and distribute the Work and such Derivative Works in Source or Object form.
3. Grant of Patent License. Subject to the terms and conditions of this License, each Contributor hereby grants to You a perpetual, worldwide, non-exclusive, no-charge, royalty-free, irrevocable (except as stated in this section) patent license to make, have made, use, offer to sell, sell, import, and otherwise transfer the Work, where such license applies only to those patent claims licensable by such Contributor that are necessarily infringed by their Contribution(s) alone or by combination of

their Contribution(s) with the Work to which such Contribution(s) was submitted. If You institute patent litigation against any entity (including a cross-claim or counterclaim in a lawsuit) alleging that the Work or a Contribution incorporated within the Work constitutes direct or contributory patent infringement, then any patent licenses granted to You under this License for that Work shall terminate as of the date such litigation is filed.

4. Redistribution. You may reproduce and distribute copies of the Work or Derivative Works thereof in any medium, with or without modifications, and in Source or Object form, provided that You meet the following conditions:
 1. You must give any other recipients of the Work or Derivative Works a copy of this License; and
 2. You must cause any modified files to carry prominent notices stating that You changed the files; and
 3. You must retain, in the Source form of any Derivative Works that You distribute, all copyright, patent, trademark, and attribution notices from the Source form of the Work, excluding those notices that do not pertain to any part of the Derivative Works; and
 4. If the Work includes a "NOTICE" text file as part of its distribution, then any Derivative Works that You distribute must include a readable copy of the attribution notices contained within such NOTICE file, excluding those notices that do not pertain to any part of the Derivative Works, in at least one of the following places: within a NOTICE text file distributed as part of the Derivative Works; within the Source form or documentation, if provided along with the Derivative Works; or, within a display generated by the Derivative Works, if and wherever such third-party notices normally appear. The contents of the NOTICE file are for informational purposes only and do not modify the License. You may add Your own attribution notices within Derivative Works that You distribute, alongside or as an addendum to the NOTICE text from the Work, provided that such additional attribution notices cannot be construed as modifying the License.

You may add Your own copyright statement to Your modifications and may provide additional or different license terms and conditions for use, reproduction, or distribution of Your modifications, or for any such Derivative Works as a whole, provided Your use, reproduction, and distribution of the Work otherwise complies with the conditions stated in this License.

5. Submission of Contributions. Unless You explicitly state otherwise, any Contribution intentionally submitted for inclusion in the Work by You to the Licensor shall be under the terms and conditions of this License, without any additional terms or conditions. Notwithstanding the above, nothing herein shall supersede or modify the terms of any separate license agreement you may have executed with Licensor regarding such Contributions.
6. Trademarks. This License does not grant permission to use the trade names, trademarks, service marks, or product names of the Licensor, except as required for reasonable and customary use in describing the origin of the Work and reproducing the content of the NOTICE file.
7. Disclaimer of Warranty. Unless required by applicable law or agreed to in writing, Licensor provides the Work (and each Contributor provides its Contributions) on an "AS IS" BASIS, WITHOUT WARRANTIES OR CONDITIONS OF ANY KIND, either express or implied, including, without limitation, any warranties or conditions of TITLE, NON-INFRINGEMENT, MERCHANTABILITY, or FITNESS FOR A PARTICULAR PURPOSE. You are solely responsible for determining the appropriateness of using or redistributing the Work and assume any risks associated with Your exercise of permissions under this License.
8. Limitation of Liability. In no event and under no legal theory, whether in tort (including negligence), contract, or otherwise, unless required by applicable law (such as deliberate and grossly negligent acts) or agreed to in writing, shall any Contributor be liable to You for damages, including any direct, indirect, special, incidental, or consequential damages of any character arising as a result of this License or out of the use or inability to use the Work (including but not limited to damages for loss of

goodwill, work stoppage, computer failure or malfunction, or any and all other commercial damages or losses), even if such Contributor has been advised of the possibility of such damages.

9. **Accepting Warranty or Additional Liability.** While redistributing the Work or Derivative Works thereof, You may choose to offer, and charge a fee for, acceptance of support, warranty, indemnity, or other liability obligations and/or rights consistent with this License. However, in accepting such obligations, You may act only on Your own behalf and on Your sole responsibility, not on behalf of any other Contributor, and only if You agree to indemnify, defend, and hold each Contributor harmless for any liability incurred by, or claims asserted against, such Contributor by reason of your accepting any such warranty or additional liability.

END OF TERMS AND CONDITIONS

Enter keywords in the search window and click  (Search).

You can search for target pages in this guide.

Entry example: "(your product's model name) load paper"

Search Tips

You can search for target pages by entering keywords in the search window.

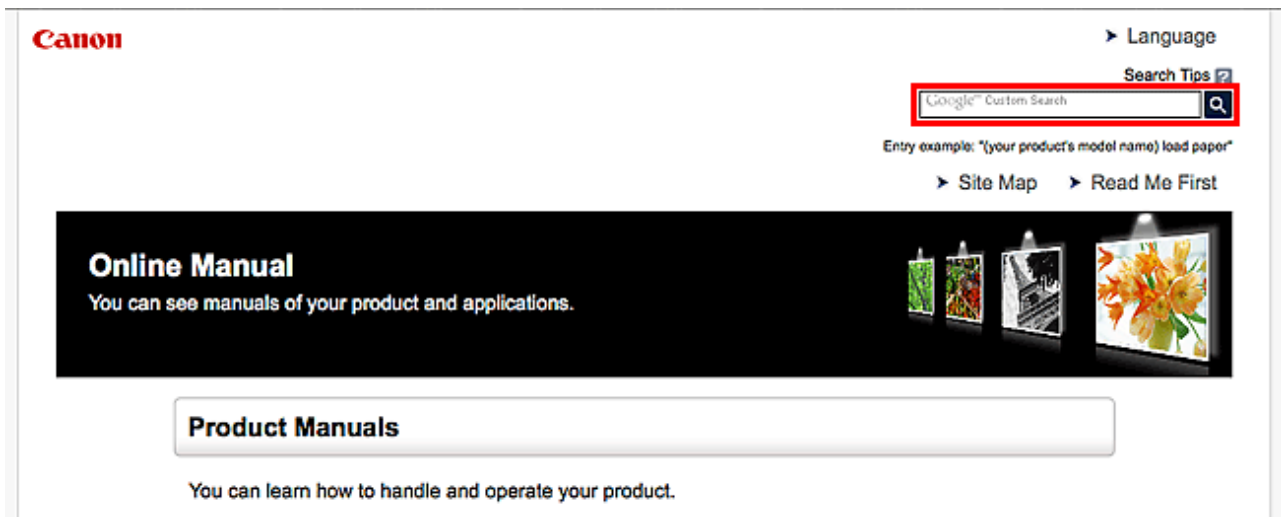

►►► Note

- The displayed screen may vary.
- When searching from this page or the "Home" page without entering your product's model name or your application's name, all products supported by this guide will be considered for the search. If you want to narrow down the search results, add your product's model name or your application's name to the keywords.

- **Searching for Functions**

Enter your product's model name and a keyword for the function you want to learn about

Example: When you want to learn how to load paper

Enter "(your product's model name) load paper" in the search window and perform a search

- **Troubleshooting Errors**

Enter your product's model name and a support code

Example: When the following error screen appears

Enter "(your product's model name) 1000" in the search window and perform a search

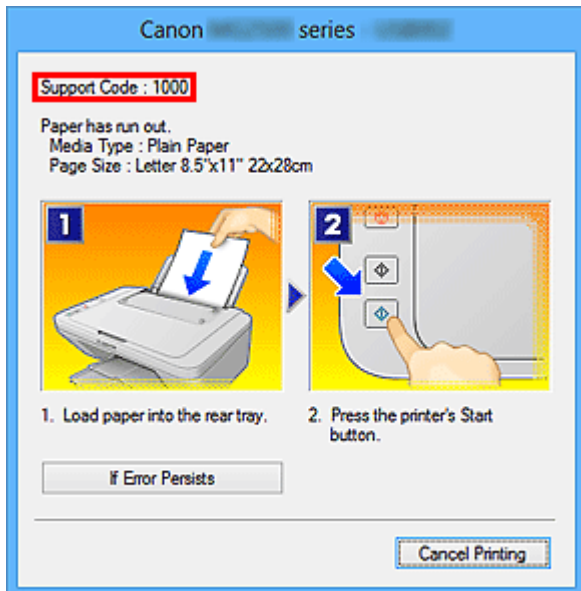

►►► Note

- The displayed screen varies depending on your product.

• Searching for Application Functions

Enter your application's name and a keyword for the function you want to learn about

Example: When you want to learn how to print collages with My Image Garden

Enter "My Image Garden collage" in the search window and perform a search

• Searching for Reference Pages

Enter your model name and a reference page title*

* You can find reference pages more easily by entering the function name as well.

Example: When you want to browse the page referred to by the following sentence on a scanning procedure page

Refer to "Color Settings Tab" for your model from Home of the *Online Manual* for details.

Enter "(your product's model name) scan Color Settings Tab" in the search window and perform a search

Notes on Operation Explanations

In this guide, most of the operations are described based on the windows displayed when Windows 8.1 operating system (called Windows 8.1 below) or Windows 8 operating system (called Windows 8 below) is used.

Useful Functions Available on the Machine

- ▶ **Connect Wirelessly with Ease in "Access Point Mode"**
- ▶ **Print Photos Easily Using My Image Garden**
- ▶ **Download a Variety of Content Materials**
- ▶ **Print Items with Easy-PhotoPrint+ (Web Application)**
- ▶ **Connection Methods Available on the Machine**
- ▶ **Using PIXMA Cloud Link**
- ▶ **Printing with Google Cloud Print**
- ▶ **Printing from AirPrint Compliant Device**
- ▶ **Checking Printer Information**
- ▶ **Online Storage Integration Function**
- ▶ **Print Easily from a Smartphone or Tablet with PIXMA Printing Solutions**
- ▶ **Printing with Windows RT**
- ▶ **Easy Scanning with Auto Scan**
- ▶ **Scanning Items Larger than the Platen (Image Stitch)**
- ▶ **Scanning Multiple Items at One Time**

Connect Wirelessly with Ease in "Access Point Mode"

The machine supports "access point mode" in which you can connect to the machine wirelessly from a computer or smartphone even in an environment without a wireless LAN router.

Switch to "access point mode" with simple steps to enjoy scanning and printing wirelessly.

When you use the machine with the access point mode, be sure to specify the access point name of the machine and the security setting in advance.

■ [Using the Machine with the Access Point Mode](#)



Print Photos Easily Using My Image Garden

Organize Images Easily

In My Image Garden, you can register the names of people and events to photos. You can organize photos easily as you can display them not only by folder but also by calendar, event, and person. This also allows you to find the target photos easily when you search for them later on.

<Calendar View>



<People View>



Display Recommended Items in Slide Shows

Based on the information registered to photos, Quick Menu automatically selects the photos on your computer and creates recommended items such as collages and cards. The created items appear in slide shows.



If there is an item you like, you can easily print it in just two steps.

1. In Image Display of Quick Menu, select the item you want to print.
2. Print the item with My Image Garden.



Place Photos Automatically

Delightful items are created easily as the selected photos are placed automatically according to the theme.



Other Various Functions

My Image Garden has many other useful functions.

Refer to "What You Can Do with My Image Garden" for details.

Download a Variety of Content Materials

CREATIVE PARK

A "printing materials site" where you can download all the printing materials for free.

Various types of content such as seasonal cards and paper crafts that can be made by assembling paper parts are provided.

It is easily accessible from Quick Menu.

CREATIVE PARK PREMIUM

A service where customers using models that support PREMIUM Contents can download exclusive printing materials.

PREMIUM Contents can be downloaded easily via My Image Garden. Downloaded PREMIUM Contents can be printed directly with My Image Garden.

To download PREMIUM Contents, make sure that genuine Canon ink tanks/ink cartridges are installed for all colors on a supported printer.



►► Note

- The designs of PREMIUM Contents provided in this page are subject to change without prior notice.

Print Items with Easy-PhotoPrint+ (Web Application)

You can easily create and print personalized items such as calendars and collages, anytime and anywhere, by simply accessing Easy-PhotoPrint+ on the web from a computer or tablet.

By using Easy-PhotoPrint+, you can create items in the latest environment without going through the trouble of installation.

Moreover, you can use various photos for your item through integration with social networks such as Facebook, or with online storage, web albums, etc.

Refer to "Easy-PhotoPrint+ Guide" for details.



Connection Methods Available on the Machine

The following connection methods are available on the machine.

Wireless Connection

With a wireless router



Without a wireless router



USB Connection



Wireless Connection

There are two methods for connecting the printer to your device (such as a smartphone). One method is to connect using a wireless router, and the other method is to connect without using a wireless router. The two connection methods cannot be used at the same time.

If you have a wireless router, it is recommended that you use the method described in Connection Using a Wireless Router.

When connecting another device while a device is already connected to the printer, connect it using the same connection method as the connected device.

If you connect using a different connection method, the connection to the device in use will be disabled.

Connection Using a Wireless Router



- Connect the printer and a device using a wireless router.
- Connection methods vary depending on the wireless router type.
- You can change network settings such as the SSID and security protocol on the printer.
- When the connection between a device and a wireless router is completed and  (Wi-Fi icon) is displayed in the device's screen, you can connect the device to the printer using the wireless router.

Connection without Using a Wireless Router



- Connect the printer and a device without using a wireless router. Connect a device and the printer directly using the printer's access point mode function.
- When establishing a connection in access point mode, Internet connection may become unavailable. In that case, web services for the printer cannot be used.
- If you connect a device connected to the Internet via a wireless router to the printer that is in access point mode, the connection between the device and wireless router will be disabled. In that case, the connection of the device may switch to a mobile data connection automatically depending on your device. Transmission fees for connecting to the Internet using a mobile data connection apply.
- In access point mode, you can connect up to five devices at the same time. If you try to connect a sixth device while five devices are already connected, an error will appear. If an error appears, disconnect a device that does not use the printer, then configure settings again.
- Network settings such as the SSID and security protocol can be changed on the printer.

When Using Windows XP:

Connection without Using a Wireless Router (Windows XP)

USB Connection

Connect the printer and a computer with a USB cable. Prepare a USB cable.

Restrictions

(Appears in a new window)

Connection without Using a Wireless Router (Windows XP)

Restrictions

(Appears in a new window)

1. Press the **Setup** button (A) on the printer.

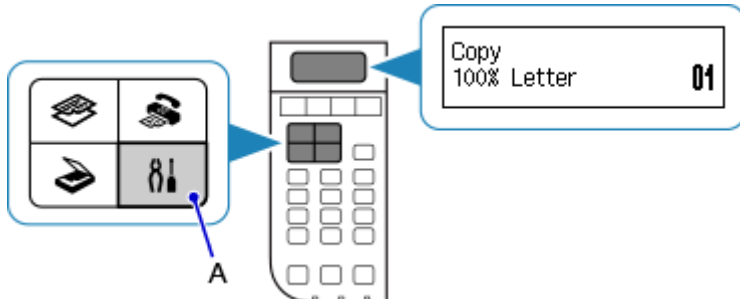

2. Use the ◀ or ▶ button (B) to select **Device settings**, then press the **OK** button.

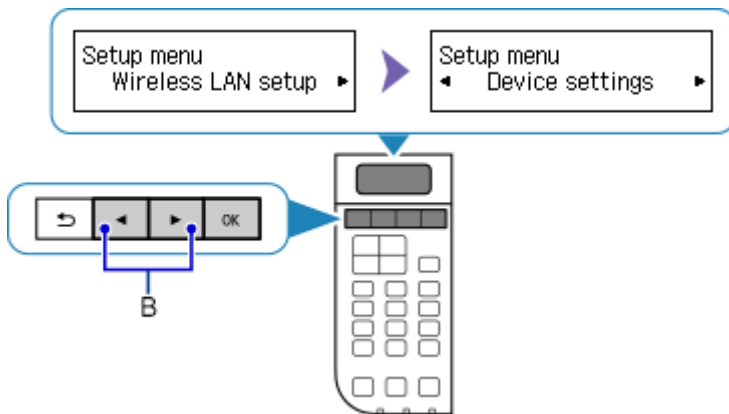

3. Select **LAN settings**, then press the **OK** button.

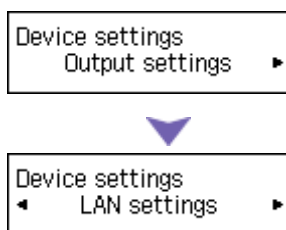

4. Select **Change LAN**, then press the **OK** button.

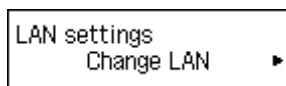

5. Select **Access point mode**, then press the **OK** button.

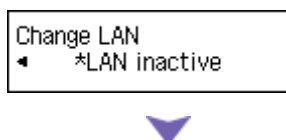

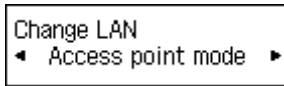

6. Select **SSID**, then press the **OK** button.

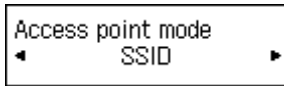
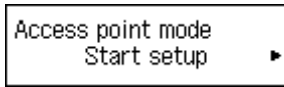

7. Check **SSID information** in the printer screen, then press the **Back** button (C).

You will use the **SSID information** in the subsequent steps.

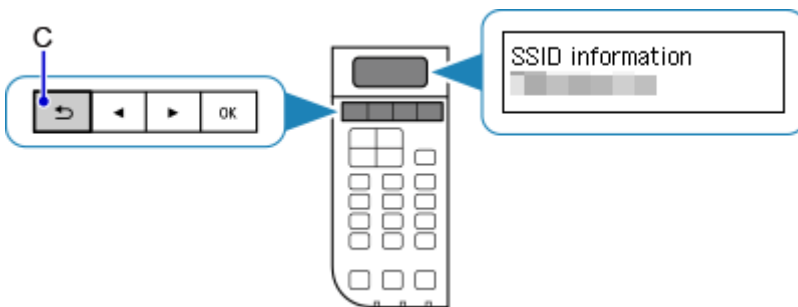

8. Select **Security protocol**, then press the **OK** button.

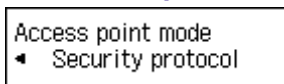
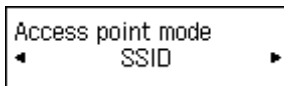

9. Check the **Password** (network key), then press the **Back** button.

You will use the **Password** (network key) in the subsequent steps.

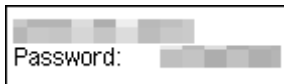

10. Select **Start setup**, then press the **OK** button.

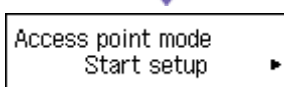
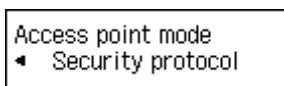

11. Right-click the **Wireless Network Connection** icon in the notification area of the taskbar on the computer, then select **View Available Wireless Networks**.



12. Select the network name (SSID) you want to use, then click **Connect**.

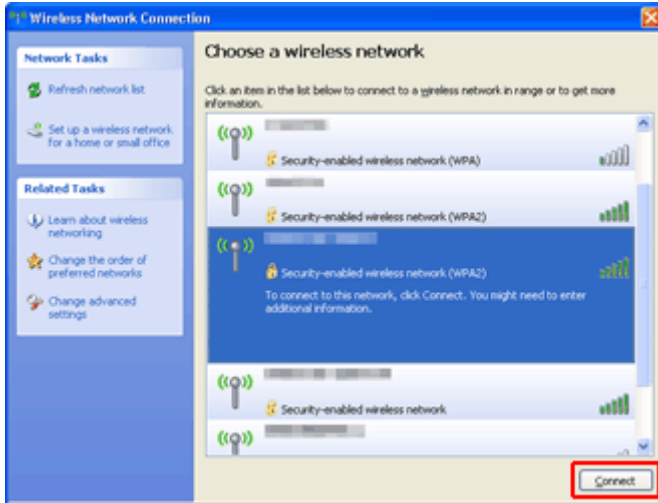

13. Enter the **Password (Network key)**, then click **Connect**.



14. When connection is complete, click **Back** until the screen below appears. Proceed with the setup.

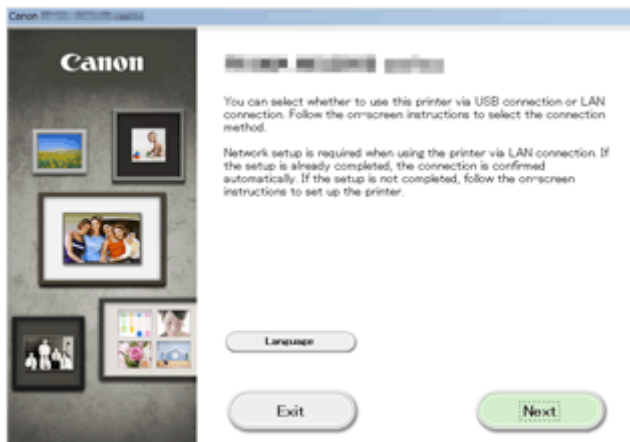

Restrictions

When connecting another device while a device (such as a smartphone) is already connected to the printer, connect it using the same connection method as the connected device.

If you connect using a different connection method, the connection to the device in use will be disabled.

Connection Using a Wired Network cannot be performed on printers that do not support a wired connection.

Connection Using a Wireless Router

- This printer cannot be used over wireless and wired connections at the same time.
- Make sure that a device and a wireless router are connected. For details on how to check the settings, refer to the manual supplied with the wireless router or contact its manufacturer.
As for a device already connected to the printer without using a wireless router, reconnect it via a wireless router.
- The configuration, router functions, setup procedures and security settings of the network device vary depending on your system environment. For details, refer to the manual of your network device or contact its manufacturer.
- Check if your device supports IEEE802.11n (2.4 GHz), IEEE802.11g or IEEE802.11b.
- If your device is set to the "IEEE802.11n only" mode, WEP or TKIP cannot be used as a security protocol. Change the security protocol for your device to something other than WEP and TKIP or change the setting to something other than "IEEE802.11n only."
The connection between your device and the wireless router will be temporarily disabled while changing the setting. Do not operate the screen of this guide until the setup is complete.
- For office use, consult your network administrator.
- Take added care when connecting to a network that is not protected with security measures, as there is a risk of disclosing data such as your personal information to a third party.

Connection without Using a Wireless Router

Important

- If you connect a device connected to the Internet via a wireless router to the printer that is in access point mode, the connection between the device and wireless router will be disabled. In that case, the connection of the device may switch to a mobile data connection automatically depending on your device. When you connect to the Internet using a mobile data connection, charges may apply depending on your contract.
 - When you connect a device and the printer in access point mode, the connection information will be saved to Wi-Fi settings. The device may be connected to the printer automatically even after disconnecting it or connecting it to another wireless router.
 - You cannot connect to a wireless router and the printer that is in access point mode at the same time. If you have a wireless router, it is recommended that you use the wireless router to connect to the printer.
 - To prevent automatic connection to the printer that is in access point mode, change the connection mode after using the printer, or set not to connect automatically in the Wi-Fi settings of the device.
For details on how to change the settings of a device, refer to the manual supplied with the device or contact its manufacturer.
- When connecting a device and the printer in access point mode, Internet connection may become unavailable. In that case, web services for the printer cannot be used.

- In access point mode, you can connect up to five devices at the same time. If you try to connect a sixth device while five devices are already connected, an error will appear.
If an error appears, disconnect a device that does not use the printer, then configure settings again.
- Devices connected to the printer in access point mode cannot communicate with each other.
- Firmware updates for the printer are not available while using the access point mode.
- When a device has been connected to the printer without using a wireless router and you want to set it up again using the same connection method, disconnect it first. Disable the connection between the device and printer in the Wi-Fi setting screen.

Connection Using a Wired Network

- This printer cannot be used over wireless and wired connections at the same time.
- When using a router, connect the printer and a device to the LAN side (same network segment).

Notice for Web Service Printing

When Using Web Service

- Canon does not guarantee the continuity and reliability of the web services provided, the availability of site access, or permission to download the materials.
- Canon may at any time update, change, or delete the information provided through the web service, or may suspend or discontinue the service without prior notice. Canon shall not be held responsible for any damages resulting from such actions.
- In no event shall Canon be liable for any damages whatsoever resulting from the use of the web services.
- User registration is necessary before using the photo sharing site.
When you use the photo sharing site, observe the conditions of use of the site and use the service within your own responsibility.
- All or part of the web service may not be available depending on the country or region you live in.
- Depending on your network environment, some functions on web service are not available. Even if they are available, it may take a while to print or display the contents, or communication may be interrupted while operation is in progress.
- When you use web service, your machine's name, information of your region or country, your selected language, and what kind of service you use (e.g. photo sharing site) are sent to and saved in our server. Canon is unable to identify specific customers using this information.
- Your login name and password for the photo sharing site are saved in the machine's memory (not encrypted).
If you hand over the machine to anyone or dispose of it, delete your login name and password from the machine's memory in advance.
- The account information will be sent to Canon Inc. server (located in Japan), then forwarded to the service provider's server.
- Canon handles your account information as follows:
 - Your account information will be used in personal identification process of the selected service.
 - Canon will not provide your account information to any third party without your consent, except for sending to the service provider or providing based on laws and regulations.
 - After the conclusion of non-disclosure agreement, Canon may deposit your account information to the contractor to achieve the purpose of use.
 - Canon endeavors to secure the safety of your account information.
 - It is at your option to enter and send your account information. However, the service that requires to enter your account information is not available unless you enter and send it.
 - Your account information does not remain in Canon Inc. server. At the latest, it will be deleted when you have disconnected your printer from LAN.
 - For details, contact a Canon-authorized sales representative in the country or region you live in.

To Those Living in Mainland China

- PIXMA/MAXIFY Cloud Link, Easy-PhotoPrint+, and some functions of PIXMA/MAXIFY Printing Solutions, which are included with this machine, are provided by Canon Inc.
However, as the server is installed outside of mainland China, some of these services may not be available yet.

Copyrights and Rights of Publicity

When printing from the photo sharing site:

- Observe the conditions of use of the photo sharing site when you use photos on the site.
- It is unlawful to reproduce or edit the copyrighted work of another person without permission from the copyright holder, except for personal use, use within the home, or other use within the limited scope as defined by the copyright. Additionally, reproducing or editing photographs of people may infringe on Rights of Publicity.

When printing downloaded template forms:

1. The copyright of each material (photos, illustrations, logos, or documents: hereinafter referred to as "the materials") provided on the web template printing service belongs to their respective owners. Issues pertaining to Rights of Publicity may arise regarding the use of any of people or characters displayed on the web template printing service.

Except as otherwise permitted (please see "2" below), copying, modifying or distributing all or a portion of any of the materials contained on the web template printing service without prior consent of the respective rights (Rights of Publicity and Copyright) holder is strictly prohibited.

2. All of the materials provided on the web template printing service can be freely used for personal and non-commercial purposes.

Using PIXMA Cloud Link

By using PIXMA Cloud Link, you can connect your printer to a cloud service, such as CANON iMAGE GATEWAY, Evernote, or Twitter, and use the following functions without using a computer:

- Print images from a photo-sharing service
- Print documents from a data management service
- Use Twitter to report the printer status, such as no paper or low ink levels.

In addition, you can use various functions by adding and registering apps that are linked with various cloud services.

■ [Using PIXMA Cloud Link from Your Smartphone, Tablet, or Computer](#)



▶▶▶ Important

- In certain countries, PIXMA Cloud Link may not be available or the available apps may be different.
- Some apps require that you have an account before you use those apps. For such apps, please set up an account beforehand.
- To find out which models support PIXMA Cloud Link check the Canon homepage.
- The screen display may change without prior notice.

Using PIXMA Cloud Link from Your Smartphone, Tablet, or Computer

- ▶ **Before Using Canon Inkjet Cloud Printing Center**
- ▶ **Preparations Before Using Canon Inkjet Cloud Printing Center**
- ▶ **Using Canon Inkjet Cloud Printing Center**
- ▶ **Adding a Printer**
- ▶ **Adding a PIXMA Cloud Link User**
- ▶ **Troubleshooting Canon Inkjet Cloud Printing Center**

Before Using Canon Inkjet Cloud Printing Center

Canon Inkjet Cloud Printing Center is a service that links with the cloud function of the printer and allows you to perform operations such as registering and managing apps from your smartphone or tablet device, and checking the print status, print error, and ink status of the printer. You can also print app photos and documents from your smartphone or tablet.

First, check the following content:

- **Precautions**

If you plan to use the web service to print documents, be sure to check these [precautions](#) beforehand.

- **Printer specification**

Check that Canon Inkjet Cloud Printing Center supports the printer.

- **Network environment**

The printer must be connected to a LAN and to the Internet.

▶▶▶ Important

- The user will bear the cost of Internet access.

- **Operating requirements**

For computers, smartphones, and tablet devices, see "[Requirements for Canon Inkjet Cloud Printing Center operation](#)".

▶▶▶ Important

- This service may not be available in certain countries or regions. Also even if the service is available, there are apps that cannot be used in certain regions.

■ [Preparations Before Using Canon Inkjet Cloud Printing Center](#)

Requirements for Canon Inkjet Cloud Printing Center operation

Computer

CPU	x86 or x64 1.6 GHz or higher
RAM	2 GB or higher
Monitor display	Resolution 1024 x 768 pixels or higher Number of display colors 24 bits (true-color) or higher

OS	Browser
Windows XP SP3 or later	Internet Explorer 8* Mozilla Firefox Google Chrome
Windows Vista SP1 or later	Internet Explorer 8*, 9 Mozilla Firefox Google Chrome
Windows 7	Internet Explorer 8*, 9, 10, 11 Mozilla Firefox Google Chrome
Windows 8	Internet Explorer 10 Mozilla Firefox Google Chrome
Windows 8.1	Internet Explorer 11 Mozilla Firefox Google Chrome
Mac OS X v10.6-OS X Mavericks v10.9	Safari 5.1, 6, 7

* When you use Internet Explorer 8, the web pages may not display correctly. Canon recommends that you upgrade to Internet Explorer 9 or later, or use another browser.

Smartphone or tablet

OS	Browser	Resolution
iOS 5.1 or later	OS standard browser	320 x 480 (HVGA) or higher
Android 2.3.3 or later		480 x 800 (HVGA) or higher

*Android3.x is not supported.

Important

- On the browser you are using, enable JavaScript and cookies.
- If you use the zoom function or change the font size on your browser, the web pages may not display correctly.
- If you use the translation function of Google Chrome, the web pages may not display correctly.
- If you use a proxy server outside of your country, the service may not be able to determine the correct region.
- In an in-house network environment, the 5222 port must be released. For confirmation instructions, contact the network administrator.

Preparations Before Using Canon Inkjet Cloud Printing Center

To use the Canon Inkjet Cloud Printing Center, you need to follow the steps described below and register the user information.



Print registration information from the printer

1. On the printer operation panel, select the  **Setup** button, and then select **Web service setup -> Connection setup -> IJCloudPrintingCtr -> Register w/ service**
2. In the registration confirmation window, Select **Yes**

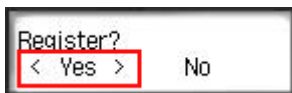

3. In the print settings, select the display language

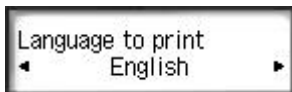

4. Follow the instructions displayed in the window, and print the URL of the authentication site and the **Printer registration ID**

Set A4 size or Letter size or Legal size plain paper and select **OK**.
The authentication URL and **Printer registration ID** are printed.

▶▶▶ Note

- You will use this printed page in the next step.

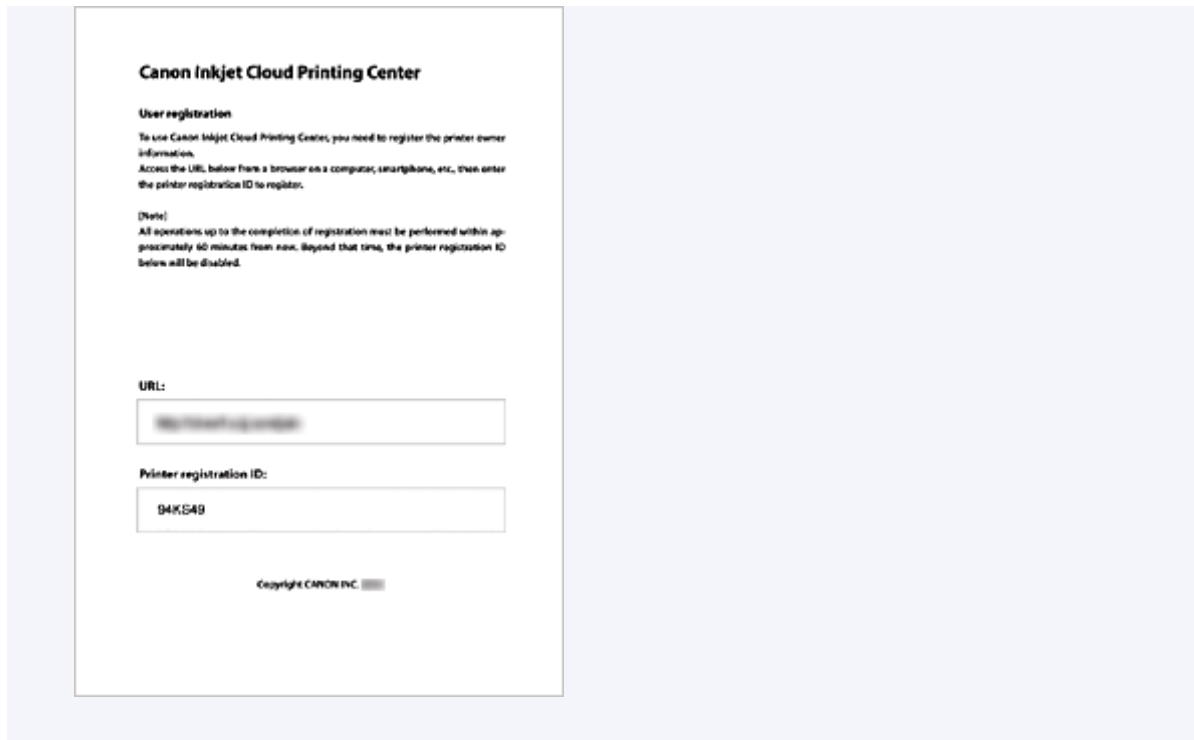

▶▶▶ Important

- The operation to complete the registration should be done within 60 minutes.

Access the URL on the printed page, and then enter the e-mail address and other necessary information

▶▶▶ Important

- Do not use the Back button of the web browser while an operation is processing. The screen may not transition properly.

1. Use the web browser on your PC, smartphone, tablet, or other devices to access the authentication URL

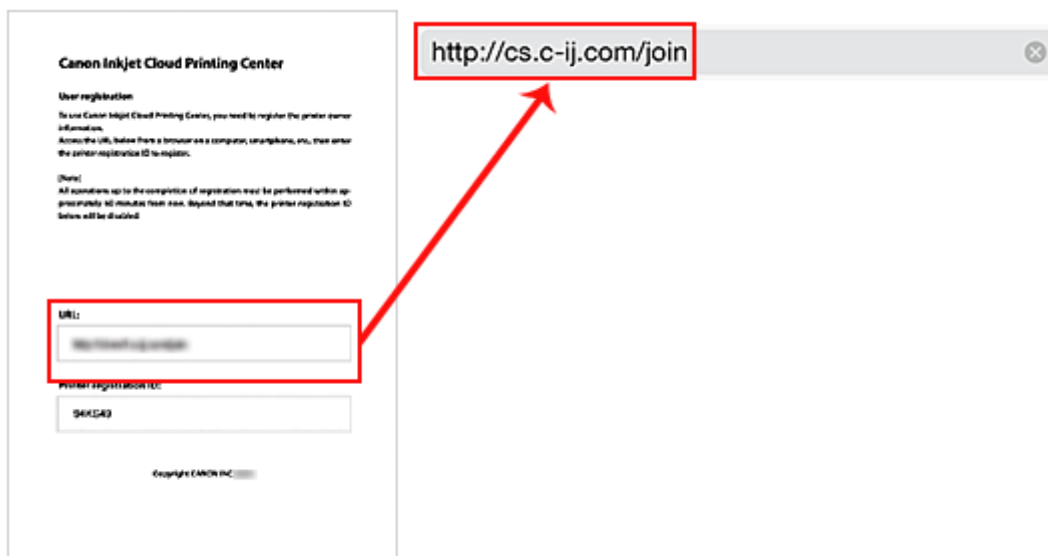

2. When the printer registration screen is displayed, select **Create new account**



3. Enter the **E-mail address** and **Printer registration ID** of the printer's owner, and then select **OK**

The registration page URL is sent to the e-mail address entered.

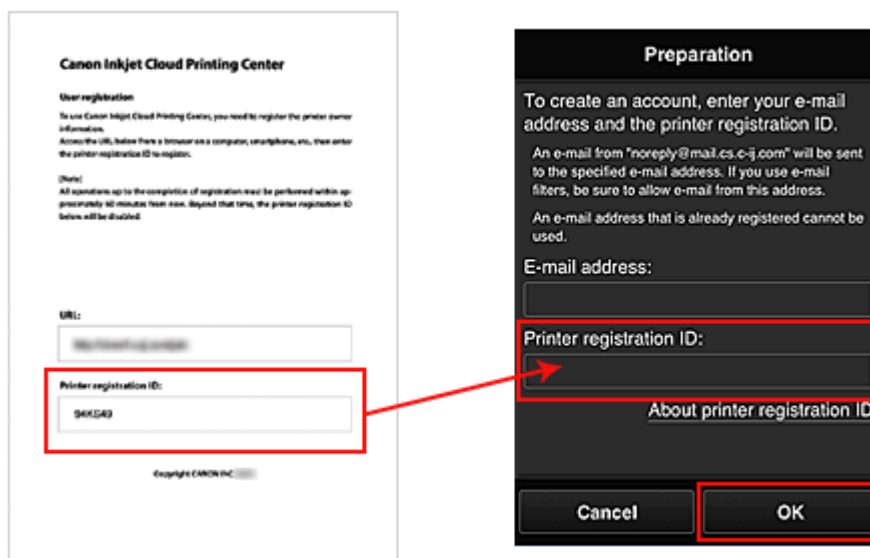

➤➤➤ Important

- There are character restrictions for the e-mail address, as shown below.
 - Up to 255 characters consisting of single-byte alphanumeric characters and symbols (!\$*/^_{}|~.-@). (Uppercase and lowercase letters are differentiated.)
 - Multibyte characters cannot be used.
You will get an error if the e-mail address you enter contains a character that cannot be used.
- If you registered a different e-mail address by mistake, you can cancel the registration by selecting the **Setup** button on the printer operation panel, and then selecting **Web service setup -> Connection setup -> IJCloudPrintingCtr -> Delete from service**.
- You may not be able to receive the notification if you are using a spam filter. If you have a setting to receive only the e-mails from certain domains, be sure to change the setting to allow

receiving e-mails from "noreply@mail.cs.c-ij.com".

There will be no error display even if you could not receive the e-mail because of the spam filter setting or if you entered an incorrect e-mail address.

Access the URL in the e-mail, register the information, and complete the user registration

1. When an e-mail with the subject "Information on Canon Inkjet Cloud Printing Center" is sent to the e-mail address that you entered, select the URL
2. In the **License agreement** and **Privacy statement** windows of Canon Inkjet Cloud Printing Center, read the statements, and select **Agree** if you agree

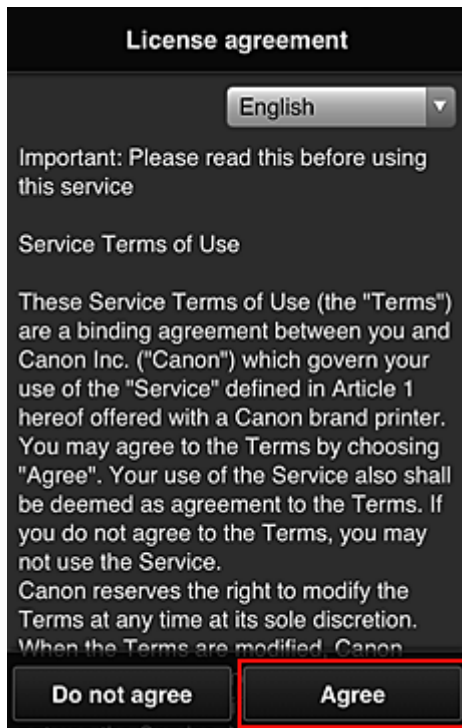

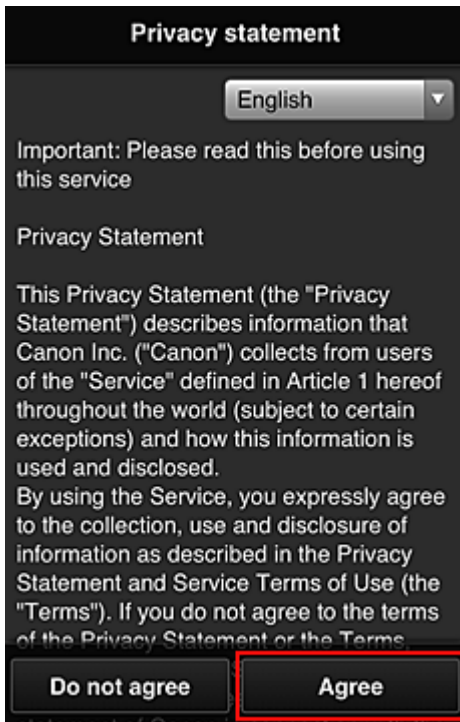

3. In the user information entry screen, enter your **Password**, and select **Next**

Enter your password for logging in to the Canon Inkjet Cloud Printing Center.

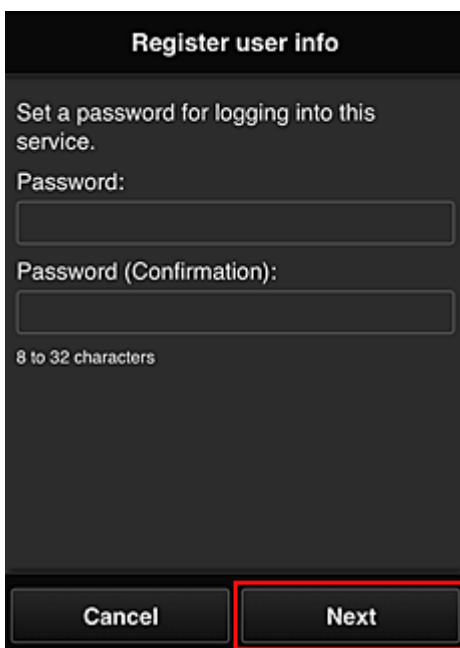

»» Important

- There are character restrictions for the **Password**, as shown below.
 - The password must be between 8 and 32 characters long, using single-byte alphanumeric characters and symbols (!"#\$%&'()*+,-./:;<=>?@[\\]^_`{|}~). (Alphabets are case-sensitive)

4. Enter the **User Name**

Enter the name that identifies the user.

Register user info

User Name:
[Text Field]

1 to 20 characters

Time zone:
(UTC) Coordinated Universal Time

Back Next

»»» Important

- The **User Name** entry field has the following character restrictions:
 - The user name must be between 1 and 20 characters long, using single-byte alphanumeric characters and symbols (!"#\$\$%&'()*+,-./:;<=>?@[\\]^_`{|}~). (Alphabets are case-sensitive)

5. Specify the **Time zone** setting, and select **Next**

Select your region on the list. If you cannot find your region on the list, select the one closest to your region.

Apply daylight saving time

This appears only when there is a daylight saving time in the **Time zone** that you selected. Select whether or not to apply the daylight saving time.

Register user info

User Name:
[Text Field]

1 to 20 characters

Time zone:
(UTC) Coordinated Universal Time

Back Next

6. Enter the **Security code** and select **Done**

Enter the code for authenticating the user.



▶▶▶ Important

- You can register to this service without setting a **Security code**. However, from the viewpoint of security, we recommend that you set a **Security code**.
- The **Security code** entry field has the following character restrictions:
 - Up to 8 single-byte numbers

The registration is complete. A registration completion message is displayed.

When you select the **OK** button in the message, the login screen is displayed.

Enter the registered e-mail address and password, and [log in](#) to the Canon Inkjet Cloud Printing Center.

■ [Using Canon Inkjet Cloud Printing Center](#)

Printing Your Printer registration ID

To add a printer by using Canon Inkjet Cloud Printing Center, you will need a **Printer registration ID**.

From the operation panel of this printer, print the URL of the authentication site and your **Printer registration ID**. The procedure is as follows:

1. Check that the printer is connected to the Internet

»» Important

- To use this function, you must connect this printer to the Internet.

2. On the printer operation panel, select the  **Setup** button, and then select **Web service setup** -> **Connection setup** -> **IJCloudPrintingCtr** -> **Register w/ service**
3. In the registration confirmation window, Select **Yes**

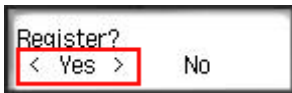

4. In the print settings, select the display language

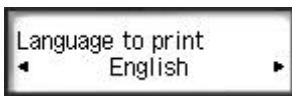

5. Follow the instructions displayed in the window, and print the URL of the authentication site and your **Printer registration ID**

When you set A4 size or Letter size or Legal size plain paper and select **OK**, the authentication site URL and your **Printer registration ID** are printed.

»» Important

- The operation to complete the registration should be done within 60 minutes.

Canon Inkjet Cloud Printing Center window

This section describes the Canon Inkjet Cloud Printing Center screens that are displayed on your smartphone, tablet device, or computer.

- [Description of the Login screen](#)
- [Description of the Main screen](#)

Description of the Login screen

This section provides the description of the Login screen of Canon Inkjet Cloud Printing Center.

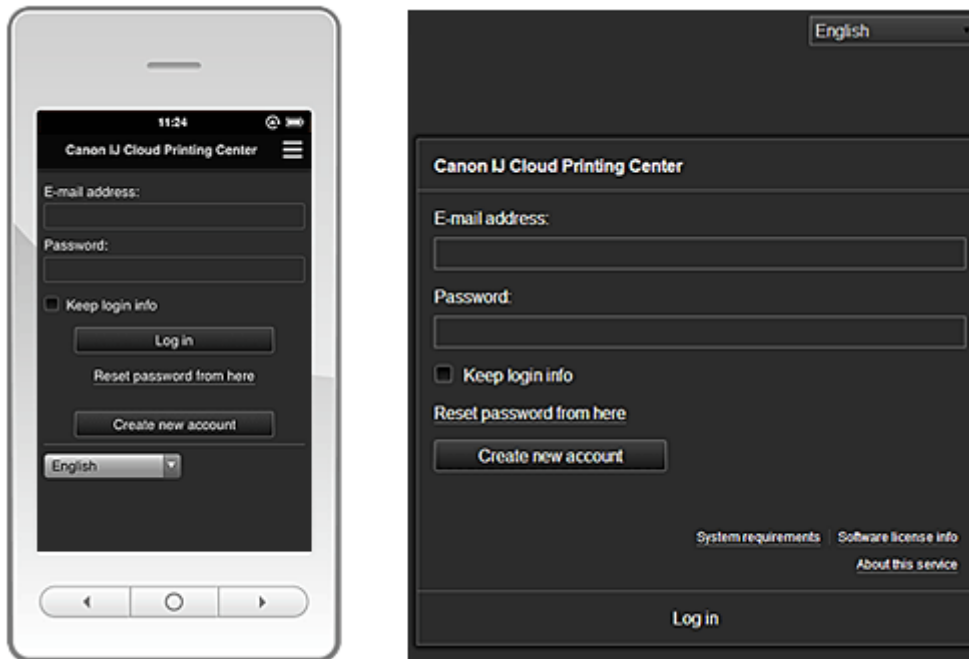

►► Important

- You have 5 tries to enter your password. If you fail, you will not be able to log in for about the next hour.
- You remain logged in for an hour after the last access.

Language

Select the language you will be using.

E-mail address

Enter the e-mail address that you entered in the user registration.

►► Important

- The e-mail address is case-sensitive. Make sure the case is correct.

Password

Enter the password that you entered in the user registration.

Keep login info

When you select the check box, the login screen is skipped for 14 days since the last day that the service screen was accessed.

Reset password from here

Select this if you forgot the password.

Reset your password by following the instructions on the screen.

Create new account

A new registration will be added to the Canon Inkjet Cloud Printing Center.

For a new registration, you need the [Printer registration ID](#).

System requirements

This displays the system requirements for the Canon Inkjet Cloud Printing Center.

Software license info

The licensing information of Canon Inkjet Cloud Printing Center is displayed.

About this service

This displays the descriptions of this service.

Description of the Main screen

When you log in to the Canon Inkjet Cloud Printing Center, the Main screen appears.

►► Important

- With this service, the functions available to [Standard user](#) of the printer are different from those available to the printer [Administrator](#).
Standard user can only use the functions marked by an asterisk (*).

You can use areas shown below to start*, add, and manage apps.

If you are using a smartphone or a tablet, you can also print photos and documents.

■ [If you are using a smartphone or tablet](#)

■ [If you are using a PC](#)

If you are using a smartphone or tablet

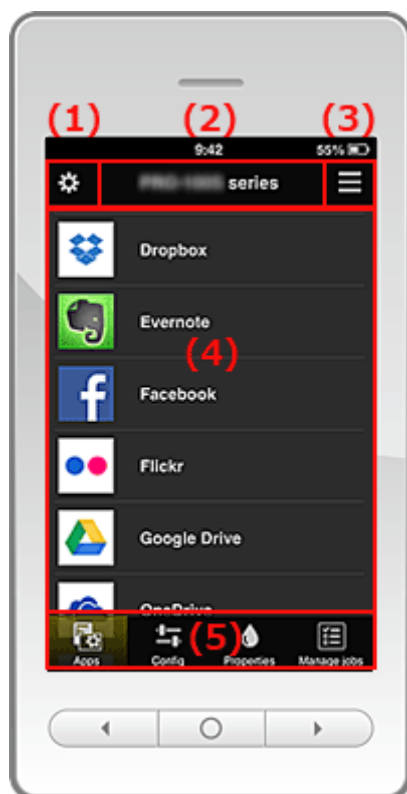

(1) [Left context menu](#)

(2) [Printer name area](#)

(3) [Right context menu](#)

- (4) [Display area](#)
- (5) [Menu area](#)

(1) Left context menu

When you select , the **Mng. printer** screen or the **Manage users** screen appears. For general users, only the **Select printer** screen appears.

Mng. printer screen (Select printer screen)

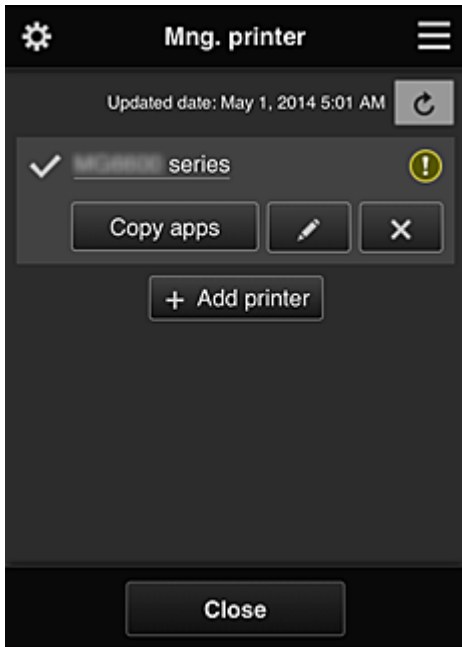

For the Administrator

From the **Mng. printer** screen, you can [check*](#) or [update*](#) printer information registered to the Canon Inkjet Cloud Printing Center, [copy apps](#), [change printer names](#), [delete printers](#), and [add printers](#).



For the Standard user

From the **Select printer** screen, you can [check*](#) or [update*](#) printer information registered to the Canon Inkjet Cloud Printing Center.

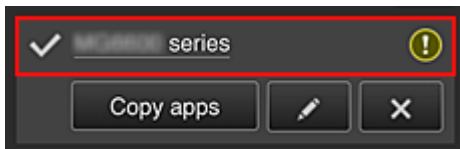
- **Check the printer information***



The registered printer name is displayed.

-  indicates the currently selected printer.
-  indicates that an error occurred on the printer.

- **Display update date/time of the printer information***

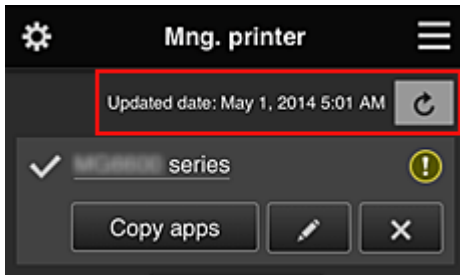

This displays the date and time the printer information was last updated.

 refreshes the information.

- **Copy apps (Administrator only)**

Select this to copy apps added in the selected printer to another printer.

When you select , the screen shown below appears.

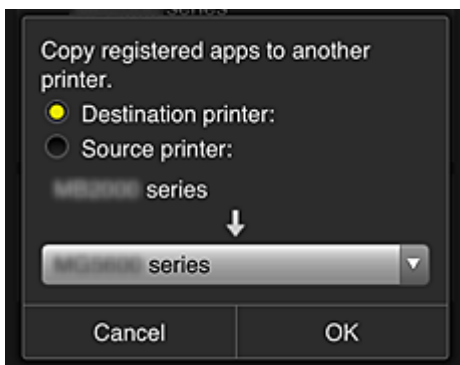

Set the **Destination printer** and the **Source printer**. Then select **OK**.

- **Change the printer name (Administrator only)**

When you select , a screen to change the printer name appears.

Follow the instructions on the screen to change the name.

Important

- The printer name entry has the following character limitation:
 - Up to 128 characters (Uppercase and lowercase letters are differentiated.)

- **Delete printers (Administrator only)**

When you select , the printer is deleted from the Canon Inkjet Cloud Printing Center.

When transferring the ownership of the printer, select **Clear the information saved on the printer**.

- **Add printers (Administrator only)**

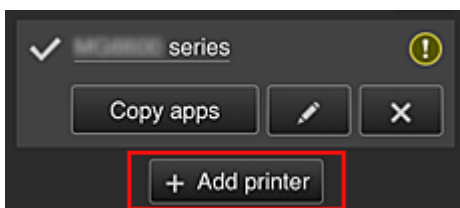

Select this to add printers to be used in the Canon Inkjet Cloud Printing Center.

You need a [Printer registration ID](#) to add a printer.

»» Note

- Although the number of printers that can be registered for one e-mail address is not limited, only up to 16 printers are guaranteed to operate.

Manage users screen

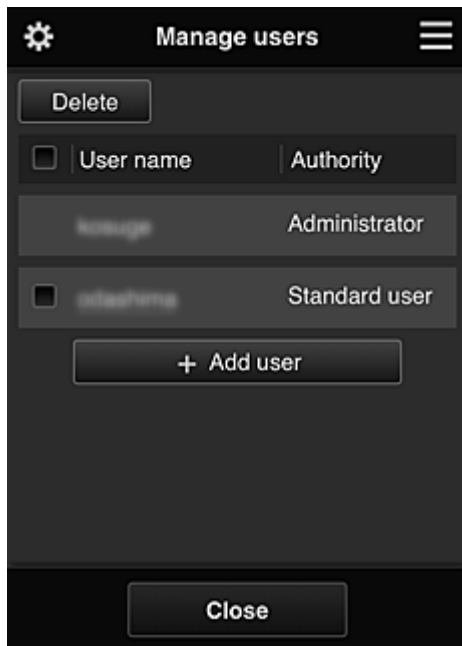

For the Administrator

From the **Manage users** screen, you can check user information registered to the Canon Inkjet Cloud Printing Center, [delete users](#), [add users](#), and [change the Administrator and Standard user settings](#).

- **User deletion (Administrator only)**

Select the check box of the user to be deleted, and select **Delete**.

However, you cannot delete yourself. To delete yourself, cancel your membership from the [user information](#) screen.

- **Adding a user (Administrator only)**

Select **Add user**. The user registration screen appears.

- **Changing Administrator and Standard user settings (Administrator only)**

You can change the privileges of the **Administrator** and **Standard users**.

(2) Printer name area

The registered name of the printer selected is displayed.

The **Administrator** can [change the printer name](#) from the **Mng. printer** screen of the left context menu.

(3) Right context menu

When you select , the context menu appears.

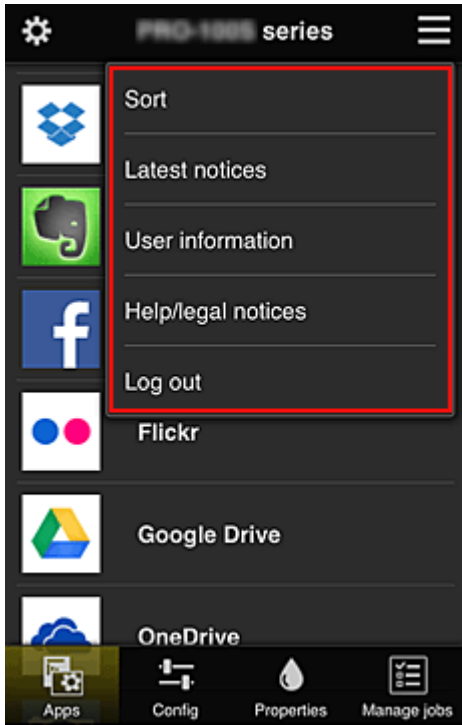

The information displayed depends on the menu currently selected in the menu area.

The  symbol indicates that there is a new unread notice.



- **Sort** **Sort (Administrator only)**

This displays the screen to sort registered apps.

You can use the   buttons to change the display order of apps. When you finish sorting, press the **Done** button to confirm the order.

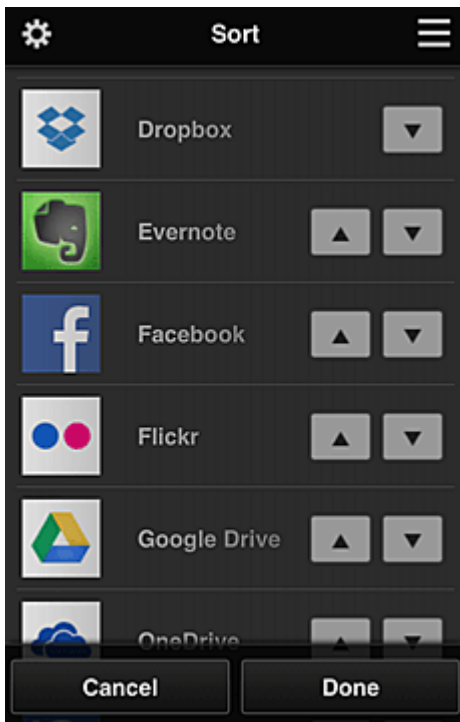

- **Latest notices** **Latest notices***

This displays the latest notices. The  symbol indicates that there is a new unread notice.

- **User information** **User information***

This displays the User information screen.

You can change the registered e-mail address, password, language, time zone, and other settings.

- **Help/legal notices** **Help/legal notices***

The description of the Canon Inkjet Cloud Printing Center screen and various reminders are displayed.

- **Log out** **Log out***

This opens the Log out screen of the Canon Inkjet Cloud Printing Center.

(4) Display area

The display changes based on the menu you select.

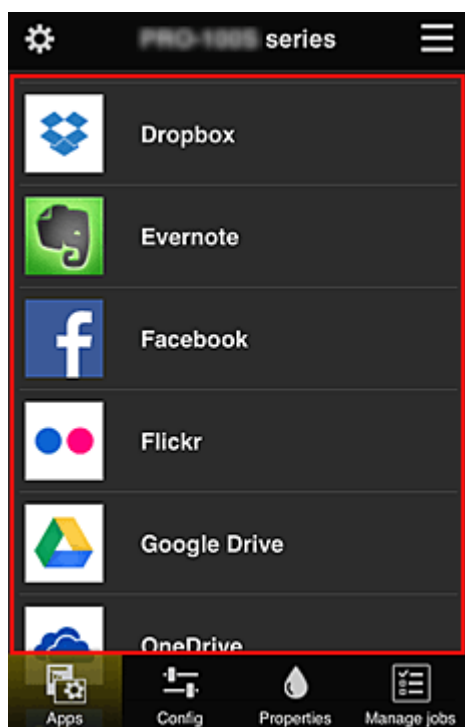

(5) Menu area

The following 4 menu buttons are displayed:

-  **Apps***

This displays the list of registered apps in the [Display area](#).

-  **Config (Administrator only)**

This displays the Register apps screen in the [Display area](#).

The display can be toggled between **Registered** and **Search apps**.

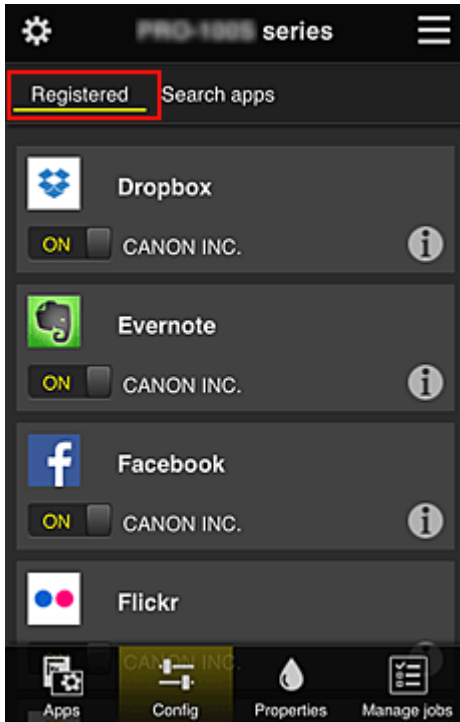

The **Registered** screen lists registered apps.

You can check the information of these apps or deregister them.



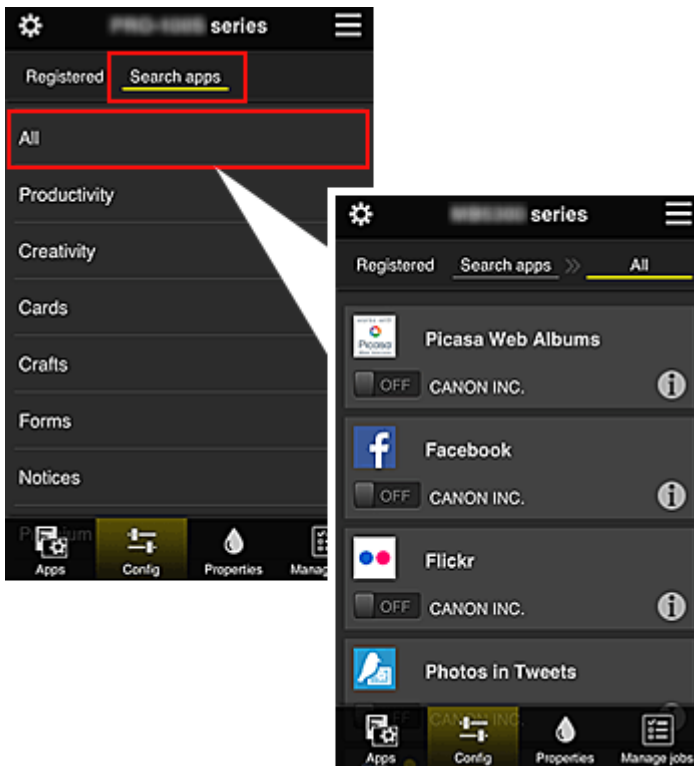

On the **Search apps** screen, the apps that you can register by using the Canon Inkjet Cloud Printing Center are displayed by category.



- When you select , the details of the app are displayed.
- When you select , you can choose to register or unregister the app.

▶▶▶ Note

- Description of displayed icons
 -  : Cannot be used because it is not yet released, not available in your region, or does not support your model.
 -  : Can be used with genuine Canon ink.



- **Properties* Properties***

This screen displays the status of the printer that is currently selected.

You can check how much ink is remaining or details about an error that occurred. You can also access the ink purchasing site and the *Online Manual*.

»»» Important

- The Properties displayed may differ from the actual status at the display time, depending on the printer status.



- **Manage jobs* Manage jobs***

This screen displays the print or scan status and history.

You can check the print or scan status by looking at **Status list**, and the print or scan history by looking at **History**.

You can also cancel print or scan jobs and delete history information.

To cancel or delete a job, select that job and then select **Cancel** or **Delete**.

If you are using a PC

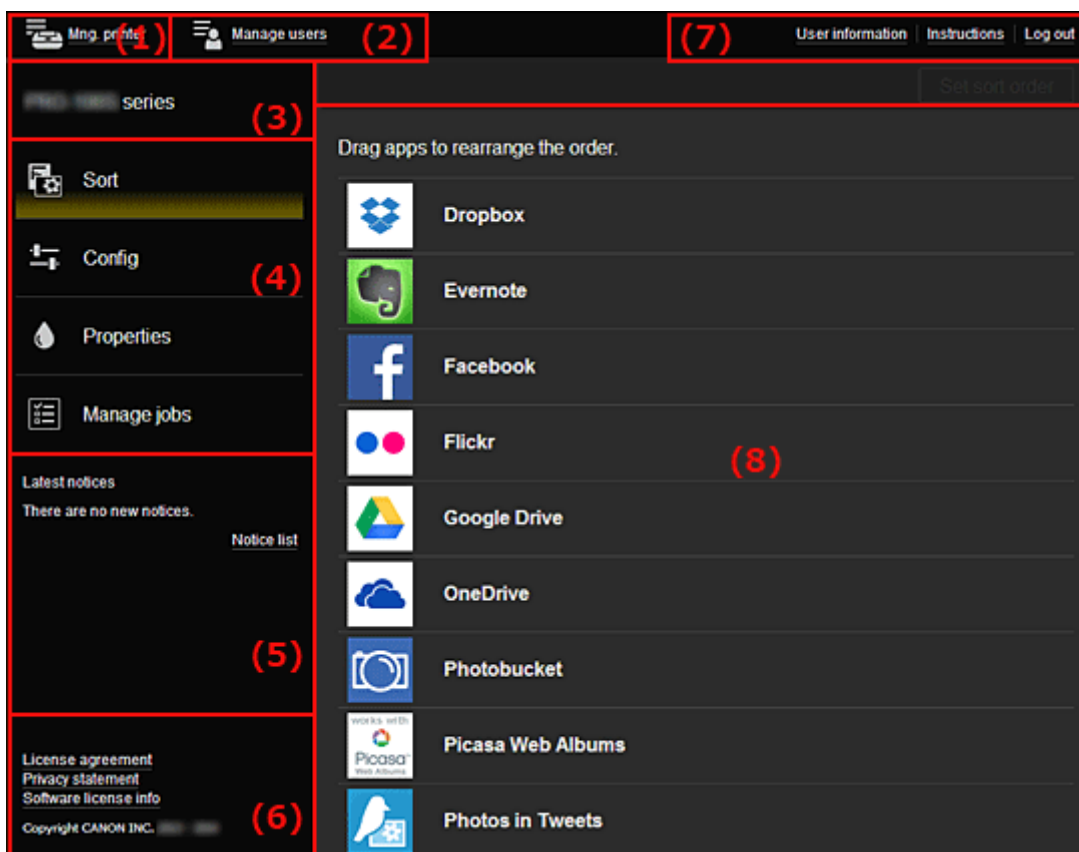

- (1) [Mng. printer \(Select printer\) button](#)
- (2) [Manage users button](#)
- (3) [Printer name area](#)
- (4) [Menu area](#)
- (5) [Notices area](#)
- (6) [Information area](#)
- (7) [Global navigation area](#)

(8) [Display area](#)

(1) Mng. printer (Select printer) button

When you select the **Mng. printer (Select printer)** button, the **Mng. printer (Select printer)** screen appears.

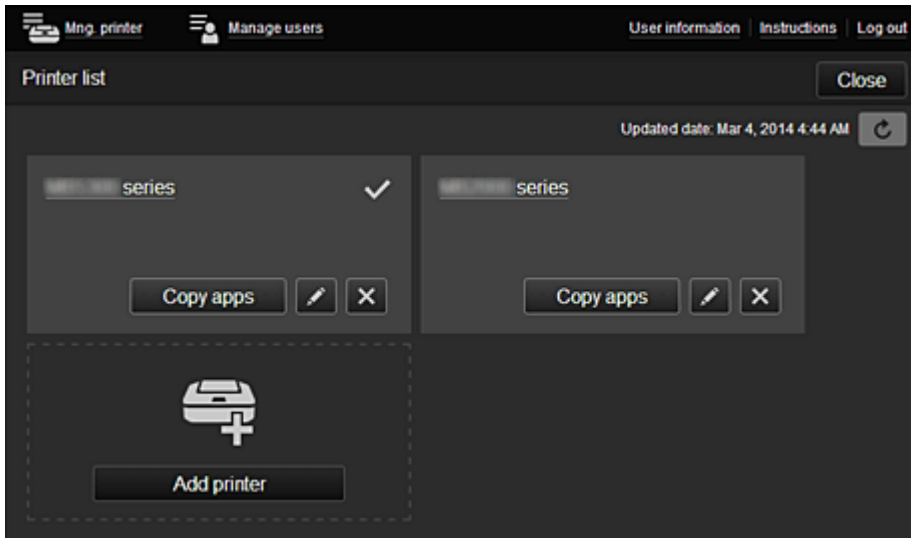

For the Administrator

From the **Mng. printer** screen, you can [check*](#) or [update*](#) printer information registered to the Canon Inkjet Cloud Printing Center, [copy apps](#), [change printer names](#), [delete printers](#), and [add printers](#).

For the Standard user

From the **Select printer** screen, you can [check*](#) or [update*](#) printer information registered to the Canon Inkjet Cloud Printing Center.

- **Check the printer information***

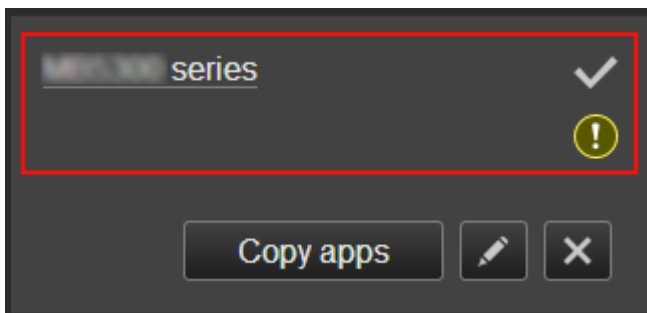



The registered printer name is displayed.

✓ indicates the currently selected printer.

⚠ indicates that an error occurred on the printer.

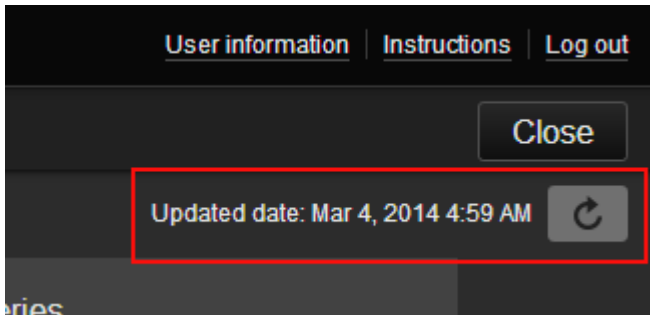
- **Display update date/time of the printer information***



This displays the date and time the printer information was last updated.  refreshes the information.

- **Copy apps (Administrator only)**

Select this to copy apps added in the selected printer to another printer.

When you select , the screen shown below appears.

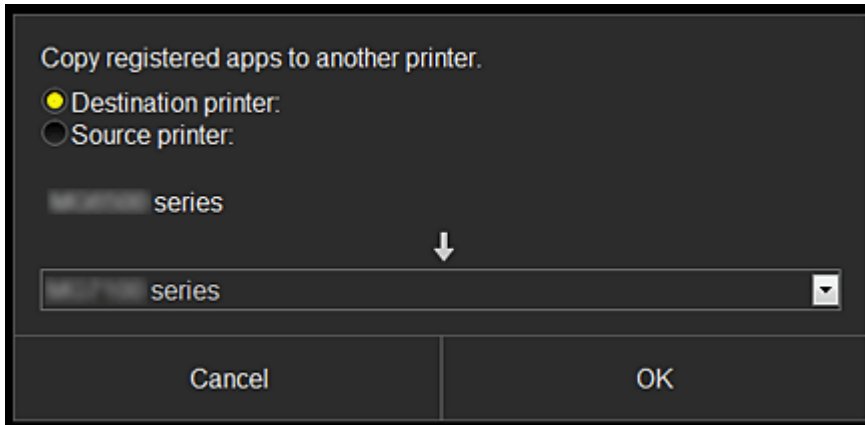

Set the **Destination printer** and the **Source printer**. Then select **OK**.

- **Change the printer name (Administrator only)**

When you select , a screen to change the printer name appears. Follow the instructions on the screen to change the name.

▶▶▶ Important

- The printer name entry has the following character limitation:
 - Up to 128 characters (Uppercase and lowercase letters are differentiated.)

- **Delete printers (Administrator only)**

When you select , the printer is deleted from the Canon Inkjet Cloud Printing Center.

When transferring the ownership of the printer, select **Clear the information saved on the printer**.

- **Add printers (Administrator only)**

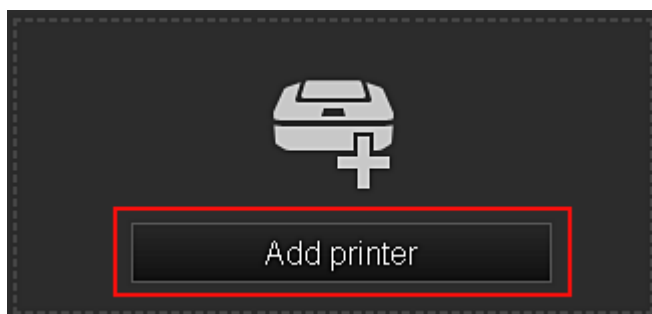

Select this to add printers to be used in the Canon Inkjet Cloud Printing Center. You need a [Printer registration ID](#) to add a printer.

▶▶▶ Note

- Although the number of printers that can be registered for one e-mail address is not limited, only up to 16 printers are guaranteed to operate.

(2) Manage users button

When you select the **Manage users** button, the Manage users screen appears.

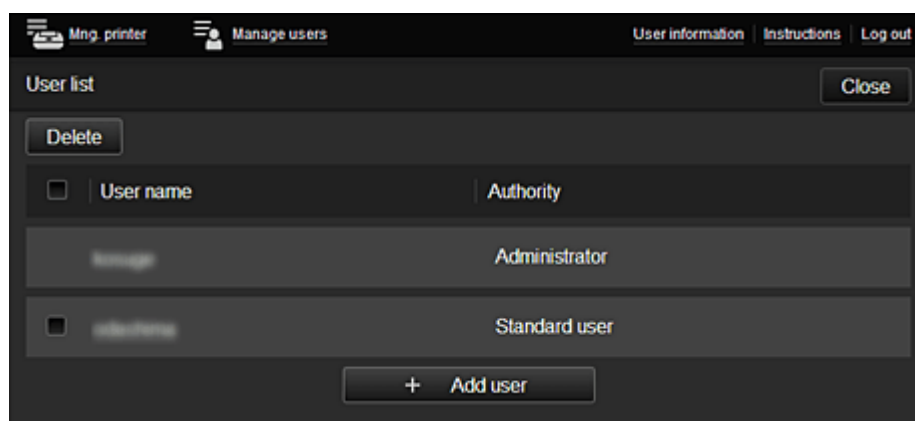

For the Administrator

From the **Manage users** screen, you can check user information registered to the Canon Inkjet Cloud Printing Center, [delete users](#), [add users](#), and [change the Administrator and Standard user settings](#).

- **User deletion (Administrator only)**

Select the check box of the user to be deleted, and select **Delete**.

However, you cannot delete yourself. To delete yourself, cancel your membership from the [user information](#) screen.

- **Adding a user (Administrator only)**

Select **Add user**. The user registration screen appears.

- **Changing Administrator and Standard user settings (Administrator only)**

You can change the privileges of the **Administrator** and **Standard users**.

(3) Printer name area

The registered name of the printer selected is displayed.

The **Administrator** can [change the printer name](#) from the **Mng. printer** screen of the **Mng. printer** button.

(4) Menu area

The following 4 menu buttons are displayed:

-  **Sort (Apps) (Administrator only)**

This displays the list of registered apps in the [Display area](#).
Drag the app to change the order.

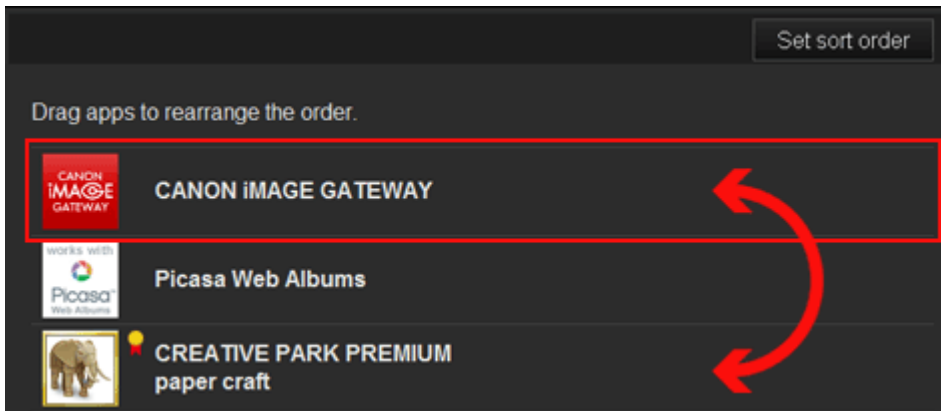

When you finish sorting, press the **Set sort order** button and confirm the order.

-  **Config (Administrator only)**

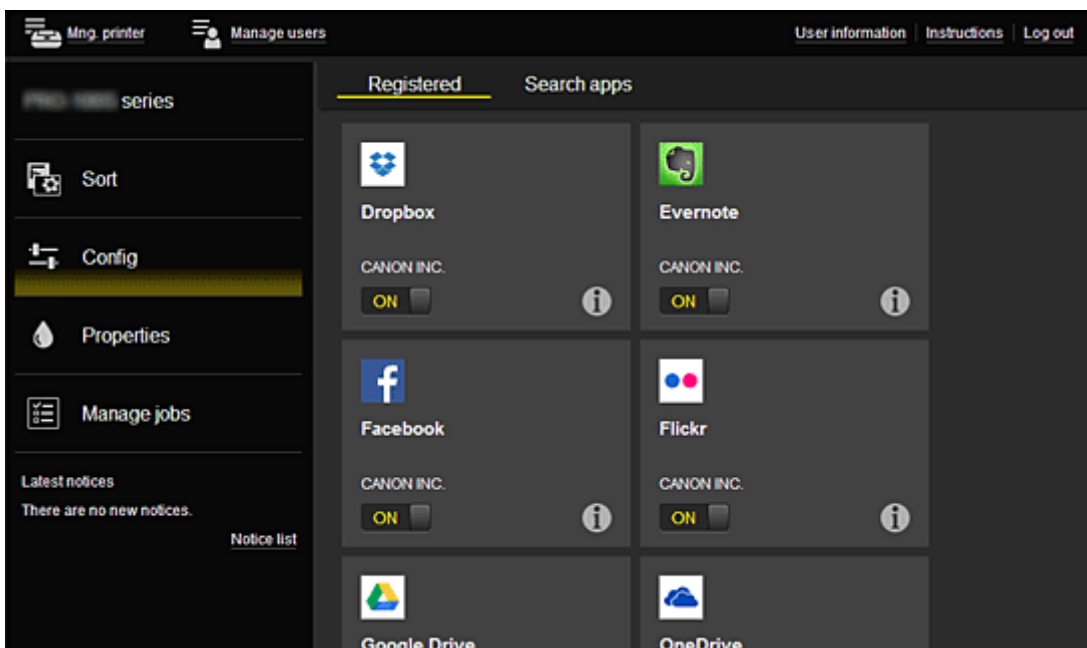

This displays the Register apps screen in the [Display area](#).
The display can be toggled between **Registered** and **Search apps**.

The **Registered** screen lists registered apps.
You can check the information of these apps or deregister them.



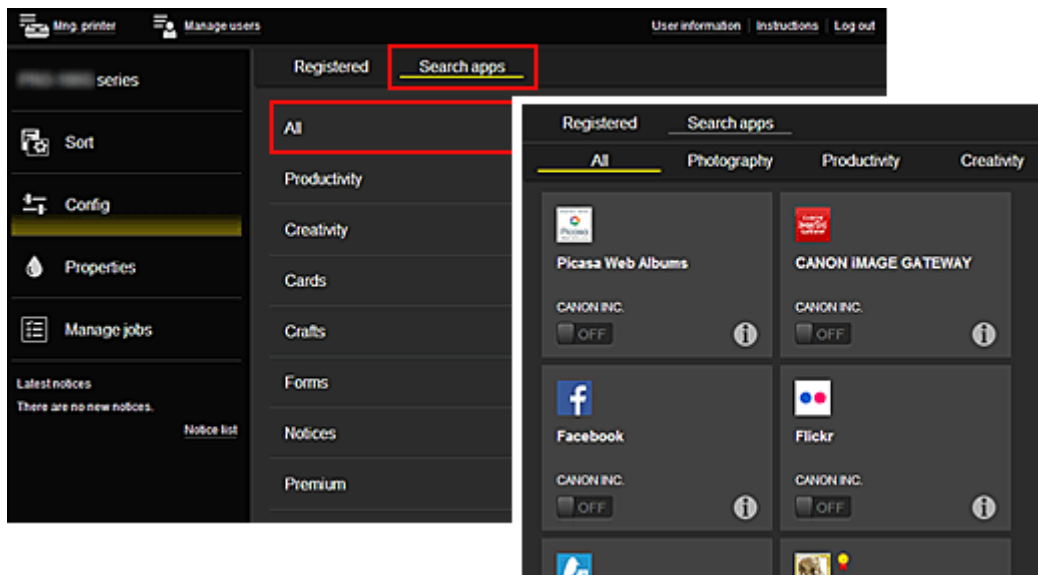

On the **Search apps** screen, the apps that you can register by using the Canon Inkjet Cloud Printing Center are displayed by category.



- When you select , the details of the app are displayed.
- When you select  / , you can choose to register or unregister the app.

»»» Note

- Description of displayed icons
 -  : Cannot be used because it is not yet released, not available in your region, or does not support your model.
 -  : Can be used with genuine Canon ink.



• Properties*

This screen displays the status of the printer that is currently selected. You can check how much ink is remaining or details about an error that occurred. You can also access the ink purchasing site and the *Online Manual*.

»»» Important

- The Properties displayed may differ from the actual status at the display time, depending on the printer status.

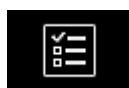

• Manage jobs*

This screen displays the print or scan status and history. You can check the print or scan status by looking at **Status list**, and the print or scan history by looking at **History**. You can also cancel print or scan jobs and delete history information. To cancel or delete a job, select that job and then select **Cancel** or **Delete**.

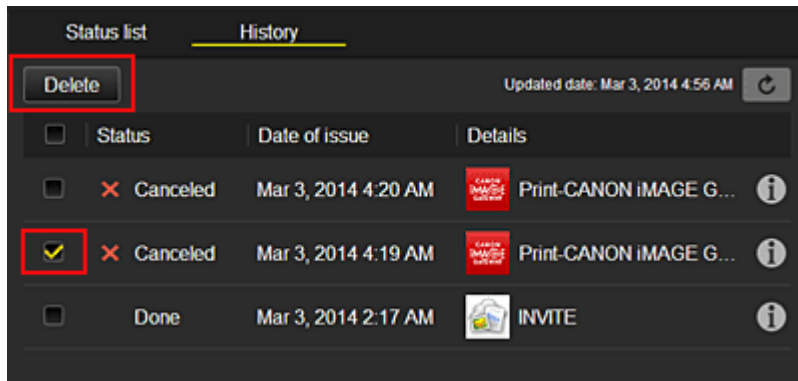

(5) Notices area

This displays the latest notice. Nothing is displayed in this area if there is no notice. When you select **Notice list**, you can display up to 40 items.

(6) Information area

This display other information, including the privacy statement and other companies' licensing information.

(7) Global navigation area

The **User information***, **Instructions***, and **Log out*** buttons are displayed. Press the **User information** to change the settings.

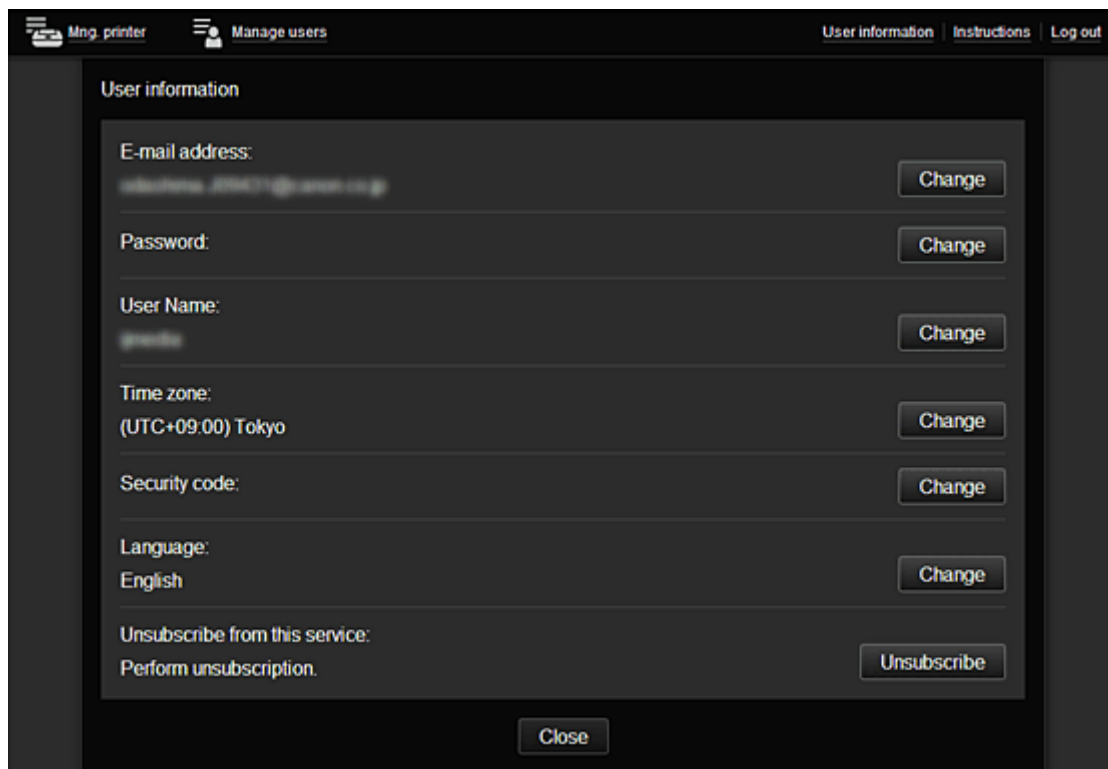

(8) Display area

The display changes based on the menu you select.

Mng. printer Manage users User information Instructions Log out

series Set sort order

Sort

Config









Properties

Manage jobs

Latest notices
There are no new notices.
[Notice list](#)

License agreement
Privacy statement
Software license info
Copyright CANON INC.

Drag apps to rearrange the order.

-  Dropbox
-  Evernote
-  Facebook
-  Flickr
-  Google Drive
-  OneDrive
-  Photobucket
-  Picasa Web Albums
-  Photos in Tweets

Using Canon Inkjet Cloud Printing Center

When the user registration is completed, you can log in to the Canon Inkjet Cloud Printing Center and use the service.

1. From your PC, smartphone, or tablet, access the service login URL (<http://cs.c-ij.com/>)
2. On the Login screen, enter the **E-mail address** and **Password**, and then select **Log in**

▶▶▶ Important

- The e-mail address and password are case-sensitive. Make sure the case is correct.

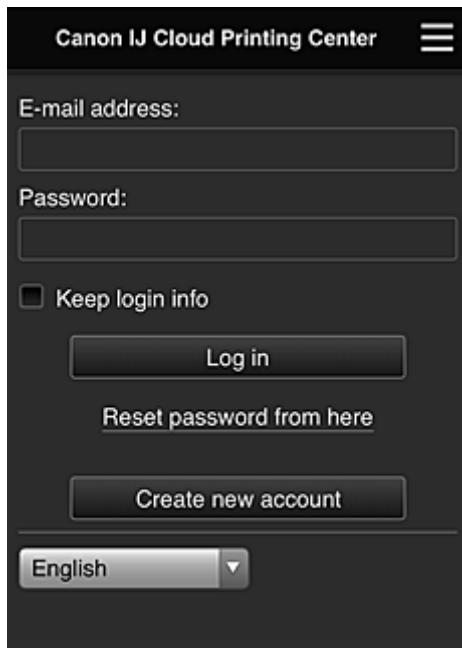

E-mail address

Enter the e-mail address that you entered in the user registration.

Password

Enter the password that you entered in the user registration.

Keep login info

When you select the check box, the login screen is skipped for 14 days since the last day that the service screen was accessed.

▶▶▶ Important

- If you fail to log in five straight times, you will not be able to login again for an hour.
- You remain logged in for an hour after the last access.
- The service may not function properly if you log in from multiple devices at the same time.

After logging in, you can use useful services such as adding/managing apps that work in conjunction with this product's cloud functionality and checking the ink status.

For screen descriptions and operation instructions, see "[Canon Inkjet Cloud Printing Center window](#)".

Printing procedure

This section introduces the photo printing procedure by using CANON IMAGE GATEWAY as an example.

▶▶▶ Important

- The available functions differ depending on the app.
- The printing procedure differs depending on the app.
- You need to get the account and register photo and other data beforehand.
- The following file formats can be printed: jpg, jpeg, pdf, docx, doc, xlsx, xls, pptx, ppt, and rtf.
The file formats that can be printed differ depending on the app.
- Before you print, check that printer is on and is connected to the network. Then start.
- This is available if you are using a smartphone or tablet.

▶▶▶ Note

- You can use CANON IMAGE GATEWAY to print jpg and jpeg file formats.

1. On the Main screen, select the app to be used
2. Enter the information according to the instructions on the authentication screen, and then select **Log in**

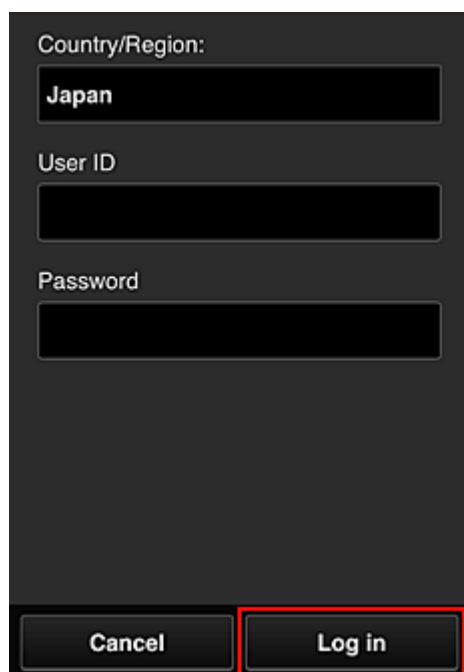

The screenshot shows a dark-themed authentication screen. At the top, it says "Country/Region:" followed by a dropdown menu showing "Japan". Below that is a "User ID" field, and then a "Password" field. At the bottom, there are two buttons: "Cancel" and "Log in". The "Log in" button is highlighted with a red rectangular border.

3. In the displayed album list, select the album of your choice

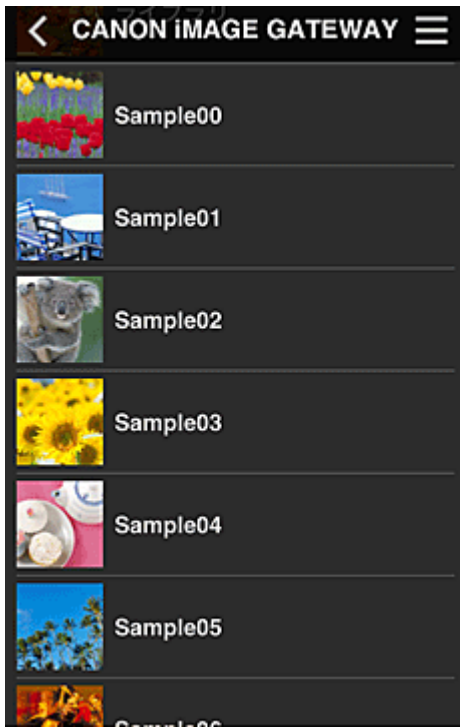

4. In the displayed image list, select the image that you want to print, and then select **Next**



5. Make the necessary print settings, and then select **Print**

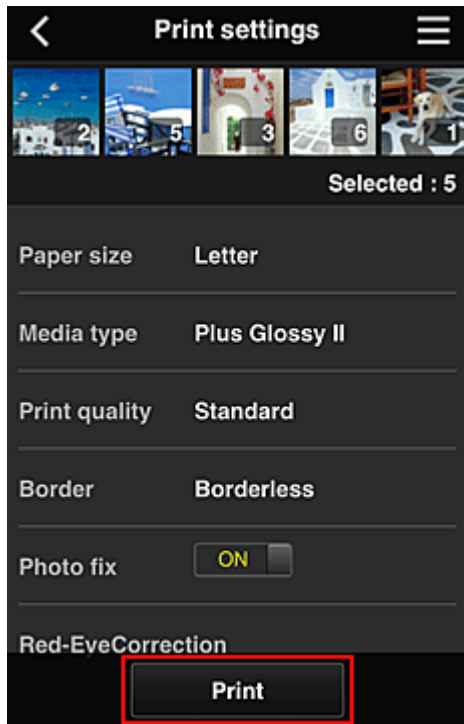

6. A print job completion message appears, and printing starts

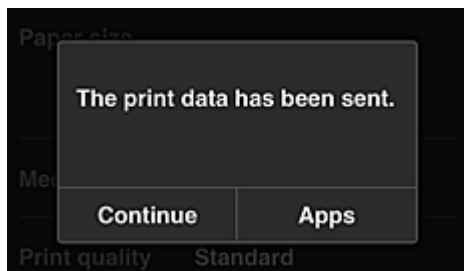

To continue printing, select **Continue**, and perform the operation from Step 3.
To end the printing, select **Apps**. The screen returns to the apps list screen.

»» Important

- If a print job is not printed within 24 hours after the print job is issued, the print job will expire and cannot be printed.
- With premium apps that limit the number of print jobs, print jobs that expire and cannot be printed are also included in the print count.

■ [Adding a Printer](#)

Adding a Printer

With one account, you can use the Canon Inkjet Cloud Printing Center services on multiple printers.

The procedure for adding a printer is as follows:

1. Print the [registration information](#) from the printer to be added
2. From the browser on your smartphone, tablet, or computer, access the authentication site URL

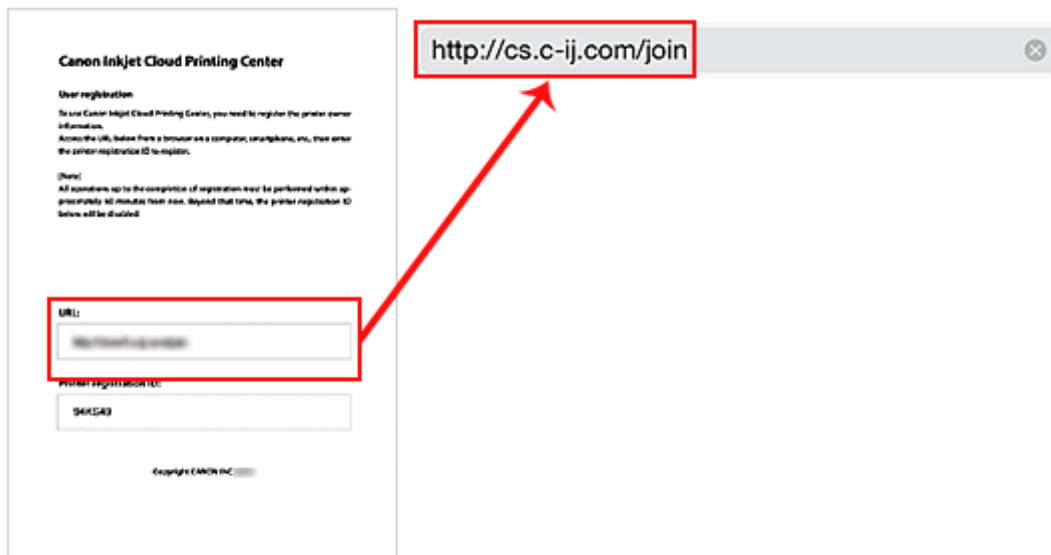

3. When the printer registration screen is displayed, select **Add printer**

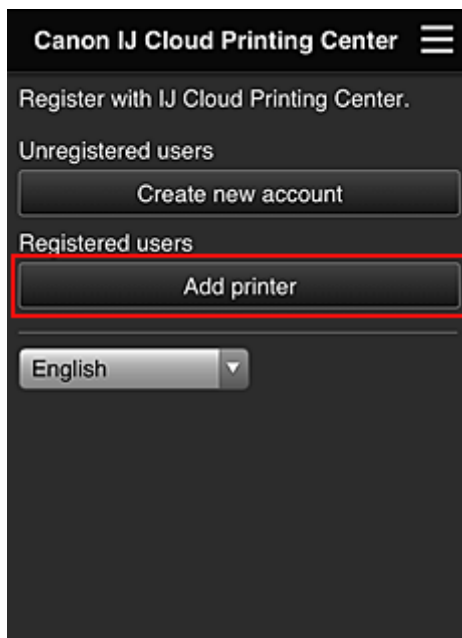

4. Enter the information according to the instructions on the authentication screen, and then select **Log in**
5. Enter your **Printer registration ID**, and select **OK**

Add printer

Add a printer. Enter the printer registration ID.

Printer registration ID:

[About printer registration ID](#)

Cancel OK

▶▶▶ **Note**

- When you access the service from **Remote UI**, the **Printer registration ID** is entered automatically.

Printer addition is completed.

If a printer added message is not displayed, follow the instructions on the displayed screen.

■ [Adding a PIXMA Cloud Link User](#)

Adding a PIXMA Cloud Link User

Several people can use one printer.

This section describes the user addition procedure and the user privileges.

Adding a user

1. On the service screen, select **Manage users**

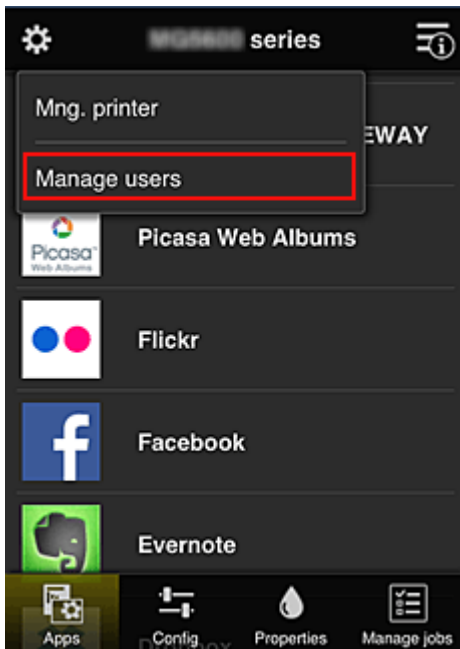

2. Select **Add user**

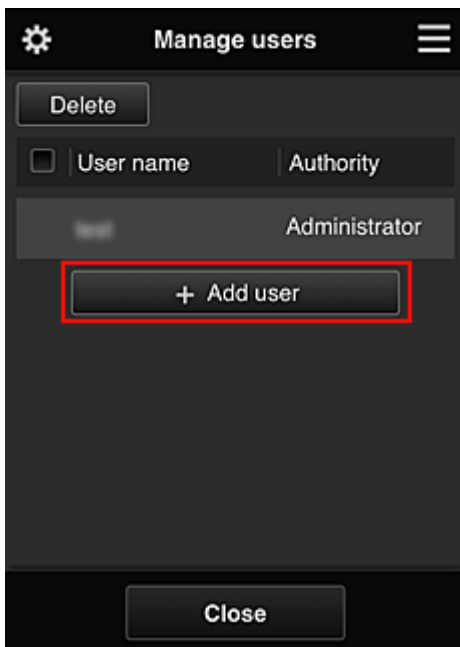

➤➤➤ Note

- When you select **Add user**, the service first checks whether the maximum number of users has been reached. If new users can be added, the user registration screen appears.
- The maximum number of users that can be added for 1 printer is 20.

3. Enter the e-mail address of the user to be added, and then select **OK**

The URL for completing the registration is then sent to the entered e-mail address.

4. Access the URL reported in the e-mail

5. Read the terms displayed in the **License agreement** and **Privacy statement** screens. If you agree to the terms, select **Agree**.

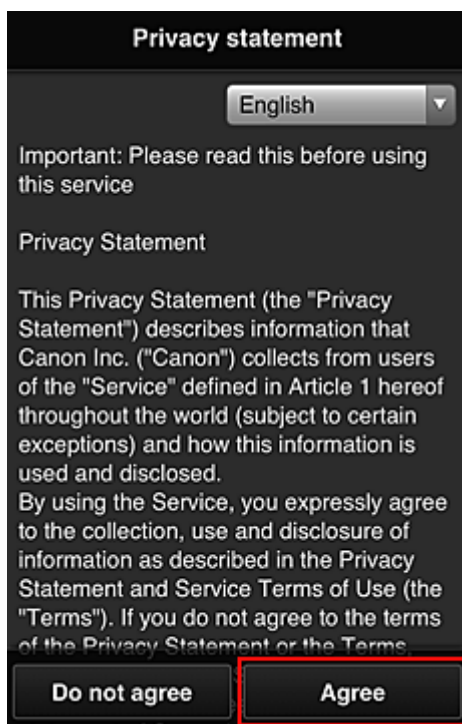
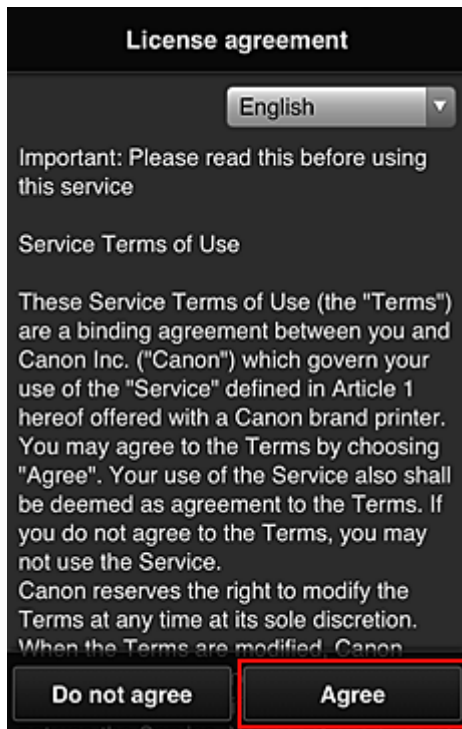

6. In the user information entry screen, enter your **Password**, and select **Next**

Enter your password for logging in to the Canon Inkjet Cloud Printing Center.

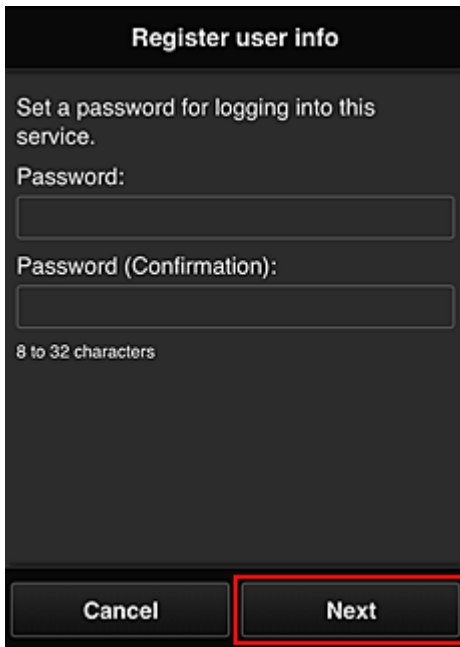

The screenshot shows a dark-themed interface titled "Register user info". Below the title, it says "Set a password for logging into this service." There are two input fields: "Password:" and "Password (Confirmation):". Below the second field, it says "8 to 32 characters". At the bottom, there are two buttons: "Cancel" and "Next". The "Next" button is highlighted with a red border.

»» Important

- There are character restrictions for the **Password**, as shown below.
 - The password must be between 8 and 32 characters long, using single-byte alphanumeric characters and symbols (!"#\$\$%&'()*+,-./:;<=>?@[\\]^_`{|}~). (Alphabets are case-sensitive)

7. Enter the **User Name**

Enter the name that identifies the user.

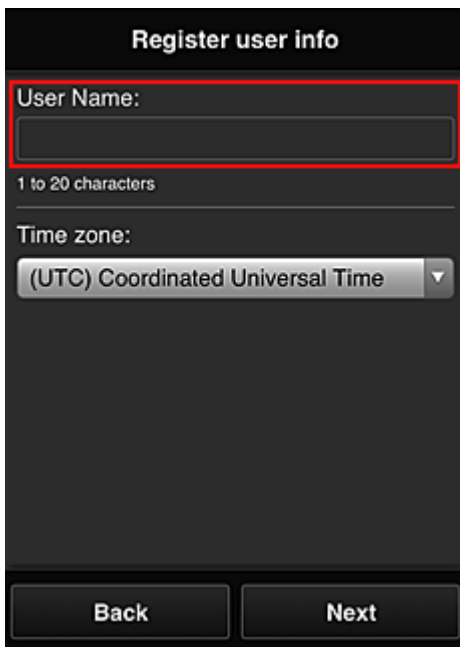

The screenshot shows the same "Register user info" screen. The "User Name:" field is highlighted with a red border. Below it, it says "1 to 20 characters". There is a "Time zone:" dropdown menu with "(UTC) Coordinated Universal Time" selected. At the bottom, there are two buttons: "Back" and "Next".

»» Important

- The **User Name** entry field has the following character restrictions:
 - The user name must be between 1 and 20 characters long, using single-byte alphanumeric characters and symbols (!"#\$\$%&'()*+,-./:;<=>?@[\\]^_`{|}~). (Alphabets are case-sensitive)

8. Specify the **Time zone** setting, and select **Next**

Select your region on the list. If you cannot find your region on the list, select the one closest to your region.

Apply daylight saving time

This appears only when there is a daylight saving time in the **Time zone** that you selected.

Select whether or not to apply the daylight saving time.

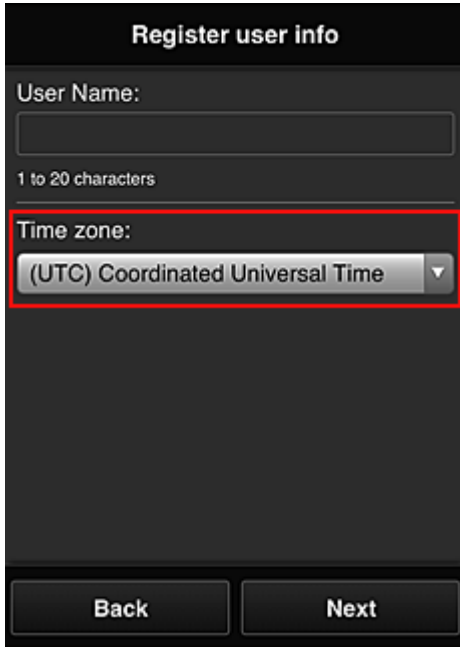

The screenshot shows a mobile application screen titled "Register user info". It features a "User Name:" label above a text input field with a character count "1 to 20 characters" below it. Below the text field is a "Time zone:" label above a dropdown menu. The dropdown menu is open, showing the selected option "(UTC) Coordinated Universal Time" with a downward arrow. At the bottom of the screen are two buttons: "Back" and "Next". A red rectangular box highlights the "Time zone:" label and the dropdown menu.

9. Enter the **Security code** and select **Done**

Enter the code for authenticating the user.



The screenshot shows a mobile application screen titled "Register user info". It features the text "Set security code." followed by a link "[About security code](#)". Below this is a "Security code:" label above a text input field. Below the text field is a "Security code (confirmation):" label above another text input field. Below the second text field is a character count "0 to 8 digits". At the bottom of the screen are two buttons: "Back" and "Done".

Important

- You can register to this service without setting a **Security code**. However, from the viewpoint of security, we recommend that you set a **Security code**.
- The **Security code** entry field has the following character restrictions:

- Up to 8 single-byte numbers

The main registration is complete, and a registration completion e-mail is sent.

▶▶ Note

- A cookie for the selected user is added to the printer, and the login status of each user is recovered. Cookies for up to 8 users can be registered to 1 printer.

Printer user privileges

If several users are using the cloud service for 1 printer, each user is categorized as the **Administrator** or a **Standard user**.

▶▶ Note

- The user who is registered first becomes the **Administrator**. The administrator can change the privileges of users from the [Manage users screen](#).

An **Administrator** can change printer information, add and delete apps, manage users, and perform various other operations.

A **Standard user** can check printer information and start apps.

For information about the functions that each user can use, refer to the "[Canon Inkjet Cloud Printing Center window](#)".

■ [Troubleshooting Canon Inkjet Cloud Printing Center](#)

Troubleshooting Canon Inkjet Cloud Printing Center

- [If an app cannot be installed](#)
- [If the registered app is not in the Apps list](#)
- [If the information is not updated when you press the **Update** button](#)
- [If you do not receive the registration e-mail](#)
- [If you cannot print](#)
- [Printing starts on its own even if you do not do anything](#)
- [If you are unable to log in correctly even after entering the correct password in iOS or Mac](#)

If an app cannot be installed

Check the country or region where the printer was purchased.

If the printer is taken outside the country or region where it was purchased, apps cannot be installed.

If the registered app is not in the Apps list

Check the display language of Canon Inkjet Cloud Printing Center.

If the display language is switched to a language that does not support an app, the app will not be displayed in the apps list but will continue to be registered.

If you switch back to the target language of the app, it will be displayed in the apps list and you will be able to start, register, or unregister the app.

If the information is not updated when you press the Update button

Because the Properties screen requires network connection with this product, the information may not be reflected immediately. Please wait awhile, and then try updating the information again.

If the information is still not updated, then check that the product is connected to the Internet.

If you do not receive the registration e-mail

You may have entered a different e-mail address during the user registration of Canon Inkjet Cloud Printing Center.



On the printer operation panel, select the **Setup** button, and then select **Web service setup** -> **Connection setup** -> **IJCloudPrintingCtr** -> **Delete from service** to delete the service registration. After resetting the printer, repeat the user registration of Canon Inkjet Cloud Printing Center from the beginning.

If you cannot print

Check the following if you cannot print.

- Check that the printer is connected to the Internet.
- Check that the printer is connected to a LAN and the LAN environment is connected to the Internet.
- Check that no error message is displayed on the printer's LCD monitor.

- If printing does not start even after you wait awhile, go to the printer operation panel, select **Setup**, and run **Web service inquiry**. If printing does not start, run the inquiry several times.



If the problem is not resolved, use the printer driver from your computer to perform the print job and check whether the data can be printed normally on the printer.

If you still cannot print, see the troubleshooting page for your model on the Home of the *Online Manual*.

▶▶▶ Note

- With a wireless LAN connection, after the printer is turned on, it may take several minutes before communication is possible. Check that your printer is connected to the wireless network, and wait a while before you start printing.
- If the printer is not turned on or is not connected to the Internet, and consequently a print job is not processed within 24 hours after it was submitted, the print job is automatically canceled. If this happens, check the printer power and the Internet connection, and then re-submit the print job.

Printing starts on its own even if you do not do anything

A third party may be able to illegally use the Canon Inkjet Cloud Printing Center services.



On the printer operation panel, select the **Setup** button, and then select **Web service setup** -> **Connection setup** -> **IJCloudPrintingCtr** -> **Delete from service** to delete the service registration. After resetting the printer, repeat the user registration of Canon Inkjet Cloud Printing Center from the beginning.

If you are unable to log in correctly even after entering the correct password in iOS or Mac

If you are using iOS or Mac and the password contains the ¥ or # symbol, enter a backslash instead. For instructions on entering a backslash, see the OS help.

Printing with Google Cloud Print

The printer is compatible with Google Cloud Print™ (Google Cloud Print is a service provided by Google Inc.).

By using Google Cloud Print, you can print from anywhere with applications or services supporting Google Cloud Print.

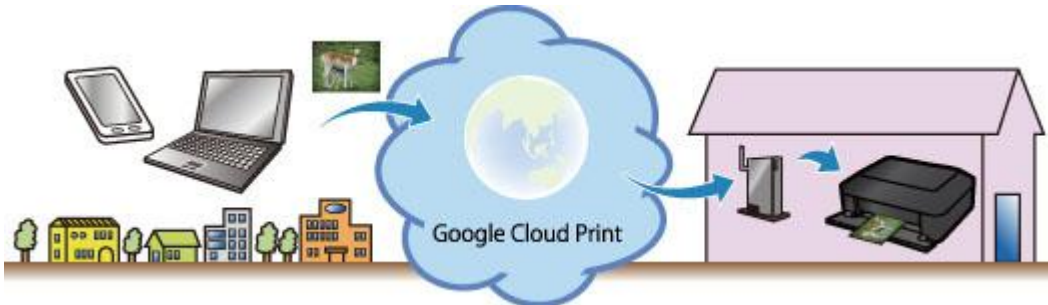

1. [Preparations for Printing with Google Cloud Print](#)
2. [Printing from Computer or Smartphone with Google Cloud Print](#)

▶▶ Important

- LAN connection with the printer and Internet connection are required to register the printer and to print with Google Cloud Print. Internet connection fees apply.
- This function may not be available depending on the country or region you live in.

Preparations for Printing with Google Cloud Print

To print with Google Cloud Print, you need to get Google account and register the printer with Google Cloud Print in advance.

■ [Getting Google Account](#)

If you already have Google account, register the printer.

■ [Registering the Printer with Google Cloud Print](#)

Getting Google Account

First, get your Google account in order to register the printer with Google Cloud Print.

Access to Google Cloud Print with the web browser on the computer or the mobile device, then register the required information.

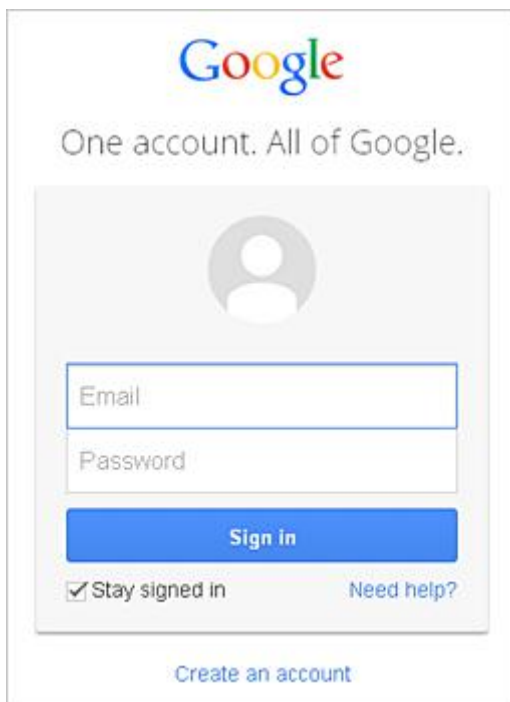

* The screen above may change without prior notice.

Registering the Printer with Google Cloud Print

Register the printer with Google Cloud Print.

■ [Registration Using Google Chrome](#)

■ [Registration from the Printer](#)

▶▶▶ Important

- When you register a printer, the printer must be connected to the LAN and the LAN environment must be connected to the Internet. Note that the customer is responsible for all Internet connection fees.
- When the printer owner changes, [delete the printer registration from Google Cloud Print](#).

Registration Using Google Chrome

1. Start the Google Chrome browser on your computer, smartphone, or tablet device.

Then from  (Chrome menu), select **Sign in to Chrome...**, and log in to your Google account

2. From  (Chrome menu), select **Settings**
3. Click **Show advanced settings...** to display the information. Then for **Google Cloud Print**, select **Manage**
4. Select **Add printers** for the printer to be added
5. When the confirmation message for registering the printer appears, select **OK**

Printer registration is complete.

Registration from the Printer

The authentication procedure using the web browser on the computer or the mobile device is required in the process of registering. Because the authentication URL is printed from printer when the authentication process is performed, prepare A4 size or Letter size or Legal size plain paper.

1. Make sure that the printer is turned on
2. From the operation panel, select the **Setup** button
3. Select **Web service setup -> Connection setup -> GoogleCloudPrint -> Register w/ service**

Note

- If you have already registered the printer with Google Cloud Print, the confirmation message to re-register the printer is displayed.

4. When the confirmation screen to register the printer is displayed, select **Yes**
5. Select a display language on the print setting screen of Google Cloud Print
The confirmation message to print the authentication URL is displayed.
6. Set A4 size or Letter size or Legal size plain paper and select **OK**
The authentication URL is printed.
7. Ensure that the authentication URL is printed, select **Yes**

8. Perform the authentication process using the web browser on the computer or the mobile device

Access to the URL using the web browser on the computer or the mobile device and perform the authentication process following the on-screen instructions.

▶▶▶ Note

- Perform the authentication process with your Google account which you have gotten in advance.

9. When the message that the registration is complete is displayed on the LCD of the printer, select **OK**

When authentication process is complete properly, the registration items are displayed. When authentication process is complete, [you can print the data with Google Cloud Print](#).

When authentication process is not complete properly and the error message is displayed, select **OK**. When the confirmation message to print the authentication URL is displayed, print the authentication URL, then perform the authentication process on the computer again.

Deleting the Printer from Google Cloud Print

To change the printer owner or to re-register the printer, first delete the printer from Google Cloud Print by using the respective procedure.

■ [Deletion from Google Chrome](#)

■ [Deletion from the Printer](#)

Deletion from Google Chrome

1. Start the Google Chrome browser on your computer, smartphone, or tablet device.

Then from  (Chrome menu), select **Sign in to Chrome...**, and log in to your Google account

2. From  (Chrome menu), select **Settings**
3. Click **Show advanced settings...** to display the information. Then for **Google Cloud Print**, select **Manage**
4. Select **Delete** for the printer to be deleted
5. When the confirmation message for deleting the printer appears, select **OK**

Deletion from the Printer

1. Make sure that the printer is turned on
2. From the operation panel, select the **Setup** button

3. Select **Web service setup** -> **Connection setup** -> **GoogleCloudPrint** -> **Delete from service**
4. When the confirmation screen to delete the printer is displayed, select **Yes**

Printing from Computer or Smartphone with Google Cloud Print

When you send print data with Google Cloud Print, the printer receives the print data and prints it automatically if the printer is turned on.

When printing from a smartphone, tablet, computer, or other external device by using Google Cloud Print, load paper into the printer in advance.

Sending the Print Data with Google Cloud Print

1. Make sure that the printer is turned on

▶▶▶ Note

- If you want to send the print data from an outside location, turn on the printer in advance.

2. Send print data from your smartphone, tablet, or computer

The figure below is an example of when printing from the web browser corresponding with Google Cloud Print. The screen differs depending on the applications or services supporting Google Cloud Print.

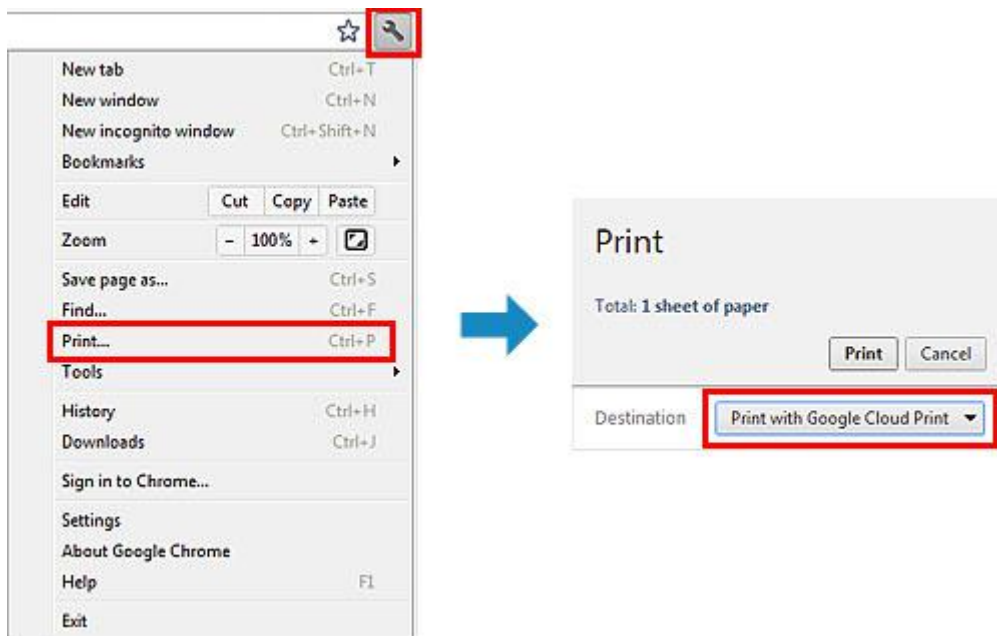

When the preparation for printing with Google Cloud Print is complete and when the printer is turned on, the printer receives the print data and prints it automatically.

▶▶▶ Note

- Depending on the communication status, it may take a while to print the print data or the printer may not receive the print data.
- While printing with Google Cloud Print, the printing may be canceled depending on the printer's status, such as when the printer is being operated or an error has occurred. To resume printing, check the printer's status, then print with Google Cloud Print again.
- For print settings:
 - If you select the media type other than plain paper or if you select the paper size other than A4/ Letter/B5/A5-size, the print data is printed in single-sided even when you select the duplex print setting. (* The paper size differs depending on the model of your printer. For information about

the supported paper sizes, go to the *Online Manual* home page, and refer to the "Cannot Print Properly with Automatic Duplex Printing" for your model.)

- If you select plain paper as media type or if you select B5/A5/Legal-size as paper size, the print data is printed with border even when you select the borderless print setting.
- The print results may differ from the print image depending on the print data.
- Depending on the device sending the print data, you may not select the print settings when sending the print data with Google Cloud Print.

When you want to print from Google Cloud Print immediately

When the printer cannot receive the print data, or you want to start printing immediately, you can check whether there is a print job on the Google Cloud Print and start printing manually.

Follow the steps below.

1. Make sure that the printer is turned on
2. From the operation panel, select the **Setup** button
3. Select **Web service inquiry**

Note

- If you have not registered the printer with Google Cloud Print, **Web service inquiry** is not displayed.

[Register the printer with Google Cloud Print.](#)

4. Select **GoogleCloudPrint**
5. Press the **OK** button

Connect to the server. If print data is available, print that data.

Printing from AirPrint Compliant Device

This document explains how to use AirPrint to print wirelessly from your iPad, iPhone and iPod touch to a Canon printer.

AirPrint enables you to print photos, email, Web pages and documents from your Apple device directly to your printer without installing a driver.



Checking Your Environment

First, check your environment.

- **AirPrint Operation Environment**

To use AirPrint, you will need one of the following Apple devices running the latest version of iOS:

- iPad (all models)
- iPhone (3GS or later)
- iPod touch (3rd generation or later)

- **Network Environment**

The Apple device (iPad, iPhone, or iPod touch) and this printer must be connected to the same Wi-Fi network or connected in AP mode.

Printing with AirPrint

1. Check that this printer is turned on and the Apple device and this printer is connected to the LAN or connected in AP mode.
2. From the app of your Apple device, tap the operation icon to display the menu options.

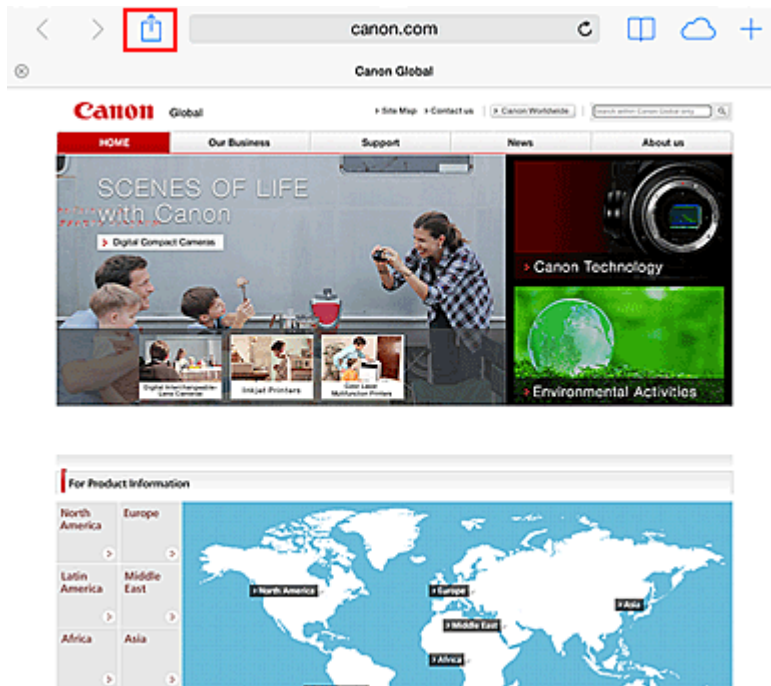

3. From the menu options, tap **Print**.

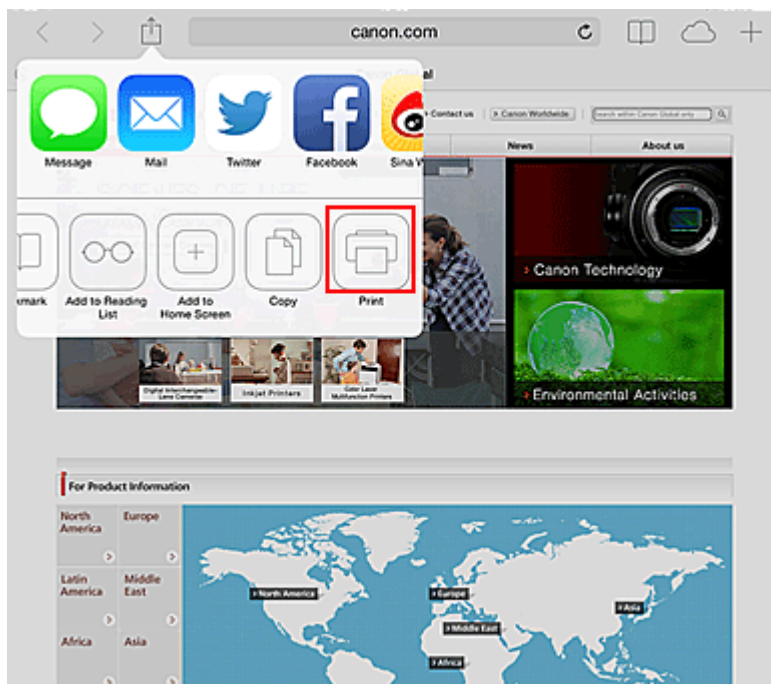

4. From **Printer Options**, select the model that you are using.

»»» Important

- Because some app does not support AirPrint, **Printer Options** may not be displayed. If an app does not let you use printer options, you cannot print from that app.

»»» Note

- The **Printer Options** differ depending on the app and model you are using.

5. When printing a file type that has multiple pages, such as a PDF file, click **Range** and then click **All Pages** or select the range of pages to be printed.
6. For **1 Copy**, click **+** or **-** to set the number of required copies.
7. For **Duplex Printing**, click **On** to enable duplex printing or click **Off** to disable the function.
8. Tap the **Print**.

When you execute printing, the printer prints according to the specified settings.

Paper Size

With AirPrint, the paper size is selected automatically according to the app being used on the Apple device and the region in which AirPrint is used.

When Apple's photo app is used, the default paper size is L size in Japan, and 4"x6" or KG in other countries and regions.

When documents are printed from Apple's Safari app, the default paper size is letter size in the U.S. region, and A4 in Japan and Europe.

»» Important

- Your app may support different paper sizes.

Checking the Print Status

During printing, a **Print Center** icon is displayed in the list of recently used apps, and you can use it to check the print progress.

Press the **Home** button on the Apple device twice to set the **Multitasking** mode. Then swipe to the right to display the **Print Center** icon and a **Print Summary**.

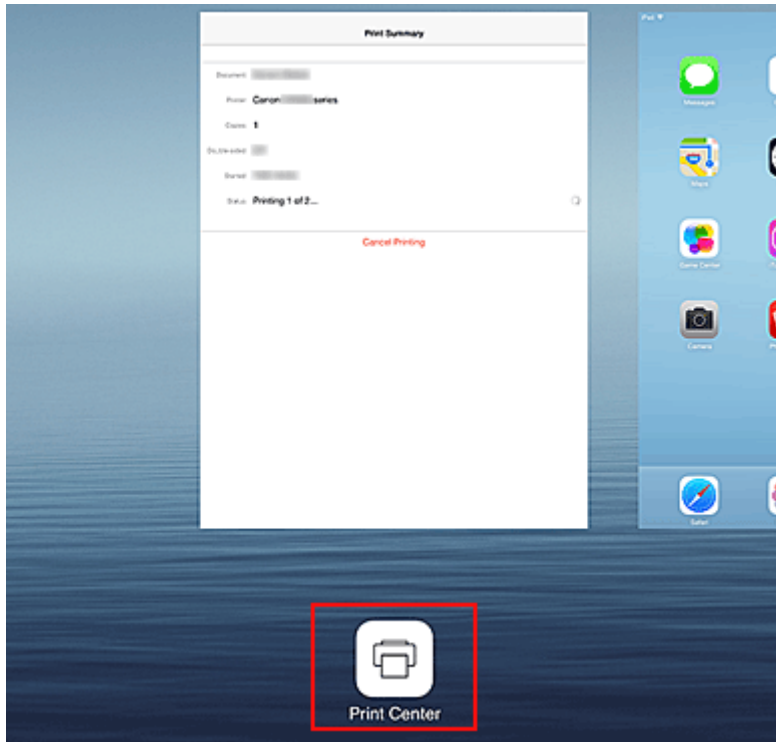

Deleting a Print Job

To delete a print job with AirPrint, use one of the following two methods:

- From the printer: Use the operation panel to cancel the print job.
- From an Apple device: Press the **Home** button on the Apple device twice to set the **Multitasking** mode, and then swipe to the right. Tap the **Print Center** icon to display a **Print Summary**. Tap the print job to be canceled, and then tap **Cancel Printing**.

AirPrint Troubleshooting

If the document does not print, check the following:

1. Check that the printer power is on. If the printer power is on, turn it off and then back on again, and check whether the issue is resolved.
2. Check that the printer is connected by LAN to the same network subnet as the device on which iOS is installed.
3. Check that the printer has enough paper and ink.
4. Check that no error message is displayed on the printer's LCD monitor.

If the problem persists, use the printer driver on your computer to execute printing and check whether the document can be printed normally on the printer.

If the document cannot be printed, refer to the *Online Manual* for your model.

»» Note

- After you turn on the printer, it may take few minutes before the printer can communicate through a wireless LAN connection. Confirm that the printer is connected to the wireless LAN, and then try printing.
 - If Bonjour on the printer is disabled, AirPrint cannot be used. Check the LAN settings on the printer, and enable Bonjour.
-

»» Note

- The windows used in the explanations may differ from those displayed by your Apple device or app.
-

Checking Printer Information

You can use your smartphone, tablet, or computer to check the **Printer status** and execute utility functions from apps such as Canon Inkjet Print Utility and PIXMA Printing Solutions.

You can also use the convenient web services presented by Canon.

1. Selecting Printer Information in an Apps Screen

▶▶▶ Note

- You can also enter IPv4 address directly in the web browser to display printer information.
 1. Load one sheet of A4 size or Letter size or Legal size plain paper
 2. On the printer operation panel, select the  **Setup** button, and then select **Device settings** -> **LAN settings** -> **Print LAN details**
IPv4 address printing starts.
Check the IPv4 address that was printed.
 3. Check that the printer is connected to the same Wi-Fi network. Then from your smartphone, tablet device, or computer, open the Web browser, and enter the following URL:
`http:// <Printer IPv4 address>`
For <Printer IPv4 address>, enter the IPv4 address that you checked in the previous procedure. Entries enclosed in brackets are not required.

2. Entering **Username** and Administrator's Password

From the authentication screen, enter the **Username** and **Password**.

Username: ADMIN

Password: See "[About the Administrator Password.](#)"

▶▶▶ Note

- The **Username** display may differ depending on your browser.

3. Displaying Printer Information

The top screen for printer information is displayed.

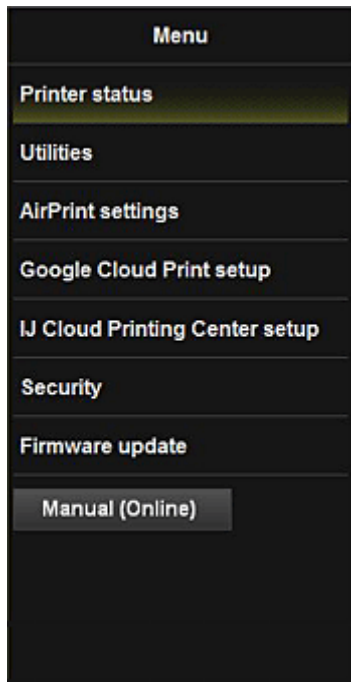

Printer status

This function displays printer information such as the remaining ink amount, the status, and detailed error information.

You can also connect to the ink purchase site or support page, and use Web Services.

Utilities

This function allows you to set and execute the printer utility functions such as cleaning.

AirPrint settings

This function allows you to specify the Apple AirPrint settings, such as position information.

Google Cloud Print setup

This function allows you to register this printer to Google Cloud Print or delete the printer.

IJ Cloud Printing Center setup

Allows you to register to IJ Cloud Printing Center or to delete a registration.

Security

Allows you to set the **Administrator's** password and **Operation restrictions** for the machine.

▶▶▶ Important

- For the initial **Password**, see "[About the Administrator Password.](#)"
For Security reasons, we recommend that you change the **Password** to an individual password.
- There are character restrictions for the password, as shown below.
 - Up to 32 single-byte alphanumeric characters. (Uppercase and lowercase letters are differentiated.)

Firmware update

This function allows you to update the firmware and check version information.

Manual (Online)

This function displays the *Online Manual*.

Online Storage Integration Function

The printer can integrate with online storage services such as Evernote.



Integration with Online Notetaking Service "Evernote"

If an Evernote client application is installed on your computer, you can import scanned images into the application and upload them to the Evernote server.

The uploaded images can be browsed from other computers, smartphones, etc.

To use Evernote, you need to create an account. See the "CREATE ACCOUNT" page of Evernote for account creation.

- **Settings**

In the Settings Dialog Box of IJ Scan Utility, select the item you want to set, then select Evernote for **Send to an application** in **Application Settings**.

Refer to "Settings Dialog Box" for your model from Home of the *Online Manual* for details.

»» Important

- The Evernote service features are subject to change or termination without prior notice.

Print Easily from a Smartphone or Tablet with PIXMA Printing Solutions

Use PIXMA Printing Solutions to easily print photos saved on a smartphone or tablet wirelessly. You can also receive scanned data (PDF or JPEG) directly on a smartphone or tablet without using a computer.

PIXMA Printing Solutions can be downloaded from App Store and Google Play.



Printing with Windows RT

When you use Windows RT 8.1 or a later version, printing is easy because you simply connect this printer to the network.

For information about connecting to the network, see the setup URL (<http://www.canon.com/ijsetup>) for using this product from your computer, smartphone, or tablet device.

When the connection is complete, the Canon Inkjet Print Utility software, which allows you to specify detailed print settings, is downloaded automatically.

By using Canon Inkjet Print Utility, you can check the **Printer status** and specify detailed print settings. (The available functions will differ depending on your usage environment and connection method.)

Overview of the Machine

▶ **Safety Guide**

- Safety Precautions
- Regulatory and Safety Information

▶ **Main Components and Basic Operations**

- Main Components
- About the Power Supply of the Machine
- LCD and Operation Panel
- Entering Numbers, Letters, and Symbols

▶ **Loading Paper / Originals**

- Loading Paper
- Loading Originals

▶ **Replacing a FINE Cartridge**

- Replacing a FINE Cartridge
- Checking the Ink Status

▶ **Maintenance**

- When Printing Becomes Faint or Colors Are Incorrect
- Performing Maintenance from a Computer
- Cleaning the Machine

▶ **Changing the Machine Settings**

- Changing Machine Settings from Your Computer
- Changing the Machine Settings on the LCD

▶ **Information about Network Connection**

- Useful Information about Network Connection

▶ **About Network Communication**

- Changing and Confirming Network Settings
- Screens for Network Connection of IJ Network Tool
- Other Screens of IJ Network Tool
- Appendix for Network Communication

▶ **Tips for Ensuring Optimal Printing Quality**

- Useful Information about Ink
- Key Points to Successful Printing
- Be Sure to Check Paper Settings before Printing
- Be Sure to Set Cassette Paper Information after Loading Paper
- Canceling a Print Job
- Storing Printed Images
- Key to Enjoying Consistent Printing Quality
- Precautions for Safe Transport of the Machine

▶ **Legal Limitations on Use of Your Product and Use of Images**

▶ **Specifications**

Safety Guide

- ▶ **Safety Precautions**
- ▶ **Regulatory and Safety Information**

Safety Precautions

Choosing a location

- Do not install the machine in a location that is unstable or subject to excessive vibration.
- Do not install the machine in locations that are very humid or dusty, in direct sunlight, outdoors, or close to a heating source.
To avoid the risk of fire or electric shocks, use the machine under the operating environment specified in the On-screen Manual.
- Do not place the machine on a thick rug or carpet.
- Do not place the machine with its back attached to the wall.

Power supply

- Ensure that the area around the power outlet is kept clear at all times so you can easily unplug the power cord if necessary.
- Never remove the plug by pulling on the cord.
Pulling the cord may damage the power cord, leading to possible fire or electrical shock.
- Do not use an extension lead/cord.

Working around the machine

- Never put your hands or fingers in the machine while it is printing.
- When moving the machine, carry the machine at both ends. In case the machine weighs more than 14 kg, it is recommended to have two people lifting the machine. Accidental dropping of the machine causes injury. For the machine's weight, refer to the On-screen Manual.
- Do not place any object on the machine. Especially do not place metal objects (paper clips, staples, etc.) or containers of flammable solvents (alcohol, thinners, etc.) on top of the machine.
- Do not transport or use the machine on a slant, vertically or upside-down, as the ink may leak and damage the machine.

Working around the machine (For the multifunction printer)

- When loading a thick book on the Platen Glass, do not press hard on the Document Cover. The Platen Glass may break and cause injury.

Print Heads/ink tanks and FINE Cartridges

- Keep ink tanks out of the reach of children. In case ink* is accidentally licked or swallowed, rinse out mouth or give one or two glasses of water to drink. If irritation or discomfort occurs, obtain medical advice immediately.
* Clear Ink contains nitrate salts (For models containing Clear Ink).
- In case ink gets in contact with eyes, rinse with water immediately. In case ink gets in contact with skin, wash with soap and water immediately. If irritation to eyes or skin persists, obtain medical advice immediately.
- Never touch the electrical contacts on a Print Head or FINE Cartridges after printing.
The metal parts may be very hot and could cause burns.
- Do not throw ink tanks and FINE Cartridges into fire.
- Do not attempt to disassemble or modify the Print Head, ink tanks, and FINE Cartridges.

Regulatory and Safety Information

For models containing lithium battery

- Dispose of used batteries according to the local regulations.
- Risk of explosion if battery is replaced by an incorrect type.

IMPORTANT SAFETY INSTRUCTIONS

SAVE THESE INSTRUCTIONS

When using your telephone equipment, basic safety precautions should always be followed to reduce the risk of fire, electric shock and injury to persons, including the following:

1. Do not use this product near water, for example, near a bath tub, wash bowl, kitchen sink or laundry tub, in a wet basement or near a swimming pool.
2. Avoid using this product during an electrical storm. There may be a remote risk of electric shock from lightning.
3. Do not use this product to report a gas leak in the vicinity of the leak.

"CAUTION - To reduce the risk of fire, use only No. 26 AWG or larger telecommunication line cord."

IMPORTANTES MESURES DE SÉCURITÉ

CONSERVER CES INSTRUCTIONS

Certaines mesures de sécurité doivent être prises pendant l'utilisation de matériel téléphonique afin de réduire les risques d'incendie, de choc électrique et de blessures.

En voici quelquesunes :

1. Ne pas utiliser l'appareil près de l'eau, p.ex., près d'une baignoire, d'un lavabo, d'un évier de cuisine, d'un bac à laver, dans un sous-sol humide ou près d'une piscine.
2. Éviter d'utiliser l'appareil pendant un orage électrique. Ceci peut présenter un risque de choc électrique causé par la foudre.
3. Ne pas utiliser l'appareil pour signaler une fuite de gaz s'il est situé près de la fuite.

"ATTENTION - Pour réduire les risques d'incendie, utiliser uniquement des conducteurs de télécommunications 26 AWG au de section supérieure."

Users in the U.S.A.

FCC Notice (U.S.A. Only)

For 120V, 60Hz model

Model Number: K10415 (Contains FCC Approved WLAN Module K30357)

This device complies with Part 15 of the FCC Rules. Operation is subject to the following two conditions:

(1) This device may not cause harmful interference, and (2) this device must accept any interference received, including interference that may cause undesired operation.

Note: This equipment has been tested and found to comply with the limits for a Class B digital device, pursuant to Part 15 of the FCC Rules. These limits are designed to provide reasonable protection against harmful interference in a residential installation. This equipment generates, uses and can radiate radio frequency energy and, if not installed and used in accordance with the instructions, may cause harmful interference to radio communications.

However, there is no guarantee that interference will not occur in a particular installation. If this equipment does cause harmful interference to radio or television reception, which can be determined by turning the

equipment off and on, the user is encouraged to try to correct the interference by one or more of the following measures:

- Reorient or relocate the receiving antenna.
- Increase the separation between the equipment and receiver.
- Connect the equipment into an outlet on a circuit different from that to which the receiver is connected.
- Consult the dealer or an experienced radio/TV technician for help.

Use of a shielded cable is required to comply with Class B limits in Subpart B of Part 15 of the FCC Rules.

Do not make any changes or modifications to the equipment unless otherwise specified in the manual. If such changes or modifications should be made, you could be required to stop operation of the equipment.

FCC ID:AZDK30357

Changes or modifications not expressly approved by the party responsible for compliance could void the user's authority to operate equipment.

This transmitter must not be co-located or operating in conjunction with any other antenna or transmitter.

The equipment complies with FCC radiation exposure limits for at uncontrolled equipment. This equipment should be installed and operated with minimum distance at least 20cm between the radiator and persons body (excluding extremities: hands, wrists, feet and ankles) and must not be colocated or operated with any other antenna or transmitter.

Canon U.S.A., Inc.
One Canon Park
Melville, New York 11747
1-800-652-2666

Pre-Installation Requirements

Order Information

When ordering service from the telephone company for this equipment, the following may be required.

Universal Service Order Code (USOC): RJ11C

The Facility Interface Code (FIC): 02LS2

Service Order Code (SOC): 9.0F

Connection of the Equipment

This equipment complies with Part 68 of the FCC rules and the requirements adopted by the ACTA.

A label on this equipment contains, among other information, a product identifier in the format US:AAAEQ##TXXXX. If requested, this number must be provided to the telephone company.

The REN is used to determine the number of devices that may be connected to a telephone line.

Excessive RENs on a telephone line may result in the devices not ringing in response to an incoming call. In most but not all areas, the sum of RENs should not exceed five (5.0). To be certain of the number of devices that may be connected to a line, as determined by the total RENs, contact the local telephone company. The REN for this product is part of the product identifier that has the format US:AAAEQ##TXXXX. The digits represented by ## are the REN without a decimal point (e.g., 03 is a REN of 0.3).

A plug and jack used to connect this equipment to the premises wiring and telephone network must comply with the applicable FCC Part 68 rules and requirements adopted by the ACTA. A compliant

telephone cord and modular plug is provided with this product. It is designed to be connected to a compatible modular jack that is also compliant. See installation instructions for details.

Connection to party lines is subjected to state tariffs. Contact the state public utility commission, public service commission or corporation commission for information.

If your home has specially wired alarm equipment connected to the telephone line, ensure the installation of this equipment does not disable your alarm equipment. If you have questions about what will disable alarm equipment, consult your telephone company or a qualified installer.

In Case of Equipment Malfunction

Should any malfunction occur which cannot be corrected by the procedures described in the Online Manual, disconnect the equipment from the telephone line cable, turn off the power and disconnect the power cord. The telephone line cable should not be reconnected or the main power switch turned ON until the problem is completely resolved. Users should contact their local authorized Canon Facsimile Service Dealer for the servicing of equipment.

Information regarding Authorized Service Facility locations can be obtained by calling the Canon Customer Center.

Rights of the Telephone Company

If this equipment causes harm to the telephone network, the telephone company may temporarily disconnect service. The telephone company also retains the right to make changes in facilities and services that may affect the operation of this equipment. When such changes are necessary, the telephone company is required to give adequate prior notice to the user. However, if advance notice is not possible, the telephone company will notify the customer as soon as possible. Also, the customer will be advised of his/her right to file a complaint with the FCC if he/she believes it is necessary.

Warning

The Telephone Consumer Protection Act of 1991 makes it unlawful for any person to use a computer or other electronic device to send any message via a telephone FAX machine unless such message clearly contains in a margin at the top or bottom of each transmitted page, or on the first page of the transmission, the date and time it is sent and an identification of the business or other entity, or other individual sending the message and the telephone number of the sending machine or such business, other entity, or individual.

In order to program this information into your FAX machine, you should complete the procedure to register your name, unit's telephone number, time, and date. Refer to the Online Manual.

Users in Canada

This device complies with Industry Canada license-exempt RSS standard(s). Operation is subject to the following two conditions:

(1) this device may not cause interference, and (2) this device must accept any interference, including interference that may cause undesired operation of the device.

This equipment complies with IC radiation exposure limits set forth for an uncontrolled environment and meets RSS-102 of the IC radio frequency (RF) Exposure rules. This equipment should be installed and operated keeping the radiator at least 20cm or more away from person's body (excluding extremities: hands, wrists, feet and ankles).

Pre-Installation Requirements

Notice

This equipment meets the applicable Industry Canada technical specifications.

The Ringer Equivalence Number is an indication of the maximum number of devices allowed to be connected to a telephone interface. The termination on an interface may consist of any combination of devices subject only to the requirement that the sum of the RENs of all the devices does not exceed five.

Pour les usagers résidant au Canada

Le présent appareil est conforme aux CNR d'Industrie Canada applicables aux appareils radio exempts de licence. L'exploitation est autorisée aux deux conditions suivantes :

(1) l'appareil ne doit pas produire de brouillage, et (2) l'utilisateur de l'appareil doit accepter tout brouillage radioélectrique subi, même si le brouillage est susceptible d'en compromettre le fonctionnement.

Cet équipement est conforme aux limites d'exposition aux rayonnements énoncées pour un environnement non contrôlé et respecte les règles d'exposition aux fréquences radioélectriques (RF) CNR-102 de l'IC. Cet équipement doit être installé et utilisé en gardant une distance de 20 cm ou plus entre le dispositif rayonnant et le corps (à l'exception des extrémités : mains, poignets, pieds et chevilles).

Conditions de pré-installation

Avis

Le présent matériel est conforme aux spécifications techniques applicables d'Industrie Canada.

L'indice d'équivalence de la sonnerie (IES) sert à indiquer le nombre maximal de terminaux qui peuvent être raccordés à une interface téléphonique. La terminaison d'une interface peut consister en une combinaison quelconque de dispositifs, à la seule condition que la somme d'indices d'équivalence de la sonnerie de tous les dispositifs n'excède pas 5.

Users in New Zealand

The grant of a Telepermit for any item of terminal equipment indicates only that Spark has accepted that the item complies with minimum conditions for connection to its network. It indicates no endorsement of the product by Spark, nor does it provide any sort of warranty. Above all, it provides no assurance that any item will work correctly in all respects with another item of Telepermitted equipment of a different make or model, nor does it imply that any product is compatible with all of Spark's network services. This equipment is not capable, under all operating conditions, of correct operation at the higher speeds for which it is designed. Spark will accept no responsibility should difficulties arise in such circumstances. This condition typically applies to 56 kbit/s modems and V34 facsimile machines. Please note when you connect an extension phone to this device, if you use an extension phone which has features such as "last number redial", redial memory numbers may be lost. The automatic calling functions of this equipment must not be used to a nuisance to other Spark customers. Telepermitted equipment only may be connected to the telephone port. The telephone port is not specifically designed for 3-wire connected equipment. 3-wire connected equipment might not respond to incoming ringing when attached to this port.

Users in Jordan

This printer contains WLAN Module approved by TRC/LPD/2013/130

Only for European Union and EEA (Norway, Iceland and Liechtenstein)



This symbol indicates that this product is not to be disposed of with your household waste, according to the WEEE Directive (2012/19/EU) and national legislation. This product should be handed over to a designated collection point, e.g., on an authorized one-for-one basis when you buy a new similar product or to an authorized collection site for recycling waste electrical and electronic equipment (EEE). Improper handling of this type of waste could have a possible negative impact on the environment and human health due to potentially hazardous substances that are generally associated with EEE. At the same time, your cooperation in the correct disposal of this product will contribute to the effective usage of natural resources. For more information about where you can drop off your waste equipment for recycling, please contact your local city office, waste authority, approved WEEE scheme or your household waste disposal service. For more information regarding return and recycling of WEEE products, please visit www.canon-europe.com/weee.

Korisnici u Srbiji



Ovaj simbol označava da ovaj proizvod ne sme da se odlaže sa ostalim kućnim otpadom, u skladu sa WEEE Direktivom (2012/19/EU) i nacionalnim zakonima. Ovaj proizvod treba predati određenom centru za prikupljanje, npr. na osnovi "jedan-za-jedan" kada kupujete sličan novi proizvod, ili ovlašćenom centru za prikupljanje za reciklažu istrošene električne i elektronske opreme (EEE). Nepravilno rukovanje ovom vrstom otpada može da ima moguće negativne posledice po životnu sredinu i ljudsko zdravlje usled potencijalno opasnih materijala koji se uglavnom vezuju za EEE. U isto vreme, vaša saradnja na ispravnom odlaganju ovog proizvoda će doprineti efikasnom korišćenju prirodnih resursa. Za više informacija o tome gde možete da predate vašu staru opremu radi recikliranja, vas molimo, da kontaktirate lokalne gradske vlasti, komunalne službe, odobreni plan reciklaže ili Gradsku čistoću. Za više informacija o vraćanju i recikliranju WEEE proizvoda, posetite stranicu www.canon-europe.com/weee.

Environmental Information

Reducing your environmental impact while saving money

Power Consumption and Activation Time

The amount of electricity a device consumes depends on the way the device is used. This product is designed and set in a way to allow you to reduce your electricity costs. After the last print it switches to Ready Mode. In this mode it can print again immediately if required. If the product is not used for a time, the device switches to its Power Save Mode. The devices consume less power (Watt) in these modes. If you wish to set a longer Activation Time or would like to completely deactivate the Power Save Mode, please consider that this device may then only switch to a lower energy level after a longer period of time or not at all.

Canon does not recommend extending the Activation Times from the optimum ones set as default.

Energy Star®

The Energy Star® programme is a voluntary scheme to promote the development and purchase of energy efficient models, which help to minimise environmental impact.

Products which meet the stringent requirements of the Energy Star® programme for both environmental benefits and the amount of energy consumption will carry the Energy Star® logo accordingly.

Paper types

This product can be used to print on both recycled and virgin paper (certified to an environmental stewardship scheme), which complies with EN12281 or a similar quality standard. In addition it can support printing on media down to a weight of 64g/m², lighter paper means less resources used and a lower environmental footprint for your printing needs.

RMC

Regulatory Model Code (RMC) is for identification and proof that the product complies with the regulations. Please note that RMC is different from the marketing model number of the product.



Main Components and Basic Operations

- ▶ **Main Components**
- ▶ **About the Power Supply of the Machine**
- ▶ **LCD and Operation Panel**
- ▶ **Entering Numbers, Letters, and Symbols**

Main Components

- ▶ **Front View**
- ▶ **Rear View**
- ▶ **Inside View**
- ▶ **Operation Panel**

Front View

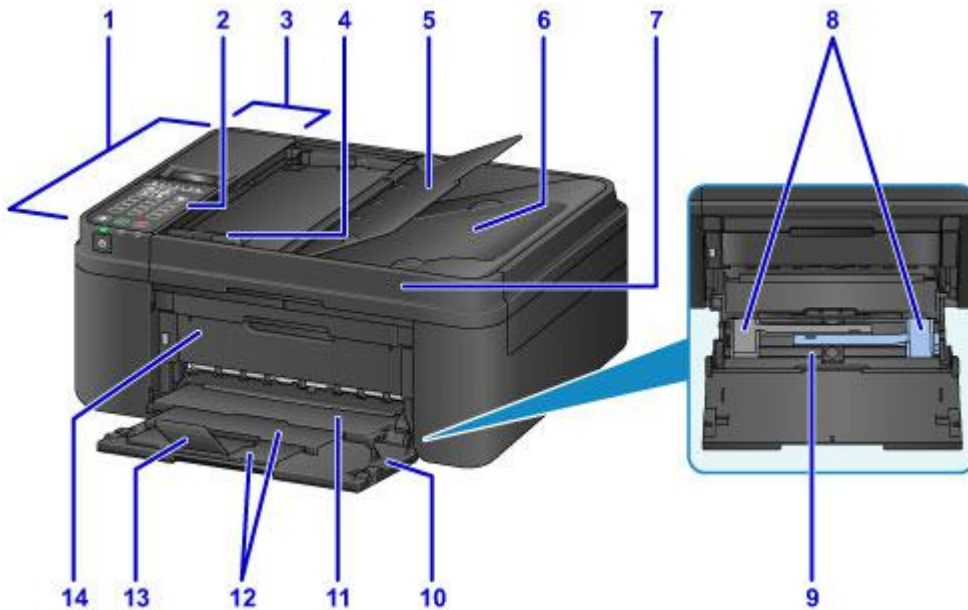

(1) ADF (Auto Document Feeder)

Load a document here. The documents loaded in the document tray are scanned automatically one sheet at a time.

■ [Loading Documents in the ADF \(Auto Document Feeder\)](#)

(2) operation panel

Use to change the settings of the machine or to operate it.

■ [Operation Panel](#)

(3) document feeder cover

Open when clearing jammed documents.

(4) document guide

Adjust this guide to match the width of document in the ADF.

(5) document tray

Open to load a document in the ADF. You can load two or more sheets of document of the same size and thickness. Load the document with the side you want to scan facing up.

(6) document output slot

Documents scanned from the ADF are delivered here.

(7) document cover

Open to load an original on the platen glass.

(8) paper guides

Align with both sides of the paper stack.

(9) cassette

Load paper here. Two or more sheets of the same size and type of paper can be loaded at the same time, and fed automatically one sheet at a time.

■ [Loading Plain Paper / Photo Paper](#)

■ [Loading Envelopes](#)

(10) front cover

Open to load paper in the cassette.

(11) paper output tray

Printed paper is ejected.

(12) paper output support

Pull out to support ejected paper.

(13) output tray extension

Open to support ejected paper.

(14) paper output cover

Open to replace the FINE cartridge or remove jammed paper inside the machine.



(15) POWER lamp

Lights after flashing when the power is turned on.

(16) FAX Memory lamp

Lights when there are received or unsend documents stored in the machine's memory.

(17) Alarm lamp

Lights or flashes when an error occurs.

(18) ON button

Turns the power on or off. Before turning on the power, make sure that the document cover is closed.

■ [Turning the Machine On and Off](#)

(19) platen glass

Load an original here.

Rear View



(1) power cord connector

Plug in the supplied power cord.

(2) transport unit

Open when removing jammed paper.

(3) telephone line jack

Connect the telephone line.

(4) external device jack

Connect an external device such as telephone or answering machine.

(5) USB port

Plug in the USB cable to connect the machine with a computer.

»» Important

- Do not touch the metal casing.
- Do not plug in or unplug the USB cable while the machine is printing or scanning originals with the computer.

Inside View

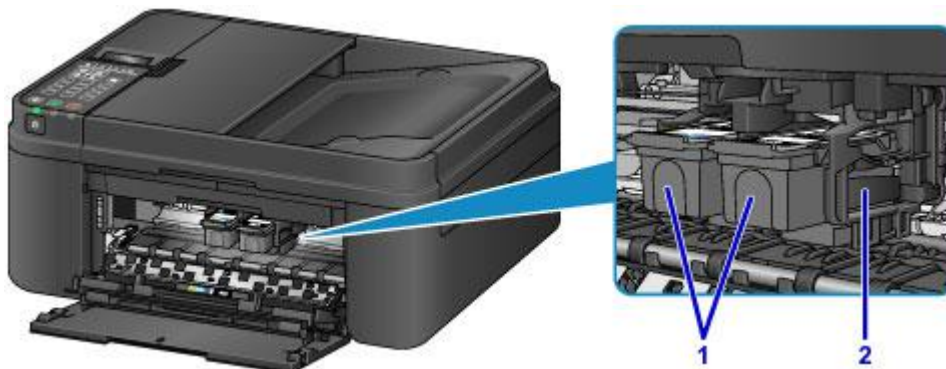

(1) FINE cartridge (ink cartridges)

A replaceable cartridge that integrates print head and ink tank.

(2) FINE cartridge holder

Install the FINE cartridges here.

The color FINE cartridge should be installed into the left slot and the black FINE cartridge should be installed into the right slot.

▶▶ Note

- For details on replacing a FINE cartridge, see [Replacing a FINE Cartridge](#).

▶▶ Important

- The area around the parts (A) may be splattered with ink. This does not affect the performance of the machine.
- Do not touch the parts (A). The machine may not print properly if you touch them.



Operation Panel

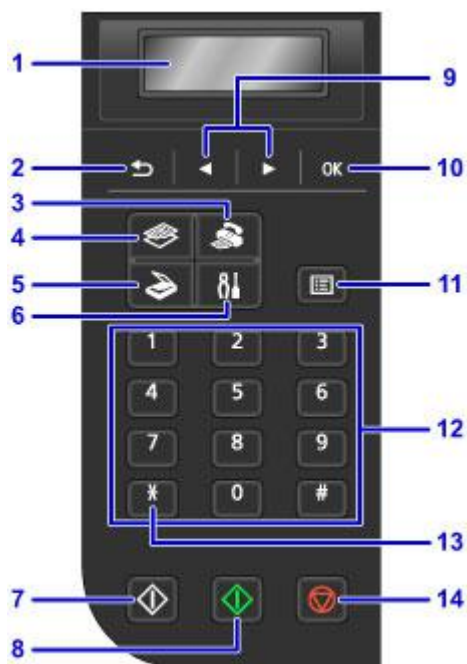

(1) LCD (Liquid Crystal Display)

Displays messages, menu items, and the operational status.

(2) Back button

Returns the LCD to the previous screen.

(3) FAX button

Switches the machine to the fax mode.

(4) COPY button

Switches the machine to the copy mode.

(5) SCAN button

Switches the machine to the scan mode.

(6) Setup button

Displays the **Setup menu** screen. With this menu, you can perform machine maintenance and change machine settings.

(7) Black button

Starts black & white copying, scanning, faxing, etc.

(8) Color button

Starts color copying, scanning, faxing, etc.

(9) ◀ and ▶ buttons

Used to select a menu or setting item. The ◀ or ▶ button is also used when entering characters.

■ [LCD and Operation Panel](#)

(10) OK button

Finalizes the selection of a menu or setting item. This button is also used to resolve an error or ejects documents in the ADF (Auto Document Feeder).

(11) Menu button

Displays the **Copy menu**, **Scan menu**, or **FAX menu** screen.

(12) Numeric buttons

Used to enter numerical values such as the number of copies, as well as fax/telephone numbers and characters.

(13) Tone button

Switches to tone dialing temporarily if your machine is connected to a rotary pulse line.

(14) Stop button

Cancels operation when print, copy, scan, or fax transmission/reception job is in progress.

»» Note

- The machine makes the beep sound when pressing keypad buttons on the operation panel. The keypad sound can be enabled or disabled in **Sound control** of **Dev. user settings**.

■ [Dev. user settings](#)

About the Power Supply of the Machine

- **Confirming that the Power Is On**
- **Turning the Machine On and Off**
- **Notice for the Power Plug/Power Cord**
- **Notice for Unplugging the Power Cord**

Confirming that the Power Is On

The **POWER** lamp is lit when the machine is turned on.

Even if the LCD is off, if the **POWER** lamp is lit, the machine is on.



▶▶▶ Note

- It may take a while for the machine to start printing immediately after you turn on the machine.
- The LCD will turn off if the machine is not operated for about 5 minutes. To restore the display, press any button except the **ON** button or perform the print operation. The display will be also restored when receiving faxes. You cannot change the wait time before the LCD turns off.

Turning the Machine On and Off

Turning on the machine

1. Press the **ON** button to turn on the machine.

The **POWER** lamp flashes and then remains lit.

■ [Confirming that the Power Is On](#)



▶▶▶ Note

- It may take a while for the machine to start printing immediately after you turn on the machine.
- If the **Alarm** lamp lights up or flashes and an error message is displayed on the LCD, see [A Message Is Displayed](#).

Turning off the machine

1. Press the **ON** button to turn off the machine.

When the **POWER** lamp stops flashing, the machine is turned off.



▶▶▶ Important

- When you [unplug the power cord](#) after turning off the machine, be sure to confirm that the **POWER** lamp is off.

▶▶▶ Note

- The machine cannot send or receive faxes when the power is turned off.
- The power cannot be turned off while the machine is sending or receiving a fax, or when unsent faxes are stored in the machine's memory.
- You can set the machine to automatically turn off when no operations are performed for a certain interval. This feature is set to on by default. However, the machine does not turn off automatically when the machine is connected via a wireless LAN or to a telephone line.

■ [Managing the Printer Power](#)

Notice for the Power Plug/Power Cord

Check the power plug/power cord once a month to confirm that it does not have anything unusual described below.

- The power plug/power cord is hot.
- The power plug/power cord is rusty.
- The power plug/power cord is bent.
- The power plug/power cord is worn.
- The power plug/power cord is split.

Caution

- If you find anything unusual with the power plug/power cord described above, [unplug the power cord](#) and call for service. Using the machine with one of the unusual conditions above may cause a fire or an electric shock.

Notice for Unplugging the Power Cord

To unplug the power cord, follow the procedure below.

▶▶▶ Important

- When you unplug the power cord, press the **ON** button, then confirm that the **POWER** lamp is off. Unplugging the power cord while the **POWER** lamp is lit or flashing may cause drying or clogging of the print head and print quality may be reduced.
- If the power cord is unplugged, the date/time settings will be reset and all documents stored in the machine's memory will be lost. Send or print a necessary document before unplugging the power cord.

1. Press the **ON** button to turn the machine off.



2. Confirm that the **POWER** lamp is off.



3. Unplug the power cord.

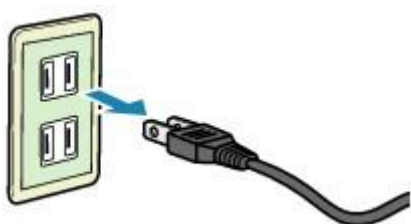

The specification of the power cord differs depending on the country or region of use.

LCD and Operation Panel

The mode button (A) on the operation panel allows you to switch between the copy mode, scan mode, fax mode, and setup menu screen.

Pressing the **Menu** button (B) in the respective modes shows the menu screen to select various functions or settings.

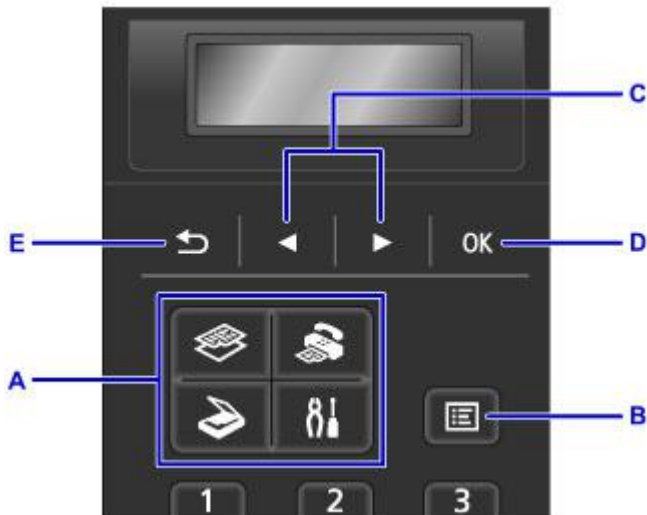

Selecting a Menu or Setting Item

On the menu screen or settings screen, use the ◀ or ▶ button (C) to select an item or option, then press the **OK** button (D) to proceed with the procedure.

To return to the previous screen, press the **Back** button (E).

Example: Changing the scan contrast for faxing.

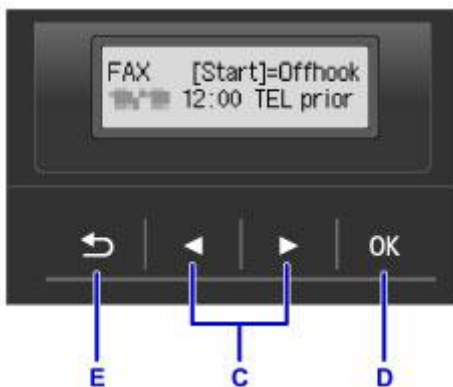

Press the **Menu** button in the Fax standby screen.



Press the ◀ or ▶ button (C) to select **FAX TX settings**.

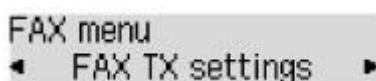

Press the **OK** button (D).

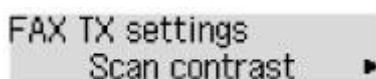

Select **Scan contrast**, press the **OK** button (D).



Use the ◀ or ▶ button (C) to change the contrast, then press the **OK** button (D).

Entering Numbers, Letters, and Symbols

Use the Numeric buttons to enter or edit such information as unit name, a recipient's name for the directory, etc.

Switching the Input Mode

Each time the **Tone** button is pressed, the input mode is switched in the following order: lowercase mode (:a), uppercase mode (:A), then numeric mode (:1).

The current input mode appears at the upper right corner of the LCD.

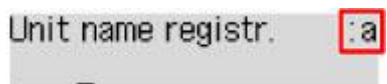

Entering Numbers, Letters, and Symbols

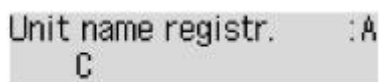

Press the **Tone** button to switch the input mode.

Use the Numeric buttons to enter the desired characters.

- To insert a space
Press the **#** button five times.
- To delete the last entered character
Press the **Back** button.

Editing Entered Numbers, Letters, and Symbols

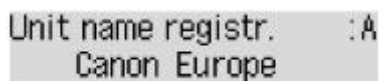

Press the **◀** or **▶** button to move the cursor under the position you want to edit.

- To insert a space
Press the **#** button five times.
- To insert a character
Move the cursor under the character to the right of the insertion position, then enter the character. The character on the cursor will move to the right and the new character will be inserted.
- To delete a character
Move the cursor under the character, then press the **Back** button.

List of Characters Assigned to Each Numeric Button

Button	Lowercase mode (:a)	Uppercase mode (:A)	Numeric mode (:1)	Fax/Telephone no.
1			1	1
2	abcâäåãäæç	ABCÄÅÄÅÄÆÇ	2	2

3	deféèèèè	DEFĚĚĚĚĚĚ	3	3
4	gh i i i i i	GH I I I I I	4	4
5	jkl	JKL	5	5
6	mnoñøóóóóó	MNOŇØÓÓÓÓÓ	6	6
7	pqrsp	PQRSP	7	7
8	tuvüúúúú	TUVÜÚÚÚÚ	8	8
9	wxyzý	WXYZÝ	9	9
0			0	0
#	. @ - _ SP*1 *#!" , ; : ^ ` = / ' ? \$ % & + () [] { } < > \^2 ~*2			#
✖	Switch the input mode.			*

*1 "SP" indicates a space.

*2 Displayed only when entering characters in the LAN settings.

Loading Paper / Originals

- ▶ **Loading Paper**
- ▶ **Loading Originals**

Loading Paper

- ▶ **Loading Plain Paper / Photo Paper**
- ▶ **Loading Envelopes**
- ▶ **Media Types You Can Use**
- ▶ **Media Types You Cannot Use**
- ▶ **Printing Area**

Loading Plain Paper / Photo Paper

You can load plain paper or photo paper.

▶▶▶ Important

- If you cut plain paper into small size such as 4" x 6" (10 x 15 cm) or 5" x 7" (13 x 18 cm) to perform trial print, it can cause paper jams.

▶▶▶ Note

- We recommend Canon genuine photo paper for printing photos.
For details on the Canon genuine paper, see [Media Types You Can Use](#).
- You can use general copy paper.
For the page size and paper weight you can use for this machine, see [Media Types You Can Use](#).

1. Prepare paper.

Align the edges of paper. If paper is curled, flatten it.

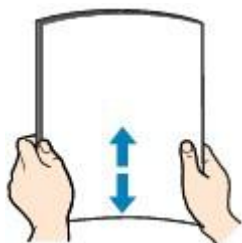

▶▶▶ Note

- Align the edges of paper neatly before loading. Loading paper without aligning the edges may cause paper jams.
- If paper is curled, hold the curled corners and gently bend them in the opposite direction until the paper becomes completely flat.
For details on how to flatten curled paper, see "Load the paper after correcting its curl." in [Paper Is Smudged/Printed Surface Is Scratched](#).
- When using Photo Paper Plus Semi-gloss SG-201, even if the sheet is curled, load one sheet at a time as it is. If you roll up this paper to flatten, this may cause cracks on the surface of the paper and reduce the print quality.

2. Open the front cover (A) gently.

The paper output tray (B) opens.



3. Grab the right and left sides of the front cover and pull out the cassette until it stops.



4. Use the right paper guide (C) to slide both paper guides all the way out.

5. Load the paper in the center of the cassette WITH THE PRINT SIDE FACING DOWN.

Push the paper stack all the way to the back of the cassette.



* The above figure shows the machine with the paper output tray raised.

►► Important

- Always load paper in the portrait orientation (D). Loading paper in the landscape orientation (E) can cause paper jams.

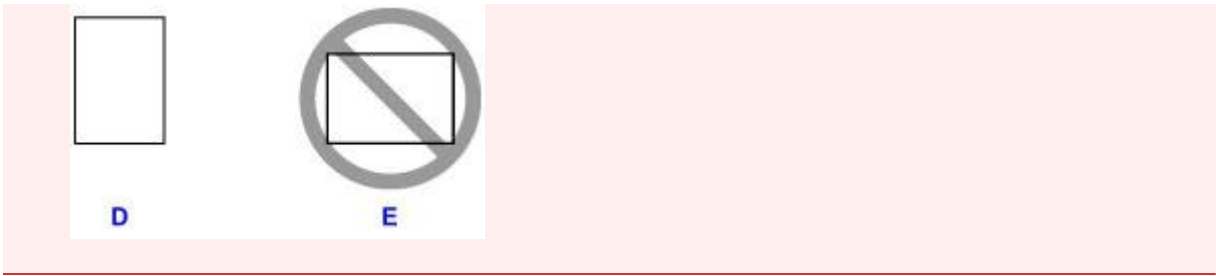

6. Slide the right paper guide (C) to align the paper guides with both sides of the paper stack.
Do not slide the paper guides too hard against the paper. The paper may not be fed properly.



* The above figure shows the machine with the paper output tray raised.

►► Note

- Do not load sheets of paper higher than the load limit mark (F).
- Keep the paper stack height below the tabs (G) of the paper guides.



* The above figure shows the machine with the paper output tray raised.

- Load small size paper, such as 4" x 6" (10 x 15 cm), by pushing it in all the way to the back of the cassette.

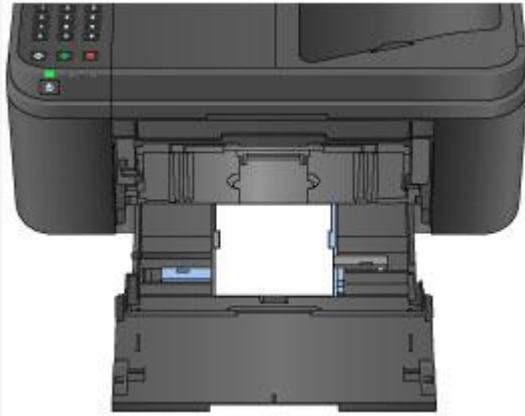

* The above figure shows the machine with the paper output tray raised.

7. Grab the right and left sides of the front cover and push the cassette back until the arrow (▶) on the front cover is aligned with the edge of the machine.

After pushing the cassette back properly, the machine makes an electronic sound and the paper information registration screen is displayed on the LCD.

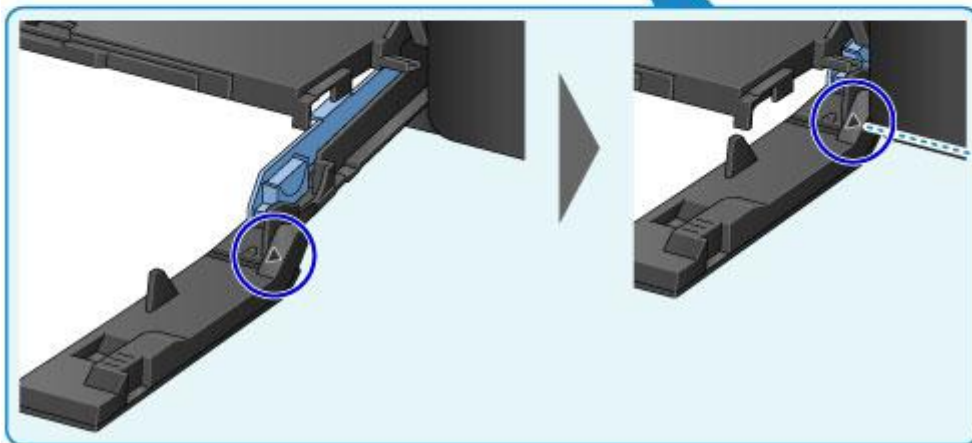

▶▶▶ Note

- When you set the alarm to be silent in **Sound control** of **Dev. user settings**, the alarm will not beep even if the cassette is pushed back.

■ [Dev. user settings](#)

8. Press the **OK** button.

Register the cassette pa
[OK]Next

- Use the ◀ or ▶ button to select the size of the loaded paper in the cassette, then press the **OK** button.

Size: ◀ A4 ▶
Type: *PlusGlossyII

▶▶▶ **Note**

- The asterisk "*" will appear with the current page size and media type settings.

■ [Paper setting for Printing](#)

- Use the ◀ or ▶ button to select the type of the loaded paper in the cassette, then press the **OK** button.

Size: A4
Type: Plain paper ▶

- Pull the paper output support (H) out from the paper output tray.
- Open the output tray extension (I).



▶▶▶ **Note**

- When printing, select the size and type of the loaded paper on the print settings screen of the operation panel or printer driver.

Loading Envelopes

You can load Envelope DL and Envelope Com 10.

The address is automatically rotated and printed according to the envelope's direction by specifying with the printer driver properly.

▶▶▶ Important

- Printing of envelopes from the operation panel is not supported.
- Do not use the following envelopes. They could jam in the machine or cause the machine to malfunction.
 - Envelopes with an embossed or treated surface
 - Envelopes with a double flap
 - Envelopes whose gummed flaps are already moistened and adhesive

1. Prepare envelopes.

- Press down on all four corners and edges of the envelopes to flatten them.

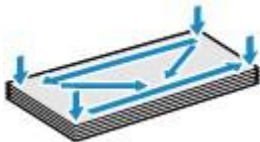

- If the envelopes are curled, hold the opposite corners and gently twist them in the opposite direction.



- If the corner of the envelope flap is folded, flatten it.
- Use a pen to press the leading edge in the inserting direction flat and sharpen the crease.

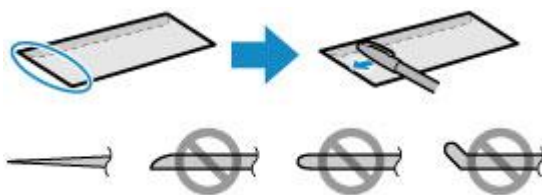

The figures above show a side view of the leading edge of the envelope.

▶▶▶ Important

- The envelopes may jam in the machine if they are not flat or the edges are not aligned. Make sure that no curl or puff exceeds 0.1 inch (3 mm).

2. Open the front cover (A) gently.

The paper output tray (B) opens.



3. Grab the right and left sides of the front cover and pull out the cassette until it stops.



4. Use the right paper guide (C) to slide both paper guides all the way out.

5. Load the envelopes in the center of the cassette WITH THE ADDRESS SIDE FACING DOWN.

The folded flap of the envelope will be faced up on the left side.

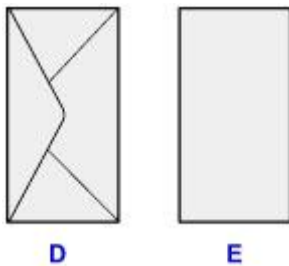

D: Rear side

E: Address side

Push the envelopes all the way to the back of the cassette.

Up to 5 envelopes can be loaded at once.



* The above figure shows the machine with the paper output tray raised.

6. Slide the right paper guide (C) to align the paper guides with both sides of the envelopes.

Do not slide the paper guides too hard against the envelopes. The envelopes may not be fed properly.

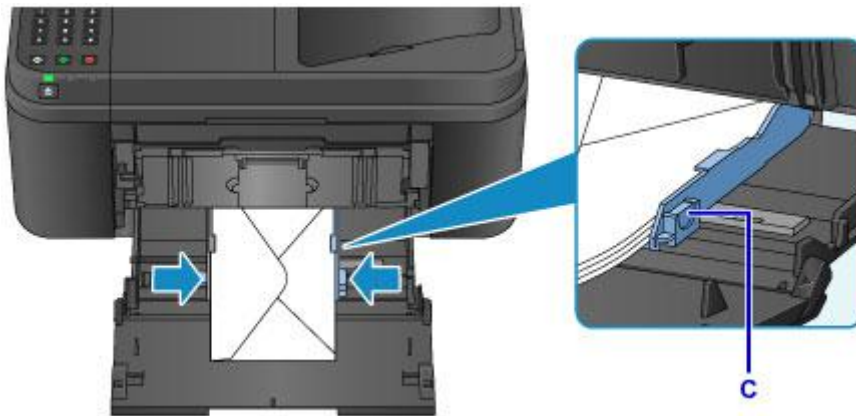

* The above figure shows the machine with the paper output tray raised.

►►► **Note**

- Do not load envelopes higher than the load limit mark (F).
- Keep the envelope stack height below the tabs (G) of the paper guides.

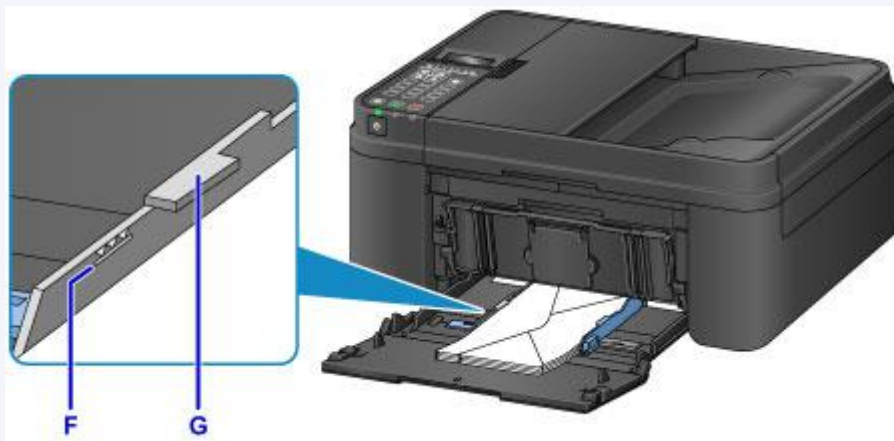

* The above figure shows the machine with the paper output tray raised.

7. Grab the right and left sides of the front cover and push the cassette back until the arrow (▶) on the front cover is aligned with the edge of the machine.

After pushing the cassette back properly, the machine makes an electronic sound and the paper information registration screen is displayed on the LCD.

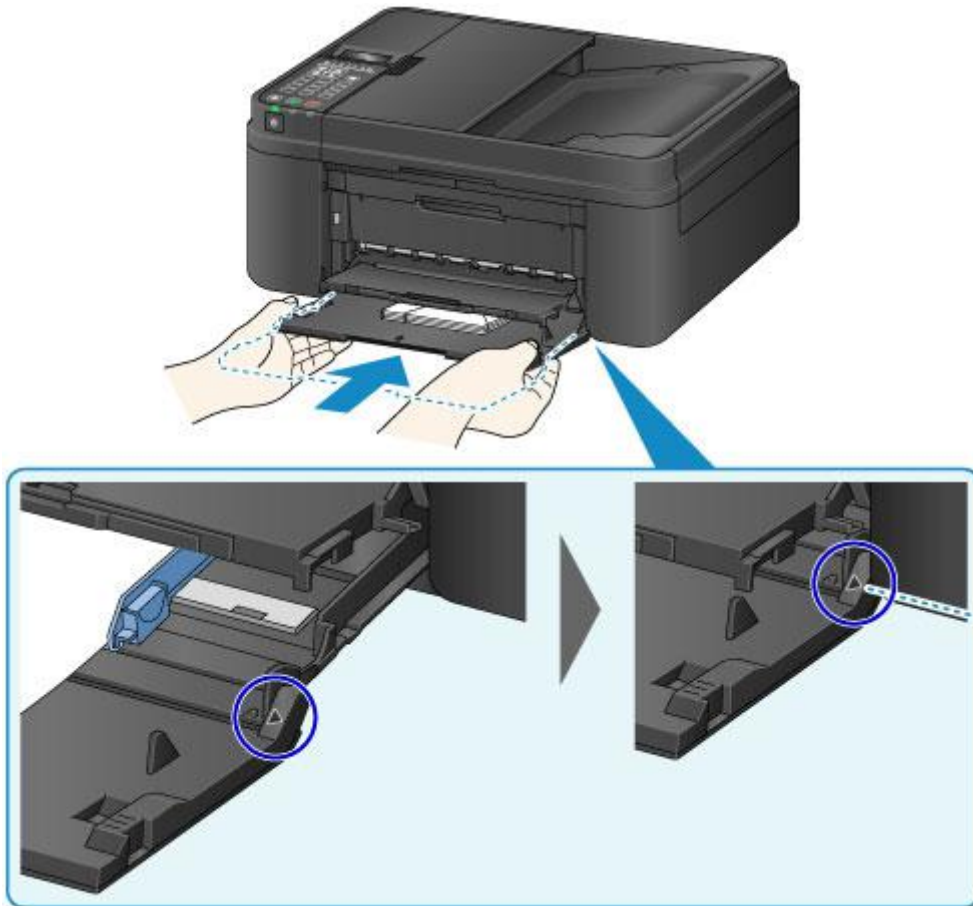

▶▶▶ **Note**

- When you set the alarm to be silent in **Sound control** of **Dev. user settings**, the alarm will not beep even if the cassette is pushed back.

■ [Dev. user settings](#)

8. Press the **OK** button.

Register the cassette pa
[OK]Next

9. Use the ◀ or ▶ button to select the size of the loaded envelopes in the cassette, then press the **OK** button.

Size: ◀ Envelope DL ▶
Type: *Plain paper

▶▶▶ **Note**

- The asterisk "*" will appear with the current page size and media type settings.

■ [Paper setting for Printing](#)

10. Use the ◀ or ▶ button to select the type of the loaded envelopes in the cassette, then press the **OK** button.

Size: Envelope DL
Type: ◀ Envelope ▶

11. Pull the paper output support (H) out from the paper output tray.

12. Open the output tray extension (I).



▶▶▶ Note

- When printing, select the size and type of the loaded envelopes on the print settings screen of the printer driver.

Media Types You Can Use

To get the best printing result, choose paper suitable for printing. Canon provides various types of paper suitable for documents as well as paper suitable for photos or illustrations. We recommend the use of Canon genuine paper for printing your important photos.

Media Types

Commercially available papers

- Plain Paper (including recycled paper)
- Envelopes*[1](#)

Canon genuine papers

The Model Number of Canon genuine paper is shown in brackets. Refer to the instruction manual supplied with the paper for detailed information on the printable side and notes on handling paper. For information on the page sizes available for each Canon genuine paper, access our website.

▶▶▶ Note

- You may not be able to purchase some Canon genuine papers depending on the country or region of purchase. Paper is not sold in the US by Model Number. Purchase paper by name.

Paper for printing photos:

- Photo Paper Pro Platinum <PT-101>
- Glossy Photo Paper "Everyday Use" <GP-501/GP-601>
- Photo Paper Glossy <GP-601>
- Photo Paper Plus Glossy II <PP-201>
- Photo Paper Pro Luster <LU-101>
- Photo Paper Plus Semi-gloss <SG-201>
- Matte Photo Paper <MP-101>

Paper for printing business documents:

- High Resolution Paper <HR-101N>*[1](#)

*1 Printing to this paper from the operation panel is not supported.

■ [Paper Load Limit](#)

■ [Paper Settings on the Printer Driver and the Printer \(Media Type\)](#)

Page Sizes

You can use the following page sizes.

▶▶▶ Note

- Printing of envelopes from the operation panel is not supported.

Standard sizes:

- Letter
- Legal
- A5
- A4

- B5
- 4" x 6" (10 x 15 cm)
- 5" x 7" (13 x 18 cm)
- 8" x 10" (20 x 25 cm)
- Envelope DL
- Envelope Com 10

Non-standard sizes:

You can print on non-standard size paper within the following ranges.

- Minimum size: 4.00 x 6.00 inches (101.6 x 152.4 mm)
- Maximum size: 8.50 x 26.61 inches (215.9 x 676.0 mm)

Paper Weight

You can use paper in the following weight range.

- 17 to 28 lb (64 to 105 g /m²) (plain paper except for Canon genuine paper)

Do not use heavier or lighter paper (except for Canon genuine paper), as it could jam in the machine.

Notes on Storing Paper

- Take out only the necessary number of paper from the package, just before printing.
- To avoid curling, when you do not print, put unused paper back into the package and keep it on a level surface. And also, store it avoiding heat, humidity, and direct sunlight.

Paper Load Limit

Commercially Available Papers

Media Name	Cassette	Paper Output Tray
Plain Paper (including recycled paper)* 1	Approx. 100 sheets (10 sheets: Legal)	Approx. 50 sheets (10 sheets: Legal)
Envelopes	5 envelopes	*2

Canon Genuine Papers

▶▶▶ Note

- We recommend that you remove the previously printed sheet from the paper output tray before continuously printing to avoid blurs and discoloration (except for High Resolution Paper <HR-101N>).

Paper for printing photos:

Media Name <Model No.>	Cassette
Photo Paper Pro Platinum <PT-101> *3	10 sheets: A4, Letter, and 8" x 10" (20 x 25 cm) 20 sheets: 4" x 6" (10 x 15 cm)
Glossy Photo Paper "Everyday Use" <GP-501/GP-601> *3	10 sheets: A4 and Letter 20 sheets: 4" x 6" (10 x 15 cm)
Photo Paper Glossy <GP-601> *3	10 sheets: A4 and Letter 20 sheets: 4" x 6" (10 x 15 cm)
Photo Paper Plus Glossy II <PP-201> *3	10 sheets: A4, Letter, 5" x 7" (13 x 18 cm), and 8" x 10" (20 x 25 cm) 20 sheets: 4" x 6" (10 x 15 cm)
Photo Paper Pro Luster <LU-101> *3	10 sheets: A4 and Letter
Photo Paper Plus Semi-gloss <SG-201> *3	10 sheets: A4, Letter, 5" x 7" (13 x 18 cm), and 8" x 10" (20 x 25 cm) 20 sheets: 4" x 6" (10 x 15 cm)
Matte Photo Paper <MP-101>	10 sheets: A4 and Letter 20 sheets: 4" x 6" (10 x 15 cm)

Paper for printing business documents:

Media Name <Model No.>	Cassette	Paper Output Tray
High Resolution Paper <HR-101N>	80 sheets	50 sheets

*1 Proper feeding of paper may not be possible at the maximum capacity depending on the type of paper or environmental conditions (either very high or low temperature or humidity). In such cases, reduce the number of paper you load at a time to less than half.

*2 We recommend that you remove the previously printed envelope from the paper output tray before continuously printing to avoid blurs and discoloration.

*3 When loading paper in stacks, the print side may become marked as it is fed or paper may not feed properly. In this case, load one sheet at a time.

Media Types You Cannot Use

Do not use the following types of paper. Using such paper will cause not only unsatisfactory results, but also the machine to jam or malfunction.

- Folded, curled, or wrinkled paper
- Damp paper
- Paper that is too thin (weighing less than 17 lb (64 g /m²))
- Paper that is too thick (plain paper weighing more than 28 lb (105 g /m²), except for Canon genuine paper)
- Paper thinner than a postcard, including plain paper or notepad paper cut to a small size (when printing on paper smaller than A5)
- Picture postcards
- Postcards affixed with photos or stickers
- Envelopes with a double flap
- Envelopes with an embossed or treated surface
- Envelopes whose gummed flaps are already moistened and adhesive
- Any type of paper with holes
- Paper that is not rectangular
- Paper bound with staples or glue
- Paper with adhesives
- Paper decorated with glitter, etc.

Printing Area

- ▶ **Printing Area**
- ▶ **Other Sizes than Letter, Legal, Envelopes**
- ▶ **Letter, Legal**
- ▶ **Envelopes**

Printing Area

To ensure the best print quality, the machine allows a margin along each edge of media. The actual printable area will be the area inside these margins.

Recommended printing area  : Canon recommends that you print within this area.

Printable area  : The area where it is possible to print. However, printing in this area can affect the print quality or the paper feed precision.

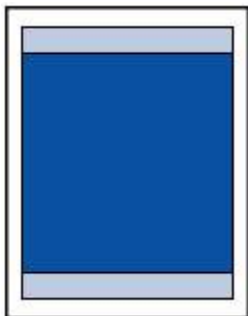

►► Note

- When performing borderless copying, you can specify the amount of images that extends off the paper by **Extended copy amt.** in **Output settings**.

■ [Output settings](#)

- By selecting Borderless Printing option, you can make prints with no margins.
- When performing Borderless Printing, slight cropping may occur at the edges since the printed image is enlarged to fill the whole page.
- For Borderless Printing, use the following paper:
 - Photo Paper Pro Platinum <PT-101>
 - Glossy Photo Paper "Everyday Use" <GP-501/GP-601>
 - Photo Paper Glossy <GP-601>
 - Photo Paper Plus Glossy II <PP-201>
 - Photo Paper Pro Luster <LU-101>
 - Photo Paper Plus Semi-gloss <SG-201>
 - Matte Photo Paper <MP-101>

Performing Borderless Printing on any other type of paper may substantially reduce printing quality and/or result in printouts with altered color hues.

Borderless Printing on plain paper may result in printouts with reduced quality. Use them only for test printing. Borderless Printing onto plain paper from the operation panel is not supported.

- Borderless Printing is not available for legal, A5, or B5 sized paper, or envelopes.
- Depending on the type of paper, Borderless Printing may reduce the print quality at the top and bottom edges of the paper or cause these parts to become smudged.

Other Sizes than Letter, Legal, Envelopes

Size	Printable Area (width x height)
A5	5.56 x 7.95 inches (141.2 x 202.0 mm)
A4	8.00 x 11.38 inches (203.2 x 289.0 mm)
B5	6.90 x 9.80 inches (175.2 x 249.0 mm)
4" x 6" (10 x 15 cm)	3.73 x 5.69 inches (94.8 x 144.4 mm)
5" x 7" (13 x 18 cm)	4.73 x 6.69 inches (120.2 x 169.8 mm)
8" x 10" (20 x 25 cm)	7.73 x 9.69 inches (196.4 x 246.0 mm)

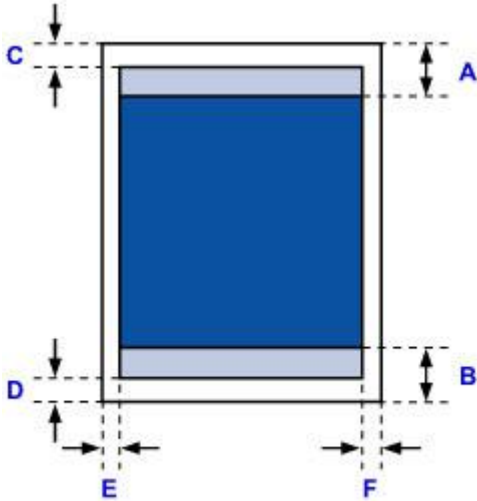

 Recommended printing area

A: 1.28 inches (32.5 mm)

B: 1.32 inches (33.5 mm)

 Printable area

C: 0.12 inch (3.0 mm)

D: 0.20 inch (5.0 mm)

E: 0.13 inch (3.4 mm)

F: 0.13 inch (3.4 mm)

Letter, Legal

Size	Printable Area (width x height)
Letter	8.00 x 10.69 inches (203.2 x 271.4 mm)
Legal	8.00 x 13.69 inches (203.2 x 347.6 mm)

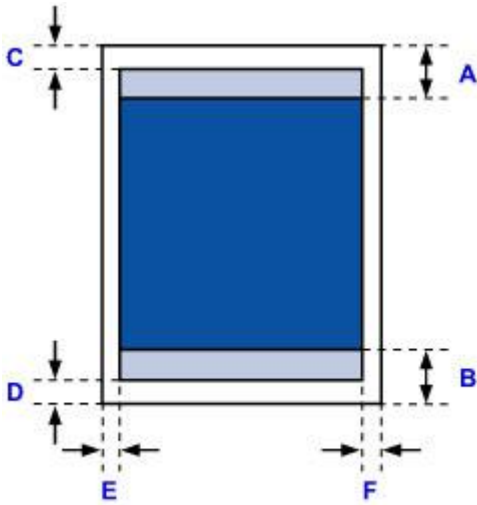

 Recommended printing area

A: 1.28 inches (32.5 mm)

B: 1.32 inches (33.5 mm)

 Printable area

C: 0.12 inch (3.0 mm)

D: 0.20 inch (5.0 mm)

E: 0.25 inch (6.4 mm)

F: 0.25 inch (6.3 mm)

Envelopes

Size	Recommended Printing Area (width x height)
Envelope DL	3.88 x 7.20 inches (98.8 x 183.0 mm)
Envelope Com 10	3.68 x 8.04 inches (93.5 x 204.3 mm)

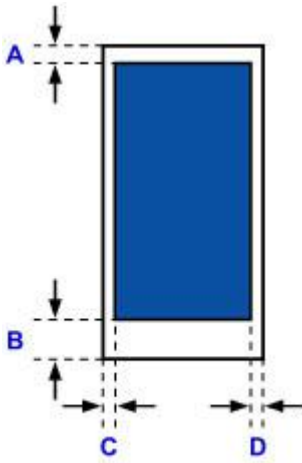

 Recommended printing area

A: 0.31 inch (8.0 mm)

B: 1.14 inches (29.0 mm)

C: 0.22 inch (5.6 mm)

D: 0.22 inch (5.6 mm)

Loading Originals

- ▶ **Position to Load Originals**
- ▶ **Loading Originals on the Platen Glass**
- ▶ **Loading Documents in the ADF (Auto Document Feeder)**
- ▶ **How to Load Originals for Each Function**
- ▶ **Originals You Can Load**

Position to Load Originals

The machine has two positions to load originals: platen glass and ADF (Auto Document Feeder).

Select the position to load the original according to the size, type, or usage.

■ [Originals You Can Load](#)

Loading Documents, Photos, or Book on the platen glass



Loading Two or More Sheets of Document of the Same Size and Thickness in the ADF

You can also load a sheet of document in the ADF.



▶▶ Note

- To scan the original at optimum quality, load it on the platen glass.

Loading Originals on the Platen Glass

1. Open the document cover.
2. Load the original WITH THE SIDE TO SCAN FACING DOWN on the platen glass.

■ [Originals You Can Load](#)

■ [How to Load Originals for Each Function](#)



▶▶ Important

- Be sure to observe the following when loading the original on the platen glass.
 - Do not place any objects weighing 4.4 lb (2.0 kg) or more on the platen glass.
 - Do not put any pressure of 4.4 lb (2.0 kg) or more on the platen glass, such as pressing down the original.

Failure to observe the above may cause the scanner to malfunction or the platen glass to break.

3. Close the document cover gently.



▶▶ Important

- After loading the original on the platen glass, be sure to close the document cover before starting to copy, fax, or scan.

Loading Documents in the ADF (Auto Document Feeder)

▶▶▶ Note

- To scan a document at optimum quality, load it on the platen glass.

1. Make sure that any original has been removed from the platen glass.
2. Open the document tray.



3. Insert the document in the document tray until you hear a beep sound.

Load the document WITH THE SIDE TO SCAN FACING UP in the document tray.

■ [Originals You Can Load](#)

▶▶▶ Note

- When you set the alarm to be silent in **Sound control** of **Dev. user settings**, the alarm will not beep even if the document is inserted in the document tray.

■ [Dev. user settings](#)

4. Adjust the document guide (A) at the front of the machine to match the width of the document.

Do not slide the document guide too hard against the document. The document may not be fed properly.



How to Load Originals for Each Function

Load the original in the correct position according to the function to use. If you do not load the original correctly, it may not be scanned properly.

Loading the Original to Be Aligned with the alignment mark

- Load originals to copy or fax
- In the scan mode,
 - select **Auto scan** for **Document type** to scan text documents, magazines, or newspapers
 - select **Document** or **Photo** for **Document type** and specify a standard size (A4, Letter, etc.) for **Scan size** to scan originals
- With a software application on a computer,
 - scan text documents, magazines, or newspapers
 - select a standard size (A4, Letter, etc.) to scan originals

Place the original WITH THE SIDE TO SCAN FACING DOWN on the platen glass and align it with the alignment mark . Portions placed on the diagonally striped area cannot be scanned.

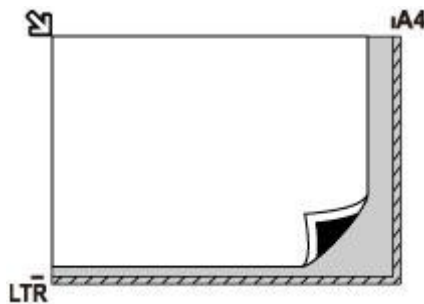

Important

- The machine cannot scan the striped area (A) (0.04 inch (1 mm) from the edges of the platen glass).

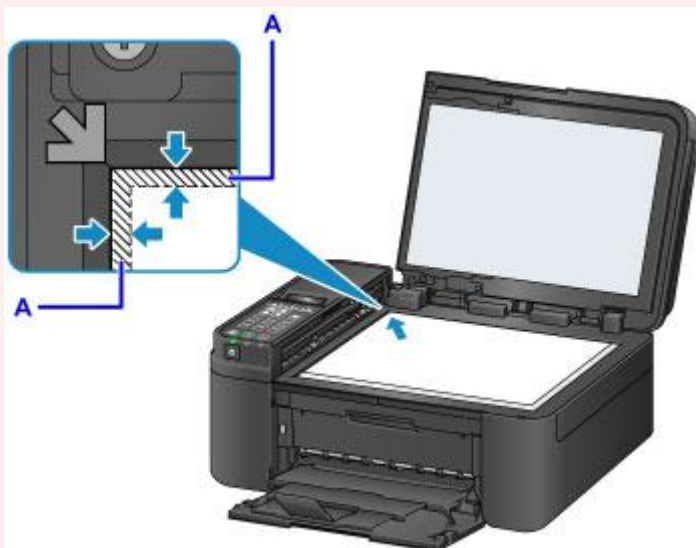

Loading Only One Original in the Center of the platen glass

- In the scan mode,
 - select **Auto scan** for **Document type** to scan one printed photo, postcard, business card, or disc

- select **Photo** for **Document type** and specify **Auto scan(A) -Singl** for **Scan size** to scan one original

- Scan one printed photo, postcard, business card, or disc with a software application on a computer

Place the original WITH THE SIDE TO SCAN FACING DOWN, with 0.4 inch (1 cm) or more space between the edges (diagonally striped area) of the platen glass. Portions placed on the diagonally striped area cannot be scanned.

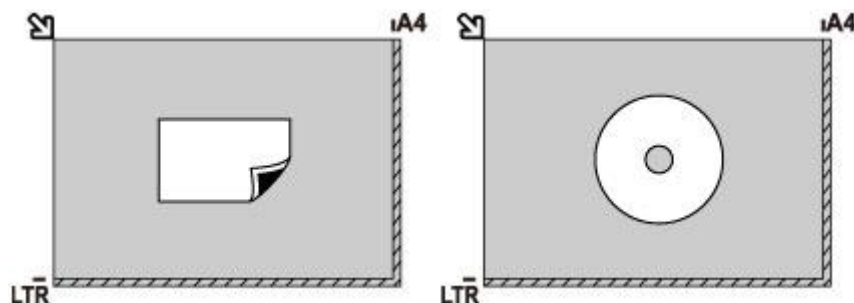

Loading Two or More Originals on the platen glass

- In the scan mode,
 - select **Auto scan** for **Document type** to scan two or more printed photos, postcards, or business cards
 - select **Photo** for **Document type** and specify **Auto scan(A) -Multi** for **Scan size** to scan two or more originals
- Scan two or more printed photos, postcards, or business cards with a software application on a computer

Place the originals WITH THE SIDE TO SCAN FACING DOWN. Allow 0.4 inch (1 cm) or more space between the edges (diagonally striped area) of the platen glass and the originals, and between the originals. Portions placed on the diagonally striped area cannot be scanned.

You can place up to 12 items.

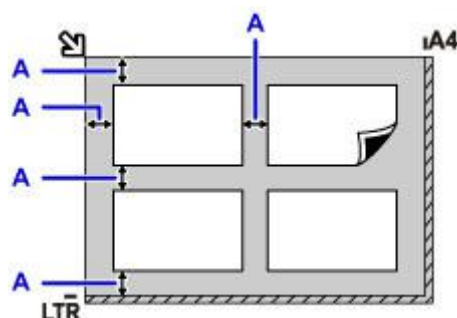

A: More than 0.4 inch (1 cm)

►► Note

- The Skew Correction function automatically compensates for the originals placed at an angle of up to approximately 10 degrees. Slanted photos with a long edge of 7.1 inches (180 mm) or more cannot be corrected.
- Non-rectangular or irregular shaped photos (such as cut out photos) may not be scanned properly.

Originals You Can Load

platen glass

Item	Details
Types of originals	- Text document, magazine, or newspaper - Printed photo, postcard, business card, or disc (BD/DVD/CD, etc.) - Documents that are not suitable for the ADF
Size (width x height)	Max. 8.5 x 11.7 inches (216 x 297 mm)
Quantity	1 sheet or multiple sheets*
Thickness	Max. 0.20 inch (5 mm)

* Two or more originals can be loaded on the platen glass depending on the selected function.

■ [How to Load Originals for Each Function](#)

ADF (Auto Document Feeder)

Item	Details
Types of originals	Multipage plain-paper documents of the same size, thickness, and weight
Size	A4/Letter/Legal Only A4 or Letter-sized documents for 2-on-1 copy and 4-on-1 copy
Quantity	- A4 or Letter size: Max. 20 sheets (20 lb (75 g /m ²) paper), up to 0.08 inch (2 mm) in height - Legal size: Max. 5 sheets (20 lb (75 g /m ²) paper), up to 0.02 inch (0.5 mm) in height
Thickness	0.003 to 0.005 inch (0.07 to 0.13 mm)
Weight	16.0 to 25.3 lb (60 to 95 g /m ²)

▶▶ Note

- Make sure any glue, ink, correction fluid, or the like on the document is completely dry before loading it on the platen glass or in the ADF.

However, do not load glued documents in the ADF even if the glue is dry, as this may cause paper jams.

- Remove all staples, paper clips, and the like before feeding the document.
- Load Legal-sized documents in the ADF.
- Do not load the following types of documents in the ADF. They will jam.
 - Wrinkled or creased paper
 - Curled paper
 - Torn paper
 - Paper with holes
 - Glued paper
 - Paper with sticky notes
 - Carbon paper or carbon-backed paper
 - Surface treated paper
 - Onion skin or thin paper

- Photo or thick paper
-

Replacing a FINE Cartridge

- ▶ [Replacing a FINE Cartridge](#)
- ▶ [Checking the Ink Status](#)

Replacing a FINE Cartridge

When remaining ink cautions or errors occur, the message will appear on the LCD to inform you of the error. Take appropriate action according to the message.

■ [A Message Is Displayed](#)

▶▶▶ Note

- For precautionary notes on handling FINE cartridges, see [Notes on FINE cartridges](#).

Replacing Procedure

When you need to replace a FINE cartridge, follow the procedure below.

1. Make sure that the power is turned on.
2. Open the front cover (A).

The paper output tray (B) opens.

▶▶▶ Note

- Remove any paper in the cassette.



3. Open the paper output cover.

The FINE cartridge holder (C) moves to the replacement position.



⚠ Caution

- Do not hold the FINE cartridge holder to stop or move it forcibly. Do not touch the FINE cartridge holder until it stops completely.

➤➤ Important

- The inside of the machine may be stained with ink. Be careful not to stain your hands or clothing when replacing the FINE cartridge. You can easily wipe off the ink from the inside of the machine with tissue paper or the like.
- Do not touch the metallic parts or other parts inside the machine.
- If the paper output cover is left open for more than 10 minutes, the FINE cartridge holder may move and the **Alarm** lamp light. In this case, close the paper output cover, then open it again.

4. Push down the empty FINE cartridge until it clicks.

You hear an electronic sound twice.

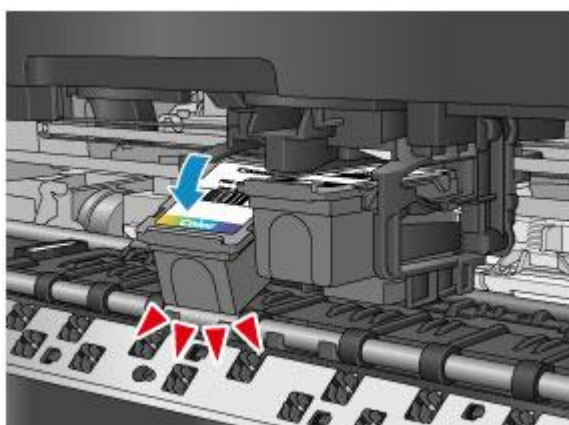

➤➤ Note

- When you set the alarm to be silent in **Sound control** of **Dev. user settings**, the alarm will not beep even if the FINE cartridge is detached.

■ [Dev. user settings](#)

5. Remove the FINE cartridge.

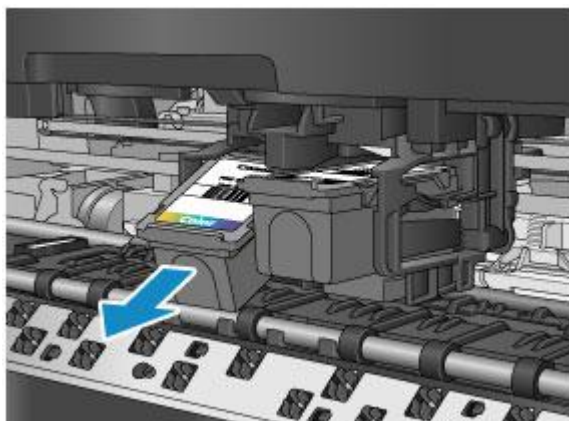

➤➤ Important

- Handle the FINE cartridge carefully to avoid staining of clothing or the surrounding area.

- Discard the empty FINE cartridge according to the local laws and regulations regarding disposal of consumables.

6. Take a new FINE cartridge out of its package and remove the protective tape (D) gently.

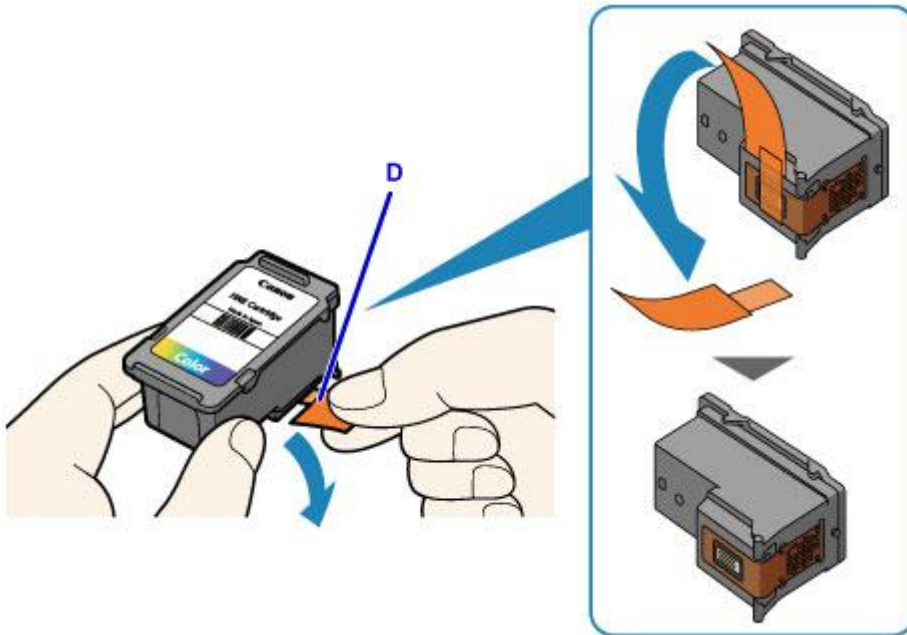

►► Important

- If you shake a FINE cartridge, ink may spill out and stain your hands and the surrounding area. Handle a FINE cartridge carefully.
- Be careful not to stain your hands and the surrounding area with ink on the removed protective tape.
- Do not reattach the protective tape once you have removed it. Discard it according to the local laws and regulations regarding disposal of consumables.
- Do not touch the electrical contacts or print head nozzle on a FINE cartridge. The machine may not print properly if you touch them.

7. Insert the new FINE cartridge at a slant into the FINE cartridge holder.

The color FINE cartridge should be installed into the left slot and the black FINE cartridge should be installed into the right slot.

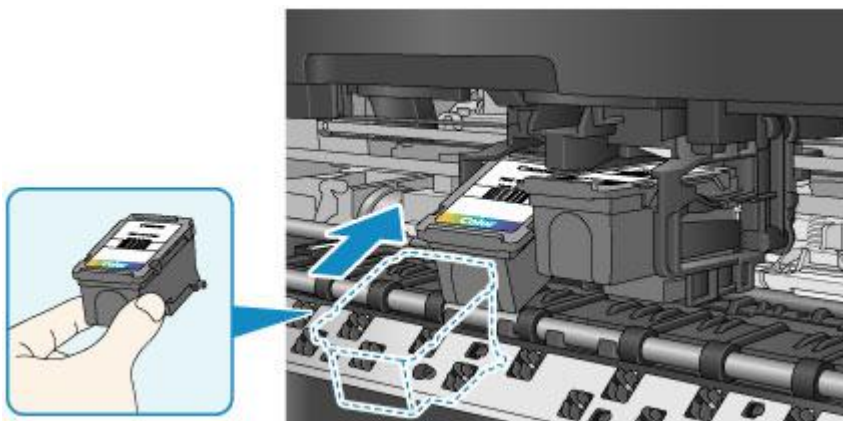

Important

- Insert the FINE cartridge gently so that it does not hit the electrical contacts on the FINE cartridge holder.



8. Push the FINE cartridge in and up firmly until it snaps into place.

You hear an electronic sound once.

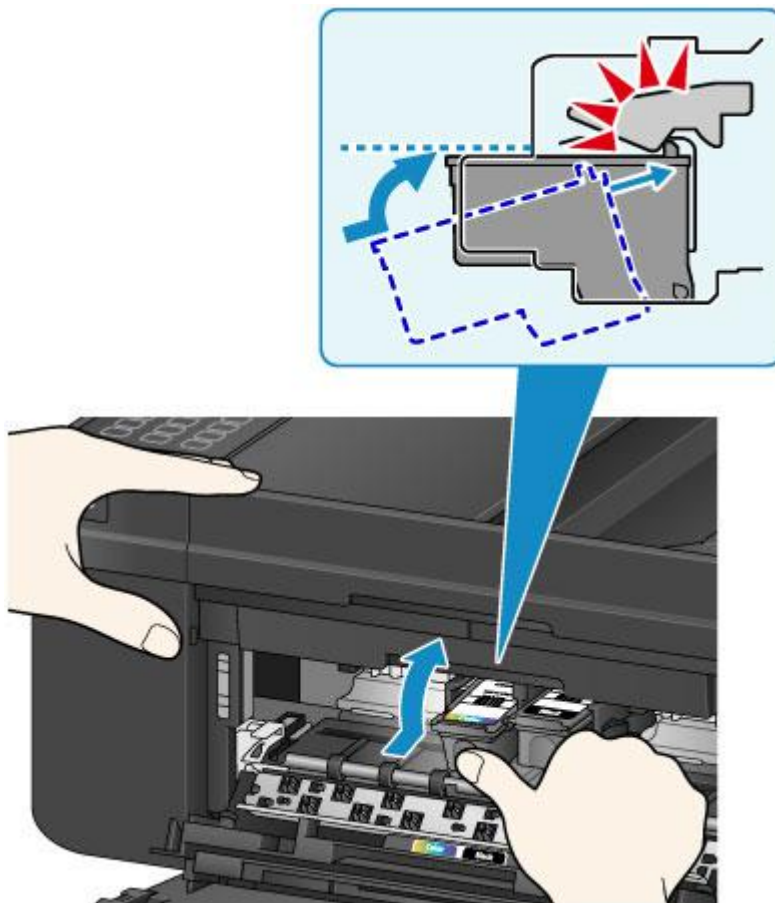

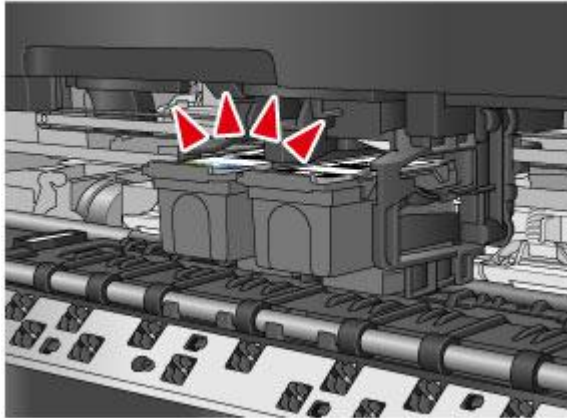

▶▶▶ Important

- Check if the FINE cartridge is installed correctly.



- The machine cannot print unless both the color FINE cartridge and black FINE cartridge are installed. Be sure to install both cartridges.

▶▶▶ Note

- When you set the alarm to be silent in **Sound control** of **Dev. user settings**, the alarm will not beep even if the FINE cartridge is attached.

■ [Dev. user settings](#)

9. Close the paper output cover.



▶▶▶ Note

- If the error message appears after the paper output cover is closed, take appropriate action.

■ [A Message Is Displayed](#)

- When you start printing after replacing the FINE cartridge, the machine starts cleaning the print head automatically. Do not perform any other operations until the machine completes the cleaning of the print head.
- If the print head is out of alignment, as indicated by misaligned printed ruled lines or similar symptoms, [align the print head](#).
- The machine may make noise during operation.

Notes on FINE cartridges

►► Important

- Do not touch the electrical contacts (A) or print head nozzle (B) on a FINE cartridge. The machine may not print properly if you touch them.

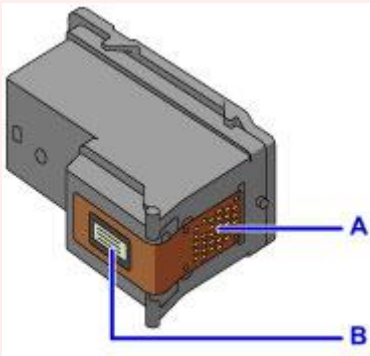

- If you remove a FINE cartridge, replace it immediately. Do not leave the machine with the FINE cartridge removed.
- Use a new FINE cartridge for replacement. Installing a used FINE cartridge may cause the nozzles to clog.

Furthermore, with such a FINE cartridge, the machine will not be able to inform you when to replace the FINE cartridge properly.

- Once a FINE cartridge has been installed, do not remove it from the machine and leave it out in the open. This will cause the FINE cartridge to dry out, and the machine may not operate properly when it is reinstalled. To maintain optimal printing quality, use a FINE cartridge within six months of first use.

►► Note

- If a FINE cartridge runs out of ink, you can print with either color or black FINE cartridge, in whichever ink remains, only for a while. However the print quality may be reduced compared to when printing with both cartridges. We recommend to use a new FINE cartridge in order to obtain optimum qualities.

Even when printing with one ink only, print with leaving the empty FINE cartridge installed. If either of the color FINE cartridge or black FINE cartridge is not installed, an error occurs and the machine cannot print.

For information on how to configure this setting, see [Setting the Ink Cartridge to be Used](#).

- Color ink may be consumed even when printing a black-and-white document or when black-and-white printing is specified.

Both color ink and black ink are also consumed in the standard cleaning and deep cleaning of the print head, which may be necessary to maintain the performance of the machine. When ink runs out, replace the FINE cartridge immediately with a new one.

■ [Useful Information about Ink](#)

Checking the Ink Status

- ▶ **Checking the Ink Status with the LCD on the Machine**

You can also check the ink status on the computer screen.

- ▶ **Checking the Ink Status from Your Computer**

Checking the Ink Status with the LCD on the Machine

▶▶▶ Note

- The ink level detector is mounted on the machine to detect the remaining ink level. The machine considers as ink is full when a new FINE cartridge is installed, and then starts to detect a remaining ink level. If you install a used FINE cartridge, the indicated ink level of it may not be correct. In such case, refer to the ink level information only as a guide.
- When remaining ink cautions or errors occur, the message will appear on the LCD to inform you of the error. Take appropriate action according to the message.

■ [A Message Is Displayed](#)

1. Make sure that the power is turned on, then press the **Setup** button.

The **Setup menu** screen will appear.

2. Use the ◀ or ▶ button to select **Ink information**, then press the **OK** button.

■ [LCD and Operation Panel](#)

3. Use the ◀ or ▶ button to select **Remaining ink**, then press the **OK** button.

Remaining ink is shown in the area (A).



Example: [!]

The ink is running low. Prepare a new ink cartridge.

▶▶▶ Note

- To print the model number of the FINE cartridge, select **Ink information** from **Setup menu**, then select **Print ink number**.
- You can also check the ink status on the LCD when you press the **COPY** or **FAX** button. The current remaining ink level will be displayed on the LCD for a few seconds.
- You can also check the ink status on the computer screen.

■ [Checking the Ink Status from Your Computer](#)

Maintenance

- **When Printing Becomes Faint or Colors Are Incorrect**
- **Performing Maintenance from a Computer**
- **Cleaning the Machine**

When Printing Becomes Faint or Colors Are Incorrect

- **Maintenance Procedure**
- **Printing the Nozzle Check Pattern**
- **Examining the Nozzle Check Pattern**
- **Cleaning the Print Head**
- **Cleaning the Print Head Deeply**
- **Aligning the Print Head**

Maintenance Procedure

If print results are blurred, colors are not printed correctly, or print results are unsatisfactory (e.g. misaligned printed ruled lines), perform the maintenance procedure below.

►►► Important

- Do not rinse or wipe the FINE cartridge. This can cause trouble with the FINE cartridge.

►►► Note

- Check if ink remains in the FINE cartridge.

- [Checking the Ink Status with the LCD on the Machine](#)

Check if the FINE cartridge is installed correctly.

- [Replacing Procedure](#)

Also check if the protective tape on the bottom of the FINE cartridge is removed.

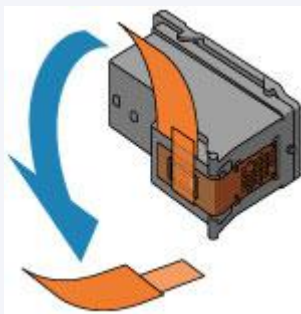

- If an error message appears on the LCD, see [A Message Is Displayed](#).
- Increasing the print quality in the printer driver settings may improve the print result.

- [Changing the Print Quality and Correcting Image Data](#)

When the Print Results Are Blurred or Uneven:

Step1 Print the nozzle check pattern.

From the machine

- [Printing the Nozzle Check Pattern](#)

From the computer

- [Use Your Computer to Print a Nozzle Check Pattern](#)

Step2 [Examine the nozzle check pattern.](#)

If there are missing lines or horizontal white streaks in the pattern:



Step3 Clean the print head.

From the machine

- [Cleaning the Print Head](#)

From the computer

■ [Cleaning the Print Heads from Your Computer](#)

After cleaning the print head, print and examine the nozzle check pattern: ➔ [Step1](#)

If the problem is not resolved after performing from step 1 to step 3 twice:



|| **Step4** Clean the print head deeply.

From the machine

■ [Cleaning the Print Head Deeply](#)

From the computer

■ [Cleaning the Print Heads from Your Computer](#)

If the problem is not resolved, turn off the power and clean the print head deeply again after 24 hours. Do not unplug the power cord when turning off the power.

If the problem is still not resolved:



|| **Step5** Replace a FINE cartridge.

■ [Replace a FINE cartridge](#)

▶▶▶ **Note**

- If the problem is still not resolved after replacing the FINE cartridge, contact the service center.

When the Print Results Are Not Even such as the Ruled Lines Are Misaligned:

|| **Step** Align the print head.

From the machine

■ [Aligning the Print Head](#)

From the computer

■ [Aligning the Print Head Position Automatically from Your Computer](#)

Printing the Nozzle Check Pattern

Print the nozzle check pattern to determine whether the ink ejects properly from the print head nozzle.

▶▶▶ Note

- If the remaining ink level is low, the nozzle check pattern will not be printed correctly. [Replace the FINE cartridge](#) whose ink is low.

You need to prepare: a sheet of A4 or Letter-sized plain paper

1. Make sure that the power is turned on.
2. Load a sheet of A4 or Letter-sized plain paper in the cassette.

After pushing the cassette back, the paper information registration screen is displayed on the LCD. Select **A4** or **Letter** for **Size:** and **Plain paper** for **Type:**, then press the **OK** button.



3. Pull the paper output support out from the paper output tray, then open the output tray extension.
4. Press the **Setup** button, use the ◀ or ▶ button to select **Maintenance**, then press the **OK** button.

■ [LCD and Operation Panel](#)

5. Use the ◀ or ▶ button to select **Nozzle check**, then press the **OK** button.

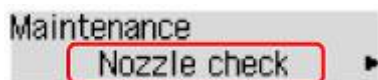

The nozzle check pattern will be printed.

6. [Examine the nozzle check pattern.](#)

Examining the Nozzle Check Pattern

Examine the nozzle check pattern, and clean the print head if necessary.

1. Check if there are missing lines in the pattern A or horizontal white streaks in the pattern B.



C: Number of sheets printed so far

If there are missing lines in the pattern A:

[Cleaning the print head](#) is required.



D: Good

E: Bad (lines are missing)

If there are horizontal white streaks in the pattern B:

[Cleaning the print head](#) is required.



F: Good

G: Bad (horizontal white streaks are present)

►► Note

- The total number of sheets printed so far is shown in increments of 50 sheets on the printout of the nozzle check pattern.

Cleaning the Print Head

Clean the print head if lines are missing or if horizontal white streaks are present in the printed nozzle check pattern. Cleaning unclogs the nozzles and restores the print head condition. Cleaning the print head consumes ink, so clean the print head only when necessary.

1. Make sure that the power is turned on.
2. Press the **Setup** button, use the ◀ or ▶ button to select **Maintenance**, then press the **OK** button.

■ [LCD and Operation Panel](#)

3. Use the ◀ or ▶ button to select **Cleaning**, then press the **OK** button.

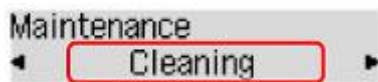

The machine starts cleaning the print head.

Do not perform any other operations until the machine completes the cleaning of the print head. This takes about 30 seconds.

4. Check the print head condition.

To check the print head condition, [print the nozzle check pattern](#).

▶▶▶ Note

- If the problem is not resolved after cleaning the print head twice, [clean the print head deeply](#).

Cleaning the Print Head Deeply

If print quality does not improve by the standard cleaning of the print head, clean the print head deeply. Cleaning the print head deeply consumes more ink than the standard cleaning of the print head, so clean the print head deeply only when necessary.

1. Make sure that the power is turned on.
2. Press the **Setup** button, use the ◀ or ▶ button to select **Maintenance**, then press the **OK** button.

■ [LCD and Operation Panel](#)

3. Use the ◀ or ▶ button to select **Deep cleaning**, then press the **OK** button.

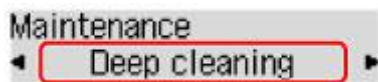

The machine starts cleaning the print head deeply.

Do not perform any other operations until the machine completes the deep cleaning of the print head. This takes about 1 minute.

4. Check the print head condition.

To check the print head condition, [print the nozzle check pattern](#).

If the problem is not resolved, turn off the power and clean the print head deeply again after 24 hours. Do not unplug the power cord when turning off the power.

If the problem is still not resolved, [replace the FINE cartridge](#) with a new one. If the problem is still not resolved after replacing the FINE cartridge, contact the service center.

Aligning the Print Head

If printed ruled lines are misaligned or print results are otherwise unsatisfactory, adjust the print head position.

▶▶▶ Note

- If the remaining ink level is low, the print head alignment sheet will not be printed correctly.
[Replace the FINE cartridge](#) whose ink is low.

You need to prepare: a sheet of A4 or Letter-sized plain paper (including recycled paper)*

* Be sure to use paper that is white and clean on both sides.

1. Make sure that the power is turned on.
2. Load a sheet of A4 or Letter-sized plain paper in the cassette.

After pushing the cassette back, the paper information registration screen is displayed on the LCD. Select **A4** or **Letter** for **Size:** and **Plain paper** for **Type:**, then press the **OK** button.



3. Pull the paper output support out from the paper output tray, then open the output tray extension.
4. Press the **Setup** button, use the ◀ or ▶ button to select **Maintenance**, then press the **OK** button.

■ [LCD and Operation Panel](#)

5. Use the ◀ or ▶ button to select **Head alignment**, then press the **OK** button.

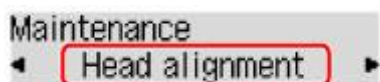

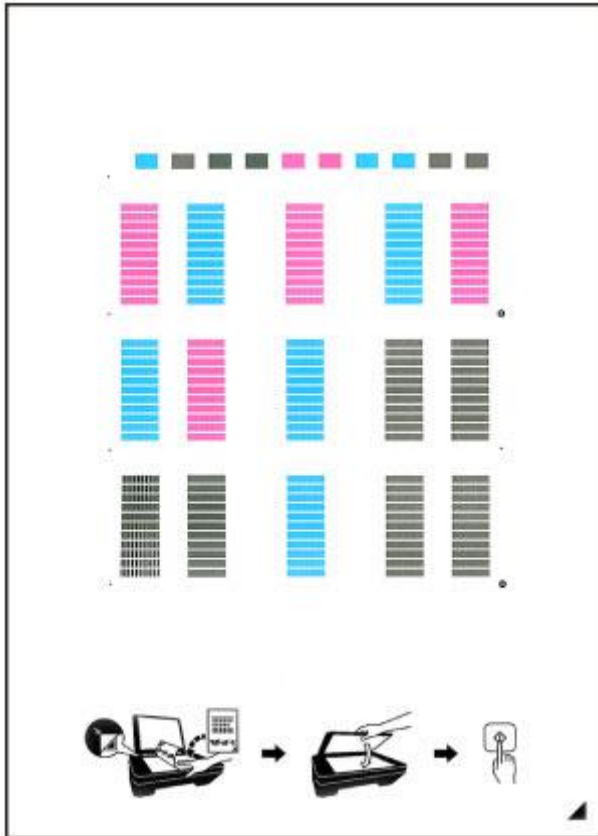

The print head alignment sheet will be printed.



»» Important

- Do not touch any printed part on the print head alignment sheet. If the sheet is stained or wrinkled, it may not be scanned properly.
- If the print head alignment sheet was not printed correctly, press the **Stop** button, then redo this procedure from the beginning.

6. Confirm the message, then load the print head alignment sheet on the platen glass.

Load the print head alignment sheet WITH THE PRINTED SIDE FACING DOWN and align the mark  on the bottom right corner of the sheet with the alignment mark .



»» Note

- The print head alignment sheet cannot be scanned if it is loaded in the ADF (Auto Document Feeder).

7. Close the document cover gently, then press the **Black** or **Color** button.

The machine starts scanning the print head alignment sheet, and the print head position will be adjusted automatically.

When adjusting the print head position is complete, remove the print head alignment sheet on the platen glass.

▶▶▶ Important

- Do not open the document cover or move the print head alignment sheet on the platen glass until adjusting the print head position is complete.
- If the error message appears on the LCD, press the **OK** button to release the error, then take appropriate action.

■ [A Message Is Displayed](#)

▶▶▶ Note

- If the print results are still not satisfactory after adjusting the print head position as described above, adjust the print head position manually from the computer.

■ [Aligning the Print Head Position from Your Computer](#)

- To print and check the current head position adjustment values, select **Print align value** from the **Maintenance** menu.

Performing Maintenance from a Computer

- ▶ **Cleaning the Print Heads from Your Computer**
- ▶ **Aligning the Print Head**
- ▶ **Aligning the Print Head Position Automatically from Your Computer**
- ▶ **Aligning the Print Head Position from Your Computer**
- ▶ **Use Your Computer to Print a Nozzle Check Pattern**

Cleaning the Print Heads from Your Computer

The print head cleaning function allows you to clear up clogged print head nozzle. Perform print head cleaning if printing is faint or a specific color fails to print, even though there is enough ink.

The procedure for cleaning the print head is as follows:



Cleaning

1. Open the [printer driver setup window](#)

2. Click **Cleaning** on the **Maintenance** tab

When the **Print Head Cleaning** dialog box opens, select the ink group for which cleaning is to be performed.

Click **Initial Check Items** to display the items you need to check before performing cleaning.

3. Execute cleaning

Make sure that the printer is on and then click **Execute**.

Print head cleaning starts.

4. Complete cleaning

The **Nozzle Check** dialog box opens after the confirmation message.

5. Check the results

To check whether the print quality has improved, click **Print Check Pattern**. To cancel the check process, click **Cancel**.

If cleaning the head once does not resolve the print head problem, clean it once more.

»» Important

- **Cleaning** consumes a small amount of ink.
Cleaning the print head frequently will rapidly deplete your printer's ink supply. Consequently, perform cleaning only when necessary.



Deep Cleaning

Deep Cleaning is more thorough than cleaning. Perform deep cleaning when two **Cleaning** attempts do not resolve the print head problem.

1. Open the [printer driver setup window](#)

2. Click **Deep Cleaning** on the **Maintenance** tab

When the **Deep Cleaning** dialog box opens, select the ink group for which deep cleaning is to be performed.

Click **Initial Check Items** to display the items you need to check before performing deep cleaning.

3. Execute deep cleaning

Make sure that the printer is on and then click **Execute**.

Click **OK** when the confirmation message appears.

Print head deep cleaning starts.

4. Complete deep cleaning

The **Nozzle Check** dialog box opens after the confirmation message.

5. Check the results

To check whether the print quality has improved, click **Print Check Pattern**. To cancel the check process, click **Cancel**.

►► Important

- **Deep Cleaning** consumes a larger amount of ink than **Cleaning**.
Cleaning the print head frequently will rapidly deplete your printer's ink supply. Consequently, perform cleaning only when necessary.

►► Note

- If there is no sign of improvement after **Deep Cleaning**, turn off the printer, wait 24 hours, and then perform **Deep Cleaning** again. If there is still no sign of improvement, see "[Ink Is Not Ejected](#)."

Related Topic

- [Use Your Computer to Print a Nozzle Check Pattern](#)

Aligning the Print Head

When you perform head position adjustment, errors in the print head adjustment position are corrected and conditions such as color and line streaking are improved.

If the print results appear uneven because of line shifts or other conditions, adjust the position of the print head.

On this printer, you can adjust the print head either [automatically](#) or [manually](#).

Aligning the Print Head Position from Your Computer

Print head alignment corrects the installation positions of the print head and improves deviated colors and lines.

This printer supports two head alignment methods: [automatic head alignment](#) and manual head alignment.

The procedure for performing manual print head alignment is as follows:



Print Head Alignment

1. Open the [printer driver setup window](#)
2. Click **Custom Settings** on the **Maintenance** tab
The **Custom Settings** dialog box opens.
3. Switch head alignment to manual
Check the **Align heads manually** check box.
4. Apply the settings
Click **OK** and when the confirmation message appears, click **OK**.
5. Click **Print Head Alignment** on the **Maintenance** tab
The **Start Print Head Alignment** dialog box opens.
6. Load paper in the printer
Load three sheets of A4 size or Letter size plain paper into the cassette.

▶▶▶ Note

- If the cassette paper information registered on the printer is not set to A4 size and plain paper, an error may occur. For instructions on what to do if an error occurs, see "[Paper setting for Printing.](#)"
For details about the cassette paper information to be registered on the printer, see the following:
 - [Paper Settings on the Printer Driver and the Printer \(Media Type\)](#)
 - [Paper Settings on the Printer Driver and the Printer \(Paper Size\)](#)

7. Execute head alignment
Make sure that the printer is on and click **Align Print Head**.
Follow the instruction in the message.

▶▶▶ Important

- Do not open the paper output cover while printing is in progress.

8. Check the printed pattern

Enter the numbers of the patterns with the least noticeable streaks in the associated boxes.
 Even if the patterns with the least noticeable streaks are clicked in the preview window, their numbers are automatically entered in the associated boxes.

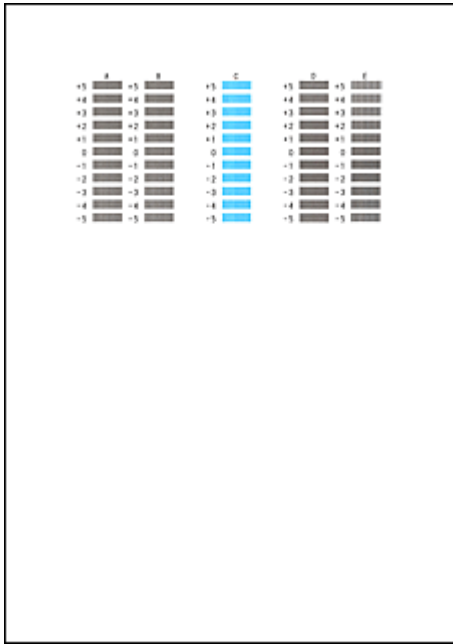

When you have entered all the necessary values, click **OK**.

▶▶▶ Note

- If it is difficult to pick the best pattern, pick the setting that produces the least noticeable vertical streaks.



(A)



(B)

- (A) Least noticeable vertical streaks
- (B) Most noticeable vertical streaks

9. Confirm the displayed message and click **OK**

The second pattern is printed.

▶▶▶ Important

- Do not open the paper output cover while printing is in progress.

10. Check the printed pattern

Enter the numbers of the patterns with the least noticeable streaks in the associated boxes.
 Even if the patterns with the least noticeable streaks are clicked in the preview window, their numbers are automatically entered in the associated boxes.

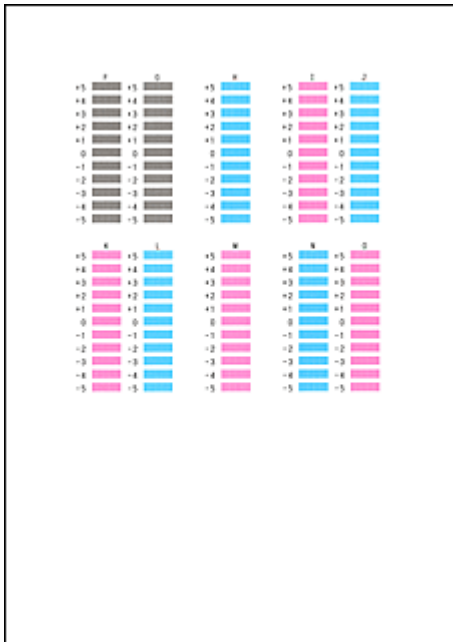

When you have entered all the necessary values, click **OK**.

▶▶ Note

- If it is difficult to pick the best pattern, pick the setting that produces the least noticeable vertical streaks.



(A)



(B)

- (A) Least noticeable vertical streaks
- (B) Most noticeable vertical streaks

11. Confirm the displayed message and click **OK**

The third pattern is printed.

▶▶ Important

- Do not open the paper output cover while printing is in progress.

12. Check the printed pattern

Enter the numbers of the patterns with the least noticeable stripes in the associated boxes.

Even if the patterns with the least noticeable stripes are clicked in the preview window, their numbers are automatically entered in the associated boxes.

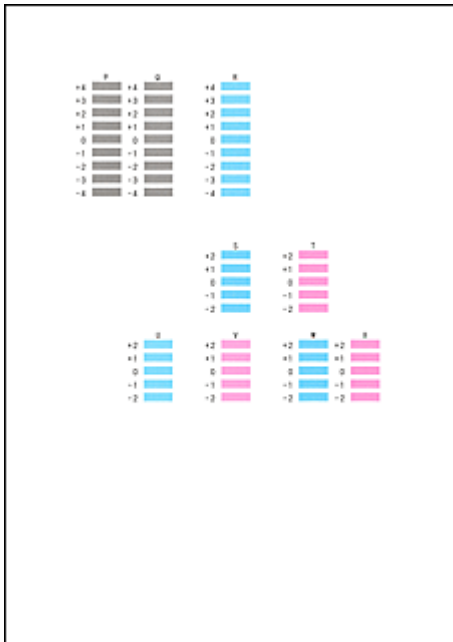

When you have entered all the necessary values, click **OK**.

►► Note

- If it is difficult to pick the best pattern, pick the setting that produces the least noticeable horizontal stripes.



(A)



(B)

(A) Least noticeable horizontal stripes

(B) Most noticeable horizontal stripes

►► Note

- To print and check the current setting, open the **Start Print Head Alignment** dialog box, and click **Print Alignment Value**.

Aligning the Print Head Position Automatically from Your Computer

Print head alignment corrects the installation positions of the print head and improves deviated colors and lines.

This printer supports two head alignment methods: automatic head alignment and manual head alignment. Normally, the printer is set for automatic head alignment. If the printing results of automatic print head alignment are not satisfactory, [perform manual head alignment](#).

The procedure for performing automatic print head alignment is as follows:

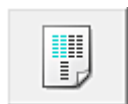

Print Head Alignment

1. Open the [printer driver setup window](#)
2. Click **Print Head Alignment** on the **Maintenance** tab

The **Start Print Head Alignment** dialog box opens.

3. Load paper in the printer

Load one sheet of A4 size or Letter size plain paper into the cassette.

▶▶▶ Note

- The number of sheets to be used differs when you select the manual head alignment.
- If the cassette paper information registered on the printer is not set to A4 size and plain paper, an error may occur. For instructions on what to do if an error occurs, see "[Paper setting for Printing](#)."

For details about the cassette paper information to be registered on the printer, see the following:

- [Paper Settings on the Printer Driver and the Printer \(Media Type\)](#)
- [Paper Settings on the Printer Driver and the Printer \(Paper Size\)](#)

4. Print head alignment pattern printing

Make sure that the printer is on and click **Align Print Head**.

The adjustment pattern is printed.

▶▶▶ Important

- Do not open the paper output cover while printing is in progress.

5. Adjustment pattern scanning

After the adjustment pattern is printed, a message is displayed.

As instructed in the message, load the adjustment pattern onto the platen, and press the **Start** button on the printer.

Print head alignment starts.

»» **Note**

- To print and check the current setting, open the **Start Print Head Alignment** dialog box, and click **Print Alignment Value**.

Use Your Computer to Print a Nozzle Check Pattern

The nozzle check function allows you to check whether the print head is working properly by printing a nozzle check pattern. Print the pattern if printing becomes faint, or if a specific color fails to print.

The procedure for printing a nozzle check pattern is as follows:



Nozzle Check

1. Open the [printer driver setup window](#)
2. Click **Nozzle Check** on the **Maintenance** tab

The **Nozzle Check** dialog box opens.

Click **Initial Check Items** to display the items that you need to check before printing the nozzle check pattern.

3. Load paper in the printer

Load one sheet of A4 size or Letter size plain paper into the cassette.

▶▶▶ Note

- If the cassette paper information registered on the printer is not set to A4 size and plain paper, an error may occur. For instructions on what to do if an error occurs, see "[Paper setting for Printing.](#)"

For details about the cassette paper information to be registered on the printer, see the following:

- [Paper Settings on the Printer Driver and the Printer \(Media Type\)](#)
- [Paper Settings on the Printer Driver and the Printer \(Paper Size\)](#)

4. Print a nozzle check pattern

Make sure that the printer is on and click **Print Check Pattern**.

Printing of the nozzle check pattern begins.

Click **OK** when the confirmation message appears.

The **Pattern Check** dialog box opens.

5. Check the print result

Check the print result. If the print result is normal, click **Exit**.

If the print result is smudged or if there are any unprinted sections, click **Cleaning** to clean the print head.

Related Topic

- [Cleaning the Print Heads from Your Computer](#)

Cleaning the Machine

- **Cleaning the Exterior of the Machine**
- **Cleaning the Platen Glass and Document Cover**
- **Cleaning the ADF (Auto Document Feeder)**
- **Cleaning the Paper Feed Roller**
- **Cleaning the Inside of the Machine (Bottom Plate Cleaning)**

Cleaning the Exterior of the Machine

Be sure to use a soft and dry cloth such as eyeglasses cleaning cloth and wipe off dirt on the surface gently. Smooth out wrinkles on the cloth if necessary before cleaning.

Important

- Be sure to turn off the power and unplug the power cord before cleaning the machine.
 - The power cannot be turned off while the machine is sending or receiving a fax, or when unsend faxes are stored in the machine's memory. Make sure if the machine completed sending or receiving all the faxes before unplugging the power cord.
 - The machine cannot send or receive faxes when the power is turned off.
 - If the power cord is unplugged, the date/time settings will be reset and all documents stored in the machine's memory will be lost. Send or print a necessary document before unplugging the power cord.
- Do not use tissue paper, paper towels, rough-textured cloth, or similar materials for cleaning so as not to scratch the surface. Paper tissue powder or fine threads may remain inside the machine and cause problems such as print head blockage and poor printing results.
- Never use volatile liquids such as thinners, benzene, acetone, or any other chemical cleaner to clean the machine, as this may cause a malfunction or damage the surface of the machine.

Cleaning the Platen Glass and Document Cover

►► Important

- Be sure to turn off the power and unplug the power cord before cleaning the machine.
 - The power cannot be turned off while the machine is sending or receiving a fax, or when unsent faxes are stored in the machine's memory. Make sure if the machine completed sending or receiving all the faxes before unplugging the power cord.
 - The machine cannot send or receive faxes when the power is turned off.
 - If the power cord is unplugged, the date/time settings will be reset and all documents stored in the machine's memory will be lost. Send or print a necessary document before unplugging the power cord.
- Do not use tissue paper, paper towels, rough-textured cloth, or similar materials for cleaning so as not to scratch the surface. Paper tissue powder or fine threads may remain inside the machine and cause problems such as print head blockage and poor printing results.
- Never use volatile liquids such as thinners, benzene, acetone, or any other chemical cleaner to clean the machine, as this may cause a malfunction or damage the surface of the machine.

Use a soft, clean, lint-free and dry cloth. Wipe the platen glass (A) and the inner side of the document cover (white sheet) (B) gently. Make sure not to leave any residue, especially on the glass surface.

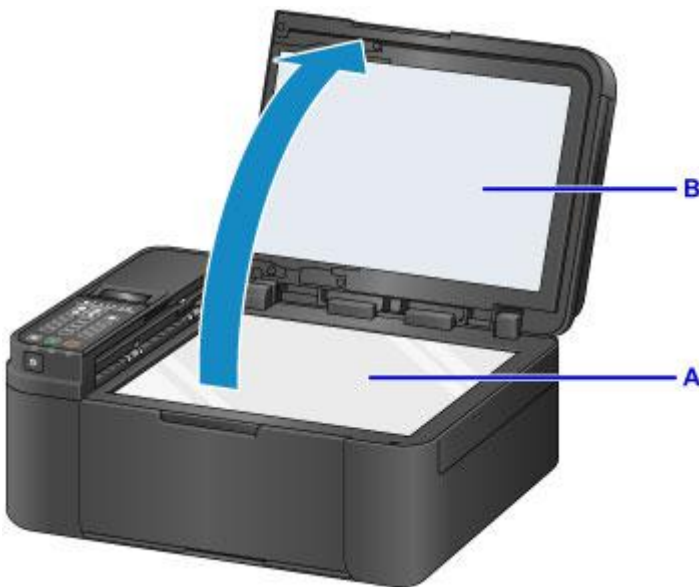

►► Important

- The inner side of the document cover (white sheet) (B) is easily damaged, so wipe it gently.

Cleaning the ADF (Auto Document Feeder)

Be sure to use a soft, clean, lint-free and dry cloth to clean the ADF (Auto Document Feeder).

»» Important

- Be sure to turn off the power and unplug the power cord before cleaning the machine.
 - The power cannot be turned off while the machine is sending or receiving a fax, or when unsent faxes are stored in the machine's memory. Make sure if the machine completed sending or receiving all the faxes before unplugging the power cord.
 - The machine cannot send or receive faxes when the power is turned off.
 - If the power cord is unplugged, the date/time settings will be reset and all documents stored in the machine's memory will be lost. Send or print a necessary document before unplugging the power cord.
- Do not use tissue paper, paper towels, rough-textured cloth, or similar materials for cleaning so as not to scratch the surface. Paper tissue powder or fine threads may remain inside the machine and cause problems such as print head blockage and poor printing results.
- Never use volatile liquids such as thinners, benzene, acetone, or any other chemical cleaner to clean the machine, as this may cause a malfunction or damage the surface of the machine.

1. Open the document cover.



2. Open the document feeder cover.



3. With the clean cloth, wipe off any paper dust from the inside of the document feeder cover (A).
4. Wipe the glass of the ADF (B) and the inner side of the document feeder cover (white area) (C) gently.

Make sure not to leave any residue, especially on the glass surface.



»» Important

- If any foreign substances such as glue, ink or correction fluid are adhered to the glass of the ADF (B) as shown in the figure above, some black streaks will appear on the scanned image. In this case, wipe the dirt off gently.

5. After wiping, close the document feeder cover by pushing it until it clicks into place.
6. Close the document cover gently.

Cleaning the Paper Feed Roller

If the paper feed roller is dirty or paper powder is attached to it, paper may not be fed properly.

In this case, clean the paper feed roller. Cleaning will wear out the paper feed roller, so perform this only when necessary.

You need to prepare: a sheet of A4 or Letter-sized plain paper or cleaning sheet available on the market

1. Make sure that the power is turned on.
2. Remove any paper from the cassette, then push it back.

▶▶▶ Note

- If a message is displayed on the screen after pushing the cassette back, press the **OK** button.

3. Press the **Setup** button, use the ◀ or ▶ button to select **Maintenance**, then press the **OK** button.

■ [LCD and Operation Panel](#)

4. Use the ◀ or ▶ button to select **Roller cleaning**, then press the **OK** button.

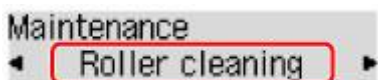

The paper feed roller will rotate as it is cleaned.

5. Make sure that the paper feed roller has stopped rotating, then load a sheet of A4 or Letter-sized plain paper or cleaning sheet available on the market in the cassette.

After pushing the cassette back, the paper information registration screen is displayed on the LCD. Select **A4** or **Letter** for **Size:** and **Plain paper** for **Type:**, then press the **OK** button.



6. Pull the paper output support out from the paper output tray, then open the output tray extension.
7. Make sure that **Roller cleaning** is selected, then press the **OK** button.

The machine starts cleaning. The cleaning will be complete when the paper is ejected.

If the problem is not resolved after cleaning the paper feed roller, contact the service center.

Cleaning the Inside of the Machine (Bottom Plate Cleaning)

Remove stains from the inside of the machine. If the inside of the machine becomes dirty, printed paper may get dirty, so we recommend performing cleaning regularly.

You need to prepare: a sheet of A4 or Letter-sized plain paper*

* Be sure to use a new piece of paper.

1. Make sure that the power is turned on, then remove any paper from the cassette.
2. Fold a single sheet of A4 or Letter-sized plain paper in half widthwise, then unfold the paper.
3. Fold one side of the opened paper in another half, aligning the edge with the center crease, then unfold the paper.

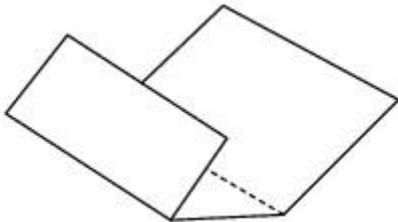

4. Load only this sheet of paper in the cassette with the ridges of the creases facing up and the edge of the half with no crease facing to the far side.

After pushing the cassette back, the paper information registration screen is displayed on the LCD. Select **A4** or **Letter** for **Size:** and **Plain paper** for **Type:**, then press the **OK** button.

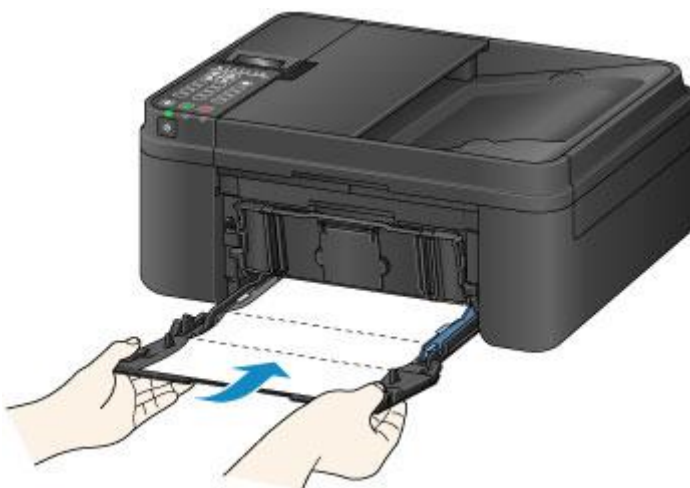

5. Pull the paper output support out from the paper output tray, then open the output tray extension.

6. Press the **Setup** button, use the ◀ or ▶ button to select **Maintenance**, then press the **OK** button.

■ [LCD and Operation Panel](#)

7. Use the ◀ or ▶ button to select **Bottom cleaning**, then press the **OK** button.

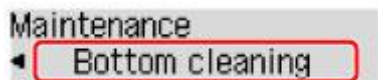

The paper cleans the inside of the machine as it feeds through the machine.

Check the folded parts of the ejected paper. If they are smudged with ink, perform Bottom Plate Cleaning again.

▶▶▶ Note

- When performing Bottom Plate Cleaning again, be sure to use a new piece of paper.

If the problem is not resolved after performing cleaning again, the protrusions inside the machine may be stained. Wipe off any ink from the protrusions using a cotton swab or the like.

▶▶▶ Important

- Be sure to turn off the power and unplug the power cord before cleaning the machine.
 - The power cannot be turned off while the machine is sending or receiving a fax, or when unsent faxes are stored in the machine's memory. Make sure if the machine completed sending or receiving all the faxes before unplugging the power cord.
 - The machine cannot send or receive faxes when the power is turned off.
 - If the power cord is unplugged, the date/time settings will be reset and all documents stored in the machine's memory will be lost. Send or print a necessary document before unplugging the power cord.



Changing the Machine Settings

- ▶ **Changing Machine Settings from Your Computer**
- ▶ **Changing the Machine Settings on the LCD**

Changing Machine Settings from Your Computer

- **Changing the Print Options**
- **Registering a Frequently Used Printing Profile**
- **Setting the Ink Cartridge to be Used**
- **Managing the Printer Power**
- **Reducing the Printer Noise**
- **Changing the Printer Operation Mode**

Changing the Print Options

You can change the detailed printer driver settings for print data that is sent from an application software. Specify this option if you encounter print failures such as part of an image data being cut off.

The procedure for changing the print options is as follows:

1. Open the [printer driver setup window](#)
2. Click **Print Options...** on the **Page Setup** tab

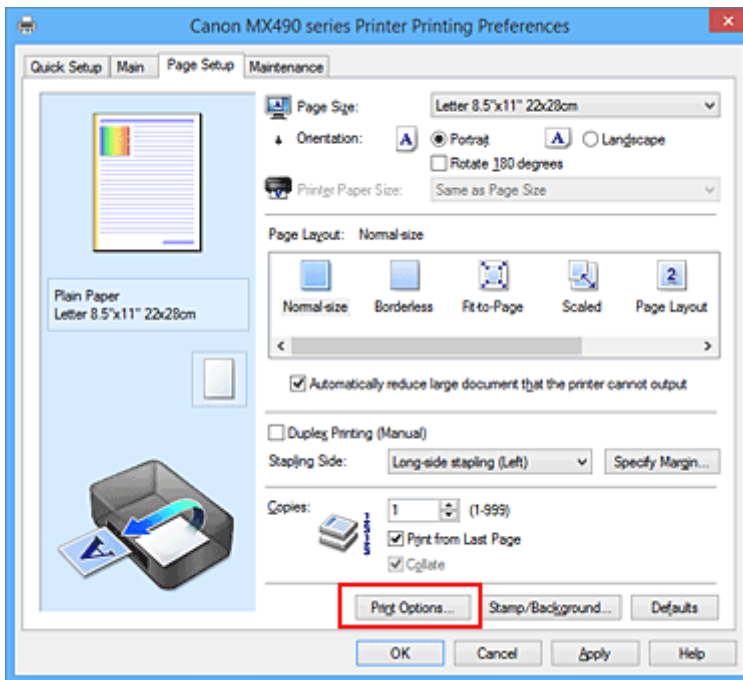

The **Print Options** dialog box opens.

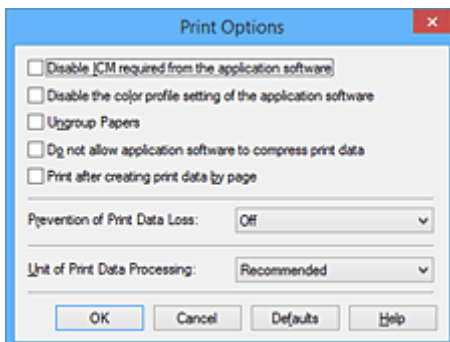

▶▶▶ Note

- When you use the XPS printer driver, the functions available to you are different.

3. Change the individual settings

If necessary, change the setting of each item, and then click **OK**.

The **Page Setup** tab is displayed again.

Registering a Frequently Used Printing Profile

You can register the frequently used printing profile to **Commonly Used Settings** on the **Quick Setup** tab. Unnecessary printing profiles can be deleted at any time.

The procedure for registering a printing profile is as follows:

Registering a Printing Profile

1. Open the [printer driver setup window](#)

2. Set the necessary items

From **Commonly Used Settings** on the **Quick Setup** tab, select the printing profile to be used and if necessary, change the settings after **Additional Features**.

You can also register necessary items on the **Main** and **Page Setup** tabs.

3. Click **Save...**

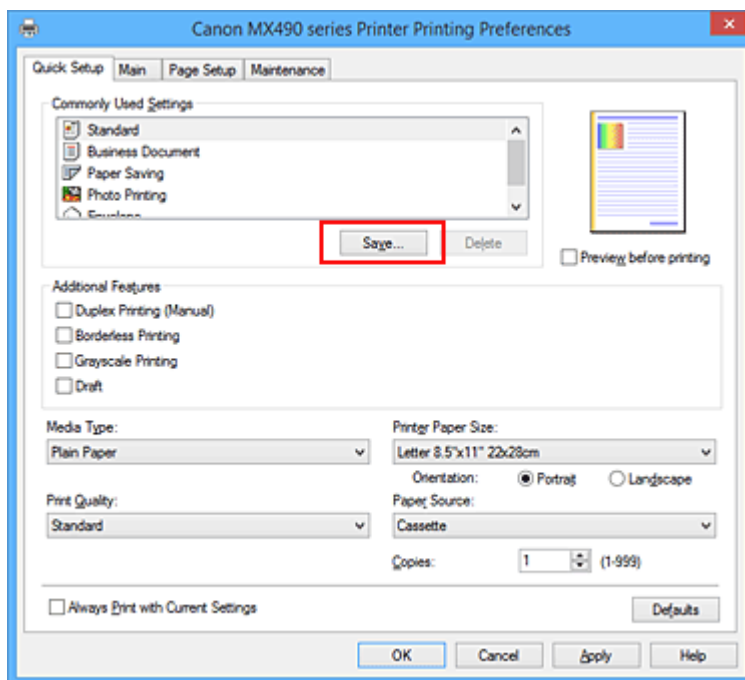

The **Save Commonly Used Settings** dialog box opens.



4. Save the settings

Enter a name in the **Name** field. If necessary, click **Options...**, set the items, and then click **OK**.

In the **Save Commonly Used Settings** dialog box, click **OK** to save the print settings and return to the **Quick Setup** tab.

The name and icon are displayed in **Commonly Used Settings**.

»» Important

- To save the page size, orientation, and number of copies that was set in each sheet, click **Options...**, and check each item.

»» Note

- When you re-install the printer driver or upgrade the printer driver version, the print settings that are already registered will be deleted from **Commonly Used Settings**.
Registered print settings cannot be saved and preserved. If a profile is deleted, register the print settings again.

Deleting Unnecessary Printing Profile

1. Select the printing profile to be deleted

Select the printing profile you want to delete from the **Commonly Used Settings** list on the **Quick Setup** tab.

2. Delete the printing profile

Click **Delete**. When the confirmation message appears, click **OK**.

The selected printing profile is deleted from the **Commonly Used Settings** list.

»» Note

- Printing profiles that are registered in the initial settings cannot be deleted.

Setting the Ink Cartridge to be Used

This feature enables you to specify the most appropriate FINE cartridge among installed cartridges according to an intended use.

When one of the FINE cartridges becomes empty and cannot be replaced immediately by a new one, you can specify the other FINE cartridge that still has ink and continue printing.

The procedure for specifying the FINE cartridge is as follows:



Ink Cartridge Settings

1. Open the [printer driver setup window](#)
2. Click **Ink Cartridge Settings** on the **Maintenance** tab

The **Ink Cartridge Settings** dialog box appears.

3. Select the FINE cartridge to be used

Select the FINE cartridge to be used for printing and click **OK**.

The specified FINE cartridge will be used from the next printing.

►► Important

- When the following settings are specified, **Black Only** does not function because the printer uses the color FINE cartridge to print documents.
 - Other than **Plain Paper**, or **Envelope** is selected for **Media Type** on the **Main** tab
 - **Borderless** is selected from the **Page Layout** list on the **Page Setup** tab
- Do not detach the FINE cartridge that is not in use. Printing cannot be performed while either FINE cartridge is detached.

Managing the Printer Power

This function allows you to manage the printer power from the printer driver.

The procedure for managing the printer power is as follows:



Power Off

The **Power Off** function turns off the printer. When you use this function, you will not be able to turn the printer on from the printer driver.

1. Open the [printer driver setup window](#)
2. Execute power off

Click **Power Off** on the **Maintenance** tab. When the confirmation message appears, click **OK**.

The printer power switches off, and the **Maintenance** tab is displayed again.

▶▶▶ Important

- You cannot receive faxes when the printer is switched off.



Auto Power

Auto Power allows you to set **Auto Power Off**.

The **Auto Power Off** function automatically turns off the printer when there are no operations from the printer driver or the printer for a specified period of time.

1. Open the [printer driver setup window](#)
2. Make sure that the printer is on and then click **Auto Power** on the **Maintenance** tab

The **Auto Power Setting** dialog box opens.

▶▶▶ Note

- If the printer is off or if communication between the printer and the computer is disabled, an error message may appear because the computer cannot collect the printer status. If this happens, click **OK** to display the most recent settings specified on your computer.

3. If necessary, complete the following setting:

Auto Power Off

Specify the time from the list. When this time lapses without any operations from the printer driver or the printer, the printer is turned off automatically.

4. Apply the settings

Click **OK**. When the confirmation message appears, click **OK**.

The **Maintenance** tab is displayed again.

The setting is enabled after this. If you want to disable this function, select **Disable** from the list according to the same procedure.

»» Important

- In the following cases, you can set **Auto Power Off** but the power will not be turned off automatically.
 - When you use the printer by connecting it to a network
 - When you use the printer by connecting it to a telephone line via a modular cable

Reducing the Printer Noise

The silent function allows you to reduce the operating noise of this printer. Select when you wish to reduce the operating noise of the printer at night, etc.

Using this function may lower the print speed.

The procedure for using the quiet mode is as follows:



Quiet Settings

1. Open the [printer driver setup window](#)
2. Click **Quiet Settings** on the **Maintenance** tab

The **Quiet Settings** dialog box opens.

▶▶▶ Note

- If the printer is off or if communication between the printer and the computer is disabled, an error message may appear because the computer cannot collect the printer status.

3. Set the quiet mode

If necessary, specify one of the following items:

Do not use quiet mode

Select this option when you wish to use the printer with volume of normal operating noise.

Always use quiet mode

Select this option when you wish to reduce the operating noise of the printer.

Use quiet mode during specified hours

Select this option when you wish to reduce the operating noise of the printer during a specified period of time.

Set the **Start time** and the **End time** of the quiet mode you wish to be activated. If both are set to the same time, the quiet mode will not function.

▶▶▶ Important

- You can set the quiet mode from the operation panel of the printer, the printer driver, or ScanGear (scanner driver).
No matter how you use to set the quiet mode, the mode is applied when you perform operations from the operation panel of the printer or printing and scanning from the computer.

4. Apply the settings

Make sure that the printer is on and click **OK**.

Click **OK** when the confirmation message appears.

The settings are enabled hereafter.

▶▶▶ Note

- The effects of the quiet mode may be less depending on the print quality settings.

Changing the Printer Operation Mode

If necessary, switch between various modes of printer operation.

The procedure for configuring **Custom Settings** is as follows:



Custom Settings

1. Open the [printer driver setup window](#)
2. Make sure that the printer is on, and then click **Custom Settings** on the **Maintenance** tab

The **Custom Settings** dialog box opens.

▶▶▶ Note

- If the printer is off or if communication between the printer and the computer is disabled, an error message may appear because the computer cannot collect the printer status. If this happens, click **OK** to display the most recent settings specified on your computer.

3. If necessary, complete the following settings:

Prevent paper abrasion

The printer can increase the gap between the print head and the paper during high-density printing to prevent paper abrasion.

Check this check box to prevent paper abrasion.

Align heads manually

Usually, the **Print Head Alignment** function on the **Maintenance** tab is set to automatic head alignment, but you can change it to manual head alignment.

If the printing results of automatic print head alignment are not satisfactory, [perform manual head alignment](#).

Check this check box to perform the manual head alignment. Uncheck this check box to perform the automatic head alignment.

Prevent paper double-feed

Select this check box only if the printer is feeding multiple sheets of plain paper at the same time.

▶▶▶ Important

- Using this function slows down the print speed.

Rotate 90 degrees left when orientation is [Landscape]

On the **Page Setup** tab, you can change the rotation direction of the **Landscape** in the **Orientation**.

To rotate the print data 90 degrees to the left during printing, select this item. To rotate the print data 90 degrees to the right during printing, clear this item.

▶▶▶ Important

- Do not change this setting while the print job is displayed in the print wait list. Otherwise, characters may be omitted or the layout may become corrupt.

Don't detect mismatch of paper settings when printing from computer

When you print documents from your computer and the paper settings on the printer driver and the cassette paper information registered on the printer do not match, this setting disables the message display and allows you to continue printing.

To disable detection of paper setting mismatches, select this check box.

Ink Drying Wait Time

You can set the length of the printer rest time until printing of the next page begins. Moving the slider to the right increases the pause time, and moving the slider to the left decreases the time. If the paper gets stained because the next page is ejected before the ink on the printed page dries, increase the ink drying wait time.

Reducing the ink drying wait time speeds up printing.

4. Apply the settings

Click **OK** and when the confirmation message appears, click **OK**.

The printer operates with the modified settings hereafter.

Changing the Machine Settings on the LCD

- ▶ **Changing the Machine Settings on the LCD**
- ▶ **Fax settings**
- ▶ **Output settings**
- ▶ **LAN settings**
- ▶ **Dev. user settings**
- ▶ **Firmware update**
- ▶ **Cassette settings**
- ▶ **Reset setting**
- ▶ **About Quiet setting**
- ▶ **Using the Machine with the Access Point Mode**

Changing the Machine Settings on the LCD

This section describes the procedure to change the settings in the **Device settings** screen, taking the steps to specify **Extended copy amt.** as an example.

▶▶▶ Note

- The * (asterisk) on the LCD indicates the current setting.

1. [Make sure that the machine is turned on.](#)

2. Press the **Setup** button.

The **Setup menu** screen is displayed.

3. Use the ◀▶ button to select **Device settings**, then press the **OK** button.

When you change the fax settings, press the **Setup** button, then select **Fax settings**.

4. Use the ◀▶ button to select **Output settings**, then press the **OK** button.

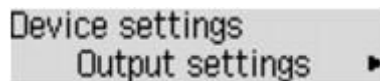

5. Use the ◀▶ button to select **Extended copy amt.**, then press the **OK** button.

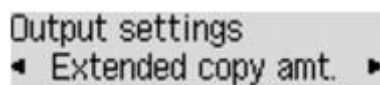

6. Use the ◀▶ button to select a setting item, then press the **OK** button.

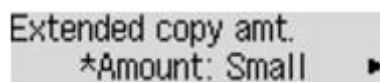

For details on each setting item:

■ [Fax settings](#)

■ [Output settings](#)

■ [LAN settings](#)

■ [Dev. user settings](#)

■ [Firmware update](#)

■ [Cassette settings](#)

■ [Reset setting](#)

▶▶▶ Note

- You can reduce the operating noise when printing at night.

■ [About Quiet setting](#)

Fax settings

This section describes the setting items in **Fax settings**.

■ [Easy setup](#)

■ [TEL no. registration](#)

■ [FAX user settings](#)

■ [Adv. FAX settings](#)

■ [Auto print settings](#)

■ [Security control](#)

▶▶▶ Note

- Before changing the settings, you can confirm the current settings by printing USER'S DATA LIST.

■ [Summary of Reports and Lists](#)

Easy setup

The machine must be set up depending on your telephone line and use of the faxing function. Follow the procedure according to the instructions on the LCD.

▶▶▶ Note

- You can specify the setup setting individually or the advanced setting.

For details on how to specify the setting:

■ [Preparing for Faxing](#)

TEL no. registration

You can register the recipient's fax/telephone number to the machine.

■ [Registering Recipients Using the Operation Panel of the Machine](#)

FAX user settings

- **Unit TEL no. registr.**

Registers your fax/telephone number printed on sent faxes.

■ [Registering User Information](#)

- **Unit name registr.**

Registers your name printed on sent faxes.

■ [Registering User Information](#)

- **Telephone line type (Country or region of purchase other than China)**

Selects the telephone line type setting for the machine.

■ [Setting the Telephone Line Type](#)

▶▶▶ Note

- This setting may not be available depending on the country or region of purchase.

- **TEL line auto select (China only)**

If you select **ON**, the telephone line type is selected automatically.

If you select **OFF**, you can select the telephone line type manually.

■ [Setting the Telephone Line Type](#)

Adv. FAX settings

- **Auto redial**

Enables/disables automatic redialing.

If you select **ON**, you can specify the maximum number of redial attempts and the length of time the machine waits between redial attempts.

- **Dial tone detect**

Avoids mistransmission when reception and transmission occur at the same time.

If you select **ON**, the machine transmits the fax after confirming the dial tone.

▶▶ Note

- This setting may not be available depending on the country or region of purchase.

- **Pause time settings**

Sets the length of pause time for each when you enter "P" (pause).

- **TTI position**

Selects the position of the sender information (outside or inside the image area).

- **Remote RX**

Enables/disables remote reception.

If you select **ON**, you can specify the remote reception ID.

■ [Remote Reception](#)

- **Color transmission**

When faxing color documents using the ADF, selects whether to convert them into black & white data if the recipient's fax machine does not support color faxing.

If you select **If incompatible, end**, the machine does not send color documents when the recipient's fax machine does not support color faxing.

- **RX image reduction**

Enables/disables automatic reduction of incoming faxes so that they fit in the selected paper.

If you select **ON**, you can select the image reduction direction.

- **Adv. communication**

- **ECM TX**

Selects whether to send faxes in Error Correction Mode (ECM).

■ [Transmission/Reception of Faxes Using ECM](#)

- **ECM RX**

Selects whether to receive faxes in Error Correction Mode (ECM).

■ [Transmission/Reception of Faxes Using ECM](#)

- **TX start speed**

Selects the fax transmission speed.

Ex:

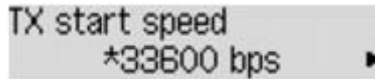

The following settings are available.

33600 bps/14400 bps/9600 bps/4800 bps

The * (asterisk) on the LCD indicates the current setting.

The fax transmission start speed will be faster as the value is bigger.

Some of settings are not available depending on the country or region of purchase.

When the telephone line condition or connection is poor, selecting a lower transmission start speed may solve transmission problems.

- **RX start speed**

Selects the fax reception speed.

Ex:

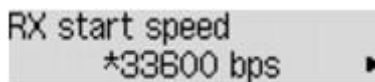

The following settings are available.

33600 bps/14400 bps/9600 bps/4800 bps

The * (asterisk) on the LCD indicates the current setting.

The fax reception start speed will be faster as the value is bigger.

Some of settings are not available depending on the country or region of purchase.

When the telephone line condition or connection is poor, selecting a lower reception start speed may solve reception problems.

Auto print settings

- **Received documents**

Selects whether to print the received fax automatically when receiving a fax.

If you select **Do not print**, the received fax is stored in the machine's memory.

For details on the received fax stored in the machine's memory:

■ [Document Stored in Machine's Memory](#)

- **Activity report**

Selects whether to print ACTIVITY REPORT automatically.

If you select **Print**, the machine prints ACTIVITY REPORT for the 20 histories of sent and received faxes automatically.

For details on the procedure to print ACTIVITY REPORT manually:

■ [Summary of Reports and Lists](#)

- **TX report**

Selects whether to print TX REPORT/ERROR TX REPORT automatically after sending a fax.

If you print the report, select **Print error only** or **Print for each TX**.

If you select **Print error only** or **Print for each TX**, you can specify the print setting that the first page of the fax is printed along with the report.

- **RX report**

Selects whether to print RX REPORT automatically after receiving a fax.

If you print RX REPORT, select **Print error only** or **Print for each RX**.

- **Print when no ink**

Sets whether to continue printing the received fax without storing it in the machine's memory when the ink has run out.

However, part or all of the fax may not be printed since the ink has run out.

Security control

- **FAX no. re-entry**

If you select **ON**, you can set the machine to send faxes after using the Numeric buttons to enter the number twice. By using this setting, you can avoid the mistransmission of faxes.

- **Check RX FAX info**

If you select **ON**, the machine checks whether the recipient's fax machine information matches the dialed number. If it matches the number, the machine starts to send faxes.

■ [Preventing Mistransmission of Faxes](#)

- **Hook setting**

If you select **Enable**, you can use the on hook dial function.

- **FAX RX reject**

If you select **ON**, the machine rejects the reception of faxes with no sender information or faxes from specific senders.

■ [Rejecting Fax Reception](#)

- **Caller rejection**

If you subscribe to the Caller ID service, the machine detects the sender's Caller ID. If the sender's ID matches the condition specified in this setting, the machine rejects the phone call or fax reception from the sender.

If you select **Subscribed**, you can specify the settings of rejection.

■ [Using the Caller ID Service to Reject Calls](#)

▶▶▶ Note

- This setting may not be supported depending on the country or region of purchase. Contact your telephone company to confirm whether it provides this service.

Output settings

- **Prevent abrasion**

Use this setting only if the print surface becomes smudged.

▶▶▶ Important

- Be sure to set this back to **OFF** after printing since it may result in lower printing speed or lower print quality.

- **Extended copy amt.**

Selects the amount of image that extends off the paper when copying in Borderless (full).

Slight cropping may occur at the edges since the copied image is enlarged to fill the whole page. You can change the width to be cropped from the borders of the original image as needed.

Cropped area will be larger if **Amount: Large** is selected.

▶▶▶ Note

- If printouts contain margins even though you are copying in Borderless, specifying **Amount: Large** for this setting may help solve the problem.

- **Prevent double-feed**

Select **ON** to prevent double-feed of plain paper.

▶▶▶ Important

- Select **ON** only when double-feed of plain paper occurs.

LAN settings

- **Change LAN**

Enables/disables either wireless LAN or access point mode.

- **Wireless LAN setup**

If your wireless router is compatible with WPS, set up wireless LAN following the on-screen instructions. If not, select one of the setup methods below.

- **Standard setup**

Select when you perform settings for wireless LAN manually using the operation panel of the machine.

- **WPS (Push button)**

Select when you perform settings for wireless LAN using a wireless router supporting a Wi-Fi Protected Setup (WPS) push button method. Follow the on-screen instructions during setup.

- **Other setup**

- Manual setup**

Select when you perform settings for wireless LAN manually. You can specify multiple WEP keys.

- WPS (PIN code)**

Select when you perform settings for wireless LAN using a wireless router supporting a Wi-Fi Protected Setup (WPS) PIN code method. Follow the on-screen instructions during setup.

- Cableless setup**

Select if you specify the settings of the access point information to the machine directly from a device (such as a smartphone) without operating the wireless router. Follow the on-screen instructions of the connecting device for the setup procedure.

- **AP mode settings**

When you use the machine as an access point (wireless router), specify the access point name (SSID) and the security setting.

 [Using the Machine with the Access Point Mode](#)

- **Print LAN details**

You can print out the network settings of the machine such as its IP address and SSID.

For more information on the machine's network setting is printed out, refer to [Printing Out Network Setting Information](#).

Important

- This printout contains valuable information about your computer. Handle it with care.

- **Other settings**

Important

- You cannot select the items below when **LAN inactive** is selected for **Change LAN**.

- **Set printer name**

Specifies the printer name. You can use up to 15 characters for the name.

»» Note

- You cannot use the same printer name as that already used for other LAN connected devices.
- You cannot use a hyphen for the initial or last character of the printer name.

◦ TCP/IP settings

Performs IPv4 or IPv6 setting.

◦ WSD setting

Setting items when you use WSD (one of the network protocols supported in Windows 8.1, Windows 8, Windows 7, and Windows Vista).

Enable/disable WSD

Selects whether WSD is enabled or disabled.

»» Note

- When this setting is enabled, the printer icon is displayed on the Network Explorer in Windows 8.1, Windows 8, Windows 7, and Windows Vista.

WSD scan from dev.

Selecting **Active** allows you to transfer the scanned data to the computer using WSD.

Timeout setting

Specifies the timeout length.

◦ Bonjour settings

Setting items for LAN using Bonjour for Mac OS.

Enab./disab. Bonjour

Selecting **Active** allows you to use Bonjour to perform the network settings.

Enter service name

Specifies the Bonjour service name. You can use up to 48 characters for the name.

»» Note

- You cannot use the same service name as that already used for other LAN connected devices.

◦ LPR setting

Enables/disables the LPR setting.

◦ DRX setting

Selecting **Active** allows you to enable discontinuous reception when using wireless LAN. It allows you to save electricity.

»» Note

- Depending on the wireless router you are using, discontinuous reception may not be enabled even though **Active** is selected.
- Discontinuous reception is enabled only while the machine is on standby. (The LCD is in the screen saver mode.)

Dev. user settings

- **Date/time setting**

Sets the current date and time.

■ [Setting the Sender Information](#)

▶▶▶ Important

- If a power failure occurs or you unplug the power cord, the date/time settings will be reset.

- **Date display format**

Sets the format of dates displayed on the LCD and printed on sent faxes.

- **DST setting**

Some countries adopt the daylight saving time (summer time) system that shifts the clock time forward at certain periods of the year.

You can set your machine to automatically change the time by registering the date and time that daylight saving time (summer time) begins and ends.

■ [Setting the Sender Information](#)

▶▶▶ Note

- This setting may not be available depending on the country or region of purchase.

- **Sound control**

Selects whether the beep sound in operations is enabled or not.

- **Keypad sound**

Selects whether the beep sound is enabled or not when pressing the buttons on the operation panel.

- **Alarm sound**

Selects whether the alarm is enabled or not.

- **Line monitor sound**

Selects whether the line monitor sound is enabled or not.

- **Offhook alarm**

Selects whether the alarm is enabled or not when the phone receiver is not put on the hook properly.

- **Country or region**

Selects the country or region where you are using the machine.

▶▶▶ Note

- This setting may not be available depending on the country or region of purchase.

- **Language selection**

Changes the language for LCD messages and menus.

Japanese / English / German / French / Italian / Spanish / Dutch / Portuguese / Norwegian / Swedish / Danish / Finnish / Russian / Ukrainian / Polish / Czech / Slovak / Hungarian / Slovene / Croatian /

Romanian / Bulgarian / Turkish / Greek / Estonian / Latvian / Lithuanian / Simplified Chinese / Traditional Chinese / Korean / Indonesian / Vietnamese

- **Key repeat**

Enables/Disables continuous input by pressing and holding down the ◀▶ button when setting the number of copies, the zoom ratio, etc.

- **Device info sending**

Selects whether you will send the printer usage information to Canon server. The information sent to Canon will be utilized to develop better products. Select **ON** to send the printer usage information to Canon server.

- **Auto power off**

The machine turns off automatically if no operation is made or no printing data is sent to the machine for a specified period of time. Select **OFF** if you want the machine not to turn off automatically.

▶▶▶ Important

- Under the following conditions, the machine does not turn off automatically even though this setting is enabled.
 - When using the machine via a network and the network connection is enabled
 - When the machine is connected to a telephone line using a modular cable

▶▶▶ Note

- You can select whether you turn off the machine automatically from the operation panel of the machine, the printer driver, or ScanGear (scanner driver).
- The machine does not have a function to turn itself on automatically.

Firmware update

You can update the firmware of the machine, check the firmware version, or perform settings of a notification screen, a DNS server and a proxy server.

▶▶▶ Note

- Only **Current version** is available when **LAN inactive** is selected for **Change LAN** in **LAN settings**.

- **Install update**

Performs the firmware update of the machine.

- **Current version**

You can check the current firmware version.

- **Update notification**

When **ON** is selected and the firmware update is available, the screen to inform you of the firmware update is displayed on the LCD.

- **DNS server setup**

Performs settings for a DNS server. Select **Auto setup** or **Manual setup**. If you select **Manual setup**, follow the display on the LCD to perform settings.

- **Proxy server setup**

Performs settings for a proxy server. Follow the display on the LCD to perform settings.

Cassette settings

By registering the paper size and the media type loaded in the cassette, you can prevent the machine from misprinting by displaying the message before printing starts when the paper size or the media type of the loaded paper differs from the print settings.

For details:

■ [Paper setting for Printing](#)

- **Register paper info**

Registers the paper size and the media type you load in the cassette.

▶▶▶ Note

- For details on the combination of paper settings you can specify by the printer driver or on the LCD:

- [Paper Settings on the Printer Driver and the Printer \(Media Type\)](#)

- [Paper Settings on the Printer Driver and the Printer \(Paper Size\)](#)

- **Det. paper mismatch**

If you select **ON**, the machine detects whether the paper size and the media type are the same as those registered in **Register paper info**. If printing starts with the settings that do not match, an error message is displayed on the LCD.

▶▶▶ Note

- When **OFF** is selected, **Detect reinsertion** is disabled.

- **Detect reinsertion**

If you select **ON**, the machine detects the cassette is reinserted. When the **Register paper info** screen is displayed, register the paper size and the media type.

Reset setting

Returns all settings you made to the machine back to the default. However, some data may not be changed, depending on the current usage state of your machine.

▶▶▶ Important

- Depending on the setting item, it is necessary to perform connection or setup again after you have returned the setting back to the default.

- **Web service setup**

Returns the Web service settings back to the default.

- **LAN settings**

Returns the LAN settings other than the administrator password specified by IJ Network Tool back to the default.

After resetting, perform setup again as necessary.

- **Telephone no. data**

Returns the telephone/fax number settings to default.

- **Setting data**

Returns the settings such as the paper size, media type, or other setting items back to the default. The LAN settings and the telephone/fax number are not returned back to the default.

- **Device info sending**

Returns only the device information sending settings back to the default.

- **FAX settings**

Returns the fax settings back to the default. Disconnect the telephone line from the machine before you return this setting item back to the default.

After resetting, perform setup again as necessary.

- **All data**

Returns all settings you made to the machine back to the default. The administrator password specified by IJ Network Tool returns to the default setting.

After resetting, perform setup again as necessary.

▶▶▶ Note

- You cannot return the following setting items back to the default:
 - The language displayed on the LCD
 - The current position of the print head
 - The country or region selected for **Country or region**

About Quiet setting

Enables this function on the machine if you want to reduce the operating noise, such as when printing at night. In addition, you can specify the time range to reduce the operating noise.

▶▶▶ Important

- Set the current date and time in advance.

■ [Setting the Sender Information](#)

Follow the procedure below to perform setting.

1. [Make sure that the machine is turned on.](#)
2. Press the **Setup** button.
The **Setup menu** screen is displayed.
3. Use the ◀▶ button to select **Quiet setting**, then press the **OK** button.
4. Use the ◀▶ button to select **ON** or **Use in specified hrs**, then press the **OK** button.

- When **ON** is selected:

You can reduce the operating noise while printing is in progress.

- When **Use in specified hrs** is selected:

The screen to specify starting/ending time is displayed. Use the ◀▶ button to move the cursor under the desired position, use the Numeric buttons to enter the time, then press the **OK** button.

Start time	21:00
End time	07:00

You can reduce the operating noise during the specified time.

▶▶▶ Important

- Operating speed may be reduced compared to when **OFF** is selected.
- This function may not be so effective depending on the machine's setting. Furthermore, certain noise, such as when the machine is preparing for printing, is not reduced.

▶▶▶ Note

- You can set the quiet mode from the operation panel of the machine, the printer driver, or ScanGear (scanner driver). No matter how you set the quiet mode, the mode is applied when you perform operations from the operation panel of the machine or printing and scanning from the computer.

Using the Machine with the Access Point Mode

By using the machine as an access point in an environment that does not have wireless router, or by using the machine as an access point temporarily in an environment that has wireless router, you can connect the machine to an external device such as a computer or a smartphone and print/scan from them.

This section describes how to enable the access point mode, the access point name of the machine, and the security setting.

■ [How to enable the Access Point Mode](#)

■ [Printing/Scanning with the Access Point Mode](#)

■ [How to terminate the Access Point Mode](#)

■ [Setting of the Access Point Mode](#)

▶▶▶ Important

- Before using the machine with the access point mode, confirm the usage restrictions then switch the machine to the access point mode.

■ [Restrictions](#)

- If you use the machine with the access point mode for the long time, we recommend that you change the default access point name and the default password to the combination of numbers and letters from the point of view of security.

How to enable the Access Point Mode

Enable the access point mode following the procedure below.

1. [Make sure that the machine is turned on.](#)
2. Press the **Setup** button.
The **Setup menu** screen is displayed.
3. Use the ◀▶ button to select **Device settings**, then press the **OK** button.
The **Device settings** screen is displayed.
4. Use the ◀▶ button to select **LAN settings**, then press the **OK** button.
5. Use the ◀▶ button to select **Change LAN**, then press the **OK** button.
6. Use the ◀▶ button to select **Access point mode**, then press the **OK** button.
7. Use the ◀▶ button to select **Start setup**, then press the **OK** button.

The access point mode is enabled and the machine can be used as an access point.

▶▶▶ Note

- If you select **SSID** or **Security protocol** using the ◀▶ button and press the **OK** button, you can confirm the current access point name (SSID) and the current security setting.

Printing/Scanning with the Access Point Mode

Print/Scan with the access point mode following the procedure below.

1. Connect an external device such as a computer or a smartphone to the machine via wireless LAN.

Perform wireless LAN settings with your external device, then assign the access point name (SSID) specified for the machine as a destination.

▶▶▶ Note

- For details on how to perform wireless LAN settings with an external device, refer to the device's instruction manual.
- When a WPA2-PSK (AES) password is valid on the machine, entering the password is required to connect an external device to the machine via wireless LAN. Enter the password specified for the machine.

2. Start printing or scanning from an external device such as a computer or a smartphone.

▶▶▶ Note

- For details on how to print or scan from an external device such as a computer or a smartphone via wireless LAN, refer to the device's or application's instruction manual.

How to terminate the Access Point Mode

In environments that the machine is usually connected with the computer over the wireless LAN, set the machine to the wireless LAN connection following the procedure below when you finish using the machine with the access point mode temporarily.

1. Press the **Setup** button.

The **Setup menu** screen is displayed.

2. Use the ◀▶ button to select **Device settings**, then press the **OK** button.

The **Device settings** screen is displayed.

3. Use the ◀▶ button to select **LAN settings**, then press the **OK** button.

4. Use the ◀▶ button to select **Change LAN**, then press the **OK** button.

5. Use the ◀▶ button to select **Wireless LAN**, then press the **OK** button.

If you do not use the machine over wireless LAN, select **LAN inactive**.

Setting of the Access Point Mode

Specify the settings for the access point mode following the procedure below.

1. [Make sure that the machine is turned on.](#)

2. Press the **Setup** button.

The **Setup menu** screen is displayed.

3. Use the ◀▶ button to select **Device settings**, then press the **OK** button.

The **Device settings** screen is displayed.

4. Use the ◀▶ button to select **LAN settings**, then press the **OK** button.

5. Use the ◀▶ button to select **AP mode settings**, then press the **OK** button.

The screen to enter the access point name (SSID) is displayed.

6. Enter the access point name (up to 32 characters).

Enter the access point name when you use the machine as an access point.

7. Press the **OK** button to finish entering the name.

8. Use the ◀▶ button to select the security setting, then press the **OK** button.

WPA2-PSK (AES)

Specifies the security setting applying WPA2-PSK (AES). Proceed to the next step when the screen to specify the password is displayed.

Disable

Finishes the access point settings without specifying the security setting.

9. Enter the password (8 to 10 characters).

10. Press the **OK** button to finish specifying the password setting.

▶▶ Note

- If you change the access point mode setting of the machine, also change the access point setting of the external device such as a computer or a smartphone.

Information about Network Connection

- ▶ [Useful Information about Network Connection](#)

Useful Information about Network Connection

- ▶ **Default Values Set at Factory (Network)**
- ▶ **Connecting the Machine to the Computer Using a USB Cable**
- ▶ **When Detecting the Printers Have the Same Name during Setup**
- ▶ **Connecting to Other Computer with LAN/Changing the Connection Method from USB to LAN**
- ▶ **Printing Out Network Setting Information**

Default Values Set at Factory (Network)

Default Values of the LAN Connection

Item	The default
Change LAN	LAN inactive
SSID	BJNPSETUP
Communication mode	Infrastructure
Wireless LAN security	Disable
IP address (IPv4)	Auto setup
IP address (IPv6)	Auto setup
Set printer name	XXXXXX000000
TCP/IP settings	IPv4/IPv6
Enable/disable IPv6	Active
Enable/disable WSD	Active
Timeout setting	1 minute
Enab./disab. Bonjour	Active
Service name (Bonjour settings)	Canon MX490 series
LPR setting	Active
DRX setting	Active

("XXXXXX" is the last six digits of MAC address of the machine.)

Default Values of the Access Point Mode

Item	The default
SSID (access point name)	XXXXXX-MX490series
Security setting	WPA2-PSK (AES)
Password	Serial number of the machine

("XXXXXX" is the last six digits of MAC address of the machine.)

Connecting the Machine to the Computer Using a USB Cable

Connect the machine and the computer using a USB cable as the illustration below. The USB port is located on the rear of the machine.



When Detecting the Printers Have the Same Name during Setup

When the printer is detected during setup, you may see multiple printers of the same name on the detection result screen.

Select a printer with checking the MAC address or the serial number set to the printer against that on the detection result screen.

▶▶▶ Note

- A serial number may not be displayed on the detection result screen.

To check the MAC address of the printer, print out the network setting information using the operation panel of the printer.

■ [Printing Out Network Setting Information](#)

Connecting to Other Computer with LAN/Changing the Connection Method from USB to LAN

To add the computer connecting the machine with LAN or to change the connection method between the machine and the computer from USB to LAN, perform setup with the Setup CD-ROM or perform it according to the instructions on our website.

Connecting to Other Computer with LAN

To add the computer connecting the machine with LAN, perform setup with the Setup CD-ROM or perform it according to the instructions on our website.

Changing the Connection Method from USB to LAN

To change the connection method to LAN while you are using the machine with USB connection, perform setup again with the Setup CD-ROM or perform it again according to the instructions on our website and select **Change Connection Method**.

Printing Out Network Setting Information

You can print out the current network settings of the machine.

▶▶▶ Important

- This print out contains valuable information about your computer. Handle it with care.

1. [Make sure that the machine is turned on.](#)
2. [Load a sheet of A4 or Letter-sized plain paper.](#)
3. Press the **Setup** button.
The **Setup menu** screen is displayed.
4. Use the ◀▶ button to select **Device settings**, then press the **OK** button.
5. Use the ◀▶ button to select **LAN settings**, then press the **OK** button.
6. Use the ◀▶ button to select **Print LAN details**, then press the **OK** button.

The machine starts printing the network setting information.

The following information on the machine's network setting is printed out.

Item	Explanations of the item	Setting
Wireless LAN	Wireless LAN	Enable/Disable
Connection	Connection status	Active/Inactive
MAC Address	MAC Address	XX:XX:XX:XX:XX:XX
SSID	SSID	SSID of the wireless LAN/SSID of the access point mode
Password	Password	Password of the access point mode (8 to 10 alphanumeric characters)
Communication Mode	Communication Mode	Infrastructure/Access Point Mode
Channel *1	Channel	XX (1 to 13)
Encryption	Method of the Encryption	none/WEP/TKIP/AES
WEP Key Length	WEP Key Length	Inactive/128/64
Authentication	Method of the Authentication	none/auto/open/shared/WPA-PSK/WPA2-PSK
Signal Strength	Signal Strength	0 to 100 [%]
TCP/IP Version	TCP/IP Version	IPv4 & IPv6/IPv4
IPv4 IP Address	Selected IP Address (IPv4)	XXX.XXX.XXX.XXX
IPv4 Default Gateway	Default Gateway (IPv4)	XXX.XXX.XXX.XXX

Subnet Mask	Subnet Mask	XXX.XXX.XXX.XXX
IPv6 IP Address *2	Selected IP Address (IPv6)	XXXX:XXXX:XXXX:XXXX XXXX:XXXX:XXXX:XXXX
IPv6 Default Gateway *2	Default Gateway (IPv6)	XXXX:XXXX:XXXX:XXXX XXXX:XXXX:XXXX:XXXX
Subnet Prefix Length *2	Subnet Prefix Length	XXX
IPsec *3	IPsec setting	Active
Security Protocol *3	Method of the Security Protocol	ESP/ESP & AH/AH
Wireless LAN DRX	Discontinuous reception (wireless LAN)	Enable/Disable
Other Settings	Other settings	-
Printer Name	Printer name	Printer name (Up to 15 alphanumeric characters)
WSD	WSD setting	Enable/Disable
WSD Timeout	Timeout	1/5/10/15/20 [min]
LPR Protocol	LPR protocol setting	Enable/Disable
Bonjour	Bonjour setting	Enable/Disable
Bonjour Service Name	Bonjour service name	Bonjour service name (Up to 52 alphanumeric characters)
DNS Server	Getting DNS Server automatically	Auto/Manual
Primary Server	Primary server address	XXX.XXX.XXX.XXX
Secondary Server	Secondary server address	XXX.XXX.XXX.XXX
Proxy Server	Proxy Server setting	Enable/Disable
Proxy Port	Specifying Proxy Port	1 to 65535
Proxy Address	Proxy Address	XXXXXXXXXXXXXXXXXXXX

("XX" represents alphanumeric characters.)

*1 Depending on the country or region of purchase, one of the channels from 1 to 11 is printed.

*2 Only when IPv6 is enabled, the status of the network is printed.

*3 Only when IPv6 and the IPsec setting are enabled, the status of the network is printed.

About Network Communication

- ▶ **Changing and Confirming Network Settings**
- ▶ **Screens for Network Connection of IJ Network Tool**
- ▶ **Other Screens of IJ Network Tool**
- ▶ **Appendix for Network Communication**

Changing and Confirming Network Settings

- ▶ **IJ Network Tool**
- ▶ **Changing the Settings in the Wireless LAN Sheet**
- ▶ **Changing the WEP Detailed Settings**
- ▶ **Changing the WPA/WPA2 Detailed Settings**
- ▶ **Changing the Settings in the Wired LAN Sheet**
- ▶ **Changing the Settings in the Admin Password Sheet**
- ▶ **Monitoring Wireless Network Status**
- ▶ **Initializing the Network Settings of the Machine**
- ▶ **Viewing the Modified Settings**

IJ Network Tool

IJ Network Tool is a utility that enables you to display and modify the machine network settings. It is installed when the machine is set up.

►► Important

- To use the machine over LAN, make sure you have the equipment necessary for the connection type, such as a wireless router or a LAN cable.
- Do not start up IJ Network Tool while printing.
- Do not print when IJ Network Tool is running.
- If the firewall function of your security software is turned on, a message may appear warning that Canon software is attempting to access the network. If the warning message appears, set the security software to always allow access.
- IJ Network Tool has been verified to work on Windows XP, however, it does not support Fast User Switching. We recommend to exit IJ Network Tool before switching users.

Starting up IJ Network Tool

1. Start up IJ Network Tool as shown below.

- In Windows 8.1 or Windows 8, select **IJ Network Tool** on the **Start** screen to start IJ Network Tool. If **IJ Network Tool** is not displayed on the **Start** screen, select the **Search** charm, then search for "IJ Network Tool".
- In Windows 7, Windows Vista, or Windows XP, click **Start** and select **All programs, Canon Utilities, IJ Network Tool**, and then **IJ Network Tool**.

Depending on the printer you are using, an administrator password is already specified for the printer at the time of purchase. When you change the network settings, authentication by the administrator password is required.

For details:

■ [About the Administrator Password](#)

For improving security, we recommend to change the administrator password.

■ [Changing the Settings in the Admin Password Sheet](#)

Changing the Settings in the Wireless LAN Sheet

To change the wireless network settings of the printer, connect the printer and the computer with a USB cable temporarily. If you modify the wireless network settings of the computer over wireless connection without USB connection, your computer may not be able to communicate with the machine after modifying the settings.

▶▶▶ Note

- This screen is not available depending on the printer you are using.
- Enable the wireless LAN setting of the printer to change the settings in the **Wireless LAN** sheet.

1. [Start up IJ Network Tool.](#)

2. Select the printer in **Printers:**.

When the printer is connected to the computer with a USB cable temporarily, select the printer with "USBnnn" (where "n" is a number) appearing in the **Port Name** column.

3. Select **Configuration...** on the **Settings** menu.

4. Click the **Wireless LAN** tab.

The **Wireless LAN** sheet is displayed.

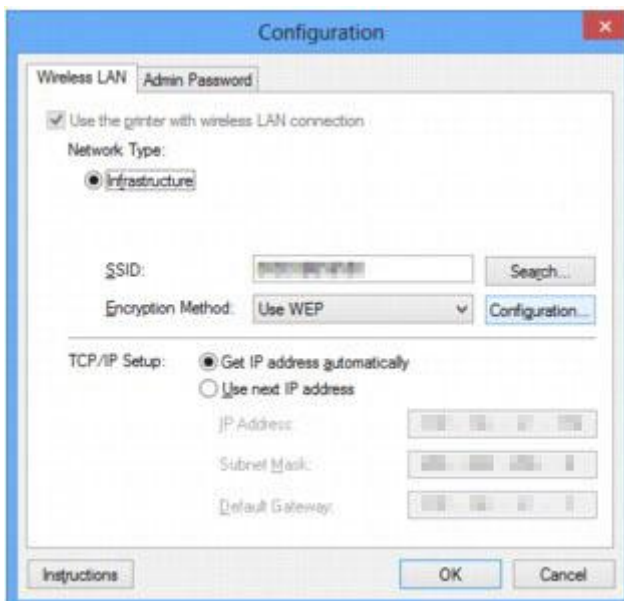

For details on the **Wireless LAN** sheet, see [Wireless LAN Sheet](#).

5. Change the settings or confirm.

SSID:

Enter the same value that was set for the target wireless router.

When the printer is connected with USB, the **Search** screen appears by clicking **Search...**. Set the SSID of the wireless router by selecting the one of the detected wireless routers.

■ [Search Screen](#)

»» Note

- Enter the same SSID that the wireless router is configured to use. The SSID is case-sensitive.

Encryption Method:

Select the encryption method used over the wireless LAN.

You can change WEP settings with selecting **Use WEP** and clicking **Configuration....**

■ [Changing the WEP Detailed Settings](#)

You can change WPA/WPA2 settings with selecting **Use WPA/WPA2** and clicking **Configuration....**

■ [Changing the WPA/WPA2 Detailed Settings](#)

»» Important

- If all encryption types of the wireless router, printer, or computer do not match, the printer cannot communicate with the computer. If the printer cannot communicate with the computer after the encryption type of the printer was switched, make sure that encryption types for the computer and the wireless router match that set to the printer.
- If you connect to a network that is not protected with security measures, there is a risk of disclosing data such as your personal information to a third party.

TCP/IP Setup:

Sets the IP address of the printer to be used over the LAN. Specify a value appropriate for your network environment.

6. Click **OK**.

After changing configuration, a screen is displayed asking you for confirmation before the settings are sent to the printer. If you click **Yes**, the settings are sent to the printer and the **Transmitted Settings** screen is displayed.

»» Note

- Changing the network settings with the USB cable temporarily may switch the default printer. In this case, reset **Set as Default Printer**.

Changing the WEP Detailed Settings

▶▶▶ Note

- This screen is not available depending on the printer you are using.

To change the wireless network settings of the printer, connect the printer and the computer with a USB cable temporarily. If you modify the wireless network settings of the computer over wireless connection without USB connection, your computer may not be able to communicate with the machine after modifying the settings.

1. [Start up IJ Network Tool.](#)

2. Select the printer in **Printers:**.

When the printer is connected to the computer with a USB cable temporarily, select the printer with "USBnnn" (where "n" is a number) appearing in the **Port Name** column.

3. Select **Configuration...** on the **Settings** menu.

4. Click the **Wireless LAN** tab.

5. Select **Use WEP** in **Encryption Method:** and click **Configuration....**

The **WEP Details** screen is displayed.

6. Change the settings or confirm.

When changing the password (WEP key), the same change must be made to the password (WEP key) of the wireless router.



1. **WEP Key:**

Enter the same key as the one set to the wireless router.

The number of characters and character type that can be entered differ depending on the combination of the key length and key format.

		Key Length	
		64bit	128bit
Key Format	ASCII	5 characters	13 characters
	Hexadecimal (Hex)	10 digits	26 digits

2. **Key Length:**

Select either **64bit** or **128bit**.

3. **Key Format:**

Select either **ASCII** or **Hex**.

4. **Key ID:**

Select the Key ID (index) set to the wireless router.

5. **Authentication:**

Select the authentication method to authenticate the printer's access to the wireless router.

Normally, select **Auto**. If you want to specify the method manually, select **Open System** or **Shared Key** according to the setting of the wireless router.

7. Click **OK**.

 **Important**

- If the printer cannot communicate with the computer after the encryption type of the printer was switched, make sure that encryption types for the computer and the wireless router match that set to the printer.

 **Note**

- Changing the network settings with the USB cable temporarily may switch the default printer. In this case, reset **Set as Default Printer**.

Changing the WPA/WPA2 Detailed Settings

»» Note

- This screen is not available depending on the printer you are using.

To change the wireless network settings of the printer, connect the printer and the computer with a USB cable temporarily. If you modify the wireless network settings of the computer over wireless connection without USB connection, your computer may not be able to communicate with the machine after modifying the settings.

The example screenshots in this section refer to the WPA detailed settings.

1. [Start up IJ Network Tool.](#)

2. Select the printer in **Printers:**.

When the printer is connected to the computer with a USB cable temporarily, select the printer with "USBnnn" (where "n" is a number) appearing in the **Port Name** column.

3. Select **Configuration...** on the **Settings** menu.

4. Click the **Wireless LAN** tab.

5. Select **Use WPA/WPA2** in **Encryption Method:** and click **Configuration...**

The **WPA/WPA2 Details** screen is displayed.

If encryption is not set to the printer, the **Authentication Type Confirmation** screen is displayed. Go to step 7.

6. Click **Change Settings...**

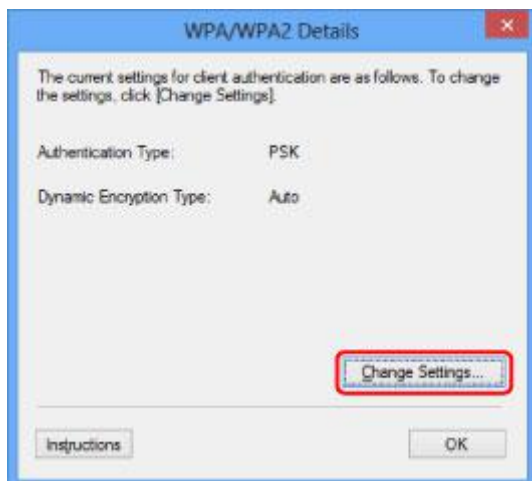

7. Check the client authentication type and click **Next>**.



8. Enter the passphrase, then click **Next>**.

Enter the passphrase set to the wireless router. The passphrase should be a string of 8 to 63 alphanumeric characters or a 64-digit hexadecimal value.

If you do not know the wireless router passphrase, refer to the instruction manual provided with the wireless router or contact its manufacturer.

The dynamic encryption method is selected from either TKIP (basic encryption) or AES (secure encryption) automatically.

»»» Important

- If **Auto** is not displayed on **Dynamic Encryption Type**;, select either **TKIP(Basic Encryption)** or **AES(Secure Encryption)**.



9. Click **Finish**.

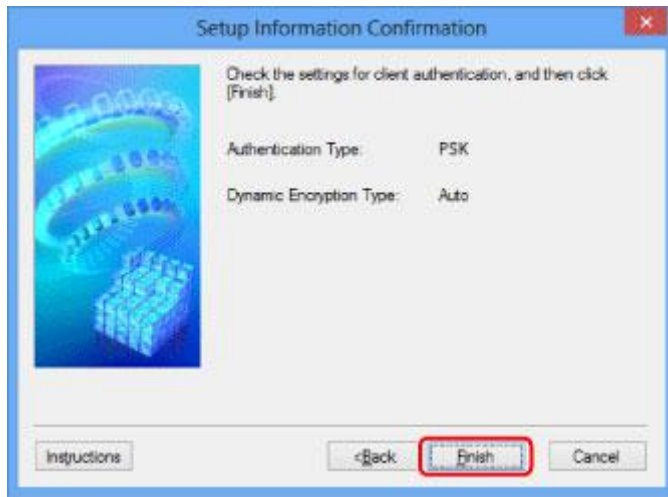

»» Important

- If the printer cannot communicate with the computer after the encryption type of the printer was switched, make sure that encryption types for the computer and the wireless router match that set to the printer.

»» Note

- Changing the network settings with the USB cable temporarily may switch the default printer. In this case, reset **Set as Default Printer**.

Changing the Settings in the Wired LAN Sheet

►► Note

- This screen is not available depending on the printer you are using.
- Enable the wired LAN setting of the printer to change the settings in the **Wired LAN** sheet.

1. [Start up IJ Network Tool.](#)
2. Select the printer in **Printers:**.
3. Select **Configuration...** on the **Settings** menu.
4. Click the **Wired LAN** tab.

The **Wired LAN** sheet is displayed.

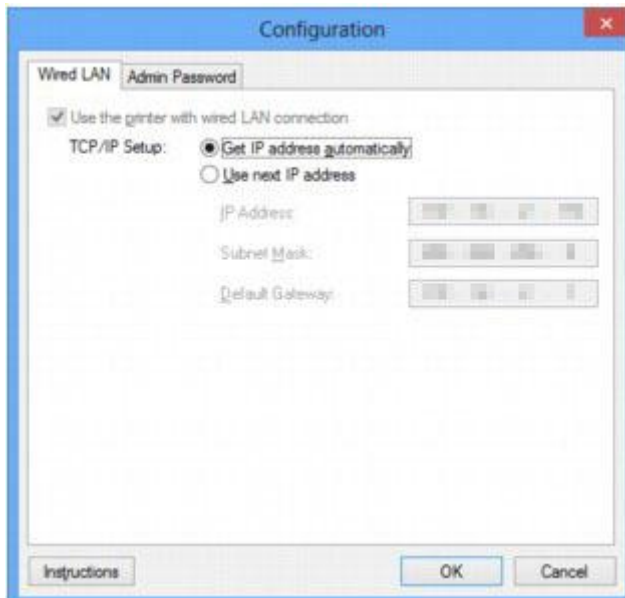

For details on the **Wired LAN** sheet, see [Wired LAN Sheet](#).

5. Change the settings or confirm.

Set the IP address of the printer to be used over the LAN. Specify a value appropriate for your network environment.

6. Click **OK**.

After changing configuration, a screen is displayed asking you for confirmation before the settings are sent to the printer. If you click **Yes**, the settings are sent to the printer and the **Transmitted Settings** screen is displayed.

Changing the Settings in the Admin Password Sheet

►► Note

- You cannot change the settings when using the access point mode.

1. [Start up IJ Network Tool.](#)
2. Select the printer in **Printers:**.
3. Select **Configuration...** on the **Settings** menu.
4. Click the **Admin Password** tab.

The **Admin Password** sheet is displayed.

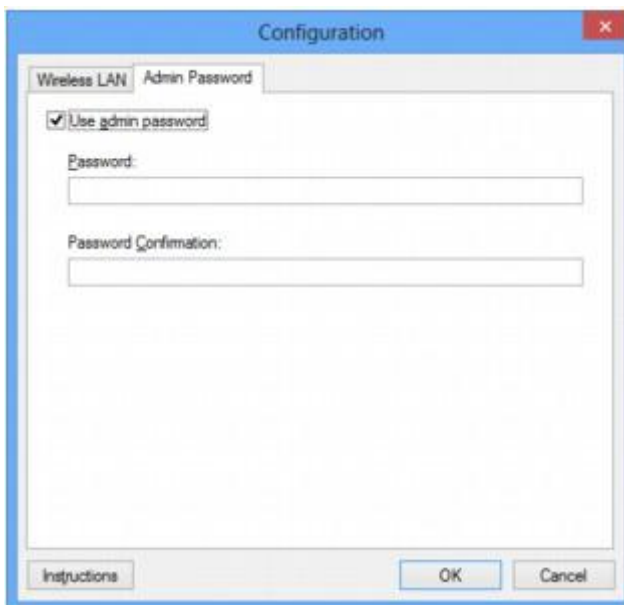

For details on the **Admin Password** sheet, see [Admin Password Sheet](#).

5. Change the settings or confirm.

To use an administrator password, select the **Use admin password** check box and enter a password.

►► Important

- The password should consist of alphanumeric characters and be no longer than 32 characters. The password is case-sensitive. Do not forget the password you set.
If you forget the administrator password you specified, initialize the printer to return the password to the default setting.

6. Click **OK**.

A screen is displayed asking you for confirmation before the settings are sent to the printer. If you click **Yes**, the settings are sent to the printer and the **Transmitted Settings** screen is displayed.

Monitoring Wireless Network Status

►► Note

- This screen is not available depending on the printer you are using.
- When using the machine over the wired LAN, you cannot monitor network status.

1. [Start up IJ Network Tool.](#)
2. Select the printer in **Printers:**.
3. Select **Status** on the **View** menu.

The **Status** screen is displayed and you can check the printer status and connection performance.

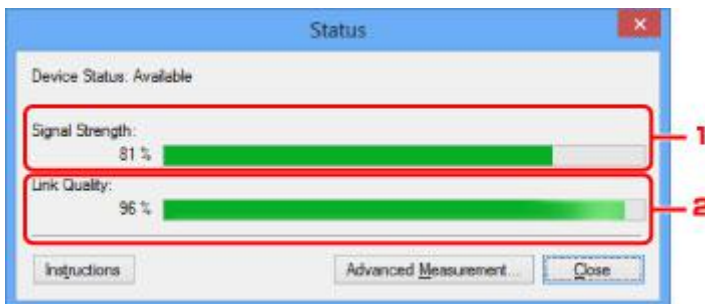

1. **Signal Strength:**

Indicates the strength of the signal received by the printer, ranging from 0% to 100%.

2. **Link Quality:**

Indicates the signal quality excluding the noise while communicating, ranging from 0% to 100%.

►► Important

- If the indicated value is low, move your printer closer to the wireless network device.

4. If you measure the connection performance in detail, click **Advanced Measurement...**

The **Connection Performance Measurement** screen is displayed.

5. Click **Next>**.

The measurement starts and the status displays. Measurement takes a few minutes.

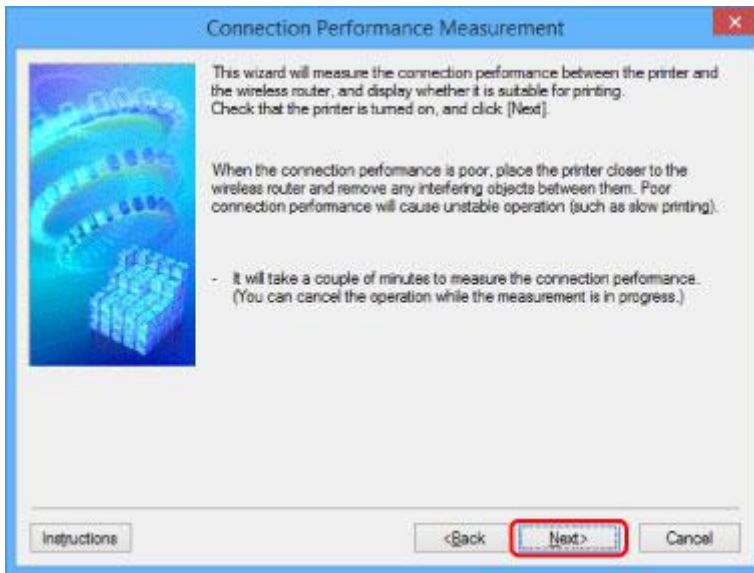

6. Check the status.

When the measurement is complete, the status is displayed.

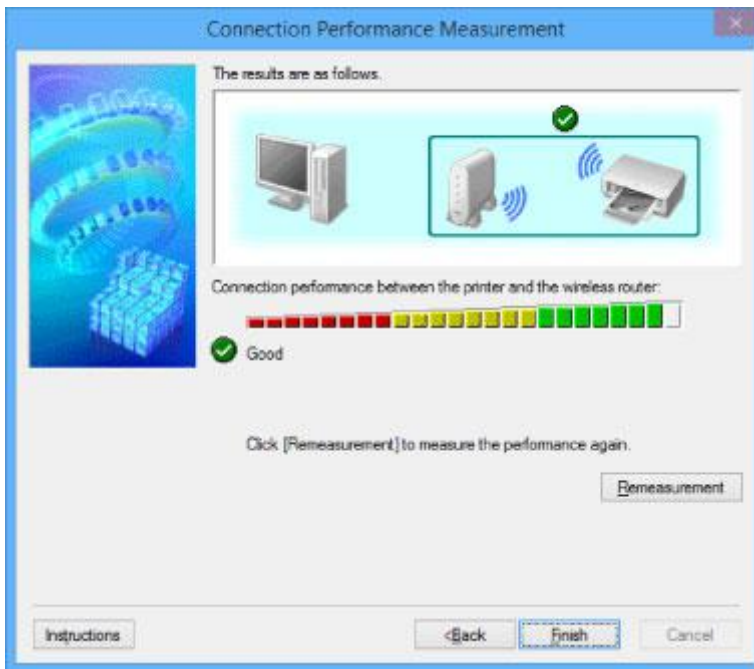

When  is displayed in **Connection Performance between the Printer and the Wireless Router**;, the printer can communicate with the wireless router. Otherwise, refer to displayed comments and the following to improve the status of communication link, and click **Remeasurement**.

- Check that the printer and the wireless router are located within the wireless connectivity range with no obstacles between them.
- Check if the distance between the printer and the wireless router is not too far.

If they are too far, move them closer together (within 164 ft. / 50 m).

- Check that there is no barrier or obstacle between the printer and the wireless router.

In general, connection performance decreases for communications through walls or between different floors. Adjust the locations to avoid such situations.

- Check that there are no sources of radio interference near the printer and the wireless router.

The wireless connection may use the same frequency band as microwave ovens and other sources of radio interference. Try to keep the printer and the wireless router away from such sources.

- Check if the radio channel of the wireless router is close to that of other wireless routers nearby.

If the radio channel of the wireless router is close to that of other wireless routers nearby, the connection performance may become unstable. Be sure to use a radio channel that does not interfere with other wireless routers.

- Check that the printer and the wireless router face each other.

Connection performance may depend on the orientations of the wireless devices. Replace the wireless router and the printer in another direction to achieve the best performance.

- Check whether other computers are not accessing the printer.

If  appears in the result of the measurement, check whether other computers are not accessing the printer.

If  still appears even if you have tried the above, finish the measurement, then restart the IJ Network Tool to start over the measurement.

7. Click **Finish**.

Note

- If any messages appear on **Overall Network Performance:**, move the machine and wireless router as instructed on the screen to improve the performance.

Initializing the Network Settings of the Machine

Important

- Note that initialization erases all network settings on the machine, and printing or scanning operation from a computer over network becomes impossible. To use the machine over network, perform setup with the Setup CD-ROM or perform setup according to the instructions on our website.

1. [Start up IJ Network Tool.](#)
2. Select the printer in **Printers:**.
3. Select **Maintenance...** on the **Settings** menu.
The **Maintenance** screen is displayed.
4. Click **Initialize**.

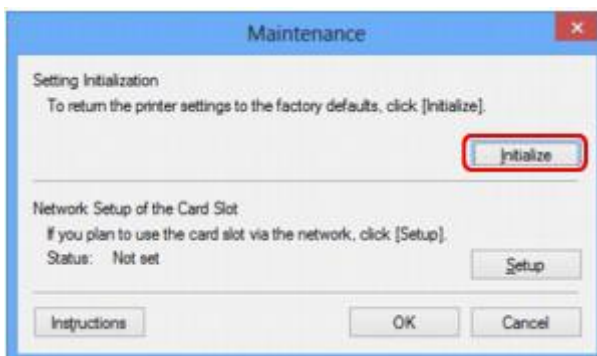

5. When the confirmation screen is displayed, click **Yes**.

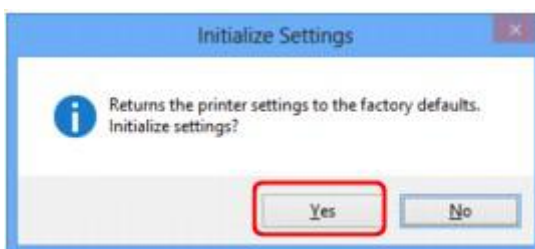

The network settings of the printer are initialized.

Do not turn off the printer during initialization.

Click **OK** when initialization is complete.

Performing initialization when connected over wireless LAN will break the connection, so perform setup with the Setup CD-ROM or perform setup according to the instructions on our website.

Note

- You can change the network settings of the printer using IJ Network Tool with USB connection after initializing the LAN settings. To change the network settings using Canon IJ Network Tool, enable wireless LAN in advance.

Viewing the Modified Settings

The **Confirmation** screen is displayed after you modified the printer settings on the **Configuration** screen. When you click **Yes** on the **Confirmation** screen, the following screen is displayed for confirming the modified settings.



Screens for Network Connection of IJ Network Tool

- ▶ **Canon IJ Network Tool Screen**
- ▶ **Configuration Screen**
- ▶ **Wireless LAN Sheet**
- ▶ **Search Screen**
- ▶ **WEP Details Screen**
- ▶ **WPA/WPA2 Details Screen**
- ▶ **Authentication Type Confirmation Screen**
- ▶ **PSK:Passphrase and Dynamic Encryption Setup Screen**
- ▶ **Setup Information Confirmation Screen**
- ▶ **Wired LAN Sheet**
- ▶ **Admin Password Sheet**
- ▶ **Network Information Screen**
- ▶ **Access Control Sheet**
- ▶ **Edit Accessible MAC Address Screen/Add Accessible MAC Address Screen**
- ▶ **Edit Accessible IP Address Screen/Add Accessible IP Address Screen**

Canon IJ Network Tool Screen

This section describes the items and menus displayed on the **Canon IJ Network Tool** screen.

■ Items on the Canon IJ Network Tool Screen

■ Canon IJ Network Tool Menus

Items on the Canon IJ Network Tool Screen

The following item is displayed on the **Canon IJ Network Tool** screen.

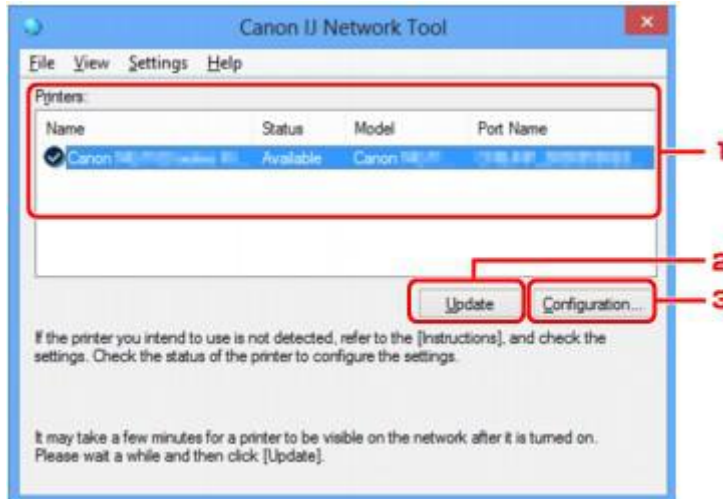

1. Printers:

The printer name, status, printer model name, and port name are displayed.

A check mark next to the printer in the **Name** list indicates it is set as the default printer.

Configuration changes are applied to the selected printer.

2. Update

Performs printer detection again. Click this button if the target printer is not displayed.

►► Important

- To change the printer's network settings using IJ Network Tool, it must be connected via a LAN.
- If **No Driver** is displayed for the name, associate the port with the printer.
 - [When the Printer Driver Is Not Associated with a Port](#)
- If **Not Found** is displayed for the status, check the followings:
 - The wireless router is turned on.
 - When using wired LAN, the LAN cable is connected properly.
- If the printer on a network is not detected, make sure that the printer is turned on, then click **Update**. It may take several minutes to detect printers. If the printer is not yet detected, connect the machine and the computer with a USB cable, then click **Update**.
- If the printer is being used from another computer, a screen is displayed informing you of this condition.

►►► Note

- This item has the same function as **Refresh** in the **View** menu.

3. Configuration...

Click to configure settings of the selected printer.

■ [Configuration Screen](#)

►►► Note

- You cannot configure a printer that has the status **Not Found**.
- This item has the same function as **Configuration...** in the **Settings** menu.

Canon IJ Network Tool Menus

The following menu is displayed from the **Canon IJ Network Tool** screen.

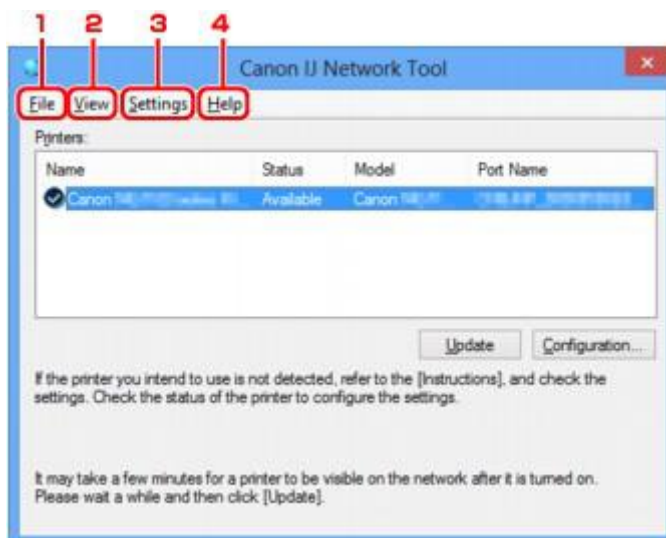

1. File menu

Exit

Exits IJ Network Tool.

2. View menu

Status

Displays the **Status** screen to confirm the printer connection status and wireless communication status.

In the access point mode, this item is grayed out and you cannot confirm the printer connection status.

■ [Status Screen](#)

Refresh

Updates and displays the contents of **Printers:** on the **Canon IJ Network Tool** screen to the latest information.

►►► Important

- To change the printer's network settings using IJ Network Tool, it must be connected via a LAN.

- If **No Driver** is displayed for the name, associate the port with the printer.
 ■■ [When the Printer Driver Is Not Associated with a Port](#)
- If **Not Found** is displayed for the status, check the followings:
 - The wireless router is turned on.
 - When using wired LAN, the LAN cable is connected properly.
- If the printer on a network is not detected, make sure that the printer is turned on, then select **Refresh**. It may take several minutes to detect printers. If the printer is not yet detected, connect the machine and the computer with a USB cable, then select **Refresh**.
- If the printer is being used from another computer, a screen is displayed informing you of this condition.

▶▶▶ Note

- This item has the same function as **Update** in the **Canon IJ Network Tool** screen.

Network Information

Displays the **Network Information** screen to confirm the network settings of the printer and the computer.

■■ [Network Information Screen](#)

Display Warning Automatically

Enables or disables automatic display of the instruction screen.

When this menu is selected, the instruction screen is displayed if one or more ports are unavailable for printing.

3. Settings menu

Configuration...

Displays the **Configuration** screen to configure settings of the selected printer.

■■ [Configuration Screen](#)

▶▶▶ Note

- This item has the same function as **Configuration...** in the **Canon IJ Network Tool** screen.

Enable switch printer function

When you cannot use your printer, you can use the same one on the network instead. When you enable this function and you cannot use your printer, the screen to confirm if you start searching the same printer as yours is displayed. Follow the message on the screen.

▶▶▶ Note

- When this function is enabled, a check mark appears on the menu.

Associate Port...

Displays the **Associate Port** screen and you can associate a port with the printer.

■■ [Associate Port Screen](#)

This menu is available when **No Driver** is displayed for the selected printer. Associating a port with the printer enables you to use it.

Maintenance...

Displays the **Maintenance** screen to return the network settings of the printer to factory default and to mount the card slot as the network drive.

■ [Maintenance Screen](#)

Set up printer's access point mode...

You can change the access point mode settings. Perform settings following the message on the screen.

If you change the **Encryption Method:** setting and the **Password:** setting on the **Set up printer's access point mode** screen, the changed settings are applied to the printer settings.

▶▶ Note

- You can use this function only when you are using a computer compatible with the wireless LAN.

4. Help menu

Instructions

Displays this guide.

About

Displays the version of IJ Network Tool.

Configuration Screen

You can change the configuration of the printer selected on the **Canon IJ Network Tool** screen.

Click the tab to select the sheet to change the settings.

The following screen is the example to change the setting on the **Wireless LAN** sheet.

▶▶▶ Note

- This screen is not available depending on the printer you are using.

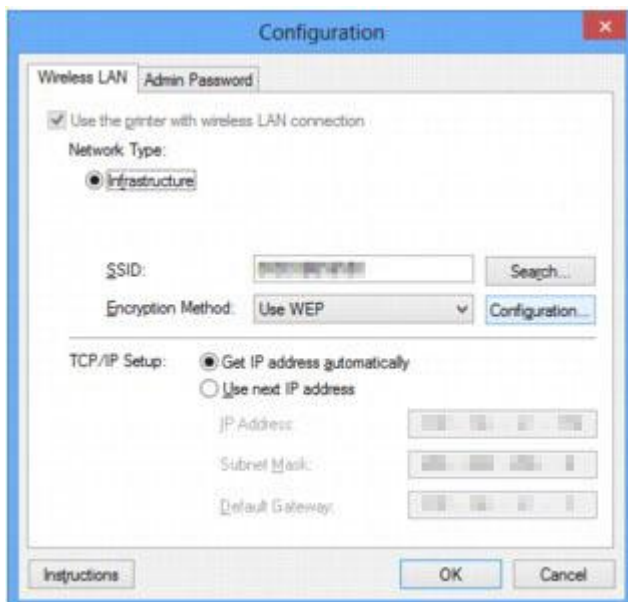

For details on each sheet, see the following.

■ [Wireless LAN Sheet](#)

■ [Wired LAN Sheet](#)

■ [Admin Password Sheet](#)

Wireless LAN Sheet

▶▶▶ Note

- This screen is not available depending on the printer you are using.

Allows you to set the printer with wireless LAN connection.

To display the **Wireless LAN** sheet, click the **Wireless LAN** tab on the **Configuration** screen.

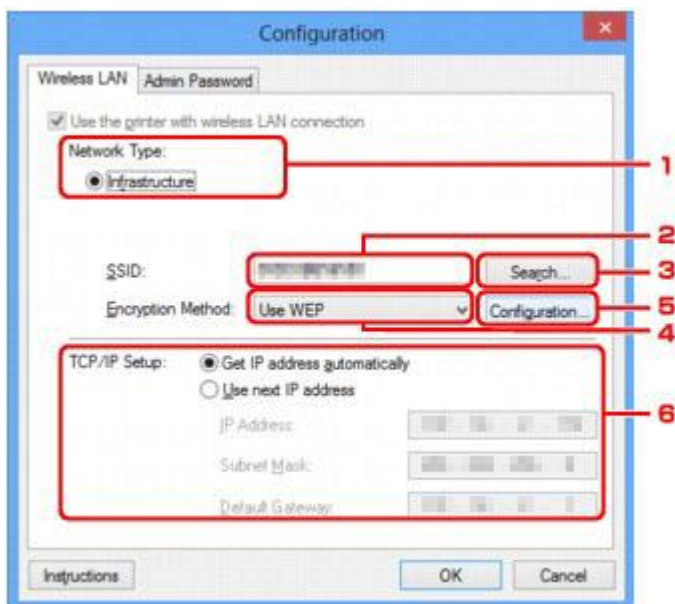

1. Network Type:

Displays the wireless LAN mode currently selected.

Infrastructure

Connects the printer to the wireless LAN with a wireless router.

Access point mode

Connects external wireless communication devices (e.g. computers, smartphones, or tablets) to the printer using it as an access point (wireless router).

▶▶▶ Note

- When **Access point mode** is displayed on **Network Type:**, you cannot change the settings on the **Wireless LAN** sheet or the **Admin Password** sheet.
- You can perform setting from **Set up printer's access point mode...** on the **Settings** menu when you use the printer with the access point mode.

Depending on the printer you are using, you can change the settings using the operation panel.

2. SSID:

The network name (SSID) of the wireless LAN currently used is displayed.

In the access point mode, the access point name (SSID) of the printer is displayed.

As the initial settings, the unique value is displayed.

▶▶▶ Note

- Enter the same SSID that the wireless router is configured to use. The SSID is case-sensitive.

3. Search...

The **Search** screen is displayed to select a wireless router to connect to.

■ [Search Screen](#)

▶▶▶ Note

- When IJ Network Tool runs over a LAN, the button is grayed out and cannot be selected. Connect the printer and the computer with a USB cable temporarily to change the settings.

4. Encryption Method:

Select the encryption method used over the wireless LAN.

Do not use

Select to disable encryption.

Use WEP

Transmission is encrypted using a WEP key you specified.

If a WEP key has not been set, the **WEP Details** screen is displayed automatically. To change WEP settings set before, click **Configuration...** to display the screen.

■ [Changing the WEP Detailed Settings](#)

Use WPA/WPA2

Transmission is encrypted using a WPA/WPA2 key you specified.

The security has been strengthened more than WEP.

If a WPA/WPA2 key has not been set, the **Authentication Type Confirmation** screen is displayed automatically. To change WPA/WPA2 settings set before, click **Configuration...** to display the **WPA/WPA2 Details** screen.

■ [Changing the WPA/WPA2 Detailed Settings](#)

5. Configuration...

The detailed settings screen is displayed. The WEP or the WPA/WPA2 key selected in **Encryption Method:** can be confirmed and changed.

For details on WEP setting:

■ [Changing the WEP Detailed Settings](#)

For details on WPA/WPA2 setting:

■ [Changing the WPA/WPA2 Detailed Settings](#)

6. TCP/IP Setup:

Sets the IP address of the printer to be used over the LAN. Specify a value appropriate for your network environment.

Get IP address automatically

Select this option to use an IP address automatically assigned by a DHCP server. DHCP server functionality must be enabled on your wireless router.

Use next IP address

Select this option if no DHCP server functionality is available in your setup where you use the printer, or you want to use a particular IP address or a fixed IP address.

Search Screen

▶▶▶ Note

- This screen is not available depending on the printer you are using.

The wireless routers detected are listed.

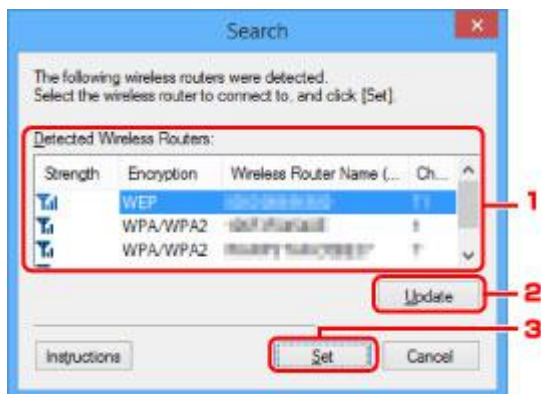

1. Detected Wireless Routers:

The signal strength from the wireless router, encryption type, name of wireless router, and the radio channel can be confirmed.

▶▶▶ Important

- If you connect to a network that is not protected with security measures, there is a risk of disclosing data such as your personal information to a third party.

▶▶▶ Note

- Signal strength is displayed as follows.

 : Good

 : Fair

 : Poor

- Type of encryption is displayed as follows.

Blank: No encryption

WEP: WEP is set

WPA/WPA2: WPA/WPA2 is set

2. Update

Click to update the list of wireless routers when your target wireless router is not detected.

If the target wireless router is set to the stealth mode, click **Cancel** to return to the previous screen and enter the wireless router's SSID in **SSID**: on the **Wireless LAN** sheet.

[Wireless LAN Sheet](#)

▶▶▶ Note

- When detecting your target wireless router, make sure that the wireless router is turned on.

3. Set

Click to set the wireless router's SSID in **SSID:** on the **Wireless LAN** sheet.

Note

- The **WPA/WPA2 Details** screen or the **WEP Details** screen appears if the selected wireless router is encrypted. In this case, configure the details to use the same encryption settings set to the wireless router.
- Wireless routers that cannot be used by this machine (including those configured to use different encryption methods) are displayed grayed out and cannot be configured.

WEP Details Screen

►►► Note

- This screen is not available depending on the printer you are using.

Specifies the printer WEP settings.

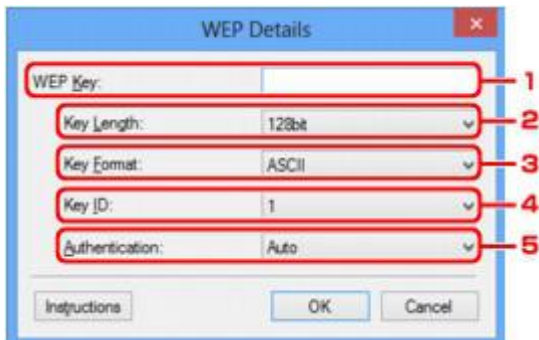

►►► Note

- When changing the password (WEP key) of the printer, the same change must be made to the password (WEP key) of the wireless router.

1. WEP Key:

Enter the same key as the one set to the wireless router.

The number of characters and character type that can be entered differ depending on the combination of the key length and key format.

		Key Length	
		64bit	128bit
Key Format	ASCII	5 characters	13 characters
	Hexadecimal (Hex)	10 digits	26 digits

2. Key Length:

Select either **64bit** or **128bit**.

3. Key Format:

Select either **ASCII** or **Hex**.

4. Key ID:

Select the Key ID (index) set to the wireless router.

5. Authentication:

Select the authentication method to authenticate the printer's access to the wireless router.

Select **Auto** or **Open System** or **Shared Key**.

WPA/WPA2 Details Screen

►► Note

- This screen is not available depending on the printer you are using.

Specify the printer WPA/WPA2 settings.

The value displayed on the screen differs depending on the present settings.

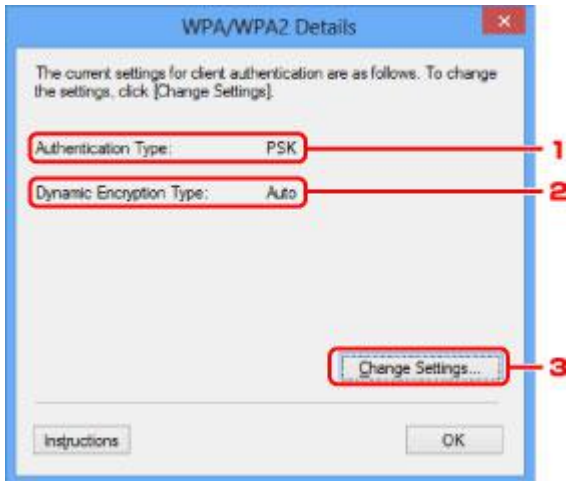

1. Authentication Type:

Displays the type of authentication used for client authentication. This machine supports the PSK authentication method.

2. Dynamic Encryption Type:

Displays the dynamic encryption method.

3. Change Settings...

Displays the **Authentication Type Confirmation** screen.

■ [Authentication Type Confirmation Screen](#)

Authentication Type Confirmation Screen

►► Note

- This screen is not available depending on the printer you are using.

Type of authentication used for client authentication is displayed.



1. Authentication Type

Type of authentication used for client authentication is displayed.

PSK

This machine supports the **PSK** authentication method.

This authentication type **PSK** uses a passphrase.

PSK:Passphrase and Dynamic Encryption Setup Screen

►► Note

- This screen is not available depending on the printer you are using.

Enter the passphrase and select the dynamic encryption method.

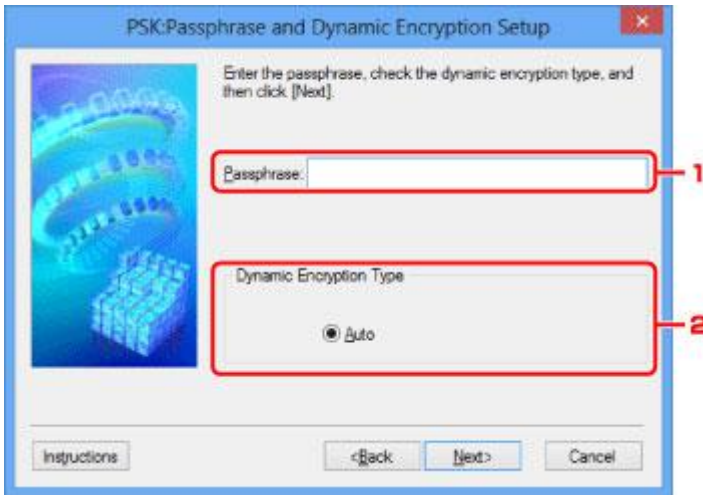

1. **Passphrase:**

Enter the passphrase set to the wireless router. The passphrase should be a string of 8 to 63 alphanumeric characters or a 64-digit hexadecimal value.

If you do not know the wireless router passphrase, refer to the instruction manual provided with the wireless router or contact its manufacturer.

2. **Dynamic Encryption Type**

The dynamic encryption method is selected from either TKIP (basic encryption) or AES (secure encryption) automatically.

Setup Information Confirmation Screen

»» Note

- This screen is not available depending on the printer you are using.

Displays the settings used for client authentication.

Confirm the settings and click **Finish**.

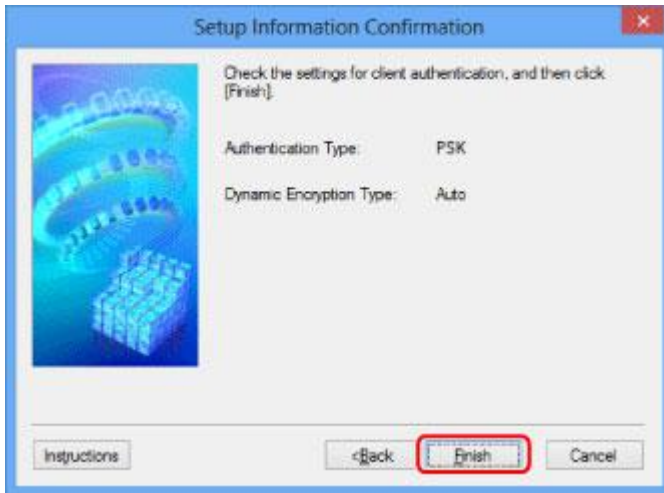

Wired LAN Sheet

▶▶▶ Note

- This screen is not available depending on the printer you are using.

Allows you to set the printer with wired LAN connection.

To display the **Wired LAN** sheet, click the **Wired LAN** tab on the **Configuration** screen.

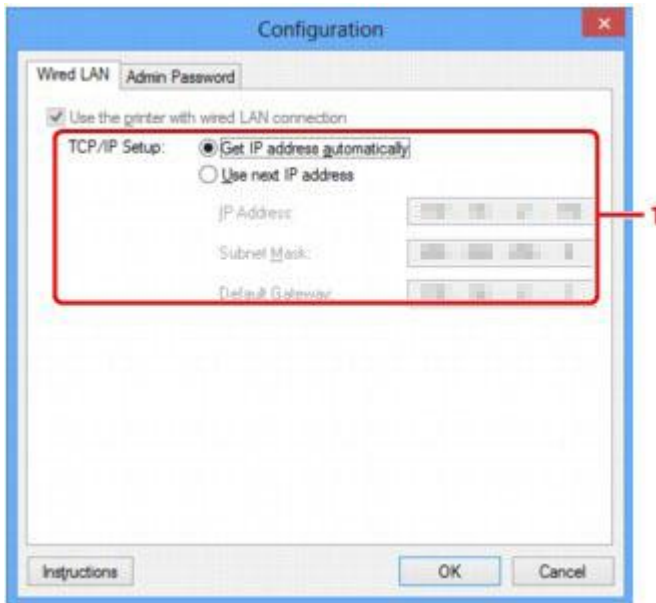

1. TCP/IP Setup:

Sets the IP address of the printer to be used over the LAN. Specify a value appropriate for your network environment.

Get IP address automatically

Select this option to use an IP address automatically assigned by a DHCP server. DHCP server functionality must be enabled on your router.

Use next IP address

Select this option if no DHCP server functionality is available in your setup where you use the printer, or you want to use a particular IP address or a fixed IP address.

Admin Password Sheet

Sets a password for the printer to allow specific people to perform setup and configurations operation.

To display the **Admin Password** sheet, click the **Admin Password** tab on the **Configuration** screen.

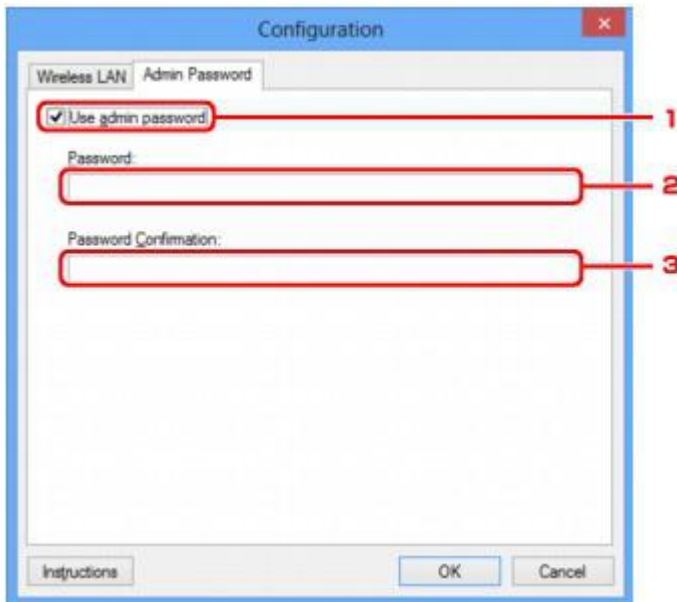

1. Use admin password

Sets an administrator password with privileges to set up and change detailed options. To use this feature, select this check box and enter a password.

2. Password:

Enter the password to set.

3. Password Confirmation:

Enter the password again for confirmation.

»» Important

- If you forget the administrator password you specified, initialize the printer to return the password to the default setting.

Network Information Screen

Displays the network information that is set for the printers and the computers.

To display the **Network Information** screen, select **Network Information** from the **View** menu.

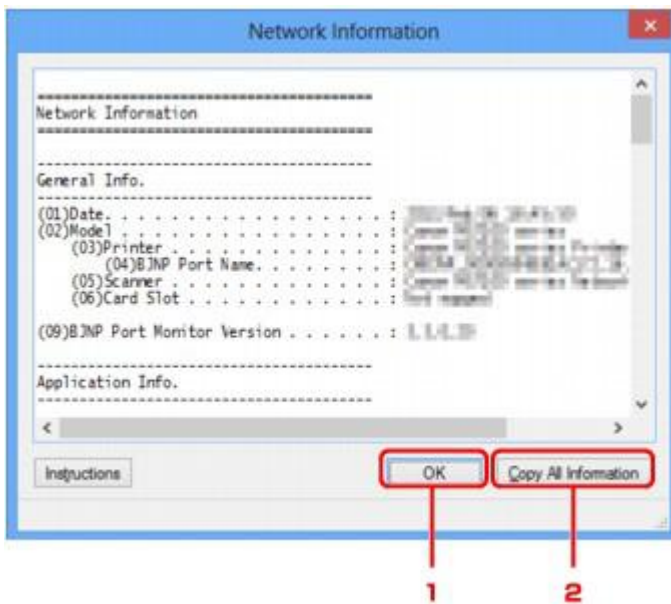

1. **OK**

Returns to the **Canon IJ Network Tool** screen.

2. **Copy All Information**

All network information displayed is copied to the clipboard.

Access Control Sheet

»» Note

- This screen is not available depending on the printer you are using.

You can register the MAC addresses or the IP addresses of computers or network devices to allow access.

To display the **Access Control** sheet, click the **Access Control** tab on the **Configuration** screen.

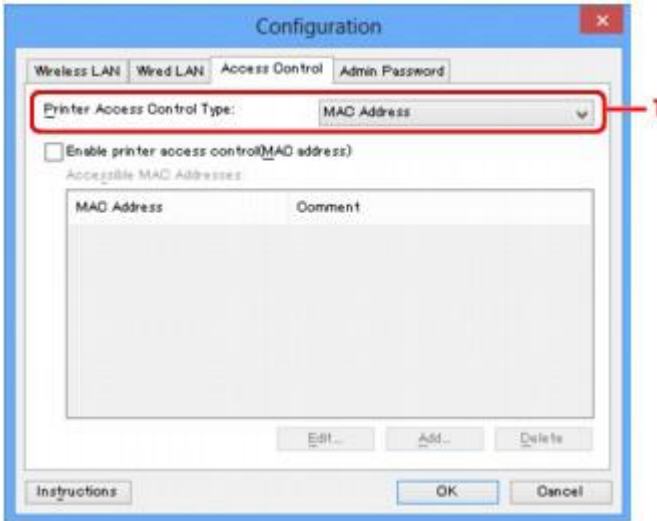

1. Printer Access Control Type:

Select the type of access control with which to limit access of computers or network devices to the printer over a network.

The setting items may differ depending on the choice of access control methods.

■ [When Selecting MAC address](#)

■ [When Selecting IP address](#)

When Selecting MAC address

The accessible computers or network devices are specified by their MAC addresses. Computers or network devices whose MAC addresses appear on the list are allowed access.

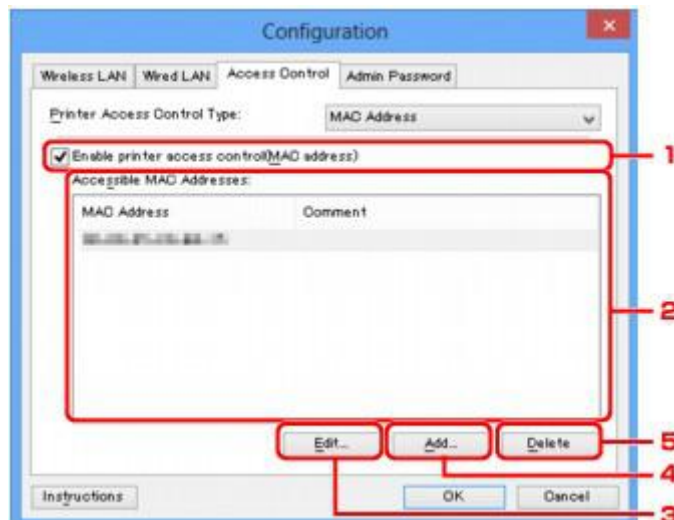

1. Enable printer access control(MAC address)

Select to enable access control to the printer by MAC address.

▶▶▶ Note

- The two types of access control (i.e., by MAC address and by IP address) can be enabled at the same time.
An access control type is enabled as long as the **Enable printer access control** check box is selected, regardless of the type currently displayed by selecting in **Printer Access Control Type**:
- When both access control types are enabled at the same time, a computer or a network device whose address is registered to either list will be allowed access to the printer.

2. Accessible MAC Addresses:

Shows the registered MAC addresses and any comments.

3. Edit...

The **Edit Accessible MAC Address** screen is displayed to edit the settings selected in **Accessible MAC Addresses**:

■ [Edit Accessible MAC Address Screen/Add Accessible MAC Address Screen](#)

4. Add...

The **Add Accessible MAC Address** screen is displayed to register the MAC address of a computer or a network device from which to access the printer over the network.

▶▶▶ Important

- Add the MAC address of all computers or network devices within the network from which to access the printer. The printer cannot be accessed from a computer or a network device that is not on the list.

5. Delete

Deletes the selected MAC address from the list.

When Selecting IP address

The accessible computers or network devices are specified by their IP addresses. Computers or network devices whose IP addresses appear on the list are allowed access.

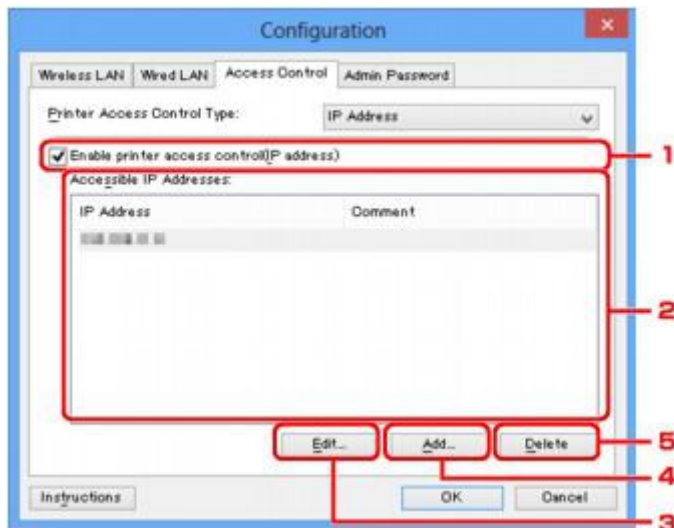

1. Enable printer access control(IP address)

Select to enable access control to the printer by IP address.

➤➤➤ Note

- The two types of access control (i.e., by MAC address and by IP address) can be enabled at the same time.
- An access control type is enabled as long as the **Enable printer access control** check box is selected, regardless of the type currently displayed by selecting in **Printer Access Control Type**:
- When both access control types are enabled at the same time, a computer or a network device whose address is registered to either list will be allowed access to the printer.

2. Accessible IP Addresses:

Shows the registered IP addresses and any comments.

3. Edit...

The **Edit Accessible IP Address** screen is displayed to edit the settings selected in **Accessible IP Addresses**:

[Edit Accessible IP Address Screen/Add Accessible IP Address Screen](#)

4. Add...

The **Add Accessible IP Address** screen is displayed to register the IP address of a computer or a network device from which to access the printer over the network.

➤➤➤ Important

- Add the IP address of all computers or network devices within the network from which to access the printer. The printer cannot be accessed from a computer or a network device that is not on the list.
- Up to 16 IP addresses can be registered. IP addresses specified by Range Specification are counted as one address. Use Range Specification when you intend to register 17 or more IP addresses.

5. Delete

Deletes the selected IP address from the list.

Edit Accessible MAC Address Screen/Add Accessible MAC Address Screen

»» Note

- This screen is not available depending on the printer you are using.

The example screenshots in this section refer to the **Add Accessible MAC Address** Screen.



1. **MAC Address:**

Enter the MAC address of a computer or a network device to allow access.

2. **Comment:**

Optionally enter any information to identify the device, such as the name of the computer.

»» Important

- Comments will be displayed only on the computer used to enter them.

Edit Accessible IP Address Screen/Add Accessible IP Address Screen

»» Note

- This screen is not available depending on the printer you are using.

The example screenshots in this section refer to the **Add Accessible IP Address** Screen.

1. Specification Method:

Select either **Single Address Specification** or **Range Specification** to add the IP address(es).

Single Address Specification

Specify each IP address separately.

Range Specification

Specify a range of successive IP addresses.

2. IP Address:

Enter the IP address of a computer or a network device to allow access when you selected **Single Address Specification** in **Specification Method**:

An IP address is expressed as four values ranging from 0 to 255.

Start IP Address:

Enter the first IP address in the range of addresses of the computers or network devices to allow access when you selected **Range Specification** in **Specification Method**:

An IP address is expressed as four values ranging from 0 to 255.

End IP Address:

Enter the last IP address in the range of addresses of the computers or network devices to allow access when you selected **Range Specification** in **Specification Method**:

An IP address is expressed as four values ranging from 0 to 255.

»» Note

- The **Start IP Address**: must be a smaller value than the **End IP Address**:

3. Comment:

Optionally enter any information to identify the device, such as the name of the computer.

»» Important

- Comments will be displayed only on the computer used to enter them.

Other Screens of IJ Network Tool

- ▶ **Canon IJ Network Tool Screen**
- ▶ **Status Screen**
- ▶ **Connection Performance Measurement Screen**
- ▶ **Maintenance Screen**
- ▶ **Network Setup of the Card Slot Screen**
- ▶ **Associate Port Screen**
- ▶ **Network Information Screen**

Canon IJ Network Tool Screen

This section describes the items and menus displayed on the **Canon IJ Network Tool** screen.

■ Items on the Canon IJ Network Tool Screen

■ Canon IJ Network Tool Menus

Items on the Canon IJ Network Tool Screen

The following item is displayed on the **Canon IJ Network Tool** screen.

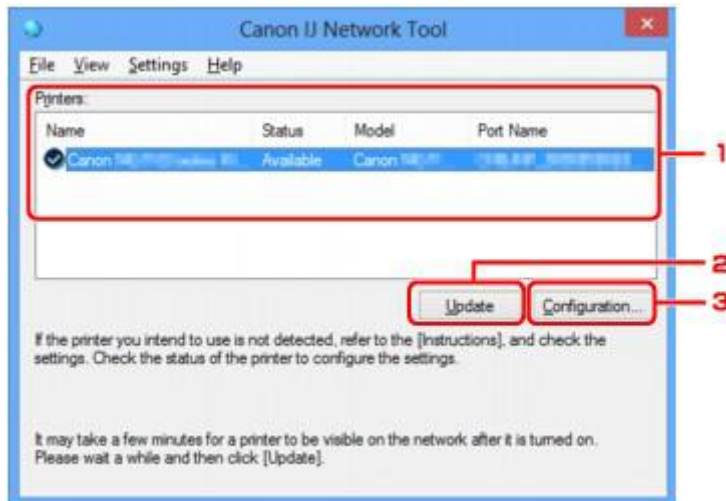

1. Printers:

The printer name, status, printer model name, and port name are displayed.

A check mark next to the printer in the **Name** list indicates it is set as the default printer.

Configuration changes are applied to the selected printer.

2. Update

Performs printer detection again. Click this button if the target printer is not displayed.

►► Important

- To change the printer's network settings using IJ Network Tool, it must be connected via a LAN.
- If **No Driver** is displayed for the name, associate the port with the printer.
 - [When the Printer Driver Is Not Associated with a Port](#)
- If **Not Found** is displayed for the status, check the followings:
 - The wireless router is turned on.
 - When using wired LAN, the LAN cable is connected properly.
- If the printer on a network is not detected, make sure that the printer is turned on, then click **Update**. It may take several minutes to detect printers. If the printer is not yet detected, connect the machine and the computer with a USB cable, then click **Update**.
- If the printer is being used from another computer, a screen is displayed informing you of this condition.

►►► Note

- This item has the same function as **Refresh** in the **View** menu.

3. Configuration...

Click to configure settings of the selected printer.

■ [Configuration Screen](#)

►►► Note

- You cannot configure a printer that has the status **Not Found**.
- This item has the same function as **Configuration...** in the **Settings** menu.

Canon IJ Network Tool Menus

The following menu is displayed from the **Canon IJ Network Tool** screen.

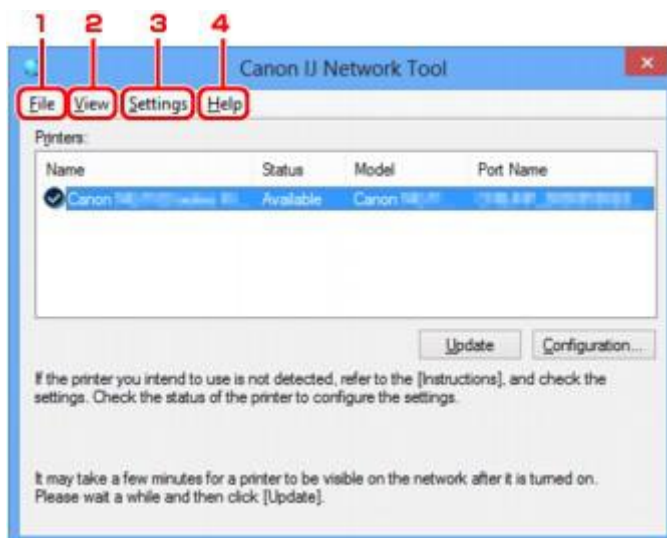

1. File menu

Exit

Exits IJ Network Tool.

2. View menu

Status

Displays the **Status** screen to confirm the printer connection status and wireless communication status.

In the access point mode, this item is grayed out and you cannot confirm the printer connection status.

■ [Status Screen](#)

Refresh

Updates and displays the contents of **Printers:** on the **Canon IJ Network Tool** screen to the latest information.

►►► Important

- To change the printer's network settings using IJ Network Tool, it must be connected via a LAN.

- If **No Driver** is displayed for the name, associate the port with the printer.
[■ ■ When the Printer Driver Is Not Associated with a Port](#)
- If **Not Found** is displayed for the status, check the followings:
 - The wireless router is turned on.
 - When using wired LAN, the LAN cable is connected properly.
- If the printer on a network is not detected, make sure that the printer is turned on, then select **Refresh**. It may take several minutes to detect printers. If the printer is not yet detected, connect the machine and the computer with a USB cable, then select **Refresh**.
- If the printer is being used from another computer, a screen is displayed informing you of this condition.

▶▶▶ Note

- This item has the same function as **Update** in the **Canon IJ Network Tool** screen.

Network Information

Displays the **Network Information** screen to confirm the network settings of the printer and the computer.

[■ ■ Network Information Screen](#)

Display Warning Automatically

Enables or disables automatic display of the instruction screen.

When this menu is selected, the instruction screen is displayed if one or more ports are unavailable for printing.

3. Settings menu

Configuration...

Displays the **Configuration** screen to configure settings of the selected printer.

[■ ■ Configuration Screen](#)

▶▶▶ Note

- This item has the same function as **Configuration...** in the **Canon IJ Network Tool** screen.

Enable switch printer function

When you cannot use your printer, you can use the same one on the network instead. When you enable this function and you cannot use your printer, the screen to confirm if you start searching the same printer as yours is displayed. Follow the message on the screen.

▶▶▶ Note

- When this function is enabled, a check mark appears on the menu.

Associate Port...

Displays the **Associate Port** screen and you can associate a port with the printer.

[■ ■ Associate Port Screen](#)

This menu is available when **No Driver** is displayed for the selected printer. Associating a port with the printer enables you to use it.

Maintenance...

Displays the **Maintenance** screen to return the network settings of the printer to factory default and to mount the card slot as the network drive.

■ [Maintenance Screen](#)

Set up printer's access point mode...

You can change the access point mode settings. Perform settings following the message on the screen.

If you change the **Encryption Method:** setting and the **Password:** setting on the **Set up printer's access point mode** screen, the changed settings are applied to the printer settings.

▶▶ Note

- You can use this function only when you are using a computer compatible with the wireless LAN.

4. Help menu

Instructions

Displays this guide.

About

Displays the version of IJ Network Tool.

Status Screen

You can check the printer status and connection performance.

To display the **Status** screen, select **Status** from the **View** menu.

►►► Note

- This screen is not available depending on the printer you are using.
- When using wired LAN, **Signal Strength:**, **Link Quality:** and **Advanced Measurement...** are not available.

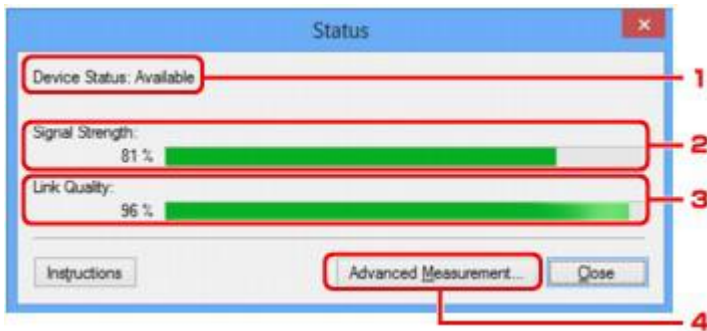

1. Device Status:

The device status is displayed as **Available** or **Unavailable**.

2. Signal Strength:

Indicates the strength of the signal received by the printer, ranging from 0% to 100%.

3. Link Quality:

Indicates the signal quality excluding the noise while communicating, ranging from 0% to 100%.

4. Advanced Measurement...

To examine the connection performance between the printer and the wireless router or between the printer and the computer.

When you click, the **Connection Performance Measurement** is displayed.

■ [Connection Performance Measurement Screen](#)

Connection Performance Measurement Screen

►►► Note

- This screen is not available depending on the printer you are using.

Displays to execute the connection performance measurement.

■ ■ [Connection Performance Measurement Screen \(Initial Screen\)](#)

■ ■ [Connection Performance Measurement Screen \(Completion Screen\)](#)

Connection Performance Measurement Screen (Initial Screen)

Click **Next>** to start measurement.

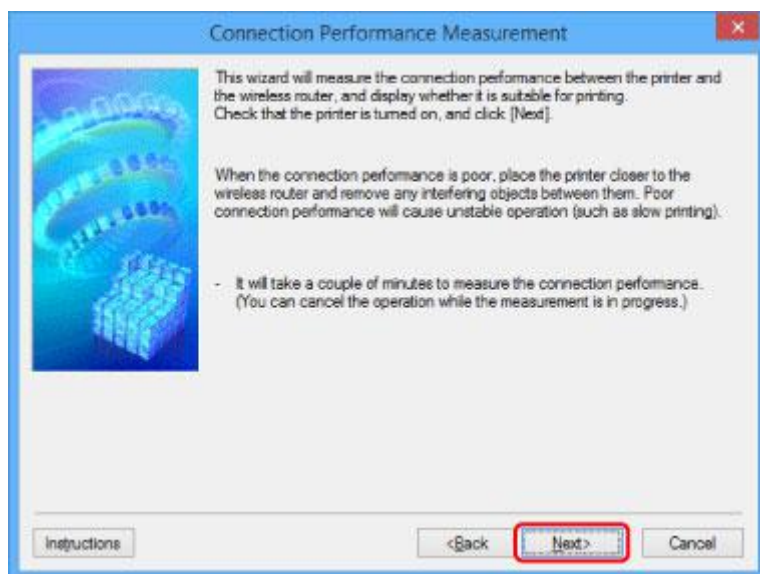

Connection Performance Measurement Screen (Completion Screen)

Displays when the measurement is finished.

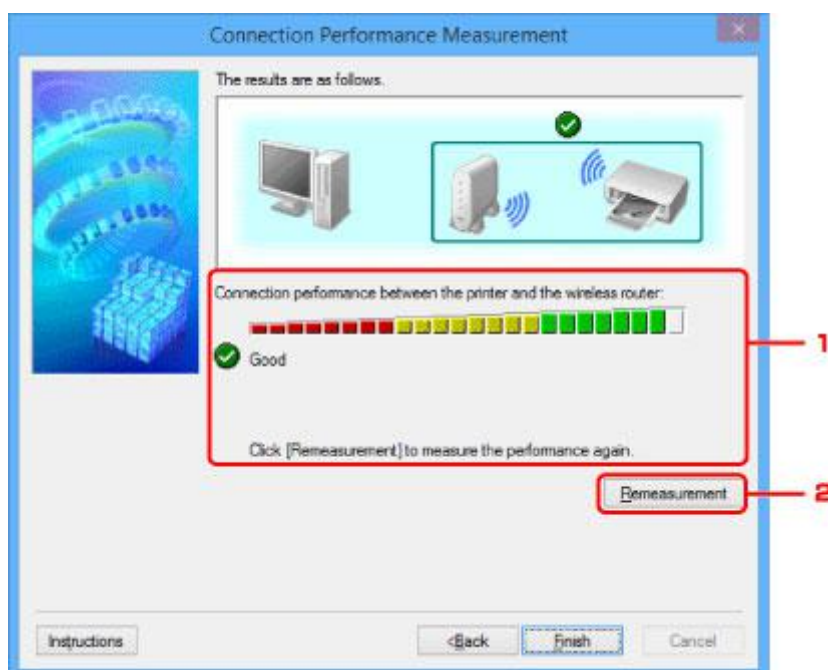



1. Connection Performance between the Printer and the Wireless Router:

A mark indicates the result of the connection performance measurement between the printer and the wireless router.

: Good connection performance

: Unstable connection performance

: Cannot connect

: Measurement is canceled, or cannot measure

2. Remeasurement

Measures the connection performance again.

Note

- If any messages appear on **Overall Network Performance**:, move the machine and wireless router as instructed to improve the performance.

Maintenance Screen

Displays to perform **Setting Initialization** and **Network Setup of the Card Slot**.

To display the **Maintenance** screen, select **Maintenance...** on the **Settings** menu.

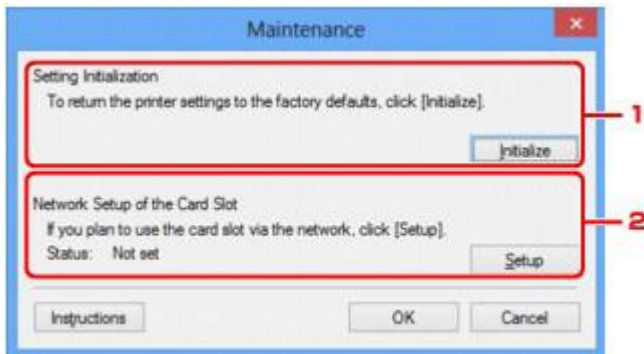

1. Setting Initialization

Returns all the network settings of the printer to factory default. Click **Initialize** to display the **Initialize Settings** screen and click **Yes** to initialize the network settings of the printer. Do not turn off the printer during initialization. Click **OK** when initialization is complete.

Performing initialization when connected over wireless LAN will break the connection, so perform setup with the Setup CD-ROM or perform setup according to the instructions on our website.

2. Network Setup of the Card Slot

▶▶▶ Note

- This item is not available depending on the printer you are using.

Status displays whether the card slot is mapped as a network drive.

When you click, the **Network Setup of the Card Slot** is displayed.

■ [Network Setup of the Card Slot Screen](#)

Network Setup of the Card Slot Screen

►► Note

- This function is not available depending on the printer you are using. To confirm whether this function is available with your printer, refer to [List of Function for Each Model](#).

Displays settings of the card slot and allows you to map a card slot on the network as a network drive on the computer.

Displays when you click **Setup** on the **Maintenance** screen.

■ [Network Setup of the Card Slot Screen \(Setup Screen\)](#)

■ [Network Setup of the Card Slot Screen \(Setup Failed Screen\)](#)

►► Note

- You can change the network settings of the printer using IJ Network Tool with USB connection after initializing the LAN settings. To change the network settings using IJ Network Tool, enable the LAN settings in advance.

Network Setup of the Card Slot Screen (Setup Screen)

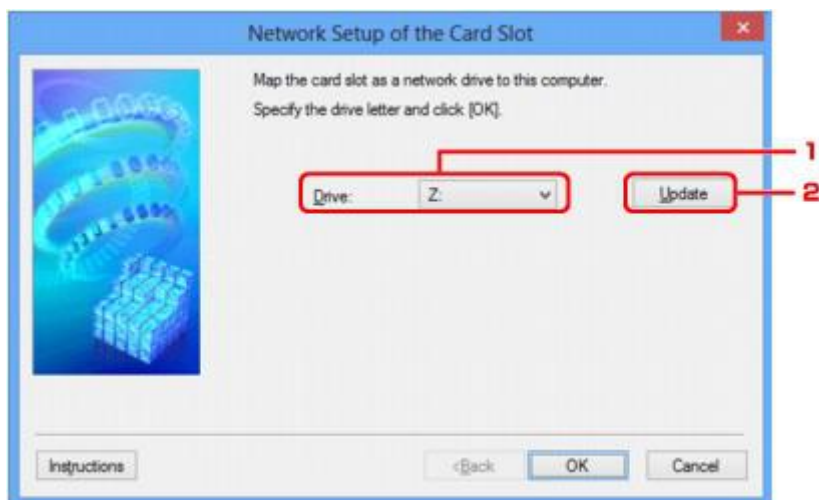

1. Drive:

Select the drive letter to assign to the network drive.

2. Update

Reloads the drive letters that are unassigned in **Computer (My Computer in Windows XP)** and displays them in the **Drive:** list.

Network Setup of the Card Slot Screen (Setup Failed Screen)

Displayed when the network setup of the card slot is failed.

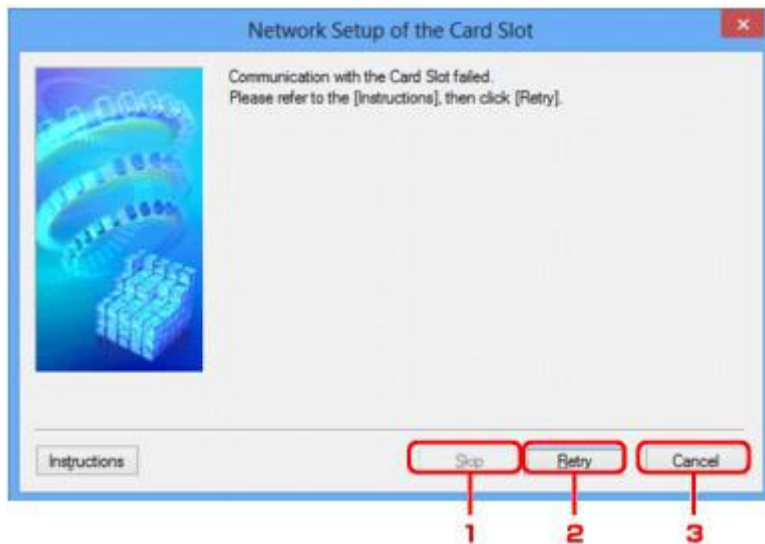

1. Skip

Completes the setup without mapping a network drive to the card slot.

2. Retry

Returns to **Network Setup of the Card Slot** screen and re-executes the network drive mapping.

3. Cancel

Cancels the card slot setup. When IJ Network Tool is running over LAN, the **Cancel** button is displayed grayed out and cannot be clicked.

Associate Port Screen

Allows you to associate a created port with a printer driver.

Select the printer for which you want to change the association, then click **OK**.

►►► Note

- You cannot print with the printer unless the printer driver is associated with the port.

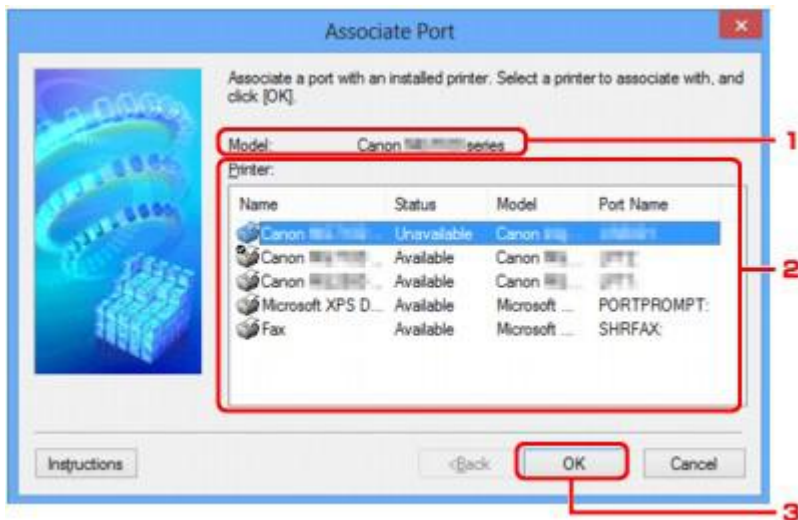

1. **Model:**

Displays the name of device specified as a destination port.

It is blank if the name of device is not detected.

2. **Printer:**

Displays the printer driver installed in the computer.

Select the printer for which you want to change the association.

3. **OK**

Performs association.

Network Information Screen

Displays the network information that is set for the printers and the computers.

To display the **Network Information** screen, select **Network Information** from the **View** menu.

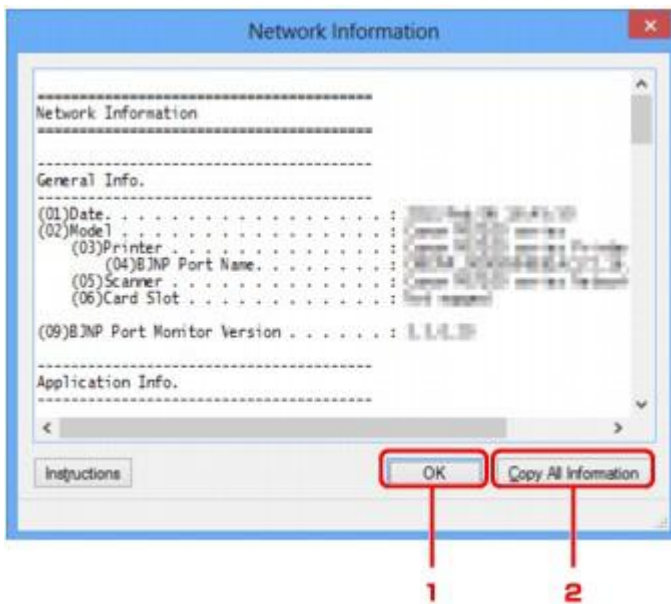

1. OK

Returns to the **Canon IJ Network Tool** screen.

2. Copy All Information

All network information displayed is copied to the clipboard.

Appendix for Network Communication

- **Using the Card Slot over a Network**
- **When the Printer Driver Is Not Associated with a Port**
- **About Technical Terms**
- **Restrictions**
- **About Firewall**

Using the Card Slot over a Network

▶▶▶ Note

- This function is not available depending on the printer you are using. To confirm whether this function is available with your printer, refer to [List of Function for Each Model](#).

■ ■ [Mounting the Card Slot as the Network Drive](#)

■ ■ [Restrictions on Card Slot Use over a Network](#)

Mounting the Card Slot as the Network Drive

The card slot must be mounted to use it over a network.

To mount the card slot as the network drive, follow the procedure below.

1. Insert a memory card into the card slot of the machine.
2. [Start up IJ Network Tool](#).
3. Select the machine in **Printers**:
4. Select **Maintenance...** on the **Settings** menu.
5. Click **Setup**.

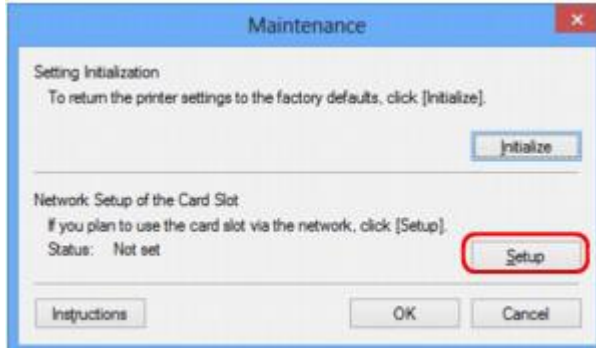

6. Specify the drive letter, then click **OK**.

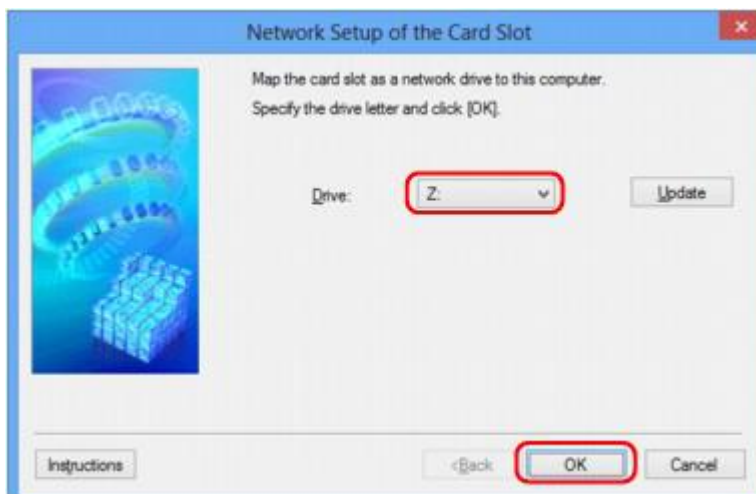

7. Make sure that the card slot is mounted.

When the card slot is mounted, the following icon appears on **Computer** (or **My Computer**).

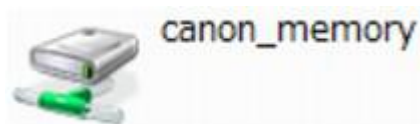

Restrictions on Card Slot Use over a Network

- The card slot can be shared by multiple computers, if the machine is connected to a network. Multiple computers can read files from a memory card in the card slot at the same time. However, while one computer is writing a file into a memory card, other computers cannot access the same file.
- If your computer joins a domain, the card slot may not be mounted as the network drive.
- If you use the memory card stored the large size files or many files, a large amount of card access may be generated. In this case, the operation in the memory card may be impossible or slow. Operate after the **Access** lamp of the machine is lit.

- When you access the network drive for the card slot over the network, file names consisting of eight or less lowercase letters (not including its extension) may be shown in uppercase.

For example, a file name such as "abcdefg.doc" will be "ABCDEFGG.DOC", while a name such as "AbcdeFG.doc" will appear the same.

The file is not actually renamed, but merely appears to be changed.

- When you enable a memory card in the card slot of the machine to be writable only from a USB-connected computer, you cannot access the network drive of the card slot. On the other hand, when you enable it to be writable only from a LAN-connected computer, the card slot is not detected via USB. Make sure that the card slot setting is selected properly according to your connection method.
To read files from a memory card via USB and over a network, disable the function to write files to a memory card from a computer. You cannot write files to a memory card in either way with this setting.
- When you enable a memory card in the card slot of the machine to be writable only from a LAN-connected computer, you can write files to a memory card from a computer connected to a network. Note that it may increase the risk that the data on the memory card is infected by computer viruses or accessed illegally.

We recommend to use the access control function of the machine or connect to the Internet via a router. For information on using a router, contact your Internet service provider or a network device manufacturer.

- If you write files to a memory card over a network when IJ Network Scanner Selector EX is not running, the Date Modified of the files may not be proper. Make sure to start up IJ Network Scanner Selector EX before you write files to a memory card over the network. For details, refer to "IJ Network Scanner Selector EX Menu and Setting Screen" from the HOME of your product's *Online Manual*.

When the Printer Driver Is Not Associated with a Port

If **No Driver** is displayed for the printer's name on the **Canon IJ Network Tool** screen, the printer driver is not associated with a created port.

To associate a port with a printer driver, follow the procedure below.

1. [Start up IJ Network Tool.](#)
2. Select the printer displayed as **No Driver** on **Name**.
3. Select **Associate Port...** on the **Settings** menu.

The **Associate Port** screen is displayed.

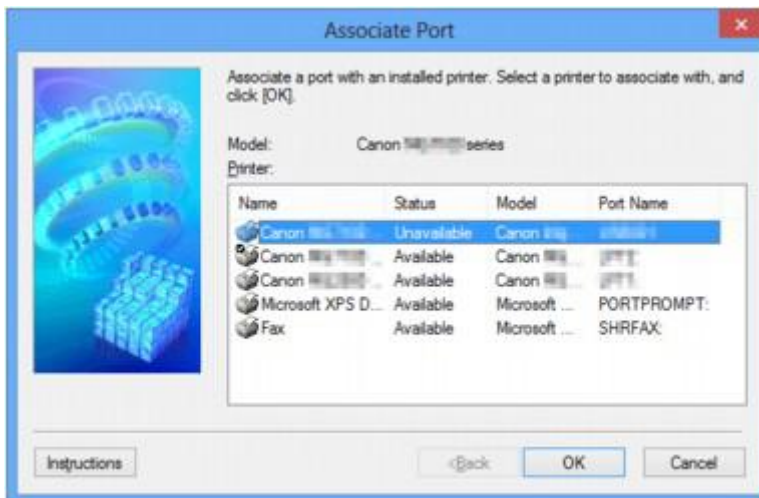

4. Select a printer to associate with a port.

The list of the printers that the printer driver is installed is displayed at **Printer:** on the **Associate Port** screen. Select a printer to associate with a created port.

5. Click **OK**.

About Technical Terms

In this section, technical terms used in the manual are explained.

[A](#)

[B](#)

[C](#)

[D](#)

[E](#)

[F](#)

[G](#)

[H](#)

[I](#)

[J](#)

[K](#)

[L](#)

[M](#)

[N](#)

[O](#)

[P](#)

[Q](#)

[R](#)

[S](#)

[T](#)

[U](#)

[V](#)

A

- **Access point mode**

The machine is used as a wireless router to connect external wireless communication devices (e.g. computers, smartphones, or tablets) in an environment where no wireless router is available. You can connect up to 5 devices to the machine using the access point mode.

- **Ad-hoc**

Client computer and machine setting where wireless communication occurs on a peer-to-peer basis, i.e., all clients in with the same SSID/network name communicate directly with each other. No wireless router is required. This machine does not support ad-hoc communication.

- **Admin Password**

Administrator password in IJ Network Tool to restrict access to network users. It must be entered to access the printer and change printer settings.

- **AES**

An encryption method. It is optional for WPA/WPA2. Strong cryptographic algorithm adopted within U.S. government organizations for information processing.

- **Authentication Method**

The method that a wireless router uses to authenticate a printer through a wireless LAN. The methods are agreeable each other.

When using WEP as an encryption method, the authentication method is able to fix to **Open System** or **Shared Key**.

For WPA/WPA2, authentication method is PSK.

- **Auto**

The printer automatically changes its authentication method to match the wireless router.

- **Open System**

In this authentication method, the communication partner is authenticated without using WEP key even if **Use WEP** is selected.

- **Shared Key**

In this authentication method, the communication partner is authenticated using the WEP key that was set for encryption.

B

- **Bonjour**

A service built into Mac OS X operating system to detect the connectable devices on a network automatically.

C

- **Channel**

Frequency channel for wireless communication. In the infrastructure mode, the channel is automatically adjusted to match that set to the wireless router. This machine supports channels 1 to 13. (Channels 12 and 13 are not supported depending on the country or region of purchase.) Note that the number of channels that can be used for your wireless LAN varies depending on the region or country.

D

- **Default Gateway**

A relay device to connect to another network such as a router or a computer.

- **DHCP server functionality**

The router assigns an IP address automatically whenever the printer or the personal computer on a network starts up.

- **DNS server**

A server that converts device names into IP addresses. When specifying IP addresses manually, specify the addresses of both a primary and a secondary server.

F

- **Firewall**

It is a system that prevents an unlawful computer access in the network. To prevent, you can use the firewall function of a broadband router, the security software installed in the computer, or operation system for computer.

I

- **IEEE 802.11b**

International standard for wireless LAN using the 2.4 GHz frequency range with a throughput of up to 11 Mbps.

- **IEEE 802.11g**

International standard for wireless LAN using the 2.4 GHz frequency range with a throughput of up to 54 Mbps. Compatible with 802.11b.

- **IEEE 802.11n**

International standard for wireless LAN using the 2.4 GHz and 5 GHz frequency ranges. Even when using two or more antennas simultaneously or obtaining a bigger transfer rate than before by using multiple communication channels at the same time, the transmission speed may be influenced by the connected apparatus.

At the maximum transfer rate of 600 Mbps, it is possible to communicate with multiple computer terminals within a dozen or so metre radius.

Compatible with 802.11b and 802.11g.

- **Infrastructure**

Client computer and machine setup where all wireless communications pass through a wireless router.

- **IP Address**

A unique number with four parts separated by dots. Every network device that is connected to the Internet has an IP address. Example: 192.168.0.1

An IP address is usually assigned by a wireless router or a DHCP server of the router automatically.

- **IPv4/IPv6**

They are internet-layer protocol used on the internet. IPv4 uses 32-bit addresses and IPv6 uses 128-bit addresses.

K

- **Key Format**

Select either **ASCII** or **Hex** as the WEP key format. The character that can be used for the WEP key differs depending on the selected key formats.

- ASCII

Specify with a 5 or 13-character string that can include alphanumeric and underscore "_" characters. It is case-sensitive.

- Hex

Specify a 10-digit or 26-digit string that can contain hexadecimal (0 to 9, A to F, and a to f).

- **Key Length**

Length of the WEP key. Select either 64 bits or 128 bits. Longer key length allows you to set a more complex WEP key.

L

- **Link Quality**

The status of the connection between the wireless router and the printer excluding noise (interference) is indicated with a value from 0 to 100%.

- **LPR**

A platform-independent printing protocol used in TCP/IP networks. It does not support bidirectional communication.

M

- **MAC Address**

Also known as the physical address. A unique and permanent hardware identifier that is assigned to network devices by its manufacturer. MAC addresses are 48 bits long and are written as a hexadecimal number separated by colons, i.e., 11:22:33:44:55:66.

O

- **Operation Status**

Indicates the status on whether the printer can be used.

P

- **Proxy server**

A server that links a LAN-connected computer to the Internet. When using a proxy server, specify the address and the port number of the proxy server.

- **PSK**

An encryption method employed by WPA/WPA2.

R

- **Router**

A relay device to connect to another network.

S

- **Signal Strength**

The strength of the signal received by the printer from the wireless router is indicated with a value from 0 to 100%.

- **SSID**

Unique label for wireless LAN. It is often represented such as a network name or a wireless router name.

SSID distinguishes one wireless LAN from another to prevent interference.

The printer and all clients on a wireless LAN must use the same SSID in order to communicate with each other. The SSID can be up to 32 characters long, and is made up of alphanumeric characters. The SSID may also be referred to by its network name.

- **Stealth**

In the stealth mode, a wireless router hides itself by not broadcasting its SSID. The client must specify the SSID set to the wireless router to detect it.

- **Subnet Mask**

IP address has two components, the network address and the host address. Subnet Mask used to calculate the Subnet Mask address from the IP address. A Subnet Mask is usually assigned by a wireless router or a DHCP server of the router automatically.

Example:

IP Address: 192.168.127.123

Subnet Mask: 255.255.255.0

Subnet Mask Address: 192.168.127.0

T

- **TCP/IP**

Suite of communications protocols used to connect hosts on the Internet or the LAN. This protocol allows different terminals to communicate with each other.

- **TKIP**

An encryption protocol employed by WPA/WPA2.

U

- **USB**

Serial interface designed to enable you to "hot-swap" devices, i.e., by plugging and unplugging them without turning off the power.

W

- **WCN (Windows Connect Now)**

Users running Windows Vista or later can obtain the setting information directly via wireless network (WCN-NET).

- **WEP/WEP Key**

An encryption method employed by IEEE 802.11. Shared security key used to encrypt and decrypt data sent over wireless networks. This printer supports key length of 64 bits or 128 bits, key format of ASCII code or Hexadecimal, and key number of 1 to 4.

- **Wi-Fi**

International association that certifies interoperability of wireless LAN products based on the IEEE 802.11 specification.

This machine is a Wi-Fi authorized product.

- **Wireless LAN**

A network that, instead of being connected by physical wires, is connected by a wireless technology, such as Wi-Fi.

- **Wireless Router**

A wireless transceiver or base station that receives information from wireless clients/the machine and rebroadcasts it. Required in an infrastructure network.

- **WPA**

Security framework announced by the Wi-Fi Alliance in October 2002. The security has been strengthened more than WEP.

- Authentication

WPA defines the following authentication methods: PSK that can be used without an authentication server, plus WPA-802.1x that do require an authentication server.

This machine supports WPA-PSK.

- Passphrase

This encrypted key is used to perform WPA-PSK authentication.

The passphrase should be a string of 8 to 63 alphanumeric characters or a 64-digit hexadecimal value.

- **WPA2**

Security framework released by the Wi-Fi Alliance in September 2004 as a later version of WPA. Provides a stronger encryption mechanism through Advanced Encryption Standard (AES).

- Authentication

WPA2 defines the following authentication methods: PSK that can be used without an authentication server, plus WPA2-802.1x that do require an authentication server.

This machine supports WPA2-PSK.

- Passphrase

This encrypted key is used to perform WPA2-PSK authentication.

The passphrase should be a string of 8 to 63 alphanumeric characters or a 64-digit hexadecimal value.

- **WPS (Wi-Fi Protected Setup)**

WPS is a standard for easy and secure establishment of a wireless network.

There are 2 primary methods used in the Wi-Fi Protected Setup:

PIN entry: a mandatory method of setup for all WPS certified devices

Push button configuration (PBC): an actual push button on the hardware or through a simulated push button in the software.

Restrictions

If you use a printer over the wireless LAN, the printer may recognize nearby wireless systems, you should set a network key (WEP or WPA/WPA2) to the wireless router to encrypt wireless transmission. Wireless communication with a product that does not comply with the Wi-Fi standard cannot be guaranteed.

Connecting with too many computers may affect the printer performance, such as printing speed.

About Firewall

A firewall is a function of the security software installed in the computer or operation system for computer, and is a system that is designed to prevent unauthorized access to a network.

Precautions When a Firewall Function is Enabled

- A firewall function may limit communications between a printer and a computer. This may disable printer setup and communications.
- During the printer setup, you may be prompted to enable or disable communications, depending on the firewall function of the security software or operation system. If so, choose to enable communications.
- When using IJ Network Tool, you may be prompted to enable or disable communications, depending on the firewall function of the security software. If so, choose to enable communications.
- If you cannot set up the printer, temporarily disable the firewall function of the security software or operation system.

▶▶▶ Important

- If you disabled the firewall function, disconnect your network from the Internet.
- Some applications (like the network configuration software) override firewall settings. Check the application's settings beforehand.
- If the printer you use is set to **Get IP address automatically**, the IP address changes every time the printer connects to the network. This may disable printer setup and communications, depending on the firewall settings. In this case, either change the firewall settings or assign a fixed IP address to the printer. An IP address can be set using IJ Network Tool.

■ [Changing the Settings in the Wireless LAN Sheet](#)

■ [Changing the Settings in the Wired LAN Sheet](#)

When assigning a fixed IP address to the printer, you will need to specify an IP address with which the computer can communicate.

▶▶▶ Note

- For the operation system firewall settings or the security software firewall settings, refer to the instruction manual of the computer or software, or contact its manufacturer.

Tips for Ensuring Optimal Printing Quality

- ▶ **Useful Information about Ink**
- ▶ **Key Points to Successful Printing**
- ▶ **Be Sure to Check Paper Settings before Printing**
- ▶ **Be Sure to Set Cassette Paper Information after Loading Paper**
- ▶ **Canceling a Print Job**
- ▶ **Storing Printed Images**
- ▶ **Key to Enjoying Consistent Printing Quality**
- ▶ **Precautions for Safe Transport of the Machine**

Useful Information about Ink

How is ink used for various purposes other than printing?

Ink may be used for purposes other than printing. Ink is not only used for printing, but also for cleaning the print head to maintain the optimal printing quality.

The machine has the function to automatically clean the ink jet nozzles to prevent clogging. In the cleaning procedure, used ink for nozzle cleaning is limited to a small amount.

Does black-and-white printing use color ink?

Black-and-white printing may use ink other than black ink depending on the type of printing paper or the settings of the printer driver. So, color ink is consumed even when printing in black-and-white.

Key Points to Successful Printing

Check the machine status before printing!

- Is the print head OK?

If a print head nozzle is clogged, print will be faint and papers will be wasted. Print the nozzle check pattern to check the print head.

■ [Maintenance Procedure](#)

- Is the inside of the machine smeared with ink?

After printing large quantities of paper or performing borderless printing, the area where papers go through may get smeared with ink. Clean the inside of your machine with [Bottom Plate Cleaning](#).

Check how to load the paper correctly!

- Is the paper loaded in the correct orientation?

To load paper in the cassette, load paper WITH THE PRINTING SIDE FACING DOWN.

■ [Loading Paper](#)



- Is the paper curled?

The curled paper causes paper jam. Flatten the curled paper, then reload it.

■ "Load the paper after correcting its curl." in [Paper Is Smudged/Printed Surface Is Scratched](#)

Be Sure to Check Paper Settings before Printing

Before printing, make paper settings in the operation panel or the computer screen.

There are various types of paper, such as paper with a special surface coating for printing photos at optimal quality and paper suitable for documents.

Each media type has specific preset settings (how ink is used and sprayed, distance from nozzles, etc.), that allow you to print to that type with optimal image quality. The wrong paper settings may cause poor printout color quality or scratches on the printed surface.

If you notice blurring or uneven colors, increase the print quality setting and try printing again.

Be Sure to Set Cassette Paper Information after Loading Paper

When you insert a cassette into the machine after loading paper, the screen for setting the type and size of paper is displayed. Set the cassette paper information according to the type and size of loaded paper.

To prevent incorrect printing, this machine has a function that detects whether the information set for the paper loaded in the cassette matches the paper settings. Before printing, make paper settings in accordance with the cassette paper information. When this function is enabled, an error message is displayed if these settings do not match to prevent incorrect printing. When this error message is displayed, check and correct the paper settings.

To check cassette paper information, display the paper information screen on the operation panel.

Canceling a Print Job

Never press the ON button!

If you press the **ON** button while printing is in progress, the print data sent from the computer queues in the machine and you may not be able to continue to print.

Press the **Stop** button to cancel printing.

Storing Printed Images

Store printed images in albums, clear photo sleeves, or glass frames to protect them from direct exposure to air.



►► Note

- Storing printed images without sufficient drying may cause blurring or discoloration.

Key to Enjoying Consistent Printing Quality

The key to printing with the optimal printing quality is to prevent the print head from drying or clogging. Always observe the following rules for optimal printing quality.

▶▶▶ Note

- Depending on the type of paper, ink may blur if you trace the printed area with a highlight pen or paint-stick, or bleed if water or sweat comes in contact with the printed area.

Never unplug the power cord until the power is turned off!

If you press the **ON** button to turn off the power, the machine caps the print head (nozzles) automatically to prevent from drying. If you unplug the power cord from the wall outlet before the **POWER** lamp is turned off, the print head will not be capped properly and this will cause drying or clogging.

When [unplugging the power cord](#), make sure that the **POWER** lamp is not lit.

▶▶▶ Important

- If the power cord is unplugged, the date/time settings will be reset and all documents stored in the machine's memory will be lost. Send or print a necessary document before unplugging the power cord.

Print periodically!

Just as the tip of a felt pen becomes dry and unusable if it has not been used for a long time, even if it is capped, the print head too, may become dried or clogged if the machine has not been used for a long time. We recommend you to use the machine at least once a month.

Precautions for Safe Transport of the Machine

When relocating the machine, make sure of the following.

▶▶▶ Important

- Pack the machine in a sturdy box so that it is placed with its bottom facing down, using sufficient protective material to ensure safe transport.
- With the FINE cartridge left installed in the machine, press the **ON** button to turn off the power. This allows the machine to automatically cap the print head, thus preventing it from drying.
- After packing, do not tilt the box containing the machine or turn it on its side or upside down. Doing so may cause the ink to leak during transport and cause damage to the machine.
- When a shipping agent is handling transport of the machine, have its box marked "THIS SIDE UP" to keep the machine with its bottom facing down. Mark also with "FRAGILE" or "HANDLE WITH CARE".

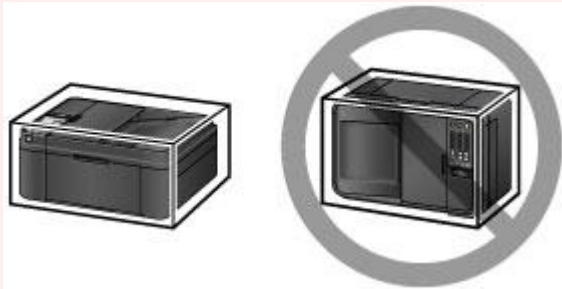

1. Turn the machine off.
2. Confirm that the **POWER** lamp is off and [unplug the power cord](#).

▶▶▶ Important

- Do not unplug the machine while the **POWER** lamp is lit or flashing, as it may cause malfunction or damage to the machine, making the machine unable to print.

3. Retract the paper output support with the output tray extension closed.
4. Close the front cover.
5. Unplug the printer cable from the computer and from the machine, then unplug the power cord from the machine.
6. Use adhesive tape to secure all the covers on the machine to keep them from opening during transportation. Then pack the machine in the plastic bag.
7. Attach the protective material to the machine when packing the machine in the box.

▶▶▶ Important

- We recommend to hold and carry out this machine as shown in the figure below. If you hold the front cover or the cassette, it may fall out of the machine.



Legal Limitations on Use of Your Product and Use of Images

It may be unlawful to make copies of, scan, print, or use reproductions of the following documents.

The list provided is non-exhaustive. When in doubt, check with a legal representative in your jurisdiction.

- Paper money
- Money orders
- Certificates of deposit
- Postage stamps (canceled or uncanceled)
- Identifying badges or insignias
- Selective service or draft papers
- Checks or drafts issued by governmental agencies
- Motor vehicle licenses and certificates of title
- Traveler's checks
- Food stamps
- Passports
- Immigration papers
- Internal revenue stamps (canceled or uncanceled)
- Bonds or other certificates of indebtedness
- Stock certificates
- Copyrighted works/works of art without permission of copyright owner

Specifications

General Specifications

Printing resolution (dpi)	4800* (horizontal) x 1200 (vertical) * Ink droplets can be placed with a pitch of 1/4800 inch at minimum.
Interface	USB Port: Hi-Speed USB *1 LAN Port: Wireless LAN: IEEE802.11n / IEEE802.11g / IEEE802.11b *2 *1 A computer that complies with Hi-Speed USB standard is required. Since the Hi-Speed USB interface is fully upwardly compatible with USB 1.1, it can be used at USB 1.1. *2 Setup possible through Standard setup, WPS (Wi-Fi Protected Setup), WCN (Windows Connect Now) or Cableless setup. USB and LAN can be used at the same time.
Print width	8 inches/203.2 mm (for Borderless Printing: 8.5 inches/216 mm)
Operating environment	Temperature: 41 to 95 °F (5 to 35 °C) Humidity: 10 to 90 % RH (no condensation) * The performance of the printer may be reduced under certain temperature and humidity conditions. Recommended conditions: Temperature: 59 to 86 °F (15 to 30 °C) Humidity: 10 to 80 % RH (no condensation) * For the temperature and humidity conditions of papers such as photo paper, refer to the paper's packaging or the supplied instructions.
Storage environment	Temperature: 32 to 104 °F (0 to 40 °C) Humidity: 5 to 95 % RH (no condensation)
Power supply	AC 100-240 V, 50/60 Hz
Power consumption	Printing (Copy): Approx. 7 W Standby (minimum): Approx. 0.9 W *1*2 OFF: Approx. 0.3 W *1 *1 USB connection to PC *2 The wait time for standby cannot be changed.
External dimensions	Approx. 17.2 (W) x 11.7 (D) x 7.5 (H) inches Approx. 435 (W) x 295 (D) x 189 (H) mm * With the Front Cover retracted.
Weight	Approx. 13.0 lb (Approx. 5.9 kg) * With the FINE Cartridges installed.
Canon FINE Cartridge	Total 1280 nozzles (BK 320 nozzles, C/M/Y each 320 nozzles)

ADF capacity	<p>A4 or Letter size: max. 20 sheets (20 lb/75 g /m² paper), up to 0.08 inch/2 mm in height</p> <p>Legal size: max. 5 sheets (20 lb/75 g /m² paper), up to 0.02 inch/0.5 mm in height</p>
---------------------	---

Copy Specifications

Multiple copy	max. 99 pages
Intensity adjustment	9 positions, Auto intensity (AE copy)
Reduction / Enlargement	25 % - 400 % (1 % unit)

Scan Specifications

Scanner driver	<p>Windows: TWAIN 1.9 Specification, WIA</p> <p>Mac OS: ICA</p>
Maximum scanning size	<p>Platen Glass: A4/Letter, 8.5" x 11.7"/216 x 297 mm</p> <p>ADF: A4/Letter/Legal, 8.5" x 14.0"/216 x 356 mm</p>
Scanning resolution	<p>Optical resolution (horizontal x vertical) max: 600 x 1200 dpi *1</p> <p>Interpolated resolution max: 19200 x 19200 dpi *2</p> <p>*1 Optical Resolution represents the maximum sampling rate based on ISO 14473.</p> <p>*2 Increasing the scanning resolution will limit the maximum possible scanning area.</p>
Gradation (Input / Output)	<p>Gray: 16 bit/8 bit</p> <p>Color: 48 bit/24 bit (RGB each 16 bit/8 bit)</p>

Fax Specifications

Applicable line	Public Switched Telephone Network (PSTN)
Communication mode	Super G3, G3
Data compressing system	<p>Black: MH, MR, MMR</p> <p>Color: JPEG</p>
Modem speed	<p>max. 33.6 kbps</p> <p>(Automatic fallback)</p>
Transmission speed	<p>Black: Approx. 3 seconds/page at 33.6 kbps (Based on ITU-T No.1 chart for US specifications and Canon FAX Standard chart No.1 for others, both in standard mode.)</p> <p>Color: Approx. 1 minute/page at 33.6 kbps (Based on Canon COLOR FAX TEST SHEET.)</p>
Gradation	<p>Black: 256 levels</p> <p>Color: 24 bit Full Color (RGB each 8 bit)</p>

Density adjustment	3 levels
Memory	Transmission/reception: approx. 50 pages (Based on ITU-T No.1 chart for US specifications and Canon FAX Standard chart No.1 for others, both in standard mode.)
Fax resolution	Black Standard: 203 pels/inch x 98 lines/inch (8 pels/mm x 3.85 lines/mm) Black Fine, Photo: 203 pels/inch x 196 lines/inch (8 pels/mm x 7.70 lines/mm) Black Extra fine: 300 x 300 dpi Color: 200 x 200 dpi
Dialing	Automatic dialing - Recipient (max. 20 destinations) - Group dial (max. 19 destinations) Regular dialing (with Numeric buttons) Automatic redialing Manual redialing (max. 10 destinations)
Others	Activity report (after every 20 transactions) Sequential broadcasting (max. 21 destinations) Rejected numbers (max. 10 destinations)

Network Specifications

Communication protocol	TCP/IP
Wireless LAN	Supported Standards: IEEE802.11n / IEEE802.11g / IEEE802.11b Frequency bandwidth: 2.4 GHz Channel: 1-11 or 1-13 * Frequency bandwidth and available channels differ depending on country or region. Communication distance: Indoors 164 feet/50 m * Effective range varies depending on the installation environment and location. Security: WEP (64/128 bits) WPA-PSK (TKIP/AES) WPA2-PSK (TKIP/AES) Setup: Standard setup WPS (Push button configuration/PIN code method) WCN (WCN-NET) Cableless setup Other Features: Administration password

Minimum System Requirements

Conform to the operating system's requirements when higher than those given here.

Windows

Operating System	Windows 8.1*, Windows 8 Windows 7, Windows 7 SP1 Windows Vista SP1, Windows Vista SP2 Windows XP SP3 32-bit only * Windows 8.1 includes Windows 8.1 Update.
Browser	Internet Explorer 8 or later
Hard Disk Space	3 GB Note: For bundled software installation. The necessary amount of hard disk space may be changed without notice.
Display	XGA 1024 x 768

Mac OS

Operating System	Mac OS X v10.7.5 or later
Browser	Safari 5 or later
Hard Disk Space	1.5 GB Note: For bundled software installation. The necessary amount of hard disk space may be changed without notice.
Display	XGA 1024 x 768

Other Supported OS

Some functions may not be available with each OS. Refer to the Canon web site for details on operation with iOS, Android, and Windows RT.

Mobile Printing Capability

Apple AirPrint
Google Cloud Print
PIXMA Cloud Link

- An internet connection is required to use all the *Online Manual*.
- Windows: Operation can only be guaranteed on a computer with Windows 8.1, Windows 8, Windows 7, Windows Vista or Windows XP pre-installed.
- Windows: A CD-ROM Drive or internet connection is required during software installation.
- Windows: Internet Explorer 8, 9, 10 or 11 is required to install Easy-WebPrint EX.
- Windows: Some functions may not be available with Windows Media Center.
- Windows: .NET Framework 4 or 4.5 must be installed to use the Windows software.
- Windows: XPS Essentials Pack is required to print on Windows XP.
- Windows: The TWAIN driver (ScanGear) is based on the TWAIN 1.9 Specification and requires the Data Source Manager bundled with the operating system.
- Mac OS: Hard Disk must be formatted as Mac OS Extended (Journaled) or Mac OS Extended.
- Mac OS: For Mac OS, an internet connection is required during software installation.

- In an in-house network environment, the 5222 port must be open. Contact the network administrator for details.

Information in this guide is subject to change without notice.

About the Administrator Password

An administrator password "canon" is already specified for the printer at the time of purchase.

»» Important

- For security reasons, it is recommended to change the password before you use the printer.
- You can change the password using one of the tools below. (Some tools may not be available depending on the printer you are using.)
 - operation panel of the printer
 - IJ Network Tool
 - printer information screen displayed on some Canon application software
- When you change the password, use 0 to 32 alphanumeric characters.
- If the password has been changed while you are sharing the printer and you do not know the password, ask the administrator of the printer you are using.
- The password reverts to the default setting by initializing the printer settings.

List of Function for Each Model

- [MG series](#)
- [MX series](#)
- [MB series](#)
- [E series](#)
- [P series](#)
- [iP series](#)
- [iX series](#)
- [iB series](#)
- [PRO series](#)

MG series

Model name	Card slot
MG7530F	✓
MG7500	✓
MG7100	✓
MG6730	✓
MG6600	✓
MG6500	✓
MG6400	✓
MG5600	–
MG5500	–
MG3500	–
MG2900	–
MG2500	–
MG2400	–

MX series

Model name	Card slot
MX920	–
MX720	–
MX530	–
MX520	–
MX490	–
MX470	–
MX450	–
MX390	–

MB series

Model name	Card slot
MB5300	–
MB5000	–
MB2300	–
MB2000	–

E series

Model name	Card slot
E610	–
E560	–
E480	–
E460	–
E400	–

P series

Model name	Card slot
P200	–

iP series

Model name	Card slot
iP8700	–
iP2800	–
iP110	–

iX series

Model name	Card slot
iX6800	–
iX6700	–

iB series

Model name	Card slot
iB4000	–

PRO series

Model name	Card slot
PRO-100S	–

PRO-10S	-
---------	---

Printing

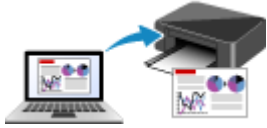

Printing from a Computer



Printing Using the Operation Panel of the Machine



Paper setting for Printing

Printing from a Computer

- ▶ **Printing with Application Software that You are Using (Printer Driver)**

Printing with Application Software that You are Using (Printer Driver)

- ▶ **Printing with Easy Setup** 📌 **Basic**
- ▶ **Various Printing Methods**
- ▶ **Changing the Print Quality and Correcting Image Data**
- ▶ **Overview of the Printer Driver**
- ▶ **Printer Driver Description**
- ▶ **Updating the MP Drivers**

Printing with Easy Setup

This section describes the simple procedure for setting the [Quick Setup tab](#) so that you can carry out appropriate printing on this printer.

1. [Check that the printer is turned on](#)
2. [Load paper](#) on the printer
3. Open the [printer driver setup window](#)
4. Select a frequently used profile

In **Commonly Used Settings** on the **Quick Setup** tab, select a printing profile suited for the purpose. When you select a printing profile, the **Additional Features**, **Media Type**, and **Printer Paper Size** settings are automatically switched to the values that were preset.

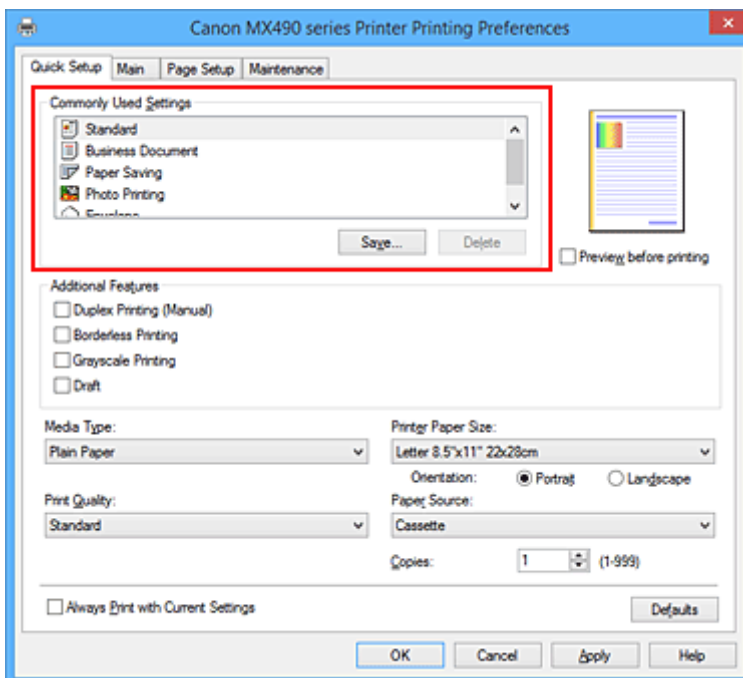

5. Select the print quality

For **Print Quality**, select **High**, **Standard**, or **Draft** according to your purpose.

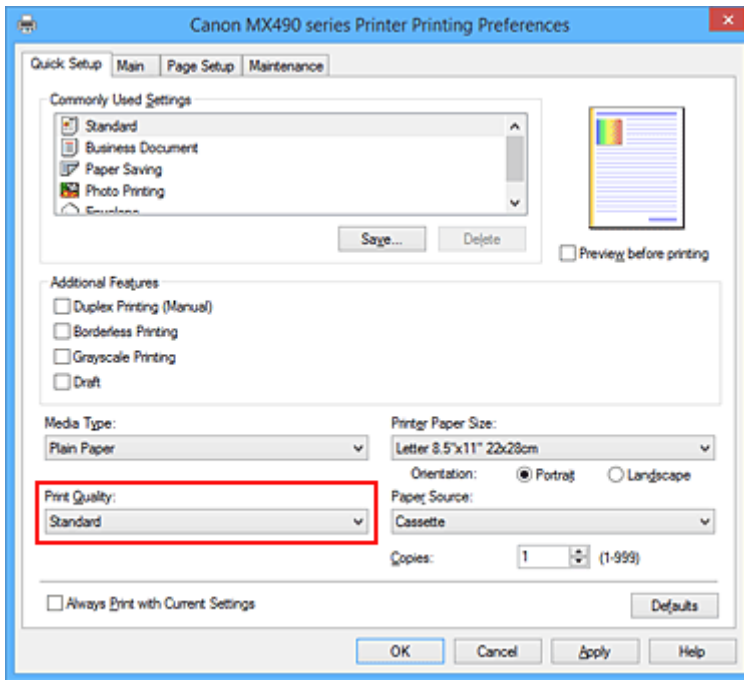

►►► Important

- The print quality settings that can be selected may differ depending on a printing profile.

6. Complete the setup

Click **OK**.

When you execute print, the document is printed with settings that match your purpose.

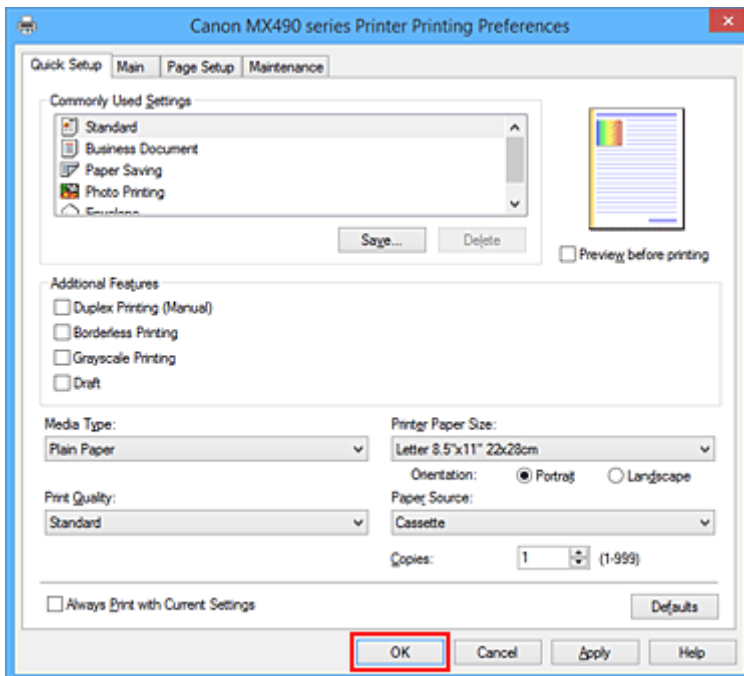

►►► Important

- When you select the **Always Print with Current Settings** check box, all settings specified on the **Quick Setup**, **Main**, and **Page Setup** tabs are saved, and you can print with the same settings from the next time as well.
- In the **Commonly Used Settings** window, click **Save...** to [register the specified settings](#).

»» Note

- If the paper settings on the printer driver differ from the cassette paper information registered on the printer, an error may occur. For instructions on what to do if an error occurs, see "[Paper setting for Printing.](#)"

For details about the cassette paper information to be registered on the printer, see the following:

- [Paper Settings on the Printer Driver and the Printer \(Media Type\)](#)
- [Paper Settings on the Printer Driver and the Printer \(Paper Size\)](#)

Paper Settings on the Printer Driver and the Printer (Media Type)

When you use this printer, selecting a media type and [paper size](#) that matches the print purpose will help you achieve the best print results.

You can use the following media types on this printer.

Commercially available papers

Media name	Media Type in the printer driver	Cassette paper information registered on the printer
Plain Paper (including recycled paper)	Plain Paper	Plain paper
Envelopes	Envelope	Envelope
Other Photo Paper	Other Photo Paper	Other Photo

Canon genuine papers (Photo Printing)

Media name <Model No.>	Media Type in the printer driver	Cassette paper information registered on the printer
Photo Paper Plus Glossy II <PP-201>	Photo Paper Plus Glossy II	PlusGlossyII
Photo Paper Pro Platinum <PT-101>	Photo Paper Pro Platinum	ProPlatinum
Photo Paper Pro Luster <LU-101>	Photo Paper Pro Luster	Pro Luster
Photo Paper Plus Semi-gloss <SG-201>	Photo Paper Plus Semi-gloss	Semi-gloss
Photo Paper Glossy <GP-501/GP-601>	Glossy Photo Paper	Glossy
Matte Photo Paper <MP-101>	Matte Photo Paper	Matte

Canon genuine papers (Business Letter Printing)

Media name <Model No.>	Media Type in the printer driver	Cassette paper information registered on the printer
High Resolution Paper <HR-101N>	High Resolution Paper	High Res

Paper Settings on the Printer Driver and the Printer (Paper Size)

When you use this printer, selecting a paper size that matches the print purpose will help you achieve the best print results.

You can use the following paper sizes on this printer.

Printer Paper Size in the printer driver	Cassette paper information registered on the printer
Letter 8.5"x11" 22x28cm	Letter
Legal 8.5"x14" 22x36cm	Legal
A5	A5
A4	A4
B5	B5
4"x6" 10x15cm	KG/4"x6"
5"x7" 13x18cm	2L/5"x7"
8"x10" 20x25cm	8"x10"
Envelope Com 10	Env. Com 10
Envelope DL	Envelope DL
Custom Size	Others

Various Printing Methods

- ▶ **Setting a Page Size and Orientation**
- ▶ **Setting the Number of Copies and Printing Order**
- ▶ **Setting the Stapling Margin**
- ▶ **Execute Borderless Printing**
- ▶ **Fit-to-Page Printing**
- ▶ **Scaled Printing**
- ▶ **Page Layout Printing**
- ▶ **Tiling/Poster Printing**
- ▶ **Booklet Printing**
- ▶ **Duplex Printing**
- ▶ **Stamp/Background Printing**
- ▶ **Registering a Stamp**
- ▶ **Registering Image Data to be Used as a Background**
- ▶ **Setting Up Envelope Printing**
- ▶ **Displaying the Print Results before Printing**
- ▶ **Setting Paper Dimensions (Custom Size)**
- ▶ **Editing the Print Document or Reprinting from the Print History**

Setting a Page Size and Orientation

The paper size and orientation are essentially determined by the application software. When the page size and orientation set for **Page Size** and **Orientation** on the **Page Setup** tab are same as those set with the application software, you do not need to select them on the **Page Setup** tab.

When you are not able to specify them with the application software, the procedure for selecting a page size and orientation is as follows:

You can also set page size and orientation on the **Quick Setup** tab.

1. Open the [printer driver setup window](#)
2. Select the paper size

Select a page size from the **Page Size** list on the **Page Setup** tab.

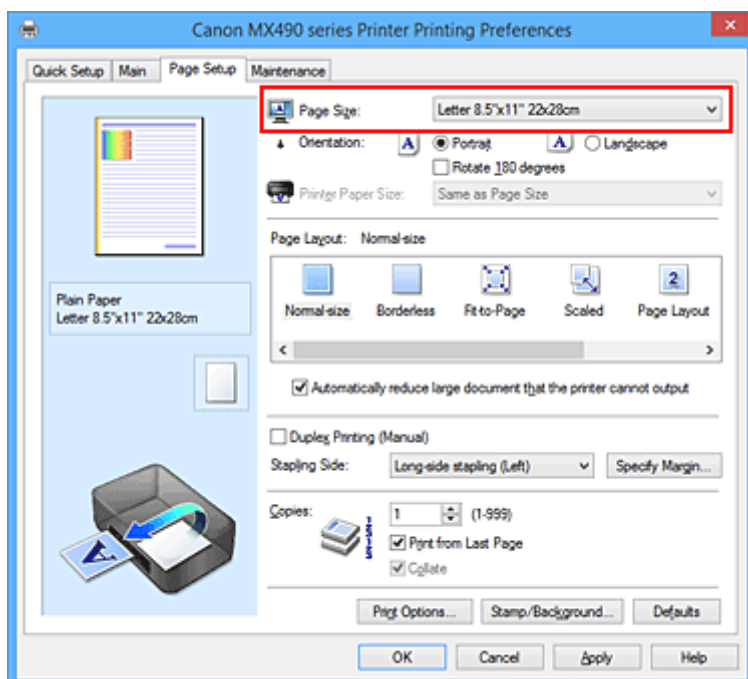

3. Set **Orientation**

Select **Portrait** or **Landscape** for **Orientation**. Check **Rotate 180 degrees** check box when you want to perform printing with the original being rotated 180 degrees.

4. Complete the setup

Click **OK**.

When you execute print, the document will be printed with the selected page size and the orientation.

▶▶▶ Note

- If **Normal-size** is selected for **Page Layout**, then **Automatically reduce large document that the printer cannot output** is displayed. Normally, you can leave the check box checked. During printing, if you do not want to reduce large documents that cannot be printed on the printer, uncheck the check box.

Setting the Number of Copies and Printing Order

The procedure for specifying the number of copies and printing order is as follows:
You can also set the number of copies on the **Quick Setup** tab.

1. Open the [printer driver setup window](#)
2. Specify the number of copies to be printed

For **Copies** on the **Page Setup** tab, specify the number of copies to be printed.

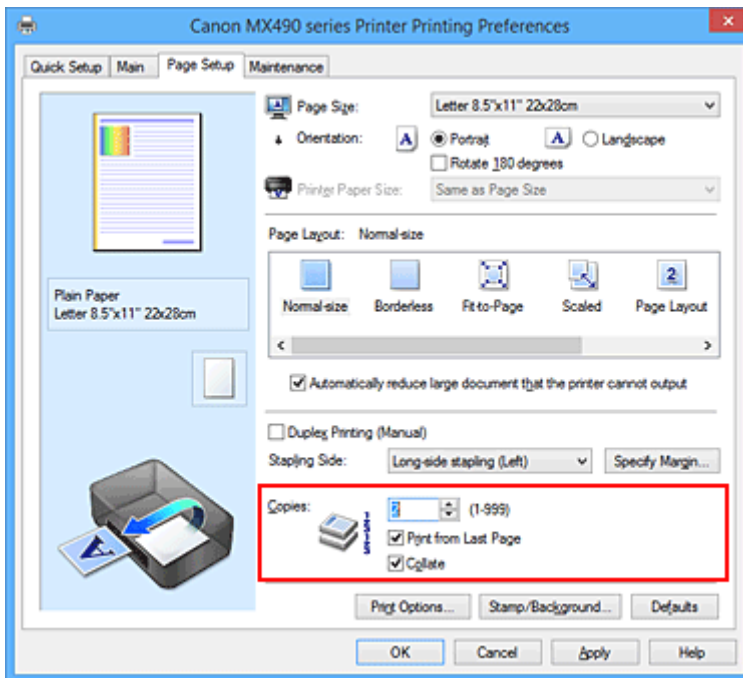

3. Specify the print order

Check the **Print from Last Page** check box when you want to print from the last page in order, and uncheck the check box when you want to print from the first page.

Check the **Collate** check box when you are printing multiple copies of a document and want to print out all pages in each copy together. Uncheck this check box when you want to print all pages with the same page number together.

- **Print from Last Page:** / **Collate:**

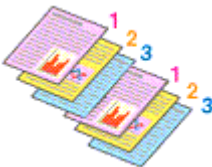

- **Print from Last Page:** / **Collate:**

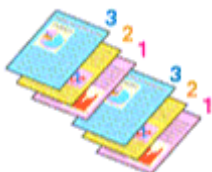

- **Print from Last Page:** / **Collate:**

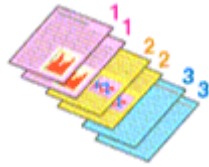

- **Print from Last Page:** / **Collate:**

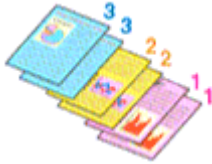

4. Complete the setup

Click **OK**.

When you execute print, the specified number of copies will be printed with the specified printing order.

»» Important

- When the application software that you used to create the document has the same function, specify the settings on the printer driver. However, if the print results are not acceptable, specify the function settings on the application software. When you specify the number of copies and the printing order with both the application software and this printer driver, the number of copies may be multiplied numbers of the two settings or the specified printing order may not be enabled.
- **Print from Last Page** appears grayed out and is unavailable when **Tiling/Poster** is selected for **Page Layout**.
- When **Booklet** is selected for **Page Layout**, **Print from Last Page** and **Collate** appear grayed out and cannot be set.
- When **Duplex Printing (Manual)** is selected, **Print from Last Page** appears grayed out and cannot be set.

»» Note

- By setting both **Print from Last Page** and **Collate**, you can perform printing so that papers are collated one by one starting from the last page.
These settings can be used in combination with **Normal-size**, **Borderless**, **Fit-to-Page**, **Scaled**, and **Page Layout**.

Setting the Stapling Margin

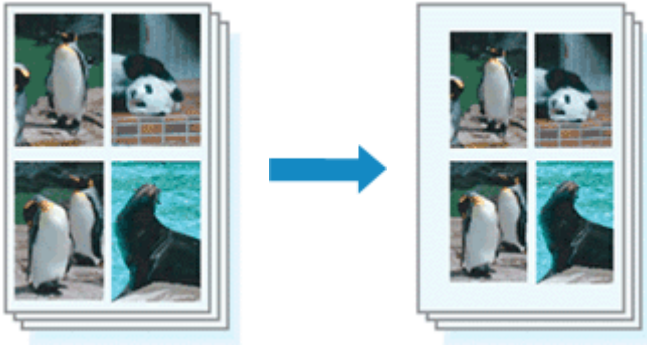

The procedure for setting the staple side and the margin width is as follows:

1. Open the [printer driver setup window](#)
2. Specify the side to be stapled

Check the position of the stapling margin from **Stapling Side** on the **Page Setup** tab.

The printer analyzes the **Orientation** and **Page Layout** settings, and automatically selects the best staple position. When you want to change the setting, select from the list.

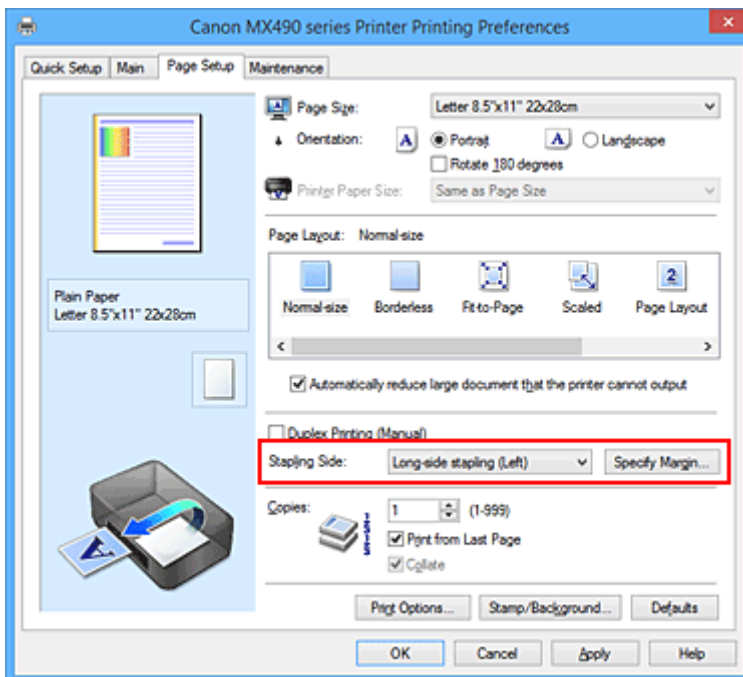

3. Set the margin width

If necessary, click **Specify Margin...** and set the margin width, and then click **OK**.

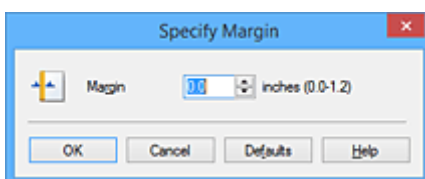

»» Note

- The printer automatically reduces the print area depending on the staple position margin.

4. Complete the setup

Click **OK** on the **Page Setup** tab.

When you execute print, the data is printed with the specified staple side and margin width.

»» Important

- **Stapling Side** and **Specify Margin...** appear grayed out and are unavailable when:
 - **Borderless, Tiling/Poster, or Booklet** is selected for **Page Layout**
 - **Scaled** is selected for **Page Layout** (When **Duplex Printing (Manual)** is also selected, only **Stapling Side** can be specified.)

Execute Borderless Printing

The borderless printing function allows you to print data without any margin by enlarging the data so that it extends slightly off the paper. In standard printing, margins are created around the document area. However, in borderless printing function, these margins are not created. When you want to print data such as a photo without providing any margin around it, set borderless printing.

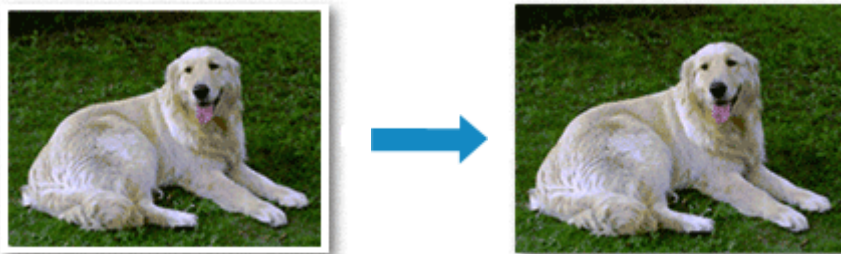

The procedure for performing borderless printing is as follows:

You can also set borderless printing in **Additional Features** on the **Quick Setup** tab.

Setting Borderless Printing

1. Open the [printer driver setup window](#)
2. Set borderless printing

Select **Borderless** from the **Page Layout** list on the **Page Setup** tab.

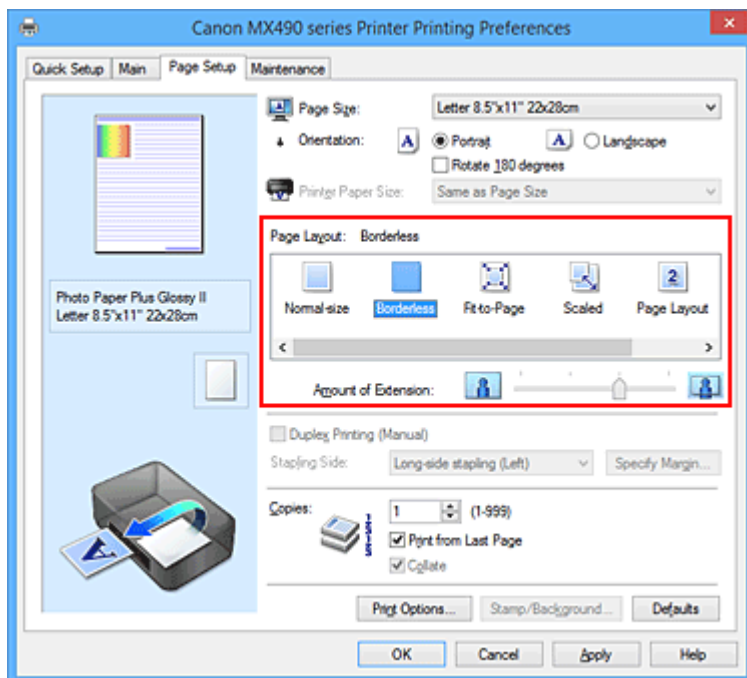

Click **OK** when the confirmation message appears.

When a message prompting you to change the media type appears, select a media type from the list and click **OK**.

3. Check the paper size

Check the **Page Size** list. When you want to change it, select another page size from the list. The list displays only sizes that can be used for borderless printing.

4. Adjust the amount of extension from the paper

If necessary, adjust the amount of extension using the **Amount of Extension** slider.

Moving the slider to the right increases the amount extending off the paper, and moving the slider to the left decreases the amount.

It is recommended to set the slider at the second position from the right for most cases.



»» Important

- When the **Amount of Extension** slider is set to the rightmost position, the back side of the paper may become smudged.

5. Complete the setup

Click **OK**.

When you execute print, the data is printed without any margins on the paper.

»» Important

- When a page size that cannot be used for borderless printing is selected, the size is automatically changed to the valid page sizes for borderless printing.
- When **Borderless** is selected, the **Printer Paper Size**, **Duplex Printing (Manual)**, **Stapling Side** settings, and the **Stamp/Background... (Stamp...)** button on the **Page Setup** tab appear grayed out and are unavailable.
- When **Envelope**, or **High Resolution Paper** is selected from the **Media Type** list on the **Main** tab, you cannot perform borderless printing.
- Depending on the type of the media used during borderless printing, the print quality may deteriorate at the top and bottom of the sheet or stains may form.
- When the ratio of the height to the width differs from the image data, a portion of the image may not be printed depending on the size of the media used.
In this case, crop the image data with an application software according to the paper size.

»» Note

- When **Plain Paper** is selected for **Media Type** on the **Main** tab, borderless printing is not recommended. Therefore, the message for media selection appears.
When you are using plain paper for test printing, select **Plain Paper**, and click **OK**.

Expanding the Range of the Document to Print

Setting a large amount of extension allows you to perform borderless printing with no problems. However, the portion of the document extending off the paper range will not be printed and for this reason, the subjects around the perimeter of a photo may not be printed.

When you are not satisfied with the result of borderless printing, reduce the amount of extension. The extension amount decreases as the **Amount of Extension** slider is moved to the left.

»» Important

- When the amount of extension is decreased, an unexpected margin may be produced on the print, depending on the size of the paper.

»» Note

- When the **Amount of Extension** slider is set to the leftmost position, image data will be printed in the full size.
- When **Preview before printing** is checked on the **Main** tab, you can confirm whether there will be no margin before printing.

Fit-to-Page Printing



The procedure for printing a document that is automatically enlarged or reduced to fit the page size to be used is as follows:

1. Open the [printer driver setup window](#)
2. Set fit-to-page printing

Select **Fit-to-Page** from the **Page Layout** list on the **Page Setup** tab.

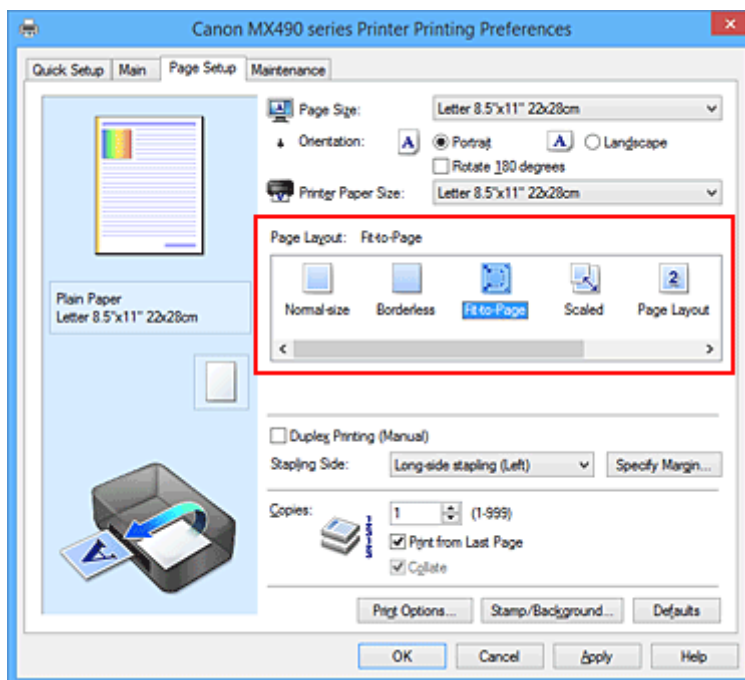

3. Select the paper size of the document

Using **Page Size**, select the page size that is set with your application software.

4. Select the print paper size

Select the size of the paper loaded in the printer from the **Printer Paper Size** list.

When the **Printer Paper Size** is smaller than the **Page Size**, the page image will be reduced. When the **Printer Paper Size** is larger than the **Page Size**, the page image will be enlarged.

The current settings are displayed in the settings preview on the left side of the printer driver.

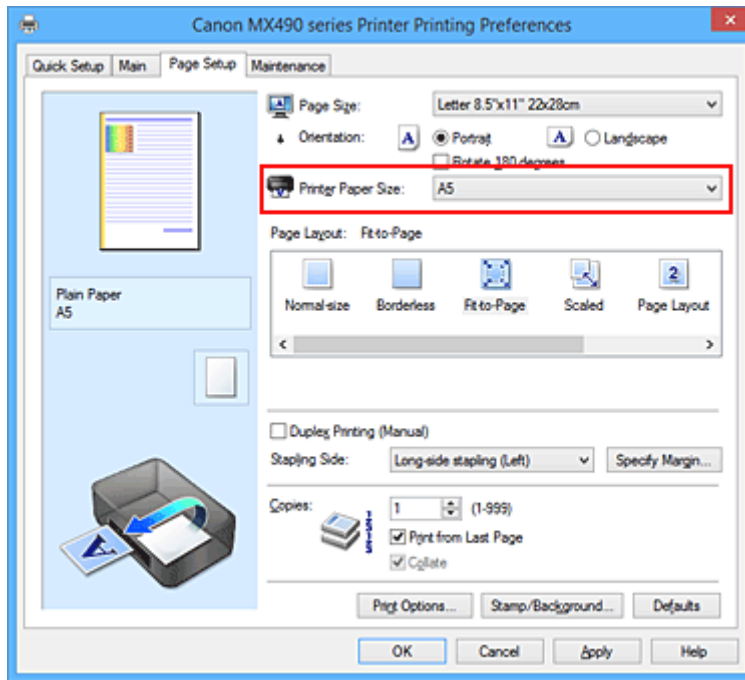

5. Complete the setup

Click **OK**.

When you execute print, the document will be enlarged or reduced to fit to the page size.

Scaled Printing



The procedure for printing a document with pages enlarged or reduced is as follows:

1. Open the [printer driver setup window](#)
2. Set scaled printing

Select **Scaled** from the **Page Layout** list on the **Page Setup** tab.

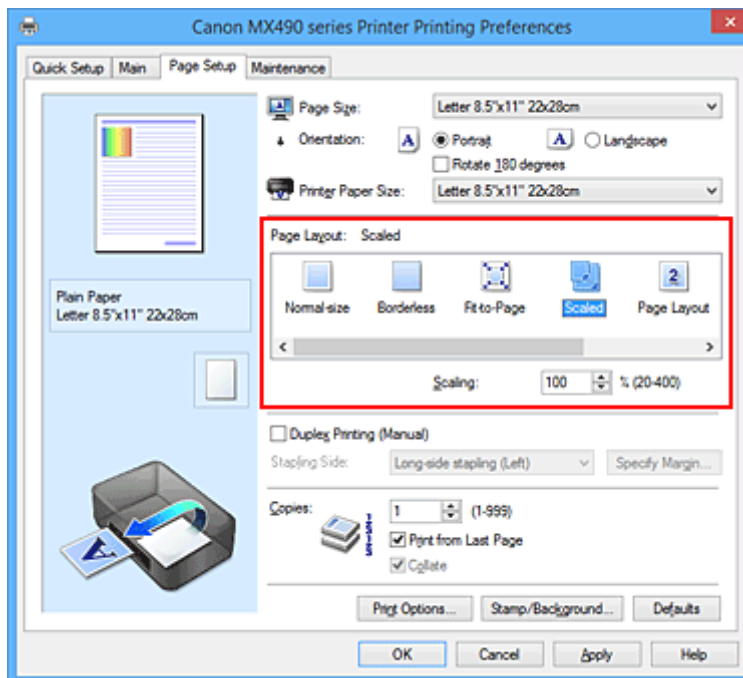

3. Select the paper size of the document

Using **Page Size**, select the page size that is set with your application software.

4. Set the scaling rate by using one of the following methods:

- Select a **Printer Paper Size**

When the printer paper size is smaller than the **Page Size**, the page image will be reduced. When the printer paper size is larger than the **Page Size**, the page image will be enlarged.

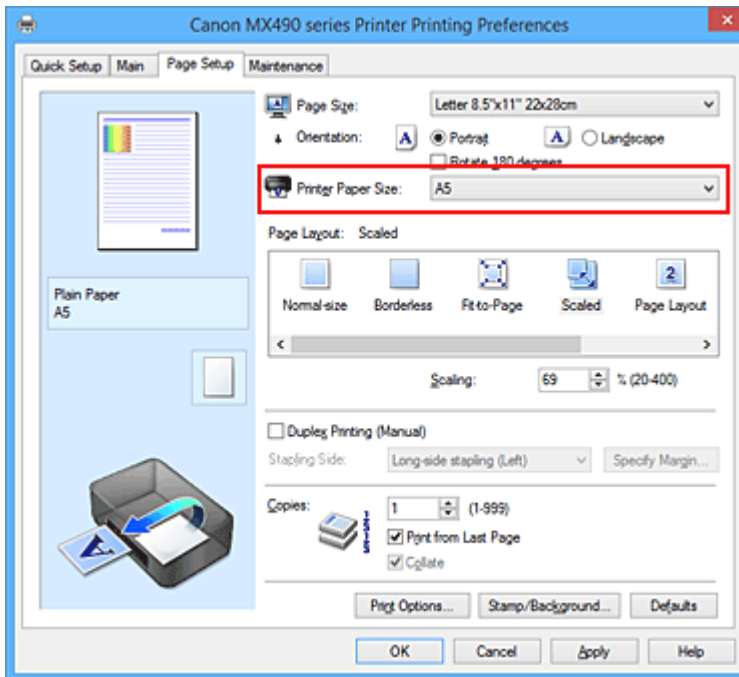

- Specify a scaling factor

Directly type in a value into the **Scaling** box.

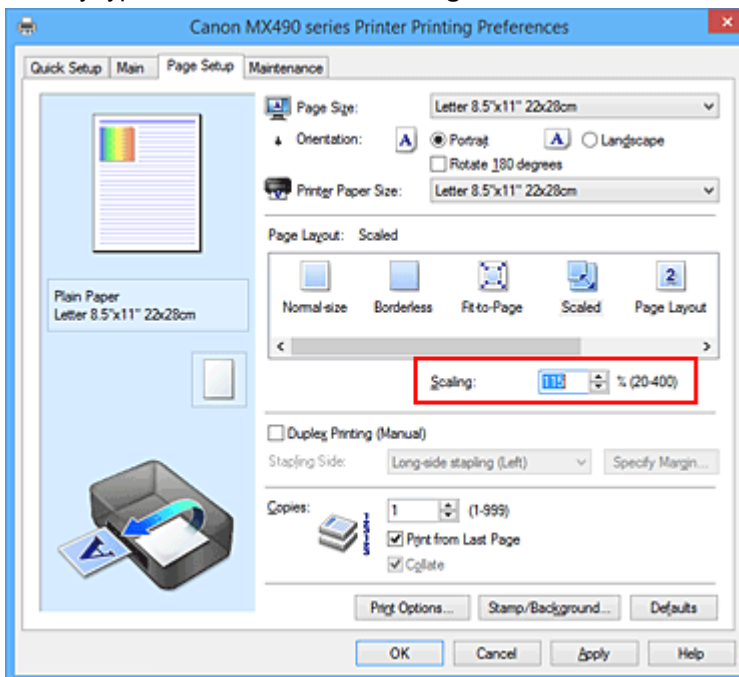

The current settings are displayed in the settings preview on the left side of the printer driver.

5. Complete the setup

Click **OK**.

When you execute print, the document will be printed with the specified scale.

»»» Important

- When the application software which you used to create the original has the scaled printing function, configure the settings on your application software. You do not need to configure the same setting in the printer driver.

»» Note

- Selecting **Scaled** changes the printable area of the document.

Page Layout Printing

The page layout printing function allows you to print more than one page image on a single sheet of paper.



The procedure for performing page layout printing is as follows:

1. Open the [printer driver setup window](#)
2. Set page layout printing

Select **Page Layout** from the **Page Layout** list on the **Page Setup** tab.

The current settings are displayed in the settings preview on the left side of the printer driver.

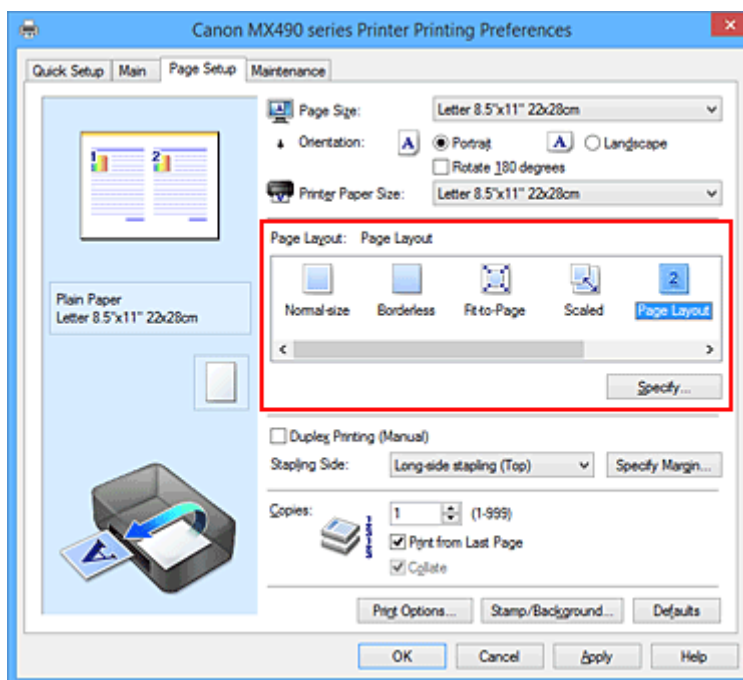

3. Select the print paper size

Select the size of the paper loaded in the printer from the **Printer Paper Size** list.

4. Set the number of pages to be printed on one sheet and the page order

If necessary, click **Specify...**, specify the following settings in the **Page Layout Printing** dialog box, and click **OK**.

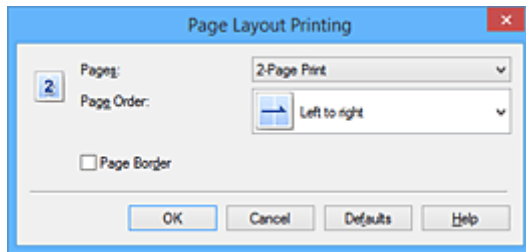

Pages

To change the number of pages to be printed on a single sheet of paper, select the number of pages from the list.

Page Order

To change the page arrangement order, select a placement method from the list.

Page Border

To print a page border around each document page, check this check box.

5. Complete the setup

Click **OK** on the **Page Setup** tab.

When you execute print, the specified number of pages will be arranged on each sheet of paper in the specified order.

Tiling/Poster Printing

The tiling/poster printing function allows you to enlarge image data, divide it into several pages, and print these pages on separate sheets of paper. You can also paste the pages together to create a large print like a poster.

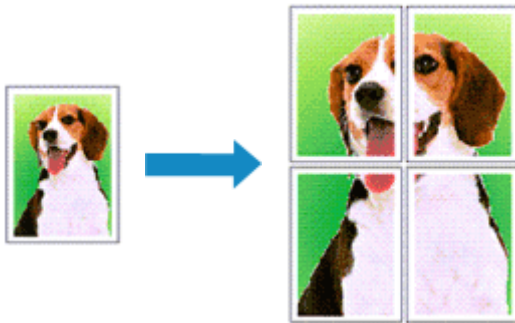

The procedure for performing tiling/poster printing is as follows:

Setting Tiling/Poster Printing

1. Open the [printer driver setup window](#)
2. Set tiling/poster printing

Select **Tiling/Poster** from the **Page Layout** list on the **Page Setup** tab.

The current settings are displayed in the settings preview on the left side of the printer driver.

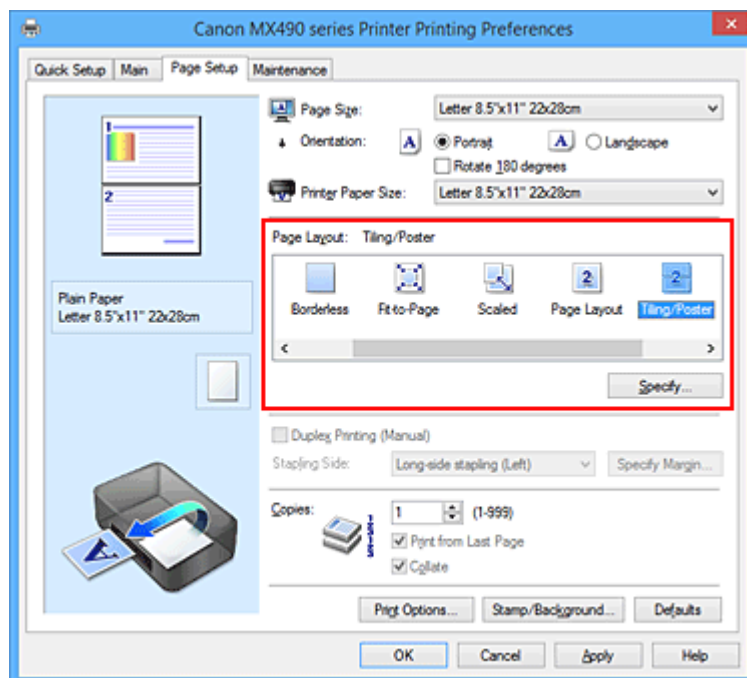

3. Select the print paper size
Select the size of the paper loaded in the printer from the **Printer Paper Size** list.
4. Set the number of image divisions and the pages to be printed

If necessary, click **Specify...**, specify the following settings in the **Tiling/Poster Printing** dialog box, and then click **OK**.

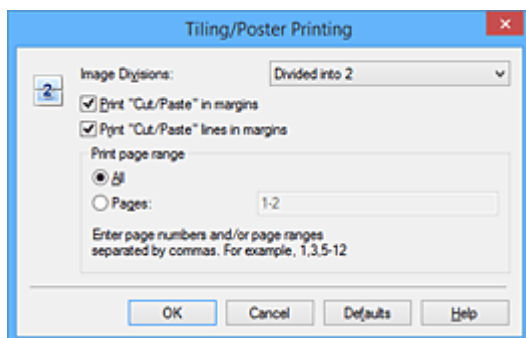

Image Divisions

Select the number of divisions (vertical x horizontal).

As the number of divisions increases, the number of sheets used for printing increases. If you are pasting pages together to create a poster, increasing the number of divisions allows you to create a larger poster.

Print "Cut/Paste" in margins

To leave out words "Cut" and "Paste", uncheck this check box.

►►► Note

- This feature may be unavailable when certain printer drivers or operating environments are used.

Print "Cut/Paste" lines in margins

To leave out cut lines, uncheck this check box.

Print page range

Specifies the printing range. Select **All** under normal circumstances.

To reprint only a specific page, select **Pages** and enter the page number you want to print. To specify multiple pages, enter the page numbers by separating them with commas or by entering a hyphen between the page numbers.

►►► Note

- You can also specify the print range by clicking the pages in the settings preview.

5. Complete the setup

Click **OK** on the **Page Setup** tab.

When you execute print, the document will be divided into several pages during printing.

Printing Only Specific Pages

If ink becomes faint or runs out during printing, you can reprint only the specific pages by following the procedure below:

1. Set the print range

In the settings preview on the left of the **Page Setup** tab, click the pages that do not need to be printed.

The pages that were clicked are deleted, and only the pages to be printed are displayed.

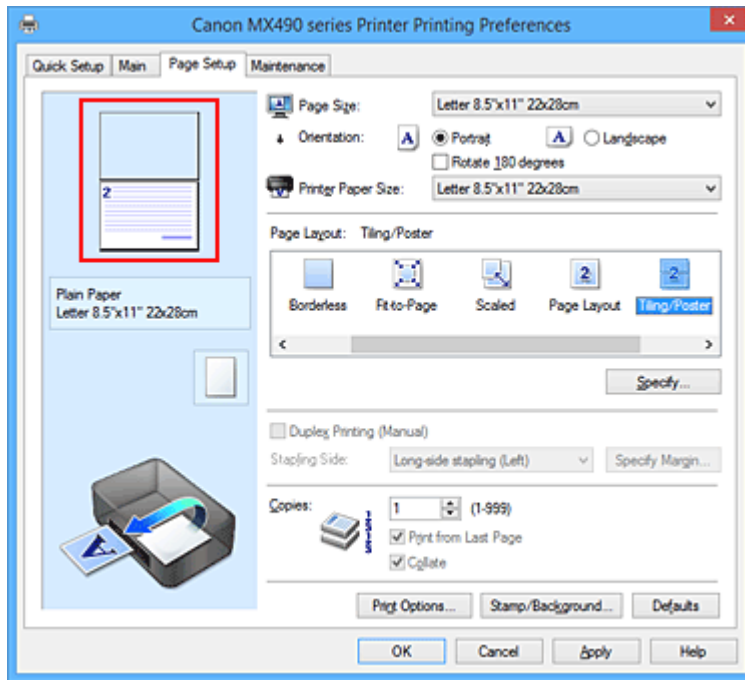

➤➤➤ Note

- Click the deleted pages to display them again.
- Right-click the settings preview to select **Print all pages** or **Delete all pages**.

2. Complete the setup

After completing the page selection, click **OK**.

When you execute print, only specified pages will be printed.

➤➤➤ Important

- Since tiling/poster printing enlarges the document when printing it, the print results may become coarse.

Booklet Printing

The booklet printing function allows you to print data for a booklet. Data is printed on both sides of the paper. This type of printing ensures that pages can be collated properly, in page number order, when the printed sheets are folded and stapled at the center.

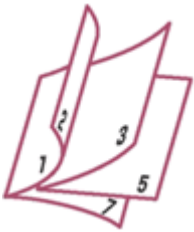

The procedure for performing booklet printing is as follows:

1. Open the [printer driver setup window](#)
2. Set booklet printing

Select **Booklet** from the **Page Layout** list on the **Page Setup** tab.

The current settings are displayed in the settings preview on the left side of the window.

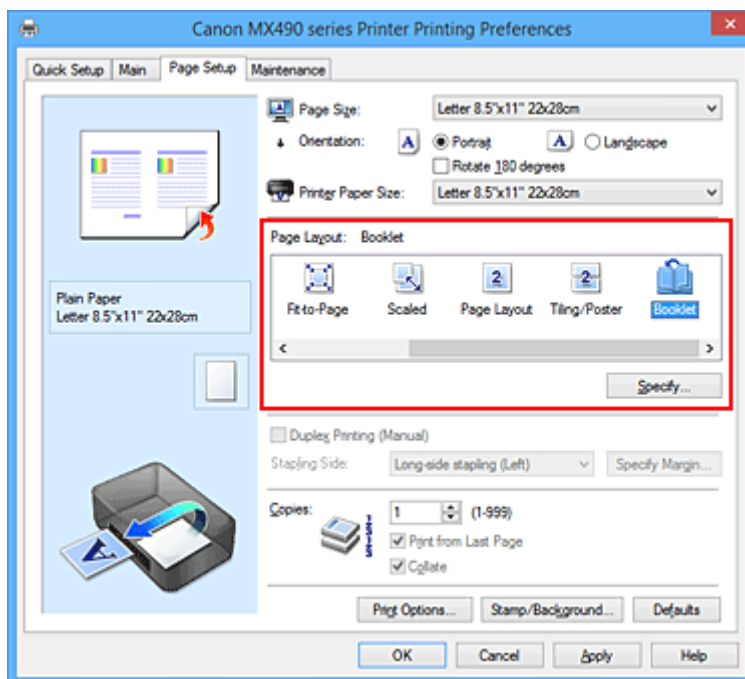

3. Select the print paper size

Select the size of the paper loaded in the printer from the **Printer Paper Size** list.

4. Set the margin for stapling and the margin width

Click **Specify...** and specify the following settings in the **Booklet Printing** dialog box, and then click **OK**.

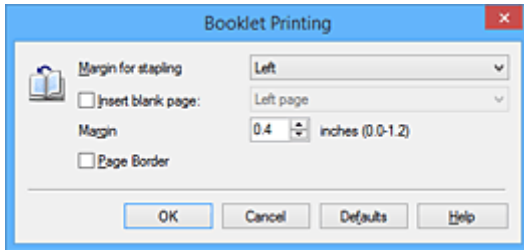

Margin for stapling

Select which side should the stapling margin be on when the booklet is completed.

Insert blank page

To leave one side of a sheet blank, check the check box, and select the page to be left blank.

Margin

Enter the margin width. The specified width from the center of the sheet becomes the margin width for one page.

Page Border

To print a page border around each document page, check the check box.

5. Complete the setup

Click **OK** on the **Page Setup** tab.

When you execute print, the document will be printed on one side of a sheet of paper. When the printing of one side is complete, set the paper correctly by following the message and click **OK**.

When the printing of the other side is complete, fold the paper at the center of the margin and make a booklet.

▶▶▶ Important

- **Booklet** cannot be selected when a media type other than **Plain Paper** is selected for **Media Type** on the **Main** tab.

▶▶▶ Note

- The stamp and background are not printed on the inserted blank sheets with the **Insert blank page** function of booklet printing.

Duplex Printing

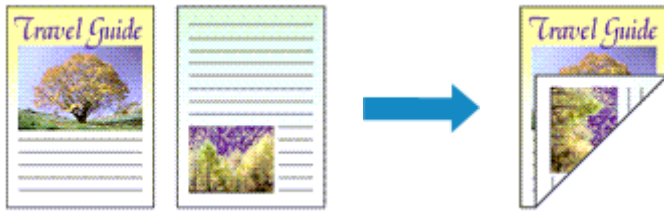

The procedure for printing data on both sides of one sheet of paper is as follows:
You can also set duplex printing in **Additional Features** on the **Quick Setup** tab.

1. Open the [printer driver setup window](#)
2. Set duplex printing

Check the **Duplex Printing (Manual)** check box on the **Page Setup** tab.

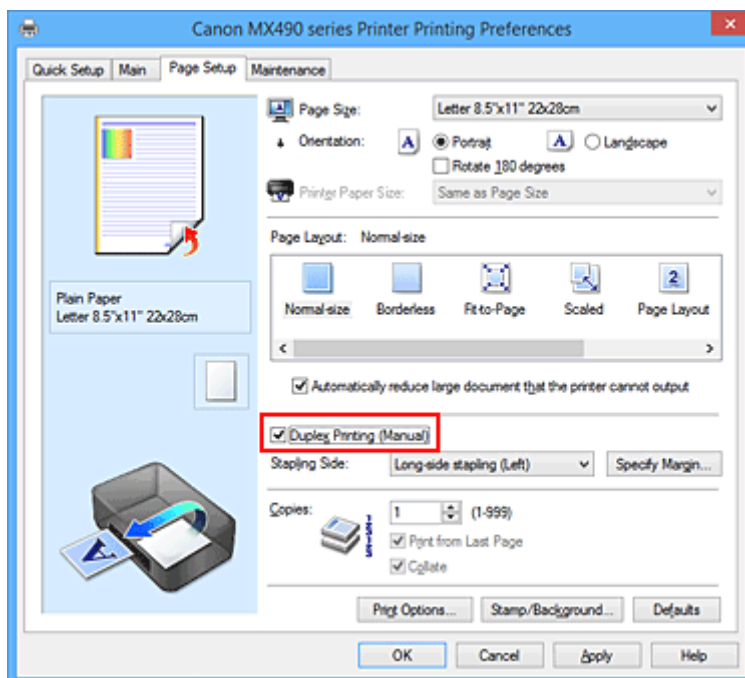

3. Select the layout

Select **Normal-size**, **Fit-to-Page**, **Scaled**, or **Page Layout** from the **Page Layout** list.

4. Specify the side to be stapled

The best **Stapling Side** is selected automatically from the **Orientation** and **Page Layout** settings. To change the setting, select another stapling side from the list.

5. Set the margin width

If necessary, click **Specify Margin...** and set the margin width, and then click **OK**.

6. Complete the setup

Click **OK** on the **Page Setup** tab.

When you execute print, the document is first printed on one side of a sheet of paper. After one side is printed, reload the paper correctly according to the message.

Then click **Start Printing** to print the opposite side.

Important

- When a media type other than **Plain Paper** is selected from **Media Type** on the **Main** tab, **Duplex Printing (Manual)** appears grayed out and is unavailable.
- When **Borderless**, **Tiling/Poster** or **Booklet** is selected from the **Page Layout** list, **Duplex Printing (Manual)** and **Stapling Side** appear grayed out and are unavailable.

Related Topics

- [Changing the Printer Operation Mode](#)

Stamp/Background Printing

Stamp or **Background** may be unavailable when certain printer drivers or operating environments are used.

The **Stamp** function allows you to print a stamp text or a bitmap over or behind document data. It also allows you to print date, time and user name. The **Background** function allows you to print a light illustration behind the document data.

The procedure for performing stamp/background printing is as follows:

Printing a Stamp

"CONFIDENTIAL," "IMPORTANT," and other stamps that are used often in companies are pre-registered.

1. Open the [printer driver setup window](#)
2. Click **Stamp/Background... (Stamp...)** on the **Page Setup** tab

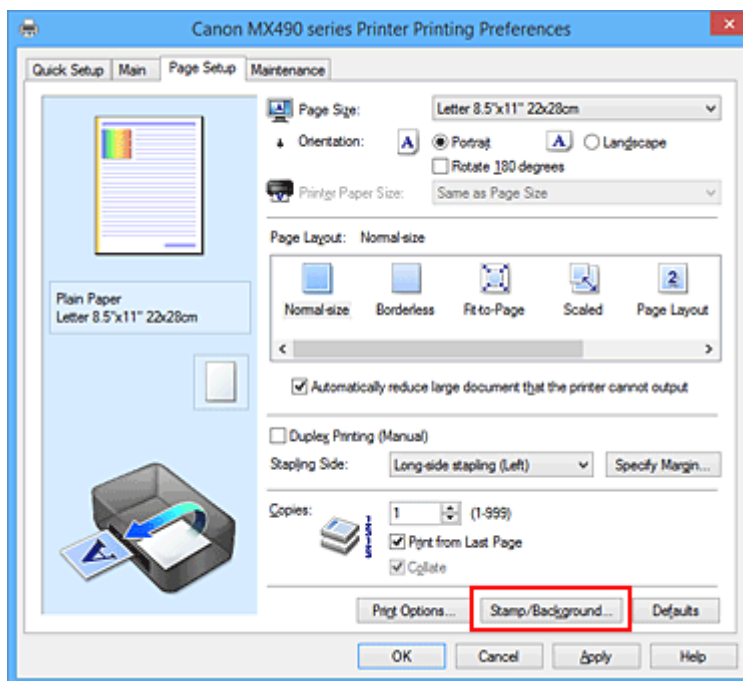

The **Stamp/Background (Stamp)** dialog box opens.

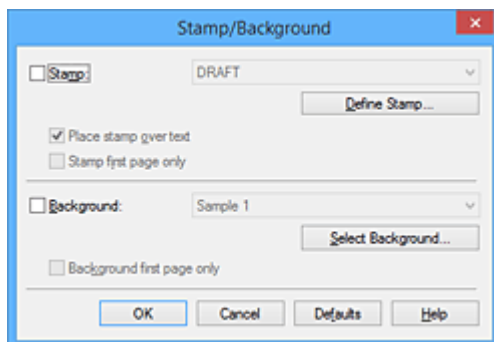

➤➤➤ Note

- With the XPS printer driver, the **Stamp/Background...** button has become the **Stamp...** button and only the stamp function can be used.

3. Select a stamp

Check the **Stamp** check box, and select the stamp to be used from the list.

The current settings are displayed in the settings preview on the left side of the **Page Setup** tab.

4. Set the stamp details

If necessary, specify the following settings, and then click **OK**.

Define Stamp... button

To [change the stamp text, bitmap, or position](#), click this.

Place stamp over text

To print the stamp on the front of the document, check this check box.

»»» Note

- The stamp is given priority because the stamp is printed over the document data in the sections where the stamp and the document data overlap. When this check box is unchecked, the stamp is printed behind the document data and may be hidden in the overlapping sections depending on the application software used.
- **Place stamp over text** cannot be used when the XPS printer driver is used. When the XPS printer driver is used, the stamp is normally printed in the foreground of the document.

Print semitransparent stamp

Check this check box to print a semi-transparent stamp on the document.

This function is available only when the XPS printer driver is used.

Stamp first page only

To print the stamp only on the first page, check this check box.

5. Complete the setup

Click **OK** on the **Page Setup** tab.

When you execute print, the data is printed with the specified stamp.

Printing a Background

Two bitmap files are pre-registered as samples.

1. Open the [printer driver setup window](#)

2. Click **Stamp/Background...** on the **Page Setup** tab

The **Stamp/Background** dialog box opens.

3. Select the background

Check the **Background** check box, and select the background to be used from the list.

The current settings are displayed in the settings preview on the left side of the **Page Setup** tab.

4. Set the background details

If necessary, complete the following settings, and then click **OK**.

Select Background... button

To [use another background or change the layout or density of a background](#), click this.

Background first page only

To print the background only on the first page, check this check box.

5. Complete the setup

Click **OK** on the **Page Setup** tab.

When you execute print, the data is printed with the specified background.

►► Important

- When **Borderless** is selected, the **Stamp/Background... (Stamp...)** button appears grayed out and is unavailable.

►► Note

- The stamp and background are not printed on blank sheets inserted with the **Insert blank page** function of booklet printing.

Related Topics

- [Registering a Stamp](#)
- [Registering Image Data to be Used as a Background](#)

Registering a Stamp

This feature may be unavailable when certain printer drivers or operating environments are used.

You can create and register a new stamp. You can also change and re-register some of the settings of an existing stamp. Unnecessary stamps can be deleted at any time.

The procedure for registering a new stamp is as follows:

Registering a New Stamp

1. Open the [printer driver setup window](#)
2. Click **Stamp/Background... (Stamp...)** on the **Page Setup** tab

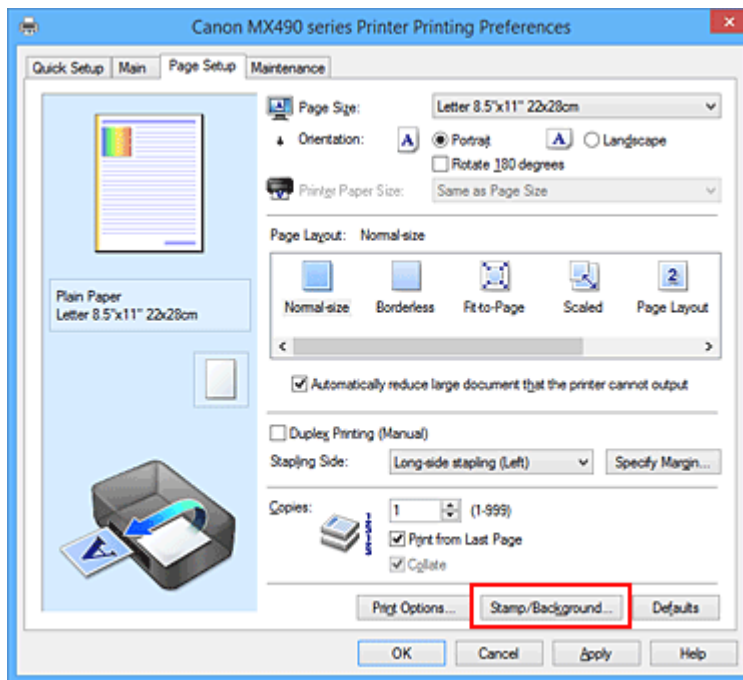

The **Stamp/Background (Stamp)** dialog box opens.

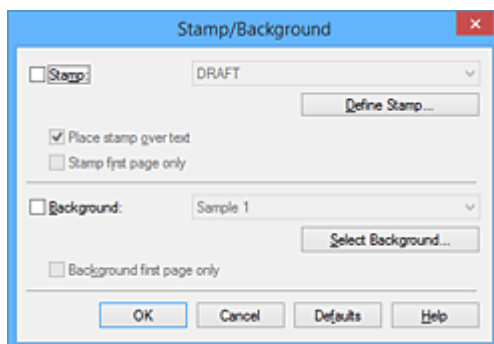

➤➤➤ Note

- With the XPS printer driver, the **Stamp/Background...** button has become the **Stamp...** button and only the stamp function can be used.

3. Click **Define Stamp...**

The **Stamp Settings** dialog box opens.

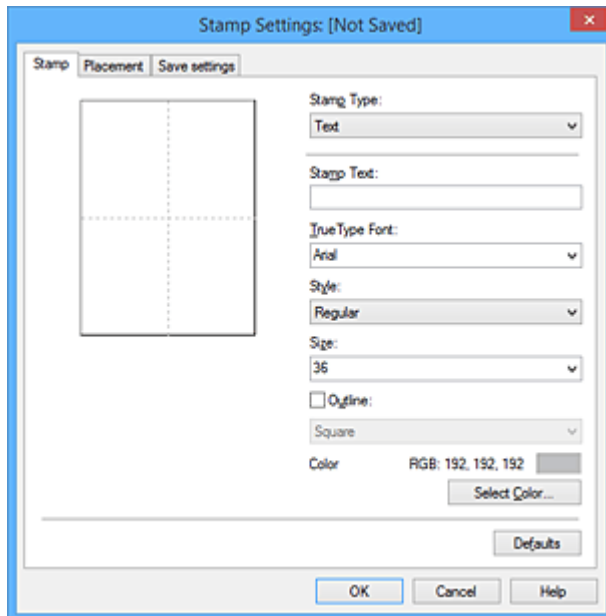

4. Configure the stamp while viewing the preview window

- **Stamp** tab

Select **Text**, **Bitmap**, or **Date/Time/User Name** that matches your purpose for **Stamp Type**.

- For **Text** registration, the characters must already be entered in **Stamp Text**. If necessary, change the **TrueType Font**, **Style**, **Size**, and **Outline** settings. You can select the color of the stamp by clicking **Select Color...**
- For **Bitmap**, click **Select File...** and select the bitmap file (.bmp) to be used. If necessary, change the settings of the **Size** and **Transparent white area**.
- For **Date/Time/User Name**, the creation date/time and user name of the printed object are displayed in **Stamp Text**. If necessary, change the settings of **TrueType Font**, **Style**, **Size**, and **Outline**. You can select the color of the stamp by clicking **Select Color...**

»»» Important

- **Stamp Text** appears grayed out and is unavailable when **Date/Time/User Name** is selected.

- **Placement** tab

Select the stamp position from the **Position** list. You can also select **Custom** from the **Position** list and specify coordinates for **X-Position** and **Y-Position**.

You can also change the stamp position by dragging the stamp in the preview window.

To change the stamp position angle, type a value in the **Orientation** box directly.

»»» Important

- **Orientation** cannot be changed when **Bitmap** is selected for **Stamp Type** on the **Stamp** tab.

5. Save the stamp

Click the **Save settings** tab and enter a title in the **Title** box, and then click **Save**.

Click **OK** when the confirmation message appears.

»»» Note

- Spaces, tabs, and returns cannot be entered at the beginning or end of a title.

6. Complete the setup

Click **OK**. The **Stamp/Background (Stamp)** dialog box opens again.
The registered title appears in the **Stamp** list.

Changing and Registering Some of Stamp Settings

1. Select the stamp for which the settings are to be changed

Select the **Stamp** check box in the **Stamp/Background (Stamp)** dialog box. Then from the list, select the title of the stamp to be changed.

2. Click **Define Stamp...**

The **Stamp Settings** dialog box opens.

3. Configure the stamp while viewing the preview window

4. Overwrite save the stamp

Click **Save overwrite** on the **Save settings** tab.

When you want to save the stamp with a different title, type a new title in the **Title** box and click **Save**.
Click **OK** when the confirmation message appears.

5. Complete the setup

Click **OK**. The **Stamp/Background (Stamp)** dialog box opens again.
The registered title appears in the **Stamp** list.

Deleting an Unnecessary Stamp

1. Click **Define Stamp...** in the **Stamp/Background (Stamp)** dialog box

The **Stamp Settings** dialog box opens.

2. Select the stamp to be deleted

Select the title of the stamp you want to delete from the **Stamps** list on the **Save settings** tab. Then click **Delete**.

Click **OK** when the confirmation message appears.

3. Complete the setup

Click **OK**. The **Stamp/Background (Stamp)** dialog box opens again.

Registering Image Data to be Used as a Background

This feature may be unavailable when certain printer drivers or operating environments are used.

You can select a bitmap file (.bmp) and register it as a new background. You can also change and register some of the settings of an existing background. An unnecessary background can be deleted.

The procedure for registering image data to be used as a background is as follows:

Registering New Background

1. Open the [printer driver setup window](#)
2. Click **Stamp/Background...** on the **Page Setup** tab

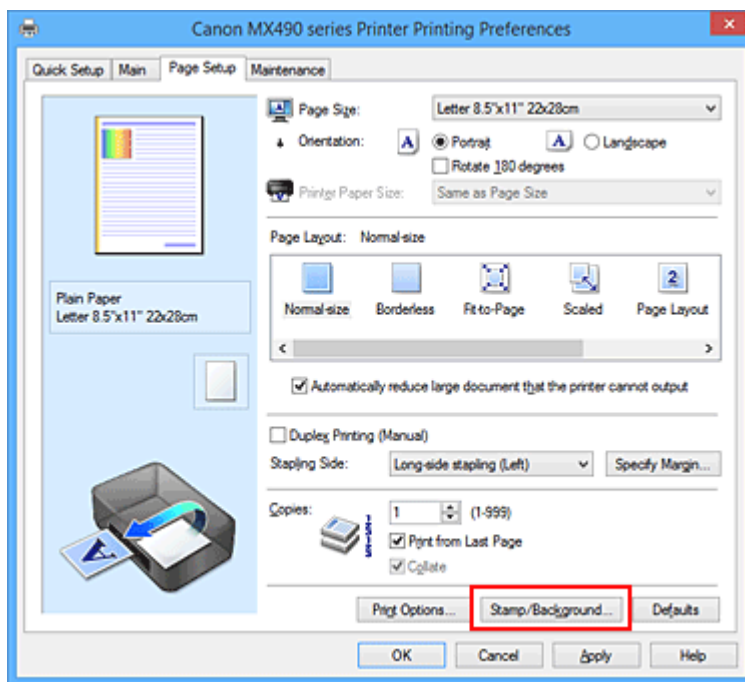

The **Stamp/Background** dialog box opens.

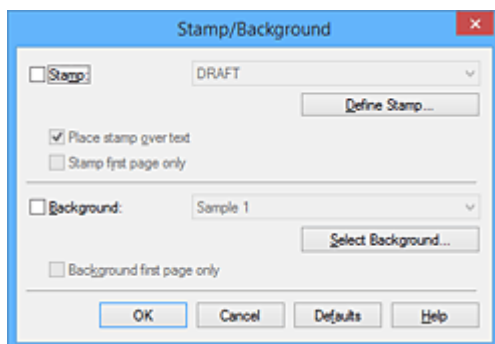

➤➤➤ Note

- With the XPS printer driver, the **Stamp/Background...** button has become the **Stamp...** button and **Background** cannot be used.

3. Click **Select Background...**

The **Background Settings** dialog box opens.

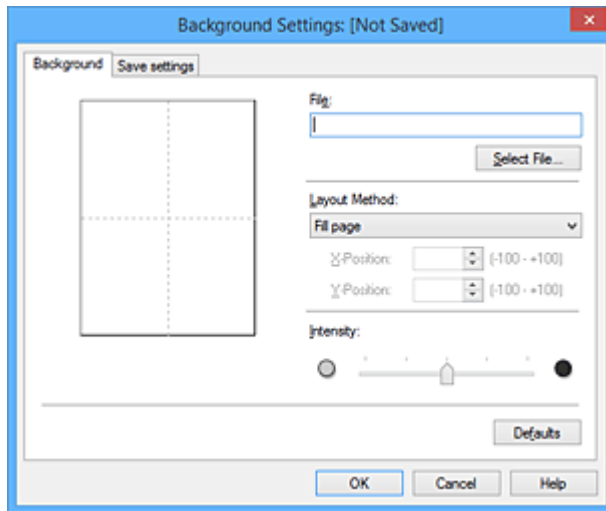

4. Select the image data to be registered to the background

Click **Select File....** Select the target bitmap file (.bmp), and then click **Open**.

5. Specify the following settings while viewing the preview window

Layout Method

Select how the background image data is to be placed.

When **Custom** is selected, you can set coordinates for **X-Position** and **Y-Position**.

You can also change the background position by dragging the image in the preview window.

Intensity

Set the intensity of the background image data with the **Intensity** slider. Moving the slider to the right darkens the background, and moving the slider to the left lightens the background. To print the background at the original bitmap intensity, move the slider to the rightmost position.

6. Save the background

Click the **Save settings** tab and enter a title in the **Title** box, and then click **Save**.

Click **OK** when the confirmation message appears.

➤➤➤ Note

- Spaces, tabs, and returns cannot be entered at the beginning or end of a title.

7. Complete the setup

Click **OK**, then it returns to **Stamp/Background** dialog box.

The registered title appears in the **Background** list.

Changing and Registering Some Background Settings

1. Select the background for which the settings are to be changed

Select the **Background** check box in the **Stamp/Background** dialog box. Then from the list, select the title of the background you want to change.

2. Click **Select Background...**

The **Background Settings** dialog box opens.

3. Specify each item on the **Background** tab while viewing the preview window

4. Save the background

Click **Save overwrite** on the **Save settings** tab. When you want to save the background with a different title, enter a new title in the **Title** box and click **Save**.

Click **OK** when the confirmation message appears.

5. Complete the setup

Click **OK**, then it returns to **Stamp/Background** dialog box.

The registered title appears in the **Background** list.

Deleting an Unnecessary Background

1. Click **Select Background...** in the **Stamp/Background** dialog box

The **Background Settings** dialog box opens.

2. Select the background to be deleted

Select the title of the background you want to delete from the **Backgrounds** list on the **Save settings** tab, and then click **Delete**.

Click **OK** when the confirmation message appears.

3. Complete the setup

Click **OK**, then it returns to **Stamp/Background** dialog box.

Setting Up Envelope Printing

The procedure for performing envelope printing is as follows:

1. [Load envelope](#) on the printer
2. Open the [printer driver setup window](#)
3. Select the media type

Select **Envelope** from **Commonly Used Settings** on the **Quick Setup** tab.

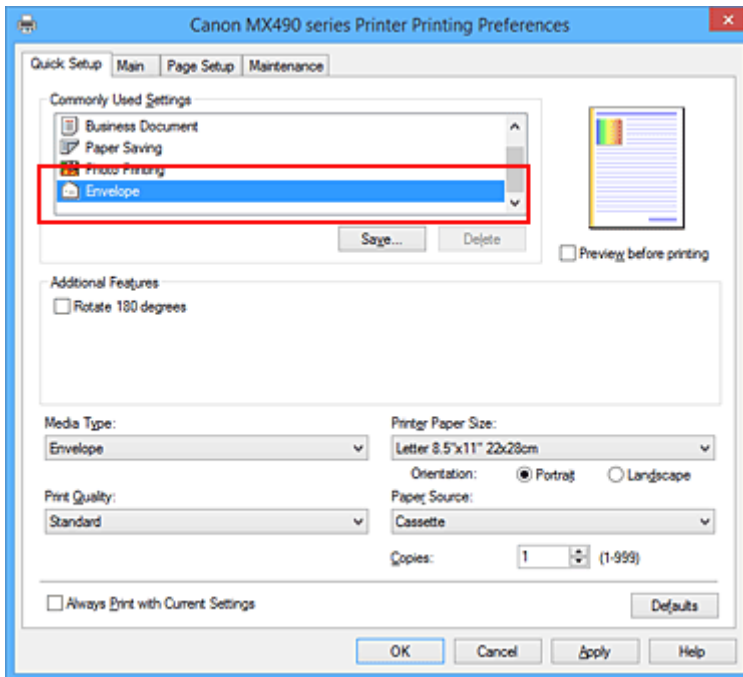

4. Select the paper size

When the **Envelope Size Setting** dialog box is displayed, select **Envelope Com 10** or **Envelope DL**, and then click **OK**.

5. Set the orientation

To print the addressee horizontally, select **Landscape** for **Orientation**.

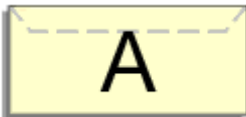

6. Select the print quality

Select **High** or **Standard** that matches your purpose for **Print Quality**.

7. Complete the setup

Click **OK**.

When you execute print, the information is printed on the envelope.

»» Note

- If the paper settings on the printer driver differ from the cassette paper information registered on the printer, an error may occur. For instructions on what to do if an error occurs, see "[Paper setting for Printing.](#)"

For details about the cassette paper information to be registered on the printer, see the following:

- [Paper Settings on the Printer Driver and the Printer \(Media Type\)](#)
- [Paper Settings on the Printer Driver and the Printer \(Paper Size\)](#)

Displaying the Print Results before Printing

If you are using the XPS printer driver, replace "Canon IJ Preview" with "Canon IJ XPS Preview" when reading this information.

You can display and check the print result before printing.

The procedure for displaying the print result before printing is as follows:

You can also set the print results display on the **Quick Setup** tab.

1. Open the [printer driver setup window](#)
2. Set the preview

Check the **Preview before printing** check box on the **Main** tab.

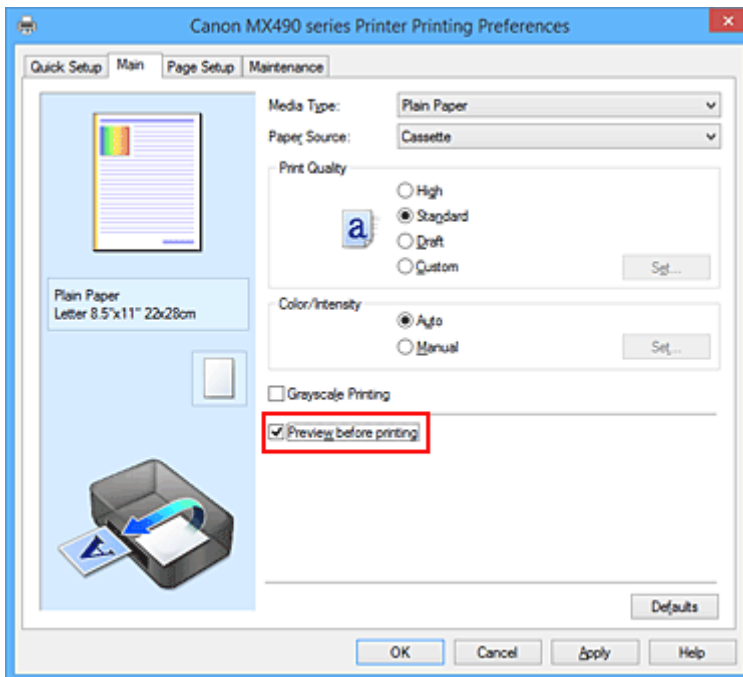

3. Complete the setup

Click **OK**.

When you execute print, the Canon IJ Preview opens and displays the print results.

▶▶▶ Important

- In the **Manual Color Adjustment** dialog box, the **Color Adjustment** tab contains the **Print a pattern for color adjustment** check box. When this check box is selected, the **Preview before printing** appears grayed out and is unavailable.

Related Topic

- [Canon IJ Preview](#)

Setting Paper Dimensions (Custom Size)

You can specify the height and width of paper when its size cannot be selected from the **Page Size**. Such a paper size is called "custom size."

The procedure for specifying a custom size is as follows:

You can also set a custom size in **Printer Paper Size** on the **Quick Setup** tab.

1. Open the [printer driver setup window](#)
2. Select the paper size

Select **Custom...** for **Page Size** on the **Page Setup** tab.

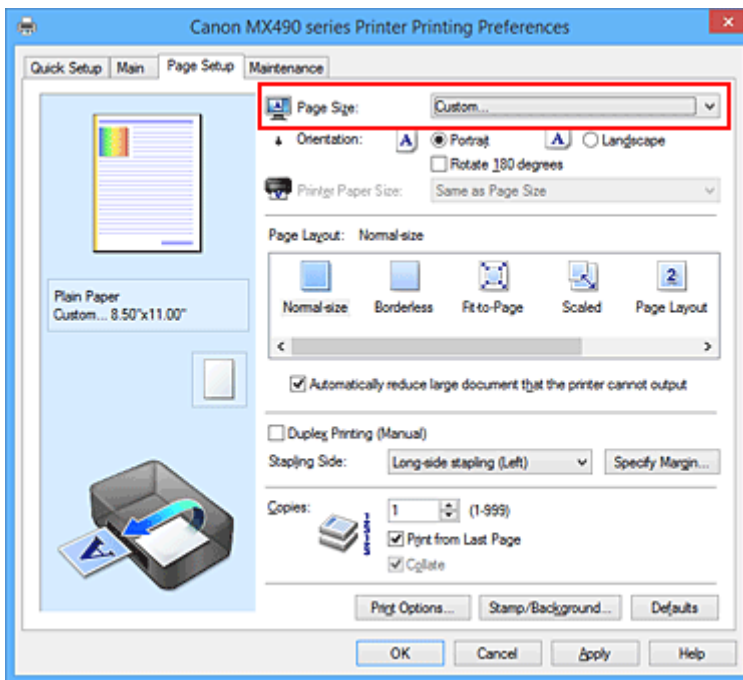

The **Custom Paper Size** dialog box opens.

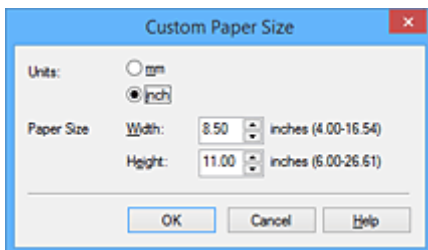

3. Set the custom paper size

Specify **Units**, and enter the **Width** and **Height** of the paper to be used. Then click **OK**.

4. Complete the setup

Click **OK** on the **Page Setup** tab.

When you execute print, the data is printed with the specified paper size.

»» Important

- If the application software that created the document has a function for specifying height and width values, use the application software to set the values. If the application software does not have such a function or if the document does not print correctly, perform the above procedure from the printer driver to set the values.
- Printing may be disabled depending on the size of the specified user-defined media.
For information about printable sizes for user-defined media, see "[Media Types You Can Use](#)."

»» Note

- If the paper settings on the printer driver differ from the cassette paper information registered on the printer, an error may occur. For instructions on what to do if an error occurs, see "[Paper setting for Printing](#)."

For details about the cassette paper information to be registered on the printer, see the following:

- [Paper Settings on the Printer Driver and the Printer \(Media Type\)](#)
- [Paper Settings on the Printer Driver and the Printer \(Paper Size\)](#)

Editing the Print Document or Reprinting from the Print History

This function is unavailable when the standard IJ printer driver is used.

In the Canon IJ XPS preview window, you can edit the print document or retrieve the document print history to print the document.

The procedure for using the Canon IJ XPS Preview is as follows:

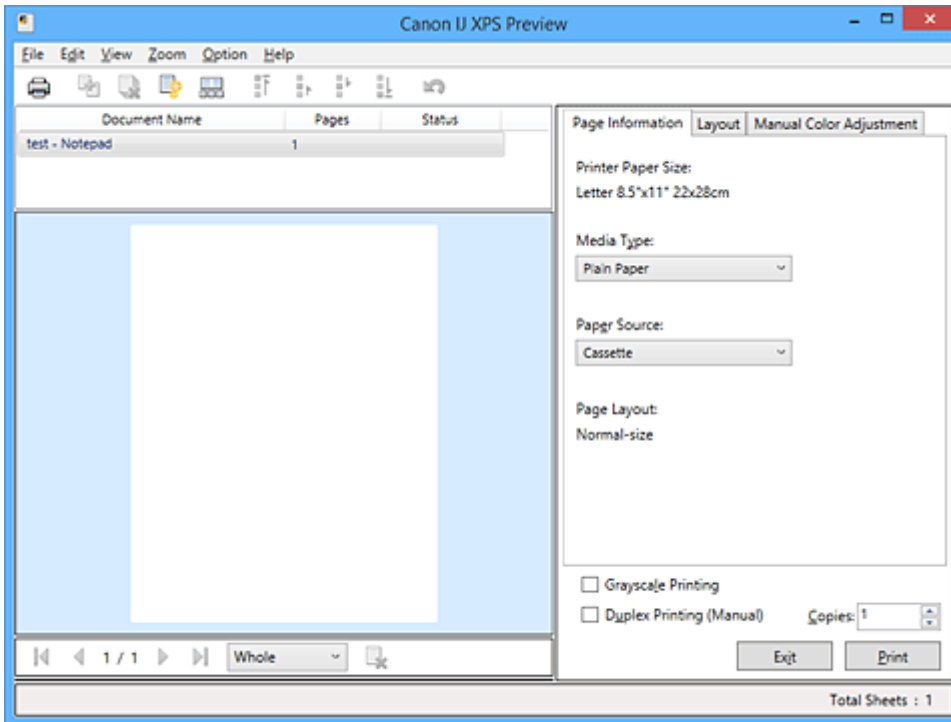

Print



Combine Documents



Delete Document



Reset Documents



View Thumbnails



Move Document



Undo





Move Page



Delete Page

▶▶▶ Note

- By clicking  **View Thumbnails**, you can display or hide thumbnails of the print documents selected in the **Document Name** list.
- Clicking  **Undo** reverses the change that just performed.

Editing and Printing a Print Document

When printing multiple documents or pages, you can combine documents, change the print sequence of the documents or pages, or delete documents or pages.

1. Open the [printer driver setup window](#)

2. Set the preview

Check the **Preview before printing** check box on the **Main** tab.

3. Complete the setup

Click **OK**.

The Canon IJ XPS Preview will start and the print result will be displayed before printing.

4. Editing print documents and print pages

- Combining print documents

You can combine multiple print documents to form a single document. By combining print documents, you can prevent blank pages from being inserted when you execute duplex printing or page layout printing.

From the **Document Name** list, select the documents to be combined. On the **Edit** menu, select **Combine Documents** from **Documents** to combine the documents in the listed sequence.

To select multiple print documents, hold down the Ctrl key and click the documents to be merged, or hold down the Shift key and press the upper arrow or lower arrow key. You can also click a blank area in the document list and drag the mouse to select multiple documents.

When you combine documents, the documents selected before the combining are deleted from the list and the combined document is added to the list.

- Changing the sequence of print documents or print pages

- To change the sequence of the print documents, go to the **Document Name** list, and select the print document to be moved. Next, on the **Edit** menu, select **Move Document** from **Documents**, and select the appropriate item. You can also click and drag a print document to change the print sequence.

- To change the sequence of the print pages, click **View Thumbnails** from the **Option** menu, and select the print page to be moved. Next, on the **Edit** menu, select **Move Page** from **Pages**, and select the appropriate item. You can also click and drag a print page to change the print sequence.

- Deleting print documents and print pages

- To delete a print document, select the target document from the **Document Name** list, and on the **Edit** menu, choose **Documents** and then **Delete Document**.

- To delete a print page, click **View Thumbnails** from the **Option** menu, and select the print page to be deleted. Next, on the **Edit** menu, select **Delete Page** from **Pages**.

- Print page recovery

You can recover pages that were deleted with **Delete Page**.

To recover pages, select the **View Deleted Pages** check box from the **Option** menu, and select the pages to be recovered from among the displayed thumbnail pages. Then from the **Edit** menu chose **Pages** and then **Restore Page**.

After editing the print documents or print pages, you can change the print settings on the **Page Information**, **Layout** and **Manual Color Adjustment** tabs as necessary.

»» Important

- To display the multiple documents in the list, open the preview and execute print again.
- To return the print documents to their original condition before they were edited in the preview, on the **Edit** menu, select **Reset Documents** from **Documents**.
- If the documents to be combined have different print settings, a message may be displayed. Check the contents of the displayed message before combining the documents.
- If the documents to be combined have different output paper sizes and duplex printing or page layout printing is to be performed, the printer may not produce the expected print results for certain print pages.
Check the preview before printing.
- Depending on the print settings of the print document, some functions may not be available in the Canon IJ XPS preview.

»» Note

- You can rename **Document Name** to any name.

5. Executing print

Click **Print**.

When you execute print, the printer uses the specified settings to print the data.

Reprinting from the Print History

When you click **Save Print History** on the **File** menu to enable the setting, the document printed from the preview is saved, and you can reprint the document with the same settings.

1. Displaying the print history

Open the [printer driver setup window](#). Then on the **Maintenance** tab, select **View Print History**. The saved print document is displayed in the preview.

»» Important

- To limit the number of print history registrations, click **History Entry Limit** on the **File** menu.
- If the limit on the number of registration is exceeded, the print history registrations are deleted starting from the oldest one.

2. Selecting a print document

From the **Document Name** list, select the document to be printed.

3. Executing print

Click **Print**.

Related Topic

- [Displaying the Print Results before Printing](#)

Changing the Print Quality and Correcting Image Data

- **Setting the Print Quality Level (Custom)**
- **Printing a Color Document in Monochrome**
- **Specifying Color Correction**
- **Optimal Photo Printing of Image Data**
- **Adjusting Colors with the Printer Driver**
- **Printing with ICC Profiles**
- **Adjusting Color Balance**
- **Adjusting Color Balance Using Sample Patterns (Printer Driver)**
- **Adjusting Brightness**
- **Adjusting Intensity**
- **Adjusting Contrast**
- **Adjusting Intensity/Contrast Using Sample Patterns (Printer Driver)**

Setting the Print Quality Level (Custom)

The print quality level can be set in the **Custom**.

The procedure for setting the print quality level is as follows:

1. Open the [printer driver setup window](#)
2. Select the print quality

On the **Main** tab, select **Custom** for **Print Quality**, and click **Set...**

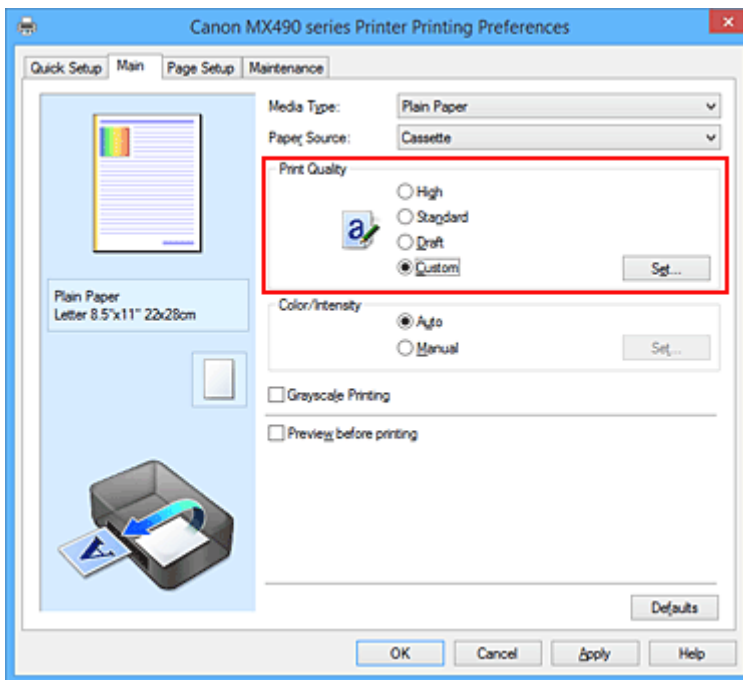

The **Custom** dialog box opens.

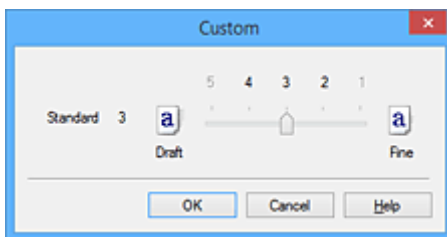

3. Setting the print quality level

Drag the slider bar to select the print quality level and click **OK**.

4. Complete the setup

Click **OK** on the **Main** tab.

When you execute print, the image data is printed with the selected print quality level.

►► Important

- Certain print quality levels cannot be selected depending on the settings of **Media Type**.

Related Topics

- [Specifying Color Correction](#)

- [Adjusting Color Balance](#)
- [Adjusting Brightness](#)
- [Adjusting Intensity](#)
- [Adjusting Contrast](#)

Printing a Color Document in Monochrome

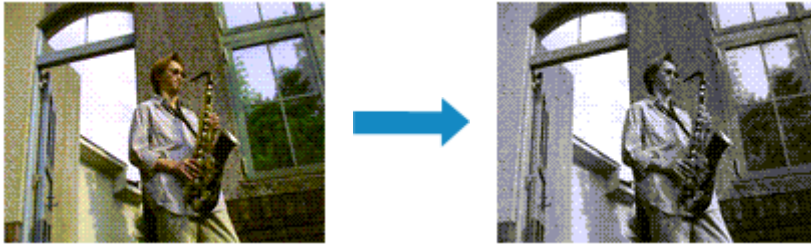

The procedure for printing a color document in monochrome is as follows:

You can also set a grayscale printing in **Additional Features** on the **Quick Setup** tab.

1. Open the [printer driver setup window](#)
2. Set grayscale printing

Check the **Grayscale Printing** check box on the **Main** tab.

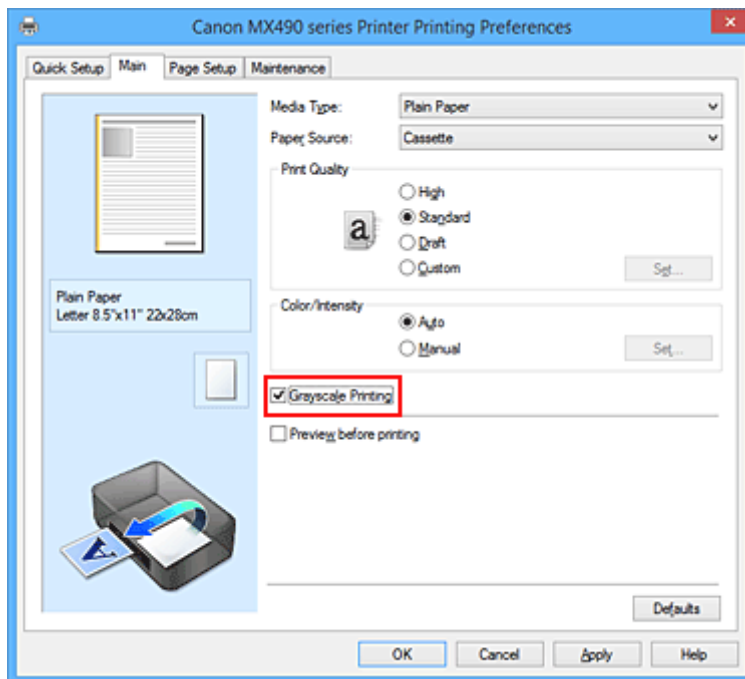

3. Complete the setup

Click **OK**.

When you execute print, the document is converted to grayscale data. It allows you to print the color document in monochrome.

►► Important

- When the **Grayscale Printing** check box is checked, the printer driver processes image data as sRGB data. In this case, actual colors printed may differ from those in the original image data. When using the grayscale printing function to print Adobe RGB data, convert the data to sRGB data using an application software.

►► Note

- During **Grayscale Printing**, inks other than black ink may be used as well.

Specifying Color Correction

You can specify the color correction method suited to the type of document to be printed.

Normally, the printer driver adjusts the colors by using Canon Digital Photo Color so that data is printed with color tints that most people prefer. This method is suitable for printing sRGB data.

When you want to print by using the color space (Adobe RGB or sRGB) of the image data effectively, select **ICM (ICC Profile Matching)**. When you want to use an application software to specify a printing ICC profile, select **None**.

The procedure for specifying color correction is as follows:

You can also set color correction on the **Quick Setup** tab by choosing **Photo Printing** under **Commonly Used Settings**, and then choosing **Color/Intensity Manual Adjustment** under **Additional Features**.

1. Open the [printer driver setup window](#)
2. Select the manual color adjustment

On the **Main** tab, select **Manual** for **Color/Intensity**, and click **Set...**

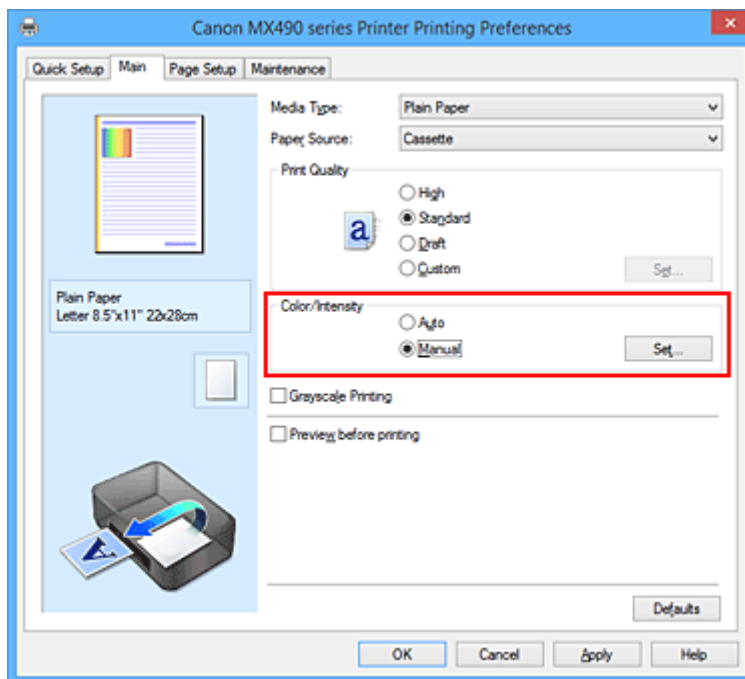

The **Manual Color Adjustment** dialog box opens.

3. Select color correction

Click **Matching** tab, select **Color Correction** setting that matches your purpose from the following, and click **OK**.

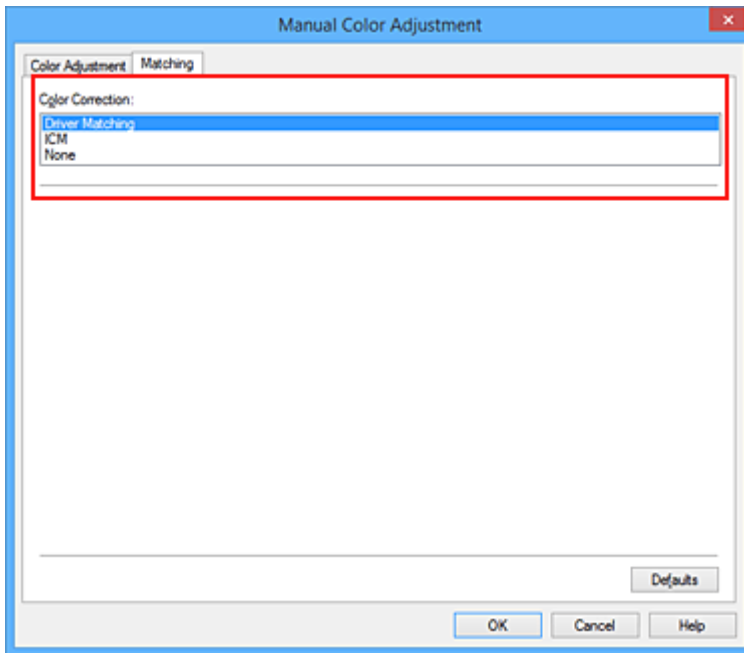

Driver Matching

With Canon Digital Photo Color, you can print sRGB data with color tints that most people prefer.

ICM (ICC Profile Matching)

Adjusts the colors by using an ICC profile when printing.
Specify the input profile to be used.

None

The printer driver does not perform color correction. Select this value when you are specifying an individually created printing ICC profile in an application software to print data.

4. Complete the setup

Click **OK** on the **Main** tab.

When you execute print, the document data is printed with the specified color correction.

»» Important

- When ICM is disabled in the application software, **ICM** is unavailable for **Color Correction** and the printer may not be able to print the image data properly.
- When the **Grayscale Printing** check box on the **Main** tab is checked, **Color Correction** appears grayed out and is unavailable.

Related Topics

- [Optimal Photo Printing of Image Data](#)
- [Adjusting Colors with the Printer Driver](#)
- [Printing with ICC Profiles](#)

Optimal Photo Printing of Image Data

When people print images taken with digital cameras, they sometimes feel that the printed color tones differ from those of actual image or those displayed on the monitor.

To get the print results as close as possible to the desired color tones, you must select a printing method that is best suited to the application software used or to your purpose.

Color Management

Devices such as digital cameras, scanners, monitors, and printers handle color differently. Color management (color matching) is a method that manages device-dependent "colors" as a common color space.

For Windows, a color management system called "ICM" is built into the operating system.

Adobe RGB and sRGB are popularly used as common color spaces. Adobe RGB has a wider color space than sRGB.

ICC profiles convert device-dependent "colors" into a common color space. By using an ICC profile and carrying out color management, you can draw out the color space of the image data within the color reproduction area that the printer can express.

Selecting a Printing Method Suited to the Image Data

The recommended printing method depends on the color space (Adobe RGB or sRGB) of the image data or the application software to be used.

There are two typical printing methods.

Check the color space (Adobe RGB or sRGB) of the image data and the application software to be used, and then select the printing method suited to your purpose.

Adjusting Colors with the Printer Driver

Describes the procedure for printing sRGB data by using the color correction function of the printer driver.

- To print using Canon Digital Photo Color

The printer prints data with color tints that most people prefer, reproducing colors of the original image data and producing three-dimensional effects and high, sharp contrasts.

- To print by directly applying editing and touch-up results of an application software

When printing the data, the printer brings out subtle color difference between dark and light areas, while leaving the darkest and lightest areas intact.

When printing the data, the printer applies fine adjustment results, such as brightness adjustments made with an application software.

Printing with ICC Profiles

Describes the procedure for printing by using the color space of Adobe RGB or sRGB effectively.

You can print with a common color space by setting up the application software and the printer driver so that the color management matches the input ICC profile of the image data.

The method for setting up the printer driver differs depending on the application software to be used.

Adjusting Colors with the Printer Driver

You can specify the color correction function of the printer driver to print sRGB data with color tints that most people prefer through the use of Canon Digital Photo Color.

When printing from an application software that can identify ICC profiles and allows you to specify them, use a printing ICC profile in the application software, and select settings for color management.

The procedure for adjusting colors with the printer driver is as follows:

1. Open the [printer driver setup window](#)

2. Select the manual color adjustment

On the **Main** tab, select **Manual** for **Color/Intensity**, and click **Set...**

The **Manual Color Adjustment** dialog box opens.

3. Select color correction

Click **Matching** tab, and select **Driver Matching** for **Color Correction**.

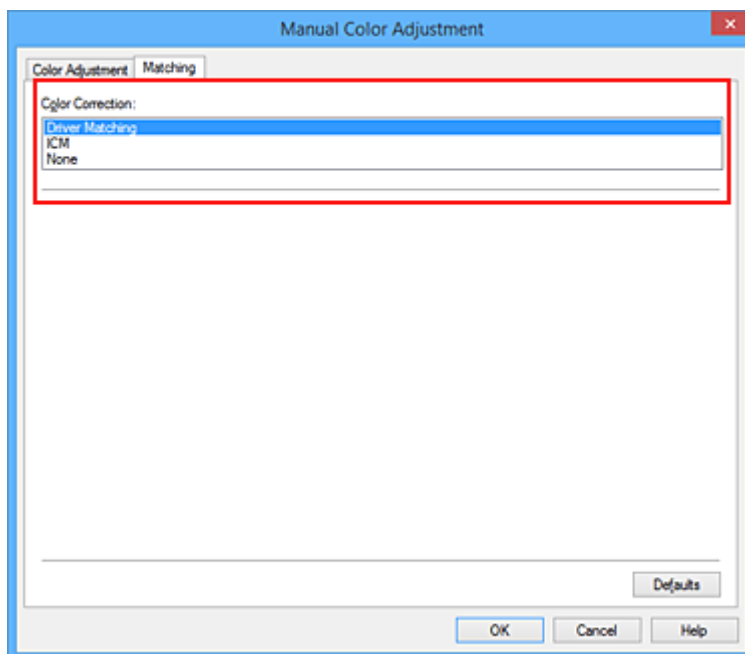

4. Set the other items

If necessary, click **Color Adjustment** tab, and adjust the color balance (**Cyan, Magenta, Yellow**) and adjust **Brightness, Intensity, and Contrast** settings, and then click **OK**.

5. Complete the setup

Click **OK** on the **Main** tab.

When you execute print, the printer driver adjusts the colors when printing the data.

Related Topics

- [Setting the Print Quality Level \(Custom\)](#)
- [Specifying Color Correction](#)
- [Adjusting Color Balance](#)
- [Adjusting Brightness](#)

■ [Adjusting Intensity](#)

■ [Adjusting Contrast](#)

Printing with ICC Profiles

When the image data has a specified input ICC profile, you can print by using the color space (Adobe RGB or sRGB) of the data effectively.

The printer driver setting procedure varies depending on the application software used to print.

Specify an ICC Profile from the Application Software and Print the Data

When you print the editing and touch-up results of Adobe Photoshop, Canon Digital Photo Professional, or any application software that allows you to specify input and printing ICC profiles, you print by effectively using the color space of the input ICC profile specified in the image data.

To use this printing method, use your application software to select color management items and specify an input ICC profile and a printing ICC profile in the image data.

Even if you print using a printing ICC profile that you created yourself from your application software, be sure to select color management items from your application software.

For instructions, refer to the manual of the application software you are using.

1. Open the [printer driver setup window](#)

2. Select the manual color adjustment

On the **Main** tab, select **Manual** for **Color/Intensity**, and click **Set...**

The **Manual Color Adjustment** dialog box opens.

3. Select color correction

Click **Matching** tab, and select **None** for **Color Correction**.

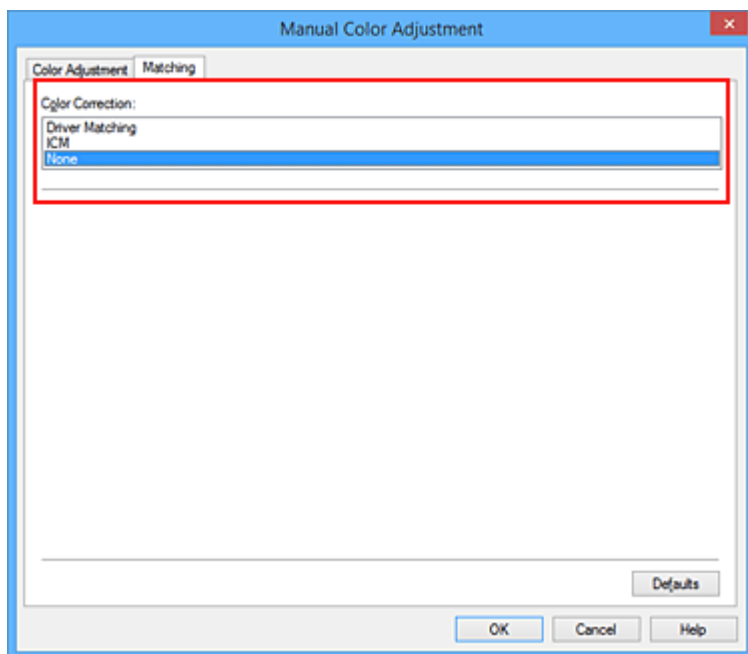

4. Set the other items

If necessary, click **Color Adjustment** tab, and adjust the color balance (**Cyan, Magenta, Yellow**) and adjust **Brightness, Intensity, and Contrast** settings, and then click **OK**.

5. Complete the setup

Click **OK** on the **Main** tab.

When you execute print, the printer uses the color space of the image data.

Specify an ICC Profile with the Printer Driver, and then Print

Print from an application software that cannot identify input ICC profiles or does allow you to specify one by using the color space of the input ICC profile (sRGB) found in the data. When printing Adobe RGB data, you can print the data with the Adobe RGB color space even if the application software does not support Adobe RGB.

1. Open the [printer driver setup window](#)

2. Select the manual color adjustment

On the **Main** tab, select **Manual** for **Color/Intensity**, and click **Set...**

The **Manual Color Adjustment** dialog box opens.

3. Select color correction

Click **Matching** tab, and select **ICM (ICC Profile Matching)** for **Color Correction**.

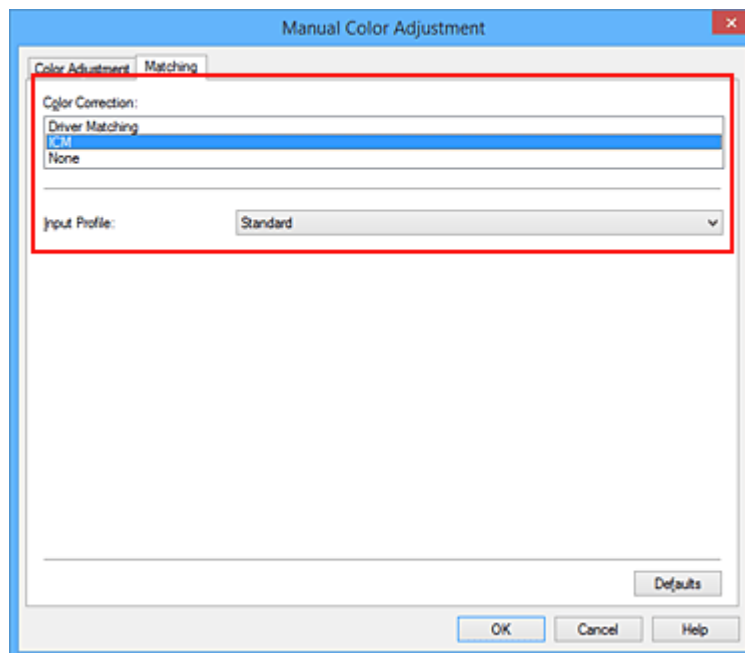

4. Select the input profile

Select an **Input Profile** that matches the color space of the image data.

- For sRGB data or data without an input ICC profile:
Select **Standard**.
- For Adobe RGB data:
Select **Adobe RGB (1998)**.

►► Important

- When the application software specifies an input profile, the input profile setting of the printer driver becomes invalid.

- **Adobe RGB (1998)** is not displayed when input profiles of Adobe RGB are not installed.

5. Set the other items

If necessary, click **Color Adjustment** tab, and adjust **Cyan, Magenta, Yellow, Brightness, Intensity,** and **Contrast** settings, and then click **OK**.

6. Complete the setup

Click **OK** on the **Main** tab.

When you execute print, the printer uses the color space of the image data.

Related Topics

- [Setting the Print Quality Level \(Custom\)](#)
- [Specifying Color Correction](#)
- [Adjusting Color Balance](#)
- [Adjusting Brightness](#)
- [Adjusting Intensity](#)
- [Adjusting Contrast](#)

Adjusting Color Balance

You can adjust the color tints when printing.

Since this function adjusts color balance of the output by changing the ink ratios of each color, it changes the total color balance of the document. Use the application software when you want to change the color balance significantly. Use the printer driver only when you want to adjust the color balance slightly.

The following sample shows the case when color balance is used to intensify cyan and to diminish yellow so that the overall colors are more uniform.



No adjustment Adjust color balance

The procedure for adjusting color balance is as follows:

You can also set color balance on the **Quick Setup** tab by choosing **Photo Printing** under **Commonly Used Settings**, and then choosing **Color/Intensity Manual Adjustment** under **Additional Features**.

1. Open the [printer driver setup window](#)
2. Select the manual color adjustment

On the **Main** tab, select **Manual** for **Color/Intensity**, and click **Set...**

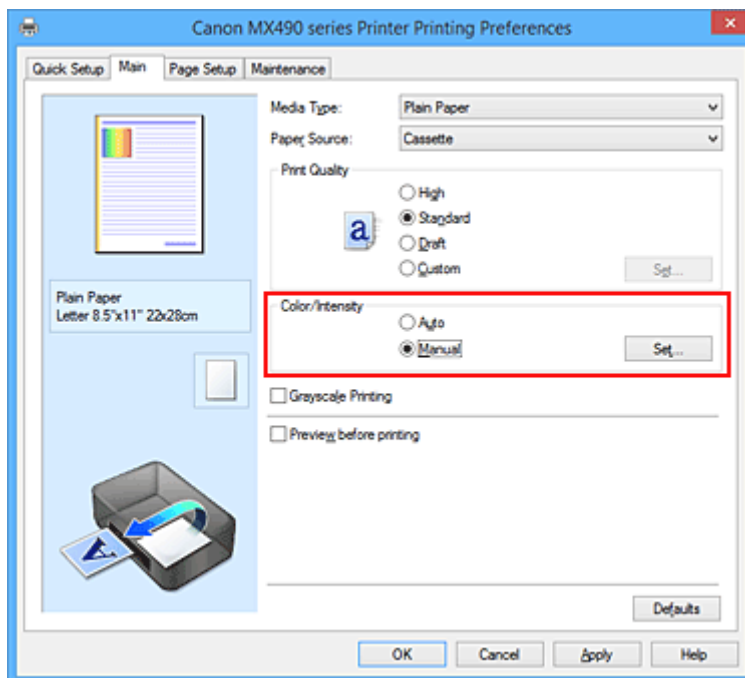

The **Manual Color Adjustment** dialog box opens.

3. Adjust color balance

There are individual sliders for **Cyan**, **Magenta**, and **Yellow**. Each color becomes stronger when the corresponding slider is moved to the right, and becomes weaker when the corresponding slider is moved to the left. For example, when cyan becomes weaker, the color red becomes stronger.

You can also directly enter a value linked to the slider. Enter a value in the range from -50 to 50. The current settings are displayed in the settings preview on the left side of the printer driver.

After adjusting each color, click **OK**.

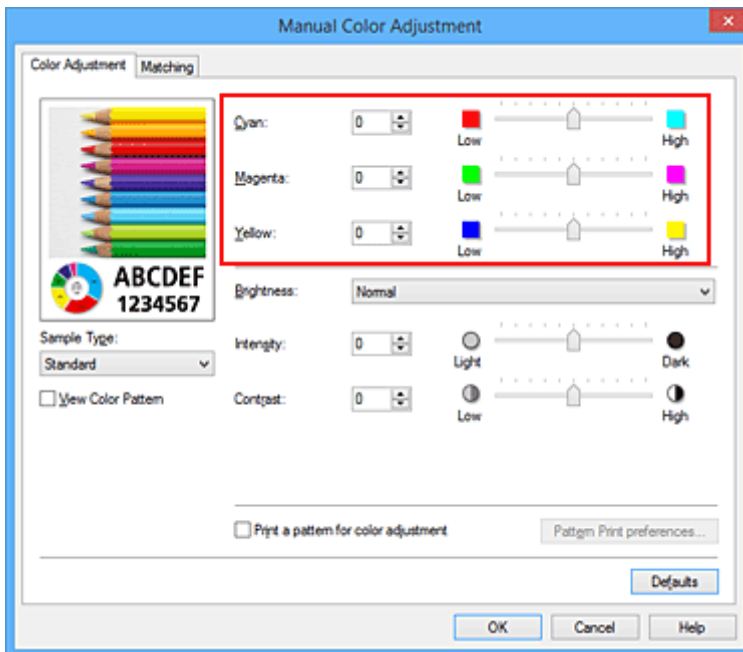

4. Complete the setup

Click **OK** on the **Main** tab.

When you execute print, the document is printed with the adjusted color balance.

►►► Important

- When the **Grayscale Printing** check box on the **Main** tab is checked, the color balance (**Cyan**, **Magenta**, **Yellow**) appear grayed out and are unavailable.

Related Topics

- [Setting the Print Quality Level \(Custom\)](#)
- [Specifying Color Correction](#)
- [Adjusting Color Balance Using Sample Patterns \(Printer Driver\)](#)
- [Adjusting Brightness](#)
- [Adjusting Intensity](#)
- [Adjusting Contrast](#)
- [Adjusting Intensity/Contrast Using Sample Patterns \(Printer Driver\)](#)

Adjusting Color Balance Using Sample Patterns (Printer Driver)

You can look at the print results of pattern print and adjust the color balance.

When you change the color balance or intensity/contrast of a document, the pattern print function prints the adjustment results in a list, together with the adjustment values.

Described below is the procedure for adjusting the color balance while looking at the pattern.

1. Open the [printer driver setup window](#)
2. Select the manual color adjustment

On the **Main** tab, select **Manual** for **Color/Intensity**, and click **Set...**

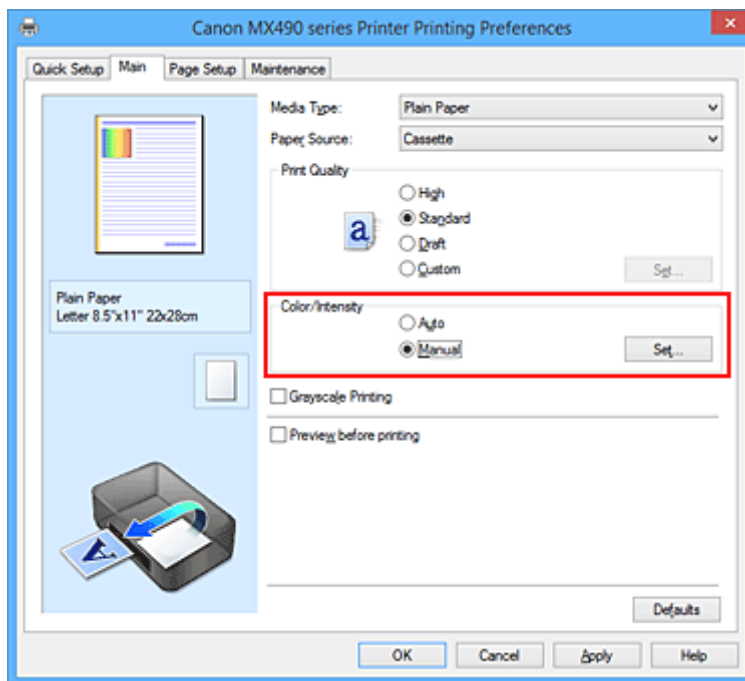

The **Manual Color Adjustment** dialog box opens.

3. Selecting pattern print

On the **Color Adjustment** tab, select the **Print a pattern for color adjustment** check box, and click **Pattern Print preferences....**

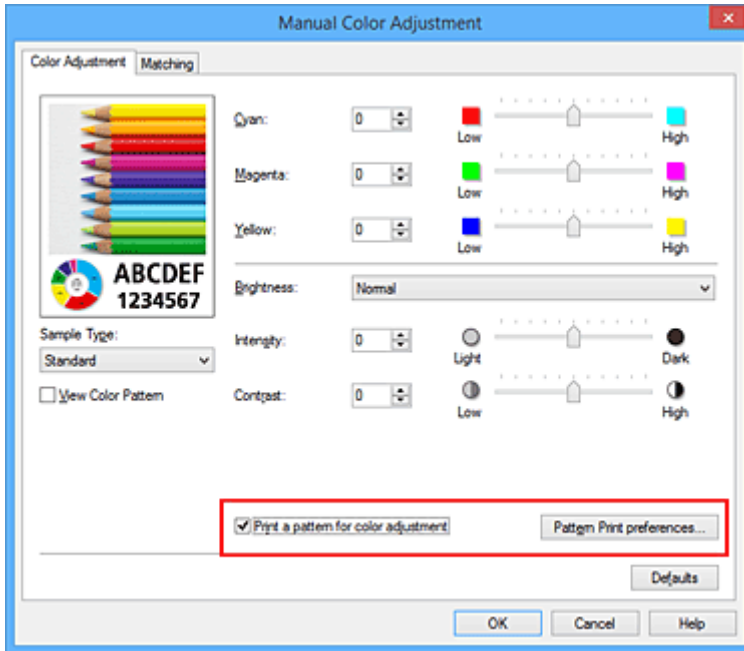

4. Setting pattern print

When the **Pattern Print** dialog box opens, set the following items, and then click **OK**.

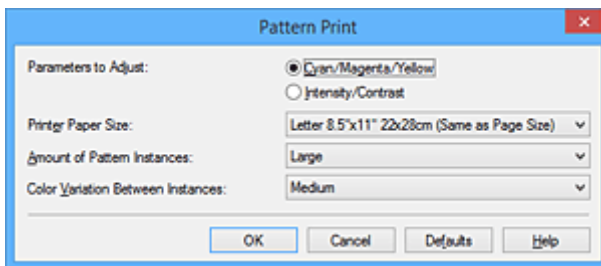

Parameters to Adjust

Select **Cyan/Magenta/Yellow**.

►►► Important

- When the **Grayscale Printing** check box on the **Main** tab is checked, **Cyan/Magenta/Yellow** appear grayed out and are unavailable.

Printer Paper Size

Select the paper size to be used for pattern printing.

►►► Note

- Depending on the paper size selected on the **Page Setup** tab, there may be sizes that cannot be selected.

Amount of Pattern Instances

Select **Largest**, **Large**, or **Small** to set the number of patterns to be printed.

►►► Note

- **Largest** and **Large** cannot be selected when certain paper sizes or output paper sizes are selected.

Color Variation Between Instances

Set the amount of color change between neighboring patterns.

►► Note

- **Large** is about double the size of **Medium**, and **Small** is about half the size of **Medium**.

5. Checking the print results of pattern print

On the **Color Adjustment** tab, select **OK** to close the **Manual Color Adjustment** dialog box.

On the **Main** tab, select **OK**, and then execute printing. The printer then prints a pattern in which the color balance that you set is the center value.



►► Important

- Normally, patterns are printed with the color balance settings as the center values. However, when **Black Only** is selected for **Ink Cartridge Settings** on the **Maintenance** tab, the color balance settings are not applied to pattern printing.

6. Adjusting the color balance

Look at the print results and select the image that you like best. Then enter the color balance numbers indicated at the bottom of that image into the **Cyan**, **Magenta**, and **Yellow** fields on the **Color Adjustment** tab.

Clear the **Print a pattern for color adjustment** check box, and click **OK**.

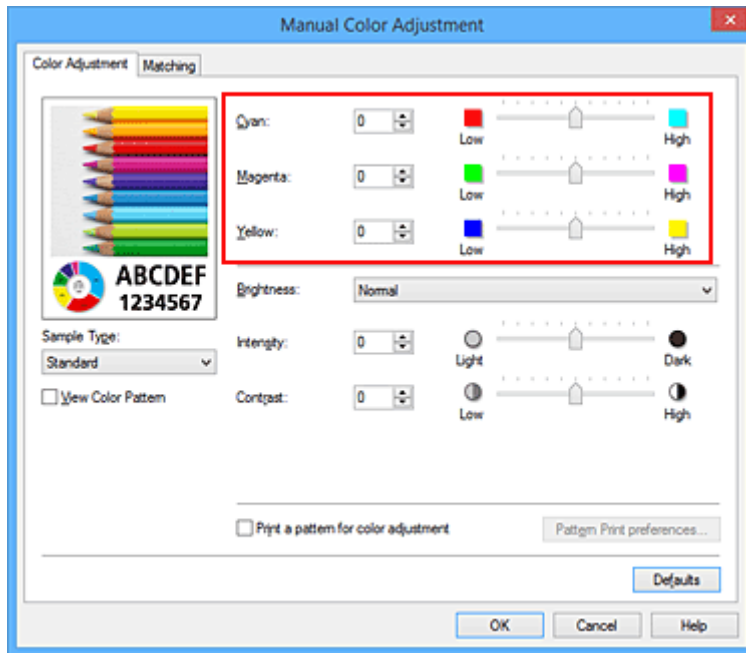

►►► Note

- You can also set color balance on the **Quick Setup** tab by choosing **Photo Printing** under **Commonly Used Settings**, and then choosing **Color/Intensity Manual Adjustment** under **Additional Features**.

7. Complete the setup

Click **OK** on the **Main** tab.

Then when you execute printing, the document is printed with the color balance that was adjusted by the pattern print function.

►►► Important

- When **Print a pattern for color adjustment** is selected on the **Color Adjustment** tab, the following items are grayed out and cannot be set:
 - **Preview before printing** on the **Main** tab
 - **Stapling Side** and **Specify Margin...** on the **Page Setup** tab (When **Duplex Printing (Manual)** is set, only **Stapling Side** can be set.)
- You can print a pattern only if the **Page Layout** setting on the **Page Setup** tab is **Normal-size** or **Borderless**.
- When the **Grayscale Printing** check box on the **Main** tab is checked, **Cyan**, **Magenta**, and **Yellow** appear grayed out and are unavailable.
- Depending on your application software, this function may not be available.

Related Topics

- [Adjusting Color Balance](#)
- [Adjusting Intensity](#)
- [Adjusting Contrast](#)
- [Adjusting Intensity/Contrast Using Sample Patterns \(Printer Driver\)](#)

Adjusting Brightness

You can change the brightness of the overall image data during printing.

This function does not change pure white or pure black but it changes the brightness of the intermediate colors.

The following sample shows the print result when the brightness setting is changed.



Light is selected



Normal is selected



Dark is selected

The procedure for adjusting brightness is as follows:

You can also set brightness on the **Quick Setup** tab by choosing **Photo Printing** under **Commonly Used Settings**, and then choosing **Color/Intensity Manual Adjustment** under **Additional Features**.

1. Open the [printer driver setup window](#)
2. Select the manual color adjustment

On the **Main** tab, select **Manual** for **Color/Intensity**, and click **Set...**

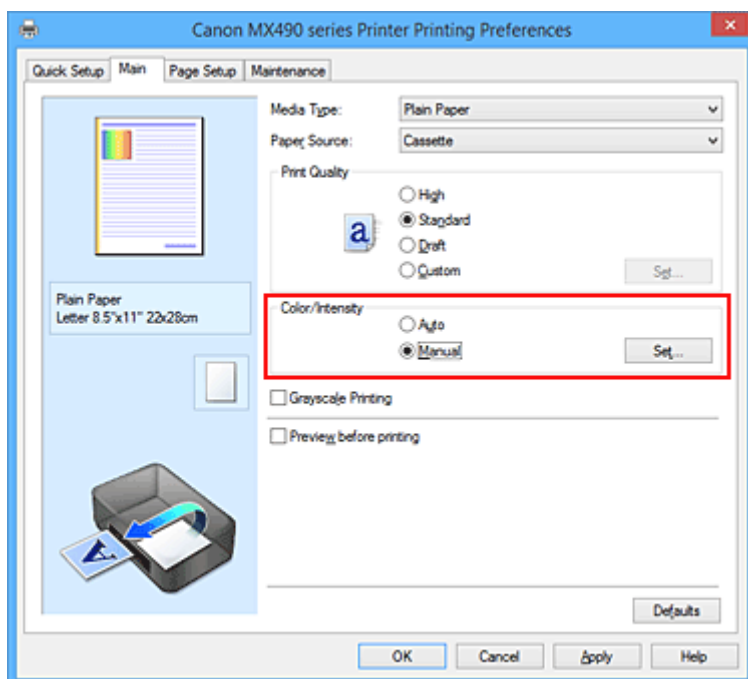

The **Manual Color Adjustment** dialog box opens.

3. Specify the brightness

Select **Light**, **Normal**, or **Dark** for **Brightness**, and click **OK**. The current settings are displayed in the settings preview on the left side of the printer driver.

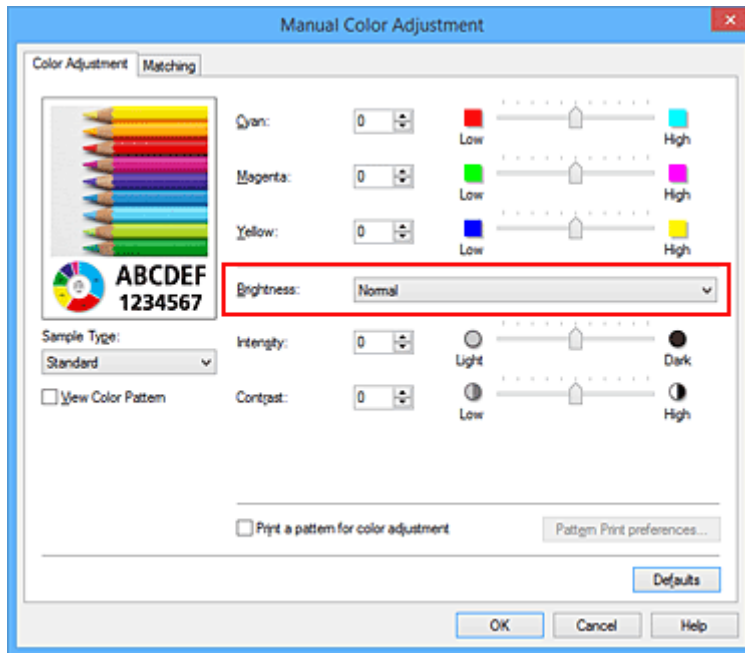

4. Complete the setup

Click **OK** on the **Main** tab.

When you execute print, the data is printed at the specified brightness.

Related Topics

- [Setting the Print Quality Level \(Custom\)](#)
- [Specifying Color Correction](#)
- [Adjusting Color Balance](#)
- [Adjusting Intensity](#)
- [Adjusting Contrast](#)

Adjusting Intensity

You can dilute (brighten) or intensify (darken) the colors of the overall image data during printing. The following sample shows the case when the intensity is increased so that all colors become more intense when the image data is printed.



No adjustment



Higher intensity

The procedure for adjusting intensity is as follows:

You can also set intensity on the **Quick Setup** tab by choosing **Photo Printing** under **Commonly Used Settings**, and then choosing **Color/Intensity Manual Adjustment** under **Additional Features**.

1. Open the [printer driver setup window](#)
2. Select the manual color adjustment

On the **Main** tab, select **Manual** for **Color/Intensity**, and click **Set...**

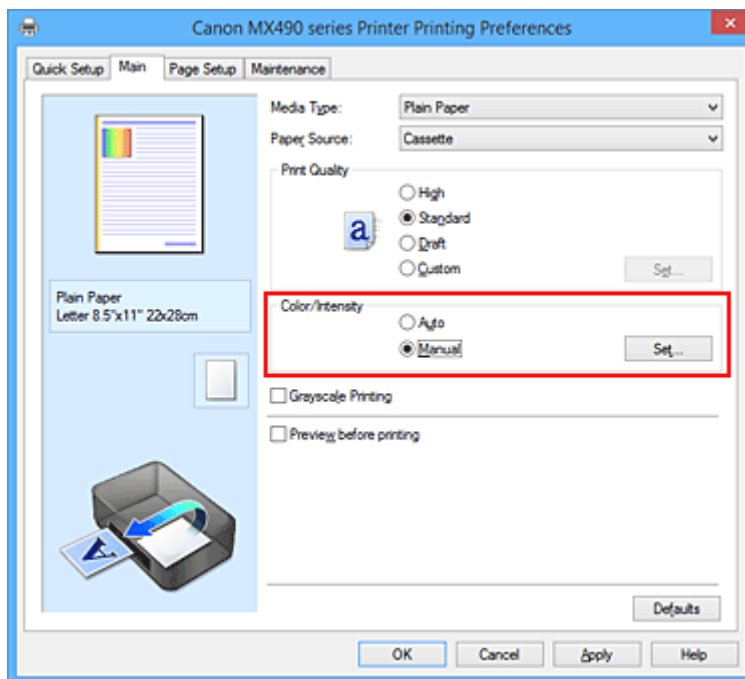

The **Manual Color Adjustment** dialog box opens.

3. Adjust intensity

Moving the **Intensity** slider to the right intensifies (darkens) the colors, and moving the slider to the left dilutes (brightens) the colors.

You can also directly enter a value linked to the slider. Enter a value in the range from -50 to 50. The current settings are displayed in the settings preview on the left side of the printer driver.

After adjusting each color, click **OK**.

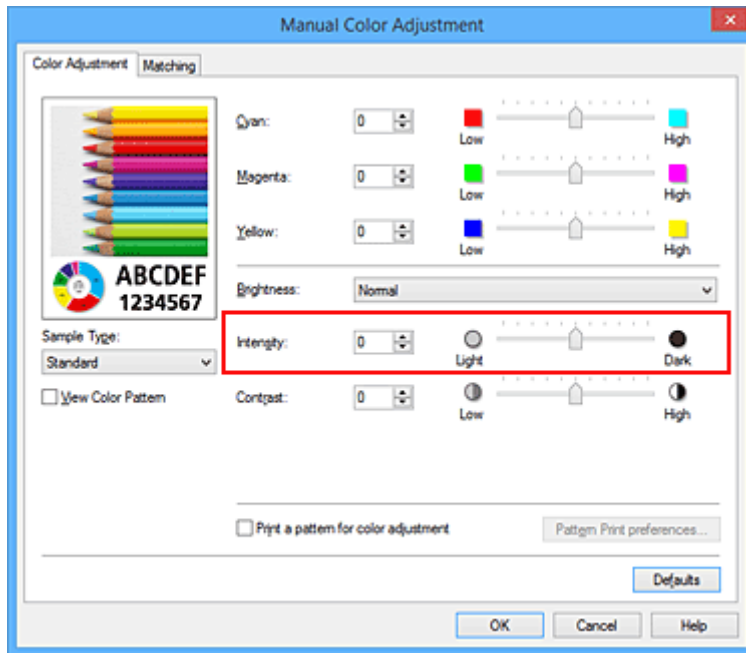

4. Complete the setup

Click **OK** on the **Main** tab.

When you execute print, the image data is printed with the adjusted intensity.

Related Topics

- [Setting the Print Quality Level \(Custom\)](#)
- [Specifying Color Correction](#)
- [Adjusting Color Balance](#)
- [Adjusting Color Balance Using Sample Patterns \(Printer Driver\)](#)
- [Adjusting Brightness](#)
- [Adjusting Contrast](#)
- [Adjusting Intensity/Contrast Using Sample Patterns \(Printer Driver\)](#)

Adjusting Contrast

You can adjust the image contrast during printing.

To make the differences between the light and dark portions of images greater and more distinct, increase the contrast. On the other hand, to make the differences between the light and dark portions of images smaller and less distinct, reduce the contrast.



No adjustment

Adjust the contrast

The procedure for adjusting contrast is as follows:

You can also set contrast on the **Quick Setup** tab by choosing **Photo Printing** under **Commonly Used Settings**, and then choosing **Color/Intensity Manual Adjustment** under **Additional Features**.

1. Open the [printer driver setup window](#)
2. Select the manual color adjustment

On the **Main** tab, select **Manual** for **Color/Intensity**, and click **Set...**

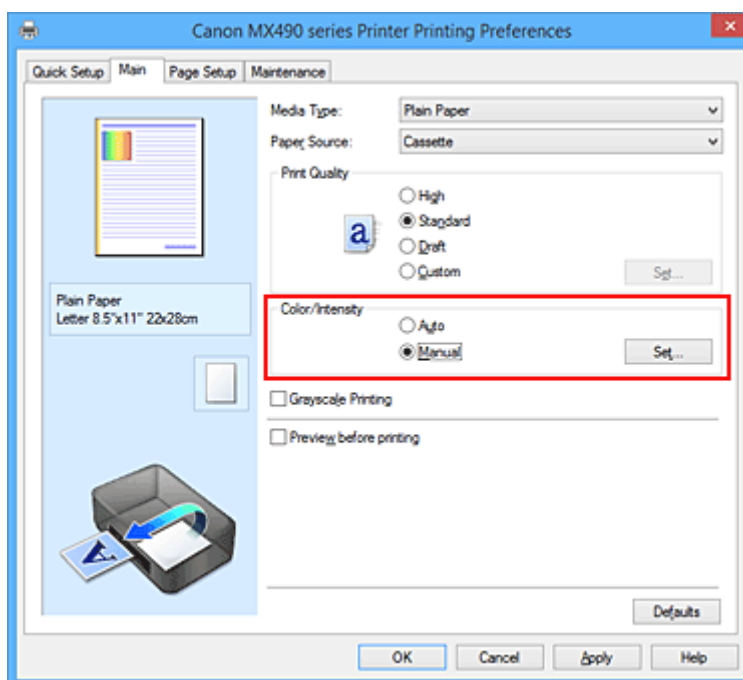

The **Manual Color Adjustment** dialog box opens.

3. Adjust the contrast

Moving the **Contrast** slider to the right increases the contrast, and moving the slider to the left decreases the contrast.

You can also directly enter a value linked to the slider. Enter a value in the range from -50 to 50. The current settings are displayed in the settings preview on the left side of the printer driver.

After adjusting each color, click **OK**.

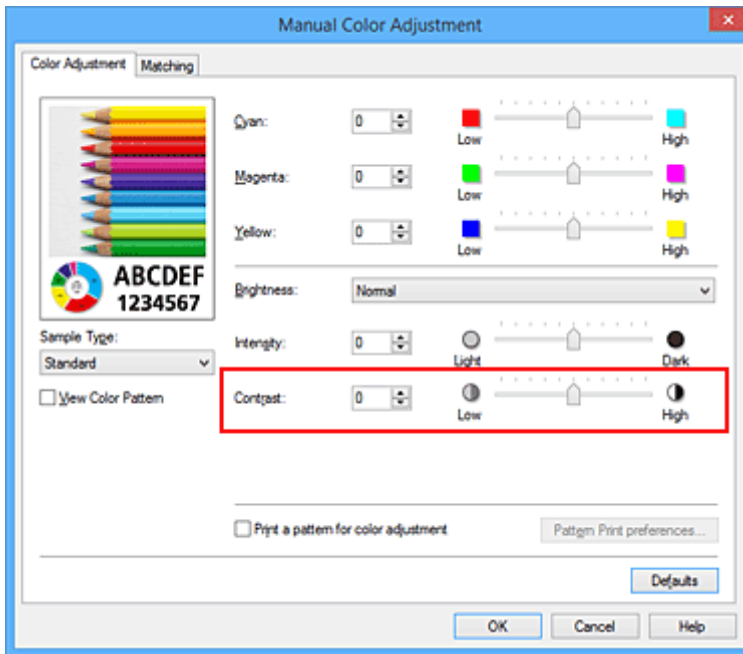

4. Complete the setup

Click **OK** on the **Main** tab.

When you execute print, the image is printed with the adjusted contrast.

Related Topics

- [Setting the Print Quality Level \(Custom\)](#)
- [Specifying Color Correction](#)
- [Adjusting Color Balance](#)
- [Adjusting Color Balance Using Sample Patterns \(Printer Driver\)](#)
- [Adjusting Brightness](#)
- [Adjusting Intensity](#)
- [Adjusting Intensity/Contrast Using Sample Patterns \(Printer Driver\)](#)

Adjusting Intensity/Contrast Using Sample Patterns (Printer Driver)

You can look at the print results of pattern print and adjust the intensity/contrast.

When you change the color balance or intensity/contrast of a document, the pattern print function prints the adjustment results in a list, together with the adjustment values.

Described below is the procedure for adjusting the intensity/contrast while looking at the pattern.

1. Open the [printer driver setup window](#)
2. Select the manual color adjustment

On the **Main** tab, select **Manual** for **Color/Intensity**, and click **Set...**

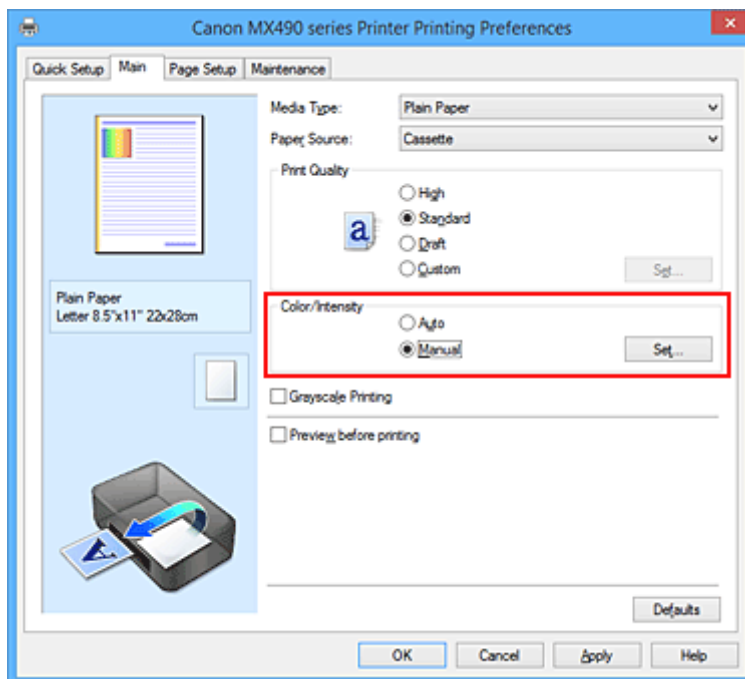

The **Manual Color Adjustment** dialog box opens.

3. Selecting pattern print

On the **Color Adjustment** tab, select the **Print a pattern for color adjustment** check box, and click **Pattern Print preferences....**

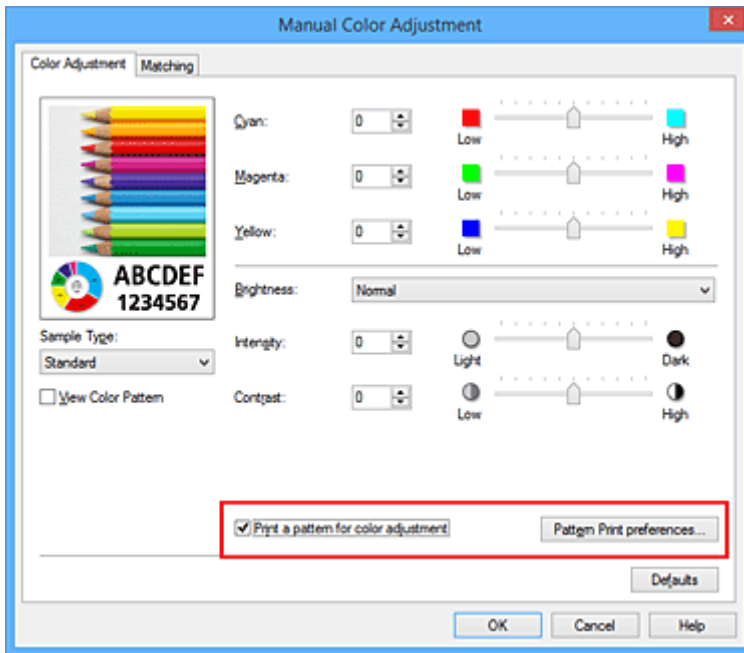

4. Setting pattern print

When the **Pattern Print** dialog box opens, set the following items, and then click **OK**.

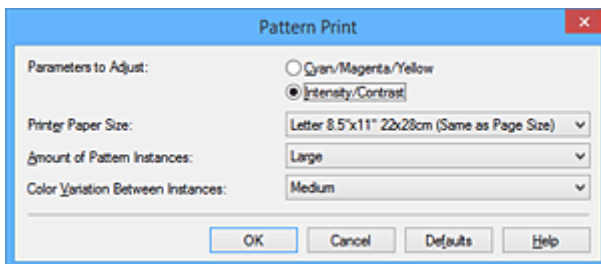

Parameters to Adjust

Select **Intensity/Contrast**.

Printer Paper Size

Select the paper size to be used for pattern printing.

➤➤➤ Note

- Depending on the paper size selected on the **Page Setup** tab, there may be sizes that cannot be selected.

Amount of Pattern Instances

Select **Largest**, **Large**, or **Small** to set the number of patterns to be printed.

➤➤➤ Note

- **Largest** and **Large** cannot be selected when certain paper sizes or output paper sizes are selected.

Color Variation Between Instances

Set the amount of color change between neighboring patterns.

➤➤➤ Note

- **Large** is about double the size of **Medium**, and **Small** is about half the size of **Medium**.

5. Checking the print results of pattern print

On the **Color Adjustment** tab, select **OK** to close the **Manual Color Adjustment** dialog box.
 On the **Main** tab, select **OK**, and then execute printing. The printer then prints a pattern in which the intensity/contrast that you set is the center value.



6. Adjusting the intensity/contrast

Look at the print results and select the image that you like best. Then enter the intensity/contrast numbers indicated at the bottom of that image into the **Intensity** and **Contrast** fields on the **Color Adjustment** tab.

Clear the **Print a pattern for color adjustment** check box, and click **OK**.

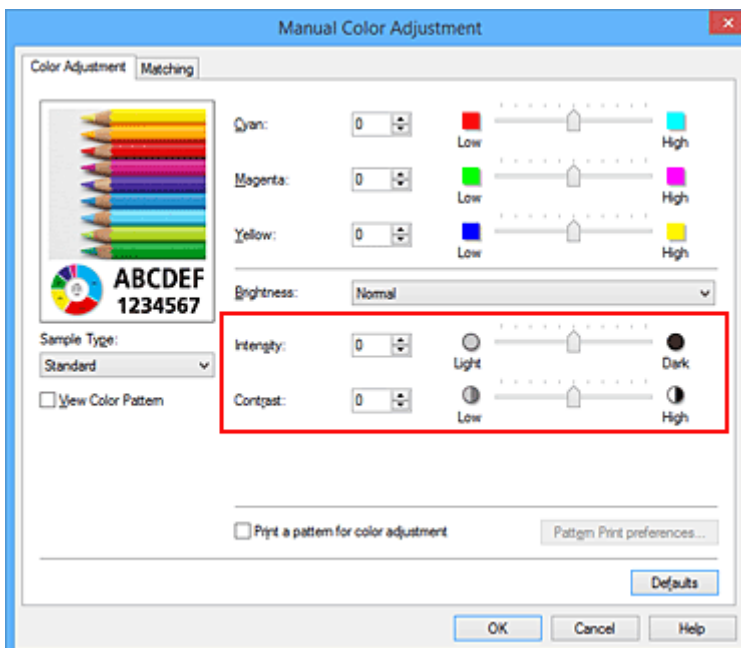

»» Note

- You can also set intensity/contrast on the **Quick Setup** tab by choosing **Photo Printing** under **Commonly Used Settings**, and then choosing **Color/Intensity Manual Adjustment** under **Additional Features**.

7. Complete the setup

Click **OK** on the **Main** tab.

Then when you execute printing, the document is printed with the intensity/contrast that was adjusted by the pattern print function.

»» Important

- When **Print a pattern for color adjustment** is selected on the **Color Adjustment** tab, the following items are grayed out and cannot be set:
 - **Preview before printing** on the **Main** tab
 - **Stapling Side** and **Specify Margin...** on the **Page Setup** tab (When **Duplex Printing (Manual)** is set, only **Stapling Side** can be set.)
- You can print a pattern only if the **Page Layout** setting on the **Page Setup** tab is **Normal-size** or **Borderless**.
- Depending on your application software, this function may not be available.

Related Topics

- [Adjusting Color Balance](#)
- [Adjusting Color Balance Using Sample Patterns \(Printer Driver\)](#)
- [Adjusting Intensity](#)
- [Adjusting Contrast](#)

Overview of the Printer Driver

- ▶ **Canon IJ Printer Driver**
- ▶ **How to Open the Printer Driver Setup Window**
- ▶ **Canon IJ Status Monitor**
- ▶ **Checking the Ink Status from Your Computer**
- ▶ **Canon IJ Preview**
- ▶ **Deleting the Undesired Print Job**
- ▶ **Instructions for Use (Printer Driver)**

Canon IJ Printer Driver

The Canon IJ printer driver (called printer driver below) is a software that is installed on your computer for printing data with this printer.

The printer driver converts the print data created by your application software into data that your printer can understand, and sends the converted data to the printer.

Because different models support different print data formats, you need a printer driver for the specific model you are using.

Printer Driver Types

On Windows Vista SP1 or later, you can install the XPS printer driver in addition to the regular printer driver.

The XPS printer driver is suited to print from an application software that supports XPS printing.

►► Important

- To use the XPS printer driver, the standard printer driver must already be installed on your computer.

Installing the Printer Driver

- To install the regular printer driver, load the Setup CD-ROM that comes with the printer, and then install the driver from **Start Setup Again**.
- To install the XPS printer driver, load the Setup CD-ROM that comes with the printer, and then select **XPS Driver** from **Add Software**.

Specifying the Printer Driver

To specify the printer driver, open the **Print** dialog box of the application software you are using, and select "XXX Printer" (where "XXX" is your model name) to specify the regular printer driver or select "XXX Printer XPS" (where "XXX" is your model name) to specify the XPS printer driver.

Displaying the Manual from the Printer Driver

To display a description of a tab in the printer driver setup window, click the **Help** button found on the tab.

Related Topic

- [How to Open the Printer Driver Setup Window](#)

How to Open the Printer Driver Setup Window

You can display the printer driver setup window from the application software in use or from the printer icon.

Open the Printer Driver Setup Window through the Application Software

Follow the procedure below to configure printing profile when printing.

1. Select the command that you perform printing on the application software

In general, select **Print** on the **File** menu to open the **Print** dialog box.

2. Select your model name and click **Preferences** (or **Properties**)

The printer driver setup window appears.

▶▶▶ Note

- Depending on application software you use, command names or menu names may vary and there may be more steps. For details, refer to the user's manual of your application software.

Opening the Printer Driver Setup Window from the Printer Icon

Follow the procedure below to perform printer maintenance operations such as print head cleaning, or to configure a printing profile that is common to all application software.

1. Select as described below:

- If you are using Windows 8.1 or Windows 8, from the Desktop charms, select **Settings** -> **Control Panel** -> **Hardware and Sound** -> **Devices and Printers**.
- If you are using Windows 7, select the **Start** menu -> **Devices and Printers**.
- If you are using Windows Vista, select the **Start** menu -> **Control Panel** -> **Hardware and Sound** -> **Printers**.
- If you are using Windows XP, select the **start** menu -> **Control Panel** -> **Printers and Other Hardware** -> **Printers and Faxes**.

2. Right-click your model name icon, and then select **Printing preferences** from the displayed menu

The printer driver setup window appears.

▶▶▶ Important

- Opening the printer driver setup window through **Printer properties** (Windows 8.1, Windows 8, Windows 7) or **Properties** (Windows Vista, Windows XP) displays such tabs regarding the Windows functions as the **Ports** (or **Advanced**) tab. Those tabs do not appear when opening through **Printing preferences** or application software. For tabs regarding Windows functions, refer to the user's manual for the Windows.

Canon IJ Status Monitor

The Canon IJ Status Monitor is an application software that shows the status of the printer and the progress of printing. You will know the status of the printer with graphics, icons, and messages.

Launching the Canon IJ Status Monitor

The Canon IJ Status Monitor launches automatically when print data is sent to the printer. When launched, the Canon IJ Status Monitor appears as a button on the task bar.



Click the button of the status monitor displayed on the task bar. The Canon IJ Status Monitor appears.

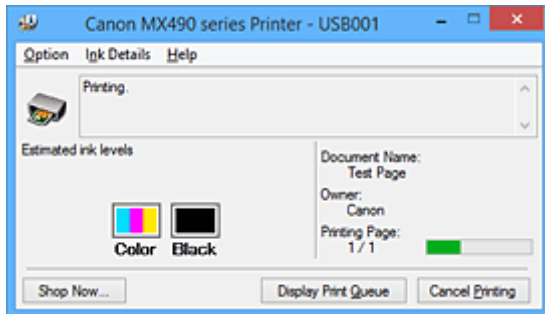

►► Note

- To open the Canon IJ Status Monitor when the printer is not printing, open the [printer driver setup window](#) and click **View Printer Status** on the **Maintenance** tab.
- The information displayed on the Canon IJ Status Monitor may differ depending on the country or region where you are using your printer.

When Errors Occur

The Canon IJ Status Monitor is automatically displayed if an error occurs (e.g., if the printer runs out of paper or if the ink is low).

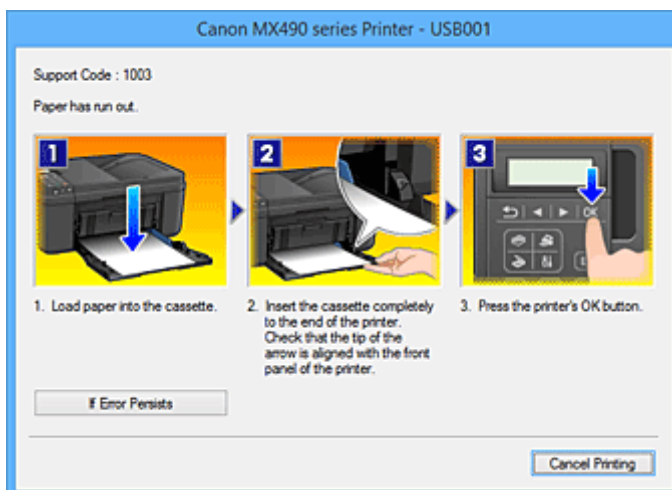

In such cases, take the appropriate action as described.

Checking the Ink Status from Your Computer

You can check the remaining ink level and the FINE cartridge types for your model.

1. Open the [printer driver setup window](#)
2. Launching the Canon IJ Status Monitor

On the **Maintenance** tab, click **View Printer Status**.

The Canon IJ Status Monitor opens and displays an image of the ink status.

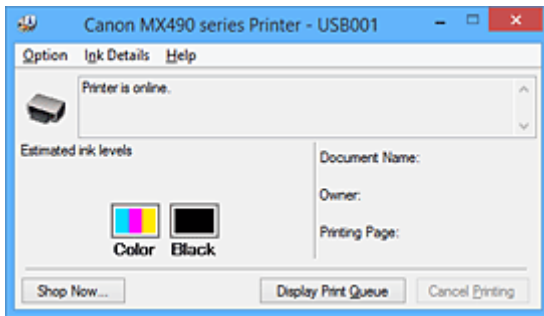

►► Note

- The information displayed on the Canon IJ Status Monitor may differ depending on the country or region where you are using your printer.

3. If necessary, click **Ink Details**

You can check the ink-related information.

If a warning or error related to the remaining ink amount occurs, a notification icon is displayed at the top of the image in the **Ink Details** dialog box.

In such cases, take the appropriate action as described on the screen.

►► Note

- You can also display the **Ink Details** dialog box by selecting the ink icon on the Canon IJ Status Monitor.

Canon IJ Preview

The Canon IJ Preview is an application software that displays what the print result will look like before a document is actually printed.

The preview reflects the information that is set within the printer driver and allows you to check the document layout, print order, and number of pages. You can also change the media type settings.

When you want to display a preview before printing, open the [printer driver setup window](#), click the **Main** tab, and check the **Preview before printing** check box.

When you do not want to display a preview before printing, uncheck the check box.

Important

- If you are using the XPS printer driver, see "[Editing the Print Document or Reprinting from the Print History](#)."

Related Topic

- [Displaying the Print Results before Printing](#)

Deleting the Undesired Print Job

If you are using the XPS printer driver, replace "Canon IJ Status Monitor" with "Canon IJ XPS Status Monitor" when reading this information.

If the printer does not start printing, canceled or failed print job data may be remaining. Delete the undesired print job by using the Canon IJ Status Monitor.

1. Display the Canon IJ Status Monitor

Click the icon of the Canon IJ Status Monitor displayed on the task bar.
The Canon IJ Status Monitor appears.

2. Display the print jobs

Click **Display Print Queue**.
The print queue window opens.

3. Delete the print jobs

Select **Cancel All Documents** from the **Printer** menu.
When the confirmation message appears, click **Yes**.
The deletion of the print job is complete.

▶▶▶ Important

- Users who have not been granted access permission for printer management cannot delete the print job of another user.

▶▶▶ Note

- When you perform this operation, all print jobs are deleted. If the print queue list contained a necessary print job, start the printing process over from the beginning.

Instructions for Use (Printer Driver)

This printer driver is subject to the following restrictions. Keep the following points in mind when using the printer driver.

Restrictions on the Printer Driver

- With some applications, the **Copies** setting in the **Page Setup** tab of the printer driver may not be enabled.

In this case, use the copies setting in the **Print** dialog box of the application software.

- If the selected **Language** in the **About** dialog box of the **Maintenance** tab does not match the operating system interface language, the printer driver setup window may not be displayed properly.
- Do not change the **Advanced** tab items of the printer properties. If you change any of the items, you will not be able to use the following functions correctly.

Also, if **Print to file** is selected in the **Print** dialog box of the application software and with applications that prohibit EMF spooling, such as Adobe Photoshop LE and MS Photo Editor, the following functions will not operate.

- **Preview before printing** on the **Main** tab
 - **Prevention of Print Data Loss** in the **Print Options** dialog box on the **Page Setup** tab
 - **Page Layout, Tiling/Poster, Booklet, Duplex Printing (Manual), Specify Margin..., Print from Last Page, Collate, and Stamp/Background... (Stamp...)** on the **Page Setup** tab
 - **Print a pattern for color adjustment** on the **Color Adjustment** tab in the **Manual Color Adjustment** dialog box
- Since the resolution in the preview display differs from the printing resolution, text and lines in the preview display may appear different from the actual print result.
 - With some applications, the printing is divided into multiple print jobs.
To cancel printing, delete all divided print jobs.
 - If image data is not printed correctly, display the **Print Options** dialog box from the **Page Setup** tab and change the setting of **Disable ICM required from the application software**. This may solve the problem.

▶▶ Note

- **Disable ICM required from the application software** cannot be used when the XPS printer driver is used.

- Do not start up the Canon IJ Network Tool while printing.
- Do not print when the Canon IJ Network Tool is running.

Points to Note About Applications with Restrictions

- There are following restrictions in Microsoft Word (Microsoft Corporation).
 - When Microsoft Word has the same printing functions as the printer driver, use Word to specify them.
 - When **Fit-to-Page, Scaled, or Page Layout** is used for **Page Layout** on the **Page Setup** tab of the printer driver, the document may not print normally in certain versions of Word.
 - When **Page Size** in Word is set to "XXX Enlarge/Reduce", the document may not print normally in certain versions of Word.

If this happens, follow the procedure below.

1. Open Word's **Print** dialog box.
2. Open the [printer driver setup window](#), and on the **Page Setup** tab, set **Page Size** to the same paper size that you specified in Word.

3. Set the **Page Layout** that you want, and then click **OK** to close the window.
 4. Without starting printing, close the **Print** dialog box.
 5. Open Word's **Print** dialog box again.
 6. Open the printer driver setup window and click **OK**.
 7. Start printing.
- If bitmap printing is enabled in Adobe Illustrator (Adobe Systems Incorporated), printing may take time or some data may not be printed. Print after unchecking the **Bitmap Printing** check box in the **Print** dialog box.

Printer Driver Description

- ▶ **Quick Setup tab Description**
- ▶ **Main tab Description**
- ▶ **Page Setup tab Description**
- ▶ **Maintenance tab Description**
- ▶ **Canon IJ Preview Description**
- ▶ **Canon IJ XPS Preview Description**
- ▶ **Canon IJ Status Monitor Description**

Quick Setup tab Description

The **Quick Setup** tab is for registering commonly used print settings. When you select a registered setting, the printer automatically switches to the preset items.

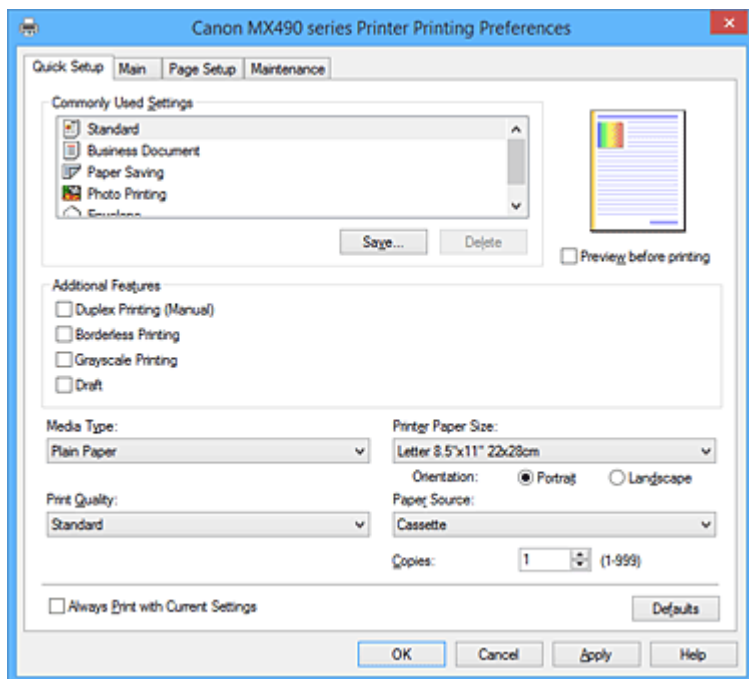

Commonly Used Settings

The names and icons of frequently used printing profiles are registered. When you select a printing profile according to the purpose of the document, settings that match the purpose are applied.

In addition, functions that are thought to be useful for the selected printing profile are displayed in **Additional Features**.

You can also change a printing profile and register it under a new name. You can delete the registered printing profile.

You can rearrange the profiles either by dragging the individual profiles or by holding down the Ctrl key and pressing the up or down arrow keys.

Standard

These are the factory settings.

If **Page Size**, **Orientation**, and **Copies** were set from the application software, those settings have priority.

Business Document

Select this setting when printing a general document.

If **Page Size**, **Orientation**, and **Copies** were set from the application software, those settings have priority.

Paper Saving

Select this setting to save paper when printing a general document. The **2-on-1 Printing** and **Duplex Printing (Manual)** check boxes are checked automatically.

If **Page Size**, **Orientation**, and **Copies** were set from the application software, those settings have priority.

Photo Printing

If you select this setting when printing a photo, the photo paper and photo size generally used are set. The **Borderless Printing** check box is checked automatically.

If **Orientation** and **Copies** were set from the application software, those settings have priority.

Envelope

If you select this setting for printing an envelope, **Media Type** is set automatically to **Envelope**. In the **Envelope Size Setting** dialog box, select the size of the envelope to be used.

▶▶▶ Note

- The combination of the **Additional Features** that was displayed for the printing profile that had been selected when the added printing profile was saved is also displayed when that added printing profile is selected.

Save...

Displays the [Save Commonly Used Settings dialog box](#).

Click this button when you want to save the information that you set on the **Quick Setup**, **Main**, and **Page Setup** tabs to **Commonly Used Settings**.

Delete

Deletes a registered printing profile.

Select the name of the setting to be deleted from **Commonly Used Settings**, and click **Delete**. When a confirmation message is displayed, click **OK** to delete the specified printing profile.

▶▶▶ Note

- Printing profiles that are registered in the initial settings cannot be deleted.

Settings Preview

The paper illustration shows how the original will be laid out on a sheet of paper.

You can check an overall image of the layout.

Preview before printing

Shows what the print result will look like before you actually print the data.

Check this check box to display a preview before printing.

Uncheck this check box if you do not want to display a preview.

▶▶▶ Important

- To use the Canon IJ XPS Preview, you must have Microsoft .NET Framework 4 Client Profile installed on your computer.

Additional Features

Displays the frequently used, convenient functions for the printing profile that you selected for **Commonly Used Settings** on the **Quick Setup** tab.

When you move the mouse pointer near a function that can be changed, a description of that function is displayed.

To enable a function, check the corresponding check box.

For some functions, you can set detailed settings from the **Main** and **Page Setup** tabs.

▶▶▶ Important

- Depending on the printing profiles, certain function may be grayed out and you will not be able to change them.

2-on-1 Printing

Prints two pages of the document, side by side, on one sheet of paper.

To change the page sequence, click the **Page Setup** tab, select **Page Layout** for **Page Layout**, and click **Specify...**. Then in the [Page Layout Printing dialog box](#) that appears, specify the **Page Order**.

4-on-1 Printing

Prints four pages of the document, side by side, on one sheet of paper.

To change the page sequence, click the **Page Setup** tab, select **Page Layout** for **Page Layout**, and click **Specify...** Then in the [Page Layout Printing dialog box](#) that appears, specify the **Page Order**.

Duplex Printing (Manual)

Select whether to print the document to both sides of the paper manually or to one side of the paper.

To change the staple side or the margins, set the new values from the **Page Setup** tab.

Borderless Printing

Performs borderless printing without any margins on the paper.

With the borderless printing function, the document to be printed is enlarged, so that it extends slightly off the paper. In other words, the document is printed without any margin.

To adjust the amount that the document extends beyond the paper, click the **Page Setup** tab, choose **Borderless**, and enter the value in **Amount of Extension**.

Grayscale Printing

This function converts the data to monochrome data when printing your document.

Draft

This setting is appropriate for test printing.

Rotate 180 degrees

Prints the document by rotating it 180 degrees against the paper feed direction.

The width of print area and the amount of extension that are configured in other application software will be reversed vertically and horizontally.

Color/Intensity Manual Adjustment

Select when you set the **Color Correction** method and individual settings such as **Cyan, Magenta, Yellow, Brightness, Intensity, and Contrast**, etc.

Media Type

Selects a type of printing paper.

Select a media type that matches the paper that is loaded in the printer. This ensures that printing is carried out properly for the specified paper.

Printer Paper Size

Selects the size of paper actually loaded into the printer.

Normally, the paper size is set automatically according to the output paper size setting, and the document is printed with no scaling.

When you set **2-on-1 Printing** or **4-on-1 Printing** in **Additional Features**, you can manually set the paper size with **Page Size** on the **Page Setup** tab.

If you select a paper size that is smaller than the **Page Size**, the document size will be reduced. If you select a paper size that is larger, the document size will be enlarged.

Also if you select **Custom...**, the [Custom Paper Size dialog box](#) opens and allows you to specify any vertical and horizontal dimensions for the paper size.

Orientation

Selects the printing orientation.

If the application used to create your document has a similar function, select the same orientation that you selected in that application.

Portrait

Prints the document so that its top and bottom positions are unchanged relative to the paper feed direction. This is the default setting.

Landscape

Prints the document by rotating it 90 degrees relative to the paper feed direction.

You can change the rotation direction by going to the **Maintenance** tab, opening the **Custom Settings** dialog box, and then using **Rotate 90 degrees left when orientation is [Landscape]** check box.

To rotate the document 90 degrees to the left when printing, select the **Rotate 90 degrees left when orientation is [Landscape]** check box.

Print Quality

Selects your desired printing quality.

Select one of the following to set the print quality level that is appropriate for the purpose.

To set the print quality level individually, click the **Main** tab, and for **Print Quality**, select **Custom**. The **Set...** becomes enabled. Click **Set...** to open the [Custom dialog box](#), and then specify the desired settings.

High

Gives priority to print quality over printing speed.

Standard

Prints with average speed and quality.

Draft

This setting is appropriate for test printing.

Paper Source

Shows the source from which paper is supplied.

Cassette

Paper is always supplied from the cassette.

Copies

Specifies the number of copies you want to print. You can specify a value from 1 to 999.

▶▶▶ Important

- When the application software that you used to create the document has the same function, specify the settings on the printer driver. However, if the print results are not acceptable, specify the function settings on the application software.

Always Print with Current Settings

Prints documents with the current settings starting from the next print execution.

When you select this function and then close the [printer driver setup window](#), the information that you set on the **Quick Setup**, **Main**, and **Page Setup** tabs are saved and printing with the same settings is possible starting from the next print execution.

▶▶▶ Important

- If you log on with a different user name, the settings that were set when this function was enabled are not reflected in the print settings.
- If a setting was specified on the application software, it has priority.

Defaults

Restores all the settings you have changed to their default values.

Click this button to return all settings on the **Quick Setup**, **Main**, and **Page Setup** tabs to their default values (factory settings).

Save Commonly Used Settings dialog box

This dialog box allows you to save the information that you set on the **Quick Setup**, **Main**, and **Page Setup** tabs and add the information to the **Commonly Used Settings** list on the **Quick Setup** tab.

Name

Enter the name for the printing profile you wish to save.

Up to 255 characters can be entered.

The name appears, with its associated icon, in the **Commonly Used Settings** list on the **Quick Setup** tab.

Options...

Opens the [Save Commonly Used Settings dialog box](#).

Changes the details of printing profile to be saved.

Save Commonly Used Settings dialog box

Select the icons of the printing profiles to be registered to **Commonly Used Settings**, and change the items to be saved in the printing profiles.

Icon

Select the icon for the printing profile you wish to save.

The selected icon appears, with its name, in the **Commonly Used Settings** list on the **Quick Setup** tab.

Save the paper size setting

Saves the paper size to the printing profile in **Commonly Used Settings**.

To apply the saved paper size when the printing profile is selected, check this check box.

If this check box is unchecked, the paper size is not saved, and consequently the paper size setting is not applied when the printing profile is selected. Instead the printer prints with the paper size specified with the application software.

Save the orientation setting

Saves the **Orientation** to the printing profile in **Commonly Used Settings**.

To apply the saved print orientation when the printing profile is selected, check this check box.

If this check box is unchecked, the print orientation is not saved, and consequently the **Orientation** setting is not applied when the printing profile is selected. Instead the printer prints with the print orientation specified with the application software.

Save the copies setting

Saves the **Copies** setting to the printing profile in **Commonly Used Settings**.

To apply the saved copies setting when the printing profile is selected, check this check box.

If this check box is unchecked, the copies setting is not saved, and consequently the **Copies** setting is not applied when the printing profile is selected. Instead the printer prints with the copies setting specified with the application software.

Custom Paper Size dialog box

This dialog box allows you to specify the size (width and height) of the custom paper.

Units

Select the unit for entering a user-defined paper size.

Paper Size

Specifies the **Width** and the **Height** of the custom paper. Measurement is shown according to the units specified in **Units**.

Related Topics

- [Printing with Easy Setup](#)
- [Setting a Page Size and Orientation](#)
- [Setting the Number of Copies and Printing Order](#)
- [Execute Borderless Printing](#)
- [Duplex Printing](#)
- [Setting Up Envelope Printing](#)
- [Displaying the Print Results before Printing](#)
- [Setting Paper Dimensions \(Custom Size\)](#)
- [Printing a Color Document in Monochrome](#)
- [Specifying Color Correction](#)
- [Adjusting Color Balance](#)
- [Adjusting Color Balance Using Sample Patterns \(Printer Driver\)](#)
- [Adjusting Brightness](#)
- [Adjusting Intensity](#)
- [Adjusting Contrast](#)
- [Adjusting Intensity/Contrast Using Sample Patterns \(Printer Driver\)](#)
- [Registering a Frequently Used Printing Profile](#)

Main tab Description

The **Main** tab allows you to create a basic print setup in accordance with the media type. Unless special printing is required, normal printing can be performed just by setting the items on this tab.

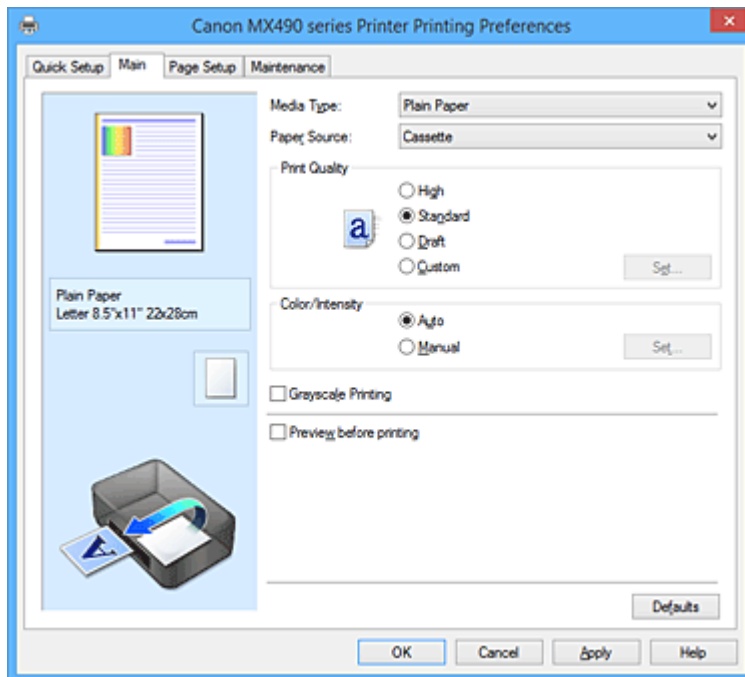

Settings Preview

The paper illustration shows how the original will be laid out on a sheet of paper. You can check an overall image of the layout.

Media Type

Selects a type of printing paper.

Select a media type that matches the paper that is loaded in the printer. This ensures that printing is carried out properly for the specified paper.

Paper Source

Shows the source from which paper is supplied.

Cassette

Paper is always supplied from the cassette.

Print Quality

Selects your desired printing quality.

Select one of the following to set the print quality level that is appropriate for the purpose.

►►► Important

- Depending on the **Media Type** settings, the same print results may be produced even if the **Print Quality** is changed.

High

Gives priority to print quality over printing speed.

Standard

Prints with average speed and quality.

Draft

This setting is appropriate for test printing.

Custom

Select this when you want to set the printing quality level individually.

Set...

Select **Custom** for **Print Quality** to enable this button.

Open the [Custom dialog box](#). You can then individually set the print quality level.

Color/Intensity

Selects color adjustment method.

Auto

Cyan, Magenta, Yellow, Brightness, Intensity, and Contrast, and so on are adjusted automatically.

Manual

Select when you set the individual settings such as **Cyan, Magenta, Yellow, Brightness, Intensity, and Contrast**, etc. and **Color Correction** method.

Set...

Select **Manual** for **Color/Intensity** to enable this button.

In the **Manual Color Adjustment** dialog box, you can adjust individual color settings such as **Cyan, Magenta, Yellow, Brightness, Intensity, and Contrast** on the [Color Adjustment tab](#), and select the **Color Correction** method on the [Matching tab](#).

▶▶▶ Note

- If you want to use an ICC profile to adjust colors, use the **Manual Color Adjustment** dialog box to set the profile.

Grayscale Printing

This function converts the data to monochrome data when printing your document.

Check this check box to print a color document in monochrome.

Preview before printing

Shows what the print result will look like before you actually print the data.

Check this check box to display a preview before printing.

▶▶▶ Important

- To use the Canon IJ XPS Preview, you must have Microsoft .NET Framework 4 Client Profile installed on your computer.

Defaults

Restores all the settings you have changed to their default values.

Clicking this button restores all the settings on the current screen to their default values (factory settings).

Custom dialog box

Set the quality level, and select the desired print quality.

Quality

You can use the slider bar to adjust the print quality level.

▶▶▶ Important

- Certain print quality levels cannot be selected depending on the settings of **Media Type**.

▶▶▶ Note

- The **High, Standard, or Draft** print quality modes are linked with the slider bar. Therefore when the slider bar is moved, the corresponding quality and value are displayed on the left. This is the same as when the corresponding radio button is selected for **Print Quality** on the **Main** tab.

Color Adjustment Tab

This tab allows you to adjust the color balance by changing the settings of the **Cyan, Magenta, Yellow, Brightness, Intensity,** and **Contrast** options.

Preview

Shows the effect of color adjustment.

The color and brightness change when each item is adjusted. You can check the color adjustment status easily by changing the preview image to one similar to the results to be printed with **Sample Type**.

▶▶▶ Note

- The graphic is in monochrome when the **Grayscale Printing** check box is checked.

Sample Type

Selects a preview image displayed on the **Color Adjustment** tab.

If necessary, select a preview image from **Standard, Landscape,** or **Graphics,** whichever is most similar to the print results.

View Color Pattern

Displays a pattern for checking color changes produced by color adjustment.

If you want to display the preview image with a color pattern, check this check box.

Cyan / Magenta / Yellow

Adjusts the strengths of **Cyan, Magenta,** and **Yellow.**

Moving the slider to the right makes a color stronger, and moving the slider to the left makes a color weaker.

You can also directly enter a value linked to the slider. Enter a value in the range from -50 to 50.

This adjustment changes the relative amount of ink of each color used, which alters the total color balance of the document. Use your application if you want to change the total color balance significantly. Use the printer driver only if you want to adjust the color balance slightly.

▶▶▶ Important

- When **Grayscale Printing** is checked on the **Main** tab, **Cyan, Magenta,** and **Yellow** appear grayed out and are unavailable.

Brightness

Selects the brightness of your print.

You cannot change the levels of pure white and black. However, the brightness of the colors between white and black can be changed.

Intensity

Adjusts the overall intensity of your print.

Moving the slider to the right increases the intensity, and moving the slider to the left decreases the intensity.

You can also directly enter a value linked to the slider. Enter a value in the range from -50 to 50.

Contrast

Adjusts the contrast between light and dark in the image to be printed.

Moving the slider to the right increases the contrast, moving the slider to the left decreases the contrast.

You can also directly enter a value linked to the slider. Enter a value in the range from -50 to 50.

Print a pattern for color adjustment

When the color balance or intensity/contrast is changed, the pattern printing function prints a list of the adjustment results along with the adjustment values.

Select this function when printing a pattern for color adjustment.

Pattern Print preferences...

Check **Print a pattern for color adjustment** to enable this button.

The [Pattern Print dialog box](#) opens and allows you to set pattern printing settings.

Pattern Print dialog box

Performs the setup for printing of patterns that allow you to check the color balance and intensity/contrast of documents.

Parameters to Adjust

Select the item to be checked by pattern printing.

Cyan/Magenta/Yellow

Prints a pattern that allows you to check the cyan/magenta/yellow balance.

▶▶▶ Important

- When **Grayscale Printing** is checked on the **Main** tab, **Cyan/Magenta/Yellow** appear grayed out and are unavailable.

Intensity/Contrast

Prints a pattern that allows you to check the intensity/contrast balance.

Printer Paper Size

Selects the paper size to be used for pattern printing.

This setting is linked to **Printer Paper Size** on the **Page Setup** tab.

▶▶▶ Note

- Depending on the paper size selected on the **Page Setup** tab, there may be sizes that cannot be selected.

Amount of Pattern Instances

Sets the number of patterns to be printed.

You can select from **Largest**, **Large**, and **Small**. When you select a pattern size, the number of patterns that can be printed is as follows:

▶▶▶ Note

- **Largest** and **Large** cannot be selected when certain paper sizes or output paper sizes are selected.
- The setting preview on the **Main** tab displays an image that allows you to check the overall layout.

Largest

Cyan/Magenta/Yellow 37

Intensity/Contrast 49

Large

Cyan/Magenta/Yellow 19

Intensity/Contrast 25

Small

Cyan/Magenta/Yellow 7

Intensity/Contrast 9

Color Variation Between Instances

Sets the amount of color change between neighboring patterns.

Select from **Large**, **Medium**, and **Small**. **Large** produces a large amount of change, and **Small** produces a small amount of change.

▶▶▶ Note

- **Large** is about double the size of **Medium**, and **Small** is about half the size of **Medium**.

Matching Tab

Allows you to select the method for adjusting colors to match the type of document to be printed.

Color Correction

Allows you to select **Driver Matching**, **ICM (ICC Profile Matching)**, or **None** to match the purpose of the print operation.

▶▶▶ Important

- When **Grayscale Printing** is checked on the **Main** tab, **Color Correction** appears grayed out and is unavailable.

Driver Matching

With Canon Digital Photo Color, you can print sRGB data with color tints that most people prefer.

ICM (ICC Profile Matching)

Adjusts the colors by using an ICC profile when printing.

Specify the input profile to be used.

▶▶▶ Important

- If the application software is set so that ICM is disabled, **ICM (ICC Profile Matching)** is unavailable for **Color Correction** and the printer may not be able to print the image data properly.

None

Disables color adjustment with the printer driver.

Input Profile

Specifies the input profile to be used when you select **ICM (ICC Profile Matching)** for **Color Correction**.

Standard

The standard printer profile (sRGB), which supports the color space of ICM, is used. This is the default setting.

Adobe RGB (1998)

The Adobe RGB profile, which supports a wider color space than sRGB, is used.

▶▶▶ Important

- **Adobe RGB (1998)** is not displayed when input profiles of Adobe RGB are not installed.

▶▶▶ Note

- In the XPS printer driver, **ICM** has become **ICC Profile Matching**.

Related Topics

- [Setting the Print Quality Level \(Custom\)](#)
- [Adjusting Color Balance](#)

- [Adjusting Brightness](#)
- [Adjusting Intensity](#)
- [Adjusting Contrast](#)
- [Adjusting Color Balance Using Sample Patterns \(Printer Driver\)](#)
- [Adjusting Intensity/Contrast Using Sample Patterns \(Printer Driver\)](#)
- [Specifying Color Correction](#)
- [Adjusting Colors with the Printer Driver](#)
- [Printing with ICC Profiles](#)
- [Printing a Color Document in Monochrome](#)
- [Displaying the Print Results before Printing](#)

Page Setup tab Description

The **Page Setup** tab allows you to determine how a document is to be arranged on the paper. Also, this tab allows you to set the number of copies and the order of printing. If the application which created the document has a similar function, set them with the application.

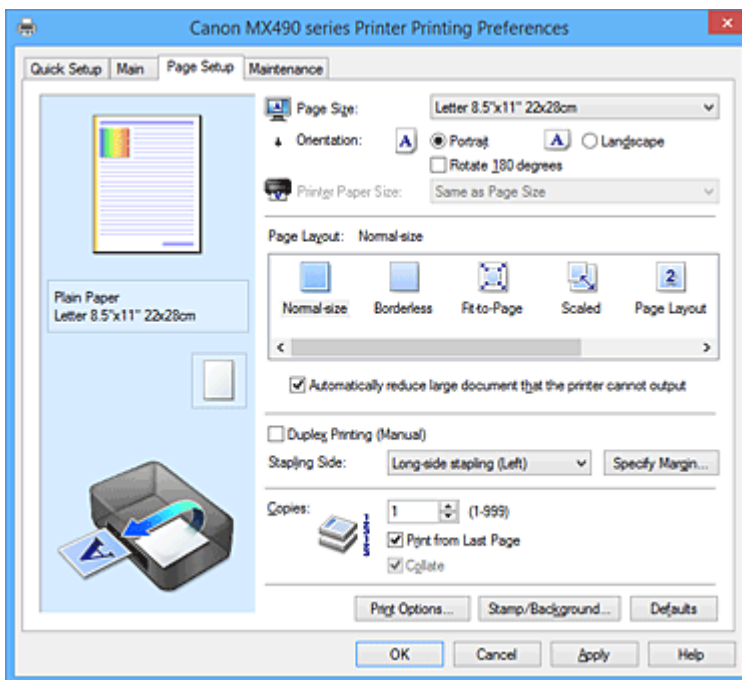

Settings Preview

The paper illustration shows how the original will be laid out on a sheet of paper. You can check an overall image of the layout.

Page Size

Selects a page size.

Ensure that you select the same page size as you selected within the application.

If you select **Custom...**, the [Custom Paper Size dialog box](#) opens and allows you to specify any vertical and horizontal dimensions for the paper size.

Orientation

Selects the printing orientation.

If the application used to create your document has a similar function, select the same orientation that you selected in that application.

Portrait

Prints the document so that its top and bottom positions are unchanged relative to the paper feed direction. This is the default setting.

Landscape

Prints the document by rotating it 90 degrees relative to the paper feed direction.

You can change the rotation direction by going to the **Maintenance** tab, opening the **Custom Settings** dialog box, and then using **Rotate 90 degrees left when orientation is [Landscape]** check box.

To rotate the document 90 degrees to the left when printing, select the **Rotate 90 degrees left when orientation is [Landscape]** check box.

Rotate 180 degrees

Prints the document by rotating it 180 degrees against the paper feed direction.

The width of print area and the amount of extension that are configured in other application software will be reversed vertically and horizontally.

Printer Paper Size

Selects the size of paper actually loaded into the printer.

The default setting is **Same as Page Size** to perform normal-sized printing.

You can select a printer paper size when you select **Fit-to-Page**, **Scaled**, **Page Layout**, **Tiling/Poster**, or **Booklet** for **Page Layout**.

If you select a paper size that is smaller than the **Page Size**, the document size will be reduced. If you select a paper size that is larger, the document size will be enlarged.

Also if you select **Custom...**, the [Custom Paper Size dialog box](#) opens and allows you to specify any vertical and horizontal dimensions for the paper size.

Page Layout

Selects the size of the document you want to print and the type of printing.

Normal-size

This is the normal printing method. Select this when you do not specify any page layout.

Automatically reduce large document that the printer cannot output

If the printer cannot print the paper size of a document, the printer can automatically reduce the size when it prints the document.

Check this check box to reduce the size when printing the document.

Borderless

Chooses whether you are printing on a full page without any page margins or printing with page margins.

In borderless printing, originals are enlarged to extend slightly off the paper. Thus, printing can be performed without any margins (border).

Use **Amount of Extension** to adjust how much of the document extends off the paper during borderless printing.

Amount of Extension

Adjusts how much of the document extends off the paper during borderless printing.

Moving the slider to the right increases the amount of extension and allows you to perform borderless printing with no problems.

Moving the slider to the left reduces the amount of extension and expands the range of the document to print.

Fit-to-Page

This function enables you to automatically enlarge or reduce documents to fit to the paper size loaded in the printer without changing the paper size you specified in your application software.

Scaled

Documents can be enlarged or reduced to be printed.

Specify the size in **Printer Paper Size**, or enter the scaling ratio in the **Scaling** box.

Scaling

Specifies an enlargement or reduction ratio for the document you want to print.

Page Layout

Multiple pages of document can be printed on one sheet of paper.

Specify...

Opens the [Page Layout Printing dialog box](#).

Click this button to set details on page layout printing.

Tiling/Poster

This function enables you to enlarge the image data and divide the enlarged data into several pages to be printed. You can also glue together these sheets of paper to create large printed matter, such as a poster.

Specify...

Opens the [Tiling/Poster Printing dialog box](#).

Click this button to set details on tiling/poster printing.

Booklet

The booklet printing function allows you to print data for a booklet. Data is printed on both sides of the paper. This type of printing ensures that pages can be collated properly, in page number order, when the printed sheets are folded and stapled at the center.

Specify...

Opens the [Booklet Printing dialog box](#).

Click this button to set details on booklet printing.

Duplex Printing (Manual)

Select whether to print the document to both sides of the paper manually or to one side of the paper. Check this check box to print the document on both sides.

This function can be used only when **Plain Paper** is selected for **Media Type** and one of **Normal-size**, **Fit-to-Page**, **Scaled**, or **Page Layout** is selected.

Stapling Side

Selects the stapling margin position.

The printer analyzes the **Orientation** and **Page Layout** settings, and automatically selects the best stapling margin position. Check **Stapling Side**, and select from the list to change it.

Specify Margin...

Opens the [Specify Margin dialog box](#).

You can specify the width of the margin.

Copies

Specifies the number of copies you want to print. You can specify a value from 1 to 999.

»»» Important

- If the application used to create your document has a similar function, specify the number of copies with the application without specifying it here.

Print from Last Page

Check this check box when you want to print from the last page in order. If you do this, you do not need to sort the pages into their correct order after printing.

Uncheck this check box to print your document in normal order, starting from the first page.

Collate

Check this check box to group together the pages of each copy when you want to print multiple copies. Uncheck this check box when you want to print with all pages of the same page number grouped together.

»»» Important

- When the application software that you used to create the document has the same function, give priority to the printer driver settings. However, if the print results are not acceptable, specify the function settings on the application software. When you specify the number of copies and the printing order with both the application and this printer driver, the number of copies may be multiplied numbers of the two settings or the specified printing order may not be enabled.

Print Options...

Opens the [Print Options dialog box](#).

Changes detailed printer driver settings for print data that is sent from applications.

Stamp/Background... (Stamp...)

Opens the [Stamp/Background \(Stamp\) dialog box](#).

The **Stamp** function allows you to print a stamp text or a bitmap over or behind document data. It also allows you to print date, time and user name. The **Background** function allows you to print a light illustration behind the document data.

▶▶▶ Note

- With the XPS printer driver, the **Stamp/Background...** button has become the **Stamp...** button and only the stamp function can be used.

Depending on the type of printer driver you are using and the environment, **Stamp** and **Background** may not be available.

Custom Paper Size dialog box

This dialog box allows you to specify the size (width and height) of the custom paper.

Units

Select the unit for entering a user-defined paper size.

Paper Size

Specifies the **Width** and the **Height** of the custom paper. Measurement is shown according to the units specified in **Units**.

Page Layout Printing dialog box

This dialog box allows you to select the number of document pages to be placed on one sheet of paper, the page order, and whether a page border line is to be printed around each document page.

The settings specified in this dialog box can be confirmed in the settings preview on the printer driver.

Preview Icon

Shows the settings made on the **Page Layout Printing** dialog box.

You can check what the print result will look like before you actually print the data.

Pages

Specifies the number of document pages to fit on one sheet.

Page Order

Specifies the document orientation to be printed on a sheet of paper.

Page Border

Prints a page border line around each document page.

Check this check box to print the page border line.

Tiling/Poster Printing dialog box

This dialog box allows you to select the size of the image to be printed. You can also make settings for cut lines and paste markers which are convenient for pasting together the pages into a poster.

The settings specified in this dialog box can be confirmed in the settings preview on the printer driver.

Preview Icon

Shows the settings of the **Tiling/Poster Printing** dialog box.

You can check what the print result will look like.

Image Divisions

Select the number of divisions (vertical x horizontal).

As the number of divisions increases, the number of sheets used for printing increases. If you are pasting pages together to create a poster, increasing the number of divisions allows you to create a larger poster.

Print "Cut/Paste" in margins

Specifies whether to print the words "Cut" and "Paste" in the margins. These words serve as guidelines for pasting together the pages into a poster.

Check this check box to print the words.

➤➤➤ Note

- Depending on the type of printer driver you are using and the environment, this function may not be available.

Print "Cut/Paste" lines in margins

Specifies whether to print cut lines that serve as guidelines for pasting together the pages into a poster.

Check this check box to print the cut lines.

Print page range

Specifies the printing range. Select **All** under normal circumstances.

Select **Pages** to specify a specific page or range.

➤➤➤ Note

- If some of the pages have not been printed well, specify the pages that do not need to be printed by clicking them in the settings preview of the **Page Setup** tab. Only the pages shown on the screen will be printed this time.

Booklet Printing dialog box

This dialog box allows you to set how to bind the document as a booklet. Printing only on one side and printing a page border, can also be set in this dialog box.

The settings specified in this dialog box can be confirmed in the settings preview on the printer driver.

Preview Icon

Shows the settings made on the **Booklet Printing** dialog box.

You can check what the document will look like when printed as a booklet.

Margin for stapling

Specifies which side of the booklet is to be stapled.

Insert blank page

Selects whether to print the document on one side or both sides of the booklet.

Check this check box to print the document on one side of the booklet and select the side to be left blank from the list.

Margin

Specifies the width of the stapling margin.

The specified width becomes the stapling margin from the center of the sheet.

Page Border

Prints a page border line around each document page.

Check this check box to print the page border line.

Specify Margin dialog box

This dialog box allows you to specify the margin width for the side to be stapled. If a document does not fit on one page, the document is reduced when printed.

Margin

Specifies the width of the stapling margin.

The width of the side specified by **Stapling Side** becomes the stapling margin.

Print Options dialog box

Makes changes to print data that is sent to the printer.

Depending on the type of printer driver you are using and the environment, this function may not be available.

Disable ICM required from the application software

Disables the ICM function required from the application software.

When an application software uses Windows ICM to print data, unexpected colors may be produced or the printing speed may decrease. If these problems occur, checking this check box may resolve the problems.

►►► Important

- Uncheck this check box under normal circumstances.
- This function does not work when **ICM** is selected for **Color Correction** on the **Matching** tab of the **Manual Color Adjustment** dialog box.

►►► Note

- **Disable ICM required from the application software** tab cannot be used with the XPS printer driver.

Disable the color profile setting of the application software

Checking this check box disables information in the color profile that was set on the application software.

When the information in the color profile set on the application software is output to the printer driver, the print result may contain unexpected colors. If this happens, checking this check box may resolve the problem.

►►► Important

- Even when this check box is checked, only some of the information in the color profile is disabled, and the color profile can still be used for printing.
- Uncheck this check box under normal circumstances.

Ungroup Papers

Sets the display method of **Media Type**, **Page Size**, and **Printer Paper Size**.

To display the items separately, select the check box.

To display the items as a group, clear the check box.

Do not allow application software to compress print data

Compression of the application software print data is prohibited.

If the print result has missing image data or unintended colors, selecting this check box may improve the condition.

▶▶▶ Important

- Uncheck this check box under normal circumstances.

▶▶▶ Note

- **Do not allow application software to compress print data** tab cannot be used with the XPS printer driver.

Print after creating print data by page

The print data is created in page units, and printing starts after the processing of one page of print data is complete.

If a printed document contains unintended results such as streaks, selecting this check box may improve the results.

▶▶▶ Important

- Uncheck this check box under normal circumstances.

Scale images using nearest-neighbor interpolation

When an image is to be enlarged or reduced when printed, the printer uses a simple interpolation process to enlarge or reduce the image.

If the image data in a printed document is not printed clearly, selecting this check box may improve the results.

▶▶▶ Important

- Uncheck this check box under normal circumstances.

▶▶▶ Note

- **Scale images using nearest-neighbor interpolation** can be used only with the XPS printer driver.

Prevention of Print Data Loss

You can reduce the size of the print data that was created with the application software and then print the data.

Depending on the application software being used, the image data may be cut off or may not be printed properly. In such cases, select **On**. If you will not be using this function, select **Off**.

▶▶▶ Important

- When using this function, the print quality may drop depending on the print data.

Unit of Print Data Processing

Selects the processing unit of the print data to be sent to the printer.

Select **Recommended** under normal circumstances.

▶▶▶ Important

- A large amount of memory may be used for certain settings.
Do not change the setting if your computer has a small amount of memory.

▶▶▶ Note

- **Unit of Print Data Processing** tab cannot be used with the XPS printer driver.

Stamp/Background (Stamp...) dialog box

The **Stamp/Background (Stamp...)** dialog box allows you to print a stamp and/or background over or behind the document pages. In addition to the pre-registered ones, you can register and use your original stamp or background.

►►► Note

- With the XPS printer driver, the **Stamp/Background...** button has become the **Stamp...** button and only the stamp function can be used.

Stamp

Stamp printing is a function that prints a stamp over a document.

Check this check box and select a title from the list to print a stamp.

Define Stamp...

Opens the [Stamp Settings dialog box](#).

You can check the details of a selected stamp or save a new stamp.

Place stamp over text

Sets how the stamp is to be printed over the document.

Check the **Stamp** check box to enable this.

Check this check box to print a stamp over the printed document page. The printed data may be hidden behind the stamp.

Uncheck this check box to print the document data over the stamp. The printed data will not be hidden behind the stamp. However, the sections of the stamp that are overlapped by the document may be hidden.

Print semitransparent stamp

Sets how the stamp is to be printed over the document.

Check the **Stamp** check box to enable this.

Check this check box to print a semi-transparent stamp over the printed document page.

Uncheck this check box to print the stamp over the document data. The printed data may be hidden behind the stamp.

►►► Note

- You can use **Print semitransparent stamp** only with the XPS printer driver.

Stamp first page only

Selects whether the stamp is to be printed on the first page only or on all pages when the document has two or more pages.

Check the **Stamp** check box to enable this.

Check this check box to print a stamp on the first page only.

Background

Background printing is a function that allows you to print an illustration or a similar object (bitmap) behind the document.

Check this check box to print a background and select a title from the list.

Select Background...

Opens the [Background Settings dialog box](#).

You can register a bitmap as a background, and change layout method and intensity of the selected background.

Background first page only

Selects whether to print the background on the first page only or print on all pages when the document has two or more pages.

Check the **Background** check box to enable this.

Check this check box to print a background on the first page only.

Stamp Tab

The Stamp tab allows you to set the text and bitmap file (.bmp) to be used for a stamp.

Preview Window

Shows the status of the stamp configured in each tab.

Stamp Type

Specifies the stamp type.

Select **Text** to create a stamp with characters. Select **Bitmap** to create with a bitmap file. Select **Date/Time/User Name** to display the creation date/time and user name of the printed document.

The setting items in the **Stamp** tab change depending on the selected type.

When Stamp Type is Text or Date/Time/User Name

Stamp Text

Specifies the stamp text string.

Up to 64 characters can be entered.

For **Date/Time/User Name**, the creation date/time and user name of the printed object are displayed in **Stamp Text**.

►► Important

- **Stamp Text** appears grayed out and is unavailable if **Date/Time/User Name** is selected.

TrueType Font

Selects the font for the stamp text string.

Style

Selects the font style for the stamp text string.

Size

Selects the font size for the stamp text string.

Outline

Selects a frame that encloses the stamp text string.

If a large font size is selected for **Size**, characters may extend outside of the stamp border.

Color/Select Color...

Shows the current color for the stamp.

To select a different color, click **Select Color...** to open the **Color** dialog box, and select or create a color you wish to use as a stamp.

When Stamp Type is Bitmap

File

Specifies the name of the bitmap file to be used as the stamp.

Select File...

Opens the dialog box to open a file.

Click this button to select a bitmap file to be used as a stamp.

Size

Adjusts the size of the bitmap file to be used as a stamp.

Moving the slider to the right increases the size, moving the slider to the left decreases the size.

Transparent white area

Specifies whether to make white-filled areas of the bitmap transparent.

Check this check box to make white-filled areas of the bitmap transparent.

►►► Note

- Click **Defaults** to set **Stamp Type** to text, **Stamp Text** to blank, **TrueType Font** to Arial, **Style** to Regular, **Size** to 36 points, **Outline** unchecked, and **Color** to gray with the RGB values (192, 192, 192).

Placement Tab

The Placement tab allows you to set the position where the stamp is to be printed.

Preview Window

Shows the status of the stamp configured in each tab.

Position

Specifies the stamp position on the page.

Selecting **Custom** from the list allows you to enter values for the **X-Position** and **Y-Position** coordinates directly.

Orientation

Specifies the angle of rotation for the stamp. The angle can be set by entering the number of degrees.

Negative values rotate the stamp clockwise.

►►► Note

- **Orientation** is enabled only when **Text** or **Date/Time/User Name** is selected for **Stamp Type** on the **Stamp** tab.

►►► Note

- Click **Defaults** to set the stamp position to **Center** and the orientation to 0.

Save settings Tab

The **Save settings** tab allows you to register a new stamp or delete an unnecessary stamp.

Title

Enter the title to save the stamp you created.

Up to 64 characters can be entered.

►►► Note

- Spaces, tabs, and returns cannot be entered at the beginning or end of a title.

Stamps

Shows a list of saved stamp titles.

Specify a title to display the corresponding stamp in **Title**.

Save/Save overwrite

Saves the stamp.

Enter a title in **Title**, and then click this button.

Delete

Deletes an unnecessary stamp.

Specify the title of an unnecessary stamp from the **Stamps** list, and click this button.

Background Tab

The Background tab allows you to select a bitmap file (.bmp) to be used as a background or determine how to print the selected background.

Preview Window

Shows the status of the bitmap set on the **Background** tab.

File

Specifies the name of the bitmap file to be used as the background.

Select File...

Opens the dialog box to open a file.

Click this button to select a bitmap file (.bmp) to be used as the background.

Layout Method

Specifies how the background image is to be placed on the paper.

When **Custom** is selected, you can set coordinates for **X-Position** and **Y-Position**.

Intensity

Adjusts the intensity of the bitmap to be used as a background.

Moving the slider to the right increases the intensity, and moving the slider to the left decreases the intensity. To print the background at the original bitmap intensity, move the slider to the rightmost position.

►► Note

- Depending on the type of printer driver you are using and the environment, this function may not be available.
- Click **Defaults** to set **File** to blank, **Layout Method** to **Fill page**, and the **Intensity** slider to the middle.

Save settings Tab

The **Save settings** tab allows you to register a new background or delete an unnecessary background.

Title

Enter the title to save the background image you specified.

Up to 64 characters can be entered.

►► Note

- Spaces, tabs, and returns cannot be entered at the beginning or end of a title.

Backgrounds

Shows a list of registered background titles.

Specify a title to display the corresponding background in **Title**.

Save/Save overwrite

Saves the image data as a background.

After inserting the **Title**, click this button.

Delete

Deletes an unnecessary background.

Specify the title of an unnecessary background from the **Backgrounds** list, and then click this button.

Maintenance tab Description

The **Maintenance** tab allows you to perform printer maintenance or change the settings of the printer.

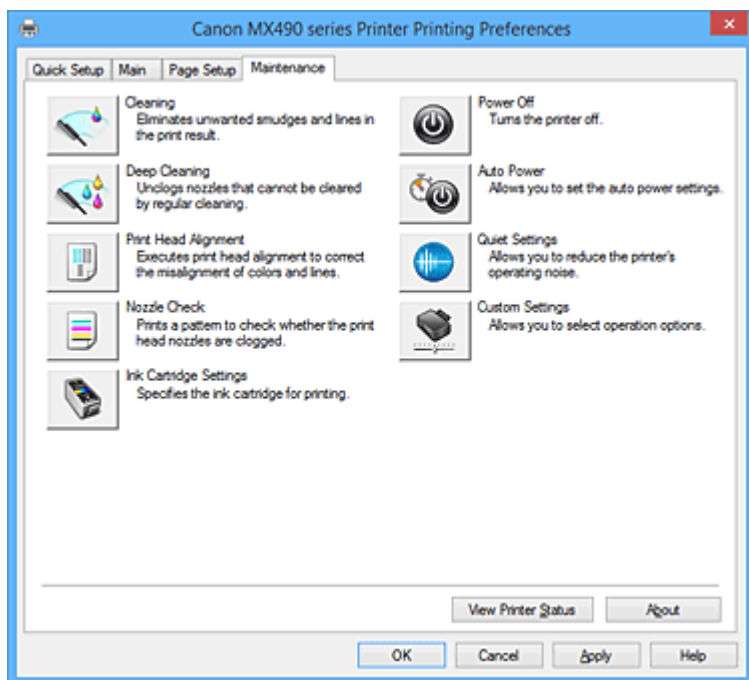

Cleaning

Performs print head cleaning.

Print head cleaning removes any blockage in the print head nozzles.

Perform cleaning when printing becomes faint, or a specific color fails to print, even though all ink levels are sufficiently high.



Deep Cleaning

Performs deep cleaning.

Perform deep cleaning when two cleaning attempts do not resolve the print head problem.

▶▶▶ Note

- **Deep Cleaning** consumes a larger amount of ink than **Cleaning**.
Cleaning the print heads frequently will rapidly deplete your printer's ink supply. Therefore, perform cleaning only when necessary.

Ink Group

When you click **Cleaning** or **Deep Cleaning**, the **Ink Group** window is displayed.

Selects the ink group that you want to clean the print head for.

Click [Initial Check Items](#) to display the items that you need to check before you execute cleaning or deep cleaning.



Print Head Alignment

Print head alignment corrects the installation positions of the print head and improves deviated colors and lines.

Align the print head immediately after installing the print head.

When you click **Print Head Alignment**, the [Start Print Head Alignment dialog box](#) is displayed.

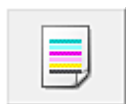

Nozzle Check

Prints a nozzle check pattern.

Perform this function if printing becomes faint or a specific color fails to print. Print a nozzle check pattern, and check whether the print head is working properly.

If the print result for a specific color is faded, or if there are any unprinted sections, click **Cleaning** to clean the print head.

To display a list of items that you should check before printing the nozzle check pattern, click [Initial Check Items](#).

Print Check Pattern

This function prints a pattern that allows you to check whether any of the ink nozzles are clogged.

Click **Print Check Pattern**. When the confirmation message is displayed, click **OK**. The **Pattern Check** dialog box is then displayed.

Left-side bitmap (good)

The print head nozzles are not clogged.

Right-side bitmap (bad)

The print head nozzles may be clogged.

Exit

Closes the **Pattern Check** dialog box, and returns to the **Maintenance** tab.

Cleaning

Performs print head cleaning.

Print head cleaning removes any blockage in the print head nozzles.

Perform cleaning when printing becomes faint, or if a specific color fails to print, even though all ink levels are sufficiently high.



Ink Cartridge Settings

Opens the [Ink Cartridge Settings dialog box](#).

Use this function to specify the FINE cartridge you want to use.



Power Off

Turns off the printer from the printer driver.

Perform this function to turn off the printer when you cannot press the ON button (POWER button) on the printer because the printer is out of your reach.

You must press the ON button (POWER button) on the printer to turn the printer on again after clicking this button. When you use this function, you will not be able to turn the printer on from the printer driver.



Auto Power

Opens the [Auto Power Settings dialog box](#).

Specify settings for operating the printer power automatically. Perform this function if you want to change the auto power settings.

»» Note

- If the printer is off or if communication between the printer and the computer is disabled, an error message may appear because the computer cannot collect the printer status.
If this happens, click **OK** to display the most recent settings specified on your computer.



Quiet Settings

Opens the [Quiet Settings dialog box](#).

Quiet Settings dialog box allows you to specify a setting that reduces the operating noise of the printer. This mode comes in handy when the operating noise of the printer becomes a concern, such when printing at night. Perform this operation when you want to change the quiet mode setting.

»» Note

- If the printer is off or if communication between the printer and the computer is disabled, an error message may appear because the computer cannot collect the printer status.



Custom Settings

Opens the [Custom Settings dialog box](#).

Perform this function to change the settings of this printer.

»» Note

- If the printer is off or if communication between the printer and the computer is disabled, an error message may appear because the computer cannot collect the printer status.
If this happens, click **OK** to display the most recent settings specified on your computer.

View Print History

This function starts the Canon IJ XPS preview, and displays the print history.

»» Note

- You can use this function only with the XPS printer driver.

View Printer Status

Starts the Canon IJ Status Monitor.

Perform this function when you want to check the printer status and how a print job is proceeding.

»» Note

- If you are using the XPS printer driver, the "Canon IJ Status Monitor" becomes the "Canon IJ XPS Status Monitor".

About

Opens the [About dialog box](#).

The version of the printer driver, plus a copyright notice, can be checked.

In addition, the language to be used can be switched.

Initial Check Items

Before running **Cleaning** or **Deep Cleaning**, check that the printer power is on, and open the cover of the printer.

Check the following items for each ink.

- [Check the amount of ink](#) remaining in the cartridge.

- Make sure that you push in the ink cartridge completely until you hear a clicking sound.
- If an orange tape is adhered to the ink cartridge, peel it off completely.
Any remaining tape will hinder ink output.
- Check that the ink cartridges are installed in their correct positions.

Start Print Head Alignment dialog box

This dialog box allows you to adjust the attachment position for the print head, or to print the current setting value for the print head position.

Align Print Head

Aligns the print head.

Print head alignment corrects the installation positions of the print head and improves deviated colors and lines.

Align the print head immediately after installing the print head.

Print Alignment Value

Click this button to check the current setting value of the print head position.

Prints the current setting value for the print head position.

Print Head Alignment dialog box

To adjust the print head position manually, click **Align Print Head** in the **Start Print Head Alignment** dialog box, and perform the operations instructed in the messages. The **Print Head Alignment** dialog box is then displayed.

This dialog box allows you to check the printed pattern and adjust the print head position.

Preview Window

Displays the pattern of **Print Head Alignment**, and checks the position of the selected pattern.

You can also change the setting by clicking the pattern on the screen directly.

Select the Pattern Number

Compare the printed adjustment patterns, and enter the pattern number of the pattern with the least visible streaks or horizontal stripes into the corresponding box.

▶▶▶ Note

- If you do not know how to analyze the printed pattern, see [Aligning the Print Head Position from Your Computer](#).

Initial Check Items

Before running **Nozzle Check**, check that the printer power is on, and open the cover of the printer. Check the following items for each ink.

- [Check the amount of ink](#) remaining in the cartridge.
- Make sure that you push in the ink cartridge completely until you hear a clicking sound.
- If an orange tape is adhered to the ink cartridge, peel it off completely.
Any remaining tape will hinder ink output.
- Check that the ink cartridges are installed in their correct positions.

Ink Cartridge Settings dialog box

When you click **Ink Cartridge Settings**, the **Ink Cartridge Settings** dialog box is displayed.

This feature enables you to specify the most appropriate FINE cartridge among installed cartridges

according to an intended use.

When one of the FINE cartridges becomes empty and cannot be replaced immediately by a new one, you can specify the other FINE cartridge that still has ink and continue printing.

Ink Cartridge

Selects the FINE cartridge you use for printing.

Color Only

Uses the color FINE cartridge only.

Black Only

Uses the black FINE cartridge only.

Both Black and Color

Uses the FINE cartridges installed on the printer, which are color and black.

»» Important

- When the following settings are specified, **Black Only** does not function because the printer uses the color FINE cartridge to print documents.
 - Other than **Plain Paper**, or **Envelope** is selected for **Media Type** on the **Main** tab
 - **Borderless** is selected from the **Page Layout** list on the **Page Setup** tab
- Do not detach the FINE cartridge that is not in use. Printing cannot be performed while either FINE cartridge is detached.

Auto Power Settings dialog box

When you click **Auto Power**, the **Auto Power Settings** dialog box is displayed.

This dialog box allows you to manage the printer power from the printer driver.

Auto Power Off

Selects the auto power-off setting.

If a printer driver operation or a printer operation is not performed within the specified time, the printer turns off.

»» Important

- In the following cases, you can set **Auto Power Off** but the power will not be turned off automatically.
 - When you use the printer by connecting it to a network
 - When you use the printer by connecting it to a telephone line via a modular cable

Quiet Settings dialog box

When you click **Quiet Settings**, the **Quiet Settings** dialog box is displayed.

Quiet Settings dialog box allows you to specify a setting that reduces the operating noise of the printer.

Select when you wish to reduce the operating noise of the printer at night, etc.

Using this function may lower the print speed.

Do not use quiet mode

Select this option when you wish to use the printer with volume of normal operating noise.

Always use quiet mode

Select this option when you wish to reduce the operating noise of the printer.

Use quiet mode during specified hours

Select this option when you wish to reduce the operating noise of the printer during a specified period of time.

Set the **Start time** and the **End time** of the quiet mode you wish to be activated. If both are set to the same time, the quiet mode will not function.

»» Important

- You can set the quiet mode from the operation panel of the printer, the printer driver, or ScanGear (scanner driver).
No matter how you use to set the quiet mode, the mode is applied when you perform operations from the operation panel of the printer or printing and scanning from the computer.

Custom Settings dialog box

When you click **Custom Settings**, the **Custom Settings** dialog box is displayed.

If necessary, switch between various modes of printer operation.

Prevent paper abrasion

The printer can increase the gap between the print head and the paper during high-density printing to prevent paper abrasion.

Check this check box to enable this function.

Align heads manually

Usually, the **Print Head Alignment** function on the **Maintenance** tab is set to automatic head alignment, but you can change it to manual head alignment.

If the printing results of automatic print head alignment are not satisfactory, [perform manual head alignment](#).

Check this check box to perform the manual head alignment.

Prevent paper double-feed

Select this check box only if the printer is feeding multiple sheets of plain paper at the same time.

»» Important

- Using this function slows down the print speed.

Rotate 90 degrees left when orientation is [Landscape]

On the **Page Setup** tab, you can change the rotation direction of the **Landscape** in the **Orientation**.

To rotate the document 90 degrees to the left when printing, select the check box.

Don't detect mismatch of paper settings when printing from computer

When you print documents from your computer and the paper settings on the printer driver and the cassette paper information registered on the printer do not match, this setting disables the message display and allows you to continue printing.

To disable detection of paper setting mismatches, select this check box.

Ink Drying Wait Time

The printer can pause before printing a subsequent page. Moving the slider to the right increases the pause time, and moving the slider to the left decreases the time.

If the paper gets stained because the next page is ejected before the ink on the printed page dries, increase the ink drying wait time.

Reducing the ink drying wait time speeds up printing.

About dialog box

When you click **About**, the **About** dialog box is displayed.

This dialog box displays the version, copyright, and module list of the printer driver. You can select the language to be used and switch the language displayed in the setup window.

Modules

Lists the printer driver modules.

Language

Specifies the language you wish to use in the [printer driver setup window](#).

►►► Important

- If the font for displaying the language of your choice is not installed in your system, the characters will be garbled.

Related Topics

- [Cleaning the Print Heads from Your Computer](#)
- [Aligning the Print Head Position from Your Computer](#)
- [Use Your Computer to Print a Nozzle Check Pattern](#)
- [Setting the Ink Cartridge to be Used](#)
- [Managing the Printer Power](#)
- [Reducing the Printer Noise](#)
- [Changing the Printer Operation Mode](#)

Canon IJ Preview Description

Canon IJ Preview is an application software that displays what the print result will look like before a document is actually printed.

The preview reflects the information that is set within the printer driver and allows you to check the document layout, print order, and number of pages. You can also change the media type and paper source settings.

When you want to display a preview before printing, open the [printer driver setup window](#), and check the **Preview before printing** check box on the **Main** tab.

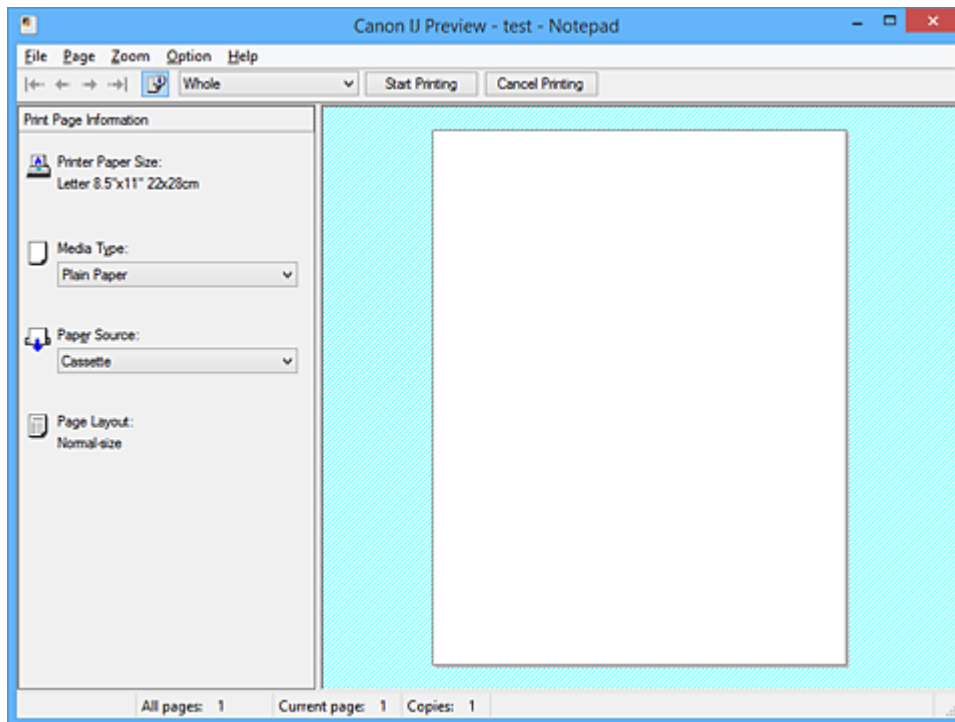

File Menu

Selects the print operation.

Start Printing

Ends the Canon IJ Preview and then starts printing the document that is displayed on the preview screen.

This command has the same function as the **Start Printing** on the toolbar.

Cancel Printing

Ends the Canon IJ Preview and cancels the printing of the document that is displayed on the preview screen.

This command has the same function as the **Cancel Printing** on the toolbar.

Exit

Ends the Canon IJ Preview.

Page Menu

This menu includes the following commands to select page to be displayed.

All of these commands except **Page Selection...** can also be selected from the toolbar.

►►► Note

- If the pages are being spooled, the last spooled page becomes the last page.
- If the **Page Layout** setting on the **Page Setup** tab is specified to **Page Layout**, **Tiling/Poster**, or **Booklet**, the number of pages is the number of sheets to be used for printing, and not the number of pages in the original document created with the application software.

- If duplex printing manually has been set, the front pages which will be printed first are all displayed together, and then the back pages are displayed.

First Page

Displays the first page of the document.

If the currently displayed page is the first page, this command is grayed out and cannot be selected.

Previous Page

Displays the page located before the currently displayed page.

If the currently displayed page is the first page, this command is grayed out and cannot be selected.

Next Page

Displays the page located after the currently displayed page.

If the currently displayed page is the last page, this command is grayed out and cannot be selected.

Last Page

Displays the last page of the document.

If the currently displayed page is the last page, this command is grayed out and cannot be selected.

Page Selection...

Displays the **Page Selection** dialog box.

This command allows you to specify the page number of the page to be displayed.

Zoom Menu

Selects the ratio of the actual size printed on the paper to the preview display size.

You can also select the ratio from the drop-down list box located on the toolbar.

Whole

Displays the entire page of data as one page.

50%

Reduces the displayed data to 50% of the actual size to be printed.

100%

Displays the data at the actual size to be printed.

200%

Enlarges the displayed data to 200% of the actual size to be printed.

400%

Enlarges the displayed data to 400% of the actual size to be printed.

Option Menu

This menu includes the following command:

Displays Print Page Information

Displays print setup information (including printer paper size, media type, and page layout) for each page at the left side of the preview screen.

This screen also allows you to change the media type and paper source settings.

Help Menu

When you select this menu item, the Help window for Canon IJ Preview is displayed, and you can check the version and copyright information.

Start Printing button

Prints the documents selected in the document list.

The printed documents are deleted from the list, and when all documents are printed, the Canon IJ XPS Preview closes.

Cancel Printing button

Ends the Canon IJ Preview, and cancels the printing of the document that is displayed on the preview screen.

You can click this button while spooling.

Print Page Information Screen

Displays print setup information for each page at the left side of the preview screen.

This screen also allows you to change the media type and paper source settings.

»» Important

- If the media type and paper source are set from the application software, those settings have priority and the changed settings may become ineffective.

Printer Paper Size

Displays the paper size of the document to be printed.

Media Type

You can select the media type of the document to be printed.

Paper Source

You can select the paper source of the document to be printed.

Page Layout

Displays the page layout of the document to be printed.

Canon IJ XPS Preview Description

Canon IJ XPS Preview is an application software that displays what the print result will look like before a document is actually printed.

The preview reflects the information which is set within the printer driver and allows you to check the document layout, print order, and number of pages. The preview also allows you to edit the print document, edit the print pages, change the print settings, and perform other functions.

When you want to display a preview before printing, open the [printer driver setup window](#), and check the **Preview before printing** check box on the **Main** tab.

»»» Important

- To use the Canon IJ XPS Preview, you must have Microsoft .NET Framework 4 Client Profile installed on your computer.

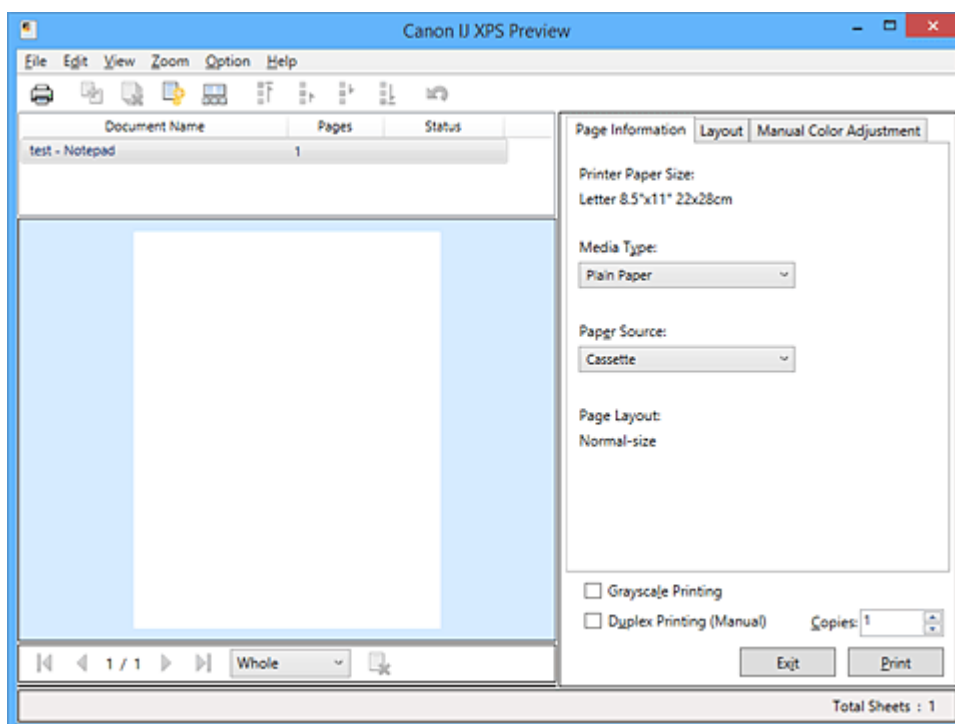

File Menu

Selects print operation and print history settings:

Print

Prints the documents selected in the document list.

The printed documents are deleted from the list, and when all documents are printed, the Canon IJ XPS Preview closes.

This command has the same function as  (Print) on the toolbar and the **Print** in the print settings area.

Print All Documents

Prints all documents in the document list and closes the Canon IJ XPS Preview.

Save Print History

Switches whether the documents printed from the Canon IJ XPS Preview are to be saved as print history entries.

History Entry Limit

Switches the maximum number of print history registrations.

Select **10 Entries**, **30 Entries**, or **100 Entries**.

»» Important

- If the limit on the number of registration is exceeded, the print history registrations are deleted starting from the oldest one.

Add documents from history to the list

Adds the document saved in the print history to the document list.

Exit

Ends the Canon IJ XPS Preview. The documents remaining in the document list will be deleted from the list.

This command has the same function as the **Exit** in the print settings area.

Edit Menu

Selects the method for editing multiple documents or pages.

Undo

Reverses the previous change.

If the change cannot be reversed, this function is grayed out and cannot be selected.

This command has the same function as the  (Undo) on the toolbar.

Documents

Selects the method for editing print documents.

Combine Documents

Combines the documents selected in the document list into one document.

If only one document is selected, this command is grayed out and cannot be selected.

This command has the same function as the  (Combine Documents) on the toolbar.

Reset Documents

Returns the document selected in the document list to their status before they were added to the Canon IJ XPS Preview.

The combined documents are separated, and the original documents are restored.

This command has the same function as the  (Reset Documents) on the toolbar.

Move Document

Use the following command to change the order of the documents selected in the document list.

Move to First

Moves the selected print document to the beginning of the document list.

If the currently selected document is the first document, this command is grayed out and cannot be selected.

Move Up One

Moves the selected print document one up from its current position.

If the currently selected document is the first document, this command is grayed out and cannot be selected.

Move Down One

Moves the selected print document one down from its current position.

If the currently selected document is the last document, this command is grayed out and cannot be selected.

Move to Last

Moves the selected print document to the end of the document list.

If the currently selected document is the last document, this command is grayed out and cannot be selected.

Delete Document

Deletes the selected document from the document list.

If the document list contains only one document, the document is grayed out and cannot be selected.

This command has the same function as the  (Delete Document) on the toolbar.

Grayscale Printing

Allows you to change the monochrome print settings.

This command has the same functionality as the **Grayscale Printing** check box in the print settings area.

Page Layout Printing...

Opens the **Page Layout Printing** dialog box.

This dialog box allows you to set **Page Layout Printing**, **Pages**, **Page Order**, and **Page Border**.

Duplex Printing...

Opens the **Duplex Printing** dialog box.

This dialog box allows you to set **Duplex Printing (Manual)**, **Stapling Side**, and **Margin**.

Copies...

Opens the **Copies** dialog box.

This dialog box allows you to set **Copies**, **Collate**, and **Print from Last Page**.

Pages

Selects the method for editing print pages.

Delete Page

Deletes the currently selected page.

If page layout printing is set, the pages enclosed with red frame will be deleted.

This command has the same function as the  (Delete Page) on the toolbar.

Restore Page

Restores pages that were deleted with the **Delete Page** function.

To restore pages, you must select the **View Deleted Pages** check box on the **Option** menu and display the deleted pages as thumbnails.

Move Page

Use the following command to change the order of the currently selected pages.

Move to First

Moves the currently selected page to the beginning of the document.

If the currently selected page is the first page, this command is grayed out and cannot be selected.

Move Forward One

Moves the currently selected page one position in front of its current position.

If the currently selected page is the first page, this command is grayed out and cannot be selected.

Move Backward One

Moves the currently selected page one position after its current position.

If the currently selected page is the last page, this command is grayed out and cannot be selected.

Move to Last

Moves the currently selected page to the end of the document.

If the currently selected page is the last page, this command is grayed out and cannot be selected.

View Menu

Selects the documents and pages to be displayed.

Documents

Use the following command to select the document to display.

First Document

Displays the first document in the document list.

If the currently selected document is the first document, this command is grayed out and cannot be selected.

Previous Document

Displays the document located before the currently displayed document.

If the currently selected document is the first document, this command is grayed out and cannot be selected.

Next Document

Displays the document located after the currently displayed document.

If the currently selected document is the last document, this command is grayed out and cannot be selected.

Last Document

Displays the last document in the document list.

If the currently selected document is the last document, this command is grayed out and cannot be selected.

Pages

Use the following command to select the page to be displayed.

▶▶ Note

- If the **Page Layout** setting in the printer driver is specified to **Tiling/Poster**, or **Booklet**, the number of pages is the number of sheets to be used for printing, and not the number of pages in the original document created with the application software.

First Page

Displays the first page of the document.

If the currently displayed page is the first page, this command is grayed out and cannot be selected.

Previous Page

Displays the page located before the currently displayed page.

If the currently displayed page is the first page, this command is grayed out and cannot be selected.

Next Page

Displays the page located after the currently displayed page.

If the currently displayed page is the last page, this command is grayed out and cannot be selected.

Last Page

Displays the last page of the document.

If the currently displayed page is the last page, this command is grayed out and cannot be selected.

Page Selection...

Displays the **Page Selection** dialog box.

This command allows you to specify the page number of the page to be displayed.

Zoom Menu

Selects the ratio of the actual size printed on the paper to the preview display size.

You can also select the ratio from the drop-down list box located on the toolbar.

Whole

Displays the entire page of data as one page.

50%

Reduces the displayed data to 50% of the actual size to be printed.

100%

Displays the data at the actual size to be printed.

200%

Enlarges the displayed data to 200% of the actual size to be printed.

400%

Enlarges the displayed data to 400% of the actual size to be printed.

Option Menu

Toggles the show / hide status of the following information.

View Thumbnails

Reduces all pages in the document selected in the document list and displays them at the bottom of the preview window.

This command has the same function as the  (View Thumbnails) on the toolbar.

View Document List

Displays the print document list at the top of the preview window.

View Print Settings Area

Displays the print settings area at the right side of the preview window.

View Deleted Pages

When the thumbnails are displayed, this function displays pages that were deleted with the **Delete Page** function.

To check deleted pages, you must first select the **View Thumbnails** check box.

Keep printed documents on the list

Leaves the printed document in the document list.

Print Settings Displayed at Startup

Switches the tab of the print settings area to be displayed when the Canon IJ XPS Preview is started.

Select **Page Information**, **Layout**, or **Manual Color Adjustment**.

Help Menu

When you select this menu item, the Help window for Canon IJ XPS Preview is displayed, and you can check the version and copyright information.



(Print)

Prints the documents selected in the document list.

The printed documents are deleted from the list, and when all documents are printed, the Canon IJ XPS Preview closes.



(Combine Documents)

Combines the documents selected in the document list into one document.

If only one document is selected, this command is grayed out and cannot be selected.



(Delete Document)

Deletes the selected document from the document list.

If the document list contains only one document, the document is grayed out and cannot be selected.



(Reset Documents)

Returns the document selected in the document list to their status before they were added to the Canon IJ XPS Preview.

The combined documents are separated, and the original documents are restored.



(View Thumbnails)

Reduces all pages in the document selected in the document list and displays them at the bottom of the preview window.

To hide the print pages, click **View Thumbnails** again.



(Move to First)

Moves the selected print document to the beginning of the document list.

If the currently selected document is the first document, this command is grayed out and cannot be selected.



(Move Up One)

Moves the selected print document one up from its current position.

If the currently selected document is the first document, this command is grayed out and cannot be selected.



(Move Down One)

Moves the selected print document one down from its current position.

If the currently selected document is the last document, this command is grayed out and cannot be selected.



(Move to Last)

Moves the selected print document to the end of the document list.

If the currently selected document is the last document, this command is grayed out and cannot be selected.



(Undo)

Reverses the previous change.

If the change cannot be reversed, this function is grayed out and cannot be selected.



(Delete Page)

Deletes the currently selected page.

If page layout printing is set, the pages enclosed with red frame will be deleted.

Document list

Displays the list of the print documents.

The document selected in the document list becomes the target for preview display and editing.

Document Name

Displays the name of the print document.

If you click the name of the selected print document, a text box is displayed, and you can rename the document to any name.

Pages

Displays the number of pages in the print document.

»» Important

- The number displayed in **Pages** and the output page count are different.
- To check the output page count, check the status bar at the bottom of the preview window.

Status

Displays the status of the print documents.

Documents that are undergoing data processing are displayed as **Processing data**.

»» Important

- Documents showing **Processing data** cannot be printed or edited.
Wait until the data processing ends.

Print Settings Area Screen

Allows you to check and change the print settings of the documents selected in the document list.

Print Settings Area is displayed on the right side of the preview window.

Page Information tab

The print settings are displayed for each page.

You can change the media type and paper source settings.

Printer Paper Size

Displays the paper size of the document to be printed.

Media Type

Allows you to select the media type of the document to be printed.

Paper Source

Allows you to select the paper source of the document to be printed.

Page Layout

Displays the page layout of the document to be printed.

Layout tab

You can specify settings for page layout printing.

To apply the specified settings, click **Apply**.

If the page layout print settings cannot be changed for the print document, the individual items are grayed out and cannot be selected.

Manual Color Adjustment tab

This tab allows you to adjust the color balance by changing the settings of the **Cyan, Magenta, Yellow, Brightness, Intensity**, and **Contrast** options.

Cyan/Magenta/Yellow

Adjusts the strengths of **Cyan, Magenta**, and **Yellow**.

Moving the slider to the right makes a color stronger, and moving the slider to the left makes a color weaker.

You can also directly enter a value linked to the slider. Enter a value in the range from -50 to 50.

This adjustment changes the relative amount of ink of each color used, which alters the total color balance of the document.

Use your application software if you want to change the total color balance significantly. Use the printer driver only if you want to adjust the color balance slightly.

»» Important

- When **Grayscale Printing** is checked, **Cyan**, **Magenta**, and **Yellow** appear grayed out and are unavailable.

Brightness

Selects the brightness of your print.

Pure white and black will not change, but colors between white and black will change.

Intensity

Adjusts the overall intensity of your print.

Moving the slider to the right increases the intensity, and moving the slider to the left decreases the intensity.

You can also directly enter a value linked to the slider. Enter a value in the range from -50 to 50.

Contrast

Adjusts the contrast between light and dark in the image to be printed.

Moving the slider to the right increases the contrast, moving the slider to the left decreases the contrast.

You can also directly enter a value linked to the slider. Enter a value in the range from -50 to 50.

Defaults

Restores all the settings you have changed to their default values.

Clicking this button restores all the settings on this tab to their default values (factory settings).

Grayscale Printing

Allows you to change the monochrome print settings.

Duplex Printing (Manual)

Select whether to print the document to both sides of the paper manually or to one side of the paper.

If the duplex print settings cannot be changed for the print document, this item is grayed out and is unavailable.

»» Important

- When you select **Booklet** for **Page Layout**, **Duplex Printing (Manual)** of the print settings area will be set automatically. In this case, **Duplex Printing (Manual)** is grayed out and is unavailable.

Copies

Specifies the number of copies you want to print. You can specify a value from 1 to 999.

If the numbers of copies cannot be changed for the print document, this item is grayed out and is unavailable.

Exit

Ends the Canon IJ XPS Preview.

The documents remaining in the document list will be deleted from the list.

Print

Prints the documents selected in the document list.

The printed documents are deleted from the list, and when all documents are printed, the Canon IJ XPS Preview closes.

Canon IJ Status Monitor Description

The Canon IJ Status Monitor displays the status of the printer and the printing progress. The monitor uses graphics, icons, and messages to let you know the printer status.

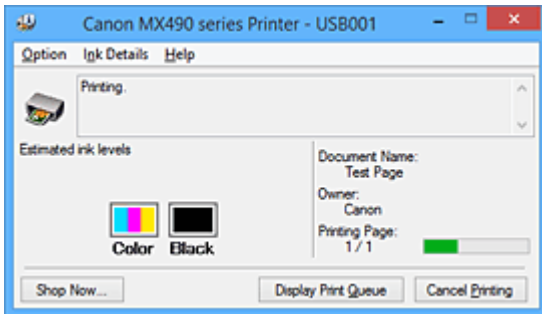

Canon IJ Status Monitor Features

The Canon IJ Status Monitor offers the following advantages:

You can check the status of the printer on the screen.

The status of the printer is shown on the screen in real time.

You can check the printing progress of each printing document (print job).

Error types and solutions are shown on the screen.

Shown when a printer error occurs.

You can immediately check how to respond.

You can check the ink status.

This function displays graphics showing the FINE cartridge type and the estimated ink levels.

Icons and messages are displayed when ink is running low (ink level warning).

Canon IJ Status Monitor Overview

Canon IJ Status Monitor allows you to check the status of the printer and ink with graphics and messages.

You can check the information on the printing document and the printing progress during printing.

When a printer error occurs, it shows the cause and solution. Follow the instruction in the message.

Printer

Canon IJ Status Monitor shows an icon when a warning or error occurs to the printer.

⚠ : Indicates that a warning (operator call error) has occurred or the printer is working.

✖ : There has been an error which requires a service.

FINE cartridge

Canon IJ Status Monitor shows an icon when a low ink warning or a no ink error occurs.

In addition, this function displays graphics showing the estimated ink levels of the FINE cartridge.

In this case, click the graphics to open the **Ink Details** dialog box. You can check the detail information such as the remaining ink level and the FINE cartridge types for your printer.

Document Name

Shows the name of the document to be printed.

Owner

Shows the owner's name of the document to be printed.

Printing Page

Shows the number of printing page and total printing pages.

Display Print Queue

Shows the print window used to manage the print job that is being printed or being in the print queue.

Cancel Printing

Cancels the current print job.

Important

- The **Cancel Printing** button is enabled only while print data is being sent to the printer. Once the print data has been sent, the button is grayed out and becomes unavailable.

Option Menu

If you select **Enable Status Monitor**, when a printer related message is generated the Canon IJ Status Monitor starts.

When **Enable Status Monitor** is selected, following commands are available.

Always Display Current Job

Displays the Canon IJ Status Monitor during printing.

Always Display on Top

Displays the Canon IJ Status Monitor in front of other windows.

Display Warning Automatically

When a Low Ink Warning Occurs

Starts the Canon IJ Status Monitor window automatically and displays it in front of the other windows when a low ink warning occurs.

Start when Windows is Started

Starts the Canon IJ Status Monitor automatically when you start Windows.

Ink Details Menu

Select this menu to display the **Ink Details** dialog box. Check the detail information such as the remaining ink level and the FINE cartridge types for your printer.

Ink Details dialog box

This function displays graphics and messages showing the FINE cartridge type and the estimated ink levels.

Ink Information (displayed at left)

Shows the FINE cartridge types with graphics.

If a warning or error related to the remaining ink level occurs, the printer driver displays an icon to let you know.

If the icon is displayed, operate the printer according to the instructions displayed on the screen.

Message (displayed at right)

Shows information such as the ink status and ink colors with sentences.

Ink Model Number

Shows the FINE cartridge types for your printer.

Close

Closes the **Ink Details** dialog box to return to Canon IJ Status Monitor.

Help Menu

When you select this menu item, the Help window for Canon IJ Status Monitor is displayed, and you can check the version and copyright information.

Updating the MP Drivers

- **Obtaining the Latest MP Drivers**
- **Deleting the Unnecessary MP Drivers**
- **Before Installing the MP Drivers**
- **Installing the MP Drivers**

Obtaining the Latest MP Drivers

The MP Drivers include a printer driver, ScanGear (scanner driver), and fax driver.

By updating the MP Drivers to the latest version of the MP Drivers, unresolved problems may be solved.

You can access our website and download the latest MP Drivers for your model.

»» Important

- You can download the MP Drivers for free, but any Internet access charges incurred are your responsibility.
- Before installing the latest MP Drivers, [delete the previously installed version](#).

Related Topics

- [Before Installing the MP Drivers](#)
- [Installing the MP Drivers](#)

Deleting the Unnecessary MP Drivers

The MP Drivers which you no longer use can be deleted.

When deleting the MP Drivers, first exit all programs that are running.

The procedure to delete the unnecessary MP Drivers is as follows:

1. Start the uninstaller

- If you are using Windows 8.1 or Windows 8, from the Desktop charms, select **Settings -> Control Panel -> Programs -> Programs and Features**.
From the program list, select "XXX MP Drivers" (where "XXX" is your model name) and then click **Uninstall**.
- If you are using Windows 7 or Windows Vista, select **Start menu -> Control Panel -> Programs -> Programs and Features**.
From the program list, select "XXX MP Drivers" (where "XXX" is your model name) and then click **Uninstall**.
- If you are using Windows XP, select **Start menu -> Control Panel -> Add or Remove Programs**.
From the program list, select "XXX MP Drivers" (where "XXX" is your model name) and then click **Remove**.

The confirmation window for uninstalling the model appears.

Important

- In Windows 8.1, Windows 8, Windows 7, or Windows Vista, a confirmation/warning dialog box may appear when starting, installing or uninstalling software.
This dialog box appears when administrative rights are required to perform a task.
When you are logged on to an administrator account, click **Yes** (or **Continue**, **Allow**) to continue.
Some applications require an administrator account to continue. In such cases, switch to an administrator account, and restart the operation from the beginning.

2. Execute the uninstaller

Click **Execute**. When the confirmation message appears, click **Yes**.

When all the files have been deleted, click **Complete**.

The deletion of the MP Drivers is complete.

Important

- Printer driver, XPS printer driver, ScanGear (scanner driver), and fax driver will be deleted when you uninstall the MP Drivers.

Before Installing the MP Drivers

This section describes the items that you should check before installing the MP Drivers. You should also refer to this section if the MP Drivers cannot be installed.

Checking the Printer Status

- Turn off the printer.

Checking the Personal Computer Settings

- Terminate all running applications.
- Log on as a user who has the administrator account.

Important

- Before installing the latest MP Drivers, [delete the previously installed version](#).

Related Topics

- [Obtaining the Latest MP Drivers](#)
- [Installing the MP Drivers](#)

Installing the MP Drivers

You can access our web site through the Internet and download the latest MP Drivers and XPS printer driver for your model.

The procedure for installing the downloaded MP Drivers is as follows:

1. Turn off the printer

2. Start the installer

Double-click the icon of the downloaded file.

The installation program starts.

►►► Important

- In Windows 8.1, Windows 8, Windows 7, or Windows Vista, a confirmation/warning dialog box may appear when starting, installing or uninstalling software.
This dialog box appears when administrative rights are required to perform a task.
When you are logged on to an administrator account, click **Yes** (or **Continue**, **Allow**) to continue.
Some applications require an administrator account to continue. In such cases, switch to an administrator account, and restart the operation from the beginning.

3. Install the MP Drivers

Take the appropriate action as described on the screen.

4. Complete the installation

Click **Complete**.

Depending on the environment you are using, a message prompting you to restart the computer may be displayed. To complete the installation properly, restart the computer.

►►► Important

- You can install the XPS printer driver with the same procedure for installing the MP Drivers. However, when installing the XPS printer driver, first complete installation of the MP Drivers.
- You can download the MP Drivers and XPS printer driver for free, but any Internet access charges incurred are your responsibility.
- Before installing the latest MP Drivers, [delete the previously installed version](#).

Related Topics

- [Obtaining the Latest MP Drivers](#)
- [Deleting the Unnecessary MP Drivers](#)
- [Before Installing the MP Drivers](#)

Printing Using the Operation Panel of the Machine

- ▶ [Printing Template Forms Such As Lined Paper or Graph Paper](#)

Printing Template Forms Such As Lined Paper or Graph Paper

You can print a template form such as lined paper, graph paper, or checklist, etc. on A4, B5, or Letter-sized plain paper.

■ [Printable template forms](#)

■ [Printing template forms](#)

Printable template forms

The following templates are available:

- **Notebook paper**



You can select three line spacing formats.

Setting on the LCD:

- **Notebook paper 1:** 8 mm spacing
- **Notebook paper 2:** 7 mm spacing
- **Notebook paper 3:** 6 mm spacing

▶▶▶ **Note**

- You cannot print Notebook paper on B5 sized paper.

- **Graph paper**



You can select two square sizes.

Setting on the LCD:

- **Graph paper 1:** Graph 5 mm
- **Graph paper 2:** Graph 3 mm

▶▶▶ **Note**

- You cannot print Graph paper on B5 sized paper.

- **Checklist**



You can print a notepad with checkboxes.

Setting on the LCD:

Checklist

- **Staff paper**



You can print staff paper with 10 or 12 staves.

Setting on the LCD:

- **Staff paper 1:** 10 staves
- **Staff paper 2:** 12 staves

- **Handwriting paper**



You can print handwriting paper.

Setting on the LCD:

Handwriting paper

- **Weekly schedule**

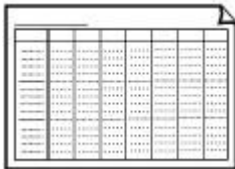

You can print a weekly schedule form.

Setting on the LCD:

Weekly schedule

- **Monthly schedule**

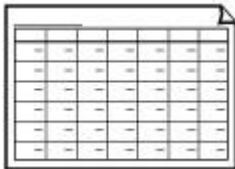

You can print a monthly schedule form.

Setting on the LCD:

Monthly schedule

Printing template forms

Print template form following the procedure below.

1. [Make sure that the machine is turned on.](#)
2. [Load A4, B5, or Letter-sized plain paper.](#)
3. Press the **Setup** button.
The **Setup menu** screen is displayed.
4. Use the ◀▶ button to select **Template print**, then press the **OK** button.
5. Use the ◀▶ button to select the template you want to print, then press the **OK** button.

■ [Printable template forms](#)

6. Use the ◀▶ button to specify the paper size, then press the **OK** button.

▶▶ **Note**

- The * (asterisk) on the LCD indicates the current setting.

7. Make sure that **Plain paper** is selected, then press the **OK** button.

8. Use the ◀ (-) ▶ (+) button or the Numeric buttons to specify the number of copies.

9. Press the **OK** button to start printing.

▶▶ **Note**

- You can also press the **Color** button or **Black** button to start printing.

Paper setting for Printing

By registering the paper size and the media type loaded in the cassette, you can prevent the machine from misprinting by displaying the message before printing starts when the paper size or the media type of the loaded paper differs from the print settings.

- **When you insert the cassette with paper loaded:**

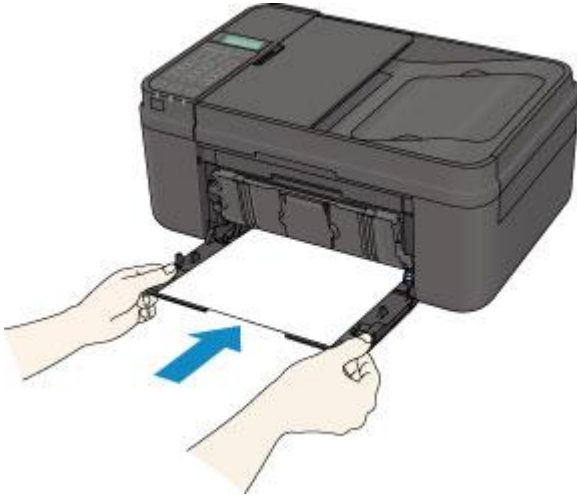

The screen to register the cassette paper information is displayed.

Register the cassette pa
[OK]Next

Register the paper size and the media type according to the loaded paper.

Press the **OK** button, then register the paper size and the media type according to the loaded paper.

▶▶▶ Important

- For details on the proper combination of paper settings you can specify by the printer driver or on the LCD:
 - [Paper Settings on the Printer Driver and the Printer \(Media Type\)](#)
 - [Paper Settings on the Printer Driver and the Printer \(Paper Size\)](#)
- For copying, specify the paper settings for copying so that they match the cassette paper information.

▶▶▶ Note

- Depending on the registered cassette paper information, the screen to confirm if you apply the registered information to the paper settings for copying is displayed. If you select **Yes**, the information is applied to the paper settings for copying.

- **When the paper settings for printing or copying are different from the cassette paper information registered to the machine:**

Ex:

- Paper setting for printing or copying: B5
- Cassette paper information registered to the machine: A4

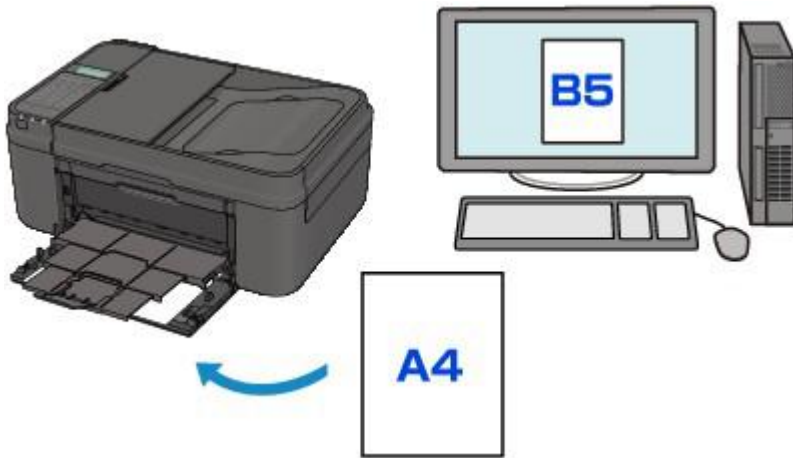

When you start printing or copying, a message is displayed.

```
The size/type of lo 2110  
[OK]Select option
```

Confirm the message, then press the **OK** button. When the screen to select the operation is displayed, select one of the operations below.

»» Note

- Depending on the setting, the choices below may not be displayed.

Use cass. settings

Select if you want to print on the paper loaded in the cassette without changing the paper settings.

For example, when the paper setting for printing or copying is B5 and the cassette paper information registered to the machine is A4, the machine starts printing or copying with B5 on the paper loaded in the cassette.

Replace the paper

Select if you want to print after replacing the paper of the cassette.

For example, when the paper setting for printing or copying is B5 and the cassette paper information registered to the machine is A4, you load B5 sized paper in the cassette before you start printing or copying.

The cassette paper information registration screen is displayed after replacing the paper and inserting the cassette. Register the cassette paper information according to the paper you loaded in the cassette.

»» Note

- If you do not know what paper information to register to the machine, press the **Back** button when the screen to select the operation is displayed. When the previous screen is displayed, confirm the paper size and the media type, then register them to the machine.
- For details on the proper combination of paper settings you can specify by the printer driver or on the LCD:

■ [Paper Settings on the Printer Driver and the Printer \(Media Type\)](#)

■ [Paper Settings on the Printer Driver and the Printer \(Paper Size\)](#)

Cancel

Cancels printing.

Select when you change the paper settings specified for printing or copying. Change the paper settings, then try printing again.

»» Important

- About the default setting for displaying the message which prevents misprinting:

The default setting is different between when you print or copy from the operation panel of the machine and when you print using the printer driver.

- When you print or copy from the operation panel of the machine, the message which prevents misprinting is enabled by default.

To change the setting for printing or copying using the operation panel of the machine:

■ [Cassette settings](#)

- When you print using the printer driver, the message which prevents misprinting is disabled by default.

To change the setting for printing using the printer driver:

■ [Changing the Printer Operation Mode](#)

- When the message which prevents misprinting is disabled:

The machine starts printing or copying even though the paper settings for printing or copying and the cassette paper information registered to the machine are different.

Copying



Making Copies **Basic**



Reducing or Enlarging a Copy



About Special copy Menu



Collated Copying

Making Copies

This section describes the basic procedure to perform standard copying.



1. [Make sure that the machine is turned on.](#)
2. [Load paper.](#)
3. Press the **COPY** button.
The Copy standby screen is displayed.
4. [Load the original document on the platen glass or in the ADF.](#)
5. Confirm the page size and magnification.



1. Magnification
2. Page size

▶▶▶ Note

- To change or confirm the page size, magnification, or other settings, press the **Menu** button, then use the ◀▶ button to display the desired setting item.
[■ Setting Items for Copying](#)
- Press the **COPY** button to reset the magnification to 100%.

6. Use the ◀ (-) ▶ (+) button or the Numeric buttons to specify the number of copies.
7. Press the **Color** button for color copying, or the **Black** button for black & white copying.

The machine starts copying.

Remove the original on the platen glass or from the document output slot after copying is complete.

▶▶▶ Important

- If you load the original on the platen glass, do not open the document cover or remove the original while **Scanning...** is displayed on the screen.
- If you load the original in the ADF, do not move the original until copying is complete.

▶▶▶ Note

- To cancel copying, press the **Stop** button.
- If you load the original on the platen glass, you can add the copying job while printing.

Adding the Copying Job (Reserve copy)

If you load the original on the platen glass, you can add the copying job while printing (Reserve copy).

The screen below is displayed when you can reserve copy.

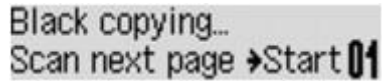

Black copying...
Scan next page → Start 01

Load the original on the platen glass and press the same button (the **Color** button or the **Black** button) as the one which you previously pressed.

▶▶ Important

- When you load the original on the platen glass, move the document cover gently.

▶▶ Note

- When **Print quality** is set **High**, or you load the original in the ADF, you cannot add the copying job.
- When you add the copying job, the number of copies or the settings such as the page size or media type cannot be changed.
- If you press the **Stop** button while reserve copying is in progress, the screen to select the method to cancel copying is displayed. If you select **Cancel all reserv.** then press the **OK** button, you can cancel copying all scanned data. If you select **Cancel last reserv.**, then press the **OK** button, you can cancel the last copying job.
- If you set a document of too many pages to reserve copy, **Memory is full** may appear on the LCD. Press the **OK** button and wait a while, then try copying again.
- If **Try again** appears on the LCD when scanning, press the **OK** button, then press the **Stop** button to cancel copying. After that, copy the documents that have not been finished copying.

Setting Items for Copying

You can change the copy settings such as the page size, media type, and intensity.

Press the **Menu** button, use the ◀▶ button to select a setting item, then press the **OK** button.

Use the ◀▶ button to adjust each setting item, then press the **OK** button. The next setting item is displayed.

The LCD returns to the Copy standby screen when all the settings are complete.

▶▶▶ Note

- The * (asterisk) on the LCD indicates the current setting.
- Some settings cannot be specified in combination with the setting of other setting items or the copy menu.
- The settings of the page size, media type, etc. are retained even if the machine is turned off.

• Enlarge/Reduce

Select the reduction/enlargement method.

■ [Reducing or Enlarging a Copy](#)

Ex:

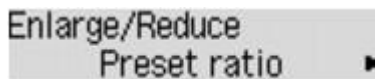

▶▶▶ Note

- This setting item is displayed under the following conditions.
 - When standard copying is selected
 - When **Borderless copy** is selected for **Special copy**

• Copy intensity

Change the intensity.

Ex:

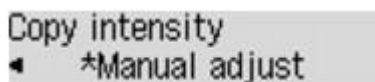

▶▶▶ Note

- If you select **Auto adjust**, load the original on the platen glass.
- If you select **Manual adjust**, use the ◀ button to decrease the intensity or the ▶ button to increase it.

• Page size

Select the page size of the loaded paper.

Ex:

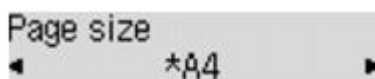

▶▶▶ Note

- Some of setting items are not available depending on the country or region of purchase.

• Media type

Select the media type of the loaded paper.

Ex:

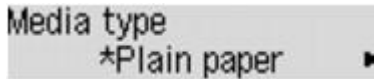

• Print quality

Select the print quality according to the original.

Ex:



▶▶▶ Note

- If you use **Draft** with the media type set to **Plain paper** and the quality is not as good as expected, select **Standard** or **High** and try copying again.
- Select **High** to copy in grayscale. Grayscale renders tones in a range of grays instead of black or white.

• 4-on-1 layout

Select the layout when copying four original pages onto a single sheet of paper by reducing each image. Four different layouts are available.

Ex:

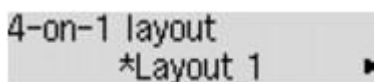

▶▶▶ Note

- This setting item is displayed only when **4-on-1 copy** is selected for **Special copy**.

■ [Copying Four Pages to Fit onto a Single Page](#)

• Collate

Select whether to obtain sorted printouts when making multiple copies of a multi-paged original.

Ex:



▶▶▶ Note

- This setting item is displayed when standard copying is selected.

Reducing or Enlarging a Copy

You can specify the magnification optionally or select the preset-ratio copying or fit-to-page copying.

In the copy mode, press the **Menu** button, use the ◀▶ button to select **Enlarge/Reduce**, then press the **OK** button.

Use the ◀▶ button to select the reduction/enlargement method, then press the **OK** button.

Ex:

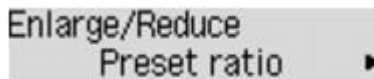

▶▶▶ Note

- Some of the reduction/enlargement methods are not available depending on the copy menu.

• Preset ratio

You can select one of the preset ratios to reduce or enlarge copies.



Use the ◀▶ button to select a preset ratio to match the size of your original document and printing paper, then press the **OK** button.

• Magnification

You can specify the copy ratio as a percentage to reduce or enlarge copies.



Use the ◀ (-) ▶ (+) button or the Numeric buttons to specify the reduction or enlargement ratio (25 - 400%), then press the **OK** button.

▶▶▶ Note

- Press and hold the ◀ (-) ▶ (+) button to quickly advance through the ratios. For details, see [Key repeat](#).

• Fit to page

The machine automatically reduces or enlarges the image to fit the page size.



▶▶▶ Note

- When you select **Fit to page**, the size of your original document may not be detected correctly depending on the original. In this case, select **Preset ratio** or **Magnification**.
- When **Fit to page** is selected, load the original on the platen glass.

About Special copy Menu

The following menus are selectable in the **Special copy** menu.

- **Frame erase copy**

When copying thick originals such as books, you can make a copy without black margins around the image and gutter shadows.

■ [Copying Thick Originals Such as Books](#)

- **Borderless copy**

You can copy images so that they fill the entire page without borders.

■ [Copying without Borders](#)

- **2-on-1 copy**

You can copy two original pages onto a single sheet of paper by reducing each image.

■ [Copying Two Pages to Fit onto a Single Page](#)

- **4-on-1 copy**

You can copy four original pages onto a single sheet of paper by reducing each image.

■ [Copying Four Pages to Fit onto a Single Page](#)

▶▶ Note

- In addition to the copying method in the **Special copy** menu, the methods below are available.
 - You can specify the magnification optionally or select the preset-ratio copying or fit-to-page copying.

■ [Reducing or Enlarging a Copy](#)
 - You can obtain sorted printouts when making multiple copies of a multi-paged original.

■ [Collated Copying](#)

Copying Two Pages to Fit onto a Single Page

You can copy two original pages or a two sided page onto a single sheet of paper by reducing each image.

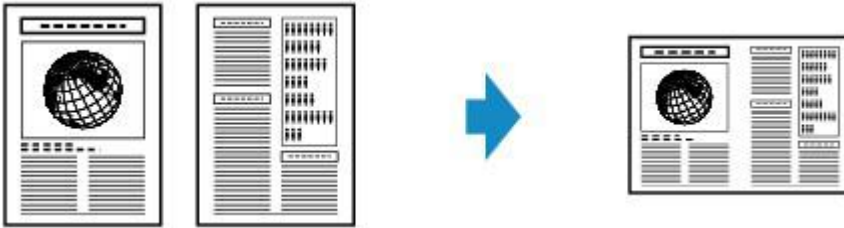

1. [Make sure that the machine is turned on.](#)

2. [Load paper.](#)

3. Press the **COPY** button.

The Copy standby screen is displayed.

4. Press the **Menu** button.

The **Copy menu** screen is displayed.

5. Use the ◀▶ button to select **Special copy**, then press the **OK** button.

6. Use the ◀▶ button to select **2-on-1 copy**, then press the **OK** button.

If a page size setting or a media type setting that cannot be used in 2-on-1 copying is selected, the LCD displays the following message.

```
Size: ◀ *B5 ▶  
Type: *Plain paper
```

1. Use the ◀▶ button to select the page size, then press the **OK** button.

2. Use the ◀▶ button to select the media type, then press the **OK** button.

7. [Load the original document on the platen glass or in the ADF.](#)

8. Use the ◀ (-) ▶ (+) button or the Numeric buttons to specify the number of copies.

Change the print settings as necessary.

■ [Setting Items for Copying](#)

9. Press the **Color** button for color copying, or the **Black** button for black & white copying.

- When the document has been loaded on the platen glass:

When the machine finishes scanning the first page, the message below is displayed.

```
Scan next page →[OK]  
Start print →[*]
```

If you have the next page to scan, load it on the platen glass and press the **OK** button. The machine starts copying.

If you do not need more scanning, press the **Tone** button to start copying. The machine starts copying.

▶▶▶ Note

- You can add the copying job while printing.

■ [Adding the Copying Job \(Reserve copy\)](#)

- When the document has been loaded in the ADF:

The machine starts scanning the next sheet of document automatically after one sheet of document finishes being scanned.

▶▶▶ Note

- If **Memory is full** appears on the LCD when scanning, set the print quality to **Standard** or reduce the number of sheets of documents, then try copying again. If the problem is not resolved, set the print quality to **Draft** and try copying again.

Copying Four Pages to Fit onto a Single Page

You can copy four original pages onto a single sheet of paper by reducing each image. Four different layouts are available.

- When **Layout 1** is selected for **4-on-1 layout**:

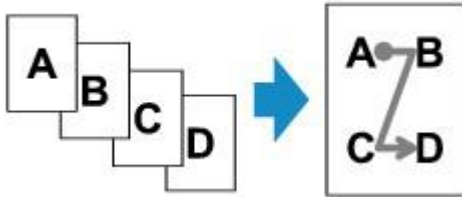

- When **Layout 2** is selected for **4-on-1 layout**:

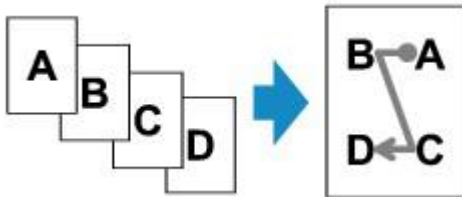

- When **Layout 3** is selected for **4-on-1 layout**:

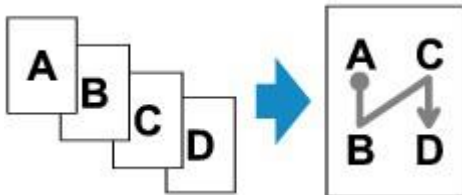

- When **Layout 4** is selected for **4-on-1 layout**:

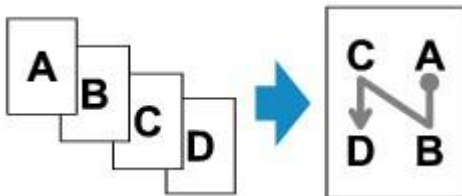

1. [Make sure that the machine is turned on.](#)

2. [Load paper.](#)

3. Press the **COPY** button.

The Copy standby screen is displayed.

4. Press the **Menu** button.

The **Copy menu** screen is displayed.

5. Use the ◀▶ button to select **Special copy**, then press the **OK** button.

6. Use the ◀▶ button to select **4-on-1 copy**, then press the **OK** button.

If a page size setting or a media type setting that cannot be used in 4-on-1 copying is selected, the LCD displays the following message.

Size: ◀ *B5 ▶
Type: *Plain paper

1. Use the ◀▶ button to select the page size, then press the **OK** button.
2. Use the ◀▶ button to select the media type, then press the **OK** button.

7. Specify the print settings and the layout.

Press the **Menu** button, then use the ◀▶ button to select a setting item.

Select **4-on-1 layout**, press the **OK** button, then select the layout.

■ [Setting Items for Copying](#)

▶▶▶ Note

- The * (asterisk) on the LCD indicates the current setting.

8. [Load the original document on the platen glass or in the ADF.](#)

9. Use the ◀ (-) ▶ (+) button or the Numeric buttons to specify the number of copies.

10. Press the **Color** button for color copying, or the **Black** button for black & white copying.

- When the document has been loaded on the platen glass:

When the machine finishes scanning the first to the third page, the message below is displayed.

Scan next page →[OK]
Start print →[*]

If you have the next page to scan, load it on the platen glass and press the **OK** button. The machine starts copying.

If you do not need more scanning, press the **Tone** button to start copying. The machine starts copying.

▶▶▶ Note

- You can add the copying job while printing.

■ [Adding the Copying Job \(Reserve copy\)](#)

- When the document has been loaded in the ADF:

The machine starts scanning the next page automatically after a page finishes being scanned.

▶▶▶ Note

- If **Memory is full** appears on the LCD when scanning, set the print quality to **Standard** or reduce the number of sheets of documents, then try copying again. If the problem is not resolved, set the print quality to **Draft** and try copying again.

Copying Thick Originals Such as Books

When copying thick originals such as books, you can make a copy without black margins around the image and gutter shadows. Using this function, you can reduce unnecessary ink consumption.



1. [Make sure that the machine is turned on.](#)
2. [Load paper.](#)
3. Press the **COPY** button.
The Copy standby screen is displayed.
4. Press the **Menu** button.
The **Copy menu** screen is displayed.
5. Use the ◀▶ button to select **Special copy**, then press the **OK** button.
6. Use the ◀▶ button to select **Frame erase copy**, then press the **OK** button.
7. [Load the original document on the platen glass.](#)

▶▶▶ Note

- When you use this function, load the original on the platen glass.

8. Use the ◀ (-) ▶ (+) button or the Numeric buttons to specify the number of copies.
Change the print settings as necessary.

■ [Setting Items for Copying](#)

9. Press the **Color** button for color copying, or the **Black** button for black & white copying.
The machine starts copying.

▶▶▶ Note

- Close the document cover.
- There may be a narrow black margin that appears around the image. This function removes the dark margins only. If a scanned book is too thin or when the machine is used near a window or in a bright environment, a faint black frame may remain. Also, if the color of an original is dark, the machine cannot distinguish the document color from the shadow and this may cause slight cropping or a shadow on the crease.

Copying without Borders

You can copy images so that they fill the entire page without borders.

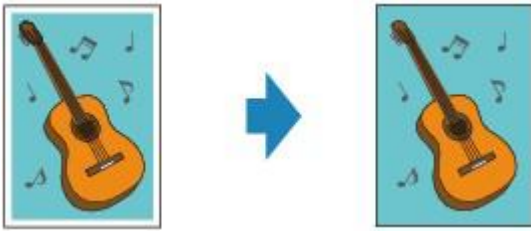

1. [Make sure that the machine is turned on.](#)

2. [Load the photo paper.](#)

3. Press the **COPY** button.

The Copy standby screen is displayed.

4. Press the **Menu** button.

The **Copy menu** screen is displayed.

5. Use the ◀▶ button to select **Special copy**, then press the **OK** button.

6. Use the ◀▶ button to select **Borderless copy**, then press the **OK** button.

If a page size setting or a media type setting that cannot be used in borderless copying is selected, the LCD displays the following message.

Size: ◀ *A4 ▶
Type: *Plain paper

1. Use the ◀▶ button to select the page size, then press the **OK** button.

2. Use the ◀▶ button to select the media type, then press the **OK** button.

7. [Load the original document on the platen glass.](#)

▶▶▶ Note

- When you use this function, load the original on the platen glass.

8. Use the ◀ (-) ▶ (+) button or the Numeric buttons to specify the number of copies.

Change the print settings as necessary.

■ [Setting Items for Copying](#)

9. Press the **Color** button for color copying, or the **Black** button for black & white copying.

The machine starts borderless copying.

»» Note

- Slight cropping may occur at the edges since the copied image is enlarged to fill the whole page. You can change the width to be cropped from the borders of the original image as needed. However, the cropped area will be larger if the extension amount is large.

For details:

■ [Extended copy amt.](#)

- For details on the paper size and the media type available for borderless copying:

■ [Printing Area](#)

Collated Copying

When you select **ON** for **Collate** on **Copy menu**, you can obtain sorted printouts when making multiple copies of a multi-paged original. In addition, you can copy originals on both sides of paper.

- When **ON** is selected:

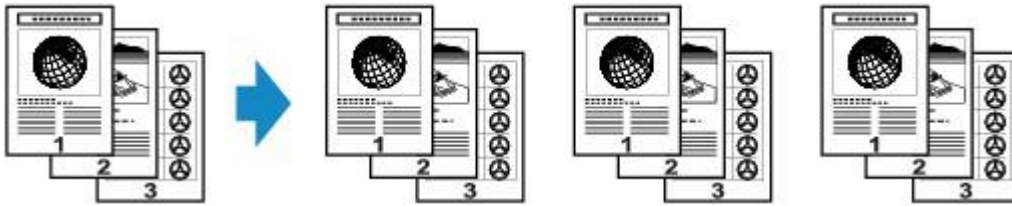

- When **OFF** is selected:

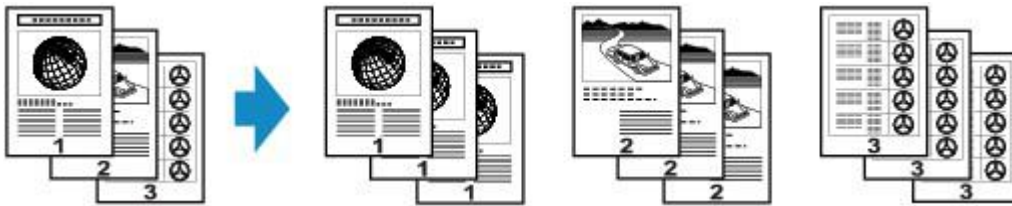

▶▶▶ Note

- When you use this function, load the original in the ADF.
- The number of pages the machine can read varies with the original. If **Memory is full** appears on the LCD when scanning, reduce the number of original pages to scan and try copying again.

Scanning



Scanning from a Computer



Scanning from the Operation Panel of the
Machine

Scanning from a Computer

- ▶ **Scanning with IJ Scan Utility**
- ▶ **Scanning with Application Software that You are Using (ScanGear)**
- ▶ **Useful Information on Scanning**
- ▶ **IJ Network Scanner Selector EX Menu and Setting Screen**
- ▶ **Other Scanning Methods**
- ▶ **Placing Items (When Scanning from a Computer)**

Scanning with IJ Scan Utility

- ▶ **What Is IJ Scan Utility (Scanner Software)?**
- ▶ **Starting IJ Scan Utility**
- ▶ **Easy Scanning with Auto Scan  Basic**
- ▶ **Scanning Documents**
- ▶ **Scanning Photos**
- ▶ **Scanning with Favorite Settings**
- ▶ **Scanning Items Larger than the Platen (Image Stitch)**
- ▶ **Scanning Multiple Items at One Time**
- ▶ **Scanning Multiple Documents at One Time from the ADF (Auto Document Feeder)**
- ▶ **Saving after Checking Scan Results**
- ▶ **Sending Scanned Images via E-mail**
- ▶ **Extracting Text from Scanned Images (OCR)**
- ▶ **IJ Scan Utility Screens**

What Is IJ Scan Utility (Scanner Software)?

IJ Scan Utility is an application that allows you to easily scan documents, photos, etc.

You can complete from scanning to saving at one time by simply clicking the corresponding icon in the IJ Scan Utility main screen.

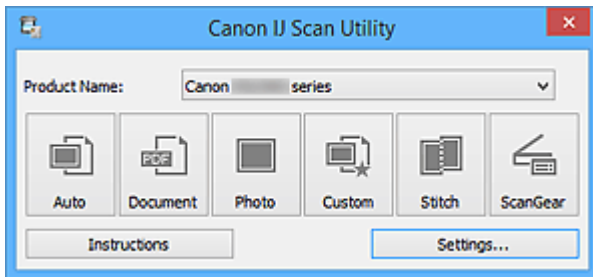

What You Can Do with IJ Scan Utility

Scan Easily according to Purposes

You can scan by simply clicking an icon such as **Auto** to scan easily, **Document** to sharpen text in a document or magazine for better readability, or **Photo** to scan with settings suitable for photos, according to the item type or your purpose.

►► Note

- Refer to "[IJ Scan Utility Main Screen](#)" for details on the IJ Scan Utility main screen.

Save Scanned Images Automatically

Scanned images are automatically saved in a preset folder. You can change the folder as required.

►► Note

- The default save folders are as follows.
 - Windows 8.1: **Documents** folder
 - Windows 8: **My Documents** folder
 - Windows 7: **My Documents** folder
 - Windows Vista: **Documents** folder
 - Windows XP: **My Documents** folder
- Refer to "[Settings Dialog Box](#)" for how to specify a folder.

Integrate with Applications

You can utilize scanned images through integration with other applications; display scanned images in your favorite application, attach them to e-mails, extract text from images, and more.

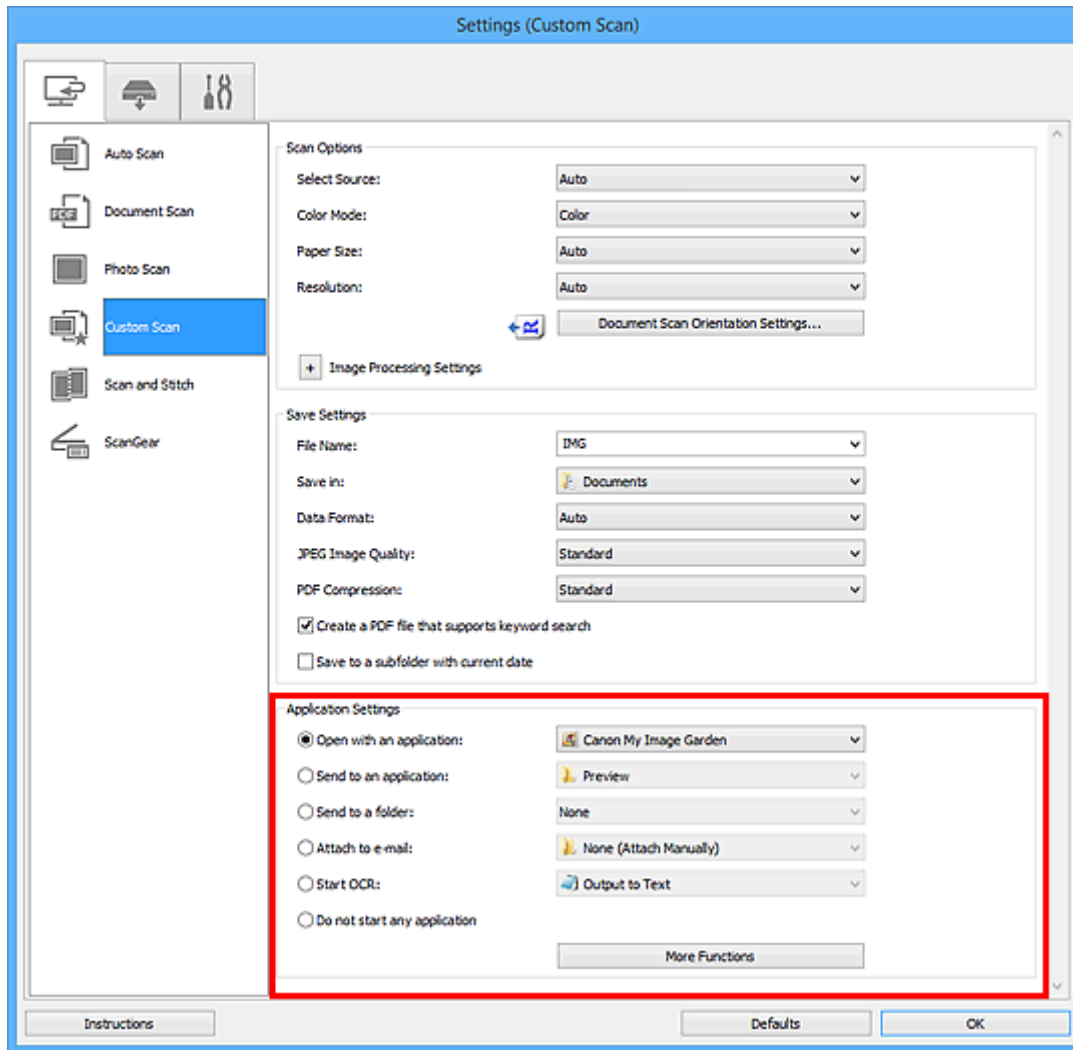

►►► Important

- Some functions are available only when My Image Garden is installed.

►►► Note

- Refer to "[Settings Dialog Box](#)" for how to set the applications to integrate with.

Starting IJ Scan Utility

►►► Note

- If you have more than one scanner or have changed the connection from USB connection to network connection, set up the network environment from IJ Scan Utility.

■ [Network Scan Settings](#)

Follow the steps below to start IJ Scan Utility.

Windows 8.1/Windows 8:

Select **IJ Scan Utility** on the Start screen to start IJ Scan Utility.

If **IJ Scan Utility** is not displayed on the Start screen, select the **Search** charm, then search for "IJ Scan Utility".

Windows 7/Windows Vista/Windows XP:

From the **Start** menu, select **All Programs > Canon Utilities > IJ Scan Utility > IJ Scan Utility** to start IJ Scan Utility.

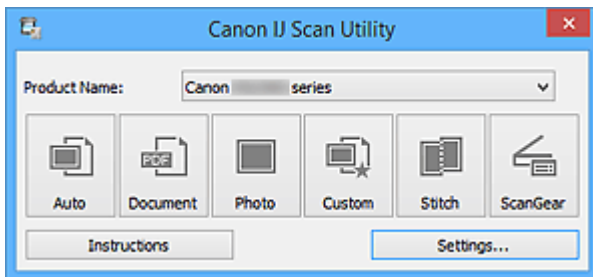

Easy Scanning with Auto Scan

You can scan easily by automatically detecting the item type.

►► Important

- The following types of items may not be scanned correctly. In that case, adjust the cropping frames (scan areas) in whole image view of ScanGear (scanner driver) and scan again.
 - Photos that have a whitish background
 - Items printed on white paper, hand-written documents, business cards, etc.
 - Thin items
 - Thick items
- When scanning two or more documents from the ADF (Auto Document Feeder), place documents of the same size.

1. Make sure that your scanner or printer is turned on.
2. Place items on the platen or ADF of your scanner or printer.
 - [Placing Items \(When Scanning from a Computer\)](#)
3. [Start IJ Scan Utility.](#)
4. Click **Auto**.

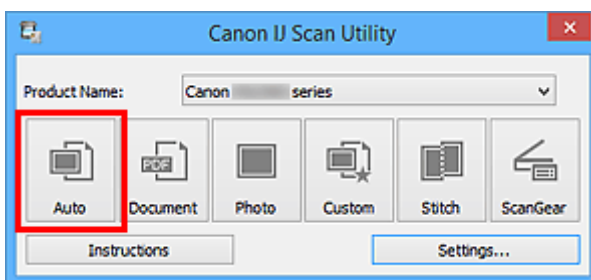

Scanning starts.

►► Note

- Click **Cancel** to cancel the scan.
- To apply suitable corrections based on the item type, click **Settings...**, then select the **Apply recommended image correction** checkbox in the **Settings (Auto Scan)** dialog box.
- Scanned images are saved in the folder set for **Save in** in the [Settings \(Auto Scan\) dialog box](#) displayed by clicking **Settings...**. In the **Settings (Auto Scan)** dialog box, you can also make advanced scan settings.
- Refer to the following pages to scan by specifying the item type.
 - [Scanning Photos](#)
 - [Scanning Documents](#)
 - [Scanning with Favorite Settings](#)
 - [Scanning Multiple Documents at One Time from the ADF \(Auto Document Feeder\)](#)

Scanning Documents

You can scan items placed on the platen with settings suitable for documents.

1. Place the item on the platen.

■ [Placing Items \(When Scanning from a Computer\)](#)

2. [Start IJ Scan Utility.](#)

3. Click **Settings...**, then set the paper size, resolution, etc. in the [Settings \(Document Scan\) dialog box](#) as required.

When setting is completed, click **OK**.

4. Click **Document**.

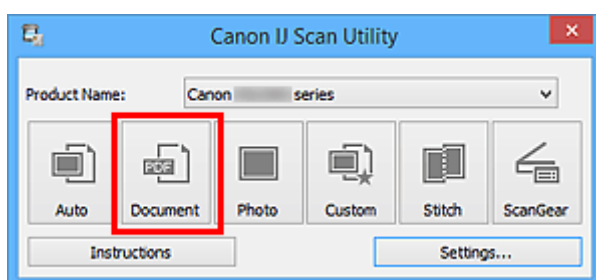

Scanning starts.

▶▶▶ Note

- Click **Cancel** to cancel the scan.
- Scanned images are saved in the folder set for **Save in** in the [Settings \(Document Scan\) dialog box](#) displayed by clicking **Settings...**. In the **Settings (Document Scan)** dialog box, you can also make advanced scan settings.

Scanning Photos

You can scan photos placed on the platen with settings suitable for photos.

1. Place the photo on the platen.

■ [Placing Items \(When Scanning from a Computer\)](#)

2. [Start IJ Scan Utility.](#)

3. Click **Settings...**, then set the paper size, resolution, etc. in the [Settings \(Photo Scan\) dialog box](#) as required.

When setting is completed, click **OK**.

4. Click **Photo**.

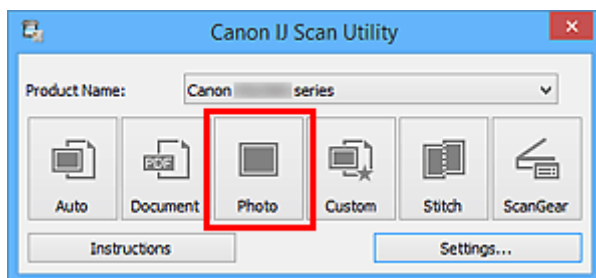

Scanning starts.

▶▶▶ Note

- Click **Cancel** to cancel the scan.
- Scanned images are saved in the folder set for **Save in** in the [Settings \(Photo Scan\) dialog box](#) displayed by clicking **Settings...**. In the **Settings (Photo Scan)** dialog box, you can also make advanced scan settings.

Scanning with Favorite Settings

You can scan items placed on the platen with your favorite settings saved beforehand.

This is convenient for saving frequently used settings or when specifying scan settings in detail.

1. [Start IJ Scan Utility.](#)
2. Click **Settings...**, then set the item type, resolution, etc. in the [Settings \(Custom Scan\) dialog box](#) as required.

When setting is completed, click **OK**.

▶▶▶ Note

- Once the settings are made, you can scan with the same settings from the next time.

3. Place the item on the platen.

■ [Placing Items \(When Scanning from a Computer\)](#)

4. Click **Custom**.

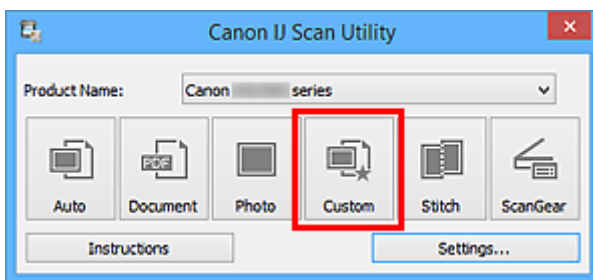

Scanning starts.

▶▶▶ Note

- Click **Cancel** to cancel the scan.
- Scanned images are saved in the folder set for **Save in** in the [Settings \(Custom Scan\) dialog box](#) displayed by clicking **Settings...**. In the **Settings (Custom Scan)** dialog box, you can also make advanced scan settings.

Scanning Items Larger than the Platen (Image Stitch)

You can scan the left and right halves of an item larger than the platen and combine them back into one image. Items up to approximately twice as large as the platen are supported.

▶▶▶ Note

- The following explains how to scan from the item to be placed on the left side.

1. [Start IJ Scan Utility](#).
2. Click **Settings...**, then set the item type, resolution, etc. in the [Settings \(Scan and Stitch\) dialog box](#) as required.

When setting is completed, click **OK**.

3. Click **Stitch**.

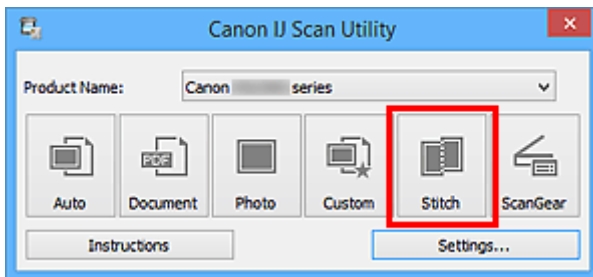

The **Image Stitch** window appears.

4. In **Select Output Size**, select an output size according to the paper size.

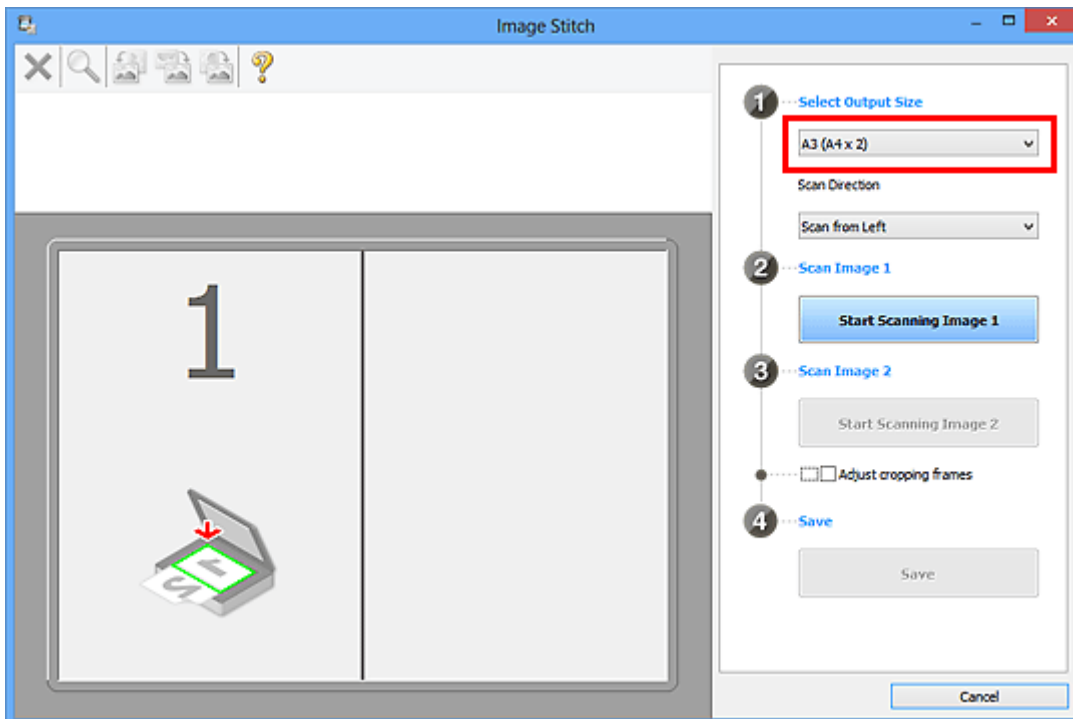

5. Make sure that **Scan from Left** is selected in **Scan Direction**.

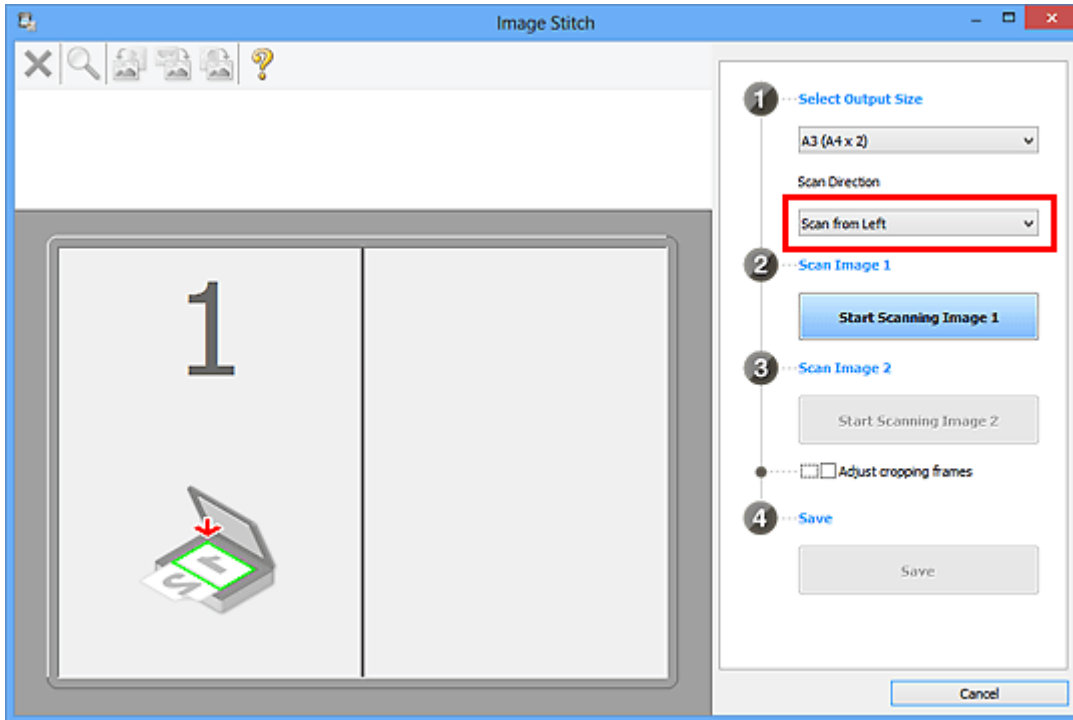

6. Place the item that is to be displayed on the left side of the screen face-down on the platen.

7. Click **Start Scanning Image 1**.

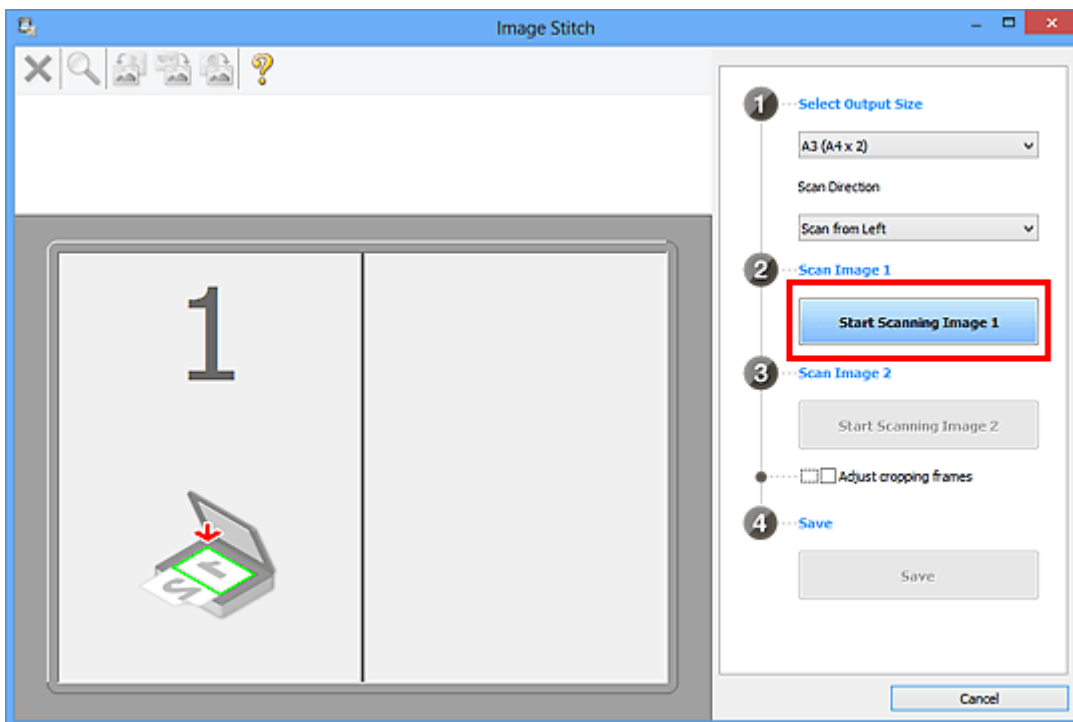

The first item is scanned and appears in 1.

Note

- Click **Cancel** to cancel the scan.

8. Place the item that is to be displayed on the right side of the screen face-down on the platen.

9. Click **Start Scanning Image 2**.

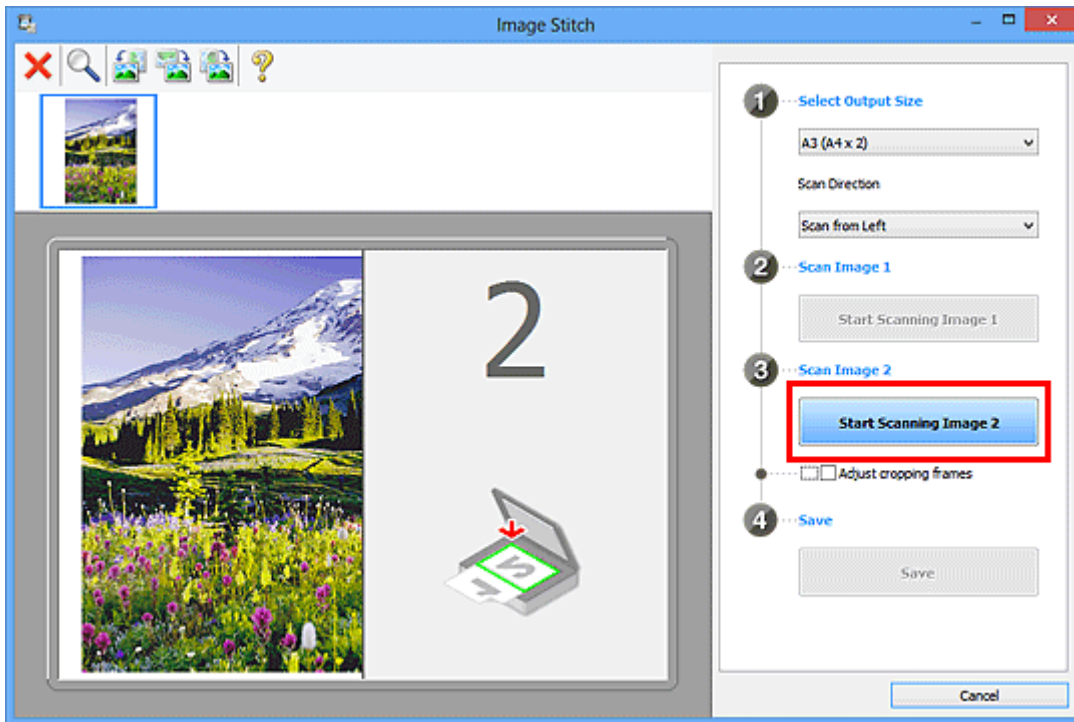

The second item is scanned and appears in 2.

►►► **Note**

- Click **Cancel** to cancel the scan.

10. Adjust the scanned images as required.

Use the Toolbar to rotate or zoom in/out, or drag the images to adjust their positions.

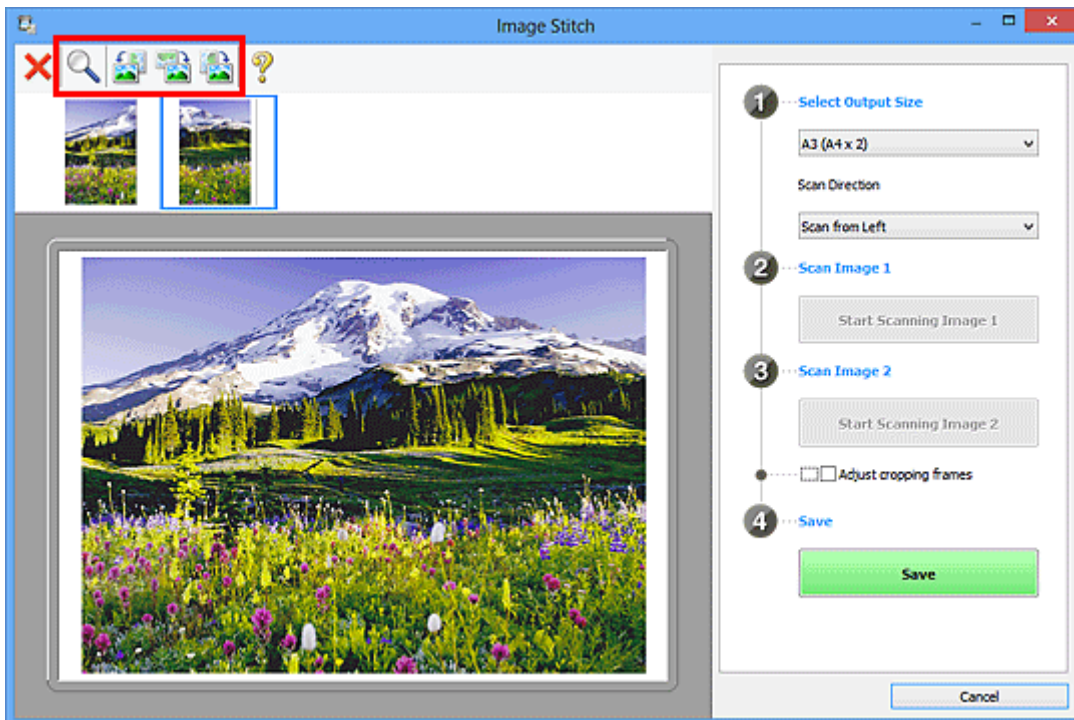

►►► **Note**

- Select the **Adjust cropping frames** checkbox to specify the area to be saved.

■ [Adjusting Cropping Frames in the Image Stitch Window](#)

- To scan an item again, select the image in the Preview area or the thumbnail at the top of the screen, then click  (Delete). The selected image is deleted, allowing you to scan the item again.

11. Click **Save**.

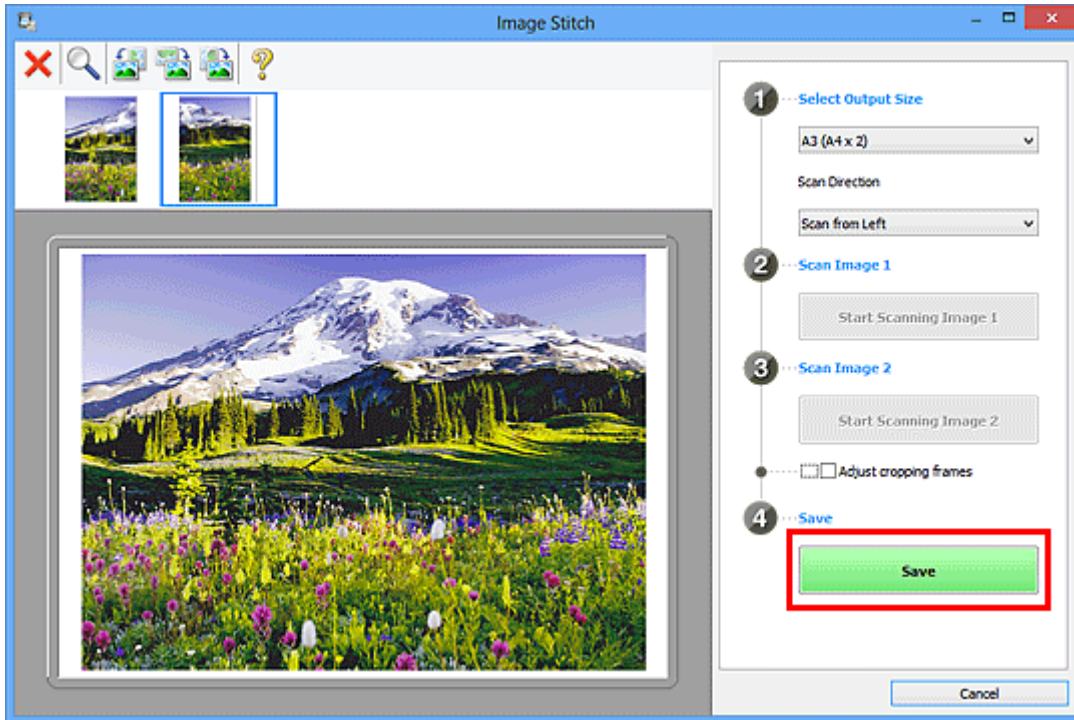

The combined image is saved.

»» Note

- Refer to "[Image Stitch Window](#)" for details on the **Image Stitch** window.
- You can make advanced scan settings in the [Settings \(Scan and Stitch\) dialog box](#) displayed by clicking **Settings....**

Scanning Multiple Items at One Time

You can scan two or more photos (small items) placed on the platen at one time and save each image individually.

►► Important

- The following types of items may not be scanned correctly. In that case, adjust the cropping frames (scan areas) in whole image view of ScanGear (scanner driver) and scan again.
 - Photos that have a whitish background
 - Items printed on white paper, hand-written documents, business cards, etc.
 - Thin items
 - Thick items

Refer to "Scanning Multiple Documents at One Time with ScanGear (Scanner Driver)" for your model from Home of the *Online Manual* for details.

Using Auto Scan:

Whether there are multiple items or not is detected automatically. Click **Auto** in the IJ Scan Utility main screen and scan.

- [Easy Scanning with Auto Scan](#)

Not Using Auto Scan:

In the Settings dialog box, set **Paper Size** to **Auto scan** and scan.

►► Note

- The screens for scanning with favorite settings are used as examples in the following descriptions.

1. Place the items on the platen.

- [Placing Items \(When Scanning from a Computer\)](#)

2. [Start IJ Scan Utility.](#)

3. Click **Settings....**

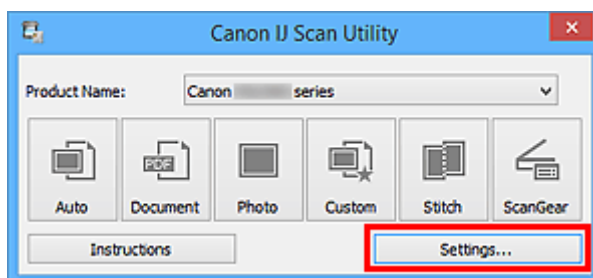

The Settings dialog box appears.

4. Click **Custom Scan.**

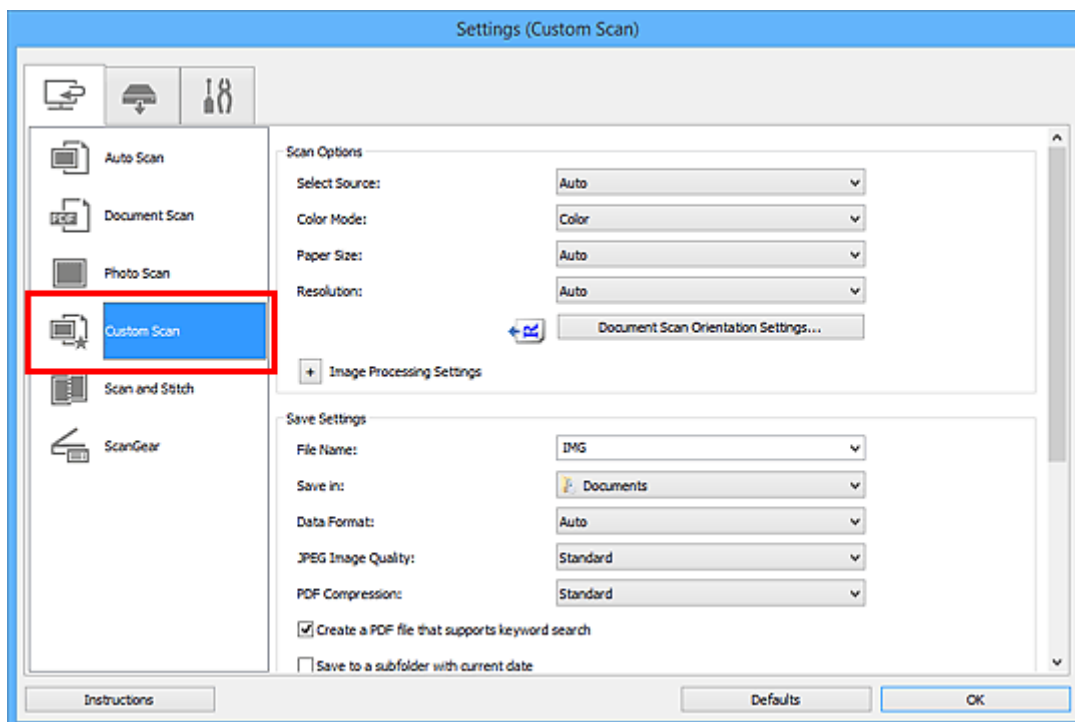

5. Select **Select Source** according to the items to be scanned.

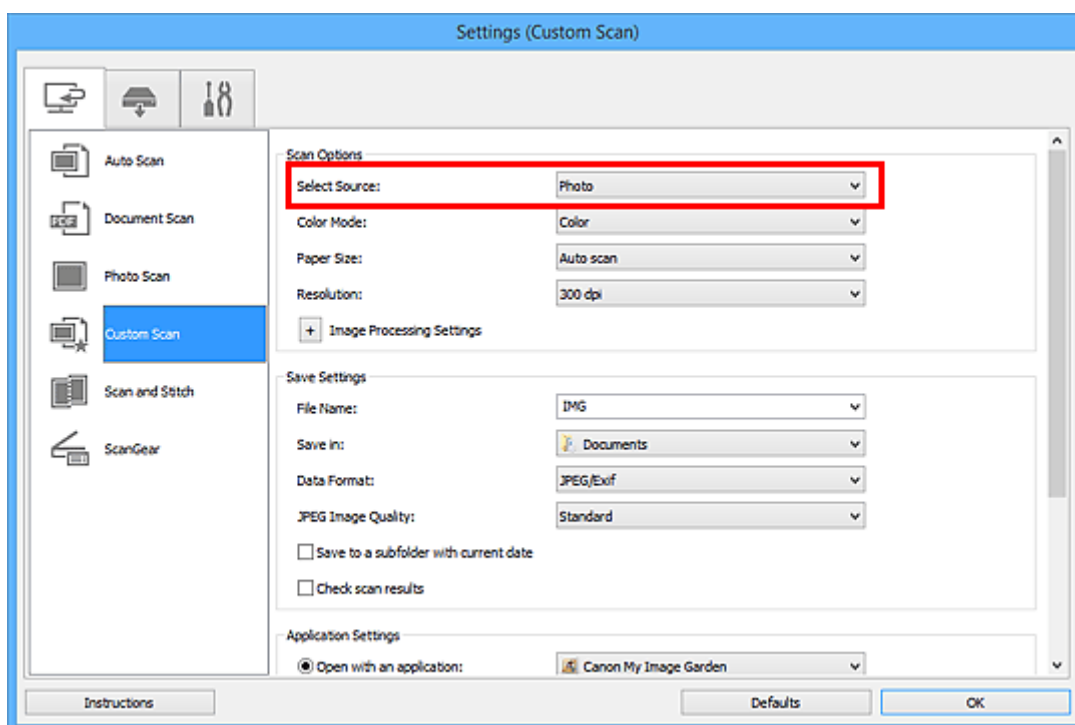

6. Select **Auto scan** for **Paper Size**, then click **OK**.

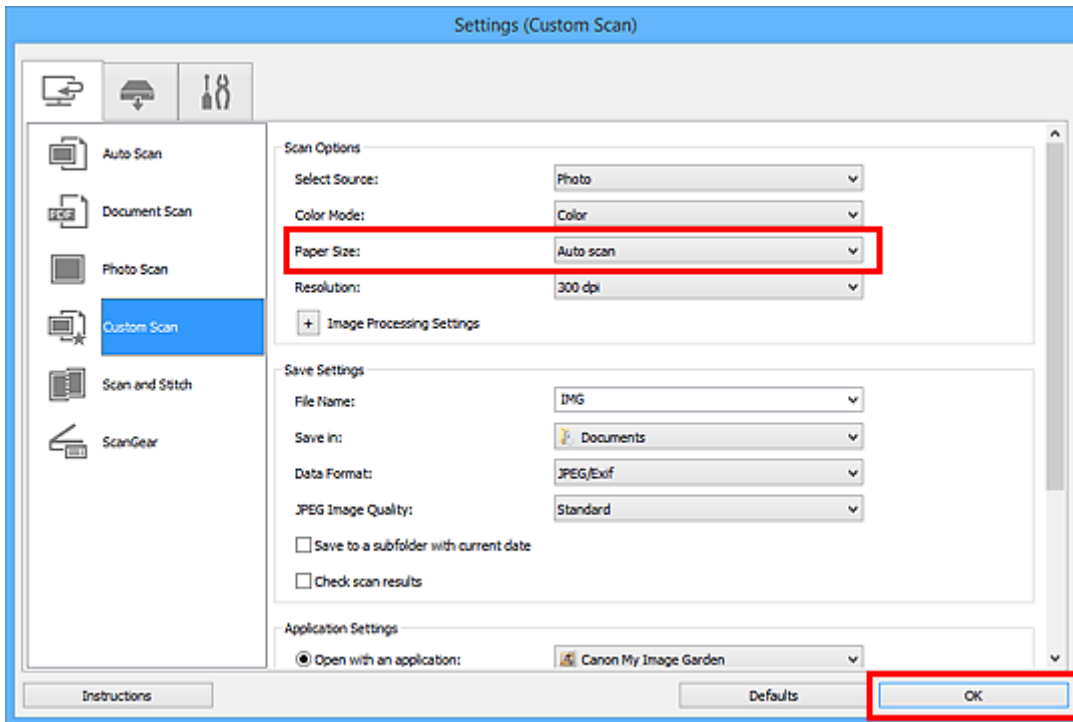

The IJ Scan Utility main screen appears.

►►► Note

- Refer to the following pages for details on the setting items in the Settings dialog box.

■ [Settings \(Document Scan\) Dialog Box](#)

■ [Settings \(Photo Scan\) Dialog Box](#)

■ [Settings \(Custom Scan\) Dialog Box](#)

7. Click **Custom**.

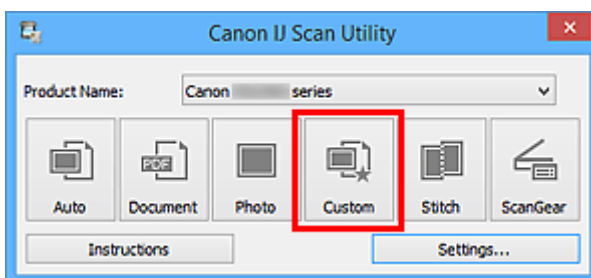

Multiple items are scanned at one time.

►►► Note

- Click **Cancel** to cancel the scan.
- Scanned images are saved in the folder set for **Save in** in the corresponding Settings dialog box displayed by clicking **Settings...**. In each Settings dialog box, you can also make advanced scan settings.

Scanning Multiple Documents at One Time from the ADF (Auto Document Feeder)

Place multiple documents on the ADF (Auto Document Feeder) and scan at one time.

▶▶▶ Note

- You can scan multiple documents at one time from the ADF when scanning via **Auto**, **Document**, **Custom**, or **ScanGear**.
Refer to "Scanning with Application Software that You are Using (ScanGear)" for your model from Home of the *Online Manual* for how to scan using ScanGear (scanner driver).

Using Auto Scan:

The item type is detected automatically. Click **Auto** in the IJ Scan Utility main screen and scan.

- [Easy Scanning with Auto Scan](#)

Not Using Auto Scan:

In the Settings dialog box, set **Select Source** to ADF or **Auto**, and scan.

▶▶▶ Note

- The screens for scanning documents are used as examples in the following descriptions.

1. Place the documents on the ADF.

- [Placing Documents \(ADF \(Auto Document Feeder\)\)](#)

2. [Start IJ Scan Utility.](#)

3. Click **Settings....**

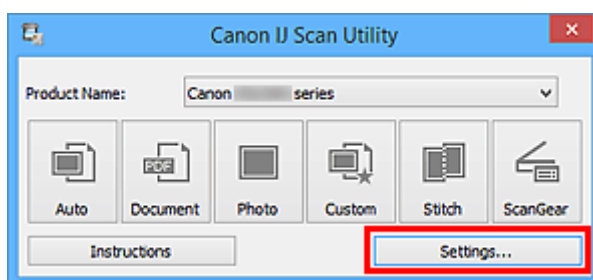

The Settings dialog box appears.

4. Click **Document Scan**.

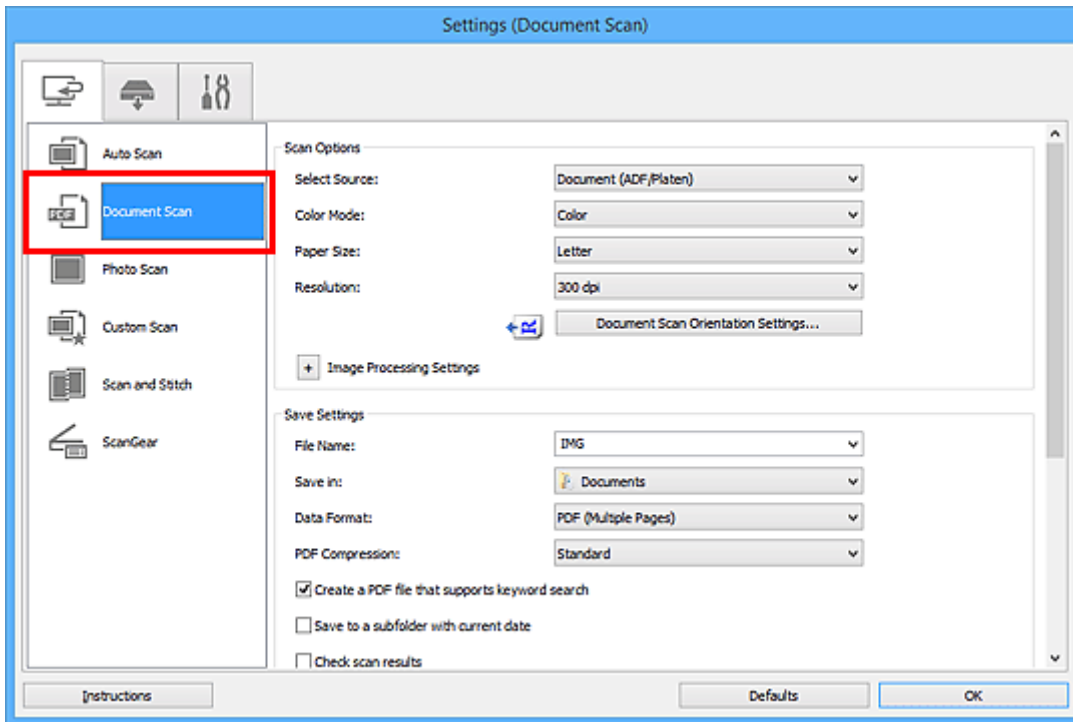

5. Select **Select Source** according to the documents to be scanned.

To scan only the front side of each document, select **Document (ADF/Platen)** or **Document (ADF Simplex)**.

To scan the front side then the back side of each document, select **Document (ADF Manual Duplex)**.

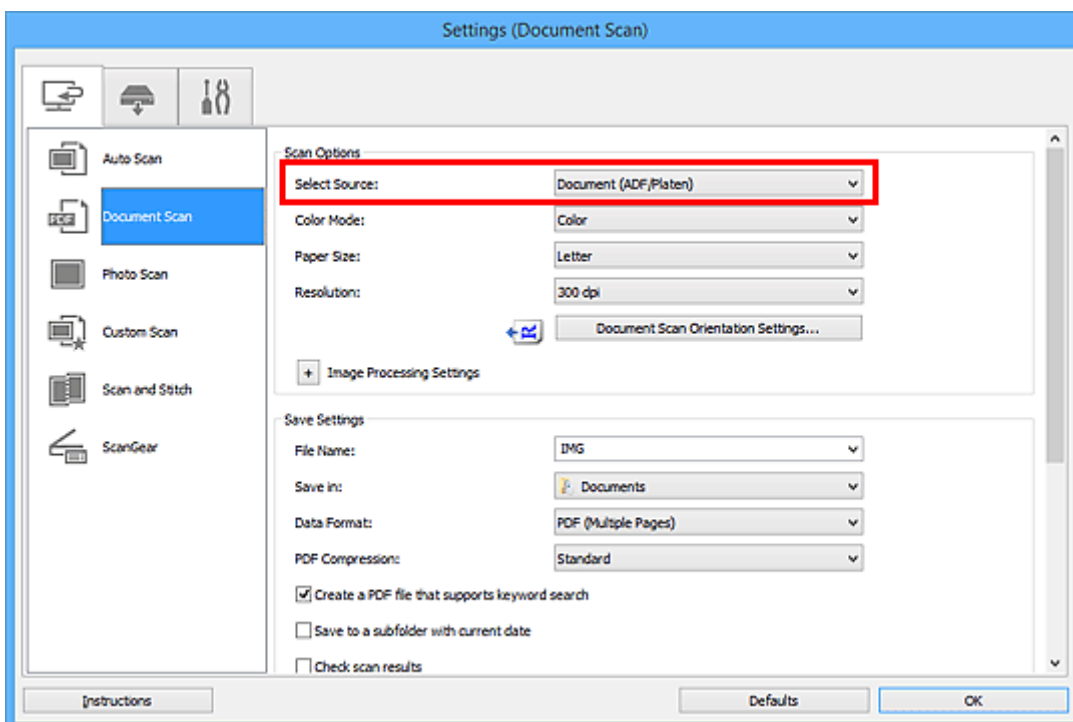

6. Set the color mode, document size, and scanning resolution as required.

Click **Document Scan Orientation Settings...** to specify the orientation of the documents to be scanned. In the displayed dialog box, you can specify the **Orientation** and **Binding Side**. How to place the documents when scanning the back sides depends on the **Binding Side**.

When setting is completed, click **OK**.

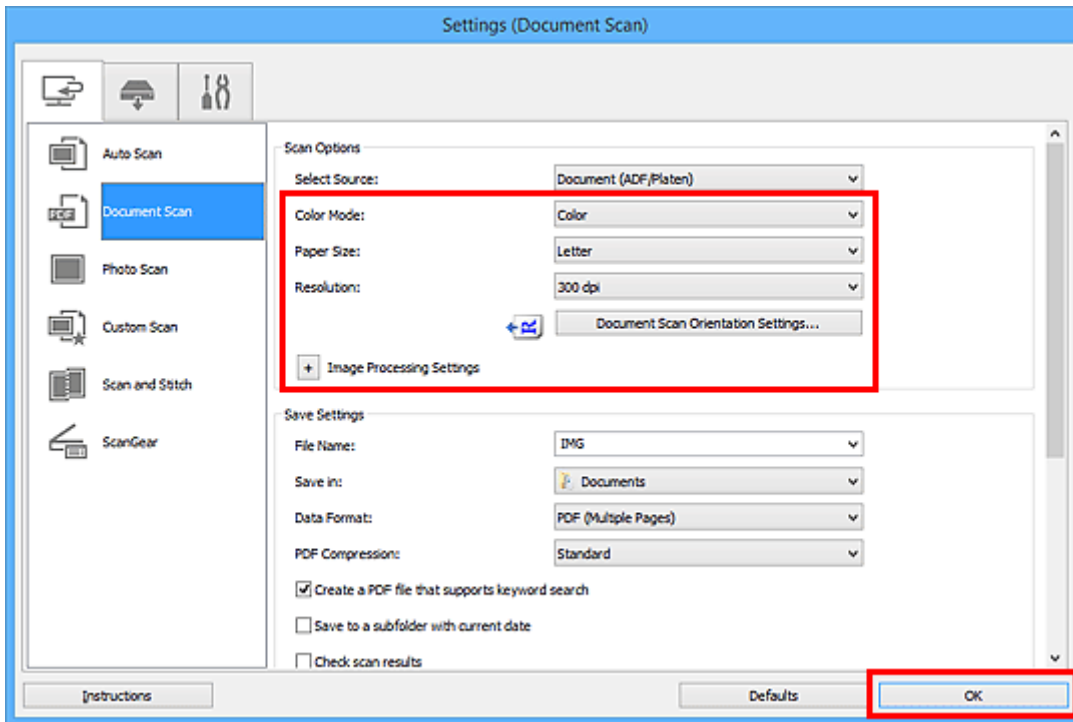

The IJ Scan Utility main screen appears.

►►► Note

- Refer to the following pages for details on the setting items in the Settings dialog box.

■ [Settings \(Document Scan\) Dialog Box](#)

■ [Settings \(Custom Scan\) Dialog Box](#)

7. Click **Document**.

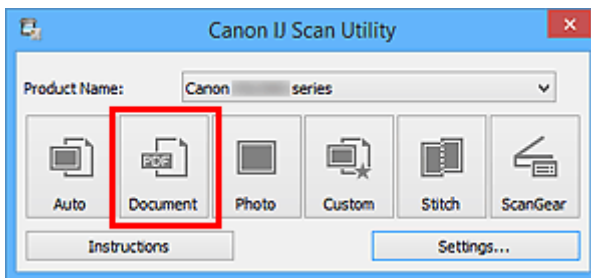

Scanning starts.

►►► Note

- Click **Cancel** to cancel the scan.

When **Document (ADF Manual Duplex)** is selected for **Select Source**, proceed to Step 8.

8. Follow the on-screen instructions to place the documents.

►►► Note

- The screens for scanning with **Orientation** set to **Portrait** are used as examples in the following descriptions.

When Long edge is Selected for Binding Side in Document Scan Orientation Settings...:

Place the documents after rotating the output documents 180 degrees.

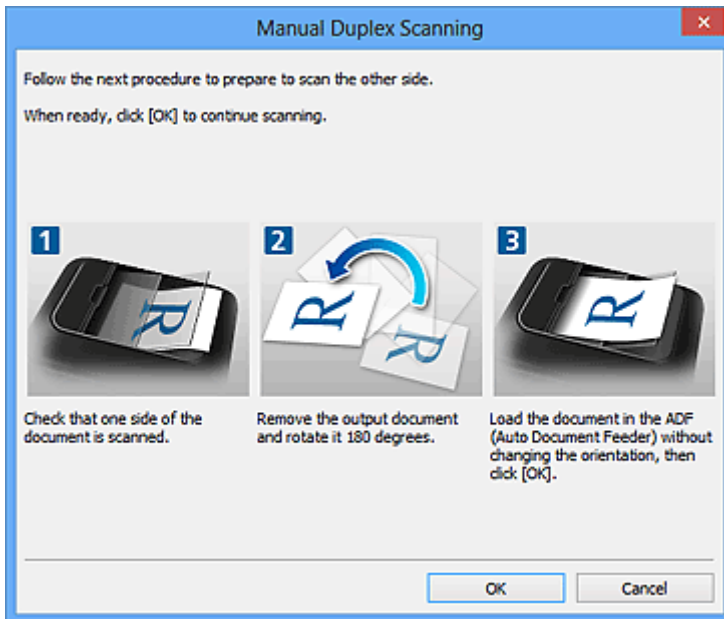

When Short edge is Selected for Binding Side in Document Scan Orientation Settings...:

Place the documents without changing the orientation of the output documents.

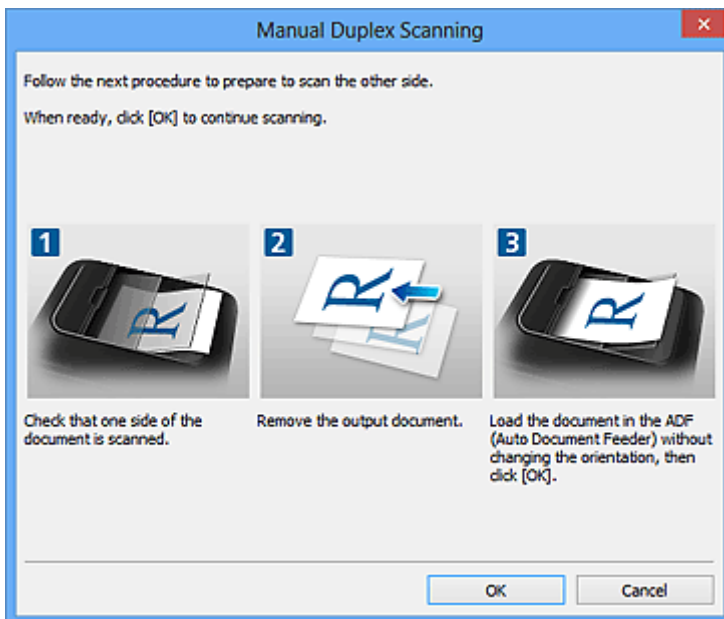

9. Click **OK**.

Scanning starts.

▶▶▶ Note

- Click **Cancel** to cancel the scan.
- Scanned images are saved in the folder set for **Save in** in the corresponding Settings dialog box displayed by clicking **Settings...** In each Settings dialog box, you can also make advanced scan settings.

Saving after Checking Scan Results

You can check the scan results, then save the images to a computer.

▶▶▶ Important

- You cannot check the scan results before saving when scanned using **Auto** scan or the operation panel.

▶▶▶ Note

- The screens for scanning photos are used as examples in the following descriptions.

1. [Start IJ Scan Utility](#).
2. Click **Settings...**

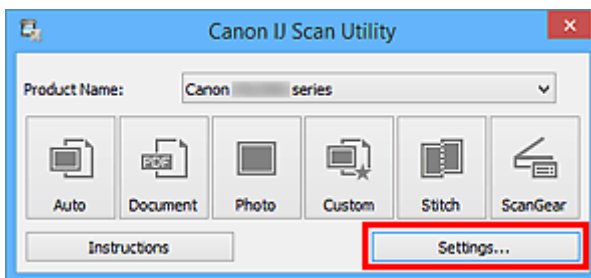

The [Settings dialog box](#) appears.

3. Click **Photo Scan**.

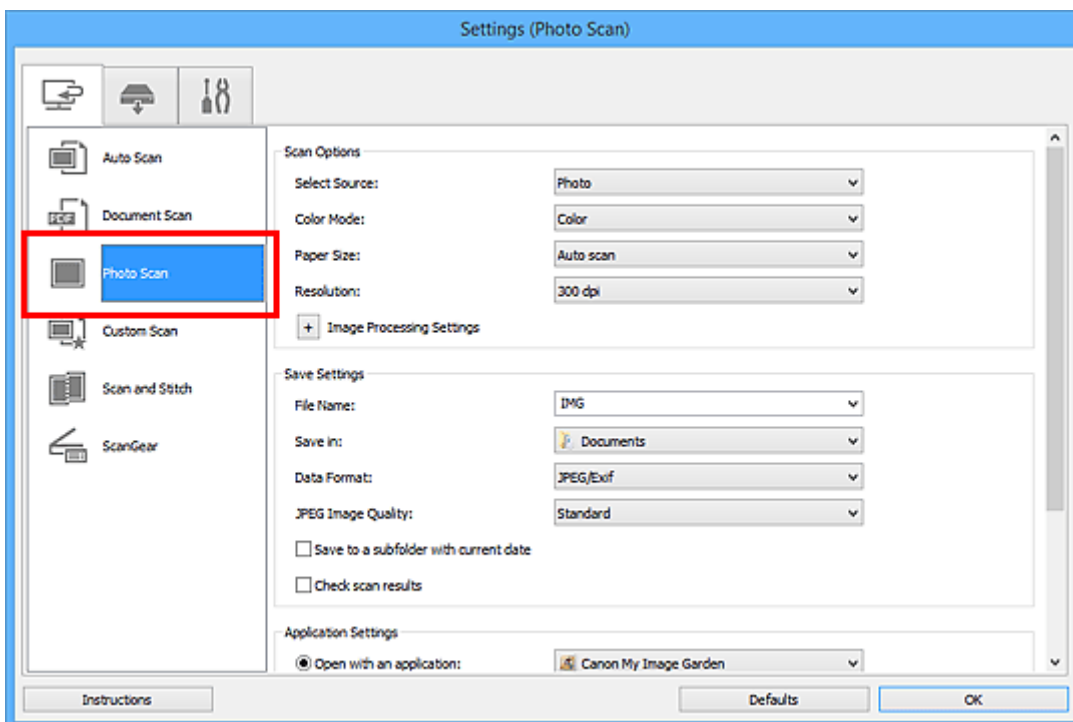

4. Select the **Check scan results** checkbox, then click **OK**.

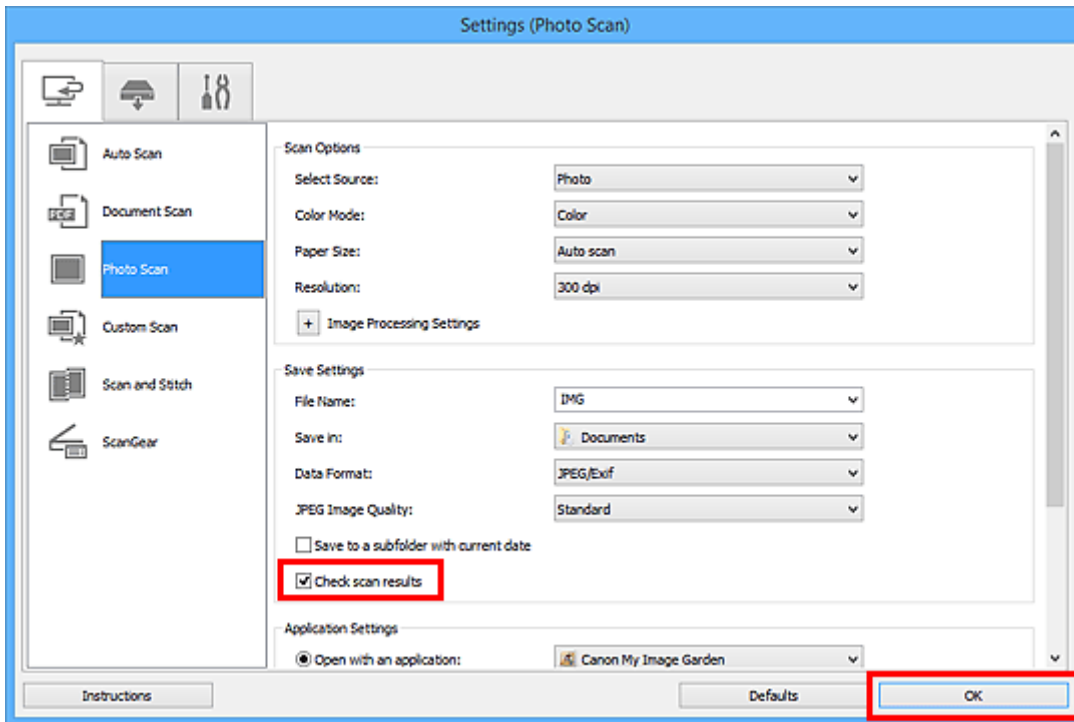

The IJ Scan Utility main screen appears.

►►► Note

- Refer to the following pages for details on the setting items in the Settings dialog box.

- [Settings \(Document Scan\) Dialog Box](#)
- [Settings \(Photo Scan\) Dialog Box](#)
- [Settings \(Custom Scan\) Dialog Box](#)
- [Settings \(Scan and Stitch\) Dialog Box](#)
- [Settings \(ScanGear\) Dialog Box](#)

5. Click **Photo**.

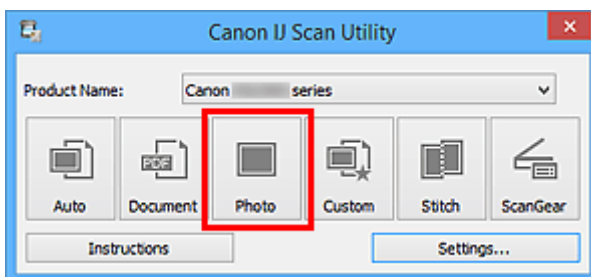

Scanning starts.

When scanning is completed, the **Save Settings** dialog box appears.

►►► Note

- Click **Cancel** to cancel the scan.

6. Change the image order or file save options as required.

You can change the image order or file save options in the [Save Settings dialog box](#).

»» Note

- The default save folders are as follows.
 - Windows 8.1: **Documents** folder
 - Windows 8: **My Documents** folder
 - Windows 7: **My Documents** folder
 - Windows Vista: **Documents** folder
 - Windows XP: **My Documents** folder

7. Click **OK**.

Scanned images are saved according to the settings.

Sending Scanned Images via E-mail

You can send scanned images via e-mail.

►►► Note

- The screens for scanning photos are used as examples in the following descriptions.

1. [Start IJ Scan Utility](#).
2. Click **Settings...**

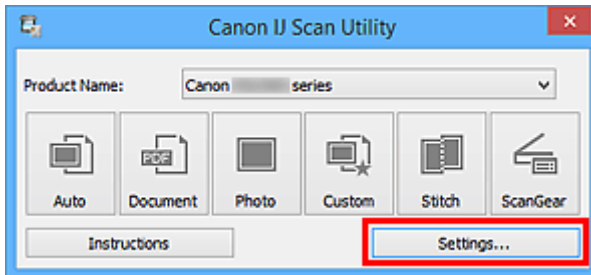

The [Settings dialog box](#) appears.

3. Click **Photo Scan**.

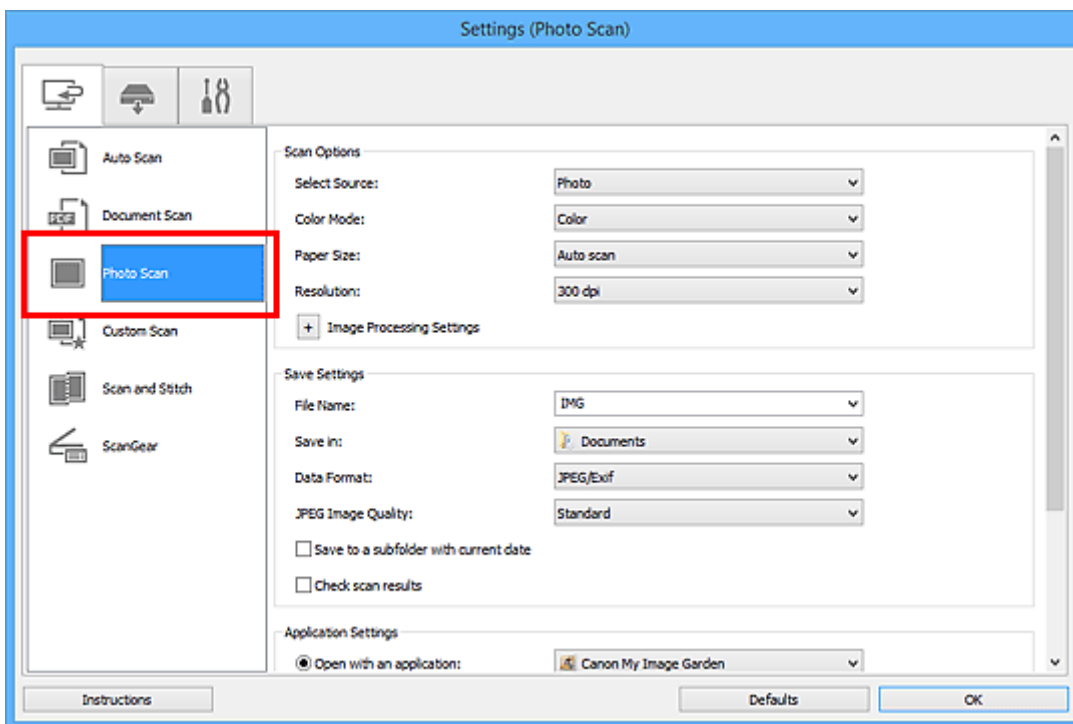

4. Select **Attach to e-mail** in **Application Settings**, then select an e-mail client.

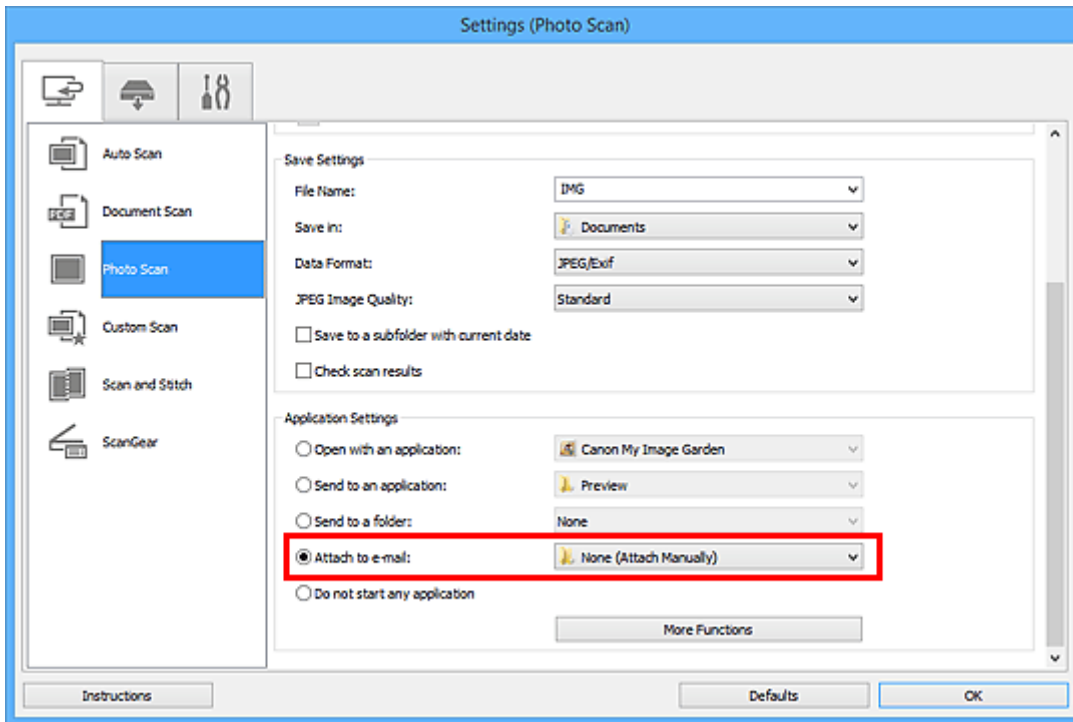

►►► Note

- You can add e-mail clients to use for attachments from the pull-down menu.
- If **None (Attach Manually)** is selected, manually attach scanned and saved images to e-mail.

5. Click **OK**.

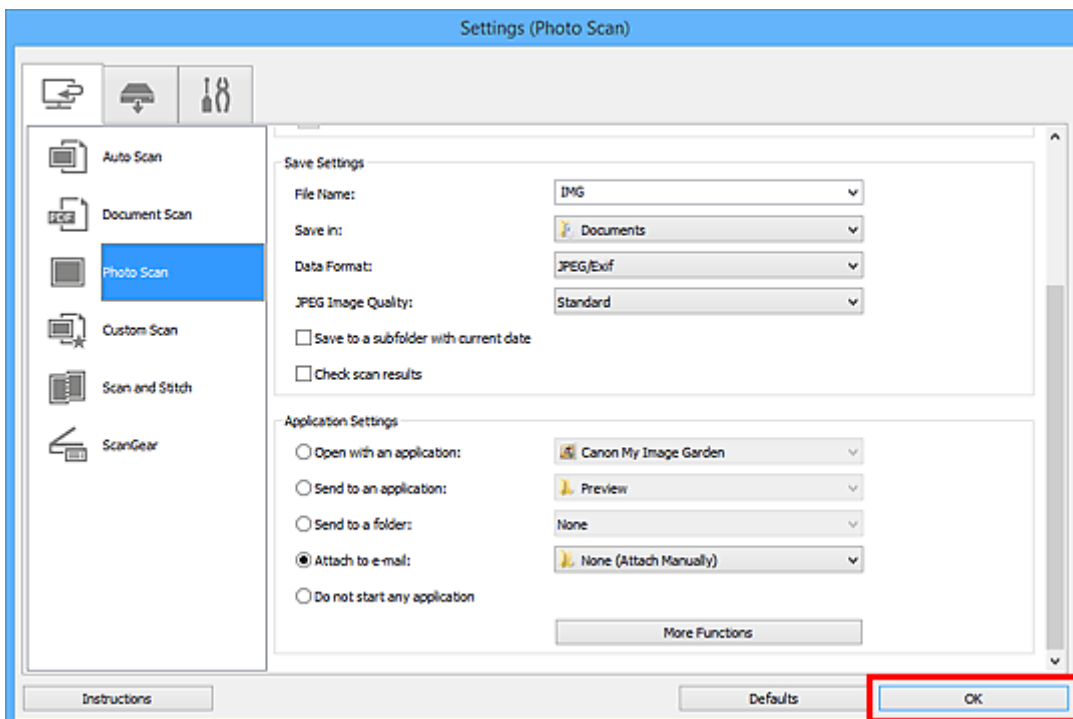

The IJ Scan Utility main screen appears.

►►► Note

- Refer to the following pages for details on the setting items in the Settings dialog box.

■ [Settings \(Auto Scan\) Dialog Box](#)

■ [Settings \(Document Scan\) Dialog Box](#)

- [Settings \(Photo Scan\) Dialog Box](#)
- [Settings \(Custom Scan\) Dialog Box](#)
- [Settings \(ScanGear\) Dialog Box](#)

6. Click **Photo**.

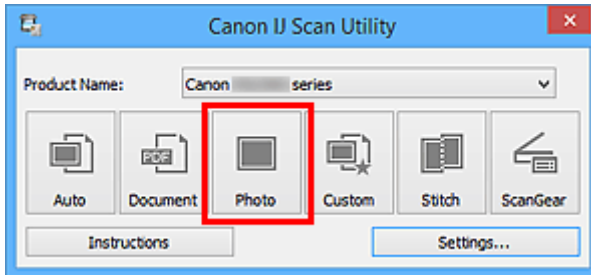

Scanning starts.

When scanning is completed, the specified e-mail client starts and the images will be attached to a new message.

►► Note

- Click **Cancel** to cancel the scan.
- The scanned images are saved according to the settings made in the Settings dialog box.
- When the **Check scan results** checkbox is selected in the Settings dialog box, the [Save Settings dialog box](#) appears. After you set the save options and click **OK**, the scanned images are saved and automatically attached to a new message of the specified e-mail client.

7. Specify the recipient, enter the subject and message, then send e-mail.

Refer to the manual of your e-mail client for e-mail settings.

Extracting Text from Scanned Images (OCR)

Scan text in scanned magazines and newspapers and display it in your text editor.

►►► Note

- You can extract text when scanning via **Document**, **Custom**, or **ScanGear**.
- The screens for scanning documents are used as examples in the following descriptions.

1. [Start IJ Scan Utility](#).
2. Click **Settings....**

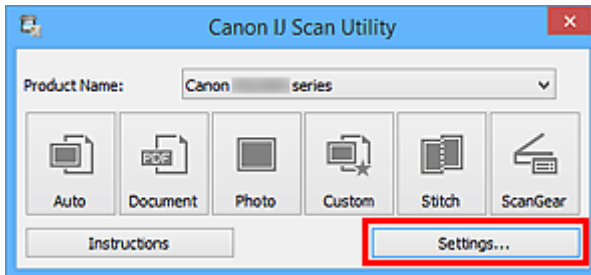

The [Settings dialog box](#) appears.

3. Click **Document Scan**.

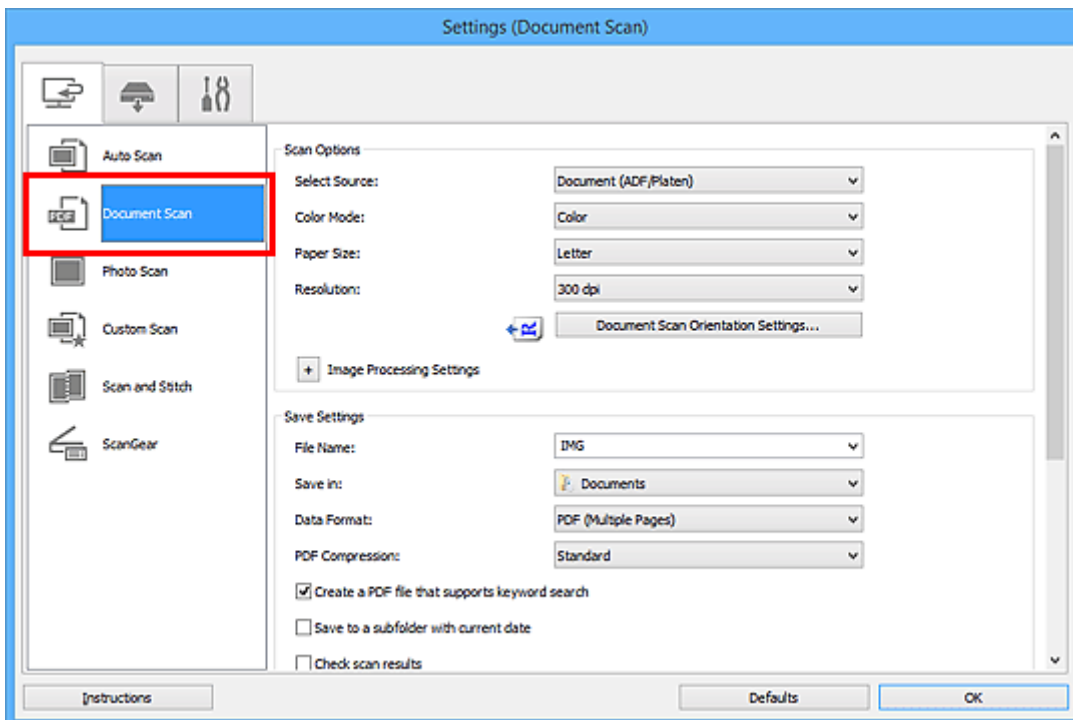

►►► Note

- For **Resolution**, only **300 dpi** or **400 dpi** can be set when **Start OCR** is selected in **Application Settings**.

4. Select **Start OCR** for **Application Settings**, then select the application in which you want to display the result.

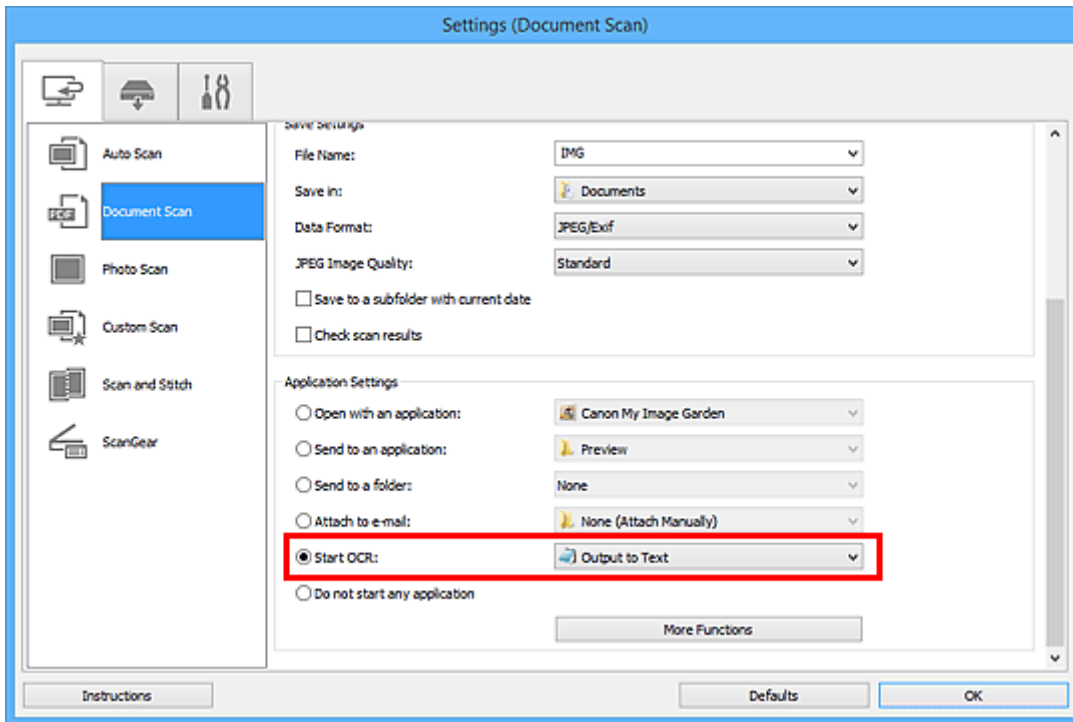

»» Note

- If a compatible application is not installed, the text in the image is extracted and appears in your text editor.
Text to be displayed is based on **Document Language** in the [Settings \(General Settings\) dialog box](#). Select the language you want to extract in **Document Language** and scan.
- You can add the application from the pull-down menu.

5. Click **OK**.

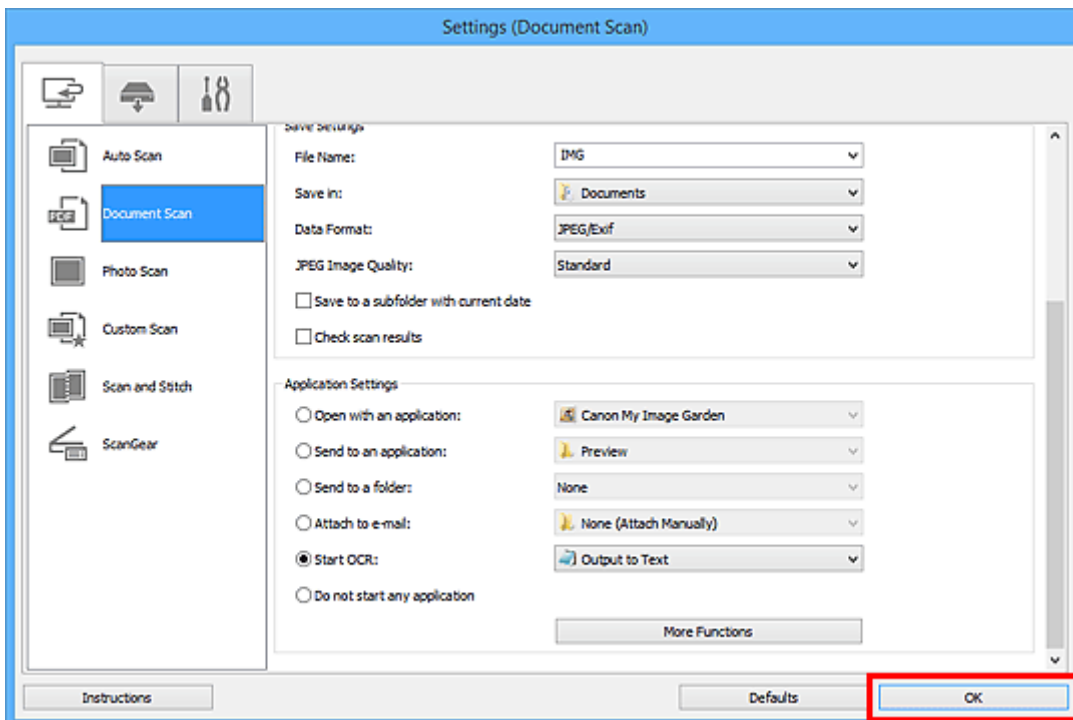

The IJ Scan Utility main screen appears.

▶▶▶ Note

- Refer to the following pages for details on the setting items in the Settings dialog box.

■ [Settings \(Document Scan\) Dialog Box](#)

■ [Settings \(Custom Scan\) Dialog Box](#)

■ [Settings \(ScanGear\) Dialog Box](#)

6. Click **Document**.

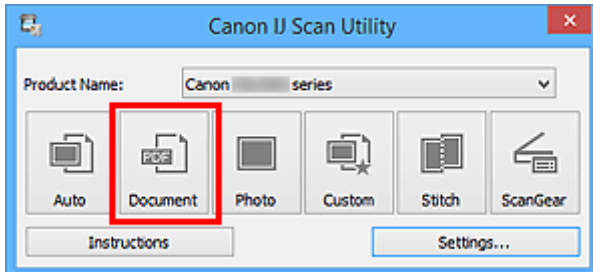

Scanning starts.

When scanning is completed, the scanned images are saved according to the settings, and the extracted text appears in the specified application.

▶▶▶ Note

- Click **Cancel** to cancel the scan.
- Text displayed in your text editor is for guidance only. Text in the image of the following types of documents may not be detected correctly.
 - Documents containing text with font size outside the range of 8 points to 40 points (at 300 dpi)
 - Slanted documents
 - Documents placed upside down or documents with text in the wrong orientation (rotated characters)
 - Documents containing special fonts, effects, italics, or hand-written text
 - Documents with narrow line spacing
 - Documents with colors in the background of text
 - Documents containing multiple languages

IJ Scan Utility Screens

- ▶ **IJ Scan Utility Main Screen**
- ▶ **Settings Dialog Box**
 - **Settings (Auto Scan)** Dialog Box
 - **Settings (Document Scan)** Dialog Box
 - **Settings (Photo Scan)** Dialog Box
 - **Settings (Custom Scan)** Dialog Box
 - **Settings (Scan and Stitch)** Dialog Box
 - **Settings (ScanGear)** Dialog Box
 - **Settings (Save to PC (Auto))** Dialog Box
 - **Settings (Save to PC (Photo))** Dialog Box
 - **Settings (Save to PC (Document))** Dialog Box
 - **Settings (General Settings)** Dialog Box
- ▶ **Save Settings Dialog Box**
- ▶ **Image Stitch Window**

IJ Scan Utility Main Screen

Follow the steps below to start IJ Scan Utility.

Windows 8.1/Windows 8:

Select **IJ Scan Utility** on the Start screen to start IJ Scan Utility.

If **IJ Scan Utility** is not displayed on the Start screen, select the **Search** charm, then search for "IJ Scan Utility".

Windows 7/Windows Vista/Windows XP:

From the **Start** menu, select **All Programs > Canon Utilities > IJ Scan Utility > IJ Scan Utility** to start IJ Scan Utility.

You can complete from scanning to saving at one time by simply clicking the corresponding icon.

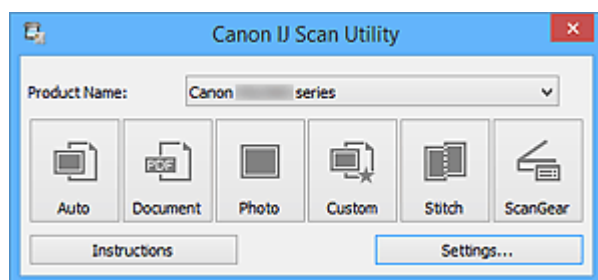

Product Name

Displays the name of the product that IJ Scan Utility is currently set to use.

If the displayed product is not the one you want to use, select the desired product from the list.

In addition, for network connection, select one with "Network" after the product name.

►► Note

- Refer to "[Network Scan Settings](#)" for how to set up a network environment.

Auto

Detects the item type automatically and saves them to a computer. The data format for saving will also be set automatically.

Save settings and the response after scanning can be specified in the [Settings \(Auto Scan\) dialog box](#).

Document

Scans items as documents and saves them to a computer.

Scan/save settings and the response after scanning can be specified in the [Settings \(Document Scan\) dialog box](#).

Photo

Scans items as photos and saves them to a computer.

Scan/save settings and the response after scanning can be specified in the [Settings \(Photo Scan\) dialog box](#).

Custom

Scans items with your favorite settings and saves the images to a computer. The item type can be automatically detected.

Scan/save settings and the response after scanning can be specified in the [Settings \(Custom Scan\) dialog box](#).

Stitch

Displays the **Image Stitch** window in which you can scan the left and right halves of an item larger than the platen and combine the scanned images back into one image.

Scan/save settings and the response after scanning can be specified in the [Settings \(Scan and Stitch\) dialog box](#).

ScanGear

Starts ScanGear (scanner driver) in which you can make image corrections and color adjustments when scanning.

Scan/save settings and applications can be specified in the [Settings \(ScanGear\) dialog box](#).



Instructions

Opens this guide.

Settings...

Displays the [Settings dialog box](#) in which you can specify the scan/save settings and the response after scanning.

Settings Dialog Box

There are three tabs in the Settings dialog box:  (Scanning from a Computer),  (Scanning from the Operation Panel), and  (General Settings). When you click a tab, the view in the red frame switches and you can make advanced settings to functions on each tab.

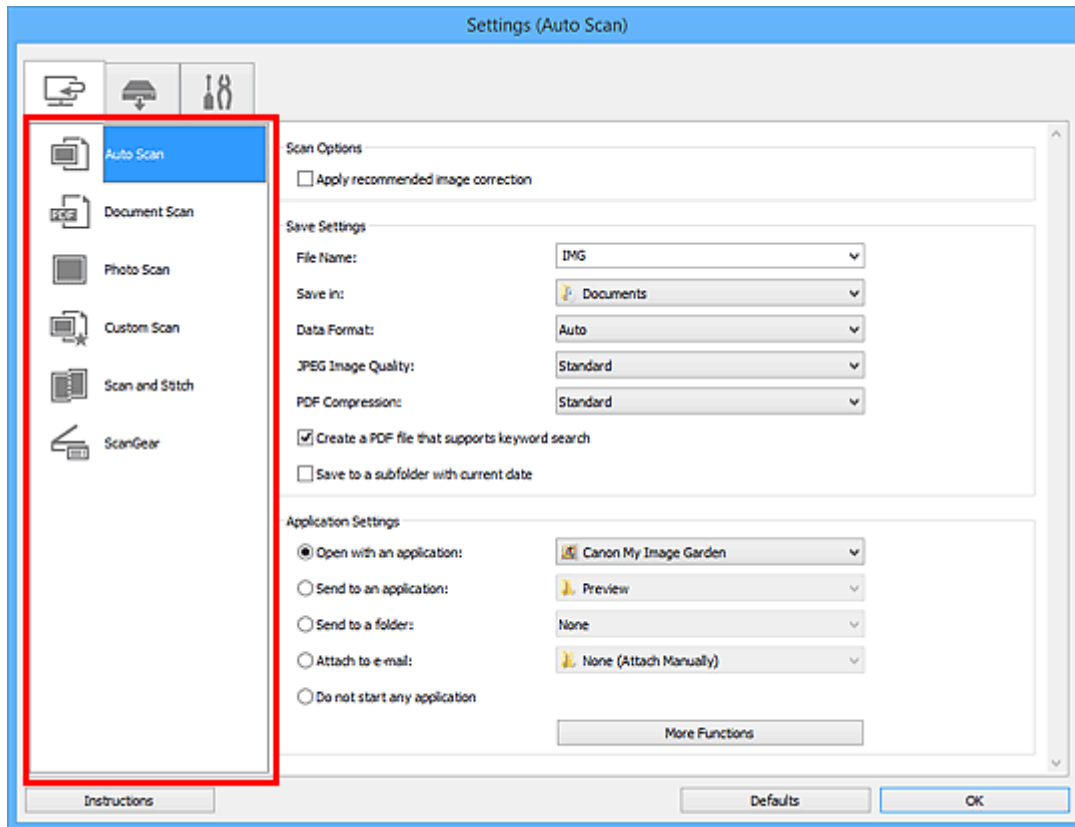

(Scanning from a Computer) Tab

You can specify how to respond when scanning from IJ Scan Utility or My Image Garden.

- [Settings \(Auto Scan\) Dialog Box](#)
- [Settings \(Document Scan\) Dialog Box](#)
- [Settings \(Photo Scan\) Dialog Box](#)
- [Settings \(Custom Scan\) Dialog Box](#)
- [Settings \(Scan and Stitch\) Dialog Box](#)
- [Settings \(ScanGear\) Dialog Box](#)

(Scanning from the Operation Panel) Tab

You can specify how to respond when scanning from the operation panel.

- [Settings \(Save to PC \(Auto\)\) Dialog Box](#)
- [Settings \(Save to PC \(Photo\)\) Dialog Box](#)
- [Settings \(Save to PC \(Document\)\) Dialog Box](#)

»» Important

- When the Settings dialog box is displayed from My Image Garden, the  (Scanning from the Operation Panel) tab does not appear.



(General Settings) Tab

You can set the product to use, file size restriction on e-mail attachment, language to detect text in images, and folder in which to save images temporarily.

■ [Settings \(General Settings\) Dialog Box](#)

Settings (Auto Scan) Dialog Box

Click **Auto Scan** on the  (Scanning from a Computer) tab to display the **Settings (Auto Scan)** dialog box.

In the **Settings (Auto Scan)** dialog box, you can make advanced scan settings to scan by automatically detecting the item type.

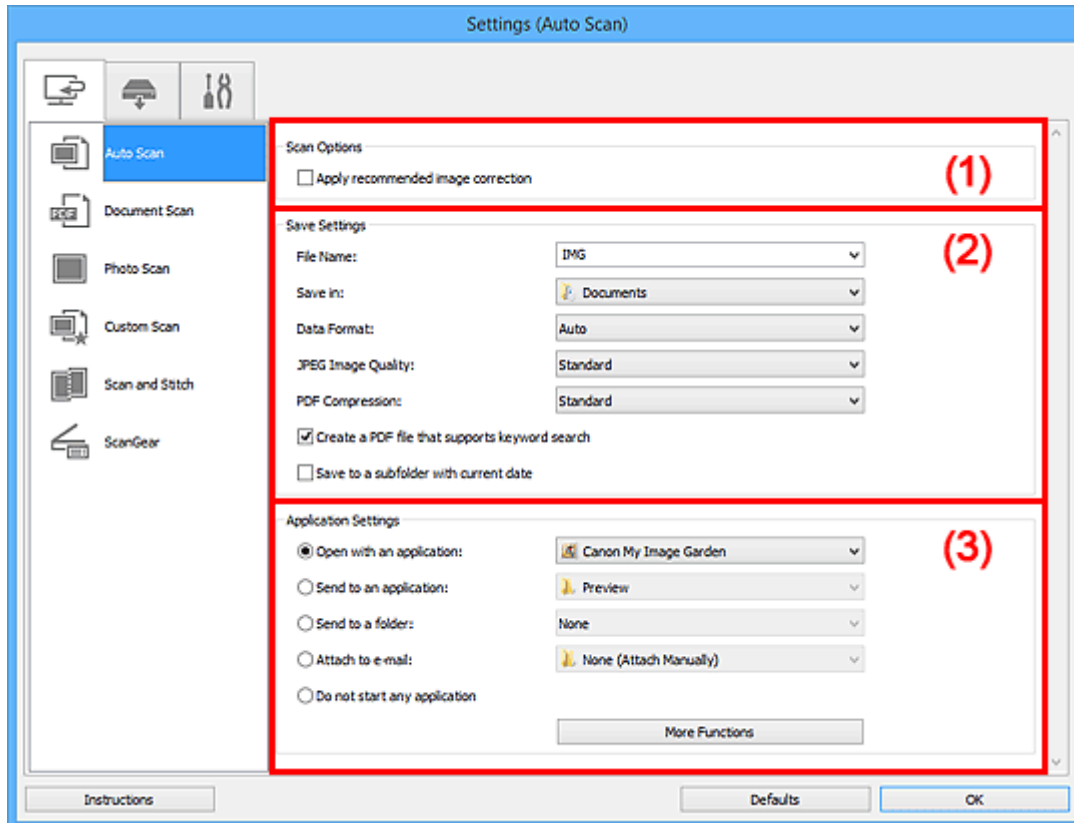

- [\(1\) Scan Options Area](#)
- [\(2\) Save Settings Area](#)
- [\(3\) Application Settings Area](#)

►►► Important

- When the Settings dialog box is displayed from My Image Garden, the setting items for **Application Settings** do not appear.

Supported Items

Photos, postcards, business cards, magazines, newspapers, documents, and BD/DVD/CD.

►►► Important

- To scan the following types of items, specify the item type and size in the **Settings (Document Scan)** dialog box, **Settings (Photo Scan)** dialog box, or **Settings (Custom Scan)** dialog box, then click **Photo**, **Document**, or **Custom** in the IJ Scan Utility main screen. You cannot scan correctly with **Auto**.
 - A4 size photos
 - Text documents smaller than 2L (5 inches x 7 inches) (127 mm x 178 mm), such as paperback pages with the spine cut off
 - Items printed on thin white paper
 - Long narrow items such as panoramic photos
- Reflective disc labels may not be scanned as expected.

- Place items to be scanned on the platen correctly. Otherwise, items may not be scanned correctly. Refer to "[Placing Items \(When Scanning from a Computer\)](#)" for how to place items.
- When scanning two or more documents from the ADF (Auto Document Feeder), place documents of the same size.

▶▶▶ Note

- To reduce moire in scans, set **Select Source** to **Magazine** in the **Settings (Document Scan)** dialog box or **Settings (Custom Scan)** dialog box, then click **Document** or **Custom** in the IJ Scan Utility main screen.

(1) Scan Options Area

Apply recommended image correction

Applies suitable corrections automatically based on the item type.

▶▶▶ Important

- The color tone may differ from the source image due to corrections. In that case, deselect the checkbox and scan.

▶▶▶ Note

- Scanning takes longer than usual when you enable this function.

(2) Save Settings Area

File Name

Enter the file name of the image to be saved. When you save a file, the date and four digits are appended to the set file name in the "_20XX0101_0001" format.

▶▶▶ Note

- When you select the **Save to a subfolder with current date** checkbox, the date and four digits are appended to the set file name.

Save in

Displays the folder in which to save the scanned images. To add a folder, select **Add...** from the pull-down menu, then click **Add** in the displayed **Select Destination Folder** dialog box and specify the destination folder.

The default save folders are as follows.

- Windows 8.1: **Documents** folder
- Windows 8: **My Documents** folder
- Windows 7: **My Documents** folder
- Windows Vista: **Documents** folder
- Windows XP: **My Documents** folder

▶▶▶ Important

- When the Settings dialog box is displayed from My Image Garden, this option does not appear.

Data Format

Auto is selected. The following data formats are automatically applied according to the item type when saving.

- Photos, postcards, BD/DVD/CD, and business cards: JPEG
- Magazines, newspapers, and documents: PDF

»» Important

- The save format may differ depending on how you place the item.
 - [Placing Items \(When Scanning from a Computer\)](#)

JPEG Image Quality

You can specify the image quality of JPEG files.

PDF Compression

Select the compression type for saving PDF files.

Standard

It is recommended that you normally select this setting.

High

Compresses the file size when saving, allowing you to reduce the load on your network/server.

Create a PDF file that supports keyword search

Select this checkbox to convert text in images into text data and create PDF files that support keyword search.

»» Note

- PDF files that are searchable in the language selected in **Document Language** on the  (General Settings) tab of the Settings dialog box are created.

Save to a subfolder with current date

Select this checkbox to create a current date folder in the folder specified in **Save in** and save scanned images in it. The folder will be created with a name such as "20XX_01_01" (Year_Month_Date).

If this checkbox is not selected, files are saved directly in the folder specified in **Save in**.

(3) Application Settings Area

Open with an application

Select this when you want to enhance or correct the scanned images.

You can specify the application from the pull-down menu.

Send to an application

Select this when you want to use the scanned images as they are in an application that allows you to browse or organize images.

You can specify the application from the pull-down menu.

Send to a folder

Select this when you also want to save the scanned images to a folder other than the one specified in **Save in**.

You can specify the folder from the pull-down menu.

Attach to e-mail

Select this when you want to send e-mails with the scanned images attached.

You can specify the e-mail client you want to start from the pull-down menu.

Do not start any application

Saves to the folder specified in **Save in**.

»» Note

- To add an application or folder to the pull-down menu, select **Add...** from the pull-down menu, then click **Add** in the displayed **Select Application** or **Select Destination Folder** dialog box and specify the application or folder.

Instructions

Opens this guide.

Defaults

You can restore the settings in the displayed screen to the default settings.

Settings (Document Scan) Dialog Box

Click **Document Scan** on the  (Scanning from a Computer) tab to display the **Settings (Document Scan)** dialog box.

In the **Settings (Document Scan)** dialog box, you can make advanced scan settings to scan items as documents.

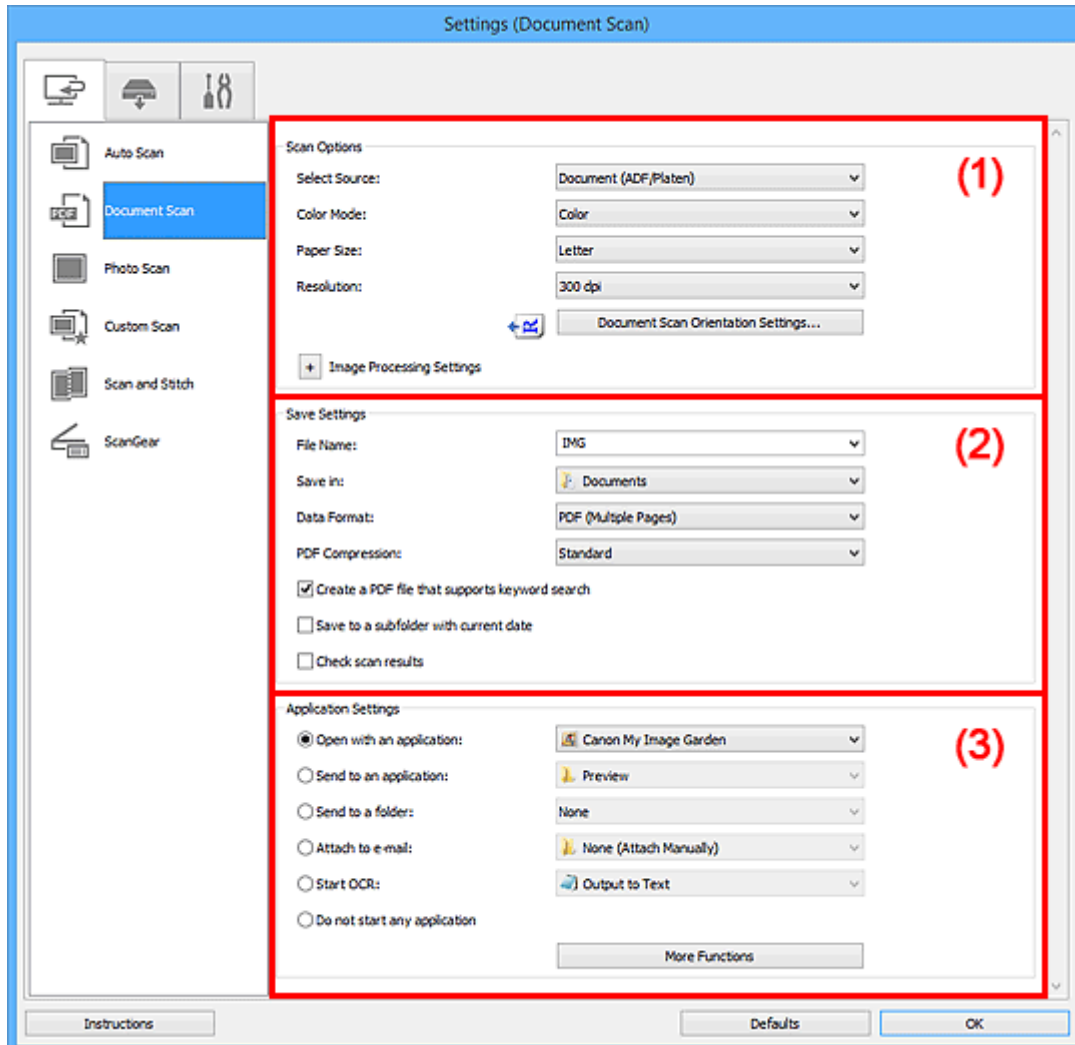

- [\(1\) Scan Options Area](#)
- [\(2\) Save Settings Area](#)
- [\(3\) Application Settings Area](#)

►►► Important

- When the Settings dialog box is displayed from the Scan screen of My Image Garden, the setting items for **Application Settings** do not appear.

(1) Scan Options Area

Select Source

Select the type of item to be scanned.

- Scanning documents: **Document** or **Document (ADF/Platen)**
- Scanning magazines: **Magazine**
- Scanning documents from the ADF (Auto Document Feeder): **Document (ADF Simplex)**, **Document (ADF Manual Duplex)**, or **Document (ADF/Platen)**

»»» Note

- When **Document (ADF/Platen)** is selected and documents are placed both on the platen and ADF, those placed on the ADF will be scanned.

Color Mode

Select the color mode in which to scan the item.

Paper Size

Select the size of the item to be scanned.

When you select **Custom**, a screen in which you can specify the paper size appears. Select a **Unit**, then enter the **Width** and **Height**, and then click **OK**.

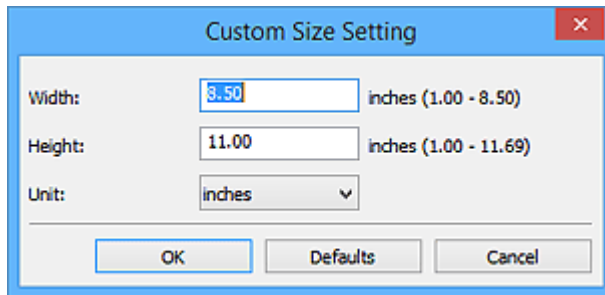

»»» Note

- Click **Defaults** to restore the specified settings to the default settings.

Resolution

Select the resolution of the item to be scanned.

The higher the resolution (value), the more detail in your image.

■ [Resolution](#)

»»» Note

- Only **300 dpi** or **400 dpi** can be set when **Start OCR** is selected in **Application Settings**.

Document Scan Orientation Settings...

This appears when you select ADF for **Select Source**.

Click to display the **Document Scan Orientation Settings** dialog box in which you can set the orientation and binding side of the documents to be scanned from the ADF.

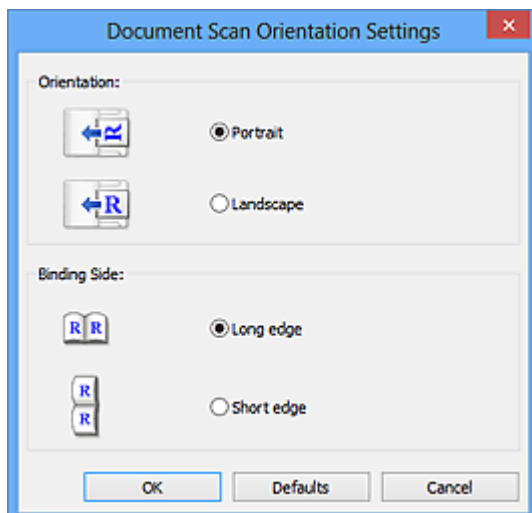

▶▶▶ Important

- **Binding Side** cannot be specified when scanning only the front side of each document.

Image Processing Settings

Click  (Plus) to set the following.

▶▶▶ Note

- The displayed items vary by **Select Source** and **Color Mode**.

Apply Auto Document Fix

Select this checkbox to sharpen text in a document or magazine for better readability.

▶▶▶ Important

- The color tone may differ from the source image due to corrections. In that case, deselect the checkbox and scan.

▶▶▶ Note

- Scanning takes longer than usual when you enable this function.

Sharpen outline

Emphasizes the outline of the subjects to sharpen the image.

Reduce show-through

Sharpens text in an item or reduces show-through in newspapers, etc.

Reduce moire

Reduces moire patterns.

Printed materials are displayed as a collection of fine dots. "Moire" is a phenomenon where uneven gradation or a stripe pattern appears when such photos or pictures printed with fine dots are scanned.

▶▶▶ Note

- Scanning takes longer than usual when you enable **Reduce moire**.

Reduce gutter shadow/Reduce gutter shadow (platen)

Reduces gutter shadows that appear between pages when scanning open booklets.

▶▶▶ Important

- This function is available only when scanning from the platen.

▶▶▶ Note

- Use ScanGear (scanner driver)'s **Advanced Mode** tab to correct gutter shadows when scanning non-standard size items or specified areas.
Refer to "Gutter Shadow Correction" for your model from Home of the *Online Manual* for details.
- When you enable this function, scanning may take longer than usual with network connection.

Correct slanted text document

Detects the scanned text and corrects the angle (within -0.1 to -10 degrees or +0.1 to +10 degrees) of the document.

»» Important

- The following types of documents may not be corrected properly since the text cannot be detected correctly.
 - Documents in which the text lines are inclined more than 10 degrees or the angles vary by line
 - Documents containing both vertical and horizontal text
 - Documents with extremely large or small fonts
 - Documents with small amount of text
 - Documents containing figures/images
 - Hand-written text
 - Documents containing both vertical and horizontal lines (tables)

»» Note

- Scanning takes longer than usual when you enable **Correct slanted text document**.

Detect the orientation of text document and rotate image

Automatically rotates the image to the correct orientation by detecting the orientation of text in the scanned document.

»» Important

- Only text documents written in the language selected from **Document Language** in the [Settings \(General Settings\) dialog box](#) are supported.
- The orientation may not be detected for the following types of settings or documents since the text cannot be detected correctly.
 - Resolution is outside the range of 300 dpi to 600 dpi
 - Font size is outside the range of 8 points to 48 points
 - Documents containing special fonts, effects, italics, or hand-written text
 - Documents with patterned backgrounds

In that case, select the **Check scan results** checkbox and rotate the image in the [Save Settings dialog box](#).

(2) Save Settings Area

File Name

Enter the file name of the image to be saved. When you save a file, the date and four digits are appended to the set file name in the "_20XX0101_0001" format.

»» Note

- When you select the **Save to a subfolder with current date** checkbox, the date and four digits are appended to the set file name.

Save in

Displays the folder in which to save the scanned images. To add a folder, select **Add...** from the pull-down menu, then click **Add** in the displayed **Select Destination Folder** dialog box and specify the destination folder.

The default save folders are as follows.

- Windows 8.1: **Documents** folder
- Windows 8: **My Documents** folder

- Windows 7: **My Documents** folder
- Windows Vista: **Documents** folder
- Windows XP: **My Documents** folder

»»» Important

- When the Settings dialog box is displayed from My Image Garden, this option does not appear.

Data Format

Select the data format in which to save the scanned images.

You can select **JPEG/Exif**, **TIFF**, **PNG**, **PDF**, or **PDF (Multiple Pages)**.

»»» Important

- You cannot select **JPEG/Exif** when **Color Mode** is **Black and White**.
- When **Start OCR** is selected in **Application Settings**, you cannot select **PDF** or **PDF (Multiple Pages)**.

»»» Note

- With network connection, scanning may take longer than usual when you set **TIFF** or **PNG** in **Data Format**.

PDF Compression

Select the compression type for saving PDF files.

Standard

It is recommended that you normally select this setting.

High

Compresses the file size when saving, allowing you to reduce the load on your network/server.

»»» Important

- This appears only when **PDF** or **PDF (Multiple Pages)** is selected in **Data Format**.
- When **Black and White** is selected in **Color Mode**, this option does not appear.

JPEG Image Quality

You can specify the image quality of JPEG files.

»»» Important

- This appears only when **JPEG/Exif** is selected in **Data Format**.

Create a PDF file that supports keyword search

Select this checkbox to convert text in images into text data and create PDF files that support keyword search.

»»» Important

- This appears only when **PDF** or **PDF (Multiple Pages)** is selected in **Data Format**.

»»» Note

- PDF files that are searchable in the language selected in **Document Language** on the  (General Settings) tab of the Settings dialog box are created.

Save to a subfolder with current date

Select this checkbox to create a current date folder in the folder specified in **Save in** and save scanned images in it. The folder will be created with a name such as "20XX_01_01" (Year_Month_Date).

If this checkbox is not selected, files are saved directly in the folder specified in **Save in**.

Check scan results

Displays the [Save Settings dialog box](#) after scanning.

»» Important

- When the Settings dialog box is displayed from My Image Garden, this option does not appear.

(3) Application Settings Area

Open with an application

Select this when you want to enhance or correct the scanned images.

You can specify the application from the pull-down menu.

Send to an application

Select this when you want to use the scanned images as they are in an application that allows you to browse or organize images.

You can specify the application from the pull-down menu.

Send to a folder

Select this when you also want to save the scanned images to a folder other than the one specified in **Save in**.

You can specify the folder from the pull-down menu.

Attach to e-mail

Select this when you want to send e-mails with the scanned images attached.

You can specify the e-mail client you want to start from the pull-down menu.

Start OCR

Select this when you want to convert text in the scanned image into text data.

You can specify the application from the pull-down menu.

Do not start any application

Saves to the folder specified in **Save in**.

»» Note

- To add an application or folder to the pull-down menu, select **Add...** from the pull-down menu, then click **Add** in the displayed **Select Application** or **Select Destination Folder** dialog box and specify the application or folder.

Instructions

Opens this guide.

Defaults

You can restore the settings in the displayed screen to the default settings.

Settings (Photo Scan) Dialog Box

Click **Photo Scan** on the  (Scanning from a Computer) tab to display the **Settings (Photo Scan)** dialog box.

In the **Settings (Photo Scan)** dialog box, you can make advanced scan settings to scan items as photos.

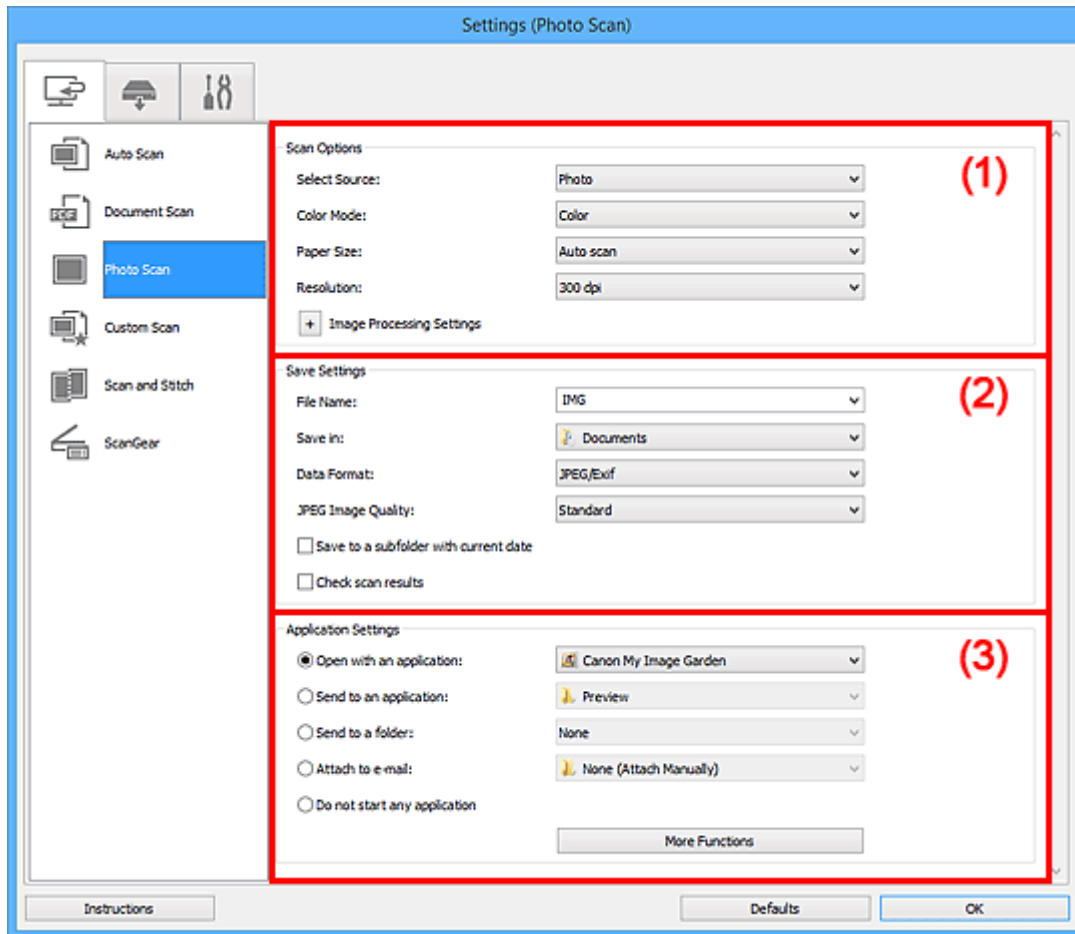

- [\(1\) Scan Options Area](#)
- [\(2\) Save Settings Area](#)
- [\(3\) Application Settings Area](#)

»»» Important

- When the Settings dialog box is displayed from My Image Garden, the setting items for **Application Settings** do not appear.

(1) Scan Options Area

Select Source

Photo is selected.

Color Mode

Select the color mode in which to scan the item.

Paper Size

Select the size of the item to be scanned.

When you select **Custom**, a screen in which you can specify the paper size appears. Select a **Unit**, then enter the **Width** and **Height**, and then click **OK**.

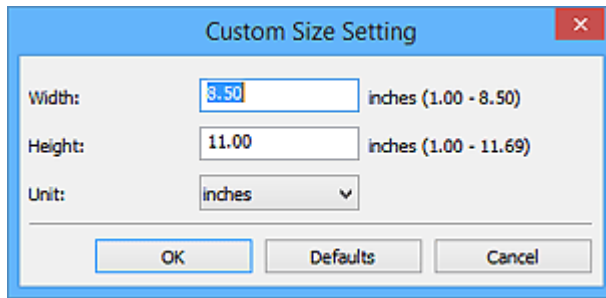

►►► Note

- Click **Defaults** to restore the specified settings to the default settings.

Resolution

Select the resolution of the item to be scanned.

The higher the resolution (value), the more detail in your image.

■ [Resolution](#)

Image Processing Settings

Click  (Plus) to set the following.

►►► Important

- When **Color Mode** is **Black and White**, **Image Processing Settings** is not available.

Sharpen outline

Emphasizes the outline of the subjects to sharpen the image.

(2) Save Settings Area

File Name

Enter the file name of the image to be saved. When you save a file, the date and four digits are appended to the set file name in the "_20XX0101_0001" format.

►►► Note

- When you select the **Save to a subfolder with current date** checkbox, the date and four digits are appended to the set file name.

Save in

Displays the folder in which to save the scanned images. To add a folder, select **Add...** from the pull-down menu, then click **Add** in the displayed **Select Destination Folder** dialog box and specify the destination folder.

The default save folders are as follows.

- Windows 8.1: **Documents** folder
- Windows 8: **My Documents** folder
- Windows 7: **My Documents** folder
- Windows Vista: **Documents** folder
- Windows XP: **My Documents** folder

►►► Important

- When the Settings dialog box is displayed from My Image Garden, this option does not appear.

Data Format

Select the data format in which to save the scanned images.

You can select **JPEG/Exif**, **TIFF**, or **PNG**.

▶▶▶ Important

- You cannot select **JPEG/Exif** when **Color Mode** is **Black and White**.

▶▶▶ Note

- With network connection, scanning may take longer than usual when you set **TIFF** or **PNG** in **Data Format**.

JPEG Image Quality

You can specify the image quality of JPEG files.

▶▶▶ Important

- This appears only when **JPEG/Exif** is selected in **Data Format**.

Save to a subfolder with current date

Select this checkbox to create a current date folder in the folder specified in **Save in** and save scanned images in it. The folder will be created with a name such as "20XX_01_01" (Year_Month_Date).

If this checkbox is not selected, files are saved directly in the folder specified in **Save in**.

Check scan results

Displays the [Save Settings dialog box](#) after scanning.

▶▶▶ Important

- When the Settings dialog box is displayed from My Image Garden, this option does not appear.

(3) Application Settings Area

Open with an application

Select this when you want to enhance or correct the scanned images.

You can specify the application from the pull-down menu.

Send to an application

Select this when you want to use the scanned images as they are in an application that allows you to browse or organize images.

You can specify the application from the pull-down menu.

Send to a folder

Select this when you also want to save the scanned images to a folder other than the one specified in **Save in**.

You can specify the folder from the pull-down menu.

Attach to e-mail

Select this when you want to send e-mails with the scanned images attached.

You can specify the e-mail client you want to start from the pull-down menu.

Do not start any application

Saves to the folder specified in **Save in**.

»» Note

- To add an application or folder to the pull-down menu, select **Add...** from the pull-down menu, then click **Add** in the displayed **Select Application** or **Select Destination Folder** dialog box and specify the application or folder.

Instructions

Opens this guide.

Defaults

You can restore the settings in the displayed screen to the default settings.

Settings (Custom Scan) Dialog Box

Click **Custom Scan** on the  (Scanning from a Computer) tab to display the **Settings (Custom Scan)** dialog box.

In the **Settings (Custom Scan)** dialog box, you can make advanced scan settings to scan according to your preference.

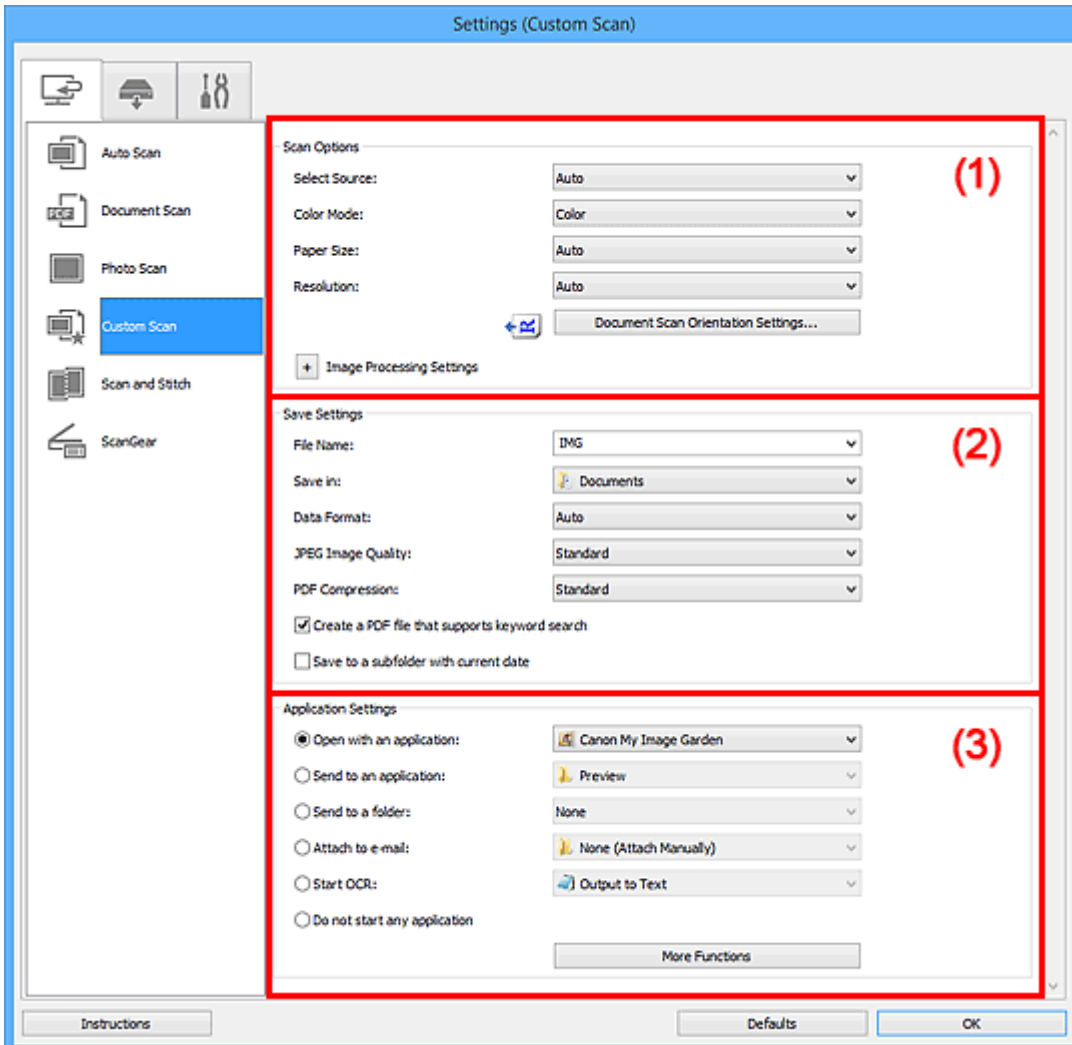

- [\(1\) Scan Options Area](#)
- [\(2\) Save Settings Area](#)
- [\(3\) Application Settings Area](#)

Important

- When the Settings dialog box is displayed from the Scan screen of My Image Garden, the setting items for **Application Settings** do not appear.

(1) Scan Options Area

Select Source

Select the type of item to be scanned. Select **Auto** to detect the item type automatically and to set **Color Mode**, **Paper Size**, and **Resolution** automatically as well.

»»» Important

- Item types supported by **Auto** are photos, postcards, business cards, magazines, newspapers, documents, and BD/DVD/CD.
 - To scan the following types of items, specify the item type or size. You cannot scan correctly with **Auto**.
 - A4 size photos
 - Text documents smaller than 2L (5 inches x 7 inches) (127 mm x 178 mm), such as paperback pages with the spine cut off
 - Items printed on thin white paper
 - Long narrow items such as panoramic photos
 - Reflective disc labels may not be scanned as expected.
 - Place items correctly according to the type of item to be scanned. Otherwise, items may not be scanned correctly.
- Refer to "[Placing Items \(When Scanning from a Computer\)](#)" for how to place items.
- When scanning two or more documents from the ADF (Auto Document Feeder), place documents of the same size even if **Auto** is set.

»»» Note

- To convert text in the image into text data after scanning, specify **Select Source** instead of selecting **Auto**.
- To reduce moire, set **Select Source** to **Magazine** or select the **Reduce moire** checkbox in **Image Processing Settings**.

Color Mode

Select the color mode in which to scan the item.

»»» Note

- Only **Color** is available when **Select Source** is **Auto**.

Paper Size

Select the size of the item to be scanned.

When you select **Custom**, a screen in which you can specify the paper size appears. Select a **Unit**, then enter the **Width** and **Height**, and then click **OK**.

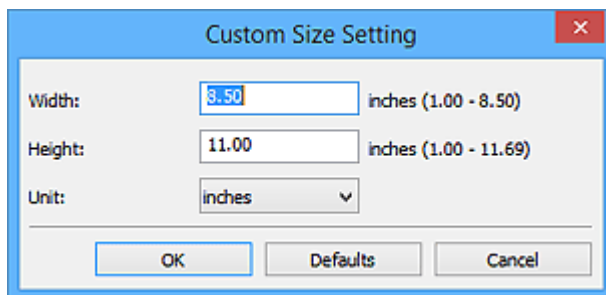

»»» Note

- Only **Auto** is available when **Select Source** is **Auto**.
- Click **Defaults** in the screen in which you can specify the paper size to restore the specified settings to the default settings.

Resolution

Select the resolution of the item to be scanned.

The higher the resolution (value), the more detail in your image.

■ Resolution

▶▶▶ Note

- Only **Auto** is available when **Select Source** is **Auto**.
- Only **300 dpi** or **400 dpi** can be set when **Start OCR** is selected in **Application Settings**.

Document Scan Orientation Settings...

This appears when you select ADF or **Auto** for **Select Source**.

Click to display the **Document Scan Orientation Settings** dialog box in which you can set the orientation and binding side of the documents to be scanned from the ADF.

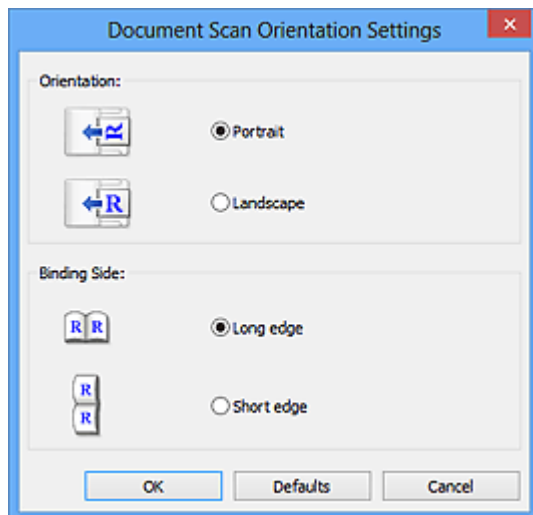

▶▶▶ Important

- **Binding Side** cannot be specified when scanning only the front side of each document.

Image Processing Settings

Click  (Plus) to set the following. Available setting items vary by **Select Source**.

- **When Select Source is Auto:**

Apply recommended image correction

Applies suitable corrections automatically based on the item type.

▶▶▶ Important

- The color tone may differ from the source image due to corrections. In that case, deselect the checkbox and scan.

▶▶▶ Note

- Scanning takes longer than usual when you enable this function.

- **When Select Source is Photo:**

▶▶▶ Important

- When **Color Mode** is **Black and White**, **Image Processing Settings** is not available.

Sharpen outline

Emphasizes the outline of the subjects to sharpen the image.

- **When Select Source is Magazine or Document:**

▶▶▶ Note

- The displayed items vary by **Select Source** and **Color Mode**.

Apply Auto Document Fix

Select this checkbox to sharpen text in a document or magazine for better readability.

▶▶▶ Important

- The color tone may differ from the source image due to corrections. In that case, deselect the checkbox and scan.

▶▶▶ Note

- Scanning takes longer than usual when you enable this function.

Sharpen outline

Emphasizes the outline of the subjects to sharpen the image.

Reduce show-through

Sharpens text in an item or reduces show-through in newspapers, etc.

Reduce moire

Reduces moire patterns.

Printed materials are displayed as a collection of fine dots. "Moire" is a phenomenon where uneven gradation or a stripe pattern appears when such photos or pictures printed with fine dots are scanned.

▶▶▶ Note

- Scanning takes longer than usual when you enable **Reduce moire**.

Reduce gutter shadow

Reduces gutter shadows that appear between pages when scanning open booklets.

▶▶▶ Important

- This function is available only when scanning from the platen.

▶▶▶ Note

- Use ScanGear (scanner driver)'s **Advanced Mode** tab to correct gutter shadows when scanning non-standard size items or specified areas.
Refer to "Gutter Shadow Correction" for your model from Home of the *Online Manual* for details.
- When you enable this function, scanning may take longer than usual with network connection.

Correct slanted text document

Detects the scanned text and corrects the angle (within -0.1 to -10 degrees or +0.1 to +10 degrees) of the document.

▶▶▶ Important

- The following types of documents may not be corrected properly since the text cannot be detected correctly.

- Documents in which the text lines are inclined more than 10 degrees or the angles vary by line
- Documents containing both vertical and horizontal text
- Documents with extremely large or small fonts
- Documents with small amount of text
- Documents containing figures/images
- Hand-written text
- Documents containing both vertical and horizontal lines (tables)

▶▶▶ Note

- Scanning takes longer than usual when you enable **Correct slanted text document**.

Detect the orientation of text document and rotate image

Automatically rotates the image to the correct orientation by detecting the orientation of text in the scanned document.

▶▶▶ Important

- Only text documents written in languages that can be selected from **Document Language** in the [Settings \(General Settings\) dialog box](#) are supported.
- The orientation may not be detected for the following types of settings or documents since the text cannot be detected correctly.
 - Resolution is outside the range of 300 dpi to 600 dpi
 - Font size is outside the range of 8 points to 48 points
 - Documents containing special fonts, effects, italics, or hand-written text
 - Documents with patterned backgrounds

In that case, select the **Check scan results** checkbox and rotate the image in the [Save Settings dialog box](#).

(2) Save Settings Area

File Name

Enter the file name of the image to be saved. When you save a file, the date and four digits are appended to the set file name in the "_20XX0101_0001" format.

▶▶▶ Note

- When you select the **Save to a subfolder with current date** checkbox, the date and four digits are appended to the set file name.

Save in

Displays the folder in which to save the scanned images. To add a folder, select **Add...** from the pull-down menu, then click **Add** in the displayed **Select Destination Folder** dialog box and specify the destination folder.

The default save folders are as follows.

- Windows 8.1: **Documents** folder
- Windows 8: **My Documents** folder
- Windows 7: **My Documents** folder
- Windows Vista: **Documents** folder
- Windows XP: **My Documents** folder

»»» Important

- When the Settings dialog box is displayed from My Image Garden, this option does not appear.

Data Format

Select the data format in which to save the scanned images.

You can select **JPEG/Exif**, **TIFF**, **PNG**, **PDF**, **PDF (Multiple Pages)**, or **Auto**.

»»» Important

- When **Auto** is selected, the save format may differ depending on how you place the item.
 - [Placing Items \(When Scanning from a Computer\)](#)
- You cannot select **JPEG/Exif** when **Color Mode** is **Black and White**.
- When **Start OCR** is selected in **Application Settings**, you cannot select **PDF**, **PDF (Multiple Pages)**, or **Auto**.

»»» Note

- **Auto** appears only when **Auto** is selected for **Select Source**.
- With network connection, scanning may take longer than usual when you set **TIFF** or **PNG** in **Data Format**.

JPEG Image Quality

You can specify the image quality of JPEG files.

»»» Important

- This appears only when **JPEG/Exif** or **Auto** is selected in **Data Format**.

PDF Compression

Select the compression type for saving PDF files.

Standard

It is recommended that you normally select this setting.

High

Compresses the file size when saving, allowing you to reduce the load on your network/server.

»»» Important

- This appears only when **PDF**, **PDF (Multiple Pages)**, or **Auto** is selected in **Data Format**.
- When **Black and White** is selected in **Color Mode**, this option does not appear.

Create a PDF file that supports keyword search

Select this checkbox to convert text in images into text data and create PDF files that support keyword search.

»»» Important

- This appears only when **PDF**, **PDF (Multiple Pages)**, or **Auto** is selected in **Data Format**.

»»» Note

- PDF files that are searchable in the language selected in **Document Language** on the  (General Settings) tab of the Settings dialog box are created.

Save to a subfolder with current date

Select this checkbox to create a current date folder in the folder specified in **Save in** and save scanned images in it. The folder will be created with a name such as "20XX_01_01" (Year_Month_Date).

If this checkbox is not selected, files are saved directly in the folder specified in **Save in**.

Check scan results

Displays the [Save Settings dialog box](#) after scanning.

»» Important

- This does not appear when **Select Source** is **Auto**.
- When the Settings dialog box is displayed from My Image Garden, this option does not appear.

(3) Application Settings Area

Open with an application

Select this when you want to enhance or correct the scanned images.

You can specify the application from the pull-down menu.

Send to an application

Select this when you want to use the scanned images as they are in an application that allows you to browse or organize images.

You can specify the application from the pull-down menu.

Send to a folder

Select this when you also want to save the scanned images to a folder other than the one specified in **Save in**.

You can specify the folder from the pull-down menu.

Attach to e-mail

Select this when you want to send e-mails with the scanned images attached.

You can specify the e-mail client you want to start from the pull-down menu.

Start OCR

Select this when you want to convert text in the scanned image into text data.

You can specify the application from the pull-down menu.

Do not start any application

Saves to the folder specified in **Save in**.

»» Note

- To add an application or folder to the pull-down menu, select **Add...** from the pull-down menu, then click **Add** in the displayed **Select Application** or **Select Destination Folder** dialog box and specify the application or folder.

Instructions

Opens this guide.

Defaults

You can restore the settings in the displayed screen to the default settings.

Settings (Scan and Stitch) Dialog Box

Click **Scan and Stitch** on the  (Scanning from a Computer) tab to display the **Settings (Scan and Stitch)** dialog box.

In the **Settings (Scan and Stitch)** dialog box, you can make advanced scan settings for scanning items larger than the platen.

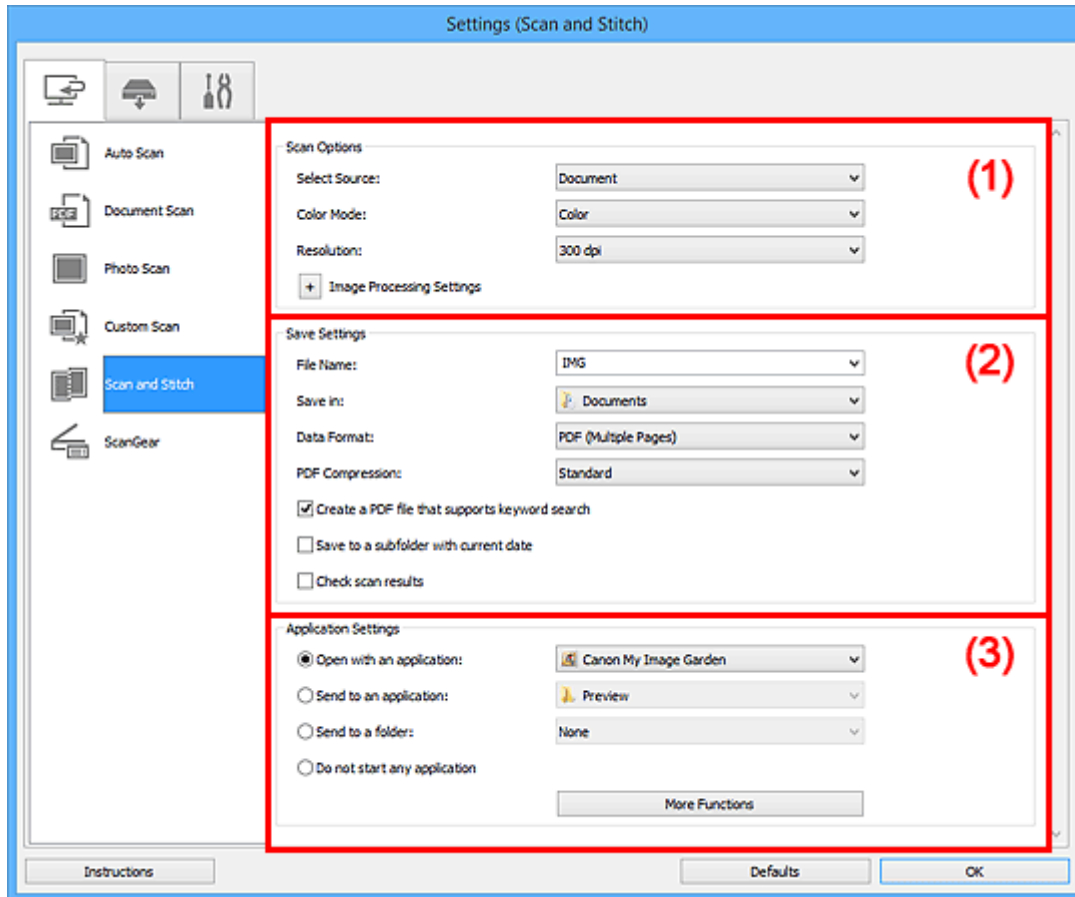

- [\(1\) Scan Options Area](#)
- [\(2\) Save Settings Area](#)
- [\(3\) Application Settings Area](#)

►►► Important

- When the Settings dialog box is displayed from the Scan screen of My Image Garden, the setting items for **Application Settings** do not appear.

(1) Scan Options Area

Select Source

Select the type of item to be scanned.

- Scanning photos: **Photo**
- Scanning documents: **Document**
- Scanning magazines: **Magazine**

►►► Note

- To reduce moire, set **Select Source** to **Magazine** or select the **Reduce moire** checkbox in **Image Processing Settings**.

Color Mode

Select the color mode in which to scan the item.

Resolution

Select the resolution of the item to be scanned.

The higher the resolution (value), the more detail in your image.

■ [Resolution](#)

Image Processing Settings

Click  (Plus) to set the following. Available setting items vary by **Select Source**.

▶▶▶ Important

- When **Color Mode** is **Black and White**, **Image Processing Settings** is not available.

- **When Select Source is Photo:**

Sharpen outline

Emphasizes the outline of the subjects to sharpen the image.

- **When Select Source is Magazine or Document:**

Sharpen outline

Emphasizes the outline of the subjects to sharpen the image.

Reduce show-through

Sharpens text in an item or reduces show-through in newspapers, etc.

Reduce moire

Reduces moire patterns.

Printed materials are displayed as a collection of fine dots. "Moire" is a phenomenon where uneven gradation or a stripe pattern appears when such photos or pictures printed with fine dots are scanned.

▶▶▶ Note

- Scanning takes longer than usual when you enable **Reduce moire**.

(2) Save Settings Area

File Name

Enter the file name of the image to be saved. When you save a file, the date and four digits are appended to the set file name in the "_20XX0101_0001" format.

▶▶▶ Note

- When you select the **Save to a subfolder with current date** checkbox, the date and four digits are appended to the set file name.

Save in

Displays the folder in which to save the scanned images. To add a folder, select **Add...** from the pull-down menu, then click **Add** in the displayed **Select Destination Folder** dialog box and specify the destination folder.

The default save folders are as follows.

- Windows 8.1: **Documents** folder
- Windows 8: **My Documents** folder

- Windows 7: **My Documents** folder
- Windows Vista: **Documents** folder
- Windows XP: **My Documents** folder

»»» Important

- When the Settings dialog box is displayed from My Image Garden, this option does not appear.

Data Format

Select the data format in which to save the scanned images.

You can select **JPEG/Exif**, **TIFF**, **PNG**, **PDF**, or **PDF (Multiple Pages)**.

»»» Important

- You cannot select **JPEG/Exif** when **Color Mode** is **Black and White**.

»»» Note

- With network connection, scanning may take longer than usual when you set **TIFF** or **PNG** in **Data Format**.

PDF Compression

Select the compression type for saving PDF files.

Standard

It is recommended that you normally select this setting.

High

Compresses the file size when saving, allowing you to reduce the load on your network/server.

»»» Important

- This appears only when **PDF** or **PDF (Multiple Pages)** is selected in **Data Format**.
- When **Black and White** is selected in **Color Mode**, this option does not appear.

Create a PDF file that supports keyword search

Select this checkbox to convert text in images into text data and create PDF files that support keyword search.

»»» Important

- This appears only when **PDF** or **PDF (Multiple Pages)** is selected in **Data Format**.

»»» Note

- PDF files that are searchable in the language selected in **Document Language** on the  (General Settings) tab of the Settings dialog box are created.

JPEG Image Quality

You can specify the image quality of JPEG files.

»»» Important

- This appears only when **JPEG/Exif** is selected in **Data Format**.

Save to a subfolder with current date

Select this checkbox to create a current date folder in the folder specified in **Save in** and save scanned images in it. The folder will be created with a name such as "20XX_01_01" (Year_Month_Date).

If this checkbox is not selected, files are saved directly in the folder specified in **Save in**.

Check scan results

Displays the [Save Settings dialog box](#) after scanning.

»» Important

- When the Settings dialog box is displayed from My Image Garden, this option does not appear.

(3) Application Settings Area

Open with an application

Select this when you want to enhance or correct the scanned images.

You can specify the application from the pull-down menu.

Send to an application

Select this when you want to use the scanned images as they are in an application that allows you to browse or organize images.

You can specify the application from the pull-down menu.

Send to a folder

Select this when you also want to save the scanned images to a folder other than the one specified in **Save in**.

You can specify the folder from the pull-down menu.

Do not start any application

Saves to the folder specified in **Save in**.

»» Note

- To add an application or folder to the pull-down menu, select **Add...** from the pull-down menu, then click **Add** in the displayed **Select Application** or **Select Destination Folder** dialog box and specify the application or folder.

Instructions

Opens this guide.

Defaults

You can restore the settings in the displayed screen to the default settings.

Settings (ScanGear) Dialog Box

Click **ScanGear** on the  (Scanning from a Computer) tab to display the **Settings (ScanGear)** dialog box.

In the **Settings (ScanGear)** dialog box, you can specify how to save images when scanning items by starting ScanGear (scanner driver) and how to respond after saving them.

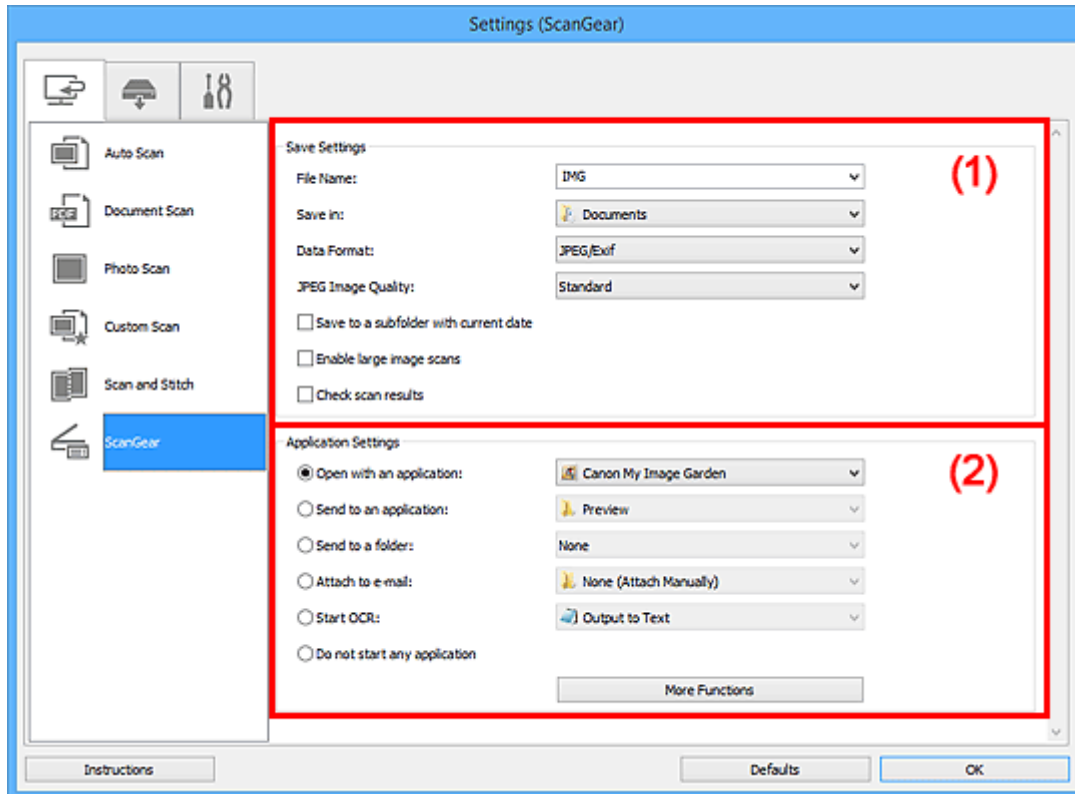

■ (1) [Save Settings Area](#)

■ (2) [Application Settings Area](#)

►►► Important

- When the Settings dialog box is displayed from My Image Garden, the setting items for **Application Settings** do not appear.

(1) Save Settings Area

File Name

Enter the file name of the image to be saved. When you save a file, the date and four digits are appended to the set file name in the "_20XX0101_0001" format.

►►► Note

- When you select the **Save to a subfolder with current date** checkbox, the date and four digits are appended to the set file name.

Save in

Displays the folder in which to save the scanned images. To add a folder, select **Add...** from the pull-down menu, then click **Add** in the displayed **Select Destination Folder** dialog box and specify the destination folder.

The default save folders are as follows.

- Windows 8.1: **Documents** folder
- Windows 8: **My Documents** folder
- Windows 7: **My Documents** folder
- Windows Vista: **Documents** folder
- Windows XP: **My Documents** folder

»»» Important

- When the Settings dialog box is displayed from My Image Garden, this option does not appear.

Data Format

Select the data format in which to save the scanned images.

You can select **JPEG/Exif**, **TIFF**, **PNG**, **PDF**, or **PDF (Multiple Pages)**.

»»» Note

- When **PDF** or **PDF (Multiple Pages)** is selected, images up to 9600 pixels x 9600 pixels can be scanned.
- When the **Enable large image scans** checkbox is selected in **Save Settings**, or when **Start OCR** is selected in **Application Settings**, you can select **JPEG/Exif**, **TIFF**, or **PNG**.
- With network connection, scanning may take longer than usual when you set **TIFF** or **PNG** in **Data Format**.

JPEG Image Quality

You can specify the image quality of JPEG files.

»»» Important

- This appears only when **JPEG/Exif** is selected in **Data Format**.

PDF Compression

Select the compression type for saving PDF files.

Standard

It is recommended that you normally select this setting.

High

Compresses the file size when saving, allowing you to reduce the load on your network/server.

»»» Important

- This appears only when **PDF** or **PDF (Multiple Pages)** is selected in **Data Format**.

Create a PDF file that supports keyword search

Select this checkbox to convert text in images into text data and create PDF files that support keyword search.

»»» Important

- This appears only when **PDF** or **PDF (Multiple Pages)** is selected in **Data Format**.

»»» Note

- PDF files that are searchable in the language selected in **Document Language** on the  (General Settings) tab of the Settings dialog box are created.

Save to a subfolder with current date

Select this checkbox to create a current date folder in the folder specified in **Save in** and save scanned images in it. The folder will be created with a name such as "20XX_01_01" (Year_Month_Date).

If this checkbox is not selected, files are saved directly in the folder specified in **Save in**.

Enable large image scans

Select this checkbox to scan images up to 21000 pixels x 30000 pixels and 1.8 GB.

▶▶▶ Important

- When this checkbox is selected, you cannot select **Send to an application**, **Send to a folder**, **Attach to e-mail**, or **Start OCR**.
- When the Settings dialog box is displayed from My Image Garden, this option does not appear.

▶▶▶ Note

- When this checkbox is not selected, images up to 10208 pixels x 14032 pixels can be scanned.

Check scan results

Displays the [Save Settings dialog box](#) after scanning.

▶▶▶ Important

- When the Settings dialog box is displayed from My Image Garden, this option does not appear.

(2) Application Settings Area

Open with an application

Select this when you want to enhance or correct the scanned images.

You can specify the application from the pull-down menu.

Send to an application

Select this when you want to use the scanned images as they are in an application that allows you to browse or organize images.

You can specify the application from the pull-down menu.

Send to a folder

Select this when you also want to save the scanned images to a folder other than the one specified in **Save in**.

You can specify the folder from the pull-down menu.

Attach to e-mail

Select this when you want to send e-mails with the scanned images attached.

You can specify the e-mail client you want to start from the pull-down menu.

Start OCR

Select this when you want to convert text in the scanned image into text data.

You can specify the application from the pull-down menu.

Do not start any application

Saves to the folder specified in **Save in**.

»» Note

- To add an application or folder to the pull-down menu, select **Add...** from the pull-down menu, then click **Add** in the displayed **Select Application** or **Select Destination Folder** dialog box and specify the application or folder.

Instructions

Opens this guide.

Defaults

You can restore the settings in the displayed screen to the default settings.

Settings (Save to PC (Auto)) Dialog Box

Click **Save to PC (Auto)** on the  (Scanning from the Operation Panel) tab to display the **Settings (Save to PC (Auto))** dialog box.

In the **Settings (Save to PC (Auto))** dialog box, you can specify how to respond when saving images to a computer after scanning them from the operation panel by automatically detecting the item type.

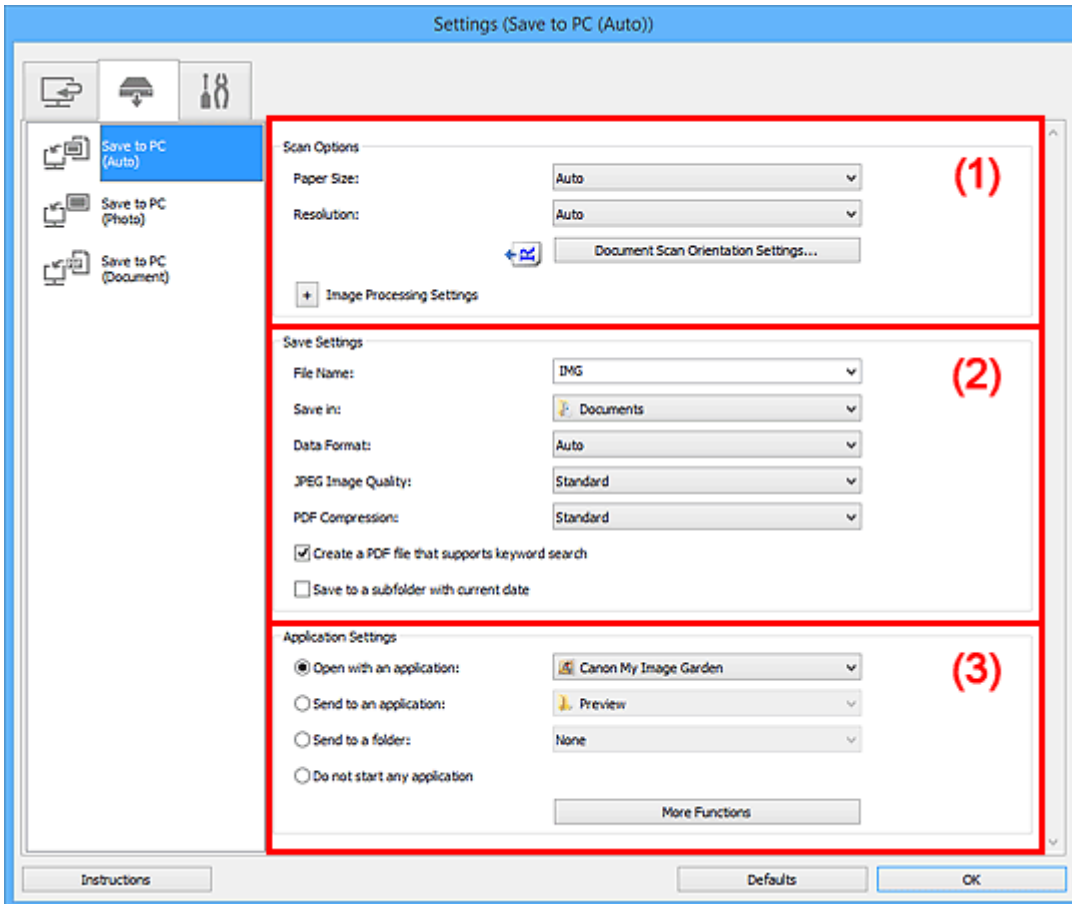

- [\(1\) Scan Options Area](#)
- [\(2\) Save Settings Area](#)
- [\(3\) Application Settings Area](#)

(1) Scan Options Area

Paper Size

Auto is selected.

Resolution

Auto is selected.

Document Scan Orientation Settings...

Click to display the **Document Scan Orientation Settings** dialog box in which you can set the orientation of the documents to be scanned from the ADF.

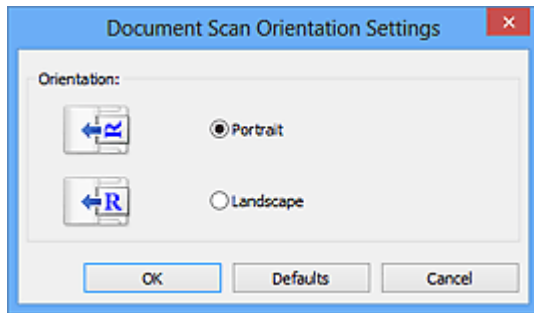



Image Processing Settings

Click  (Plus) to set the following.

Apply recommended image correction

Applies suitable corrections automatically based on the item type.

►►► Important

- The color tone may differ from the source image due to corrections. In that case, deselect the checkbox and scan.

►►► Note

- Scanning takes longer than usual when you enable this function.

(2) Save Settings Area

File Name

Enter the file name of the image to be saved. When you save a file, the date and four digits are appended to the set file name in the "_20XX0101_0001" format.

►►► Note

- When you select the **Save to a subfolder with current date** checkbox, the date and four digits are appended to the set file name.

Save in

Displays the folder in which to save the scanned images. To add a folder, select **Add...** from the pull-down menu, then click **Add** in the displayed **Select Destination Folder** dialog box and specify the destination folder.

The default save folders are as follows.

- Windows 8.1: **Documents** folder
- Windows 8: **My Documents** folder
- Windows 7: **My Documents** folder
- Windows Vista: **Documents** folder
- Windows XP: **My Documents** folder

Data Format

Auto is selected. The following data formats are automatically applied according to the item type when saving.

- Photos, postcards, BD/DVD/CD, and business cards: JPEG
- Magazines, newspapers, and documents: PDF

►►► Important

- The save format may differ depending on how you place the item.

Refer to "[Placing Items \(When Scanning from a Computer\)](#)" for how to place items.

JPEG Image Quality

You can specify the image quality of JPEG files.

PDF Compression

Select the compression type for saving PDF files.

Standard

It is recommended that you normally select this setting.

High

Compresses the file size when saving, allowing you to reduce the load on your network/server.

Create a PDF file that supports keyword search

Select this checkbox to convert text in images into text data and create PDF files that support keyword search.

►►► Note

- PDF files that are searchable in the language selected in **Document Language** on the  (General Settings) tab of the Settings dialog box are created.

Save to a subfolder with current date

Select this checkbox to create a current date folder in the folder specified in **Save in** and save scanned images in it. The folder will be created with a name such as "20XX_01_01" (Year_Month_Date).

If this checkbox is not selected, files are saved directly in the folder specified in **Save in**.

(3) Application Settings Area

Open with an application

Select this when you want to enhance or correct the scanned images.

You can specify the application from the pull-down menu.

Send to an application

Select this when you want to use the scanned images as they are in an application that allows you to browse or organize images.

You can specify the application from the pull-down menu.

Send to a folder

Select this when you also want to save the scanned images to a folder other than the one specified in **Save in**.

You can specify the folder from the pull-down menu.

Do not start any application

Saves to the folder specified in **Save in**.

►►► Note

- To add an application or folder to the pull-down menu, select **Add...** from the pull-down menu, then click **Add** in the displayed **Select Application** or **Select Destination Folder** dialog box and specify the application or folder.

Instructions

Opens this guide.

Defaults

You can restore the settings in the displayed screen to the default settings.

Settings (Save to PC (Photo)) Dialog Box

Click **Save to PC (Photo)** on the  (Scanning from the Operation Panel) tab to display the **Settings (Save to PC (Photo))** dialog box.

In the **Settings (Save to PC (Photo))** dialog box, you can specify how to respond when saving images to a computer as photos after scanning them from the operation panel.

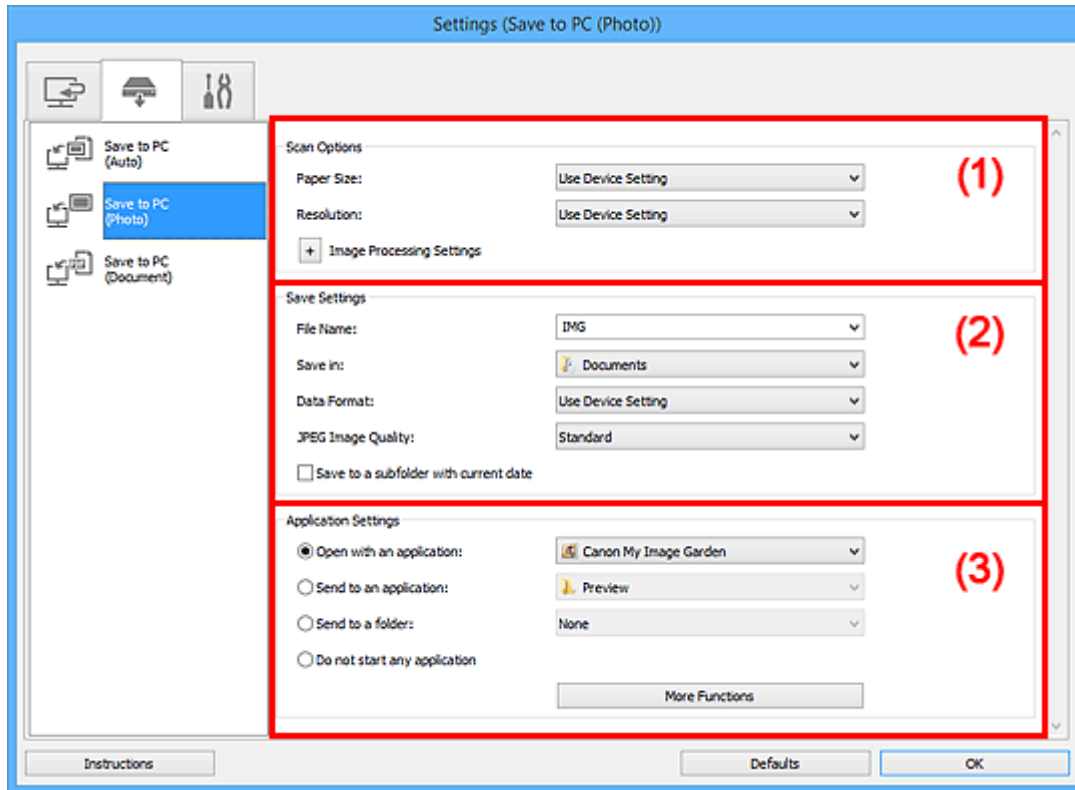

- [\(1\) Scan Options Area](#)
- [\(2\) Save Settings Area](#)
- [\(3\) Application Settings Area](#)

(1) Scan Options Area

Paper Size

Set from the operation panel.

Resolution

Set from the operation panel.

Image Processing Settings

Click  (Plus) to set the following.

Sharpen outline

Emphasizes the outline of the subjects to sharpen the image.

(2) Save Settings Area

File Name

Enter the file name of the image to be saved. When you save a file, the date and four digits are appended to the set file name in the "_20XX0101_0001" format.

»» Note

- When you select the **Save to a subfolder with current date** checkbox, the date and four digits are appended to the set file name.

Save in

Displays the folder in which to save the scanned images. To add a folder, select **Add...** from the pull-down menu, then click **Add** in the displayed **Select Destination Folder** dialog box and specify the destination folder.

The default save folders are as follows.

- Windows 8.1: **Documents** folder
- Windows 8: **My Documents** folder
- Windows 7: **My Documents** folder
- Windows Vista: **Documents** folder
- Windows XP: **My Documents** folder

Data Format

Set from the operation panel.

JPEG Image Quality

You can specify the image quality of JPEG files.

Save to a subfolder with current date

Select this checkbox to create a current date folder in the folder specified in **Save in** and save scanned images in it. The folder will be created with a name such as "20XX_01_01" (Year_Month_Date).

If this checkbox is not selected, files are saved directly in the folder specified in **Save in**.

(3) Application Settings Area

Open with an application

Select this when you want to enhance or correct the scanned images.

You can specify the application from the pull-down menu.

Send to an application

Select this when you want to use the scanned images as they are in an application that allows you to browse or organize images.

You can specify the application from the pull-down menu.

Send to a folder

Select this when you also want to save the scanned images to a folder other than the one specified in **Save in**.

You can specify the folder from the pull-down menu.

Do not start any application

Saves to the folder specified in **Save in**.

»» Note

- To add an application or folder to the pull-down menu, select **Add...** from the pull-down menu, then click **Add** in the displayed **Select Application** or **Select Destination Folder** dialog box and specify the application or folder.

Instructions

Opens this guide.

Defaults

You can restore the settings in the displayed screen to the default settings.

Settings (Save to PC (Document)) Dialog Box

Click **Save to PC (Document)** on the  (Scanning from the Operation Panel) tab to display the **Settings (Save to PC (Document))** dialog box.

In the **Settings (Save to PC (Document))** dialog box, you can specify how to respond when saving images to a computer as documents after scanning them from the operation panel.

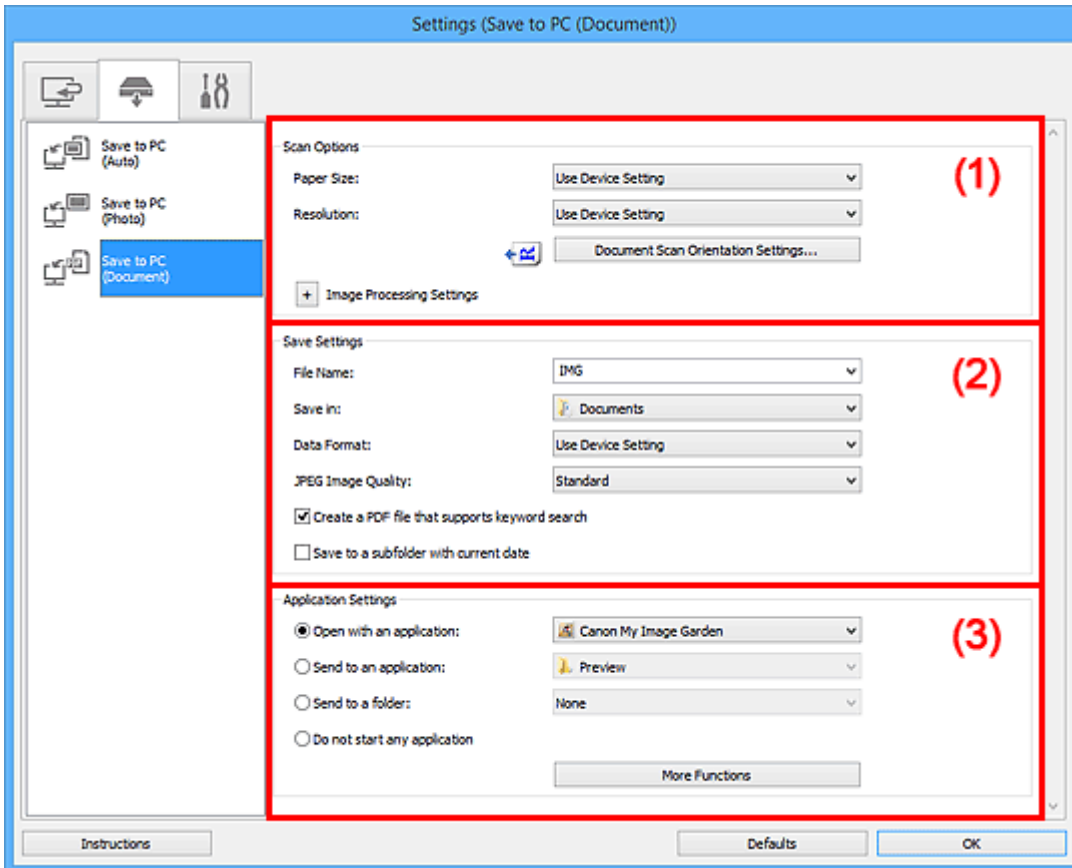

- [\(1\) Scan Options Area](#)
- [\(2\) Save Settings Area](#)
- [\(3\) Application Settings Area](#)

(1) Scan Options Area

Paper Size

Set from the operation panel.

Resolution

Set from the operation panel.

Document Scan Orientation Settings...

Click to display the **Document Scan Orientation Settings** dialog box in which you can set the orientation of the documents to be scanned from the ADF.

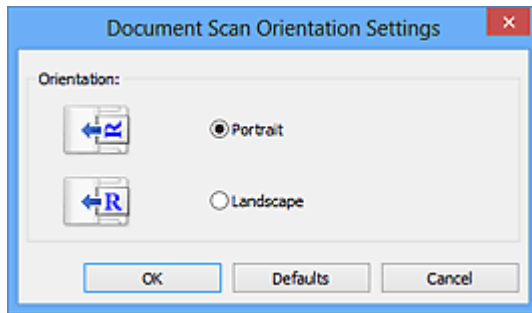



Image Processing Settings

Click  (Plus) to set the following.

Apply Auto Document Fix

Select this checkbox to sharpen text in a document or magazine for better readability.

►►► Important

- The color tone may differ from the source image due to corrections. In that case, deselect the checkbox and scan.

►►► Note

- Scanning takes longer than usual when you enable this function.

Sharpen outline

Emphasizes the outline of the subjects to sharpen the image.

Reduce show-through

Sharpens text in an item or reduces show-through in newspapers, etc.

Reduce moire

Reduces moire patterns.

Printed materials are displayed as a collection of fine dots. "Moire" is a phenomenon where uneven gradation or a stripe pattern appears when such photos or pictures printed with fine dots are scanned.

►►► Note

- Scanning takes longer than usual when you enable **Reduce moire**.

Reduce gutter shadow (platen)

Reduces gutter shadows that appear between pages when scanning open booklets.

►►► Important

- This function is available only when scanning from the platen.

►►► Note

- When you enable this function, scanning may take longer than usual with network connection.

Correct slanted text document

Detects the scanned text and corrects the angle (within -0.1 to -10 degrees or +0.1 to +10 degrees) of the document.

»» Important

- The following types of documents may not be corrected properly since the text cannot be detected correctly.
 - Documents in which the text lines are inclined more than 10 degrees or the angles vary by line
 - Documents containing both vertical and horizontal text
 - Documents with extremely large or small fonts
 - Documents with small amount of text
 - Documents containing figures/images
 - Hand-written text
 - Documents containing both vertical and horizontal lines (tables)

»» Note

- Scanning takes longer than usual when you enable **Correct slanted text document**.

Detect the orientation of text document and rotate image

Automatically rotates the image to the correct orientation by detecting the orientation of text in the scanned document.

»» Important

- Only text documents written in languages that can be selected from **Document Language** in the [Settings \(General Settings\) dialog box](#) are supported.
- The orientation may not be detected for the following types of settings or documents since the text cannot be detected correctly.
 - Resolution is outside the range of 300 dpi to 600 dpi
 - Font size is outside the range of 8 points to 48 points
 - Documents containing special fonts, effects, italics, or hand-written text
 - Documents with patterned backgrounds

(2) Save Settings Area

File Name

Enter the file name of the image to be saved. When you save a file, the date and four digits are appended to the set file name in the "_20XX0101_0001" format.

»» Note

- When you select the **Save to a subfolder with current date** checkbox, the date and four digits are appended to the set file name.

Save in

Displays the folder in which to save the scanned images. To add a folder, select **Add...** from the pull-down menu, then click **Add** in the displayed **Select Destination Folder** dialog box and specify the destination folder.

The default save folders are as follows.

- Windows 8.1: **Documents** folder
- Windows 8: **My Documents** folder
- Windows 7: **My Documents** folder
- Windows Vista: **Documents** folder

- Windows XP: **My Documents** folder

Data Format

Set from the operation panel.

JPEG Image Quality

You can specify the image quality of JPEG files.

Create a PDF file that supports keyword search

Select this checkbox to convert text in images into text data and create PDF files that support keyword search.

»» Note

- PDF files that are searchable in the language selected in **Document Language** on the  (General Settings) tab of the Settings dialog box are created.

Save to a subfolder with current date

Select this checkbox to create a current date folder in the folder specified in **Save in** and save scanned images in it. The folder will be created with a name such as "20XX_01_01" (Year_Month_Date).

If this checkbox is not selected, files are saved directly in the folder specified in **Save in**.

(3) Application Settings Area

Open with an application

Select this when you want to enhance or correct the scanned images.

You can specify the application from the pull-down menu.

Send to an application

Select this when you want to use the scanned images as they are in an application that allows you to browse or organize images.

You can specify the application from the pull-down menu.

Send to a folder

Select this when you also want to save the scanned images to a folder other than the one specified in **Save in**.

You can specify the folder from the pull-down menu.

Do not start any application

Saves to the folder specified in **Save in**.

»» Note

- To add an application or folder to the pull-down menu, select **Add...** from the pull-down menu, then click **Add** in the displayed **Select Application** or **Select Destination Folder** dialog box and specify the application or folder.

Instructions

Opens this guide.

Defaults

You can restore the settings in the displayed screen to the default settings.

Settings (General Settings) Dialog Box

Click the  (General Settings) tab to display the **Settings (General Settings)** dialog box.

In the **Settings (General Settings)** dialog box, you can set the product to use, file size restriction on e-mail attachment, language to detect text in images, and folder in which to save images temporarily.

►►► Important

- When the Settings dialog box is displayed from My Image Garden, some options may not appear.

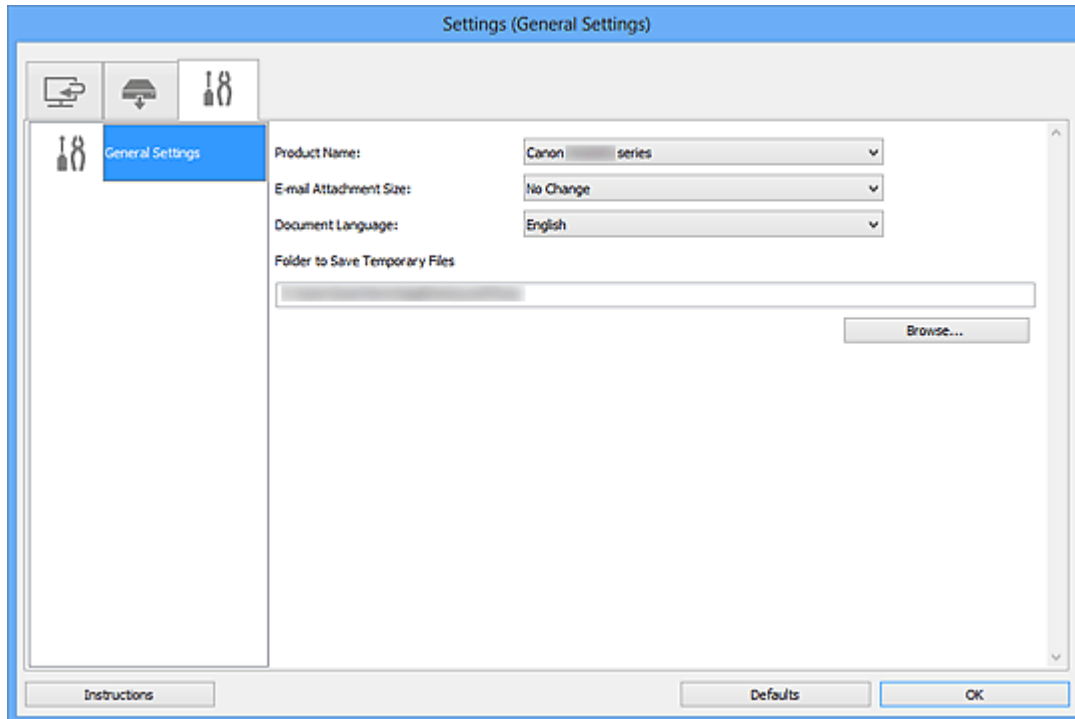

Product Name

Displays the name of the product that IJ Scan Utility is currently set to use.

If the displayed product is not the one you want to use, select the desired product from the list.

In addition, for network connection, select one with "Network" after the product name.

►►► Note

- With network connection, **Select** appears on the right side of the product name. Click **Select** to display IJ Network Scanner Selector EX from which you can change the scanner to use. Refer to "[Network Scan Settings](#)" for the setting procedure.

E-mail Attachment Size

You can restrict the size of scanned images to be attached to an e-mail.

You can select **Small (Suitable for 640 x 480 Windows)**, **Medium (Suitable for 800 x 600 Windows)**, **Large (Suitable for 1024 x 768 Windows)**, or **No Change**.

Document Language

You can select the language for detecting text in images and for use with search when a PDF file that supports keyword search is created.

Folder to Save Temporary Files

Displays the folder in which to save images temporarily. Click **Browse...** to specify the destination folder.

Instructions

Opens this guide.

Defaults

You can restore the settings in the displayed screen to the default settings.

Save Settings Dialog Box

Select the **Check scan results** checkbox in **Save Settings** of the Settings dialog box to display the **Save Settings** dialog box after scanning.

You can specify the data format and destination while viewing the thumbnails of scan results.

»»» Important

- After scanning from My Image Garden or the operation panel, the **Save Settings** dialog box does not appear.

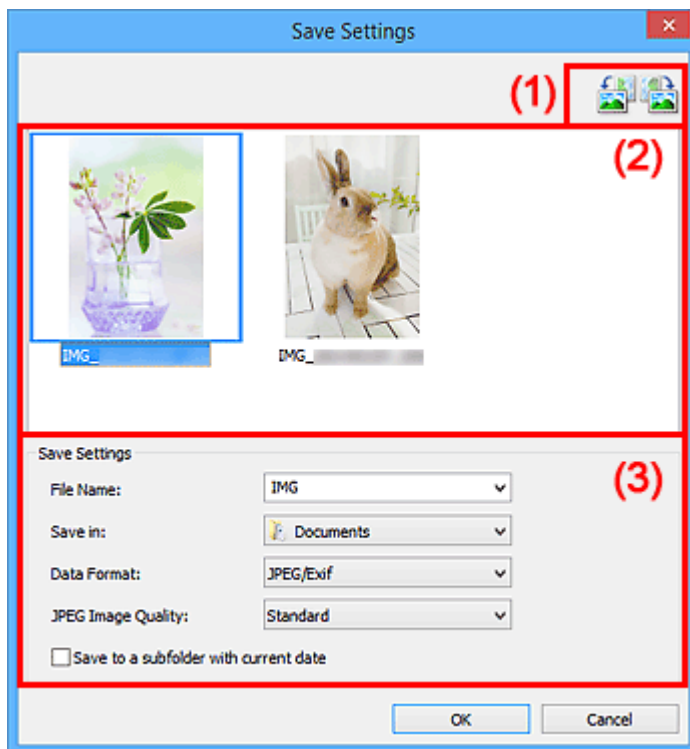

- (1) [Preview Operation Buttons](#)
- (2) [Scan Results Area](#)
- (3) [Save Settings Area](#)

(1) Preview Operation Buttons



(Rotate Left 90°)/(Rotate Right 90°)

Rotates scanned images 90 degrees counter-clockwise or clockwise.

Select the image you want to rotate, then click  (Rotate Left 90°) or  (Rotate Right 90°).

»»» Important

- The preview operation buttons do not appear when the **Enable large image scans** checkbox is selected in the **Settings (ScanGear)** dialog box.

(2) Scan Results Area

Displays the thumbnails of the scanned images. You can change the save order of images via drag-and-drop. The file names for saving appear below the thumbnails.

(3) Save Settings Area

File Name

Enter the file name of the image to be saved. When you save a file, the date and four digits are appended to the set file name in the "_20XX0101_0001" format.

▶▶▶ Note

- When you select the **Save to a subfolder with current date** checkbox, the date and four digits are appended to the set file name.

Save in

Displays the folder in which to save the scanned images. To add a folder, select **Add...** from the pull-down menu, then click **Add** in the displayed **Select Destination Folder** dialog box and specify the destination folder.

The default save folders are as follows.

- Windows 8.1: **Documents** folder
- Windows 8: **My Documents** folder
- Windows 7: **My Documents** folder
- Windows Vista: **Documents** folder
- Windows XP: **My Documents** folder

Data Format

Select the data format in which to save the scanned images.

You can select **JPEG/Exif**, **TIFF**, **PNG**, **PDF**, or **PDF (Multiple Pages)**.

▶▶▶ Important

- You cannot select **PDF** or **PDF (Multiple Pages)** in the following cases.
 - When scanned by clicking **Photo** in the IJ Scan Utility main screen
 - The **Enable large image scans** checkbox is selected in **Save Settings** of the **Settings (ScanGear)** dialog box
 - **Start OCR** is selected in **Application Settings** of the **Settings (Document Scan)**, **Settings (Custom Scan)**, or **Settings (ScanGear)** dialog box
- You cannot select **JPEG/Exif** when **Color Mode** is **Black and White**.

▶▶▶ Note

- With network connection, scanning may take longer than usual when you set **TIFF** or **PNG** in **Data Format**.

JPEG Image Quality

You can specify the image quality of JPEG files.

▶▶▶ Important

- This appears only when **JPEG/Exif** is selected in **Data Format**.

PDF Compression

Select the compression type for saving PDF files.

Standard

It is recommended that you normally select this setting.

High

Compresses the file size when saving, allowing you to reduce the load on your network/server.

»» Important

- This appears only when **PDF** or **PDF (Multiple Pages)** is selected in **Data Format**.
- When **Black and White** is selected in **Color Mode**, this option does not appear.

Create a PDF file that supports keyword search

Select this checkbox to convert text in images into text data and create PDF files that support keyword search.

»» Important

- This appears only when **PDF** or **PDF (Multiple Pages)** is selected in **Data Format**.

»» Note

- PDF files that are searchable in the language selected in **Document Language** on the  (General Settings) tab of the Settings dialog box are created.

Save to a subfolder with current date

Select this checkbox to create a current date folder in the folder specified in **Save in** and save scanned images in it. The folder will be created with a name such as "20XX_01_01" (Year_Month_Date).

If this checkbox is not selected, files are saved directly in the folder specified in **Save in**.

Image Stitch Window

Click **Stitch** in the IJ Scan Utility main screen to display the **Image Stitch** window.

You can scan the left and right halves of an item larger than the platen and combine them back into one image. You can scan items up to approximately twice as large as the platen.

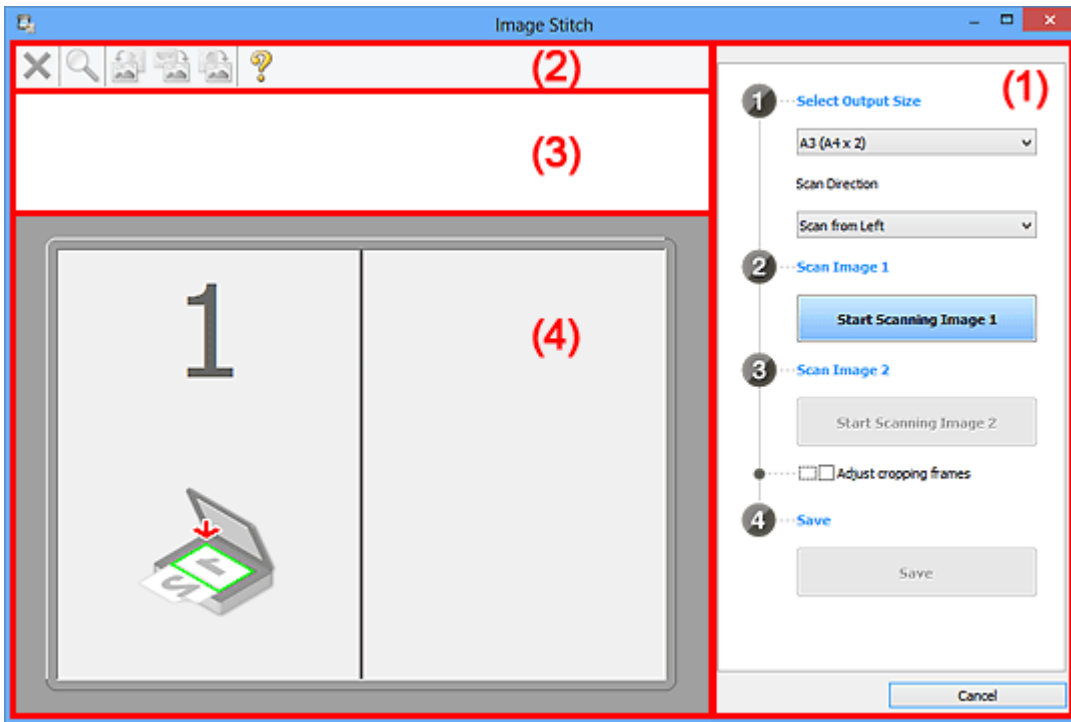

- (1) [Settings and Operation Buttons](#)
- (2) [Toolbar](#)
- (3) [Thumbnail View Area](#)
- (4) [Preview Area](#)

▶▶▶ Note

- The displayed items vary depending on the select source and view.

(1) Settings and Operation Buttons

Select Output Size

B4 (B5 x 2)

Scans the left and right halves of a B4 size item separately.

A3 (A4 x 2)

Scans the left and right halves of an A3 size item separately.

11 x 17 (Letter x 2)

Scans the left and right halves of an item twice as large as Letter size separately.

Full Platen x 2

Scans the left and right halves of an item twice as large as the platen separately.

Scan Direction

Scan from Left

Displays the first scanned image on the left side.

Scan from Right

Displays the first scanned image on the right side.

Scan Image 1

Start Scanning Image 1

Scans the first item.

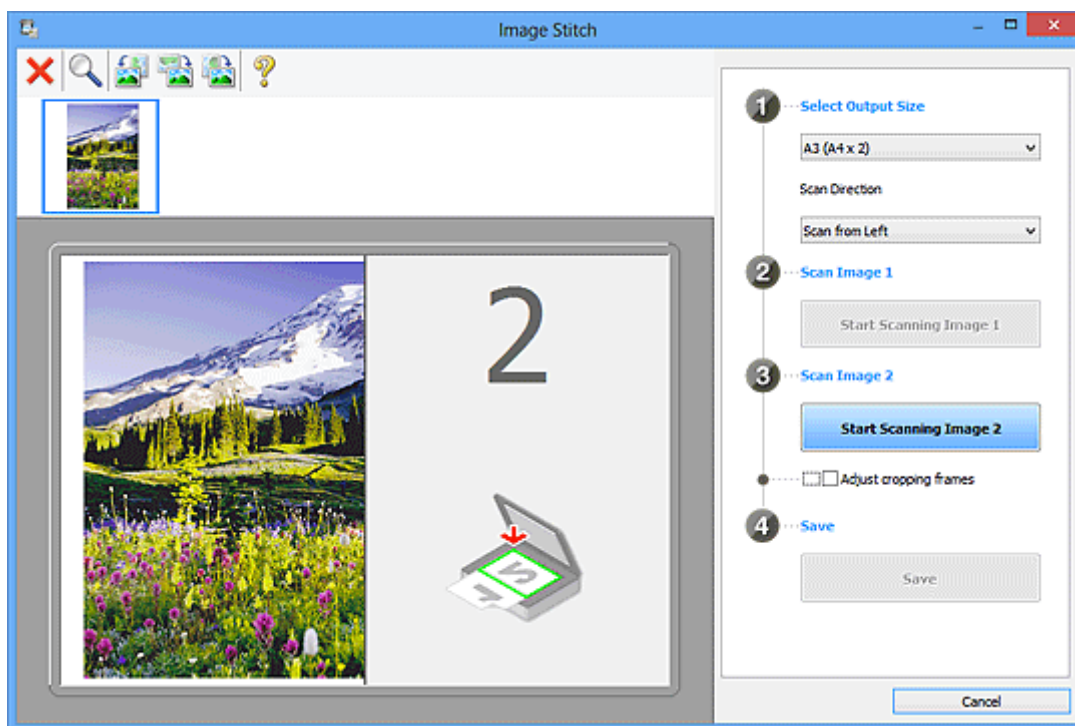

Scan Image 2

Start Scanning Image 2

Scans the second item.

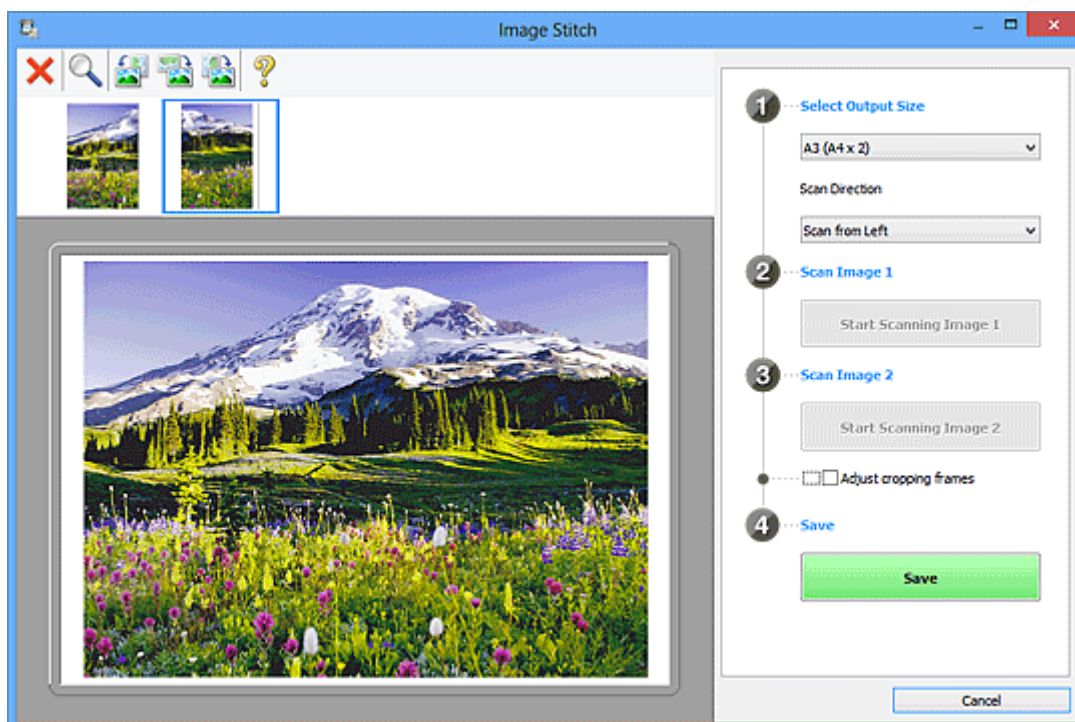

Adjust cropping frames

You can adjust the scan area in preview.

If no area is specified, the image of the size selected in **Select Output Size** will be saved. If an area is specified, only the image in the cropping frame will be scanned and saved.

■ [Adjusting Cropping Frames in the Image Stitch Window](#)

Save

Save

Saves the two scanned images as one image.

Cancel

Cancels **Stitch** scan.

(2) Toolbar

You can delete the scanned images or adjust the previewed images.



(Delete)

Deletes the image selected in the Thumbnail View area.



(Enlarge/Reduce)

Allows you to enlarge or reduce the preview image.

Left-clicking the Preview area enlarges the displayed image.

Right-clicking the Preview area reduces the displayed image.



(Rotate Left)

Rotates the preview image 90 degrees counter-clockwise.



(Rotate 180°)

Rotates the preview image 180 degrees.



(Rotate Right)

Rotates the preview image 90 degrees clockwise.



(Open Guide)

Opens this page.

(3) Thumbnail View Area

Displays the thumbnails of the scanned images. Appears blank if none has been scanned.

(4) Preview Area

Displays the scanned images. You can adjust the layout by dragging the scanned image or check the results of the settings made in "[\(1\) Settings and Operation Buttons.](#)"

When no image has been scanned:

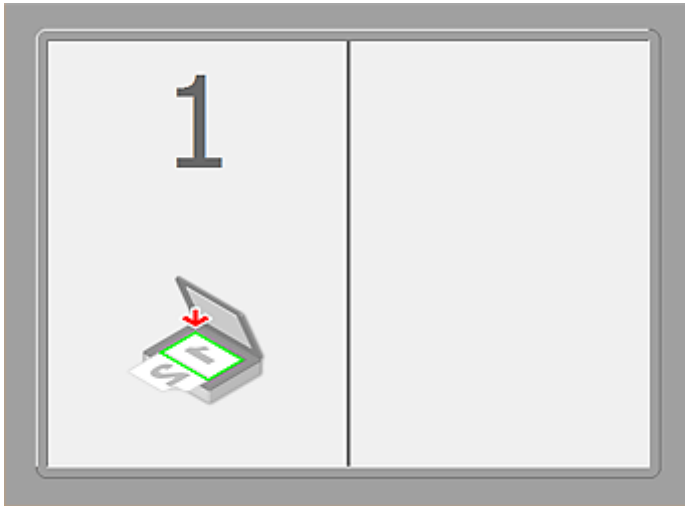

After scanning the first item by clicking Start Scanning Image 1:

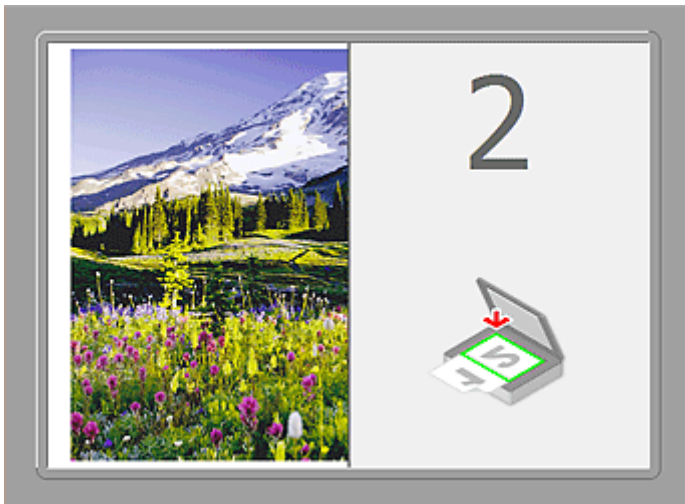

The image is scanned in the direction specified in **Scan Direction**, and **2** appears next to it.

After scanning the second item by clicking Start Scanning Image 2:



The two scanned images appear.

Related Topic

- [Scanning Items Larger than the Platen \(Image Stitch\)](#)

Scanning with Application Software that You are Using (ScanGear)

- ▶ **What Is ScanGear (Scanner Driver)?**
- ▶ **Scanning with Advanced Settings Using ScanGear (Scanner Driver)**
- ▶ **Starting ScanGear (Scanner Driver)**
- ▶ **Scanning in Basic Mode**
- ▶ **Scanning in Advanced Mode**
- ▶ **Scanning Multiple Documents from the ADF (Auto Document Feeder) in Advanced Mode**
- ▶ **Scanning Multiple Documents at One Time with ScanGear (Scanner Driver)**
- ▶ **Correcting Images and Adjusting Colors with ScanGear (Scanner Driver)**
- ▶ **ScanGear (Scanner Driver) Screens**
- ▶ **Placing Items (When Scanning from a Computer)**
- ▶ **Adjusting Cropping Frames (ScanGear)**
- ▶ **General Notes (Scanner Driver)**

▶▶▶ Important

- Available functions and settings vary depending on your scanner or printer.

What Is ScanGear (Scanner Driver)?

ScanGear (scanner driver) is software required for scanning documents. It enables you to specify the output size and make image corrections when scanning.

ScanGear can be started from IJ Scan Utility or applications that are compatible with a standard interface called TWAIN. (ScanGear is a TWAIN-compatible driver.)

What You Can Do with This Software

This software enables you to preview scan results or set document type and output size, etc. when scanning documents. It is useful when you want to scan in a specific color tone, as it allows you to make various corrections and adjust brightness, contrast, etc.

Screens

There are two modes: Basic Mode and Advanced Mode.

Switch modes by clicking a tab on the upper right of the screen.

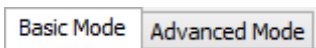

►► Note

- ScanGear starts in the last used mode.
- Settings are not retained when you switch modes.

Basic Mode

Use the **Basic Mode** tab to scan easily by following three simple on-screen steps (1 , 2 , and 3).

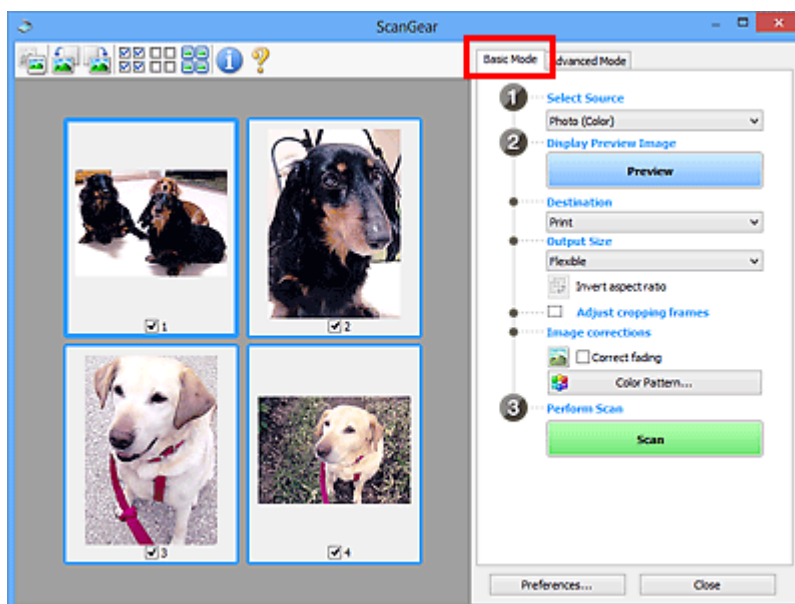

Advanced Mode

Use the **Advanced Mode** tab to specify the color mode, output resolution, image brightness, color tone, etc. when scanning.

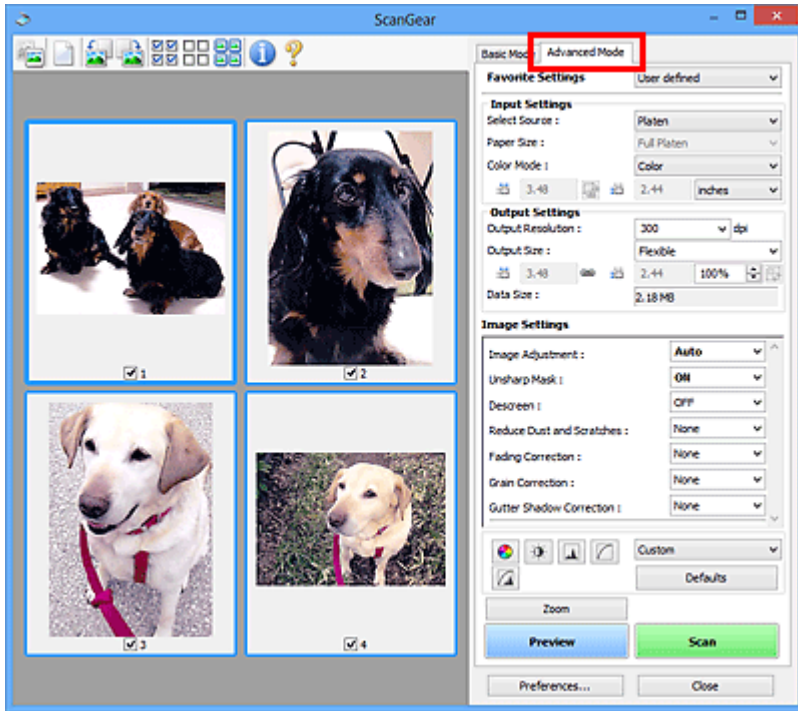

Scanning with Advanced Settings Using ScanGear (Scanner Driver)

- ▶ **Starting ScanGear (Scanner Driver)**
- ▶ **Scanning in Basic Mode**
- ▶ **Scanning in Advanced Mode**
- ▶ **Scanning Multiple Documents from the ADF (Auto Document Feeder) in Advanced Mode**
- ▶ **Scanning Multiple Documents at One Time with ScanGear (Scanner Driver)**

Starting ScanGear (Scanner Driver)

Use ScanGear (scanner driver) to make image corrections and color adjustments when scanning. ScanGear can be started from IJ Scan Utility or other applications.

▶▶▶ Note

- Set up the network environment if you have more than one scanner or have a network compatible model and changed the connection from USB connection to network connection.

Starting IJ Scan Utility

Follow these steps to start ScanGear from IJ Scan Utility.

1. Start IJ Scan Utility.

Refer to "Starting IJ Scan Utility" for your model from Home of the *Online Manual* for how to start IJ Scan Utility.

2. Click ScanGear in the IJ Scan Utility main screen.

The ScanGear screen appears.

Starting from an Application

Follow these steps (example) to start ScanGear from an application.

The procedure varies depending on the application. For details, refer to the application's manual.

1. Start the application.
2. On the menu of the application, select the machine.

▶▶▶ Note

- When you want to use a network compatible model by connecting to a network, select one with "Network" displayed after the product name.

3. Select the command to scan a document.

The ScanGear screen appears.

Scanning in Basic Mode

Use the **Basic Mode** tab to scan easily by following the on-screen steps.

Refer to "[Scanning Multiple Documents at One Time with ScanGear \(Scanner Driver\)](#)" to scan multiple documents at one time from the Platen.

When scanning from the ADF (Auto Document Feeder), documents are scanned without preview.

►► Important

- The following types of documents may not be scanned correctly. In that case, click  (Thumbnail) on the Toolbar to switch to whole image view and scan.
 - Photos that have a whitish background
 - Documents printed on white paper, hand-written text, business cards, etc.
 - Thin documents
 - Thick documents
- The following types of documents may not be scanned correctly.
 - Documents smaller than 1.2 inches (3 cm) square
 - Photos that have been cut to various shapes

►► Note

- When using a model supporting ADF duplex scanning, you can scan both sides of the documents automatically from the ADF.

1. Place the document on the Platen or ADF, then start ScanGear (scanner driver).

■ [Placing Items \(When Scanning from a Computer\)](#)

■ [Starting ScanGear \(Scanner Driver\)](#)

2. Set **Select Source** according to the document placed on the Platen or ADF.

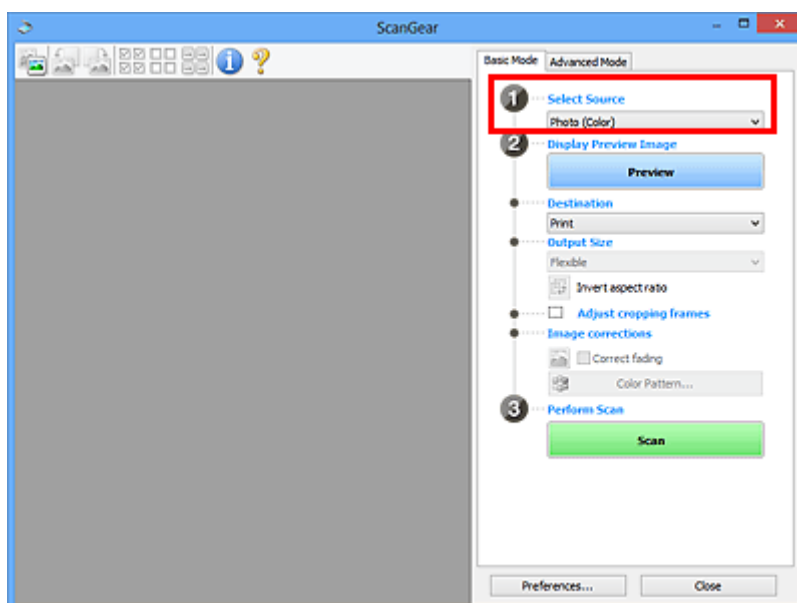

▶▶▶ Important

- Some applications do not support continuous scanning from the ADF. For details, refer to the application's manual.

▶▶▶ Note

- To scan magazines containing many color photos, select **Magazine (Color)**.

3. Click **Preview**.

Preview image appears in the Preview area.

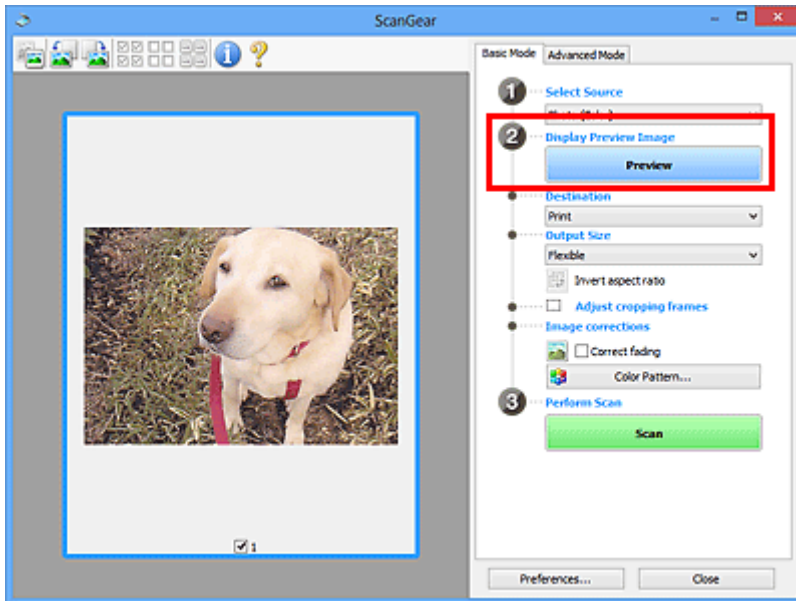

▶▶▶ Important

- **Preview** is not displayed when an ADF type is selected for **Select Source**.

▶▶▶ Note

- Colors are adjusted based on the document type selected in **Select Source**.

4. Set **Destination**.

▶▶▶ Note

- Skip ahead to Step 7 when an ADF type is selected for **Select Source**.

5. Set **Output Size** according to purpose.

Output size options vary by the item selected in **Destination**.

6. Adjust the cropping frames (scan areas) as required.

Adjust the size and position of the cropping frames on the preview image.

■ [Adjusting Cropping Frames \(ScanGear\)](#)

7. Set **Image corrections** as required.

8. Click **Scan**.

Scanning starts.

▶▶▶ Note

- Click  (Information) to open a dialog box in which you can check the current scan settings (document type, etc.).
- A response of ScanGear after scanning can be specified in **Status of ScanGear dialog after scanning** on the [Scan tab](#) of the **Preferences** dialog box.

Related Topic

- [Basic Mode Tab](#)

Scanning in Advanced Mode

Use the **Advanced Mode** tab to specify the color mode, output resolution, image brightness, color tone, etc. when scanning.

Refer to "[Scanning Multiple Documents at One Time with ScanGear \(Scanner Driver\)](#)" to scan multiple documents at one time.

Refer to "[Scanning Multiple Documents from the ADF \(Auto Document Feeder\) in Advanced Mode](#)" to scan multiple documents placed on the ADF (Auto Document Feeder).

▶▶▶ Important

- The following types of documents may not be scanned correctly. In that case, click  (Thumbnail) on the Toolbar to switch to whole image view and scan.
 - Photos that have a whitish background
 - Documents printed on white paper, hand-written text, business cards, etc.
 - Thin documents
 - Thick documents
- The following types of documents may not be scanned correctly.
 - Documents smaller than 1.2 inches (3 cm) square
 - Photos that have been cut to various shapes

1. Place the document on the Platen, then start ScanGear (scanner driver).

- [Placing Items \(When Scanning from a Computer\)](#)
- [Starting ScanGear \(Scanner Driver\)](#)

2. Click the **Advanced Mode** tab.

The tab switches to **Advanced Mode**.

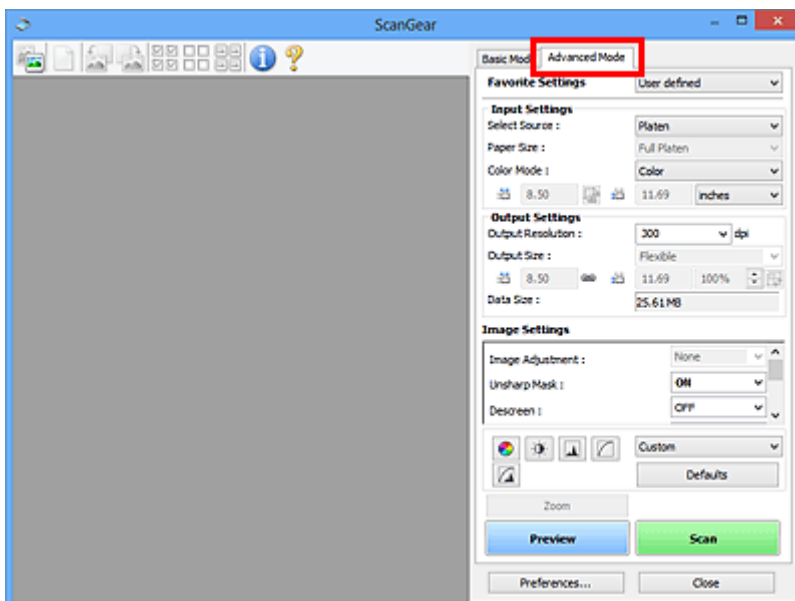

▶▶▶ Note

- Settings are not retained when you switch modes.

3. Set [Input Settings](#) according to the document or purpose.
4. Click **Preview**.

Preview images appear in the Preview area.

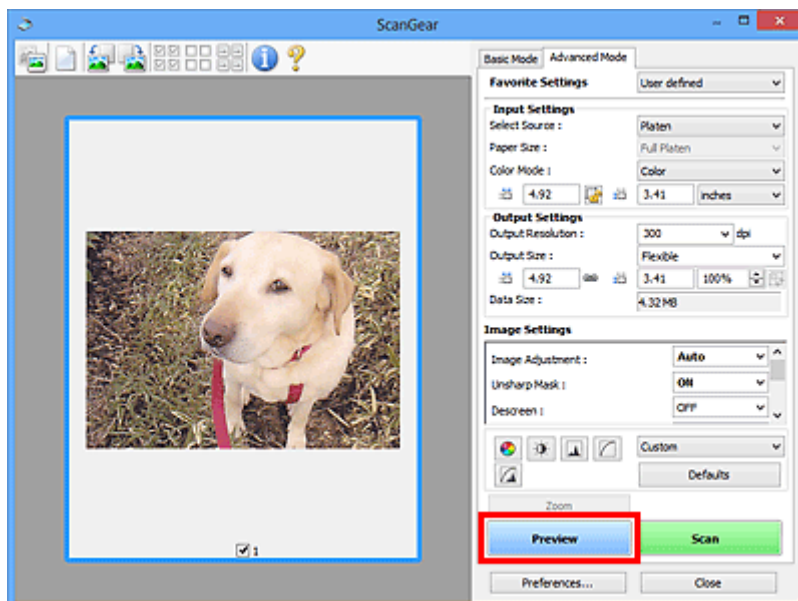

5. Set [Output Settings](#).
6. Adjust the cropping frame (scan area), correct image, and adjust colors as required.
 - [Adjusting Cropping Frames \(ScanGear\)](#)
 - [Image Settings](#)
 - [Color Adjustment Buttons](#)

7. Click **Scan**.

Scanning starts.

▶▶▶ Note

- Click  (Information) to open a dialog box in which you can check the current scan settings (document type, etc.).
- A response of ScanGear after scanning can be specified in **Status of ScanGear dialog after scanning** on the [Scan tab](#) of the **Preferences** dialog box.

Related Topic

- [Advanced Mode Tab](#)

Scanning Multiple Documents from the ADF (Auto Document Feeder) in Advanced Mode

Use the **Advanced Mode** tab to specify the image brightness, color tone, etc. and scan multiple documents placed on the ADF (Auto Document Feeder) at one time. When using a model supporting ADF duplex scanning, you can scan both sides of the documents automatically from the ADF.

When scanning from the ADF, documents are scanned without preview.

1. Place the documents on the ADF of the machine, then start ScanGear (scanner driver).

- [Placing Documents \(ADF \(Auto Document Feeder\)\)](#)

- [Starting ScanGear \(Scanner Driver\)](#)

2. Click the **Advanced Mode** tab and select **Document (ADF Simplex)** or **Document (ADF Duplex)** for **Select Source**.

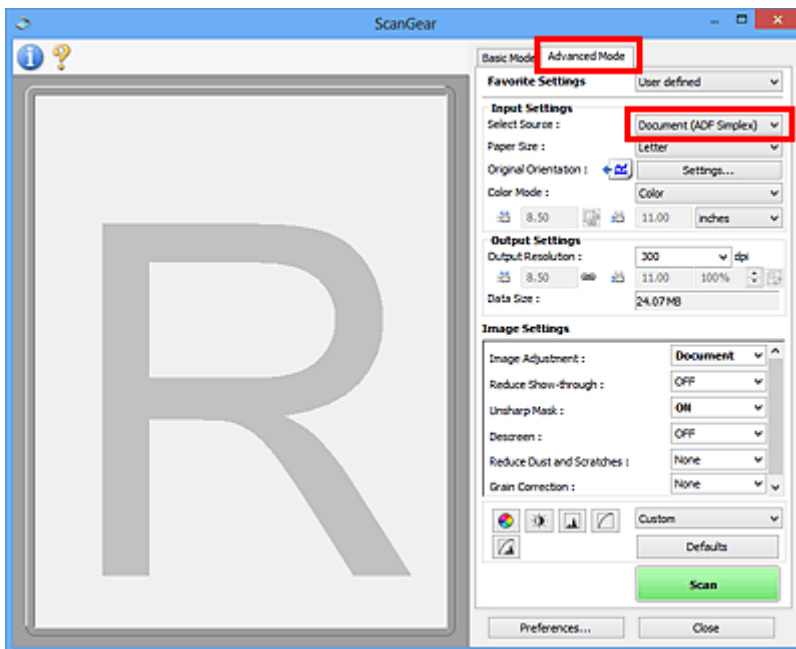

►►► Note

- Settings are not retained when you switch modes.
- You can select **Document (ADF Duplex)** when using a model supporting ADF duplex scanning.

3. Set [Input Settings](#) according to the document or purpose.

4. Set [Output Settings](#).

5. Make image corrections and color adjustments as required.

- [Image Settings](#)

- [Color Adjustment Buttons](#)

6. Click **Scan**.

Scanning starts.

»» Note

- Click  (Information) to open a dialog box in which you can check the current scan settings (document type, etc.).
- A response of ScanGear after scanning can be specified in **Status of ScanGear dialog after scanning** on the [Scan tab](#) of the **Preferences** dialog box.

Related Topic

- [Advanced Mode Tab](#)

Scanning Multiple Documents at One Time with ScanGear (Scanner Driver)

You can scan two or more photos (small documents) on the Platen at one time on the **Basic Mode** tab and **Advanced Mode** tab.

This section explains how to scan multiple documents from the **Basic Mode** tab.

▶▶▶ Important

- To scan multiple documents as a single image, scan in whole image view.
- The following types of documents may not be cropped correctly. In that case, adjust the cropping frames (scan areas) in whole image view and scan.
 - Photos that have a whitish background
 - Documents printed on white paper, hand-written text, business cards, etc.
 - Thin documents
 - Thick documents
- [Scanning Multiple Documents in Whole Image View](#)
- The following types of documents may not be scanned correctly.
 - Documents smaller than 1.2 inches (3 cm) square
 - Photos that have been cut to various shapes

▶▶▶ Note

- You can also scan multiple documents at one time from the **Advanced Mode** tab. Use the **Advanced Mode** tab to make advanced scan settings such as the color mode, output resolution, image brightness, and color tone.
- Refer to the corresponding sections below for details on the **Basic Mode** tab and **Advanced Mode** tab.
 - [Basic Mode Tab](#)
 - [Advanced Mode Tab](#)

1. Place the document on the Platen, then start ScanGear (scanner driver).

- [Placing Items \(When Scanning from a Computer\)](#)
- [Starting ScanGear \(Scanner Driver\)](#)

2. Set **Select Source** according to the document placed on the Platen.

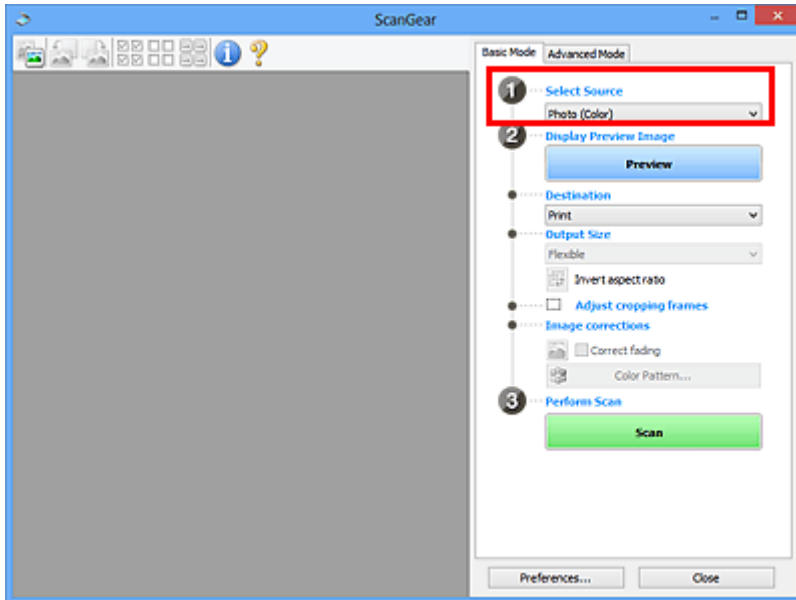

3. Click **Preview**.

Thumbnails of the preview images appear in the Preview area. Cropping frames are specified automatically according to the document size.

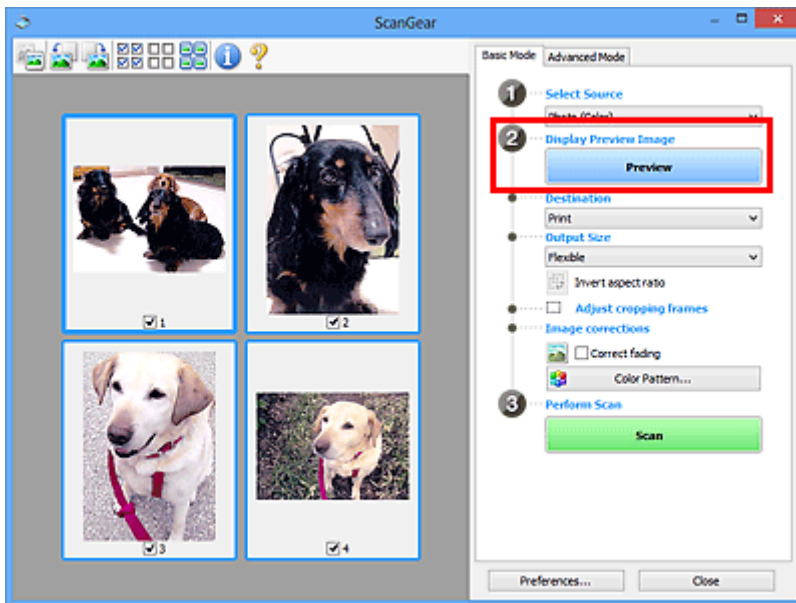

4. Set **Destination**.

5. Set **Output Size** according to purpose.

6. Adjust the cropping frames and set **Image corrections** as required.

►►► **Note**

- You can correct each image separately. Select the frame you want to correct.
- In thumbnail view, you can only create one cropping frame per image. To create multiple cropping frames in an image, scan in whole image view.

■ [Scanning Multiple Documents in Whole Image View](#)

7. Select the images you want to scan.

Select the checkboxes of the images you want to scan.

8. Click **Scan**.

Scanning Multiple Documents in Whole Image View

Follow these steps if thumbnails are not displayed correctly when previewed or if you want to scan multiple documents as a single image.

►►► Note

- Positions of slanted documents are not corrected in whole image view.

1. After previewing images, click  (Thumbnail) on the Toolbar.

Switch to whole image view.

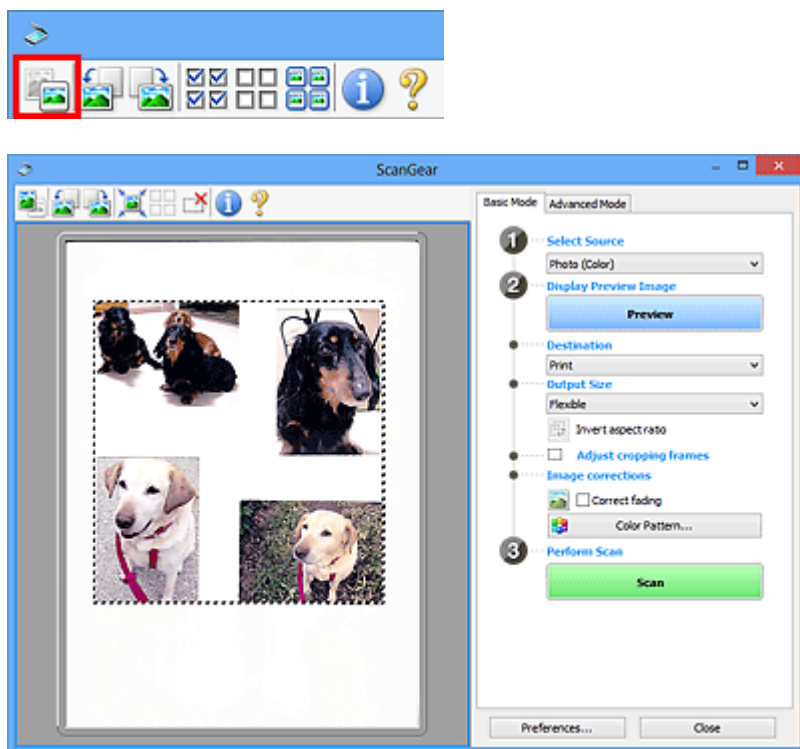

►►► Note

- When the whole image is displayed, the icon changes to  (Whole Image).

2. Set **Destination**.

3. Set **Output Size** according to purpose.

Invert aspect ratio will be enabled when **Output Size** is set to anything but **Flexible**. Click this button to rotate the cropping frame. Click again to return it to the original orientation.

4. Adjust the cropping frames.

Adjust the size and position of the cropping frames on the preview image. You can also create two or more cropping frames.

If an area is not specified, the document will be scanned at the document size (Auto Crop). If an area is specified, only the portion in the specified area will be scanned.

■ [Adjusting Cropping Frames \(ScanGear\)](#)

5. Set **Image corrections** as required.

6. Click **Scan**.

Areas framed by broken lines are scanned.

▶▶ **Note**

- A response of ScanGear after scanning can be specified in **Status of ScanGear dialog after scanning** on the [Scan tab](#) of the **Preferences** dialog box.

Correcting Images and Adjusting Colors with ScanGear (Scanner Driver)

- ▶ **Correcting Images (Unsharp Mask, Reduce Dust and Scratches, Fading Correction, etc.)**
- ▶ **Adjusting Colors Using a Color Pattern**
- ▶ **Adjusting Saturation and Color Balance**
- ▶ **Adjusting Brightness and Contrast**
- ▶ **Adjusting Histogram**
- ▶ **Adjusting Tone Curve**
- ▶ **Setting Threshold**

Correcting Images (Unsharp Mask, Reduce Dust and Scratches, Fading Correction, etc.)

The **Image Settings** functions on the **Advanced Mode** tab of ScanGear (scanner driver) allow you to enhance the outline of the subjects, reduce dust/scratches, and correct faded colors when scanning images.

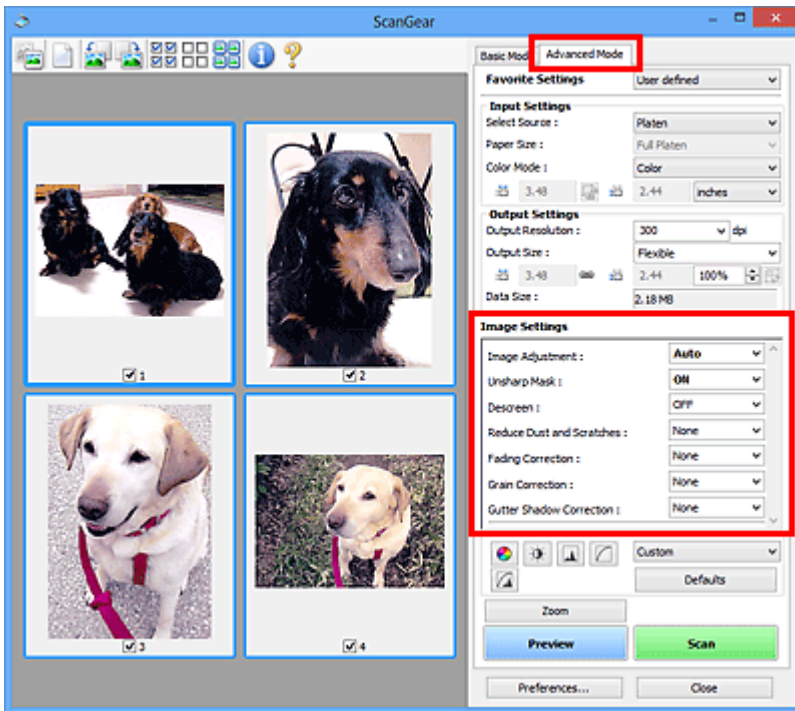

Setting Items

Click  (Arrow) of a function and select an item from the pull-down menu.

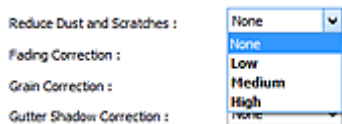

Important

- Do not apply these functions to images without moire, dust/scratches, or faded colors. The color tone may be adversely affected.
- Refer to "[Image Settings](#)" for details and precautions on each function.

Note

- Refer to "[Scanning in Advanced Mode](#)" to start the **Advanced Mode** tab of ScanGear and scan.

Adjusting the image brightness and color tone

Set **Image Adjustment** to **Auto**, **Photo**, **Magazine**, or **Document** according to the document type.

None	Auto
------	------



Reducing show-through in text documents or lightening the base color in recycled paper, newspapers, etc. when scanning documents

Set **Reduce Show-through** to **ON**.

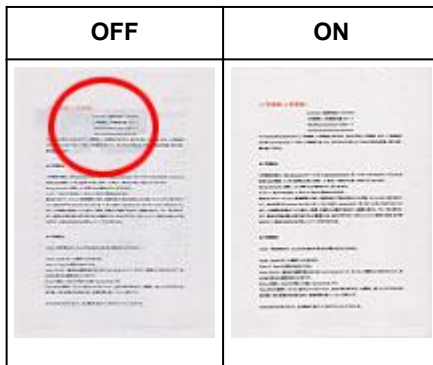

Sharpening slightly out-of-focus images

Set **Unsharp Mask** to **ON**.

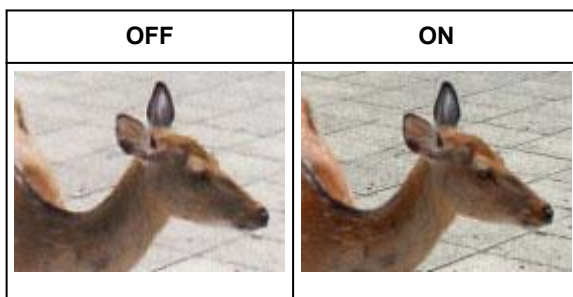

Reducing gradations and stripe patterns

Set **Descreen** to **ON**.

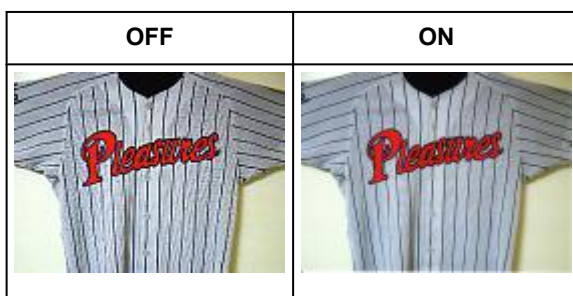

►► Note

- Printed photos and pictures are displayed as a collection of fine dots. "Moire" is a phenomenon where uneven gradation or a stripe pattern appears when such photos or pictures printed with fine dots are scanned. **Descreen** is the function for reducing this moire effect.

Reducing dust and scratches

Set **Reduce Dust and Scratches** to **Low**, **Medium**, or **High** according to the degree of dust and scratches.

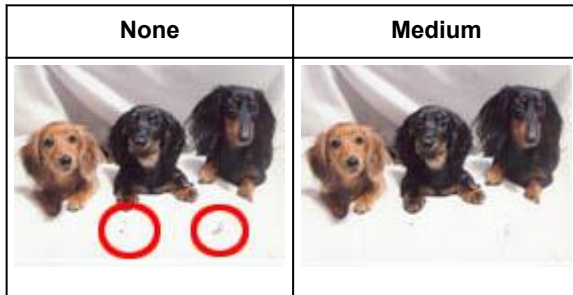

Correcting photos that have faded with time or due to colorcast

Set **Fading Correction** to **Low**, **Medium**, or **High** according to the degree of fading or colorcast.

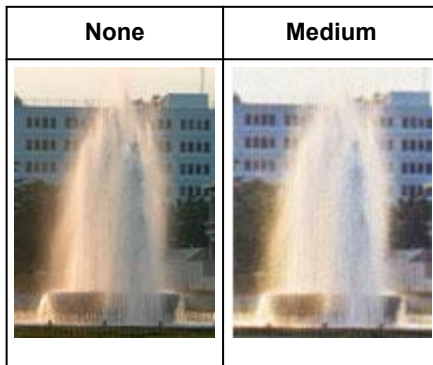

Reducing graininess

Set **Grain Correction** to **Low**, **Medium**, or **High** according to the degree of graininess.

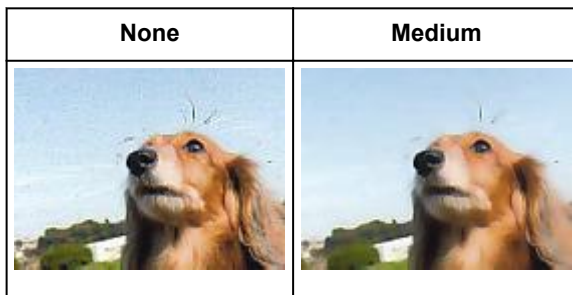

Correcting shadows that appear between pages when scanning open booklets

Set **Gutter Shadow Correction** to **Low**, **Medium**, or **High** according to the degree of shadows.

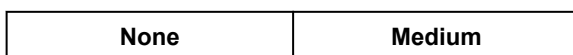

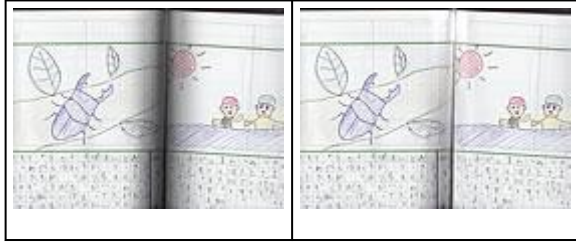

Adjusting Colors Using a Color Pattern

You can preview color changes and reproduce natural colors by using the color pattern function in ScanGear (scanner driver)'s **Basic Mode** tab.

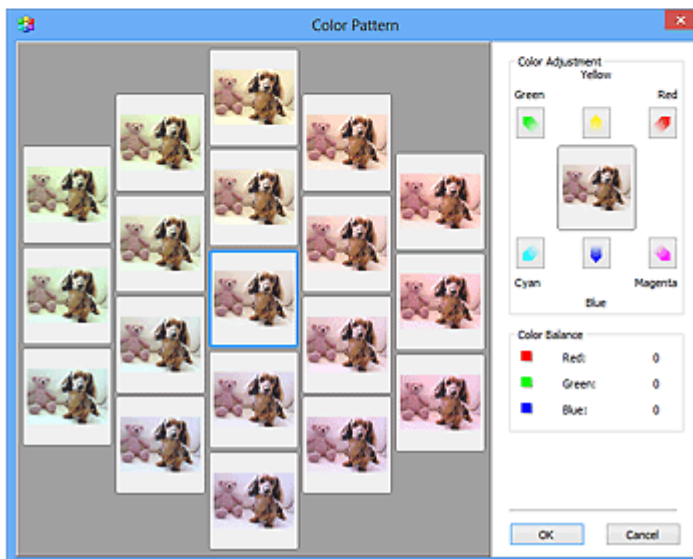
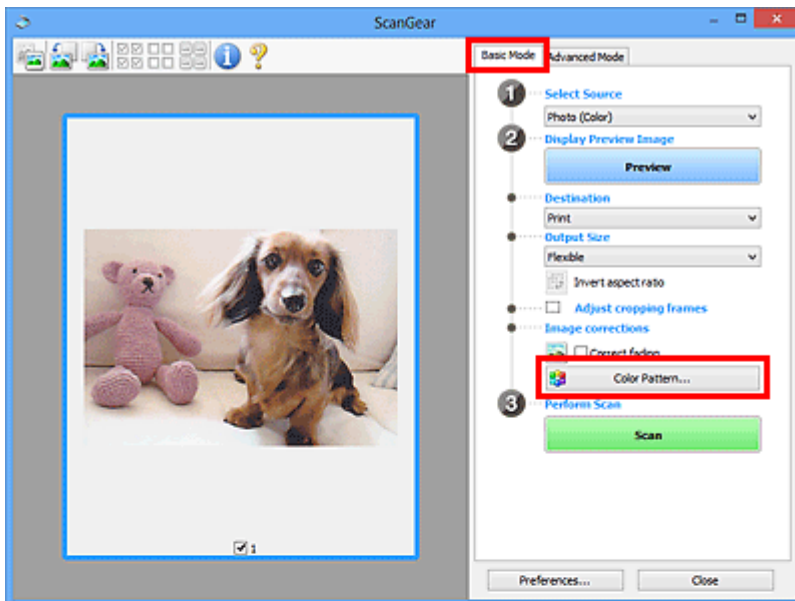

Color Adjustment

Correct colors that have faded with time or due to colorcast. "Colorcast" is a phenomenon where a specific color affects the entire picture due to the weather or ambient strong colors.

Click an arrow in **Color Adjustment** to emphasize the corresponding color.

Cyan & red, magenta & green, and yellow & blue are complementary color pairs (each pair produces a shade of gray when mixed). You can reproduce the natural colors of the scene by reducing the cast color and increasing the complementary color.

It is recommended that you find a portion in the image where it should be white, and adjust the colors so that the portion turns white.

Preview image appears in the center. Preview image colors change as you adjust them.

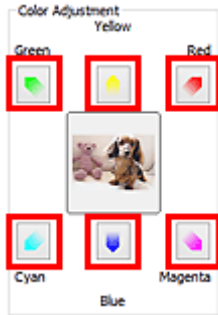

Below is an example of correcting a bluish image.

Since **Blue** and **Green** are too strong, click the **Yellow** and **Magenta** arrows to correct.



➤➤ **Note**

- Color adjustments are applied only to the cropping frames (scan areas) or the frame selected in thumbnail view.
- You can select multiple frames or cropping frames by clicking them while pressing the Ctrl key.
- You can also select a color tone from the color pattern displayed on the left of the **Color Pattern** screen.
- You can also use this function to add a specific tint to an image. Increase the magenta to add a warm tint, and increase the blue to add a cool tint.

Adjusting Saturation and Color Balance

You can brighten colors that have faded with time or due to colorcast by using  (Saturation/Color Balance) in ScanGear (scanner driver)'s **Advanced Mode** tab.

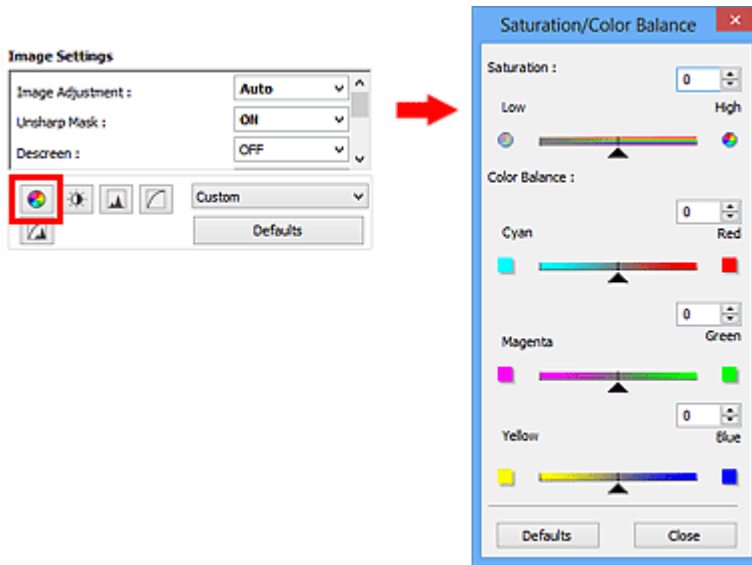

▶▶▶ Note

- Click **Defaults** to reset all adjustments in the current window.

Saturation

Adjust the image's saturation (vividness). You can brighten colors that have faded with time, etc.

Move ▲ (Slider) under **Saturation** to the left to decrease the saturation (darken the image), and to the right to increase the saturation (brighten the image). You can also enter a value (-127 to 127).



Saturation decreased	Original image	Saturation increased
		

▶▶▶ Note

- The natural color tone of the original image may be lost if you increase saturation too much.

Color Balance

Adjust images that have a colorcast. "Colorcast" is a phenomenon where a specific color affects the entire picture due to the weather or ambient strong colors.

Move ▲ (Slider) under **Color Balance** to the left or right to emphasize the corresponding color.

Cyan & Red

Magenta & Green

Yellow & Blue

These are complementary color pairs (each pair produces a shade of gray when mixed). You can reproduce the natural colors of the scene by reducing the cast color and increasing the complementary color.

It is usually difficult to correct the image completely by adjusting only one color pair. It is recommended that you find a portion in the image where it should be white, and adjust all three color pairs so that the portion turns white.

You can also enter a value (-127 to 127).

Below is an example of an image in which the "Cyan & Red" pair has been adjusted.

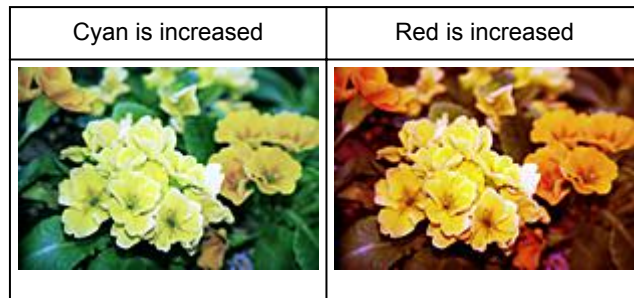

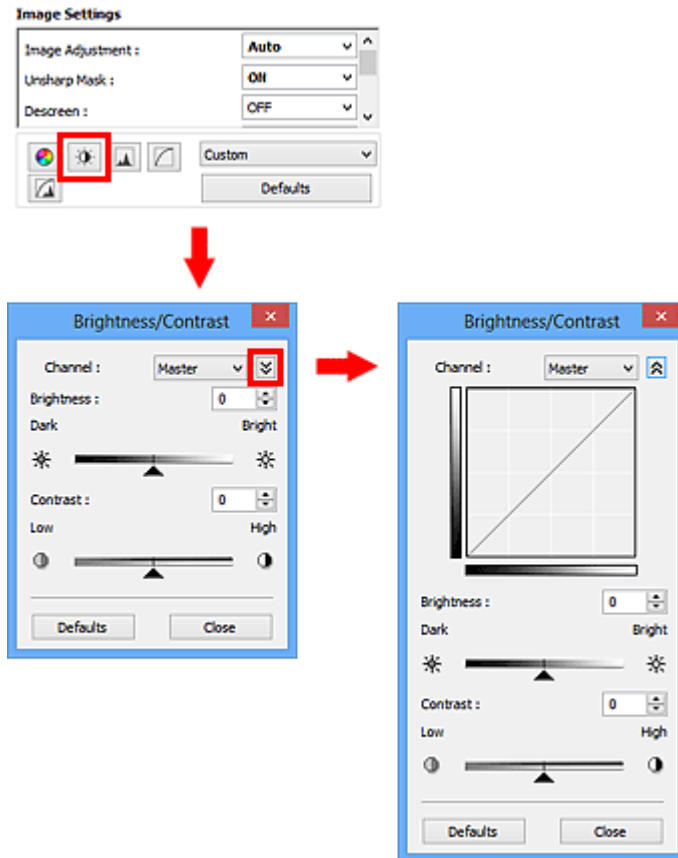

Adjusting Brightness and Contrast

You can adjust images that are too dark or bright, or too flat due to lack of contrast by using  (Brightness/Contrast) in ScanGear (scanner driver)'s **Advanced Mode** tab.



►► Note

- Click  (Down arrow) to switch to detailed view. Click  (Up arrow) to return to the previous view.
- Click **Defaults** to reset all adjustments in the current window.

Channel

Each dot of an image is a mixture of Red, Green, and Blue in various proportions (gradation). These colors can be adjusted individually as a "channel."

Master

Adjust the Red, Green, and Blue combined.

Red

Adjust the Red channel.

Green

Adjust the Green channel.

Blue

Adjust the Blue channel.

►► Note

- Only **Grayscale** will be displayed in **Channel** when **Color Mode** is **Grayscale**.

Brightness

Adjust the image brightness.

Move ▲ (Slider) under **Brightness** to the left to darken and right to brighten the image. You can also enter a value (-127 to 127).

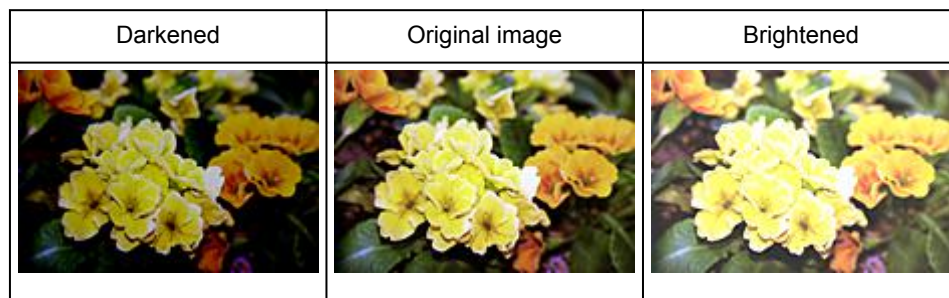

►► Note

- Highlights may be lost if you brighten the image too much, and shadows may be lost if you darken the image too much.

Contrast

"Contrast" is the degree of difference between the brighter and darker parts of an image. Increasing contrast will increase the difference, thus sharpening the image. Decreasing contrast will decrease the difference, thus softening the image.

Move ▲ (Slider) under **Contrast** to the left to decrease and right to increase the contrast of the image. You can also enter a value (-127 to 127).



►► Note

- Increasing the contrast is effective in adding a three-dimensional feel to soft images. However, shadows and highlights may be lost if you increase the contrast too much.

Adjusting Histogram

You can adjust the image color tone by using a graph (histogram) showing brightness distribution, via (Histogram) in ScanGear (scanner driver)'s **Advanced Mode** tab.

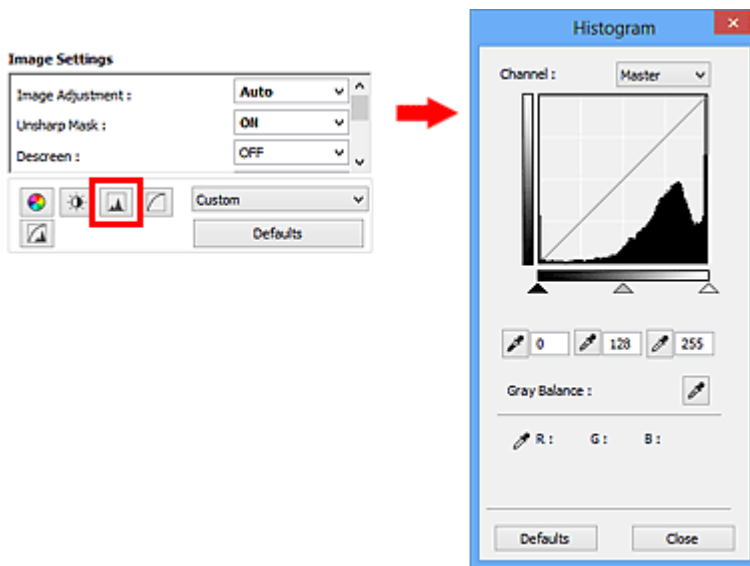

▶▶▶ Note

- Click **Defaults** to reset all adjustments in the current window.

Channel

Each dot of an image is a mixture of Red, Green, and Blue in various proportions (gradation). These colors can be adjusted individually as a "channel."

Master

Adjust the Red, Green, and Blue combined.

Red

Adjust the Red channel.

Green

Adjust the Green channel.

Blue

Adjust the Blue channel.

▶▶▶ Note

- Only **Grayscale** will be displayed in **Channel** when **Color Mode** is **Grayscale**.

Reading Histograms

You can see the histogram of a specified area for each **Channel**. The higher the histogram peak, the more data is distributed to that level.

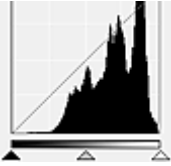
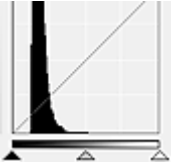
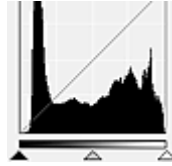

(1) Bright area	(2) Dark area	(3) Whole image
		
More data is distributed to the highlight side.	More data is distributed to the shadow side.	Data is widely distributed between the highlight and shadow.

Adjusting Histograms (Using the Slider)

Select a **Channel**, then move ▲ (Black-point Slider) or △ (White-point Slider) to specify the level to be set as the shadow or highlight.

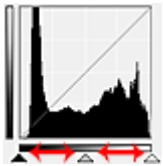

- All parts to the left of ▲ (Black-point Slider) will be black (level 0).
- The parts at △ (Mid-point Slider) will turn to the color exactly between the black-point and white-point.
- All parts to the right of △ (White-point Slider) will turn white (level 255).

When **Image Adjustment** is set to anything but **None**, the adjustments shown below are performed automatically.

Moving the Black-point and White-point Sliders

Move the Black-point Slider or White-point Slider to adjust brightness.

Images with more data distributed to the highlight side

Move the Black-point Slider toward the highlight side.

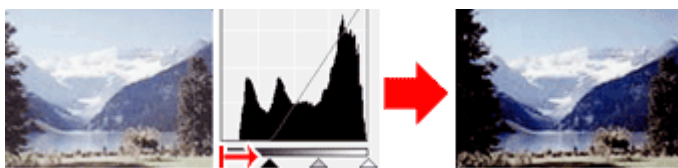

Images with more data distributed to the shadow side

Move the White-point Slider toward the shadow side.

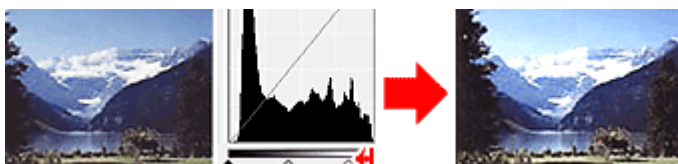

Images with widely distributed data

Move the Black-point Slider toward the highlight side, and White-point Slider toward the shadow side.

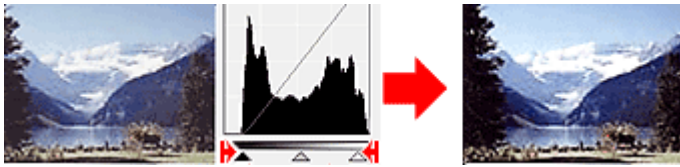

Moving the Mid-point Slider

Move the Mid-point Slider to specify the level to be set as the middle of the tonal range.

Images with more data distributed to the highlight side

Move the Mid-point Slider toward the highlight side.

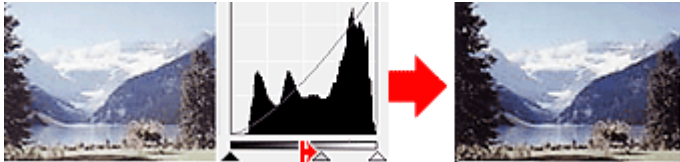

Images with more data distributed to the shadow side



Move the Mid-point Slider toward the shadow side.



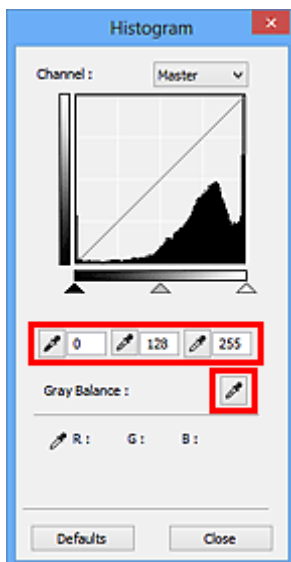

Adjusting Histograms (Using the Droppers)

When you select a **Channel** and click the Black-point, Mid-point, or White-point Dropper, the mouse pointer on the preview image changes to a dropper. Click a Dropper displayed below the histogram to change the setting.



- The point clicked with  (Black-point Dropper) will be the darkest point. You can also enter a value (0 to 245).
- The point clicked with  (Mid-point Dropper) will be the middle of the tonal range. You can also enter a value (5 to 250).

- The point clicked with  (White-point Dropper) will be the brightest point. You can also enter a value (10 to 255).
- Click  (Dropper) for **Gray Balance** and click the area you want to adjust the color in the preview image.

The clicked point will be set as the achromatic color reference, and the rest of the image is adjusted accordingly. For instance, if snow in a photo appears bluish, click the bluish part to adjust the whole image and reproduce natural colors.

Adjusting Tone Curve

You can adjust the brightness of an image by selecting the type of graph (tone curve) showing the balance of tone input and output, via  (Tone Curve Settings) in ScanGear (scanner driver)'s **Advanced Mode** tab.

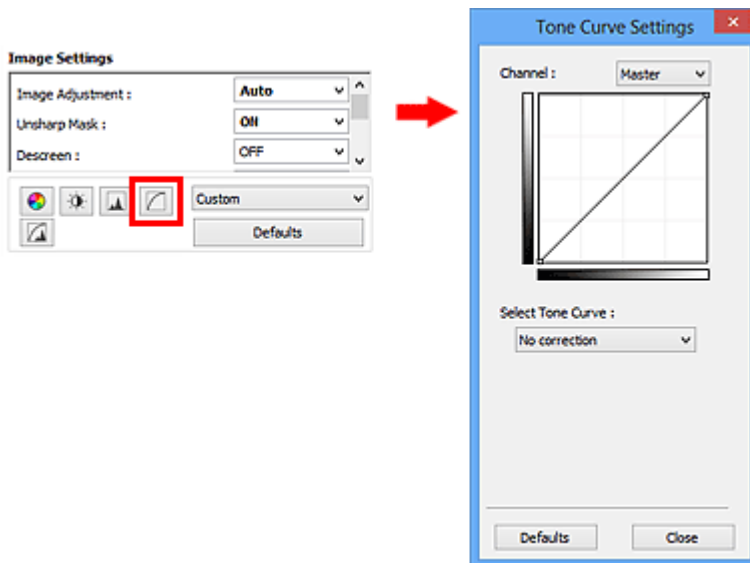

►► Note

- Click **Defaults** to reset all adjustments in the current window.

Channel

Each dot of an image is a mixture of Red, Green, and Blue in various proportions (gradation). These colors can be adjusted individually as a "channel."

Master

Adjust the Red, Green, and Blue combined.

Red

Adjust the Red channel.

Green

Adjust the Green channel.

Blue

Adjust the Blue channel.

►► Note

- Only **Grayscale** will be displayed in **Channel** when **Color Mode** is **Grayscale**.

Reading Tone Curves

With ScanGear, scanning images via a scanner is the input, and displaying to a monitor is the output. "Tone Curve" shows the balance of tone input and output for each **Channel**.

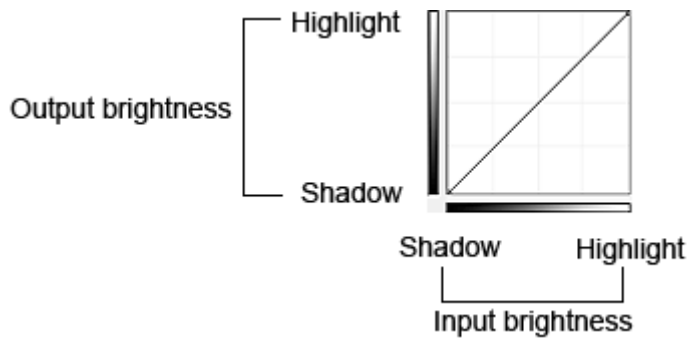

Adjusting Tone Curve

In **Select Tone Curve**, select a tone curve from **No correction**, **Overexposure**, **Underexposure**, **High contrast**, **Reverse the negative/positive image**, and **Edit custom curve**.

No correction (No adjustment)

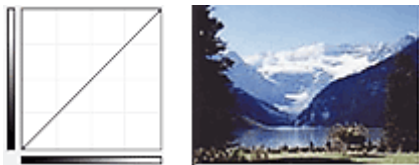

Overexposure (Convex curve)

The midtone data of the input side is stretched toward the highlight of the output side, resulting in a bright-toned image when viewed on a monitor.

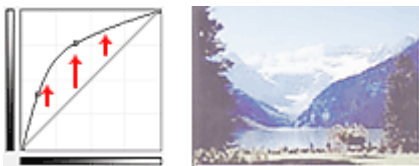

Underexposure (Concave curve)

The midtone data of the input side is stretched toward the shadow of the output side, resulting in a dark-toned image when viewed on a monitor.



High contrast (S curve)

The highlight and shadow of the input side are enhanced, resulting in a high-contrast image.

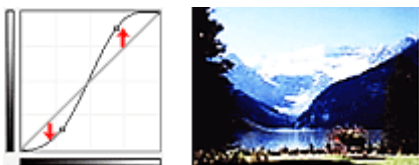

Reverse the negative/positive image (Downward-sloping line)

The input and output sides are reversed, resulting in a negative-positive inverted image.

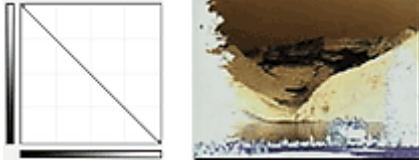

Edit custom curve

You can drag specific points on the Tone Curve to freely adjust the brightness of the corresponding areas.

Setting Threshold

You can sharpen text in a document or reduce show-through in newspapers by adjusting the threshold level via  (Threshold) in ScanGear (scanner driver)'s **Advanced Mode** tab.

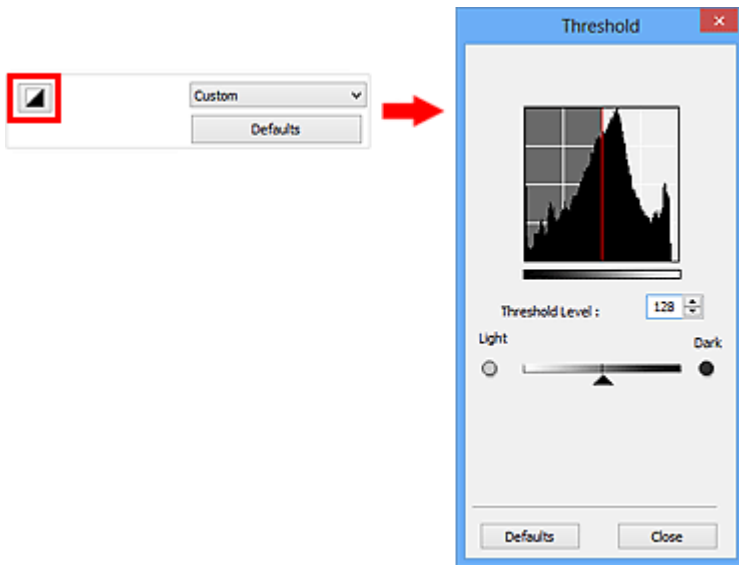

►► Note

- This function is available when **Color Mode** is **Black and White**.
- Click **Defaults** to reset all adjustments in the current window.

Adjusting Threshold

The brightness of color and grayscale images is expressed in a value between 0 and 255. However, in creating black and white images, all colors are mapped to either black (0) or white (255). "Threshold" is the borderline value that determines a color as black or white.

Move ▲ (Slider) to the right to increase the threshold value and thus increase the black areas. Move the slider to the left to decrease the value and thus increase the white areas. You can also enter a value (0 to 255).



ScanGear (Scanner Driver) Screens

- ▶ **Basic Mode Tab**
- ▶ **Advanced Mode Tab**
 - **Input Settings**
 - **Output Settings**
 - **Image Settings**
 - **Color Adjustment Buttons**
- ▶ **Preferences Dialog Box**
 - **Scanner Tab**
 - **Preview Tab**
 - **Scan Tab**
 - **Color Settings Tab**

Basic Mode Tab

This mode allows you to scan easily by following the on-screen steps.

This section describes the settings and functions available on the **Basic Mode** tab.

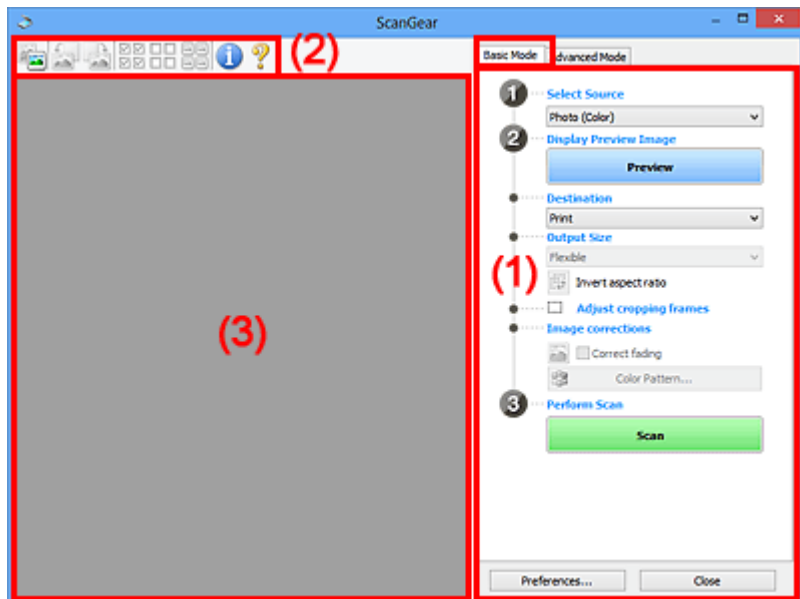

- [\(1\) Settings and Operation Buttons](#)
- [\(2\) Toolbar](#)
- [\(3\) Preview Area](#)

►►► Note

- The displayed items vary by document type and view.
- The preview function is not available when scanning from the ADF (Auto Document Feeder).

(1) Settings and Operation Buttons

Select Source

Photo (Color)

Scan color photos.

Magazine (Color)

Scan color magazines.

Document (Color)

Scan documents in color.

Document (Grayscale)

Scan documents in black and white.

Document (Color) ADF Simplex

Scan documents from the ADF in color.

Document (Grayscale) ADF Simplex

Scan documents from the ADF in black and white.

Document (Color) ADF Duplex (only for models supporting ADF duplex scanning)

Scan both sides of documents from the ADF in color.

Document (Grayscale) ADF Duplex (only for models supporting ADF duplex scanning)

Scan both sides of documents from the ADF in black and white.

»» Important

- Some applications do not support continuous scanning from the ADF. For details, refer to the application's manual.

»» Note

- When you select a document type, the unsharp mask function will be active.
- When you select an option other than the ADF types, the image adjustment function which adjusts images based on the document type will also be active.
- If you select **Magazine (Color)**, the descreen function will be active.

Display Preview Image

Preview

Performs a trial scan.

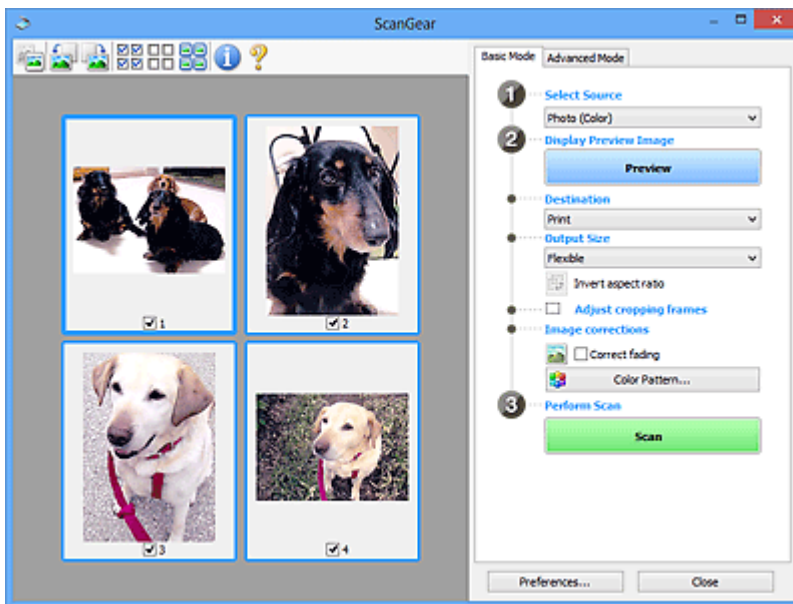

»» Note

- When using the machine for the first time, scanner calibration starts automatically. Wait a while until the preview image appears.

Destination

Select what you want to do with the scanned image.

Print

Select this to print the scanned image on a printer.

Image display

Select this to view the scanned image on a monitor.

OCR

Select this to use the scanned image with OCR software.

"OCR software" is software that converts text scanned as an image into text data that can be edited in word processors and other programs.

Output Size

Select an output size.

Output size options vary by the item selected in **Destination**.

Flexible

Allows you to freely adjust the cropping frames (scan areas).

In thumbnail view:

Drag the mouse over a thumbnail to display a cropping frame. When a cropping frame is displayed, the portion within the cropping frame will be scanned. When no cropping frame is displayed, each frame is scanned individually.

In whole image view:

When no cropping frame is displayed, the entire Preview area will be scanned. When a cropping frame is displayed, the portion within the cropping frame will be scanned.

Paper Size (L, A4, etc.)

Select an output paper size. The portion within the cropping frame will be scanned at the size of the selected paper size. You can drag the cropping frame to enlarge/reduce it while maintaining the aspect ratio.

Monitor Size (1024 x 768 pixels, etc.)

Select an output size in pixels. A cropping frame of the selected monitor size will be displayed and the portion within the cropping frame will be scanned. You can drag the cropping frame to enlarge/reduce it while maintaining the aspect ratio.

Add/Delete...

Opens the **Add/Delete the Output Size** dialog box, in which you can specify custom output sizes. You can select this option when **Destination** is **Print** or **Image display**.

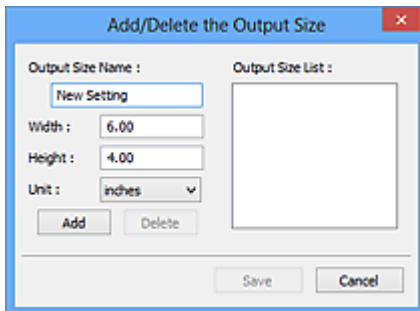

In the **Add/Delete the Output Size** dialog box, you can specify multiple output sizes and save them at one time. Saved items will be registered to the **Output Size** list and can be selected, along with the predefined items.

Adding:

Enter **Output Size Name**, **Width**, and **Height**, then click **Add**. For **Unit**, you can select **inches** or **mm** when **Destination** is **Print** but you can only select **pixels** when **Destination** is **Image display**. The name of the added size appears in **Output Size List**. Click **Save** to save the items listed in **Output Size List**.

Deleting:

Select the output size you want to delete in **Output Size List**, then click **Delete**. Click **Save** to save the items listed in **Output Size List**.

»» Important

- You cannot delete predefined output sizes such as **A4** and **1024 x 768 pixels**.

▶▶▶ Note

- Save up to 10 items.
- An error message appears when you enter a value outside the setting range. Enter a value within the setting range.

▶▶▶ Note

- For details on whether or how the cropping frame is initially displayed on a preview image, refer to **Cropping Frame on Previewed Images** in "[Preview Tab](#)" (**Preferences** dialog box).



Invert aspect ratio

Available when **Output Size** is set to anything but **Flexible**.

Click this button to rotate the cropping frame. Click again to return it to the original orientation.

Adjust cropping frames

You can adjust the scan area within the Preview area.

If an area is not specified, the document will be scanned at the document size (Auto Crop). If an area is specified, only the portion in the cropping frame will be scanned.

- [Adjusting Cropping Frames \(ScanGear\)](#)

Image corrections

Allows you to apply corrections to images.

▶▶▶ Important

- **Apply Auto Document Fix** and **Correct fading** are available when **Recommended** is selected on the **Color Settings** tab of the **Preferences** dialog box.

▶▶▶ Note

- Available functions vary by the document type selected in **Select Source**.

Apply Auto Document Fix

Sharpens text in a document or magazine for better readability.

▶▶▶ Important

- Scanning may take longer than usual when this checkbox is selected.
- The color tone may change from the source image due to corrections. In that case, deselect the checkbox and scan.
- Correction may not be applied properly if the scan area is too small.

Correct fading

Corrects and scans photos that have faded with time or have a colorcast.

Reduce gutter shadow

Corrects shadows that appear between pages when scanning open booklets.

▶▶▶ Important

- For precautions on using this function, refer to "[Gutter Shadow Correction](#)."

Color Pattern...

Allows you to adjust the image's overall color. You can correct colors that have faded due to colorcast, etc. and reproduce natural colors while previewing color changes.

- [Adjusting Colors Using a Color Pattern](#)

»» Important

- This setting is not available when you select **Color Matching** on the **Color Settings** tab of the **Preferences** dialog box.

Perform Scan

Scan

Starts scanning.

»» Note

- When scanning starts, the progress will be displayed. Click **Cancel** to cancel the scan.

Preferences...

Opens the [Preferences dialog box](#) in which you can make scan/preview settings.

Close

Closes ScanGear (scanner driver).

(2) Toolbar

You can adjust or rotate preview images. The buttons displayed on the Toolbar vary by view.

In thumbnail view:



In whole image view:

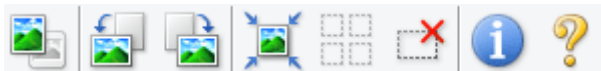

Switches the view in the Preview area.

■ (3) [Preview Area](#)



(Rotate Left)

Rotates the preview image 90 degrees counter-clockwise.

- The result will be reflected in the scanned image.
- The image returns to its original state when you preview again.



(Rotate Right)

Rotates the preview image 90 degrees clockwise.

- The result will be reflected in the scanned image.
- The image returns to its original state when you preview again.



(Auto Crop)

Displays and adjusts the cropping frame automatically to the size of the document displayed in the Preview area. The scan area is reduced every time you click this button if there are croppable areas within the cropping frame.



(Check All Frames)

Available when two or more frames are displayed.

Selects the checkboxes of the image in thumbnail view.



(Uncheck All Frames)

Available when two or more frames are displayed.

Deselects the checkboxes of the image in thumbnail view.



(Select All Frames)

Available when two or more frames are displayed.

Selects the images in thumbnail view and outlines them in blue.



(Select All Cropping Frames)

Available when two or more cropping frames are specified.

Turns the cropping frames into thick broken lines and applies the settings to all of them.



(Remove Cropping Frame)

Removes the selected cropping frame.



(Information)

Displays the version of ScanGear and the current scan settings (document type, etc.).



(Open Guide)

Opens this page.

(3) Preview Area



This is where a trial image appears after you click **Preview**. You can also check the results of the settings (image corrections, color adjustments, etc.) made in "[\(1\) Settings and Operation Buttons](#)."

When  (Thumbnail) is displayed on the Toolbar:

Cropping frames are specified according to the document size, and thumbnails of scanned images are displayed. Only the images with the checkbox selected will be scanned.



►► Note

- When multiple images are previewed, different outlines indicate different selection status.
 - Focus Frame (thick blue outline): The displayed settings will be applied.
 - Selected Frame (thin blue outline): The settings will be applied to the Focus Frame and Selected Frames simultaneously. You can select multiple images by clicking them while pressing the Ctrl key.
 - Unselected (no outline): The settings will not be applied.
- Double-click a frame to zoom in on the image. Click   (Frame Advance) at the bottom of the screen to display the previous or next frame. Double-click the frame again to return the display to its non-magnified state.

When (Whole Image) is displayed on the Toolbar:

Items on the Platen are scanned and displayed as a single image. All portions in the cropping frames will be scanned.



►► Note

- You can specify the cropping frame on the displayed image. In thumbnail view, you can only create one cropping frame per image. In whole image view, you can create multiple cropping frames.

■ [Adjusting Cropping Frames \(ScanGear\)](#)

Related Topic

■ [Scanning in Basic Mode](#)

Advanced Mode Tab

This mode allows you to make advanced scan settings such as the color mode, output resolution, image brightness, and color tone.

This section describes the settings and functions available on the **Advanced Mode** tab.

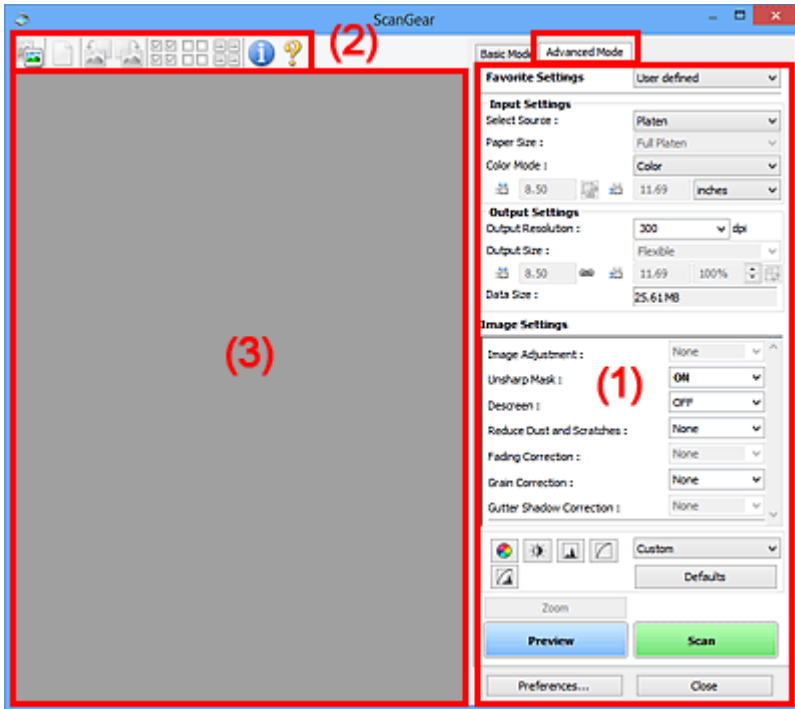

- (1) [Settings and Operation Buttons](#)
- (2) [Toolbar](#)
- (3) [Preview Area](#)

►►► Note

- The displayed items vary by document type and view.
- The preview function is not available when scanning from the ADF (Auto Document Feeder).

(1) Settings and Operation Buttons

Favorite Settings

You can name and save a group of settings (Input Settings, Output Settings, Image Settings, and Color Adjustment Buttons) on the **Advanced Mode** tab, and load it as required. It is convenient to save a group of settings if you will be using it repeatedly. You can also use this to reload the default settings.

Select **Add/Delete...** from the pull-down menu to open the **Add/Delete Favorite Settings** dialog box.

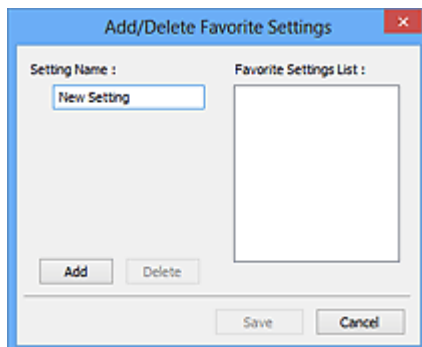

Enter **Setting Name** and click **Add**; the name appears in **Favorite Settings List**.

When you click **Save**, the item appears in the **Favorite Settings** list and can be selected, along with the predefined items.

To delete an item, select it in **Favorite Settings List** and click **Delete**. Click **Save** to save the settings displayed in **Favorite Settings List**.

»»» Note

- You can set **Add/Delete...** in **Favorite Settings** after preview.
- Save up to 10 items.

Input Settings

Specify the input settings such as the document type and size.

Output Settings

Specify the output settings such as the output resolution and size.

Image Settings

Enable/disable various image correction functions.

Color Adjustment Buttons

Fine corrections to the image brightness and color tones can be made including adjustments to the image's overall brightness or contrast and adjustments to its highlight and shadow values (histogram) or balance (tone curve).

Zoom

Zooms in on a frame, or zooms in on the image in the area specified with a cropping frame (scan area). When zoomed in, **Zoom** changes to **Undo**. Click **Undo** to return the display to its non-magnified state.

In thumbnail view:

When multiple images are displayed in thumbnail view, clicking this button zooms in on the selected frame. Click  (Frame Advance) at the bottom of the screen to display the previous or next frame.

»»» Note

- You can also zoom in on an image by double-clicking the frame. Double-click the frame again to return the display to its non-magnified state.

In whole image view:

Rescans the image in the area specified with a cropping frame at higher magnification.

»»» Note

- **Zoom** rescans the document and displays high-resolution image in Preview.
-  (Enlarge/Reduce) on the Toolbar zooms in on the preview image quickly. However, the resolution of the displayed image will be low.

Preview

Performs a trial scan.

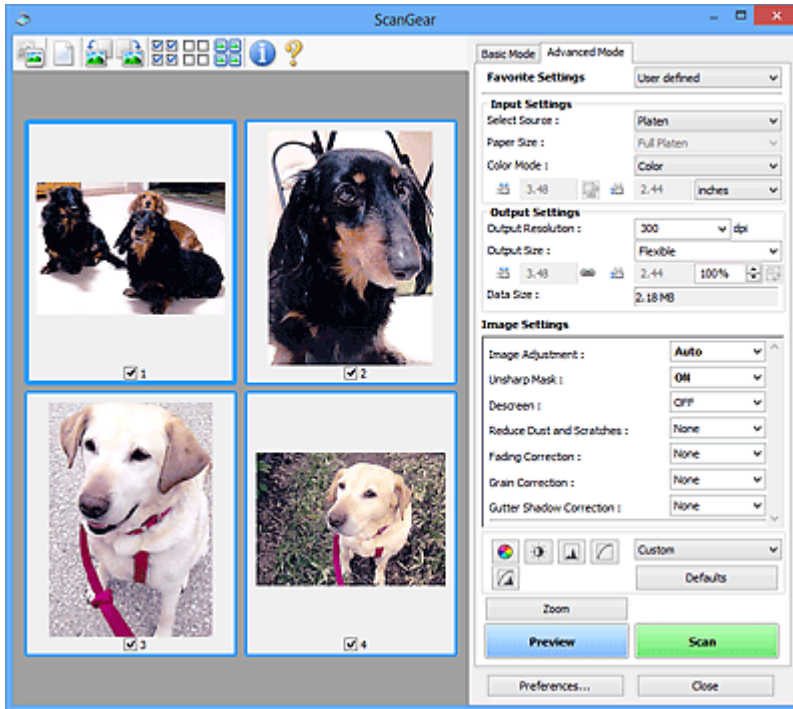

Scan

Starts scanning.

►►► Note

- When scanning starts, the progress will be displayed. Click **Cancel** to cancel the scan.
- When scanning is completed, a dialog box prompting you to select the next action may appear. Follow the prompt to complete. For details, refer to **Status of ScanGear dialog after scanning** in [Scan Tab \(Preferences dialog box\)](#).
- It will take time to process the images if the total size of the scanned images exceeds a certain size. In that case, a warning message appears; it is recommended that you reduce the total size. To continue, scan in whole image view.

Preferences...

Opens the [Preferences dialog box](#) in which you can make scan/preview settings.

Close

Closes ScanGear (scanner driver).

(2) Toolbar

You can adjust or rotate preview images. The buttons displayed on the Toolbar vary by view.

In thumbnail view:



In whole image view:



Switches the view in the Preview area.

■ (3) [Preview Area](#)



(Clear)

Deletes the preview image from the Preview area.

It also resets the Toolbar and color adjustment settings.



(Crop)

Allows you to specify the scan area by dragging the mouse.



(Move Image)

Allows you to drag the image until the part you want to see is displayed when an image enlarged in the Preview area does not fit in the screen. You can also move the image using the scroll bars.



(Enlarge/Reduce)

Allows you to zoom in on the Preview area by clicking the image. Right-click the image to zoom out.



(Rotate Left)

Rotates the preview image 90 degrees counter-clockwise.

- The result will be reflected in the scanned image.
- The image returns to its original state when you preview again.



(Rotate Right)

Rotates the preview image 90 degrees clockwise.

- The result will be reflected in the scanned image.
- The image returns to its original state when you preview again.



(Auto Crop)

Displays and adjusts the cropping frame automatically to the size of the document displayed in the Preview area. The scan area is reduced every time you click this button if there are croppable areas within the cropping frame.



(Check All Frames)

Available when two or more frames are displayed.

Selects the checkboxes of the image in thumbnail view.



(Uncheck All Frames)

Available when two or more frames are displayed.

Deselects the checkboxes of the image in thumbnail view.



(Select All Frames)

Available when two or more frames are displayed.

Selects the images in thumbnail view and outlines them in blue.



(Select All Cropping Frames)

Available when two or more cropping frames are specified.

Turns the cropping frames into thick broken lines and applies the settings to all of them.



(Remove Cropping Frame)

Removes the selected cropping frame.



(Information)

Displays the version of ScanGear and the current scan settings (document type, etc.).



(Open Guide)

Opens this page.

(3) Preview Area

This is where a trial image appears after you click **Preview**. You can also check the results of the settings (image corrections, color adjustments, etc.) made in "[\(1\) Settings and Operation Buttons.](#)"



When **(Thumbnail)** is displayed on the Toolbar:

Cropping frames are specified according to the document size, and thumbnails of scanned images are displayed. Only the images with the checkbox selected will be scanned.



▶▶▶ Note

- When multiple images are previewed, different outlines indicate different selection status.
 - Focus Frame (thick blue outline): The displayed settings will be applied.
 - Selected Frame (thin blue outline): The settings will be applied to the Focus Frame and Selected Frames simultaneously. You can select multiple images by clicking them while pressing the Ctrl key.
 - Unselected (no outline): The settings will not be applied.



When **(Whole Image)** is displayed on the Toolbar:

Items on the Platen are scanned and displayed as a single image. All portions in the cropping frames will be scanned.



▶▶ Note

- You can specify the cropping frame on the displayed image. In thumbnail view, you can only create one cropping frame per image. In whole image view, you can create multiple cropping frames.

■ [Adjusting Cropping Frames \(ScanGear\)](#)

Related Topic

■ [Scanning in Advanced Mode](#)

■ [Scanning Multiple Documents from the ADF \(Auto Document Feeder\) in Advanced Mode](#)

Input Settings

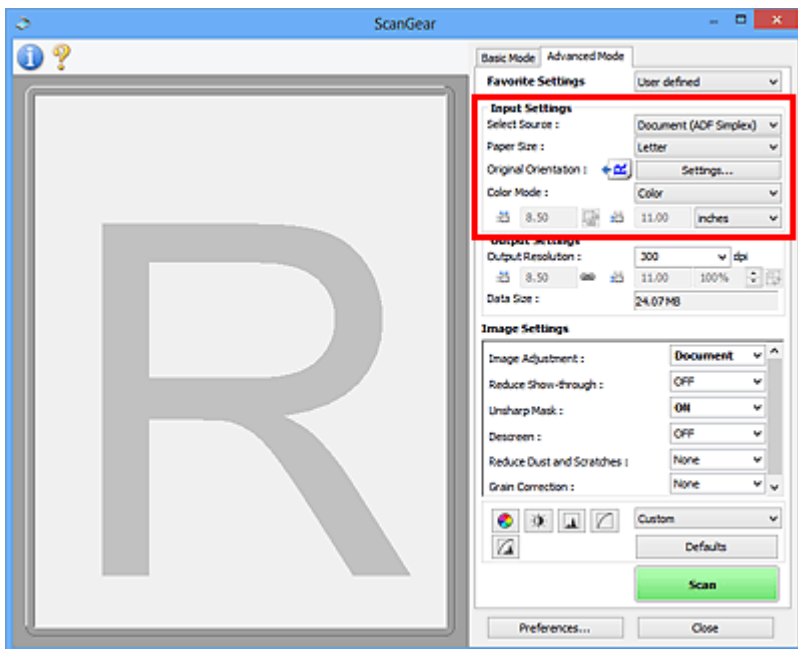

Input Settings allows you to set the following items:

Select Source

The type of document to be scanned is displayed. To scan from the Platen, select **Platen**; to scan from the ADF (Auto Document Feeder), select **Document (ADF Simplex)** or **Document (ADF Duplex)**.

►►► Important

- Some applications do not support continuous scanning from the ADF. For details, refer to the application's manual.

►►► Note

- You can select **Document (ADF Duplex)** when using a model supporting ADF duplex scanning.

Paper Size

Select the size of the document to be scanned. This setting is available in whole image view only.



When scanning both sides of the documents automatically from the ADF, select **A4** or **Letter**.

When you select a size, the Preview area size changes accordingly.

►►► Important

- Some applications have a limit to the amount of scan data they can receive. Available scan range is as follows.
 - 21000 pixels x 30000 pixels or less
- If you change **Paper Size** after previewing, the preview image will be deleted.

►►► Note

- If you are not sure which size you should select for **Paper Size**, set **Paper Size** to **Full Platen**, then measure the size of the document and enter the values into  (Width) and  (Height).

Original Orientation

Set the orientation and stapling side of the documents to scan from the ADF.

Click **Settings...** to open the **Orientation** dialog box.

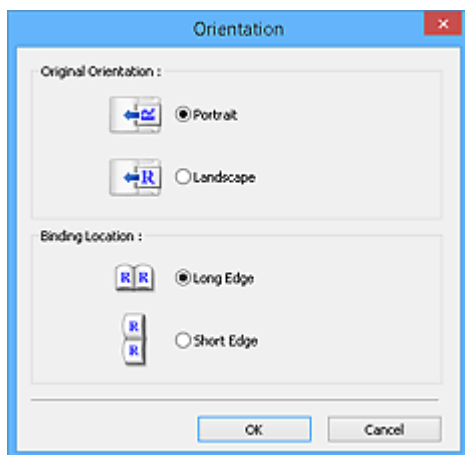

»» Important

- The **Orientation** dialog box can only be opened when **Select Source** is **Document (ADF Simplex)** or **Document (ADF Duplex)**.
- **Binding Location** is displayed when using a model supporting ADF duplex scanning.
- **Binding Location** cannot be specified when **Select Source** is **Document (ADF Simplex)**.

Color Mode

Select how to scan the document.

Color

Select this mode to scan color documents or to create color images. This mode renders the image in 256 levels (8 bit) of R(ed), G(reen), and B(lue).

Grayscale

Select this mode to scan black and white photos or to create black and white images. This mode renders the image in 256 levels (8 bit) of black and white.

Black and White



Select this mode to scan photos and documents in black and white. This mode renders the image in black and white. The contrast in the image is divided at certain levels (threshold level) into black and white and is rendered in two colors. The threshold level can be set with  (Threshold).

Input Size

In thumbnail view, the cropped document size is displayed after preview.

In whole image view, the **Paper Size** is displayed before preview, and the cropping frame (scan area) size is displayed after preview.

You can adjust the cropping frame size by entering the values into  (Width) and  (Height).

Click  (Change Aspect Ratio) and change it to  (Keep Aspect Ratio) to maintain the aspect ratio when you specify the cropping frame size.

»» Important

- Input size settings are available only when **Output Size** in **Output Settings** is **Flexible**. If you select a size other than **Flexible**, a cropping frame calculated from **Output Size** and **Output Resolution** is displayed, and its aspect ratio is fixed.

»» Note

- The values you can enter will be within the range of the selected document size. The minimum size is 96 pixels x 96 pixels when **Output Resolution** is 600 dpi, scaled at 100 %.
- When Auto Crop is performed in whole image view, the aspect ratio will not be maintained since the size will be prioritized.
- Refer to "[Adjusting Cropping Frames \(ScanGear\)](#)" for details on cropping frames.

Output Settings

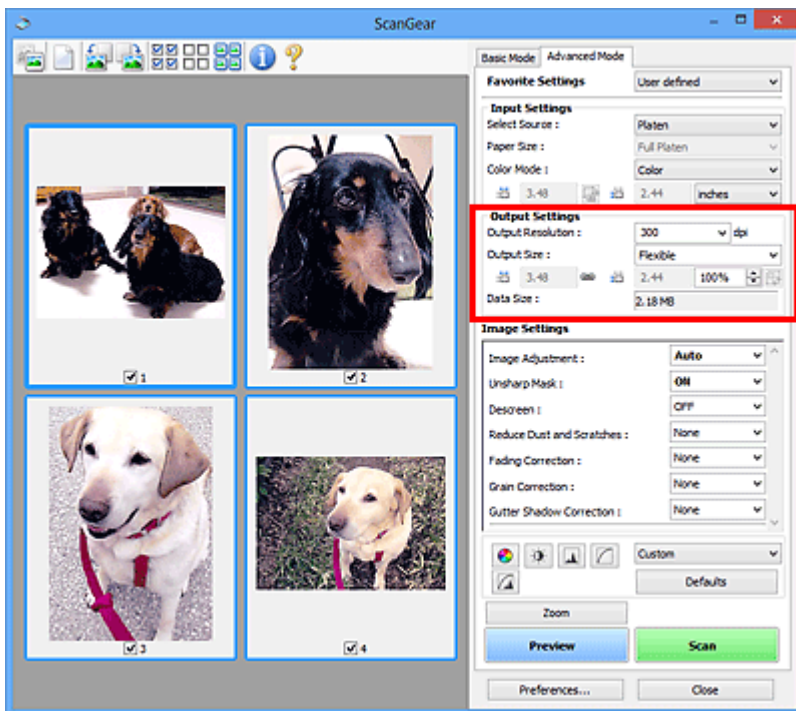

Output Settings allows you to set the following items:

Output Resolution

Select the resolution to scan at.

The higher the resolution (value), the more detail in your image.

Select a resolution from the options displayed by clicking the button, or enter a value in 1 dpi increments.

Refer to "Resolution" for your model from Home of the *Online Manual* for details.

When Select Source is Platen:

You can enter a value within the range of 25 dpi to 19200 dpi.

When Select Source is Document (ADF Simplex) or Document (ADF Duplex):

You can enter a value within the range of 25 dpi to 600 dpi.

Output Size

Select an output size.

Select **Flexible** to set custom sizes or select a size for printing or displaying. Select **Add/Delete...** to set custom size and save it as a new output size option.

Flexible

You can specify the output resolution and scale, and adjust the cropping frames (scan areas).



In thumbnail view:

Drag the mouse over a thumbnail to display a cropping frame. When a cropping frame is displayed, the portion within the cropping frame will be scanned. When no cropping frame is displayed, each frame is scanned individually.



In whole image view:

When no cropping frame is displayed, the entire Preview area will be scanned. When a cropping frame is displayed, the portion within the cropping frame will be scanned.

➤➤➤ Note

- To enlarge/reduce the scanned image, enter values into  (Width) and  (Height) in **Output Settings** or specify a value (by 1 %) for %. Although the maximum value available for % depends on the **Output Resolution**, it can be specified for up to 19200 dpi (the maximum available output resolution).

Paper Size (L, A4, etc.) & Monitor Size (1024 x 768 pixels, etc.)

 (Width),  (Height), and scale cannot be specified. The preview image will be cropped according to the selected output size and resolution. The portion within the cropping frame will be scanned at the size of the selected paper/monitor size. You can drag the cropping frame to enlarge, reduce, or move it while maintaining the aspect ratio.

Add/Delete...

Opens the **Add/Delete the Output Size** dialog box, in which you can specify custom output sizes.

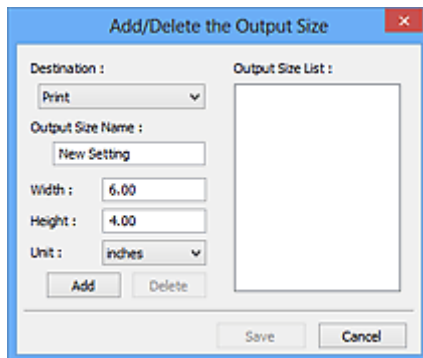

In the **Add/Delete the Output Size** dialog box, you can specify multiple output sizes and save them at one time. Saved items will be registered to the **Output Size** list and can be selected, along with the predefined items.

Adding:

Select **Print** or **Image display** for **Destination**, then enter **Output Size Name**, **Width**, and **Height**, then click **Add**. For **Unit**, you can select **inches** or **mm** when **Destination** is **Print** but you can only select **pixels** when **Destination** is **Image display**. The name of the added size appears in **Output Size List**. Click **Save** to save the items listed in **Output Size List**.

Deleting:

Select the output size you want to delete in **Output Size List**, then click **Delete**. Click **Save** to save the items listed in **Output Size List**.

➤➤➤ Important

- You cannot delete predefined output sizes such as **A4** and **1024 x 768 pixels**.

➤➤➤ Note

- Save up to 10 items for each destination.
- An error message appears when you enter a value outside the setting range. Enter a value within the range displayed in the message.

»» Note

- Refer to "[Adjusting Cropping Frames \(ScanGear\)](#)" for details on cropping frames.
- For details on whether or how the cropping frame is initially displayed on a preview image, refer to **Cropping Frame on Previewed Images** in "[Preview Tab](#)" (**Preferences** dialog box).



(Switch Aspect Ratio)

Available when **Output Size** is set to anything but **Flexible**.

Click this button to rotate the cropping frame. Click again to return it to the original orientation.

Data Size

The data size when scanned with the current settings is displayed.

»» Note

- When the data size exceeds a certain size, the value appears in red. In that case, a warning message appears when you click **Scan**. It is recommended that you adjust the settings to reduce **Data Size**. To continue, scan in whole image view.

Image Settings

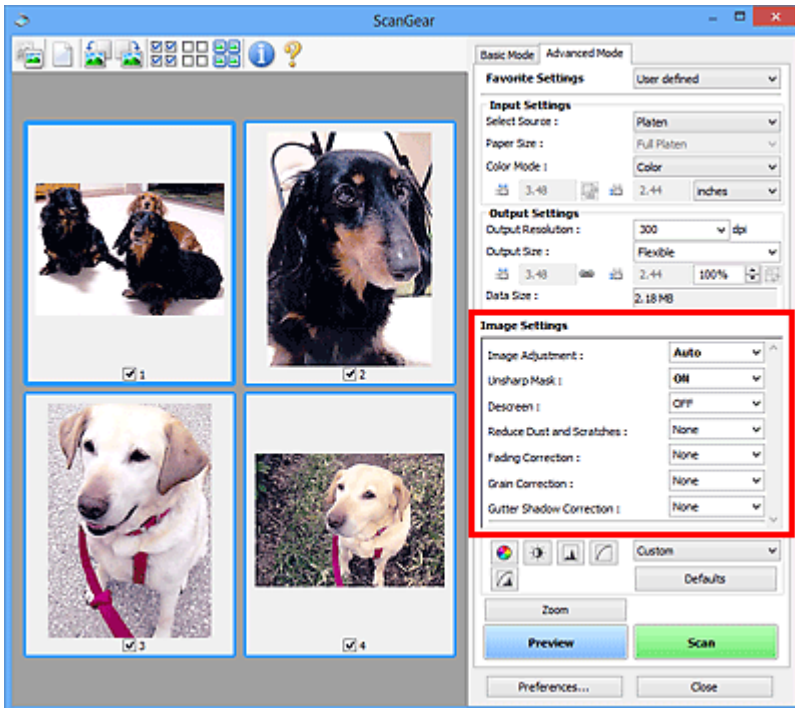

►►► Important

- Do not apply these functions to images without moire, dust/scratches, or faded colors. The color tone may be adversely affected.
- Image correction results may not be reflected in the preview image.

►►► Note

- Selectable settings depend on **Color Mode** settings.
- Scanning may take longer than usual when you use **Image Settings**.

Image Settings allows you to set the following items:

Image Adjustment

When Image Adjustment is set, the brightness of the specified portion of the image is optimized. Images can be adjusted according to the automatically detected document type or the specified document type. The result of the adjustment will be reflected in the entire image.

None

Image Adjustment will not be applied.

Auto

Applies Image Adjustment by automatically detecting the document type. It is recommended that you normally select this setting.

Photo

Applies Image Adjustment suitable for photos.

Magazine

Applies Image Adjustment suitable for magazines.

Document

Applies Image Adjustment suitable for text documents.

►►► Important

- You can set **Image Adjustment** after preview.

- You can set this setting when **Recommended** is selected on the **Color Settings** tab of the **Preferences** dialog box.

▶▶▶ Note

- If the image is not adjusted properly with **Auto**, specify the document type.
- The color tone may change from the source image due to the Image Adjustment. In that case, set **Image Adjustment** to **None**.

Reduce Show-through

Use this function to reduce show-through in duplex documents or lighten the base color in recycled paper and other colored paper when scanning documents.

OFF

Show-through will not be reduced.

ON

Select this to reduce show-through in duplex documents or lighten the base color. It is recommended that you normally select this setting.

▶▶▶ Important

- **Reduce Show-through** can be set when **Recommended** is selected on the **Color Settings** tab of the **Preferences** dialog box and **Document** or **Magazine** is selected for **Image Adjustment**.

Unsharp Mask

Emphasizes the outline of the subjects to sharpen the image when scanning photos.

OFF

Unsharp Mask will not be applied.

ON

Emphasizes the outline of the subjects to sharpen the image. It is recommended that you normally select this setting.

Descreen

Printed photos and pictures are displayed as a collection of fine dots. "Moire" is a phenomenon where uneven gradation or a stripe pattern appears when such photos or pictures printed with fine dots are scanned. **Descreen** is the function for reducing this moire effect.

OFF

Moire will not be reduced.

ON

Reduces moire. It is recommended that you normally select this setting.

▶▶▶ Note

- Even if **Descreen** is set to **ON**, some moire effects may remain if **Unsharp Mask** is set to **ON**. In that case, set **Unsharp Mask** to **OFF**.

Reduce Dust and Scratches

Scanned photos may contain white dots caused by dust or scratches. Use this function to reduce such noise.

None

Dust and scratches will not be reduced.

Low

Select this to reduce small dust particles and scratches. Large ones may remain.

Medium

It is recommended that you normally select this setting.

High

Select this to reduce large dust particles and scratches; however, evidence of the reduction process may remain or delicate parts of the image may be removed.

»» Important

- This function may not be effective for some types of photos.

»» Note

- It is recommended that you select **None** when scanning printed materials.

Fading Correction

Use this function to correct photos that have faded with time or have a colorcast. "Colorcast" is a phenomenon where a specific color affects the entire picture due to the weather or ambient strong colors.

None

Fading Correction will not be applied.

Low

Select this to correct a small amount of fading and colorcast.

Medium

It is recommended that you normally select this setting.

High

Select this to correct a large amount of fading and colorcast. This can affect the tone of the image.

»» Important

- You can set **Fading Correction** after preview.
- You can set this setting when **Recommended** is selected on the **Color Settings** tab of the **Preferences** dialog box.
- Correction may not be applied properly if the scan area is too small.

Grain Correction

Use this function to reduce graininess (roughness) in photos taken with high-speed or sensitized film.

None

Graininess will not be reduced.

Low

Select this when the photo is slightly grainy.

Medium

It is recommended that you normally select this setting.

High

Select this when the photo is very grainy. This can affect the gradation and sharpness of the image.

»» Important

- Correction may not be applied properly if the scan area is too small.

Gutter Shadow Correction

Use this function to correct shadows that appear between pages when scanning open booklets.

When you set the **Gutter Shadow Correction** setting in the preview image, the result will be reflected. Preview the effects before scanning, as results vary depending on the type of document and how it is pressed.

Unclear or blurred text/lines caused by curved pages are not corrected.

None

Gutter shadow will not be corrected.

Low

Select this when the effect level is too strong with the medium setting.

Medium

It is recommended that you normally select this setting.

High

Select this when the effect level is too weak with the medium setting.

»» Important

- You can set **Gutter Shadow Correction** after preview.
- Do not place objects that weigh 4.4 lbs (2.0 kg) or more on the platen. Also, do not press on the document with a force exceeding 4.4 lbs (2.0 kg). If you press heavily, the scanner may not work correctly or you might break the glass.
- Align the document with the edge of the Platen. If not, the shadow will not be corrected properly.



- Shadows may not be corrected properly depending on the document. If the page background is not white, shadows may not be detected correctly or may not be detected at all.
- While scanning, press down on the spine with the same amount of pressure you used to preview the scan. If the binding part is not even, the shadow will not be corrected properly.



- How to place the document depends on your model and the document to be scanned.

»» Note

- Cover the document with black cloth if white spots, streaks, or colored patterns appear in scan results due to ambient light entering between the document and the Platen.
- If the shadow is not corrected properly, adjust the cropping frame (scan area) on the preview image.

Color Adjustment Buttons

The Color Adjustment Buttons allow you to make fine corrections to the image brightness and color tones including adjustments to the image's overall brightness or contrast and adjustments to its highlight and shadow values (histogram) or balance (tone curve).

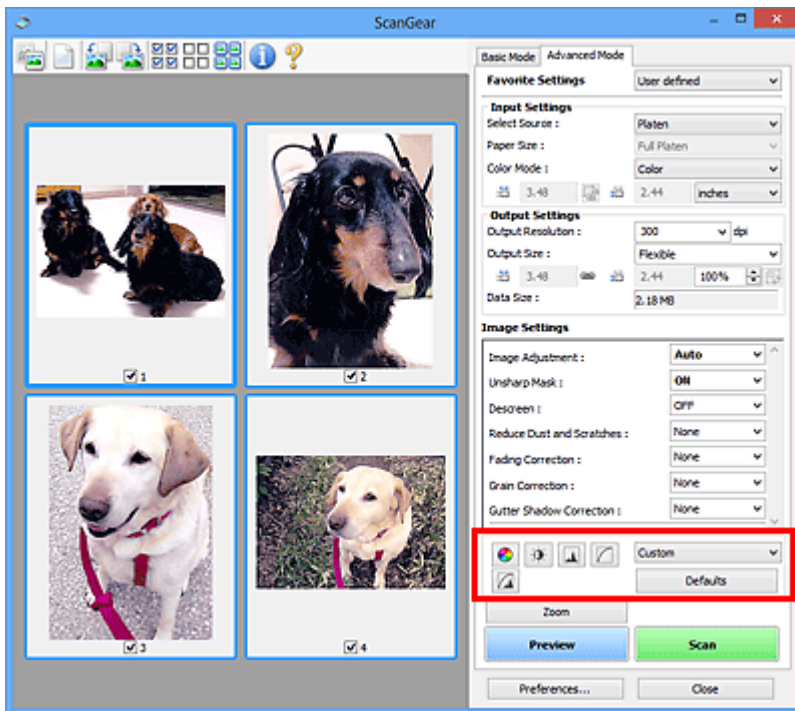

►►► Important

- The Color Adjustment Buttons are not available when you select **Color Matching** on the **Color Settings** tab of the **Preferences** dialog box.

►►► Note

- Selectable settings depend on **Color Mode** settings.
- When you adjust the image via the Color Adjustment Buttons, the results will be reflected in the preview image.

Click a Color Adjustment Button to set the following items:



(Saturation/Color Balance)

Adjust the saturation (vividness) and color tone of the image. Use this function to brighten colors that have faded with time or due to colorcast. "Colorcast" is a phenomenon where a specific color affects the entire picture due to the weather or ambient strong colors.

■ [Adjusting Saturation and Color Balance](#)



(Brightness/Contrast)

Adjust the brightness and contrast of the image. If the image is too dark or too bright, or if the image quality is flat due to lack of contrast, you can adjust the levels of brightness and contrast.

■ [Adjusting Brightness and Contrast](#)



(Histogram)

A histogram allows you to see the data concentration at each brightness level of an image. You can specify the brightest level (highlight) and darkest level (shadow) within an image, cut the levels and expand the middle of the tonal range of the image.

■ [Adjusting Histogram](#)



(Tone Curve Settings)

Adjust the brightness of an image by selecting the type of graph (tone curve) showing the balance of tone input and output. You can make fine adjustments to the brightness of a specific area.

■ [Adjusting Tone Curve](#)



(Final Review)

Make a final check of color adjustments. The final synthesized tone curve and the histogram derived from the subsequent image processing will be displayed. There are no settings to make in this screen.

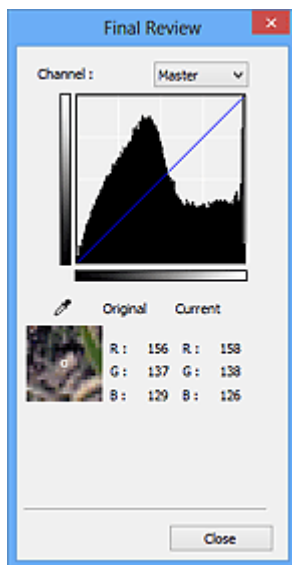

- For a color image, select a color in **Channel** to check either **Red**, **Green**, or **Blue**, or select **Master** to check three colors together.
- If you place the cursor on the preview image, the portion will be enlarged and its RGB values (only L when **Color Mode** is **Grayscale**) before and after the adjustments will be displayed.



(Threshold)

Set the boundary (threshold) at which black and white are divided. By adjusting the threshold level, you can sharpen text in a document or reduce show-through in newspapers.

■ [Setting Threshold](#)

Custom

You can name and save a set of tone curve and threshold settings of the Color Adjustment Buttons.

Select **Add/Delete...** from the pull-down menu; when **Color Mode** is set to anything but **Black and White**, the **Add/Delete Tone Curve Settings** dialog box opens; when **Color Mode** is **Black and White**, the **Add/Delete Threshold Settings** dialog box opens.

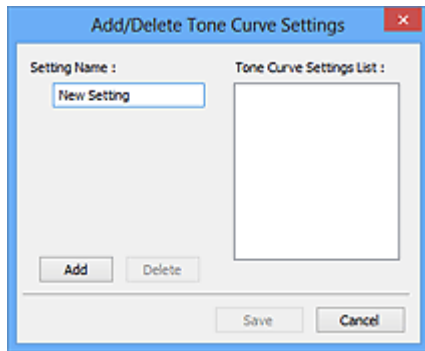

Enter **Setting Name** and click **Add**; the name appears in **Tone Curve Settings List** or **Threshold Settings List**. Click **Save** to save.

To delete an item, select it in **Tone Curve Settings List** or **Threshold Settings List** and click **Delete**. Click **Save** to save the settings displayed in **Tone Curve Settings List** or **Threshold Settings List**.

You can load and apply the saved tone curve/threshold settings to a preview image. To load the settings, select the saved item from the pull-down menu.

►►► Note

- Save up to 20 items.

Defaults

Reset all adjustments (saturation/color balance, brightness/contrast, histogram, and tone curve).

Preferences Dialog Box

In the **Preferences** dialog box, you can make advanced settings to ScanGear (scanner driver) functions via the **Scanner**, **Preview**, **Scan**, and **Color Settings** tabs.

Click **Preferences...** in the ScanGear screen to open the **Preferences** dialog box.

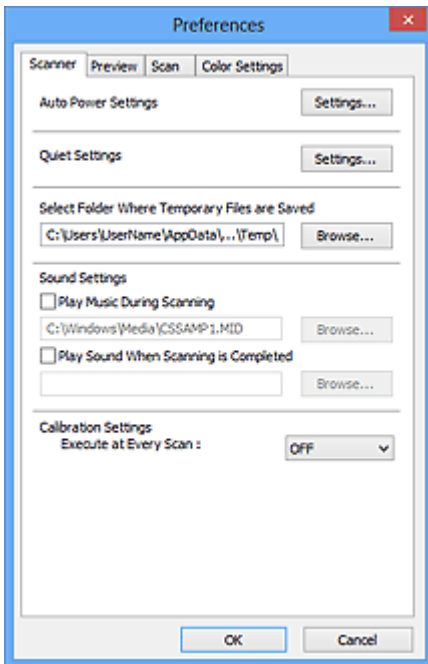

Scanner Tab

Allows you to set the quiet mode, specify the folder in which to save images temporarily, and set the music file to play during or at the end of a scan.

Preview Tab

Allows you to select what to do with Preview when ScanGear is started, how to display cropping frames after previewing images, and the cropping size for thumbnails of scanned documents.

Scan Tab

Allows you to select what to do with ScanGear after scanning image.

Color Settings Tab

Allows you to select how to adjust color, and specify the monitor gamma value.

Scanner Tab

On the **Scanner** tab, you can specify the following settings.

»» Important

- Available functions and settings vary depending on your scanner or printer.

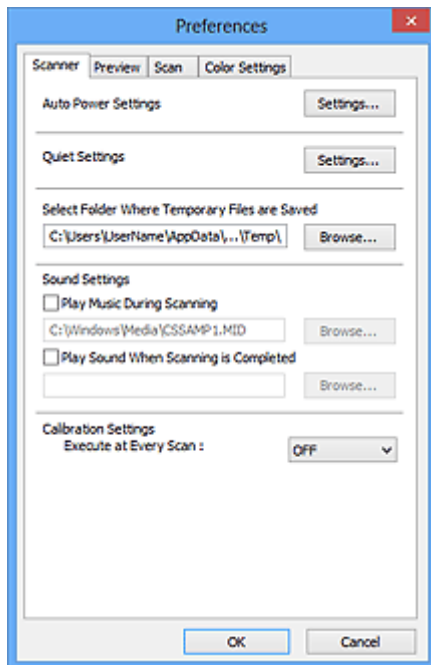

Auto Power Settings

You can set to turn the machine on or off automatically.

Click **Settings...** to display the **Auto Power Settings** dialog box.

»» Note

- If the machine is off or bi-directional communication is disabled, a message may appear because the computer cannot collect the machine status. In that case, click **OK** to exit ScanGear (scanner driver).

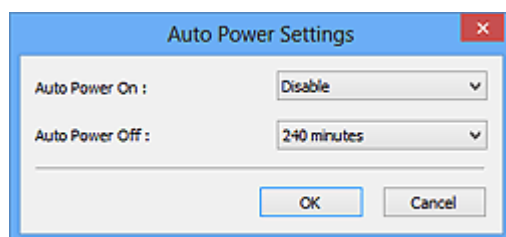

Auto Power On

Select **Enable** to turn on the machine automatically when data is received.

Auto Power Off

Specify the amount of time you want to set from the list. When this time lapses without any data being received, the machine turns off automatically.

»» Important

- When using a network compatible model by connecting to a network, the power does not turn off automatically even if **Auto Power Off** is set.

Quiet Settings

The silent function allows you to reduce the operating noise of this machine. Use this when you wish to reduce the operating noise such as when scanning or printing at night.

Click **Settings...** to set the quiet mode.

►►► Note

- You can set the quiet mode from the operation panel of the machine, the printer driver, or ScanGear.
- No matter how the setting is made, it applies to operations from the operation panel of the machine or when printing/scanning from a computer, etc.
- Scanning or printing may take longer than usual when this function is used.

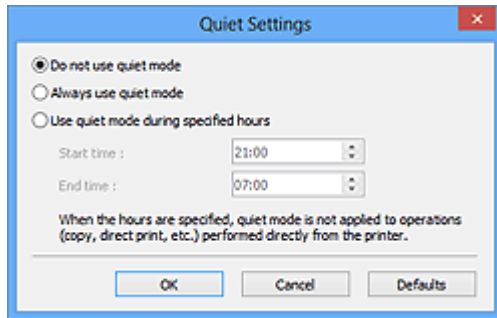

Do not use quiet mode

Select this option when you wish to use the machine with volume of normal operating noise.

Always use quiet mode

Select this option when you wish to reduce the operating noise of the machine.

Use quiet mode during specified hours

Select this option when you wish to reduce the operating noise of the machine during a specified period of time.

Set the **Start time** and **End time** during which quiet mode is to be activated.

►►► Important

- The time specified in **Start time** and in **End time** must be different.
- If your scanner or printer does not support fax functions, quiet mode is not applied to operations (copy, direct print, etc.) performed directly from the machine even if the hours are specified.

Select Folder Where Temporary Files are Saved

Displays the folder in which to save images temporarily. To change the folder, click **Browse...** to specify another one.

Sound Settings

You can set the machine to play music during/at the end of a scan.

Select the **Play Music During Scanning** or **Play Sound When Scanning is Completed** checkbox, then click **Browse...** and specify a sound file.

You can specify the following files.

- MIDI file (*.mid, *.rmi, *.midi)
- Audio file (*.wav, *.aif, *.aiff)
- MP3 file (*.mp3)

Calibration Settings

When you set **Execute at Every Scan** to **ON**, the scanner will be calibrated every time before previewing and scanning, to reproduce correct color tones in scanned images.

▶▶ Note

- Even when **Execute at Every Scan** is set to **OFF**, the scanner may be calibrated automatically in some cases (such as immediately after you turn the machine on).
- Calibration may take time depending on your computer.

Preview Tab

On the **Preview** tab, you can specify the following settings.

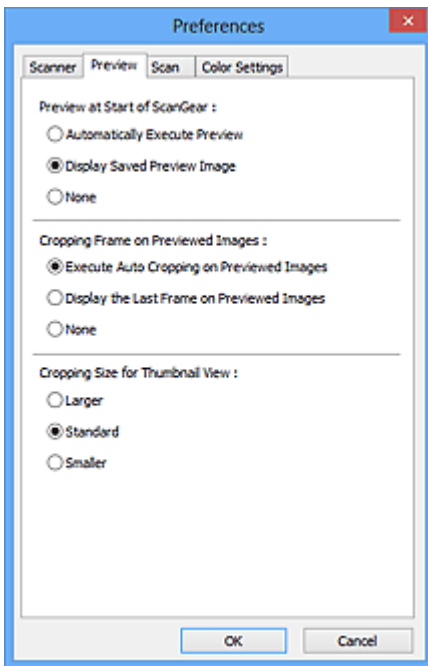

Preview at Start of ScanGear

Select what to do with Preview when ScanGear (scanner driver) is started.

Automatically Execute Preview

ScanGear will automatically start previewing at startup.

Display Saved Preview Image

The previously previewed image will be displayed.

The Color Adjustment Button settings, the Toolbar settings, and the **Advanced Mode** tab settings are also saved.

None

No preview image will be displayed at startup.

►►► Note

- Select **None** if you do not want to save the preview image.

Cropping Frame on Previewed Images

Select how to display cropping frames after previewing images.

Execute Auto Cropping on Previewed Images

The cropping frame (scan area) will automatically be displayed in the document size after previewing.

Display the Last Frame on Previewed Images

A cropping frame of the same size as the last used cropping frame will be displayed after previewing.

None

No cropping frame will be displayed after previewing.

Cropping Size for Thumbnail View

Select the cropping size for thumbnails of scanned documents.

Larger

Displays 105 % (in width and height) of the area displayed for the standard size.

Standard

The standard size.

Smaller

Displays 95 % (in width and height) of the area displayed for the standard size.

►► Note

- When you change the **Cropping Size for Thumbnail View** setting, the preview images will be refreshed and cropped to the new size. As the preview images are refreshed, the color adjustments and other settings applied to them are reset.

Scan Tab

On the **Scan** tab, you can specify the following settings.

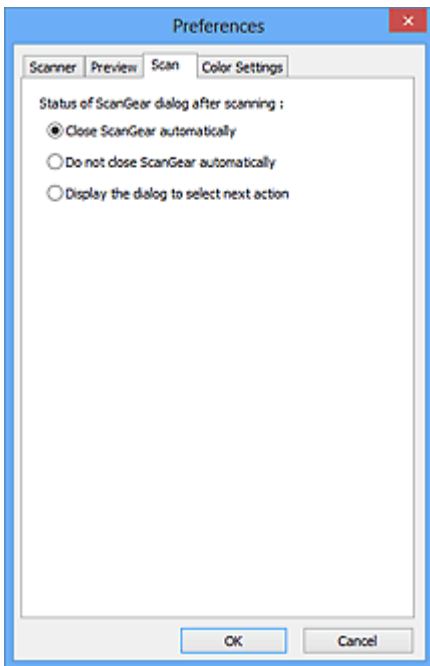

Status of ScanGear dialog after scanning

Select what to do with ScanGear (scanner driver) after scanning images.

Close ScanGear automatically

Select this to return to the original application when scanning is completed.

Do not close ScanGear automatically

Select this to return to the ScanGear screen for another scan when scanning is completed.

Display the dialog to select next action

Select this to open a screen and select what to do when scanning is completed.

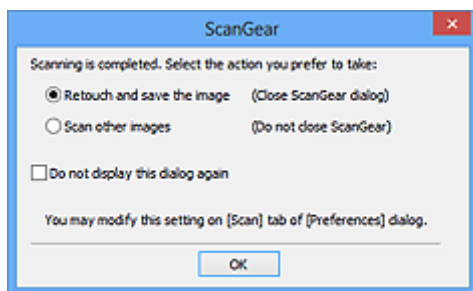

▶▶▶ Note

- Even if **Do not close ScanGear automatically** or **Display the dialog to select next action** is set, some applications may not support it.

Color Settings Tab

On the **Color Settings** tab, you can specify the following settings.

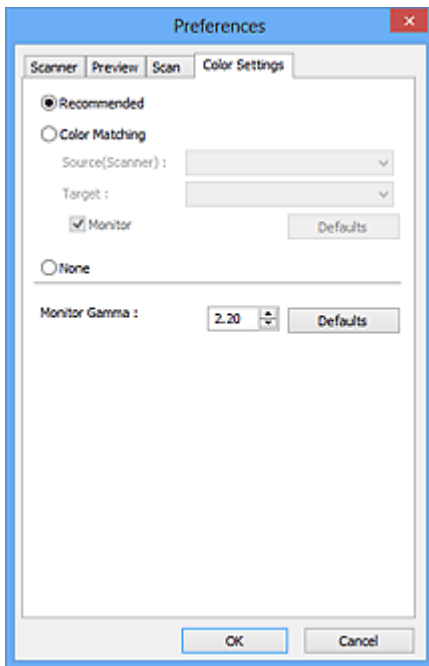

Color Adjustment

Select one of the following.

Recommended

Select this to vividly reproduce the tone of a document on the screen. It is recommended that you normally select this setting.

Color Matching

Select this to automatically match the scanner, monitor, and color printer colors, thus reducing time and trouble to manually match the monitor and printer colors.

Source(Scanner)

Select scanner profile.

Target

Select target profile.

Monitor

Select this checkbox to display preview image with optimum correction for monitor.

Defaults

Returns to the default **Color Matching** settings.

▶▶▶ Note

- The Color Adjustment Buttons on the **Advanced Mode** tab are not available when you select **Color Matching**.
- This function is available when **Color Mode** is **Color**.

None

Select this to disable color correction provided by ScanGear (scanner driver).

»» Note

- Depending on your scanner or printer, this setting may not be available when scanning from the ADF (Auto Document Feeder).
- You can select one when **Color Mode** is **Color** or **Grayscale**.
- Color Matching is available when ScanGear, monitor, color management-compliant application (such as Adobe Photoshop), and printer are set up correctly.

Refer to the corresponding manual for the monitor, printer, and application settings.

Monitor Gamma

By setting the gamma value of a monitor, you can adjust the input data to the brightness characteristics of the monitor. Adjust the value if your monitor's gamma value does not match the default value set in ScanGear, and the colors of the original image are not accurately reflected in the monitor.

Click **Defaults** to return to the default Monitor Gamma value (2.20).

»» Note

- Refer to the manual of your monitor to check its gamma value. If it is not written in the manual, contact the manufacturer.

Placing Items (When Scanning from a Computer)

Learn how to place items on the platen or ADF (Auto Document Feeder) of your scanner or printer. Place items correctly according to the type of item to be scanned. Otherwise, items may not be scanned correctly.

▶▶▶ Important

- Do not place objects on the document cover. When you open the document cover, the objects may fall into your scanner or printer, resulting in malfunction.
- Close the document cover when scanning.
- Do not touch the operation panel buttons or LCD (Liquid Crystal Display) when opening/closing the document cover. May result in unintended operation.

■ [Placing Items \(Platen\)](#)

■ [Placing Documents \(ADF \(Auto Document Feeder\)\)](#)

Placing Items (Platen)

Place items as described below to scan by detecting the item type or size automatically.

▶▶▶ Important

- When scanning by specifying the paper size in IJ Scan Utility or ScanGear (scanner driver), align an upper corner of the item with the corner at the arrow (alignment mark) of the platen.
- Photos that have been cut to various shapes and items smaller than 1.2 inches (3 cm) square cannot be cropped accurately when scanning.
- Reflective disc labels may not be scanned as expected.

For Photos, Postcards, Business Cards, or BD/DVD/CD	For Magazines, Newspapers, or Documents
<div data-bbox="220 1198 726 1332" data-label="Image"> </div> <p data-bbox="188 1377 438 1406">Placing a Single Item:</p> <p data-bbox="188 1429 829 1563">Place the item face-down on the platen, with 0.4 inch (1 cm) or more space between the edges (diagonally striped area) of the platen and the item. Portions placed on the diagonally striped area cannot be scanned.</p> <div data-bbox="188 1579 694 1937" data-label="Diagram"> </div> <p data-bbox="188 1971 399 2004">▶▶▶ Important</p> <ul data-bbox="215 2027 821 2083" style="list-style-type: none"> • Large items (such as A4 size photos) that cannot be placed away from the edges/arrow (alignment mark) of 	<div data-bbox="933 1198 1316 1332" data-label="Image"> </div> <p data-bbox="845 1366 1428 1500">Place the item face-down on the platen and align an upper corner of the item with the corner at the arrow (alignment mark) of the platen. Portions placed on the diagonally striped area cannot be scanned.</p> <div data-bbox="845 1512 1348 1892" data-label="Diagram"> </div> <p data-bbox="845 1915 1061 1948">▶▶▶ Important</p> <ul data-bbox="869 1960 1412 2060" style="list-style-type: none"> • Refer to "Loading Originals" for your model from Home of the <i>Online Manual</i> for details on the portions in which items cannot be scanned.

the platen may be saved as PDF files. To save in a format other than PDF, scan by specifying the data format.

Placing Multiple Items:

Allow 0.4 inch (1 cm) or more space between the edges (diagonally striped area) of the platen and items, and between items. Portions placed on the diagonally striped area cannot be scanned.

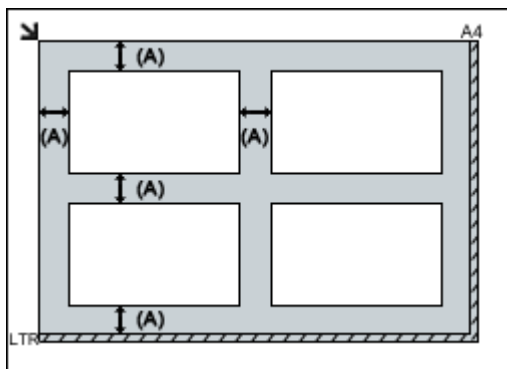

(A) more than 0.4 inch (1 cm)

►►► Note

- You can place up to 12 items.
- You can place up to four items when the **Compress scanned images upon transfer** checkbox is selected in the Settings dialog box of IJ Scan Utility.
- With network connection, items may not be scanned correctly when five or more items are placed. In that case, reduce the number of items placed on the platen to four or less, then scan again.
- Positions of slanted items (10 degrees or less) are corrected automatically.

Placing Documents (ADF (Auto Document Feeder))

►►► Important

- Do not leave thick items on the platen when scanning from the ADF. May result in paper jam.
- Place and align documents of the same size when scanning two or more documents.
- Refer to "Originals You Can Load" for your model from Home of the *Online Manual* for details on supported document sizes when scanning from the ADF.

1. Open the document tray.

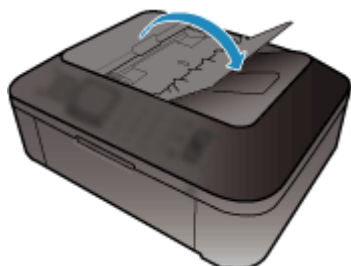

2. Place the documents on the ADF, then adjust the document guides to the width of the documents.

Insert the documents face-up until a beep sounds.

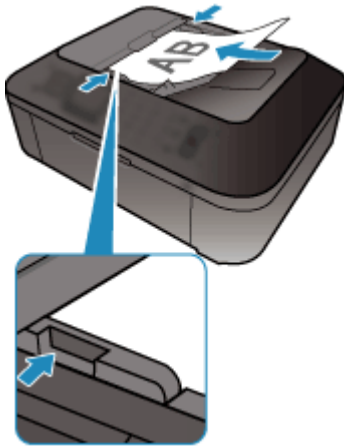

▶▶▶ Note

- When scanning duplex documents, place the front sides facing up. They will not be scanned in the correct page order if placed the other way around.

Adjusting Cropping Frames (ScanGear)

"Cropping" is the act of selecting the area you want to keep in an image and discarding the rest when scanning it.

On the **Basic Mode** tab and **Advanced Mode** tab, you can specify cropping frames (scan areas) on the image(s) displayed in the Preview area of the screen.

When you perform a scan, each area specified with a cropping frame will be scanned as a separate image.

►►► Note

- In whole image view, you can specify multiple cropping frames on the preview image.
- Refer to "Adjusting Cropping Frames in the Image Stitch Window" for your model from Home of the *Online Manual* for how to adjust cropping frames with IJ Scan Utility.

Initial Cropping Frame

In thumbnail view:

No cropping frame is specified. You can drag the mouse over a thumbnail to specify a cropping frame.

In whole image view:

An active cropping frame is automatically specified around the preview image. You can drag the cropping frame in the Preview area to specify the area.

►►► Note

- You can change the auto crop setting in the **Preferences** dialog box. Refer to **Cropping Frame on Previewed Images** in "[Preview Tab](#)" for details.

Cropping Frame Types

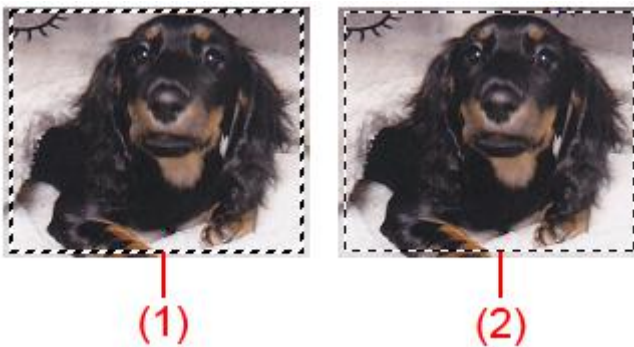

(1) Thick cropping frame (rotating or stationary)

Represents a selected cropping frame. Appears only in whole image view. You can select multiple cropping frames by clicking them while pressing the Ctrl key. Output size, image corrections, and other settings on the **Basic Mode** tab or **Advanced Mode** tab will be applied to all the selected cropping frames.

(2) Thin cropping frame

In thumbnail view:

Output size, image corrections, and other settings on the **Basic Mode** tab or **Advanced Mode** tab will be applied.

In whole image view:

Represents an unselected cropping frame. The settings on the **Basic Mode** tab or **Advanced Mode** tab will not be applied.

Adjusting a Cropping Frame





The cursor will change into  (Arrow) when it is positioned over a cropping frame. If you click and drag the mouse in the direction of the arrow, the cropping frame will expand or contract accordingly.



The cursor will change into  (Crosshair Arrow) when it is positioned within a cropping frame. Click and drag the mouse to move the entire cropping frame.



►► Note

- On the **Advanced Mode** tab, you can specify the cropping frame size by entering the values into  (Width) and  (Height) in [Input Settings](#).
- You can rotate a cropping frame 90 degrees by clicking  (Switch Aspect Ratio). However,  (Switch Aspect Ratio) is not available when **Output Size** is **Flexible**.

Creating Multiple Cropping Frames

In thumbnail view:

You can only create one cropping frame per image.

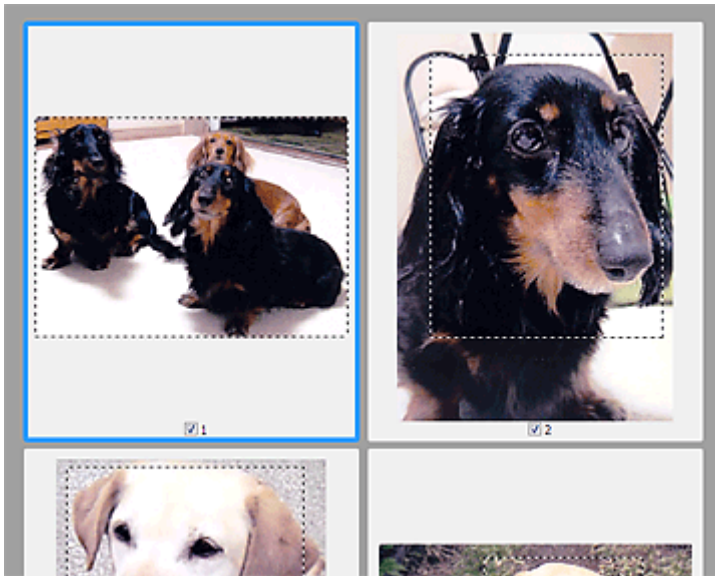

In whole image view:

Click and drag the mouse in a space outside the existing cropping frame in the Preview area. The new cropping frame will be the active cropping frame, and the old cropping frame will be the unselected cropping frame.

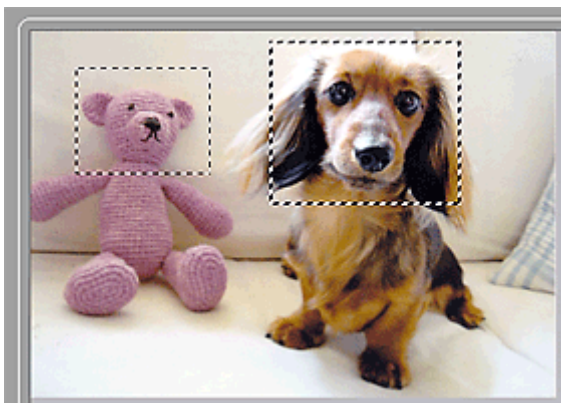

You can create multiple cropping frames and apply different scan settings to each cropping frame.

You can also select multiple cropping frames by clicking them while pressing the Ctrl key.

If you select multiple cropping frames and change the settings on a tab at the right of ScanGear, the settings will be applied to all the selected cropping frames.

When you create a new cropping frame, it retains the settings of the latest cropping frame.

►► Note

- Create up to 12 cropping frames.
- Scanning takes longer than usual when multiple cropping frames are selected.

Deleting Cropping Frames

In thumbnail view:

To delete a cropping frame, click an area outside the cropping frame on an image.

In whole image view:

To delete a cropping frame, select it and click  (Remove Cropping Frame) on the Toolbar. Alternatively, press the Delete key.

When there are multiple cropping frames, all the selected cropping frames (active cropping frame and selected cropping frames) are deleted simultaneously.

General Notes (Scanner Driver)

ScanGear (scanner driver) is subject to the following restrictions. Keep these points in mind when using it.

Scanner Driver Restrictions

- When using the NTFS file system, the TWAIN data source may not be invoked. This is because the TWAIN module cannot be written to the winnt folder for security reasons. Contact the computer's administrator for help.
- Some computers (including laptops) connected to the machine may not resume correctly from standby mode. In that case, restart the computer.
- Do not connect two or more scanner or multifunction printers with scanner function to the same computer simultaneously. If multiple scanning devices are connected, you cannot scan from the operation panel of the machine and also may experience errors while accessing the devices.
- Scanning may fail if the computer has resumed from sleep or standby mode. In that case, follow these steps and scan again.
 1. Turn off the machine.
 2. Exit ScanGear, then disconnect the USB cable from the computer and reconnect it.
 3. Turn on the machine.
- ScanGear cannot be opened in multiple applications at the same time. Within an application, ScanGear cannot be opened for the second time when it is already open.
- Be sure to close the ScanGear window before closing the application.
- When using a network compatible model by connecting to a network, the machine cannot be accessed from multiple computers at the same time.
- When using a network compatible model by connecting to a network, scanning takes longer than usual.
- Make sure that you have adequate disk space available when scanning large images at high resolutions. For example, at least 300 MB of free space is required to scan an A4 document at 600 dpi in full-color.
- ScanGear and WIA driver cannot be used at the same time.
- Do not enter the computer into sleep or hibernate state during scanning.

Applications with Restrictions on Use

- If you start Media Center included in Windows XP Media Center Edition 2005, you may not be able to scan using the operation panel of the machine. In that case, restart the computer.
- You cannot scan images with Media Center included in Windows XP Media Center Edition 2005. Scan with other applications such as IJ Scan Utility.
- Some applications may not display the TWAIN user interface. In that case, refer to the application's manual and change the settings accordingly.
- Some applications do not support continuous scanning of multiple documents. In some cases, only the first scanned image is accepted, or multiple images are scanned as one image. For such applications, do not scan multiple documents from the ADF (Auto Document Feeder).
- To import scanned images into Microsoft Office 2000, first save them using IJ Scan Utility, then import the saved files from the **Insert** menu.
- When scanning Platen size images into Microsoft Office 2003 (Word, Excel, PowerPoint, etc.), click **Custom Insert** in the **Insert Picture from Scanner or Camera** screen. Otherwise, images may not be scanned correctly.
- When scanning images into Microsoft Office 2007/Microsoft Office 2010 (Word, Excel, PowerPoint, etc.), use Microsoft Clip Organizer.

- Images may not be scanned correctly in some applications. In that case, increase the operating system's virtual memory and retry.
- When image size is too large (such as when scanning large images at high resolution), your computer may not respond or the progress bar may remain at 0 % depending on the application. In that case, cancel the action (for example by clicking **Cancel** on the progress bar), then increase the operating system's virtual memory or reduce the image size/resolution and retry. Alternatively, scan the image via IJ Scan Utility first, then save and import it into the application.

Useful Information on Scanning

- ▶ [Adjusting Cropping Frames in the Image Stitch Window](#)
- ▶ [Resolution](#)
- ▶ [Data Formats](#)
- ▶ [Color Matching](#)

Adjusting Cropping Frames in the Image Stitch Window

"Cropping" is the act of selecting the area you want to keep in an image and discarding the rest when scanning it.

In the **Image Stitch** window, you can specify a cropping frame on the image displayed in the Preview area.

»» Note

- Refer to "Adjusting Cropping Frames (ScanGear)" for your model from Home of the *Online Manual* for how to adjust cropping frames with ScanGear (scanner driver).

Initial Cropping Frame

No cropping frame is specified. When you select the **Adjust cropping frames** checkbox, an active cropping frame is automatically specified around the image in the Preview area. You can drag the cropping frame to specify the area.

When you perform a scan, the image in the area specified with the cropping frame will be scanned.

Adjusting a Cropping Frame

The cursor will change into  (Arrow) when it is positioned over a cropping frame. Click and drag the mouse to expand or contract the cropping frame.



The cursor will change into  (Crosshair Arrow) when it is positioned within a cropping frame. Click and drag the mouse to move the entire cropping frame.



Deleting Cropping Frames

To delete the cropping frame, deselect the **Adjust cropping frames** checkbox.

Resolution

The data in the image you have scanned is a collection of dots carrying information about brightness and color. The density of these dots is called "resolution," and resolution will determine the amount of detail your image contains. The unit of resolution is dots per inch (dpi). Dpi is the number of dots per inch (2.5 cm).

The higher the resolution (value), the more detail in your image; the lower the resolution (value), the less detail.



How to Set the Resolution

You can set the resolution in the following screens.

IJ Scan Utility:

Resolution on the  (Scanning from a Computer) tab of the Settings dialog box

ScanGear (Scanner Driver):

Output Resolution in **Output Settings** on the **Advanced Mode** tab

Appropriate Resolution Settings

Set the resolution according to the use of the scanned image.

Item Type	Use	Color Mode	Appropriate Resolution
Color photo	Copying (Printing)	Color	300 dpi
	Creating a postcard	Color	300 dpi
	Saving to a computer	Color	300 dpi
	Using on a website or attaching to e-mail	Color	150 dpi
Black and white photo	Saving to a computer	Grayscale	300 dpi
	Using on a website or attaching to e-mail	Grayscale	150 dpi
Text document (document or magazine)	Copying	Color, Grayscale, or Black and White	300 dpi
	Attaching to e-mail	Color, Grayscale, or Black and White	150 dpi
	Scanning text using OCR	Color or Grayscale	300 dpi

»» Important

- If you double the resolution, the data size of the scanned image quadruples. If the file is too large, the processing speed will slow down significantly, and you will experience inconvenience such as lack of memory. Set the minimum required resolution according to the use of the image.

»» Note

- When you will be printing the scanned image by enlarging it, scan by setting a higher resolution than the recommended one above.

Data Formats

You can select a data format when saving scanned images. You should specify the most suitable data format according to how you want to use the image on which application.

Available data formats vary by application and operating system (Windows or Mac OS).

See below for the characteristics of each image data format.

PNG (Standard File Extension: .png)

A data format often used on websites.

PNG is suitable for editing saved images.

JPEG (Standard File Extension: .jpg)

A data format often used on websites and for digital camera images.

JPEG features high compression rates. JPEG images slightly degrade every time they are saved, and cannot be returned to their original state.

JPEG is not available for black and white images.

TIFF (Standard File Extension: .tif)

A data format featuring a relatively high compatibility between various computers and applications.

TIFF is suitable for editing saved images.

►► Note

- Some TIFF files are incompatible.
- IJ Scan Utility supports the following TIFF file formats.
 - Uncompressed, black and white binary
 - Uncompressed, RGB (8 bits per channel)
 - Uncompressed, Grayscale

PDF (Standard File Extension: .pdf)

A data format for electronic documents, developed by Adobe Systems Incorporated.

It can be used on various computers and operating systems, and fonts can be embedded as well; therefore, people in different environments can exchange the files without being aware of the differences.

Color Matching

"Color Matching" is the act of making adjustments so that the color tones match between the original item, the monitor display, and the color printout. On your scanner or printer, the color tones are adjusted as shown below.

Example: When sRGB is selected as the output profile (target):

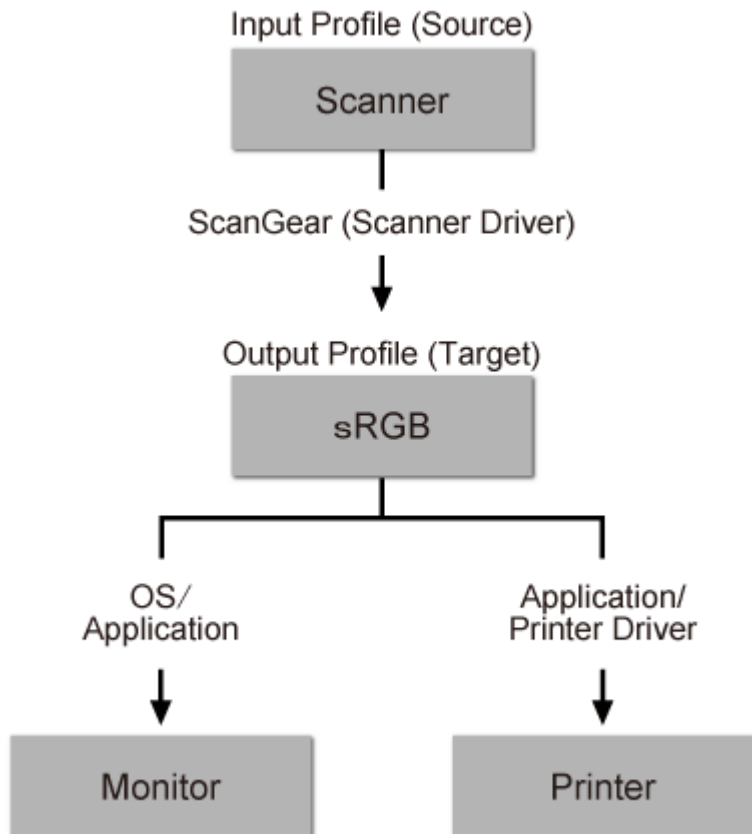

The image's color space is converted from the scanner's color space to sRGB by ScanGear.

When displaying on a monitor, the image's color space is converted from sRGB to the monitor's color space based on the operating system's monitor settings and the application's working space settings.

When printing, the image's color space is converted from sRGB to the printer's color space based on the application's print settings and the printer driver's settings.

IJ Network Scanner Selector EX Menu and Setting Screen

IJ Network Scanner Selector EX allows you to select the scanners or printers to be used for scanning or printing over a network from your computer or the operation panel.

After installation, IJ Network Scanner Selector EX appears in the notification area on the desktop.

▶▶▶ Important

- If you cannot scan over a network, download and upgrade to the latest MP Drivers from our website.
- While IJ Network Scanner Selector EX is enabled, it periodically transmits packets to check whether it can communicate with your scanner or printer over the network. When using the computer in a network environment other than the one used to set up your scanner or printer, disable IJ Network Scanner Selector EX.

▶▶▶ Note

- If the icon is not displayed in the notification area on the desktop, follow the procedure below to start.
 - **Windows 8.1/Windows 8:**
Click **IJ Network Scanner Selector EX** on the Start screen.
If **IJ Network Scanner Selector EX** is not displayed on the Start screen, select the **Search** charm, then search for "IJ Network Scanner Selector EX".
 - **Windows 7/Windows Vista/Windows XP:**
From the **Start** menu, click **All Programs > Canon Utilities > IJ Network Scanner Selector EX > IJ Network Scanner Selector EX**.

Menu

Displays a menu when you right-click  (IJ Network Scanner Selector EX) in the notification area on the desktop.

Disable Canon IJ Network Scanner Selector EX / Enable Canon IJ Network Scanner Selector EX

Enables or disables IJ Network Scanner Selector EX.

When you select **Disable Canon IJ Network Scanner Selector EX**, you will not be able to scan over a network from the operation panel.

Enabled:  , Disabled: 

▶▶▶ Important

- When using a model with which you cannot scan over a network from the operation panel, you cannot scan using the operation panel even if this setting is enabled.

Settings...



The Scan-from-PC Settings screen appears. You can select the model you want to use.

About

Displays the version information.

In the displayed dialog box, you can change the language to be used in the application. The change will be reflected after restarting the computer.

Exit

Exits IJ Network Scanner Selector EX;  (Enabled) or  (Disabled) disappears from the notification area on the desktop.

Scan-from-PC Settings Screen

Right-click the icon from the notification area on the desktop, then select **Settings...** to display the Scan-from-PC Settings screen.

Your scanner or printer must be selected with IJ Network Scanner Selector EX before scanning over a network.

Scanners

MAC addresses of the scanners or printers that can be used over the network are displayed.

You can select one scanner or printer per model. Selecting a scanner or printer automatically enables scanning from the operation panel.

Instructions

Opens this guide.

Scan-from-Operation-Panel Settings

The Scan-from-Operation-Panel Settings screen appears. You can select up to three scanners and printers in total for scanning from the operation panel. You can scan items using the operation panel of the selected scanner or printer, and send the scanned images to your computer over a network.

Important

- When using a model with which you cannot scan over a network from the operation panel, that model does not appear in **Scanners** and the setting is not available.

Scan-from-Operation-Panel Settings Screen

Click **Scan-from-Operation-Panel Settings** in the Scan-from-PC Settings screen to display the Scan-from-Operation-Panel Settings screen.

Scanners

MAC addresses of the scanners or printers that can be used over the network are displayed.

You can select up to three scanners and printers in total at the same time. Selecting a scanner or printer automatically enables scanning from the operation panel.

Instructions

Opens this guide.

Important

- When using a model with which you cannot scan over a network from the operation panel, **Scan-from-Operation-Panel Settings** may appear in the Scan-from-PC Settings screen; however, the setting is not available.

Note

- If your scanner or printer does not appear, check the following, click **OK** to close the screen, then reopen it and try selecting again.
 - MP Drivers is installed
 - Network settings of your scanner or printer is completed after installing the MP Drivers

- Network communication between your scanner or printer and computer is enabled

If your scanner or printer still does not appear, refer to "Problems with Network Communication" for your model from Home of the *Online Manual*.

- You do not need to use this software when scanning via USB. Refer to "[Uninstalling IJ Network Scanner Selector EX](#)" to delete it. You can scan via USB even if it is not deleted.
-

Uninstalling IJ Network Scanner Selector EX

Follow the procedure below to uninstall IJ Network Scanner Selector EX from your computer.

►► Important

- You cannot scan over a network after uninstalling IJ Network Scanner Selector EX.
- Log into a user account with administrator privilege.

1. Uninstall IJ Network Scanner Selector EX.

• Windows 8.1/Windows 8:

1. Click the **Settings** charm > **Control Panel** > **Programs** > **Programs and Features**.
2. Double-click **Canon IJ Network Scanner Selector EX**.

►► Note

- If the **User Account Control** screen appears, click **Continue**.

• Windows 7/Windows Vista:

1. From the **Start** menu, select **Control Panel** > **Programs** > **Programs and Features**.
2. Select **Canon IJ Network Scanner Selector EX**, then click **Uninstall/Change**.

►► Note

- If the **User Account Control** screen appears, click **Continue**.

• Windows XP:

1. From the **Start** menu, select **Control Panel** > **Add or Remove Programs**.
2. Select **Canon IJ Network Scanner Selector EX**, then click **Change/Remove**.

2. Click **Yes** when the confirmation message appears.

3. When uninstallation is complete, click **OK**.

►► Note

- When the message prompting you to restart your computer appears, click **OK** to restart your computer.

Other Scanning Methods

- ▶ [Scanning with WIA Driver](#)
- ▶ [Scanning Using the Control Panel \(Windows XP Only\)](#)

Scanning with WIA Driver

You can scan an item from a WIA (Windows Image Acquisition)-compliant application.

WIA is a driver model implemented in Windows XP or later. It allows you to scan items without using an application.

The procedure varies depending on the application. The following procedures are examples only.

Refer to the application's manual for details.

►► Important

- In Windows XP, you cannot scan using the WIA driver via a network connection.
- Some applications do not support continuous scanning from the ADF (Auto Document Feeder). Refer to the application's manual for details.
- Follow these steps to enable scanning over a network.

The setting may have been completed already depending on your environment. In that case, **Uninstall** appears.

1. Follow the procedure below to open **Network**.

- Windows 8.1/Windows 8: Select the **Search** charm, then click **Network** displayed by searching for "Network".
- Windows 7: From the **Start** menu, select **Computer > Network**.
- Windows Vista: From the **Start** menu, select **Network**.

2. Right-click **XXX_MAC address** (where "XXX" is the model name) in the displayed screen, then select **Install**.

Scanning with WIA Driver 2.0

The following is an example of scanning using "Windows Fax and Scan."

1. Place the item on the platen or ADF.

■ [Placing Items \(When Scanning from a Computer\)](#)

2. Select **New** on the **File** menu of "**Windows Fax and Scan**," then click **Scan....**

The scan setting screen appears.

►► Note

- If you have more than one scanner or printer, a scanner selection screen may appear. Double-click the scanner you want to use.
 - For USB connection: **Canon XXX series** (where "XXX" is the model name)
 - For network connection: **XXX series_MAC address** (where "XXX" is the model name)

3. Specify the settings.

Scanner

The currently set product name is displayed. To change the scanner, click **Change...** and select the product you want to use.

Profile

Select **Photo (Default)** or **Documents** according to the type of item to be scanned. To save a new **Profile**, select **Add profile...** You can specify the details in the **Add New Profile** dialog box.

Source

Select a scanner type. To scan from the platen, select **Flatbed**. To scan from the ADF, select **Feeder (Scan one side)**.

Paper size

Select the paper size. **Paper size** can be set only when **Source** is **Feeder (Scan one side)**.

Color format

Select the color mode in which to scan the item.

File type

Select a data format from JPEG, BMP, PNG, and TIFF.

Resolution (DPI)

Enter the resolution. Specify a value between 50 dpi and 600 dpi.

■ [Resolution](#)

►► Note

- When using the scanner or printer with network connection, the following resolutions can be specified.
150 dpi / 300 dpi / 600 dpi

Brightness

Move the slider to adjust the brightness. Move it to the left to darken and right to brighten the image. You can also enter a value (-100 to 100).

Contrast

Move the slider to adjust the contrast. Moving it to the left will decrease the contrast of the image, thus softening the image. Moving it to the right will increase the contrast of the image, thus sharpening the image. You can also enter a value (-100 to 100).

Preview or scan images as separate files

Select this checkbox to preview or scan multiple images as separate files.

►► Important

- When using the scanner or printer with network connection, you cannot specify **Brightness**, **Contrast**, and **Preview or scan images as separate files**.

4. Click **Preview** to preview the image.

The preview image appears on the right.

►► Important

- With network connection, scan without preview when scanning documents from the ADF. If you preview, place the document again and scan.
If there is document left in the ADF after previewing, press the **OK** button on the operation panel and remove the document.

5. Click **Scan**.

Scanning starts, then the scanned image appears in the application.

Scanning with WIA Driver 1.0

The following is an example of scanning using "Paint."

1. Place the item on the platen or ADF.

■ [Placing Items \(When Scanning from a Computer\)](#)

2. Click **From scanner or camera** from the **File** menu of Paint. (Select the command to scan an item in the application.)

▶▶▶ Note

- If you have more than one scanner or printer, a scanner selection screen may appear. Double-click the scanner you want to use.
 - For USB connection: **Canon XXX series** (where "XXX" is the model name)
 - For network connection: **XXX series_MAC address** (where "XXX" is the model name)

3. Select the paper source and type of picture according to the item to be scanned.

To scan from the platen, select **Flatbed** for **Paper source**. To scan from the ADF, select **Document Feeder**.

Select the type of picture from **Color picture**, **Grayscale picture**, **Black and white picture or text**, and **Custom Settings**.

▶▶▶ Note

- When using the scanner or printer with network connection, the options for the type of picture may differ from those displayed with USB connection.
- To scan with the values previously set in **Adjust the quality of the scanned picture**, select **Custom Settings**.
- Selecting **Document Feeder** for **Paper source** enables you to select **Page size**.

4. Click **Adjust the quality of the scanned picture** and set the preferences as required.

Brightness

Move the slider to adjust the brightness. Move it to the left to darken and right to brighten the image. You can also enter a value (-127 to 127).

Contrast

Move the slider to adjust the contrast. Moving it to the left will decrease the contrast of the image, thus softening the image. Moving it to the right will increase the contrast of the image, thus sharpening the image. You can also enter a value (-127 to 127).

Resolution (DPI)

Enter the resolution. Specify a value between 50 dpi and 600 dpi.

■ [Resolution](#)

▶▶▶ Note

- When using the scanner or printer with network connection, the following resolutions can be specified.
150 dpi / 300 dpi / 600 dpi

Picture type

Select the type of scan you want for your item.

Reset

Click to restore the original settings.

»» Important

- When using the scanner or printer with network connection, you cannot specify **Brightness** and **Contrast**.

5. Click **Preview** to preview the image.

The preview image appears on the right. Drag to specify the scan area.

»» Important

- With network connection, scan without preview when scanning documents from the ADF. If you preview, place the document again and scan.
If there is document left in the ADF after previewing, press the **OK** button on the operation panel and remove the document.

6. Click **Scan**.

Scanning starts, then the scanned image appears in the application.

Scanning Using the Control Panel (Windows XP Only)

You can scan images via the Control Panel of Windows XP using the WIA driver.

►► Important

- When using the scanner or printer with network connection, you cannot scan using the WIA driver.

1. From the **Start** menu, select **Control Panel**.
2. Click **Printers and Other Hardware > Scanners and Cameras**, then double-click **Canon XXX series** (where "XXX" is the model name).

The **Scanner and Camera Wizard** dialog box appears.

3. Click **Next**.
4. Select **Picture type** according to the item to be scanned.

To scan from the platen, select **Flatbed** for **Paper source**. To scan from the ADF (Auto Document Feeder), select **Document Feeder**.

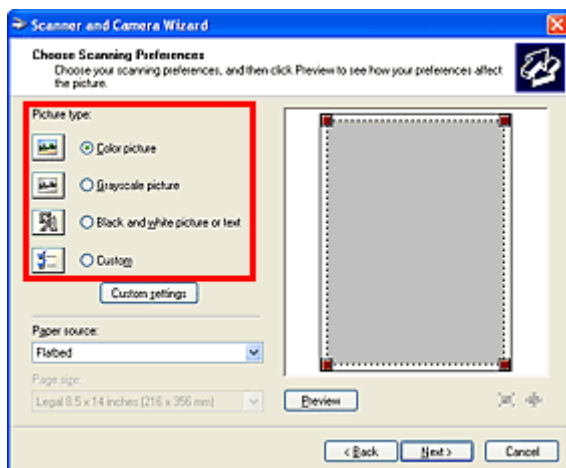

►► Note

- To scan with the values previously set in **Custom settings**, select **Custom**.
- Selecting **Document Feeder** for **Paper source** enables you to select **Page size**.

5. Click **Custom settings** to set the preferences as required.

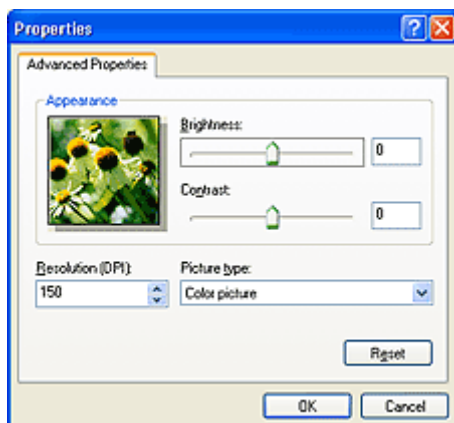

Brightness

Move the slider to adjust the brightness. Move it to the left to darken and right to brighten the image. You can also enter a value (-127 to 127).

Contrast

Move the slider to adjust the contrast. Moving it to the left will decrease the contrast of the image, thus softening the image. Moving it to the right will increase the contrast of the image, thus sharpening the image. You can also enter a value (-127 to 127).

Resolution (DPI)

Enter the resolution. Specify a value between 50 dpi and 600 dpi.

 [Resolution](#)

Picture type

Select the type of scan you want for your item.

Reset

Click to restore the original settings.

6. Click **Preview** to preview the image.

The preview image appears on the right. Drag  to specify the scan area.

7. Click **Next** and follow the instructions.

Placing Items (When Scanning from a Computer)

Learn how to place items on the platen or ADF (Auto Document Feeder) of your scanner or printer. Place items correctly according to the type of item to be scanned. Otherwise, items may not be scanned correctly.

▶▶▶ Important

- Do not place objects on the document cover. When you open the document cover, the objects may fall into your scanner or printer, resulting in malfunction.
- Close the document cover when scanning.
- Do not touch the operation panel buttons or LCD (Liquid Crystal Display) monitor when opening/closing the document cover. May result in unintended operation.

■ [Placing Items \(Platen\)](#)

■ [Placing Documents \(ADF \(Auto Document Feeder\)\)](#)

Placing Items (Platen)

Place items as described below to scan by detecting the item type or size automatically.

▶▶▶ Important

- When scanning by specifying the paper size in IJ Scan Utility or ScanGear (scanner driver), align an upper corner of the item with the corner at the arrow (alignment mark) of the platen.
- Photos that have been cut to various shapes and items smaller than 1.2 inches (3 cm) square cannot be cropped accurately when scanning.
- Reflective disc labels may not be scanned as expected.

For Photos, Postcards, Business Cards, or BD/DVD/CD	For Magazines, Newspapers, or Documents
<div data-bbox="220 1198 726 1332" data-label="Image"> </div> <p data-bbox="188 1377 438 1406">Placing a Single Item:</p> <p data-bbox="188 1429 805 1563">Place the item face-down on the platen, with 0.4 inch (1 cm) or more space between the edges (diagonally striped area) of the platen and the item. Portions placed on the diagonally striped area cannot be scanned.</p> <div data-bbox="188 1579 694 1937" data-label="Diagram"> </div> <p data-bbox="188 1971 399 2004">▶▶▶ Important</p> <ul data-bbox="215 2027 821 2083" style="list-style-type: none"> • Large items (such as A4 size photos) that cannot be placed away from the edges/arrow (alignment mark) of 	<div data-bbox="925 1198 1308 1332" data-label="Image"> </div> <p data-bbox="837 1366 1420 1500">Place the item face-down on the platen and align an upper corner of the item with the corner at the arrow (alignment mark) of the platen. Portions placed on the diagonally striped area cannot be scanned.</p> <div data-bbox="837 1512 1348 1892" data-label="Diagram"> </div> <p data-bbox="837 1915 1053 1948">▶▶▶ Important</p> <ul data-bbox="861 1960 1404 2072" style="list-style-type: none"> • Refer to "Loading Originals" for your model from Home of the <i>Online Manual</i> for details on the portions in which items cannot be scanned.

the platen may be saved as PDF files. To save in a format other than PDF, scan by specifying the data format.

Placing Multiple Items:

Allow 0.4 inch (1 cm) or more space between the edges (diagonally striped area) of the platen and items, and between items. Portions placed on the diagonally striped area cannot be scanned.

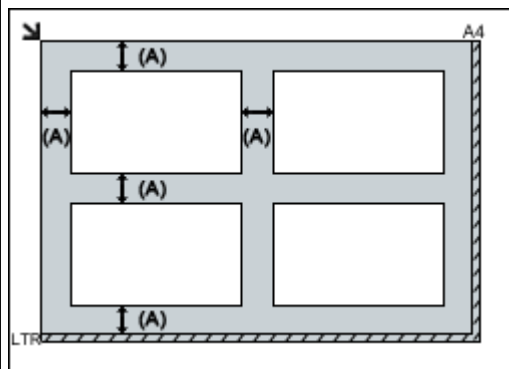

(A) more than 0.4 inch (1 cm)

▶▶▶ Note

- You can place up to 12 items.
- Positions of slanted items (10 degrees or less) are corrected automatically.

Placing Documents (ADF (Auto Document Feeder))

▶▶▶ Important

- Do not leave thick items on the platen when scanning from the ADF. May result in paper jam.
- Place and align documents of the same size when scanning two or more documents.
- Refer to "Originals You Can Load" for your model from Home of the *Online Manual* for details on supported document sizes when scanning from the ADF.

1. Open the document tray.

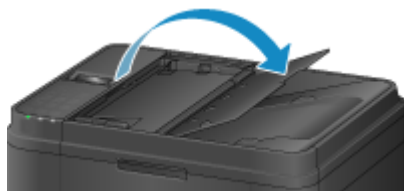

2. Place the documents on the ADF, then adjust the document guides to the width of the documents.

Insert the documents face-up until a beep sounds.



Scanning from the Operation Panel of the Machine

- ▶ **Forwarding Scanned Data to the Computer Using the Operation Panel of the Machine** 📄 **Basic**
- ▶ **Setting Items for Scanning Using the Operation Panel of the Machine**
- ▶ **Network Scan Settings**
- ▶ **Selecting a Response to Commands from the Operation Panel Using IJ Scan Utility**

Forwarding Scanned Data to the Computer Using the Operation Panel of the Machine

Before forwarding scanned data to the computer, confirm the following:

- **MP Drivers are installed.**

If MP Drivers are not yet installed, install MP Drivers with the Setup CD-ROM or install them from our website.

- **The machine is connected to a computer correctly.**

Make sure that the machine is connected to the computer correctly.

Do not plug in or unplug the USB cable while the machine is in operation, or when the computer is in the sleep or standby mode.

If you perform scanning via a network connection, make sure that all the required settings have been specified.

■ [Network Scan Settings](#)

- **The destination and the file name are specified in Canon IJ Scan Utility.**

You can specify the destination and the file name in Canon IJ Scan Utility. For details on settings of Canon IJ Scan Utility:

■ [Settings Dialog Box](#)

Follow the procedure below to forward scanned data to the computer.

1. [Make sure that the machine is turned on.](#)

2. Press the **SCAN** button.

If you forward the scanned data to a computer for the first time, the **Scan menu** screen is displayed. Go to step 3.

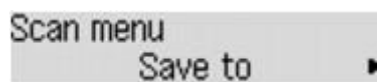

If you have forwarded the scanned data to a computer, the Scan standby screen is displayed.

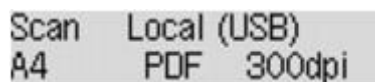

* The Scan standby screen for USB-connected computer

If you change the destination or scan settings, press the **Menu** button, then go to step 3.

Go to step 8 if you do not change the destination or scan settings.

3. Use the ◀▶ button to select **Save to**, then press the **OK** button.

4. Use the ◀▶ button to select the computer to forward the scanned data, then press the **OK** button.

If you forward the data to the USB-connected computer, select **Local (USB)**.

If you forward the data to the LAN-connected computer, select a name of the computer to forward the scanned data.

▶▶▶ Note

- If you select **Search again** and press the **OK** button, the machine starts searching for the connected computers again.
- When you forward the scanned data to the computer using WSD (one of the network protocols supported in Windows 8.1, Windows 8, Windows 7, and Windows Vista), select **Active** for **WSD scan from dev.** on **WSD setting** on **Other settings** in **LAN settings** under **Device settings**.

5. Make sure that **Document type** is selected, then press the **OK** button.

6. Use the ◀▶ button to select the document type, then press the **OK** button.

▶▶▶ Note

- When you forward the scanned data to the computer searched using WSD, you cannot select the document type.
- The * (asterisk) on the LCD indicates the current setting.

Auto scan

The machine detects the type of the originals automatically and the image is forwarded in the optimized size, resolution and data format.

▶▶▶ Important

- Load originals properly according to their type; otherwise, some originals may not be scanned properly.

For details on how to load the original:

■ [Loading Originals](#)

- The following items can be scanned:

Photos, postcards, visiting cards, magazines, newspapers, documents, BD/DVD/CDs

- The following items cannot be scanned properly.

- A4 sized photos
- Documents smaller than 5 inches x 7 inches (127 mm x 178 mm) such as a paperback with its backbone cut off
- Originals on thin white paper
- Long and narrow originals such as panoramic photographs

- When you scan originals from the ADF, it may take longer to scan the first page.

Document

Scans the original on the platen glass or in the ADF applying the optimized settings for scanning a document.

Photo

Scans the original on the platen glass as a photo data applying the optimized settings for scanning a photo.

7. Specify the scan settings.

Specify each scan setting in order.

Use the ◀▶ button to select a setting item, then press the **OK** button.

Use the ◀▶ button to adjust each setting item, then press the **OK** button. The next setting item is displayed.

▶▶▶ Note

- For details on each setting item:
 - [Setting Items for Scanning Using the Operation Panel of the Machine](#)
- Go to step 8 when **Auto scan** is selected for **Document type**.

The Scan standby screen is displayed after all the settings have been specified.

Scan	Local (USB)
A4	PDF 300dpi

8. [Load the original document on the platen glass or in the ADF.](#)

9. Press the **Color** button for color scanning, or the **Black** button for black & white scanning.

▶▶▶ Note

- When you forward the scanned data to the computer using WSD, press the **Color** button.
- If the original is not loaded properly, a message is displayed on the LCD. Load the original on the platen glass or in the ADF according to the scan settings.

- **If you load the original in the ADF:**

The machine starts scanning and scanned data is forwarded to the computer.

- **If you load the original on the platen glass:**

- When you select **JPEG** or **TIFF** for **Data format**, the machine starts scanning and scanned data is forwarded to the computer.
- When you select **PDF** or **Compact PDF** for **Data format**, the confirmation screen asking you if you continue scanning is displayed after scanning is complete.

Selecting **Yes** and pressing the **OK** button allow you to scan the originals continuously. Load the next document on the platen glass and start scanning.

By selecting **No** and pressing the **OK** button, scanning is complete and the data is forwarded to the computer in one PDF file.

Scanned data is forwarded to the computer according to the settings specified in Canon IJ Scan Utility.

Remove the original on the platen glass or from the document output slot after scanning is complete.

▶▶▶ Important

- If the scanning result with **Auto scan** is not satisfactory, select **Document** or **Photo** according to the original in step 6, then specify the scan size or other setting items in step 7.

When the program selection screen is displayed:

- **If you are using Windows 8.1, Windows 8, Windows 7, or Windows Vista:**

The program selection screen may be displayed after pressing the **Color** or **Black** button. In this case, select **Canon IJ Scan Utility** and click **OK**.

- **If you are using Windows XP:**

The program selection screen may be displayed after pressing the **Color** or **Black** button for the first time. In this case, specify **Canon IJ Scan Utility** as the application software to use, select **Always use this program for this action**, then click **OK**. From the next time, Canon IJ Scan Utility is automatically started.

If you want to scan originals with advanced settings, or if you want to edit or print the scanned images:

If you scan originals from a computer using My Image Garden, My Image Garden enables you to edit the scanned images, such as optimizing or trimming.

In addition, you can edit or print the scanned images using the compatible application software to make better use of them.

■ Scanning Photos and Documents

▶▶ Note

- You can use a WIA-compliant application software and the Control Panel (Windows XP only) to scan originals with this machine.

For details:

■ [Other Scanning Methods](#)

- If you want to convert a scanned document to text:

■ [Extracting Text from Scanned Images \(OCR\)](#)

Setting Items for Scanning Using the Operation Panel of the Machine

You can change the scan settings such as the scan size, resolution, or data format.

Use the ◀▶ button to select a setting item, then press the **OK** button.

Use the ◀▶ button to adjust each setting item, then press the **OK** button. The next setting item is displayed.

▶▶▶ Note

- The * (asterisk) on the LCD indicates the current setting.
- The scan setting cannot be specified under the following conditions:
 - When **Auto scan** is selected for **Document type** to forward the scanned data to the computer
 - When you forward the scanned data to the computer using WSD (one of the network protocols supported in Windows 8.1, Windows 8, Windows 7, and Windows Vista)
- Some setting items cannot be specified in combination with other setting items, the document type, or the destination to save the data.
- The settings of the scan size, resolution, and data format are retained even if the machine is turned off.
- When you forward the scanned data to the computer, you can specify the destination and file name using Canon IJ Scan Utility.

■ [Settings Dialog Box](#)

- If you scan originals from the computer, you can scan with advanced settings. For details on scanning from the computer:

■ [Scanning Photos and Documents](#)

• **Scan size**

Select the size of the original.

Ex:

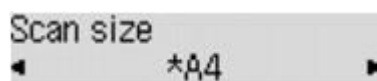

If you select **Auto scan(A) -Singl**, the machine detects the page size automatically and starts scanning.

If you select **Auto scan(A) -Multi** to save to the computer, you can scan several originals at a time.

▶▶▶ Note

- When **Legal** is selected, load the original in the ADF.
- When **4"x6"**, **10x15**, **5"x7"**, **13x18**, or **Auto scan(A) -Singl** is selected, load the original on the platen glass.
- Some of setting items are not available depending on the country or region of purchase.

• **Data format**

Select the data format of the scanned data.

Ex:

Data format
◀ *PDF ▶

- **Scan resolution**

Select the resolution for scanning.

Ex:

Scan resolution
◀ *300dpi ▶

Network Scan Settings

You can connect your scanner or printer to a network to share it among multiple computers or scan images into a specified computer.

►►► Important

- Multiple users cannot scan at the same time.

►►► Note

- Complete the network settings of your scanner or printer beforehand from the Setup CD-ROM or by following the instructions on the web page.
- With network connection, scanning takes longer than USB connection.

Complete the following settings to enable scanning over a network.

Specifying Your Scanner or Printer

Use IJ Network Scanner Selector EX to specify the scanner you want to use. By specifying the scanner, you can scan over a network from your computer or the operation panel.

►►► Important



- If the product you want to use is changed with IJ Network Scanner Selector EX, the product used for scanning with IJ Scan Utility changes as well. The product for scanning from the operation panel also changes.

If your scanner or printer is not selected in IJ Scan Utility, check that it is selected with IJ Network Scanner Selector EX.

Refer to "IJ Network Scanner Selector EX Menu and Setting Screen" for your model from Home of the *Online Manual* for details.

- To scan from the operation panel, specify your scanner or printer with IJ Network Scanner Selector EX beforehand.

1. Check that IJ Network Scanner Selector EX is running.

If IJ Network Scanner Selector EX is running,  (IJ Network Scanner Selector EX) appears in the notification area on the desktop. Click  to check the hidden icons as well.

►►► Note

- If the icon is not displayed in the notification area on the desktop, follow the procedure below to start.

- **Windows 8.1/Windows 8:**

- Click **IJ Network Scanner Selector EX** on the Start screen.

- If **IJ Network Scanner Selector EX** is not displayed on the Start screen, select the **Search** charm, then search for "IJ Network Scanner Selector EX".

- **Windows 7/Windows Vista/Windows XP:**

- From the **Start** menu, click **All Programs > Canon Utilities > IJ Network Scanner Selector EX > IJ Network Scanner Selector EX**.

The icon appears in the notification area on the desktop, and the Scan-from-PC Settings screen appears. In that case, skip ahead to Step 3.

2. In the notification area on the desktop, right-click  (IJ Network Scanner Selector EX), then select **Settings...**

The Scan-from-PC Settings screen appears.

3. Select your scanner or printer from **Scanners**.

Normally, the MAC address of your scanner or printer is already selected after the network setup. In that case, you do not need to select it again.

▶▶▶ Important

- If multiple scanners exist on the network, multiple model names appear. In that case, you can select one scanner per model.

4. Click **OK**.

▶▶▶ Note

- The scanner selected in the Scan-from-PC Settings screen will be automatically selected in the Scan-from-Operation-Panel Settings screen as well.

Setting for Scanning with IJ Scan Utility

To scan from IJ Scan Utility using a scanner or printer connected to a network, specify your scanner or printer with IJ Network Scanner Selector EX, then follow the steps below to change the connection status between it and the computer.

1. [Start IJ Scan Utility](#).
2. Select "Canon XXX series Network" (where "XXX" is the model name) for **Product Name**.
3. Click **Settings...** to use another scanner connected to a network.

4. Click  (General Settings), then click **Select** in **Product Name**.

The Scan-from-PC Settings screen of IJ Network Scanner Selector EX appears.

Select the scanner you want to use and click **OK**.

5. In the **Settings (General Settings)** dialog box, click **OK**.

The IJ Scan Utility main screen reappears. You can scan via a network connection.

Setting for Scanning from the Operation Panel



You can make the setting for scanning from the operation panel.

»» Important

- Set IJ Scan Utility to use your scanner or printer via a network connection beforehand.

■ [Setting for Scanning with IJ Scan Utility](#)

1. Check that IJ Network Scanner Selector EX is running.

If IJ Network Scanner Selector EX is running,  (IJ Network Scanner Selector EX) appears in the notification area on the desktop. Click  to check the hidden icons as well.

»» Note

- If the icon is not displayed in the notification area on the desktop, follow the procedure below to start.

- **Windows 8.1/Windows 8:**

Click **IJ Network Scanner Selector EX** on the Start screen.

If **IJ Network Scanner Selector EX** is not displayed on the Start screen, select the **Search** charm, then search for "IJ Network Scanner Selector EX".

- **Windows 7/Windows Vista/Windows XP:**

From the **Start** menu, click **All Programs > Canon Utilities > IJ Network Scanner Selector EX > IJ Network Scanner Selector EX**.

The icon appears in the notification area on the desktop, and the Scan-from-PC Settings screen appears. In that case, skip ahead to Step 3.

2. In the notification area on the desktop, right-click  (IJ Network Scanner Selector EX), then select **Settings...**

The Scan-from-PC Settings screen appears.

3. Click **Scan-from-Operation-Panel Settings**.

The Scan-from-Operation-Panel Settings screen appears.

4. Select your scanner or printer from **Scanners** and click **OK**.

Select the MAC address of your scanner or printer.

»» Note

- When multiple scanners are connected via a network, you can select up to three scanners.

5. In the Scan-from-PC Settings screen, click **OK**.

»» Note

- If your scanner or printer does not appear, check the following, click **OK** to close the screen, then reopen it and try selecting again.
 - MP Drivers is installed
 - Network settings of your scanner or printer is completed after installing the MP Drivers
 - Network communication between your scanner or printer and computer is enabled

If your scanner or printer still does not appear, refer to "Problems with Network Communication" for your model from Home of the *Online Manual*.

Selecting a Response to Commands from the Operation Panel Using IJ Scan Utility

IJ Scan Utility allows you to specify how to respond when scanning from the operation panel.

►►► Note

- The screens for scanning with Auto Scan from the operation panel are used as examples in the following descriptions.

1. [Start IJ Scan Utility.](#)
2. Click **Settings....**

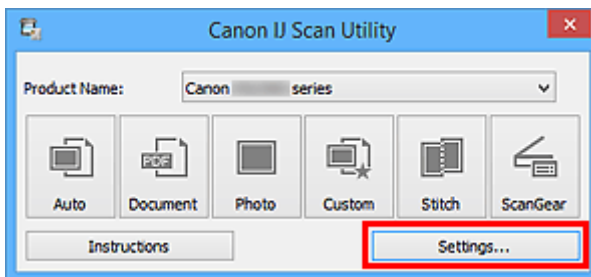

The Settings dialog box appears.

3. Select a scan mode on the  (Scanning from the Operation Panel) tab.

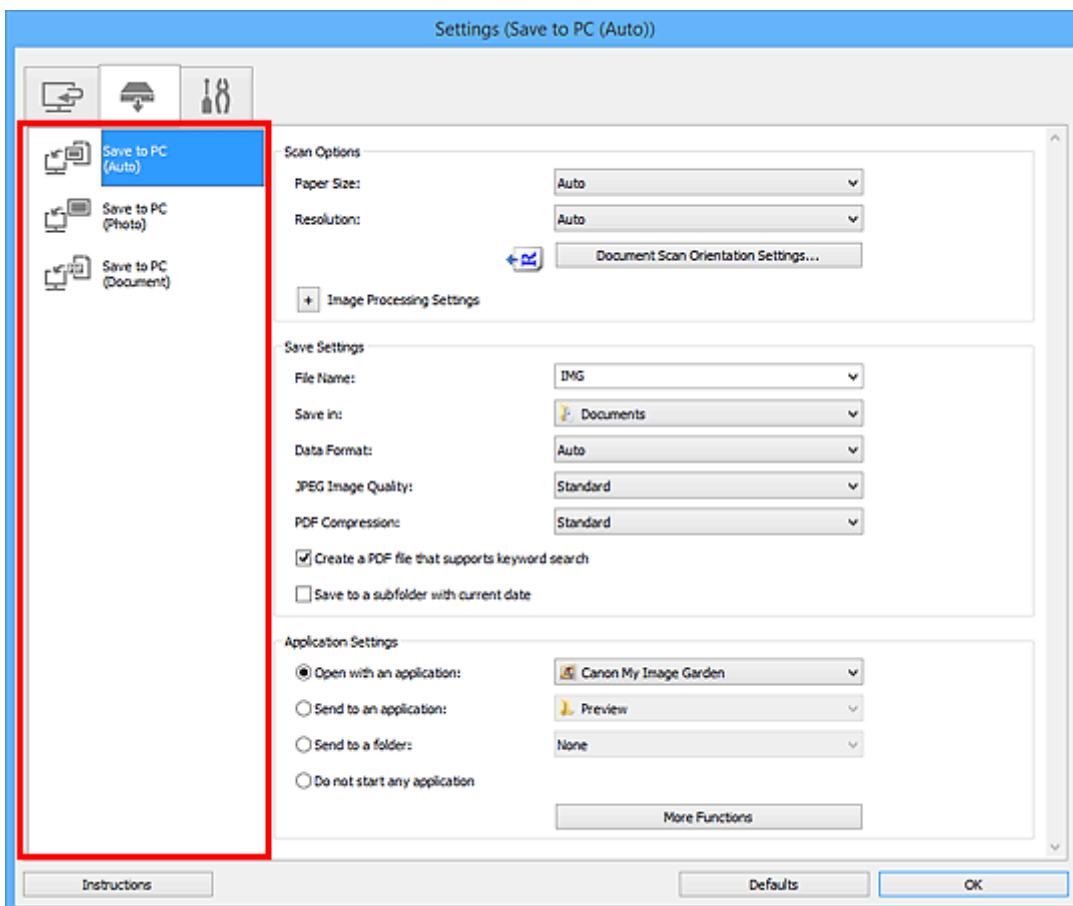

»»» Note

- Refer to the following for details.

- [Settings \(Save to PC \(Auto\)\) Dialog Box](#)
- [Settings \(Save to PC \(Photo\)\) Dialog Box](#)
- [Settings \(Save to PC \(Document\)\) Dialog Box](#)

4. Set **Scan Options**.

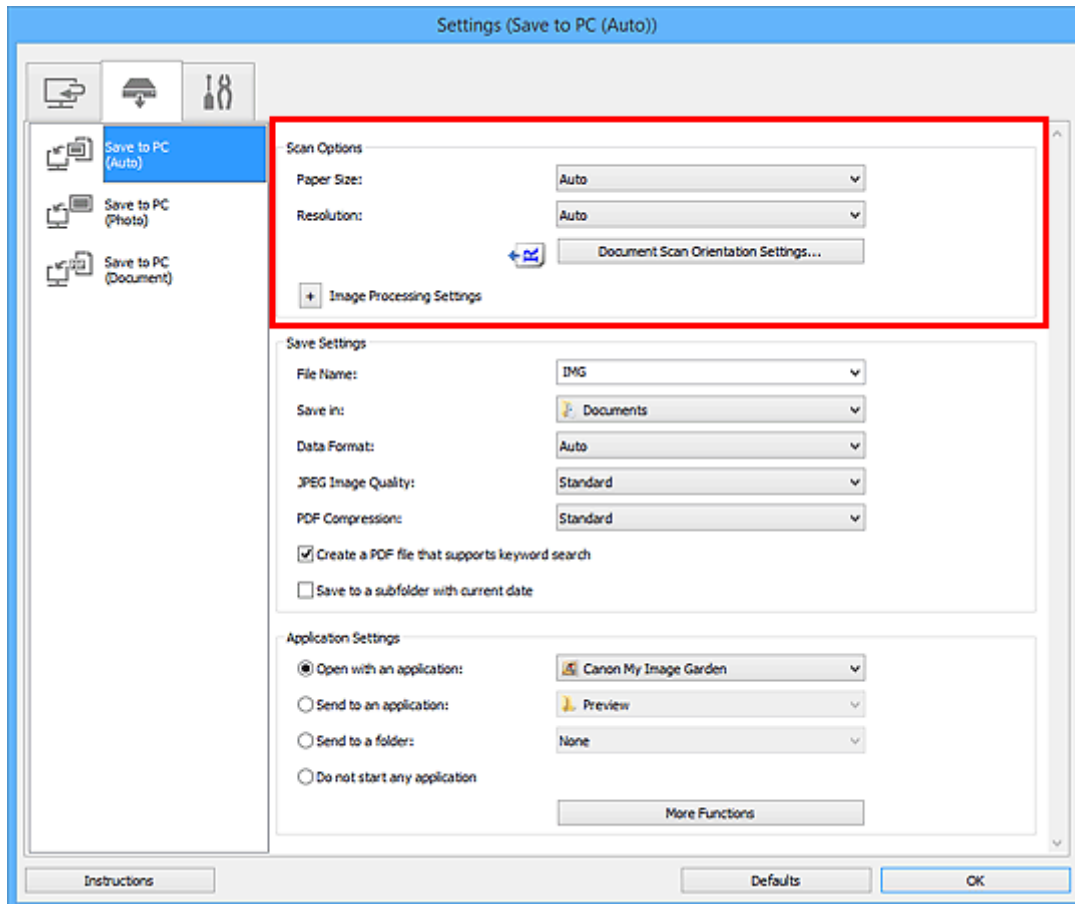

5. Specify the file name and other settings in **Save Settings**.

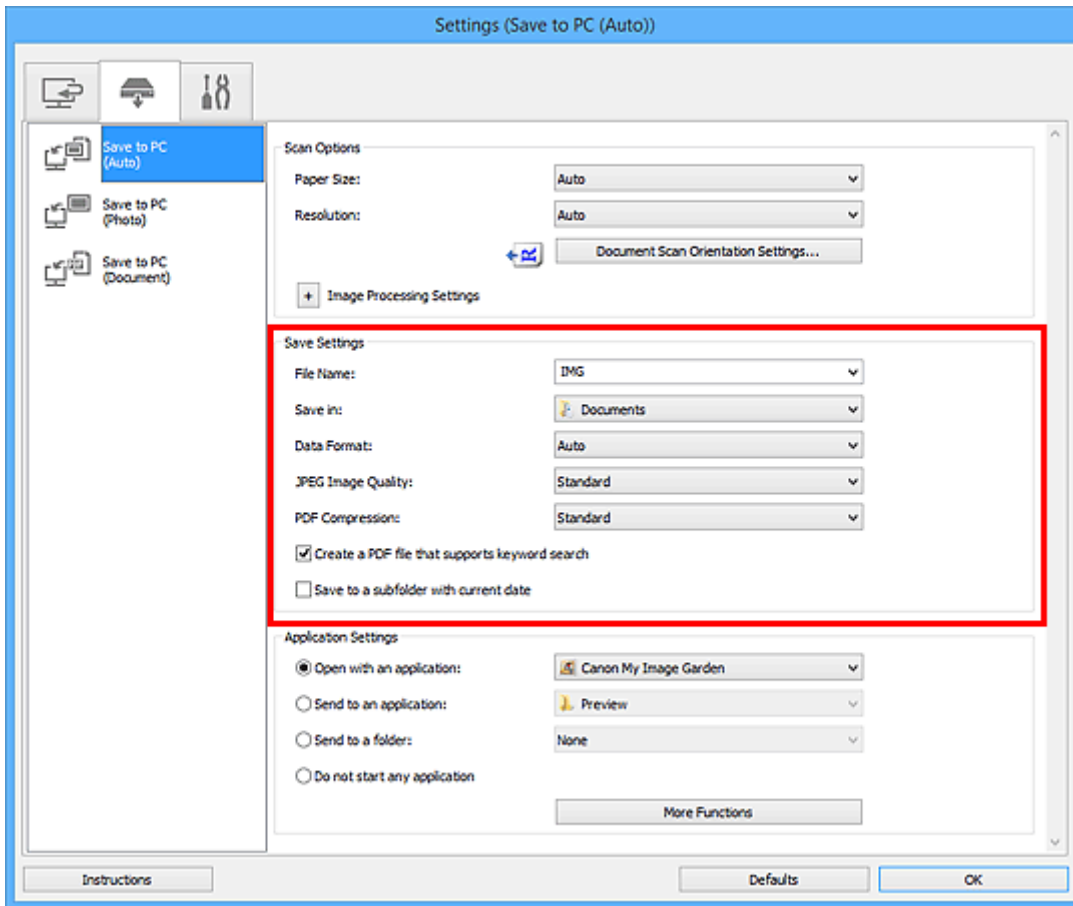

6. Select the application you want to start after scanning in **Application Settings**.

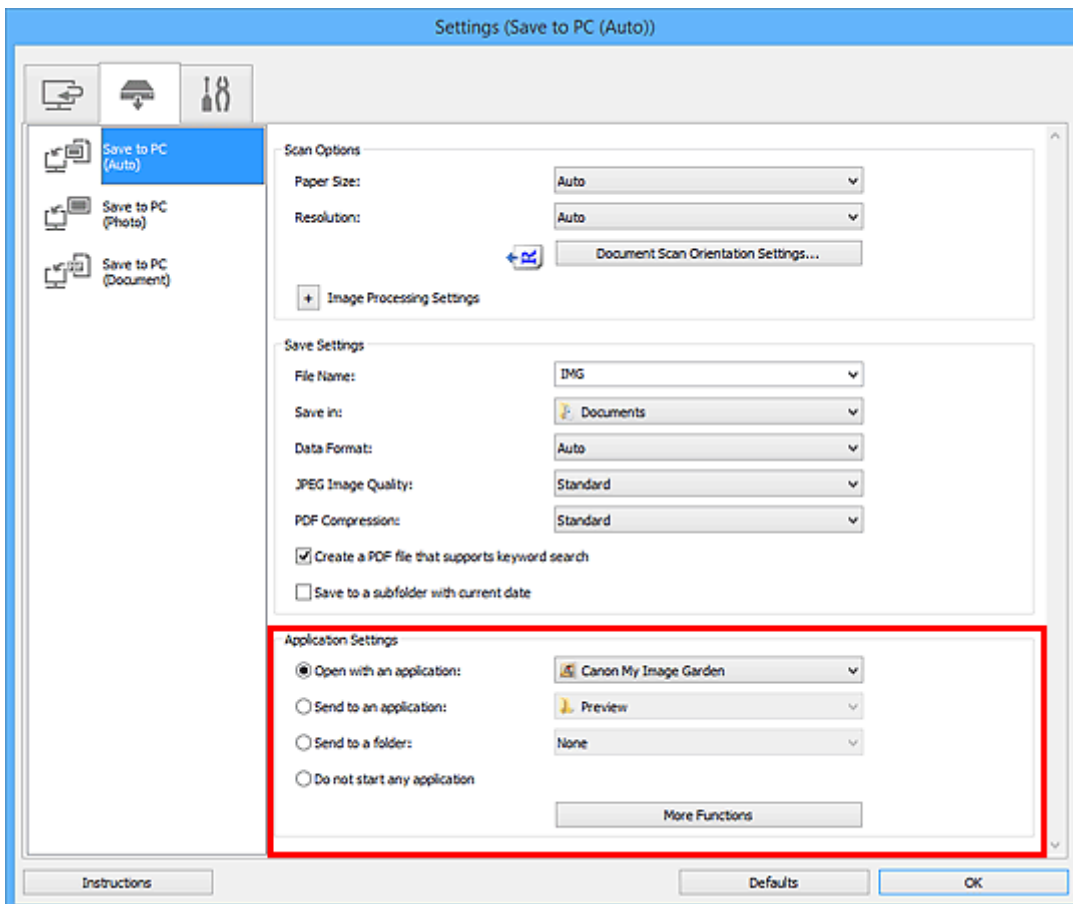

7. Click **OK**.

The responses will be executed according to the specified settings when you start scanning from the operation panel.

Faxing

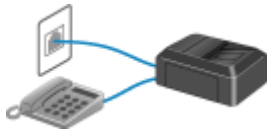

Preparing for Faxing



Sending Faxes Using the Operation Panel of the Machine



Registering Recipients



Receiving Faxes



Other Useful Fax Functions



Sending Faxes from a Computer

Preparing for Faxing

Connect the machine to the telephone line and set up the machine before using the faxing functions. Then specify the basic setting such as sender information, date/time, and daylight saving time.

▶▶▶ Important

- If the Power Disconnects Unexpectedly:

If there is a power failure or if you accidentally unplug the power cord, the date/time settings will be reset.

- The settings for user information and directory will be retained.
- All faxes stored in the machine's memory, such as unsent and received faxes, will be lost.

If the power disconnects, the following will apply:

- You will not be able to send or receive faxes, make copies, or scan originals.
- When you are connecting the telephone, whether or not you can use it depends upon your telephone line or telephone.

Setting Up the Machine

The machine must be set up depending on your telephone line and use of the faxing function. Follow the procedure below to set up the machine.

1. [Connecting the Telephone Line](#)

Connect the machine to your telephone line.

2. [Setting the Telephone Line Type](#)

Set the correct telephone line type for your telephone line.

3. [Setting the Receive Mode](#)

Set the receiving operation (receiving mode).

▶▶▶ Note

- You can set the fax setting according to the instruction on the LCD.

- [Easy setup](#)

If you set up according to the instruction on the LCD, the receive mode is set to **TEL priority mode** or **Fax only mode**. To receive faxes with **DRPD** or **Network switch**, change the receive mode.

- [Setting the Receive Mode](#)

Specifying the Basic Settings for Faxing

You can specify the basic setting such as sender information, date/time, and daylight saving time.

- [Setting the Sender Information](#)

Connecting the Telephone Line

The connection method differs depending on your telephone line.

- If you connect the machine to wall telephone line directly/If you connect the machine with the xDSL splitter:

■ [Basic Connection](#)

- If you connect the machine to another line such as an xDSL:

■ [Connecting Various Lines](#)

If the connection is incorrect, the machine cannot send/receive faxes. Connect the machine correctly.

▶▶▶ Important

- Do not connect fax machines and/or telephones in parallel (US and Canada only).

If two or more fax machines and/or telephones are connected in parallel, the following problems may occur and the machine may not operate properly.

- If you pick up the handset of the telephone that is connected in parallel during fax transmission or reception, the fax image may be corrupted or a communication error may occur.
- Such services as Caller ID, etc. may not operate properly on the telephone.

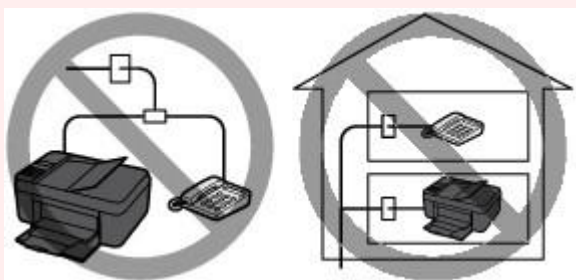

If you cannot avoid parallel connections, set the receive mode to **TEL priority mode**, understanding that the above problems may occur. You will only be able to receive faxes manually.

Basic Connection

Make sure that the machine is turned off, connect one end of supplied telephone line cable to the telephone line jack near the "LINE" mark of the machine, then connect the other end to the telephone line jack on the wall or to the telephone line jack of the xDSL splitter.

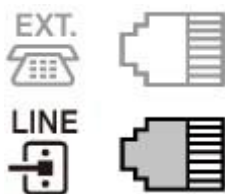

When you connect the telephone to the machine, make sure that the machine is turned off, connect one end of the modular cable to the external device jack near the "EXT." mark of the machine, then connect the other end to the telephone line jack of the telephone.

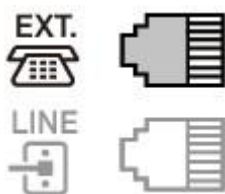

►►► Important

- Be sure to connect the telephone line before the machine is turned on.

If you connect the telephone line when the machine is turned on, turn the machine off and unplug the power cord. Wait for 1 minute then connect the telephone line and power plug.

►►► Note

- Refer to [Rear View](#) for the position of the telephone line jack and the external device jack.
- Before connecting a telephone or answering machine, remove the Telephone connector cap.
- **For users in the UK:**

If the connector of the external device cannot be connected to the jack on the machine, you will need to purchase a B.T. adapter to connect as follows:

Attach the B.T. adapter to the modular cable connecting the external device, then connect the B.T. adapter to the external device jack.

Connecting Various Lines

This section introduces how to connect various lines.

These are examples and could not be guaranteed to suit every connecting condition. For details, refer to the instruction manual supplied with the network device (control devices such as an xDSL (Digital Subscriber Line) modem or terminal adapter) you are connecting to this machine.

►►► Note

- xDSL is the generic term for the high speed digital communication technology with telephone line such as ADSL/HDSL/SDSL/VDSL.

• Connecting to an Internet Telephone

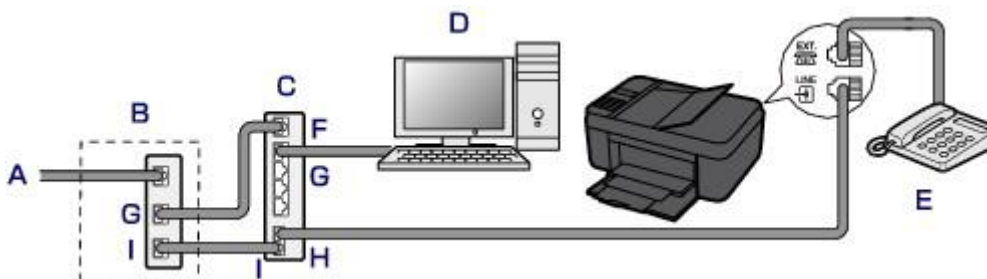

- A. Digital Subscriber Line
- B. xDSL modem (splitter may not be built-in to the modem)
- C. Broadband router compatible with Internet Telephone
- D. Computer
- E. Telephone or answering machine
- F. WAN (Wide Area Network) port
- G. LAN (Local Area Network) port
- H. TEL port
- I. LINE port

* Port configurations and names may vary depending on the product.

▶▶▶ Note

- When connecting to the xDSL line, select the same line type as you are subscribing to in **Telephone line type**.

■ [Setting the Telephone Line Type](#)

• Connecting to an xDSL

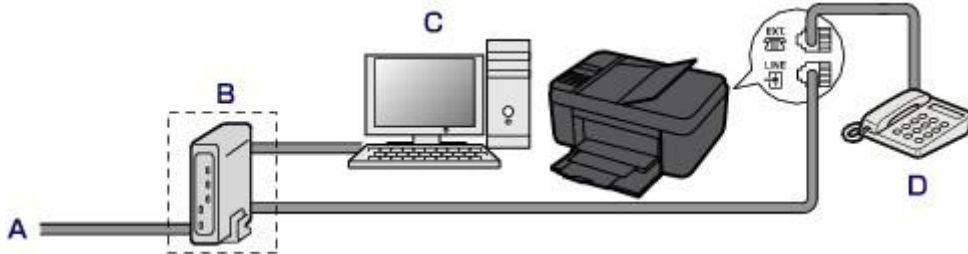

- A. Analog Subscriber Line
- B. xDSL modem (splitter may not be built-in to the modem)
- C. Computer
- D. Telephone or answering machine

▶▶▶ Important

- When the splitter is not built-in to the modem, do not branch the telephone line before the splitter (wall side). And also, do not connect splitters in parallel. The machine may not be able to operate properly.

▶▶▶ Note

- When connecting to the xDSL line, select the same line type as you are subscribing to in **Telephone line type**.

■ [Setting the Telephone Line Type](#)

• Connecting to an ISDN Line

For details on ISDN (Integrated Service Digital Network) connection and settings, refer to the manuals supplied with your terminal adapter or dial-up router.

Setting the Telephone Line Type

Before using your machine, make sure you set the correct telephone line type for your telephone line. If you are unsure of your telephone line type, contact your telephone company. For xDSL or ISDN connections, contact the telephone company or service provider to confirm your line type.

▶▶▶ Important

- **For users in China**

After plugging the power cord and turning on the machine, the telephone line type is selected automatically. However, if the machine is connected to the control device such as an xDSL modem or terminal adapter, the telephone line type may not be selected correctly.

In this case, set the line type manually.

For details on how to set the Telephone line type manually in China:

■ [Setting the Telephone Line Type Manually in China](#)

▶▶▶ Note

- **Telephone line type** will not appear in countries or regions where **Rotary pulse** is not supported.
- You can print USER'S DATA LIST to check the current setting.

■ [Summary of Reports and Lists](#)

1. [Make sure that the machine is turned on.](#)
2. Press the **Setup** button.
The **Setup menu** screen is displayed.
3. Use the ◀▶ button to select **Fax settings**, then press the **OK** button.
4. Use the ◀▶ button to select **FAX user settings**, then press the **OK** button.
5. Use the ◀▶ button to select **Telephone line type**, then press the **OK** button.
6. Use the ◀▶ button to select a telephone line type, then press the **OK** button.

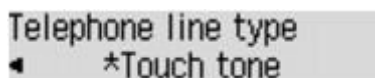

Telephone line type
◀ *Touch tone

Rotary pulse

Select when your telephone line type is pulse dialing.

Touch tone

Select when your telephone line type is tone dialing.

▶▶▶ Note

- The * (asterisk) on the LCD indicates the current setting.

7. Press the **FAX** button to return to the Fax standby screen.

Setting the Telephone Line Type Manually in China

This section describes the procedure to set the telephone line type manually in China.

1. [Make sure that the machine is turned on.](#)
2. Press the **Setup** button.
The **Setup menu** screen is displayed.
3. Use the ◀▶ button to select **Fax settings**, then press the **OK** button.
4. Use the ◀▶ button to select **FAX user settings**, then press the **OK** button.
5. Use the ◀▶ button to select **TEL line auto select**, then press the **OK** button.

The current telephone line type is displayed.

▶▶▶ Note

- If you do not need to change the telephone line type, press the **FAX** button to return to the Fax standby screen.

6. Use the ◀▶ button to select **OFF**, then press the **OK** button.
7. Use the ◀▶ button to select a telephone line type, then press the **OK** button.

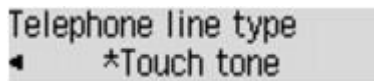

Telephone line type
◀ *Touch tone

Rotary pulse

Select when your telephone line type is pulse dialing.

Touch tone

Select when your telephone line type is tone dialing.

▶▶▶ Note

- The * (asterisk) on the LCD indicates the current setting.

8. Press the **FAX** button to return to the Fax standby screen.

Setting the Receive Mode

Set the receiving operation (receiving mode).

For details on how to set the receive mode:

■ [Setting the Receive Mode](#)

You can select the appropriate mode.

For details on the selectable receive mode:

■ [About the Receive Mode](#)

For details on the advanced settings of the receive mode:

■ [Advanced Settings of Receive Mode](#)

▶▶▶ Note

- The receiving operation procedure varies depending on the selected receive mode.

For details on receiving method depending on each receive mode:

■ [Receiving Faxes](#)

- If you want to use a single telephone line for faxes and voice calls, you need to connect a telephone or an answering machine to the external device jack of this machine.

For details on how to connect the telephone or the answering machine to the machine:

■ [Basic Connection](#)

Setting the Receive Mode

This section describes the procedure to select the receive mode.

1. [Make sure that the machine is turned on.](#)
2. Press the **FAX** button.
The Fax standby screen is displayed.
3. Press the **Menu** button.
The **FAX menu** screen is displayed.
4. Use the ◀▶ button to select **Receive mode set.**, then press the **OK** button.
5. Use the ◀▶ button to select the receive mode, then press the **OK** button.

The confirmation screen asking whether to make advanced settings is displayed.

If you select **Yes** and press the **OK** button, you can specify the advanced settings of each receive mode.

■ [Advanced Settings of Receive Mode](#)

▶▶▶ Note

- The * (asterisk) on the LCD indicates the current setting.
- For details on the receive mode:

■ [About the Receive Mode](#)

- **DRPD** is available only in the US and Canada.
- **Network switch** may not be available depending on the country or region of purchase.
- Refer to [Receiving Faxes](#) for information on receiving faxes or the procedure for each receive mode.

About the Receive Mode

You can select the receive mode suitable for your fax use conditions: whether you use a dedicated line for fax, etc.

Receive mode	Your fax use condition	Receiving operation
TEL priority mode	When mainly receiving voice calls (with a telephone or answering machine connected to the machine):	<p>When a call incomes, the telephone will ring.</p> <p>Pick up the handset.</p> <p>If the call is a voice call, talk on the telephone.</p> <p>If the call is a fax, hang up the handset after the machine starts receiving the fax.</p> <p>▶▶▶ Note</p> <ul style="list-style-type: none"> • The telephone may not ring when a call incomes even if it is connected to the machine, depending on the type or settings of the telephone.
DRPD or Network switch	When receiving voice calls (with a telephone or answering machine connected to the machine) and subscribing to a ring pattern detection service provided by your telephone company:	<p>When a call incomes, the telephone will ring. The machine detects a fax call by the fax ring pattern.</p> <p>If the call is a fax, the machine will receive the fax automatically.</p> <p>If the machine does not detect the fax ring pattern, the telephone will continue ringing.</p> <p>▶▶▶ Note</p> <ul style="list-style-type: none"> • The telephone may not ring when a call incomes even if it is connected to the machine, depending on the type or settings of the telephone.
Fax only mode	When not receiving voice calls:	When a fax incomes, the machine will receive the fax automatically.

Advanced Settings of Receive Mode

You can specify the advanced settings of each receive mode.

▶▶▶ Note

- The * (asterisk) on the LCD indicates the current setting.

- **Advanced setting in TEL priority mode**

You can specify the following setting items.

- **Manual/auto switch**

If you select **ON**, the machine automatically receives faxes after the external device rang a specified length of time.

You can specify the length of time until automatic reception is started.

- **User-friendly RX**

If you select **ON**, the machine automatically switches from telephone calling to fax reception by detecting the fax signal (CNG signal) when you lift the handset of the telephone or the answering machine answers. When you have an answering machine connected to the machine, select **ON** to switch to fax reception automatically after the answering machine answers.

If you select **OFF**, the machine does not switch from telephone calling to fax reception automatically even if the machine detects the fax signal (CNG signal). Select **OFF** if you want the machine not to switch automatically during a call.

▶▶▶ Note

- If you subscribe to Duplex Ringing service in Hong Kong, the number of times the external device rings specified with **Incoming ring** in **Fax only mode** is available in **TEL priority mode**.

If you want to specify the number of times the external device rings in **TEL priority mode**, select **Fax only mode** for **Receive mode set.** under **FAX menu**, specify the number of times the external device rings with **Incoming ring**, then switch to **TEL priority mode** for **Receive mode set.**

- If you subscribe to Duplex Ringing service in Hong Kong, we recommend that **Manual/auto switch** be set to **OFF**.

- **Advanced setting in Fax only mode**

You can specify the following setting item.

- **Incoming ring**

You can specify the number of times the external device rings when incoming.

- **Advanced setting in DRPD**

You can specify the following setting items.

- **DRPD: FAX ring pat.**

Sets the distinctive ring pattern of a call that the machine assumes is a fax call.

If you subscribe to a DRPD service, set the ring pattern to match the pattern assigned by your telephone company.

■ [Setting the DRPD Ring Pattern \(US and Canada only\)](#)

- **Incoming ring**

You can specify the number of times the external device rings when incoming.

- **Advanced setting in Network switch**

You can specify the following setting item.

- **Incoming ring**

You can specify the number of times the external device rings when incoming.

Setting the DRPD Ring Pattern (US and Canada only)

If you have subscribed to a Distinctive Ring Pattern Detection (DRPD) service provided by your telephone company, your telephone company will assign two or more telephone numbers with distinctive ring patterns to your single telephone line, allowing you to have different numbers for fax calls and voice calls using only one telephone line. Your machine will automatically monitor the ring pattern, and will automatically receive the fax if the ring pattern is a fax call.

To use DRPD, follow the procedure below to set the fax ring pattern that matches the pattern assigned by your telephone company.

▶▶▶ Note

- Contact your local telephone company for detailed information on this service.

1. [Make sure that the machine is turned on.](#)
2. Press the **FAX** button.
The Fax standby screen is displayed.
3. Press the **Menu** button.
The **FAX menu** screen is displayed.
4. Use the ◀▶ button to select **Receive mode set.**, then press the **OK** button.
5. Use the ◀▶ button to select **DRPD**, then press the **OK** button.
The confirmation screen asking whether to make advanced settings is displayed.
6. Use the ◀▶ button to select **Yes**, then press the **OK** button.
7. Use the ◀▶ button to select **DRPD: FAX ring pat.**, then press the **OK** button.
The **DRPD: FAX ring pat.** screen is displayed.
8. Use the ◀▶ button to select the ring pattern that your telephone company assigned to your fax number, then press the **OK** button.

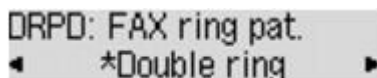

DRPD: FAX ring pat.
◀ *Double ring ▶

Select from **Normal ring**, **Double ring**, **Short-short-long**, or **Short-long-short**.

▶▶▶ Note

- The * (asterisk) on the LCD indicates the current setting.

9. Press the **FAX** button to return to the Fax standby screen.

Setting the Sender Information

You can set the sender information such as date/time, unit name, and unit fax/telephone number.

■ [About the Sender Information](#)

■ [Setting the Date and Time](#)

■ [Setting Daylight Saving Time \(Summer Time\)](#)

■ [Registering User Information](#)

About the Sender Information

If the unit name and unit fax/telephone number are registered, they are printed with date and time as sender information on the recipient's fax.

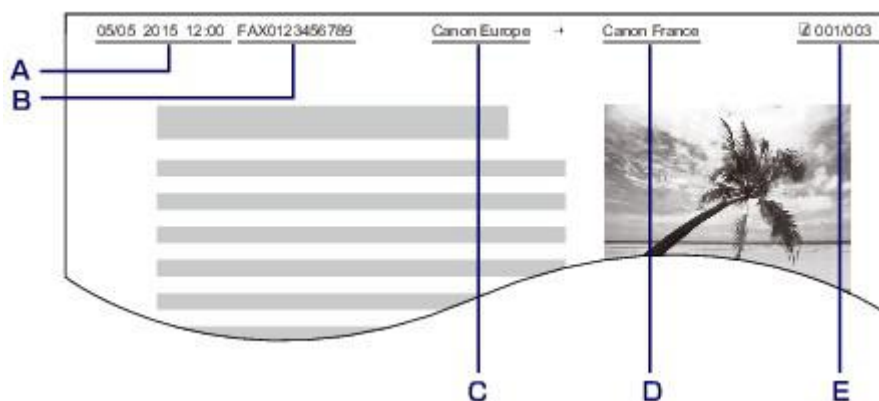

- A. Date and time of transmission
- B. Unit fax/telephone number
- C. Unit name
- D. The registered recipient's name is printed when sending faxes.
- E. Page number

►►► Note

- You can print USER'S DATA LIST to confirm the sender information you have registered.

■ [Summary of Reports and Lists](#)

- When sending faxes in black & white, you can select whether to print the sender information inside or outside the image area.

Specify the setting on **TTI position** in **Adv. FAX settings** under **Fax settings**.

■ [Adv. FAX settings](#)

- You can select the date print format from three formats: **YYYY/MM/DD**, **MM/DD/YYYY**, and **DD/MM/YYYY**.

Select the date print format on **Date display format** under **Dev. user settings**.

■ [Dev. user settings](#)

Setting the Date and Time

This section describes the procedure to set the date and time.

1. [Make sure that the machine is turned on.](#)
2. Press the **Setup** button.
The **Setup menu** screen is displayed.
3. Use the ◀▶ button to select **Device settings**, then press the **OK** button.
4. Use the ◀▶ button to select **Dev. user settings**, then press the **OK** button.
5. Use the ◀▶ button to select **Date/time setting**, then press the **OK** button.

6. Set the date and time.

Use the ◀▶ button to move the cursor under the desired position, then use the Numeric buttons to enter the date and time.

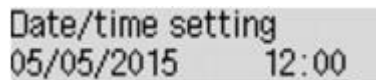

Date/time setting
05/05/2015 12:00

Enter the date and time in 24-hour format.

Enter only the last two digits of the year.

7. Press the **OK** button.
8. Press the **FAX** button to return to the Fax standby screen.

Setting Daylight Saving Time (Summer Time)

Some countries adopt the daylight saving time (summer time) system that shifts the clock time forward at certain periods of the year.

You can set your machine to automatically change the time by registering the date and time that daylight saving time (summer time) begins and ends.

▶▶▶ Important

- Not all the latest information of all countries or regions is applied for **DST setting** by default. You need to change the default setting according to the latest information of your country or region.

▶▶▶ Note

- This setting may not be available depending on the country or region of purchase.

1. [Make sure that the machine is turned on.](#)
2. Press the **Setup** button.
The **Setup menu** screen is displayed.
3. Use the ◀▶ button to select **Device settings**, then press the **OK** button.

4. Use the ◀▶ button to select **Dev. user settings**, then press the **OK** button.

5. Use the ◀▶ button to select **DST setting**, then press the **OK** button.

6. Use the ◀▶ button to select **ON**, then press the **OK** button.

To disable summer time, select **OFF**.

7. Set the date and time when summer time starts.

1. Use the ◀▶ button to select **Start date/time**, then press the **OK** button.

2. Make sure that **Set month** is selected, then press the **OK** button.

3. Use the ◀▶ button to select the month when summer time starts, then press the **OK** button.

4. Make sure that **Set week** is selected, then press the **OK** button.

5. Use the ◀▶ button to select the week when summer time starts, then press the **OK** button.

6. Make sure that **Set day of week** is selected, then press the **OK** button.

7. Use the ◀▶ button to select the day of the week when summer time starts, then press the **OK** button.

8. Make sure that **Set shift time** is selected, then press the **OK** button.

9. Use the ◀▶ button to move the cursor under the desired position, use the Numeric buttons to enter the time (in 24-hour format) when summer time starts, then press the **OK** button.

Precede single digits with a zero.

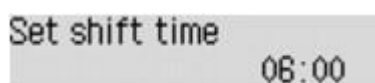
A screenshot of a device's settings menu. The text 'Set shift time' is displayed at the top. Below it, the time '06:00' is shown, with a small cursor under the first zero of the minutes.

8. Set the date and time when summer time ends.

1. Use the ◀▶ button to select **End date/time**, then press the **OK** button.

2. Make sure that **Set month** is selected, then press the **OK** button.

3. Use the ◀▶ button to select the month when summer time ends, then press the **OK** button.

4. Make sure that **Set week** is selected, then press the **OK** button.

5. Use the ◀▶ button to select the week when summer time ends, then press the **OK** button.

6. Make sure that **Set day of week** is selected, then press the **OK** button.

7. Use the ◀▶ button to select the day of the week when summer time ends, then press the **OK** button.

8. Make sure that **Set shift time** is selected, then press the **OK** button.

9. Use the ◀▶ button to move the cursor under the desired position, use the Numeric buttons to enter the time (in 24-hour format) when summer time ends, then press the **OK** button.

Precede single digits with a zero.

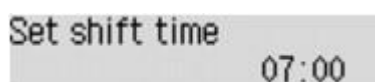
A screenshot of a device's settings menu. The text 'Set shift time' is displayed at the top. Below it, the time '07:00' is shown, with a small cursor under the first zero of the minutes.

9. Press the **FAX** button to return to the Fax standby screen.

Registering User Information

This section describes the procedure to register the user information.

►► Note

- Before sending a fax, be sure to enter your name and fax/telephone number in **Unit TEL no. registr.** and **Unit name registr.** on the **FAX user settings** screen (for US only).

1. [Make sure that the machine is turned on.](#)
2. Press the **Setup** button.
The **Setup menu** screen is displayed.
3. Use the ◀▶ button to select **Fax settings**, then press the **OK** button.
4. Use the ◀▶ button to select **FAX user settings**, then press the **OK** button.
5. Enter the unit fax/telephone number.
 1. Make sure that **Unit TEL no. registr.** is selected, then press the **OK** button.
 2. Use the Numeric buttons to enter the unit fax/telephone number.

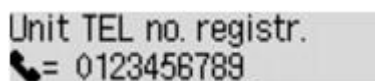

Unit TEL no. registr.
☎= 0123456789

3. Press the **OK** button.

►► Note

- You can enter the fax/telephone number up to 20 digits, including spaces.
- For details on how to enter or delete characters:

■ [Entering Numbers, Letters, and Symbols](#)

6. Enter the unit name.
 1. Make sure that **Unit name registr.** is selected, then press the **OK** button.
 2. Use the Numeric buttons to enter the unit name.

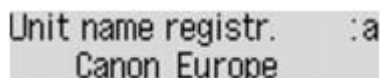

Unit name registr. :a
Canon Europe

3. Press the **OK** button.

►► Note

- You can enter the name up to 24 characters, including spaces.
- For details on how to enter or delete characters:

■ [Entering Numbers, Letters, and Symbols](#)

7. Press the **FAX** button to return to the Fax standby screen.

Sending Faxes Using the Operation Panel of the Machine

- ▶ **Sending Faxes by Entering Fax/Telephone Number** 📌 **Basic**
- ▶ **Resending Faxes (Redialing a Busy Number)**
- ▶ **Setting Items for Sending Faxes**
- ▶ **Sending Faxes Using Useful Functions**

Sending Faxes by Entering Fax/Telephone Number

This section describes dialing and sending faxes directly by entering the fax/telephone numbers.

▶▶▶ Important

- It may be possible that faxes will reach unintended recipients due to the misdialing or incorrect registration of fax/telephone numbers. When you send important documents, we recommend that you send them after speaking on the telephone.

■ [Sending a Fax after Speaking on Telephone](#)

1. [Make sure that the machine is turned on.](#)

2. Press the **FAX** button.

The Fax standby screen is displayed.

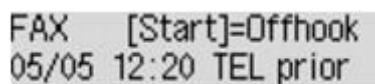

FAX [Start]=Offhook
05/05 12:20 TEL prior

3. [Load documents on the platen glass or in the ADF.](#)

▶▶▶ Important

- When sending a double-sided document, load the document on the platen glass. Double-sided documents cannot be automatically scanned and sent from the ADF.

▶▶▶ Note

- For details on the types, conditions of document, and how to load the document:

■ [Loading Originals](#)

4. Adjust the scan contrast and resolution as necessary.

■ [Setting Items for Sending Faxes](#)

5. Use the Numeric buttons to dial the recipient's fax/telephone number.

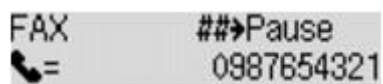

FAX ##→Pause
☎= 0987654321

Use the following buttons to dial the recipient's fax/telephone number.

Numeric buttons:

Enters the number.

▶ button:

Enters a space.

◀ button:

Deletes the last character you entered.

button:

By pressing this button once, "#" is entered. By pressing this button one more time, "P" is entered.

6. Press the **Color** button for color transmission, or the **Black** button for black & white transmission.

The machine starts scanning the document.

▶▶▶ Important

- Color transmission is available only when the recipient's fax machine supports color faxing.
- Do not open the document cover until scanning is completed.

7. Start sending.

- **If you load the document in the ADF:**

The machine scans the document automatically and starts sending the fax.

▶▶▶ Note

- To cancel a fax transmission, press the **Stop** button. To cancel a fax transmission while it is in progress, press the **Stop** button, then follow the instructions on the LCD.
- If documents remain in the ADF after the **Stop** button is pressed while scanning is in progress, **Close the feeder cover [OK]Eject the document** is displayed on the LCD. By pressing the **OK** button, the remaining documents are automatically ejected.

- **If you load the document on the platen glass:**

After scanning the document, the confirmation screen asking you if you load the next document is displayed.

To send the scanned document, press the **OK** button to start sending it.

▶▶▶ Note

- To send two or more pages, follow the message to load the next page, and press the **Color** or **Black** button. After scanning all pages, press the **OK** button to start sending.
- To cancel sending the fax, press the **Stop** button.

▶▶▶ Note

- When your machine is connected to a PBX (Private Branch Exchange) system, refer to the operating instructions of the system for details on dialing the recipient's fax/telephone number.
- In case the machine was not able to send a fax, such as when the recipient's line was busy, it has the function to automatically redial the number after a specified interval. Automatic redialing is enabled by default.

■ [Automatic Redialing](#)

- Unsent documents, such as those pending redial, are stored in the machine's memory. They are not stored in the case of a sending error.

■ [Document Stored in Machine's Memory](#)

- Do not unplug the power cord until all documents are sent. If you unplug the power cord, all unsent documents stored in the machine's memory are lost.

Resending Faxes (Redialing a Busy Number)

There are two methods of redialing: Automatic redialing and Manual redialing.

- Automatic Redialing

If you send a document and the recipient's line is busy, the machine will redial the number after a specified interval.

■ [Automatic Redialing](#)

- Manual Redialing

You can redial to the recipients dialed using the Numeric buttons.

■ [Manual Redialing](#)

▶▶▶ Important

- It may be possible that faxes will reach unintended recipients due to the misdialing or incorrect registration of fax/telephone numbers. When you send important documents, we recommend that you send them after speaking on the telephone.

■ [Sending a Fax after Speaking on Telephone](#)

▶▶▶ Note

- Automatic redialing is enabled by default.
- For details on the basic sending operations:

■ [Sending Faxes by Entering Fax/Telephone Number](#)

Automatic Redialing

You can enable or disable automatic redialing. If you enable automatic redialing, you can specify the maximum number of redial attempts and the length of time the machine waits between redial attempts.

Enable and specify the automatic redialing setting on **Auto redial** in **Adv. FAX settings** under **Fax settings**.

■ [Adv. FAX settings](#)

▶▶▶ Important

- While automatic redialing, the unsent fax is stored in the machine's memory temporarily until the sending fax is complete. If a power failure occurs or you unplug the power cord before automatic redialing is complete, all faxes stored in the machine's memory are deleted and not sent.

▶▶▶ Note

- To cancel automatic redialing, wait until the machine starts redialing, then press the **Stop** button.
- To cancel automatic redialing, delete the unsent fax from the machine's memory while the machine is on-standby for a redial operation. For details, see [Deleting a Document in Machine's Memory](#).

Manual Redialing

Follow the procedure below for manual redialing.

1. [Make sure that the machine is turned on.](#)

2. Press the **FAX** button.

The Fax standby screen is displayed.

3. [Load documents on the platen glass or in the ADF.](#)

4. Adjust the scan contrast and resolution as necessary.

■ [Setting Items for Sending Faxes](#)

5. Press the **Menu** button.

The **FAX menu** screen is displayed.

6. Use the ◀▶ button to select **Redial**, then press the **OK** button.

The **Redial** screen is displayed.



7. Use the ◀▶ button to select the recipient's number to redial, then press the **OK** button.

8. Press the **Color** button for color transmission, or the **Black** button for black & white transmission.

▶▶ Important

- Color transmission is available only when the recipient's fax machine supports color faxing.

▶▶ Note

- For manual redialing, the machine memorizes up to 10 recent recipients dialed by entering the fax/telephone numbers. Note that the machine does not memorize any recipients dialed using the redial function or selecting from the directory.
- To cancel manual redialing, press the **Stop** button. To cancel a fax transmission while it is in progress, press the **Stop** button, then follow the instructions on the LCD.
- If documents remain in the ADF after the **Stop** button is pressed while scanning is in progress, **Close the feeder cover [OK]Eject the document** is displayed on the LCD. By pressing the **OK** button, the remaining documents are automatically ejected.

Setting Items for Sending Faxes

If you select **FAX TX settings** after pressing the **Menu** button on the Fax standby screen, you can specify the settings of the scan contrast and the scan resolution.

Adjust the scan contrast and resolution following the procedure below.

1. Press the **Menu** button on the Fax standby screen.

The **FAX menu** screen is displayed.

2. Use the ◀▶ button to select **FAX TX settings**, then press the **OK** button.

3. Use the ◀▶ button to select **Scan contrast**, then press the **OK** button.

The **Scan contrast** screen is displayed.

4. Use the ◀▶ button to select the scan contrast, then press the **OK** button.



The ◀ button decreases the scan contrast, and the ▶ button increases the scan contrast.

By pressing the **OK** button, the LCD returns to the **FAX TX settings** screen.

5. Use the ◀▶ button to select **Scan resolution**, then press the **OK** button.

The **Scan resolution** screen is displayed.

6. Use the ◀▶ button to select the scan resolution.

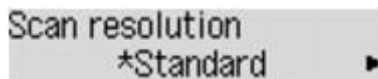

The following settings are selectable on **Scan resolution**.

Standard

Suitable for text-only documents.

Fine

Suitable for fine-print documents.

Extra fine

Suitable for detailed illustration or fine-print quality documents.

If the recipient's fax machine is not compatible with **Extra fine** (300 x 300 dpi), the fax will be sent in the **Standard** or **Fine** resolution.

Photo

Suitable for photographs.

▶▶▶ **Note**

- The * (asterisk) on the LCD indicates the current setting.

- When sending a color fax, documents are always scanned in the same resolution (200 x 200 dpi). The image quality (compression rate) is determined by which scan resolution is selected, except that **Extra fine** and **Photo** provide the same image quality.
-

7. Press the **OK** button.

The LCD returns to the Fax standby screen.

Sending Faxes Using Useful Functions

- ▶ **Sending a Fax after Speaking on Telephone**
- ▶ **Sending a Fax to the Registered Recipient**
- ▶ **Sending the Same Document to Several Recipients (Sequential Broadcasting)**
- ▶ **Preventing Mistransmission of Faxes**
- ▶ **Using the On Hook Dial Function**

Sending a Fax after Speaking on Telephone

If you want to speak to the recipient before sending a fax, or if the recipient does not have a fax machine that can receive faxes automatically, send a fax manually after speaking to the recipient on the telephone to check whether the recipient can receive faxes.

►► Important

- It may be possible that faxes will reach unintended recipients due to the misdialing or incorrect registration of fax/telephone numbers. When you send important documents, we recommend that you send them after speaking on the telephone. See below for the procedure to send a fax manually.
- With manual transmission, you cannot use the platen glass to load documents. Load the documents in the ADF.

When loading document on the platen glass, send a fax with automatic transmission.

■ [Sending Faxes by Entering Fax/Telephone Number](#)

- To speak to the recipient before sending a fax, you need to connect a telephone to the machine. For details on how to connect the telephone to the machine:

■ [Basic Connection](#)

►► Note

- For details on the basic sending operations:

■ [Sending Faxes by Entering Fax/Telephone Number](#)

1. [Make sure that the machine is turned on.](#)

2. Press the **FAX** button.

The Fax standby screen is displayed.

3. [Load documents in the ADF.](#)

4. Adjust the scan contrast and resolution as necessary.

■ [Setting Items for Sending Faxes](#)

5. Lift the handset of the telephone connected to the machine.

6. Use the telephone to dial the recipient's fax/telephone number.

7. Speak to the recipient.

When you hear a high-pitched signal instead of the recipient's voice, you cannot check whether the recipient can receive faxes. If you want to stop sending the fax, replace the handset. If you want to send the fax, go to step 9.

8. Ask the recipient to set the recipient's fax machine to receive faxes.

9. When you hear a high-pitched signal, press the **Color** button or the **Black** button.

Press the **Color** button for color transmission, or the **Black** button for black & white transmission.

Important

- Color transmission is available only when the recipient's fax machine supports color faxing.

10. Hang up the handset.

Note

- To cancel a fax transmission, press the **Stop** button. To cancel a fax transmission while it is in progress, press the **Stop** button, then follow the instructions on the LCD.
- If documents remain in the ADF after the **Stop** button is pressed while scanning is in progress, **Close the feeder cover [OK]Eject the document** is displayed on the LCD. By pressing the **OK** button, the remaining documents are automatically ejected.

Sending a Fax to the Registered Recipient

Registering recipient's fax/telephone number and name in the machine's directory enables you to send faxes easily.

▶▶▶ Important

- It may be possible that faxes will reach unintended recipients due to the misdialing or incorrect registration of fax/telephone numbers. When you send important documents, we recommend that you send them after speaking on the telephone.

■ [Sending a Fax after Speaking on Telephone](#)

▶▶▶ Note

- For details on the basic sending operations:

■ [Sending Faxes by Entering Fax/Telephone Number](#)

1. [Make sure that the machine is turned on.](#)
2. Press the **FAX** button.
The Fax standby screen is displayed.
3. [Load documents on the platen glass or in the ADF.](#)
4. Adjust the scan contrast and resolution as necessary.

■ [Setting Items for Sending Faxes](#)

5. Press the **Menu** button.
The **FAX menu** screen is displayed.
6. Use the ◀▶ button to select **Directory**, then press the **OK** button.
The screen to select a registered recipient is displayed.
7. Select a registered recipient.

You can choose a recipient with the two methods. The method can be switched by pressing the  button.

- When the following screen is displayed on the LCD:



Use the ◀▶ button to select a recipient, then press the **OK** button.

- When **Enter first letter** is displayed on the LCD:

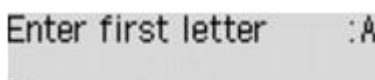

After you use the Numeric buttons to enter the first letter of the recipient's name you want to search, the registered recipients are displayed in alphabetical order.

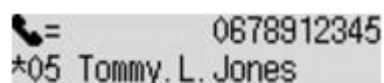

☎= 0678912345
*05 Tommy L. Jones

Use the ◀▶ button to select a recipient, then press the **OK** button.

8. Press the **Color** button for color transmission, or the **Black** button for black & white transmission.

▶▶▶ Important

- Color transmission is available only when the recipient's fax machine supports color faxing.

▶▶▶ Note

- To cancel a fax transmission, press the **Stop** button. To cancel a fax transmission while it is in progress, press the **Stop** button, then follow the instructions on the LCD.
- If documents remain in the ADF after the **Stop** button is pressed while scanning is in progress, **Close the feeder cover [OK]Eject the document** is displayed on the LCD. By pressing the **OK** button, the remaining documents are automatically ejected.
- In case the machine was not able to send a fax, such as when the recipient's line was busy, it has the function to automatically redial the number after a specified interval. Automatic redialing is enabled by default.

■ Automatic Redialing

To cancel automatic redialing, wait until the machine starts redialing, then press the **Stop** button.

Sending the Same Document to Several Recipients (Sequential Broadcasting)

This machine allows you to prepare for sending the same document to a maximum of 21 recipients in one operation. The recipients can be specified by entering the fax/telephone numbers and selecting the registered recipients (the particular recipient's number and the group dial) in combination.

The following number of recipients can be specified in combination.

- The recipient registered to the machine:
Up to 20 (total of the particular recipient's number and the group dial)
- Entering the fax/telephone numbers or redialing:
1

▶▶ Important

- It may be possible that faxes will reach unintended recipients due to the misdialing or incorrect registration of fax/telephone numbers. When you send important documents, we recommend that you send them one by one after speaking on the telephone.

■ [Sending a Fax after Speaking on Telephone](#)

▶▶ Note

- If you frequently send documents to the same group of recipients, you can group these numbers for group dialing. This will allow you to send documents to all the recipients in the group by simply operation.

■ [Registering Recipients in Group Dial](#)

- For details on the basic sending operations:

■ [Sending Faxes by Entering Fax/Telephone Number](#)

1. [Make sure that the machine is turned on.](#)
2. Press the **FAX** button.
The Fax standby screen is displayed.
3. [Load documents on the platen glass or in the ADF.](#)
4. Adjust the scan contrast and resolution as necessary.

■ [Setting Items for Sending Faxes](#)

5. Specify the first recipient.

Specify the first recipient with the one of the following methods.

- By specifying with the recipient registered to the machine:
Press the **Menu** button, use the ◀▶ button to select **Directory**, then press the **OK** button. Next, use the ◀▶ button to select a recipient, then press the **OK** button.

■ [Sending a Fax to the Registered Recipient](#)

- By entering the fax/telephone numbers:

Use the Numeric buttons to enter the recipient's fax/telephone number, then press the **OK** button.

■ [Sending Faxes by Entering Fax/Telephone Number](#)

▶▶▶ **Note**

- If **FAX no. re-entry** in **Security control** under **Fax settings** is set to **ON**, use the Numeric buttons again to enter the number, then press the **OK** button.

■ [Security control](#)

- By redialing:

Press the **Menu** button, use the ◀▶ button to select **Redial**, then press the **OK** button. Next, use the ◀▶ button to select the number you want to dial, then press the **OK** button.

■ [Manual Redialing](#)

6. Add the recipient.

If you have already specified the recipient by entering the fax/telephone numbers or if you have already specified the recipient from the outgoing call logs, specify a recipient from the registered recipients.

Broadcasting is displayed after specifying the multiple recipients.

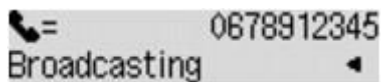

If you want to add the recipient further, repeat the same procedure.

▶▶▶ **Note**

- When **Broadcasting** is displayed, you can review the numbers you have entered by pressing the ◀▶ button.
- Pressing the **Back** button allows you to delete the recipient's number you entered last.

7. Press the **Color** button for color transmission, or the **Black** button for black & white transmission.

▶▶▶ **Important**

- Color transmission is available only when the recipient's fax machine supports color faxing.

▶▶▶ **Note**

- To cancel a fax transmission, press the **Stop** button. To cancel a fax transmission while it is in progress, press the **Stop** button, then follow the instructions on the LCD.
- If documents remain in the ADF after the **Stop** button is pressed while scanning is in progress, **Close the feeder cover [OK]Eject the document** is displayed on the LCD. By pressing the **OK** button, the remaining documents are automatically ejected.
- When you press the **Stop** button, fax transmission to all the recipients specified will be canceled. You cannot cancel a fax transmission to only one recipient.

Preventing Mistransmission of Faxes

This machine has two functions for preventing the mistransmission of faxes.

- Sending faxes after entering the fax/telephone number twice

This function requires you to re-enter the fax/telephone number after entering the number using the Numeric buttons, so that the machine prevents you from misdialing.

■ [Sending Faxes after Dialing Twice \(Fax Number Re-entry\)](#)

- Sending faxes after the machine checks the recipient's fax machine information

Before sending a fax, the machine checks whether the recipient's fax machine information matches the dialed number.

■ [Sending Faxes after Checking Information \(Checking the Recipient's Information\)](#)

Sending Faxes after Dialing Twice (Fax Number Re-entry)

Set **FAX no. re-entry** to **ON** following the procedure below.

1. [Make sure that the machine is turned on.](#)
2. Press the **Setup** button.
The **Setup menu** screen is displayed.
3. Use the ◀▶ button to select **Fax settings**, then press the **OK** button.
4. Use the ◀▶ button to select **Security control**, then press the **OK** button.
5. Use the ◀▶ button to select **FAX no. re-entry**, then press the **OK** button.
6. Use the ◀▶ button to select **ON**, then press the **OK** button.

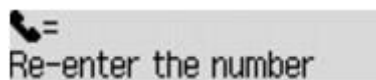

▶▶▶ Note

- If the number is not identical with the number entered first, the Fax standby screen is displayed.

Sending Faxes after Checking Information (Checking the Recipient's Information)

Set **Check RX FAX info** to **ON** following the procedure below.

▶▶▶ Important

- This function is not available when you send a fax manually.

■ [Sending a Fax after Speaking on Telephone](#)

1. [Make sure that the machine is turned on.](#)

2. Press the **Setup** button.

The **Setup menu** screen is displayed.

3. Use the ◀▶ button to select **Fax settings**, then press the **OK** button.

4. Use the ◀▶ button to select **Security control**, then press the **OK** button.

5. Use the ◀▶ button to select **Check RX FAX info**, then press the **OK** button.

6. Use the ◀▶ button to select **ON**, then press the **OK** button.

▶▶ Important

- Transmission will be canceled if the machine fails to receive the recipient's fax information or if the received information does not match the fax/telephone number.

Using the On Hook Dial Function

Follow the procedure below to send faxes with the on hook dial function.

▶▶▶ Important

- It may be possible that faxes will reach unintended recipients due to the misdialing or incorrect registration of fax/telephone numbers. When you send important documents, we recommend that you send them after speaking on the telephone.

■ [Sending a Fax after Speaking on Telephone](#)

- With manual transmission, you cannot use the platen glass to load documents. Load the documents in the ADF.

When loading document on the platen glass, send a fax with automatic transmission.

■ [Sending Faxes by Entering Fax/Telephone Number](#)

▶▶▶ Note

- You can use the on hook dial function only when **Hook setting** in **Security control** under **Fax settings** is set to **Enable**.

■ [Security control](#)

- For details on the basic sending operations:

■ [Sending Faxes by Entering Fax/Telephone Number](#)

1. [Make sure that the machine is turned on.](#)

2. Press the **FAX** button.

The Fax standby screen is displayed.

3. [Load documents in the ADF.](#)

4. Adjust the scan contrast and resolution as necessary.

■ [Setting Items for Sending Faxes](#)

5. Press the **Color** button or the **Black** button.

6. Specify the recipient.

Specify the recipient with the one of the following methods.

- By specifying with the recipient registered to the machine:

Press the **Menu** button, use the ◀▶ button to select **Directory**, then press the **OK** button. Next, use the ◀▶ button to select a recipient, then press the **OK** button.

■ [Sending a Fax to the Registered Recipient](#)

- By entering the fax/telephone numbers:

Use the Numeric buttons to enter the recipient's fax/telephone number.

■ [Sending Faxes by Entering Fax/Telephone Number](#)

- Manual redialing:

Press the **Menu** button, use the ◀▶ button to select **Redial**, then press the **OK** button. Next, use the ◀▶ button to select the number you want to dial, then press the **OK** button.

■ [Manual Redialing](#)

7. When you hear a high-pitched signal, press the **Color** button or the **Black** button.

Press the **Color** button for color transmission, or the **Black** button for black & white transmission.

▶▶ Important

- Color transmission is available only when the recipient's fax machine supports color faxing.

▶▶ Note

- To cancel a fax transmission, press the **Stop** button. To cancel a fax transmission while it is in progress, press the **Stop** button, then follow the instructions on the LCD.
- If documents remain in the ADF after the **Stop** button is pressed while scanning is in progress, **Close the feeder cover [OK]Eject the document** is displayed on the LCD. By pressing the **OK** button, the remaining documents are automatically ejected.

Registering Recipients

- ▶ Registering Recipients Using the Operation Panel of the Machine
- ▶ Registering Recipients Using Speed Dial Utility

Registering Recipients Using the Operation Panel of the Machine

Registering recipients in the machine's directory in advance allows you to dial fax/telephone numbers simply.

The following methods to register are available:

- Recipient registration

Registering the recipient's fax/telephone number and name allows you to send a fax by selecting a registered recipient in the machine directory.

■ [Registering the Fax/Telephone Number of Recipients](#)

- Group dial registration

You can combine two or more recipients registered in advance into a group. You can send the same document to all the registered recipients in the group.

■ [Registering Recipients in Group Dial](#)

You can register up to 100 recipients in total of individual recipients and group dials.

▶▶▶ Note

- To change the registered information of the recipient or the group dial, see [Changing Registered Information](#).
- To delete the registered information of the recipient or the group dial, see [Deleting Registered Information](#).
- To print a list of the recipient's fax/telephone numbers and names registered, see [Printing a List of the Registered Destinations](#).
- You can register, change, or delete the registered information of the recipient or the group dial using Speed Dial Utility on the computer.

■ [Registering Recipients Using Speed Dial Utility](#)

Registering the Fax/Telephone Number of Recipients

Before you can use the machine's directory, you need to register the recipients' fax/telephone numbers. Follow the procedure below to register the recipients' fax/telephone numbers.

1. [Make sure that the machine is turned on.](#)

2. Press the **Setup** button.

The **Setup menu** screen is displayed.

3. Use the ◀▶ button to select **Fax settings**, then press the **OK** button.

4. Use the ◀▶ button to select **TEL no. registration**, then press the **OK** button.

5. Use the ◀▶ button to select **Add directory entry**, then press the **OK** button.

6. Use the ◀▶ button to select **Recipient**, then press the **OK** button.

The screen to select an ID number is displayed.

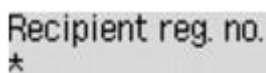

Recipient reg. no.
★

7. Use the ◀▶ button or the Numeric buttons to select an unregistered ID number, then press the **OK** button.

▶▶▶ Note

- If you already registered the recipient, the fax/telephone number is displayed next to the ID number. If you already registered the group dial, **(Not available)** is displayed.

8. Use the ◀▶ button to select a registration method, then press the **OK** button.

9. Register the recipients' fax/telephone number.

Register the recipients' fax/telephone number depending on the registration method selected.

• From call log (OUT)

When you select this registration method, the screen to select the fax/telephone number from the outgoing call logs is displayed.



Outgoing call log
☎= 0567891234

1. Use the ◀▶ button to select a fax/telephone number, then press the **OK** button.

The fax/telephone number selected from the outgoing call logs is displayed.

2. Check the fax/telephone number, then press the **OK** button.

The fax/telephone number is registered to the machine and the screen to enter the recipient's name is displayed. Go to next step.

• From call log (IN)

When you select this registration method, the screen to select the fax/telephone number or the name from the incoming call logs is displayed.

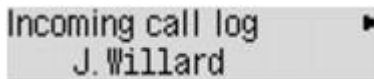

1. Use the ◀▶ button to select a fax/telephone number or a name, then press the **OK** button.

The fax/telephone number selected from the incoming call logs is displayed.

2. Check the fax/telephone number, then press the **OK** button.

The fax/telephone number is registered to the machine and the screen to enter the recipient's name is displayed. Go to next step.

▶▶▶ Note

- This registration method may not be available depending on the country or region of purchase.

• Direct entry

When you select this registration method, the screen to enter the fax/telephone number is displayed.

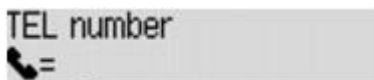

1. Use the Numeric buttons to enter the fax/telephone number you want to register.

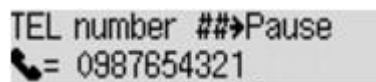

2. Press the **OK** button.

The fax/telephone number is registered to the machine and the screen to enter the recipient's name is displayed. Go to next step.

▶▶▶ Note

- You can enter the fax/telephone number up to 60 digits (40 digits for the US, Canada, Korea and some regions of Latin America), including spaces.

■ [Entering Numbers, Letters, and Symbols](#)

- Press the **#** button twice to enter a pause.
- When **Telephone line type** in **FAX user settings** under **Fax settings** is set to **Rotary pulse**, you can enter a tone ("T") by pressing the **Tone** button.

10. Use the Numeric buttons to enter the recipient's name.

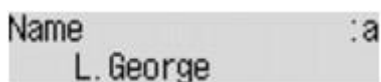

If you select a name on **From call log (IN)** in step 8, the name may be already entered. If you do not change the name, go to step 10.

▶▶▶ Note

- You can enter the name up to 16 characters, including spaces.

■ [Entering Numbers, Letters, and Symbols](#)

11. Press the **OK** button to finalize registration.

▶▶ Note

- To register another recipient's number and name, select an unregistered ID number and operate in the same procedure.
- To return to the Fax standby screen, press the **FAX** button.
- You can check the recipient's numbers and names you have registered by printing RECIPIENT TELEPHONE NUMBER LIST.

■ [Printing a List of the Registered Destinations](#)

Registering Recipients in Group Dial

If you register two or more registered recipients to a group dial, you can send the same document successively to all recipients registered to the group dial.

1. [Make sure that the machine is turned on.](#)
2. Press the **Setup** button.
The **Setup menu** screen is displayed.
3. Use the ◀▶ button to select **Fax settings**, then press the **OK** button.
4. Use the ◀▶ button to select **TEL no. registration**, then press the **OK** button.
5. Use the ◀▶ button to select **Add directory entry**, then press the **OK** button.
6. Use the ◀▶ button to select **Group dial**, then press the **OK** button.

The screen to select an ID number is displayed.

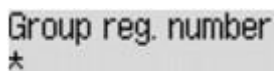

Group reg. number
★

7. Use the ◀▶ button or the Numeric buttons to select an unregistered ID number, then press the **OK** button.

▶▶▶ Note

- If you already registered the recipient, **(Not available)** is displayed next to the ID number. If you already registered the group dial, the registered group name is displayed.

The **Group member** screen is displayed.

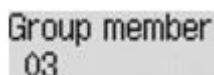

Group member
03

8. Register the registered recipient as a member of the group dial.

1. Press the **Menu** button.
2. Choose a recipient to register as a member.

You can choose a recipient with the two methods. The method can be switched by pressing the **#** button.

- When **Add to group** is displayed on the LCD:

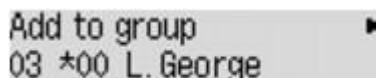

Add to group ▶
03 *00 L. George

Use the ◀▶ button to select a recipient's ID number to register to the group dial.

- When **Enter first letter** is displayed on the LCD:

Enter first letter :A

After you use the Numeric buttons to enter the first letter of the recipient's name you want to search, the registered recipients are displayed in alphabetical order.

Add to group
03 *05 Tommy. L. Jones

Use the ◀▶ button to select a recipient's ID number to register to the group dial.

3. Press the **OK** button.

The selected recipient is registered as a member of the group dial.

Group member
03 *05 Tommy. L. Jones

4. Press the **Menu** button to display the screen to select an ID number, then add another member.

Repeat this step to register the other recipient to the same group dial.

▶▶▶ Note

- You can check the recipient's ID number and name registered to the group dial by using the ◀▶ button.

9. Press the **OK** button after finishing registering the member you want to register to the group dial.

The screen to enter the group name is displayed.

Group name :a

10. Use the Numeric buttons to enter the group name.

Group name :1
Friend 1

▶▶▶ Note

- You can enter the name up to 16 characters, including spaces.

■ [Entering Numbers, Letters, and Symbols](#)

11. Press the **OK** button to finalize registration.

▶▶▶ Note

- To register another group, select an unregistered ID number and operate in the same procedure.
- To return to the Fax standby screen, press the **FAX** button.
- You can check the recipients you have registered to the group dial by printing GROUP DIAL TELEPHONE NO. LIST.

■ [Printing a List of the Registered Destinations](#)

Changing Registered Information

To change information registered for recipient and group dial, follow the procedure below.

1. [Make sure that the machine is turned on.](#)

2. Press the **Setup** button.

The **Setup menu** screen is displayed.

3. Use the ◀▶ button to select **Fax settings**, then press the **OK** button.

4. Use the ◀▶ button to select **TEL no. registration**, then press the **OK** button.

5. Use the ◀▶ button to select **Add directory entry**, then press the **OK** button.

6. Change the registered information.

- To change the recipient's information:

1. Use the ◀▶ button to select **Recipient**, then press the **OK** button.

2. Use the ◀▶ button or the Numeric buttons to select a recipient's ID number, then press the **OK** button.

3. Use the ◀▶ button to select **Edit**, then press the **OK** button.

The screen to select a registration method is displayed as well as when you register the recipient.

4. Use the ◀▶ button to select a registration method, then press the **OK** button.

5. Change the recipient's fax/telephone number, then press the **OK** button.

- **From call log (OUT)** is selected as the registration method:

The screen to select the fax/telephone number from the outgoing call logs is displayed.

After you use the ◀▶ button to select a fax/telephone number and press the **OK** button, the editing screen is displayed. Change the recipient's fax/telephone number, then press the **OK** button.

- **From call log (IN)** is selected as the registration method:

The screen to select the fax/telephone number or the name from the incoming call logs is displayed. After you use the ◀▶ button to select a fax/telephone number or a name and press the **OK** button, the editing screen is displayed. Change the recipient's fax/telephone number, then press the **OK** button.

▶▶▶ Note

- This registration method may not be available depending on the country or region of purchase.

- **Direct entry** is selected as the registration method:

the editing screen is displayed. Change the recipient's fax/telephone number, then press the **OK** button.

After editing the recipient's fax/telephone number is complete, the screen to edit the recipient's name is displayed.

»» Note

- You can enter the fax/telephone number up to 60 digits (40 digits for the US, Canada, Korea and some regions of Latin America), including spaces.

■ [Entering Numbers, Letters, and Symbols](#)



- Press the  button twice to enter a pause.
- When **Telephone line type** in **FAX user settings** under **Fax settings** is set to **Rotary pulse**, you can enter a tone ("T") by pressing the **Tone** button.

6. Change the recipient's name, then press the **OK** button.

»» Note

- You can enter the name up to 16 characters, including spaces.

■ [Entering Numbers, Letters, and Symbols](#)

- To change a group dial:
 1. Use the  button to select **Group dial**, then press the **OK** button.
 2. Use the  button or the Numeric buttons to select an ID number of group dial to change, then press the **OK** button.
 3. Use the  button to select **Edit**, then press the **OK** button.
 4. Edit the member of the group dial.

To add a member, press the **Menu** button to display the screen to select an ID number and then add another member.

To delete a member, select a member to delete and then press the **Tone** button.

5. Change the group name, then press the **OK** button.

»» Note

- You can enter the name up to 16 characters, including spaces.

■ [Entering Numbers, Letters, and Symbols](#)

»» Note

- To return to the Fax standby screen, press the **FAX** button.

Deleting Registered Information

To delete information registered for recipient and group dial, follow the procedure below.

1. [Make sure that the machine is turned on.](#)
2. Press the **Setup** button.
The **Setup menu** screen is displayed.
3. Use the ◀▶ button to select **Fax settings**, then press the **OK** button.
4. Use the ◀▶ button to select **TEL no. registration**, then press the **OK** button.
5. Use the ◀▶ button to select **Add directory entry**, then press the **OK** button.
6. Delete the registered information.
 - To delete the recipient's information:
 1. Use the ◀▶ button to select **Recipient**, then press the **OK** button.
 2. Use the ◀▶ button or the Numeric buttons to select an ID number of group dial to delete, then press the **OK** button.
 3. Use the ◀▶ button to select **Delete**, then press the **OK** button.
 4. Use the ◀▶ button to select **Yes**, then press the **OK** button.
 - To delete a group dial:
 1. Use the ◀▶ button to select **Group dial**, then press the **OK** button.
 2. Use the ◀▶ button or the Numeric buttons to select an ID number of group dial to delete, then press the **OK** button.
 3. Use the ◀▶ button to select **Delete**, then press the **OK** button.
 4. Use the ◀▶ button to select **Yes**, then press the **OK** button.

▶▶▶ Note

- To return to the Fax standby screen, press the **FAX** button.

Printing a List of the Registered Destinations

You can print a list of the fax/telephone numbers and can keep it near the machine to refer to when dialing.

1. [Make sure that the machine is turned on.](#)

2. [Load paper.](#)

3. Press the **FAX** button.

The Fax standby screen is displayed.

4. Press the **Menu** button.

The **FAX menu** screen is displayed.

5. Use the ◀▶ button to select **Print reports/lists**, then press the **OK** button.

6. Use the ◀▶ button to select **Directory list**, then press the **OK** button.

7. Use the ◀▶ button to select an item to print, then press the **OK** button.

- If you selected **Recipient**:

Use the ◀▶ button to select whether to print the list in alphabetical order, then press the **OK** button.

If you select **Yes**, RECIPIENT TELEPHONE NUMBER LIST is printed in alphabetical order.

If you select **No**, RECIPIENT TELEPHONE NUMBER LIST is printed in the order of the ID number.

- If you selected **Group dial**:

GROUP DIAL TELEPHONE NO. LIST is printed.

Registering Recipients Using Speed Dial Utility

About Speed Dial Utility

Speed Dial Utility is a utility for forwarding the fax/telephone numbers registered on the machine to a computer and registering/changing them on the computer. In addition, you can register the fax/telephone number, user's name, user's fax/telephone number, and rejected numbers edited on the computer to the machine. You can also save them on the computer as a backup.

For safety reasons, it is recommended that you backup the registered data on the computer using Speed Dial Utility.

■ [Starting Up Speed Dial Utility](#)

■ [Speed Dial Utility Dialog box](#)

■ [Saving Registered Information on the Machine to Your Computer](#)

■ [Registering a Fax/telephone Number Using Speed Dial Utility](#)

■ [Changing a Fax/telephone Number Using Speed Dial Utility](#)

■ [Deleting a Fax/telephone Number Using Speed Dial Utility](#)

■ [Changing Sender Information Using Speed Dial Utility](#)

■ [Registering/Changing Rejected Number Using Speed Dial Utility](#)

■ [Calling the Registered Information Up from Your Computer and Registering the Information to the Machine](#)

■ [Uninstalling Speed Dial Utility](#)

Starting Up Speed Dial Utility

Before starting up Speed Dial Utility, confirm the following:

- **The necessary application software (MP Drivers and Speed Dial Utility) is installed.**

If MP Drivers or Speed Dial Utility is not yet installed, install them with the Setup CD-ROM or install them from our website.

- **The machine is connected to a computer correctly.**

Make sure that the machine is connected to the computer correctly.

Do not plug in or unplug any cables while the machine is in operation, or when the computer is in sleep or standby mode.

If your machine is compatible with LAN connection, make sure that the machine is connected to the computer with LAN connection to use Speed Dial Utility via LAN connection.

Follow the procedure below to start up Speed Dial Utility.

1. Make sure that the machine is turned on.

2. Start up Speed Dial Utility.

- In Windows 8.1 or Windows 8, select **Speed Dial Utility** on the **Start** screen to start Speed Dial Utility. If **Speed Dial Utility** is not displayed on the **Start** screen, select the **Search** charm, then search for "Speed Dial Utility".
- In Windows 7, Windows Vista, or Windows XP, click **Start** and select **All programs**, **Canon Utilities**, **Speed Dial Utility**, and then **Speed Dial Utility**.

▶▶▶ Note

- You can also start up Speed Dial Utility from Quick Menu or Quick Toolbox.

Speed Dial Utility Dialog box

The following items are on the **Speed Dial Utility** dialog box.

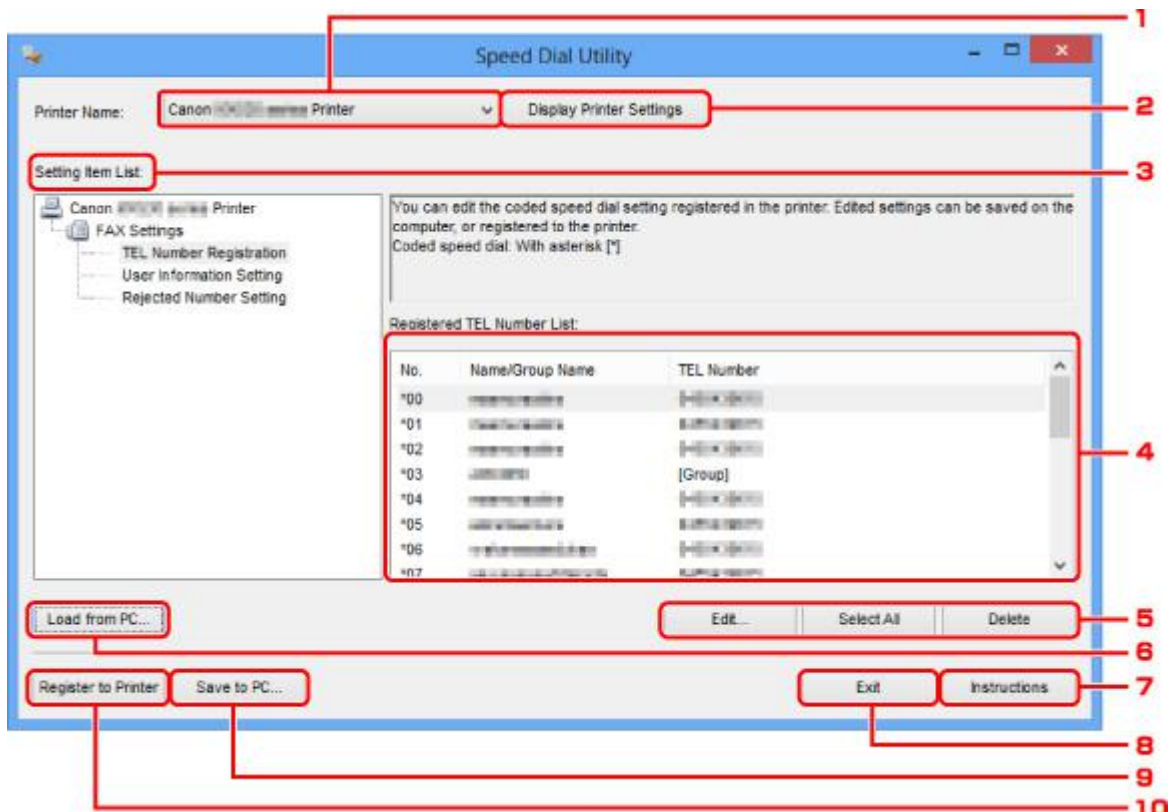

1. **Printer Name:**

Selects the machine for editing the registered information using Speed Dial Utility.

2. **Display Printer Settings**

Loads the registered information on the machine selected for **Printer Name:** into Speed Dial Utility.

3. **Setting Item List:**

Selects the registered information for editing. Choose one item from **TEL Number Registration**, **User Information Setting**, and **Rejected Number Setting**.

4. Registered information list

Displays the registered information selected for **Setting Item List:**.

5. **Edit.../Select All/Delete**

Edits/deletes the registered information or selects all the registered information selected for **Setting Item List:**.

When multiple items on the registered information list are selected, you cannot use the **Edit...** button.

6. **Load from PC...**

Displays the registered information saved on the computer.

7. **Instructions**

Displays this guide.

8. **Exit**

Quits Speed Dial Utility. Information registered or edited using Speed Dial Utility is neither saved on the computer nor registered on the machine.

9. **Save to PC...**

Saves information edited using Speed Dial Utility on the computer.

10. **Register to Printer**

Registers information edited using Speed Dial Utility to the machine.

Saving Registered Information on the Machine to Your Computer

Follow the procedure below to save the recipients' name, recipients' fax/telephone number, group dial, user's name, user's fax/telephone number, or rejected numbers that registered on the machine to the computer.

1. [Start up Speed Dial Utility.](#)
2. Select the machine from the **Printer Name:** list box, then click **Display Printer Settings.**
3. Click **Save to PC....**
4. Enter the file name on the displayed screen, then click **Save.**

Registering a Fax/telephone Number Using Speed Dial Utility

Follow the procedure below to register fax/telephone numbers.

»» Note

- Before you register fax/telephone numbers using Speed Dial Utility, make sure that no fax operations are in progress.

1. [Start up Speed Dial Utility.](#)
2. Select the machine from the **Printer Name:** list box, then click **Display Printer Settings.**
3. Click **TEL Number Registration** from **Setting Item List:**
The list of registered fax/telephone numbers is displayed.
4. Select an unoccupied code from the list, then click **Edit....**
The **Individual or Group Selection** dialog box is displayed.
5. Click **Register individual TEL number** or **Register group dial**, then click **Next....**

- If **Register individual TEL number** is selected:

Individual TEL Number Registration

No.: *00

Name:

TEL Number:

OK Cancel

1. Enter the name.
2. Enter the fax/telephone number.

- If **Register group dial** is selected:

Group Dial Registration

No.: *00

Group Name:

Registered TEL Number List:

No.	Name/Group Name	TEL Number
*01	XXXXXXXXXX	XXXXXXXXXX
*02	XXXXXXXXXX	XXXXXXXXXX
*03	[Group]	[Group]
*04	XXXXXXXXXX	XXXXXXXXXX
*05	XXXXXXXXXX	XXXXXXXXXX
*06	XXXXXXXXXX	XXXXXXXXXX
*07	XXXXXXXXXX	XXXXXXXXXX
*08	[Group]	[Group]
*09	XXXXXXXXXX	XXXXXXXXXX

Group Dial List:

No.	Member	TEL Number
-----	--------	------------

Add >>

<< Delete

OK Cancel

1. Enter the group name.
2. Select the code you want to add to the group dial, then click **Add >>**.

➤➤ Note

- You can only enter numbers that have already been registered.

6. Click **OK**.

To continue registering fax/telephone numbers or a group dial, repeat steps 4 to 6.

- To save the registered information on the computer.
 1. Click **Save to PC....**
 2. Enter the file name on the displayed screen, then click **Save**.
- To register the registered information to the machine:
 1. Click **Register to Printer**.
 2. Confirm the message on the display, then click **OK**.

The information is registered to the machine.

Changing a Fax/telephone Number Using Speed Dial Utility

Follow the procedure below to change fax/telephone numbers.

▶▶▶ Note

- Before you change fax/telephone numbers using Speed Dial Utility, make sure that no fax operations are in progress.

1. [Start up Speed Dial Utility.](#)
2. Select the machine from the **Printer Name:** list box, then click **Display Printer Settings.**
3. Click **TEL Number Registration** from **Setting Item List:**.
The list of registered fax/telephone numbers is displayed.

4. Select a code to change from the list, then click **Edit....**

- If an individual fax/telephone number is selected:

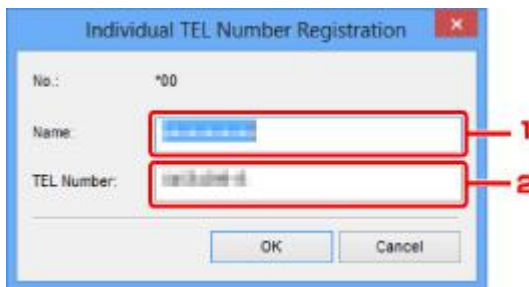

1. Enter the new name.
2. Enter the new fax/telephone number.

- If a group dial is selected:

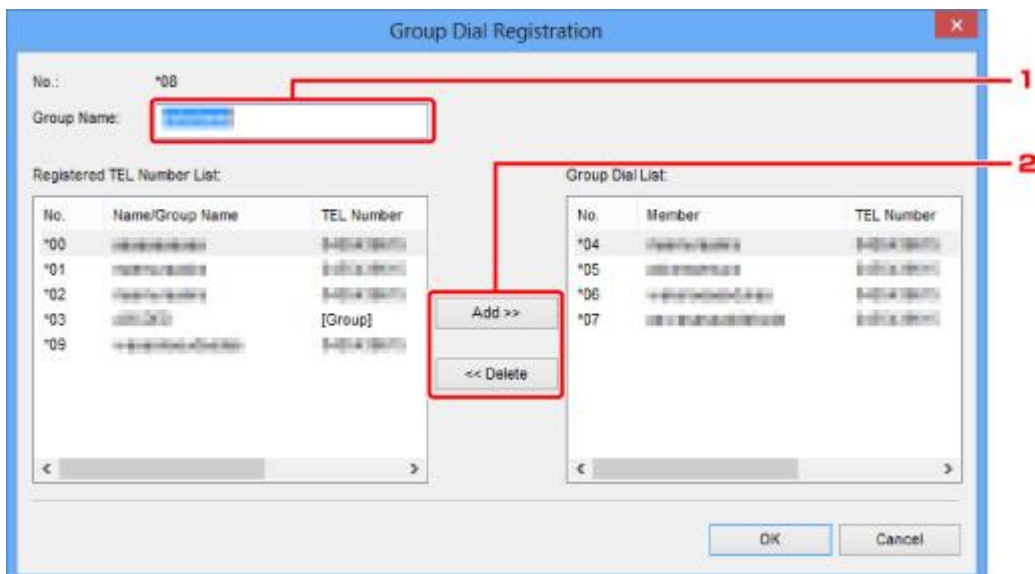

No.	Name/Group Name	TEL Number
*00		
*01		
*02		
*03	[Group]	
*09		

No.	Member	TEL Number
*04		
*05		
*06		
*07		

1. Enter the new group name.
2. Add or delete a member to/from the group dial.

To add a member:

Select the code to add to the group dial, then click **Add >>**.

To delete a member:

Select the code to delete from the group dial, then click **<< Delete**.

5. Click **OK**.

To continue changing fax/telephone numbers or group dials, repeat steps 4 and 5.

- To save the edited information on the computer.

1. Click **Save to PC...**

2. Enter the file name on the displayed screen, then click **Save**.

- To register the edited information to the machine:

1. Click **Register to Printer**.

2. Confirm the message on the display, then click **OK**.

The information is registered to the machine.

Deleting a Fax/telephone Number Using Speed Dial Utility

Follow the procedure below to delete fax/telephone numbers.

▶▶▶ Note

- Before you delete fax/telephone numbers using Speed Dial Utility, make sure that no fax operations are in progress.

1. [Start up Speed Dial Utility.](#)
2. Select the machine from the **Printer Name:** list box, then click **Display Printer Settings.**
3. Click **TEL Number Registration** from **Setting Item List:**.

The list of registered fax/telephone numbers is displayed.

4. Select a code to delete from the list, then click **Delete.**

The selected fax/telephone number is deleted.

To continue deleting fax/telephone numbers, repeat step 4.

▶▶▶ Note

- To delete all fax/telephone numbers on the list, click **Select All**, then **Delete.**

- To save the edited information on the computer.
 1. Click **Save to PC...**
 2. Enter the file name on the displayed screen, then click **Save.**
- To register the edited information to the machine:
 1. Click **Register to Printer.**
 2. Confirm the message on the display, then click **OK.**

The information is registered to the machine.

Changing Sender Information Using Speed Dial Utility

Follow the procedure below to change the user's name or fax/telephone number.

1. [Start up Speed Dial Utility.](#)

2. Select the machine from the **Printer Name:** list box, then click **Display Printer Settings.**

3. Click **User Information Setting** from **Setting Item List:**.

The user's information is displayed.

4. Select an item to change, then click **Edit...**

The **User Information** dialog box is displayed.

5. Enter the new user's name on **User Name** and new fax/telephone number in **TEL Number**, then click **OK.**

- To save the edited information on the computer:

1. Click **Save to PC...**

2. Enter the file name on the displayed screen, then click **Save.**

- To register the edited information to the machine:

1. Click **Register to Printer.**

2. Confirm the message on the display, then click **OK.**

The information is registered to the machine.

Registering/Changing Rejected Number Using Speed Dial Utility

Follow the procedure below to register, change, or delete rejected numbers.

1. [Start up Speed Dial Utility.](#)
2. Select the machine from the **Printer Name:** list box, then click **Display Printer Settings.**
3. Click **Rejected Number Setting** from **Setting Item List:**.

The list of rejected numbers is displayed.

- To register a rejected number:
 1. Select an unoccupied code from the list, then click **Edit...**
 2. Enter the fax/telephone number in the **Rejected Number** dialog box, then click **OK.**
- To change a rejected number:
 1. Select a code to change from the list, then click **Edit...**
 2. Enter the fax/telephone number in the **Rejected Number** dialog box, then click **OK.**
- To delete a rejected number:
 1. Select a code to delete from the list, then click **Delete.**

The selected fax/telephone number is deleted.

Note

- To delete all fax/telephone numbers on the list, click **Select All**, then **Delete.**

Calling the Registered Information Up from Your Computer and Registering the Information to the Machine

You can register the fax/telephone numbers, user's name, user's fax/telephone number, and rejected numbers saved on the computer to the machine.

1. [Start up Speed Dial Utility.](#)
2. Select the machine from the **Printer Name:** list box, then click **Display Printer Settings.**
3. Click **Load from PC....**
4. Select the RSD file (*.rsd) to register to the machine.
5. Click **Open** on the dialog box.
6. Click **Register to Printer.**

The registered information on the computer is registered to the machine.

Uninstalling Speed Dial Utility

Follow the procedure below to uninstall Speed Dial Utility.

»» Important

- Log into a user account with administrator privilege.

1. Perform the uninstalling process.

- In Windows 8.1 or Windows 8:
 1. Select **Control Panel** from the **Settings** charm on **Desktop > Programs > Programs and Features**.
 2. Select **Canon Speed Dial Utility** from the program list, then click **Uninstall**.
If the **User Account Control** screen appears, click **Continue**.
- In Windows 7 or Windows Vista:
 1. Click **Start > Control Panel > Programs > Programs and Features**.
 2. Select **Canon Speed Dial Utility** from the program list, then click **Uninstall**.
If the **User Account Control** screen appears, click **Continue**.
- In Windows XP:
 1. Click **Start > Control Panel > Add or Remove Programs**.
 2. Select **Canon Speed Dial Utility** from the program list, then click **Remove**.

2. Click **Yes** when the confirmation message appears.

When the message prompting you to restart your computer is displayed, click **OK** to restart your computer.

»» Note

- To reinstall Speed Dial Utility, uninstall Speed Dial Utility, then install it again from our website.

Receiving Faxes

- ▶ **Receiving Faxes**
- ▶ **Changing the Paper Settings**
- ▶ **Memory Reception**
- ▶ **Receiving Faxes Using Useful Functions**

Receiving Faxes

This section describes the preparation necessary for receiving a fax and how to receive a fax.

Preparing for Receiving a Fax

Prepare for receiving a fax according to the following procedure.

1. [Make sure that the machine is turned on.](#)

2. Press the **FAX** button.

The Fax standby screen is displayed.

3. Make sure of the receive mode setting.

Make sure of the receive mode setting displayed on the Fax standby screen.

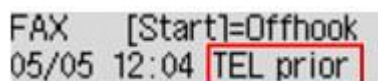

FAX [Start]=Offhook
05/05 12:04 TEL prior

▶▶▶ Note

- For details on how to change the receive mode:

■ [Setting the Receive Mode](#)

4. [Load paper.](#)

Load the sheets of plain paper.

5. Specify the paper settings as necessary.

■ [Changing the Paper Settings](#)

This completes the preparation for receiving fax.

When a fax is received, it is printed on the loaded paper automatically.

Receiving a Fax

Depending on the selected receive mode, the receive operation varies.

▶▶▶ Note

- For details on the receive mode:

■ [Setting the Receive Mode](#)

- You can specify the advanced settings of each receive mode.

For details on the advanced settings of the receive mode:

■ [Advanced Settings of Receive Mode](#)

- If the machine was not able to print a received fax, the machine stores the unprinted fax temporarily in its memory (memory receiving).

■ [Memory Reception](#)

When TEL priority mode is selected:

- **When the call is a fax:**

The telephone will ring when a call comes.

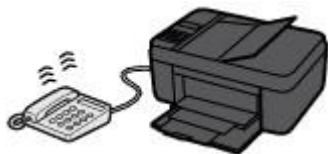

Pick up the handset. If you hear the fax tone, wait for at least 5 seconds after it stops, then hang up the handset.



The machine will receive the fax.



►► Note

- If the machine will not switch to fax reception, press the **FAX** button, then the **Color** or **Black** button to receive the fax.
- To receive a fax without picking up the handset, set **Manual/auto switch** of the advanced setting to **ON**. **RX start time** allows you to specify the number of seconds until the machine switches to fax reception.
- If you have subscribed to Duplex Ringing service in Hong Kong, the telephone will ring a specified number of times when there is an incoming call with a fax distinctive ring pattern. Then, the machine will switch to fax reception automatically without the handset being picked up.

The number of times to ring the telephone until switching to fax reception can be changed.

- Set the machine to enable you to initiate fax reception from a connected telephone (remote reception).

■ [Remote Reception](#)

- **When the answering machine is connected to the machine:**

- If the answering machine is set to the answering mode, set **User-friendly RX** of the advanced setting to **ON**. If the call is a fax, the machine will receive the fax automatically.
- If the answering mode is turned off on the answering machine, pick up the handset. If you hear the fax tone, wait for at least 5 seconds after it stops, then hang up the handset.
- If **Manual/auto switch** of the advanced setting is set to **ON**, set **RX start time** to longer than the time before the answering machine starts playing the answering message. After making this setting, we recommend that you call the answering machine using a mobile phone, etc. to confirm that messages are recorded successfully in the answering machine.
- Set your answering machine to answering mode and adjust it as follows:

- The entire message should be no longer than 15 seconds.
- In the message, tell your callers how to send a fax.

• **When the call is a voice call:**

The telephone will ring when a call comes in.

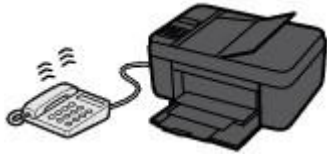

Pick up the handset, and talk on the telephone.



►► **Note**

- If the machine unexpectedly switches to fax reception during telephone calls, set **User-friendly RX** of the advanced setting to **OFF**.
- If **Manual/auto switch** of the advanced setting is set to **ON**, you must answer an incoming call by picking up the handset within the time specified in **RX start time**. Otherwise the machine will switch to fax reception.

When Fax only mode is selected:

• **When the call is a fax:**

The machine will receive the fax automatically.



►► **Note**

- If a telephone is connected to the machine, the telephone will ring when a call comes in.
- You can change the number of times to ring the telephone with **Incoming ring** of the advanced setting.

When DRPD or Network switch is selected:

• **When the call is a fax:**

The telephone will ring when a call comes in.

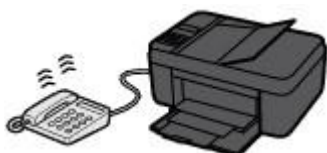

The machine will receive the fax automatically when the fax ring pattern is detected.



►► Note

- You can change the number of times to ring the telephone.

■ [Advanced Settings of Receive Mode](#)

• When the call is a voice call:

The telephone will ring when a call comes.

When the machine does not detect the fax ring pattern, the telephone will continue ringing.

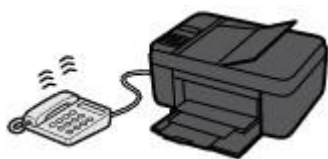

Pick up the handset, and talk on the telephone.



►► Note

- To use this feature, you need to subscribe to a compatible service provided by your telephone company.

• For DRPD

You need to select the appropriate ring pattern on the machine.

■ [Setting the DRPD Ring Pattern \(US and Canada only\)](#)

• For Network switch

The name of this service varies depending on the country or region of purchase. This setting may not be also available depending on the country or region of purchase.

Changing the Paper Settings

This machine prints received faxes to paper loaded in the machine beforehand. You can use the operation panel to change the paper settings for printing faxes. Make sure that the settings are appropriate for the loaded paper.

▶▶ Important

- If the size of loaded paper is different from that specified in the paper size setting, the received faxes are stored in the machine's memory and **Check page size** and **Press [OK]** are displayed on the LCD. In this case, load the same size of paper as that specified in the paper size setting, then press the **OK** button.

You can also press the **Stop** button to close the message and print the stored documents in the machine's memory later.

■ [Printing a Document in Machine's Memory](#)

- If no paper is loaded, or paper has run out while printing is in progress, the received faxes are stored in the machine's memory and the error message for no paper is displayed on the LCD. In this case, load paper and press the **OK** button.

You can also press the **Stop** button to close the message and print the stored documents in the machine's memory later.

■ [Printing a Document in Machine's Memory](#)

▶▶ Note

- If the sender sends a document that is larger than Letter-size or Legal-size, such as 11 x 17 inches, the sender's machine may send the fax automatically reduced in size or divided, or send only a part of the original.

1. [Make sure that the machine is turned on.](#)

2. Press the **FAX** button.

The Fax standby screen is displayed.

3. Press the **Menu** button.

The **FAX menu** screen is displayed.

4. Use the ◀▶ button to select **FAX paper settings**, then press the **OK** button.

5. Use the ◀▶ button to select a setting item, then press the **OK** button.

6. Specify the settings.

Use the ◀▶ button to adjust each setting item, then press the **OK** button. The next setting item is displayed.

The LCD returns to the Fax standby screen when all the settings are complete or when pressing the **FAX** button.

»» Note

- The * (asterisk) on the LCD indicates the current setting.

- **Page size**

Select the page size from **A4**, **Letter**, **LTR**, or **Legal**.

»» Note

- Some of page sizes are not available depending on the country or region of purchase.

- **Media type**

The paper type is set to **Plain paper**.

Memory Reception

If the machine was not able to print the received fax, the received fax is stored in the machine's memory. The **FAX Memory** lamp is lit and **Received in memory** is displayed at the Fax standby screen.

▶▶▶ Important

- If you unplug the power cord, all faxes stored in the machine's memory are deleted. The next time you turn the machine on, press the **OK** button after a confirmation screen is displayed. The list of the faxes deleted from the machine's memory (MEMORY CLEAR REPORT) will be printed.

If the machine receives a fax under one of the following conditions, the received fax will be automatically stored in the machine's memory.

- **The machine is set to store received faxes in its memory:**

When **Do not print** is selected for **Received documents** in **Auto print settings** under **Fax settings**, the received faxes are stored in the machine's memory.

You can print the faxes stored in the machine's memory from the **Memory reference** screen under **FAX menu**.

■ [Printing a Document in Machine's Memory](#)

▶▶▶ Note

- To print the received faxes automatically, select **Print** for **Received documents** in **Auto print settings** under **Fax settings**.

■ [Auto print settings](#)

- **An error has occurred on the machine:**

If you select **Print** for **Received documents** in **Auto print settings** under **Fax settings**, a received fax will be printed automatically. However, if any of the following errors occurs, the received fax will not be printed. It will instead be stored in the machine's memory.

When the error is resolved, the fax stored in the machine's memory is printed automatically.

- The amount of remaining ink is insufficient to print a fax:

Replace the FINE cartridge.

■ [Replacing a FINE Cartridge](#)

▶▶▶ Note

- You can set the machine to forcibly print a received fax even if the ink has run out.

Set **Print when no ink** in **Auto print settings** under **Fax settings** to **Print**.

However, part or all of the fax may not be printed since the ink has run out.

Also, the contents of the fax will not be stored in the machine's memory.

If the ink has already run out, we recommend that **Do not print** be selected for **Received documents** in **Auto print settings** under **Fax settings** to store the received fax in the machine's memory. After you replace the FINE cartridge and select **Print** for **Received documents** in **Auto print settings**, the fax stored in the machine's memory will be printed automatically.

■ [Auto print settings](#)

- Paper has run out:
- A different size of paper from that specified by **Page size** in **FAX paper settings** is loaded:
Load the same size of paper as that specified by **Page size**, then press the **OK** button.

- **You pressed the Stop button to cancel printing of a fax:**

Press the **FAX** button to resume printing of the fax.

▶▶ Note

- The machine can store up to max. 50 pages* (max. 20 documents) of faxes in the machine's memory.
 - * When using ITU-T No.1 chart (Standard mode)
- If the machine's memory becomes full during memory reception, only pages which already have been received are stored in the memory. Print the received faxes stored in the machine's memory, delete them from the machine's memory, and have the sender resend the faxes.

■ [Document Stored in Machine's Memory](#)

Receiving Faxes Using Useful Functions

- ▶ **Remote Reception**
- ▶ **Rejecting Fax Reception**
- ▶ **Using the Caller ID Service to Reject Calls**

Remote Reception

If the machine is located away from the telephone, pick up the handset of the telephone connected to the machine and dial 25 (the remote reception ID) to receive faxes (remote reception).

- If you use a rotary pulse line, temporarily switch your telephone to tone dialing. For details on how to switch to tone dialing, refer to your telephone's instruction manual.
- If you have an answering machine connected to the machine that can carry out remote control operations, the security code for this function may be the same as the remote reception ID. In this case, change the remote reception ID in **Remote RX ID** in **Remote RX** in **Adv. FAX settings** under **Fax settings**.

■ [Adv. FAX settings](#)

Remote reception can be disabled.

Rejecting Fax Reception

You can set the machine to reject faxes with no sender information or those from specific senders.

Select one of the following conditions to reject faxes.

- Faxes with no caller identification.
- Faxes from senders not registered in the machine's directory.
- Faxes from senders registered in the machine as rejected numbers.

Select a fax rejection condition following the procedure below.

1. [Make sure that the machine is turned on.](#)
2. Press the **Setup** button.
The **Setup menu** screen is displayed.
3. Use the ◀▶ button to select **Fax settings**, then press the **OK** button.
4. Use the ◀▶ button to select **Security control**, then press the **OK** button.
5. Use the ◀▶ button to select **FAX RX reject**, then press the **OK** button.
6. Use the ◀▶ button to select **ON**, then press the **OK** button.
7. Use the ◀▶ button to select the fax rejection condition, then press the **OK** button.

No sender info.

Rejects faxes with no caller identification.

Not in directory

Rejects faxes from the senders not registered in the machine's directory.

Rejected numbers

Rejects faxes from the senders registered in the machine as rejected numbers.

For details on how to register the rejected number, see [Registering the Rejected Number](#).

▶▶▶ Note

- The * (asterisk) on the LCD indicates the current setting.
- When the machine rejects reception, **Reception rejected** is displayed on The Fax standby screen.
- Faxes with no caller identification are also rejected when the setting other than **No sender info.** is selected.

Registering the Rejected Number

Register the rejected number following the procedure below.

1. When the confirmation screen to register the rejected number is displayed, use the ◀▶ button to select **Yes**, then press the **OK** button.

2. Use the ◀▶ button to select a registration number, then press the **OK** button.
3. Use the ◀▶ button to select a registration method, then press the **OK** button.

Register the rejected number depending on the registration method.

- **From call log (OUT)**

When you select this registration method, the screen to select the fax/telephone number from the outgoing call logs is displayed.



1. Use the ◀▶ button to select a fax/telephone number, then press the **OK** button.
2. Press the **OK** button again.

- **From call log (IN)**

When you select this registration method, the screen to select the fax/telephone number or the name from the incoming call logs is displayed.

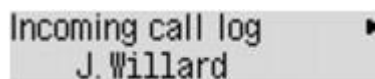

1. Use the ◀▶ button to select a fax/telephone number or a name, then press the **OK** button.
2. Press the **OK** button again.

▶▶▶ Note

- This registration method may not be available depending on the country or region of purchase.

- **Direct entry**

When you select this registration method, the screen to register the fax/telephone number is displayed.

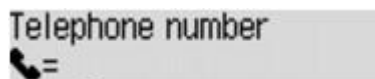

Use the Numeric buttons to enter the fax/telephone number you want to register, then press the **OK** button.

▶▶▶ Note

- To register another rejected number, use the ◀▶ button to select another registration number, then register the rejected number.
You can register up to 10 rejected numbers.
- To return to the Fax standby screen, press the **FAX** button.
- You can print the list of rejected numbers (REJECTED NUMBER LIST).
[■ Summary of Reports and Lists](#)
- To change the registered rejected number, display the screen to register the fax/telephone number in the same operation, change rejected number, then press the **OK** button.
- To delete the registered rejected number, display the screen to register the fax/telephone number in the same operation, press the **Back** button repeatedly to delete the rejected number, then press the **OK** button.

- You can register the rejected number in **Rejected numbers** in **TEL no. registration** under **Fax settings**.
-

Using the Caller ID Service to Reject Calls

If you subscribe to the Caller ID service, the machine detects the sender's Caller ID. If the sender's ID matches the condition specified in this setting, the machine rejects the phone call or fax reception from the sender.

▶▶▶ Note

- This setting may not be supported depending on the country or region of purchase.
Contact your telephone company to confirm whether it provides this service.

Specify the setting following the procedure below.

1. [Make sure that the machine is turned on.](#)
2. Press the **Setup** button.
The **Setup menu** screen is displayed.
3. Use the ◀▶ button to select **Fax settings**, then press the **OK** button.
4. Use the ◀▶ button to select **Security control**, then press the **OK** button.
5. Use the ◀▶ button to select **Caller rejection**, then press the **OK** button.
6. Use the ◀▶ button to select **Subscribed**, then press the **OK** button.
You can now perform settings for **Caller rejection**.
7. Use the ◀▶ button to select whether to reject a phone call or fax reception from an anonymous number, then press the **OK** button.
8. Use the ◀▶ button to select whether to reject a phone call or fax reception out of the subscribed service area, then press the **OK** button.
9. Use the ◀▶ button to select whether to reject a phone call or fax reception from the specified numbers, then press the **OK** button.

If you select **Reject**, you can register the fax/telephone number to reject.

When **Register rejected no.?** is displayed on the LCD, use the ◀▶ button to select **Yes**, then register the fax/telephone number to reject.

For details on how to register the rejected number, see [Registering the Rejected Number](#).

▶▶▶ Note

- Even if you select **Reject**, the machine rings once.
(The machine may not ring depending on the country or region of purchase.)

Other Useful Fax Functions

- ▶ **Using the Information Services**
- ▶ **Transmission/Reception of Faxes Using ECM**
- ▶ **Document Stored in Machine's Memory**
- ▶ **Summary of Reports and Lists**

Using the Information Services

You can use various information services such as provided by banks, and make airline reservations or hotel reservations. Since these services require tone dialing to use their services, you need to temporarily switch to tone dialing if your machine is connected to a rotary pulse line.

■ ■ [Using the Touch Tone Line](#)

■ ■ [Using the Rotary Pulse Line](#)

▶▶▶ Important

- You may need to contract with the service providers for some information services. For details, contact the service providers.

Using the Touch Tone Line

- **Dialing by Using the On Hook Dial Function**

▶▶▶ Note

- You can use the on hook dial function only when **Hook setting** in **Security control** under **Fax settings** is set to **Enable**.

■ ■ [Security control](#)

1. [Make sure that the machine is turned on.](#)
 2. Press the **FAX** button.
The Fax standby screen is displayed.
 3. Press the **Color** button or the **Black** button.
 4. Use the Numeric buttons to dial the number of the information service.
 5. When the recorded message for the information service answers, use the Numeric buttons to press the numbers in accordance with the message.
 6. Press the **Stop** button to finish using the service.
- **Dialing by Using the Telephone Connected to the Machine**
 1. [Make sure that the machine is turned on.](#)
 2. Press the **FAX** button.
The Fax standby screen is displayed.
 3. Lift the handset of the telephone.
 4. Use the telephone to dial the number of the information service.
 5. When the recorded message for the information service answers, use the telephone to press the numbers in accordance with the message.
 6. Hang up the handset to finish using the service.

Using the Rotary Pulse Line

- **Dialing by Using the On Hook Dial Function**

▶▶▶ Note

- You can use the on hook dial function only when **Hook setting** in **Security control** under **Fax settings** is set to **Enable**.

■ [Security control](#)

1. [Make sure that the machine is turned on.](#)
2. Press the **FAX** button.
The Fax standby screen is displayed.
3. Press the **Color** button or the **Black** button.
4. Use the Numeric buttons to dial the number of the information service.
5. When the recorded message for the information service answers, press the **Tone** button to switch to tone dialing.
6. Use the Numeric buttons to press the numbers in accordance with the message.
7. Press the **Stop** button to finish using the service.

- **Dialing by Using the Telephone Connected to the Machine**

1. [Make sure that the machine is turned on.](#)
2. Press the **FAX** button.
The Fax standby screen is displayed.
3. Lift the handset of the telephone.
4. Use the telephone to dial the number of the information service.
5. When the recorded message for the information service answers, use the telephone to switch to tone dialing.

When you dial the number of the information service using the telephone connected to the machine, you cannot use the machine to switch to tone dialing. For instructions on how to switch to tone dialing, refer to your telephone's instruction manual.
6. Use the telephone to press the numbers in accordance with the message.
7. Hang up the handset to finish using the service.

Transmission/Reception of Faxes Using ECM

This machine is set to send/receive faxes in Error Correction Mode (ECM). If the recipient's fax machine is compatible with ECM, ECM automatically corrects errors and resends the fax.

▶▶▶ Note

- If the sender's or recipient's fax machine is not compatible with ECM, the fax will be sent/received without automatic error correction.
- To receive color faxes, make sure that **ECM RX** in **Adv. communication** in **Adv. FAX settings** under **Fax settings** is set to **ON**.

■ [Adv. FAX settings](#)

To disable ECM transmission/reception, set **ECM TX** and **ECM RX** in **Adv. communication** to **OFF**.

- Transmission may take longer when ECM is enabled.

Document Stored in Machine's Memory

If the sending faxes is not complete or the machine was not able to print the received faxes, these faxes are stored in the machine's memory.

If an error occurred during a fax transmission, the document is not stored in the machine's memory.

In the following cases, the machine is not able to print the received fax and will automatically store the fax in its memory.

- **The amount of remaining ink is insufficient to print a fax.**
- **Paper has run out.**
- **A different size of paper from that specified by Page size in FAX paper settings is loaded.**
- **Do not print is selected for Received documents in Auto print settings under Fax settings.**
- **You pressed the Stop button to cancel printing of a received fax.**

▶▶▶ Important

- If you unplug the power cord of the machine, all faxes stored in the machine's memory are deleted.
For details on how to unplug the power cord, refer to [Notice for Unplugging the Power Cord](#).

You can print or delete the faxes stored in the machine's memory.

- To print a document in the machine's memory:
[■ Printing a Document in Machine's Memory](#)
- To delete a document in the machine's memory:
[■ Deleting a Document in Machine's Memory](#)

▶▶▶ Note

- When confirming, printing, or deleting a document stored in the machine's memory, you specify it by its transaction number. If you do not know the transaction number for your target document, print the list of documents (MEMORY LIST) first.
For details on how to print MEMORY LIST, see [Printing a Document in Machine's Memory](#).

Printing a Document in Machine's Memory

You can print a specified document in the machine's memory or print all the received documents in its memory at a time.

When printing a specified document, you specify it by its transaction number. If you do not know the transaction number for your target document, print the list of documents (MEMORY LIST) first.

1. [Make sure that the machine is turned on.](#)

2. [Load paper.](#)

3. Press the **FAX** button.

The Fax standby screen is displayed.

4. Press the **Menu** button.

The **FAX menu** screen is displayed.

5. Use the ◀▶ button to select **Memory reference**, then press the **OK** button.

▶▶▶ Note

- If no document is stored in the machine's memory, **No documents in memory** is displayed on the LCD.

6. Use the ◀▶ button to select a print menu, then press the **OK** button.

You can select the following print menus.

- **Print memory list**

You can print a list of the documents in the machine's memory (MEMORY LIST).

MEMORY LIST shows the transaction number of the unsent or unprinted fax (TX/RX NO.), transaction mode, recipient's number, and the date and time of the transaction.

A transaction number from "0001" to "4999" on MEMORY LIST indicates a document being sent. A transaction number from "5001" to "9999" on MEMORY LIST indicates a document being received.

- **Print specified doc.**

You can specify the document and print it.

If you select this menu, the document selection screen is displayed.

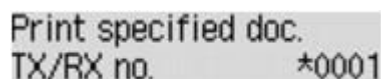

Print specified doc.
TX/RX no. *0001

▶▶▶ Note

- A transaction number from "0001" to "4999" indicates a document being sent. A transaction number from "5001" to "9999" indicates a document being received.
- Each mark before the transaction number indicates the following:
 - No mark: Indicates a black and white document.
 - *: Indicates a color document.

#: Indicates the document during transmission.

Ⓢ: Indicates the document sent with sequential broadcasting.

- By pressing the **#** button or the **Tone** button, the transaction number displayed on the LCD is switched to transaction time or fax/telephone number.

Specify the document and print it following the procedure below.

1. Use the ◀▶ button to select the transaction number (TX/RX no.) of the document you want to print, then press the **OK** button.
2. Use the ◀▶ button to select whether to print only the first page of the document, then press the **OK** button.
 - If you select **Yes**:

Only the first page of the document will be printed.

The document is still stored in the machine's memory.
 - If you select **No**:

All pages of the document will be printed.

The screen to confirm whether to delete the printed document in the machine's memory is displayed.

If you select **Yes** using the ◀▶ button and press the **OK** button, the printed document in the machine's memory is deleted.

▶▶▶ Note

- If there is not the specified document in the machine's memory, **No document** is displayed, and the machine returns to the previous screen.
- To return to the Fax standby screen, press the **Stop** button.

• Print all RX docs

If you select this menu, the confirmation screen is displayed.

You can print all the received documents in the machine's memory.

If you select **Yes** using the ◀▶ button and press the **OK** button, all the documents in the machine's memory will be printed.

Each time a document is printed, the screen to confirm whether to delete the printed document in the machine's memory is displayed.

If you select **Yes** using the ◀▶ button and press the **OK** button, the printed document in the machine's memory is deleted.

Deleting a Document in Machine's Memory

You can delete a specified document in the machine's memory or delete all the documents in its memory at a time.

▶▶▶ Note

- When deleting a specified document, you specify it by its transaction number. If you do not know the transaction number for your target document, print the list of documents (MEMORY LIST) first.

■ [Printing a Document in Machine's Memory](#)

1. [Make sure that the machine is turned on.](#)
2. Press the **FAX** button.
The Fax standby screen is displayed.
3. Press the **Menu** button.
The **FAX menu** screen is displayed.
4. Use the ◀▶ button to select **Memory reference**, then press the **OK** button.

▶▶▶ Note

- If no document is stored in the machine's memory, **No documents in memory** is displayed on the LCD.

5. Use the ◀▶ button to select a delete menu, then press the **OK** button.

You can select the following delete menus.

- **Del. specified doc.**

You can specify the document and delete it.

If you select this menu, the document selection screen is displayed.

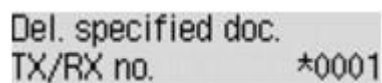

Del. specified doc.
TX/RX no. *0001

▶▶▶ Note

- A transaction number from "0001" to "4999" indicates a document being sent. A transaction number from "5001" to "9999" indicates a document being received.
- Each mark before the transaction number indicates the following:
 - No mark: Indicates a black and white document.
 - *: Indicates a color document.
 - #: Indicates the document during transmission.
 - ⊗: Indicates the document sent with sequential broadcasting.
- By pressing the # button or the **Tone** button, the transaction number displayed on the LCD is switched to transaction time or fax/telephone number.

Specify the document and delete it following the procedure below.

1. Use the ◀▶ button to select the transaction number (TX/RX no.) of the document you want to delete, then press the **OK** button.

The confirmation screen is displayed.

2. Use the ◀▶ button to select the transaction number of the document you want to delete, then press the **OK** button.

The specified document will be deleted from machine's memory.

▶▶ Note

- If there is not the specified document in the machine's memory, **No document** is displayed, and the machine returns to the previous screen.
- To return to the Fax standby screen, press the **Stop** button.

• Delete all docs

If you select this menu, the confirmation screen is displayed.

You can delete all the documents in the machine's memory.

If you select **Yes** using the ◀▶ button and press the **OK** button, all the documents in the machine's memory will be deleted.

Summary of Reports and Lists

The machine prints the report of sending or receiving a fax automatically. You can print the list of the fax/ telephone number or the current settings.

■ [Type of Reports and Lists](#)

■ [Printing Report or List](#)

Type of Reports and Lists

Report or List	Description
ACTIVITY REPORT	Shows recent fax transactions at sight. <ul style="list-style-type: none"> You can print ACTIVITY REPORT manually. For details on the procedure to print, see Printing Report or List. The * (asterisk) is appended to the history already printed on ACTIVITY REPORT. If you select Print for Activity report in Auto print settings under Fax settings, the machine prints ACTIVITY REPORT for the 20 histories of sent and received faxes automatically. ■ Auto print settings
Directory list <ul style="list-style-type: none"> RECIPIENT TELEPHONE NUMBER LIST GROUP DIAL TELEPHONE NO. LIST 	Lists the numbers and names registered. You can print the lists of the recipient and group dial. For details on the procedure to print, see Printing Report or List .
USER'S DATA LIST	Lists the current settings of the machine and the registered sender information. For details on the procedure to print, see Printing Report or List .
MEMORY LIST	Lists the documents currently stored in the machine's memory. For details on the procedure to print, see Printing Report or List . ▶▶▶ Note <ul style="list-style-type: none"> You can print MEMORY LIST by selecting Print memory list in Memory reference under FAX menu. ■ Printing a Document in Machine's Memory
REJECTED NUMBER LIST	Lists the rejected numbers. For details on the procedure to print, see Printing Report or List .
CALLER HISTORY	Lists the caller history. This list is available when Caller ID service is subscribed. For details on the procedure to print, see Printing Report or List . This list may not be supported depending on the country or region of purchase.
TX REPORT/ERROR TX REPORT	Either of these reports is printed after each fax transmission. <ul style="list-style-type: none"> At the time of purchase, ERROR TX REPORT is set to be printed only when a transmission error occurred.

	<p>You can set the machine to print TX REPORT each time it sends a document, or disable printing of the report by selecting TX report in Auto print settings under Fax settings.</p> <p>You can also specify the print setting so that the first page of the fax is printed along with the report.</p> <p>■ Auto print settings</p> <p>▶▶ Note</p> <div style="border: 1px solid black; background-color: #e0e0e0; padding: 5px;"> <ul style="list-style-type: none"> • The first page of the fax is not printed in color transmission. </div> <ul style="list-style-type: none"> • MULTI TRANSMISSION REPORT is printed after sequential broadcasting of a document. • If an error occurs when you send a fax, the error number is printed on ERROR TX REPORT (there are some errors for which the cause is also printed). <p>For details on the error number, see Errors When You Send a Fax.</p>
MULTI TRANSMISSION REPORT	<p>This report is printed after sequential broadcasting of a document.</p> <p>Confirms whether the transmission to all the recipients has been completed successfully.</p> <p>The procedure to print and the error number is same as TX REPORT.</p>
RX REPORT	<p>This report is printed after each fax reception.</p> <ul style="list-style-type: none"> • At the time of purchase, the machine is set so that RX REPORT is not printed at all. <p>You can set the machine to print RX REPORT each time it receives a document, or only when an error occurs by selecting RX report in Auto print settings under Fax settings.</p> <p>■ Auto print settings</p> <ul style="list-style-type: none"> • If an error occurs when you receive a fax, the error number is printed on RX REPORT (there are some errors for which the cause is also printed). <p>For details on the error number, see Errors When You Receive a Fax.</p>
MEMORY CLEAR REPORT	<p>Lists the deleted faxes in the machine's memory if the faxes stored in the machine's memory are deleted by a power failure or unplugging the power cord.</p> <p>When the machine is turned on, Data error and Press [OK] are displayed on the LCD. MEMORY CLEAR REPORT is printed by pressing the OK button.</p>

Printing Report or List

This section describes the procedure to print the report or the list manually.

Print the following report or list manually.

- ACTIVITY REPORT
- Directory list (RECIPIENT TELEPHONE NUMBER LIST/GROUP DIAL TELEPHONE NO. LIST)
- USER'S DATA LIST
- MEMORY LIST
- REJECTED NUMBER LIST
- CALLER HISTORY

►► Note

- CALLER HISTORY may not be supported depending on the country or region of purchase.

1. [Make sure that the machine is turned on.](#)
2. [Load paper.](#)
3. Press the **FAX** button.
The Fax standby screen is displayed.
4. Press the **Menu** button.
The **FAX menu** screen is displayed.
5. Use the ◀▶ button to select **Print reports/lists**, then press the **OK** button.
6. Use the ◀▶ button to select the report or list you want to print, then press the **OK** button.
 - When you select **Directory list**:
Use the ◀▶ button to select **Recipient** or **Group dial**, then press the **OK** button.
If you select **Recipient**, select whether to print RECIPIENT TELEPHONE NUMBER LIST in alphabetical order, then press the **OK** button. If you select **Yes**, the machine prints RECIPIENT TELEPHONE NUMBER LIST in alphabetical order. If you select **No**, the machine prints RECIPIENT TELEPHONE NUMBER LIST in numerical order.
If you select **Group dial**, the machine prints GROUP DIAL TELEPHONE NO. LIST.
 - When you select an item other than **Directory list**:
Press the **OK** button.
The machine prints the selected report or list.

Errors When You Send a Fax

If an error occurs when you send a fax, the error number is printed on ERROR TX REPORT or ACTIVITY REPORT (there are some errors for which the cause is also printed).

The causes corresponding to the error numbers are as follows.

No.	Cause	Action
#001	Document is jammed in the ADF.	The document is jammed in the ADF. When the error is cleared, redo the operation.
#003	Document is too long.	You attempted to send a document longer than 15.75 inches / 400 mm. You cannot send a document longer than 15.75 inches / 400 mm from the ADF. "#003" is also printed if it takes time to send a page. Divide the document or set the image quality (Fax resolution) to a lower setting, then resend it.
#005	No answer.	The recipient's fax machine does not respond.

		Contact the recipient and have the recipient check that the telephone line is connected correctly.
#012	Try again.	There is no paper in the recipient's fax machine. Contact the recipient and have the recipient load paper.
#017	No tone is detected.	The machine could not detect the dial tone. Dial tone detect in Adv. FAX settings under Fax settings is set to ON. Set to OFF. ■ Adv. FAX settings
#018	Line was busy.	The fax/telephone number you dialed is busy. Try dialing again after waiting for a moment.
#022	Number is deleted.	The fax/telephone number registered in the machine's directory is incorrect. Check the recipient's fax/telephone number, correct the fax/telephone number registered in the machine's directory, then send the document again. ■ Changing Registered Information
#037	Memory is full.	The machine could not send a fax because its memory is full. Delete contents in memory, then send a fax again. ■ Document Stored in Machine's Memory
#059	Transmission has been canceled due to a fax information mismatch.	Transmission has been canceled because the machine could not detect the recipient's fax machine information or the information did not match the dialed number. This message is displayed when Check RX FAX info in Security control under Fax settings is set to ON . For details, see Sending Faxes after Checking Information (Checking the Recipient's Information) .
#085	Try again in black & white transmission.	The recipient's fax machine is not color-compatible. Resend the document in black & white.
#099	The Stop button was pressed during transmission.	The Stop button was pressed to cancel transmission of the document. Resend it if necessary.
#412	The fax could not be sent from the computer.	The fax could not be sent from the computer (Windows only). Ensure that the machine is connected with the computer correctly and redo operation.
#995	The unsent fax was deleted while automatic redialing.	While automatic redialing, the unsent fax is stored in the machine's memory temporarily until the sending fax is complete. If a power failure occurs or you unplug the power cord before automatic redialing is complete, all faxes stored in the machine's memory are deleted and not sent. Resend the document.

Errors When You Receive a Fax

If an error occurs when you receive a fax, the error number is printed on RX REPORT or ACTIVITY REPORT (there are some errors for which the cause is also printed).

The causes corresponding to the error numbers are as follows.

No.	Cause	Action
#003	It takes too long to receive a page.	Contact the sender and have the sender divide the fax or set the image quality (Fax resolution) to a lower setting and resend it.
#005	No answer.	When receiving a fax manually, the machine could not detect the signals from the sender's fax machine. Contact the sender and have the sender resend it, or set the machine to receive the fax automatically.
#037	Memory is full.	The machine could not receive a fax because its memory is full. Delete contents in memory, then ask the sender to resend the fax. See Document Stored in Machine's Memory .
#046	Reception has been rejected due to the specified fax rejection condition.	Reception has been rejected because the fax matches the fax rejection condition specified by FAX RX reject in Security control under Fax settings . For details, see Rejecting Fax Reception .
#099	The Stop button was pressed during reception.	The Stop button was pressed to cancel reception of the fax. Contact the sender and have the sender resend it if necessary.
#995	The received fax was deleted.	The received fax was deleted before being printed. Contact the sender and have the sender resend it if necessary.

Sending Faxes from a Computer

- ▶ **Sending a FAX (Fax Driver) 📌Basic**
- ▶ **Creating an Address Book (Fax Driver)**
- ▶ **Edit or Remove a Recipient from an Address Book (Fax Driver)**
- ▶ **Search for a Recipient in an Address Book (Fax Driver)**
- ▶ **Troubleshooting Problems Sending Faxes (Fax Driver)**
- ▶ **How to Open the Setting Screen of the Fax Driver**
- ▶ **General Notes (Fax Driver)**

Sending a FAX (Fax Driver)

You can send faxes using the fax driver from applications that support document printing.

►►► Note

- Only black and white transmission is supported.

1. Make sure that the machine is turned on.
2. Open the document you want to fax with an application (such as Notepad), and then click the Print command. (The command is **Print...** on the **File** menu.)
3. In **Select Printer** or **Name** in the **Print** dialog box, select **Canon XXX series FAX** (where "XXX" is the model name).
4. Click **Print** or **OK**.

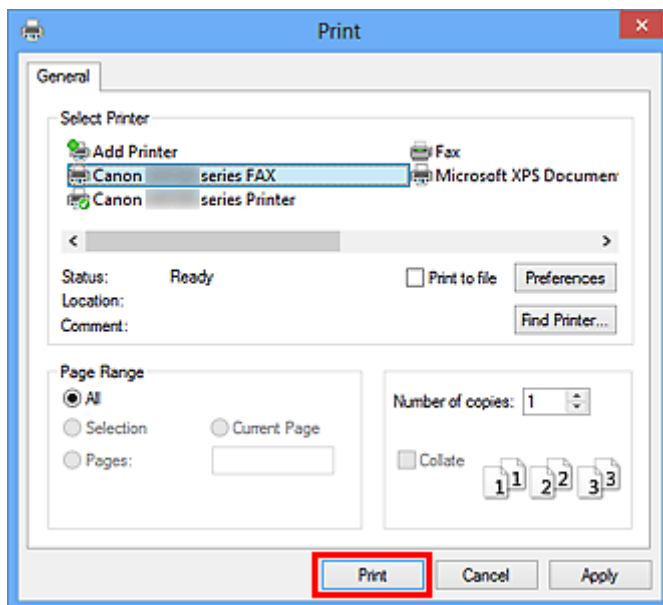

* Print dialog box in Notepad

►►► Note

- Click **Preferences** or **Properties** in the **Print** dialog box to open the print settings dialog box of the fax driver in which you can set the paper size and print orientation. For details on how to open the print settings dialog box of the fax driver, see "[How to Open the Setting Screen of the Fax Driver.](#)"

5. Click **Display Address Book...** in **Set Recipient** in the **Send FAX** dialog box.

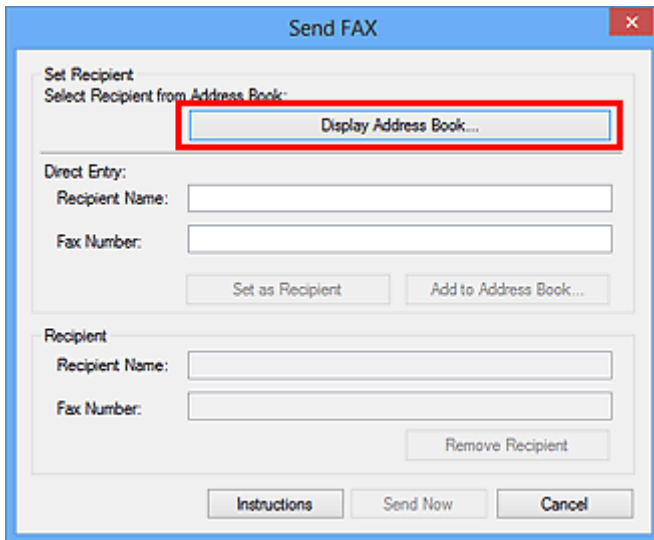

6. Select a recipient from **Recipient Name** in the **Select Recipient from Address Book** dialog box, then click **Set as Recipient**.

The selected recipient is reflected in **Recipient** in the **Send FAX** dialog box.

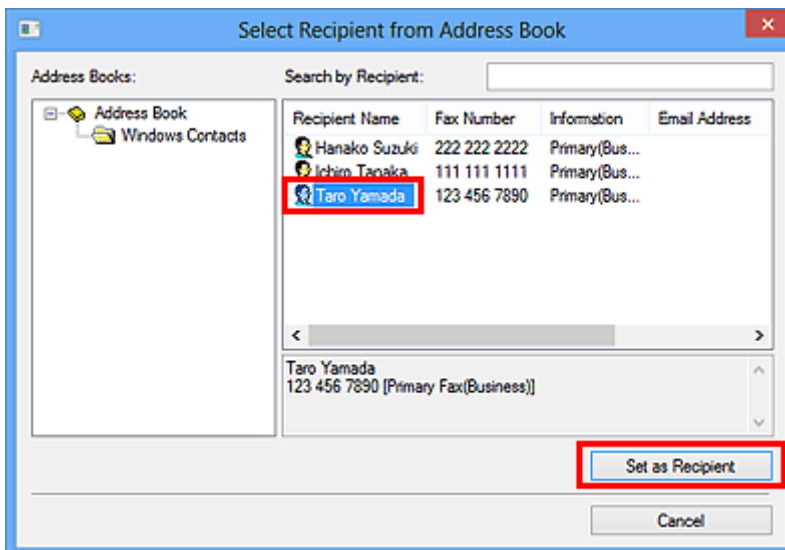

Important

- You cannot specify a recipient if there is no recipient registered in the address book. Register the recipient in the address book and reopen the address book.
For details on how to register recipients in the address book, see "[Creating an Address Book \(Fax Driver\)](#)."
- If the recipient's fax/telephone number is entered incorrectly or the registered fax/telephone number is incorrect, the fax may be sent to an unexpected recipient. When sending an important fax, it is recommended that you send it after confirming the entered information and recipient's status.

Note

- You can also specify **Recipient** by entering the **Recipient Name** and **Fax Number** in **Direct Entry** in the **Send FAX** dialog box and then clicking **Set as Recipient**.
 - For details on valid characters, see "[General Notes \(Fax Driver\)](#)."
 - You can send faxes even if only the **Fax Number** is entered.

- You can register the recipient you entered to the address book by clicking **Add to Address Book...** For details on how to register recipients in the address book, see "[Creating an Address Book \(Fax Driver\)](#)."
- Add the outside line access number before the fax number as needed.
(Example: When the outside line access number is "0" and the fax number is "XXX-XXXX", enter "0XXX-XXXX".)

7. Click **Send Now**.

When a confirmation message is displayed, click **OK**.

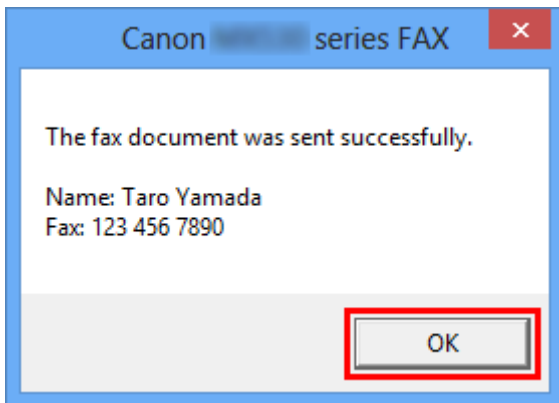

Important

- If you cannot send a fax due to line failure, etc., see "[Troubleshooting Problems Sending Faxes \(Fax Driver\)](#)."

Canceling Transmission

If you click **Send Now** in the **Send FAX** dialog box, the printer icon is displayed in the taskbar. Double-click this icon to display the list of fax jobs awaiting transmission or being sent.

Right-clicking a job and selecting **Cancel** stops transmission.

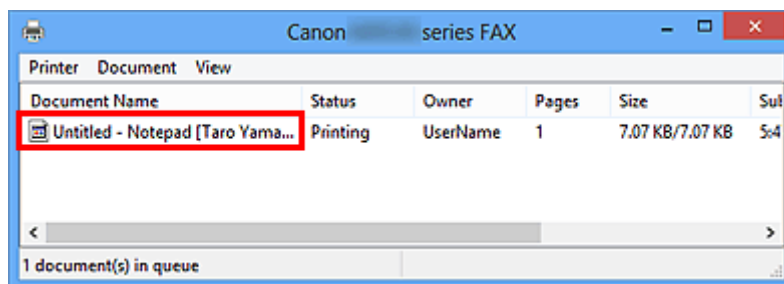

Creating an Address Book (Fax Driver)

By using the address book, you can send a fax by simply specifying a recipient from it. You can register the recipient's name, fax number and other information in the address book.

Registering a recipient (WAB contact) in the address book

You can register an individual recipient (Contact) in the address book.

1. [Open the print settings dialog box of the fax driver.](#)
2. Click **Address Book...** in the displayed dialog box.

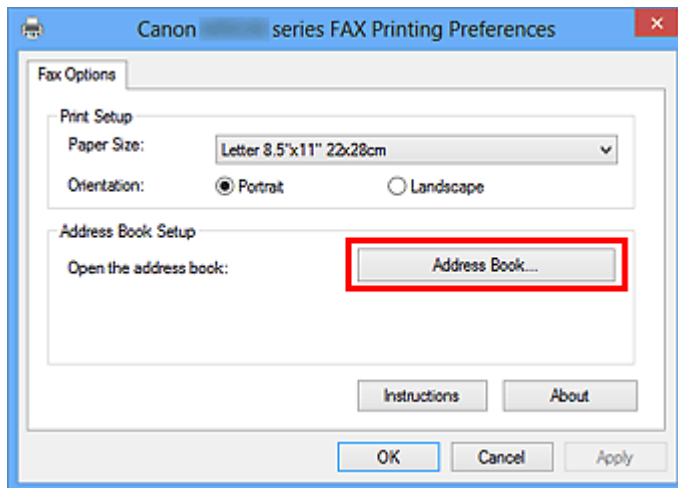

➤➤➤ Note

- In Windows XP, when you open the address book for the first time, the **Setup Windows Address Book** dialog box will be displayed. Refer to "[Setup when Opening the Address Book for the First Time \(Windows XP\)](#)" for details.
- In Windows 8.1/Windows 8/Windows 7/Windows Vista, you can register an individual recipient (Contact) in the address book folder (Windows Contacts) as an address book file (.contact file) which can be used in multiple applications. However, you cannot change the address book you use, as only one address book can be created per user.

Follow the steps below to open Windows Contacts.

- **Windows 8.1/Windows 8:**
Select the **Search** charm, then search for "Contacts".
- **Windows 7/Windows Vista:**
Select **XXXX (user name)** from the **Start** menu, then double-click **Contacts**.

3. In the **Address Book** dialog box, click **New**.

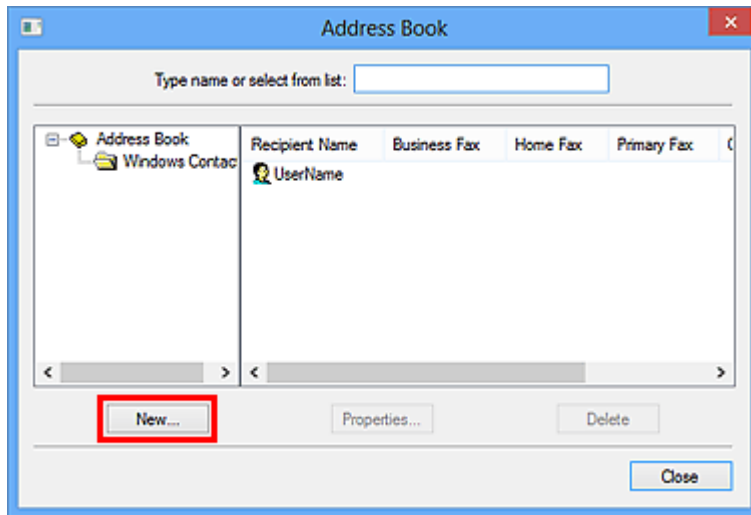

4. Select **Contact** in the **New Entry** dialog box, then click **OK**.

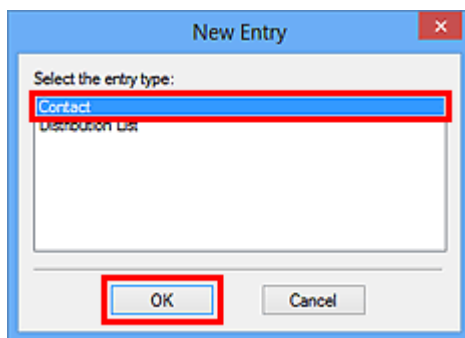

➤➤➤ Note

- For faxing, you can only specify the **Contact** (one recipient). You cannot specify a **Distribution List**.

5. Enter the **First**, **Middle**, and **Last** of the contact in the **Name and E-mail** tab (**Name** tab when using Windows XP) on the Properties dialog box.

The recipient's name will be printed at the top of the fax received by the recipient.

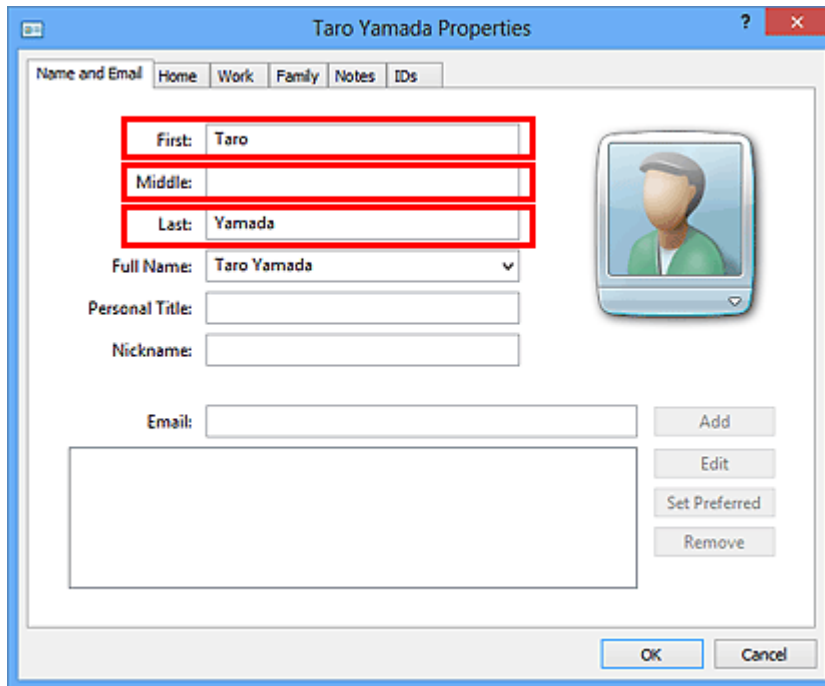

6. Enter the fax number on the **Home** or **Work** tab, then click **OK**.

An individual recipient (Contact) is registered in the address book.

➤➤➤ Note

- You can also register a recipient by clicking the **Add to Address Book...** button on the **Send FAX** dialog box after entering the recipient.

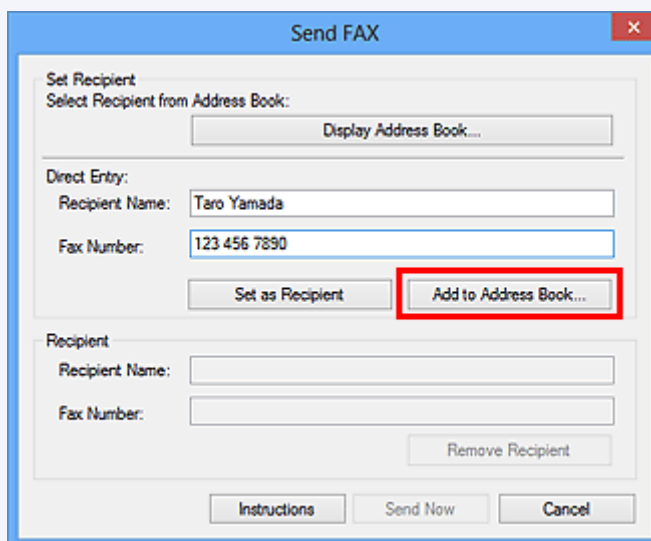

- Add the outside line access number before the fax number as needed.
(Example: When the outside line access number is "0" and the fax number is "XXX-XXXX", enter "0XXX-XXXX".)
- If you upgrade from Windows XP to Windows Vista, the address book you created in Windows XP may not be reflected in Windows Vista. In this case, open the address book in the following procedure and reflect the information to a new address book.
 1. From the **Start** menu, select **Control Panel > Appearance and Personalization > Folder Options**.
 2. Click the **View** tab of the **Folder Options** dialog box, select **Show hidden files and folders** in **Advanced settings**, then click **OK**.

3. From the **Start** menu, select **XXXX (user name)**, then double-click **AppData > Roaming > Canon > MP5** to open the folder.

4. Double-click the ".wab" file.

The address book will be reflected in Windows Vista automatically.

Related Topic

■ [Edit or Remove a Recipient from an Address Book \(Fax Driver\)](#)

■ [Search for a Recipient in an Address Book \(Fax Driver\)](#)

Setup when Opening the Address Book for the First Time (Windows XP)

In Windows XP, when you open the address book for the first time, the **Setup Windows Address Book** dialog box will be displayed and you can set the Windows Address Book you want to use.

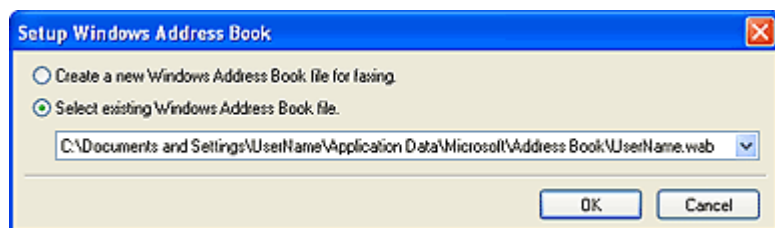

To Create a New Windows Address Book (WAB File) Exclusively for Faxing:

Select **Create a new Windows Address Book file for faxing.**, then click **OK**.

To Use an Existing Windows Address Book:

Click **Select existing Windows Address Book file.**, select an address book file from the list, then click **OK**.

Using an existing Windows Address Book enables you to share it with other applications that use Windows Address Books.

This option cannot be selected if there is no Windows Address Book file created.

►►► Note

- You can also change the setting by clicking **Address Book Profile...** in the print settings dialog box of the fax driver so as to use another Windows Address Book.
- You can import the entries from one Windows Address Book file into another, combining both sets of Windows Address Book entries. To import fax recipient contacts in an Address Book file to an existing Address Book file, follow the steps below.
 1. From the **Start** menu, select **Search**.
 2. Click **All files and folders**.
 3. In the file name box, enter ".wab".
 4. Select the **Search hidden files and folders** checkbox in **More advanced options**, then click **Search**.
 5. From the found Windows Address Book files, double-click an existing Windows Address Book file.

The existing Windows Address Book opens.
 6. In the **File** menu, in **import**, select **Address Book (WAB)...**
 7. Select the Windows Address Book containing fax recipient contacts, then click **Open**.
 8. When a completion message appears, click **OK**.

How to Open the Setting Screen of the Fax Driver

The following explains how to display the print settings dialog box or the Properties dialog box of the fax driver from your application or from the fax/printer icon.

Opening the Print Settings Dialog Box of the Fax Driver from an Application

1. Click the Print command in the application.

In general, you can open the **Print** dialog box by selecting Print from the File menu.

2. Select "your model name," then click **Preferences** (or **Properties**).

The print settings dialog box of the fax driver appears.

Opening the Print Settings Dialog Box of the Fax Driver from the Fax/Printer Icon

• Windows 8.1/Windows 8:

1. Click the **Settings** charm > **Control Panel** > **Hardware and Sound** > **Devices and Printers**.
2. Right-click the **Canon XXX series Printer** icon or **Canon XXX series FAX** icon and select **Printing Preferences**, then **Canon XXX series FAX**. (Where "XXX" is the model name.)

• Windows 7:

1. From the **Start** menu, select **Control Panel** > **Hardware and Sound** > **Devices and Printers**.
2. Right-click the **Canon XXX series Printer** icon or **Canon XXX series FAX** icon and select **Printing Preferences**, then **Canon XXX series FAX**. (Where "XXX" is the model name.)

• Windows Vista:

1. From the **Start** menu, select **Control Panel** > **Hardware and Sound** > **Printers**.
2. Right-click the **Canon XXX series FAX** icon (where "XXX" is the model name) and select **Printing Preferences....**

• Windows XP:

1. From the **Start** menu, select **Control Panel** > **Printers and Other Hardware** > **Printers and Faxes**.

2. Right-click the **Canon XXX series FAX** icon (where "XXX" is the model name) and select **Printing Preferences....**

Opening the Properties Dialog Box of the Fax Driver from the Fax/Printer Icon

- **Windows 8.1/Windows 8:**

1. Click the **Settings** charm > **Control Panel** > **Hardware and Sound** > **Devices and Printers**.
2. Right-click the **Canon XXX series Printer** icon or **Canon XXX series FAX** icon and select **Printer Properties**, then **Canon XXX series FAX**. (Where "XXX" is the model name.)

- **Windows 7:**

1. From the **Start** menu, select **Control Panel** > **Hardware and Sound** > **Devices and Printers**.
2. Right-click the **Canon XXX series Printer** icon or **Canon XXX series FAX** icon and select **Printer Properties**, then **Canon XXX series FAX**. (Where "XXX" is the model name.)

- **Windows Vista:**

1. From the **Start** menu, select **Control Panel** > **Hardware and Sound** > **Printers**.
2. Right-click the **Canon XXX series FAX** icon (where "XXX" is the model name) and select **Properties**.

- **Windows XP:**

1. From the **Start** menu, select **Control Panel** > **Printers and Other Hardware** > **Printers and Faxes**.
2. Right-click the **Canon XXX series FAX** icon (where "XXX" is the model name) and select **Properties**.

Edit or Remove a Recipient from an Address Book (Fax Driver)

You can change the recipients' names, fax numbers and other information, or delete recipients registered in the address book.

Editing Recipients in an address book

1. [Open the print settings dialog box of the fax driver.](#)
2. Click **Address Book...** in the displayed dialog box.

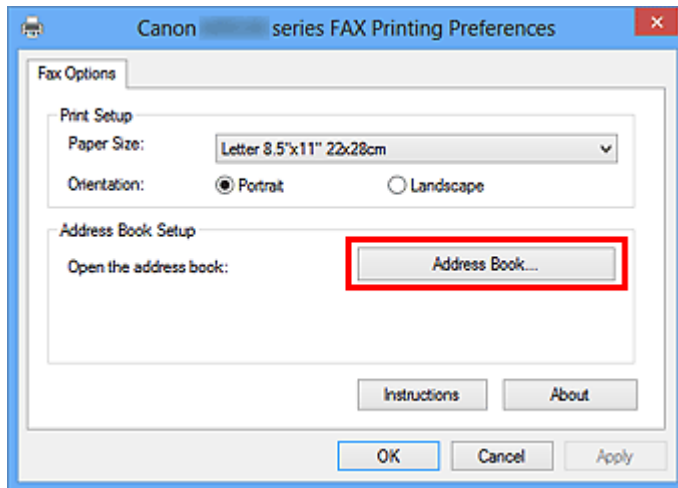

3. Select the recipient you want to edit from the **Address Book** dialog box, then click **Properties....**

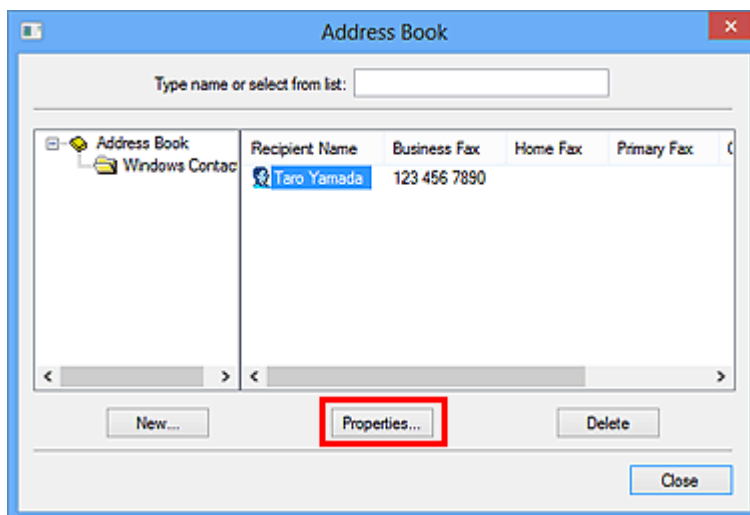

4. Change information as needed on the Properties dialog box, then click **OK**.

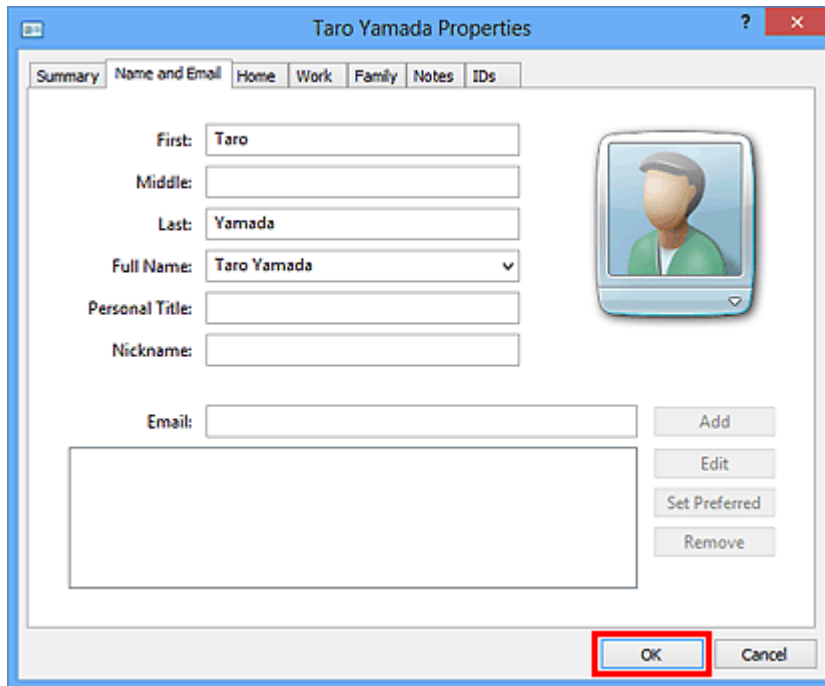

Removing Recipients from an address book

1. [Open the print settings dialog box of the fax driver.](#)
2. Click **Address Book...** in the displayed dialog box.

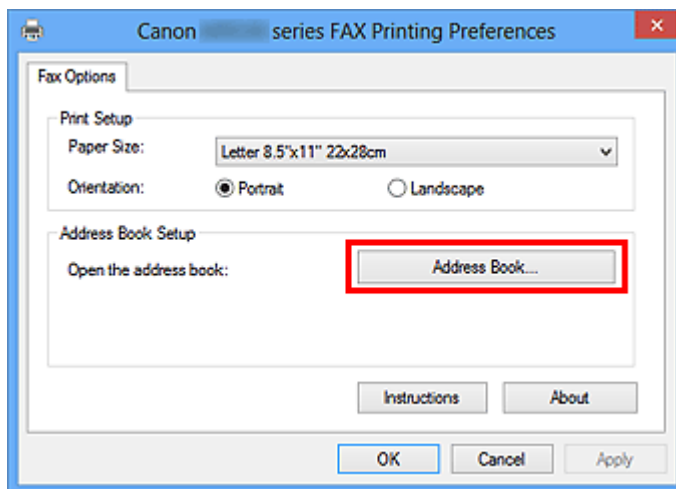

3. Select the recipient you want to delete from the **Address Book** dialog box, then click **Delete**.

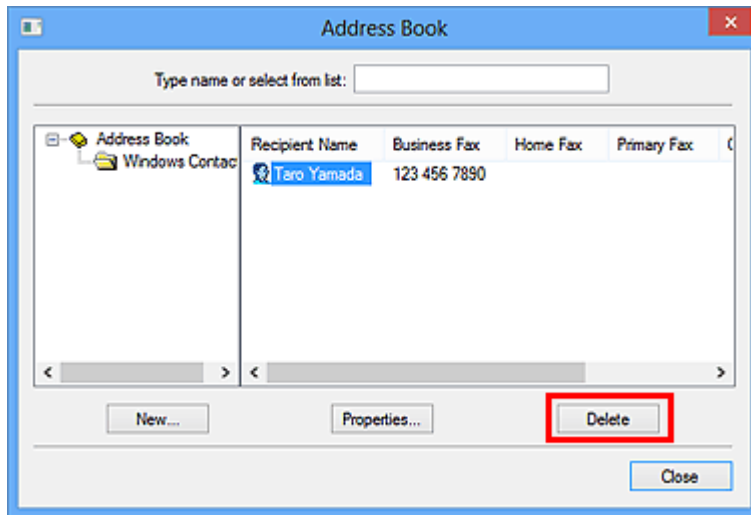

4. When a confirmation message is displayed, click **Yes**.

Search for a Recipient in an Address Book (Fax Driver)

You can search for recipients registered in the address book by name.

1. Open the document you want to fax with an application (such as Notepad), and then click the Print command. (The command is **Print...** on the **File** menu.)
2. In **Select Printer** or **Name** in the **Print** dialog box, select **Canon XXX series FAX** (where "XXX" is the model name).
3. Click **Print** or **OK**.

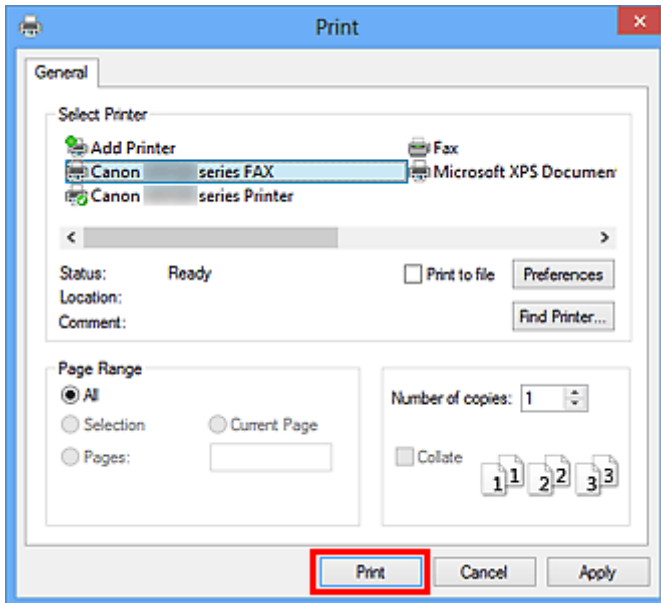

* **Print** dialog box in Notepad

4. Click **Display Address Book...** in **Set Recipient** in the **Send FAX** dialog box.

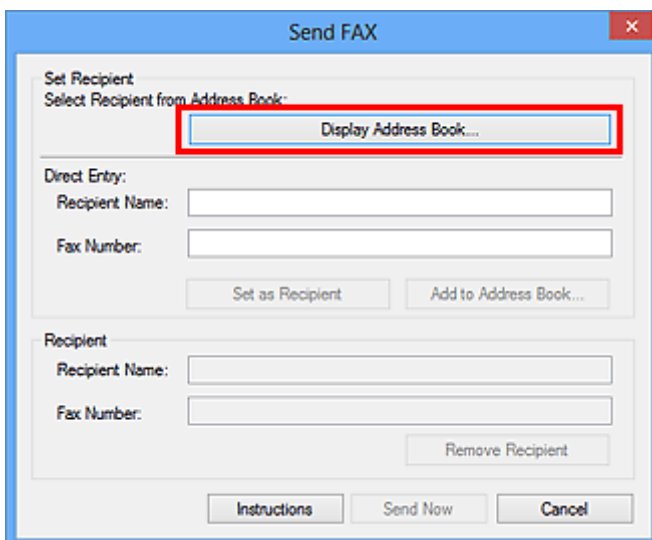

5. Enter the name of the recipient you want to search for in **Search by Recipient** in the **Select Recipient from Address Book** dialog box.

If the entered name is found, the recipient will be displayed in the contact list with its name selected.

While the name is selected, click **Set as Recipient** to enter it as the recipient.

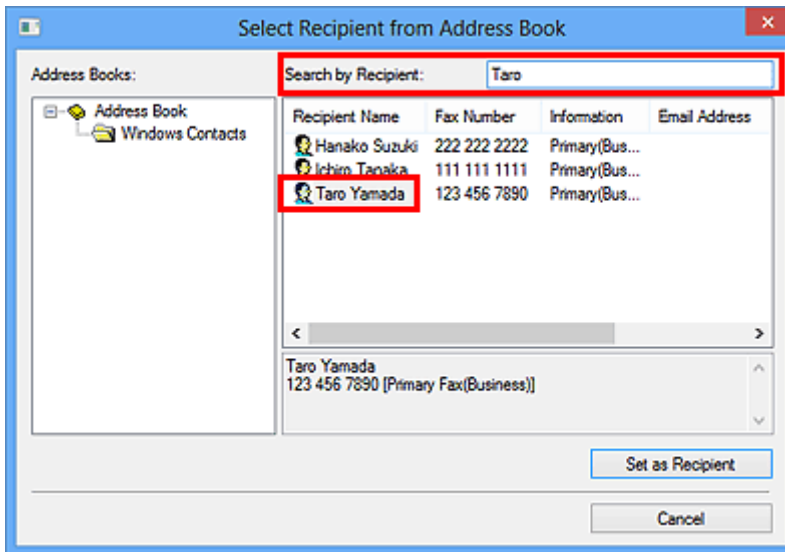

▶▶▶ Important

- You cannot search by criteria other than name.

Troubleshooting Problems Sending Faxes (Fax Driver)

Check 1 Is the power turned on?

You cannot send faxes if the power is turned off. Press the **ON** button to turn the power on.

If you disconnected the power cord without turning off the power (one of the buttons on the operation panel is lit), reconnecting it turns on the power.

If you disconnected the power cord after pressing the **ON** button to turn off the power (no buttons on the operation panel are lit), reconnect it, then press the **ON** button to turn on the power.

If the power was turned off due to power failure, etc., the power is automatically turned on when the power failure is resolved.

▶▶▶ Important

- Confirm that all lamps on the operation panel are off before unplugging the power cord, then unplug the power cord.

If a power failure occurs or you unplug the power cord, all faxes stored in the machine's memory are deleted.

▶▶▶ Note

- If the faxes stored in the machine's memory are deleted by a power failure or unplugging the power cord, the list of the faxes deleted from the machine's memory will be printed after turning the machine on.

Check 2 Is a document being sent from memory or a fax being received into memory?

When the message for the transmission/reception is displayed on the machine's LCD (Liquid Crystal Display) monitor, a fax is being sent from/received into machine's memory. Wait until the transmission/reception is complete.

Check 3 Is the telephone line type set correctly?

Check the telephone line type setting and change it as necessary.

Check 4 Is **Dial tone detect** set to **ON**?

Resend the fax after a while.

If you still cannot send the fax, select **OFF** for **Dial tone detect** in **Advanced FAX settings** under **FAX settings**.

Check 5 Is the recipient's fax number correct?

Check the recipient's fax number, then send the document again.

■ [Sending a FAX \(Fax Driver\)](#)

▶▶▶ Note

- For details on how to change the recipients registered in the address book, see "[Edit or Remove a Recipient from an Address Book \(Fax Driver\)](#)."

Check 6 Does an error occur during transmission?

Check if a message is displayed in the computer screen.

If displayed, check the message, then resolve the error.

Check 7 Does a printer error occur?

Check if a message is displayed on the LCD monitor.

If a support code is displayed, see "Support Code List" for your model from Home of the *Online Manual*.

If no support code is displayed, see "A Message Is Displayed" for your model from Home of the *Online Manual*.

If you are in a hurry, press the **Stop** button to close the message, then send the fax.

Check 8 Is the telephone line connected correctly?

Reconnect the telephone line cable to the telephone line jack.

If the telephone line is connected correctly, then there is a problem with your telephone line. Contact your telephone company and the manufacturer of your terminal adapter or telephone adapter.

General Notes (Fax Driver)

This fax driver is subject to the following restrictions. Keep the following points in mind when using the fax driver.

- The fax driver may not work correctly when sending a Microsoft Excel 2002 document as a fax with the **Allow A4/Letter Paper Resizing** option checked in Microsoft Excel 2002. Follow the instructions below to solve the problem:
 1. Click **Options...** from the **Tools** menu.
 2. Uncheck the **Allow A4/Letter Paper Resizing** option on the **International** tab.
- When using a network compatible printer, you cannot send faxes from multiple computers at the same time. If you try to send a fax from a computer while a fax is being sent from another computer, a message appears and your fax cannot be sent.

Make sure that a fax is not being sent from another computer.

- If you assign the fax driver to the Bluetooth port, you cannot send a fax from the computer.
- You can use the following characters for **Fax Number**:

Character	Explanation
0 - 9 * #	For use in telephone and fax numbers.
, p	To place a pause between numbers.
P	To place a pause at the end of a sequence of numbers.
T	Numbers after the T will be sent as a tone signal.
+ - (), space	To make the number easier to read. You cannot insert a space at the front of a number.

*You cannot use ".", "R", "M", or "E".

- You can enter the following number of characters in **Recipient Name** and **Fax Number**.

Recipient Name: Up to 16 characters

Fax Number: Up to 60 characters

* The number of characters you can enter differs in some regions.

- The fax driver does not work correctly if you uncheck the **Enable printer pooling** option on the **Ports** tab of the **Canon XXX series FAX Properties** dialog box (where "XXX" is the model name). Check that the option is checked.

For details on how to open the **Canon XXX series FAX Properties** dialog box, see "[Opening the Properties Dialog Box of the Fax Driver from the Fax/Printer Icon.](#)"

Troubleshooting

- ▶ **The Machine Cannot Be Powered On**
- ▶ **Printing Does Not Start**
- ▶ **Paper Does Not Feed Properly/"No Paper" Error Occurs**
- ▶ **Print Results Not Satisfactory**
- ▶ **Ink Is Not Ejected**
- ▶ **Paper Jams**
- ▶ **If an Error Occurs**
- ▶ **Cannot Send a Fax**
- ▶ **Cannot Receive a Fax, Cannot Print a Fax**
- ▶ **List of Support Code for Error**

Search Each Function

- ▶ **Problems with Network Communication**
- ▶ **Problems while Printing/Scanning from Smartphone/Tablet**
- ▶ **Problems with Printing**
- ▶ **Problems with Scanning**
- ▶ **Problems with Faxing**
- ▶ **Problems with the Machine**
- ▶ **Problems with Installation/Downloading**
- ▶ **About Errors/Messages Displayed**
- ▶ **If You Cannot Resolve the Problem**

Problems with Network Communication

- **Cannot Detect a Machine on a Network**
- **Problems with the Machine while Using with Network**
- **Other Problems with Network**

Cannot Detect a Machine on a Network

- ▶ **Cannot Detect the Machine when Setting Up Network Communication**
- ▶ **The Machine Cannot Be Detected in the Wireless LAN**

Cannot Detect the Machine when Setting Up Network Communication

If the machine could not be detected on the network when setting up the network communication, confirm the network settings before redetecting the machine.

■ [Cannot Detect the Machine during Wireless LAN Setup: Check 1](#)

▶▶ Important

- If the machine cannot be detected while you are setting up the network communication using a USB cable, the machine may be in the access point mode. In this case, finish the access point mode and enable the wireless LAN, then try to redetect the machine.

■ [Using the Printer with the Access Point Mode](#)



Cannot Detect the Machine during Wireless LAN Setup: Check 1



Are the machine and network device (router, etc.) turned on?

Make sure that the machine is turned on.

■ [Confirming that the Power Is On](#)

Make sure that the network device (router, etc.) is turned on.

If the machine or the network device is turned off:

Turn on the machine or the network device.

After turning on the machine or the network device, it may take some time until ready for use. After a while just turning on the machine or the network device, click **Redetect** on the **Check Printer Settings** screen.

When the machine is detected, follow the instructions on the screen to continue to set up the network communication.

If the machine and the network device are turned on:

If the machine could not be detected after clicking **Redetect** even when the machine and the network device are turned on, or when you have turned them on, go to check 2.

■ [Cannot Detect the Machine during Wireless LAN Setup: Check 2](#)



Cannot Detect the Machine during Wireless LAN Setup: Check 2



Is the wireless LAN setting of the machine enabled?

Make sure that the  or  icon is displayed on the LCD.



If the icon is not displayed:

The wireless LAN setting of the machine is disabled. Enable the wireless LAN setting of the machine.

After enabling the wireless LAN setting, click **Back to Top** on the **Check Printer Settings** screen to try to set up the network communication from the beginning.

If the icon is displayed:

Go to check 3.

[Cannot Detect the Machine during Wireless LAN Setup: Check 3](#)



Cannot Detect the Machine during Wireless LAN Setup: Check 3



Is the machine connected to the wireless router?

By using the icon on the LCD, make sure that the machine is connected to the wireless router.



If the icon is displayed:

The machine may be placed far away from the wireless router. Place the machine near the wireless router temporarily, then click **Redetect** on the **Check Printer Settings** screen.

When the machine is detected, follow the instructions on the screen to continue to set up the network communication.

If the machine cannot be detected, the machine is not connected to the wireless router. Connect the machine to the wireless router.

Click **Back to Top** on the **Check Printer Settings** screen to try to set up the network communication from the beginning.

If the icon is displayed:

Go to check 4.

■ [Cannot Detect the Machine during Wireless LAN Setup: Check 4](#)



Cannot Detect the Machine during Wireless LAN Setup: Check 4



Does the firewall function of your security software or operating system for computer interfere with setting up the network communication?

The firewall function of your security software or operating system for computer may limit communications between the machine and your computer. Confirm the setting of firewall function of your security software or operating system or the message appearing on your computer.

If the firewall function interferes with setting up:

- **When the message appears on your computer:**

If the message warning that Canon software is attempting to access the network appears on the computer, set the security software to allow access.

- **When the message does not appear on your computer:**

Cancel to set up, then set the security software to allow Canon software* to access the network.

* On the Setup CD-ROM, select **win > Driver > DrvSetup**, then set the security software to allow the file **Setup.exe** or **Setup64.exe** to access the network.

After setting the security software, try to set up the network communication from the beginning.

▶▶ Note

- For the operating system firewall settings or the security software firewall settings, refer to the instruction manual of the computer or software, or contact its manufacturer.

If there is no problem with the firewall settings:

Go to check 5.

■ [Cannot Detect the Machine during Wireless LAN Setup: Check 5](#)



Cannot Detect the Machine during Wireless LAN Setup: Check 5



Check the settings of the wireless router.

Check the settings of the wireless router for the network connection such as IP address filtering, MAC address filtering, or DHCP function.

Make sure that the radio channel of the wireless router and that assigned to the machine are the same.

For details on how to check the settings of the wireless router, refer to the instruction manual supplied with the wireless router or contact its manufacturer.

If there is no problem with the settings of the wireless router:

Go to check 6.

■ [Cannot Detect the Machine during Wireless LAN Setup: Check 6](#)



Cannot Detect the Machine during Wireless LAN Setup: Check 6



Make sure that the machine is not placed far away from the wireless router.

The wireless router is located indoors within the effective range for wireless communication. Locate the machine within 164 ft. / 50 m from the wireless router.

In addition, check where the machine and the wireless router are located and take the appropriate action.

- Make sure that there is no obstruction between the machine and the wireless router.

Wireless communication between different rooms or floors is generally poor. Adjust the location of the machine and the wireless router.

- Make sure that there is no source of radio wave interference near the machine or the wireless router.

If a device (e.g. microwave oven) using the same frequency bandwidth as the wireless station is placed nearby, the device may cause interference. Place the machine or the wireless router as far away from the interference source as possible.

After checking above and taking the appropriate action, perform setup again.

▶▶ Note

- You can set up the network communication via USB. To set up via USB, select the **Set up the network connection via USB** check box on the **Check Printer Settings** screen and click **Next**.



The Machine Cannot Be Detected in the Wireless LAN



Check1 Make sure that the machine is turned on.

Check2 Is **Change LAN** in **LAN settings** under **Device settings** set to **LAN inactive**?

Check3 When the machine is connected to the computer temporarily using a USB cable, make sure that the USB cable is connected properly.

When you set up the wireless LAN connection or change the wireless LAN settings using IJ Network Tool through USB connection, make sure that the machine is connected to the computer with a USB cable securely.

■ [Connecting the Machine to the Computer Using a USB Cable](#)

Check4 Make sure that the machine setup is completed.

If not, perform setup with the Setup CD-ROM or perform it according to the instructions on our website.

Check5 When using IJ Network Tool, click **Update** to search for the machine again.

■ [Canon IJ Network Tool Screen](#)

Check6 When searching for a machine over a network, make sure that the machine is associated with the port.

When **No Driver** is displayed under **Name** in IJ Network Tool, there is no association. Select **Associate Port** on the **Settings** menu, then associate the port with the machine.

■ [When the Printer Driver Is Not Associated with a Port](#)

Check7 Make sure that the network settings in the machine are identical with those of the wireless router.

Refer to the instruction manual provided with the wireless router or contact its manufacturer to check the wireless router settings, and then modify the machine settings.

■ [How to Set an Encryption Key](#)

Check8 Make sure that there is no obstruction.

Wireless communication between different rooms or floors is generally poor. Adjust the location of the devices.

Check9 Make sure that the machine is not placed far away from the wireless router.

The wireless router is located indoors within the effective range for wireless communication. Locate the machine within 164 ft. / 50 m from the wireless router.

Check10 Make sure that there is no source of radio wave interference in your vicinity.

If a device (e.g. microwave oven) using the same frequency bandwidth as the wireless station is placed nearby, the device may cause interference. Place the wireless station as far away from the interference source as possible.

Check11 Make sure that the network settings of the computer are correct.

Make sure that the computer can communicate with the wireless router over the wireless LAN.

Check12 Make sure that **Enable bidirectional support** is selected in the **Ports** sheet of the properties dialog box of the printer driver.

Check13 Make sure that the firewall of the security software is disabled.

If the firewall function of your security software is turned on, a message may appear warning that Canon software is attempting to access the network. If the warning message appears, set the security software to always allow access.

If using any programs that switch the network environment, check their settings. Some programs will enable a firewall by default.

Check14 When using a router, connect the machine and computer to the LAN side (same network segment).

If the problem is not resolved, perform setup again with the Setup CD-ROM or perform it according to the instructions on our website.

Problems with the Machine while Using with Network

- ▶ **The Machine Stopped Working Suddenly**
- ▶ **Forgot a Wireless Router Name, SSID, or a Network Key**
- ▶ **The Administrator Password Set to the Machine Was Forgotten**
- ▶ **Cannot Use the Machine on Replacing a Wireless Router or Changing Its Settings**
- ▶ **Printing Speed Is Slow**
- ▶ **Ink Remaining Level Is Not Displayed on Printer Status Monitor of the Machine**

The Machine Stopped Working Suddenly

■ [Cannot Communicate with the Machine after the Network Settings Are Changed](#)

■ [Cannot Communicate with the Machine over the Wireless LAN](#)

■ [Cannot Communicate with the Machine while It Is in the Access Point Mode](#)

■ [Cannot Print, Scan, or Fax from a Computer Connected to the Network](#)

Cannot Communicate with the Machine after the Network Settings Are Changed

A

It may take a while for the computer to obtain the IP address, or you may need to restart your computer.

Search for the machine again after confirming a valid IP address is assigned to the computer.

Cannot Communicate with the Machine over the Wireless LAN

A

Check1 Make sure that the machine is turned on.

Check2 Are the network settings of the machine identical with those of the wireless router?

Make sure that the network settings of the machine (e.g. wireless router name, SSID, network key, etc.) are identical with those of the wireless router.

To check the settings of the wireless router, refer to the instruction manual provided with it or contact its manufacturer.

To check the current network settings of the machine, print out the network setting information.

■ [Printing Out Network Setting Information](#)

If the network settings of the machine are not identical with those of the wireless router, change the network settings of the machine to match with those of the wireless router using IJ Network Tool.

Check3 Make sure that the machine is not placed far away from the wireless router.

The wireless router is located indoors within the effective range for wireless communication. Locate the machine within 164 ft. / 50 m from the wireless router.

Check4 Make sure that there is no obstruction.

Wireless communication between different rooms or floors is generally poor. Adjust the location of the devices.

Check5 Make sure that there is no source of radio wave interference in your vicinity.

If a device (e.g. microwave oven) using the same frequency bandwidth as the wireless station is placed nearby, the device may cause interference. Place the wireless station as far away from the interference source as possible.

Check6 Make sure that the network settings of the computer are correct.

For the procedures to connect a network device to the computer and set them up, refer to the instruction manual of your network device or contact its manufacturer.

Check7 Make sure that the radio status is good and adjust the installation positions while monitoring the radio status with IJ Network Tool.

[Monitoring Wireless Network Status](#)

Check8 Make sure that a valid wireless channel is used.

The wireless channel to be used may be limited depending on wireless network devices installed in the computer. Refer to the instruction manual provided with your computer or your wireless network device to specify the valid wireless channel.

Check9 Make sure that the channel confirmed in Check 8 can communicate with the computer.

If not, change the channel set to the wireless router.

Check10 Make sure that the firewall of the security software is disabled.

If the firewall function of your security software is turned on, a message may appear warning that Canon software is attempting to access the network. If the warning message appears, set the security software to always allow access.

If using any programs that switch the network environment, check their settings. Some programs will enable a firewall by default.

Check11 When using a router, connect the machine and computer to the LAN side (same network segment).

If the problem is not resolved, perform setup again with the Setup CD-ROM or perform it according to the instructions on our website.

• **For placement:**

Make sure that there is no barrier or obstacle between the wireless router and the machine.

▶▶▶ Note

• **When you connect the machine to a Windows XP computer by cableless setup:**

Follow the procedure below to perform settings of the machine and the computer.

1. [Enable the access point mode of the machine.](#)
2. Right-click the **Wireless Network Connections** icon on the notification area on the desktop, then click **View Available Wireless Networks**.
3. Select the network name on the screen displayed, then click **Connect**.
Select "XXXXXX-MXXXXseries" ("XX" represents alphanumeric characters.) as the network name.
4. Enter the network key on the screen displayed, then click **Connect**.

As a default, the serial number of the machine is used as a network key. Confirm the serial number on the rear of the machine.

5. Perform setup with the Setup CD-ROM or perform it according to the instructions on our website.

Cannot Communicate with the Machine while It Is in the Access Point Mode

Check1 Make sure that the machine is turned on.

Check2 Is **Change LAN** in **LAN settings** under **Device settings** set to **LAN inactive** or **Wireless LAN**?

Select **Access point mode**.

Check3 Have you selected the machine as the destination of your external communication devices (e.g. computers, smartphones, or tablets)?

Select the access point name (SSID) of the machine with your external communication devices.

Check4 Have you entered the proper password specified for the access point mode?

If the security setting of the access point mode is enabled, you need to enter the password to connect your external communication device to the machine. Confirm the specified password, then enter the proper one.

Check5 Make sure that external communication devices are not placed far away from the machine.

Locate your external communication device close enough to communicate with the machine.

Check6 Make sure that there is no obstruction.

Wireless communication between different rooms or floors is generally poor. Adjust the location of the devices.

Check7 Make sure that there is no source of radio wave interference in your vicinity.

If a device (e.g. microwave oven) using the same frequency bandwidth as the wireless station is placed nearby, the device may cause interference. Place the wireless station as far away from the interference source as possible.

Check8 Are you trying to connect 6 devices or more?

You can connect up to 5 devices using the access point mode.

Cannot Print, Scan, or Fax from a Computer Connected to the Network

Check1 Make sure that the network settings of the computer are correct.

For the procedures to set up the computer, refer to the instruction manual of your computer or contact its manufacturer.

Check2 If the MP Drivers are not installed, install them.

Install the MP Drivers with the Setup CD-ROM or install them from our website.

Check3 Make sure that access control is not set to the wireless router.

For the procedures to connect a wireless router and set it up, refer to the instruction manual of your wireless router or contact its manufacturer.

▶▶ Note

- To check the MAC address or the IP address of the computer, see [Checking the IP Address or the MAC Address of the Computer](#).

Forgot a Wireless Router Name, SSID, or a Network Key

■ [Cannot Connect with a Wireless Router to Which a WEP or WPA/WPA2 Key Is Set \(You Forgot the WEP or WPA/WPA2 Key\)](#)

■ [How to Set an Encryption Key](#)

Cannot Connect with a Wireless Router to Which a WEP or WPA/WPA2 Key Is Set (You Forgot the WEP or WPA/WPA2 Key)

A

For information on how to set up the wireless router, refer to the instruction manual provided with the wireless router or contact its manufacturer. Make sure that the computer and the wireless router can communicate with each other.

After that, set up the machine to match the settings of the wireless router using IJ Network Tool.

How to Set an Encryption Key

A

For information on how to set up the wireless router, refer to the instruction manual provided with the wireless router or contact its manufacturer. Make sure that the computer and the wireless router can communicate with each other.

After that, set up the machine to match the settings of the wireless router using IJ Network Tool.

- **When using WEP**

The key length, key format, the key to use (one of 1 to 4), and the authentication method must match among the wireless router, the machine, and the computer.

In order to communicate with a wireless router that uses automatically generated WEP keys, you must configure the machine to use the key generated by the wireless router by entering it in hexadecimal format.

Normally, select **Auto** for the authentication method. Otherwise, select **Open System** or **Shared Key** according to the setting of the wireless router.

When the **WEP Details** screen appears after clicking **Set** on the **Search** screen, follow the on-screen instructions and set the key length, the key format, the key number, and the authentication method to enter a WEP key.

For details, see [Changing the WEP Detailed Settings](#).

- **When using WPA/WPA2**

The authentication method, passphrase, and dynamic encryption type must match on the wireless router, the machine, and the computer.

Enter the passphrase configured on the wireless router (a sequence of between 8 and 63 alphanumeric characters, or a 64-character hexadecimal number).

Either TKIP (basic encryption) or AES (secure encryption) is selected automatically for the dynamic encryption method.

For details, see [Changing the WPA/WPA2 Detailed Settings](#).

▶▶ Note

- This machine supports WPA/WPA2-PSK (WPA/WPA2-Personal) and WPA2-PSK (WPA2-Personal).



The Administrator Password Set to the Machine Was Forgotten



Initialize the machine settings.

Select **All data**, then the administrator password returns to the default.

■ [Reset setting](#)

After initializing the machine settings, perform setup with the Setup CD-ROM or perform it according to the instructions on our website.



Cannot Use the Machine on Replacing a Wireless Router or Changing Its Settings



When you replace a wireless router, perform network setup of the machine again.

Perform network setup again with the Setup CD-ROM or perform it again according to the instructions on our website.

If the problem is not resolved, see below.

■ [Cannot Communicate with the Machine after Applying MAC/IP Address Filtering or Entering an Encryption Key to the Wireless Router](#)

■ [When Encryption Is Enabled, Cannot Communicate with the Machine after the Encryption Type Was Switched on the Wireless Router](#)



Cannot Communicate with the Machine after Applying MAC/IP Address Filtering or Entering an Encryption Key to the Wireless Router



Check1 Confirm the wireless router setting.

Refer to the instruction manual provided with the wireless router or contact its manufacturer to confirm the wireless router setting. Make sure that the computer and the wireless router can communicate with each other under this setting.

Check2 If you are performing MAC address filtering or IP address filtering at the wireless router, confirm that the MAC address or IP address for both the computer or the network device and the machine are registered.

Check3 If you are using a WEP or WPA/WPA2 key, make sure that the encryption key for the computer or the network device and the machine matches that set to the wireless router.

Besides the WEP key itself, the key length, key format, the key ID to use, and the authentication method must match among the machine, the wireless router, and the computer.

Normally, select **Auto** for the authentication method. If you want to specify the method manually, select **Open System** or **Shared Key** according to the setting of the wireless router.

■ [How to Set an Encryption Key](#)

Q When Encryption Is Enabled, Cannot Communicate with the Machine after the Encryption Type Was Switched on the Wireless Router

A

If the machine cannot communicate with the computer after the encryption type of the machine was switched, make sure that encryption types for the computer and the wireless router matches that set to the machine.

■ [Cannot Communicate with the Machine after Applying MAC/IP Address Filtering or Entering an Encryption Key to the Wireless Router](#)



Printing Speed Is Slow



Check1 The machine may be printing out a large job issued from another computer.

Check2 Make sure that the radio status is good and adjust the installation positions while monitoring the radio status with IJ Network Tool.

■ [Monitoring Wireless Network Status](#)

Make sure that there is no barrier or obstacle between the wireless router and the machine. Wireless communication between different rooms or floors is generally poor. The metal, concrete, or timber including the metallic material, mud wall, or insulator may interrupt a wireless communication. If the machine cannot communicate with the computer over a wireless LAN for the wall material, place the machine and the computer in the same room or floor.

Check3 Make sure that there is no source of interference in your vicinity.

If a device (e.g. microwave oven) using the same frequency bandwidth as the wireless station is placed nearby, the device may cause interference. Place the wireless station as far away from the interference source as possible.



Ink Remaining Level Is Not Displayed on Printer Status Monitor of the Machine



Use the printer driver with bidirectional communication.

Select **Enable bidirectional support** in the **Ports** sheet of the properties dialog box of the printer driver.

■ [How to Open the Printer Driver Setup Window](#)

Other Problems with Network

- ▶ **The Message Is Displayed on the Computer Screen during Setup**
- ▶ **Packets Are Sent Steadily**
- ▶ **Checking Information about the Network**
- ▶ **How to Restore the Machine's Network Settings to Factory Default**

The Message Is Displayed on the Computer Screen during Setup

■ [The Enter Password Screen Is Displayed during Setup](#)

■ [The Screen for Setting the Encryption Is Displayed After Selecting the Wireless Router in the Search Screen](#)

■ ["You are connecting the machine to the non encrypted wireless network" Is Displayed](#)

Q The Enter Password Screen Is Displayed during Setup

A

The following screen is displayed if an administrator password is set to the machine which has already been set up to use via a network.



Enter the administrator password you have set.

»» Note

- An administrator password is already specified for the machine at the time of purchase.

For details:

■ [About the Administrator Password](#)

For improving security, we recommend to change the administrator password.

■ [Changing the Settings in the Admin Password Sheet](#)

Q The Screen for Setting the Encryption Is Displayed After Selecting the Wireless Router in the Search Screen

A

This screen is displayed automatically if the selected wireless router is encrypted. In this case, configure the details to use the same encryption settings set to the wireless router.

For information on the encryption settings, see [Changing the Settings in the Wireless LAN Sheet](#).

Q "You are connecting the machine to the non encrypted wireless network" Is Displayed

A

Security is not configured on the wireless router. The machine can still be used, so continue the setup procedure to complete it.

»» Important

- If you connect to a network that is not protected with security measures, there is a risk of disclosing data such as your personal information to a third party.



Packets Are Sent Steadily



While IJ Network Scanner Selector EX is enabled, it periodically transmits packets to check whether it can communicate with the machine over the network. When using the computer in a network environment other than the one used to set up the machine, disable IJ Network Scanner Selector EX.

To disable IJ Network Scanner Selector EX, right-click the  icon on the notification area on the desktop, then select **Disable Canon IJ Network Scanner Selector EX**.

Checking Information about the Network

■ [Checking the IP Address or the MAC Address of the Machine](#)

■ [Checking the IP Address or the MAC Address of the Computer](#)

■ [Checking If the Computer and the Machine, or Computer and the Wireless Router Can Communicate](#)

■ [Checking the Network Setting Information](#)



Checking the IP Address or the MAC Address of the Machine



To check the IP address or the MAC address of the machine, print out the network setting information using the operation panel of the machine.

■ [Printing Out Network Setting Information](#)

To display the network setting information using IJ Network Tool, select **Network Information** on the **View** menu.

■ [Canon IJ Network Tool Screen](#)



Checking the IP Address or the MAC Address of the Computer



To check the IP address or MAC address assigned to the computer, follow the procedure below.

1. Select **Command Prompt** as shown below.

- In Windows 8.1 or Windows 8, select **Command Prompt** from the **Start** screen. If **Command Prompt** is not displayed on the **Start** screen, select the **Search** charm, then search for "**Command Prompt**".
- In Windows 7, Windows Vista, or Windows XP, click **Start > All Programs > Accessories > Command Prompt**.

2. Enter "ipconfig/all" and press the **Enter** key.

The IP addresses and the MAC addresses of the network devices installed on your computer are displayed. When the network device is not connected to the network, the IP address is not displayed.



Checking If the Computer and the Machine, or Computer and the Wireless Router Can Communicate



To check that communication is available, perform the ping test.

1. Select **Command Prompt** as shown below.

- In Windows 8.1 or Windows 8, select **Command Prompt** from the **Start** screen. If **Command Prompt** is not displayed on the **Start** screen, select the **Search** charm, then search for "**Command Prompt**".
- In Windows 7, Windows Vista, or Windows XP, click **Start > All Programs > Accessories > Command Prompt**.

2. Type the ping command and the IP address of the target machine or the target wireless router, and then press the **Enter** key.

```
ping XXX.XXX.XXX.XXX
```

"XXX.XXX.XXX.XXX" is the IP address of the target device.

If the communication is available, a message such as the following is displayed.

```
Reply from XXX.XXX.XXX.XXX: bytes=32 time=10ms TTL=255
```

When **Request timed out** is displayed, the communication is not available.

Checking the Network Setting Information

A

To check the network setting information of the machine, print out the network setting information using the operation panel of the machine.

■ [Printing Out Network Setting Information](#)



How to Restore the Machine's Network Settings to Factory Default



▶▶ Important

- Note that initialization erases all network settings on the machine, and printing, scanning, or faxing operation from a computer over network becomes impossible. To use the machine over network, perform setup with the Setup CD-ROM or perform it according to the instructions on our website.

Select **LAN settings** on the operation panel of the machine to initialize the network setting.

■ [Reset setting](#)

Problems while Printing/Scanning from Smartphone/Tablet

- ▶ **Cannot Print/Scan from Smartphone/Tablet**



Cannot Print/Scan from Smartphone/Tablet



If you cannot print from your smartphone/tablet, it is possible that your smartphone/tablet cannot communicate with the machine.

Confirm the cause of your problem according to the connection method.

■ [Cannot Communicate with the Machine over the Wireless LAN](#)

■ [Cannot Communicate with the Machine while It Is in the Access Point Mode](#)

▶▶▶ Note

- For problems on printing with other connection methods or details on how to perform settings of each connection method:

■ [Using PIXMA Cloud Link](#)

■ [Printing with Google Cloud Print](#)

■ [Printing from AirPrint Compliant Device](#)

Cannot Communicate with the Machine over the Wireless LAN

If your smartphone/tablet cannot communicate with the machine, check the following.

Check1 Make sure that the machine is turned on.

Check2 Is **Change LAN** in **LAN settings** under **Device settings** set to **LAN inactive** or **Access point mode**?

Select **Wireless LAN**.

Check3 Are the network settings of the machine identical with those of the wireless router?

Make sure that the network settings of the machine (e.g. wireless router name, SSID, network key, etc.) are identical with those of the wireless router.

To check the settings of the wireless router, refer to the instruction manual provided with it or contact its manufacturer.

To check the current network settings of the machine, print out the network setting information.

■ [Printing Out Network Setting Information](#)

If the network settings of the machine are not identical with those of the wireless router, change the network settings of the machine to match with those of the wireless router using IJ Network Tool.

Check4 Are the network settings of your smartphone/tablet identical with those of the wireless router?

Make sure that the network settings of your smartphone/tablet (e.g. wireless router name, SSID, network key, etc.) are identical with those of the wireless router.

To check the settings of your smartphone/tablet, refer to the instruction manual provided with it.

If the network settings of your smartphone/tablet are not identical with those of the wireless router, change the network settings of it to match with those of the wireless router.

Check5 Make sure that the machine is not placed far away from the wireless router.

The wireless router is located indoors within the effective range for wireless communication. Locate the machine within 164 ft. / 50 m from the wireless router.

Check6 Make sure that there is no obstruction.

Wireless communication between different rooms or floors is generally poor. Adjust the location of the devices.

Check7 Make sure that there is no source of radio wave interference in your vicinity.

If a device (e.g. microwave oven) using the same frequency bandwidth as the wireless station is placed nearby, the device may cause interference. Place the wireless station as far away from the interference source as possible.

Cannot Communicate with the Machine while It Is in the Access Point Mode

If your smartphone/tablet cannot communicate with the machine in the access point mode, check the following.

Check1 Make sure that the machine is turned on.

Check2 Is **Change LAN** in **LAN settings** under **Device settings** set to **LAN inactive** or **Wireless LAN**?

Select **Access point mode**.

Check3 Confirm the settings of your smartphone/tablet.

Make sure that your smartphone/tablet can use the wireless LAN.

For details on how to perform setting of the wireless LAN, refer to the instruction manual provided with your smartphone/tablet.

Check4 Have you selected the machine as the destination of your smartphone/tablet?

Select the access point name (SSID) of the machine with your smartphone/tablet.

Check5 Have you entered the proper password specified for the access point mode?

If the security setting of the access point mode is enabled, you need to enter the password to connect your smartphone/tablet to the machine. Confirm the specified password, then enter the proper one.

Check6 Make sure that the machine is not placed far away from the wireless router.

Locate your smartphone/tablet close enough to communicate with the machine.

Check7 Make sure that there is no obstruction.

Wireless communication between different rooms or floors is generally poor. Adjust the location of the devices.

Check8 Make sure that there is no source of radio wave interference in your vicinity.

If a device (e.g. microwave oven) using the same frequency bandwidth as the wireless station is placed nearby, the device may cause interference. Place the wireless station as far away from the interference source as possible.

Check9 Are you trying to connect 6 smartphones/tablets or more?

You can connect up to 5 smartphones/tablets using the access point mode.

Problems with Printing

- **Printing Does Not Start**
- **Paper Jams**
- **Print Results Not Satisfactory**
- **Ink Is Not Ejected**
- **Paper Does Not Feed Properly/"No Paper" Error Occurs**
- **Copying/Printing Stops Before It Is Completed**



Printing Does Not Start



Check1 Make sure that the power plug is securely plugged in, then press the **ON** button to turn the machine on.

While the **POWER** lamp is flashing, the machine is initializing. Wait until the **POWER** lamp stops flashing and remains lit.

▶▶▶ Note

- When printing large data such as a photo or graphics, it may take longer to start printing. While the **POWER** lamp is flashing, the computer is processing data and sending it to the machine. Wait until printing starts.

Check2 Make sure that the machine is connected to your computer properly.

When the machine is connected to your computer with a USB cable, make sure that the USB cable is securely plugged in to the machine and the computer, then check the followings:

- If you are using a relay device such as a USB hub, disconnect it, connect the machine directly to the computer, and try printing again. If printing starts normally, there is a problem with the relay device. Consult the reseller of the relay device for details.
- There could also be a problem with the USB cable. Replace the USB cable and try printing again.

When you use the machine over LAN, make sure that the machine is set up to be used over network correctly.

Check3 Is the access point mode enabled?

When you print using a mode other than the access point mode, disable the access point mode in advance.

Check4 Make sure that the paper output tray is open.

Check5 Are the paper settings identical with those registered to the cassette?

When the paper settings are not identical with those registered to the cassette, an error message is displayed. Resolve the error according to the instructions on the LCD.

■ [Paper setting for Printing](#)

▶▶▶ Note

- You can disable the message which prevents misprinting.
 - To change the setting using the operation panel:
 - [Cassette settings](#)
 - To change the setting using the printer driver:
 - [Changing the Printer Operation Mode](#)

Check6 If you are printing from the computer and there are any unnecessary print jobs, delete them.

[Deleting the Undesired Print Job](#)

Check7 Make sure that your machine's name is selected in the Print dialog box.

The machine will not print properly if you are using a printer driver for a different printer.

Make sure that "Canon XXX series Printer" (where "XXX" is your machine's name) is selected in the Print dialog box.

Note

- To make the machine the one selected by default, select **Set as Default Printer**.

Check8 Configure the printer port appropriately.

Make sure that the printer port is configured appropriately.

1. Log on as a user account with administrator privilege.
2. Select items as shown below.
 - In Windows 8.1 or Windows 8, select **Control Panel** from the **Settings** charm on **Desktop > Hardware and Sound > Devices and Printers**.
 - In Windows 7, select **Devices and Printers** from the **Start** menu.
 - In Windows Vista, select the **Start** menu > **Control Panel > Hardware and Sound > Printers**.
 - In Windows XP, select the **Start** menu > **Control Panel > Printers and Other Hardware > Printers and Faxes**.
3. Open the properties of the printer driver for the machine.
 - In Windows 8.1, Windows 8, or Windows 7, right-click the "Canon XXX series Printer" icon (where "XXX" is your machine's name), then select **Printer properties**.
 - In Windows Vista or Windows XP, right-click the "Canon XXX series Printer" icon (where "XXX" is your machine's name), then select **Properties**.
4. Click the **Ports** tab to confirm the port settings.

Make sure that a port named "USBnnn" (where "n" is a number) with "Canon XXX series Printer" appearing in the **Printer** column is selected for **Print to the following port(s)**.

Note

- When the machine is used over LAN, the port name of the machine is displayed as "CNBJNP_XXXXXXXX". "XXXXXXXX" is the character string generated from the MAC address or a character string specified by the user when setting up the machine.

- If the setting is incorrect:

Reinstall the MP Drivers with the Setup CD-ROM or install them from our website.

- Printing does not start even though the machine is connected to the computer using a USB cable and the port named "USBnnn" is selected:

In Windows 8.1 or Windows 8, select **My Printer** on the **Start** screen to start **My Printer**. If **My Printer** is not displayed on the **Start** screen, select the **Search** charm, then search for "**My Printer**".

Set the correct printer port on **Diagnose and Repair Printer**. Follow the on-screen instructions to set the correct printer port, then select your machine's name.

In Windows 7, Windows Vista, or Windows XP, click **Start** and select **All programs, Canon Utilities, Canon My Printer, Canon My Printer**, then select **Diagnose and Repair Printer**. Follow the on-screen instructions to set the correct printer port, then select your machine's name.

If the problem is not resolved, reinstall the MP Drivers with the Setup CD-ROM or install them from our website.

- Printing does not start even though the port named "CNBJNP_XXXXXXXX" is selected when the machine is used over LAN:

Launch IJ Network Tool, and select "CNBJNP_XXXXXXXX" as you confirmed in step 4, then associate the port with the printer using **Associate Port** in the **Settings** menu.

If the problem is not resolved, reinstall the MP Drivers with the Setup CD-ROM or install them from our website.

Check9 Is the size of the print data extremely large?

Click **Print Options** on the **Page Setup** sheet on the printer driver. Then, set **Prevention of Print Data Loss** in the displayed dialog to **On**.

* When **On** is selected for **Prevention of Print Data Loss**, print quality may be reduced.

Check10 Restart your computer if you are printing from the computer.



Paper Jams



When paper is jammed, a troubleshooting message is displayed automatically. Take the appropriate action described in the message.

- **When a Support Code and a message are displayed on the computer screen:**



- **When a Support Code and a message are displayed on the LCD:**

Paper jammed
Remove the paper f 1300

For details on how to remove the jammed paper, refer to [List of Support Code for Error \(When Paper Is Jammed\)](#).

▶▶▶ Note

- You can confirm the actions against errors with Support Codes on your computer or on the LCD by searching a Support Code.

■ [Click Here to Search](#)



Print Results Not Satisfactory



If the print result is not satisfactory due to white streaks, misaligned lines, or uneven colors, confirm the paper and print quality settings first.

Check1 Do the page size and media type settings match the size and type of the loaded paper?

When these settings are incorrect, you cannot obtain a proper print result.

If you are printing a photograph or an illustration, incorrect paper type settings may reduce the quality of the printout color.

Also, if you print with an incorrect paper type setting, the printed surface may be scratched.

In borderless printing, uneven coloring may occur depending on the combination of the paper type setting and the loaded paper.

To copy by operating the machine	Confirm by using the operation panel on the machine. Setting Items for Copying
To print from a computer	Confirm by using the printer driver. Printing with Easy Setup

Check2 Make sure that the appropriate print quality is selected referring to the table in Check 1.

Select a print quality option suitable for the paper and image for printing. If you notice blurs or uneven colors, increase the print quality and try printing again.

Check3 If the problem is not resolved, there may be other causes.

See also the sections below:

[Cannot Print to End of Job](#)

[No Printing Results/Printing Is Blurred/Colors Are Wrong/White Streaks](#)

[Colors Are Unclear](#)

[Lines Are Misaligned](#)

[Line Does Not Print or Prints Partially](#)

[Image Does Not Print or Prints Partially](#)

[Printed Paper Curls or Has Ink Blots](#)

[Paper Is Smudged/Printed Surface Is Scratched](#)

[Back of the Paper Is Smudged](#)

[Vertical Lines Are Printed on the Sides of the Printout](#)

[Colors Are Uneven or Streaked](#)

If the Printed Paper Has Been Discolored

Colors may fade with time if the printed paper is left for a long period of time.

After printing, dry the paper sufficiently, avoid high temperatures, high humidity, and direct sunlight, and store or display indoors at room temperature and normal humidity.

To avoid direct exposure to air, we recommend that you store the paper in an album, plastic folder, photo frame, etc.



Cannot Print to End of Job



Check1 Select the setting not to compress the printing data.

If you select the setting not to compress the printing data with an application software you are using, the printing result may be improved.

Click **Print Options** on the **Page Setup** sheet on the printer driver. Select the **Do not allow application software to compress print data** check box, then click **OK**.

* Deselect the check box after printing is complete.

Check2 Is the size of the print data extremely large?

Click **Print Options** on the **Page Setup** sheet on the printer driver. Then, set **Prevention of Print Data Loss** in the displayed dialog to **On**.

* When **On** is selected for **Prevention of Print Data Loss**, print quality may be reduced.

Check3 Is the space of your computer's hard disk sufficient?

Delete unnecessary files to free disk space.



No Printing Results/Printing Is Blurred/Colors Are Wrong/White Streaks

❖ No Printing Results



❖ Printing Is Blurred

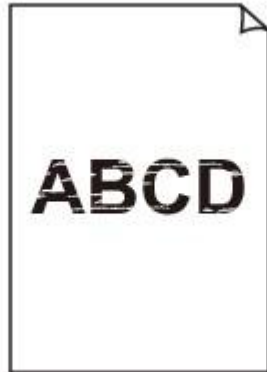

❖ Colors Are Wrong



White Streaks

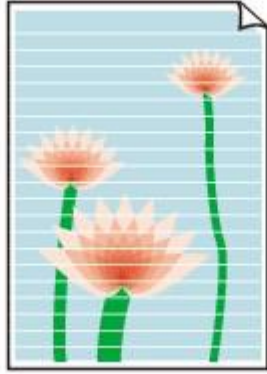

A

Check1 Did you confirm the paper and print quality settings?

Print Results Not Satisfactory

Check2 Print the Nozzle Check Pattern and perform any necessary maintenance operations such as Print Head Cleaning.

Print the Nozzle Check Pattern to determine whether the ink ejects properly from the print head nozzles.

Refer to [When Printing Becomes Faint or Colors Are Incorrect](#) for the Nozzle Check Pattern printing, Print Head Cleaning, and Print Head Deep Cleaning.

- If the Nozzle Check Pattern is not printed correctly:

After performing the Print Head Cleaning, print the Nozzle Check Pattern and examine the pattern.

- If the problem is not resolved after performing the Print Head Cleaning twice:

Perform the Print Head Deep Cleaning.

If the problem is not resolved after performing the Print Head Deep Cleaning, turn off the machine and perform another Print Head Deep Cleaning after 24 hours. When you turn the machine off, do not unplug it from the power supply.

- If the problem is not resolved after performing the Print Head Deep Cleaning twice:

Ink may have run out. Replace the FINE cartridge.

Check3 When a FINE cartridge runs out of ink, replace it with a new one.

Check4 When using paper with one printable surface, make sure that the paper is loaded with the printable side facing down.

Printing on the wrong side of such paper may cause unclear prints or prints with reduced quality.

Load paper with the printable side facing down.

Refer to the instruction manual supplied with the paper for detailed information on the printable side.

Check5 Is the FINE cartridge installed properly?

If the FINE cartridge is not installed securely, ink may not be ejected correctly.

Open the paper output cover, then remove the FINE cartridges.

Then install the FINE cartridges again. Push up the FINE cartridge until it clicks into place.

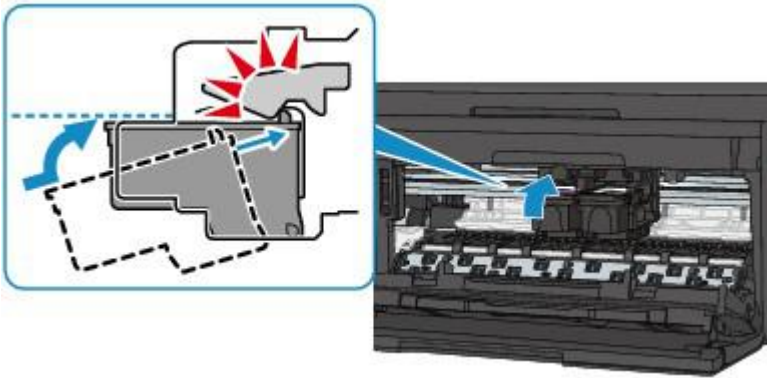

When the FINE cartridge is installed properly, you hear an electric sound once.

After confirming that the FINE cartridge is installed properly, close the paper output cover.

- **When copying, see also the sections below:**

Check6 Is the platen glass or the glass of ADF dirty?

Clean the platen glass or the glass of ADF.

[Cleaning the Platen Glass and Document Cover](#)

Note

- If the glass of ADF is dirty, black streaks appear on the paper as shown below.



Check7 Check that the original is loaded correctly on the platen glass or in the ADF.

[Loading Originals](#)

Check8 Is the original document is loaded with the proper side facing up/down?

When loading the original on the platen glass, the side to be copied should be face down. When loading the original in the ADF, the side to be copied should be face up.

Check9 Did you copy a printout done by this machine?

If you use a printout done by this machine as the original, print quality may be reduced depending on the condition of the original.

Print from the machine directly, or reprint from the computer if you can reprint from it.



Colors Are Unclear



Check1 Is the Nozzle Check Pattern printed properly?

Print the Nozzle Check Pattern to determine whether the ink ejects properly from the print head nozzles.

Refer to [When Printing Becomes Faint or Colors Are Incorrect](#) for the Nozzle Check Pattern printing, Print Head Cleaning, and Print Head Deep Cleaning.

- If the Nozzle Check Pattern is not printed correctly:
After performing the Print Head Cleaning, print the Nozzle Check Pattern and examine the pattern.
- If the problem is not resolved after performing the Print Head Cleaning twice:
Perform the Print Head Deep Cleaning.
If the problem is not resolved after performing the Print Head Deep Cleaning, turn off the machine and perform another Print Head Deep Cleaning after 24 hours. When you turn the machine off, do not unplug it from the power supply.
- If the problem is not resolved after performing the Print Head Deep Cleaning twice:
Ink may have run out. Replace the FINE cartridge.

Check2 When a FINE cartridge runs out of ink, replace it with a new one.

Check3 Is the FINE cartridge installed properly?

If the FINE cartridge is not installed securely, ink may not be ejected correctly.

Open the paper output cover, then remove the FINE cartridges.

Then install the FINE cartridges again. Push up the FINE cartridge until it clicks into place.

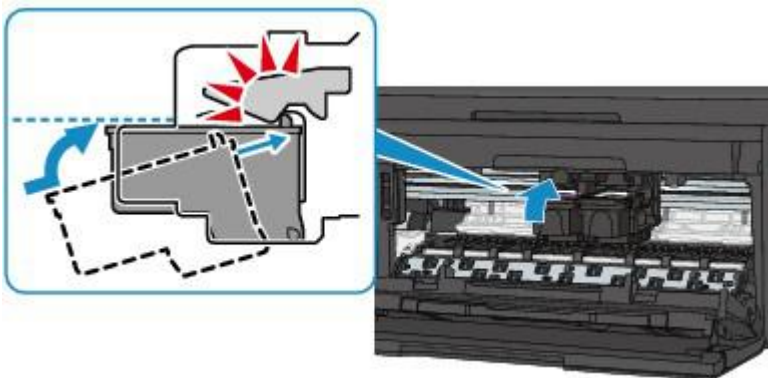

When the FINE cartridge is installed properly, you hear an electric sound once.

After confirming that the FINE cartridge is installed properly, close the paper output cover.

►► Note

- Printed colors may not match screen colors due to basic differences in the methods used to produce colors. Color control settings and environmental differences can also affect how colors appear on the screen. Therefore, colors of printing results may be different from those on the screen.



Lines Are Misaligned



Check1 Did you confirm the paper and print quality settings?

[Print Results Not Satisfactory](#)

Check2 Perform Print Head Alignment.

If printed lines are misaligned or print results are otherwise unsatisfactory, adjust the print head position.

[Aligning the Print Head](#)

Note

- If the problem is not resolved after performing the Print Head Alignment, perform Print Head Alignment manually referring to [Aligning the Print Head Position from Your Computer](#).

Check3 Increase the print quality and try printing again.

Increasing the print quality on the operation panel of the machine or in the printer driver may improve the print result.



Line Does Not Print or Prints Partially



Check1 Is the Page Layout Printing performed or the Binding margin function used?

When the Page Layout Printing or Binding margin function is being used, thin lines may not be printed. Try thickening the lines in the document.

Check2 Is the size of the print data extremely large?

Click **Print Options** on the **Page Setup** sheet on the printer driver. Then, set **Prevention of Print Data Loss** in the displayed dialog to **On**.

* When **On** is selected for **Prevention of Print Data Loss**, print quality may be reduced.



Image Does Not Print or Prints Partially



Check1 Select the setting not to compress the printing data.

If you select the setting not to compress the printing data with an application software you are using, the printing result may be improved.

Click **Print Options** on the **Page Setup** sheet on the printer driver. Select the **Do not allow application software to compress print data** check box, then click **OK**.

* Deselect the check box after printing is complete.

Check2 Is the size of the print data extremely large?

Click **Print Options** on the **Page Setup** sheet on the printer driver. Then, set **Prevention of Print Data Loss** in the displayed dialog to **On**.

* When **On** is selected for **Prevention of Print Data Loss**, print quality may be reduced.



Printed Paper Curls or Has Ink Blots

Printed Paper Has Ink Blots



Printed Paper Curls



Check1 Did you confirm the paper and print quality settings?

■ [Print Results Not Satisfactory](#)

Check2 If the intensity is set high, reduce the intensity setting and try printing again.

If you are using plain paper to print images with high intensity, the paper may absorb too much ink and become wavy, causing paper abrasion.

- When printing from your computer
You can confirm the intensity using the printer driver.

■ [Adjusting Intensity](#)

- When copying

■ [Setting Items for Copying](#)

Check3 Is Photo Paper used for printing photographs?

When printing data with high color saturation such as photographs or images in deep color, we recommend using Photo Paper Plus Glossy II or other Canon speciality paper.

■ [Media Types You Can Use](#)



Paper Is Smudged/Printed Surface Is Scratched

Paper Is Smudged

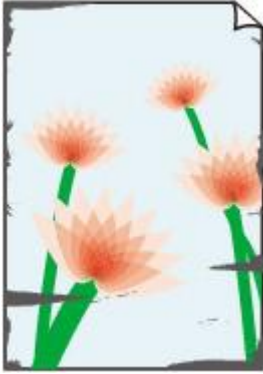

The Edges of Paper Are Smudged Printed Surface Is Smudged



Printed Surface Is Scratched



Check1 Did you confirm the paper and print quality settings?

 [Print Results Not Satisfactory](#)

Check2 Is the appropriate type of paper used? Check the followings:

- Check to see if the paper you are printing on is suitable for your printing purpose.

 [Media Types You Can Use](#)

- When performing Borderless Printing, make sure that the paper you are using is suitable for Borderless Printing.

If the paper you are using is not suitable for Borderless Printing, the print quality may be reduced at the top and bottom edges of the paper.

 [Printing Area](#)

Check3 Load the paper after correcting its curl.

When using Photo Paper Plus Semi-gloss, even if the sheet is curled, load one sheet at a time as it is. If you roll up this paper to flatten, this may cause cracks on the surface of the paper and reduce the print quality.

We recommend putting unused paper back into the package and keeping it on a level surface.

- **For Plain Paper**

Turn the paper over and reload it to print on the other side.

- **For Other Paper**

If the curl on the four corners of the paper is more than 0.1 inch / 3 mm (A) in height, the paper may be smudged or may not be fed properly. In such cases, follow the procedure described below to correct the paper curl.



1. Roll up the paper in the opposite direction to the paper curl as shown below.



2. Check that the paper is now flat.

We recommend printing curl-corrected paper one sheet at a time.

►► Note

- Depending on the media type, the paper may be smudged or may not be fed properly even if it is not curled inward. In such cases, follow the procedure described below to curl the paper outward within 0.1 inch / 3 mm (B) in height before printing. This may improve the print result.

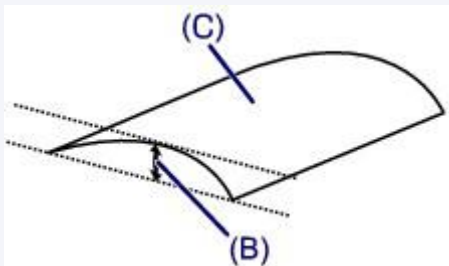

(C) Printing side

We recommend printing paper that has been curled outward one sheet at a time.

Check4 Adjust the setting to prevent paper abrasion.

Adjusting the setting to prevent paper abrasion will widen the clearance between the print head and the loaded paper. If you notice abrasion even with the media type set correctly to match the loaded paper, set the machine to prevent paper abrasion by using the operation panel or the computer.

Print speed may be reduced if you apply the setting to prevent paper abrasion setting.

* Readjust the setting not to prevent paper abrasion once printing is complete. If not, this setting remains enabled for all subsequent print jobs.

- **To set by using the operation panel**

Press the **Setup** button, then select **Device settings** and **Output settings** in this order, then set **Prevent abrasion** to **ON**.

■ [Changing the Machine Settings on the LCD](#)

- **To set by using your computer**

Open the printer driver setup window, and in **Custom Settings** in the **Maintenance** sheet, select the **Prevent paper abrasion** check box, and then click **OK**.

To open the printer driver setup window, see [How to Open the Printer Driver Setup Window](#).

Check5 If the intensity is set high, reduce the intensity setting and try printing again.

If you are using plain paper to print images with high intensity, the paper may absorb too much ink and become wavy, causing paper abrasion.

- When printing from your computer

Reduce the intensity setting in the printer driver and try printing again.

1. Open the printer driver setup window.

■ [How to Open the Printer Driver Setup Window](#)

2. On the **Main** sheet, select **Manual** for **Color/Intensity**, and then click **Set...**

3. Drag the **Intensity** slide bar on the **Color Adjustment** sheet to adjust the intensity.

- When copying

■ [Setting Items for Copying](#)

Check6 Is printing performed beyond the recommended printing area?

If you are printing beyond the recommended printing area of your printing paper, the lower edge of the paper may become stained with ink.

Resize your original document in your application software.

■ [Printing Area](#)

Check7 Is the platen glass or the glass of ADF dirty?

Clean the platen glass or the glass of ADF.

■ [Cleaning the Platen Glass and Document Cover](#)

▶▶▶ Note

- If the glass of ADF is dirty, black streaks appear on the paper as shown below.



Check8 Is the paper feed roller dirty?

Clean the paper feed roller.

■ [Cleaning the Paper Feed Roller](#)

▶▶▶ Note

- Cleaning the paper feed roller will wear the roller, so perform this procedure only when necessary.

Check9 Is the inside of the machine dirty?

When performing duplex printing, the inside of the machine may become stained with ink, causing the printout to become smudged.

Perform the Bottom Plate Cleaning to clean the inside of the machine.

■ [Cleaning the Inside of the Machine \(Bottom Plate Cleaning\)](#)

▶▶ Note

- To prevent the inside of the machine from stains, set the paper size correctly.

Check10 Set the time to dry the printed surface longer.

Doing so gives the printed surface enough time to dry so that paper smudged and scratched are prevented.

1. Make sure that the machine is turned on.
2. Open the printer driver setup window.

■ [How to Open the Printer Driver Setup Window](#)

3. Click the **Maintenance** tab and then **Custom Settings**.
4. Drag the **Ink Drying Wait Time** slide bar to set the wait time, and then click **OK**.
5. Confirm the message and click **OK**.



Back of the Paper Is Smudged

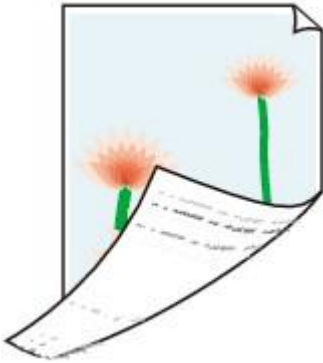

Check1 Did you confirm the paper and print quality settings?

[Print Results Not Satisfactory](#)

Check2 Perform the Bottom Plate Cleaning to clean the inside of the machine.

[Cleaning the Inside of the Machine \(Bottom Plate Cleaning\)](#)

▶▶ Note

- When performing borderless printing, duplex printing, or too much printing, the inside may become stained with ink.



Vertical Lines Are Printed on the Sides of the Printout

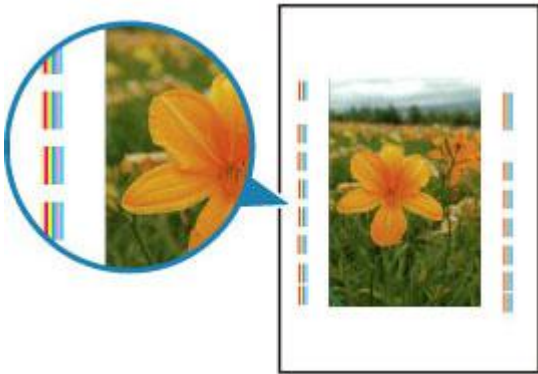

Check Is the size of the loaded paper correct?

The vertical lines may be printed in the margin if the size of the loaded paper is larger than that you have specified.

Set the paper size correctly according to the paper you loaded.

 [Print Results Not Satisfactory](#)

Note

- The direction of the vertical line pattern may vary depending on the image data or the print setting.
- This machine performs automatic cleaning when necessary to keep printouts clean. A small amount of ink is ejected for cleaning.

Although ink is usually ejected on the ink absorber, it may be ejected on the paper if you load paper larger than that you have specified.



Colors Are Uneven or Streaked

Colors Are Uneven



Colors Are Streaked



Check1 Did you confirm the paper and print quality settings?

 [Print Results Not Satisfactory](#)

Check2 Print the Nozzle Check Pattern and perform any necessary maintenance operations such as Print Head Cleaning.

Print the Nozzle Check Pattern to determine whether the ink ejects properly from the print head nozzles.

Refer to [When Printing Becomes Faint or Colors Are Incorrect](#) for the Nozzle Check Pattern printing, Print Head Cleaning, and Print Head Deep Cleaning.

- If the Nozzle Check Pattern is not printed correctly:
After performing the Print Head Cleaning, print the Nozzle Check Pattern and examine the pattern.
- If the problem is not resolved after performing the Print Head Cleaning twice:
Perform the Print Head Deep Cleaning.

If the problem is not resolved after performing the Print Head Deep Cleaning, turn off the machine and perform another Print Head Deep Cleaning after 24 hours. When you turn the machine off, do not unplug it from the power supply.

- If the problem is not resolved after performing the Print Head Deep Cleaning twice:

Ink may have run out. Replace the FINE cartridge.

Check3 Perform Print Head Alignment.

[Aligning the Print Head](#)

Note

- If the problem is not resolved after performing the Print Head Alignment, perform Print Head Alignment manually referring to [Aligning the Print Head Position from Your Computer](#).



Ink Is Not Ejected



Check1 When a FINE cartridge runs out of ink, replace it with a new one.

Check2 Is the FINE cartridge installed properly?

If the FINE cartridge is not installed securely, ink may not be ejected correctly.

Open the paper output cover, then remove the FINE cartridges.

Then install the FINE cartridges again. Push up the FINE cartridge until it clicks into place.

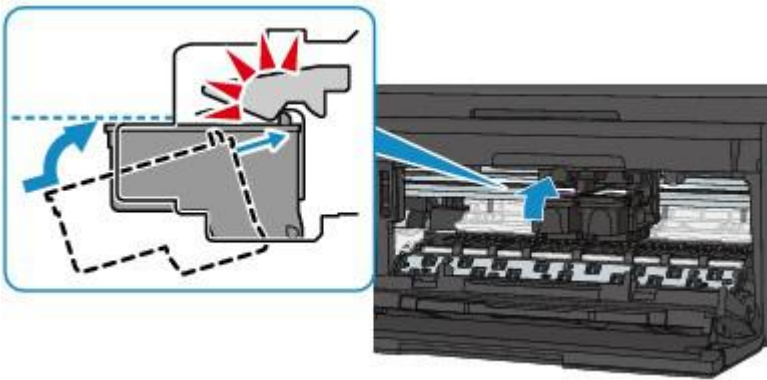

When the FINE cartridge is installed properly, you hear an electric sound once.

After confirming that the FINE cartridge is installed properly, close the paper output cover.

Check3 Are the print head nozzles clogged?

Print the Nozzle Check Pattern to determine whether the ink ejects properly from the print head nozzles.

Refer to [When Printing Becomes Faint or Colors Are Incorrect](#) for the Nozzle Check Pattern printing, Print Head Cleaning, and Print Head Deep Cleaning.

- If the Nozzle Check Pattern is not printed correctly:

After performing the Print Head Cleaning, print the Nozzle Check Pattern and examine the pattern.

- If the problem is not resolved after performing the Print Head Cleaning twice:

Perform the Print Head Deep Cleaning.

If the problem is not resolved after performing the Print Head Deep Cleaning, turn off the machine and perform another Print Head Deep Cleaning after 24 hours. When you turn the machine off, do not unplug it from the power supply.

- If the problem is not resolved after performing the Print Head Deep Cleaning twice:

Ink may have run out. Replace the FINE cartridge.



Paper Does Not Feed Properly/"No Paper" Error Occurs



Check1 Make sure that paper is loaded.

[Loading Paper](#)

Check2 Make sure of the following when you load paper.

- When loading two or more sheets of paper, flip through the paper before loading.



- When loading two or more sheets of paper, align the edges of the sheets before loading.
- When loading two or more sheets of paper, make sure that the paper stack does not exceed the paper load limit.

However, proper feeding of paper may not be possible at this maximum capacity depending on the type of paper or environmental conditions (either very high or low temperature and humidity). In such cases, reduce the sheets of paper you load at a time to less than half of the paper load limit.

- Always load the paper in portrait orientation, regardless of the printing orientation.
- When you load the paper, load the paper with the print side facing DOWN and slide the paper guides to align with the both sides of the paper.

[Loading Paper](#)

- When you load the paper, insert the paper stack until the leading edge touches the far end of the front tray.

Check3 Check to see if the paper you are printing on is not too thick or curled.

[Media Types You Cannot Use](#)

Check4 Make sure of the following when you load envelopes.

When printing on envelopes, refer to [Loading Paper](#), and prepare the envelopes before printing.

Once you have prepared the envelopes, load them in portrait orientation. If the envelopes are placed in landscape orientation, they will not feed properly.

Check5 Is the cassette set properly?

Push the cassette so that the mark on the cassette aligns with the front panel as illustrated below.

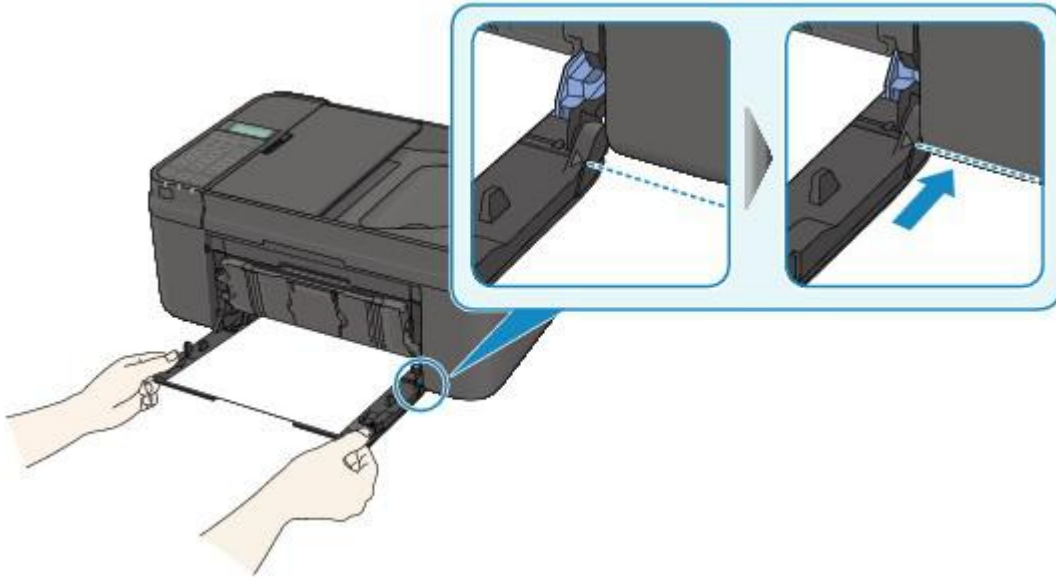

When the cassette is set properly, you hear an electric sound once.

Check6 Confirm that the media type and the paper size settings correspond with the loaded paper.

Check7 If multiple sheets of plain paper is fed from the machine, select the setting for preventing double-feed of plain paper.

If multiple sheets of plain paper is fed from the machine, select the setting for preventing double-feed of plain paper using the operation panel or your computer.

* After printing is finished, disable the setting for preventing double-feed of plain paper; otherwise, the setting is applied from the next time.

- **To set by using the operation panel**

Press the **Setup** button, select **Device settings** and **Output settings** in this order, and then set **Prevent double-feed** to **ON**.

■ [Changing the Machine Settings on the LCD](#)

- **To set by using your computer**

Open the printer driver setup window, and in **Custom Settings** in the **Maintenance** sheet, select the **Prevent paper double-feed** check box, and then click **OK**.

To open the printer driver setup window, see [How to Open the Printer Driver Setup Window](#).

▶▶▶ **Note**

- Printing speed will be reduced if Prevent paper double-feed function is enabled.

Check8 Clean the paper feed roller.

■ [Cleaning the Paper Feed Roller](#)

▶▶▶ **Note**

- Cleaning the paper feed roller will wear the roller, so perform this procedure only when necessary.



Copying/Printing Stops Before It Is Completed



Check1 Is the paper loaded?

Make sure that paper is loaded.

If the machine has run out of paper, load paper.

Check2 Do the printing documents have lots of photographs or illustrations?

As printing large data such as photos or graphics takes time for the machine and the computer to process, the machine may appear to have stopped operating.

In addition, when printing data that uses a large amount of ink continuously on plain paper, the machine may pause temporarily. In either case, wait until the process is complete.

▶▶▶ Note

- If you are printing a document with a large printing area or printing multiple copies of a document, printing may pause to allow the ink to dry.

Check3 Has the machine been printing continuously for a long period?

If the machine has been printing continuously for a long time, the print head or other parts around it may overheat. The machine may stop printing at a line break for a period of time and then resume printing.

In this case, wait for a while without operation. If the printing still does not resume, interrupt your print session at a convenient time and turn the machine off for at least 15 minutes.

⚠ Caution

- The print head and the surrounding area can become extremely hot inside the machine. Never touch the print head or nearby components.

Problems with Scanning

- ▶ **Problems with Scanning**
- ▶ **Scan Results Not Satisfactory**
- ▶ **Software Problems**

Problems with Scanning

- ▶ **Scanner Does Not Work**
- ▶ **ScanGear (Scanner Driver) Does Not Start**
- ▶ **Error Message Appears and the ScanGear (Scanner Driver) Screen Does Not Appear**
- ▶ **Cannot Scan Multiple Items at One Time**
- ▶ **Cannot Scan Properly with Auto Scan**
- ▶ **Slow Scanning Speed**
- ▶ **"There is not enough memory." Message Is Displayed**
- ▶ **Computer Stops Operating during Scanning**
- ▶ **Scanner Does Not Work after Upgrading Windows**
- ▶ **Scanned Image Does Not Open**



Scanner Does Not Work



Check 1 Make sure that your scanner or printer is turned on.

Check 2 Connect the USB cable to a different USB port on the computer.

Check 3 If the USB cable is connected to a USB hub, remove it from the USB hub and connect it to a USB port on the computer.

Check 4 Restart the computer.



ScanGear (Scanner Driver) Does Not Start



Check 1 Make sure that MP Drivers is installed.

If not installed, install MP Drivers from the Setup CD-ROM or the web page.

Check 2 Select your scanner or printer on the application's menu.

▶▶▶ Important

- If your scanner or printer name is displayed multiple times, select the one that does not include WIA.

▶▶▶ Note

- The operation may differ depending on the application.
- Use the WIA driver when scanning from a WIA-compliant application.

■ [Scanning with WIA Driver](#)

Check 3 Make sure that the application supports TWAIN.

You cannot start ScanGear (scanner driver) from applications not supporting TWAIN.

Check 4 Scan and save images with IJ Scan Utility and open the files in your application.



Error Message Appears and the ScanGear (Scanner Driver) Screen Does Not Appear



Check 1 Make sure that your scanner or printer is turned on.

Check 2 Turn off your scanner or printer, then reconnect the USB cable and replug the power cord.

Check 3 Connect the USB cable to a different USB port on the computer.

Check 4 If the USB cable is connected to a USB hub, remove it from the USB hub and connect it to a USB port on the computer.

Check 5 Make sure that MP Drivers is installed.

If not installed, install MP Drivers from the Setup CD-ROM or the web page.

Check 6 Select your scanner or printer on the application's menu.

▶▶▶ Note

- The operation may differ depending on the application.

Check 7 Make sure that the application supports TWAIN.

You cannot start ScanGear (scanner driver) from applications not supporting TWAIN.

Check 8 Exit ScanGear if it is running on another application.



Cannot Scan Multiple Items at One Time



Check 1 Make sure that the items are placed correctly.

■ [Placing Items \(When Scanning from a Computer\)](#)

Check 2 Check if you can properly scan one item.

Some applications do not support multiple image scanning. In that case, scan each item individually.



Cannot Scan Properly with Auto Scan



Check 1 Make sure that the items are placed correctly.

■ [Placing Items \(When Scanning from a Computer\)](#)

Check 2 Multiple item scanning may not be supported.

Some applications do not support multiple image scanning. In that case, scan each item individually.



Slow Scanning Speed



Check 1 To view the image on a monitor, set the output resolution to around 150 dpi. To print, set it to around 300 dpi.

■ [Resolution](#)

Check 2 Set **Fading Correction**, **Grain Correction**, etc. to **None**.

Refer to "Image Settings" for your model from Home of the *Online Manual* for details.

Check 3 In IJ Scan Utility, deselect the **Correct slanted text document / Detect the orientation of text document and rotate image** checkbox and scan again.

■ [Settings \(Document Scan\) Dialog Box](#)

■ [Settings \(Custom Scan\) Dialog Box](#)



"There is not enough memory." Message Is Displayed



Check 1 Exit other applications and try again.

Check 2 Reduce the resolution or output size and scan again.

■ [Resolution](#)



Computer Stops Operating during Scanning



Check 1 Restart the computer, reduce the output resolution in ScanGear (scanner driver) and scan again.

Refer to "Output Settings" for your model from Home of the *Online Manual* for details.

Check 2 Delete unnecessary files to obtain sufficient free hard disk space, then scan again.

Error message may appear if there is not enough hard disk space to scan and save, when the image size is too large (such as when scanning a large item at high resolution).

Check 3 In **Folder to Save Temporary Files** of IJ Scan Utility, specify a folder on a drive with sufficient free space.

■ [Settings \(General Settings\) Dialog Box](#)

Check 4 Multiple devices may be connected to USB ports.

Disconnect devices other than your scanner or printer.



Scanner Does Not Work after Upgrading Windows



Check Disconnect the USB cable, then uninstall (delete) and reinstall MP Drivers and IJ Scan Utility.

Step 1: Uninstall MP Drivers.

Refer to "Deleting the Unnecessary MP Drivers" for your model from Home of the *Online Manual* for how to delete MP Drivers.

Step 2: Uninstall IJ Scan Utility.

• Windows 8.1/Windows 8:

1. Click the **Settings** charm > **Control Panel** > **Programs** > **Programs and Features**.
2. Double-click **Canon IJ Scan Utility**.
3. When a confirmation appears, click **Yes**.
4. When uninstallation is complete, click **OK**.

IJ Scan Utility is deleted.

▶▶▶ Note

- In Windows 8.1 and Windows 8, a confirmation/warning dialog box may appear when installing, uninstalling, or starting up software.
This dialog box appears when administrative rights are required to perform a task.
If you are logged on to an administrator account, follow the on-screen instructions.

• Windows 7/Windows Vista:

1. From the **Start** menu, select **Control Panel** > **Programs** > **Programs and Features**.
2. Double-click **Canon IJ Scan Utility**.
3. When a confirmation appears, click **Yes**.
4. When uninstallation is complete, click **OK**.

IJ Scan Utility is deleted.

▶▶▶ Note

- In Windows 7 and Windows Vista, a confirmation/warning dialog box may appear when installing, uninstalling, or starting up software.
This dialog box appears when administrative rights are required to perform a task.
If you are logged on to an administrator account, follow the on-screen instructions.

• Windows XP:

1. From the **Start** menu, select **Control Panel** > **Add or Remove Programs**.
2. Select **Canon IJ Scan Utility**, then click **Change/Remove**.
3. When a confirmation appears, click **Yes**.
4. When uninstallation is complete, click **OK**.

IJ Scan Utility is deleted.

Step 3: Reinstall MP Drivers and IJ Scan Utility.

Reinstall MP Drivers and IJ Scan Utility from the Setup CD-ROM or the web page.



Scanned Image Does Not Open



Check If the data format is not supported by the application, scan the image again and select a popular data format such as JPEG when saving it.

Refer to the application's manual for details. If you have any questions, contact the manufacturer of the application.

Scan Results Not Satisfactory

- ▶ **Scan Quality (Image Displayed on the Monitor) Is Poor**
- ▶ **Scanned Image Is Surrounded by Extra White Areas**
- ▶ **Cannot Scan at the Correct Size**
- ▶ **Position or Size of the Image Cannot be Detected Correctly When Scanning from the Operation Panel**
- ▶ **Item Is Placed Correctly, but the Scanned Image Is Slanted**
- ▶ **Scanned Image Is Enlarged (Reduced) on the Computer Monitor**



Scan Quality (Image Displayed on the Monitor) Is Poor



Check 1 If the image is jagged, increase the scanning resolution, or select **TIFF** or **PNG** in **Data Format** of the Settings dialog box.

- [Resolution](#)
- [Settings Dialog Box](#)

Check 2 Set the display size to 100 %.

Some applications do not display images clearly if the display size is too small.

Check 3 If moire (stripe pattern) appears, take the following measures and scan again.

- Set one of the following settings in the **Settings (Document Scan)** dialog box, **Settings (Custom Scan)** dialog box, or **Settings (Scan and Stitch)** dialog box of IJ Scan Utility, then scan from the IJ Scan Utility main screen.
 - Set **Select Source** to **Magazine** and set **Color Mode** to **Color**
 - Select the **Reduce moire** checkbox in **Image Processing Settings**

- [Settings \(Document Scan\) Dialog Box](#)
- [Settings \(Custom Scan\) Dialog Box](#)
- [Settings \(Scan and Stitch\) Dialog Box](#)

- On the **Basic Mode** tab of ScanGear (scanner driver), select **Magazine (Color)** in **Select Source**.
Refer to "Basic Mode Tab" for your model from Home of the *Online Manual* for details.
- On the **Advanced Mode** tab of ScanGear, set **Descreen** in **Image Settings** to **ON**.
Refer to "Image Settings" for your model from Home of the *Online Manual* for details.

▶▶▶ Note

- If moire appears when you scan a digital print photo, take the above measures and scan again.

Check 4 Check the monitor's color depth.

Refer to Help of Windows or the monitor's manual for details on how to check the monitor's color depth.

Check 5 Clean the platen and document cover.

Check 6 If the document is in poor condition (dirty, faded, etc.), then set **Reduce Dust and Scratches**, **Fading Correction**, **Grain Correction**, etc. in **Image Settings** on the **Advanced Mode** tab of ScanGear.

Refer to "Image Settings" for your model from Home of the *Online Manual* for details.

Check 7 If the color tone of images is different from the original document, take the following measures and scan again.

- On the **Advanced Mode** tab of ScanGear, set **Image Adjustment** in **Image Settings** to **None**.
Refer to "Image Settings" for your model from Home of the *Online Manual* for details.
- On the **Color Settings** tab in the **Preferences** dialog box of ScanGear, set **Color Matching**.
Refer to "Color Settings Tab" for your model from Home of the *Online Manual* for details.



Scanned Image Is Surrounded by Extra White Areas



Check Specify the scan area.



Click  (Auto Crop) in whole image view of ScanGear (scanner driver) to automatically display the cropping frame (scan area) according to the item size.

You can also manually specify the scan area in thumbnail view or when there are white margins along the item (for example, in photos), or when you want to create custom cropping frames.

■ [Adjusting Cropping Frames in the Image Stitch Window](#)

▶▶ Note

- Refer to "Adjusting Cropping Frames (ScanGear)" for your model from Home of the *Online Manual* for how to adjust cropping frames with ScanGear (scanner driver).



Cannot Scan at the Correct Size



Check Make sure that the items are placed correctly.

- [Placing Items \(When Scanning from a Computer\)](#)



Position or Size of the Image Cannot be Detected Correctly When Scanning from the Operation Panel



Check 1 Make sure that the items are placed correctly.

- [Placing Items \(When Scanning from a Computer\)](#)

Check 2 Check that the settings match the item to be scanned.

If you cannot scan properly by automatically detecting the item type, specify the item type and size.

When Scanning from the Operation Panel:

Refer to "Setting Items for Scanning Using the Operation Panel of the Machine" for your model from Home of the *Online Manual* for details on the setting items when scanning from the operation panel.

When Scanning with IJ Scan Utility:

- [Scanning Documents](#)
- [Scanning Photos](#)
- [Scanning with Favorite Settings](#)



Item Is Placed Correctly, but the Scanned Image Is Slanted



Check When Document or **Magazine** is selected for **Select Source**, deselect the **Correct slanted text document** checkbox and scan the item again.

- [Settings \(Document Scan\) Dialog Box](#)
- [Settings \(Custom Scan\) Dialog Box](#)



Scanned Image Is Enlarged (Reduced) on the Computer Monitor



Check 1 Change the display setting in the application.

Refer to the application's manual for details. If you have any questions, contact the manufacturer of the application.

▶▶▶ Note

- You cannot reduce the image size in Paint. To reduce the display size, open the images in an application.

Check 2 Change the resolution setting in ScanGear (scanner driver) and scan again.

The higher the resolution, the larger the resulting image will be.

■ [Resolution](#)

Software Problems

- ▶ **The E-mail Client You Want to Use Does Not Appear in the Screen for Selecting an E-mail Client**



The E-mail Client You Want to Use Does Not Appear in the Screen for Selecting an E-mail Client



Check Check that the e-mail client's MAPI is enabled.

Refer to the e-mail client's manual for how to set MAPI.

If the problem is not solved even when MAPI is enabled, select **None (Attach Manually)** in the screen for selecting an e-mail client, then manually attach the image to the outgoing e-mail.

Problems with Faxing

- ▶ **Problems Sending Faxes**
- ▶ **Problems Receiving Faxes**
- ▶ **Cannot Send a Fax Clearly**
- ▶ **Telephone Problems**

Problems Sending Faxes

- ▶ **Cannot Send a Fax**
- ▶ **Cannot Perform Sequential Broadcasting by Redialing, or Cannot Dial by Entering the Numbers**
- ▶ **Errors Often Occur When You Send a Fax**



Cannot Send a Fax



Check1 Is the power turned on?

- You cannot send faxes if the power is turned off. Press the **ON** button to turn the power on.
- If you unplugged the power cord without turning off the power (the **POWER** lamp is lit), reconnecting it turns on the power automatically.
- If you unplugged the power cord after pressing the **ON** button to turn off the power (the **POWER** lamp is off), reconnect it, then press the **ON** button to turn on the power.
- If the power was turned off due to power failure, etc., the power is automatically turned on when the power failure is resolved.

▶▶▶ Important

- Confirm that the **POWER** lamp is off before unplugging the power cord, then unplug the power cord. If a power failure occurs or you unplug the power cord, all faxes stored in the machine's memory are deleted. For details on how to unplug the power cord, refer to [Notice for Unplugging the Power Cord](#).

▶▶▶ Note

- If the faxes stored in the machine's memory are deleted by a power failure or unplugging the power cord, the list of the faxes deleted from the machine's memory (MEMORY CLEAR REPORT) will be printed after turning the machine on. For details, see [Summary of Reports and Lists](#).

Check2 Is the document being sent from memory or the fax being received into memory?

When the message for the transmission/reception is displayed on the LCD, a fax is being sent from/received into machine's memory. Wait until the transmission/reception is complete.

Check3 Is the machine's memory full?

Delete contents in memory, then send a fax again.

■ [Document Stored in Machine's Memory](#)

Check4 Is the telephone line type set correctly?

Check the telephone line type setting and change it as necessary.

■ [Setting the Telephone Line Type](#)

Check5 Is Hook setting set to Disable?

When you send a fax manually, dial the number with **Enable** selected for **Hook setting** in **Security control** under **Fax settings**, or dial the number using the telephone connected to the machine.

■ [Security control](#)

Check6 Is **Dial tone detect** set to **ON**?

Resend the fax after a while.

If you still cannot send the fax, select **OFF** for **Dial tone detect** in **Adv. FAX settings** under **Fax settings**.

■ [Adv. FAX settings](#)

Check7 Is the fax number registered correctly in the machine's directory?

Check the recipient's fax/telephone number, correct the fax/telephone number registered in the machine's directory, then send the document again.

■ [Changing Registered Information](#)

▶▶▶ Note

- You can check the registered information in the machine's directory by printing RECIPIENT TELEPHONE NUMBER LIST.

■ [Summary of Reports and Lists](#)

Check8 Does an error occur during transmission?

- Ensure that a message is displayed on the Fax standby screen. When a message is displayed on the Fax standby screen, check the cause.

■ [A Message for Faxing Is Displayed on the Fax Standby Screen](#)

- Print ACTIVITY REPORT and check for an error.

■ [Summary of Reports and Lists](#)

Check9 Is the document loaded properly?

Remove the document, then reload it on the platen glass or in the ADF.

■ [Loading Originals](#)

Check10 Does a printer error occur?

Ensure that an error message is displayed on the LCD. When an error message is displayed on the LCD, check the cause.

When the error message with the support code is displayed, refer to [List of Support Code for Error](#).

When the error message without the support code is displayed, refer to [A Message Is Displayed](#).

If you are in a hurry, press the **Stop** button to close the message, then send the fax.

Check11 Is the telephone line connected correctly?

Reconnect the telephone line cable to the telephone line jack.

■ [Basic Connection](#)

If the telephone line is connected correctly, there is a problem with your telephone line. Contact your telephone company and the manufacturer of your terminal adapter or telephone adapter.



Cannot Perform Sequential Broadcasting by Redialing, or Cannot Dial by Entering the Numbers



Check Have you already selected the recipient from the redial history, or already dialed a number by entering the fax/telephone numbers?

You can dial one recipient by selecting from the redial history or by entering the fax/telephone numbers as the recipient of sequential broadcasting.

If you already have dialed by selecting from the redial history or by entering the fax/telephone numbers, select the recipient from the machine's directory.



Errors Often Occur When You Send a Fax



Check Check the telephone line condition or the connection.

If the telephone line or connection is poor, reducing the transmission start speed may correct the error.

Reduce the transmission start speed on **TX start speed** in **Adv. communication** in **Adv. FAX settings** under **Fax settings**.

■ [Adv. FAX settings](#)

Problems Receiving Faxes

- ▶ **Cannot Receive a Fax, Cannot Print a Fax**
- ▶ **Machine Does Not Switch Automatically between Voice and Fax Calls**
- ▶ **Quality of Received Fax is Poor**
- ▶ **Cannot Receive a Color Fax**
- ▶ **Errors Often Occur When You Receive a Fax**



Cannot Receive a Fax, Cannot Print a Fax



Check1 Is the power turned on?

- You cannot receive faxes if the power is turned off. Press the **ON** button to turn the power on.
- If you unplugged the power cord without turning off the power (the **POWER** lamp is lit), reconnecting it turns on the power automatically.
- If you unplugged the power cord after pressing the **ON** button to turn off the power (the **POWER** lamp is off), reconnect it, then press the **ON** button to turn on the power.
- If the power was turned off due to power failure, etc., the power is automatically turned on when the power failure is resolved.

▶▶▶ Important

- Confirm that the **POWER** lamp is off before unplugging the power cord, then unplug the power cord. If a power failure occurs or you unplug the power cord, all faxes stored in the machine's memory are deleted. For details on how to unplug the power cord, refer to [Notice for Unplugging the Power Cord](#).

▶▶▶ Note

- If the faxes stored in the machine's memory are deleted by a power failure or unplugging the power cord, the list of the faxes deleted from the machine's memory (MEMORY CLEAR REPORT) will be printed after turning the machine on. For details, see [Summary of Reports and Lists](#).

Check2 Is the machine's memory full?

Print the received faxes stored in the machine's memory, delete them from the machine's memory, and have the sender resend the faxes.

■ [Document Stored in Machine's Memory](#)

Check3 Does an error occur during reception?

- Ensure that a message is displayed on the Fax standby screen. When a message is displayed on the Fax standby screen, check the cause.

■ [A Message for Faxing Is Displayed on the Fax Standby Screen](#)

- Print ACTIVITY REPORT and check for an error.

■ [Summary of Reports and Lists](#)

Check4 Is the telephone line cable connected to the external device jack?

Reconnect it to the telephone line jack.

■ [Basic Connection](#)

Check5 Is a different size of paper from that specified by **Page size** in **FAX paper settings** loaded?

If a different size of paper from that specified by **Page size** is loaded for printing faxes, the received faxes will not be printed and will be stored in the machine's memory (Memory Reception). Load the same size of paper as that specified by **Page size**, then press the **OK** button on the machine.

Check6 Is paper loaded?

If paper is not loaded, received faxes will be stored in the machine's memory without being printed (Memory Reception). Load paper, then press the **OK** button.

Check7 Is the amount of remaining ink sufficient to print a fax?

If the amount of remaining ink is insufficient to print, received faxes will be stored in the machine's memory without being printed (Memory Reception). Replace the FINE cartridge, then print the faxes in the machine's memory.

■ [Document Stored in Machine's Memory](#)

▶▶▶ **Note**

- If the machine was receiving faxes in the fax mode, printing will start automatically after the FINE cartridge is replaced.

■ [Replacing a FINE Cartridge](#)

- You can set the machine to forcibly print a received fax even if the ink has run out.

Set **Print when no ink** in **Auto print settings** under **Fax settings** to **Print**.

However, part or all of the fax may not be printed since the ink has run out.

Also, the contents of the fax will not be stored in the machine's memory.

If the ink has already run out, we recommend that **Do not print** be selected for **Received documents** in **Auto print settings** under **Fax settings** to store the received fax in the machine's memory. After you replace the FINE cartridge and select **Print** for **Received documents** in **Auto print settings**, the fax stored in the machine's memory will be printed automatically.

■ [Auto print settings](#)

Check8 Is the machine set to the appropriate receive mode?

Check the receive mode setting and change it to a mode suited to your connection if necessary.

■ [Setting the Receive Mode](#)

Check9 Is **FAX RX reject** set to **ON**?

Select **OFF** for **FAX RX reject** in **Security control** under **Fax settings**.

For details on how to set, see [Rejecting Fax Reception](#).

Check10 Are there setting items set **Reject** in **Caller rejection**?

If you select **Reject** for any setting items in **Caller rejection** in **Security control** under **Fax settings**, the machine rejects calls for setting item selected **Reject**.

For details on how to set, see [Using the Caller ID Service to Reject Calls](#).



Machine Does Not Switch Automatically between Voice and Fax Calls



Check Is the receive mode set to **Fax only mode**?

If **Fax only mode** is selected for **Receive mode set.** under **FAX menu**, there will be no automatic switching between voice and fax calls.

Set the receive mode to **TEL priority mode**, **DRPD*1**, or **Network switch*2**.

If the receive mode is **TEL priority mode** and an answering machine is connected to the machine, check whether a proper message is played back when the answering machine answers.

■ [Setting the Receive Mode](#)

*1 This setting is available only in the US and Canada.

*2 This setting may not be available depending on the country or region of purchase.



Quality of Received Fax is Poor



Check1 Check the scan settings of the sender's fax machine.

Ask the sender to adjust the scan settings of the fax machine.

Check2 Is **ECM RX** set to **OFF**?

Select **ON** for **ECM RX** in **Adv. communication** in **Adv. FAX settings** under **Fax settings**.

If **ECM RX** is enabled, the sender's fax machine resends the fax after correcting errors automatically.

■ [Adv. FAX settings](#)

Check3 Is the sender's original document or scanning area of the sender's fax machine dirty?

The image quality of the fax is mainly determined by the sender's fax machine. Contact the sender and ask the sender to check whether the scanning area of the fax machine is dirty.

Check4 Is ECM transmission/reception enabled although the line/connection is poor, or is the sender's fax machine compatible with ECM?

- Select **ON** for **ECM RX** in **Adv. communication** in **Adv. FAX settings** under **Fax settings**.

■ [Adv. FAX settings](#)

- Contact the sender and ask the sender to check whether the machine is set to enable ECM transmission.

If the sender's or recipient's fax machine is not compatible with ECM, the fax will be sent/received without automatic error correction.

- Reduce the reception start speed on **RX start speed** in **Adv. communication** in **Adv. FAX settings** under **Fax settings**.

■ [Adv. FAX settings](#)

Check5 Did you confirm the paper and print quality settings?

■ [Print Results Not Satisfactory](#)



Cannot Receive a Color Fax



Check Is **ECM RX** set to **OFF**?

If **OFF** is select for **ECM RX** in **Adv. communication** in **Adv. FAX settings** under **Fax settings**, the machine cannot receive color faxes. The machine will disconnect the telephone line or receive color faxes in black & white according to the setting of the sender's fax machine.

Set **ECM RX** to **ON**.

■ [Adv. FAX settings](#)



Errors Often Occur When You Receive a Fax



Check1 Check the telephone line condition or the connection.

If the telephone line or connection is poor, reducing the reception start speed may correct the error.

Reduce the reception start speed on **RX start speed** in **Adv. communication** in **Adv. FAX settings** under **Fax settings**.

■ [Adv. FAX settings](#)

Check2 Is the sender's fax machine operating normally?

Contact the sender and ask the sender to check whether the fax machine is operating normally.



Cannot Send a Fax Clearly



Check1 Is the document loaded correctly?

Remove the document, then reload it on the platen glass or in the ADF.

■ [Loading Originals](#)

Check2 Is the platen glass and/or the inner side of the document cover and/or the glass of ADF dirty?

Clean the platen glass and/or the inner side of the document cover and/or the glass of ADF, then reload the document.

■ [Cleaning the Platen Glass and Document Cover](#)

▶▶▶ Note

- If the glass of ADF is dirty, black streaks appear on the paper as shown below.



Check3 Is the image quality setting or the scan contrast setting suitable for the document?

On the LCD, select an image quality setting and a scan contrast setting that are suitable for the document.

■ [Setting Items for Sending Faxes](#)

Check4 Is the original document loaded with the wrong side facing upwards or downwards?

When loading a document on the platen glass, the side to be scanned should be face down.

When loading a document in the ADF, the side to be scanned should be face up.

Check5 Are you scanning thick or curled documents?

Thick or curled documents may not be sent as good quality faxes, because of a shadow or distortion caused when such documents are scanned.

When loading a document on the platen glass, press on the document cover with your hand when scanning.

Telephone Problems

- ▶ **Cannot Dial**
- ▶ **Telephone Disconnects During a Call**



Cannot Dial



Check1 Is the telephone line cable connected correctly?

Check that the telephone line cable is connected correctly.

■ [Basic Connection](#)

Check2 Is the telephone line type of the machine or the external device set correctly?

Check the telephone line type setting and change it as necessary.

■ [Setting the Telephone Line Type](#)



Telephone Disconnects During a Call



Check Is the telephone line cable or the telephone (or a peripheral device such as an external telephone, an answering machine, or a computer modem) connected correctly?

Check that the telephone line cable and the telephone (or a peripheral device such as an external telephone, an answering machine, or a computer modem) are connected correctly.

■ [Connecting the Telephone Line](#)

Problems with the Machine

- ▶ **The Machine Cannot Be Powered On**
- ▶ **The Machine Turns Off Unintentionally**
- ▶ **Cannot Connect to Computer with a USB Cable Properly**
- ▶ **Cannot Communicate with the Machine with USB Connection**
- ▶ **LCD Cannot Be Seen At All**
- ▶ **An Unintended Language Is Displayed on the LCD**
- ▶ **FINE Cartridge Holder Does Not Move to the Position for Replacing**
- ▶ **Printer Status Monitor Is Not Displayed**



The Machine Cannot Be Powered On



Check1 Press the **ON** button.

Check2 Make sure that the power plug is securely plugged into the power cord connector of the machine, then turn it back on.

Check3 Unplug the machine from the power supply, then plug the machine back in and turn the machine back on after leaving it for at least 3 minutes.

If the problem is not resolved, contact the service center.



The Machine Turns Off Unintentionally



Check Disable the setting to turn the unit off automatically.

The machine turns off automatically according to the elapsed time you specified if the setting to turn the unit off automatically is enabled.

If you do not want the machine to turn off automatically, open the printer driver setup window and in **Auto Power** under the **Maintenance** sheet, select **Disable** for **Auto Power Off**.

▶▶▶ Note

- You can also enable the machine to turn off automatically from the operation panel of the machine or ScanGear (scanner driver).
 - From the operation panel of the machine:
 - [Auto power off](#)
 - From ScanGear (scanner driver):
 - [Scanner Tab](#)

Cannot Connect to Computer with a USB Cable Properly

Q Printing or Scanning Speed Is Slow/Hi-Speed USB Connection Does Not Work/"This device can perform faster" Message Is Displayed

A

If your system environment is not fully compatible with Hi-Speed USB, the machine will operate at a lower speed provided under USB 1.1. In this case, the machine operates properly but printing or scanning speed may slow down due to communication speed.

Check Check the following to make sure that your system environment supports Hi-Speed USB connection.

- Does the USB port on your computer support Hi-Speed USB connection?
- Does the USB cable or the USB hub support Hi-Speed USB connection?

Be sure to use a certified Hi-Speed USB cable. We recommend that the cable is no longer than around 10 feet / 3 meters.

- Does the operating system of your computer support Hi-Speed USB connection?

Obtain and install the latest update for your computer.

- Does the Hi-Speed USB driver operate properly?

Obtain the latest version of the Hi-Speed USB driver compatible with your hardware and reinstall it on your computer.

»» Important

- For details on Hi-Speed USB of your system environment, contact the manufacturer of your computer, USB cable, or USB hub.



Cannot Communicate with the Machine with USB Connection



Check1 Make sure that the machine is turned on.

Check2 Make sure that the USB cable is connected properly.

See [Connecting the Machine to the Computer Using a USB Cable](#) to connect the USB cable properly.

Check3 Do not start up IJ Network Tool while printing.

Check4 Do not print while IJ Network Tool is running.

Check5 Make sure that **Enable bidirectional support** is selected in the **Ports** sheet of the properties dialog box of the printer driver.

■ [How to Open the Printer Driver Setup Window](#)



LCD Cannot Be Seen At All



- **If the POWER lamp is off:**

The machine is not powered on. Connect the power cord and press the **ON** button.

- **If the POWER lamp is lit:**

The LCD may be in the screen-saver mode. Press a button other than the **ON** button on the operation panel.



An Unintended Language Is Displayed on the LCD



Select the language you want to be displayed according to the following procedure.

1. Press the **Setup** button, then wait for about 5 seconds.
2. Press the ► button twice, then press the **OK** button.
3. Press the ► button twice, then press the **OK** button.
4. Press the ► button repeatedly to display the rightmost menu.
5. Press the ◀ button 3 times, then press the **OK** button.
6. Use the ◀► button to select the language for the LCD, then press the **OK** button.
The desired language is displayed on the LCD.
7. Press the **Stop** button.



FINE Cartridge Holder Does Not Move to the Position for Replacing



Check1 Is the **POWER** lamp off?

Check if the **POWER** lamp is lit.

The FINE cartridge holder will not move unless the power is on. If the **POWER** lamp is off, close the paper output cover and turn the machine on.

Check2 Is the **Alarm** lamp flashing?

Close the paper output cover, confirm the number of times the **Alarm** lamp is flashing, take the appropriate action to resolve the error, and then reopen it. For details on how to resolve the error, see [List of Support Code for Error](#).

Check3 Has the paper output cover been left open for 10 minutes or longer?

If the paper output cover is left open for more than 10 minutes, the FINE cartridge holder moves to the position to protect it to prevent the print head from drying out. Close and reopen the paper output cover to return the FINE cartridge holder to the position for replacing.

Check4 Has the machine been printing continuously for a long period?

If the machine has been printing continuously for a long time, the FINE cartridge holder may not move to the position for replacing since the print head may overheat.

▶▶▶ Note

- Do not open the paper output cover while printing is in progress; otherwise, an error occurs



Printer Status Monitor Is Not Displayed



Check Is the printer status monitor enabled?

Make sure that **Enable Status Monitor** is selected on the **Option** menu of the printer status monitor.

1. Open the printer driver setup window.

■ [How to Open the Printer Driver Setup Window](#)

2. On the **Maintenance** sheet, click **View Printer Status**.
3. Select **Enable Status Monitor** on the **Option** menu if it is not selected.

Problems with Installation/Downloading

- ▶ **Cannot Install the MP Drivers**
- ▶ **Easy-WebPrint EX Does Not Start Up or Easy-WebPrint EX Menu Does Not Appear**
- ▶ **How to Update MP Drivers in Network Environment**
- ▶ **Uninstalling IJ Network Tool**



Cannot Install the MP Drivers



- If the installation does not start even after the Setup CD-ROM is inserted into your computer's disc drive:

Start the installation following the procedure below.

1. Select items as shown below.

- In Windows 8.1 or Windows 8, select the **Explorer** icon in **Taskbar** on **Desktop**, then select **Computer** from the list on the left.
- In Windows 7 or Windows Vista, click **Start** then **Computer**.
- In Windows Vista, click **Start** then **Computer**.
- In Windows XP, click **Start** then **My Computer**.

2. Double-click the  **CD-ROM** icon on the displayed window.

If the contents of the CD-ROM are displayed, double-click **MSETUP4.EXE**.

If you cannot install the MP Drivers with the Setup CD-ROM, install them from our website.

»» Note

- If the CD-ROM icon is not displayed, try the following:
 - Remove the CD-ROM from your computer, then insert it again.
 - Restart your computer.

If the icon is not yet displayed, try different discs and see if they are displayed. If other discs are displayed, there is a problem with the Setup CD-ROM. In this case, contact the service center.

- If you are unable to proceed beyond the Printer Connection screen:

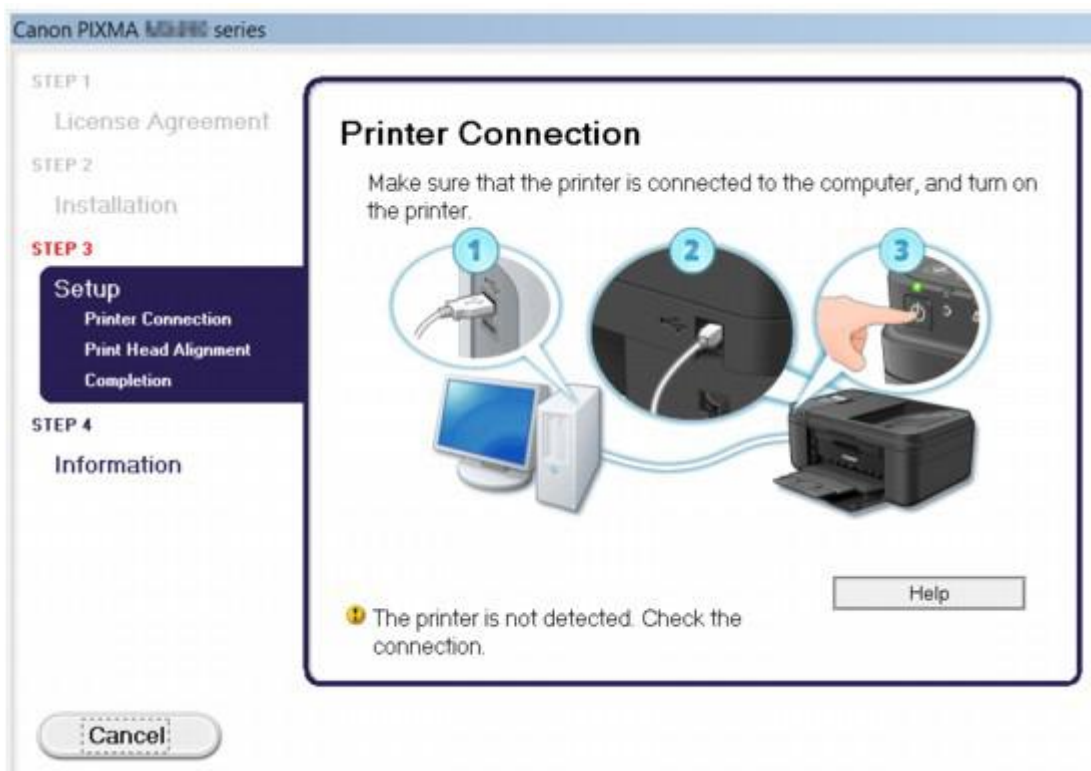

▶▶▶ Note

- **The printer is not detected. Check the connection.** may be displayed depending on the computer you use.

Check1 Make sure that the USB cable is securely plugged in to the machine and the computer.

Check2 Follow the procedure below to connect the machine and the computer again.

1. Turn the machine off.
2. Unplug the USB cable from the machine and the computer, then connect it again.
3. Turn the machine on.

Check3 If you cannot resolve the problem, follow the procedure below to reinstall the MP Drivers.

1. Click **Cancel**.
2. Click **Start Over** on the **Installation Failure** screen.
3. Click **Exit** on the "PIXMA XXX" screen (where "XXX" is your machine's name), then remove the CD-ROM.
4. Turn the machine off.
5. Restart the computer.
6. Make sure that you have no application software running.
7. Insert the CD-ROM again, then install the MP Drivers.

- **In other cases:**

Reinstall the MP Drivers.

If the MP Drivers were not installed correctly, uninstall the MP Drivers, restart your computer, and then reinstall the MP Drivers.

- [Deleting the Unnecessary MP Drivers](#)

If you reinstall the MP Drivers, install the MP Drivers with the Setup CD-ROM or install them from our website.

▶▶▶ Note

- If the installer was forced to be terminated due to a Windows error, the system may be in an unstable condition and you may not be able to install the drivers. Restart your computer before reinstalling.



Easy-WebPrint EX Does Not Start Up or Easy-WebPrint EX Menu Does Not Appear



If Easy-WebPrint EX does not start up or its menu does not appear on Internet Explorer, confirm the following.

Check1 Is **Canon Easy-WebPrint EX** displayed on the **Toolbars** menu in the Internet Explorer's **View** menu?

If **Canon Easy-WebPrint EX** is not displayed, Easy-WebPrint EX is not installed on your computer. Install the latest Easy-WebPrint EX onto your computer from our website.

»» Note

- If Easy-WebPrint EX is not installed on your computer, a message asking you to install it may be displayed on the notification area on the desktop. Click the message, then follow the instructions on the computer screen to install Easy-WebPrint EX.
- While the installation or download Easy-WebPrint EX is in progress, it is necessary to access the Internet.

Check2 Is **Canon Easy-WebPrint EX** selected on the **Toolbars** menu in the Internet Explorer's **View** menu?

If **Canon Easy-WebPrint EX** is not selected, Easy-WebPrint EX is disabled. Select **Canon Easy-WebPrint EX** to enable it.

Check3 Check the following to make sure that your system environment supports Easy-WebPrint EX.

- Is it installed on the computer with proper system requirements?
- Did you start it using a compatible version of Internet Explorer?

Visit our website to confirm the details on the system requirements of Easy-WebPrint EX.



How to Update MP Drivers in Network Environment



Download the latest MP Drivers in advance.

To obtain the latest MP Drivers, access our web site through the Internet and download the latest MP Drivers for your model.

After uninstalling the MP Drivers, install the latest MP Drivers according to the regular procedure. When the connection method selection screen is displayed, select **Use the printer with wireless LAN connection** according to the connection method you use. The machine will be detected automatically in the network.

After making sure that the machine is detected, install the MP Drivers following the on-screen instructions.

▶▶▶ Note

- You can use the machine over a LAN without performing setup again.



Uninstalling IJ Network Tool



Follow the procedure below to uninstall IJ Network Tool from your computer.

»» Important

- Even if IJ Network Tool is uninstalled, you can print and fax over network or scan from the computer. However, you cannot change the network settings over network.
- Log into a user account with administrator privilege.

1. Perform the procedure to uninstall IJ Network Tool.

- In Windows 8.1 or Windows 8:
 1. Select **Control Panel** from the **Settings** charm on **Desktop > Programs > Programs and Features**.
 2. Select **Canon IJ Network Tool** from the program list, then click **Uninstall**.
If the **User Account Control** screen appears, click **Continue**.
- In Windows 7 or Windows Vista:
 1. Click **Start > Control Panel > Programs > Programs and Features**.
 2. Select **Canon IJ Network Tool** from the program list, then click **Uninstall**.
If the **User Account Control** screen appears, click **Continue**.
- In Windows XP:
 1. Click **Start > Control Panel > Add or Remove Programs**.
 2. Select **Canon IJ Network Tool** from the program list, then click **Remove**.

2. Click **Yes** when the confirmation message appears.

When the message prompting you to restart your computer is displayed, click **OK** to restart your computer.

About Errors/Messages Displayed

- ▶ **If an Error Occurs**
- ▶ **A Message for Faxing Is Displayed on the Fax Standby Screen**
- ▶ **A Message Is Displayed**

If an Error Occurs

When an error occurs in printing such as the machine is out of paper or paper is jammed, a troubleshooting message is displayed automatically. Take the appropriate action described in the message.

When an error occurs, a Support Code (error number) is displayed on the computer screen or the LCD.

- **When a Support Code and a message are displayed on the computer screen:**

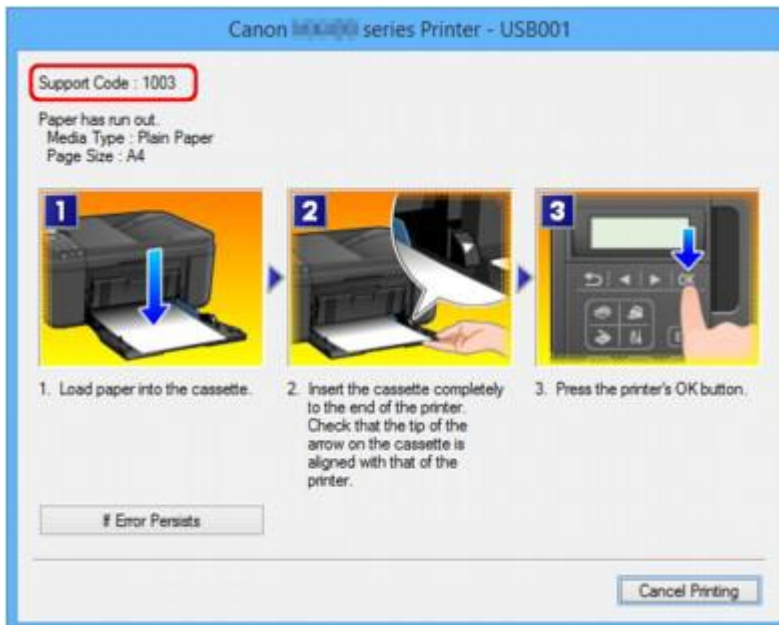

- **When a Support Code and a message are displayed on the LCD:**

Load paper
Load paper and press **1003**

▶▶▶ Note

- You can confirm the actions against errors with Support Codes on your computer by searching a Support Code.

■ [Click Here to Search](#)

For details on how to resolve errors without Support Codes, see [A Message Is Displayed](#).



A Message for Faxing Is Displayed on the Fax Standby Screen



If a message is displayed on the Fax standby screen, take the corresponding action described below.

Message	Action
Auto redial	<p>The machine is waiting to redial the recipient's number because the line was busy or the recipient did not answer when you tried to send a document. Wait for the machine to automatically redial the number. If you want to cancel automatic redialing, wait until the machine starts dialing the number, then press the Stop button. You can also delete the document from machine's memory to cancel automatic redialing.</p> <p> Resending Faxes (Redialing a Busy Number)</p>
Hang up phone	<p>The handset is not placed in the handset cradle correctly. Replace the handset correctly.</p>
Try again in B&W	<p>The recipient's fax machine is not color-compatible. Press the Black button to resend the fax.</p> <p>Alternatively, you select If incompat., B&W for Color transmission in Adv. FAX settings under Fax settings. The machine converts color documents into black & white data if the recipient's fax machine does not support color faxing.</p> <p> Adv. FAX settings</p>
No tone detected	<p>The telephone line cable with a modular plug may not be plugged in properly. Make sure that the cable is plugged in properly, and resend the fax after a while. If you still cannot send the fax, select OFF for Dial tone detect in Adv. FAX settings under Fax settings.</p> <p> Adv. FAX settings</p>
Received in memory	<p>If the machine receives a fax under one of the following conditions, the machine will not be able to print the received fax and will store it in the machine's memory. When the problem is resolved as described, the fax stored in the machine's memory is printed automatically.</p> <ul style="list-style-type: none"> The amount of remaining ink is insufficient to print a fax: Replace the FINE cartridge. <p> Replacing a FINE Cartridge</p> <p> Note</p> <ul style="list-style-type: none"> You can set the machine to forcibly print a received fax even if the ink has run out. Set Print when no ink in Auto print settings under Fax settings to Print. However, part or all of the fax may not be printed since the ink has run out. Also, the contents of the fax will not be stored in the machine's memory. <p>If the ink has already run out, we recommend that Do not print be selected for Received documents in Auto print settings under Fax settings to store the received fax in the machine's memory. After you replace the FINE cartridge and select Print for Received documents in Auto print settings, the fax stored in the machine's memory will be printed automatically.</p>

■ [Auto print settings](#)

- Paper has run out:
Load the paper and press the **OK** button.
- A different size of paper from that specified by **Page size** in **FAX paper settings** is loaded:
Load the same size of paper as that specified by **Page size**, then press the **OK** button.
- You pressed the **Stop** button to cancel printing of a fax:
Press the **FAX** button to resume printing of the fax.
- **Do not print** is selected for **Received documents** in **Auto print settings** under **Fax settings**:
You can print the faxes stored in the machine's memory from the **Memory reference** screen under **FAX menu**.

■ [Printing a Document in Machine's Memory](#)

▶▶▶ **Note**

- To print the received faxes automatically, select **Print** for **Received documents** in **Auto print settings** under **Fax settings**.
- If you did not print the fax stored in the machine's memory (e.g., if you did not resolve the problem by pressing the **Stop** button), you can delete or print the fax stored in the machine's memory later.

■ [Document Stored in Machine's Memory](#)

Busy/no signal

- The recipient's number you dialed is busy.
Try dialing again after waiting for a moment.
■ [Resending Faxes \(Redialing a Busy Number\)](#)
- The fax/telephone number dialed is incorrect.
Check the fax/telephone number and dial again.
- The recipient's fax machine did not respond (after all automatic redialing attempts).
Contact the recipient and have the recipient check the fax machine. For an overseas call, add pauses to the registered number.
- The recipient is not using a G3 machine.
The machine cannot send or receive documents to/from a fax machine that is incompatible with the G3 standard. Contact the recipient and ask the recipient to check whether the fax machine is G3 compatible.
- The touch tone/rotary pulse setting on the machine is incorrect.
Set the machine to match the telephone line you are using.

■ [Setting the Telephone Line Type](#)

Memory is full

The machine's memory is full because it has sent/received too many documents, or a detailed document.

Print the faxes stored in the machine's memory and delete them from the machine's memory.

■ [Document Stored in Machine's Memory](#)

When sending a fax, resend it. If this message still appears, delete the faxes stored in the machine's memory, divide the faxes for sending, and send them again.

When receiving a fax, have the sender resend the faxes.

FAX info does not match	<p>Transmission has been canceled because the machine could not detect the recipient's fax machine information or the information did not match the dialed number. This message is displayed when Check RX FAX info in Security control under Fax settings is set to ON.</p> <p>For details, see Sending Faxes after Checking Information (Checking the Recipient's Information).</p>
Reception rejected	<p>Reception has been rejected because the fax matches the fax rejection condition specified by FAX RX reject in Security control under Fax settings.</p> <p>For details, see Rejecting Fax Reception.</p>
Waiting for report	<p>If the machine receives a fax under one of the following conditions, the machine will not be able to print the reports. When the problem is resolved as described, the reports are printed automatically.</p> <ul style="list-style-type: none"> • The amount of remaining ink is insufficient to print a report: Replace the FINE cartridge.  Replacing a FINE Cartridge • Paper has run out: Load the paper and press the OK button. • A different size of paper from that specified by Page size in FAX paper settings is loaded: Load the same size of paper as that specified by Page size, then press the OK button. • You pressed the Stop button to cancel printing of a report: Press the FAX button to resume printing of the report.

A Message Is Displayed

This section describes some of the errors or messages.

►► Note

- A Support Code (error number) is displayed on the computer or on the LCD for some error or message. For details on errors with Support Codes, refer to [List of Support Code for Error](#).

If a message is displayed on the LCD, see below.

- [A Message Is Displayed on the LCD](#)

If a message is displayed on the computer, see below.

- [Error Regarding the Power Cord Being Unplugged Is Displayed](#)
- [Writing Error/Output Error/Communication Error](#)
- [Other Error Messages](#)
- [The Inkjet Printer/Scanner/Fax Extended Survey Program Screen Is Displayed](#)



A Message Is Displayed on the LCD



Confirm the message and take an appropriate action.

- **Check page size Press [OK]**

The size of the loaded paper is different from that specified in the paper size setting.

Load the same size of paper as that specified in the paper size setting, then press the **OK** button.

- **Data error Press [OK]**

A power failure has occurred or the power cord has been unplugged when the faxes are stored in the machine's memory.

►► Important

- If a power failure occurs or you unplug the power cord, all faxes stored in the machine's memory are deleted.
- For details on how to unplug the power cord, see [Notice for Unplugging the Power Cord](#).

Press the **OK** button.

After pressing the **OK** button, the list of the faxes deleted from the machine's memory (MEMORY CLEAR REPORT) will be printed.

For details, refer to [Summary of Reports and Lists](#).

- **Cannot connect to the server; try again**

You cannot connect to the server due to some communication error.

Press the **OK** button to dismiss the error, then try again after a while.

Error Regarding the Power Cord Being Unplugged Is Displayed

A

The power cord may have been unplugged while the machine was still on.

Check the error message that appears on the computer, then click **OK**.

The machine starts printing.

See [Notice for Unplugging the Power Cord](#) for unplugging the power cord.

Important

- If you unplug the power cord, all the faxes stored in the machine's memory are deleted.

Writing Error/Output Error/Communication Error

A

Check1 If the **POWER** lamp is off, make sure that the power plug is plugged in, then turn the machine on.

While the **POWER** lamp is flashing, the machine is initializing. Wait until the **POWER** lamp stops flashing and remains lit.

Check2 Make sure that the printer port is configured appropriately in the printer driver.

* In the following instructions, "XXX" signifies your machine's name.

1. Log on as a user account with administrator privilege.
2. Select items as shown below.
 - In Windows 8.1 or Windows 8, select **Control Panel** from the **Settings** charm on **Desktop** > **Hardware and Sound** > **Devices and Printers**.
 - In Windows 7, select **Devices and Printers** from the **Start** menu.
 - In Windows Vista, select the **Start** menu > **Control Panel** > **Hardware and Sound** > **Printers**.
 - In Windows XP, select the **Start** menu > **Control Panel** > **Printers and Other Hardware** > **Printers and Faxes**.
3. Open the properties of printer driver for the machine.
 - In Windows 8.1, Windows 8, or Windows 7, right-click the "Canon XXX series Printer" icon (where "XXX" is your machine's name), then select **Printer properties**.
 - In Windows Vista or Windows XP, right-click the "Canon XXX series Printer" icon (where "XXX" is your machine's name), then select **Properties**.

4. Click the **Ports** tab to confirm the port settings.

Make sure that a port named "USBnnn" (where "n" is a number) with "Canon XXX series Printer" appearing in the **Printer** column is selected for **Print to the following port(s)**.

►► Note

- When the machine is used over LAN, the port name of the machine is displayed as "CNBJNP_XXXXXXXX". "XXXXXXXX" is the character string generated from the MAC address or a character string specified by the user when setting up the machine.

- If the setting is incorrect:

Reinstall the MP Drivers with the Setup CD-ROM or install them from our website.

- Printing does not start even though the machine is connected to the computer using a USB cable and the port named "USBnnn" is selected:

In Windows 8.1 or Windows 8, select **My Printer** on the **Start** screen to start **My Printer**. If **My Printer** is not displayed on the **Start** screen, select the **Search** charm, then search for "**My Printer**".

Set the correct printer port on **Diagnose and Repair Printer**. Follow the on-screen instructions to set the correct printer port, then select your machine's name.

In Windows 7, Windows Vista, or Windows XP, click **Start** and select **All programs, Canon Utilities, Canon My Printer, Canon My Printer**, then select **Diagnose and Repair Printer**. Follow the on-screen instructions to set the correct printer port, then select your machine's name.

If the problem is not resolved, reinstall the MP Drivers with the Setup CD-ROM or install them from our website.

- Printing does not start even though the port named "CNBJNP_XXXXXXXX" is selected when the machine is used over LAN:

Launch IJ Network Tool, and select "CNBJNP_XXXXXXXX" as you confirmed in step 4, then associate the port with the printer using **Associate Port** in the **Settings** menu.

If the problem is not resolved, reinstall the MP Drivers with the Setup CD-ROM or install them from our website.

Check3 Make sure that the machine is connected to your computer properly.

When the machine is connected to your computer with a USB cable, make sure that the USB cable is securely plugged in to the machine and the computer, then check the followings:

- If you are using a relay device such as a USB hub, disconnect it, connect the machine directly to the computer, and try printing again. If printing starts normally, there is a problem with the relay device. Consult the reseller of the relay device for details.
- There could also be a problem with the USB cable. Replace the USB cable and try printing again.

When you use the machine over LAN, make sure that the machine is set up to be used over network correctly.

Check4 Make sure that the MP Drivers are installed correctly.

Uninstall the MP Drivers following the procedure described in [Deleting the Unnecessary MP Drivers](#), then reinstall the MP Drivers with the Setup CD-ROM or reinstall them from our website.

Check5 When the machine is connected to your computer with a USB cable, check the status of the device on your computer.

Follow the procedure below to check the status of the device.

1. Open the Device Manager on your computer as shown below.

If the **User Account Control** screen is displayed, follow the on-screen instructions.

- In Windows 8.1 or Windows 8, select **Control Panel** from the **Settings** charm on **Desktop** > **Hardware and Sound** > **Device Manager**.

- In Windows 7 or Windows Vista, click **Control Panel, Hardware and Sound**, then **Device Manager**.
 - In Windows XP, click **Control Panel, Performance and Maintenance, System**, then click **Device Manager** on the **Hardware** sheet.
2. Double-click **Universal Serial Bus controllers** then **USB Printing Support**.
- If the **USB Printing Support Properties** screen is not displayed, make sure that the machine is correctly connected to the computer.
-  **Check3** [Make sure that the machine is connected to your computer properly.](#)
3. Click the **General** tab and make sure that there is no indication of a problem with the device.
- If a device error is displayed, refer to Windows help to resolve the error.

Other Error Messages

 **Check** If an error message is displayed outside the printer status monitor, check the following:

- **"Could not spool successfully due to insufficient disk space"**
Delete any unnecessary files to increase the amount of free space on the disk.
- **"Could not spool successfully due to insufficient memory"**
Quit other running application softwares to increase available memory.
If you cannot print yet, restart your computer and retry printing.
- **"Printer driver could not be found"**
Uninstall the MP Drivers following the procedure described in [Deleting the Unnecessary MP Drivers](#), then reinstall the MP Drivers with the Setup CD-ROM or reinstall them from our website.
- **"Could not print Application name - File name"**
Try printing again once the current job is complete.

The Inkjet Printer/Scanner/Fax Extended Survey Program Screen Is Displayed

If the Inkjet Printer/Scanner/Fax Extended Survey Program is installed, a confirmation screen asking for permission to send the printer and application software usage information will be displayed every month for about ten years.

Read the instructions on the screen and follow the procedure below.

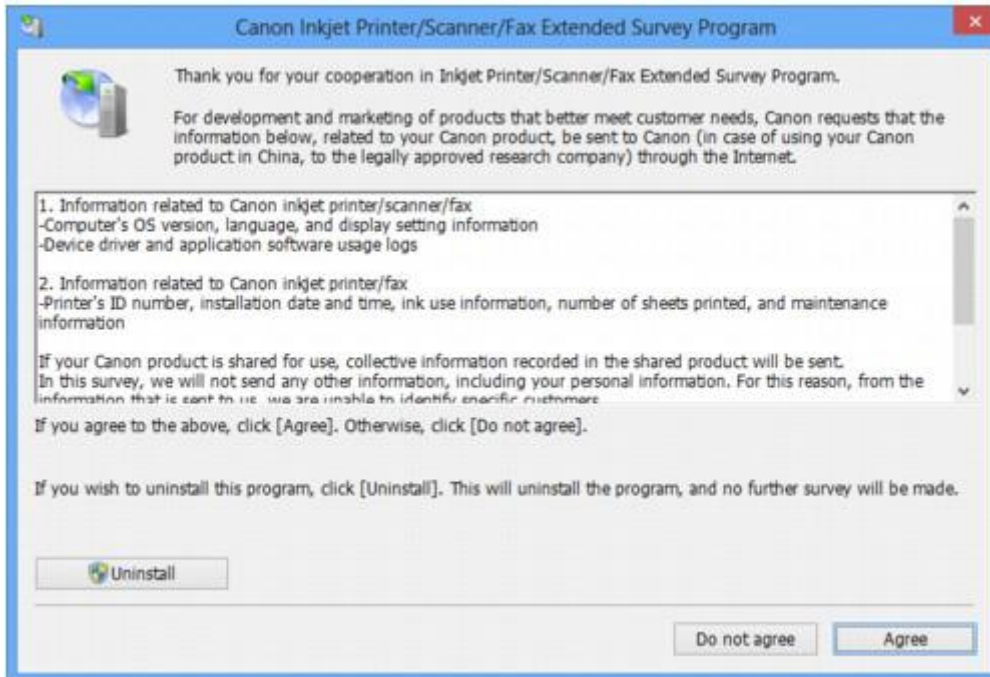

- **If you agree to participate in the survey program:**

Click **Agree**, then follow the on-screen instructions. The printer usage information will be sent via the Internet. If you have followed the on-screen instructions, the information will be sent automatically from the second time onward and the confirmation screen will not be displayed again.

▶▶▶ **Note**

- When the information is being sent, a caution screen such as an Internet security screen may be displayed. In this case, confirm that the program name is "IJPLMUI.exe", then allow it.
- If you deselect the **Send automatically from the next time** check box, the information will not be sent automatically from the second time onward and a confirmation screen will be displayed at the time of the next survey. To send the information automatically, see [Changing the confirmation screen setting](#).

- **If you do not agree to participate in the survey program:**

Click **Do not agree**. The confirmation screen will be closed, and the survey at that time is skipped. The confirmation screen will be displayed again one month later.

- **To uninstall the Inkjet Printer/Scanner/Fax Extended Survey Program:**

To uninstall the Inkjet Printer/Scanner/Fax Extended Survey Program, click **Uninstall**, then follow the on-screen instructions.

- **Changing the confirmation screen setting:**

1. Select items as shown below.
 - In Windows 8.1 or Windows 8, select **Control Panel** from the **Settings** charm on **Desktop** > **Programs** > **Programs and Features**.
 - In Windows 7, or Windows Vista, select the **Start** menu > **Control Panel** > **Programs** > **Programs and Features**.
 - In Windows XP, select the **Start** menu > **Control Panel** > **Add or Remove Programs**.

»» **Note**

- In Windows 8.1, Windows 8, Windows 7, or Windows Vista, a confirmation/warning dialog box may appear when installing, uninstalling or starting up software.
This dialog box appears when administrative rights are required to perform a task.
If you are logged on to an administrator account, follow the on-screen instructions.

2. Select **Canon Inkjet Printer/Scanner/Fax Extended Survey Program**.
3. Select **Change**.

If you select **Yes** after you have followed the on-screen instructions, the confirmation screen will be displayed at the time of the next survey.

If you select **No**, the information will be sent automatically.

»» **Note**

- If you select **Uninstall** (or **Remove** in Windows XP), the Inkjet Printer/Scanner/Fax Extended Survey Program is uninstalled. Follow the on-screen instructions.

If You Cannot Resolve the Problem

If you cannot resolve the problem with any of the workarounds in this chapter, please contact the seller of the machine or the service center.

Canon support staff are trained to be able to provide technical support to satisfy customers.

Caution

- If the machine emits any unusual sound, smoke, or odor, turn it off immediately. Unplug the power cord from the outlet and contact the seller or the service center. Never attempt to repair or disassemble the machine yourself.
- Attempts by customers to repair or take apart the machine will invalidate any warranty regardless of whether the warranty has expired.

Before contacting the service center, confirm the following:

- Product name:
 - * Your machine's name is located on the front cover of the setup manual.
- Serial number: please refer to the setup manual
- Details of the problem
- What you tried to solve the problem, and what happened

List of Support Code for Error

The support code appears on the LCD and the computer screen when an error occurs.

"Support Code" means the error number and appears with an error message.

When an error occurs, check the support code displayed on the LCD or the computer screen and take the appropriate action.

Support Code Appears on the LCD and the Computer Screen

- **1000 to 1ZZZ**

[1003](#) [1200](#) [1203](#) [1250](#) [1300](#) [1303](#)

[1401](#) [1403](#) [1485](#) [1682](#) [1684](#) [1686](#)

[1688](#) [168A](#) [1702](#) [1703](#) [1704](#) [1705](#)

[1712](#) [1713](#) [1714](#) [1715](#) [1871](#) [1890](#)

- **2000 to 2ZZZ**

[2110](#) [2120](#) [2700](#) [2801](#) [2802](#) [2803](#)

[2900](#) [2901](#)

- **4000 to 4ZZZ**

[4100](#) [4103](#)

- **5000 to 5ZZZ**

[5011](#) [5012](#) [5040](#) [5100](#) [5200](#) [5400](#)

[5B02](#) [5B03](#) [5B04](#) [5B05](#) [5B12](#) [5B13](#)

[5B14](#) [5B15](#)

- **6000 to 6ZZZ**

[6000](#) [6500](#) [6800](#) [6801](#) [6900](#) [6901](#)

[6902](#) [6910](#) [6911](#) [6930](#) [6931](#) [6932](#)

[6933](#) [6936](#) [6937](#) [6938](#) [6939](#) [693A](#)

[6940](#) [6941](#) [6942](#) [6943](#) [6944](#) [6945](#)

[6946](#)

- **9000 to 9ZZZ**

[9500](#)

- **A000 to ZZZZ**

[B201](#) [B202](#) [B203](#) [B204](#)

About the support code for paper jam, you can also refer to [List of Support Code for Error \(When Paper Is Jammed\)](#).

List of Support Code for Error (When Paper Is Jammed)

If the paper is jammed, remove it following the procedure appropriate for each case.

- If you can see the jammed paper at the paper output slot:

■ [1300](#)

- If you cannot see the jammed paper at the paper output slot:

■ [1303](#)

- If the paper tears and you cannot remove it from the paper output slot or from the transport unit:

■ [Paper Is Jammed inside the Machine](#)

- If the document is jammed in the ADF:

■ [2801](#)

- Cases other than above:

■ [In Other Cases](#)

1300

Cause

Paper is jammed in the paper output slot.

Action

If you can see the jammed paper at the paper output slot, remove the paper following the procedure below.

►► Important

- The power cannot be turned off while the machine is sending or receiving a fax, or when the received fax or the unsent fax are stored in the machine's memory.

Turn the machine off after making sure that it has completed sending or receiving all the faxes. Do not unplug the power cord when turning the machine off.

If you unplug the power cord, all the faxes stored in the machine's memory are deleted.

1. Pull the paper out slowly.

Hold the paper with your hands, then pull the paper out slowly not to tear it.



►► Note

- If you cannot pull the paper out, turn the machine off and turn it back on. The paper may be ejected automatically.
- If you need to turn off the machine to remove jammed paper during printing, press the **Stop** button to cancel print jobs before turning off the machine.
- If you cannot pull the paper out from the paper output slot, try to pull the paper out from the transport unit.
 - [1303](#)
- If the paper tears and you cannot remove the jammed paper from the paper output slot, remove the paper from inside the machine.
 - [Paper Is Jammed inside the Machine](#)

2. Reload the paper, and press the machine's **OK** button.

The printer resumes printing. Reprint the page you were printing if it was not printed properly due to the paper jam.

If you turned off the machine in step 1, all print jobs in the queue are canceled. Reprint if necessary.

»» Note

- When reloading the paper, make sure that you are using suitable paper for printing and are loading it correctly.
- We recommend you use paper other than A5 sized one to print documents with photos or graphics; otherwise, the printout may curl and cause paper exit jams.

If you cannot remove the paper or the paper tears inside the machine, or if the paper jam error continues after removing the paper, contact the service center.

1303

Cause

Paper is jammed inside the machine at the transport unit.

Action

If you cannot see the paper at the paper output slot, remove the paper from the transport unit.

Remove the paper following the procedure below.

►► Important

- The power cannot be turned off while the machine is sending or receiving a fax, or when the received fax or the unsent fax are stored in the machine's memory.

Turn the machine off after making sure that it has completed sending or receiving all the faxes. Do not unplug the power cord when turning the machine off.

If you unplug the power cord, all the faxes stored in the machine's memory are deleted.

►► Note

- If you need to turn off the machine to remove jammed paper during printing, press the **Stop** button to cancel print jobs before turning off the machine.

1. Turn the machine off, then unplug the power cord.
2. Open the document cover.
Close the document tray if it is open.
3. Stand the machine with the right side facing down.

►► Important

- Stand the machine on a wide and flat surface such as a desk.
- When you stand the machine, hold it securely and be careful not to hit it on a hard object.

4. Open the transport unit.

When you open the transport unit, support the machine with your hand so that it does not fall down.

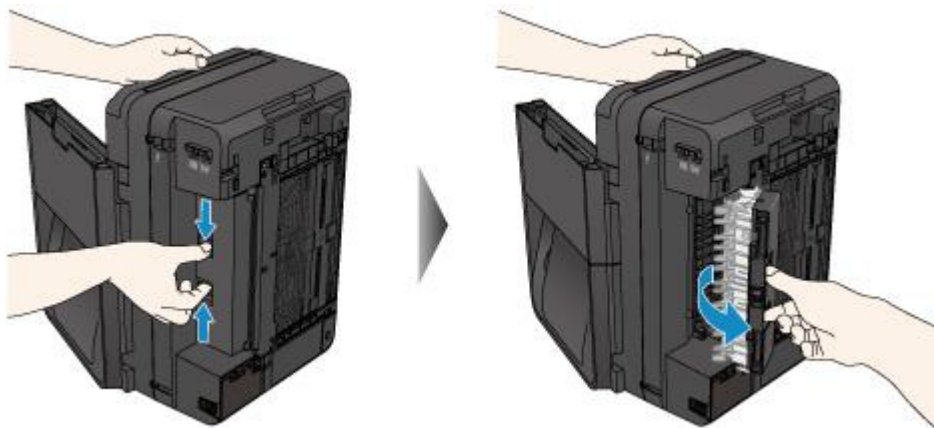

5. Pull out the jammed paper slowly.

When you pull the jammed paper, support the machine with your hand so that it does not fall down.

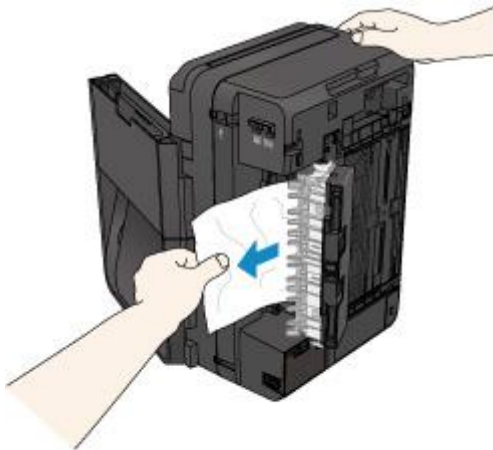

►► Note

- If the paper is rolled up and it is difficult to remove, grasp the edges of the paper, then remove the jammed paper.
- If you cannot remove the jammed paper from the transport unit, close the transport unit, take back the machine in original position, then remove the paper from inside the machine.

■ [Paper Is Jammed inside the Machine](#)

6. Close the transport unit.

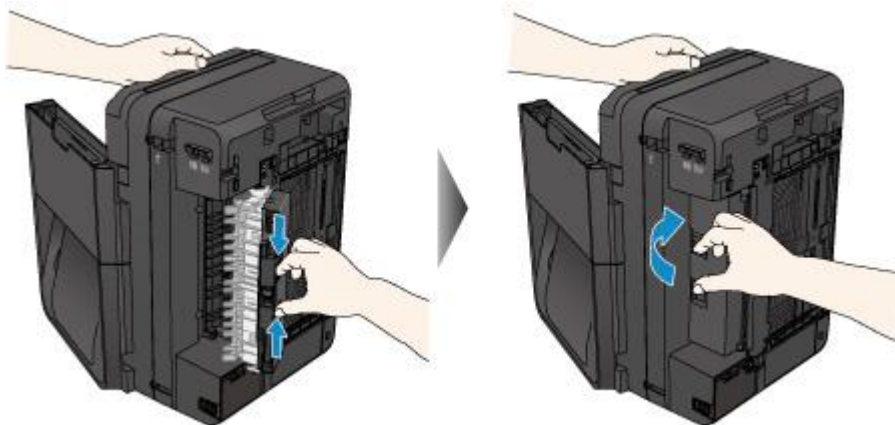

►► Note

- After you close the transport unit, take back the machine in original position at once.

7. Plug the machine back in and turn the machine back on.

8. Reload the paper.

All print jobs in the queue are canceled. Reprint if necessary.

If you cannot remove the paper or the paper tears inside the machine, or if the paper jam error continues after removing the paper, contact the service center.

2801

Cause

The document is jammed in the ADF.

Action

Remove the document following the procedure below.

►► Important

- Do not open the document cover if the document is jammed. The jammed document may be torn.
- The power cannot be turned off while the machine is sending or receiving a fax, or when the received fax or the unsent fax are stored in the machine's memory.

Turn the machine off after making sure that it has completed sending or receiving all the faxes. Do not unplug the power cord when turning the machine off.

If you unplug the power cord, all the faxes stored in the machine's memory are deleted.

- **If the original remains in the ADF by pressing the Stop button while the machine is scanning the document:**

If you press the **Stop** button during scanning then the document remained in the ADF, the message about the paper remained in the ADF appears on the LCD. Press the **OK** button so that the remaining document is automatically fed out.

- **If the original is jammed in the ADF:**

Remove the document following the procedure below.

1. If printing is in progress, press the **Stop** button.
2. Turn off the machine.
3. Open the document feeder cover slowly.

If a multi-page document is loaded, open the document feeder cover after removing any pages other than the jammed page from the ADF.



4. Pull out the jammed document from the ADF.



5. Close the document feeder cover, then turn on the machine.

When rescanning the document after clearing the error, rescan it from the first page.

If you cannot remove the document or the document tears inside the machine, or if the document jam error continues after removing the document, contact the service center.

►► Note

- The document may not feed properly depending on the media type, or your environment, such as when the temperature and humidity are either too high or too low.

In this case, reduce the number of document pages to approximately half of the loading capacity.

If the document still jams, use the platen glass instead.

• If the original is jammed in the ADF (from the paper feed side):

Remove the document following the procedure below.

1. If printing is in progress, press the **Stop** button.
2. Turn off the machine.
3. Close the document tray, then open the document feeder cover slowly.

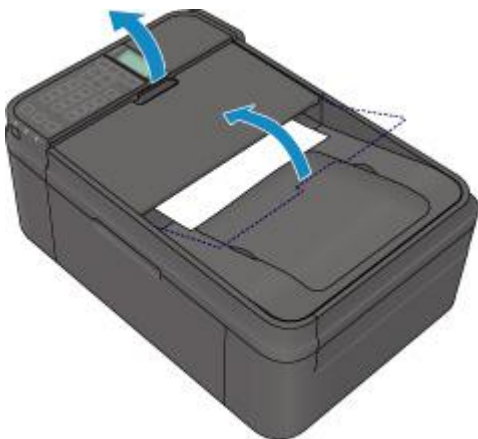

4. Pull out the jammed document from the ADF.



5. Close the document feeder cover, then turn on the machine.

When rescanning the document after clearing the error, rescan it from the first page.

If you cannot remove the document or the document tears inside the machine, or if the document jam error continues after removing the document, contact the service center.

▶▶▶ Note

- The document may not feed properly depending on the media type, or your environment, such as when the temperature and humidity are either too high or too low.

In this case, reduce the number of document pages to approximately half of the loading capacity.

If the document still jams, use the platen glass instead.

Paper Is Jammed inside the Machine

If the jammed paper tears and you cannot remove the paper either from the paper output slot or from the transport unit, or if the jammed paper remains inside the machine, remove the paper following the procedure below.

▶▶▶ Important

- The power cannot be turned off while the machine is sending or receiving a fax, or when the received fax or the unsent fax are stored in the machine's memory.

Turn the machine off after making sure that it has completed sending or receiving all the faxes. Do not unplug the power cord when turning the machine off.

If you unplug the power cord, all the faxes stored in the machine's memory are deleted.

▶▶▶ Note

- If you need to turn off the machine to remove jammed paper during printing, press the **Stop** button to cancel print jobs before turning off the machine.

1. Turn off the machine, and unplug the power cord of the machine from the power supply.
2. Open the paper output cover.

Remove the paper in the cassette if any.



▶▶▶ Important

- Do not touch the clear film (A).

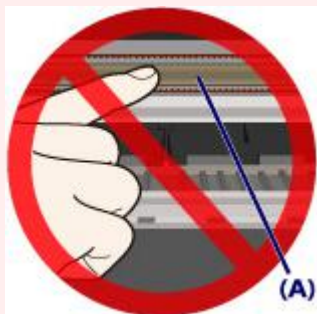

If the paper or your hands touch the clear film and blot or scratch it, the machine can be damaged.

3. Make sure that the jammed paper is not under the FINE cartridge holder.

If the jammed paper is under the FINE cartridge holder, move the FINE cartridge holder to the right edge or the left edge whichever is easier to remove the paper.

When you move the FINE cartridge holder, hold the FINE cartridge holder and slide it slowly to the right edge or the left edge.

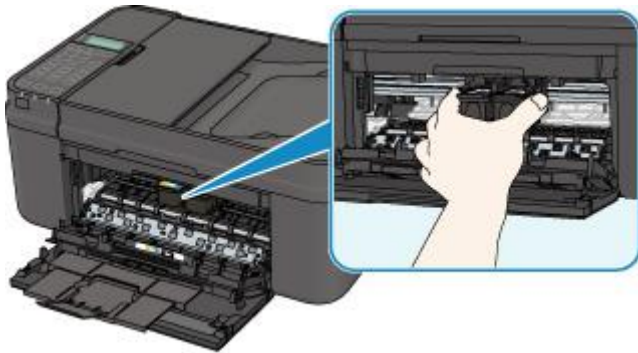

4. Hold the jammed paper with your hands.



If the paper is rolled up, pull it out.

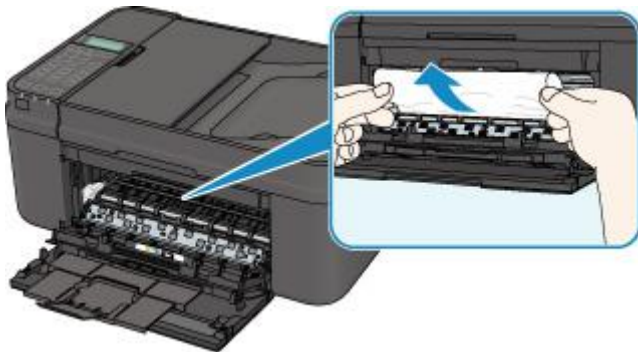

5. Pull the paper slowly not to tear it, then pull the paper out.

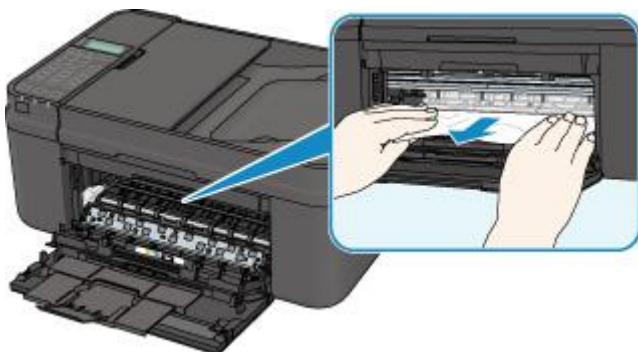

6. Make sure that all the jammed paper is removed.

If the paper is torn, a piece of paper may remain inside the machine. Check the following and remove the piece of paper if it remains.

- Does the piece of paper remain under the FINE cartridge holder?
- Does the little piece of paper remain inside the machine?
- Does the piece of paper remain in the right side or the left side space (B) inside the machine?

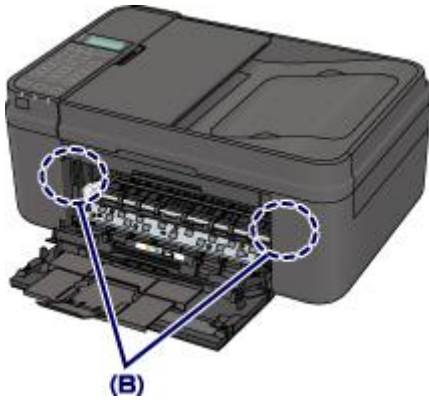

7. Close the paper output cover, then reload the paper.

All print jobs in the queue are canceled. Reprint if necessary.

▶▶ Note

- When reloading the paper, make sure that you are using suitable paper for printing and are loading it correctly. If the message about paper jam is displayed on the LCD of the machine or on the computer screen when you resume printing after removing all the jammed paper, a piece of paper may remain inside the machine. In this case, confirm that no piece of paper remains inside the machine.

If you cannot remove the paper or the paper tears inside the machine, or if the paper jam error continues after removing the paper, contact the service center.

In Other Cases

Make sure of the following:

Check1 Are there any foreign objects around the paper output slot?

Check2 Is the paper curled?

Load the paper after correcting its curl.

1003

Cause

The machine is out of paper, or paper does not feed.

Action

Close the paper output tray, pull the cassette out, then load the paper.

When you load the paper, insert the paper stack until the leading edge touches the far end of the cassette.

After loading the paper, push the cassette so that the  mark on the cassette aligns with the front panel as illustrated below.

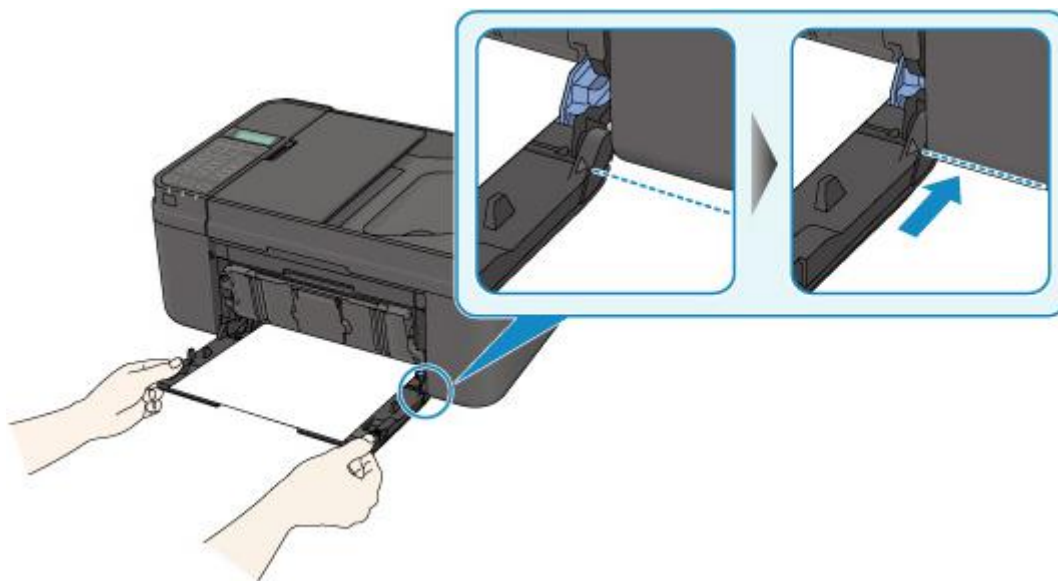

When the cassette is inserted properly, you hear an electric sound once.

Open the paper output tray, then press the machine's **OK** button.

▶▶ Note

- If you want to cancel printing, press the machine's **Stop** button.

1200

Cause

The paper output cover is open.

Action

Close the paper output cover and wait for a while.

Do not close it while you are replacing a FINE cartridge.

1203

Cause

The paper output cover is opened while printing is in progress.

Action

If paper is left inside the machine, remove the paper slowly with both hands and close the paper output cover.

Press the machine's **OK** button to dismiss the error.

The machine ejects one blank sheet of paper and resumes printing from the next paper.

The machine will not reprint the page that was printed when the paper output cover is opened. Try printing again.

►► Important

- Do not open or close the paper output cover while printing is in progress, as this can damage the machine.

1250

Cause

The paper output tray is closed.

Action

Open the paper output tray to resume printing.

1401

Cause

The FINE cartridge is not installed.

Action

Install the FINE cartridge.

If the error is not resolved, the FINE cartridge may be damaged. Contact the service center.

1403

Cause

The FINE cartridge cannot be recognized.

Action

Replace the FINE cartridge.

If the error is not resolved, the FINE cartridge may be damaged. Contact the service center.

1485

Cause

Appropriate ink cartridge is not installed.

Action

Printing cannot be executed because the ink cartridge is not compatible with this machine.

Install the appropriate ink cartridge.

If you want to cancel printing, press the machine's **Stop** button.

1682

Cause

The FINE cartridge cannot be recognized.

Action

Replace the FINE cartridge.

If the error is not resolved, the FINE cartridge may be damaged. Contact the service center.

1684

Cause

The ink cartridge cannot be recognized.

Action

Printing cannot be executed because the ink cartridge may not be installed properly or may not be compatible with this machine.

Install the appropriate ink cartridge.

If you want to cancel printing, press the machine's **Stop** button.

1686

Cause

The ink may have run out.

Action

The function for detecting the remaining ink level will be disabled since the ink level cannot be correctly detected.

If you want to continue printing without this function, press the machine's **Stop** button for at least 5 seconds.

Canon recommends to use new genuine Canon cartridges in order to obtain optimum qualities.

Please be advised that Canon shall not be liable for any malfunction or trouble caused by continuation of printing under the ink out condition.

▶▶ Note

- If the function for detecting the remaining ink level is disabled, [?] is displayed on the LCD.
- Since the information contained in the fax may be lost if it is printed in this condition, the received fax will not be printed and will be stored in the machine's memory until the ink cartridge is replaced. You must manually print out faxes that were stored in the memory. You can change the setting so that the received fax is forcibly printed out instead of being stored in the memory, but all or part of the fax information may not be printed because of the ink out condition.

1688

Cause

The ink has run out.

Action

Replace the ink cartridge and close the paper output cover.

If printing is in progress and you want to continue printing, press the machine's **Stop** button for at least 5 seconds with the ink cartridge installed. Then printing can continue under the ink out condition.

The function for detecting the remaining ink level will be disabled.

Replace the empty ink cartridge immediately after the printing. The resulting print quality is not satisfactory, if printing is continued under the ink out condition.

►► Note

- If the function for detecting the remaining ink level is disabled, [?] is displayed on the LCD.
- Since the information contained in the fax may be lost if it is printed in this condition, the received fax will not be printed and will be stored in the machine's memory until the ink cartridge is replaced. You must manually print out faxes that were stored in the memory. You can change the setting so that the received fax is forcibly printed out instead of being stored in the memory, but all or part of the fax information may not be printed because of the ink out condition.

168A

Cause

The FINE cartridge is not installed properly, or the FINE cartridge not compatible with this machine is installed.

Action

Open the paper output cover, then remove the FINE cartridges.

Make sure that the FINE cartridge compatible with the machine is installed.

Then install the FINE cartridges again. Push up the FINE cartridge until it clicks into place.

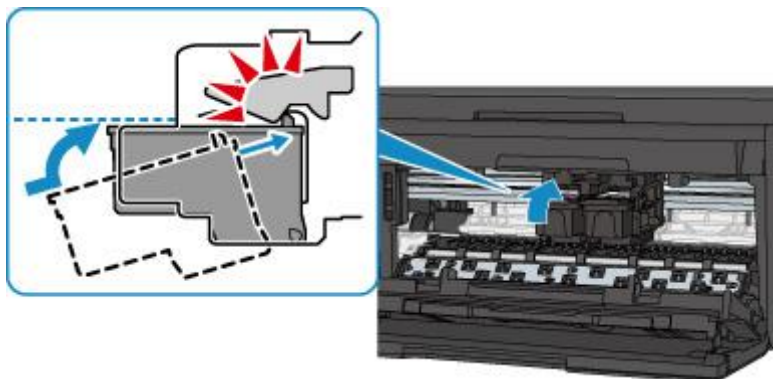

When the FINE cartridge is installed properly, you hear an electric sound once.

After installing, close the paper output cover.

1702

Cause

The ink absorber is almost full.

Action

Press the machine's **OK** button to continue printing. Contact the service center.

1703

Cause

The ink absorber is almost full.

Action

Press the machine's **OK** button to continue printing. Contact the service center.

1704

Cause

The ink absorber is almost full.

Action

Press the machine's **OK** button to continue printing. Contact the service center.

1705

Cause

The ink absorber is almost full.

Action

Press the machine's **OK** button to continue printing. Contact the service center.

1712

Cause

The ink absorber is almost full.

Action

Press the machine's **OK** button to continue printing. Contact the service center.

1713

Cause

The ink absorber is almost full.

Action

Press the machine's **OK** button to continue printing. Contact the service center.

1714

Cause

The ink absorber is almost full.

Action

Press the machine's **OK** button to continue printing. Contact the service center.

1715

Cause

The ink absorber is almost full.

Action

Press the machine's **OK** button to continue printing. Contact the service center.

1871

Cause

The cassette is not inserted.

Action

After loading the paper, push the cassette so that the  mark on the cassette aligns with the front panel as illustrated below.

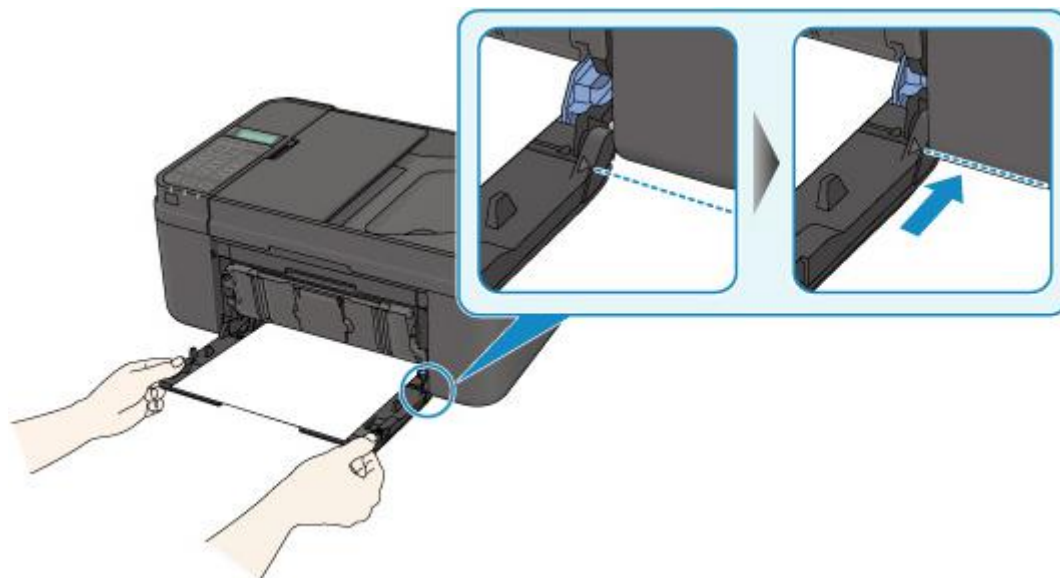

When the cassette is inserted properly, you hear an electric sound once.

Open the paper output tray, then press the machine's **OK** button.

▶▶ Note

- The cassette paper information registration screen is displayed after inserting the cassette. Register the cassette paper information according to the paper you loaded in the cassette.
- If you want to cancel printing, press the machine's **Stop** button.

1890

Cause

The protective material for the FINE cartridge holder or the tape may remain attached to the holder.

Action

Open the paper output cover, then confirm that the protective material or the tape does not remain attached to the FINE cartridge holder.

If you find the protective material or the tape remains attached, remove it, then close the paper output cover.

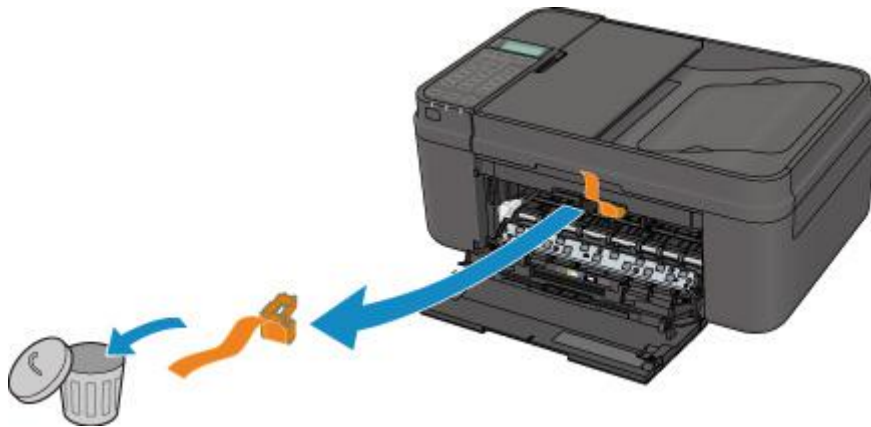

If the problem is not resolved, contact the service center.

Cause

The paper settings for printing or copying are different from the cassette paper information registered to the machine.

▶▶▶ Note

- For details on the proper combination of paper settings you can specify by the printer driver or on the LCD:
 - [Paper Settings on the Printer Driver and the Printer \(Media Type\)](#) (Windows)
 - [Paper Settings on the Printer Driver and the Printer \(Media Type\)](#) (Mac)
 - [Paper Settings on the Printer Driver and the Printer \(Paper Size\)](#) (Windows)
 - [Paper Settings on the Printer Driver and the Printer \(Paper Size\)](#) (Mac)
- For copying, specify the paper settings for copying so that they match the cassette paper information.
- For details on the cassette paper information registering to the machine:
 - [Paper setting for Printing](#) (Windows)
 - [Paper setting for Printing](#) (Mac)
 - [Paper setting for Printing](#) (Smartphone and so on)

If the paper settings for printing or copying are different from the cassette paper information registered to the machine as the following, a message is displayed on the LCD.

- Print settings specified on the printer driver:
 - Paper size: B5
 - Media type: Plain paper
- Cassette paper information registered to the machine:
 - Paper size: A4
 - Media type: Plain paper

The size/type of lo 2110
[OK]Select option

Action

Pressing the machine's **OK** button, the following screen is displayed on the LCD.

Select option
Use cass. settings ▶

Select what to do as necessary.

▶▶▶ Note

- Depending on the setting, the choices below may not be displayed.

Use cass. settings

Select if you want to print on the paper loaded in the cassette without changing the paper settings.

For example, when the paper setting for printing or copying is B5 and the cassette paper information registered to the machine is A4, the machine starts printing or copying with B5 on the paper loaded in the cassette.

Replace the paper

Select if you want to print after replacing the paper of the cassette.

For example, when the paper setting for printing or copying is B5 and the cassette paper information registered to the machine is A4, you load B5 sized paper in the cassette before you start printing or copying.

The cassette paper information registration screen is displayed after replacing the paper and inserting the cassette. Register the cassette paper information according to the paper you loaded in the cassette.

▶▶ Note

- If you do not know what paper information to register to the machine, press the **Back** button when the screen to select the operation is displayed. When the previous screen is displayed, confirm the paper size and the media type, then register them to the machine.
- For details on the proper combination of paper settings you can specify by the printer driver or on the LCD:

■ [Paper Settings on the Printer Driver and the Printer \(Media Type\)](#) (Windows)

■ [Paper Settings on the Printer Driver and the Printer \(Media Type\)](#) (Mac)

■ [Paper Settings on the Printer Driver and the Printer \(Paper Size\)](#) (Windows)

■ [Paper Settings on the Printer Driver and the Printer \(Paper Size\)](#) (Mac)

Cancel

Cancels printing.

Select when you change the paper settings specified for printing or copying. Change the paper settings, then try printing again.

▶▶ Important

- About the default setting for displaying the message which prevents misprinting:

The default setting is different between when you print or copy from the operation panel of the machine and when you print using the printer driver.

- When you print or copy from the operation panel of the machine, the message which prevents misprinting is enabled by default.

To change the setting for printing or copying using the operation panel of the machine:

■ [Cassette settings](#) (Windows)

■ [Cassette settings](#) (Mac)

■ [Cassette settings](#) (Smartphone and so on)

- When you print using the printer driver, the message which prevents misprinting is disabled by default.

To change the setting for printing using the printer driver:

■ [Changing the Printer Operation Mode](#) (Windows)

■ [Changing the Printer Operation Mode](#) (Mac)

- When the message which prevents misprinting is disabled:

The machine starts printing or copying even though the paper settings for printing or copying and the cassette paper information registered to the machine are different.

2120

Cause

The paper settings of the cassette is not complete.

Action

If the following screen is displayed, the paper settings of the cassette is not complete.



Size: ◀ *A4 ▶
Type: *Plain paper

Press the machine's **OK** button to terminate the paper settings of the cassette.

2700

Cause

Possible causes include the following.

- Some errors occurred while copying and a certain time passed.
- Document is remained in the ADF.
- Some errors occurred while scanning and the document is remained in the ADF.

Action

Take the corresponding actions below.

- When you copy, press the **OK** button to dismiss the error, and try to copy again.
- When the document is remained in the ADF, press the **OK** button to feed out the document.
- When you scan, press the **Stop** button to cancel the scanning, and try to scan again.

2802

Cause

No document in the ADF.

Action

Press the **OK** button to resolve the error, then operate again after loading documents.

2803

Cause

The document is too long or is jammed in the ADF.

Action

Press the **OK** button to dismiss the error. Then make sure that the document you are loading meets the machine's requirements before redoing the operation.

If the document is jammed, remove the jammed document following the procedure below.

►► Important

- Do not open the document cover if the document is jammed. The jammed document may be torn.
- The power cannot be turned off while the machine is sending or receiving a fax, or when the received fax or the unsend fax are stored in the machine's memory.

Turn the machine off after making sure that it has completed sending or receiving all the faxes. Do not unplug the power cord when turning the machine off.

If you unplug the power cord, all the faxes stored in the machine's memory are deleted.

- **If the original is jammed in the ADF:**

Remove the document following the procedure below.

1. If printing is in progress, press the **Stop** button.
2. Turn off the machine.
3. Open the document feeder cover slowly.

If a multi-page document is loaded, open the document feeder cover after removing any pages other than the jammed page from the ADF.



4. Pull out the jammed document from the ADF.



5. Close the document feeder cover, then turn on the machine.

When rescanning the document after clearing the error, rescan it from the first page.

If you cannot remove the document or the document tears inside the machine, or if the document jam error continues after removing the document, contact the service center.

»» Note

- The document may not feed properly depending on the media type, or your environment, such as when the temperature and humidity are either too high or too low.

In this case, reduce the number of document pages to approximately half of the loading capacity.

If the document still jams, use the platen glass instead.

• If the original is jammed in the ADF (from the paper feed side):

Remove the document following the procedure below.

1. If printing is in progress, press the **Stop** button.
2. Turn off the machine.
3. Close the document tray, then open the document feeder cover slowly.

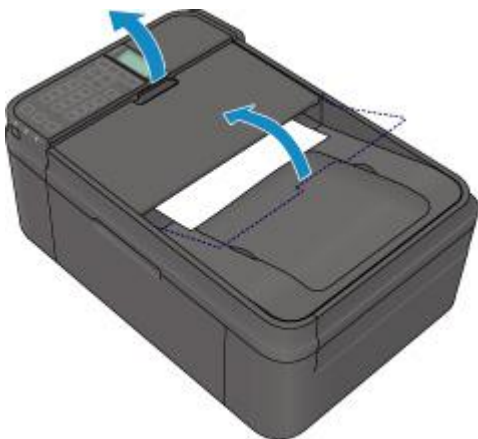

4. Pull out the jammed document from the ADF.



5. Close the document feeder cover, then turn on the machine.

When rescanning the document after clearing the error, rescan it from the first page.

If you cannot remove the document or the document tears inside the machine, or if the document jam error continues after removing the document, contact the service center.

▶▶ Note

- The document may not feed properly depending on the media type, or your environment, such as when the temperature and humidity are either too high or too low.

In this case, reduce the number of document pages to approximately half of the loading capacity.

If the document still jams, use the platen glass instead.

2900

Cause

Scanning the print head alignment sheet has failed.

Action

Press the **OK** button to dismiss the error, then take the actions described below.

- Make sure that the print head alignment sheet is set in the correct position and orientation on the platen glass.
- Make sure the platen glass and the print head alignment sheet are not dirty.
- Make sure the type and size of loaded paper is suitable for Automatic Print Head Alignment.
For Automatic Print Head Alignment, always load one sheet of A4 or Letter-sized plain paper.
- Make sure if print head nozzles are clogged.

Print the nozzle check pattern to check the status of the print head.

If the error is not resolved, perform Manual Print Head Alignment.

2901



Cause

Printing of the print head alignment pattern is complete and the machine is in waiting for scanning the sheet.

Action

Proceed to scan the printed alignment pattern.

1. Load the print head alignment sheet on the platen glass.

Load the print head alignment sheet with the printed side facing down and align the mark  on the upper left corner of the sheet with the alignment mark .

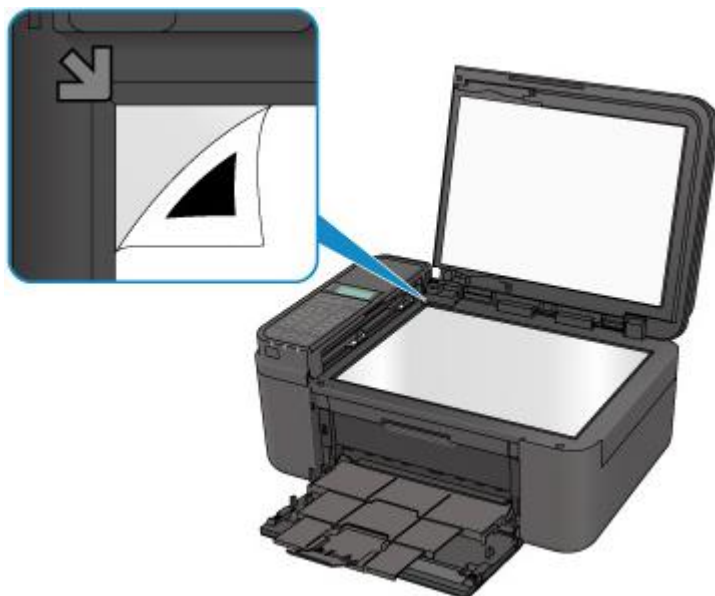

2. Close the document cover gently, then press the machine's **OK** button.

The machine starts scanning the print head alignment sheet, and the print head position will be adjusted automatically.

4100

Cause

The specified data cannot be printed.

Action

When you print the contents on CREATIVE PARK PREMIUM, confirm the message on the computer screen, make sure that genuine Canon FINE cartridges are all installed properly, then start printing again.

4103

Cause

Cannot perform printing with the current print settings.

Action

Press the machine's **Stop** button to cancel printing.

Then change the print settings and print again.

5011

Cause

Printer error has occurred.

Action

Turn off the machine, and unplug the power cord of the machine from the power supply.

Plug the machine back in and turn the machine back on.

If the problem is not resolved, contact the service center.

►► Important

- If you unplug the power cord, all the faxes stored in the machine's memory are deleted.

5012

Cause

Printer error has occurred.

Action

Turn off the machine, and unplug the power cord of the machine from the power supply.

Plug the machine back in and turn the machine back on.

If the problem is not resolved, contact the service center.

►► Important

- If you unplug the power cord, all the faxes stored in the machine's memory are deleted.

5040

Cause

Printer error has occurred.

Action

Turn off the machine, and unplug the power cord of the machine from the power supply.

Plug the machine back in and turn the machine back on.

If the problem is not resolved, contact the service center.

►► Important

- If you unplug the power cord, all the faxes stored in the machine's memory are deleted.

5100

Cause

Printer error has occurred.

Action

Cancel printing and turn off the machine. Then clear the jammed paper or protective material that is preventing the FINE cartridge holder from moving, and turn on the machine again.

Cancel printing and turn off the machine.

Then confirm the following.

- Confirm that there are no materials (e.g. the protective material or jammed paper) that is preventing the FINE cartridge holder from moving.

If any, remove the materials.

- Confirm that the FINE cartridges are installed properly.

Push up the FINE cartridge until it clicks into place.

After confirming the conditions above, turn on the machine again.

If the problem is not resolved, contact the service center.

►► Important

- When you clear the jammed paper or protective material that is preventing the FINE cartridge holder from moving, be careful not to touch the clear film (A).

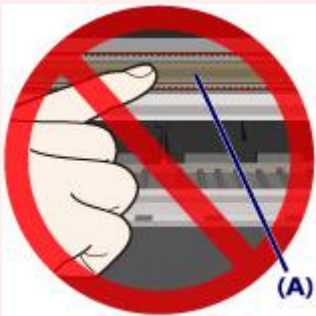

- If you unplug the power cord, all the faxes stored in the machine's memory are deleted.

5200

Cause

Printer error has occurred.

Action

Turn off the machine, and unplug the power cord of the machine from the power supply.

Plug the machine back in and turn the machine back on.

If the problem is not resolved, contact the service center.

Important

- If you unplug the power cord, all the faxes stored in the machine's memory are deleted.

5400

Cause

Printer error has occurred.

Action

Turn off the machine, and unplug the power cord of the machine from the power supply.

Plug the machine back in and turn the machine back on.

If the problem is not resolved, contact the service center.

►► Important

- If you unplug the power cord, all the faxes stored in the machine's memory are deleted.

5B02

Cause

Printer error has occurred.

Action

Contact the service center.

5B03

Cause

Printer error has occurred.

Action

Contact the service center.

5B04

Cause

Printer error has occurred.

Action

Contact the service center.

5B05

Cause

Printer error has occurred.

Action

Contact the service center.

5B12

Cause

Printer error has occurred.

Action

Contact the service center.

5B13

Cause

Printer error has occurred.

Action

Contact the service center.

5B14

Cause

Printer error has occurred.

Action

Contact the service center.

5B15

Cause

Printer error has occurred.

Action

Contact the service center.

6000

Cause

Printer error has occurred.

Action

Turn off the machine, and unplug the power cord of the machine from the power supply.

Plug the machine back in and turn the machine back on.

If the problem is not resolved, contact the service center.

►► Important

- If you unplug the power cord, all the faxes stored in the machine's memory are deleted.

6500

Cause

Printer error has occurred.

Action

Turn off the machine, and unplug the power cord of the machine from the power supply.

Plug the machine back in and turn the machine back on.

If the problem is not resolved, contact the service center.

►► Important

- If you unplug the power cord, all the faxes stored in the machine's memory are deleted.

6800

Cause

Printer error has occurred.

Action

Turn off the machine, and unplug the power cord of the machine from the power supply.

Plug the machine back in and turn the machine back on.

If the problem is not resolved, contact the service center.

►► Important

- If you unplug the power cord, all the faxes stored in the machine's memory are deleted.

6801

Cause

Printer error has occurred.

Action

Turn off the machine, and unplug the power cord of the machine from the power supply.

Plug the machine back in and turn the machine back on.

If the problem is not resolved, contact the service center.

►► Important

- If you unplug the power cord, all the faxes stored in the machine's memory are deleted.

6900

Cause

Printer error has occurred.

Action

Turn off the machine, and unplug the power cord of the machine from the power supply.

Plug the machine back in and turn the machine back on.

If the problem is not resolved, contact the service center.

►► Important

- If you unplug the power cord, all the faxes stored in the machine's memory are deleted.

6901

Cause

Printer error has occurred.

Action

Turn off the machine, and unplug the power cord of the machine from the power supply.

Plug the machine back in and turn the machine back on.

If the problem is not resolved, contact the service center.

►► Important

- If you unplug the power cord, all the faxes stored in the machine's memory are deleted.

6902

Cause

Printer error has occurred.

Action

Turn off the machine, and unplug the power cord of the machine from the power supply.

Plug the machine back in and turn the machine back on.

If the problem is not resolved, contact the service center.

►► Important

- If you unplug the power cord, all the faxes stored in the machine's memory are deleted.

6910

Cause

Printer error has occurred.

Action

Turn off the machine, and unplug the power cord of the machine from the power supply.

Plug the machine back in and turn the machine back on.

If the problem is not resolved, contact the service center.

►► Important

- If you unplug the power cord, all the faxes stored in the machine's memory are deleted.

6911

Cause

Printer error has occurred.

Action

Turn off the machine, and unplug the power cord of the machine from the power supply.

Plug the machine back in and turn the machine back on.

If the problem is not resolved, contact the service center.

Important

- If you unplug the power cord, all the faxes stored in the machine's memory are deleted.

6930

Cause

Printer error has occurred.

Action

Turn off the machine, and unplug the power cord of the machine from the power supply.

Plug the machine back in and turn the machine back on.

If the problem is not resolved, contact the service center.

►► Important

- If you unplug the power cord, all the faxes stored in the machine's memory are deleted.

6931

Cause

Printer error has occurred.

Action

Turn off the machine, and unplug the power cord of the machine from the power supply.

Plug the machine back in and turn the machine back on.

If the problem is not resolved, contact the service center.

▶▶ Important

- If you unplug the power cord, all the faxes stored in the machine's memory are deleted.

6932

Cause

Printer error has occurred.

Action

Turn off the machine, and unplug the power cord of the machine from the power supply.

Plug the machine back in and turn the machine back on.

If the problem is not resolved, contact the service center.

▶▶ Important

- If you unplug the power cord, all the faxes stored in the machine's memory are deleted.

6933

Cause

Printer error has occurred.

Action

Turn off the machine, and unplug the power cord of the machine from the power supply.

Plug the machine back in and turn the machine back on.

If the problem is not resolved, contact the service center.

►► Important

- If you unplug the power cord, all the faxes stored in the machine's memory are deleted.

6936

Cause

Printer error has occurred.

Action

Turn off the machine, and unplug the power cord of the machine from the power supply.

Plug the machine back in and turn the machine back on.

If the problem is not resolved, contact the service center.

►► Important

- If you unplug the power cord, all the faxes stored in the machine's memory are deleted.

6937

Cause

Printer error has occurred.

Action

Turn off the machine, and unplug the power cord of the machine from the power supply.

Plug the machine back in and turn the machine back on.

If the problem is not resolved, contact the service center.

▶▶ Important

- If you unplug the power cord, all the faxes stored in the machine's memory are deleted.

6938

Cause

Printer error has occurred.

Action

Turn off the machine, and unplug the power cord of the machine from the power supply.

Plug the machine back in and turn the machine back on.

If the problem is not resolved, contact the service center.

►► Important

- If you unplug the power cord, all the faxes stored in the machine's memory are deleted.

6939

Cause

Printer error has occurred.

Action

Turn off the machine, and unplug the power cord of the machine from the power supply.

Plug the machine back in and turn the machine back on.

If the problem is not resolved, contact the service center.

►► Important

- If you unplug the power cord, all the faxes stored in the machine's memory are deleted.

693A

Cause

Printer error has occurred.

Action

Turn off the machine, and unplug the power cord of the machine from the power supply.

Plug the machine back in and turn the machine back on.

If the problem is not resolved, contact the service center.

►► Important

- If you unplug the power cord, all the faxes stored in the machine's memory are deleted.

6940

Cause

Printer error has occurred.

Action

Turn off the machine, and unplug the power cord of the machine from the power supply.

Plug the machine back in and turn the machine back on.

If the problem is not resolved, contact the service center.

►► Important

- If you unplug the power cord, all the faxes stored in the machine's memory are deleted.

6941

Cause

Printer error has occurred.

Action

Turn off the machine, and unplug the power cord of the machine from the power supply.

Plug the machine back in and turn the machine back on.

If the problem is not resolved, contact the service center.

Important

- If you unplug the power cord, all the faxes stored in the machine's memory are deleted.

6942

Cause

Printer error has occurred.

Action

Turn off the machine, and unplug the power cord of the machine from the power supply.

Plug the machine back in and turn the machine back on.

If the problem is not resolved, contact the service center.

►► Important

- If you unplug the power cord, all the faxes stored in the machine's memory are deleted.

6943

Cause

Printer error has occurred.

Action

Turn off the machine, and unplug the power cord of the machine from the power supply.

Plug the machine back in and turn the machine back on.

If the problem is not resolved, contact the service center.

▶▶ Important

- If you unplug the power cord, all the faxes stored in the machine's memory are deleted.

6944

Cause

Printer error has occurred.

Action

Turn off the machine, and unplug the power cord of the machine from the power supply.

Plug the machine back in and turn the machine back on.

If the problem is not resolved, contact the service center.

▶▶ Important

- If you unplug the power cord, all the faxes stored in the machine's memory are deleted.

6945

Cause

Printer error has occurred.

Action

Turn off the machine, and unplug the power cord of the machine from the power supply.

Plug the machine back in and turn the machine back on.

If the problem is not resolved, contact the service center.

►► Important

- If you unplug the power cord, all the faxes stored in the machine's memory are deleted.

6946

Cause

Printer error has occurred.

Action

Turn off the machine, and unplug the power cord of the machine from the power supply.

Plug the machine back in and turn the machine back on.

If the problem is not resolved, contact the service center.

▶▶ Important

- If you unplug the power cord, all the faxes stored in the machine's memory are deleted.

9500

Cause

Printer error has occurred.

Action

Turn off the machine, and unplug the power cord of the machine from the power supply.

Plug the machine back in and turn the machine back on.

If the problem is not resolved, contact the service center.

►► Important

- If you unplug the power cord, all the faxes stored in the machine's memory are deleted.

B201

Cause

An error requiring you to contact the service center has occurred.

Action

Turn off the machine, and unplug the power cord of the machine from the power supply.

Contact the service center.

►► Important

- If you unplug the power cord, all the faxes stored in the machine's memory are deleted.

B202

Cause

An error requiring you to contact the service center has occurred.

Action

Turn off the machine, and unplug the power cord of the machine from the power supply.

Contact the service center.

►► Important

- If you unplug the power cord, all the faxes stored in the machine's memory are deleted.

B203

Cause

An error requiring you to contact the service center has occurred.

Action

Turn off the machine, and unplug the power cord of the machine from the power supply.

Contact the service center.

►► Important

- If you unplug the power cord, all the faxes stored in the machine's memory are deleted.

B204

Cause

An error requiring you to contact the service center has occurred.

Action

Turn off the machine, and unplug the power cord of the machine from the power supply.

Contact the service center.

»» Important

- If you unplug the power cord, all the faxes stored in the machine's memory are deleted.