

ENGLISH



Canon

Canon DIGITAL CAMERA PowerShot A95 Camera User Guide

Canon
PowerShot A95
DIGITAL CAMERA

Camera User Guide

DiG!C



- Please read the *Read This First* section (p. 4).
- Please also see the *Software Starter Guide* and the *Direct Print User Guide*.

Disclaimer

- While every effort has been made to ensure that the information contained in this guide is accurate and complete, no liability can be accepted for any errors or omissions.
- Canon reserves the right to change the specifications of the hardware and software described herein at any time without prior notice.
- No part of this guide may be reproduced, transmitted, transcribed, stored in a retrieval system, or translated into any language in any form, by any means, without the prior written permission of Canon.
- Canon makes no warranties for damages resulting from corrupted or lost data due to a mistaken operation or malfunction of the camera, the software, the CompactFlash™ cards (CF cards), personal computers, peripheral devices, or use of non-Canon CF cards.

Trademark Acknowledgements

- Canon and PowerShot are trademarks of Canon Inc..
- CompactFlash is a trademark of SanDisk Corporation.
- Macintosh, Mac OS and QuickTime are trademarks of Apple Computer, Inc, registered in the United States and other countries.
- Microsoft, Windows, and Windows NT are either registered trademarks or trademarks of Microsoft Corporation in the United States and/or other countries.
- Other names and products not mentioned above may be registered trademarks or trademarks of their respective companies.





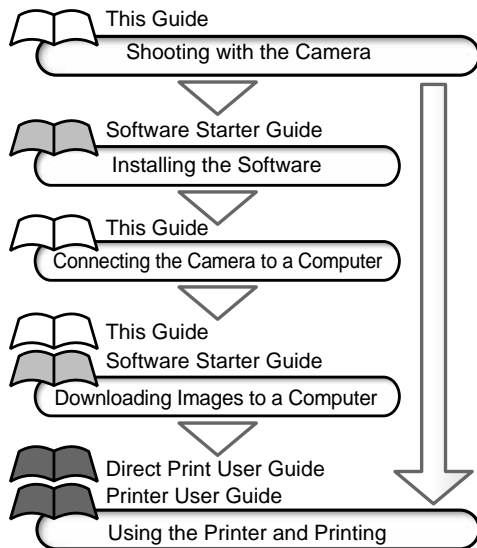

Use of genuine Canon accessories is recommended.

This product is designed to achieve excellent performance when used with genuine Canon accessories. Canon shall not be liable for any damage to this product and/or accidents such as fire, etc., caused by the malfunction of non-genuine Canon accessories (e.g., a leakage and/or explosion of a battery pack). Please note that this warranty does not apply to repairs arising out of the malfunction of non-genuine Canon accessories, although you may request such repairs on a chargeable basis.

Flowchart and Reference Guides



Symbols Used

Icons under title bars show the operations mode. As in the example below, the mode dial should be set to **AUTO**, **P**, **Tv**, **Av**, **M**, , , , , , **SCN** or .

⚡ Using the Flash

Mode Dial **AUTO** **P** **Tv** **Av** **M** , , , ,  **SCN** 





This mark denotes issues that may affect the camera's operation.









This mark denotes additional topics that complement the basic operating procedures.



Table of Contents

Items marked with ★ are lists or charts that summarize camera functions or procedures.

Read This First	4
Please Read	4
Safety Precautions	6
Preventing Malfunctions	11
Components Guide	12
Preparing the Camera	15
Installing the Batteries	15
Installing a CF Card	18
Setting the Date/Time	21
Setting the Language	22
Opening the LCD Monitor	24
★ Using the LCD Monitor	26
Basic Functions	31
Turning the Power On/Off	31
Switching between Shooting and Playback	32
Shooting – The Basics	34
 Auto Mode	34
Reviewing an Image Right after Shooting	37
Using the Mode Dial (Image Zone)	39
 Portrait	39
 Landscape	39

 Night Scene	39
 Fast Shutter	39
 Slow Shutter	39
Changing the Resolution and Compression	41
 Using the Flash	43
 Macro Mode	45
Self-timer	46
Digital Zoom	47
Continuous Shooting	48
 Shooting Panoramic Images (Stitch Assist)	49
SCN Special Scene Mode	51
Postcard Print Mode	54
 Movie Mode	56

Playback – The Basics

Displaying Images Individually (Single Image Playback)	58
 Magnifying Images	58
 Viewing Images in Sets of Nine (Index Playback)	59
Jumping Between Images	60
Viewing/Editing Movies	60

Erasing

 Erasing Images Individually	64
Erasing All Images	64

Shooting – Advanced Functions

★ Selecting Menus and Settings	66
--------------------------------------	----

★ Menu Settings and Default Settings	69
Resetting the Settings to Default	75
Using the Mode Dial (Creative Zone)	76
P Program AE	77
Tv Setting the Shutter Speed	77
Av Setting the Aperture	79
M Manually Setting the Shutter Speed and Aperture	80
Select the AF Frame	81
 Setting an AF Frame Manually	82
Switching between Light Metering Modes	83
Adjusting the Exposure	85
Adjusting the Tone (White Balance)	86
Changing the ISO Speed	89
Changing the Photo Effect	90
Adjusting the Flash Output	91
Shooting Problem Subjects for the Autofocus	92
C Saving Custom Settings	94
Setting the Auto Rotate Function	95
Playback – Advanced Functions	97
Rotating Images in the Display	97
Attaching Sound Memos to Image	98
Auto Play	99
Protecting Images	100

Various Functions 101

About Printing	101
DPOF Print Settings	103
Image Transmission Settings (DPOF Transfer Order) ..	107
Downloading Images to a Computer	108
Computer System Requirements	109
Viewing Images on a TV Set	117
Resetting the File Number	118
Customizing the Camera (My Camera Settings) ..	120
Registering My Camera Settings	121

List of Messages 124**Troubleshooting** 126**Appendix** 132

Using the Power Kits (Sold Separately)	132
Using the Lenses (Sold Separately)	135
Camera Care and Maintenance	139

Specifications 140

Battery Performance	144
CF Cards and Estimated Capacities (Recordable Images) ..	145

Photo Tips and Information 150**INDEX** 152

★ Functions Available in Each Shooting Mode 159

Read This First

Please Read

Test Shots

Before you try to photograph important subjects, we highly recommend that you shoot several trial images to confirm that the camera is operating and being operated correctly. Please note that Canon Inc., its subsidiaries and affiliates, and its distributors are not liable for any consequential damages arising from any malfunction of a camera or accessory, including CompactFlash™ cards, that results in the failure of an image to be recorded or to be recorded in a format that is machine readable.

Warning Against Copyright Infringement

Please note that Canon digital cameras are intended for personal use and should never be used in a manner that infringes upon or contravenes international or domestic copyright laws and regulations. Please be advised that in certain cases the copying of images from performances, exhibitions, or commercial properties by means of a camera or other device may contravene copyright or other legal rights even if the image was shot for personal use.

Warranty Limitations

This camera's warranty is only effective in the country of sale. If a problem arises while the camera is in use abroad, please convey it back to the country of sale before proceeding with a warranty claim to a Canon Customer Support Help Desk.

For Canon Customer Support contacts, please see the *Canon Limited Warranty* supplied with your camera.

Camera Body Temperature

If your camera is used for prolonged periods, the camera body may become warm. Please be aware of this and take care when operating the camera for an extended period.

About the LCD Monitor

The LCD monitor is produced with extremely high-precision manufacturing techniques. More than 99.99% of the pixels operate to specification. Less than 0.01% of the pixels may occasionally misfire or appear as red or black dots.

This has no effect on the recorded image and does not constitute a malfunction.

Video Format

Please set the camera's video signal format to the one used in your region before using it with a TV monitor (p. 118).

Language Setting

Please see page 22 to change the language setting.

Charging the Date/Time Battery

- The camera has a built-in rechargeable lithium battery that maintains the date, time and other camera settings. This battery recharges when the main batteries are inserted into the camera. When you first purchase the camera, place fully charged batteries in it or use the AC adapter kit (sold separately) for at least 4 hours to charge the date/time battery. It will charge even when the camera power is set to Off.
- If the Date/Time menu appears when the camera power is turned on, it means that the date/time battery charge is depleted. Recharge it as described above.

Safety Precautions

- Before using the camera, please ensure that you have read and understood the safety precautions described below. Always ensure that the camera is operated correctly.
- The safety precautions noted on the following pages are intended to instruct you in the safe and correct operation of the camera and its accessories to prevent injuries or damage to yourself, other persons and equipment.
- In the next few pages, the term “equipment” refers primarily to the camera and its power supply accessories (see the System Map for power supply accessory details).

WARNINGS

- **Do not aim the camera directly into the sun or at other intense light sources which could damage your eyesight.**
 - **Do not trigger the flash in close proximity to human or animal eyes.** Exposure to the intense light produced by the flash may damage eyesight. In particular, remain at least one meter (39 inches) away from infants when using the flash.
 - **Store this equipment out of the reach of children and infants.** Accidental damage to the camera or batteries by a child could result in serious injury. In addition, placement of the strap around a child's neck could result in asphyxiation.
 - **Do not attempt to disassemble or alter any part of the equipment that is not expressly described in this guide.** Disassembly or alteration may result in high-voltage electrical shock. Internal inspections, alterations and repairs should be conducted by qualified service personnel authorized by your camera distributor or a Canon Customer Support Help Desk.
 - **To avoid the risk of high-voltage electrical shock, do not touch the flash portion of the camera if it has been damaged.** Similarly, never touch internal portions of the equipment that become exposed as a result of damage. There is a risk of high-voltage electrical shock. Please take the first opportunity to consult your camera distributor or a Canon Customer Support Help Desk.
-

-
- **Stop operating the equipment immediately if it emits smoke or noxious fumes.** Failure to do so may result in fire or electrical shock. Immediately turn the camera's power off, remove the camera batteries or unplug the power cord from the power outlet. Confirm that smoke or fume emissions have ceased. Please consult your camera distributor or the closest Canon Customer Support Help Desk.
-
- **Stop operating the equipment if it is dropped or the casing is damaged.** Failure to do so may result in fire or electrical shock. Immediately turn the camera's power off, remove the camera batteries or unplug the power cord from the power outlet. Please consult your camera distributor or the closest Canon Customer Support Help Desk.
-
- **Do not allow the equipment to come into contact with, or become immersed in, water or other liquids.** Do not allow liquids to enter the interior. The camera has not been waterproofed. If the exterior comes into contact with liquids or salt air, wipe it dry with a soft, absorbent cloth. In the event that water or other foreign substances enter the interior, immediately turn the camera's power off and remove the camera batteries or unplug the power cord from the power outlet. Continued use of the equipment may result in fire or electrical shock. Please consult your camera distributor or the closest Canon Customer Support Help Desk.
-
- **Do not use substances containing alcohol, benzene, thinners or other flammable substances to clean or maintain the equipment.** The use of these substances may lead to fire.
-
- **Remove the power cord on a regular periodic basis and wipe away the dust and dirt that collects on the plug, the exterior of the power outlet and the surrounding area.** In dusty, humid or greasy environments, the dust that collects around the plug over long periods of time may become saturated with humidity and short-circuit, leading to fire.
-
- **Do not cut, damage, alter or place heavy items on the power adapter cord.** Any of these actions may cause an electrical short circuit, which may lead to fire or electrical shock.
-
- **Do not handle the power cord if your hands are wet.** Handling it with wet hands may lead to electrical shock. When unplugging the cord, ensure that you hold the solid portion of the plug. Pulling on the flexible portion of the cord may damage or expose the wire and insulation, creating the potential for fires or electrical shocks.
-

- **Use only the recommended power accessories.** Use of power sources not expressly recommended for this equipment may lead to overheating, distortion of the equipment, fire, electrical shock or other hazards.
- **Do not place the batteries near a heat source or expose them to direct flame or heat. Neither should you immerse them in water.** Such exposure may damage the batteries and lead to the leakage of corrosive liquids, fire, electrical shock, explosion or serious injury.
- **Do not attempt to disassemble, alter or apply heat to the batteries.** There is serious risk of injury due to an explosion. Immediately flush with water any area of the body, including the eyes and mouth, skin, or clothing that comes into contact with the inner contents of a battery.
- **Avoid dropping or subjecting the batteries to severe impacts that could damage the casings.** It could lead to leakage and injury.
- **Do not short-circuit the battery terminals with metallic objects, such as key holders.** It could lead to overheating, burns and other injuries.
- **Before you discard a battery, cover the terminals with tape or other insulators to prevent direct contact with other objects.** Contact with the metallic components of other materials in waste containers may lead to fire or explosions. Discard the batteries in specialized waste facilities if available in your area.
- **Use only recommended batteries and accessories.** Use of batteries not expressly recommended for this equipment may cause explosions or leaks, resulting in fire, injury and damage to the surroundings.
- **If using AA-size NiMH batteries, use only Canon AA-size NiMH batteries and the charger recommended for use with these batteries.** Use of another charger may cause batteries to overheat or deform, posing risk of fire or electric shock.
- **Disconnect the battery charger or compact power adapter from both the camera and power outlet after recharging and when the camera is not in use to avoid fires and other hazards.** Continuous use over a long period may cause a unit to overheat and distort, resulting in fire.

- **The camera terminal of the compact power adapter is designed for exclusive use with your camera.** Do not use it with other products or batteries. There is a risk of fire and other hazards.
- **Exercise due caution when screwing on the separately sold wide converter, tele-converter, close-up lens and conversion lens adapter.** If they loosen, fall off and shatter, the glass shards may cause an injury.

Caution about magnetic fields

Keep objects that are sensitive to magnetic fields (such as credit cards) away from the speaker of the camera (p. 12). Such items may lose data or stop working.

CAUTIONS

- **Avoid using, placing or storing the equipment in places subject to strong sunlight or high temperatures, such as the dashboard or trunk (boot) of a car.** Exposure to intense sunlight and heat may cause the batteries to leak, overheat or explode, resulting in fire, burns or other injuries. High temperatures may also cause deformation of the casing. Ensure that there is good ventilation when using the battery charger to charge the batteries or power the camera.
- **Do not store the equipment in humid or dusty areas.** Storage in such areas could lead to fire, electrical shock or other damage.
- **Be careful not to bang the camera or subject it to strong impacts or shocks that could lead to injury or damage the equipment when wearing or holding it by the strap.**
- **Be careful not to cover the flash with your fingers or clothing when shooting.** The flash may be damaged and emit smoke or noise. In addition, do not touch the surface of the flash after taking several pictures in rapid succession. Either action could result in burns.
- **Do not operate the flash with dirt, dust or other items stuck to its lens.** The resulting heat build-up could damage the flash.

- **Ensure that the battery charger or compact power adapter is plugged into a power outlet of the specified rating, not over the specified rating.** The plug of the battery charger varies according to region.
- **Do not use the battery charger or compact power adapter if the cable or plug is damaged, or if the plug is not fully inserted into the power outlet.**
- **Do not allow metal objects (such as pins or keys) or dirt to contact the charger terminals or plug.**
- **If your camera is used for prolonged periods, the camera body may become warm.** Please take care when operating the camera for an extended period as your hands may experience a burning sensation.

Preventing Malfunctions

Avoid Strong Magnetic Fields

Never place the camera in close proximity to electric motors or other equipment generating strong electromagnetic fields. Exposure to strong magnetic fields may cause malfunctions or corrupt image data.

Avoid Condensation Related Problems

Moving the equipment rapidly between hot and cold temperatures may cause condensation (water droplets) to form on its external and internal surfaces. You can avoid this by placing the equipment in an airtight, resealable plastic bag and letting it adjust to temperature changes slowly before removing it from the bag.

If Condensation Forms Inside the Camera

Stop using the camera immediately if you detect condensation. Continued use may damage the equipment. Remove the CF card, batteries or other power supply accessory from the camera and wait until the moisture evaporates completely before resuming use.

Extended Storage

When not using the camera for extended periods of time, remove the batteries from the camera or battery charger and store the equipment in a safe place. Storing the camera for extended periods with batteries installed may cause battery leaks, which can damage the camera.

However, the date, time and other camera settings may reset to default settings if the batteries have been removed for more than three weeks.

Components Guide

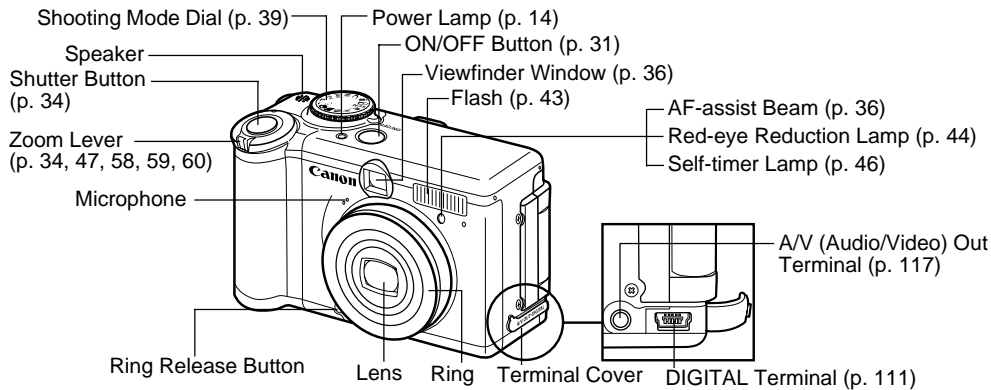

The following cables are used to connect the camera to a computer or printer.

Computer: Interface Cable IFC-400PCU (supplied with the camera)

Direct Print Compatible Printers (Sold Separately)

- CP Printers: Interface Cable IFC-400PCU (supplied with the camera) or the Direct Interface Cable DIF-100 (supplied with the CP-100/CP-10)
- Bubble Jet Printers:
 - *Bubble Jet Direct* Compatible Printers: Please refer to your Bubble Jet printer user guide.
 - *PictBridge* Compliant Printers: Interface Cable IFC-400PCU (supplied with the camera)
- *PictBridge* Compliant Non-Canon Printers: Interface Cable IFC-400PCU (supplied with the camera)

Please refer to the *System Map* or the *Direct Print User Guide* supplied with the camera for direct print compatible printer information.

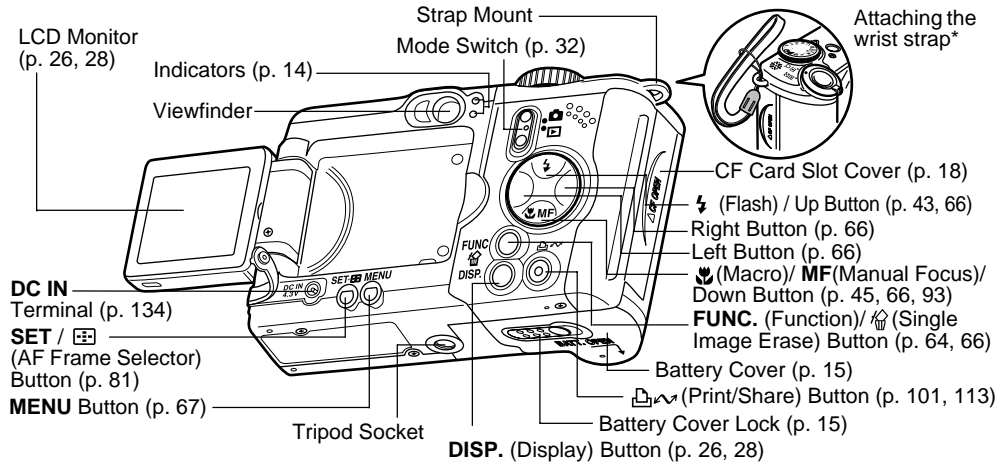

The following operations are accessible through one easy press of the  (Print/Share) button.

- **Printing:** See the *Direct Print User Guide* (separate from this guide)
 - **Downloading images** (Windows only): See page 108 of this guide and the *Software Starter Guide* (separate from this guide)
- Blue:** Ready to print/Ready to transfer images
Blinking Blue: Printing/Transferring (Depending on the direct transfer method, the indicator may not blink (p. 113))

* When carrying the camera by the strap, be careful not to swing the camera or catch it on other items.

Shooting Mode Dial

Creative Zone

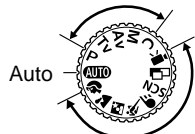

Auto

Image Zone

Use the shooting mode dial to switch between the Shooting modes.

- **AUTO**: Auto (p. 34)
The camera automatically selects settings.

- **Image Zone**

The camera automatically selects settings according to the image composition type.

- : Portrait (p. 39) : Landscape (p. 39)
- : Night Scene (p. 39) : Fast Shutter (p. 39)
- : Slow Shutter (p. 39)
- SCN: Special Scene (p. 39, 51)
- : Stitch Assist (p. 39, 49) : Movie (p. 56)

- **Creative Zone**

The user selects exposure, aperture or other settings to achieve special effects.

- **P** : Program AE (p. 77)
- **Tv** : Shutter-speed priority AE (p. 77)
- **Av** : Aperture-priority AE (p. 79)
- **M** : Manual Exposure (p. 80)
- **C** : Custom (p. 94)

Indicators

The indicators light or blink when the ON/OFF button or the shutter button is pressed.

Upper Indicator

Green: Ready to record/Ready to communicate (during a computer connection)

Blinking Green: Recording to CF card/Reading CF card/Erasing from CF card/Transmitting data (during a computer connection)/Low battery

Orange: Ready to shoot (flash on)

Blinking Orange: Ready to shoot (camera shake warning)/Flash is charging

Lower Indicator

Yellow: Macro mode/Manual Focus mode/AF Lock

Blinking Yellow: Focusing difficulty (although you can press the shutter button, you are recommended to shoot using focus lock (p. 92))

Power Lamp

Green: Power is on

Blinking Green: Low battery

Preparing the Camera

Installing the Batteries

Insert four AA-size alkaline batteries (supplied with the camera) or separately sold nickel metal hydride (NiMH) batteries.

1 Be sure that the camera power is off.

2 Slide the battery cover lock in the direction of the arrow, and open the cover.

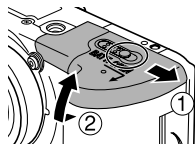

3 Insert the batteries as shown.

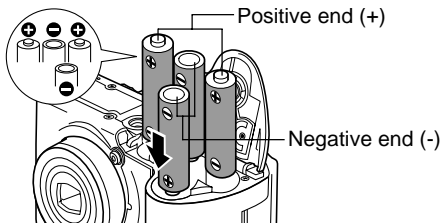

4 Close the battery cover.



When the upper indicator blinks green, do not turn off the power or open the battery cover. The camera is writing, reading, erasing or transmitting an image to or from the CF card.



- The use of the separately sold AC Adapter Kit ACK600 is recommended to power the camera during long usage sessions (p. 134).
- The separately sold battery charger kit lets you use rechargeable NiMH batteries to power the camera (p. 132).
- See *Battery Performance* (p. 144).
- For information about the Battery and Charger Kit and AA-size rechargeable NiMH batteries, see the *System Map* (separate from this guide).

Proper Battery Handling

- Use AA-size alkaline or Canon AA-size NiMH batteries (sold separately) only. For information on handling the AA-size rechargeable NiMH batteries, see *Using Rechargeable Batteries* (p. 132).

- **Since the performance of alkaline batteries may differ according to brand, the operating time of the batteries you purchase may not be as long as the batteries that came with the camera.**
 - Camera operating time may shorten at low temperatures when alkaline batteries are used. Also due to their specifications, alkaline batteries may expire faster than NiMH batteries. If you are using the camera in cold areas or for a long time, we recommend using Canon AA-size NiMH Battery Kit (a four-piece set).
 - While it is possible to use AA-size nickel-cadmium batteries, performance is unreliable and their use is not recommended.
 - **Never mix unused and partially used batteries. Always load four fresh (or fully recharged) batteries at the same time. The partially used batteries may leak.**
 - **Be careful to load the batteries with their positive (+) and negative (-) ends in the right direction.**
 - **Never mix batteries of different types or from different manufacturers. All four batteries should be identical.**
 - Before inserting the batteries, wipe the battery terminals well with a dry cloth. Oil from one's skin or other dirt may cause a considerable reduction in the number of recordable images or reduced usage time.
- Battery performance deteriorates at low temperatures (especially with alkaline batteries). If you are using the camera in cold areas and batteries are running down faster than they should, you may be able to restore performance by placing batteries in an inner pocket to warm them up prior to use. But be careful that you don't put the batteries into a pocket together with a metal key chain or other metallic objects, as these objects may cause batteries to short-circuit.
 - If you do not plan to use the camera for a long time, remove the batteries from the camera and store them in a safe place. Batteries may leak and damage the camera if left installed during prolonged periods of non-use. However, the date, time and other camera settings may reset to default settings if the batteries have been removed for more than three weeks.

⚠ WARNING

Never use damaged batteries or batteries whose outer seal is completely or partially missing or peeled off, as there is risk that such batteries may leak, overheat, or burst. Always check the seals on store-bought batteries before loading them, as some batteries may come with defective seals. Do not use batteries with defective seals.

Never use batteries that look like this.

Batteries with all or part of the seal (electrical insulation sheath) peeled off.



The positive electrode (plus terminal) is flat.



The negative terminal is correctly formed (protruding from the metal base), but the seal does not extend up over the edge of the metal base.

Battery Status Indications

The LCD monitor displays an icon or message to let you know when batteries are low or depleted.

Power lamp blinks green	Batteries are beginning to run low. Replace or recharge the batteries if you wish to continue using the camera. If the LCD monitor is off, this icon will appear when you press any of the following buttons: DISP. , ⚡ or ⏻/MF button.
	
Change the batteries	Batteries are fully depleted and the camera can no longer operate. You should replace the batteries immediately.

Installing a CF Card

1 Be sure that the camera is turned off.

2 Slide the CF card slot cover in the direction of the arrow, and open it.

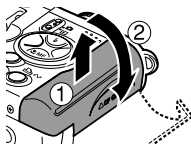

3 Insert the CF card with the label facing up.

- Push the card in until the CF card eject button fully extends.

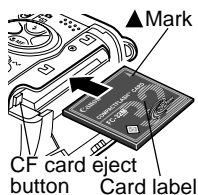

- To remove the CF card, press the CF card eject button and pull the card out.

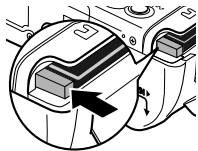

4 Close the CF card slot cover securely.



- When the upper indicator blinks green, the camera is writing, reading, erasing or transmitting an image to or from the CF card. Do not perform the following or image data may be lost or corrupted:
 - Subject the camera body to vibration or shocks.
 - Turn the camera's power off, or open the CF card slot cover.
- Please note that CF cards formatted with other manufacturers' cameras or a computer, or formatted or edited with application programs, may slow down writing to the CF card or may not operate correctly in the camera.
- You are recommended to use CF cards that have been formatted in your camera (see *Formatting a CF Card* (p. 19)). The card supplied with the camera may be used without further formatting.



See *CF Cards and Estimated Capacities (Recordable Images)* (p. 145).

About CF Cards

- CF cards are high-precision electronic devices. Do not bend them, apply force to them, or subject them to shocks or vibration.
- Do not attempt to disassemble or alter a CF card.
- Moving a CF card rapidly between temperature extremes will cause condensation to form in the card and lead to a malfunction. To avoid condensation, place the CF card in a sealed plastic bag before moving it into a different temperature zone and allow it to adjust slowly to the new temperature. If condensation forms on the CF card, store it at room temperature until the water droplets have evaporated naturally.
- Place the CF card in the supplied case for storage.
- Do not use or store CF cards in the following types of location.
 - Locations subject to dust or sand
 - Locations subject to high humidity and high temperatures

Formatting a CF Card

You should always format a new CF card or one from which you wish to erase all images and other data.



Please note that formatting a CF card erases all data, including protected images and other file types. Please check the contents of the CF card before formatting it.

1 Turn the power on (p. 31).

2 Open the LCD monitor (p. 24) and press the **MENU** button. Select the [MENU] (Set up)] menu using the left or right button.



3 Select [FORMAT] (Format) using the up or down button and press the **SET** button.



4 Select [OK] using the left or right button and press the SET button.

- To cancel formatting instead, select [Cancel] and press the **SET** button.
- The capacity of the CF card displayed after formatting will be less than the rated capacity of the CF card. This is not a malfunction of the CF card or camera.



5 Press the MENU button.



- If the camera does not work properly, the inserted CF card may be malfunctioning. Reformatting the CF card may solve the problem.
- When a non-Canon brand CF card is malfunctioning, reformatting it may solve the problem.
- CF cards formatted in another camera, computer or peripheral device may not operate correctly. When that happens, reformat the CF card with this camera. If formatting in the camera does not work properly, turn the camera off and reinsert the CF card. Then turn the camera back on and format again.

Setting the Date/Time

The Set Date/Time menu will appear the first time the camera power is turned on or whenever the built-in rechargeable lithium battery charge is low, start from Step 4.

1 Turn the power on (p. 31).

2 Press the MENU button and select the [Set up] menu using the left or right button.



3 Press the up or down button to select [Date/Time], and then press the SET button.



4 Set the date and time.

- Press the left or right button to select the item you wish to set.
- Press the up or down button to change its value.
- The date can be set up to the year 2030.

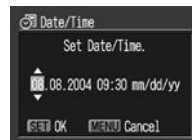

5 Press the SET button.

6 Press the MENU button.



- The date, time and other camera settings may reset to the default settings if the batteries have been removed for more than three weeks. If this happens, reset these settings.
- For embedding the date on the image data, refer to page 55.
- To set the camera so that the date and time will not appear on the image when it is being shot but only when it is printed, see either *Setting the Print Style* (p. 105) or the *Direct Print User Guide* supplied with the Camera.



Charging the date/time battery

- The camera has a built-in rechargeable lithium battery for saving settings such as the date and time. This battery is recharged by the AA-size batteries while it is in the camera. Right after purchasing the camera, leave fully charged batteries in the camera, or plug in the AC Adapter Kit ACK600 (sold separately), for about 4 hours to charge the date/time battery. It will charge even when the camera power is turned off.
- If the Date/Time menu appears when the camera power is turned on, the date/time battery charge is low. Use the above method to recharge it.

Setting the Language

Use this feature to select the language for the LCD monitor display.

1 Turn the power on (p. 31).

2 Press the MENU button and select the [M] (Set up) menu using the left or right button.



3 Select [L] (Language) using the up or down button and press the SET button.



4 Select a language using the up, down, left or right button and press the SET button.



English	Norsk
Deutsch	Svenska
Français	Español
Nederlands	汉语
Dansk	Πορτογάλ
Suomi	Português
Italiano	日本語

- The setting menu will reappear without changing the language setting if you press the **MENU** button instead of the **SET** button.

5 Press the MENU button.



Shortcut Operation

The Language menu can also be displayed in Playback mode by holding down the **SET** button and pressing the **MENU** button. (This function cannot be used while a movie clip is played back, or when a separately sold printer is connected to the camera.)

Opening the LCD Monitor

The LCD monitor can be used to check an image during shooting, to play back recorded images or to adjust menu settings. It can be opened to the following range of positions.

Opened right to left 180 degrees.

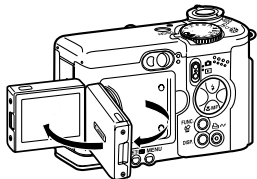

Tilted forward 180 degrees toward the lens or backward 90 degrees.

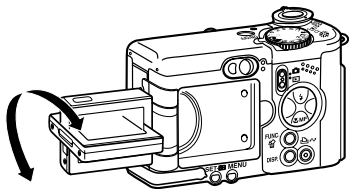

The LCD monitor will automatically turn off when it clicks shut against the camera body. For protection, always close the LCD monitor after use.

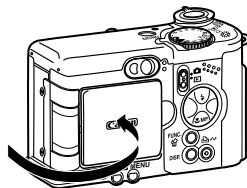

The LCD monitor can also be positioned as below.

1 Open the LCD monitor left 180 degrees and tilt it 180 degrees toward the lens.

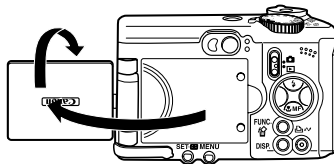

- In this position, icons and messages do not appear on the LCD monitor.

- The image shown on the LCD monitor is automatically flipped and reversed so that it appears correctly from in front of the lens. (This reverse display function can be turned off. (p. 70))

2 Fold the LCD monitor back against the camera body.

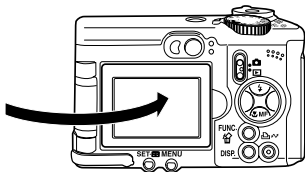

- Fold it until it clicks into place against the camera body. If it is not fully closed, the image will appear reversed and icons and messages will not display.
- Icons and messages will appear and images will show properly (not reversed) when the LCD monitor is folded the camera until it clicks.



The image in the LCD monitor may darken when the monitor is used under sunlight or other strong lighting. This is not a defect.

Using the LCD Monitor

Pressing the **DISP.** button switches the LCD monitor display mode.

Shooting Mode

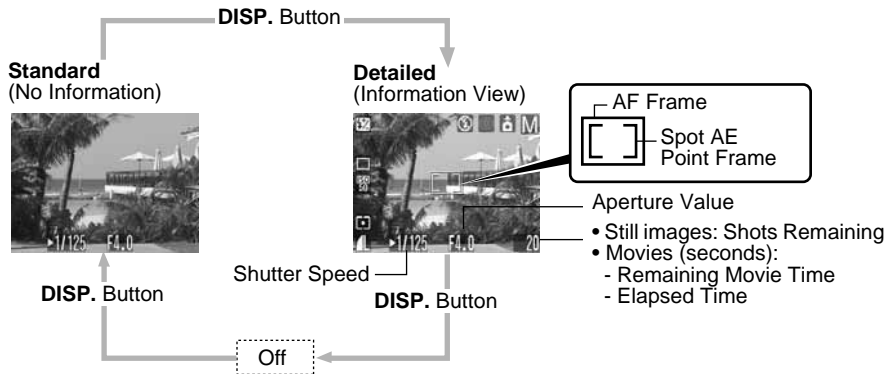

The AF frame changes according to its setting (LCD monitor On).

AF Frame set to [AiAF] (p. 81)	AF Frame set to [Center] or [FlexiZone] (p. 81)
● Green: Focusing complete (focused AF frame)	● Green: Focusing complete
● Does not appear: Focusing difficulty	● Yellow: Focusing difficulty

Icons Displayed in Shooting Mode

	Shooting Mode	p. 39, 76
-2...+2	Exposure Compensation	p. 85
	White Balance	p. 86
	Drive Mode	p. 46, 48
	ISO Speed	p. 89
	Photo Effect	p. 90
	Light Metering Mode	p. 83
	Compression	p. 41
	Resolution Postcard Print	p. 41, 54
	Flash	p. 43
	Red-eye Reduction	p. 44
	Macro Mode	p. 45
	Manual Focus	p. 93
	Auto Rotate Function	p. 95
	Movie Recording Mode	p. 56
3.8x 4.9x 6.1x 7.6x 9.3x 12x	Digital Zoom Setting ²	p. 47
	Camera Shake Warning	p. 14
	Low Battery	p. 17

*1: The icons of all the **SCN** mode options appear (p. 51).

*2: Zoom powers reflect the combined optical and digital zoom effects. These figures appear when the digital zoom is activated.

- When a Shooting mode setting is changed, the settings appear on the LCD monitor for about 6 seconds even if the LCD monitor is set to Standard (No Information) or off. (The Shooting mode settings may not appear depending on the camera setting.) You can set the flash, Macro mode, and the manual focus settings while this information appears on the LCD monitor.
- and the icons in (the shaded area of the chart) appear even when the information view is turned off.
- In addition to the above, the AF frame, spot metering frame, shutter speed, aperture value, recordable images or recordable movie time are displayed as in the example to the left.
- Setting the shooting mode dial to or modes turns the LCD monitor on regardless of whether it is set to on or off.
- A slow shutter speed has likely been selected because of insufficient lighting if the upper indicator blinks orange after the metering preparations are complete and the camera shake icon () displays in the LCD monitor. Set the flash to or , or affix the camera to a tripod to shoot.
- After you take a photo by fully pressing the shutter button, the image displays on the LCD monitor for approximately two seconds (or the review duration you set from 2 to 10 seconds). If you press the **SET** button while the image is displayed, it will continue to display (p. 37).

Playback Mode

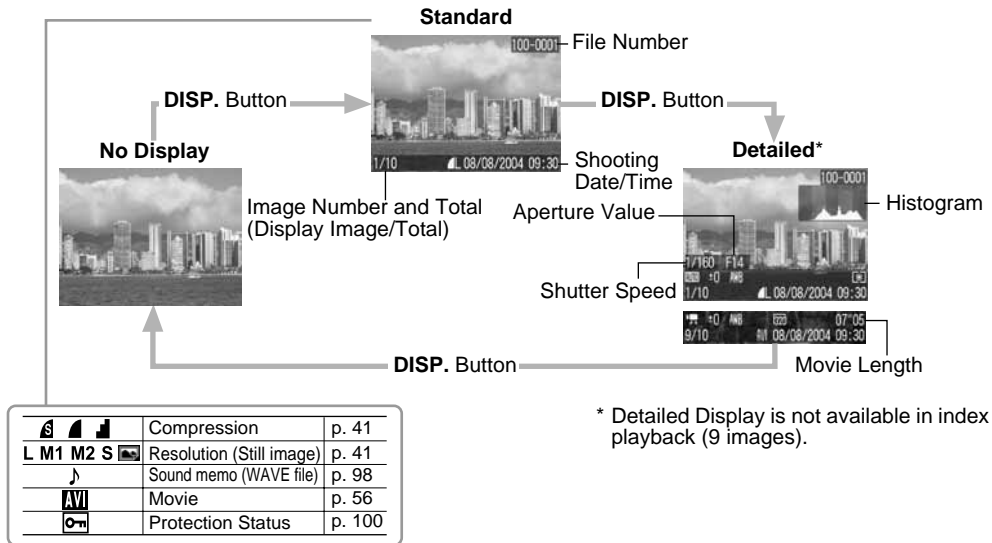

Icons Displayed in Playback Mode (Detailed Display)

	Shooting Mode	p. 39, 76
-2 ... ±0 ... +2	Exposure Compensation	p. 85
	White Balance	p. 86
	Photo Effects	p. 90
	ISO Speed	p. 89
	Flash	p. 43
	Macro Mode	p. 45
	Manual Focus	p. 93
	Light Metering Mode	p. 83
	Resolution (Movies)	p. 41
	Low Battery	p. 17

In addition to the above, the shutter speed, aperture value, histogram and recorded movie time are displayed as in the example in the figure on the left.

*1: Each mode of the **SCN** mode appears (p. 51).

*2: appears even in No Display mode.

The following information may also appear with some image files.

	An audio file other than a wave file, or a file with unrecognized format, is attached.
	JPEG file with format not conforming to Design rule for Camera File System Standards
	RAW format file
	A file with unrecognized format.



- The on/off setting of the LCD monitor display mode is memorized when the camera is turned off. When the camera is turned on again it assumes the last mode. However, when the LCD monitor is turned on and the “Change the batteries” message appears, the LCD monitor may not automatically turn on the next time the camera is started.

- While a recorded image is displayed on the LCD monitor, you can check the exposure with the graph (see *About the Histogram* (below)) that shows the distribution of the brightness data. If the exposure requires adjustment, set the exposure requires adjustment, set the exposure compensation and re-shoot. (Press the **DISP.** button if the histogram and other information is not shown.)
- Please note that image information recorded by this camera may not display correctly on other cameras and image information recorded by other cameras may not display correctly on this camera.

About the Histogram

- The histogram is a graph that allows you to judge the brightness of the shot image. The greater the bias toward the left in the graph, the darker the image. The greater the bias toward to the right, the brighter the image. If the image is too dark, adjust the exposure compensation to a positive value. Similarly, adjust the exposure compensation to a negative value if the image is too bright (p. 85).

Sample Histograms



Dark image



Balanced image



Bright image

Basic Functions

Turning the Power On/Off

Turning the Camera On

- 1 Press the ON/OFF button until the power lamp lights green (p. 14).

Shooting Mode

- Current shooting settings will appear in the LCD monitor.



Current shooting settings will disappear in approximately 6 seconds when the LCD monitor is set to Standard (No Information) or off (p. 26)

Playback Mode

- The LCD monitor displays an image.

Turning the Camera Off

- 1 Press the ON/OFF button again to turn the power off.



- You will hear a start-up sound and see the start-up image when the power is turned on. (To change the start-up sound and image, see pages 71, 74 and 120.)
 - The start-up image does not appear when the LCD monitor is off in Shooting mode or the A/V OUT terminal is connected to a TV.
- Turning on the camera without the start-up sound and image**
- Press and hold the SET button, then turn on the power.

Power Saving Function

This camera is equipped with a power saving function. Depending on the power saving setting, the camera may power down or the LCD monitor may go off automatically.

- Auto Power Down

[On]:

Shooting mode:

Powers down approximately 3 minutes after the last time a camera control is accessed.

Playback mode:

Powers down approximately 5 minutes after the last time a camera control is accessed.

Printer connection mode:

Powers down approximately 5 minutes after the last time a camera control is accessed.

When the Auto Power Down Function Activates

Press the ON/OFF button again.

[Off]:

The power saving function does not activate.

● **Display Off**

The LCD monitor automatically shuts off approximately 1 minute* after the last time a camera control is accessed.

* This time can be changed (p. 72).

When the Display Off Function Activates

The LCD monitor display turns back on if any button other than the ON/OFF button is pressed.



The power saving function will not activate during Auto Play or during a computer connection (p. 99, 108).

Switching between Shooting and Playback

You can quickly switch between Shooting mode and Playback mode. This is convenient when you wish to shoot again after checking or erasing an image immediately after it is shot.

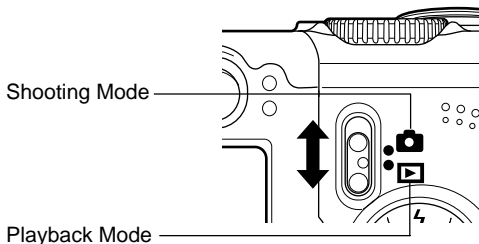

Playback Mode
The lens does not retract for approximately 1 minute after the camera switches to Playback mode.



Shooting Mode

- Slide the mode switch to .

Playback Mode

- **Open the LCD monitor and slide the mode switch to .**
- When a printer (sold separately) is connected, images can be printed (see the *Direct Print User Guide*).
- When the camera is connected to a computer, recorded images can be downloaded to and viewed with a computer (p. 108).



When a printer (sold separately) is properly connected, the , , or  icon appears on the LCD monitor.

Shooting – The Basics

See *Functions Available in Each Shooting Mode* (p. 159) at the end of this manual to find out which settings can be changed in which Shooting modes.

AUTO Auto Mode

Mode Dial **AUTO**

In this mode, all you have to do is press the shutter button and let the camera do everything else.

- 1** Check that the camera is in Shooting mode (p. 32).
- 2** Turn the shooting mode dial to **AUTO**.
- 3** Open the LCD monitor if desired.
- 4** Aim the camera at the subject you wish to shoot.

- 5** Use the zoom lever to achieve the desired composition (relative subject size in the viewfinder).

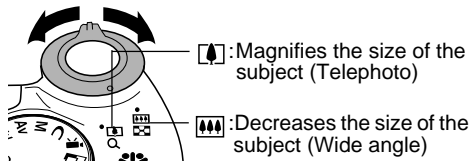

- The angle of view can be adjusted within the 38 to 114 mm range, in 35mm film equivalent.
 - When the LCD monitor is on, the combined use of the digital zoom and optical zoom enables magnified shooting up to approx. 12x (See *Digital Zoom*, p. 47).
- 6** Press the shutter button halfway.
 - The shutter button has a two-stage action.

Pressing Halfway

Pressing halfway automatically sets the exposure and focus.

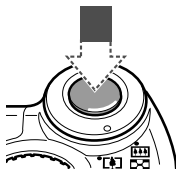

- Two beeps will sound when the camera has finished metering, and the upper indicator will light green or orange. If the LCD monitor is on, the AF frame will appear green.
- The lower indicator will blink yellow and the beep will sound one time if the subject is difficult to focus on.

7 Press the shutter button all the way.

Pressing Fully

Pressing fully releases the shutter.

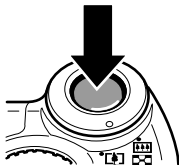

- You will hear the shutter sound when the shot is complete. Do not move the camera until you hear this sound.
- The upper indicator blinks green while data is recorded onto the CF card.

- The picture appears for approximately two seconds on the LCD monitor, if it is on.



- See page 159 for settings that can be changed in this mode.
- With the Review function, you can change the length of time images show on the LCD monitor after shooting, or set it so they do not show at all (p. 37).
- If the orange or yellow indicator blinks while you press halfway, you can still press fully to take the shot.
- Images are first saved into the camera's internal memory before being recorded onto the CF card, allowing the next images to be taken immediately as long as sufficient space is available in the internal memory.
- The beep and shutter sound can be set On/Off in the Set up menu (p. 71).
- Even when the shutter sound is set to [1], [2], [3] (On) (p. 74), no sound will be heard if [Mute] is set to [On].
- There is no shutter sound in movie mode.
- Shots cannot be taken while the flash is charging.

Shooting with the Viewfinder

You can save power by turning the LCD monitor off (p. 26) and using the viewfinder to shoot.

- 1 Compose the image so that the subject appears in the center of the frame in the viewfinder (autofocus range).**

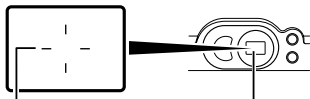

Shows approximate center of the image

Viewfinder window



About the Autofocus Function

This camera employs AiAF (artificial intelligence autofocus) technology, which uses a broad metering field to calculate the focal distance with high precision. It delivers a crisp focus even when the photographic subject is slightly off-center.

Image Seen in Viewfinder vs. Recorded Image

When shooting an image, a larger range than the one visible in the viewfinder usually gets recorded. You can confirm the actual range that will be recorded in the LCD monitor. In addition, due to the viewfinder's specification, the range visible in the viewfinder may actually differ from the actual recorded image. The closer the subject is to the lens, the more noticeable the difference will be. In some cases, portions of images shot up close that appear in the viewfinder will not appear in the recorded image. You are recommended to use the LCD monitor during macro photography (p. 45).

AF-assist Beam

- The AF-assist beam will sometimes emit when the shutter button is pressed halfway to assist focusing in certain conditions, i.e. dark conditions.
- The AF-assist beam can be turned off (p. 69).

For example, if animals are your subject, turn off the beam when shooting in the dark to avoid startling them. However, please keep in mind the following facts.

- If the AF-assist beam is turned off, it may become more difficult for the camera to focus in dark conditions.
 - The red-eye reduction lamp may emit when you press the shutter button halfway even if the AF-assist beam is turned off.
- In order to prevent any lamp from emitting before the flash fires, set both the red-eye reduction function and the AF-assist beam to [Off] in the Shooting menu.

Reviewing an Image Right after Shooting

Mode Dial 

After a photo is taken, the image displays on the LCD monitor for two seconds. In addition, the image will keep on displaying regardless of the review duration setting if one of the following operations is performed.

- **Keeping the shutter button fully pressed**
- **Pressing the SET button while the image is displayed***

Press the shutter button halfway again to stop displaying it so that you can shoot the next image.



You can perform the following while images are displayed.*

- Erase Images Individually (p. 64)
- Display the setting details of the image (p. 28).
- Magnify Images (p. 58) (When pressing the **SET** button while the image is displayed.)

* Not available in  (Stitch Assist) mode.

Changing the Image Display Duration

The length of time images are displayed after a photo has been taken can be changed from 2 seconds to 10 seconds or turned off.

1 Press the MENU button.

- The [] (Rec.) menu appears.

2 Select [] (Review) using the up or down button.



3 Select a duration setting using the left or right button and press the MENU button.

- With the [Off] option, the image will not display.
- With the [2 sec.] to [10 sec.] options, the image will appear for the time selected even if you release the shutter button.
- Another picture can be taken by pressing the shutter button even while an image is displayed.

Using the Mode Dial (Image Zone)

Settings fitting the shooting conditions of your subject can easily be set using the shooting mode dial.

Portrait



Use this mode when you want the subject to appear sharp and the background to blur.

Movie

Use this mode to shoot movies. Sound is also recorded simultaneously (p. 56).

Stitch Assist



Use this mode when taking shots that you want to combine into a panorama (p. 49).

SCN Special Scene



Select from 8 scene modes to shoot with the most appropriate settings for the scene (p. 51).

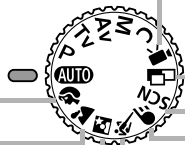

Landscape



Use this mode to shoot spacious landscape scenes.

Night Scene



Use this mode to capture human subjects against the backdrop of an evening sky or night scene. The flash is directed at the person and the shutter speed is slow, so both the person and the background can be beautifully shot.

Fast Shutter



Use this mode to shoot fast moving objects.

Slow Shutter



Use this mode to shoot moving objects to make them appear blurred, such as river rapids.

1 Turn the shooting mode dial and set the icon of the mode you wish to use to .

- Shooting procedures are the same as for the **AUTO** mode (p. 34).

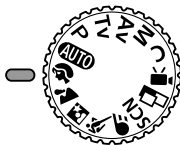

and Shooting Modes

Always use a tripod to prevent camera shake.



- See page 159 for settings that can be changed in this mode.

• **Tips for each function:**

Portrait Mode

- You can achieve a better blurring effect of the background by making sure the upper half of your subject fills the entire LCD monitor or viewfinder.
- You can enhance the blurring effect of the background even more by setting the lens to its telephoto end setting.

Landscape Mode

- The  icon (camera shake warning) may appear on the LCD monitor since slower shutter speeds are frequently used in this mode. If this happens, affix the camera to a tripod.

Night Scene Mode

- The shutter speed slows down. Even if you use the flash, tell your subjects not to move for a few moments.
- If the Night Scene mode is used to shoot mid-day shots, the same effects as with the **AUTO** mode can be obtained.

Fast Shutter

- Noise in the recorded image may increase if you shoot in dark conditions.

Changing the Resolution and Compression

Mode Dial **AUTO P Tv Av M** *

* The Postcard Print mode is not available in and .

You can change the resolution and compression (excluding movie) depending on the purpose.

Resolution		Purpose
L (Large)	2592 x 1944 pixels	High
M1 (Medium 1)	2048 x 1536 pixels	↕
M2 (Medium 2)	1600 x 1200 pixels	↓
S (Small)	640 x 480 pixels	Low
<ul style="list-style-type: none"> ● Send images as e-mail attachments ● Shoot more images 		



(Postcard Print Mode)

- The resolution is set to **M2** (1600 x 1200) and the compression is set to (Fine).

- See page 54 for Postcard Print mode information.

* Paper sizes vary according to region.

Compression		Purpose
Superfine	High Quality	Shoot higher quality images
Fine	↕	
Normal		Normal

Movies can be shot with the following resolutions.

Resolution	
640	640 x 480 pixels
320	320 x 240 pixels
160	160 x 120 pixels

1 Press the **FUNC.** button.

2 Select * using the up or down button.

* The current setting is displayed.



- 3** Select the resolution you wish to set using the left or right button.



Number _____
of recordable images
(Only displayed when the resolution,
compression or file
format is selected)

- 4** Press the SET button.

- 5** Select the compression you wish to set using the left or right button.



- You can shoot the image right after selecting settings by pressing the shutter button. This screen will appear again, once the image is shot.

- 6** Press the FUNC. button.



- *Image File Size (Estimated)* (p. 146)
- *CF Cards and Estimated Capacities (Recordable Images)* (p. 145)

⚡ Using the Flash

Mode Dial AUTO P Tv Av M SCN*

* In (Fireworks), the flash is prohibited.

Use the flash according to the guidelines below.

	Auto with red-eye reduction	The flash fires automatically as required by the lighting level, and the red-eye reduction lamp fires each time the main flash fires.
	Auto	The flash fires automatically as required by the lighting level.
	Flash on with red-eye reduction	The red-eye reduction lamp and the flash always fire.
	Flash on	The flash always fires.
	Flash off	The flash does not fire.

1 Press the ⚡ button to switch between flash modes.

- The selected flash mode appears on the LCD monitor.



- You can switch between settings by pressing the ⚡ button.

When the red-eye reduction function is on



When the red-eye reduction function is off



- This operation may not work in certain Shooting modes (p. 159).

2 Shoot the image.

- The flash will fire if the upper indicator lights orange when the shutter button is pressed halfway. (Does not fire in .)
- Shooting procedures are the same as for the **AUTO** mode (p. 34).





When shooting with a high ISO sensitivity and using the flash, there is more of a chance of overexposure the closer you are to the subject.



- When shooting in any mode other than **M** mode, the flash fires with automatic adjustments.
- The flash fires twice. A pre-flash will fire and will be followed by the main flash. The pre-flash is used by the camera to obtain the subject's exposure data so that the main flash can be set to the optimal intensity for the shot.
- In **M** mode, the flash fires with the manually set adjustments.
- The fastest shutter speed for flash synchronization is 1/500 second. The camera automatically resets the shutter speed to 1/500 second if a faster speed is selected.
- In **M** mode, the [Flash Output] option can be changed (p. 91).
- Shots cannot be taken while the flash is charging.
- The flash may take up to approximately 10 seconds to charge in some cases. Actual times will vary according to usage and the battery charge.
- The flash setting is saved when the camera is turned off in the **P**, **Tv**, **Av** and **M** Shooting modes.

Setting the Red-eye Reduction Function

The red-eye reduction lamp fires when the flash is used in dark areas. This reduces light reflecting back from the eyes and making them appear red.

- 1** In the [ (Rec.)] menu, set  (Red-eye) to [On].





-  appears on the LCD monitor.



- **Red-eye Reduction**
For this mode to be effective, the subject must be looking right at the red-eye reduction lamp. Try asking them to look directly at the lamp. Even better results can be obtained by shooting with the lens set to a wide angle, increasing the lighting in indoor settings or approaching closer to the subject.
- The red-eye reduction function cannot be set when the Special Scene mode (p. 51) is set to  (Fireworks).

🌸 Macro Mode

Mode Dial AUTO P Tv Av M     



* Macro mode is not available in  and .

Use the macro mode when the distance between the lens and the subject is in the range of 5 to 45 cm (2.0 in. to 1.5 ft.) at wide angle end and 25 to 45 cm (9.8 in. to 1.5 ft.) at telephoto end.

Use to take close-up shots of flowers or small objects.

1 Press the DISP. button to turn the LCD monitor on.

2 Press the  button.

- The  icon appears on the LCD monitor.
- Pressing the  button again cancels the macro mode.



3 Shoot the image.

- The lower indicator will light yellow when the shutter button is pressed halfway.

- Shooting procedures are the same as for the **AUTO** Mode (p. 34).





- Always use the LCD monitor to compose images in macro mode. Shooting with the viewfinder is possible, however, part of the image may not appear in the final shot (p. 36).
- When the lens is zoomed out to the wide angle end, the recordable area is approx. 56 × 42 mm (2.2 in. × 1.7 in.)^{*1}, and at telephoto end, it is 87 × 65 mm (3.4 in. × 2.6 in.)^{*2}.
When the zoom position is located between the telephoto end and the wide angle end, the distance between the front of the lens and the subject will be the same as the telephoto end.
- The exposure may not be optimal when the flash is used in macro mode.

^{*1} Closest focal distance.

^{*2} Maximum optical telephoto setting.

Self-timer



Mode Dial AUTO P Tv Av M    

- 1 Press the FUNC. button and select * (Drive Mode) using the up or down button.





* The current setting is displayed.

- 2 Select  or  using the left or right button and press the FUNC. button.

- When  is selected, the shutter release will be delayed for 10 seconds, and when  is selected, the shutter release will be delayed for 2 seconds, after you press the shutter button.

- 3 Shoot the image.

- When  is selected, the self-timer lamp starts blinking when the shutter button is pressed all the way. The self-timer sounds and the blinking gets faster two seconds before the shutter activates.

- When  is selected, the self-timer lamp blinks fast from the beginning. The shutter activates in two seconds.
- Shooting procedures are the same as for the **AUTO** mode (p. 34).



- You can change the self-timer sound by changing the setting in [Self-timer Sound] in the [ (My Camera)] menu (p. 74).
- See *Photo Tips and Information* (p. 150).

Digital Zoom

Mode Dial AUTO P Tv Av M       SCN

Images can be zoomed with the combined optical and digital zoom functions as follows.

- Approximately 3.8x, 4.9x, 6.1x, 7.6x, 9.3x and 12x

1 Press the DISP. button to turn the LCD monitor on.

2 In the [RECORD] (Rec.) menu, select  (Digital Zoom).

- See *Selecting Menus and Settings* (p. 66).



3 Select [On] using the left or right button and press the MENU button.

4 Press the zoom lever toward .

- The lens will zoom to the maximum optical telephoto setting and stop. Press the zoom lever toward  again to further zoom the image digitally.

- Press the lever toward  to zoom back out.



The combined magnifications of the optical zoom and digital zoom are displayed.

5 Shoot the image.

- Shooting procedures are the same as for the **AUTO** mode (p. 34).



The digital zoom cannot be used when the LCD monitor is off.



- Images become coarser the more they are digitally zoomed.
- Since camera shake may become a factor when using the digital zoom, the use of a tripod is recommended.

Continuous Shooting

Mode Dial P Tv Av M SCN

Use this mode to shoot successive frames while the shutter button is pressed.

	Standard Continuous Shooting	Use this mode to view the images on the LCD monitor as you shoot continuously. The shutter interval is longer in this mode than in mode.
	High-speed Continuous Shooting	Use this mode to shoot continuously with a short shutter interval. You cannot check images while shooting continuously.

1 Press the FUNC. button.

2 Select * (Drive Mode) using the up or down button.

* The current setting is displayed.



3 Select or using the left or right button and press the FUNC. button.

4 Press the shutter button halfway to lock the focus.

5 Press the shutter button all the way to shoot.

- Shooting will stop when the shutter button is released.
- The shooting speed is as follows.
When is selected: Approx. 1.5 shots per second*
When is selected: Approx. 2.0 shots per second*

* Large/Fine mode with LCD monitor off (These figures reflect Canon's testing standard. The actual figures will vary according to the shooting conditions and settings.)



- The interval between frames may lengthen somewhat when the internal memory becomes full.
- The flash can be used, but the interval between shots will lengthen to accommodate the flash recharge time.

☐ Shooting Panoramic Images (Stitch Assist)

Mode Dial 

Stitch Assist can be used to shoot overlapping images that can later be merged (stitched) to create one panoramic image on a computer.

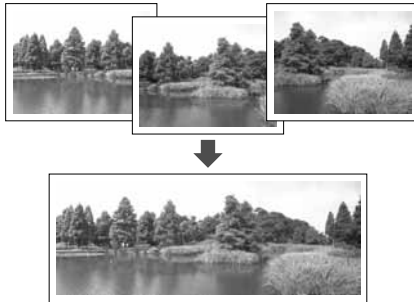

To merge the images on a computer, use PhotoStitch, one of the supplied software programs.

Framing a Subject

The PhotoStitch program detects the overlapping portions of adjoining images and merges them. When shooting, try to include a distinctive item (landmark) in the overlapping portions.





- Compose each frame so that it overlaps 30 to 50% of the adjoining image. Try to keep the vertical misalignment to within 10% of the image height.
- Do not include moving items in the overlap.
- Do not try to stitch images that include both distant and close items. Objects may appear warped or doubled up.
- Make the brightness in each image consistent. The final image will appear unnatural if the difference in brightness is too great.

- For good results, pan (swivel) the camera to take successive shots.
- To shoot close-ups, slide the camera over the subject, keeping it parallel to the subject as you move it.

Shooting

Images can be shot in the following 2 sequences in Stitch Assist mode.

	Left → Right	Left to right horizontally
	Left ← Right	Right to left horizontally

1 Turn the Shooting mode dial to .

- The LCD monitor will turn on.

2 Select the shooting sequence using the left or right button and press the SET button.

- The shooting sequence is set.
- You can also press the shutter button directly to shoot without pressing the SET button.



3 Shoot the first image.

- The exposure and white balance settings are set and locked with the first image.

4 Compose and shoot the second image so that it overlaps the first.



Sequence 

- Minor discrepancies in the overlap can be corrected with the software.
 - An image can be retaken. Press the left or right button to return to that frame.
- ### 5 Use the same procedures to shoot the remaining frames.
- A maximum of 26 images can be recorded.
- ### 6 Press the SET button after the last shot.



- A custom white balance setting (p. 87) cannot be set in  mode. To use a custom white balance setting, first set it in another Shooting mode.
- The settings in place for the first image are locked in and cannot be changed for subsequent shots.
- A TV cannot be used as the monitor for shooting in this mode.











See page 159 for settings that can be changed in this mode.

SCN Special Scene Mode

Mode Dial SCN

By simply selecting one of the following 8 modes, you can shoot the image with the most appropriate settings for the scene.



 Foliage	Appropriate for shooting images with flowers, leaves or trees to enhance color.
 Snow	Appropriate for shooting the subject against the backdrop of snowy mountains while preventing dark subjects and bluish backgrounds.
 Beach	Appropriate for shooting scenes by the sea or on sunlit sandy beaches while preventing dark subjects.
 Fireworks	Appropriate for shooting fireworks clearly with the optimal exposure.

 Underwater	Appropriate for shooting images with the Waterproof Case WP-DC50 (sold separately). This mode uses an optimal white balance setting to reduce bluish tones and record images with natural hues. The flash is controlled to fire as seldom as possible.
 Indoor	Prevents camera shake and maintains the subject's true color when shooting under fluorescent or tungsten lighting. The exposure is regulated so as to avoid the use of flash as much as possible.
 Kids & Pets	Appropriate for shooting movable subjects such as children or pets.
 Night Snapshot	Appropriate for shooting human subjects against the backdrop of an evening sky or night scene without using a tripod to reduce camera shake.

1 Turn the mode dial to SCN (Special Scene mode).

- The current Scene mode screen is displayed.

2 Select the scene you wish to shoot using the left or right button and shoot the image.

- The name of the Scene mode is displayed for six seconds each time you change the mode.
- Shooting procedures are the same as for the **AUTO** mode (p. 34) excluding .
- For the shooting procedures of , see the *Waterproof Case User Guide* included with the Waterproof Case WP-DC50 (sold separately).



- ❗ In mode, the shutter speed slows down. Use a tripod to avoid camera shake.
- In , , and modes, the ISO speed may increase and cause noise in the image.
- In , shooting subjects in the following range: 1 to 4 m (3.3 to 13 ft.) (telephoto end) or 1 m (3.3 ft.) ~ infinity (other zooming positions).



- See page 159 for settings that can be changed in this mode.
- In , using the LCD monitor is recommended.
- Results may vary depending on the subject.
- When shooting images underwater, always turn the power off before inserting the camera into the waterproof case (sold separately).
- In or modes, using waterproof case WP-DC50 (sold separately) is recommended.

Postcard Print Mode

Mode Dial AUTO P Tv Av M      

You can shoot images with settings appropriate for postcard size printing.

- When printing standard image data to postcard size, sometimes the top and bottom sides may not get printed.
- By shooting images in the Postcard Print mode, you can check the printing area (vertical/horizontal ratio of 3:2) beforehand. In addition, the resolution locks to M2 (1600 x 1200) and the compression locks to the  (Fine) setting, rendering smaller file sizes.

1 Press the FUNC. button.

2 Select L* using the up or down button.

* The current setting is displayed.



3 Select (Postcard) using the left or right button.



- You can shoot the image right after selecting settings by pressing the shutter button. The menu displays again after the shot, allowing you to change the settings easily.

4 Press the FUNC. button.

5 Shoot the image.

- When you press the shutter button halfway, the area that will not get printed (the top and bottom sides) grays out.
- Shooting procedures are the same as for the **AUTO** mode (p. 34).





Selecting  cancels the [On] setting of the digital zoom.



- Some settings are not available with certain Shooting modes. Please refer to *Functions Available in Each Shooting Mode* (p. 159).
- When [Date Stamp] (p. 55) is set to [Date] or [Date & Time],  appears on images in step 2 and 3.
- For printing instructions, refer to the *Direct Print User Guide*.

Embedding the Date in the Image Data

You can embed the date on image data when  is selected. The date will be printed on your images even if it has not been set by the computer or printer.

- Ensure that the camera's date/time is set beforehand (p. 21).
- You cannot embed the date on image data when  is not selected.

1 Check that appears on the LCD monitor.

2 Select (Date Stamp) in the [(Rec.)] menu.

- See *Selecting Menus and Settings* (p. 66).



3 Select [Off], [Date] or [Date & Time] using the left or right button.

- See *Setting the Date/Time* (p. 21).



4 Press the MENU button.

5 Shoot the image.



- Shooting procedures are the same as for the **AUTO** mode (p. 34).



- The Date Stamp cannot be deleted from the image data once it has been set.
- When using a CP printer, part of the date may not get printed if the credit card size print (54 mm x 86 mm) is selected.

Movie Mode

Mode Dial

Use this mode to shoot movies. The resolution can be set to [] (640 × 480), [] (320 × 240) or [] (160 × 120) (p. 41).

1 Turn the Shooting mode dial to





- The LCD monitor turns on and displays the maximum recording time (in seconds).

2 Press the shutter button all the way.

- Shooting and sound recording starts simultaneously.
- During the shooting a red circle appears in the upper right of the LCD monitor.

3 Press the shutter button all the way to stop recording the movie.

- The maximum length of individual movie clips is 30 seconds (10 frames/second) at the  setting and 3 minutes (15 frames/second) at the  and  settings.

- Recording times vary by the CF card. See *CF Cards and Estimated Capacities (Recordable Images)* (p. 145)

The maximum length of individual movie clips may vary with the subject and shooting conditions. Recording will automatically stop when the maximum is reached or when the CF cards runs out of free capacity.



- The recording time may not display properly during shooting or filming may stop unexpectedly with the following types of CF cards.
 - Slow recording cards
 - Cards formatted on a different camera or a computer
 - Cards which have had images recorded and erased repeatedly
 Although recording time may not display properly during shooting, the movie will be recorded correctly on the CF card. Recording time will display properly if you format the CF card in this camera (excluding slow recording CF cards).
- You are recommended to use a CF card that has been formatted in your camera to shoot movies (p. 19). The card supplied with the camera may be used without further formatting.

- Be careful not to touch the microphone while shooting.
- The AE, AF, white balance and zoom settings are set and locked to the settings of the first frame.
- After a shot, the upper indicator blinks green while the movie clip is being recorded to the CF card. You cannot shoot again until it stops blinking.



- See page 159 for settings that can be changed in this mode.
- Sound is recorded monaurally.
- There is no shutter sound in movie mode.
- QuickTime 3.0 or higher is required to playback movie files (AVI / Motion JPEG) on a computer. (QuickTime (for Windows) is bundled on the supplied Canon Digital Camera Solution Disk. On the Macintosh platform, QuickTime 3.0 or later is generally bundled with Mac OS 8.5 or later operating system.)

Playback – The Basics

Displaying Images Individually (Single Image Playback)

You can view the recorded images on the LCD monitor.

1 Open the LCD monitor.

- The position of the LCD monitor can be adjusted to suit your viewing position.

2 Slide the mode switch to .

- The last recorded image appears (single image playback).



3 Move between images using the left or right button.

- Use the left button to move to the previous image and the right button to move to the next. Holding the left or right button moves more rapidly between images, but the images will not appear as clearly.



You may not be able to play back images that have been shot with another camera or edited on a computer with other software applications.



- Press the **DISP.** button to show the data for the displayed image (p. 28).
- Press the  button to quickly delete the displayed image (p. 64).

Magnifying Images

Images can be magnified up to approximately 10 times in single image playback.

1 Slide the mode switch to .

2 Press the zoom lever toward .



— Approximate position

- You can move around the magnified image using the up, down, left or right button.
- Pressing the zoom lever toward **Q** while holding the **SET** button down magnifies the image approx. 2.5 times, approx. 5 times and 10 times in order.

Canceling the Magnified Display

1 Press the zoom lever toward **Q**.



Movie frames and index playback images cannot be magnified.



You can magnify an image while it is displayed on the LCD monitor in Shooting mode immediately after the image is shot (p. 37).

Q Viewing Images in Sets of Nine (Index Playback)

Up to 9 images can be viewed at once in index playback.

1 Slide the mode switch to **Q**.

2 Press the zoom lever toward **Q**.

- 9 images appear at once (index playback).

3 Change the image selection using the up, down, left or right button.

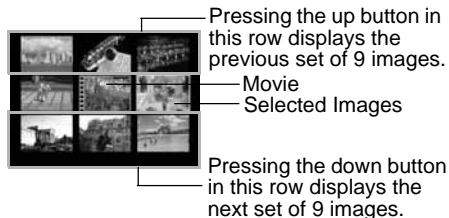

4 Press the zoom lever toward **Q**.

- Index playback cancels and the display reverts to single image playback.



Press the **DISP.** button to show the information for the displayed image (p. 28).

Jumping Between Images

The display can be advanced or set back 9 images in index playback.

1 Press the zoom lever toward while in index playback (p. 59).

- The jump bar appears.

2 Change the image selection.

- Jump 9 images back or forward using the left or right button.
- Pressing the left or right button while holding the SET button displays the first set or last set of 9 images.



Jump Bar

3 Press the zoom lever toward .

- The jump bar disappears and the camera returns to index playback.
- If you press the zoom lever once more toward , the camera returns to single image playback.

Viewing/Editing Movies



Viewing Movies

You can playback the images shot in  mode.

1 Slide the mode switch to .

- Movies cannot be viewed in index playback.

2 Select a movie using the left or right button and press the SET button.

- A movie displays with the   icon on it.
- The movie playback panel appears.

3 Select (Play) using the left or right button and press the SET button.

- The movie images and sound will play.
- You can adjust the volume using the up or down button.



Movie Playback Panel

Volume





- When a movie has finished playing, it will display the last frame.
If the **SET** button is pressed in this state, the camera will revert to the movie playback panel. If the **SET** button is pressed again, the movie will start playing from the first frame.

Pausing and Resuming Play

- Press the **SET** button to pause the movie. Press it again to resume.

Fast Forwarding/Rewinding

- Select one of the following operations using the left or right button and press the **SET** button.

-  **(Exit)** : Return to single image playback
-  **(First Frame)** : Display the first frame
-  **(Previous Frame)** : Return to the previous frame (Rewinds if the **SET** button is held down)
-  **(Next Frame)** : Proceed to the next frame (Fast forwards if the **SET** button is held down)
-  **(Last Frame)** : Display the last frame



You may experience frame dropping and audio breakup when playing back a movie on a computer with insufficient system resources.



- The volume at which movies play back can also be adjusted in the Set up menu (p. 71).
- If [Mute] (p. 71) is set to [On] in the Set up menu, the volume setting returns to 0 but it can be adjusted using the up or down button.
- Please adjust the audio sound level on the TV when viewing movie files on a TV.

Editing Movies

You can delete unwanted portions at the beginning or end of a movie clip.

1 Select the movie you wish to edit and press the SET button.

- See *Viewing Movies* (p. 60).



2 Select  (Edit) using the left or right button and press the SET button.

- The movie editing panel and the movie editing bar appear.

3 Select an editing method using the up or down button.



Movie Editing Bar

-  (Cut Beginning): Deletes frames from the beginning of the movie.
-  (Cut End): Deletes frames from the end of the movie.
-  (Exit): Reverts to the movie playback panel.

4 Select the range you wish to delete using the left or right button.



5 Select  (Play) using the up or down button and press the SET button.

- The temporarily edited movie will start playing.
- The movie will stop if you press the SET button while it is playing.

6 Select  (Save) using the up or down button and press the SET button.



- When  is selected, the edited movie is not saved and the camera reverts to the movie playback panel.

7 Select [Overwrite] or [New File] using the left or right button and press the SET button.



- [Overwrite] : Saves the edited movie under the same file name as the original movie. The original data is deleted.

- **[New File] :**
Saves the edited movie under a new file name. The original data is not deleted.
- When there is not enough space left on the CF card, only the overwrite function is available. If this happens, a small ▲ appears on the counter of the movie editing bar.



- Protected movies cannot be edited.
- It may take approx. 3 minutes to save an edited movie. In case the battery runs out during that period, the saving process may not be able to be completed. To prevent this, it is recommended to use new AA size alkaline batteries or fully charged AA-size NiMH batteries (sold separately), or the AC Adapter Kit ACK 600 (sold separately) (p. 134).



Movies with an original length of 1 second or more can be edited in 1-frame units.

Erasing



Please note that erased images cannot be recovered. Exercise caution before erasing a file.



Erasing Images Individually

1 Slide the mode switch to .

2 Select the image you wish to erase using the left or right button and press the  button.



- A confirmation screen appears.



3 Select [Erase] using the left or right button and press the **SET** button.

- To cancel instead of erasing, select [Cancel] and press the **SET** button.



Protected images cannot be erased with the erase function (p. 100).

Erasing All Images

1 In the  (Play) menu, select  (Erase all) and press the **SET** button.

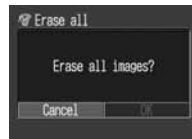

- A confirmation screen appears.

2 Select [OK] using the left or right button and press the **SET** button.

- To cancel instead of erasing, select [Cancel] and press the **SET** button.





- The [Erase all] function erases all the image data recorded on the CF card.
- Protected images cannot be erased with the erase function (p. 100).
- To erase the images and all other data recorded on the CF card, see *Formatting a CF Card* (p. 19)

Shooting – Advanced Functions

Selecting Menus and Settings

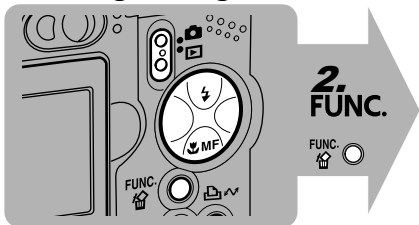
Selecting Settings with the FUNC. Button (Shooting Mode Only)



- 1 Slide the mode switch to .
- 2 Press the FUNC. button.
- 3 Select a FUNC. menu option using the up or down button.
- 4 Select the setting contents using the left or right button.
- 5 Press the FUNC. button.
- 6 Shoot the image.

3. Select a FUNC. menu option using the up or down button.
4. Select the setting contents using the left or right button.

Exposure Compensation (± 0) (p. 85)



White Balance (AWB) (p. 86)



Drive Mode () (p. 46, 48)

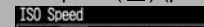

ISO Speed () (p. 89)



Photo Effect () (p. 90)

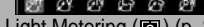

Light Metering () (p. 83)



Flash Output (p. 91)

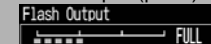

Resolution (L) (p. 41)

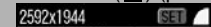

Resolution (Movies) () (p. 41)



Compression () (p. 41)



Items in () show default settings.

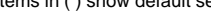
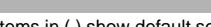

5. FUNC.



6.

Shoot the image

Selecting Settings with the MENU Button

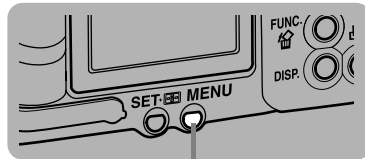

Shooting Mode

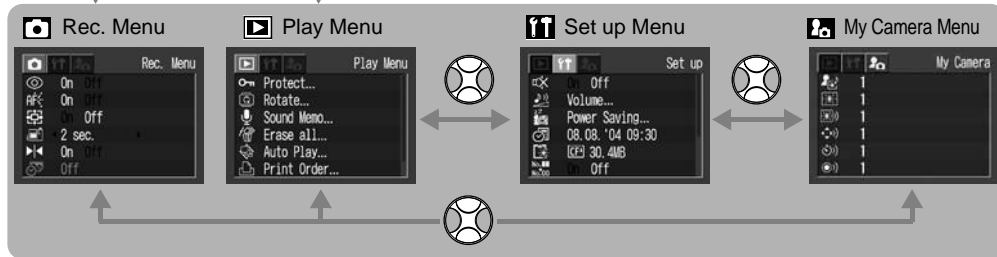

Playback Mode

- 1** Press the MENU button.
- 2** Use the left or right button to switch between menus.
 - You can also switch between menus using the zoom lever.
- 3** Use the up or down button to select a menu item.
- 4** Use the left or right button to select the settings you wish to set.
- 5** Press the MENU button.









- For items with [...] next to them, push the **SET** button and carry out the settings from the next displayed menu. Once the settings are complete, press the **SET** button again and confirm these settings.
- In the Shooting mode, you can also close the menu by pressing the shutter button halfway.







- Some menu items may not be available for selection according to the Shooting mode (p. 159).
- You can apply a desired image and sound to  and  in the My Camera menu. For details, see the *Registering My Camera Settings* (p. 121) or the *Software Starter Guide*.
- The default of all the settings changed by the menu and button operations except for [Date/Time], [Language] and [Video System] can be restored all at once (p. 75).

Menu Settings and Default Settings







Rec. Menu

Menu Item	Setting Content	Reference Page
 AF Frame	Sets the camera so that it will either automatically select the AF frame and shoot, or shoot with the AF frame fixed in the center or in the manually set frame. • AiAF*/FlexiZone/Center	81
 Red-eye	Sets whether or not the red-eye reduction lamp fires. • On*/Off	44
 Spot AE Point	Sets the option of [Spot AE Point] (one of the light metering modes) to Center (the AE point is fixed to the center) or AE Point (the AE point corresponds to the AF point). • Center*/AF Point	83
 MF-Point Zoom	Sets whether or not the focusing point is magnified when using the manual focus. • On*/Off	93
 AF-assist Beam	Sets the output of the AF-assist beam according to shooting conditions when using the auto focus. • On*/Off	36
 Digital Zoom	Sets whether or not the digital zoom combines with the optical zoom to zoom images. • On/Off*	47

* Default setting

Menu Item	Setting Content	Reference Page
 Review	Sets the duration images display on the LCD monitor after the shutter button is released. • Off/2* to 10 sec.	37
 Reverse Disp.	Sets whether or not the image will be displayed in reverse, as with a mirror, when the LCD monitor is turned 180 degrees. • On*/Off	25
 Date Stamp	Sets the date format to be embedded in image data when  is selected. • Off*/Date/Date & Time	55
C Save Settings	Saves settings selected in the Rec. menu and the function dial menu to the mode dial's C mode.	94





Play Menu











Menu Item	Setting Content	Reference Page
 Protect	Protects images from accidental erasure.	100
 Rotate	Rotates images 90 or 270 degrees clockwise in the display.	97
 Sound Memo	Adds sound memos to images.	98
 Erase All	Erases all images from a CF card (excluding protected images).	64
 Auto Play	Plays images automatically one after the other.	99
 Print Order	Sets which images and how many copies will be printed on a printer with the direct print function or at a photo lab service.	103

* Default setting





Menu Item	Setting Content	Reference Page
 Transfer Order	Specifies images before downloading to a computer	107

Set up Menu



Menu Item	Setting Content	Reference Page
 Mute	<p>Set [On] to mute the start-up sound, operation sound, self-timer sound and shutter sound all at once. For details, see <i>How the Mute setting in the [f1] (Set up)] menu and each sound setting in the [P2] (My Camera)] menu are related</i> on page 74.</p> <ul style="list-style-type: none"> • On/Off * <p>Note that the warning signal beeps even when the Mute setting is [On].</p>	-
 Volume	<p>Adjusts the volume of the start-up sound, operation sound, self-timer sound, shutter sound, or playback sound after pressing the SET button. The volume cannot be adjusted if [Mute] is set to [On].</p> <ul style="list-style-type: none"> • □□□□ (Off) • ■■■□ (3) • ■□□□ (1) • ■■■■ (4) • ■■□□ (2)* • ■■■■ (5) 	-
	<p> Start-up Vol. Adjusts the Start-up Sound volume when the camera powers up.</p>	31
	<p> Operation Vol. Adjusts the Operation Sound volume when any button except the shutter button is operated.</p>	-











Menu Item	Setting Content	Reference Page
 Volume	 Selftimer Vol. Adjusts the volume of the self-timer sound played 2 sec. before the shutter is released.	46
	 Shutter Volume Adjusts the Shutter Sound volume when the shutter button is pressed all the way. There is no shutter sound in Movie mode.	35
	 Playback Vol. Adjusts the sound volume when a sound memo or movie is played.	60, 98
 Power Saving	The Auto Power Down and Display Off settings can be set by pressing the SET button.  Auto Power Down Sets whether or not the camera automatically powers down after a specified period of time elapses without camera operation. • On* /Off	31
	 Display Off Specifies a period of time before the LCD monitor turns off when no camera operation is performed. • 10 sec. • 1 min.* • 20 sec. • 2 min. • 30 sec. • 3 min.	32
 Date/Time	Sets the date, time and date format.	21
 Format	Formats (initializes) a CF card.	19
 File No. Reset	Sets how file numbers are assigned to images. • On/Off *	118



* Default setting

Menu Item	Setting Content	Reference Page
 Auto Rotate	Sets whether or not images shot with the camera held vertically are automatically rotated in the display. • On*/Off	95
 Distance Units	Sets the format of the MF indicator's displayed distance units. • m/cm* • ft./in.	93
 Language	Sets the language used in the menus and messages on the LCD monitor. • English* (English) • Norsk (Norwegian) • Deutsch (German) • Svenska (Swedish) • Français (French) • Español (Spanish) • Nederlands (Dutch) • 汉语 (Chinese) • Dansk (Danish) • Русский (Russian) • Suomi (Finnish) • Português (Portuguese) • Italiano (Italian) • 日本語 (Japanese) You can change the language during image playback by holding the SET button and pressing the MENU button.	22
 Video System	Sets the video output signal standard. • NTSC • PAL	118

Customizing the Camera (My Camera Settings)

You can select the theme, start-up image and sound, operation sound, self-timer sound and shutter sound used on this camera. These are called My Camera settings. You can also customize the  and  options for each item with images from the CF card and newly recorded sounds or by using the supplied software. See the *Software Starter Guide* for details.

Item/Menu Screen	Setting Content	Reference Page
 Theme	Selects a common theme for the start-up image, start-up sound, operation sound, self-timer sound and shutter sound.* ¹	120
 Start-up Image	Sets the start-up image when you turn on the camera.	120
 Start-up Sound	Sets the start-up sound when you turn on the camera.* ¹	120
 Operation Sound	Sets the sound when any button other than the shutter button is operated.* ¹	120
 Selftimer Sound	Sets the sound informing you that the photo will be taken in 2 seconds.* ¹	120
 Shutter Sound	Sets the shutter sound when you depress the shutter button. There is no shutter sound in Movie mode.* ¹	120
My Camera menu settings content	 (Off)  * ² /  / 	120

*¹How the [Mute] setting in the  (Set up) menu and each sound setting in the  (My Camera) menu are related

To turn off the start-up sound, operation sound, self-timer sound and shutter sound all at once, set [Mute] in the  (Set up) menu to [On]. This setting overrides each setting for those sounds. Note that the warning signal beeps even when the [Mute] setting is [On].

*²Default setting

Resetting the Settings to Default

You can reset the menu and button operation settings to default.

1 Turn the power on.

- Can be performed from Shooting or Playback mode.

2 Press the MENU button for longer than 5 seconds.

- The message “Reset settings to default?” appears on the LCD monitor.

3 Press the left or right button to select [OK], and press the SET button.

- The screen on the right appears while resetting. The normal screen resumes when resetting is complete.
- To cancel resetting, select [Cancel] instead of [OK].

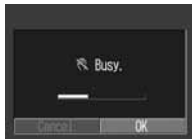

- The following settings do not reset to default.
 - [Date/Time], [Language] and [Video System] in the [M] (Set up) menu (p. 72, 73)
 - The custom white balance (p. 87)
 - Newly registered My Camera settings (p. 120)
- When the camera is connected to a computer or a printer, this operation does not work.



When the camera is in Shooting mode and mode dial is set to **C**, only **C** mode settings will revert to default. In other cases, the **C** settings will not revert to default.

Using the Mode Dial (Creative Zone)

Mode Dial P Tv Av M

You can freely select camera settings such as the shutter speed and aperture value to suit your shooting purposes. After settings are made, shooting procedures are the same as for the **AUTO** mode (p. 34).

See *Functions Available in Each Shooting Mode* (p. 159) at the end of this manual to find out which settings can be changed in which shooting modes.

How to Use the Mode Dial

- 1 Check that the camera is in Shooting mode.
- 2 Turn the mode dial and set the icon of the function you wish to use to .

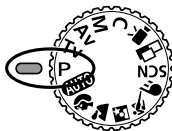

- If the LCD monitor is on, the shutter speed and aperture value appear automatically.



Shutter Speed Aperture Value

- The camera operates in the following ways according to the selected function:

P	The camera automatically sets the shutter speed and aperture value.
Tv	The user selects a shutter speed using the left or right button.
Av	The user selects an aperture value using the left or right button.
M	The user selects the setting (the shutter speed or the aperture value) using the SET button and select a shutter speed or an aperture value using the left or right button.

- The correct exposure has been set if the shutter speed and aperture value show in white on the LCD monitor.

3 Shoot the image.

P Program AE

Use the program AE mode to have the camera automatically set the shutter speed and aperture value to match the brightness of the scene.

- The shutter speed and aperture value will show in red on the LCD monitor when the correct exposure cannot be obtained. Use the following methods to obtain the correct exposure and make them appear in white.
 - Use the flash
 - Change the ISO speed setting
 - Change the light metering mode

Differences between the P and **AUTO** Modes.

- The following settings can be adjusted in **P** mode, but not in **AUTO** mode.
 - Exposure Compensation
 - White Balance
 - ISO Speed
 - Flash (Flash on)
 - AF Frame
 - Photo Effects
 - Continuous Shooting
 - Light Metering Mode
 - Manual Focus
- For the correlation between aperture value and shutter speed, see page 78.

Tv Setting the Shutter Speed

When you set the shutter speed in the shutter-speed priority AE mode, the camera automatically selects an aperture value to match the brightness. Faster shutter speeds allow you to catch an instantaneous image of a moving subject while slower speeds create a flowing effect and allow you to shoot without a flash in dark areas.



- If the aperture value shows in red, the image is underexposed (insufficient light) or overexposed (too much light). Adjust the shutter speed using the left or right button until the aperture value display turns to white.
- The nature of CCD image sensors is such that noise in the recorded image increases at slow shutter speeds. This camera, however, applies special processing to images shot at shutter speeds slower than 1.3 seconds to eliminate the noise, thereby producing high-quality images. Nevertheless, a certain amount of processing time may be required before the next image can be shot.



- When the AF frame is set to FlexiZone, you can switch between shutter speed and AF frame each time the **SET** button is pressed (p. 82).
- Please note that camera shake becomes a factor at low shutter speeds. If the camera shake warning  appears on the LCD monitor, secure the camera to a tripod before shooting.
- The aperture value and shutter speed change according to the zoom state as follows.

	Aperture Value	Shutter Speed (seconds)
Wide Angle	F2.8	to 1/1000
	F3.2 - 4.0	to 1/1250
	F4.5 - 8.0	to 1/2000
Telephoto	F4.9	to 1/1000
	F5.6 - 7.1	to 1/1250
	F8.0	to 1/2000

- The fastest shutter speed for flash synchronization is 1/500 second. The camera automatically resets the shutter speed to 1/500 second if a faster speed is selected.

Shutter Speed Display

The numbers in the table below indicate the shutter speed in seconds. 1/160 indicates 1/160 second. Also, quote marks indicate the decimal place, so that 0"3 indicates 0.3 second and 2" indicates 2 seconds.

15" 13" 10" 8" 6" 5" 4" 3" 2" 2" 5" 2" 1" 6" 1" 3"
 1" 0" 8" 0" 6" 0" 5" 0" 4" 0" 3"
 1/4 1/5 1/6 1/8 1/10 1/13 1/15 1/20 1/25 1/30
 1/40 1/50 1/60 1/80 1/100 1/125 1/160 1/200
 1/250 1/320 1/400 1/500 1/640 1/800 1/1000
 1/1250 1/1600 1/2000

Av Setting the Aperture

When you set the aperture in the aperture-priority AE mode, the camera automatically selects a shutter speed to match the brightness. Selecting a lower aperture value (opening the aperture) allows you to fade the background and create a beautiful portrait. A higher aperture value (closing it) brings the entire range from foreground to background into focus. The larger the aperture value, the greater the range of the image brought into clear focus.



- If the shutter speed shows in red on the LCD monitor, the image is underexposed (insufficient light) or overexposed (too much light). Adjust the aperture value using the left or right button until the shutter speed display turns white.
- Some aperture values may not be available with certain zoom positions (p. 78).



- When the AF frame is set to FlexiZone, you can switch between aperture value and AF frame each time the **SET** button is pressed (p. 82).
- Please note that camera shake becomes a factor with larger aperture values that slow down shutter speeds. If (camera shake warning) appears on the LCD monitor, secure the camera to a tripod before shooting.
- In this mode, the shutter speed range with synchronized flash is 1/60 second to 1/500 second. The aperture value setting may therefore be changed automatically to match the synchronized flash speed even if its value was set previously.

Aperture Value Display

The larger the aperture value, the smaller the lens aperture.



F2.8 F3.2 F3.5 F4.0 F4.5 F4.9 F5.0
F5.6 F6.3 F7.1 F8.0

M Manually Setting the Shutter Speed and Aperture

You can manually set the shutter speed and aperture to shoot images. You can select settings such as a long exposure to suit your purpose.

- When you press the shutter button halfway, the difference between the standard exposure* and the selected exposure appears on the LCD monitor. If the difference is more than ± 2 stops, “-2” or “+2” appears in red.
- * The standard exposure is calculated by the AE function according to the selected metering mode.



- See page 159 for settings that can be changed in this mode.
- If you wish to change the exposure, select the shutter speed or the aperture with the **SET** button and change the value using the left or right button.
- When the AF frame is set to FlexiZone, you can switch between shutter speed, aperture value and AF frame each time the **SET** button is pressed (p. 82).
- The LCD monitor's brightness matches the selected shutter speed and aperture value. When you select a fast shutter speed or shoot a subject in a dark place and set the flash to   (Flash On, Red-eye Reduction) or  (Flash On), the image will always be bright.
- For the correlation between aperture value and shutter speed, see page 78.

Select the AF Frame

Mode Dial P Tv Av M        **SCN**

You can change the autofocus frame (AF frame) selection method. The AF frame will appear when the LCD monitor is turned on (p. 26).

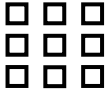
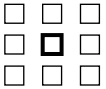
	AiAF (Auto Selection)	The camera automatically selects between 9 AF frames to focus on according to the shooting conditions.
	Center (Center Selection)	Of 9 AF frames, the middle one is selected to focus. This is convenient for making sure the focus is exactly where you want it.



**FlexiZone
(Manual
setting)**

You can move the AF frame manually to the desired position. This is convenient for focusing accurately on your chosen subject to obtain the composition you desire. It can only be selected when the mode dial is set to **P**, **TV**, **AV** or **M**.



 indicates the AF frame which appears on the monitor



e.g. AiAF



e.g. Center

1 In the [ (Rec.)] menu, select  (AF frame).

- See *Selecting Menus and Settings* (p. 66).

- 2** Select the desired AF frame using the left or right button.

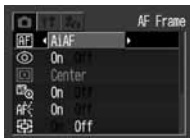

- 3** Press the MENU button.

- You can immediately shoot the image using the selected AF frame by pressing the shutter button instead of pressing the MENU button.

For operation when [FlexiZone] has been selected, see *Setting an AF Frame Manually* (on the right).

Setting an AF Frame Manually

Mode Dial P Tv Av M

You can move the AF frame manually to the desired position. This is convenient for focusing accurately on your chosen subject to obtain the composition you desire. The AF frame is fixed to center when an image is shot using the viewfinder with the LCD monitor off or when using the digital zoom, even if you previously set the AF frame to the position you desire.

- 4** Set the AF frame to [FlexiZone] (p. 81).



- 5** Press the  button several times, until the AF frame turns green.

- How many times the button should be pressed varies with the selected shooting mode.

- 6** Move the AF frame to the position you wish to set using the up, down, left or right button.



7 Press the button.



- You can immediately shoot the image using the selected AF frame by pressing the shutter button instead of pressing  button.
- The AF frame will move back to its original position (Center), if you hold down the  button.



- Turn the LCD monitor on to set the AF frame to the position you desire before shooting.
- The AF frame is locked to center when using the digital zoom.
- When the Spot AE Point is selected as the light metering mode, you can use the selected AF frame as the Spot AE Point (on the right).
- For an explanation of the AF frame colors, please refer to p. 26.
- When the shooting mode dial is set to **TV**, **Av** or **M**, pressing the **SET** button will change the item that can be set as described below.

Tv	Shutter speed / AF frame
Av	Aperture value / AF frame
M	Shutter speed / Aperture value / AF frame

Switching between Light Metering Modes

		Mode Dial	P Tv Av M
	Evaluative Light Metering		
	Center-weighted Averaging		
	Spot AE Point		
	Center		
	AF Point		

1 Select * (Evaluative) in the FUNC. menu.

- See *Selecting Menus and Settings* (p. 66).



* The current setting is displayed.



2 Select a light metering mode using the left or right button and press the FUNC. button.



If you have selected  (Spot AE Point), go to step 3.

If you have selected  (Evaluative Light Metering) or  (Center-weighted Averaging), shoot the image.

3 In the (Rec.) menu, select [Spot AE Point].

- See *Selecting Menus and Settings* (p. 66).



4 Select [Center] or [AF Point] using the left or right button, then press the MENU button.

- When [Spot AE Point] is set to [Center], the spot AE point frame appears at the center of the LCD monitor.
- When [Spot AE Point] is set to [AF Point], it appears inside the selected AF frame.









e.g. Center
Spot AE Point



- The [AF Point] can only be selected when the AF frame is set on [FlexiZone].

Adjusting the Exposure

Mode Dial P Tv Av      **FUNC.** SCN  

Adjust the exposure compensation setting to avoid making the subject too dark when it is backlit or shot against a bright background in the night.

1 Select $\pm 0^*$ (+/- (Exp.)) in the FUNC. menu.

- See *Selecting Menus and Settings* (p. 66).

* The current setting is displayed.



2 Adjust the compensation using the left or right button.

- The settings can be adjusted in 1/3 stops in the range of -2 stops to +2 stops.
- You can check the results of the compensation by viewing the image on the LCD monitor when it is on.



- You can shoot the image right after selecting settings by pressing the shutter button. The menu displays again after the shot, allowing you to change the settings easily.

3 Press the FUNC. button.

- To cancel the exposure compensation, return the setting to 0 using the left or right button.









See *Photo Tips and Information* (p. 150).

Adjusting the Tone (White Balance)

Mode Dial P Tv Av M       

When the white balance is set to match the light source, the camera reproduces colors more accurately.

Combinations of setting contents and light source are as follows.

	Auto	Settings are automatically set by the camera
	Daylight	For recording outdoors on a bright day
	Cloudy	For recording under overcast, shady or twilight skies
	Tungsten	For recording under tungsten and bulb-type 3-wavelength fluorescent lighting
	Fluorescent	For recording under warm-white, color-white or warm-white (3-wavelength) fluorescent lighting
	Fluorescent H	For recording under daylight fluorescent, or daylight fluorescent-type 3-wavelength fluorescent lighting

	Custom	For setting a custom value with a white sheet of paper, etc., to obtain the optimal white balance for the conditions.
---	---------------	---

1 Select * (Auto) in the FUNC. menu.

- See *Selecting Menus and Settings* (p. 66).
- * The current setting is displayed.



2 Select the white balance you wish to set using the left or right button.

- See *Setting a Custom White Balance* (p. 87).
- When the LCD monitor is on, you can check the setting on the display.
- A shot can be taken immediately by pressing the shutter button. The menu will reappear after the shot, allowing you to adjust the setting easily.

3 Press the FUNC. button.



The white balance cannot be adjusted when the photo effect is set to (sepia) or (B/W) (p. 90).

Setting a Custom White Balance

You can set a custom white balance to obtain the optimal setting for the shooting conditions by having the camera evaluate an object, such as a piece of white paper or cloth, or a photo-quality gray card that you wish to establish as the standard white color. Especially in the following cases, as the white balance may not be adjusted in (Auto), shoot after reading the white balance data in (Custom).

- Shooting close-ups (Macro mode)
- Shooting subjects of monotone color (such as sky, sea, or forest)
- Shooting with a peculiar source of light (such as a mercury-vapor lamp)

1 Select * (Auto) in the FUNC. menu.

- See *Selecting Menus and Settings* (p. 66).
- * The current setting is displayed.

2 Select (Custom) using the left or right button.





3 Aim the camera at a piece of white paper or cloth, or gray card and press the SET button.





- Aim the camera so that the white paper or cloth, or gray card, completely fills the frame at the center of the LCD monitor or completely fills the viewfinder.
- You can shoot right after setting the white balance. The menu displays again after the shot, allowing you to change the settings easily.

4 Press the FUNC. button.



- You are recommended to set the white balance when shooting in the following conditions.
 - **The shooting mode dial is set to P and the exposure compensation is set to ± 0 .**
The correct white balance may not be obtained when the exposure is incorrect (image is completely black or white).
 - **The zoom is positioned to the telephoto end setting.**
Set the digital zoom to [Off].
 - **A Shooting mode other than  is selected.**
In  mode, white balance data cannot be read.
 - **The flash is set to  (Flash On) or  (Flash Off).**
Use the same flash setting as the one that will be used for shooting when you set the white balance. If the white balance setting conditions and shooting conditions are not the same, the correct white balance may not be obtained.

When the flash is set to   (Auto with red-eye reduction) or  (Auto), the flash may fire while the white balance data is recorded to the custom white balance. If this happens, make sure the flash also fires when you shoot the image.

- **The ISO speed is set to the same setting to shoot the image.**
- The custom white balance setting is not canceled even if settings are reset to default settings (p. 75).

Changing the ISO Speed

Mode Dial P Tv Av M

By raising the ISO speed, you can shoot bright images even in poor lighting conditions. This function is convenient when you want to prevent camera shake, shoot without the flash or shoot with a faster shutter speed in dark conditions.

1 Select * (ISO Speed) in the FUNC. menu.

- See *Selecting Menus and Settings* (p. 66).

* The current setting is displayed.



2 Select the ISO speed using the left or right button.

- A shot can be taken immediately by pressing the shutter button. The menu will reappear after the shot, allowing you to adjust the settings easily.

3 Press the FUNC. button.



- Higher ISO speeds increase the image noise. To take clean images, use as low an ISO speed as possible.
- The AUTO setting selects the optimal speed. It will automatically raise the speed when the light from the flash is insufficient to illuminate the subject matter.









- You can easily shoot images in dark places such as indoor settings by using the  (Indoor (p. 52)) option of the SCN mode.
- See *Photo Tips and Information* (p. 151).

Changing the Photo Effect

Mode Dial P Tv Av M       

You can shoot with different saturation and contrast color effects.

	Effect Off	Records normally with this setting.
	Vivid	Emphasizes the contrast and color saturation to record in bold color.
	Neutral	Tones down the contrast and color saturation to record neutral hues.
	Low Sharpening	Records subjects with softened outlines.
	Sepia	Records in sepia tones.
	B/W	Records in black and white.

1 Select * (Effect Off) in the FUNC. menu.

- See *Selecting Menus and Settings* (p. 66).



* The current setting is displayed.

2 Select the photo effect using the left or right button.

- If the LCD monitor is on, you can check the photo effect by viewing the image on the LCD monitor.
- A shot can be taken immediately by pressing the shutter button. The menu will reappear after the shot, allowing you to adjust the settings easily.

3 Press the FUNC. button.

Adjusting the Flash Output

Mode Dial **M**

In **M** mode, the flash output can be controlled in three steps when shooting.

1 Select (Flash Output) in the FUNC. menu.

- See *Selecting Menus and Settings* (p. 66).



2 Adjust the flash output using the left or right button.

- You can shoot the image right after selecting settings by pressing the shutter button. The menu will reappear after the shot, allowing you to change the settings easily.

3 Press the FUNC. button.



When the flash output is low, less shadow appears in the image. However, when shooting a wide scene or area, the image will likely be darker due to insufficient light. When adjusting the flash output, consider all the shooting conditions, including the distance to the subject.

Shooting Problem Subjects for the Autofocus

Mode Dial 

The autofocus may not work well on the following types of subjects.

- Subjects with extremely low contrast to the surroundings
- Subjects mixing close and far objects
- Subjects with extremely bright objects at the center of the composition
- Subjects that are moving quickly
- When shooting through glass, get as close as possible to avoid reflection off the glass.
- Subject with horizontal stripes

To shoot these subjects, first aim the camera at an object at a similar distance, lock the focus and recompose the image with the desired subject, or use manual focus.

Shooting with Focus Lock

- 1 Aim the AF frame at an object at a similar distance to the subject you wish to shoot.**
- 2 Press the shutter button halfway to lock the focus.**
 - The AE setting will also lock when you do this. The exposure may occasionally be incorrect if the difference between the two items is too great. Use AF Lock when this happens.
- 3 Recompose the image and press the shutter button all the way to shoot the image.**

Shooting with AF Lock

- 1 Press the shutter button halfway to lock the focus. Keep it pressed and press the MF button.**
 - The **MF** icon appears on the LCD monitor.
 - The focus setting will lock even if the shutter button and the **MF** button are released.

- The AF lock setting will cancel if the **MF** button is pressed again.

2 Recompose the image and press the shutter button all the way to shoot the image.



AF lock is not available in **AUTO** and  modes.



- When shooting with focus lock, you can lock the focus to the subject in the center AF frame by setting **AF** to [Center] in the [ (Rec.)] menu.
- Shooting with AF Lock is convenient because you can let go of the shutter button to recompose the image. Moreover, the focus remains locked after the shutter is released, so the same focus is used in subsequent shots.





Shooting in Manual Focus Mode

The focus can be manually set.

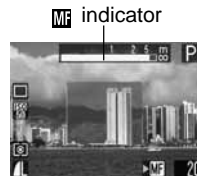
1 Press the **MF** button until **MF** appears.

- The **MF** indicator appears.



- When the [ (Rec.)] menu's [MF-Point Zoom] is set to [On], the portion of the image in that frame will appear magnified.*
- * Except in the  (Stitch Assist) or  (Movie), when the digital zoom is activated or a TV is used as the display.
- * Can also be set so that the image displayed is not magnified (p. 69).
- The **MF** indicator shows approximate figures. Use them as a shooting guideline only.
- In the **Tv**, **Av**, or **M** modes, pressing the **SET** button cycles the selection between the shutter speed, the aperture value, and the **MF** indicator. (A green  appears next to the selected item).

2 Focus using the left or right button and shoot the image.

- Adjust the focus using the left or right button until the image appears focused on the LCD monitor.
- Pressing the **MF** button again cancels the manual focus mode.



- You can use manual focus in the macro focal distance 5 to 45 cm (2.0 in. to 1.5 ft.) at wide angle end and 25 to 45 cm (9.8 in. to 1.5 ft.) at telephoto end. In this case, the fine scale is adopted.
- You can change the MF indicator displayed distance units (p. 73).

C Saving Custom Settings

Mode Dial P Tv Av M C

You can save frequently used shooting modes and various shooting settings to the **C** (Custom) mode. When necessary, you can then shoot images with previously saved settings by simply turning the shooting mode dial to **C**. Settings that are usually forgotten when the shooting mode is changed or when the power is turned off (such as Continuous Shooting and Self-timer mode) are also remembered.

1 Turn the shooting mode dial to **P**, **Tv**, **Av**, **M** or **C**.

- When you wish to re-save partially modified settings (except shooting mode) that were previously saved in the **C** mode, select **C**.

2 Set the setting contents you wish to save.

Settings that can be saved to the **C** mode

- Shooting mode (**P**, **Tv**, **Av**, **M**)
- Items that can be set in **P**, **Tv**, **Av** and **M** modes (p. 159)

- Shooting menu settings
- Zoom location
- Manual focus location

3 Select [Save Settings] in the [] (Rec.) menu and press the SET button.

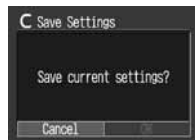

- See *Selecting Menus and Settings* (p. 66).

4 Select [OK] and press the SET button.

5 Press the MENU button.



- The setting contents do not influence other shooting modes.
- Saved settings can be reset (p. 75).

Setting the Auto Rotate Function

This camera is equipped with an Intelligent Orientation sensor that detects the orientation of an image shot with the camera held vertically and automatically rotates it to the correct viewing orientation in the display. You can set this function on/off.

1 In the [] (Set up) menu, select [] (Auto Rotate).

- See *Selecting Menus and Settings* (p. 66).



2 Select [On] and press the MENU button.

- When this function is on, an icon showing the orientation of the camera appears at the upper right corner of the LCD monitor (when information display is on).

	Normal
	Right end down
	Left end down



- This function may not operate correctly when the camera is pointed straight up or down. Check that the arrow  is pointing in the right direction and if it is not, then set the Auto Rotate function to [Off].
- Even if the Auto Rotate function is set to [On], the orientation of images downloaded to a computer will depend upon the software used to download the images.



- When the camera is held vertically to shoot, the Intelligent Orientation sensor judges the upper end to be “up” and the lower end to be “down”. It then regulates the optimal white balance and exposure for vertical photography. This function operates regardless of the on/off status of the Auto Rotate function.
- When changing the camera’s orientation between the horizontal and vertical positions, you may hear noise coming from the orientation detection mechanism. This is not a malfunction.

Playback – Advanced Functions

Rotating Images in the Display



You can rotate an image by 90° or 270° clockwise in the LCD monitor.



(Original)

90°

270°

1 In the [ (Play)] menu, select  (Rotate) and press the SET button.

- See *Selecting Menus and Settings* (p. 66).

2 Press the left or right button to select the image to be rotated and press the SET button.

- Press the SET button to rotate the image 90°, 270° and back to original orientation.

3 Press the MENU button.

- The Play menu appears again. Press the MENU button again to close the menu.



- Movie images cannot be rotated.
- When images are downloaded to a computer, the orientation of images rotated by the camera will depend upon the software used to download the images.



- Rotated images can be magnified (p. 58).
- Images taken vertically with the auto rotate function (p. 95) set to [On] will automatically be rotated to the vertical position when viewed on the LCD monitor.

Attaching Sound Memos to Image

In Playback mode (including single image playback, index playback and magnified playback), you can attach sound memos (up to 60 seconds) to an image. The sound data are saved in WAVE format.

1 Select (Sound Memo) in the [(Play)] menu and press the SET button.

- See *Selecting Menus and Settings* (p. 66).
-  appears.

2 Select the image to which you wish to attach the sound memo using the left or right button, and press the SET button.

- The Sound Memo panel appears.





Sound Memo Panel

3 Select (Record) using the left or right button and press the SET button.

- The recording starts and the elapsed time is displayed. Speak towards the microphone of the camera.
- To stop recording, press the SET button. To restart recording press the SET button again.
- Up to 60 seconds of recordings may be added to any one image.

Playing the Sound Memos

- Select  (Play) in step 3. The  icon is displayed on images with sound memos.
- To stop playback, press the SET button. To resume playback, press the SET button again. You can adjust the volume using the up or down button.

Erasing the Sound Memos

- Select  (Erase) in step 3.

Exiting the Sound Memos Settings

- Press the MENU button.



- You cannot attach sound memos to movies.
- You cannot record or play back sound memos for images that already have an incompatible sound file attached. If you attempt to record or play such images the “Incompatible WAVE format” message will display. Incompatible sound files can be deleted with this camera.
- Sound memos for protected images cannot be erased (p. 100).



- You can also adjust the volume of the sound memo in the Set up menu (p. 71).
- If you set [Mute] to [On] in the Set up menu (p. 71), no sound is reproduced. However, you can resume the sound and adjust the volume during sound playback by using the up or down button.

Auto Play

Use this feature to automatically play back all of the images in the CF card (Auto Play). The LCD monitor displays each image for approximately 3 seconds.

1 In the [(Play)] menu, select (Auto Play) and press the SET button.

- See *Selecting Menus and Settings* (p. 66).
- Once you have selected it, Auto Play starts.
- As with the single image playback mode, using the left or right button during auto play will advance through the images more rapidly.

Pausing and Resuming Auto Play

- You can pause Auto Play at any time by pressing the **SET** button. You can then restart it by pressing the **SET** button again.

Stopping Auto Play

- To stop Auto Play, press the **MENU** button.



- The display interval may vary for some images.
- Movie images play for the length of time that they were recorded.
- The power saving function is disabled during Auto Play (p. 99).

Protecting Images

Use the protect feature to protect important images from accidental erasure.

1 In the [ (Play)] menu, select **(Protect)** and press the **SET** button.

- See *Selecting Menus and Settings* (p. 66).

2 Select an image you want to protect using the left or right button and press the **SET** button.



Protected Icon

- The  icon appears on protected images.
- To release the protection, press the **SET** button again.
- Images can be selected in both single image playback and index playback modes (p. 58, 59).

3 Press the MENU button.

- The camera returns to the menu screen. Press the **MENU** button again to exit the menu screen.



Please note that formatting (initializing) a CF card (p. 19) erases all data, including protected images and other file types. Please check the contents of a CF card before formatting it.

About Printing

There are two ways of printing images shot with this camera.

- You can easily print images stored in the CF card by connecting the camera to a direct print compatible printer*1 with a cable and then pressing the camera's  button.
- You can specify the images on your CF card you want to print and how many copies you want (DPOF*2 Print Settings), and then take the CF card to a participating photo lab that supports DPOF to have them printed out later.

*1This camera complies with the industry standard *PictBridge*, therefore, you can connect the camera to non-Canon *PictBridge* compliant printers and print images.

*2Digital Print Order Format

This manual explains the DPOF print settings. For information on how to print images, refer to the *Direct Print User Guide* supplied with the camera. Also, refer to your printer's manual.

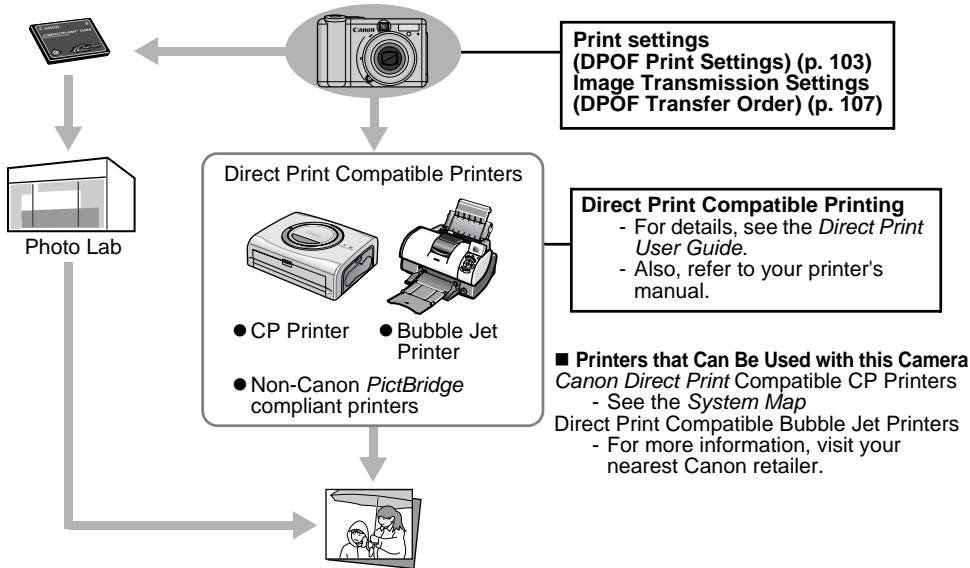

DPOF Print Settings



You can select images on a CF card for printing and specify the number of print copies in advance using the camera. This is extremely convenient for sending the images to a photo developing service that supports DPOF or for printing on a direct print function compatible printer.

Refer to the *Direct Print User Guide* for instructions on how to select print settings from the printer.



- The  mark may appear on images that have had print marks set by another DPOF compliant camera. These settings will be overwritten by any print marks set by your camera.
- The output of some digital printers or photo lab services may not reflect the specified print settings.
- Print settings cannot be set for movies.

Selecting Images for Printing

1 In the [ (Play)] menu, select  (Print Order) and press the SET button.

- See *Selecting Menus and Settings* (p. 66).

2 Select [Order] using the left or right button and press the SET button.



3 Select images for printing.

Single Images

- When the print type (p. 105) is set to [Standard] or [Both], select an image using the left or right button. You can set the number of copies (up to 99) to be printed using the up or down button.

Number of Copies



- When the print type (p. 105) is set to [Index], select an image using the left or right button and mark or remove marks from images using the up or down button. A check mark appears on the marked image.



- You can press the zoom lever toward  and use the same procedures to select images in index playback (three images).

All the Images on a CF Card

- Press the zoom lever toward  to switch to index playback (three images).
- You can set one copy of each image to print by pressing the **SET** button, then selecting [Mark all] using the up or down button, and pressing the **SET** button again.
- When the print type is set to [Standard] or [Both], the setting for the number of print copies can be changed for each image. When [Index] is selected, the print settings



can be deleted. For the instructions on changing settings, please reread Step 3 from the beginning.

- You can cancel all the settings by selecting [Clear all].

4 Press the MENU button.







- The setting will be complete and the Print Order menu will reappear.





- Images are printed in order from oldest to newest by the shooting date.
- A maximum of 998 images can be set.
- When [Print Type] is set to [Both], the number of copies can be set. When it is set to [Index], the number of copies cannot be set (only one copy will be printed).
- Print settings can also be assigned to images with the bundled software programs (ZoomBrowser EX or ImageBrowser) on a computer. However, do not set the date in the DPOF print settings when printing images that have had the date embedded with the [Date Stamp] function. This may cause the date to be printed twice.

Setting the Print Style

You can set up the print style as follows.



 Print Type	 Standard	Prints one image per page.
	 Index	Prints the selected images together at a reduced size in an index format.
	  Both	Prints the images in both the standard and index formats.
 Date		Adds the date to the print.
 File No.		Adds the file number to the print.

1 In the [] (**Play**) menu, select  (**Print Order**) and press the **SET** button.

- See *Selecting Menus and Settings* (p. 66).

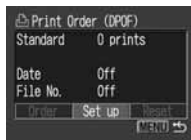
2 Select [Set up] using the left or right button and press the **SET** button.



3 Select  (**Print Type**),  (**Date**) or  (**File No.**) using the up or down button.

4 Select a setting using the left or right button.



 **Print Type**
Select [Standard], [Index] or [Both].



 **Date**
Select [On] or [Off].



 **File No.**
Select [On] or [Off].

5 Press the MENU button.

- The set up menu will close and the Print Order menu will reappear.



- When [Print Type] is set to [Index], the [Date] and [File No.] cannot be set to [On] at the same time.
- Both [Date] and [File No.] can be set to [On] if [Print Type] is set to [Both] or [Standard]. However, when connected to a CP printer, only the date is printed for the standard print and only the file number is printed for the index print.



The date prints as the date and time in the format specified in the Date/Time menu (p. 21).

Resetting the Print Settings

The Reset feature clears all print selections, and resets Print Type to [Standard], Date to [Off], and File No. to [Off].

1 In the [Play] menu, select [Print Order] and press the SET button.

- See *Selecting Menus and Settings* (p. 66).

2 Select [Reset] using the left or right button and press the SET button.



3 Select [OK] using the left or right button and press the SET button.

- Select [Cancel] and press the SET button to cancel the reset.



Image Transmission Settings (DPOF Transfer Order)

You can use the camera to specify settings for images before downloading to a computer. Refer to the *Software Starter Guide* for instructions on how to transfer images to your computer. You cannot use this function to transfer several images at once to a Mac OS X computer. The settings used on the camera comply with the Digital Print Order Format (DPOF) standards.



- The  mark may appear on images that have had transfer marks set by another DPOF compliant camera. These settings will be overwritten by any marks set by your camera.

Selecting Images for Transferring

- 1** In the [ (Play)] menu, select  (Transfer Order) and press the SET button.

- See *Selecting Menus and Settings* (p. 66).

- 2** Select [Order] using the left or right button and press the SET button.



- You can remove all the transfer marks at once by selecting [Reset].

- 3** Select images for transferring.

Single Images

- Use the left or right button to select the image and mark or remove check marks from images using the up or down button. The check marks are displayed when set.
- You can press the zoom lever toward  and use the same procedures to select images in index playback (three images).



All the Images on a CF Card

- Press the zoom lever toward  to switch to index playback (three images).
- Press the **SET** button, select [Mark all] using the up or down button and press the **SET** button again to mark all the images. (If you select [Clear all] instead of [Mark all], you can remove marks from all the images.)
- You can select images using the left or right button and change the settings using the up or down button after [Mark all] or [Clear all] has been selected.



4 Press the MENU button.

- The selection mode will turn off and the Transfer Order menu will reappear.



- Images are transferred in order from oldest to newest by the shooting date.
- A maximum of 998 images can be marked.

Downloading Images to a Computer

The following methods can be used to download images recorded by the camera to a computer. Some methods are not applicable to all operating systems.

● Downloading via a Camera to Computer Connection



- With this method, you download images using computer commands after you have installed the appropriate software.
→ See *Connecting the Camera to a Computer* (p. 109) and the separate *Software Starter Guide*.



- With this method, you download images using camera button operations after you have installed the appropriate software (the computer settings only need to be adjusted for the first download).
→ See *Connecting the Camera to a Computer* (p. 109) and *Downloading Images by Direct Transfer* (p. 113).

Windows
XP

Mac
OS X

- With this method, you download images using computer commands without installing any software.

→ See *Connecting the Camera to a Computer* (below) (software installation is not required) and *Connecting the Camera to the Computer to Download Images without Installing the Software* (p. 115).

● Downloading Directly from a CF Card

With this method, you download images using a card adapter or card reader.

→ See *Downloading Directly from a CF card* (p. 116).

Connecting the Camera to a Computer

Computer System Requirements

● Windows

OS	Windows 98 (Including Second Edition) Windows Me Windows 2000 Windows XP (Home Edition, Professional)
Computer Model	The above OS should be pre-installed on computers with built-in USB ports.

CPU	Windows 98/Windows Me/Windows 2000: Pentium 150 MHz or higher processor Windows XP: Pentium 300 MHz or higher processor For all of the above OS: Pentium 500 MHz or higher processor is recommended (for editing movies)
RAM	Windows 98/Windows Me/Windows 2000: 64 MB or more Windows XP: 128 MB or more For all of the above OS: 128 MB or more is recommended (for editing movies)
Interface	USB
Free Hard Disk Space	<ul style="list-style-type: none"> ● Canon Utilities <ul style="list-style-type: none"> - ZoomBrowser EX : 200 MB or more (Including the PhotoRecord printing program) - PhotoStitch : 40 MB or more ● Canon Camera TWAIN Driver : 25 MB or more ● Canon Camera WIA Driver : 25 MB or more
Display	800 x 600 pixels/High Color (16 bit) or better is required 1,024 x 768 pixels or better is recommended

● Macintosh

OS	Mac OS 9.0 – 9.2, Mac OS X (v10.1/v10.2/v10.3)
Computer Model	The above OS should be pre-installed on computers with built-in USB ports.
CPU	PowerPC
RAM	Mac OS 9.0 – 9.2: 64 MB or more of application memory Mac OS X (v10.1/v10.2/v10.3): 128 MB or more
Interface	USB
Free Hard Disk Space	● Canon Utilities - ImageBrowser: 120 MB or more - PhotoStitch : 30 MB or more
Display	800 x 600 pixels/32,000 colors or better is required 1,024 x 768 pixels or better is recommended

IMPORTANT

You must install the software and driver bundled on the supplied Canon Digital Camera Solution Disk onto your computer before connecting the camera to a computer.



The camera will not operate correctly if you connect it to your computer before installing the driver and software. If this happens, please refer to the *Troubleshooting* section of the *Software Starter Guide*.



- You do not need to turn off the camera or computer power when making a USB connection.
- Please refer to your computer's manual for information regarding the location of the USB port.
- You are recommended to use new AA size batteries, fully charged AA size NiMH batteries or AC Adapter Kit ACK600 (sold separately) to power the camera when connecting to a computer (p. 132, 134).
- All procedures performed with a connection to a USB 2.0 compliant board are not guaranteed.

1 Install the driver and the software applications bundled on the Canon Digital Camera Solution Disk (first time only).

- Please see the *Software Starter Guide* for the installation procedures.

2 Use the supplied interface cable to connect the computer's USB port to the camera's DIGITAL terminal.

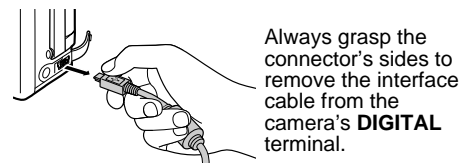
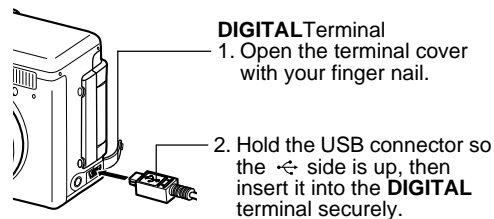
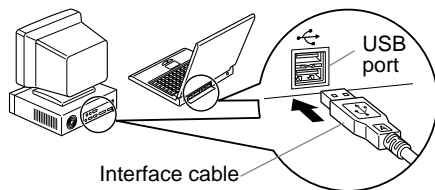

3 Slide the camera's mode switch to .

4 Press the ON/OFF button until the power lamp lights green.

- Windows
→ Proceed to steps 5 and 6 on the right.
- Macintosh
→ Refer to the *Software Starter Guide* and download images.

5 Select [Canon CameraWindow] in the events dialog that appears on the computer and click [OK] (first time only).

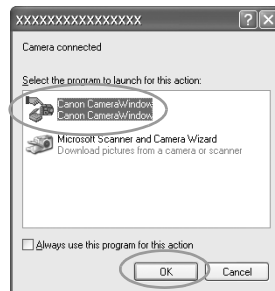

! If the events dialog fails to appear, click the [Start] menu, followed by [Programs] or [All Programs], [Canon Utilities], [CameraWindow], and [CameraWindow - Set Auto-Launch].

6 Click [Set] in the [CameraWindow - Set Auto-Launch] window (first time only).



- The Download Image window will display.





- **Using the software and computer to download images:**
→ See the *Software Starter Guide*.
- **Using the Camera to Download Images (Direct Transfer Function):**
→ See *Downloading Images by Direct Transfer* (below).

Downloading Images by Direct Transfer

Use this method to download images using camera operations.

Install the supplied software and adjust the computer settings before using this method for the first time (p. 110).

	All Images	Transfers and saves all images to the computer.
	New Images	Transfers and saves to the computer only the images that have not been previously transferred.
	DPOF Trans. Images	Transfers and saves to the computer only the images with DPOF Transfer Order settings (p. 107).

	Select & Transfer	Transfers and saves single images to the computer as you view and select them.
	Wallpaper	Transfers and saves single images to the computer as you view and select them. The transferred images display on the computer desktop.

1 Confirm that the Direct Transfer menu is displayed on the camera's LCD monitor.

- The  button will light blue.
- Press the **MENU** button if the Direct Transfer menu fails to appear.



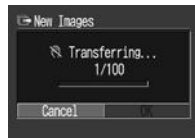

All Images/New Images/DPOF Trans. Images

2 Use the up or down button to select ,  or  and press the  button.



- To cancel the transfer, press the **SET** button.
- The images will download and the Direct Transfer menu will reappear.

Select & Transfer/Wallpaper

2 Use the up or down button to select , or  and press the  button (or SET button).

3 Use the left or right button to select images to download and press the  button (or SET button).

- The images will download.
- The  button will blink blue while downloading is in progress.



4 Press the MENU button.

- The Direct Transfer menu will display again.



Only JPEG format images can be downloaded as wallpaper for the computer. After images are transferred, they are automatically converted to BMP format.



- During the downloading of images with [All Images], [New Images] or [DPOF Trans. Images], the  button does not blink blue.
- The option selected with the  button is retained even when the camera's power is turned off. The previous setting will be in effect the next time the Direct Transfer menu is displayed. The image selection screen will appear directly when the [Select & Transfer] or the [Wallpaper] option was last selected.

Connecting the Camera to the Computer to Download Images without Installing the Software

If you are using Windows XP or Mac OS X (v10.1/v10.2/v10.3), you can use the software distributed with these operating systems to download images without installing the software bundled on the Canon Digital Camera Solution Disk. This is useful for downloading images to a computer in which the software is not installed.

However, please note that there are certain limitations to downloading images with this method. For more details, please refer to the *For Windows® XP and Mac OS X Users* leaflet.

1 Use the supplied interface cable to connect the computer's USB port to the camera's DIGITAL terminal.

- See steps 2 to 4 on page 111.

2 Follow the onscreen instructions to proceed with downloading.

Downloading Directly from a CF card

- 1 Eject the CF card from the camera and insert it into a CF card reader connected to the computer.**

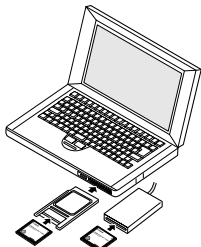

- If you are using a PC card reader or a PC card slot, first insert the CF card into a PC card adapter (sold separately) and then insert the loaded adapter into the slot.
- Refer to your card adapter's or card reader's manual for information regarding the connection between the computer and card adapter or card reader.

- 2 Double-click the icon of the drive with the CF card.**

- Depending on the operating system, a window opens automatically.

- 3 Copy images from the card into a folder of your choice on the hard disk.**

- The images are stored in the [xxx CANON] folders located in the [DCIM] folder (where xxx is a three-digit number from 100 to 998 (p. 119)).

Viewing Images on a TV Set

The supplied AV cable AVC-DC300 can be used to view images as you shoot or play them back.

- 1** Turn off the camera (p. 31) and the TV.
- 2** Attach the AV cable to the AV/Out terminal on the camera.

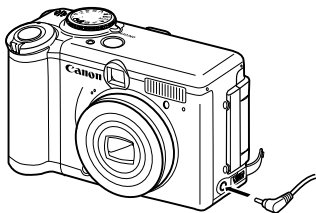

- 3** Plug the other ends of the AV cable to the video in and audio in jacks on the TV.

Yellow Plug to the Video In Jack



Black Plug to the Audio In Jack

- 4** Turn on the TV and switch it to Video mode.

- 5** Turn on the camera (p. 31).

- The image will appear on the TV. Shoot or playback images as usual.
- If the images are not appearing on the TV when shooting, press the **DISP.** button.



- No image will appear on the LCD monitor when the camera is connected to a TV monitor.
- The video output signal can be switched (NTSC or PAL) to accommodate different regional standards (p. 73). The default setting varies between regions.
 - NTSC: Japan, U.S.A., Canada, Taiwan, etc.
 - PAL: Europe, Asia (excluding Taiwan), Oceania, etc.

If the video system is set incorrectly, the camera output may not display properly.

- If the TV is a stereo model, you can plug the audio plug into either the left or right Audio In jack. Please refer to the TV's manual for details.
- A TV set cannot be used in  mode.

Resetting the File Number

You can select the way file numbers are assigned.

On	The file numbers are reset to the start (100-0001) each time a new CF card is inserted. New images recorded on CF cards with existing files are assigned the next available number.
Off	The file number of the last image to be shot is memorized so that images recorded to a new CF card start from the next number.

1 In the [] (Set up) menu, select (File No. Reset).

- See *Selecting Menus and Settings* (p. 66).



2 Select [On] or [Off] using the left or right button.

3 Press the MENU button.



Setting the File No. Reset to [Off] is useful for avoiding file name duplication when images are downloaded to a computer.

About File and Folder Numbers

Images are assigned file numbers from 0001 to 9900, and folders are assigned folder numbers from 100 to 998 (Folder numbers cannot contain 99 in the last two digits).

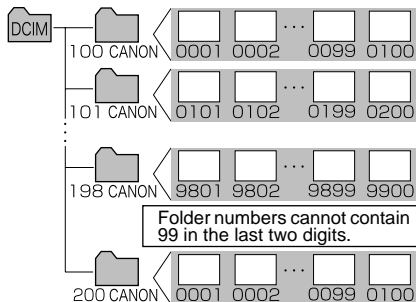

Folder File Capacity

Each folder usually contains up to 100 images. However, since images shot in continuous shooting and stitch assist mode are always saved into the same folder, a folder may contain more than 100 images. The number of images may also exceed 100 if a folder contains images copied from a computer or images shot with other cameras. Please note, however, that the images in folders containing 2001 or more images cannot be played back in this camera.

Customizing the Camera (My Camera Settings)

My Camera allows you to customize the start-up image and start-up, operation, self-timer and shutter sounds. Each menu item has three choices.

Example: Start-up image



1

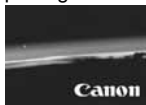

2



3

As default settings, My Camera setting 2 has a science fiction theme and My Camera setting 3 has an animal theme.

Changing My Camera Settings

1 Press the MENU button.

- The [REC.] (Rec.) or [PLAY] (Play) menu appears.



2 Select the [My Camera] menu using the left or right button and select a menu item using the up or down button.

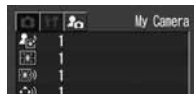

3 Select the contents you wish to set using the left or right button.



4 Press the MENU button.

- The menu closes and settings are activated.
- In Shooting mode, the menu can be closed by pressing the shutter button halfway.



- If you select [Theme] in Step 2, you can select a consistent theme for each of the My Camera settings.
- If [Mute] in the [Set up] menu is set to [On], no sound is reproduced except for the warning signal regardless of the selected My Camera settings (p. 74). The Start-up image displays.

Registering My Camera Settings

Images recorded onto the CF card and newly recorded sounds can be added to the camera. You can also use the supplied software to upload your computer's images and sounds to the camera. The following menu items can be saved to the camera.

- Start-up Image
- Start-up Sound
- Operation Sound
- Self-timer Sound
- Shutter Sound



To revert My Camera settings to default, register the default setting contents with the supplied software programs (ZoomBrowser EX/ImageBrowser) on a computer.

Registering the CF Card Images and Sounds

- 1** Slide the mode switch to .
 - The camera powers into Playback mode.
- 2** Press the MENU button.
 - The [] (Play) menu appears.



- 3** Select [] (My Camera) using the left or right button and select the menu item you wish to register using the up or down button.

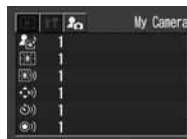

4 Select **[2]** or **[3]** using the left or right button.



- **[DISP]** **[2]** appears.

5 Press the **DISP.** button.

- An image appears.

Start-up Image: Go to step **6a**, **7a**
 Start-up Sound, Shutter Sound, Operation Sound,
 and Self-timer Sound: Go to step **6b**, **7b**

6a Select the image you wish to register using the left or right button.



7a Press the **SET** button.

6b Select **[●]** (Record) using the left or right button and press the **SET** button.



- Recording starts.
- Recording stops when the time is exceeded.
- Start-up Sound: 1second
- Operation Sound: 0.3 seconds
- Self-timer Sound: 2 seconds
- Shutter Sound: 0.3 seconds

7b Select **[2]** (Register) using the left or right button and press the **SET** button.

8 Select **[OK]** using the left or right button and press the **SET** button.





- Sounds recorded with the movies and sound memo function cannot be added as My Camera settings (p. 56, 98).
- When you register new My Camera settings, the previously registered settings are erased.

File Format of My Camera Settings

My Camera settings should conform to the below file formats. However, CF card images shot with this camera can be registered as My Camera settings regardless of the below formats. **(excluding movies and sound memos (p. 98))**





• Start-up Image

- Recording Format JPEG (baseline JPEG)
- Sampling Rate 4:2:0 or 4:2:2
- Image Size 320 x 240 pixels
- File Capacity 20 KB or less

• Start-up, Operation, Self-timer and Shutter Sounds

- Recording Format WAVE (monaural)
- Quantization Bits 8 bit
- Sampling Frequency 11.025 kHz or 8.000 kHz

• Recording Time

	11.025 kHz	8.000 kHz
 Start-up Sound	1.0 sec. or less	1.3 sec. or less
 Operation Sound	0.3 sec. or less	0.4 sec. or less
 Self-timer Sound	2.0 sec. or less	2.0 sec. or less
 Shutter Sound	0.3 sec. or less	0.4 sec. or less

Any file formats other than those described above cannot be used with this camera.

An example of this function is to record “Say Cheese” as a self-timer sound so the camera will play back this sound 2 seconds before the photo is taken. You could also record cheerful music to bring out the natural smiles of your subjects, or so they can strike a pose fitting the music. In these ways, you can customize your camera by creating and adding new My Camera settings.

See the supplied *Software Starter Guide* for more information on creating and adding to the My Camera Settings files.

List of Messages

The following messages may appear on the LCD monitor.

- For messages which may appear when a printer is connected, refer to the *Direct Print User Guide*.

Busy...	The camera is recording image data to the CF card. The playback mode is running.
No memory card	You turned on the power without a CF card installed.
Cannot record !	You attempted to shoot with no CF card installed.
Memory card error !	There is something wrong with the CF card.
Memory card full	CF card is too full to accommodate more images or print settings.
Naming error !	The file could not be created because there is a file with the same name as the directory that the camera is attempting to create, or the highest possible file number has already been reached. In the Set up menu, please set [File No. Reset] to [On]. After you save all the images you wish to retain onto a computer, format the CF card (p. 19). Please note that formatting will erase all the existing images and other data.
Change the batteries	Battery charge is insufficient to operate the camera. Replace all batteries at the same time with new AA-size alkaline batteries (p. 15) or fully recharged Canon NiMH batteries.
No image	No images recorded on CF card.
Image too large	You attempted to play back an image larger than 4064 x 3048 pixels or with a large file size.
Incompatible JPEG format	You attempted to play back an incompatible JPEG file.
Corrupted data	You attempted to play back an image with corrupted data.

RAW	You attempted to play back an image recorded in the RAW format.
Unidentified Image	You attempted to play back an image that was recorded in a special format (proprietary format used by the camera of another manufacturer, etc.) or a movie recorded by another camera.
Cannot magnify !	You attempted to magnify an image which was photographed with another camera, recorded in a different format, or edited on a computer or a movie clip.
Cannot rotate !	You attempted to rotate an image which was photographed with another camera, recorded in a different format, or edited on a computer or a movie clip.
Incompatible WAVE format	A Sound memo cannot be added to this image since the format of the existing sound memo is incorrect.
Cannot register this image !	You attempted to register an image recorded with another camera or a movie clip as a start-up image.
Protected !	You attempted to erase a protected image or movie clip.
Too many marks	Too many images have been marked for printing or transferring. Cannot process any more.
Unselectable image	You attempted to set the print settings for a non-JPEG file.
Exx	Camera malfunctioned. Turn off the power and turn on again, then re-shoot or play back. If the same message recurs frequently, the camera may be damaged. Note the error number [xx] and take the camera to a Customer Support Help Desk. If this message appears immediately after you have taken a shot, the camera may not have shot the image. Switch to the Playback mode and check whether the image was actually recorded.

Troubleshooting

Problem	Cause	Solution
The camera will not operate	Power is not turned on.	<ul style="list-style-type: none"> ● Press the ON/OFF button for a few moments.
	CF card slot cover or battery cover is open.	<ul style="list-style-type: none"> ● Be sure the cover is closed securely.
	Batteries are loaded in the wrong direction.	<ul style="list-style-type: none"> ● Reload the batteries in the correct direction.
	Batteries are depleted.	<ul style="list-style-type: none"> ● Replace with unused alkaline or fully recharged batteries (four AA-size batteries). ● Use the Compact Power Adapter.
	Batteries are not the right type.	<ul style="list-style-type: none"> ● Use only unused AA-size alkaline batteries or Canon AA-size NiMH batteries. (For information about alkaline batteries, see <i>Proper Battery Handling</i> (p. 15).)
	Poor contact between camera and battery terminals.	<ul style="list-style-type: none"> ● Wipe the battery terminals with a clean dry cloth. ● Reload the batteries several times.
The camera will not record	Camera is in Playback mode.	<ul style="list-style-type: none"> ● Change to the Shooting mode.
	Flash is charging.	<ul style="list-style-type: none"> ● Wait until the flash charges. You can press the shutter button when the upper indicator lights orange.
	CF card full.	<ul style="list-style-type: none"> ● Insert a new CF card. ● If required, download the images to a computer and erase them from the CF card to make space.



Problem	Cause	Solution
The camera will not record	CF card not formatted correctly.	<ul style="list-style-type: none"> ● Format the CF card. (See <i>Formatting a CF Card</i> (p. 19)). ● If reformatting does not work, the CF card logic circuits may be damaged. Contact the nearest Canon Customer Help Desk.
Cannot play back	You attempted to play back images shot with another camera or images edited at a computer.	<ul style="list-style-type: none"> ● Computer images that cannot be played back will playback if they are added to the camera using the bundled software program ZoomBrowser EX or ImageBrowser. See the <i>ZoomBrowser EX/ImageBrowser Software User Guide</i> (PDF).
	File name was changed with a computer or file location was changed.	<ul style="list-style-type: none"> ● Set the file name or location to the file format/structure of the camera (See <i>About File and Folder Numbers</i> (p. 119)).
Lens will not retract	Battery cover or CF card slot cover opened with camera on.	<ul style="list-style-type: none"> ● Close the CF card slot cover or battery cover, then turn off the camera.
	Battery cover or CF card slot cover opened while camera was recording to CF card (warning signal sounds).	<ul style="list-style-type: none"> ● Close the CF card slot cover or battery cover, then turn off the camera.

Problem	Cause	Solution
Batteries consumed quickly.	Batteries are not the right type.	<ul style="list-style-type: none"> ● Use only unused AA-size alkaline batteries or Canon AA-size NiMH batteries. (For information about alkaline batteries, see <i>Proper Battery Handling</i> (p. 15).)
	Battery capacity drops due to low ambient temperatures.	<ul style="list-style-type: none"> ● If shooting in a cold area, keep the batteries warm (by placing them in an inner pocket, etc.) until ready to use them.
	Battery terminals are dirty.	<ul style="list-style-type: none"> ● Wipe them well with a dry cloth before use. ● Reload the batteries several times.
	Batteries have not been used for over a year.	<ul style="list-style-type: none"> ● If using rechargeable batteries: Performance should return to normal after several charging cycles.
	If using rechargeable batteries: Battery life exceeded.	<ul style="list-style-type: none"> ● Replace all 4 batteries with new ones.
If using rechargeable batteries: Batteries do not charge in separately sold battery charger.	Batteries were placed in the charger in the wrong direction.	<ul style="list-style-type: none"> ● Put batteries back into the charger in the correct direction.
	Poor electrical contact, between batteries and the charger.	<ul style="list-style-type: none"> ● Be sure to set batteries firmly into the charger. ● Be sure that the power cord is firmly connected to the charger, and is firmly plugged in to the power outlet.
	Battery terminals are dirty.	<ul style="list-style-type: none"> ● Wipe them well with a dry cloth before charging.
	Battery life exceeded.	<ul style="list-style-type: none"> ● Replace all 4 batteries with new ones.

Problem	Cause	Solution
Image is blurred or out of focus	Camera moved	<ul style="list-style-type: none"> ● Hold the camera steady while pressing the shutter button.
	Autofocus function hampered by obstruction to AF-assist beam.	<ul style="list-style-type: none"> ● Be careful not to block the AF-assist beam flash part with a finger or other object.
	The AF-assist beam is set to [Off].	<ul style="list-style-type: none"> ● Set the [AF-assist beam] to [On] (p. 69).
	Subject out of focal range.	<ul style="list-style-type: none"> ● Ensure that there is at least 45 cm (1.5 ft.) between the camera lens and subject. ● Use the Macro mode to shoot close-ups between 5 and 45 cm (2.0 in. to 1.5 ft.) from the lens when set to wide angle and between 25 to 45 cm (9.8 in. to 1.5 ft.) when set to telephoto.
	Subject is hard to focus on.	<ul style="list-style-type: none"> ● Use the focus lock or the manual focus to shoot the image. (See <i>Shooting Problem Subjects for the Autofocus</i> (p. 92))
Subject in recorded image is too dark	Insufficient light for shooting.	<ul style="list-style-type: none"> ● Set the flash on.
	Subject dark in comparison to the background.	<ul style="list-style-type: none"> ● Set exposure compensation to a positive (+) value or use the spot metering function.
	Subject too far for flash to reach.	<ul style="list-style-type: none"> ● When the flash is used, the distance between lens and subject should not exceed 4.4 m (14 ft.) at wide angle and 2.5 m (8.2 ft.) at telephoto. ● Raise the ISO sensitivity and then shoot. (See <i>Changing the ISO Speed</i> (p. 89))

Troubleshooting

Problem	Cause	Solution
Subject in recorded image is too bright	Subject too close causing flash to be too bright.	● When the flash is used, the distance between lens and subject should be no less than 45 cm (1.5 ft.).
	Subject bright in comparison to the background	● Set exposure compensation to a negative (-) value or use the spot metering function.
	Light shining directly on subject or reflected off subject into the camera.	● Adjust the camera angle.
	Flash set to On	● Set the flash to any other mode except On.
A vertical bar of light (red, purple) appears on the LCD monitor.	Subject too bright.	● This is a normal occurrence in devices containing CCDs and does not constitute a malfunction. (This red bar of light will not be recorded when shooting still photos, but it will be recorded when shooting movies.)
White dots or white asterisks appear on the image.	Light from the flash has reflected off dust particles or insects in the air. This occurs more frequently in the following conditions: - When shooting at the wide angle end. - When shooting with a high aperture value in the aperture-priority AE mode.	● This is a phenomenon that occurs with digital cameras and does not constitute a malfunction.
Flash will not fire	Flash set to Off	● Set the flash to On.

Problem	Cause	Solution
Image not showing on TV.	Incorrect video system setting.	<ul style="list-style-type: none"> ● Set the video system to the appropriate setting, NTSC or PAL, for your TV (p. 118).
	Shooting mode set to  (Stitch Assist).	<ul style="list-style-type: none"> ● The output will not appear on a TV monitor in  (Stitch Assist) mode. Shoot in a different mode.
Zoom does not operate.	Zoom lever was pressed while shooting in Movie mode.	<ul style="list-style-type: none"> ● Operate the zoom before shooting in Movie mode.
Reading images from CF card is slow.	Currently used CF card was formatted in another device.	<ul style="list-style-type: none"> ● Use a CF card formatted in your camera. See <i>Formatting a CF Card</i> (p. 19).
Recording images to CF card takes a long time.		

Using the Power Kits (Sold Separately)

Using Rechargeable Batteries

(Battery and Charger Kit CBK4-200)

Included are the battery charger and four rechargeable AA-size NiMH (nickel metal hydride) batteries. Charge batteries as shown below.

Charge Indicator

The indicator blinks while charging, then remains lit when charging is finished.

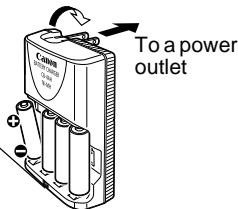

- This charger can be used only to charge Canon AA-size NiMH batteries NB-2AH. Please do not attempt to charge NB-2AH batteries in any other type of charger.
- Never mix new batteries together with batteries that have been used in other devices.

- When recharging batteries from the camera, always recharge all four of them at the same time.
- Do not mix batteries with different purchase dates or different charge states.
- Do not attempt to recharge fully charged batteries, as doing so may reduce or impair battery performance. Also, do not charge batteries for more than 24 consecutive hours.
- Do not recharge batteries in enclosed areas that tend to retain heat.
- Repeatedly recharging batteries before they become fully depleted may cause batteries to lose capacity. Do not recharge the batteries until the LCD monitor displays the "Change the batteries" message.
- Wipe the battery terminals well with a dry cloth in the following situations, as the terminals may be soiled with oil from one's skin or other dirt:
 - If the battery usage time has considerably diminished
 - If the number of recordable images has considerably diminished
 - When charging the batteries (insert and remove the batteries two or three times before charging)

- When charging completes in a matter of a few minutes (the battery charger indicator remains lit)
- You may not be able to fully charge the batteries due to their specifications right after purchase or after long periods of non-use. If this happens, use the batteries until their charge is depleted before charging them again. After doing this several times, battery performance will be restored.
- Since storing fully charged batteries for long periods of time (about 1 year) can shorten their lifecycle or affect performance, you are recommended to use the batteries in the camera until they are completely discharged and to store them at normal temperature (23 °C/73 °F) or less. If you do not use the batteries for long periods of time, charge them fully and discharge them fully in the camera at least once a year before returning them to storage.
- If battery usage time is considerably low despite their terminals being wiped and the battery charger's indicator remaining lit, it is possible that the batteries have reached the end of their lifespan. Switch to different, unused batteries. If you are purchasing new batteries, look for Canon's AA-size NiMH batteries (four piece set).

- Leaving batteries in the camera or charger may damage it causing battery leakage. Remove batteries from the camera or charger and store in a dry cool location when not in use.



- It takes approximately 250 minutes for the charger to fully recharge the batteries (as determined by testing at Canon facilities). Please do not charge batteries in areas where the temperature is outside the range of 0 to 35°C (32 to 95°F).
- Charging time varies according to ambient temperature and to the batteries' initial charge state.
- The battery charger may emit noise while charging. This is not a malfunction.
- Battery/Charger Kit CBK100 can also be used. Use Canon AA-size batteries NB-1AH with the charger included in the CBK 100 kit.

Using the AC Adapter Kit ACK600

Use of AC Adapter Kit ACK600 (sold separately) is recommended when using the camera continuously for prolonged periods of time and when connecting to a computer.



Be sure that the camera is turned off before connecting or disconnecting the compact power adapter.

1 Connect the power cord to the compact power adapter, and then plug the other end into the power outlet.

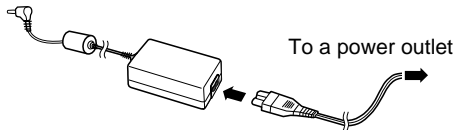

2 Open the terminal cover, and connect the compact power adapter's DC plug into the camera's DC IN terminal.

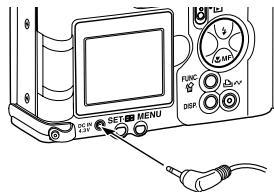

- Please unplug the adapter from the power outlet when you have finished using the camera.



Please do not attempt to use any AC adapter other than AC Adapter Kit ACK600 with your camera. Use of a different adapter may result in damage to the camera or to the adapter kit.

Using the Lenses (Sold Separately)

The camera supports use of the separately sold Wide Converter WC-DC52, Tele-converter TC-DC52A and Close-up Lens 250D (52 mm). In order to attach any of these lenses, you also need to use the separately sold Conversion Lens Adapter LA-DC52D.



- When attaching the wide converter, tele-converter or close-up lens, be sure to screw it on securely. If they come loose they may fall from the lens adapter, posing risk of injury from shattered glass.
- Never look into the sun or into strong light through the wide converter, tele-converter or the close-up lens, as this can result in blindness or impairment of vision.



- If you use the flash when shooting with the wide converter, the outer area of the recorded image (especially lower right corner) will come out relatively dark.
- When using the tele-converter, please set the focal length to the telephoto end. At other zoom settings, the image will appear as if its corners have been cut off.
- When using the wide converter, please set the camera to the wide angle end.
- The wide converter blocks part of the view through the viewfinder.

Wide Converter WC-DC52

Use this converter for taking wide-angle shots. The wide converter changes the focal length of the camera body's lens by a factor of 0.7x (the thread diameter is 52 mm.).

Tele-converter TC-DC52A

This 52 mm-threaded diameter magnifying conversion lens is for taking telephoto shots. The lens changes the focal length of the camera body's lens by a factor of 1.75x.

Close-Up Lens 250D (52 mm)

This lens makes it easy to take macro shots. With the camera set to Macro mode, you can use this option to shoot subjects that are 4 to 16 cm (1.6 to 6.3 in.) away from the front of the lens at the wide angle end, and 8 to 11 cm (3.2 to 4.3 in.) at the telephoto end.



It is not possible to attach a lens hood or filter to the wide converter or tele-converter.

Shooting Ranges in Macro Mode

	Distance between Front of the Lens and Subject	Field Coverage
Telephoto End	8 cm (3.2 in.)	45 × 34 mm (1.8 × 1.3 in.)
	11 cm (4.3 in.)	55 × 41 mm (2.2 × 1.6 in.)
Wide Angle End	4 cm (1.6 in.)	48 × 36 mm (1.9 × 1.4 in.)
	16 cm (6.3 in.)	148 × 111 mm (5.8 × 4.4 in.)

Conversion Lens Adapter LA-DC52D



This separately sold adapter is required for attaching the wide converter, tele-converter and close-up lens (52 mm thread diameter).

Attaching a Lens

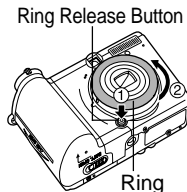

1 Be sure that the camera is turned off.

2 Press the ring release button and hold it down, and turn the ring in the direction of the arrow.

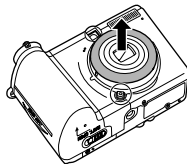

3 When the  mark on the camera and the  mark on the ring are aligned, lift off the ring.



4 Align the  mark on the conversion lens adapter with the  mark on the camera, and turn the adapter in the direction of the arrows as far as the  mark on the camera.

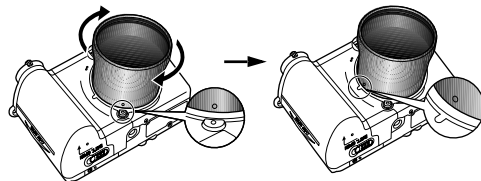

- To remove the conversion lens adapter, turn the adapter in the opposite direction with holding down the ring release button.

5 Set the lens on the adapter, and attach it securely by turning it in the indicated direction.





- Completely remove all dust and dirt from conversion lenses with a lens blower brush before use. The camera may focus on any dirt that remains.
- Exercise due caution when handling the lenses since it is easy to dirty them with finger prints.
- Be careful not to drop the camera or adapter when removing the ring.
- When shooting with these attachments, please use the LCD monitor to compose your shots. The attachments block part of the view through the viewfinder, and the area shown in the viewfinder does not match the area of the shot that is actually recorded. Also, the angle of view cannot be confirmed in the viewfinder.
- You should not shoot images in  mode when using these attachments. Although it is possible to select this mode at the camera, the PhotoStitch software will not be able to stitch the images together at the computer.

Camera Care and Maintenance

Use the following procedures to clean the camera body, lens, viewfinder, LCD monitor and other parts.

Camera Body	<p>: Wipe the camera body with a soft cloth or eyeglass lens wiper.</p>
Lens	<p>: First use a lens blower brush to remove dust and dirt, then remove any remaining dirt by wiping the lens lightly with a soft cloth.</p> <ul style="list-style-type: none"> ● Never use synthetic cleansers on the camera body or lens. If dirt remains, contact the closest Canon Customer Support Help Desk as listed on the separate Canon Customer Support leaflet.
LCD Monitor, Viewfinder	<p>: Use a lens blower brush to remove dust and dirt. If necessary, gently wipe the viewfinder and LCD monitor with a soft cloth or an eyeglass lens wiper to remove stubborn dirt.</p> <ul style="list-style-type: none"> ● Never rub or press forcefully on the LCD monitor. These actions may damage it or lead to other problems.



Never use water, paint thinner, benzene, or detergents to clean the camera, as these may cause damage or deformation.

Specifications

All data is based on Canon's standard testing methods. Subject to change without notice.



PowerShot A95

Camera Effective Pixels	Approx. 5.0 million
Image Sensor	1/1.8-inch CCD (Total number of pixels: Approx. 5.3 million)
Lens	7.8 (W) – 23.4 (T) mm (35 mm film equivalent: 38 (W) – 114 (T) mm) f/2.8 (W) – f/4.9 (T)
Digital Zoom	Approx. 4.1x (Up to approx. 12x in combination with the optical zoom)
Optical Viewfinder	Real-image zoom viewfinder
LCD Monitor	1.8-inch, low-temperature polycrystalline silicon TFT color LCD, approx. 118,000 pixels
AF System	TTL autofocus Focusing frame: 9-point AiAF/1-point AF (Fixed to center/Any position is available)
Shooting Distance (from the front of the lens)	Normal: 45 cm (1.5 ft.) – infinity Macro: 5 – 45 cm (2.0 in. – 1.5 ft.) (W) / 25 – 45 cm (9.8 in. – 1.5 ft.) (T) Manual Focus: 5 cm (2.0 in.) – infinity (W) / 25 cm (9.8 in.) – infinity (T)
Shutter	Mechanical shutter + electronic shutter
Shutter Speeds	15 – 1/2000 sec. ● The shutter speed range varies according to shooting modes. ● Slow shutter speeds of 1.3 sec. or slower operate with noise reduction.
Light Metering System	Evaluative, Center-weighted average or Spot (Center/AF-point)

Exposure Control System	Program AE, Shutter-priority AE, Aperture-priority AE, Manual exposure control
Exposure Compensation	± 2 stops in 1/3-stop increments
Sensitivity	Auto, ISO 50/100/200/400 equivalent
White Balance	Auto, pre-set (available settings: Daylight, Cloudy, Tungsten, Fluorescent or Fluorescent H) or custom
Built-in Flash	Auto*, on*, off * Red-eye reduction available
Flash Range	Normal: 45 cm – 4.4 m (1.5 – 14 ft.) (W), 45 cm – 2.5 m (1.5 – 8.2 ft.) (T) Macro: 25 – 45 cm (9.8 in. – 1.5 ft.) (W/T) (when sensitivity is set to Auto)
Shooting Modes	Auto Creative zone: Program, Shutter-speed priority, Aperture priority, Manual, Custom Image zone: Portrait, Landscape, Night scene, Fast shutter, Slow shutter, Special Scene (Foliage, Snow, Beach, Fireworks, Underwater, Indoor, Kids & Pets and Night Snapshot), Stitch assist and Movie
Continuous Shooting	High-Speed continuous shooting: Approx. 2.0 shots/sec. Standard continuous shooting: Approx 1.5 shots/sec. (Large/Fine mode, LCD monitor off).
Self-timer	Activates shutter after an approx. 10-sec./approx. 2-sec. delay
PC-controlled Shooting	Available (USB connection only. Exclusive software program is included in the camera kit.)
Recording Media	CompactFlash™ (CF) card (Type I)

(W): Wide angle (T): Telephoto

Specifications	
----------------	--

File Format	Design rule for camera file system and DPOF compliant
Image Recording Format	Still images: JPEG (Exif 2.2)*1, Movies: AVI (Image data: Motion JPEG; Audio data: WAVE (monaural))
Compression	Superfine, Fine, Normal
Number of Recording Pixels	Still Images Large: 2592 x 1944 pixels Medium 1: 2048 x 1536 pixels Medium 2: 1600 x 1200 pixels Small: 640 x 480 pixels
	Movies 640 x 480 pixels (30 sec.) 320 x 240 pixels (3 min.) 160 x 120 pixels (3 min.) The data in parentheses refer to the maximum movie length per shooting. (): 10 frames/sec., ( ): 15 frames/sec.)
Playback Modes	Single (histogram displayable), Index (9 thumbnail images), Magnified (approx. 10x (max.) in LCD monitor), Auto play or Sound memos (up to 60 sec.).
Direct Print	<i>Canon Direct Print</i> and <i>Bubble Jet Direct</i> compatible, and <i>PictBridge</i> compatible
Display Languages	14 languages available for menus and messages (English, German, French, Dutch, Danish, Finnish, Italian, Norwegian, Swedish, Spanish, Chinese, Russian, Portuguese and Japanese)
My Camera Settings	The start-up image, start-up sound, shutter sound, operation sound and self-timer sound can be customized using the following methods: 1. Using the images and sounds recorded on a camera. 2. Using downloaded data from your computer using the supplied software.
Interface	USB (mini-B, PTP [Picture Transfer Protocol]) Audio/Video output (NTSC or PAL selectable, monaural audio)

Power Source	AA-size alkaline batteries (included in the camera kit) AA-size rechargeable NiMH batteries NB4-200 (sold separately) AC Adapter Kit ACK600 (sold separately)
Operating Temperatures	0 – 40 °C (32 – 104 °F)
Operating Humidity	10 – 90%
Dimensions	101.1 x 64.6 x 34.7 mm (4.0 x 2.5 x 1.4 in.) (excluding protrusions)
Weight	Approx. 235 g (8.3 oz.) (camera body only)

*1 This digital camera supports Exif 2.2 (also called "Exif Print"). Exif Print is a standard for enhancing the communication between digital cameras and printers. By connecting to an Exif Print-compliant printer, the camera's image data at the time of shooting is used and optimized, yielding extremely high quality prints.

Battery Performance

	Number of Shots		Playback Time
	Based on the CIPA standard	LCD Monitor Off	
AA Alkaline Batteries (included with the camera)	Approx. 140 shots	Approx. 500 shots	Approx. 280 min.
AA NiMH Batteries (NB-2AH (fully charged))	Approx. 400 shots	Approx. 1000 shots	Approx. 360 min.

* The actual figures will vary according to the shooting condition and settings.

Test Conditions

Shooting:

Normal temperature (23 °C ± 2 °C/73 °F ± 3.6 °F), normal relative humidity (50% ± 20%), alternating wide angle end and telephoto end shots at 30 second intervals with the flash fired once every two shots and the camera power turned off after every tenth shot. Power is left off for a sufficient amount of time*, then the power is turned back on and the testing procedure is repeated.

- The included memory card is used.
- The LCD monitor is turned on for the CIPA standard.
- * Until the battery returns to normal temperature















Playback:



Normal temperature (23 °C ± 2 °C/73 °F ± 3.6 °F), normal relative humidity (50% ± 20%), continuous playback at 3 seconds per image.







- **For information on handling batteries, see *Proper Battery Handling* (p. 15).**

CF Cards and Estimated Capacities (Recordable Images)

CF card included with the camera

		FC-32MH	FC-64M	FC-128M	FC-256MH	FC-512MSH
L		11	24	49	99	198
		21	43	88	177	354
		43	88	176	355	709
M1		18	38	76	154	308
		33	68	137	276	552
		67	136	274	548	1096
M2		30	61	122	246	491
		54	109	219	440	879
		107	217	435	868	1736
S		119	241	482	962	1893
		195	393	788	1563	3125
		336	676	1355	2720	5209
Movie		45 sec.	92 sec.	186 sec.	374 sec.	743 sec.
		91 sec.	183 sec.	368 sec.	735 sec.	1453 sec.
		241 sec.	486 sec.	973 sec.	1954 sec.	3906 sec.

- Some CF cards are not sold in some regions.
- The maximum movie clip length is : 30 sec., : 3 min.* or : 3 min.. The times shown are the maximum continuous recording times.
* When using a 64 MB or higher capacity CF card.

-  (Superfine),  (Fine) and  (Normal) indicate the compression setting.
- **L** (Large), **M1** (Medium 1), **M2** (Medium 2), **S** (Small), ,  and  indicate the recording resolution.









L (Large)	2592 x 1944 pixels
M1 (Medium 1)	2048 x 1536 pixels
M2 (Medium 2)	1600 x 1200 pixels
S (Small)	640 x 480 pixels
	640 x 480 pixels
	320 x 240 pixels
	160 x 120 pixels

Image File Size (Estimated)

			
L (2592 x 1944 pixels)	2503 KB	1395 KB	695 KB
M1 (2048 x 1536 pixels)	1602 KB	893 KB	445 KB
M2 (1600 x 1200 pixels)	1002 KB	558 KB	278 KB
S (640 x 480 pixels)	249 KB	150 KB	84 KB
Movie	 (640 x 480 pixels)	660 KB/sec.	
	 (320 x 240 pixels)	330 KB/sec.	
	 (160 x 120 pixels)	120 KB/sec.	

NiMH Battery NB-2AH

Supplied with the separately sold NiMH Battery NB4-200 set and the Battery/Charger Kit CBK4-200.

Type	Rechargeable nickel metal hydride battery
Nominal Voltage	1.2 V DC
Typical Capacity	2300 mAh (min.: 2150 mAh)
Cycle Life	Approx. 300 times
Operating Temperatures	0 – 35 °C (32 – 95 °F)
Dimensions	Diameter: 14.5 mm (0.6 in.) Length: 50 mm (2.0 in.)
Weight	Approx. 29 g (1.0 oz.)

Battery Charger CB-4AH/CB-4AHE

Supplied with the separately sold Battery and Charger Kit CBK4-200.

Rated Input	100 – 240 V AC (50/60 Hz), 10W
Rated Output	565 mA* ¹ , 1275 mA* ²
Charging Time	Approx. 250 min.* ¹ , Approx. 110 min.* ²
Operating Temperatures	0 – 35 °C (32 – 95 °F)
Dimensions	65.0 × 105.0 × 27.5 mm (2.6 × 4.1 × 1.1 in.)
Weight	Approx. 95 g (3.4 oz.) (body only)

*¹ To charge four NB-2AH NiMH batteries

*² To charge two NB-2AH NiMH batteries loaded one at each end of the battery charger

Compact Power Adapter CA-PS500

(Supplied with the separately sold AC Adapter Kit ACK600.)

Rated Input	100 – 240 V AC (50/60 Hz), 16 VA (100V) – 26 VA (240V)
Rated Output	4.3 V DC/1.5 A
Operating Temperatures	0 – 40 °C (32 – 104 °F)
Dimensions	42.5 × 104.4 × 31.4 mm (1.7 × 4.1 × 1.2 in.)
Weight	Approx. 180 g (6.3 oz.) (body only)

CompactFlash™ Card

Card slot type	Type 1
Dimensions	36.4 × 42.8 × 3.3 mm (1.4 × 1.7 × 0.1 in.)
Weight	Approx. 10 g (0.4 oz.)

Wide Converter WC-DC52 (Sold Separately)

Magnification	Approx. 0.7x (35 mm film equivalent at wide angle end: approx. 26.6 mm)
Focusing Range (from front of lens)	Approx. 0.5 cm (0.2 in.) – infinity (when mounted on PowerShot A95, at wide angle end with using the Macro mode)
Thread Diameter	52 mm standard filter thread (Conversion Lens Adapter LA-DC52D is required when mounted on PowerShot A95.)
Dimensions	Diameter: 55.7 mm (2.2 in.) Length: 23.7 mm (0.9 in.)
Weight	Approx. 74 g (2.6 oz.)

Close-up Lens 250D 52 mm (Sold Separately)

Focal Length	250 mm
Focusing Range (from front of lens)	4 – 16 cm (1.6 – 6.3 in.) (W) 8 – 11 cm (3.2 – 4.3 in.) (T) (when mounted on PowerShot A95 with using the Macro mode)
Thread Diameter	52 mm standard filter thread (Conversion Lens Adapter LA-DC52D is required when mounted on PowerShot A95)
Dimensions	Diameter: 54 mm (2.1 in.) Length: 10.2 mm (0.4 in.)
Weight	Approx. 55 g (1.9 oz.)

Tele-converter TC-DC52A (Sold Separately)

Magnification	Approx. 1.75x (35 mm film equivalent at telephoto end: approx. 200 mm)
Focusing Range (from front of lens)	Approx. 2.2 m (Approx. 7.2 ft.) – infinity (when mounted on PowerShot A95, at telephoto end)
Thread Diameter	52 mm standard filter thread (Conversion Lens Adapter LA-DC52D is required when mounted on PowerShot A95)
Dimensions	Diameter: 55.2 mm (2.2 in.) Length: 49.3 mm (1.9 in.)
Weight	Approx. 86 g (3.0 oz.)

Conversion Lens Adapter LA-DC52D (Sold Separately)

Thread Diameter	52 mm standard filter thread
Dimensions	Diameter: 55.6 mm (2.2 in.) Length: 36.6 mm (1.4 in.)
Weight	Approx. 14 g (0.5 oz.)

Photo Tips and Information

This section offers photography tips.

- **Tip for Using the Self-timer (p. 46)**

Normally, the camera shakes a little when you press the shutter button.

Setting the self-timer to  delays the shutter release for two seconds and allows the camera to stop shaking, thus preventing a blurred image. Even better results can be obtained by placing the camera on a fixed, stable surface or by fixing the camera onto a tripod.

- **To Shoot a Night Scene without a Subject (p. 39)**

To shot a night scene without any subject in the foreground, set the flash to .

(A night scene usually consists of light sources in the night. When shooting with the flash, the light of the flash will washout these lights, so it is better to turn the flash off.)

This mode uses a slow shutter speed so always use a tripod to prevent camera shake.

- **Advanced Technique for the Macro Mode (p. 45)**

Macro mode can make unique images when used with the zoom function. For example, shooting a flower at maximum wide angle in Macro mode allows the camera to bring both the flower and the background into focus. However, shooting at maximum telephoto can throw the background out of focus to make the flower stand out.



Macro with the wide angle zoom



Macro with the telephoto zoom

- **How to Adjust the Exposure (p. 85)**

This camera automatically adjusts the exposure to shoot images with the optimal brightness. However, recorded images may sometimes be brighter or darker than the actual image depending on the shooting conditions. If this happens, adjust the exposure compensation manually.

Underexposure

The whole recorded image is dark, which makes white elements of the image appear gray. Shooting bright subjects or in backlit conditions may cause the image to be underexposed.

Adjust the exposure compensation towards the + end.

**Optimal Exposure****Overexposure**

The whole recorded image is bright, which makes black elements of the image appear gray.

Shooting dark subjects or in dark places may cause the image to be overexposed. Adjust the exposure compensation towards the - end.

**● ISO Speed (p. 89)**

The ISO speed is the numeric representation of the camera's sensitivity to light. The higher the ISO speed, the higher the sensitivity. A high ISO speed allows you to shoot images in dark indoor or outdoor conditions without a flash and also helps prevent blurred images due to camera shake. This is convenient when shooting images in places where flash photography is prohibited. The ISO speed setting makes full use of the available light, resulting in images that convey the feel of the place they were shot.



ISO 50 equivalent



ISO 400 equivalent

INDEX

A

AC Adapter Kit	134
AF Frame	81
Aperture Value	79
Aperture-Priority AE	79
Auto Mode	34
Auto Play	99
A/V Out Terminal	117

B

Batteries

Battery Cover	15
Charge	15
Handling Precautions	15
Installing	15
Low Status	17
Performance	144
Rechargeable Batteries	132
Status	17
Beep	35, 71, 74
Black and White Mode	90

C

Care	139
CF Card	18
CF Card Reader	116
Downloading Images	116
Formatting	19

Handling	19
Installing	18
Recording Capacity	145
Slot Cover	18
CompactFlash™ card	141, 147
Components	12
Compression	41
Computer System Requirements	109
Continuous Shooting	48
Creative Zone	76
Custom Settings	94

D

Date/Time	21
Default Settings	69 – 74
DIGITAL Terminal	12, 111
Digital Zoom	47
Direct Transfer	113
Display Modes	26 – 30
Detailed	26 – 29
Standard	26 – 29

DPOF

Print Settings	103
Transfer Order	107

E

Erasing

All Images	64
------------------	----

Displayed Images	37
Single Image	64
Exposure	
Aperture-Priority AE	79
Compensation	85
Shutter-Speed Priority AE	77
White Balance	86
F	
Fast Shutter	39
File No. Reset	72, 118
File Numbers	72, 119
Flash	43
Focal Length	135, 136, 148, 149
Focus	
Lock	92
Manual	93
Format	19
I	
Image Zone	39
Index Playback	59
Indicators	14
Information View	26 – 30
Interface Cable	12, 111
ISO Speed	89

J	
Jump	60
L	
Landscape Mode	39
Language	22
LCD Monitor	26 – 30
Lens	12
Close-Up Lens	136
Conversion Lens Adapter	136
Tele-converter	135
Wide Converter	135
Light Metering	
Center-Weighted Averaging	83
Evaluative	83
Spot AE Point	83
M	
Macro Mode	45
Magnifying Images	58
Maintenance	139
Manual	
Exposure	85
Focus	93
Shooting Mode	80
Menu	
FUNC	66
Playback	70

Rec.	69	LCD Monitor	28
Selecting	66	Magnifying Images	58
Set up	71 – 73	Movies	60
Messages	124 – 125	Rotating	97
Microphone	12	Single Image Playback	58
Mode Dial	39, 76	Portrait Mode	39
Movie		Postcard Print Mode	54
Editing	61	Power On/Off	31 – 32
Playback	60	Power Saving	31
Shooting	56	Power Source	31
My Camera		AC Adapter	134
Menu	74	Rechargeable Batteries	132
Registering	121	Printing	101
Settings	121	Print Style	105
N		Resetting	106
Night Scene Mode	39	Selecting Images	103 – 104
O		Settings	103
Operation Sound	71, 74, 121, 122, 142	Print/Share Button	13, 101, 114
P		Program AE	77
Photo Effect	90	Protect	100
PictBridge compliant printers	101	R	
Playback		Recordable Images	145
Auto Play	99	Red-eye Reduction	44
Index Playback	59	Resetting the Settings to Default	75
Jumping	60	Resolution	41
		Ring Release Button	12
		Rotate	97

S

Self-timer	46
Sound	74
Shooting	34, 66
Reviewing an Image	37
Switching from Playback Mode	32
TV Set	117
Shooting Mode	159
Dial	14
Functions Available	159
Shutter	
Shutter-Speed Priority AE	77
Sound	74
Speed	77
Volume	72
Shutter Button	34
Pressing Fully	35
Pressing Halfway	34
Single Image Playback	58
Slow Shutter	39
Sound Memos	98
Speaker	12
Special Scene Mode	51
Specifications	140 – 143
Start-up	
Image	74
Sound	74

Stitch Assist Mode	49
Framing a Subject	49
Shooting	50
Strap	13
T	
Telephoto	34
Transfer (Direct)	113
Transfer Order	
Reset	106
Selecting Images	107
Troubleshooting	126 – 131
V	
Video System	73
Viewfinder	13
Autofocus range	36
Volume	71
W	
WAVE Files	28, 98, 99, 123, 125, 142
White Balance	86
Wide angle	34
Z	
Zoom	47

FCC Notice

(Digital Camera, Model PC1099)

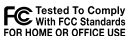

This device complies with Part 15 of the FCC Rules. Operation is subject to the following two conditions:

- (1) this device may not cause harmful interference, and
- (2) this device must accept any interference received, including interference that may cause undesired operation.

Note: This equipment has been tested and found to comply with the limits for Class B digital devices, pursuant to Part 15 of the FCC rules. These limits are designed to provide reasonable protection against harmful interference in a residential installation. This equipment generates, uses and can radiate radio frequency energy and, if not installed and used in accordance with the instructions, may cause harmful interference to radio communications. However, there is no guarantee that interference will not occur in a particular installation. If this equipment does cause harmful interference to radio or television reception, which can be determined by turning the equipment off and on, the user is encouraged to try to correct the interference by one or more of the following measures:

- Reorient or relocate the receiving antenna.
- Increase the separation between the equipment and receiver.
- Connect the equipment into an outlet on a circuit different from that to which the receiver is connected.
- Consult the dealer or an experienced radio/TV technician for help.

The cables with the ferrite core provided with the digital camera must be used with this equipment in order to comply with Class B limits in Subject B of Part 15 on the FCC rules.

Do not make any changes or modifications to the equipment unless otherwise specified in the manual. If such changes or modifications should be made, you could be required to stop operation of the equipment.

Canon U.S.A. Inc.

One Canon Plaza, Lake Success, NY 11042, U.S.A.
Tel No. (516) 328-5600

Canadian Radio Interference Regulations

This Class B digital apparatus complies with Canadian ICES-003.

Réglementation canadienne sur les interférences radio

Cet appareil numérique de la classe B est conforme à la norme NMB-003 du Canada.



MEMO



Appendix



MEMO

Functions Available in Each Shooting Mode

The following chart shows the functions and settings available in each Shooting mode.

Function		AUTO						SCN ⁽¹⁾			P	Tv	Av	M	Reference Pages
Resolution	Large L	○*	○*	○*	○*	○*	○*	○*	△*	–	○*	○*	○*	○*	41
	Medium 1 M1	○	○	○	○	○	○	○	△	–	○	○	○	○	
	Medium 2 M2	○	○	○	○	○	○	○	△	–	○	○	○	○	
	Small S	○	○	○	○	○	○	○	△	–	○	○	○	○	54
	Postcard Print	○	○	○	○	○	○	○	○	–	○	○	○	○	
	Movie	–	–	–	–	–	–	–	–	○	–	–	–	–	
	Movie	–	–	–	–	–	–	–	–	○*	–	–	–	–	41
Movie	–	–	–	–	–	–	–	–	○	–	–	–	–		
Compression	Superfine	○	○	○	○	○	○	○	△	–	○	○	○	○	41
	Fine	○*	○*	○*	○*	○*	○*	○*	△*	–	○*	○*	○*	○*	
	Normal	○	○	○	○	○	○	○	△	–	○	○	○	○	
Flash	Auto	○*	○*	○	○*	○*	○	○*	–	–	○	–	–	–	43
	On	–	○	○	○	○	○	○	△	–	○	○	○	○	
	Off	○	○	○*	○	○	○*	○	△*	–	○*	○*	○*	○*	
Red-eye Reduction	○	○	○	○	○	○	○	△	–	○	○	○	○	44	
Flash Output	–	–	–	–	–	–	–	–	–	–	–	–	○	91	
AF-assist Beam	○	○	○	○	○	○	○	○	△	○	○	○	○	36	

*: Default settings ○: Available △: Available only for the first image –: Not available

: Setting remains in effect even when the camera is turned off.



Function								SCN ⁽¹⁾			P	Tv	Av	M	Reference Pages
Drive Mode	Single Shot	○*	○*	○*	○*	○*	○*	○*	△*	○*	○*	○*	○*	○*	—
	Standard Continuous Shooting	—	○	○	○	○	○	○	—	—	○	○	○	○	48
	High-speed Continuous Shooting	—	○	○	○	○	○	○	—	—	○	○	○	○	
	Self-timer (10 sec.)	○	○	○	○	○	○	○	△	○	○	○	○	○	46
	Self-timer (2 sec.)	○	○	○	○	○	○	○	△	○	○	○	○	○	
AF Frame	AiAF	○*	○	○	○	○	○	○	○	○	○	○	○	○	81
	Center ⁽²⁾	—	○	○	○	○	○	○	—	—	○	○	○	○	
	FlexiZone	—	—	—	—	—	—	—	—	—	○	○	○	○	
AF Lock		—	○	○	○	○	○	○	—	○	○	○	○	○	92
Manual Focus		—	○	○	○	○	○	○	—	○	○	○	○	○	93
Macro Mode		○	○	—	○	○	○	○	△	○	○	○	○	○	45
Digital Zoom	ON	○	○	○	○	○	○	○	—	—	○	○	○	○	47
	OFF	○*	○*	○*	○*	○*	○*	○*	—	—	○*	○*	○*	○*	
Exposure Compensation		—	○	○	○	○	○	○	△	○	○	○	○	—	85
Light Metering System	Evaluative Metering	○	○	○	○	○	○	○	○	○	○*	○*	○*	○*	83
	Center-Weighted Averaging	—	—	—	—	—	—	—	—	—	○	○	○	○	



Function								SCN ⁽¹⁾			P	Tv	Av	M	Reference Pages
Light Metering System	Spot Metering ⁽³⁾	-	-	-	-	-	-	-	-	-	○	○	○	○	83
	Center	-	-	-	-	-	-	-	-	-	○	○	○	○	
	AF Point	-	-	-	-	-	-	-	-	-	○	○	○	○	
White Balance ⁽⁴⁾	WB	- ⁽⁵⁾	○	○	○	○	○	- ⁽⁶⁾	△	○	○	○	○	○	86
Photo Effect		-	○	○	○	○	○	- ⁽⁶⁾	△	○	○	○	○	○	90
ISO Speed	ISO	- ⁽⁶⁾	- ⁽⁶⁾	- ⁽⁶⁾	- ⁽⁶⁾	- ⁽⁶⁾	- ⁽⁶⁾	- ⁽⁶⁾	- ⁽⁶⁾	- ⁽⁶⁾	○	○	○	○ ⁽⁷⁾	89
Auto Rotate	ON	○*	○*	○*	○*	○*	○*	○*	△*	-	○*	○*	○*	○*	95
	OFF	○	○	○	○	○	○	○	△	-	○	○	○	○	

The default for the settings changed by the menu and button operations can be restored all at once except for [Date/Time], [Language] and [Video System] (p. 75).

(1) The default setting of the flash for the [Foliage] and [Fireworks] options is [Off].

The following functions cannot be set in the [Fireworks] mode.

- The [Auto] and [On] setting of the flash
- Red-eye reduction function
- AF-assist beam
- AF frame selection
- Macro mode
- AF lock
- Manual focus

The following functions cannot be set in the [Kids&Pets] mode.

- Macro mode
- AF frame selection

(2) When using the digital zoom, AF frame is set to [Center].

(3) Cannot be adjusted when the AF frame is set to [AiAF].

(4) Cannot be adjusted when the photo effect is set to [Sepia] or [B/W].

(5) The white balance is set to [AUTO].

(6) Settings automatically set by the camera.

(7) ISO [AUTO] cannot be selected.