



## **USER GUIDE**



### **Cisco Unified IP Phones 7945G and 7965G for Cisco Unified Communications Manager Express 4.3**









- 1** Overview
- 2** Operating Your Phone
- 3** Phone Features Index







## **1 Overview**

This guide provides phone operating instructions, and features descriptions for the Cisco Unified IP Phone multiline models 7945G and 7965G. The 7945G has four lines and the 7965G has six lines.

## Physical Description



	Name	Description
1	Line or speed-dial button 	Opens new line, speed-dials phone number, or ends call. Buttons light to indicate status: Green, steady: Active call or two-way intercom call Green, flashing: Held call Amber, steady: Privacy in use, one-way intercom call, DnD active. Amber, flashing: Incoming call or reverting call Red, steady: Remote line in use (shared line or BLF status)
2	Footstand adjustment	Allows you to adjust angle of phone base.
3	Display button 	Awakens the phone screen from sleep mode.
4	Messages button 	Provides access to message (voice mail) system.
5	Directories button 	Provides access to phone directories.
6	Help button 	Activates Help menu.
7	Settings button 	Provides access to phone settings such as display contrast and ring type.
8	Services button 	Provides access to phone services.
9	Volume button 	Increases or decreases handset, headset, ringer, or speakerphone volume.

	Name (continued)	Description (continued)
10	Speaker button 	Toggles speaker on and off.
11	Mute button 	Toggles mute on and off.
12	Headset button 	Toggles headset on and off.
13	4-way Navigation Pad and Select (center) button. 	<p>Allows you to scroll through menus and highlight items, displays phone numbers from your Placed Calls, when phone is on-hook. Use Select button to select an item that is highlighted on the screen.</p> <p>Navigation button:</p> <ul style="list-style-type: none"> <li>• Scroll up and down to see menus and highlight items.</li> <li>• Scroll left to open the Details view and see directory numbers and features assigned to each line button (when on call screen).</li> <li>• Scroll right to close the Details view.</li> </ul> <p>Select button: scroll to select a line using the Navigation button, then:</p> <p>If the button is mapped to a directory number, and:</p> <ul style="list-style-type: none"> <li>- The line is idle, press  to initiate a new call.</li> <li>- There is an on-hold call on the line, press  to resume the call.</li> <li>- There is an active call on the line, the Select button has no effect.</li> </ul> <p>If the button is mapped to a feature, press  to access the feature.</p>
14	Keypad	Functions as traditional telephone keypad.
15	Soft keys buttons	Engages functions visible on corresponding LCD tabs.
16	Handset with indicator light	Functions as traditional handset and provides message waiting indicator light and message-waiting (stutter) tone.
17	LCD screen	Displays information such as line/call status, phone number, and soft key tabs.

## Connecting Your Phone

This section shows and describes the connectors on your Cisco Unified IP phone.

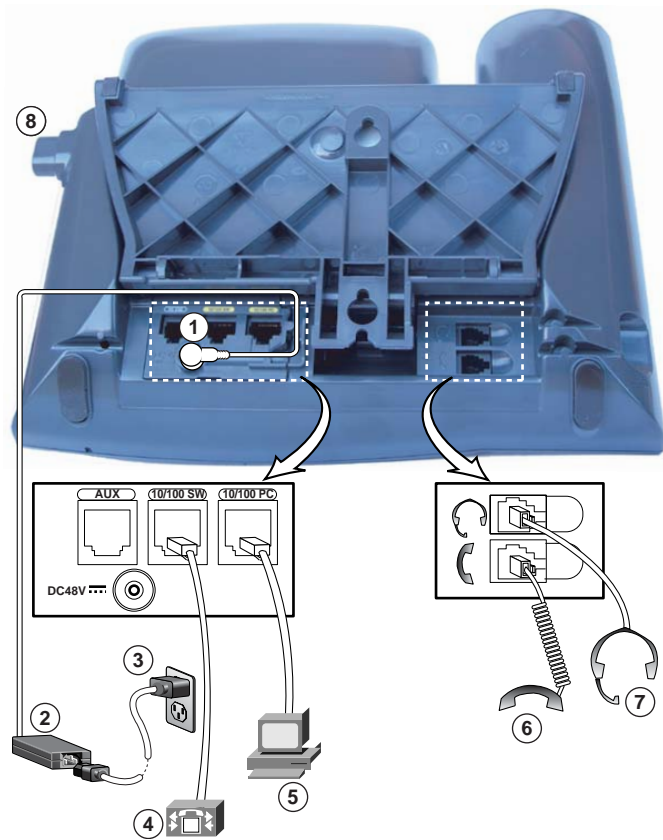

113950

1	DC adapter port (DC48V) for phones not provided with inline power
2	AC-to-DC power supply
3	AC power cord
4	Network port (10/100 SW) for connecting to the network
5	Access port (10/100 PC) for connecting your phone to your computer
6	Handset port
7	Headset port
8	Footstand button

## Adjusting the Handset Rest

When you connect your phone, you can adjust the handset rest so that the receiver will not slip out of the cradle. To adjust the handset:

1. Set the handset aside and pull the square plastic tab from the handset rest.
2. Rotate the tab halfway.
3. Slide the tab back into the handset rest. An extension protrudes from the top of the rotated tab. Return the handset to the handset rest.

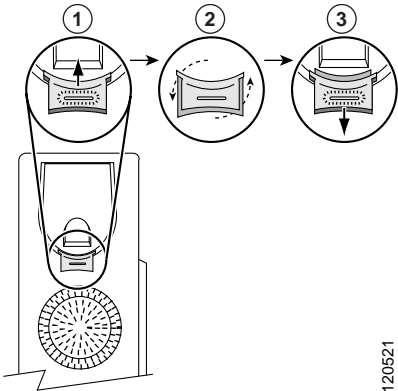

## 2 Operating Your Phone

This section describes how to operate your Cisco Unified IP phone and includes information on soft keys and phone features.



**Note** Because there are differences in phone and site configurations, not all features described here may apply to your phone. Consult your administrator for more information.

### Soft Key Descriptions

Your Cisco Unified IP phone is equipped with soft keys for call features and options. Soft keys are displayed along the bottom of the LCD screen and activated using the corresponding buttons. Soft keys can change according to the state of the phone.

Following is a comprehensive list of soft keys offered on these Cisco Unified IP Phones. Functions depends on your system configuration.

Soft Key	Function
<< or >>	Navigates to edit characters. Use the backspace soft key to erase digits that you entered incorrectly.
Answer	Answers an incoming call.
Callback	Notifies callers that the called line is free.
Cancel	Cancels the last selection.
CFwdALL	Forwards all calls.
Clear	Clears directory history.
Confrn	Connects callers to a conference call.
Delete	Deletes selected number.
Dial	Dials the displayed number.

Soft Key	Function
DnD	Enables the Do-Not-Disturb feature.
Down	Decreases the LCD screen contrast.
EditDial	Selects a number and activates the cursor for editing.
EndCall	Ends the current call.
Exit	Exits from current selection.
Flash	Provides hookflash functionality for three-way calling and call waiting services provided by the PSTN or Centrex service.
GPickUp	Selectively picks up calls coming into a phone number that is a member of a pickup group.
Hold	Places an active call on hold. Resumes call on hold.
LiveRcd	Enables the user to record a phone conversation.
Login	Provides PIN-controlled access to restricted phone features. Contact your administrator for instructions.
more	Scrolls through additional soft key options (for example, use <b>more</b> soft key to locate the DnD soft key).
NewCall	Opens a new line on the speakerphone to place a call.
Ok	Confirms the selection.
Park	Forwards calls to location from which calls can be retrieved by anyone in the system.
PickUp	Selectively picks up calls coming into another extension.
Play	Plays ring sound sample.
Redial	Redials last number dialed.
RmLstC	Removes Last Participant from the Conference Call.
Resume	Returns to active call.
Save	Saves last change.
Search	Initiates search in local directory.
Select	Selects highlighted option.
Trnsfer	Transfers active calls to another extension.
TrnsfVM	Transfers a call to voice mail.
Up	Increases LCD screen contrast.

## Place a Call

Use one of the following methods to place a call:

- Lift the handset and dial the number.
- Dial the number, and then lift the handset.
- Dial the number, and then press the **Dial** soft key.
- Press the **line** button for your extension, and then dial.
- Press the **Speaker** button, and then dial.
- Press the **New Call** soft key, and then dial.
- If you are using a headset, press the **Headset** button, and then dial.
- Dial the number, and then press the **Headset** button.
- If you have established speed-dial numbers, press a speed-dial button.
- If you have selected a number from a directory, press the **Dial** soft key.



---

**Note** Use the backspace (<<) soft key to erase digits that you enter incorrectly.

---

## Answer a Call

To answer a call:

- Lift the handset.
- If you are using a headset, press the **Headset** button. If necessary, press the **line** button to select between incoming calls.
- If you are using the speakerphone, press the **Answer** soft key or the **Speaker** button.

## End a Call

To end a call:

- Hang up the handset.
- If you are using a headset, press the **Headset** button or the **EndCall** soft key.
- If you are using a speakerphone, press the **Speaker** button or the **EndCall** soft key.

## Redial a Number

To redial the most recently dialed number:

- Lift the handset and press the **Redial** soft key.
- Press the **Redial** soft key to dial using the speakerphone.

## Hold a Call

To place a call on hold while on the call:

- Press the **Hold** soft key.

To retrieve a held call:

- Press the **Resume** soft key.
  - If multiple calls are on hold, use the **Navigation** button to select the desired call before you press **Resume**.
  - If multiple calls on multiple lines are on hold, press the **line** button for the line that you want to pick up. The active call on the other line is automatically put on hold.



---

**Note** Because the hold feature can generate music or tones, avoid using hold when dialed into a remote conference system. Conferences that are created locally on your phone can safely be placed on hold without introducing music or tones into the conference.

---

## Mute a Call

To mute a call:

- While on a call, press the **Mute** button. The **Mute** button lights, indicating that the other party cannot hear you.

To deactivate the mute function, do one of the following:

- Press the **Mute** button again.
- Lift the handset if you are using mute with your speakerphone.



---

**Note** The Mute feature does not generate music or a tone.

---

## Manage Call Waiting

If you are on a call when a second call comes in, you hear a call-waiting tone or see a flashing indicator light on the handset rest, depending on the configuration of your phone.

To answer the new call on the same line:

1. Use the **Navigation** button to select the call
2. Press the **Answer** soft key to answer the call. The call on the other line is automatically put on hold.

To return to the original call:

1. Use the **Navigation** button to reselect the call.
2. Press the **Resume** soft key to reconnect to the call.

For calls on a separate line:

- Press the **Line** button for the incoming call. The call on the other line is automatically put on hold.

To return to the original call:

- Press the **Line** button associated with the original call.

## Retrieve Voice Messages

To retrieve voice messages:

1. Select an available Cisco Unified IP phone line by lifting the handset, pressing the speakerphone button, or pressing a line button. Listen for the dial tone.
2. Press the **Messages** button, and follow the voice instructions.



---

**Note** When you have one or more new messages, the message-waiting indicator (MWI) on your handset is lit. The MWI works only if the MWI is configured on your phone.

---



---

**Note** Your company determines the voice message service that your phone system uses. For the most accurate and detailed information, refer to the documentation that came with your voice message service.

---

## Adjust the Volume for the Current Call

To adjust the handset, speakerphone, or headset volume for the current call:

1. During a call, press the **Up** or **Down Volume** button.
2. Press the **Save** soft key to apply the new volume level to future calls.

## Adjust the Ring Volume

- Press the **Up** or **Down Volume** button while the handset is in its cradle and the phone is idle.

## Select the Ring Type

To change the ringer sound:

1. Press the **Settings** button.
2. Press **2** for Ring Type, or use the **Navigation** button to scroll to Ring Type and press the **Select** soft key.
3. Use the **Navigation** button to scroll through the list of ring types. Press the **Play** soft key to hear samples.
4. Highlight the ring you want, and then press the **Select** soft key.
5. Press the **Ok** soft key to select your setting.
6. Press the **Save** soft key to save the setting, or press **Cancel** to exit to the previous menu without changing the setting.



7. Press the **Exit** soft key to go to the main directory menu.

## Adjust the Display Contrast

To adjust the contrast in your LCD display:

1. Press the **Settings** button.
2. Press **1** for Contrast, or use the **Select** soft key.
3. Use the **Down** or **Up** soft key to change the contrast.
4. Press the **Ok** soft key
5. Press the **Save** or **Exit** soft key.
6. Press the **Ok** soft key to select your contrast setting.
7. Press the **Save** soft key to save the setting, or press **Cancel** to exit to the previous menu without changing the setting.
8. Press the **Exit** soft key to go to the main directory menu.



---

**Note** In the following procedures, you may need to enter information using the keypad. Press the backspace (<<) soft key to erase digits that you enter incorrectly.

---

## Divert Incoming Calls

To forward any incoming call to the call-forward destination, for example voice mail, preset set on the Cisco Unified IP phone:

- Press the **DnD** soft key.



---

**Note** If the call-forward destination is not set, pressing the **DnD** soft key disables the ringer.

---

## Park a Call

Call park allows a phone user to place a call on hold at a designated parking spot from which the call can be retrieved by anyone on the system.



---

**Note** Contact your administrator for your call park slot number.

---

To park a call:

- Press the **Park** soft key.

The Cisco Unified Communications Manager Express system automatically selects an available call park slot and displays the number on the Cisco Unified IP phone screen.

To park a call to a specific call park slot:

- Press the transfer button followed by the call park slot number provided by your administrator.

To retrieve a parked call:

- If your phone receives a call park notification, press the **PickUp** soft key followed by the asterisk (\*).
- Press the **PickUp** soft key followed by the call park slot number.

## Call-Blocking (Toll Bar) Override

Call blocking prevents unauthorized use of phones. It is implemented by matching a pattern of specified digits during a specified time of day and day of week or date. The call-blocking override feature allows individual phone users to override the predefined call blocking.



---

**Note** Contact your administrator for your personal identification number (PIN).

---

To place calls when call-blocking is enabled:

1. Press the **Login** soft key on the Cisco Unified IP phone.
2. Enter the Personal Identification Number (PIN) that is associated with the phone.

## Transfer a Call

To transfer a selected call to another number, you can use blind transfer or consultative transfer:

### Blind Transfer

Immediately redirects the call without allowing you to speak to the transfer recipient (the person to whom you are transferring the call).

To make a blind transfer call, use the following method:

1. During a call, press the **Trnsfer** soft key. The call is placed on hold.
2. Dial the number to which you want to transfer the call.

### Consultative Transfer

Redirects the call after first allowing you to speak to the transfer recipient.

To make a consultative transfer, use the following method:

1. During a call, press the **Trnsfer** soft key. The call is placed on hold.
2. Dial the number to which you want to transfer the call.
3. Wait for the call to be answered. Speak to the transfer recipient. Then press the **Trnsfer** button or hang up the handset.
4. If the transfer fails, press the **Resume** soft key to return to the original call.

## Cancel Transfer

1. To cancel your consult call-transfer attempt:
  - Press the **EndCall** soft key.
2. To reconnect to the original caller:
  - Press the **Resume** soft key.

## Transfer to Voice Mail

1. Press **TrnsfVM**.
2. Enter the recipient's extension number and press **TrnsfVM** again.

## Forward All Calls

To forward all incoming calls to another number:

1. Press the **CFwdALL** soft key. You hear a confirmation beep.
2. Dial the number to which you want to forward all your calls. Dial the number exactly as if you were placing a call to that number. Remember to include locally required prefix numbers.  
The phone display is updated to show that calls will be forwarded.
3. Press the pound key (#) or the **EndCall** soft key.



**Note** To forward calls to voice mail, manually enter the voice mail number, or use the **CFwdALL** soft key plus the **Messages** button, followed by the **EndCall** soft key. When call forward all is set, the display will show Call Forward Icon.

To forward calls to a speed-dial number, use the **CFwdALL** soft key plus a **speed-dial** button, followed by the **EndCall** soft key.

To cancel call forwarding, use one of the following methods:

- Press the **CFwdALL** soft key.

## Pick Up Calls

To pick up a call that is on hold or a call that is ringing at another extension:

1. Press the **PickUp** soft key.
2. Dial the extension number of the Cisco Unified IP phone that you want to pick up. Control of the call is transferred to your phone.

To selectively pick up a call ringing at a number that belongs to a pickup group:

- Press the **GPickUp** soft key. If only one pickup group is defined in the entire Cisco Unified Communications Manager Express system, control of the call is transferred to your phone.
- If the ringing telephone and your phone are in the same pickup group, press the asterisk (\*) to transfer control of the call to your phone.
- If the ringing telephone and your phone are in different pickup groups, dial the pickup group number where the phone is ringing to transfer control of the call to your phone.

## Place and Establish a Conference Call

To create a three-party conference call, perform the following steps:

1. During a call, press the **more** soft key and then the **Confm** soft key to open a new line and put the first party on hold.
2. Place a call to another number.
3. When the call connects, press **Confm** again to add the new party to the call.

To establish a conference call between two- and three-party calls to a Cisco Unified IP phone, one active and the other on hold:

- Press the **Confm** soft key on the Cisco Unified IP phone.

To establish a conference call between second- and third-party calls already present on a Cisco Unified IP phone, using separate line buttons, one active and the other on hold, perform the following steps:

1. Press the **Confm** soft key on the Cisco Unified IP phone.
2. Press the **Line** button of the call you want to add to the conference.



---

**Note** Your system administrator will have configured the system for three-party or eight-party ad-hoc conferences.

---

## Place a MeetMe Conference Call

To Place a MeetMe conference call:

1. Obtain a MeetMe conference number from your administrator
  2. Distribute the MeetMe conference number to all the participants.
  3. Go offhook, press the MeetMe softkey, and dial the MeetMe conference number. All other participants join the meeting by dialing into the MeetMe conference number.
- To end the MeetMe conference call, all participants must hang up the handset or press the **EndCall** soft key.

## End a Conference Call

To end the conference call:

- Hang up the handset, or press the **EndCall** soft key.



---

**Note** Depending on configuration when the conference call initiator disconnects, the conference call terminates.

---

## Alternate Methods to End a Conference Call

Call initiators may use one of the following methods (functionality will vary according to your system configuration):

- To end the conference and remain connected to the most recent call, press the **Confrn** soft key. The older call is placed on hold.
- To disconnect from the conference, hang up the handset. The other parties remain on the conference call.

## Live Record a Call

Call initiators can use the **LiveRcd** soft key to record an active call, private line or conference call. To record a call, use this method:

1. Press the **LiveRcd**. This puts the other party on-hold and initiates a call to the configured live record number.
2. Press the **LiveRcd** again to stop the recording.

## Join a Shared-Line Call

User can join a call on a shared line using the **cBarge** softkey.

To join the shared-line call, use the following method:

1. Highlight the remote-in-use call that you want to join.
2. Press the **more** to navigate to **cBarge** and press **cBarge**.

## Place a Call from Your Local Directory

To access the local phone directory established by the administrator:

1. Press the **Directories** button.
2. Press the **Navigation Up** or **Down** button or press **4** to select the Local Directory.
3. Press the **Navigation Up** or **Down** button to select the Last, First, or Number field search option.
4. Using the keypad, enter the last name or first name for the entry.

When entering letters, select the appropriate number key of the letter you want, and press that key a number of times that equals the position of the target letter. For example, to enter a B, press the 2 key two times, and to enter a C, press the 2 key three times. Use the backspace (<<) soft key to make corrections while entering data.

5. Press the **Search** soft key to find your selection.
6. If your search results in multiple listings, use the **Navigation Up** or **Down** button to select the correct number.
7. Press the **Dial** soft key to dial the selected number.

## Program Personal Speed-Dial Buttons

After an administrator defines one or more speed-dial instances for a Cisco Unified IP phone, you can reprogram numbers that are not locked or program numbers into an instance that has an empty dial string:

1. Select an available phone line by lifting the handset, by pressing the **NewCall** soft key, or by pressing a line button. Listen for the dial tone.
2. Press the pound key (#).
3. Press the speed-dial button that you want to program. A short beep confirms that you are starting to program this button.
4. Enter the speed-dial number. The digits appear on the phone display. When you are entering speed-dial numbers, use the backspace (<<) soft key to erase digits that you entered incorrectly.
  - To remove a speed-dial number without replacing it with a new one.
1. Press the pound key (#).
2. Press the same speed-dial button a second time to indicate that you are done entering the speed-dial digits and to store the new speed-dial number.
3. Hang up the handset, or press a new speed-dial button and repeat this procedure.

## Place a Call from Your System Speed-Dial Directory

To place a call from your system speed-dial directory:

1. Select an available Cisco Unified IP phone line (off hook or **NewCall**) and get a dial tone.
2. Press the **Directories** button, or use the **Navigation** button to locate Directory and then press the **Select** soft key.
3. Use the **Navigation** button to scroll through the options. Use the **Select** soft key to select speed-dial options.
  - Press 5 for the Local Speed Dial.
  - Press 6 for the Personal Speed Dial (functionality varies depending on your system configuration).
4. Use the **Navigation** button to scroll through the speed-dial phone list.
5. To dial the selected phone number, either press the **Select** soft key or enter the number on the keypad.
6. Press the **Exit** soft key to go to the directory menu.

## View Call History

To view recent missed, received, or placed calls:

1. Press the **Directories** button.
2. Use the **Navigation** button to scroll and select the desired call list. Press the **Select** soft key, or:
  - Press 1 on the keypad for Missed Calls.
  - Press 2 on the keypad for Received Calls.
  - Press 3 on the keypad for Placed Calls.
3. Press the **Exit** soft key to return to the previous directory menu.

## Place a Call from Call History

To place a call to a number in the call history list:

1. Use the **Navigation** button to scroll through the call history list.
2. Use the **Select** soft key to select a phone number. The digits appear on the phone display.
3. To dial the number as it appears on the phone display:
  - Press the **Dial** soft key.

To edit the number on the phone display before dialing:

1. Press the **EditDial** soft key to place the cursor at the beginning of the number on the phone display.
2. Use the keypad to edit the digits as needed. Use the backspace (<<) soft key to erase digits that you enter incorrectly.
3. Press the **Dial** soft key to place the call.

## Clear Call History

To clear all numbers in the directory histories:

- Press the **Clear** soft key.



---

**Note** The **Clear** soft key clears all call history lists. Selective clearing of call history lists is not supported.

---

## Use the Intercom Feature

Cisco Unified Communications Manager Express supports intercom functionality for one-way and press-to-answer voice connections using a dedicated pair of intercoms on two phones that speed-dial each other.

To use the intercom feature:

1. Press the **Speaker** button and get the dial tone.
2. Press the speed dial key or dial the directory number to start the intercom call.



---

**Note** The called Cisco Unified IP phone automatically answers the call in speakerphone mode with mute activated or deactivated depending on configuration. The phone will beep to alert the recipient to the incoming call.

---

To respond to an intercom call:

- If Mute key is lighted, Press the **Mute** button, or lift the handset.
- If Mute key is not lighted, reply to caller handsfree.

## Activate Do Not Disturb

For visual call alerting and information without audible ringing, use Do Not Disturb (DnD). Calls receive normal call-forward-busy and no-answer treatment.

To activate the Do-Not-Disturb feature:

1. Press the **more** soft key to locate the **DnD** soft key.
2. Press the **DnD** soft key. A text message displays to indicate that the phone is in Do-Not-Disturb mode.



---

**Note** Pressing the DnD soft key immediately forwards the call to the call-forward destination set on the phone. If the call-forward destination is not set, pressing the DnD soft key disables the ringer.

---

To deactivate the Do-Not-Disturb feature, repeat Steps 1 and 2.

## Place a Call Using Your Extension Mobility (EM) Profile

Extension Mobility (EM) allows the user to temporarily configure a Cisco Unified IP phone to function as user's own phone. Once the user is logged-in to EM, the phone adopts the user's profile, including the line buttons, features, and established services.

To log-in to Extension Mobility:

1. Press **Services** button and select **Extension Mobility**.
2. Enter your User ID and Password.
3. Press **Submit**. The phone will temporarily configure user profile and settings.



---

**Note** Your administrator must configure Extension Mobility for you.

---

## Place a Call from Your Personal Speed-Dial

To place a call from your Personal Speed-Dial using My Phone Apps, use the following method:

1. Log-in to **Extension Mobility**.
2. Select **My Phone Apps** and scroll down to **Personal Speed Dial**.
3. Select **Personal Speed Dial**
4. Add a Label and Number
5. Go back to **My Phone Apps** and press **Reset Phone**. Your Personal Speed-Dial number will appear on the phone display screen.

# 3 Phone Features Index

This section provides an alphabetical list of features for your Cisco Unified IP phone. Features supported in both SIP and SCCP protocols are marked as "Supported" and features not supported in either one of the protocols are marked as "Not Supported". However, there are differences in how the feature works based on the call protocol.

**Table 1** *Features (with page number references) supported in SIP and SCCP protocols.*

<b>Features</b>	<b>SIP</b>	<b>SCCP</b>
Activate Do Not Disturb 15	Supported	Supported
Adjust the Display Contrast 10	Supported	Supported
Adjust the Ring Volume 10	Supported	Supported
Adjust the Volume for the Current Call 9	Supported	Supported
Answer a Call 8	Supported	Supported
Call-Blocking (Toll Bar) Override 11	Not Supported	Supported
Clear Call History 14	Supported	Supported
Divert Incoming Calls 10	Supported	Supported
End a Call 8	Supported	Supported
End a Conference Call 13	Supported	Supported
Forward All Calls 11	Supported	Supported
Hold a Call 8	Supported	Supported
Join a Shared-Line Call 12	Not Supported	Supported
Live Record a Call 12	Not Supported	Supported
Manage Call Waiting 9	Supported	Supported
Mute a Call 9	Supported	Supported
Park a Call 10	Not Supported	Supported
Pick Up Calls 12	Not Supported	Supported
Place a Call 8	Supported	Supported
Place a Call from Call History 14	Supported	Supported
Place a Call from Your Local Directory 13	Supported	Supported
Place a Call from Your Personal Speed-Dial 14	Not Supported	Supported
Place a Call from Your System Speed-Dial Directory 14	Supported	Supported
Place a MeetMe Conference Call 12	Not Supported	Supported
Place and Establish a Conference Call 12	Supported	Supported
Program Personal Speed-Dial Buttons 13	Not Supported	Supported
Place a Call Using Your Extension Mobility (EM) Profile 14	Not Supported	Supported
Redial a Number 8	Supported	Supported
Retrieve Voice Messages 9	Supported	Supported
Select the Ring Type 10	Supported	Supported
Transfer a Call 11	Supported	Supported
Use the Intercom Feature 14	Supported	Supported
View Call History 14	Supported	Supported



**Americas Headquarters**  
Cisco Systems, Inc.  
170 West Tasman Drive  
San Jose, CA 95134-1706  
USA  
[www.cisco.com](http://www.cisco.com)  
Tel: 408 526-4000  
800 553-NETS (6387)  
Fax: 408 527-0883

**Asia Pacific Headquarters**  
Cisco Systems (USA) Pte. Ltd.  
168 Robinson Road  
#28-01 Capital Tower  
Singapore 068912  
[www.cisco.com](http://www.cisco.com)  
Tel: +65 6317 7777  
Fax: +65 6317 7799

**Europe Headquarters**  
Cisco Systems International BV  
Haarlerbergpark  
Haarlerbergweg 13-19  
1101 CH Amsterdam  
The Netherlands  
[www-europe.cisco.com](http://www-europe.cisco.com)  
Tel: 31 0 800 020 0791  
Fax: 31 0 20 357 1100

**Cisco has more than 200 offices worldwide. Addresses, phone numbers, and fax numbers are listed on the Cisco Website at [www.cisco.com/go/offices](http://www.cisco.com/go/offices).**

Cisco, Cisco Systems, the Cisco logo, and the Cisco Systems logo are registered trademarks or trademarks of Cisco Systems, Inc. and/or its affiliates in the United States and certain other countries. All other trademarks mentioned in this document or Website are the property of their respective owners. The use of the word partner does not imply a partnership relationship between Cisco and any other company. (0705R)

© 2008 Cisco Systems, Inc. All rights reserved.

♻️ Printed in the USA on recycled paper containing 10% postconsumer waste.