



USER GUIDE

Cisco Small Business

Cisco SPA50X and SPA51X SIP IP Phones
Models SPA501G, SPA502G, SPA504G, SPA508G,
SPA509G, SPA512G, and SPA514G

Chapter 1: Getting Started	6
About This Document	6
Overview of the Cisco Small Business IP Phones	8
Caring for Your Phone	8
Understanding Your Phone Lines and Buttons	9
Softkey Buttons	11
Using Keypad Shortcuts	13
Using the Cisco Attendant Console	14
Changing the Cisco SPA500DS Attendant Console Display	14
Chapter 2: Installing Your Phone	16
Before You Begin	17
Phone Connections	17
Connecting the Handset	18
Installing the Desk Stand or Wall Mount (Optional)	19
Reverse the Handset Retention Tab	19
Connecting the Power	20
Connecting Your Phone to the Network	21
Connecting Your Phone to the Wired Network	21
Connecting the Phone to the Wireless Network	21
Connecting a PC to Your Phone	22
Connecting Wired and Wireless Headsets	22
Verifying Phone Startup	23
Updating Your Phone Firmware	24
Determining Your Current Firmware Version	24
Download the Firmware from Cisco	25
Get the Phone IP Address	25
Update the Firmware on the Phone	26
Chapter 3: Using Basic Call Management Functions	27
Managing the Audio Source and Volume	28

Adjusting Call Volume	28
Adjusting the Ringer Volume	28
Using Mute	28
Using the Speakerphone	28
Using the Headset with Your IP Phone	28
Switching Between the Handset, Headset, or Speakerphone During a Call	29
Sending Audio to the Speaker and Handset	29
Choosing Your Preferred Audio Device	29
Answering or Placing a Call	30
Answering a Call	30
Placing a Call	30
Redialing a Call	31
Putting a Call on Hold	31
Resuming a Call	31
Ending a Call	32
Transferring Calls	32
Performing an Attended Transfer	32
Performing an Unattended (Blind) Transfer	33
Transferring a Held Call to an Active Call	33
Managing Missed Calls	34
Turning the Missed Calls Shortcut On and Off	34
Forwarding Calls	35
Forwarding All Calls	35
Forwarding Calls When Your Phone is Busy	36
Forwarding Calls (Delay) Without Answering the Phone	36
Canceling Call Forwarding All	37
Call Forward Deactivation by using Star Codes	38
Setting Do Not Disturb	38
Enabling Do Not Disturb	38
Disabling Do Not Disturb	39
Setting Call Waiting	39

Picking Up a Call	40
Parking a Call	41
Placing a Three-Way Conference Call	42
Conferencing a Held Call with an Active Call	43
Using the Phone Directories	43
Using Your Personal Directory	44
Using the Corporate Directory	45
Using the Call History Lists	45
Setting or Changing a Phone Password	46
Accessing Voicemail	47

Chapter 4: Using Advanced Phone Features **48**

Configuring Privacy and Security	49
Blocking Caller ID	49
Blocking Anonymous Calls	49
Using Secure Call	50
Enabling and Using Dial Assistance	51
Creating Speed Dials	51
Creating Speed Dials on Unused Line Buttons	52
Creating Numerical Speed Dials	52
Using Speed Dials	53
Using the Paging Feature	53
Paging Another Phone	53
Paging a Group of Phones	53
Configuring Auto Answer	54
Monitoring and Accessing Another Phone	54
Customizing Your IP Phone Screen	55
Changing the IP Phone Screen Contrast	55
Changing the Screen Backlight Settings	55
Configuring the Phone Screen Saver	56
Turning on the Screen Saver	57

Using Ring Tones	58
Changing Your Ring Tone	58
Configuring Date and Time	58
Setting Your Phone's Date and Time	58
Using Star Codes	59
Using the Interactive Voice Response Menu on the Cisco SPA501G	61
Advanced Procedures for Technical Support Personnel	63
Rebooting Your Phone	64
Chapter 5: Using the Phone Web User Interface	65
Logging in to the Phone Web User Interface	65
Saving the Configuration Profile	66
Setting Voice System Parameters	67
Setting Voice Phone Parameters	68
Setting Voice User Parameters	69
Viewing Call History Lists	71
Using Your Personal Directory	72
Viewing Attendant Console Status	73
Appendix A: Where to Go From Here	74
Product Resources	74

Getting Started

This chapter provides an overview of this document and basic information about your Cisco Small Business IP phone. It contains the following sections:

- [About This Document, page 6](#)
- [Overview of the Cisco Small Business IP Phones, page 8](#)
- [Understanding Your Phone Lines and Buttons, page 9](#)
- [Using the Cisco Attendant Console, page 14](#)

About This Document

This guide describes the concepts and tasks necessary to use and configure your Cisco Small Business IP Phone.

The Cisco Small Business IP Phone features vary, depending on the type of call control system that you are using and the customizations performed by your phone system administrator. This document describes using the Cisco Small Business IP Phones with a SIP phone system, such as a Broadsoft or Asterisk system. If you are using your Cisco Small Business IP Phone with a Cisco Unified Communications 500 Series, also see the Cisco Unified Communications Manager Express Administrator Guide.

Organization

This table describes the contents of each chapter in this document.

	Title	Description
Chapter 1	Getting Started	A description of this book and an overview of the Cisco Small Business IP Phones.
Chapter 2	Installing Your Phone	How to connect and install your phone.
Chapter 3	Using Basic Call Management Functions	How to perform basic phone tasks, such as placing and answering calls, transferring calls, setting up call forwarding, and picking up calls.
Chapter 4	Using Advanced Phone Features	How to perform advanced phone tasks, such as configuring privacy and security features, speed dials, paging, and ring tones.
Chapter 5	Using the Phone Web User Interface	How to modify the phone features by using the web configuration utility.
Appendix A	Where to Go From Here	Cisco provides a wide range of resources to help you obtain the full benefits of the Cisco SPA500 Series phones. This appendix provides links to many of these resources.

Overview of the Cisco Small Business IP Phones

The Cisco Small Business IP Phones are full-featured VoIP (Voice over Internet Protocol) phones that provide voice communication over an IP network. The phones include traditional features, such as call forwarding, redialing, speed dialing, transferring calls, conference calling, and accessing voice mail. Calls can be made or received with a handset, headset, or a speaker.

The Cisco Small Business IP phones contain Ethernet ports that link them to the computer network. They also have secondary Ethernet ports that allow another Ethernet device, such as a computer, to be connected to the network through the IP phone.

Cisco Small Business IP phones require a separate power source. You can power the phones by connecting them to a switch that provides Power over Ethernet (PoE), or by using the optional a Cisco PA100 power adapter.

Caring for Your Phone

The Cisco Small Business IP phones are electronic devices that should not be exposed to excessive heat, sun, cold, or water. To clean the equipment, wipe it with a slightly moistened paper or cloth towel. Do not spray or pour cleaning solution directly onto the device.

Understanding Your Phone Lines and Buttons





The parts of a SPA509G IP phone are shown in **Figure 1**. Other models are similar, but might vary.

Figure 1 SPA509G Phone Components



Numbered objects in **Figure 1** described in the following table.

#	Phone Feature	Description
1	Handset	Pick up to place or answer a call.
2	Message Waiting indicator	Displays solid red when you have a new voice mail message. Blinks red during an incoming call.
3	IP phone screen	Displays date and time, phone station name, line extensions, and softkey options (except on the Cisco SPA501G).

#	Phone Feature	Description
4	Line keys	<p>Indicates phone line status. (Not available on the Cisco SPA502G or Cisco SPA512G.)</p> <p>When lit:</p> <p>Green: Line is idle.</p> <p>Red (steady): Line is active or in use.</p> <p>Red (flashing): Line is on hold or there is an inbound call.</p> <p>Orange: Line is unregistered (cannot be used).</p> <p>These keys can also be programmed by your system administrator to perform differently than described here or to add functions such as speed dial, call pickup, or monitor an extension.</p>
5	Softkey buttons	<p>Press a softkey button to perform the action shown on the label on the IP phone screen.</p> <p>Note: The Cisco SPA501G has the following four buttons:</p> <p> Redial—Dials the last number called.</p> <p> Cancel—Cancels an action (such as a transfer).</p> <p> Conference—While on a call, press to start a conference call and dial another number. After the second party answers, press Conference again to create the conference.</p> <p> Transfer—Transfers a call.</p>
6	Navigation button	Press an arrow key to scroll left, right, up, or down through items shown on the IP phone screen (except on the Cisco SPA501G).
7	Messages button	Press to access voice mail. (This feature must be set up by your phone system administrator).
8	Hold button	Press to place a call either on hold or to resume. NOTE SPA501 phone does not support this feature.

#	Phone Feature	Description
9	Setup button	Press to access a menu to configure features and preferences (such as your directory, status, and speed dials), access your call history, set up functions (such as call forwarding), and provide phone status information. For the Cisco SPA501G, press Setup to access the Interactive Voice Response (IVR) menu that allows you to perform tasks such as getting the IP address of the phone.
10	Mute button	Press to mute or unmute the phone. When phone is muted, the button is lit red. A blinking or steady red mute button indicates the network connection cannot be found.
11	Volume button	Press + to increase the volume and - to lower the volume of the handset, headset, speaker when the phone is off-hook, or ringer volume when the phone is on-hook.
12	Headset button	Push to turn the headset on or off. When the headset is on, the button is lit green.
13	Speaker button	Push to turn the speaker on or off. When the speaker is on, the button is lit green.
14	Keypad	Use to dial phone numbers, enter letters, and choose menu items.

Softkey Buttons

The softkey buttons on your phone display might vary depending on your phone model and the phone system setup. (Softkey buttons are not available on the Cisco SPA501G.) Press the **Right Arrow** or **Left Arrow** keys on the navigation button to view additional softkey buttons.

Below is a partial listing of softkey buttons that might be available on your phone. You might not have all of these softkey buttons on your phone, and you might have additional buttons that are not listed here, as your phone administrator might provide custom softkey buttons on your phone, such as a speed dial to a company number, or a specialized program that runs on your phone. Contact your phone administrator for more information.

Button	Function
<< or >>	Move left or right through an entry without deleting characters.
activ	Activates screen saver mode.
add	Add an entry.
bXfer	Performs a blind call transfer (transferring a call without speaking to the party to whom you are transferring the call.)
cancel	Cancel any changes you have made. (Press before ok or save .)
cfwd	Forwards all calls coming to your phone to a specified number.
-cfwd	Clears call forwarding.
conf	Initiates a conference call.
confLx	Conferences active lines on the phone together.
delChr	Deletes the last number or letter.
delete	Deletes an entire item (for example, a number from the Call History list).
dial	Dials a number.
dir	Accesses phone directories.
dnd	Do Not Disturb; prevents incoming calls from ringing your phone.
-dnd	Clears Do Not Disturb.
edit	Opens an item so that you can edit numbers or letters, or enable or disable a feature.
grPick	Allows you to answer a call ringing on an extension by discovering the number of the ringing extension.
ignore	Ignores an incoming call.
lcr	Dials the Last Call Received.
miss	Shows the Missed Calls list.
park	Puts a call on hold at a designated "park" number. The call is parked on the line until you unpark it or the caller disconnects. Must be configured by your phone system administrator.

Button	Function
pickup	Answers a call ringing on another extension by entering the extension number.
phold	Puts a call on hold on an active shared line.
redial	Displays a list of recently dialed numbers.
resume	Resumes a call that is on hold.
save	Saves your changes.
select	Selects the highlighted item on the IP phone screen.
starcode	Allows you to enter a star code. See “Using Star Codes,” on page 59.
unpark	Resumes a parked call.
xfer	Performs a call transfer.
xferLx	Transfers an active line on the phone to a called number.
y/n	Enters a submenu and when pressed, toggles between Yes or No to enable or disable an option.

Using Keypad Shortcuts

When using the phone menus, you can use the keypad to enter the number shown next to the menu or sub-menu item on the IP phone screen. (Not applicable to the Cisco SPA501G.)

For example, to obtain your IP address on the Cisco SPA 504G, press the **Setup** button and dial **9**.

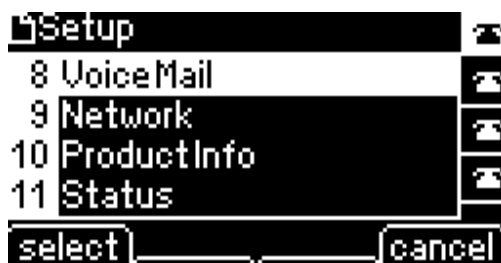

The IP address is displayed on the Network screen.

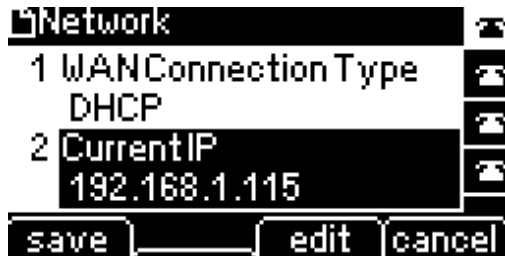

NOTE Menus and options vary depending on phone model.

Using the Cisco Attendant Console

The Cisco Attendant Consoles are accessory consoles for the Cisco SPA500 Series IP phones. The Cisco SPA500S provides 32 three-color (red, green, and orange) programmable line buttons, and the Cisco SPA500DS provides 30 buttons. The Cisco Attendant Console attaches to the IP phone with the attachment arm provided. It obtains power directly from the IP phone; it does not require a separate power supply. Two Cisco Attendant Console units can be attached to a single IP phone to monitor a total of 64 (SPA500S) or 60 (SPA500DS) separate lines.

Detailed information on the installation of the Cisco Attendant Consoles are provided in the *Cisco Small Business SPA500S Attendant Console Quick Start Guide* and the *Cisco Small Business SPA500DS 15-Button Digital Attendant Console for SPA500 Family Phones Quick Start Guide*.

Configuration of the Cisco Attendant Console and assignment of the line buttons is typically performed by the phone system administrator and is not described in this document. The Cisco Attendant Console can be configured by using the same web configuration utility for the IP phone to which the Cisco Attendant Console is attached. See the *Cisco SPA300 Series, SPA500 Series, and WIP310 Administration Guide* on Cisco.com for more information.

Changing the Cisco SPA500DS Attendant Console Display

The Cisco SPA500DS provides a backlit LCD display. The backlight is controlled by the backlight settings of the phone display and is not separately configurable; that is, the Cisco SPA500DS display is lit when the phone display is lit, and is off when the phone display is off.

You can choose the font size (10 or 12 point) of the text displayed on the Cisco SPA500DS. You can also configure the text contrast, or how dark the text appears on the display. To configure these options from the phone:

STEP 1 Press the **Setup** button.

STEP 2 Scroll to **Att. Cons. Preferences** and press **select**.

STEP 3 Choose **Font Size** or **Contrast** from the menu and press **edit**:

- To change the font size, press **option** to switch between 10 and 12 point font. Press **ok** to save.
- To change the display contrast, use the keypad to enter a number value from 1 to 30. The higher the number, the greater the contrast on the display. Press **ok** to save.

STEP 4 Press **save** to save your changes.

Installing Your Phone

This chapter describes how to install your Cisco Small Business IP Phone and connect it to your network. It contains the following sections:

- **Before You Begin, page 17**
- **Phone Connections, page 17**
- **Connecting the Handset, page 18**
- **Installing the Desk Stand or Wall Mount (Optional), page 19**
- **Connecting the Power, page 20**
- **Connecting Your Phone to the Network, page 21**
- **Connecting a PC to Your Phone, page 22**
- **Connecting Wired and Wireless Headsets, page 22**
- **Verifying Phone Startup, page 23**
- **Updating Your Phone Firmware, page 24**

Before You Begin

Before you install and connect your phone, verify with your system administrator (if applicable) that the network is ready for the phone. Read the safety notices, and make sure you have all the phone parts and documentation.



CAUTION Do not plug a telephone line cord into the port marked **AUX**. The RJ-11 port marked **AUX** is reserved for connection with the Cisco Attendant Console. It is not for use as a telephone line port or IP device connection.

Phone Connections

The phone connections are shown in [Figure 1](#).

Figure 1 Phone Connections

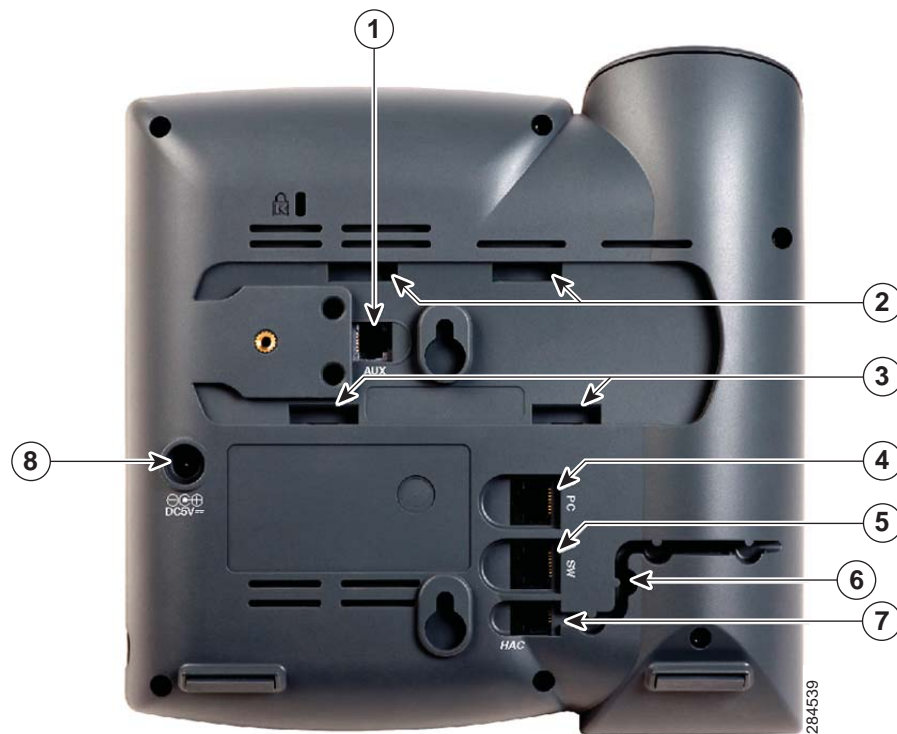

Numbered objects in **Figure 1** are described in the following table.

#	Description
1	Auxiliary port. (For use only with the Cisco Attendant Console.)
2	Upper slots.
3	Lower slots.
4	PC port.
5	Network (switch) port.
6	Cable run.
7	Handset port.
8	Power port. (Use only with a Cisco PA100 power adapter.)

Connecting the Handset

STEP 1 Turn the phone body over to expose the ports on the back of the device.



CAUTION Do not insert a telephone line cord into the auxiliary (AUX) port.

STEP 2 Insert the long end of the phone cord into the handset port on the phone body that is marked with a phone symbol.

STEP 3 (Optional) Route the phone cord through the cable slot.

STEP 4 Insert the other end of the phone cord into the port at the bottom of the handset (not shown).

Installing the Desk Stand or Wall Mount (Optional)

The phone can be set on a flat surface, such as a desk, or mounted to a wall. This section describes the installation of the desk stand. If you are attaching a Cisco SPA500S or SPA500DS attendant console, attach the console before attaching the desk stand.

To mount the phone to the wall, you must use the MB100 wall mount bracket kit (available separately). Do not attach the desk stand if you intend to mount the phone to the wall. To mount the phone on the wall, follow the instructions included with the wall mount.

To install the desk stand:

-
- STEP 1** Connect the phone stand by lining up the tabs on the stand with the slots on the phone body.
 - STEP 2** Slide the bottom tabs into the lower slots on the phone body and lightly press down on the stand. It should easily slide into the upper stand slots. Do not force it.
-

Reverse the Handset Retention Tab

If you mount the phone to a vertical surface, such as a wall, you must reverse the handset retention tab on the phone body so that the handset does not fall off the phone when it is placed on the cradle.

-
- STEP 1** Push the latch in.
 - STEP 2** Slide the retention tab up until it detaches from the phone.



- STEP 3** Rotate the tab 180° and re-insert into the phone base. The tab now catches the slot in the handset when the handset is placed onto the cradle.

Connecting the Power

The Cisco 500 Series IP phones do not ship with power supplies. If you are not using Power over Ethernet (PoE), you must order a Cisco PA100 power supply for each phone.

If you are using Power over Ethernet (PoE) to power the phone, the phone receives power when you connect an Ethernet cable from the phone SW port to a switch that provides PoE. If you are using a Cisco PA100 power adapter, insert one end of the power adapter into an outlet and insert the other end into the power port on the phone body.

Connecting Your Phone to the Network

The phone can be connected to the network by using a Cat5e or higher Ethernet cable or through a wireless network connection.

Connecting Your Phone to the Wired Network

To connect the phone by using an Ethernet cable:

-
- STEP 1** Insert one end of the Ethernet cable into the network port on the RJ-45 phone port marked “SW.”
 - STEP 2** Insert the other end of the Ethernet cable into the device, such as a switch.
-

Connecting the Phone to the Wireless Network

You can use a wireless device, such as a Cisco Wireless-N Bridge for Phone Adapters (WNBPA), to connect the IP phone to a wireless network. This example procedure requires the Cisco PA100 power adapter to provide power to the Cisco WNBPA. Cisco does not recommend connecting a PC to the network by using the phone when it is operating wirelessly.

To connect your phone to the Cisco WNBPA:

-
- STEP 1** Configure the Cisco WNBPA by using the Setup Wizard.
 - STEP 2** When instructed to do so by the Setup Wizard, insert the Ethernet cable of the wireless bridge into the RJ-45 phone port marked SW, located on the back of the IP phone base station.
 - STEP 3** Connect the power cable of the Cisco WNBPA to the power port on the phone base.
 - STEP 4** Connect one end of the IP phone power adapter into the power port of the wireless bridge.
 - STEP 5** Connect the other end of the IP phone power adapter into an electrical outlet.
-

Connecting a PC to Your Phone

A PC can be connected to the network through the phone. Cisco does not recommend connecting a PC to the phone if the phone is connected to the network wirelessly.

To connect a PC to your phone:

-
- STEP 1** To provide network access to a PC, connect one end of a Cat5e or higher Ethernet cable (not provided) to the **PC** port on the back of the phone body. See **Figure 1**.
 - STEP 2** Connect the other end of the Ethernet cable to the RJ-45 port on your PC.
-

Connecting Wired and Wireless Headsets

The IP phones support headsets from different manufacturers. For a list of supported models, contact your reseller. Additional information can be found at the manufacturer websites.

Each brand and type of headset might require different steps for connection. Consult the documentation for your particular headset for more information. In general, to connect a headset:

- **Wireless**—Connect the headset telephone cord into the telephone port on the back of the IP Phone.

- **Wired headsets**—Connect the 2.5mm connector from the headset into the headset port on the right side of the IP phone:



Verifying Phone Startup

After receiving power and network connectivity, the phone executes a boot-up sequence. During this sequence, phones with screens display the Cisco logo and then **Initializing Network**. All of the lights on the phone flash.

After your phone is successfully connected to the network and receives a basic configuration, your phone line keys should glow green (on models with phone line keys).

On models with screens, the phone displays the standard menu for the phone. The date, name and number of the phone display on the top line of the IP phone screen. At the bottom of the IP phone screen, softkeys are displayed over their associated soft buttons.

On models with no screen, such as the Cisco SPA501G, the lines glow green and you hear a dial tone when picking up the handset or pressing the speakerphone button.

If the phone does not start, confirm your installation and connections. If these are correct, try unplugging the phone and plugging it back in again. If you still do not see the display, contact your phone administrator or Internet Telephony Service Provider (ITSP).

Updating Your Phone Firmware

Your phone ships with pre-installed firmware. However, later firmware versions might be available that add features and fix problems with your phone. It is necessary to use the latest firmware for ideal performance.



CAUTION

If you are using your phone with an Internet Telephony Service Provider system, do not update your phone firmware without consulting your service provider. Your provider can automatically update your phones without any action on your part necessary.

To update your phone firmware, do one of the following:

- Download the firmware from Cisco.com and install it from your PC. (See the next section for instructions.)
- Update by using the Cisco Voice System Setup Wizard (for example, if your phone is part of a Cisco Voice System network). See the *Cisco Voice System Setup Wizard User Guide*.

Determining Your Current Firmware Version

**Cisco SPA502G, Cisco SPA504G, Cisco SPA508G, Cisco SPA509G,
Cisco SPA512G, Cisco SPA514G:**

STEP 1 Press the **Setup** button.

STEP 2 Scroll to **Product Info** and press **select**.

STEP 3 Scroll to **Software Version**. The firmware version number is displayed.

Cisco SPA501G:

STEP 1 Press the **Setup** button.

STEP 2 Enter **150**, then press **#**. The firmware version is recited.

Download the Firmware from Cisco

Go to www.cisco.com/cisco/software/navigator.html?a=a&i=rpm, and enter the phone model number (for example, SPA504G) in the Software Search box. Save the firmware to your desktop.

Get the Phone IP Address

Before you upgrade, you'll need the IP address of the phone you are upgrading. To get your IP address for all phones (except on the Cisco SPA501G):

STEP 1 Press **Setup**.

STEP 2 Scroll to **Network** and press **Select**.

STEP 3 Scroll to view **Current IP**. This is the IP address of your phone.

To get your IP address for the Cisco SPA501G phone:

STEP 1 Press the **Setup** button.

STEP 2 Enter **110**, then press **#**. The IP address is recited.

Update the Firmware on the Phone

To update the firmware on the phone:

STEP 1 Download the updated firmware onto your PC.

NOTE If you are in a VPN connection, you might need to disconnect from the network before proceeding so that your PC can communicate directly with your phone for the upgrade.

STEP 2 Run the executable file for the firmware upgrade (for example, double click spa50x-30x-7-4-9c.exe). A message regarding upgrading your phone displays.

STEP 3 Click **Continue**.

STEP 4 Enter the IP address of your phone and verify the address of your PC.

STEP 5 Click **OK**. The system displays information about your phone firmware and hardware.

STEP 6 Click **Upgrade** to begin the upgrade.



CAUTION Do not disconnect your phone power until the upgrade is complete (the lights on your phone are no longer blinking).

STEP 7 Click **OK** to dismiss the status message of the upgrade.

Using Basic Call Management Functions

This chapter provides instructions on using your basic phone functions. It includes the following sections:

- **Managing the Audio Source and Volume, page 28**
- **Answering or Placing a Call, page 30**
- **Putting a Call on Hold, page 31**
- **Resuming a Call, page 31**
- **Ending a Call, page 32**
- **Transferring Calls, page 32**
- **Redialing a Call, page 31**
- **Managing Missed Calls, page 34**
- **Forwarding Calls, page 35**
- **Setting Do Not Disturb, page 38**
- **Setting Call Waiting, page 39**
- **Picking Up a Call, page 40**
- **Parking a Call, page 41**
- **Placing a Three-Way Conference Call, page 42**
- **Using the Phone Directories, page 43**
- **Using the Call History Lists, page 45**
- **Setting or Changing a Phone Password, page 46**
- **Accessing Voicemail, page 47**

Managing the Audio Source and Volume

Adjusting Call Volume

To adjust the volume of the handset or speaker, lift the handset or press the **Speaker** button. Press **+** on the **Volume** button to increase the volume, or press **-** to decrease the volume. Press **Save**. (Not available for the Cisco SPA501G.)

Adjusting the Ringer Volume

To adjust the ringer volume, press **+** on the **Volume** button to increase the volume, or press **-** to decrease the volume when the handset is on-hook and the speaker button is off. Press **Save**. (Not available for the Cisco SPA501G.)

Using Mute

To mute the handset, speaker, and headset microphones, press **Mute**. The button lights red. Press **Mute** again to unmute.

If no audio device is on, pressing **Mute** has no effect. When switching from the speaker phone to the handset, the phone is unmuted automatically.

Using the Speakerphone

To use the speakerphone, press **Speaker** (the handset can be either on or off hook).

Using the Headset with Your IP Phone

Install the headset as described in the [“Connecting Wired and Wireless Headsets” section on page 22](#). Steps to use your headset with the IP phone might vary. Consult the user documentation for your headset for more information.

To use a wired headset, press **Headset** on your phone and dial the number to place a call, or press **Headset** to answer a ringing call.

To use a wireless headset, lift the receiver off hook before speaking or listening through the headset.

Switching Between the Handset, Headset, or Speakerphone During a Call

The headset, handset, or speaker phone can be used during a call, but only one of these devices at a time can be used.

The handset can be on hook when using the speakerphone or headset. If switching from the handset to the speakerphone, make sure the speakerphone or headset light is illuminated before placing the handset back on the hook. If you are switching from the handset to a wireless headset, do not replace the handset or you will disconnect the call.

Sending Audio to the Speaker and Handset

You can send the audio to the speaker while the handset is lifted (except on the Cisco SPA501G). The handset operates normally, but the speaker is muted.

To send the audio to the speaker when the handset is lifted:

-
- STEP 1** Press the **Setup** button.
 - STEP 2** Select **Preferences > Send Audio to Speaker > edit**.
 - STEP 3** Press **y/n** to enable or disable the feature.
 - STEP 4** Press **ok**.
 - STEP 5** Press **Save**.
-

Choosing Your Preferred Audio Device

This option designates the headset or the speaker as the preferred audio device. When you answer a call by pressing the line button, the audio is directed to the headset or the speaker. (Not available for the Cisco SPA501G.)

To choose your preferred audio device:

-
- STEP 1** Press the **Setup** button.
 - STEP 2** Select **Preferences > Preferred Audio Device > edit**.
 - STEP 3** Press **option** to scroll through the choices. When the option you want is displayed, press **ok**.
-

STEP 4 Press **save**.

Answering or Placing a Call

You can answer, place, or redial a call.

Answering a Call

To answer a call:

- Pick up the receiver.
- Press **Speaker**.
- Press **Headset**.
- Press an (optionally) configured blinking red line button. (Not applicable to the Cisco SPA502G or Cisco SPA512G.)

If you are on a call and another call comes in, press the flashing red line button or press **Hold** to place the call on hold and answer the incoming call.

To return to the first call, press the line button for the call or select it using the **Up** or **Down** navigation buttons and press the **Resume** softkey. (Not applicable to the Cisco SPA502G or Cisco SPA512G.)

Placing a Call

To place a call, pick up the receiver or press **Speaker** or **Headset** and dial the number. It might be necessary to dial a prefix number or numbers to reach an outside line. (Ask your phone administrator.) You can also redial a number or select a number from the call history. It might be necessary to modify a number selected from a call history list so that the phone will dial it correctly.

Redialing a Call

To redial the last number on a Cisco SPA501G, press the **Redial** button.

To redial another number from a history list on all phones except the Cisco SPA501G:

-
- STEP 1** Press the **redial** softkey and select the desired number from the Redial list. Or press the **Setup** button, select **Call History**, select the desired call history list, and highlight the desired number.

It might be necessary to modify the number to add a prefix or area code. Press **edit** and use the **Softkey Buttons** to modify a number. When you are finished, press **ok**.

- STEP 2** Lift the handset or press **dial** to dial the selected number.
-

Putting a Call on Hold

To put an active call on hold, press the **Hold** button or the **Hold** softkey. A series of beeps (default or optional) or music on hold plays for the caller to indicate that the call is on hold.

Resuming a Call

To resume the call that has been put on hold, press the flashing red line button for the call or the **Hold** button or the **Resume** softkey (if the default behavior is configured.)

Ending a Call

To end a call, do one of the following:

- If you are using the handset, hang up.
- If you are using the speakerphone, press **Speaker**.
- If you are using a headset, either press **Headset** (wired) or replace the handset (wireless).

Transferring Calls

You can perform types of transfers:

- **Attended**—Call the person to whom you are transferring the call and speak to them before transferring the call.
- **Blind**—Transfer the call without speaking to the other party to whom you are transferring the call.

Performing an Attended Transfer

To perform an attended transfer for all phones (except the Cisco SPA501G):

STEP 1 During an active call, press **xfer**. The call is placed on hold and a new line is opened to dial the number.

STEP 2 Either:

- Enter the number to which you want to transfer the call, then press **dial** or wait a few seconds.
- Press **dir** and either choose a number from the personal directory or (if configured) select the **Corporate Directory**, then press **dial**.

If you hang up before the second call rings, the transfer fails and the first call is disconnected. If you misdial, use the **delChar**, **clear**, or **cancel** key to make your changes before the call is transferred. (Not available for the Cisco SPA502G.)

- STEP 3** Press **xfer** after the phone begins to ring, or at any time after the phone is answered.
-

To perform an attended transfer for the Cisco SPA501G:

- STEP 1** During an active call, press **Transfer**.
- STEP 2** Enter the number to where you want to transfer the call.
- STEP 3** After the phone begins to ring or after the person you are calling answers, press **Transfer** again.
-

Performing an Unattended (Blind) Transfer

To perform an unattended transfer for all phones (except the Cisco SPA501G):

- STEP 1** During an active call, press the **bXfer** softkey.
- STEP 2** Enter the number to where you want to transfer the call. The call is transferred with no further action required on your part.
-

Transferring a Held Call to an Active Call

If you have one call on hold and one active call, you can transfer one of the calls to the other call, connecting the two callers. This is different from a conference call, because you no longer remain part of the call after the transfer. (Not available for the Cisco SPA501G.)

With one active call and one or more calls on hold, press the **xferLx** softkey.

If you have only one call on hold, the call is transferred to the active party and you are disconnected.

If you have more than one call on hold, choose the held call you want to transfer by pressing the line button of the call on hold.

Managing Missed Calls

When enabled, the IP phone screen on your IP phone notifies you if a call came in that was unanswered. (Not available for the Cisco SPA501G.)

To view and return a missed call:

- If the IP phone screen shows a missed call, press the **lcr** softkey to return the missed call. Press the **miss** softkey to view a list of missed calls, select a call, and press **dial**.
- If the IP phone screen does not show a missed call, you can return a call from the Missed Call list:
 - Press the **Setup** button.
 - Select **Call History**.
 - Select **Missed Calls**.
 - To call a missed call number, chose the call you want to return and press **dial**.

NOTE If the call was from a long distance number, it might be necessary to edit the call before returning it. Press the **edit** softkey to edit the call and use the softkey buttons and keypad to edit the number.

Turning the Missed Calls Shortcut On and Off

To remove the **lcr** and **miss** softkeys that appear on the IP phone screen when you miss a call (except on the Cisco SPA501G):

-
- STEP 1** Press **Setup**.
 - STEP 2** Select **Preferences**.
 - STEP 3** Choose **Miss Call Shortcut** and press **edit**.
 - STEP 4** Press **y/n** to enable or disable the feature.
 - STEP 5** Press **ok**.
 - STEP 6** Press **save**.
-

Forwarding Calls

You can forward all calls, forward calls when the phone is busy, or forward calls to a phone when there is no answer.

For the Cisco SPA501G, you can only use the IP phone Web interface or **Call Forward All Star Code** to set call forwarding.

Forwarding All Calls

You can forward all incoming calls to another number. For example, your voice mailbox, another extension, or an outside line. If forwarding calls to an outside line, be sure to use any steering digits, access codes, or area codes required to complete the call.

Call Forward All Softkey

-
- STEP 1** Press the **cfwd** softkey.
 - STEP 2** Enter a number to where all calls should be forwarded.
 - STEP 3** Press **dial**. The IP phone screen displays Calls Forwarded.
-

Call Forward All Star Code

Press *72 and enter the number to where all calls should be forwarded. Enter *73 to deactivate call forwarding. For the Cisco SPA501G, the Message indicator light flashes to indicate Call Forwarding All is enabled.

Call Forward All by using Setup

-
- STEP 1** Press **Setup** and select **Call Forward > CFWD All Number**.
 - STEP 2** Press **edit**.
 - STEP 3** Enter a number to where all calls should be forwarded.
 - STEP 4** Press **ok**.
 - STEP 5** Press **save**.
-

Forwarding Calls When Your Phone is Busy

You can forward all incoming calls to another number when your phone is busy. For example, forward calls to voice mail, another extension, or an outside line. If forwarding calls to an outside line, be sure to use any access and area codes required to complete the call.

Call Forward Busy Star Code

Press *90 and enter the number to where all calls should be forwarded. Enter *91 to deactivate call forward busy.

Call Forward Busy by using Setup

-
- STEP 1** Press the **Setup** button and select **Call Forward > CFWD Busy Number**.
 - STEP 2** Press the **edit** softkey.
 - STEP 3** Enter a number to where all calls should be forwarded. To connect the call to voice mail (if this feature has been set up by your phone administrator), press the **Right** navigation button, press the **alpha** softkey, and enter **vm** by using the keypad. Press the **Left** navigation button.
 - STEP 4** Press **ok**.
 - STEP 5** Press **save**.
-

Forwarding Calls (Delay) Without Answering the Phone

You can forward an incoming call to another number if you do not answer the phone. For example, forward calls to your voice mailbox, another extension, or an outside line. If forwarding calls to an outside line, be sure to use any access and area codes required to complete the call

Call Forward Delay Star Code

Press *92 and enter the number to where the call should be forwarded after the delay. Enter *93 to deactivate call forward delay.

Call Forward Delay by using Setup

-
- STEP 1** Press the **Setup** button and select **Call Forward > CFWD No Ans Number**.
 - STEP 2** Press the **edit** softkey.
-

STEP 3 Enter **vm** for voice mail, or dial the number to where the call should be forwarded.

STEP 4 Press **ok**.

STEP 5 Press **save**.

Setting the Call Forwarding Delay Interval

Sets a delay interval that must elapse before the call is forwarded because there is no answer at your phone. The delay timer is ignored when the **Call Forward No Answer** value is blank. On the Cisco SPA501G, the delay interval is set by using the web configuration utility.

To set the interval by using the IP phone screen:

STEP 1 Press the **Setup** button and select **Call Forward > CFWD No Ans Delay**.

STEP 2 Press the **edit** softkey.

STEP 3 Enter the number of seconds to delay before forwarding calls.

STEP 4 Press **ok**.

STEP 5 Press **save**.

Canceling Call Forwarding All

This procedure only cancels the **Call Forward All** feature; it does not cancel **Call Forward Busy** or **Call Forward No Answer**. To stop **Call Forwarding All**, press the **-cfd** softkey, or:

STEP 1 Press the **Setup** button and select **Call Forward > edit**.

STEP 2 Press **clear**.

STEP 3 Press **ok**.

STEP 4 Press **save**.

Call Forward Deactivation by using Star Codes

Enter *73 to deactivate call forwarding all.

Enter *91 to deactivate call forward busy.

Enter *93 to deactivate call forward no answer.

Setting Do Not Disturb

Use the Do Not Disturb feature to prevent incoming calls from ringing your phone. If you have voice mail configured, incoming callers can be immediately routed to voice mail. If voice mail is not configured, callers will hear a busy signal or a message.

You can also set Do Not Disturb from your PC by using the web configuration utility.

For the Cisco SPA501G, you can only set Do Not Disturb in the web configuration utility or set [Do Not Disturb by using the Star Code](#).

Enabling Do Not Disturb

Do Not Disturb Softkey

To activate Do Not Disturb, press the **dnd** softkey. The IP phone screen indicates that Do Not Disturb is turned on for your phone (except on the Cisco SPA501G).

Do Not Disturb by using the Star Code

Enter *78 to activate Do Not Disturb. Enter *79 to deactivate Do Not Disturb. On the Cisco SPA501G, the Message Indicator Light blinks red when Do Not Disturb is enabled.

Do Not Disturb by using Setup

To access Do Not Disturb:

-
- STEP 1** Press the **Setup** button and select **Preferences > Do Not Disturb**.
 - STEP 2** Press the **edit** softkey.
 - STEP 3** Press **y/n** and choose **y**.
 - STEP 4** Press **ok**.

STEP 5 Press **save**.

Disabling Do Not Disturb

Do Not Disturb Softkey

To deactivate Do Not Disturb, press the **-dnd** softkey.

Do Not Disturb Deactivation by using the Star Code

Enter *79 to deactivate Do Not Disturb.

Do Not Disturb Deactivation by using Setup

You can also deactivate Do Not Disturb by pressing the **Setup** button and selecting **Preferences > Do Not Disturb**.

Setting Call Waiting

Call waiting alerts you to an incoming call while you are on another call by ringing your phone and displaying a status message. If you turn call waiting off, incoming calls do not ring your phone while you are on another call; the incoming call hears a busy signal or message. Call waiting can be enabled continuously or on a per-call basis.

You can also turn call waiting on or off from your PC by using the IP phone Web interface.

For the Cisco SPA501G, you can only configure Call Waiting in the web configuration utility or set **Call Waiting by using the Star Code**.

Using Setup

STEP 1 Press **Setup**.

STEP 2 Select **Preferences**.

STEP 3 Choose **Call Waiting** and press **edit**.

STEP 4 Press the **y/n** softkey to toggle call waiting on or off.

STEP 5 Press **ok**.

STEP 6 Press **save**.

Call Waiting by using the Star Code

Enter *56 to activate call waiting.

Enter *71 before dialing a number to activate call waiting during that call.

Call Waiting Deactivation by using the Star Code

Enter *57 to deactivate call waiting.

Enter *72 before dialing a number to deactivate call waiting for that call.

Picking Up a Call

You can pick up a call that is ringing at another extension. Depending on the way your telephone network is configured, you can pick up a call in the following ways:

- Pick up a call that is ringing at an extension in your group by using the **grPick** softkey. (Not available for the Cisco SPA501G.)
- Pick up a call that is ringing at specific extension using the **pickup** softkey. (Not available for the Cisco SPA501G.)
- Pick up a call ringing at an extension that is configured on one of the line buttons on your phone by pressing the flashing line button. Requires configuration by your phone administrator. (Not available for the Cisco SPA502G.)

To pick up a call ringing at an extension in your group by using the softkey:

STEP 1 Press the **grPick** softkey. The phone displays any stations in the group that have ringing calls. Press **dial** to see a list of calls.

STEP 2 Choose the call you want to pick up and press **dial**.

To pick up a call ringing at a specific extension by using the softkey:

-
- STEP 1** Press the **pickup** softkey.
 - STEP 2** Enter the extension number of the phone from which you are picking up the call and press **dial**.
 - STEP 3** Press **dial** again.
-

Parking a Call

You can park a call on a designated line so that another person in your company can pick up the call. The call is active until it is unparked or the caller hangs up. (Not available for the Cisco SPA501G.)

Not all phone systems support call park. If this feature is not working, verify with your phone administrator that it has been configured. This section describes the default behavior.

To park a call:

-
- STEP 1** While on an active call, press the **park** softkey.
 - STEP 2** Enter a number to identify the park line and press **dial**. The **park line number** does not correspond to a physical phone extension number; you can pick any easily-remembered number (for example, 100). The call is then parked on that line, and the caller hears music-on-hold or messages.
 - STEP 3** You or another person must then unpark the call.
-

To unpark a call, you can either use the **unpark** softkey (if you know the park line number), or view a list of parked calls and unpark it from the list.

To unpark if you know the park line number:

-
- STEP 1** Press the **unpark** softkey.
 - STEP 2** Enter the number of the park line (for example, the number that was entered in Step 2 of “parking a call.”)

STEP 3 Press **dial**. The call is picked up on your phone.

To view a list of parked calls (and unpark from the list):

STEP 1 Press the **Setup** button.

STEP 2 Select **Call Park Status**.

STEP 3 Choose the parked call you want to retrieve and press **unpark**.

Placing a Three-Way Conference Call

You can start conference calls by:

- calling both numbers and pressing the **conf** softkey.
- conferencing an active and held call using the **confLX** softkey (except on the Cisco SPA501G).

Three-way Conference Calling (except the Cisco SPA501G)

To initiate a conference call:

STEP 1 Press the **conf** softkey during an active call. The first call is placed on hold, a second line is opened, and you hear a dial tone.

STEP 2 Dial the second telephone number.

STEP 3 Press the **conf** softkey again. All three parties are connected in the conference call. When you hang up, the other two parties are disconnected.

Three-way Conference Calling by using a Cisco SPA501G

To initiate a conference call:

STEP 1 Press the **Conference** button during an active call. The first call is placed on hold, a second line is opened, and you hear a dial tone.

STEP 2 Dial the second person's telephone number.

- STEP 3** Press the **Conference** button again. All three parties are connected in the conference call.

When you hang up, the all parties are disconnected.

Conferencing a Held Call with an Active Call

If you have a call on hold and an active call, you can create a conference call that includes the active call and the call on hold (except on the Cisco SPA501G).

With an active call and one or more calls on hold, press the **confLx** softkey.

- If you have only one call on hold, the conference call is created between the three of you.
- If you have more than one call on hold, choose the held call you want to conference in by pressing the line button of the call on hold.

Using the Phone Directories

Your IP phones provide several different types of phone directories, depending on the phone model and what the system administrator has set up for the company. (except on the Cisco SPA501G).

The phones provide the following types of directories:

- A Personal directory that provides a place for you to store and view frequently dialed numbers. You can also dial numbers from the directory.
- The Corporate Directory lists the phones and extension numbers in your company. Depending on your phone network configuration, you might have the following directories available:
 - Corporate Directory (LVS)
 - Directory using Lightweight Directory Access Protocol (LDAP)

Using Your Personal Directory

To access the Phone Directory, press the **dir** softkey, or press the **Setup** button and select **Directory**. You can also view and edit the directory from your PC using the web configuration utility. See the “[Using Your Personal Directory](#)” section on page 72.

To add a new entry to the directory:

STEP 1 In the Directory screen, when New Entry is selected, press the **add** softkey.

STEP 2 Use the keypad to enter the name of the directory entry:

- Press the number key multiple times to move to a different letter under that number. (For example, to enter “Mary,” you would press **6** and then pause (for M); press **2** and then pause (for A), press **7** three times rapidly (for R), then press **9** three times rapidly (for Y).
- Use the **delChr** softkey to delete letters, the **<<<** and **>>>** softkeys to move to the left or the right of the string.
- Use the **clear** softkey to clear the entire name.

When finished with the name, use the navigation button to go down to the Number field.

STEP 3 Enter the phone number, including any digits you must dial to access an outside line and the appropriate area code.

STEP 4 (Optional) To change the ring type for the caller:

- a. Press the **option** softkey.
- b. Scroll through the available ring types.
- c. Press the **play** softkey to play the selected ring tone or press the **select** softkey to assign that ringtone to the number you are adding to the directory.

STEP 5 Press **save** to save the entry.

Using the Corporate Directory

Depending on your Internet Telephony Service Provider or corporate network setup, you might not have a corporate directory available to you.

To use the corporate directory:

-
- STEP 1** Press the **dir** softkey, or press the **Setup** button and select **Directory**.
 - STEP 2** Select **Corporate Directory**.
 - STEP 3** Choose an entry and press the **dial** softkey. Press **cancel** to exit.
-

To use the Lightweight Directory Access Protocol (LDAP) directory:

-
- STEP 1** Press the **dir** softkey or press the **Setup** button and select **Directories**.
 - STEP 2** Scroll to the **LDAP Directory Name** and press **Select**. (The name of the LDAP directory is configured by the phone administrator and can differ.)
 - STEP 3** Enter information in the fields and press **search**.
 - STEP 4** In the results, press **Dial** to dial the contact or choose one of the other options.
-

Using the Call History Lists

You can also view the Call History Lists from your PC using the web configuration utility. See the “**Viewing Call History Lists**” section on page 71.

You can only view call history lists for the Cisco SPA501G using the web configuration utility.

To view or call a number on the Call History lists:

-
- STEP 1** Press the **Setup** button.
 - STEP 2** Select **Call History**.

STEP 3 Select the Call History list you want to view. Available Call History lists are:

- **Redial List**—Shows the last 60 numbers dialed from your phone.
- **Answered Calls**—Shows the caller ID of the last 60 answered calls.
- **Missed Calls**—Shows the last 60 missed calls.

To dial a number from one of the Call History lists, choose the call and press **dial**.

If the call was from a long distance number, you might have to edit the call before dialing it. Press the **Edit** softkey to edit the call and use the softkey buttons and keypad to edit the number.

To delete a number from the call history lists:

STEP 1 In the Redial, Answered Calls, or Missed Calls list, choose the call.

STEP 2 Press **delete**.

STEP 3 Press **OK**.

To save a call history number to your directory:

STEP 1 In the Redial, Answered Calls, or Missed Calls list, choose the call.

STEP 2 Use the navigation button to scroll to the right to access more softkey buttons and press **save**.

STEP 3 Edit the information (if desired) and press **save** again. The entry is added to your directory.

Setting or Changing a Phone Password

You can set or change the password for your phone to prevent unauthorized use. To set a password for your phone:

STEP 1 Press the **Setup** button.

STEP 2 Select **Set Password**.

STEP 3 Enter a numeric password. Enter the same password again to verify the accuracy.

STEP 4 Press **save**.

Accessing Voicemail

To access voicemail, press the **Messages** button on your phone. Your system administrator should configure your phone with the correct voicemail number so that pressing the **Messages** button automatically dials your voicemail system.

If you need to change the number for your voicemail (for example, if your phone is not part of a Cisco Voice System and you have external voicemail), perform the following steps:

STEP 1 Press the **Setup** button.

STEP 2 Scroll to **Voice Mail** and press **select**.

STEP 3 Enter the number to dial for voicemail. For a Cisco Voice System, this is normally **vmm**. For an external system, enter the phone number, including any digits that must be dialed to reach an outside line.

To clear the field of a previous entry, press **clear**. To enter letters, press the **Right** navigation button to scroll, then press the **alpha** softkey.

STEP 4 Press **save**.

Using Advanced Phone Features

This chapter describes how to configure advanced features on your IP Phone. It contains the following sections:

- [Configuring Privacy and Security, page 49](#)
- [Enabling and Using Dial Assistance, page 51](#)
- [Using the Paging Feature, page 53](#)
- [Monitoring and Accessing Another Phone, page 54](#)
- [Customizing Your IP Phone Screen, page 55](#)
- [Using Ring Tones, page 58](#)
- [Configuring Date and Time, page 58](#)
- [Using Star Codes, page 59](#)
- [Using the Interactive Voice Response Menu on the Cisco SPA501G, page 61](#)
- [Advanced Procedures for Technical Support Personnel, page 63](#)

You can also configure many of these features by using your PC and the web configuration utility.

For the Cisco SPA501G, configure these features by using the web configuration utility or the star codes (described below).

Configuring Privacy and Security

Blocking Caller ID

You can block Caller ID from your phone so that your phone number does not appear to the person you call.

Using the Setup button:

-
- STEP 1** Press the **Setup** button.
 - STEP 2** Select **Preferences**.
 - STEP 3** Choose **Block Caller ID** and press **edit**.
 - STEP 4** Press **y/n** to choose **yes** (enable) or **no** (disable).
 - STEP 5** Press **ok**.
 - STEP 6** Press **save**.
-

Using the star code:

Press ***67** before dialing the number. (Caller ID blocking will remain enabled until you enter ***68**.)

Blocking Anonymous Calls

Blocking anonymous calls prevents calls with unknown Caller ID from ringing your phone. (For example, if a caller set his phone to not display Caller ID, the call is considered anonymous.) These callers receive a busy signal or message.

Using the Setup button:

-
- STEP 1** Press the **Setup** button.
 - STEP 2** Select **Preferences**.
 - STEP 3** Choose **Block Anonymous Call** and press **edit**.
 - STEP 4** Press **y/n** to choose **yes** (enable) or **no** (disable).
 - STEP 5** Press **ok**.
-

STEP 6 Press **save**.

Using the star code:

Press ***77**. Anonymous call rejection will be enabled until you enter ***87**.

Using Secure Call

With the secure call feature, the active call is encrypted so that others cannot eavesdrop. Before attempting to enable Secure Call, verify with your phone service provider that Secure Call is available.

Using the **Setup** button (not applicable to Cisco SPA501G):

STEP 1 Press the **Setup** button.

STEP 2 Select **Preferences**.

STEP 3 Choose **Secure Call** and press **edit**.

STEP 4 Press **y/n** to choose **yes** (enable) or **no** (disable).

STEP 5 Press **ok**.

STEP 6 Press **save**. When you dial, you will hear a tone before the call.

Using star codes:

- ***16**—Activate Secure Call feature for all calls.
- ***18**—Activate Secure Call feature for a single call.

To deactivate secure call:

- ***17**—Deactivate Secure Call feature for all calls.
- ***19**—Deactivate Secure Call feature for a single call.

Enabling and Using Dial Assistance

If you enable dial assistance, when you place calls, the display shows phone numbers based on the best matched entries from the Directory and Call History lists. You can call a number on the matched entries list. (Not available for the Cisco SPA501G.)

To enable dial assistance:

-
- STEP 1** Press the **Setup** button.
 - STEP 2** Select **Preferences**.
 - STEP 3** Choose **Dial Preferences** and press **edit**.
 - STEP 4** Press **y/n** to choose **yes** (enable) or **no** (disable).
 - STEP 5** Press **ok**.
 - STEP 6** Press **save**.
-

To place a call by using Dial Assistance

-
- STEP 1** Use the navigation buttons to scroll down and highlight a phone number on the screen.
 - STEP 2** Press **dial** to initiate the call.
-

Creating Speed Dials

You can configure different types of speed dials:

- Depending on the phone model and how your extensions are configured, you can assign unused line buttons on your phone or attendant console to act as speed dials.
- You can create speed dials assigned to a number, that, when pressed on the keypad, dials the number assigned to it. Each speed dial can be a phone number, IP address or URL.

You can create and edit speed dials using your PC and the web configuration utility.

NOTE For the Cisco SPA501G, create speed dials by using the web configuration utility. See “**Setting Voice User Parameters,**” on page 69.

Creating Speed Dials on Unused Line Buttons

-
- STEP 1** Press the unused line button and hold down for three seconds. The **Define Speed Dial window** displays.
 - STEP 2** Enter the name for the speed dial.
 - STEP 3** Press the **Down Arrow** key to reach the phone number field. Enter the phone number and press **Save**.
 - STEP 4** After creating the speed dial, it displays next to the line button. Press the line button to use the speed dial.

NOTE For the Cisco SPA501G, your phone administrator can use the web interface to create speed dials. This is an administrative function available from the **Admin > Advanced Configuration** pages.

Creating Numerical Speed Dials

-
- STEP 1** Press the **Setup** button.
 - STEP 2** Select **Speed Dial**.
 - STEP 3** For a new speed dial, scroll to select an unused speed dial (marked with Not Assigned). To edit a previously existing speed dial, select it.
 - STEP 4** Press **edit**.
 - STEP 5** Enter the number to assign to the speed dial and press **ok**.
-

Using Speed Dials

Cisco SPA502G, Cisco SPA504G, Cisco SPA508G, Cisco SPA509G, Cisco SPA512G, Cisco SPA514G:

To call one of your configured speed dial numbers, either:

- Open a phone line and press the number on the phone keypad for the speed dial, then press **Dial**.
- Press the **Setup** button, select **Speed Dial**, choose the number, and press **Dial**.

Cisco SPA504G, Cisco SPA508G, Cisco SPA509G, Cisco SPA514G, Attendant Console:

Press the unused line button you have configured for a speed dial.

Cisco SPA501G:

Press the number on the phone keypad for the speed dial and wait a few seconds.

Using the Paging Feature

Your IP phone can automatically answer pages from other Cisco IP phones in the Cisco Voice System. When your phone is paged, the phone emits a series of beeps, and two-way audio is established between your phone and the phone that called you. You do not have to accept the page.

Your phone must be part of a Cisco Voice Network to use this feature.

Paging Another Phone

To page another phone, dial ***96** plus the extension of the phone you are paging. If the phone you are paging is not set up to auto answer pages, the call will ring as a normal voice call.

Paging a Group of Phones

A phone can be configured to be part of a paging group. Each paging group has a number associated with it. Your administrator must give you the number of the groups that are configured. To page this group just dial the number of the paging group.

Configuring Auto Answer

To configure your phone to auto answer pages:

-
- STEP 1** Press the **Setup** button.
 - STEP 2** Select **Preferences**.
 - STEP 3** Choose **Auto Answer Page** and press **edit**.
 - STEP 4** Press **y/n** to choose **yes** (enable) or **no** (disable).
 - STEP 5** Press **ok**.
 - STEP 6** Press **save**.
-

Monitoring and Accessing Another Phone

Your system administrator can configure your phone so that you can monitor other phones on the network from your phone if the feature is available on your system. If this feature is configured, some line buttons on your phone are assigned to display the status of another user phone. For example, if your line 4 is configured to display Bob's phone line, the button color shows you the status of that phone line:

- **Green:** Line is idle.
- **Red (steady):** Line is active or in use.
- **Red (blinking):** Line is ringing.
- **Orange (solid):** Line status cannot be monitored.
- **Orange (blinking):** The phone is subscribing to monitor the line status.

In addition, if your system administrator has configured it, you can press the same line button (4) to speed dial Bob's extension, or to pick up a ringing call at his extension.

NOTE User cannot configure BLF on the SPA502G and SPA512G phones as they have only 1 line and no line buttons, but the BLF function can be configured on the attendant console.

Customizing Your IP Phone Screen

You can customize the appearance of the IP phone screen (except on the Cisco SPA501G).

Changing the IP Phone Screen Contrast

You can also change your IP phone screen contrast from your PC using the web configuration utility.

To adjust the contrast of the IP phone screen:

-
- STEP 1** Press the **Setup** button.
 - STEP 2** Scroll to **LCD Contrast** and press the **Select** softkey.
 - STEP 3** Use the navigation button to adjust the screen contrast. Pressing the **Left** navigation button decreases the contrast. Pressing the **Right** navigation button increases the contrast.
 - STEP 4** Press **save**.
-

Changing the Screen Backlight Settings

The screen backlight turns off after a specified period of time. You can change this time period so that the screen backlight is on for a longer period, or keep the backlight always on.

-
- STEP 1** Press the **Setup** button.
 - STEP 2** Select **Preferences**.
 - STEP 3** Choose **Back Light Timer** and press **edit**.
 - STEP 4** Press Option to choose the desired setting:
 - 10 seconds
 - 20 seconds
 - 30 seconds
 - always on

STEP 5 Press **ok**.

STEP 6 Press **save**.

Configuring the Phone Screen Saver

You can enable your phone's screen saver and specify its appearance and the amount of time for the phone to be idle before it begins. Some of these options can be configured from your PC using the web configuration utility.

To configure your screen saver:

STEP 1 Press the **Setup** button.

STEP 2 Select **Screen Saver Mode**.

To enable your screen saver:

STEP 1 In **Screen Saver Mode**, Choose **Enable Screen Saver** and press **edit**.

STEP 2 Press **y/n** to choose **yes** (enable) or **no** (disable).

STEP 3 Press **ok**.

STEP 4 Press **save**.

To specify the amount of time before the screen saver turns on if your phone is idle:

STEP 1 In **Screen Saver Mode**, choose **Screen Saver Wait Time** and press **edit**.

STEP 2 Enter the time, in seconds, to wait before the screen saver starts.

STEP 3 Press **ok**.

STEP 4 Press **save**.

To change your screen saver picture:

-
- STEP 1** In **Screen Saver Mode**, choose **Screen Saver Icon** and press **edit**.
- STEP 2** Press **option** multiple times to display the choices available until the one you want is displayed. Options are:
- **Background Picture**—Displays your phone's background picture.
 - **Station Time**—Overlays the phone's station ID and time onto the picture.
 - **Lock**—Overlays a lock graphic onto the picture.
 - **Phone**—Overlays a phone graphic onto the picture.
 - **Date/Time**—Overlays the date and time onto the picture.
- STEP 3** Press **ok**.
- STEP 4** Press **save**.
-

Turning on the Screen Saver

To immediately turn on your phone's screen saver:

-
- STEP 1** Press the **Setup** button.
- STEP 2** Scroll to **Screen Saver Mode** and press **activ**. (The screen saver must be enabled in order to immediately activate it.)
-

Using Ring Tones

Each extension of your phone can have a different ring tone. You can also create your own ring tones (except on the Cisco SPA501G).

Changing Your Ring Tone

To change a ring tone:

-
- STEP 1** Press the **Setup** button.
 - STEP 2** Select **Ring Tone**.
 - STEP 3** Choose the extension for which to choose a ring tone and press **change**.
 - STEP 4** Scroll through the ring tones and press **play** to play the highlighted ring tone. Press **select** to choose the highlighted ringtone for that extension.
-

Configuring Date and Time

Setting Your Phone's Date and Time

The date and time for your phone normally come from the SIP proxy server or NTP server. However, if you need to change some date and time parameters, you can follow these steps:

-
- STEP 1** Press the **Setup** button.
 - STEP 2** Select **Time/Date**.
 - STEP 3** Enter the date in the following format: mm*dd*yy (this will display as m/d).
 - STEP 4** Enter the time in the following format: hh*mm*ss (this will display as (h:mm).
 - STEP 5** If the time does not display am (a) or pm (p) correctly, adjust with Offset. To change from a.m. to p.m., enter *12*00*00, to change from p.m. to a.m., enter #12*00*00.
 - STEP 6** Press **save**.

You can set just one of these choices, if necessary.

Using Star Codes

Your IP phone can support numerous “star codes” to access phone supplementary services. These codes, which start with *, are entered before dialing a telephone number and provide services. For example, to block caller ID (star code 67), you would dial *67, followed by the telephone number you are calling.

Following is a list of commonly-used star codes. Some star codes may not be available to you; consult your system administrator for more information.

Code	Definition
16	Activate Secure Call feature for all calls.* See Using Secure Call, page 50 .
17	Deactivate Secure Call feature for all calls.* See Using Secure Call, page 50 .
18	Activate Secure Call feature for a single call.* See Using Secure Call, page 50 .
19	Deactivate Secure Call feature for a single call.* See Using Secure Call, page 50 .
36	Pick up a call at another extension.* See Picking Up a Call, page 40 .
37	Pick up a group call.* See Picking Up a Call, page 40 .
38	Park a call.* See Parking a Call, page 41 .
39	Unpark a call.* See Parking a Call, page 41 .
56	Activate call waiting. See Setting Call Waiting, page 39 .
57	Deactivate call waiting. See Setting Call Waiting, page 39 .
66	Activate Call Back. Causes the IP phone to repeatedly dial a busy number until the called party rings or answers. The IP phone then alerts you that the call has gone through.

Code	Definition
67	Block Caller ID. See Blocking Caller ID, page 49 .
68	Unblock Caller ID. See Blocking Caller ID, page 49 .
69	Calls the last number that called your phone.
70	Deactivate call waiting for a single call. See Setting Call Waiting, page 39 .
71	Activate call waiting for a single call. See Setting Call Waiting, page 39 .
72	Activate Call Forward All. See Forwarding Calls, page 35 .
73	Deactivate Call Forward All. See Forwarding Calls, page 35 .
77	Activate anonymous call blocking. See Blocking Anonymous Calls, page 49 .
78	Activate Do Not Disturb. See Setting Do Not Disturb, page 38 .
79	Deactivate Do Not Disturb. See Setting Do Not Disturb, page 38 .
86	Deactivate Call Back.
87	Deactivate anonymous call blocking. See Blocking Anonymous Calls, page 49 .
90	Activate Call Forward Busy. See Forwarding Calls, page 35 .
91	Deactivate Call Forward Busy. See Forwarding Calls, page 35 .
92	Activate Call Forward No Answer. See Forwarding Calls, page 35 .
93	Deactivate Call Forward No Answer. See Forwarding Calls, page 35 .
96	Page an extension.** See Using the Paging Feature, page 53 .
98	Perform a blind transfer. Transferring Calls, page 32 .

*Requires that your IP phone be part of a Cisco Voice System.

**Requires that the paged extension be part of a Cisco Voice System.

Using the Interactive Voice Response Menu on the Cisco SPA501G

The Cisco SPA501G provides an interactive voice response menu. You can enter options and receive information about the phone and its operation.

To access the IVR:

STEP 1 Press the **Setup** button.

Enter the IVR option by pressing the numbers of the option, then press **#**. Some menus require entering of further information or numbers.

Typical options you might use are listed in the following table:

Number	Option
100	Tells you if Dynamic Host Configuration Protocol (DHCP) is enabled.
110	Recites the IP address of the phone.
120	Recites the netmask of the phone.
130	Recites the gateway address.
140	Recites the MAC (hardware) address of the phone.
150	Recites the phone software version.
160	Recites the primary DNS server address.
170	Recites the HTTP port on which the web server listens. Defaults to 80.
180	Recites the IP multicast address (used by a Cisco Voice System to communicate with the IP phone).
220	Recites the method of call control (SIP or SPCP).
221	<p>Set call control—enter the value for the call control method you want, then press #:</p> <ul style="list-style-type: none"> ▪ 0: SIP ▪ 1: SPCP <p>To save, press 1; to review, press 2; to re-enter, press 3; to exit, press *.</p>

Number	Option
73738	<p>Restore the phone to the factory default software and settings.</p> <p>Enter 1 to confirm, or * to exit. If you chose to reset, hang up to exit and begin the restore process.</p>
87778	<p>Restore the phone's user settings to the default. (Clears all user settings such as speed dials.)</p> <p>Enter 1 to confirm, or * to exit. If you chose to reset, hang up to exit and begin the restore process.</p>
732668	<p>Reboot the phone. After entering #, hang up to begin rebooting.</p>
111	<p>Set a static IP address. Enter the address (use * to enter the "." value), then press #.</p> <p>To save, press 1; to review, press 2; to re-enter, press 3; to exit, press *.</p> <p>NOTE DHCP must be disabled to use this option; if DHCP is not disabled, you receive an error message.</p>
121	<p>Set a netmask. Enter the address (use * to enter the "." value), then press #.</p> <p>To save, press 1; to review, press 2; to re-enter, press 3; to exit, press *.</p> <p>NOTE DHCP must be disabled to use this option; if DHCP is not disabled, you receive an error message.</p>
131	<p>Set a gateway. Enter the address (use * to enter the "." value), then press #.</p> <p>To save, press 1; to review, press 2; to re-enter, press 3; to exit, press *.</p> <p>NOTE DHCP must be disabled to use this option; if DHCP is not disabled, you receive an error message.</p>
161	<p>Set the address of the primary Domain Name Server (DNS). Enter the address (use * to enter the "." value), then press #.</p> <p>To save, press 1; to review, press 2; to re-enter, press 3; to exit, press *.</p>
181	<p>Set the IP multicast address (used by a Cisco Voice System to communicate with the IP phone). Enter the address (use * to enter the "." value), then press #.</p> <p>To save, press 1. To review the value you entered, press 2. To re-enter, press 3. To exit, press *.</p>

Number	Option
7932	Enable or disable the web server. Press 1 to enable or 0 to disable, then press # . To save, press 1 ; to review, press 2 ; to re-enter, press 3 ; to exit, press * .
723646	Enable or disables access to the administrative (admin) login on the web interface. Press 1 to enable or 0 to disable, then press # . To save, press 1 ; to review, press 2 ; to re-enter, press 3 ; to exit, press * .

Advanced Procedures for Technical Support Personnel



CAUTION These menus are used to configure and troubleshoot your phone and the phone network. You should not change these settings or perform these actions unless directed to do so by your phone administrator.

To access advanced menus on the Cisco SPA502G, Cisco SPA504G, Cisco SPA508G, Cisco SPA509G, Cisco SPA512G, Cisco SPA514G, follow the procedures below. For the Cisco SPA501G, many of these options can be performed in the IVR. See the [“Using the Interactive Voice Response Menu on the Cisco SPA501G” section on page 61](#).

STEP 1 Press the **Setup** button.

STEP 2 Choose from the following options:

- **Network:** This setting is to configure and troubleshoot the network. You should not change this settings unless directed to by your Administrator as this can seriously alter your phone’s functions.
- **Product Info:** This setting displays the product name, serial number, software version, hardware version, MAC address and Client Certificate.
- **Status:** This setting displays the status of the phone, extension and line buttons.
- **Reboot:** See [Rebooting Your Phone, page 64](#).

- Restart: Restarts your phone.
- Factory Reset: Resets your phone to the factory default settings.



CAUTION If you choose factory reset, you will return the phone to the original factory settings and will erase *all* current settings, including the directory and call logs. It is also possible that your phone extension will change.

- Custom Reset: Resets your phone to the latest customization profiles.
- Language: Changes the language on your phone (subject to availability and configuration by your system administrator).

Rebooting Your Phone

This setting is to configure and troubleshoot the network. You should not change this settings unless directed to by your phone administrator as this can negatively affect your phone's function.

To reboot your phone:

**Cisco SPA502G, Cisco SPA504G, Cisco SPA508G, Cisco SPA509G,
Cisco SPA512G, Cisco SPA514G:**

- STEP 1** Press the **Setup** button.
- STEP 2** Scroll to **Reboot** and press **select**.
- STEP 3** Press **ok**.

Cisco SPA501G:

- STEP 1** Press the **Setup** button.
- STEP 2** At the IVR menu, enter 732668, then press #.
- STEP 3** Hang up to begin the reboot.

Using the Phone Web User Interface

Your Cisco IP Phone provides a web interface for the phone user that allows you to configure some features of your phone by using a web browser. Your phone system administrator can allow you to view the phone statistics and modify some or all of the parameters by using the web configuration utility. The features of the Cisco SPA phones that can be modified by the user by using the web configuration utility are described in this chapter; however, not all features are available on all phones.

This chapter contains the following sections:

- [Logging in to the Phone Web User Interface, page 65](#)
- [Saving the Configuration Profile, page 66](#)
- [Setting Voice System Parameters, page 67](#)
- [Setting Voice Phone Parameters, page 68](#)
- [Setting Voice User Parameters, page 69](#)
- [Viewing Call History Lists, page 71](#)
- [Using Your Personal Directory, page 72](#)

Logging in to the Phone Web User Interface

To log into the web configuration utility:

STEP 1 Get the IP address of your phone:

**Cisco SPA502G, Cisco SPA504G, Cisco SPA508G, Cisco SPA509G,
Cisco SPA512G, Cisco SPA514G:**

- Press the **Setup** button.
- Scroll to **network** and press **select**.

- c. Scroll to view **Current IP**. This is the IP address of your phone.

Cisco SPA501G:

- a. Press the **Setup** button.
- b. Enter **110**, then press **#**. The IP address is recited.

STEP 2 On your PC, open a Web browser window. Your PC must be on the same subnetwork as the phone.

STEP 3 Enter the IP address in the browser address bar. For example, 192.168.1.244. The web configuration utility displays.

The web configuration utility has four main tabs:

- **Voice**—Contains information about your phone, including the following sub-tabs:
 - **Info**—System, reboot history, product, status, extension, and line information (read only).
 - **System**—Password and network settings.
 - **Phone**—Screen saver.
 - **User**—Call forwarding, speed dials, call waiting, privacy settings, and audio settings.
- **Call History**—Calls received and made from your phone.
- **Personal Directory**—Personal address book.
- **Attendant Console Status**—Information about Cisco SPA500S or SPA500DS Attendant Consoles, if installed.

TSaving the Configuration Profile

Click **Submit All Changes** when you have finished modifying the fields in the web configuration utility to update the configuration profile. The phone is rebooted and the changes are applied.

Click **Undo All Changes** if you want to clear all changes made this session and return to the parameter values set before the session began or since the last time you clicked **Submit All Changes**.

Setting Voice System Parameters

The voice system parameters control password protection for the phone configuration profile and the values used to identify the phone to the network. Typically a user should not modify these parameters.

The table identifies and describes the parameters in the System tab.

Parameter	Description
User Password	Alphanumeric string that allows access to the configuration profile.
Connection Type	Type of connection, DHCP or static.
Static IP	Static IP address, if the IP address is not assigned by a DHCP server.
Netmask	Subnetwork mask.
Gateway	Gateway IP address.
HostName	Hostname of the phone.
Domain	Network domain name.
Primary DNS	Primary DNS server IP address.
Secondary DNS	Secondary DNS server IP address.

Setting Voice Phone Parameters

The voice phone parameters control the screen saver.

The table identifies and describes the parameters in the Phone tab.

Parameter	Description
Screen Saver Enable	Choose yes from the drop-down menu to enable the phone screen saver. Choose no to disable the screen saver.
Screen Saver Wait	Enter the number of seconds that must elapse before the phone goes into screen saver mode.
Screen Saver Icon	Choose the icon that displays when the device is in screen saver mode from the drop-down menu. <ul style="list-style-type: none"> ▪ Background Picture—message scroll. ▪ Station Time—station time displayed in the middle of the IP phone screen. ▪ Lock—A moving padlock icon. When the phone is locked, the status line displays a scrolling message “Press any key to unlock your phone.” ▪ Phone—moving phone icon. ▪ Date Time—station date and time displays in the middle of the IP phone screen.

Setting Voice User Parameters

The voice User parameters control the phone user options, such as caller ID and speed dial numbers.

The table identifies and describes the parameters in the User tab.

Parameter	Description
Cfwd Setting	Choose yes from the drop-down menu to enable call forwarding. Choose no to disable the feature.
Cfwd All Dest	Enter the target phone number to where all calls are forwarded. When this field is anything other than blank, the phone rings once and the call is forwarded.
CFWD Busy Dest	Enter the target phone number to where all calls are forwarded when this phone is busy.
CFWD No Ans Dest	Enter the target phone number to where all calls are forwarded.
CFWD No Ans Delay	Enter the number of seconds to delay before forwarding calls because there is no answer at your phone.
Speed Dial X	Enter the target a phone number, IP address, or URL that will be called or launched when you press the speed dial number. You can configure up to eight speed dials, one for each of the numbered keys 2 through 9 .
CW Setting	Choose yes from the drop-down menu to enable call waiting. Choose no to disable the feature. Call waiting alerts you when you are on a call by ringing the phone and displaying a status message that you have an incoming call. If you turn call waiting off, incoming calls do not ring your phone when you are on another call, and the caller hears a busy signal or message.
Block CID Setting	Choose yes from the drop-down menu to block your caller ID from displaying on another phone. Choose no to disable the feature.

Parameter	Description
Block ANC Setting	Choose yes from the drop-down menu to block anonymous callers. Choose no to disable the feature. Blocking anonymous calls prevents a call with an unknown Caller ID from ringing your phone. For example, if a caller set their phone to not display their Caller ID, the call is considered anonymous. These callers receive a busy signal or message.
DND Setting	Choose yes from the drop-down menu to enable Do Not Disturb. Choose no to disable the feature. When enabled, the Do Not Disturb feature prevents incoming calls from ringing your phone. The IP phone screen indicates that Do Not Disturb is turned on for your phone. On the Cisco SPA501G, the Message Indicator Light blinks red when Do Not Disturb is enabled. If you have voice mail configured, incoming callers are immediately sent to voice mail. If voice mail is not configured, callers hear a busy signal or a message.
Dial Assistance	If dial assistance is enabled, when placing calls, you will see a list of matching, recently-dialed or received phone numbers on the IP phone screen as you begin dialing.
Preferred Audio Device	Choose the preferred audio device from the drop-down menu. When you answer a call by pressing the line button, the audio is directed to the headset or the speaker.
Time Format	Choose the time format from the drop-down menu. Choose 12hr to display the time as am or pm. Choose 24hr to display the time as a 24-hour clock.
Date Format	Choose the date format from the drop-down menu. Choose month/day to display the date in month-day sequence. Choose day/month to display the date in day-month sequence.
Text Message	Choose yes from the drop-down menu to enable text messaging from the phone. Choose no to disable the feature.
Text Message from 3rd Party	Choose yes from the drop-down menu to enable receiving text messaging from others on the phone. Choose no to disable the feature.

Parameter	Description
Alert Tone Off	Choose yes from the drop-down menu to disable the alert tone sounded when a text message is received on the phone. Choose no to enable the alert tone.
Ringer Volume Speaker Volume Headset Volume Headset Volume	Enter a volume between 1 and 10, with 1 being the lowest level.
Handset Version	Handset Version—Administrator can change the handset version manually. Auto—Phone automatically sets the handset version based on the hardware version and model. (Default) Original—Handset set to Version 2 and below. V3—Handset set to Version 3. This parameter should not be modified, unless you are requested to do so by your phone system administrator.
Deep Bass	Standard tone or enhanced bass tone.
LCD Contrast	Enter a number between 1 and 10, with 1 being the lowest contrast.

Viewing Call History Lists

To view Call History Lists:

-
- STEP 1** Log in to the web configuration utility.
- STEP 2** Click the **Call History** tab. A window appears with the call history lists for your phone. These include:
- **Placed**—Shows the last 100 numbers dialed from your phone.
 - **Answered**—Shows the caller ID of the last 100 answered calls.
 - **Missed**—Shows the last 100 missed calls.

Click the tab for each list to view it.

Using Your Personal Directory

Your IP phone provides a phone directory for you to store and view frequently dialed numbers. This directory appears on your phone, and you can dial numbers from the directory. The Cisco SPA502G, Cisco SPA504G, Cisco SPA508G, and Cisco SPA509G support up to 100 entries. The Cisco SPA512G and Cisco SPA514G support up to 150 entries. (Not available for the Cisco SPA501G.)

To view and edit your personal directory:

-
- STEP 1** Log in to the web configuration utility.
 - STEP 2** Click the **Personal Directory** tab. A window appears with the Personal Directory listings for your phone.
 - STEP 3** To enter a new item into the directory, select the line and enter the information in the following format:

`n=entryname;p=nnnnnnnnnn`

where “n=” indicates the name for the entry and “p=” indicates the phone number (including area code), for example 5045551212.

- STEP 4** At the bottom of the page, click **Submit Changes**.
-

Viewing Attendant Console Status

The SPA500S or SPA500DS user parameters are displayed in the Attendant Console Status window.

The table identifies and describes the values in the Attendant Console Status tab.

Parameter	Description
Unit Enable	Yes indicates the unit is enabled. No indicates it is disabled.
Unit Online	Yes indicates the unit is connected. No indicates it is not connected.
Subscribe Expires	Time in seconds when the current subscription expires. After the subscription expires, the attendant console automatically requests a new subscription.
Subscribe Retry Interval	Length of time the attendant console waits to try again if the subscription fails.
HW Version	Hardware version of the attendant console.
SW Version	Firmware (software) version of the attendant console.
Key	Name assigned to each key (1-32) on the Cisco SPA5000S or key 1-30 on the Cisco SPA500DS.
Name	Name identifying the entry.
Type	Function (for example, speed dial) that is enabled for each key on the attendant console.
Line	Displays the extension assigned to each key on the attendant console.
Station	Subscribe URI (uniform resource identifier) configured for each key on the attendant console.
Subscribed	Subscription status of the unit/key. The value can be Yes , Fail , or N/A . N/A indicates that the feature/function (fnc) of that line does not require a subscription (such as speed dial).

Where to Go From Here

Cisco provides a wide range of resources to help you obtain the full benefits of the Cisco Small Business IP phone.

Product Resources

Support	
Cisco Small Business Support Community	www.cisco.com/go/smallbizsupport
Online Technical Support and Documentation (Login Required)	www.cisco.com/support
Phone Support Contacts	www.cisco.com/en/US/support/tsd_cisco_small_business_support_center_contacts.html
Software Downloads (Login Required)	Go to tools.cisco.com/support/downloads , and enter the model number in the Software Search box.
Product Documentation	
IP Phone	www.cisco.com/en/US/products/ps10499/tsd_products_support_series_home.html
Accessories	http://cisco.com/en/US/products/ps10042/tsd_products_support_series_home.html
Cisco Voice System	www.cisco.com/en/US/products/ps10030/tsd_products_support_series_home.html
Cisco Unified Communications 500 Series for Small Business	www.cisco.com/en/US/products/ps7293/tsd_products_support_series_home.html

Regulatory Compliance and Safety Information for the Cisco SPA300 Series and Cisco SPA500 Series IP Phones	http://www.cisco.com/en/US/docs/voice_ip_comm/csbpipp/ip_phones/regulatory_compliance/guide/rcsi_500_series.pdf
Cisco Small Business	
Cisco Partner Central for Small Business (Partner Login Required)	www.cisco.com/web/partners/sell/smb
Cisco Small Business Home	www.cisco.com/smb
Marketplace	www.cisco.com/go/marketplace

List of Documents

See the following documents (available at the URLs listed above) for more information about your product.

- *Cisco Small Business SPA50X and SPA51X IP Phone Quick Start Guide*—Installation and initial configuration of your Cisco IP phone.
- *Cisco WBP54G Wireless-G Bridge for Phone Adapters User Guide*—Installation and use of the WBP54G wireless bridge with your Cisco IP phone.
- *Cisco Small Business SPA500 Series and WIP310 IP Phone Administration Guide*—Administration and advanced configuration of your Cisco IP Phone.
- *Cisco Voice System Administration Guide*—Administration and configuration of the Cisco Voice System.
- *Cisco Voice System Using Setup Wizard Installation and Configuration Guide*—Installing the Cisco Voice System using the setup wizard.
- *Cisco Voice System Web-UI Based Product Installation and Configuration Guide*—Installing the Cisco Voice System using the web user interface.

Cisco and the Cisco logo are trademarks or registered trademarks of Cisco and/or its affiliates in the U.S. and other countries. To view a list of Cisco trademarks, go to this URL: www.cisco.com/go/trademarks. Third-party trademarks mentioned are the property of their respective owners. The use of the word partner does not imply a partnership relationship between Cisco and any other company. (1110R)