



PHONES

(044) 360-7-130
(050) 336-0-130
(063) 788-0-130
(067) 233-0-130
(068) 282-0-130

130
COM.UA

Internet store of
autogoods



ICQ
294-0-130
597-0-130

SKYPE
km-130

CAR RECEIVERS — Receivers • Media receivers and stations • Native receivers • CD/DVD changers • FM-modulators/USB adapters • Flash memory • Facia plates and adapters • Antennas • Accessories |
CAR AUDIO — Car audio speakers • Amplifiers • Subwoofers • Processors • Crossovers • Headphones • Accessories | TRIP COMPUTERS — Universal computers • Model computers • Accessories |
GPS NAVIGATORS — Portable GPS • Built-in GPS • GPS modules • GPS trackers • Antennas for GPS navigators • Accessories | VIDEO — DVR • TV sets and monitors • Car TV tuners • Cameras • Videomodules
• Transcoders • Car TV antennas • Accessories | SECURITY SYSTEMS — Car alarms • Bike alarms • Mechanical blockers • Immobilizers • Sensors • Accessories | OPTIC AND LIGHT — Xenon • Bixenon • Lamps
• LED • Stroboscopes • Optic and Headlights • Washers • Light, rain sensors • Accessories | PARKTRONICS AND MIRRORS — Rear parktronic • Front parktronic • Combined parktronic • Rear-view mirrors
• Accessories | HEATING AND COOLING — Seat heaters • Mirrors heaters • Screen-wipers heaters • Engine heaters • Auto-refrigerators • Air conditioning units • Accessories | TUNING — Vibro-isolation
• Noise-isolation • Tint films • Accessories | ACCESSORIES — Radar-detectors • Handsfree, Bluetooth • Windowlifters • Compressors • Beeps, loudspeakers • Measuring instruments • Cleaners • Carsits
• Miscellaneous | MOUNTING — Installation kits • Upholstery • Grilles • Tubes • Cable and wire • Tools • Miscellaneous | POWER — Batteries • Converters • Start-charging equipment • Capacitors
• Accessories | MARINE AUDIO AND ELECTRONICS — Marine receivers • Marine audio speakers • Marine subwoofers • Marine amplifiers • Accessories | CAR CARE PRODUCTS — Additives • Washer fluid •
Care accessories • Car polish • Flavors • Adhesives and sealants | LIQUID AND OIL — Motor oil • Transmission oil • Brake fluid • Antifreeze • Technical lubricant



In store "130" you can find and buy almost all necessary goods for your auto in Kyiv and other cities, delivery by ground and postal services. Our experienced consultants will provide you with exhaustive information and help you to chose the very particular thing. We are waiting for you at the address

<http://130.com.ua>

clarion®

Owner's manual & Installation manual
Mode d'emploi et manuel d'installation
Manual de instrucciones y de instalación

CZ100

CD/MP3/WMA RECEIVER
LECTEUR CD/MP3/WMA
RECEPTOR CD/MP3/WMA

CLARION PRODUCT REGISTRATION INFORMATION

For USA and Canada only
www.clarion.com

Dear Customer:

Congratulations on your purchase of a Clarion mobile electronic products. We are confident that you'll enjoy your Clarion experience.

There are many benefits to registering your product. We invite you to visit our website at www.clarion.com to register your Clarion product.

We have made product registration simple with our easy to use website. The registration form is short and easy to complete. Once you're registered, we can keep you informed of important product information.

Register at www.clarion.com - it's easy to keep your Clarion product up to date.

INFORMATIONS DE L'ENREGISTREMENT DE PRODUITS CLARION

Pour les États Unis et le Canada seulement
www.clarion.com

Cher client:

Nous vous remercions d'avoir acheté ce produit électronique mobile Clarion. Nous sommes confiants que vous apprécierez votre expérience Clarion.

Il y a beaucoup d'avantage à enregistrer votre produits. Nous vous invitons à visiter notre site Web www.clarion.com pour enregistrer votre produit Clarion.

Nous avons facilité la tache d'enregistrement de produit simple et facile grâce à notre site Web. Le formulaire d'enregistrement est court et facile à compléter. Lorsque vous êtes enregistrer, nous pouvons vous tenir informé des informations important de produits.

Enregistrer à www.clarion.com - c'est facile de mettre à jour votre produit Clarion.

INFORMACIÓN DEL REGISTRO DE PRODUCT O DE CLARION

Para USA y Canada nomas
www.clarion.com

Querido Cliente:

Felicitaciones por su compra de producto electrónico móvil de Clarion. Estamos seguros que usted gozará de su experiencia con el producto de Clarion.

Hay muchas ventajas al registrar su producto. Le invitamos a que visite nuestro sitio en internet www.clarion.com para registrar su producto de Clarion.

Hemos hecho el registro de producto fácil en nuestro sitio. La forma de registro es corta y fácil de completar. Una vez que lo registre, podremos proporcionarle la información de su producto.

Regístrese en www.clarion.com - es fácil mantener su producto de Clarion actualizado.

Contents

Thank you for purchasing this Clarion product.

- Please fully read this owner's manual before operating this equipment.
- Check the contents of the enclosed warranty card and store it in a safe place with this manual.

1. FEATURES	2
2. PRECAUTIONS	3
Front Panel / Generalities.....	4
Remove the DCP	5
Re-attach the DCP	5
3. CONTROLS	6
Operational Panel.....	6
Names of Buttons.....	6
Remote Control	7
Notes of remote control using	7
4. CAUTIONS ON HANDLING	8
Handling Discs	8
5. OPERATIONS	9
Basic Operations	9
Radio Operations	10
CD/MP3/WMA Operations	11
AUX Operations	13
Audio Setup.....	14
System Setup	14
6. TROUBLE SHOOTING	15
7. ERROR DISPLAY	16
8. SPECIFICATIONS	17
9. INSTALLATION / WIRE CONNECTION GUIDE	18

1. FEATURES

- **MP3/WMA compatible with ID3-TAG display**
- **Detachable Front Panel with 3.5mm Auxiliary Input**
- **4ch/2V RCA Output with Subwoofer Control and BEAT-EQ with 3 Band Parametric Equalizer**



COMPACT
disc
DIGITAL AUDIO



MP3/WMA

Expanding Systems

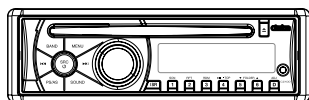
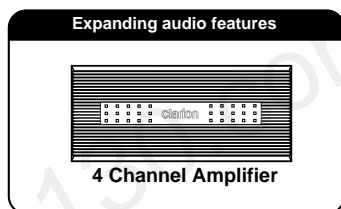

Portable Player
(Connect by AUX IN Jack)

Note:

The items listed outside of the frames are the commercial products generally sold.

2. PRECAUTIONS

⚠ WARNING

For your safety, the driver should not operate the controls while driving.
Also, while driving, keep the volume to a level at which external sounds can be heard.

- When the inside of the car is very cold and the player is used soon after switching on the heater, moisture may form on the disc or the optical parts of the player and proper playback may not be possible. If moisture forms on the disc, wipe it off with a soft cloth. If moisture forms on the optical parts of the player, do not use the player for about one hour. The condensation will disappear naturally allowing normal operation.
- Driving on extremely bumpy roads which cause severe vibration may cause the sound to skip.
- This unit uses a precision mechanism. Even in the event that trouble arises, never open the case, disassemble the unit, or lubricate the rotating parts.
- This equipment has been tested and found to comply with the limits for a Class B digital device, pursuant to Part 15 of the FCC Rules. These limits are designed to provide reasonable protection against harmful interference in a residential installation. This equipment generates, users, and can radiate radio frequency energy and, if not installed and used in accordance with the instructions, may cause harmful interference to radio communications. However, there is no guarantee that interference will not occur in a particular installation. If this equipment does cause harmful interference to radio or television reception, which can be determined by turning the equipment off and on, the user is encouraged to consult the dealer or an experienced radio/TV technician for help.

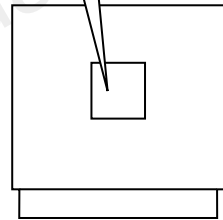
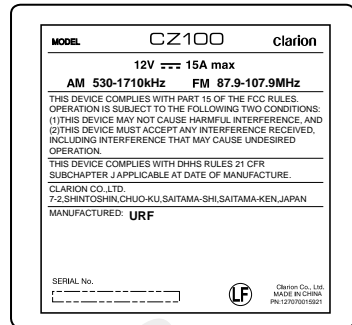

INFORMATION FOR USERS:

CHANGES OR MODIFICATIONS TO THIS PRODUCT NOT APPROVED BY THE MANUFACTURER WILL VOID THE WARRANTY AND WILL VIOLATE FCC APPROVAL.

Front Panel / Generalities

For a longer service life, be sure to read the following cautions.

- Do not allow any liquids on the set from drinks, umbrellas, etc. Doing so may damage the internal circuitry.
- Do not disassemble or modify the set in any way. Doing so may result in damage.
- Do not let cigarettes burn the display. Doing so may damage or deform the body.
- If a problem should occur, have the set inspected at your store of purchase.
- The remote control unit may not work if the remote control sensor is exposed to direct sunlight.

Cleaning the body

Use a soft, dry cloth and gently wipe off the dirt.

For tough dirt, apply some neutral detergent diluted in water to a soft cloth, wipe off the dirt gently, then wipe again with a dry cloth.

Do not use benzene, thinner, car cleaner, etc., as these substances may damage the body or cause the paint to peel. Also, leaving rubber or plastic products in contact with the body for long periods of time may cause stains.

Remove the DCP

The control panel can be detached to prevent theft. When detaching the control panel, keep it in the safety place and prevent scratches. We recommend taking the DCP with you when leaving the car.

1. Press the [] button (2 sec.) to turn off the power.
2. Deeply push in [OPEN] button to unlock the DCP.
3. Hold the side popped out, take off the DCP.

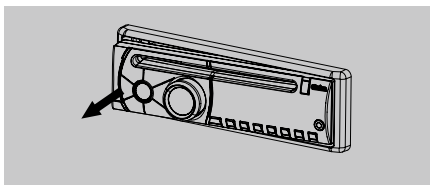

Re-attach the DCP

1. Hold the DCP and ensure that the panel faces towards you. Set the right side of the DCP into the DCP bracket.
2. Press the left side of the DCP until it locks.

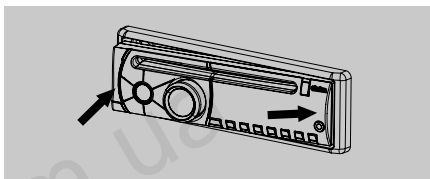

CAUTION

- The DCP can easily be damaged by shocks. After removing it, be carefully not to drop it or subject it to strong shocks.
- Once the [OPEN] button is pressed and DCP is unlocked, car vibrations can cause the DCP to fall.
- The connector connecting the source unit and the DCP is an extremely important part. Be careful not to damage it by pressing on it with fingernails, screwdrivers, etc.

Note:

If the DCP is dirty, wipe off the dirt with a soft, dry cloth only.

3. CONTROLS

Operational Panel

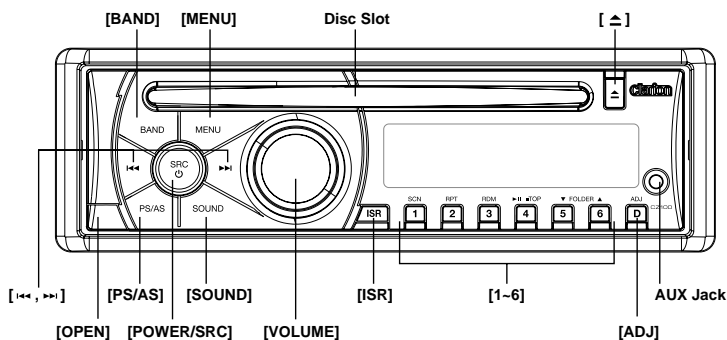

Names of Buttons

[**⏻** / SRC] Key

- Power / Toggle the audio source

[BAND] Key

- Select tuner band

[MENU] Key

- System menu

[**⏏**] Key

- Eject the disc in the unit.

[**⏮**, **⏭**] Key

- Previous(Next) / Search

[OPEN] Key

- Unlock the front panel.

[PS / AS] Key

- Preset scan / Auto memory store

[SOUND] Key

- Sound effect setting

[VOLUME] Key

- Adjust volume level / Confirm

[ISR] Key

- Recall ISR station stored in memory and store current station in ISR memory (long press)

[1~6] Key

- [1] Key: Scan play / Preset station 1.
- [2] Key: Repeat play / Preset station 2.
- [3] Key: Random play / Preset station 3.
- [4] Key: Play / Pause / Top play (long press) / Preset station 4.
- [5] Key: Previous folder / Preset station 5. 10 tracks down (long press)
- [6] Key: Next folder / Preset station 6. 10 tracks up (long press)

[ADJ] Key

- Display switch / System menu

Remote Control

[SRC] Key

- Toggle the audio source / Power on / Power off (long press)

[◀◀, ▶▶] Key

- Preset station up/down / Previous/next track / Search(long press)

[SCN/PS/AS] Key

- Scan play / Preset scan / Auto memory store

[BND/TOP] Key

- Select tuner band / Top play (long press)

[▲, ▼] Key

- Volume up / down

[▶||] Key

- Play / Pause

[ISR] Key

- Recall ISR station stored in memory and store current station in ISR memory (long press)

[DISP] Key

- Display switch

[RDM] Key

- Random play

[RPT] Key

- Repeat play

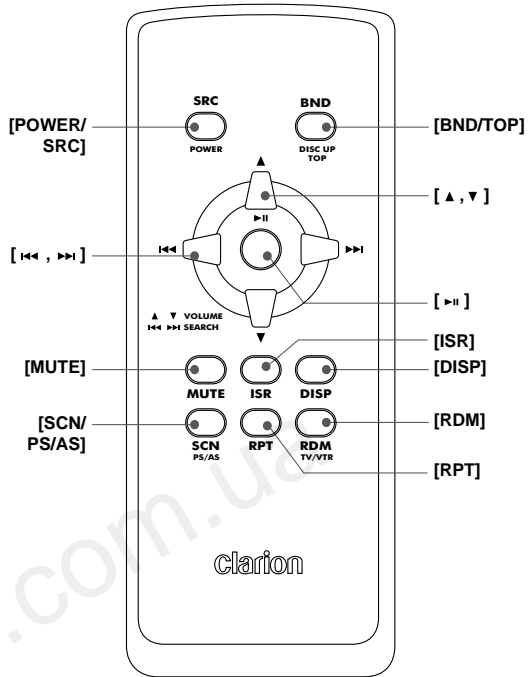

Notes of remote control using

1. Aim the remote control at the remote sensor on the unit.
2. Remove the battery from the remote control or insert a battery insulator if the battery has not been used for a month or longer.
3. DO NOT store the remote control under direct sunlight or in high temperature environment, or it may not function properly.
4. Use "button shaped" lithium battery "CR2025" (3V) only.
5. DO NOT recharge, disassemble, heat or expose the battery in fire.
6. Insert the battery in proper direction according to the (+) and (-) poles.
7. Store the battery in a place where children cannot reach to avoid the risk of accident.

Inserting the Battery

1. Slide remote control unit's rear cover in the direction shown.
2. Insert battery (CR2025) into insertion guides with printed side (+) up.
3. Press battery into compartment as shown.
4. Replace and slide cover until it clicks into place.

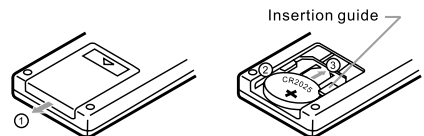

4. CAUTIONS ON HANDLING

Handling Discs

Handling

- New discs may have some roughness around the edges. If such discs are used, the player may not work or the sound may skip. Use a ball-point pen or the like to remove any roughness from the edge of the disc.

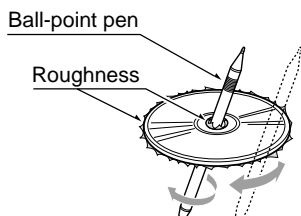

- Never stick labels on the surface of the disc or mark the surface with a pencil or pen.
- Never play a disc with any cellophane tape or other glue on it or with peeling off marks. If you try to play such a disc, you may not be able to get it back out of the player or it may damage the player.
- Do not use discs that have large scratches, are misshapen, cracked, etc. Use of such discs may cause misoperation or damage.
- To remove a disc from its storage case, press down on the center of the case and lift the disc out, holding it carefully by the edges.
- Do not use commercially available disc protection sheets or discs equipped with stabilizers, etc. These may damage the disc or cause breakdown of the internal mechanism.

Storage

- Do not expose discs to direct sunlight or any heat source.
- Do not expose discs to excess humidity or dust.
- Do not expose discs to direct heat from heaters.

Cleaning

- To remove fingermarks and dust, use a soft cloth and wipe in a straight line from the center of the disc to the circumference.
- Do not use any solvents, such as commercially available cleaners, anti-static spray, or thinner to clean discs.
- After using special disc cleaner, let the disc dry off well before playing it.

On Discs

- Exercise a good precaution when loading a disc. The operation panel will close automatically when leaving it open for a while.
- Never turn off the power and remove the unit from the car with a disc loaded.

CAUTION

For your safety, the driver should not insert or eject a disc, opening the operation panel while driving.

5. OPERATIONS

Basic Operations

Note:

- Be sure to read this chapter referring to the chapter "3. CONTROLS"

CAUTION

When the unit is turned on, starting and stopping the engine with its volume raised to the maximum level may harm your hearings.
Be careful about adjusting the volume.

Power on / off

Notes:

- Start the engine before using this unit.
 - Be careful about using this unit for a long time without running the engine. If you drain the car's battery too far, you may not be able to start the engine and this can reduce the service life of the battery.
1. Start the engine. The power button / knob illumination on the unit will light up.



Engine ON position

2. Press the [Φ] key on the front panel to turn on the power under standby mode. The unit goes back to the last status after power on.
3. Press and hold the [Φ] key on the front panel to turn off the power under work mode.

Mute

Press the [MUTE] key on the remote control to mute the volume from the unit.

Note:

Doing the operation above again or adjusting volume will release muting.

Volume adjustment

Turn the volume knob on the front panel or press the [\blacktriangle , \blacktriangledown] key on the remote control. The adjustable range of volume is 0 to 40.

CAUTION

While driving, keep the volume level at which external sounds can be heard.

Playing source selection

Press [SRC] key on the front panel and remote control repeatedly to choose desired playing source.

Notes:

1. Playing source selection means selecting work mode, such as DISC mode, Radio mode, Aux mode, etc.
2. When some devices are not ready, they cannot be selected.

Display system time

Press the [ADJ] key on the front panel or [DISP] key on the remote control to switch the display information, system time and playing source.

Radio Operations

Select tuner as playing source

Press [SRC] button once or more to enter radio mode.

Select one radio band

Press the [BAND] key on the panel or [BND] key on the remote control to select one radio band among FM1, FM2, FM3, AM.

Manual tuning

During manual tuning, the frequency will be changed in steps.

Press the [▶▶1]/[1◀◀] key on the panel to tune in a higher / lower station.

Auto tuning

Press and hold the [▶▶1]/[1◀◀] key on the panel or remote control to seek a higher / lower station.

To stop searching, repeat the operation above or press other keys having radio functions.

Note:

When a station is received, searching stops and the station is played.

Auto store

Only stations with sufficient signal strength will be detected and stored in the memory. Press and hold the [PS/AS] (2 sec.) to start automatic station search.

To stop auto store, press other keys having radio functions.

Notes:

1. After auto store, the previous stored stations will be overwritten.
2. The unit has 4 bands, such as FM1, FM2, FM3 and AM. FM3 and AM can store by AS function. Each bands can store 6 stations, CZ100 can store 24 stations in total.

Manual store

When one expected radio station has been detected, press and hold number key 1~6 to store it in the memory.

Recall the stored stations

Press one numeric key among 1 to 6 on the panel to select the corresponding stored station.

Local seeking

When LOCAL seeking is on, only those radio stations with strong radio signal could be received.

To open or close LOCAL function, press and hold the [ADJ] key on the front panel, then press [▶▶1] key repeatedly until LO or DX displays on the screen, rotate the knob to select Local or Distant mode.

Note:

The number of radio stations that can be received will decrease after the local seeking mode is on.

CD/MP3/WMA Operations

This unit can play back MP3/WMA files

Notes:

- If you play a file with DRM (Digital Rights Management) for WMA remaining ON, no audio is output (The WMA indicator blinks).

To disable DRM (Digital Rights Management)

When using Windows Media Player 9/10/11, click on TOOL -> OPTIONS -> COPY MUSIC tab, then under COPY SETTINGS, unclick the Check box for COPY PROTECT MUSIC. Then, reconstruct files.

Personally constructed WMA files are used at your own responsibility.

Precautions when creating MP3/WMA file

Usable sampling rates and bit rates

1. MP3: Sampling rate 8 kHz-48 kHz, Bit rate 8 kbps-320 kbps / VBR
2. WMA: Bit rate 8 kbps-320 kbps

File extensions

1. Always add a file extension “.MP3”, “.WMA” to MP3, WMA file by using single byte letters. If you add a file extension other than specified or forget to add the file extension, the file cannot be played.
2. Files without MP3/WMA data will not play. The files will be played soundlessly if you attempt to play files without MP3/WMA data.
 - * When VBR files are played, the play time display may differ the play location.
 - * When MP3/WMA files are played, a little no sound part is caused between tunes.

Logical format (File system)

1. When writing MP3/WMA file on a CD-R disc or CD-RW disc, please select “ISO9660 level 1, 2 or JOLIET or ROMEO” or APPLE ISO as the writing software format. Normal play may not be possible if the disc is recorded on another format.
2. The folder name and file name can be displayed as the title during MP3/WMA play but the title must be within 64 single

byte alphabetical letters and numerals (including an extension).

3. Do not affix a name to a file inside a folder having the same name.

Folder structure

A disc with a folder having more than 8 hierarchical levels will be impossible.

Number of files or folders

1. Up to 999 files can be recognized per folder.
 - Up to 999 files can be played.
2. Tracks are played in the order that they were recorded onto a disc. (Tracks might not always be played in the order displayed on the PC.)
3. Some noise may occur depending on the type of encoder software used while recording.

Eject function

Just pressing the [▲] button, ejects the disc.

Notes:

- If you force a CD into before auto reloading, this can damage the CD.
- If a CD (12 cm) is left in the ejected position for 15 seconds, the CD is automatically reloaded (Auto reload).

Listening to a disc already loaded in the unit

Press the [SRC] button to select the CD/MP3/WMA mode.

When the unit enters the CD/MP3/WMA mode, play starts automatically.



Loading a CD

Insert a CD into the center of the CD SLOT with the labeled side facing up. The CD plays automatically after loading.

Notes:

- Never insert foreign objects into the CD SLOT.
- If the CD is not inserted easily, there may be another CD in the mechanism or the unit may require service.

CD/MP3/WMA Operations

- Discs not bearing the  or  mark and CD-ROMs cannot be played by this unit.
- Some CDs recorded in CD-R/CD-RW mode may not be usable.

Pausing play

- Press the [4 / ►||] button to pause play. "PAUSE" appears in the display.
- To resume CD play, press the [4 / ►||] button again.

Displaying CD titles

This unit can display title data for MP3/WMA disc.

When SCROLL is OFF, each time you press the [BAND] button to change the title display.

MP3/WMA disc

Track > Folder > File title > Album > Title > Artist > Track ...

Notes:

- If MP3/WMA disc is not input TAG, "NO TITLE" appears in the display.
- Only ASCII characters can be displayed in Tags.

Selecting a track

Track-up

- Press the [►►] button to move ahead to the beginning of the next track.
- Each time you press the [►►] button, the track advances ahead to the beginning of the next track.
- For MP3/WMA disc, press and hold the [6] button to move ahead to +10 tracks.

Track-down

- Press the [◀◀] button to move back to the beginning of the current track.
- Press the [◀◀] button twice to move back to the beginning of the previous track.
- For MP3/WMA disc, press and hold the [5] button to move back to -10 tracks.

Fast-forward/Fast-reverse

Fast-forward

Press and hold the [►►] button .

Fast-reverse

Press and hold the [◀◀] button .

* For MP3/WMA discs, it takes some time until the start of searching and between tracks. In addition, the playing time may have a margin of error.

Folder Select

This function allows you to select a folder containing MP3/WMA files and start playing from the first track in the folder.

- Press the [5] or [6] button.
Press the [6] button to move the next folder. Press the [5] button to move the previous folder.
- To select a track, press the [◀◀] or [►►] button.

Top function

The top function resets the CD player to the first track of the disc. Press and hold the [TOP] button (2 sec.) to play the first track (track No. 1) on the disc.

* In case of MP3/WMA, the first track of a folder being played will be returned.

Other various play functions

Scan play

This function allows you to locate and play the first 10 seconds of all the tracks recorded on a disc.

Press the [SCN] button to perform scan play.

Repeat play

This function allows you to play the current track repeatedly or play a track currently being played in the MP3/WMA folder repeatedly.

CD:

- Press the [RPT] button once or more until "RPT ON" appears on the LCD to perform repeat play.

CD/MP3/WMA Operations

2. Press [RPT] button repeatedly until "RPT OFF" appears on the LCD to cancel repeat playback.

MP3/WMA:

1. Press the [RPT] button once or more until "TRACK RPT" appears on the display to perform repeat play, and "RPT" segment lights on.
2. For MP3/WMA files, press [RPT] button repeatedly until "FOLDER RPT" appears on the display for folder repeat play.

3. Press [RPT] button repeatedly until "RPT OFF" appears on the display to cancel repeat playback, and "RPT" segment goes off.

Random play

This function allows you to play all tracks recorded on a disc in a random order.

Press the [RDM] button to perform random play.

AUX Operations

Press [SRC] button on the panel or remote control to select AUX.

AUX is just for Audio content with 3.5mm Jack connector plugged into audio-in socket on the front panel.

AUX Input sensitivity setting

1. Press the [ADJ] button.
2. Turn the [VOL/SEL] knob to select "AUX MID".
3. If the output level of connected external audio player is "High", rotate [VOL/SEL] knob and choose "AUX LOW". And if the output level is "Low", choose "AUX HIGH".

130.com.ua

Audio Setup

Press the **[SOUND]** key to enter sound effect setting mode. First Press shows current EQ. Rotate the volume knob to changes BEAT EQ in this order:
OFF -> B-BOOST -> IMPACT -> EXCITE -> CUSTOM

Press the **[SOUND]** key, then press **[◀◀ , ▶▶]** to select USER preset including:

BALANCE -> FADER -> M-B EX -> LPF(low pass filter) -> SUBW VOL, rotate the volume knob to select a value.

BALANCE:LEFT 1-7->CENTER->RIGHT 1-7
FADER:LEFT 1-7->CENTER->RIGHT 1-7

M-BEX: ON/OFF

LPF: THROUGH/80/120/160

SUBW VOL: (-6)-(+6)

System Setup

At radio mode, press and hold **[ADJ]** button to enter system MENU. Press **[◀◀ , ▶▶]** to select options, rotate the volume knob to adjust.

CLOCK

Press the knob to enter clock setting mode, Rotate the knob to set clock, press **[◀◀]** or **[▶▶]** to select hour or minute, press and hold the knob to confirm.

DX/LO

Rotate the knob to choose radio local or distant at radio mode.

LO: Only stations with strong signal can be received.

DX: Stations with strong and weak signals can be received.

AUX SENS

Rotate the knob to choose AUX Input sensitivity LOW, MID or HIGH at AUX mode.

SCRN SVR: ON/OFF

Rotate the knob to choose screen saver on or off.

SCROLL: ON/OFF

For track information that is longer than the display panel:

When SCROLL is ON, the LCD will display ID3 TAG information cyclely, e.g: TRACK->FOLDER->FILE->ALBUM->TITLE->ARTIST->TRACK->...

When SCROLL is OFF, the LCD will display one of the ID3 TAG information, the default is TRACK, but user can adjust it to other ID3 TAG information by press **[BAND]**.

DIMMER: ON/OFF

Rotate the knob to choose dimmer on or off. ON: LCD dimmer is active when small light of vehicle is turned ON.

OFF: LCD always maximum brightness regardless of the vehicle small light.

REAR/S-W

Rotate the knob to choose REAR LINE OUT or SUB-WOOFER.

TEL-SW

Rotate the knob to choose TELE-PHONE MUTE, ON or OFF.

- OFF:

This unit continues normal operation even when the cellular phone is used.

- ON:

You can listen to your telephone calls from the speakers connected to this unit.

*When listening to your calls on your car speakers, you can adjust the volume by turning the **[ROTARY]** knob.

- MUTE:

The sound from this unit is muted during telephone calls.

BEEP: ON/OFF

Rotate the knob to choose button beep sound on or off.

12/24H

Rotate the knob to choose time format: 12 HOURS or 24 HOURS.

6. TROUBLE SHOOTING

GENERAL

Problem	Cause	Measure
Unit can not power on	Unit fuse blown.	Install new fuse with correct rating.
	Car battery fuse blown.	Install new fuse with correct rating.
Unit can not power on Nothing happens when buttons are pressed. Display is not accurate.	Illegal operation.	Turn off the power and open the operation panel. Press the reset button with a thin rod. Note: When the Reset button is pressed, turn off the ACC power.* * When the Reset button is pressed, frequencies of radio stations, titles, etc. stored in memory are cleared.
Remote control does not work	Battery depleted.	Change the battery.
	Battery installed incorrectly.	Install the battery correctly.
No/low audio output	Improper audio output connection.	Check wiring and correct.
	Volume set too low.	Increase volume level.
	Speakers damaged.	Replace speakers.
	Heavily biased volume balance.	Adjust the channel balance to center position.
	Speaker wiring is in contact with metal part of car.	Insulate all speaker wiring connections.
Poor sound quality or distortion	Non-standard disc used.	Use a standard disc.
	Speaker power rating does not match unit.	Replace speakers.
	Wrong connections.	Check wiring and correct.
	Speaker is shorted.	Check wiring and correct.
Tel-Mute malfunction	MUTE wire is grounded.	Check the 'MUTE' wiring and correct.
Unit resets itself when engine is off	Incorrect connection between ACC and Battery.	Check wiring and correct.

DISC Player

Problem	Cause	Measure
Disc cannot be loaded.	Another disc is already loaded.	Eject the disc before loading the new one.
	There is a foreign matter already in place.	Eject the foreign matter forcibly.
Sound skips or is noisy.	Compact disc is dirty.	Clean the compact disc with a soft cloth.
	Compact disc is heavily scratched or warped.	Replace with a compact disc with no scratches.
Sound is bad directly after power is turned on.	Water droplets may form on the internal lens when the car is parked in a humid place.	Let dry for about 1 hour with the power on.

7. ERROR DISPLAY

If an error occurs, one of the following displays is displayed. Take the measures described below to solve the problem.

Display	Cause	Measure
ERROR 3	Disc is inserted incorrectly.	Eject the disc then reload it properly.
	The disc format is not supported.	Try another disc.
ERROR 5	This is a failure of deck's mechanism.	Consult your store of purchase.

If an error display other than the ones described above appears, press the Reset button. If the problem persists, turn off the power and consult your store of purchase.

* When the Reset button is pressed, frequencies of radio stations, titles, etc. stored in memory are cleared.

8. SPECIFICATIONS

FM Tuner

Frequency range: 87.9-107.9MHz
 Usable sensitivity: 8dBu
 Frequency response: 30Hz-15kHz
 Stereo separation: 30dB(1kHz)
 Signal/noise ratio: >55dB

AM Tuner

Frequency range: 530-1710kHz
 Usable sensitivity (S/N=20dB): 30dBu

CD

System: Disc digital audio system
 Frequency response: 20Hz-20kHz
 Signal/noise ratio: >75dB
 Total harmonic distortion: Less than 0.1% (1kHz)
 Channel separation: >60dB

MP3/WMA mode

MP3 sampling rate: 8 kHz to 48 kHz
 MP3 bit rate: 8 kbps to 320 kbps / VBR
 WMA bit rate: 8 kbps to 320 kbps
 Logical format: ISO9660 level 1,2
 Joliet or Romeo file system

Audio Amplifier

Maximum power output:
 180W (45W x 4)
 Speaker impedance: 4Ω (4 to 8 Ω allowable)

Input

Audio input sensitivity:
 High: 320mV (at 1V output)
 Mid: 650mV (at 1V output)
 Low: 1.3V (at 1V output)
 (input impedance 10 kΩ or greater)
 Aux-in level: ≤2V

General

Power supply voltage:
 14.4VDC (10.8 to 15.6V allowable),
 negative ground
 Pre-Amp output voltage:
 2.0V (CD play mode: 1kHz, 0dB, 10kΩ load)
 Fuse: 15A

Dimensions of the Main Unit:

188mm Width × 58mm Height × 190mm Depth
 7-2/5(width) × 2-7/25(Height) × 7-12/25(Depth)

Weight of the Main Unit: 2.87lb. (1.30kg)

Dimensions of the Remote Control unit:

43mm Width × 11mm Height × 113mm Depth
 1-2/3(Width) × 2/5(Height) × 4-2/5(Depth)

Weight of the Remote Control Unit:

1.16oz. (36g) (including battery)

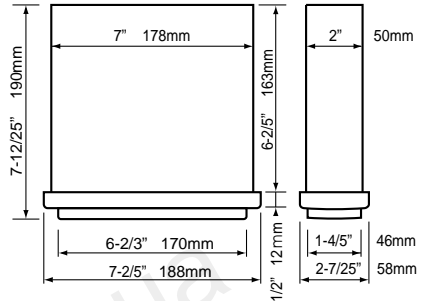

Notes:

- Specifications comply with JEITA Standards.
- Specifications and design are subject to change without notice for further improvement.

Power Output:

18W RMS x 4 Channels at 4 and 1% THD+N

Signal to Noise Ratio:

74dBA (reference: 1W into 4)



9. INSTALLATION / WIRE CONNECTION GUIDE

CONTENTS

1) BEFORE STARTING	18
2) PACKAGE CONTENTS	18
3) GENERAL CAUTIONS.....	18
4) CAUTIONS ON INSTALLATION.....	19
5) INSTALLING THE SOURCE UNIT	19
6) REMOVING THE SOURCE UNIT.....	21
7) WIRING AND CONNECTIONS.....	22
8) CONNECTING THE ACCESSORIES	23

1) Before Starting

1. This set is exclusively for use in cars with a negative ground 12 V power supply.
2. Read these instructions carefully.
3. Be sure to disconnect the battery "terminal" before starting. This is to prevent short circuits during installation. (Figure 1)

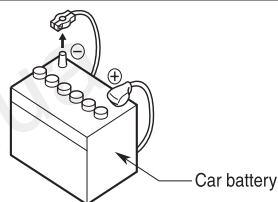

Figure 1

2) Package Contents

Source unit	1	L-key.....	2
Front panel	1	Wire connector	1
Trim ring	1	Remote control unit (with battery).....	1
Mounting bracket.....	1	Owner's manual.....	1
Special screw	1	Warranty card.....	1
Screws M5x6 mm.....	4		

3) General Cautions

1. Do not open the case. There are no user- serviceable parts inside. If you drop anything into the unit during installation, consult your dealer or an authorized Clarion service center.
2. Use a soft, dry cloth to clean the case. Never use a rough cloth, thinner, benzine, or alcohol etc. For tough dirt, apply a little cold or warm water to a soft cloth and wipe off the dirt gently.

4) Cautions on Installation

1. Prepare all articles necessary for installing the source unit before starting.
2. Install the unit within 30° of the horizontal plane. (Figure 2)
3. If you have to do any work on the car body, such as drilling holes, consult

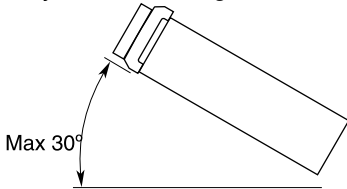

Figure 2

4. your car dealer beforehand.
4. Use the enclosed screws for installation. Using other screws can cause damage. (Figure 3)

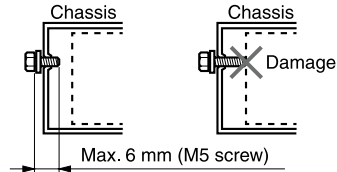

Figure 3

5) Installing the Source Unit

1. Place the mounting bracket into the instrument panel, use a screwdriver to bend each stopper of the universal mounting bracket inward, then secure the stopper.
2. Wire as shown in Section 7) .
3. Insert the source unit into the mounting bracket until it locks.
4. Take care of the top and bottom of the outer escutcheon and mount it so that all the hooks are locked.

Notes:

1. Some car models require special mounting kits for proper installation. Consult your Clarion dealer for details.
2. Fasten the front stopper securely to prevent the source unit from coming loose.

• Console opening dimensions

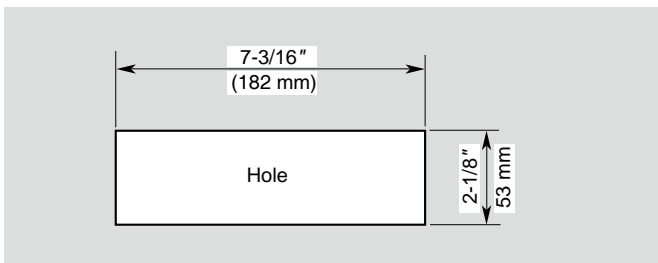

Notes of installation

1. Before installation, please make sure proper connections are conducted and the unit operates normally. Improper connection may result in damage to the unit.
2. Use only accessories designed and manufactured for this unit and other unauthorized accessories may result in damage to the unit.
3. Before installation, please fasten all power cables.
4. DO NOT install the unit in the place where close to hot area to prevent damage to electrical components such as the laser head.
5. Install the unit horizontally. Installing the unit more than 30 degree vertically may result in worse performance.
6. To prevent electric spark, connect the

positive pole first and then the negative pole.

7. DO NOT block the cooling fan exit to ensure sufficient heating dissipation of this unit, or it may result in damage to this unit.

Unit Installation

Method A

1. Insert mounting bracket into dash board, choose appropriate mounting tab according to the gap width, bending the mounting tab outwards with a screwdriver to fix the mounting bracket in place.
2. Slide the unit into the bracket until you hear a click sound.

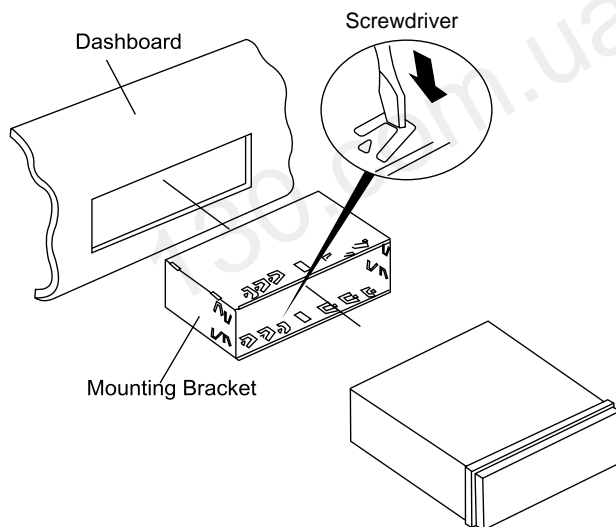

Method B

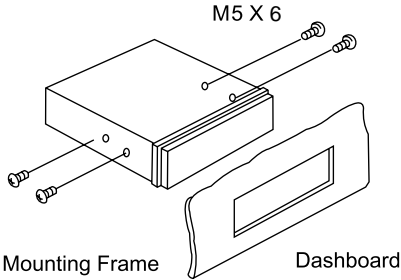
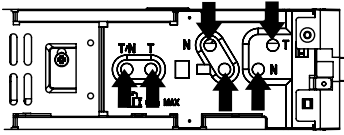

1. Insert this unit directly to the opening of the dashboard.
2. Place M5×6 cylindrical screw through the holes of the mounting frame located inside the opening to holes of the unit and fasten the screws to left & right.

Trim Ring installation

Attach the trim ring around the front panel.

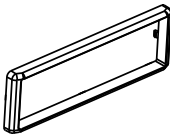

6) Removing the Source Unit

Disassemble trim ring

1. Push the trim ring to right and pull out the right part.

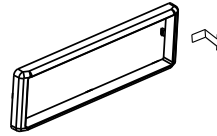

2. Push the trim ring to left and pull out the left part.

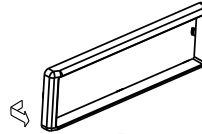

Disassemble the unit

1. Switch off the power.
2. Remove the panel.
3. Remove the trim ring.
4. Insert the removal keys straight back until they lock, then pull the unit out.

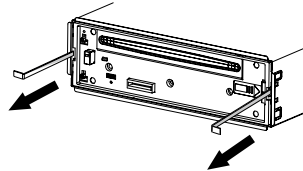

5. Disconnect all the wires.

7) Wiring and Connections

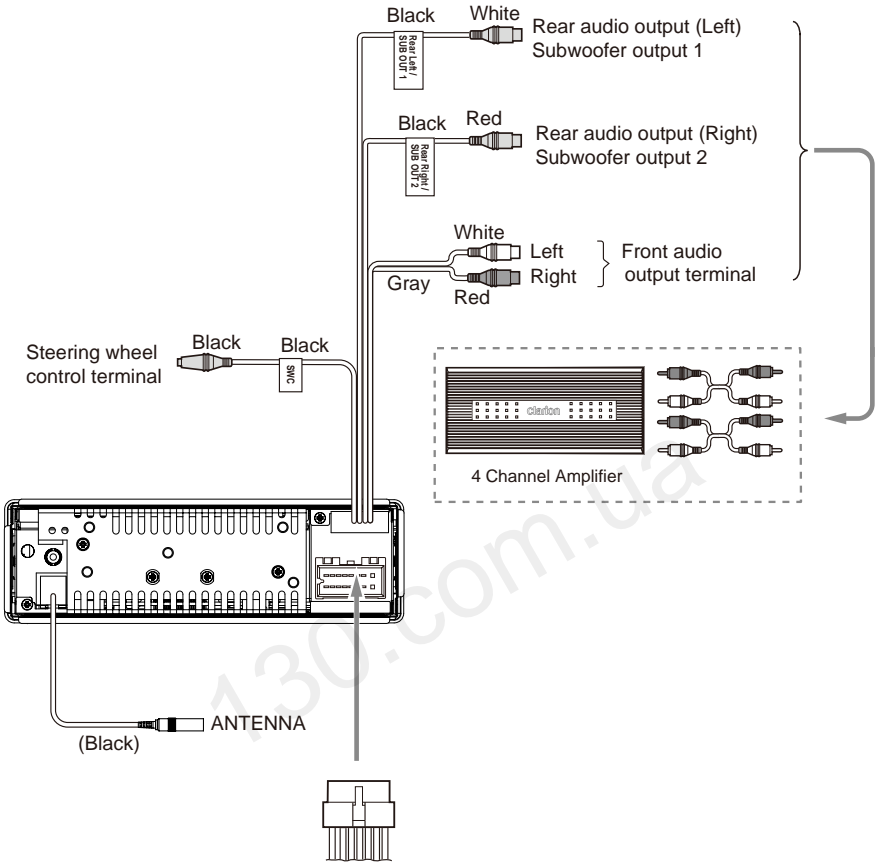

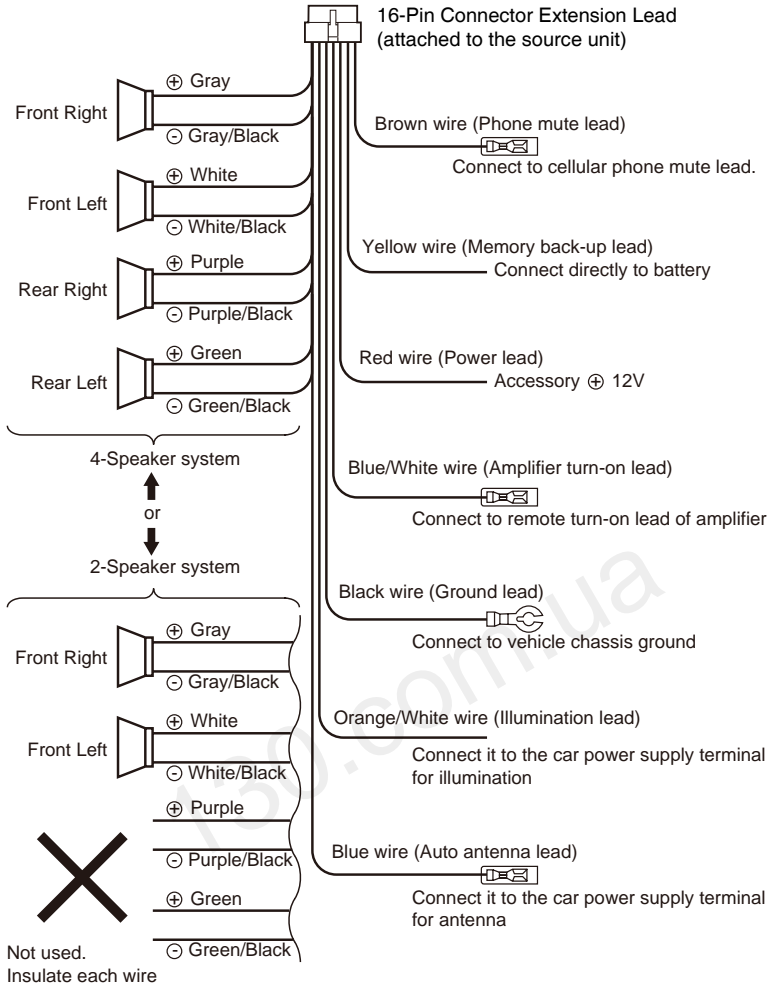

8) Connecting the accessories

• Connecting to the external amplifier

External amplifiers can be connected to the 4 channel RCA output connections. Ensure that the connectors are not grounded or shorted to prevent damage to the unit.

130.com.ua

Clarion Co., Ltd.

Todos los Derechos Reservados. Copyright © 2009: Clarion Co., Ltd.

Printed in China / Imprimé en Chine / Impreso en China

PN: 127075012416

Autogood products internet store <http://130.com.ua>