

clarion®

Owner's manual & Installation manual
Mode d'emploi et manuel d'installation
Manual de instrucciones y de instalación

CZ505

H) Radio® ((**siriusxm**))
READY READY

Bluetooth® CD/USB/MP3/WMA RECEIVER
LECTEUR Bluetooth® CD/USB/MP3/WMA
RECEPTOR Bluetooth® CD/USB/MP3/WMA

CLARION PRODUCT REGISTRATION INFORMATION

For USA and Canada only
www.clarion.com

Dear Customer:

Congratulations on your purchase of a Clarion mobile electronic products. We are confident that you'll enjoy your Clarion experience.

There are many benefits to registering your product. We invite you to visit our website at www.clarion.com to register your Clarion product.

We have made product registration simple with our easy to use website. The registration form is short and easy to complete. Once you're registered, we can keep you informed of important product information.

Register at www.clarion.com - it's easy to keep your Clarion product up to date.

INFORMATIONS DE L'ENREGISTREMENT DE PRODUITS CLARION

Pour les États Unis et le Canada seulement
www.clarion.com

Cher client:

Nous vous remercions d'avoir acheté ce produit électronique mobile Clarion. Nous sommes confiants que vous apprécierez votre expérience Clarion.

Il y a beaucoup d'avantage à enregistrer votre produits. Nous vous invitons à visiter notre site Web www.clarion.com pour enregistrer votre produit Clarion.

Nous avons facilité la tâche d'enregistrement de produit simple et facile grâce à notre site Web. Le formulaire d'enregistrement est court et facile à compléter. Lorsque vous êtes enregistré, nous pouvons vous tenir informé des informations important de produits.

Enregistrer à www.clarion.com - c'est facile de mettre à jour votre produit Clarion.

INFORMACIÓN DEL REGISTRO DE PRODUCTO DE CLARION

Para USA y Canadá nomas
www.clarion.com

Querido Cliente:

Felicitaciones por su compra de producto electrónico móvil de Clarion. Estamos seguros que usted gozará de su experiencia con el producto de Clarion.

Hay muchas ventajas al registrar su producto. Le invitamos a que visite nuestro sitio en internet www.clarion.com para registrar su producto de Clarion.

Hemos hecho el registro de producto fácil en nuestro sitio. La forma de registro es corta y fácil de completar. Una vez que lo registre, podremos proporcionarle la información de su producto. Regístrese en www.clarion.com - es fácil mantener su producto de Clarion actualizado.

Under Industry Canada regulations, this radio transmitter may only operate using an antenna of a type and maximum (or lesser) gain approved for the transmitter by Industry Canada. To reduce potential radio interference to other users, the antenna type and its gain should be so chosen that the equivalent isotropically radiated power (e.i.r.p.) is not more than that necessary for successful communication.

Conformément à la réglementation d'Industrie Canada, le présent émetteur radio peut fonctionner avec une antenne d'un type et d'un gain maximal (ou inférieur) approuvé pour l'émetteur par Industrie Canada. Dans le but de réduire les risques de brouillage radioélectrique à l'intention des autres utilisateurs, il faut choisir le type d'antenne et son gain de sorte que la puissance isotrope rayonnée équivalente (p.i.r.e.) ne dépasse pas l'intensité nécessaire à l'établissement d'une communication satisfaisante.

Contents

Thank you for purchasing this **Clarion** product.

- Please fully read this owner's manual before operating this equipment.
- Check the contents of the enclosed warranty card and store it in a safe place with this manual.

1. FEATURES	3
2. PRECAUTIONS	3
Front Panel / Generalities	4
USB Port	4
Remove the DCP	5
Attach the DCP	5
3. CONTROLS	5
Operational Panel	5
Names of Buttons	5
Notes for use of Remote Control	6
Remote Control (RCX001)	6
4. CAUTIONS ON HANDLING	7
Handling Discs	7
5. OPERATIONS	7
Basic Operations	7
System Setup	8
Audio Setup	9
Radio Operations	9
HD Radio Operations	10
SiriusXM Satellite Radio Operations	10
CD/MP3/WMA Operations	12
USB Operations	13
iPod & iPhone Operations	13
Bluetooth Operations	14
AUX Operations	15
6. TROUBLE SHOOTING	16
7. ERROR DISPLAYS	17
8. SPECIFICATIONS	17
9. INSTALLATION / WIRE CONNECTION GUIDE	18

1. FEATURES

- Built-in Bluetooth® Handsfree (HFP) and Audio Streaming (A2DP & AVRCP)
- Compatible with iPod® / iPhone® with Pandora® internet radio App
- SiriusXM-Ready™ and HD Radio Ready™ with iTunes® Tagging

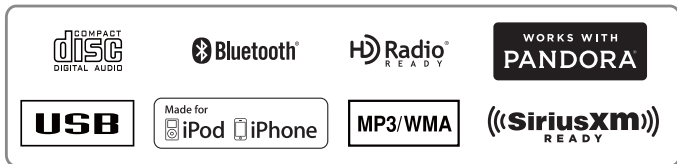

Expanding Systems

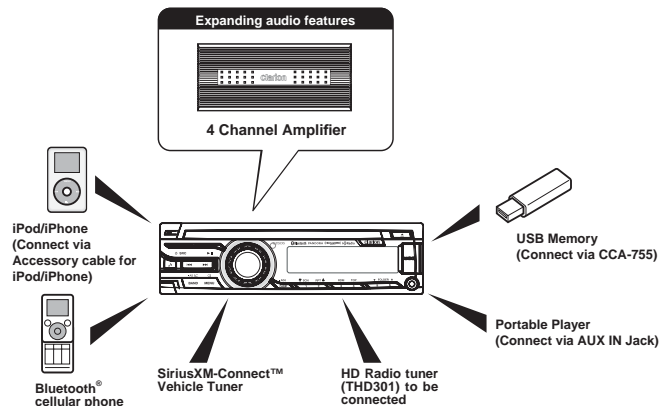

Note:

- The items listed only show connectivity options and are not included with the unit.
- CCA-755: Sold separately.
- Optional CCA-750 (iPod cable) also available, but CZ505 doesn't have iPod Video function, so even if connect to the Monitor, CZ505 doesn't playback the video.

2. PRECAUTIONS

⚠ WARNING

For your safety, the driver should not operate the controls while driving. Also, while driving, keep the volume to a level at which external sounds can be heard.

1. When the interior of the car is extremely cold and the player is used soon after switching on the heater, moisture may form on the disc or the optical parts of the player and proper playback may not be possible. If moisture forms on the disc, wipe it off with a soft cloth. If moisture forms on the optical parts of the player, do not use the player for about one hour. The condensation will disappear naturally allowing normal operation.
 2. Driving on extremely bumpy surface can cause the disc to skip during playback.
 3. This unit uses precision parts and components for its operation. In the event that trouble arises, never open the case, disassemble the unit, or lubricate the rotating parts. Contact your Clarion dealer or service center.
 4. FCC STATEMENT
 - 4.1. This device complies with Part 15 of the FCC Rules. Operation is subject to the following two conditions:
 - (1) This device may not cause harmful interference.
 - (2) This device must accept any interference received, including interference that may cause undesired operation.
 - 4.2. Changes or modifications not expressly approved by the party responsible for compliance could void the user's authority to operate the equipment.
- interference in a residential installation. This equipment generates uses and can radiate radio frequency energy and, if not installed and used in accordance with the instructions, may cause harmful interference to radio communications. However, there is no guarantee that interference will not occur in a particular installation. If this equipment does cause harmful interference to radio or television reception, which can be determined by turning the equipment off and on, the user is encouraged to try to correct the interference by one or more of the following measures:
- Reorient or relocate the receiving antenna.
 - Increase the separation between the equipment and receiver.
 - Connect the equipment into an outlet on a circuit different from that to which the receiver is connected.
 - Consult the dealer or an experienced radio/TV technician for help.
- FCC Radiation Exposure Statement
This equipment complies with FCC radiation exposure limits set forth for an uncontrolled environment. This equipment should be installed and operated with minimum distance 20cm between the radiator & your body
5. "Made for iPod" and "Made for iPhone" mean that an electronic accessory has been designed to connect specifically to iPod or iPhone, respectively, and has been certified by the developer to meet Apple performance standards. Apple is not responsible for the operation of this device or its compliance with safety and regulatory standards.

NOTE:

This equipment has been tested and found to comply with the limits for a Class B digital device, pursuant to Part 15 of the FCC Rules. These limits are designed to provide reasonable protection against harmful

Please note that the use of this accessory with iPod or iPhone may affect wireless performance.

iPhone, iPod and iTunes are trademarks of Apple Inc., registered in the U.S. and other countries.

6. Pandora, the Pandora logo, and the Pandora trade dress are trademarks or registered trademarks of Pandora Media, Inc. used with permission. Pandora is currently only available in the United States, Australia and New Zealand. If you have any issues with the Pandora application on your mobile phone, please direct them to pandora-support@pandora.com.
7. The Bluetooth word mark and logos are registered trademarks owned by the Bluetooth SIG, Inc. and any use of such marks by Clarion Co., Ltd is under license. Other trademarks and trade names are those of their respective owners.
8. Sirius, XM and all related marks and logos are trademarks of Sirius XM Radio Inc. All rights reserved.
9. HD Radio™, HD Radio Ready™, and the HD Radio Ready logo are proprietary trademarks of iBiquity Digital Corporation. This HD Radio Ready receiver is ready to receive HD Radio broadcasts when connected to the THD301, sold separately.

10. The aptX® mark and the aptX logo are trade marks of CSR plc or one of its group companies and may be registered in one or more jurisdictions.

11. - English:
This device complies with Industry Canada licence-exempt RSS standard(s). Operation is subject to the following two conditions: (1) this device may not cause interference, and (2) this device must accept any interference, including interference that may cause undesired operation of the device.

- French:

Le présent appareil est conforme aux CNR d'Industrie Canada applicables aux appareils radio exempts de licence. L'exploitation est autorisée aux deux conditions suivantes : (1) l'appareil ne doit pas produire de brouillage, et (2) l'utilisateur de l'appareil doit accepter tout brouillage radioélectrique subi, même si le brouillage est susceptible d'en compromettre le fonctionnement.

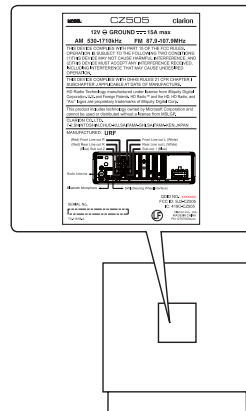

INFORMATION FOR USERS:

Changes or modifications to this product unapproved by the manufacturer will void the warranty and will violate FCC approval.

Front Panel / Generalities

For a longer service life, be sure to read the following cautions.

- Do not allow any liquids on the unit from drinks, umbrellas, etc. Doing so may damage the internal circuitry.
- Do not disassemble or modify the unit in any way. Doing so may result in damage.
- Do not let cigarettes burn the display. Doing so may damage or deform the body.
- If a problem should occur, have the unit inspected at your store of purchase.
- The remote control unit may not work if the remote control sensor is exposed to direct sunlight.

Cleaning the body

- Use a soft, dry cloth and gently wipe off any dirt or dust.
- For tough dirt, apply some neutral detergent diluted in water to a soft cloth, wipe off the dirt gently, then wipe again with a dry cloth.
- Do not use benzene, thinner, car cleaner, etc., as these substances may damage the body or cause the paint to peel. Also, leaving rubber or plastic products in contact with the body for long periods of time may cause stains.

USB Port

- The USB memory stick may stick out when inserted, so it may cause danger during driving. When connect USB memory stick to the source unit, please use the USB extension cable(CCA-755).
- The USB memory sticks must be recognized as "USB mass storage class" to work properly. Some models may not operate correctly.

When the memorized data is lost or damaged by any chance, Clarion shall not be liable for any damage.

When using the USB memory stick, we recommend that you backup your data stored on it before using a personal computer etc.

- Data files may be broken when using USB memory sticks in the following situation: When disconnecting the USB memory stick or turning the power off while reading data. When affected by static electricity or electric noise. Connect/disconnect the USB memory stick when it is not accessed.
- Connecting with the computer is not available.

Remove the DCP

The control panel can be detached to prevent theft. When detaching the control panel, keep it in the safety place and prevent scratches.

We recommend taking the DCP (DETACHABLE CONTROL PANEL) with you when leaving the car.

1. Press the [⏻ / SRC] button (1 sec.) to turn off the power.
2. Deeply push into [OPEN] button to unlock the DCP.
3. Hold the side popped out, remove the DCP.

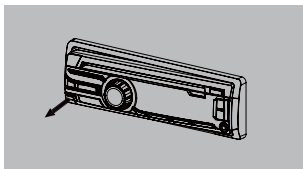

Attach the DCP

1. Hold the DCP and ensure that the panel faces towards you. Set the right side of the DCP into the DCP bracket.
2. Press the left side of the DCP until it locks.

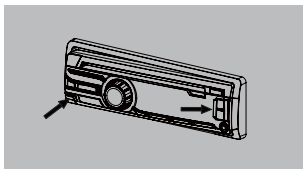

CAUTION

- The DCP can easily be damaged by shocks. After removing it, be careful not to drop it or subject it to strong shocks.
- Once the [OPEN] button is pressed and DCP is unlocked, car vibrations can cause the DCP to fall.
- The connector for the main unit and DCP is extremely important. Be careful not to damage it by pressing on it with fingernails, screwdrivers, etc.

Note:

If the DCP is dirty, wipe off the dirt with a soft, dry cloth only.

3. CONTROLS

Operational Panel

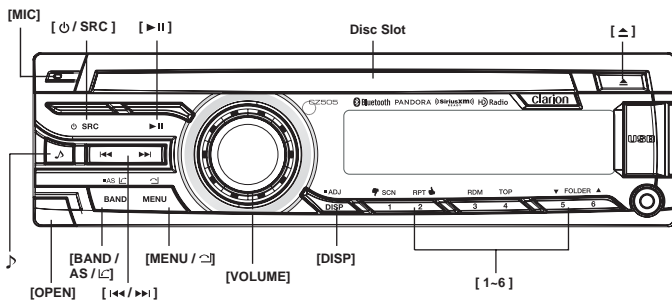

Names of Buttons

[⏻ / SRC] Button

- Toggle the audio source
- Power on / Power off (long press)

[BAND / AS / L<] Button

- **RADIO** mode – Select tuner band / Auto memory store (long press)
- **BT** mode – Dial / Answer / Transfer call / Redial (long press)
- **SiriusXM** mode – Select tuner band / Select category (long press)

[MENU / ⏏] Button

- **MP3/WMA** mode – Search function
- **CD** mode – No function
- **RADIO** mode – No function
- **AUX** mode – No function
- **USB** mode – Search function
- **iPod** mode – iPod menu
- **Pandora** mode – Station select
- **BT** mode – Terminate call
- **SiriusXM** mode – Direct select

[⏏] Button

- Press to eject disc

[▶||] Button

- Play / Pause
- **SiriusXM** mode– Channel scan (in current category) / Preset scan (long press)

[◀◀ / ▶▶] Buttons

- **RADIO** mode – Manual tuning / Auto search (long press)
- **MP3/WMA/CD/USB/iPod** mode – Previous / next track – Fast Forward / Fast Backward (long press)
- **Pandora** mode – Skip track (▶▶)

[OPEN] Button

- Unlock the front panel

[♪] Button

- Sound effect setting

[VOLUME] Knob

- Adjust volume level / Confirm (press)
- **Pandora** mode – Bookmark track
- **SiriusXM** mode – iTunes tagging (long press)

Names of Buttons

[1-6] Buttons

- [1] Button: Scan play / Preset station 1 / Preset station memory 1 (long press) / **Pandora** mode - Thumbs down
- [2] Button: Repeat play / Preset station 2 / Preset station memory 2 (long press) / **Pandora** mode - Thumbs up
- [3] Button: Random play / Preset station 3 / Preset station memory 3 (long press) / **Pandora** mode - Create new station by Artist / by Track (long press)
- [4] Button: Top play / Preset station 4 / Preset station memory 4 (long press)
- [5] Button: Previous folder / Preset station 5 / Preset station memory 5 (long press) / **Pandora** mode - Previous station
10 tracks down (long press)
- [6] Button: Next folder / Preset station 6 / Preset station memory 6 (long press)
10 tracks up (long press) / **Pandora** mode - Next Station

[DISP] Button

- Display **change**
- System setup (long press)

[MIC] Hole

- Internal microphone

Notes for use of Remote Control

1. Aim the remote control at the remote sensor on the unit.
2. Remove the battery from the remote control or insert a battery insulator if the battery has not been used for a month or longer.
3. DO NOT store the remote control under direct sunlight or in high temperature environment, or it may not function properly.
4. Use "button shaped" lithium battery "CR2025" (3V) only.
5. DO NOT subject battery to recharge, disassemble, heat or dispose in fire or water.
6. Insert the battery in proper direction according to the (+) and (-) polarities.
7. Store the battery in a place where children cannot reach to avoid the risk of accident.

Inserting the Battery

1. Slide remote control unit's rear cover in the direction shown.
2. Insert battery (CR2025) into insertion guides with printed side (+) up.
3. Press battery into compartment as shown.
4. Replace and slide cover until it clicks into place.

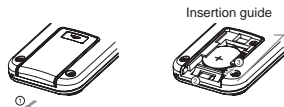

Remote Control (RCX001)

[SRC / ⏮] Button

- Toggle the audio source
- Power on / Power off (long press)

[⏮, ⏭] Buttons

- Preset station up / down
- Previous / next track
- Search (long press)
- **Pandora** mode - Skip track (▶▶)

[SCN / PS / AS] Button

- Scan play / Preset scan
- Auto store (long press)
- **Pandora** mode - Thumbs down
- **SiriusXM** mode - Channel scan (in current category) / Preset scan (long press)

[BAND / TOP] Button

- CD/MP3/WMA/USB mode - Top play
- **RADIO** mode - Select tuner band
- **Pandora** mode - Next station
- **SiriusXM** mode - Select tuner band / Select category (long press)

[▲, ▼] Buttons

- Volume up / down

[▶▶] Button

- Play / Pause

[ISR] Button

- No function

[DISP] Button

- Display change

[RDM] Button

- Random play
- **Pandora** mode - Bookmark track

[RPT] Button

- Repeat play
- **Pandora** mode - Thumbs up

[MUTE] Button

- Mute the volume

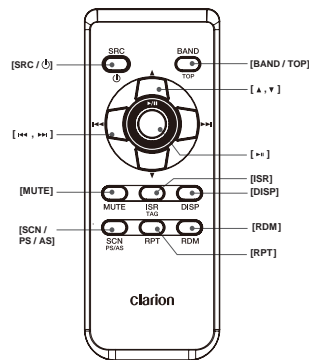

4. CAUTIONS ON HANDLING

Handling Discs

Handling

- New discs may have some roughness around the edges. If such discs are used, the player may not work or the sound may skip. Use a ball-point pen or the like to remove any roughness from the edge of the disc.

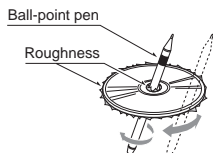

- Never stick labels on the surface of the disc or mark the surface with a pencil or pen.
- Never play a disc with any cellophane tape or other glue on it or with peeling off marks. If you try to play such a disc, you may not be able to get it back out of the player or it may damage the player.
- Do not use discs that have large scratches, are misshapen, cracked, etc. Use of such discs may cause misoperation or damage.
- To remove a disc from its storage case, press down on the center of the case and lift the disc out, holding it carefully by the edges.
- Do not use commercially available disc protection sheets or discs equipped with stabilizers, etc. These may damage the disc or cause breakdown of the internal mechanism.

Storage

- Do not expose discs to direct sunlight or any heat source.
- Do not expose discs to excess humidity or dust.
- Do not expose discs to direct heat from heaters.

Cleaning

- To remove fingermarks and dust, use a soft cloth and wipe in a straight line from the center of the disc to the circumference.
- Do not use any solvents, such as commercially available cleaners, anti-static spray, or thinner to clean discs.
- After using special disc cleaner, let the disc dry off well before playing it.

On Discs

- Never turn off the power and remove the unit from the car with a disc loaded.

CAUTION

For your safety, the driver should not insert or eject a disc while driving.

5. OPERATIONS

Basic Operations

Note:

- Refer to the diagrams in "3. CONTROLS" when reading this chapter.

CAUTION

When the unit is turned on, starting and stopping the engine with its volume raised to the maximum level may harm your hearing. Be careful about adjusting the volume.

Power on / off

Notes:

- Start the engine before using this unit.
 - Be careful about using this unit for a long time without running the engine. If you drain the battery too far, you may not be able to start the engine and this can reduce the service life of the battery.
- Start the engine. The power button / knob illumination on the unit will light up.



- Press the [DISP / SRC] button on the front panel or the remote control to turn on the power under standby mode. The unit goes back to the last status after power on.
- Press and hold the [DISP / SRC] button on the front panel or the remote control to turn off the power.

Mute

Press the [MUTE] button on the remote control to mute the volume from the unit.

Note:

Doing the operation above again or adjusting volume will release muting.

Volume adjustment

Rotate the [VOLUME] knob on the front panel or press the [▲] or [▼] button on the remote control.

The adjustable range of volume is 0 to 40.

CAUTION

While driving, keep the volume level at which external sounds can still be heard.

Playing source selection

Press [DISP / SRC] button on the front panel or remote control repeatedly to choose desired playing source.

Note:

Playing source selection means selecting which mode, such as **DISC** mode, **RADIO** mode and **AUX** mode.

Display system time

Press the [DISP] button on the front panel or remote control to change the display information from clock, station information (radio mode), or track information (CD mode).

RESET

If you have following problems, please press [RESET] button.

- Unit can not power on
- Nothing happens when buttons are pressed
- Display is not accurate

Note:

- When the [RESET] button is pressed, preset radio stations, audio setting, etc. stored in memory are cleared.

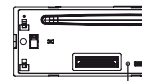

RESET

System Setup

In any mode, press and hold [DISP] button to enter system setup. Press [◀] or [▶] button to select options, rotate the [VOLUME] knob to adjust.

CLOCK

Press the [VOLUME] knob to enter clock setting mode, rotate the [VOLUME] knob to set clock, press [◀] or [▶] button to select hour or minute, press and hold the [VOLUME] knob to confirm.

DX/LO (RADIO mode)

Rotate the [VOLUME] knob to choose radio local or distant at RADIO mode.

- **LO:** Only stations with strong signal can be received.
- **DX:** Stations with strong and weak signals can be received.

S-CTRL (iPod mode) : ON/OFF

Rotate the [VOLUME] knob to choose S-CTRL (Simple control) ON or OFF.

* Refer to Page 13.

AUX SENS (AUX mode)

Rotate the [VOLUME] knob to choose AUX Input sensitivity LOW, MID or HIGH at AUX mode.

PARENTAL PASSWORD (SiriusXM mode)

Change parental password. Original code is "0000"

LOCK CH (SiriusXM mode)

Lock the current channel

UNLOCK ALL CH (SiriusXM mode)

Unlock all parental locked channels.

SELECT (BT mode)

This "SELECT" menu is intended to automatically paired by selecting a mobile phone was stored.

This unit can store three mobile phones. The mobile phone will be stored in paired order to the unit. The fourth mobile phone can not be stored. If you want to store a fourth mobile phone, please delete unwanted mobile phone from "DELETE" menu.

1. Rotate the [VOLUME] knob to choose the paired mobile phone name from the pairing list.
2. Press and hold the [VOLUME] knob to confirm.

DELETE (BT mode)

1. Rotate the [VOLUME] knob to choose the paired mobile phone name from the pairing list.
2. Press and hold the [VOLUME] knob to confirm.

DISCON (BT mode)

Disconnect currently connected mobile phone.

1. Rotate the [VOLUME] knob, mobile phone displays are currently connected.
2. Press and hold the [VOLUME] knob to disconnect.

MIC GAIN (BT mode)

Rotate the [VOLUME] knob to choose Mic gain: LOW, MID, HIGH.

You can change the gain of MIC when a telephone partner cannot hear your voice.

MIC SEL (BT mode)

Rotate the [VOLUME] knob to choose Microphone EXTERNAL or INTERNAL.

AUTO ANS (BT mode)

To answer incoming calls automatically.

Rotate the [VOLUME] knob to choose AUTO ANS ON or OFF.

AUTO CON: ON/OFF (BT mode)

Automatically connects the mobile phone was last connected.

Rotate the [VOLUME] knob to choose AUTO CON ON or OFF.

PIN CODE

Rotate and press the [VOLUME] knob to choose a 4-digit password. Press the [VOLUME] knob more than 1 seconds to confirm.

The PIN CODE default setting is "0000".

COLOR

Rotate the [VOLUME] knob to choose backlight color.

- **SCN:** The backlight change circularly.
- **COLOR 01~12:** Select a preset color.
- **USER1~3:** Select your favorite color. Press the knob to enter color setting mode, press [◀] or [▶] button to select GREEN, BLUE or RED, the rotate the [VOLUME] knob to select a color.

Press and hold [VOLUME] knob to memory.

SCRN SVR: ON/OFF

Rotate the [VOLUME] knob to choose SCRN SVR (screen saver) ON or OFF.

SCROLL: ON/OFF

For track information that is longer than the display panel:

When SCOLL is ON, the LCD will scroll the ID3 TAG information across the display, e.g.: TRACK->FILE->FOLDER->TITLE->ARTIST->ALBUM->TRACK->...

When SCROLL is OFF, the LCD will display one of the ID3 TAG information, the default is TRACK, but user can adjust it to other ID3 TAG information by press [DISP] button.

REAR/S-W

Rotate the [VOLUME] knob to choose REAR or S-WOOFER (SUB-WOOFER).

SW PHASE

Rotate the [VOLUME] knob to choose SUBWOOFER phase REVERSE or NORMAL.

TEL-SW

Rotate the [VOLUME] knob to choose MUTE, ON or OFF.

- **MUTE:**

The sound from this unit is muted during telephone calls.

- **OFF:**

This unit continues normal operation even when the cellular phone is used.

- **ON:**

You can listen to your telephone calls from the speakers connected to this unit.

*When listening to your calls on your car speakers, you can adjust the volume by turning the [VOLUME] knob.

DIMMER: ON/OFF

Rotate the [VOLUME] knob to choose DIMMER ON or OFF.

- **ON:** LCD dimmer is active when small light of vehicle is turned ON.
- **OFF:** LCD always maximum brightness regardless of the vehicle small light.

BEEP: ON/OFF

Rotate the [VOLUME] knob to choose button beep sound ON or OFF.

12/24H

Rotate the [VOLUME] knob to choose time format: 12 or 24 hours.

Audio Setup

Press the [] button to enter sound effect setting mode. First press shows current EQ. Rotate the [VOLUME] knob to changes BEAT EQ in this order:
OFF -> B-BOOST -> IMPACT -> EXCITE -> CUSTOM

Rotate the [VOLUME] knob to changes CUSTOM, and press the [VOLUME] knob, the press [] or [] button to select it including: BASS-G -> BASS-F -> BASS-Q -> MID-G -> MID-F -> MID-Q -> TREBLE-G -> TREBLE-F -> TREBLE-Q, rotate the [VOLUME] knob to select a value.

BASS-G / MID-G / TREBLE-G: (-7) - (+7)

BASS-F: 50 / 100 / 200

BASS-Q: 0.7 / 1.0 / 1.4 / 2.0

MID-F: 500 / 1K / 2K

MID-Q: 0.7 / 1.0 / 1.4 / 2.0

TREBLE-F: 5k / 10k / 15k
TREBLE-Q: 0.7 / 1.0 / 1.4 / 2.0

Press the [] button, then press [] or [] button to select USER preset including:

BALANCE -> FADER -> M-B EX -> HPF (high pass filter) -> LPF (low pass filter) -> SUBW VOL (Subwoofer Volume), rotate the [VOLUME] knob to select a value.

BALANCE: LEFT 1-7 -> CENTER -> RIGHT 1-7

FADER: FRONT 1-7 -> CENTER -> REAR 1-7

M-BEX: ON / OFF

HPF: THROUGH / 60 / 90 / 120

LPF: THROUGH / 60 / 90 / 120

SUBW VOL: (-6) - (+6)

Radio Operations

Select tuner as playing source

Press [D] / SRC button once or more to enter RADIO mode.

Selecting the radio band

Press the [BAND] button on the panel or on the remote control to select one radio band among FM1, FM2, FM3, AM.

Manual tuning

During manual tuning, the frequency will be changed in steps.

Press the [] or [] button on the panel to tune in a lower / higher station.

Press the [] or [] button on the remote control to select preset stations.

Auto tuning

Press and hold the [] or [] button to seek a lower / higher station.

To stop searching, repeat the operation above or press other buttons having radio functions.

Note:

When a station is received, searching stops and the station is played.

Preset scan

Preset scan receives the stations stored in preset memory in order. This function is useful when searching for a desired station in memory.

1. Press the [SCN/PS/AS] on the remote control button.
2. When a desired station is tuned in, press the [SCN/PS/AS] button again to continue receiving that station.

Note:

Be careful not to press and hold the [SCN/PS/AS] button for 1 second or longer, otherwise the auto store function will begin and the unit starts storing stations.

Auto store

The unit stores the strongest stations found in the entire Band.

Press and hold the [BAND/AS/LC] button (1 sec.) or [PS/AS] button on the remote control to start automatic station search.

To stop auto store, press other buttons having radio functions.

Notes:

1. After auto store, the previous stored stations will be overwritten.
2. The unit has 4 bands, such as FM1, FM2, FM3 and AM. FM3 and AM can store by AS function. Each band can store 6 stations, CZ505 can store 24 stations in total.

Manual store

When one expected radio station has been detected, press and hold number button 1-6 to store it in the memory.

Recall the stored stations

Press one numeric button among 1 to 6 on the panel to select the corresponding stored station.

Local seeking

When LOCAL seeking is ON, only those radio stations with strong radio signal could be received. To select LOCAL function, press and hold the [DISP] button on the front panel, then press [] button repeatedly until LO or DX displays on the screen, and rotate the [VOLUME] knob to select Local or Distant mode.

Note:

The number of radio stations that can be received will decrease when Local mode is ON.

HD Radio Operations

About HD Radio™ Technology

HD Radio Technology allows CD-quality digital broadcasting of your local AM and FM radio stations. HD Radio broadcasts can include multiple channels on the same frequency, which is called multicasting. With multicasting, you can receive up to eight additional multicast channels: HD1–HD8. With an HD Radio tuner connected, you will receive HD Radio digital broadcasts automatically when tuned to a station that offers HD Radio Technology.

NOTE: Not all FM or AM stations offer HD Radio (digital) broadcasting. You can receive both analog and digital stations with the unit.

Accessing radio mode

Press the [🔊 / SRC] button on the front panel or remote control to switch to the HD RADIO source, and HD icon will illuminate.

Select a band

Press the [BAND/AS/L] button to change between three FM and one AM bands. Each band stores up to six preset stations.

Tuning

- Seek Tuning

Press and hold the [◀▶] or [▶▶] button to seek the next/previous station automatically.

- Manual Tuning

Press the [◀▶] or [▶▶] button to move the radio frequency number up or down one step.

HD Radio multicast channels

To tune to an HD Radio multicast channel, tune to the main signal and then press the [MENU / ↵] button on the panel. PTY and SUB CH are displayed. Select PTY or SUB CH by rotate [VOLUME] knob and push to confirm.

- Select PTY type from the category list by rotate [VOLUME] knob and push.
- Select SUB CH by rotate [VOLUME] knob and push.

- Multi channel is available when a digital signal is detected, the DIGITAL icon will illuminate. If the digital signal becomes unavailable, the unit will revert to Analog reception.

Preset stations

Up to six stations on each band can be stored as presets, which can then be instantly recalled by pressing the associated preset button. To store a station, turn the radio on and select the desired band and station. Press and hold the desired preset button (numbered one through six on the face of the radio or remote control) for more than 1 second. When stored, the preset number will appear in the display. The station is now stored and can be recalled by pressing the corresponding preset button. Repeat for the remaining five presets on the current band and for presets on the other four bands.

NOTE: Multicast stations can be stored as presets, but the unit must be in Digital or Auto reception mode to receive them.

Preset scan

Press the [PS/AS] button to scan and play all preset stations for 10 seconds each. Press [PS/AS] again to stop scanning and play the current station.

Note:

Be careful not to press and hold the [PS/AS] button for 1 second or longer, otherwise the auto store function is engaged and the unit starts storing stations.

Automatic store (AS)

Press and hold the [PS/AS] button (1 sec.) to select six strong stations and store them in the FM3 or AM band using the Auto Store feature. After entering the stations into memory, the unit will automatically stop at each station for five seconds, allowing you to preview each selection. When using the Auto Store feature, the new stations replace any stations already stored in preset memory.

Note:

You can stop the Auto Store function at any time by pressing the [PS/AS] button again.

SiriusXM Satellite Radio Operations

Only SiriusXM® brings you more of what you love to listen to, all in one place.

Get over 140 channels, including commercial-free music plus the best sports, news, talk, comedy and entertainment. Welcome to the world of satellite radio.

A SiriusXM Vehicle Tuner and Subscription are required. For more information, visit www.siriusxm.com.

Displaying the Radio ID

Before you listen to satellite radio, you must subscribe to the service using the SiriusXM Radio ID number.

1. Press [🔊 / SRC] button to activate SiriusXM-mode.
2. Press [◀▶] or [▶▶] to select channel "0". The unit displays Radio ID.

Activating your SiriusXM Subscription

After installing your SiriusXM-Connect Vehicle Tuner and antenna, power on your headunit and select SiriusXM mode. You should be able to hear the SiriusXM preview channel on Channel 1. If you cannot hear the preview channels, please check the installation instructions to make sure your SiriusXM Connect tuner is properly installed.

After you can hear the Preview channel, tune to Channel 0 to find the Radio ID of your tuner. In addition, the Radio ID is located on the bottom of the SiriusXM Connect Vehicle Tuner and its' packaging. You will need this number to activate your subscription. Write the number down for reference.

Note: the SiriusXM Radio ID does not include the letters I, O, S or F.

In the USA, you can activate online or by calling SiriusXM Listener care:

- Visit www.siriusxm.com/activatenow
- Call SiriusXM Listener Care at 1-866-635-2349

For Canadian Subscriptions, please contact:

- Visit www.siriusxm.ca/activatexm
- Call XM customer Care at 1-877-438-9677

As part of the activation process, the SiriusXM satellites will send an activation message to your tuner. When your radio detects that the tuner has received the activation message, your radio will display: "Subscription Updated". Once subscribed, you can tune to channels in your subscription plan. Note, the activation process usually takes 10 to 15 minutes, but may take up to an hour. Your radio will need to be powered on and receiving the SiriusXM signal to receive the activation message.

Storing Channel Presets

1. Press [BAND/AS/L] to select the desired band you want to store the preset in. There are 3 Satellite Radio Preset bands. Each press of [BAND/AS/L] changes the band:
SXM1 -> SXM2 -> SXM3 -> SXM1
2. Tune to the desired channel and then press and hold one of the preset buttons (1 through 6), to store the channel.
3. Repeat the procedure to store up to 5 other channels on to the same band.

Note:

A total of 18 channels can be stored in the preset memory, 6 channels for each band (SXM1, SXM2 and SXM3).

Tuning Channels using Presets

1. Press [BAND/AS/L] to select the desired band of Presets you wish to access.
2. Press the preset button (1 through 6) that has your desired Satellite Radio channel stored in memory.

Category Browsing

1. Press and hold [BAND/AS/L] to activate the Category Browsing mode.
2. Rotate the [VOLUME] knob to select desired category.
3. Press [◀▶] or [▶▶] to select desired channel within the selected Category. You can see channel name, channel number, artist, title or content by pressing [DISP].

SiriusXM Satellite Radio Operations

4. Press **[VOLUME]** to tune to selected channel.

Note:

If no operation is performed for 10 seconds, the Category Browsing mode is canceled.

Preset scan

Preset scan receives the stations stored in preset memory in order. This function is useful when searching for a desired station in memory.

1. Press and hold the **[▶||]** key or press and hold the **[SCN/PS/AS]** button on the remote control.
2. When a desired station is tuned in, press the **[SCN/PS/AS]** button again to continue receiving that station.

Channel scan (in current category)

Channel scan receives the channel (in current category) in order. This function is useful when searching for a desired channel in current category.

1. Press the **[▶||]** key or press the **[SCN/PS/AS]** button on the remote control.
2. When a desired channel is tuned in, press the **[SCN/PS/AS]** button again to continue receiving that channel.

Note:

- Be careful not to press and hold the **[SCN/PS/AS]** button for 1 second or longer, otherwise the preset scan function will begin and the unit starts scanning presets.

iTunes® song tagging

With iTunes song tagging, you can tag songs you hear while listening to SiriusXM Satellite Radio. The tagging information is saved in your radio until you connect your iPod or iPhone and then the tagging information is transferred to your iPod/iPhone. When your iPod/iPhone is connected to iTunes, you will then be able to preview and purchase the song that you heard while listening to SiriusXM Satellite Radio.

Information on using the iTunes song tagging feature is described below.

1. A song may be tagged while listening to a SiriusXM channel if the display shows the "TAG" icon.
2. Press and hold the **[VOLUME]** knob while the desired song is playing.
3. When completed, "STORED TAG X OF 64" is displayed.
X means the number of tag stored.

Notes:

- During tagging, the iPod/iPhone takes priority to save the tag information. If no iPod/iPhone is connected, the tag information is saved to this unit.
- This unit can store up to 64 pieces of tag information. When the memory of the unit is full, "MEMORY FULL" may be displayed.
- When iPod/iPhone that doesn't support the tagging function is connected, "TRANSFER FAIL" may be displayed.
- If there is stored tag information on the unit, when an iPod/iPhone supporting the tag function is connected, the stored tag information will be transferred to iPod/iPhone automatically.
- If tag information already exists, "ALREADY TAGGED" will be displayed when you try to tag information again.
- Tagging may be canceled by changing the frequency or station.
- If a song is tagged and the remaining storage volume of the connected iPod/iPhone is sufficient to hold the song's tag information, it will be saved on the iPod/iPhone.

Changing the Display

Text information, such as the channel name, artist name/feature, song/program title and content is available with each SiriusXM channel. The unit can display this text information as explained below.

1. In SiriusXM mode, press **[DISP]** button.
Each time you press this button, the display changes as shown below.
Band/Channel number/channel name =>
Artist Name => Song Title=> Content Info
=> Category Name => Clock => Band/
Channel number/channel name

- * If there is no text information, nothing will be displayed.

Parental Lock / Unlock

The SiriusXM Parental Control feature allows you to control access to channels that you consider inappropriate for younger listener. When enabled, the Parental Control feature requires you to enter a password to tune to the locked channels. Information on setting up the password, setting up the channels to be locked, and the method to access the locked channels is described below.

1. For setting up the password, press and hold **[DISP]** and press **[▶||]** to select "PARENTAL PASSWORD". Press **[VOLUME]** knob to change password. Enter old password, new password. To enter code, rotate **[VOLUME]** knob to decide number and **[◀◀]** or **[▶▶]** to select digit. Each time you need to press and hold **[VOLUME]** knob to confirm password. (Original password is "0000")
2. For setting up the channels to be locked, press and hold **[DISP]** during tuning to the desired channel, and select "LOCK CH" and press **[VOLUME]** knob to start to lock channel. You will be asked to input password. Enter password and "LOCK" will be displayed if it is successful.
3. For unlocking the locked channel, press and hold **[DISP]**, and press **[▶||]** to select "UNLOCKCH". Enter password and you can unlock the channel.
4. For accessing the locked channels, select channel by "DIRECT SELECT". Press and hold **[MENU/⏏]** and select "DIRECT SELECT" by pressing **[VOLUME]** knob. Input desired locked channel (need to input 3 digit) and input password, then you can tune to that locked channel.

CD/MP3/WMA Operations

This unit can playback MP3/WMA files

Note:

- If you play a WMA file with active DRM (Digital Rights Management), there will be no audio.

To disable DRM

(Digital Rights Management)

When using Windows Media Player 9/10/11, click on Tool -> Options -> Copy Music tab, then under Copy settings, unclick the Check box for Copy project music. Then, reconstruct files.

Personally constructed WMA files are used at your own responsibility.

Precautions when creating MP3/WMA file

Usable sampling rates and bit rates

- MP3: Sampling rate 8 kHz-48 kHz, Bit rate 8 kbps-320 kbps / VBR
- WMA: Bit rate 8 kbps-320 kbps

File extensions

- Always add a file extension “.MP3”, “.WMA” to MP3, WMA file by using single byte letters. If you add a file extension other than specified or forget to add the file extension, the file cannot be played.
- Files without MP3/WMA data will not play. The files will not play if you attempt to play files without MP3/WMA data.
- When VBR files are played, the play time display may differ the play location.
- When MP3/WMA files are played, a little no sound part is caused between tunes.

Logical format (File system)

- When writing MP3/WMA file on a CD-R disc or CD-RW disc, please select “ISO9660 level 1, 2 or Joliet” or Apple ISO as the writing software format. Normal play may not be possible if the disc is recorded on another format.

- The folder name and file name can be displayed as the title during MP3/WMA play but the title must be within 32 single byte alphabetical letters and numerals (including an extension).
- Do not affix a name to a file inside a folder having the same name.

Folder structure

A disc with a folder having more than 8 hierarchical levels will be impossible.

Number of files or folders

- Up to 999 files can be recognized per folder.
Up to 3000 files can be played.
- Tracks are played in the order that they were recorded onto a disc. (Tracks may not always be played in the order displayed on the PC.)
- Some noise may occur depending on the type of encoder software used while recording.

Eject function

Just pressing the [\pm] button, ejects the disc.

Notes:

- If you force a CD into before auto reloading, this can damage the CD.
- If a CD (12 cm) is left ejected for 15 seconds, the CD is automatically reloaded (Auto reload).

Listening to a disc already loaded in the unit



Press the [\odot / SRC] button to select the CD/MP3/WMA mode.

When the unit enters the CD/MP3/WMA mode, play starts automatically.

Loading a CD

Insert a CD into the center of the CD SLOT with label facing up. The CD plays automatically after loading.

Notes:

- Never insert foreign objects into the CD SLOT.
- If the CD is not inserted easily, there may be another CD in the mechanism or the unit may require service.
- Discs without the  or  mark and CD-ROMs cannot be played by this unit.
- Some CD-R/CD-RW discs may not be usable.

Pausing play

- Press the [$\text{P} \parallel$] button to pause play. “PAUSE” appears in the display.
- To resume CD play, press the [$\text{P} \parallel$] button again.

Displaying CD titles

This unit can display title data for MP3/WMA disc.

When SCROLL is OFF, each time you press the [DISP] button to change the title display.

MP3/WMA disc

TRACK->FILE->FOLDER->TITLE->ARTIST->ALBUM->TRACK->...

Notes:

- If MP3/WMA disc has no ID3 TAG, “NO TITLE” appears in the display.
- Only ASCII characters can be displayed in Tags.

Selecting a track

Track-up

- Press the [$\text{P} \gg$] button to move ahead to the beginning of the next track.
- Each time you press the [$\text{P} \gg$] button, the track advances ahead to the beginning of the next track.
- For MP3/WMA disc, press and hold the [6] button (1 sec.) to move ahead to +10 tracks.

Track-down

- Press the [$\ll \text{P}$] button to move back to the beginning of the current track.
- Press the [$\ll \text{P}$] button twice to move back to the beginning of the previous track.
- For MP3/WMA disc, press and hold the [5] button (1 sec.) to move back to -10 tracks.

Fast-forward/Fast-reverse

Fast-forward

Press and hold the [$\gg \text{P}$] button .

Fast-reverse

Press and hold the [$\ll \text{P}$] button .

- For MP3/WMA discs, it takes some time until the start of searching and between tracks. In addition, some errors may occur in the play time.

Folder Select

This function allows you to select a folder containing MP3/WMA files and start playing from the first track in the folder.

- Press the [5] or [6] button.

Press the [6] button to move the next folder. Press the [5] button to move the previous folder.

- To select a track, press the [$\ll \text{P}$] or [$\text{P} \gg$] button.

Search Function

- Press the [MENU] button to enter FOLD SCH mode. Press the [VOLUME] button to enter the folder list search mode.
- Turn the [VOLUME] knob to select a folder.
- Press the [VOLUME] button to enter the file list search mode. And then the track list appears in the display.
- Turn the [VOLUME] knob to select a track.
- Press the [VOLUME] knob to play.
- When play back MP3 / WMA file, this function is performed in the current folder.

CD/MP3/WMA Operations

Top function

The top function resets the CD player to the first track of the disc. Press [4] button to play the first track (track No. 1) on the disc.

- * In case of MP3/WMA, the first track of the current folder will be played.

Other various play functions

Scan play

This function allows you to locate and play the first 10 seconds of all the tracks recorded on a disc.

Press the [1] button to perform scan play.

Repeat play

This function allows you to play the current track repeatedly or play a track currently being played in the MP3/WMA folder repeatedly.

CD:

1. Press the [2] button once or more until "RPT ON" appears on the LCD to perform repeat play.

2. Press [2] button again to cancel repeat playback, "RPT OFF" appears on the LCD.

MP3/WMA:

1. Press the [2] button once or more until "TRACK RPT" appears on the display to perform repeat play, and "RPT" segment lights on.
2. For MP3/WMA files, press [2] button repeatedly until "FOLD RPT" appears on the display for folder repeat play.
3. Press [2] button repeatedly until "RPT OFF" appears on the display to cancel repeat playback, and "RPT" segment goes off.

Random play

This function allows you to play all tracks recorded on a disc in a random order.

Press the [3] button to perform random play.

USB Operations

1. Open the cover of the USB connector to the right. Insert a USB cable (optional CCA-755) into the USB connector. Insert a USB device into the USB cable. When connecting a USB device, the unit will read the files automatically.
2. To remove the USB device, you should first select another source or turn off the power, in order to avoid damaging the USB device. **Then remove the USB device. Close the cover.**
3. Operation is the same as MP3/WMA operation.

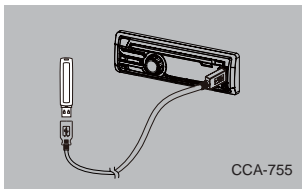

iPod & iPhone Operations

Connect

Connect an iPod or iPhone to the USB connector via **accessory cable for iPod/iPhone**.

When connecting a device, the unit will read the files automatically. The track information displays on the screen once playback start.

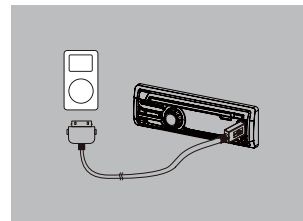

MENU

In the S-CTRL OFF mode, press [MENU] button, then press the [VOLUME] knob after appear the "MUSIC", then rotate the [VOLUME] knob to select PLAYLISTS / ARTISTS / ALBUMS / SONGS / GENRES / COMPOSERS, and press the [VOLUME] knob to confirm.

Repeat play

This function allows you to play the current track repeatedly or play all tracks in your iPod/iPhone repeatedly.

1. Press the [2] button once or more until "RPT ON" appears on the LCD to perform repeat play.
2. Press [2] button repeatedly until "RPT OFF" appears on the LCD to cancel repeat playback.

Random play

This function allows you to play all tracks recorded on your iPod/iPhone in a random order.

1. Press [3] button repeatedly until "RDM ALBUM" appears on the LCD for album random play.
2. Press the [3] button once or more until "RDM SONG" appears on the LCD to perform random play.
3. Press [3] button repeatedly until "RDM OFF" appears on the LCD to cancel random playback.

Setting iPod simple control mode

Use this function if you wish to operate through your iPod connected to this unit via the USB cable.

- * The factory default setting is "OFF".
1. Press and hold [DISP] button to enter system setup.
 2. Press [<] or [>] button to select "S-CTRL".
 3. Rotate the [VOLUME] knob to select "ON" or "OFF".

When using iPhone 5s with iOS 8.1 and S-CTRL OFF, operations can still be made through the iPod.

Notes:

- When performing iPod operations using simple control mode, make the operations slowly. If repetitive operations are performed too quickly, unforeseen errors may occur.
- When performing iPod operations using simple control mode, please do not operate the iPod and the unit at the same time, otherwise there may be unexpected event happened.
- Some iPod models do not support this function. Consult your nearest **Clarion** dealer or website to confirm which models do not support this function.

iPod menu alphabet search

This function searches the subfolders for desired alphabetical letters.

1. Press the [MENU] button to select the iPod menu mode.
2. Press the [VOLUME] knob to switch

iPod & iPhone Operations

between categories.

MUSIC: PLAYLISTS, ARTISTS, ALBUMS, SONGS, GENRES, COMPOSERS
VIDEO: MOVIES, MUSIC VIDEOS, TV SHOWS, VIDEO PODCASTS, RENTALS

3. Press the **[VOLUME]** knob. (The contents of the category are displayed.)
4. Press and hold the **[DISP]** button (1 sec.).
5. Rotate the **[VOLUME]** knob to select the desired letter to search.
6. Press the **[DISP]** button again to next perform search.
7. Press the **[VOLUME]** knob to confirm.

Listening to Pandora®

You can stream Pandora internet radio by connecting an iPhone/iPod that has the Pandora mobile application already installed. To start streaming, connect the iPod/iPhone with Pandora already launched.

When the unit displays **"PLEASE LAUNCH Pandora APPLICATION ON MOBILE DEVICE"** in Pandora mode, please launch the Pandora Application by operating the iPod/iPhone connected.

1. Press the **[◂ / SRC]** button to enter the Pandora mode.

Selecting a station from list

Press the **[MENU/↵]** button and select "BY DATE" or "A-Z" by rotating the **[VOLUME]** knob and press the **[VOLUME]** knob.

- BY DATE: List in an created date order
- A-Z: List in an alphabetical order

Go to next station or previous station(an alphabetical order)

Press the **[5]** button on the panel to go to previous station.

Press the **[6]** button on the panel or the **[BAND/TOP]** button on the remote control to go to next station.

Thumbs up/down

Thumbs up:
press the **[2]** button on the panel or the **[RPT]** button on the remote control for thumbs up.

Giving a track the thumbs up will tell Pandora to play more tracks like that one.

Thumbs down:
press the **[1]** button on the panel or the **[SCN]** button on the remote control for thumbs down. Giving a track the thumbs down will skip to the next track (subject to skip limit), and Pandora will remember not to play that track on the station again.

Notes:

- You can personalize your stations by "thumbs up" or "thumbs down".
- If you give a track the thumbs down after the skip limit has been exceeded, your feedback will be saved but the current track will continue to play.

BOOKMARK track

Short-press the **[VOLUME]** knob or the **[RDM]** button on the remote control to Bookmark current track.

Creating new stations

Short-press the **[3]** button on the panel to create a new station from the current artist.

Long-press the **[3]** button on the panel to create a new track.

Note:

If the name of the station you wish to create for a track title or an artist name is the same as the station name currently playing, **"NOW PLAY"** appears on the display and the station will not be created.

Skip

Press the **[▶▶]** button on the panel or on the remote control for the next tracks in station.

Note:

- Pandora limits the number of skips allowed on their service. If you attempt to skip tracks beyond the limit, **"SKIP LIMIT"** is displayed.

Play/Pause

Press the **[▶||]** button on the panel or on the remote control for play / pause.

Bluetooth Operations

The Bluetooth allows you to utilize your car's built-in audio system for wireless mobile phone or music handsfree communication. Some Bluetooth mobile phones have the audio features, and some portable audio players support Bluetooth feature. This system can play audio data stored in a Bluetooth audio device. The audio system with Bluetooth will be able to retrieve phonebook contacts, received call, dialed call, missed call, incoming calls, outgoing call and listen to music.

Notes:

- Do not leave the microphone of Bluetooth handsfree in the places with wind passing such as air outlet of the air conditioner, etc. This may cause a malfunction.
- If leave it in the places subjected to direct sun, high temperature can cause distortion, discoloration which may result in a malfunction.
- This system will not operate or may operate improperly with some Bluetooth audio players.
- **Clarion** cannot guarantee the compatibility of all mobile phones together with unit.
- Audio playback will be set to the same volume level as set during telephone call. This might cause problems, if extreme volume level is set during telephone call.

Handsfree Operations Pairing

1. Turn on Bluetooth function of your mobile phone.
2. Enter mobile phone's Bluetooth setup menu.
3. Search for new Bluetooth devices.
4. Select **CZ505** from the pairing list on the mobile phone.
5. Enter **"0000"** as the password (The password default setting is "0000").
6. After pairing successfully, the unit will enter Bluetooth mode automatically, and **"BLUETOOTH CONNECTED"** will appear on the LCD.
7. The unit can connect three units.

- * During pairing, depending on type of mobile phone, a six digit PIN code will be shown on both the source unit's display and the mobile phone.

In this case, please make sure that you have the same PIN code on both devices, and then confirm on the mobile phone.

Making a call

Operation from Bluetooth menu

Press the **[◂ / SRC]** button to switch the source to "BLUETOOTH". Press **[MENU/↵]** button to select a way to make outgoing call.

• Dial Number

1. Press the **[MENU/↵]** button.
2. Rotate the **[VOLUME]** knob to switch **"DIAL NUMBER"**.
3. Press the **[VOLUME]** knob to confirm the selection.
4. Rotate the **[VOLUME]** knob to select a number, press the knob to confirm and ready to input the next digit. Repeat the above until all numbers inputted.
5. Press the **[BAND/AS/↵]** button to dial.
6. Press **[MENU/↵]** to terminate call.

• Dialed/Missed/ Received

You can search any Dialed/Missed/ Received.

1. Rotate the **[VOLUME]** knob to select **"DIALED"**, **"MISSED"**, **"RECEIVED"**.
2. Press the **[VOLUME]** knob to enter the selected call history.
3. Rotate the **[VOLUME]** knob to scroll the contacts.
4. When the contact name or mobile phone No. is displayed, press the **[VOLUME]** knob to call the mobile phone No. of that contact.

- * Press the **[MENU/↵]** button to end the call.

• Call from Phonebook

You can search the contact name in the phonebook and make call.

Bluetooth Operations

1. Rotate the [VOLUME] knob to select "USER PHONEBOOK".
2. Press the [VOLUME] knob to enter the selected phonebook.
3. Rotate the [VOLUME] knob to scroll the contacts.
4. The phone number and the name to scroll display. When the contact name is displayed, press the [VOLUME] knob to call the mobile phone No. of that contact.

* Press the [MENU/↵] button to end the call.

Notes:

- Some mobile phones may not be able to transfer data of Phonebook.
- After RESET, please wait few minutes until data transferred following to the Bluetooth mode selection. During that, "PHONEBOOK UPDATING" is on the display.

• Redial

You can call last dialed number.
Press and hold the [BAND/AS/L] button (1sec).

• Call Transfer

You can switch Handsfree call and mobile phone call.
Press the [BAND/AS/L] button during call.

• Answering a call

- You can answer an incoming call by pressing the [BAND/AS/L] button.
- * Press the [MENU/↵] button to reject an incoming call.

Audio Streaming Operations

What is audio streaming?

Audio streaming is a technique for transferring audio data such that it can be processed as a steady and continuous stream. Users can stream music from their external audio player to their audio system wirelessly and listen to the tracks through the car's speakers. Please consult your nearest **Clarion** dealer for more information on the product of wireless audio streaming transmitter offered.

⚠ CAUTION

Please avoid operating your connected mobile phone while audio streaming as this may cause noise or sound choppy on the song playback.

Audio streaming may or may not resume after telephone interrupt as this is dependent on mobile phone.

System will always return to Radio mode if audio streaming is disconnected.

Note:

Be sure to read the chapter "Pairing" before proceeding.

Play / Pause a track

1. Push the [▶||] button to pause audio playback.
2. To resume audio playback, push the [▶||] knob again.

Selecting a track

Track-up

1. Press the [▶▶] button to move to the beginning of the next track.
2. Each time the [▶▶] button is pressed, playback proceeds to another track in the advancing direction.

Track-down

1. Press the [◀◀] button to move to the beginning of the previous track.
2. Each time the [◀◀] button is pressed, playback proceeds to previous track in the reverse direction.

Note:

Playing order will depend on Bluetooth audio player. When [◀◀] button is pressed, some A2DP devices will restart the current track depends on the duration of playback.

During music streaming playback, "A2DP" will be shown on the display. When A2DP and HFP device is disconnected, "BLUETOOTH DISCONNECT" will be shown on the

display and return to previously selected audio source. Some Bluetooth audio players may not have play / pause synchronized with this unit. Please make sure both device and main unit are in the same play / pause status in BT MUSIC mode.

ID3TAG display

During music streaming playback, for music information that is longer than the display panel: When SCROLL is ON, the LCD will display ID3 TAG information cyclely, e.g: ALBUM->TITLE ->ARTIST...

When SCROLL is OFF, the LCD will display one of the ID3 TAG information, the default is TRACK, but user can adjust it to other ID3 TAG information by press [DISP] button.

AUX Operations

The front AUX terminals of this system is provided to allow playback of sounds and music from external devices connected to this unit.

Press [⏪ / SRC] button on the panel to select "AUX".

AUX Input sensitivity setting

1. Press and hold the [DISP] button (1 sec.).
2. Press [◀◀] or [▶▶] button to select "AUX SENS".
3. If the output level of connected external audio player is "HIGH", rotate [VOLUME] knob and choose "MID" or "LOW". And if the output level is "LOW", choose "MID" or "HIGH".

6. TROUBLE SHOOTING

GENERAL

Problem	Cause	Measure
Unit can not power on.	Unit fuse blown.	Replace with new fuse of correct rating.
	Car battery fuse blown.	Replace with new fuse of correct rating.
Unit can not power on. Nothing happens when buttons are pressed.	The microprocessor has malfunctioned due to noise, etc.	Turn off the power and remove the DCP. Press the [RESET] button with a thin rod.
Display is not accurate.		Note: When the [RESET] button is pressed, turn off the ACC power.* * When the [RESET] button is pressed, frequencies of radio stations, audio setting, etc. stored in memory are cleared.
No/low audio output.	Improper audio output connection.	Check wiring and correct.
	Volume set too low.	Increase volume level.
	Speakers damaged.	Replace speakers.
	Heavily biased volume balance.	Adjust the channel balance to center position.
	Speaker wiring is in contact with metal part of car.	Insulate all speaker wiring connections.
Poor sound quality or distortion.	Non-standard disc used.	Use a standard disc.
	Speaker power rating does not match unit.	Replace speakers.
	Wrong connections.	Check wiring and correct.
	Speaker is shorted.	Check wiring and correct.
Unit resets itself when engine is off.	Incorrect connection between ACC and Battery.	Check wiring and correct.

DISC Player

Problem	Cause	Measure
Disc cannot be loaded.	Another disc is already loaded.	Eject the disc before loading the new one.
	There is a foreign object stuck inside the unit.	Remove the object inside the unit.
Sound skips or is noisy.	Compact disc is dirty.	Clean the compact disc with a soft cloth.
	Compact disc is heavily scratched or warped.	Replace with a compact disc with no scratches.
Sound is bad when power is first turned on.	Condensation may form on the internal lens when the car is parked in a humid place.	Let dry for about 1 hour with power on.

USB device

Problem	Cause	Measure
USB device cannot be inserted.	The USB device has been inserted with wrong direction.	Reversing the connection direction of the USB device, try it again.
	The USB connector is broken.	Replace with a new USB device.
USB device is not recognized.	The USB device is damaged.	Disconnect the USB device and reconnect. If the device is still not recognized, try replacing with a different USB device.
	Connectors are loose.	
No sound heard with the display "No File" shown.	No MP3/WMA file is stored in the USB device.	Store these files properly in the USB device.
Sound skips or is noisy.	MP3/WMA files are not encoded properly.	Use MP3/WMA files encoded properly.

Bluetooth

Problem	Cause	Measure
Cannot pair the Bluetooth enabled device with the audio system.	The device does not support the profiles required for the system.	Use another device to connect.
	The Bluetooth function of the device is not enabled.	Refer to the user manual of the device for how to enable the function.
The audio quality is poor after connection with a Bluetooth-enabled device.	The microphone is not correctly positioned.	Adjust the position of the microphone. For example, stick the microphone onto the dashboard where close to the driver.
	The Bluetooth reception is poor.	Move the device closer to the audio system or remove any obstacle between the device and the system.

SiriusXM Advisory Messages

Message	Description
CHK ANTENA	The radio has detected a fault with the SiriusXM antenna. The antenna cable may be either disconnected or damaged. Verify that the antenna cable is connected to the SiriusXM Connect Vehicle Tuner. Inspect the antenna cable for damage and kinks. Replace the antenna if the cable is damaged. SiriusXM products are available at your local car audio retailer or online at www.shop.siriusxm.com .
CHEK TUNER	The radio is having difficulty communicating with the SiriusXM Connect Vehicle Tuner. The tuner may be disconnected or damaged. Verify that the SiriusXM Connect Vehicle Tuner cable is securely connected to the radio.
NO SIGNAL	The SiriusXM Connect Vehicle Tuner is having difficulty receiving the SiriusXM satellite signal. Verify that your vehicle is outdoors with a clear view of the sky. Verify that the SiriusXM magnetic mount antenna is mounted on a metal surface on the outside of the vehicle. Move the SiriusXM antenna away from any obstructions. Inspect the antenna cable for damage and kinks. Consult the SiriusXM Connect Vehicle tuner installation manual for more information on antenna installation. Replace the antenna if the cable is damaged. SiriusXM products are available at your local car audio retailer or online at www.shop.siriusxm.com .
SUBSCRIPTIN UPDATED	The radio has detected a change in your SiriusXM subscription status. Press rotary knob to clear the message. Visit www.siriusxm.com or call 866-635-2349 if you have questions about your subscription.
CH UNAVAIL	The channel that you have requested is not a valid SiriusXM channel or the channel that you were listening to is no longer available. You may also see this message briefly when first connecting a new SiriusXM Connect Vehicle tuner. Visit www.siriusxm.com for more information about the SiriusXM channel lineup.

7. ERROR DISPLAYS

If an error occurs, one of the following displays is displayed.
Take the measures described below to solve the problem.

Display	Cause	Measure
ERROR 3	Disc is inserted incorrectly.	Eject the disc then reload it properly.
	The disc format is not supported.	Try another disc.
ERROR 5	This is a failure of deck's mechanism.	Consult your store of purchase.

If an error display other than the ones described above appears, press the **[RESET]** button. If the problem persists, turn off the power and consult your store of purchase.

* When the **[RESET]** button is pressed, frequencies of radio stations, audio setting, etc. stored in memory are cleared.

8. SPECIFICATIONS

FM Tuner

Frequency range: 87.9 - 107.9MHz
Usable sensitivity: 8dBf
Frequency response: 30Hz-15kHz
Stereo separation: 30dB(1kHz)
Signal/noise ratio: >55dB

AM Tuner

Frequency range: 530 - 1710KHz
Usable sensitivity (S/N=20dB): 30dBμ

CD Player

System: Disc digital audio system
Frequency response: 20Hz-20kHz
Signal/noise ratio: >94dB
Total harmonic distortion: Less than 0.1% (1kHz)
Channel separation: >60dB

MP3/WMA mode

MP3 sampling rate: 8 kHz to 48 kHz
MP3 bit rate: 8 kbps to 320 kbps / VBR
WMA bit rate: 8 kbps to 320 kbps
Logical format: ISO9660 level 1,2
Joliet file system

USB

Specification: USB 1.0/2.0
Playable audio format:
MP3(.mp3): MPEG 1/2/Audio Layer-3
WMA(.wma): Ver 7/8/9.1/9.2

Bluetooth

Specification: Bluetooth Ver. 2.1+EDR
Profile: HFP (Hands-free Profile)
A2DP (Advanced Audio Distribution Profile)
AVRCP (AV Remote Control Profile)
PBAP (Phone Book Access Profile)
Send/Receive Sensitivity: Class 2

Audio Amplifier

Maximum power output:
180W (45W x 4)
Speaker impedance: 4Ω (4 to 8 Ω allowable)

Input

Audio input sensitivity:
High: 320mV (at 1V output)
Mid: 650mV (at 1V output)
Low: 1.3V (at 1V output)
1.3V (input impedance 10 kΩ or greater)
Aux-in level: ≤2V

General

Power supply voltage:
12VDC (10.8 to 15.6V allowable),
negative ground
Pre-Amp output voltage:
2.0V (CD play mode: 1kHz, 0dB, 10kΩ load)
Fuse: 15A
Dimensions of the Main Unit:
188mm Width x 58mm Height x 179mm Depth
7-2/5"(width) x 2-7/25"(Height) x 7"(Depth)
Weight of the Main Unit: 2.64lb.(1.20kg)
Dimensions of the Remote Control unit:
43mm Width x 11mm Height x 113mm Depth
1-2/3"(Width) x 2/5"(Height) x 4-2/5"(Depth)
Weight of the Remote Control Unit:
1.16oz. (36g) (including battery)

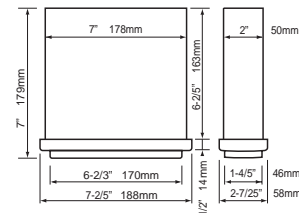

Note:

- Specifications and design are subject to change without notice for further improvement.

Power Output:
21W RMS x 4 Channels at 4Ω
and 1% THD+N

Signal to Noise Ratio:
93dB (reference: 1W into 4)



9. INSTALLATION / WIRE CONNECTION GUIDE

CONTENTS

1) Before Starting	18
2) Package Contents	18
3) General Cautions	18
4) Cautions on Installation	18
5) Installing the Source Unit	18
6) Removing the Source Unit	19
7) Wiring and Connections	20
8) Connecting the accessories	20

1) Before Starting

1. This set is exclusively for use with a negative ground 12 V power supply.
2. Read these instructions carefully.
3. Be sure to disconnect the battery "terminal" before starting. This is to prevent short circuits during installation. (Figure 1)

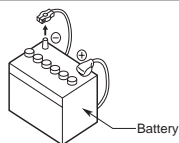

Figure 1

2) Package Contents

Source unit	1	Owner's manual.....	1
Front panel	1	Warranty card.....	1
Trim ring	1	Special screw (M2*5mm, front panel lock).....	1
Mounting bracket.....	1	Screws M5x6 mm Double Sems	4
L-key.....	2	Remote control unit	1
Power supply cable	1	Battery (CR2025).....	1

3) General Cautions

1. Do not open the case. There are no user serviceable parts inside. If you drop anything into the unit during installation, consult your dealer or an authorized **Clarion** service center.
2. Use a soft, dry cloth to clean the case. Never use a rough cloth, thinner, benzine, or alcohol etc. For tough dirt, apply a little cold or warm water to a soft cloth and wipe off the dirt gently.

4) Cautions on Installation

1. Prepare all articles necessary for installing the source unit before starting.
2. Install the unit within 30° of the horizontal plane. (Figure 2)
3. If you have to do any work on the car body, such as drilling holes, consult your car dealer beforehand.
4. Use the enclosed screws for installation. Using other screws can cause damage. (Figure 3)

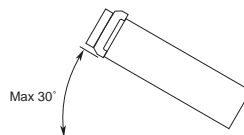

Figure 2

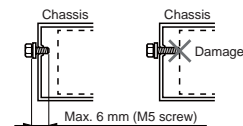

Figure 3

5) Installing the Source Unit

1. Place the mounting bracket into the instrument panel, use a screwdriver to bend each stopper of the mounting bracket inward, then secure the stopper.
2. Wire as shown in Section 7) .
3. Insert the source unit into the mounting bracket until it locks.
4. Take care of the top and bottom of the trim ring and mount it so that all the hooks are locked.

Notes:

1. Some car models require special mounting kits for proper installation. Consult your **Clarion** dealer for details.
2. Fasten the front stopper securely to prevent the source unit from coming loose.

• Console opening dimensions

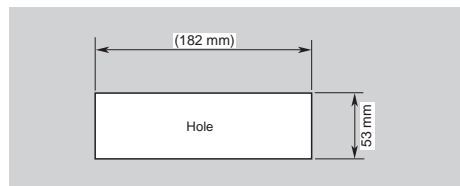

Notes of installation

1. Before installation, please make sure proper connections are conducted and the unit operates normally. Improper connection may result in damage to the unit.
2. Use only accessories designed and manufactured for this unit and other unauthorized accessories may result in damage to the unit.
3. Before installation, please fasten all power cables.
4. DO NOT install the unit in the place where close to hot area to prevent damage to electrical components such as the laser head.
5. Install the unit horizontally. Installing the unit more than 30 degree vertically may result in worse performance.

6. To prevent electric spark, connect the positive pole first and then the negative pole.

Unit Installation

Method A

1. Insert mounting bracket into dash board, choose appropriate mounting tab according to the gap width, bending the mounting tab outwards with a screwdriver to fix the mounting bracket in place.
2. Slide the unit into the bracket until you hear a click sound.

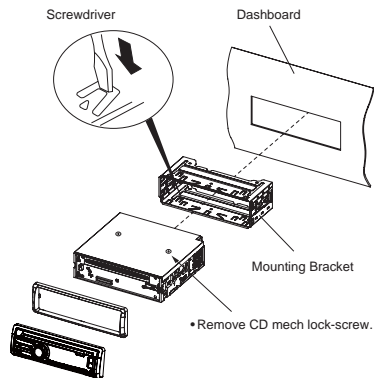

Method B

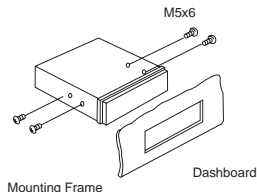
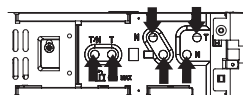

1. Insert this unit directly to the opening of the dashboard.
2. Place M5x6 cylindrical screw through the holes of the mounting frame located inside the opening to holes of the unit and fasten the screws to left & right.

Trim ring installation

Attach the trim ring around the front panel. Take care of the top and bottom of the trim ring and mount it so that all the hooks are locked.

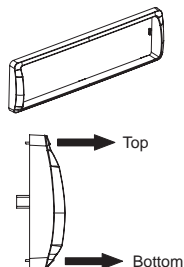

6) Removing the Source Unit

Disassemble trim ring

1. Push the trim ring to right and pull out the right part.

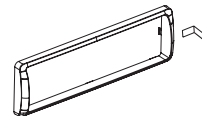

2. Push the trim ring to left and pull out the left part.

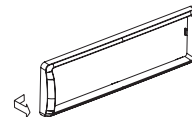

Disassemble the unit

1. Turn off the power.
2. Remove the panel.
3. Remove the trim ring.
4. Insert the removal keys straight back until they lock, then pull the unit out.

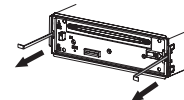

5. Disconnect all the wires.

7) Wiring and Connections

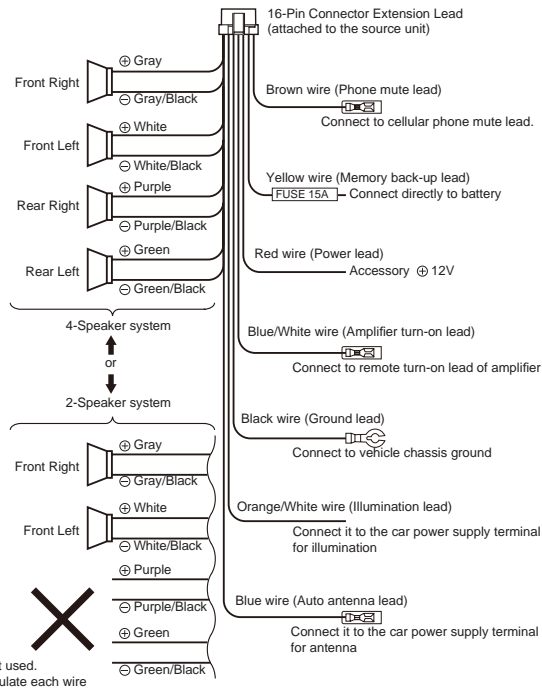
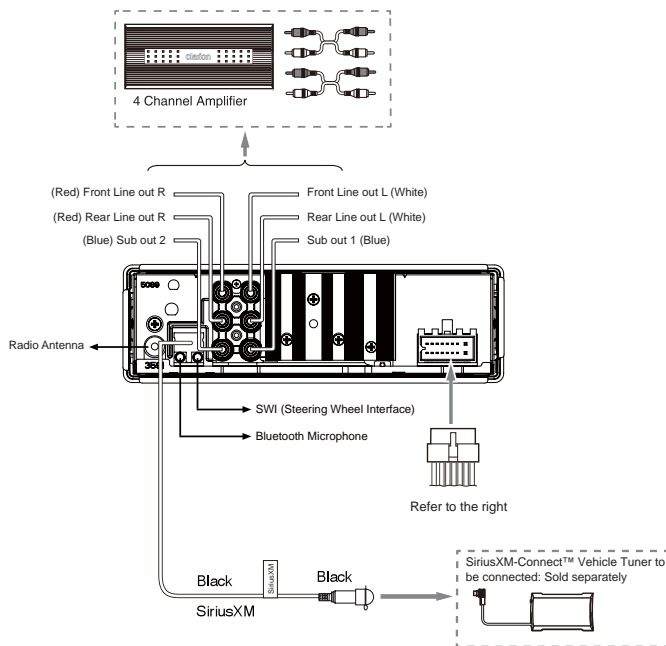

8) Connecting the accessories

• Connecting to the external amplifier

External amplifiers can be connected to the 4 channel RCA output connections. Ensure that the connectors are not grounded or shorted to prevent damage to the unit.

Clarion Co., Ltd.

Copyright © 2014 Clarion Co., Ltd.
Printed in China / Imprimé en Chine / Impreso en China