

clarion®

Owner's manual & Installation manual

NZ503

HD Radio **(((siriusxm)))**
R E A D Y R E A D Y

DVD MULTIMEDIA STATION WITH BUILT-IN
NAVIGATION & 7" TOUCH PANEL CONTROL

CLARION PRODUCT REGISTRATION INFORMATION

For USA and Canada only
www.clarion.com

Dear Customer:

Congratulations on your purchase of a Clarion mobile electronic products. We are confident that you'll enjoy your Clarion experience.

There are many benefits to registering your product. We invite you to visit our website at www.clarion.com to register your Clarion product.

We have made product registration simple with our easy to use website. The registration form is short and easy to complete. Once you're registered, we can keep you informed of important product information.

Register at www.clarion.com - it's easy to keep your Clarion product up to date.

INFORMATIONS DE L'ENREGISTREMENT DE PRODUITS CLARION

Pour les États Unis et le Canada seulement
www.clarion.com

Cher client:

Nous vous remercions d'avoir acheté ce produit électronique mobile Clarion. Nous sommes confiants que vous apprécierez votre expérience Clarion.

Il y a beaucoup d'avantage à enregistrer votre produits. Nous vous invitons à visiter notre site Web www.clarion.com pour enregistrer votre produit Clarion.

Nous avons facilité la tâche d'enregistrement de produit simple et facile grâce à notre site Web. Le formulaire d'enregistrement est court et facile à compléter. Lorsque vous êtes enregistrer, nous pouvons vous tenir informé des informations important de produits.

Enregistrer à www.clarion.com - c'est facile de mettre à jour votre produit Clarion.

INFORMACIÓN DEL REGISTRO DE PRODUCTO DE CLARION

Para USA y Canada nomas
www.clarion.com

Querido Cliente:

Felicitaciones por su compra de producto electrónico móvil de Clarion. Estamos seguros que usted gozará de su experiencia con el producto de Clarion.

Hay muchas ventajas al registrar su producto. Le invitamos a que visite nuestro sitio en internet www.clarion.com para registrar su producto de Clarion.

Hemos hecho el registro de producto fácil en nuestro sitio. La forma de registro es corta y fácil de completar. Una vez que lo registre, podremos proporcionarle la información de su producto.

Regístrese en www.clarion.com - es fácil mantener su producto de Clarion actualizado.

Under Industry Canada regulations, this radio transmitter may only operate using an antenna of a type and maximum (or lesser) gain approved for the transmitter by Industry Canada. To reduce potential radio interference to other users, the antenna type and its gain should be so chosen that the equivalent isotropically radiated power (e.i.r.p.) is not more than that necessary for successful communication.

Conformément à la réglementation d'Industrie Canada, le présent émetteur radio peut fonctionner avec une antenne d'un type et d'un gain maximal (ou inférieur) approuvé pour l'émetteur par Industrie Canada. Dans le but de réduire les risques de brouillage radioélectrique à l'intention des autres utilisateurs, il faut choisir le type d'antenne et son gain de sorte que la puissance isotrope rayonnée équivalente (p.i.r.e.) ne dépasse pas l'intensité nécessaire à l'établissement d'une communication satisfaisante.

1. FEATURES.....	4
Expanding Systems	4
2. PRECAUTIONS.....	5
3. CAUTIONS ON HANDLING.....	7
Operation Panel	7
USB Port	7
Cleaning	7
Handling Discs	8
4. PANEL CONTROLS.....	9
NZ503 Functions of Buttons	9
5. REMOTE CONTROL.....	11
Functions of Remote Control Buttons	12
6. MAIN MENU OPERATIONS.....	14
Front Zone Source	14
Rear Zone Source	14
7. DVD SYSTEM	15
DVD Video Features.....	15
Discs	15
About the registered marks, etc.	16
8. DVD VIDEO PLAYER OPERATIONS	17
Change DVD System Settings	17
Watching to a disc	18
Operate the DVD Player menu	18
Operate the Video files Player menu.....	21
9. DVD AUDIO PLAYER OPERATIONS.....	22
Showing CD Player mode screen	22
Operate the CD Player menu	22
Listening To MP3/WMA	23
10. USB AUDIO OPERATIONS	26
Notes on using USB memories.....	26
Select USB Audio mode	26
Playing MP3/WMA files in USB memory	27
11. USB VIDEO OPERATIONS.....	29
Notes on using USB memories.....	29
Select USB Video mode	29
Playing video files in USB memory	29
USB Video Menu Operations.....	30
12. iPod/iPhone OPERATIONS	31
Notes on using Apple iPod/iPhone	31
Controlling the iPod/iPhone	31
Selecting the iPod Video mode	33
13. SELECTING THE Pandora MODE.....	35
14. Bluetooth AUDIO PLAYER OPERATIONS.....	37
Selecting the Bluetooth Audio mode	37
Bluetooth audio player settings	37
Registering your Bluetooth audio player (Pairing).....	37
Selecting the Bluetooth audio player.....	38
Controlling the Bluetooth audio player	38
15. Bluetooth TELEPHONE OPERATIONS.....	39
Select the BT Phone mode.....	39
Bluetooth Telephone settings	39
Register your cellular phone (Pairing)	40

Select the cellular phone	41
Obtaining the Phone Book data	41
Telephone operations	41
16. RADIO OPERATIONS.....	43
17. HD Radio™ RECEIVER OPERATIONS	44
Listening to HD Radio.....	44
18. SiriusXM Satellite Radio OPERATIONS	46
Selecting a Satellite Radio mode.....	46
Displaying the Identification (ID) Code.....	46
19. AUX 1 / AUX 2 OPERATIONS.....	48
20. CAMERA OPERATIONS	48
21. REAR SOURCE OPERATIONS.....	49
DVD Video in Rear	49
AUX 1 in Rear.....	50
AUX 2 in Rear.....	50
iPod Video in Rear	50
22. SETTING OPERATIONS.....	51
General Setup Menu	51
Video Setup Menu	51
Audio Setup Menu	52
Navigation Setup Menu	52
Others Setup Menu.....	52
Set the Anti-Theft code.....	53
23. TROUBLESHOOTING	54
GENERAL.....	54
DVD PLAYER	54
USB DEVICE	55
Bluetooth	55
SiriusXM Advisory Messages.....	56
TV/VTR (When connecting an optional TV tuner, etc.).....	56
24. ERROR DISPLAY.....	57
25. SPECIFICATIONS.....	58
26. WIRING AND CONNECTIONS.....	60

1. FEATURES

- Built-in Parrot Bluetooth® Handsfree (HFP) and Audio Streaming (A2DP & AVRCP)
- Compatible with iPod® / iPhone® with PANDORA® internet radio App
- SiriusXM-Ready™ and HD Radio Ready™ with iTunes® Tagging
- Latest Map Guarantee



Expanding Systems

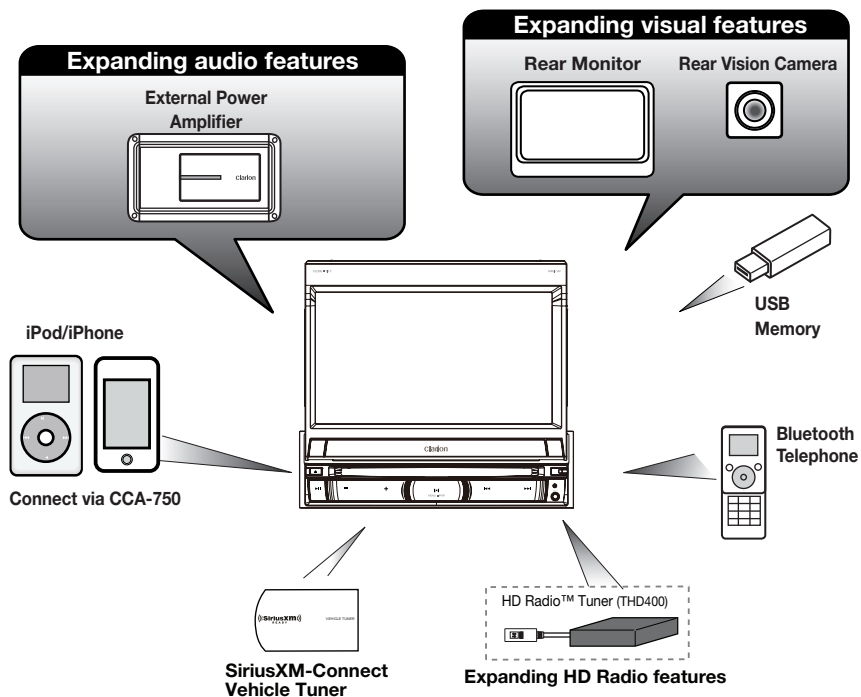

NOTE:

The items listed outside the frames are the commercial products generally sold.

CCA-750: Sold by separately.

2. PRECAUTIONS

WARNING

For your safety, the driver should not operate the controls while driving.
Also, while driving, keep the volume to a level at which external sounds can be heard.

1. When the interior of the car is extremely cold and the player is used soon after switching on the heater, moisture may form on the disc or the optical parts of the player and proper playback may not be possible. If moisture forms on the disc, wipe it off with a soft cloth. If moisture forms on the optical parts of the player, do not use the player for about one hour. The condensation will disappear naturally allowing normal operation.
2. Driving on extremely bumpy or rough roads can cause the disc to skip during playback.
3. This unit uses precision parts and components for its operation. In the event that trouble arises, never open the case, disassemble the unit, or lubricate the rotating parts. Contact your Clarion dealer or service center.
4. This equipment has been tested and found to comply with the limits for a Class B digital device, pursuant to Part 15 of the FCC Rules.
These limits are designed to provide reasonable protection against harmful interference in a residential installation. This equipment generates, uses, and can radiate radio frequency energy and, if not installed and used in accordance with the instructions, may cause harmful interference to radio communications. However, there is no guarantee that interference will not occur in a particular installation. If this equipment does cause harmful interference to radio reception, which can be determined by turning the equipment off and on, the user is encouraged to consult the dealer or an experienced radio technician for help.
5. "Made for iPod," and "Made for iPhone" mean that an electronic accessory has been designed to connect specifically to iPod, or iPhone, respectively, and has been certified by the developer to meet Apple performance standards.
Apple is not responsible for the operation of this device or its compliance with safety and regulatory standards. Please note that the use of this accessory with iPod or iPhone may affect wireless performance.
iPhone, iPod and iTunes are trademarks of Apple Inc., registered in the U.S. and other countries.
6. SiriusXM and all related marks and logos are trademarks of Sirius XM Radio, Inc. All rights reserved.
7. HD Radio™, HD Radio Ready™, and the HD Radio Ready logo are proprietary trademarks of iBiquity Digital Corporation.
This HD Radio Ready receiver is ready to receive HD Radio broadcasts when connected to the THD301, sold separately.
8.  Manufactured under license from Dolby Laboratories.
"Dolby" and the double-D symbol are trademarks of Dolby Laboratories.
9. This product incorporates copyright protection technology that is protected by U.S. patents and other intellectual property rights. Use of this copyright protection technology must be authorized by Rovi Corporation, and is intended for home and other limited viewing uses only unless otherwise authorized by Rovi Corporation. Reverse engineering or disassembly is prohibited.
Use of this product by the customer is restricted to play program materials to which the Rovi copyright protection process has been applied.
10. The Bluetooth® word mark and logos are registered trademarks owned by Bluetooth SIG, Inc. and any use of such marks by Clarion Co., Ltd. is under license.
11. This device complies with Industry Canada licence-exempt RSS standard(s). Operation is subject to the following two conditions: (1) this device may not cause interference, and (2) this device must accept any interference, including interference that may cause undesired operation of the device.

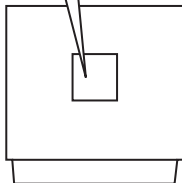
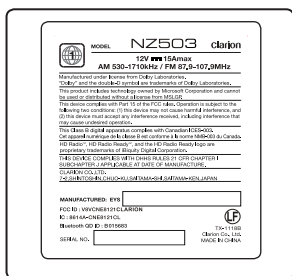

NZ503

INFORMATION FOR USERS:
Changes or modifications to this product unapproved by the manufacturer will void the warranty and will violate FCC approval.

3. CAUTIONS ON HANDLING

Operation Panel

For a longer service life, be sure to read the following cautions.

- The operation panel will operate properly in a temperature range of 0° to 60° C.
- Do not allow any liquids on the set from drinks, umbrellas etc. Doing so may damage the internal circuitry.
- Do not disassemble or modify the set in any way. Doing so may result in damage.
- Subjecting the operation panel to shocks may result in breakage, deformation or other damage.
- Do not let cigarettes burn the display.
- If a problem should occur, have the set inspected at your store of purchase.
- Do not insert objects or poke in the space between the operation panel and the main unit when the panel is tilted.
- The remote control unit may not work if the remote control sensor is exposed to direct sunlight.
- In extremely cold weather, the display movement may slow down and the display may darken, but this is not a malfunction. The display will work normally when the e temperature increases.
- Small black and shiny spots inside the liquid crystal panel are normal for LCD products.

USB Port

- The USB memory stick may stick out when inserted, so it may cause danger during driving. In such cases, you can use a commercial USB extension cable, etc., but use it safely under your own judgment.
- The USB memory sticks must be recognized as "USB mass storage class" to work properly. Some models may not operate correctly.
When the memorized data is lost or damaged by any chance, Clarion shall not be liable for any damage. When using an USB memory stick, we recommend that you backup your data stored on it before by using a personal computer etc.
- Data files may be broken when using USB memory sticks in the following situation:
 - When disconnecting the USB memory stick or turning the power off during writing or reading data. When affected by static electricity or electric noise. Connect/disconnect the USB memory stick when it is not accessed.
 - Some USB memory sticks cannot be inserted to the main unit because of their shape. In such cases, use a commercial USB extension cable to connect them.
 - Connecting with the computer is not covered.
 - Music files (MP3, WMA, etc.) stored in the USB memory stick can be played back.

Cleaning

- **Cleaning the cabinet**
Use a soft, dry cloth and gently wipe off the dirt. For tough dirt, apply some neutral detergent diluted in water to a soft cloth, wipe off the dirt gently, then wipe again with a dry cloth.
Do not use benzene, thinner, car cleaner, etc., as these substances may damage the cabinet or cause the paint to peel. Also, leaving rubber or plastic products in contact with the cabinet for long periods of time may cause stains.
- **Cleaning the liquid crystal panel**
The liquid crystal panel tends to collect dust, so wipe it off occasionally with a soft cloth. The surface is easily scratched, so do not rub it with hard objects.

Handling Discs

Handling

- New discs may have some roughness around the edges. If such discs are used, the player may not work or the sound may skip. Use a ball-point pen or the like to remove any roughness from the edge of the disc.

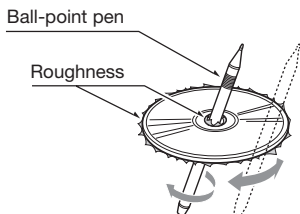

- Never stick labels on the surface of the disc or mark the surface with a pencil or pen.
- Never play a disc with any cellophane tape or other glue on it or with peeling off marks. If you try to play such a disc, you may not be able to get it back out of the DVD player or it may damage the DVD player.
- Do not use discs that have large scratches, are misshapen, cracked, etc. Use of such discs may cause misoperation or damage.
- To remove a disc from its storage case, press down on the center of the case and lift the disc out, holding it carefully by the edges.
- Do not use commercially available disc protection sheets or discs equipped with stabilizers, etc. These may damage the disc or cause breakdown of the internal mechanism.

Storage

- Do not expose discs to direct sunlight or any heat source.
- Do not expose discs to excess humidity or dust.
- Do not expose discs to direct heat from heaters.

Cleaning

- To remove fingermarks and dust, use a soft cloth and wipe in a straight line from the center of the disc to the circumference.
- Do not use any solvents, such as commercially available cleaners, anti-static spray, or thinner to clean discs.
- After using special disc cleaner, let the disc dry off well before playing it.

On Discs

- Exercise a good precaution when loading a disc. The operation panel will close automatically when leaving it open for a while.
- Never turn off the power and remove the unit from the car with a disc loaded.

⚠ CAUTION

For your safety, the driver should not insert or eject a disc, opening the operation panel while driving.

4. PANEL CONTROLS

NZ503 Functions of Buttons

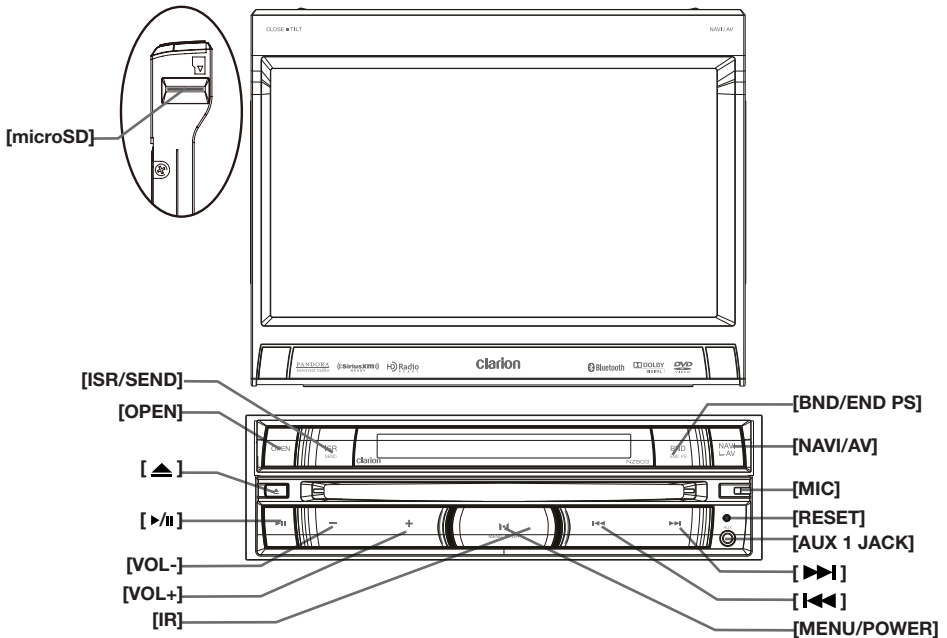

Note: Be sure to read this chapter while referring to front diagram "PANEL CONTROLS".

[NAVI/AV] Button

- Press this button to enter navigation mode; press again to return current source.
- Press and hold this button for 3 seconds to display the brightness setting panel.

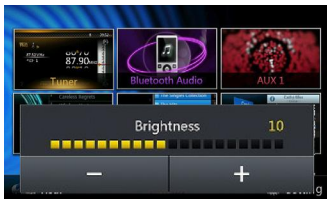

- Press this key to change display of sub LCD when panel is closed.

[▲] Eject Button

- Press to eject disc from unit.

[MIC]

- Internal microphone for use during Bluetooth phone calls. Sensitivity can be adjusted from the Settings menu.

[RESET] Button

- Press this button to hardware reset the unit.

Note: When the [RESET] button is pressed, frequencies of radio stations, titles, etc. stored in memory are cleared.

[AUX 1 JACK]

AUX 1 Connector.

[▶▶, ◀◀] Buttons

- Short press to search next track or chapter in Pandora mode.
- Short press to preset up or preset down in Tuner, SiriusXM modes.
- Press and hold to seek up or seek down in Tuner mode.
- Press and hold to channel up or channel down in SiriusXM mode.
- Short press to search previous or next track or chapter in CD/DVD, USB, iPod and BT audio modes.
- Press and hold to progressive fast forward and progressive fast reverse in CD/DVD, USB, modes.
- Press and hold to fast forward or fast backward in iPod mode.

[▶||] Button

- Press to play/pause audio or video.
- Press to MUTE in Tuner mode.
- Press and hold to stop audio or video files.

[VOL+][VOL-] Buttons

- Press to Increase and decrease volume.

[OPEN] Button

- Press this button to open/close TFT panel.
- Press and hold to enter TFT panel angle setting options.

[MENU/POWER] button

- Press this key to power on the system in power off mode.
- Keep pressing this key more than 2 second to turn off the system when system is in power on mode.
- Press this button to display main menu, press again to return current source when system is in power on mode.

[BND/END PS] Button**BND Function:**

- Press this button to enter AM/FM tuner mode from any source.
- Once in AM/FM tuner mode, you can press into change bands among FM1, FM2, FM3,AM bands.
- Press and hold to start Preset Scan. Press again to stop.

END Function:

Only be available when a call incoming or in telephone talking.

- Press to reject call when a call incoming.
- press to end a call when in telephone talking.

[ISR/SEND] Button**ISR Function:**

When in tuner mode, press and hold this button for 3 seconds to save current station and band to ISR memory, and at the same time, the tuner will enter ISR mode with current station.

Note:

In ISR mode, the tuning operation is disabled. Press this button again to quit ISR mode.

When in the other mode but not tuner mode, press this key will go to ISR memory station directly, it likes a shortcut. Press this key again to go back to previous mode.

SEND Function:

Only be available when there is a coming call.

- Press this key to accept the coming call.
- Press to switch to private mode when in talking.

[IR] SENSOR

- Receiver for the remote control unit (operating range: 30 degree in all directions).

[microSD]

- Insert a microSD in this.

Note: *The microSD card is only for navigation. Please don't remove it, otherwise, the navigation function will be disabled.*

Functions of Remote Control Buttons

You can use the remote control unit to control the NZ503.

Note:

- The wireless remote control operation may not be optimal in direct sunlight.

[▶||/■] Button

- Press this button to play or pause video and audio media.
- Press this button more than 1 second to stop video and audio media.
- Press to MUTE in Tuner mode.

[MUTE] Button

- Mute or Unmute the speaker.
- The symbol  on upper right area of the screen indicates that speaker is muted.

[POWER/SRC] Button

- Press this button to move the focus to next available source item on main menu.
- Press this button to power on when the unit is power off.
- Press this button more than 1 second to power off when the unit is power on.

Note: While panel is closed position, you cannot select any source.

[0 - 9] Buttons

- Use in the Key Pad screen to select the radio or DVB-T channels.
- Use to select the track in the track list screen.
- Press to enter DVD video chapters/titles in the Key Pad screen.

[VOLUME] Buttons

- Increase and decrease volume.

[NAVI/AV] Button

- Press this button to switch between current source and current position on navigation map.

[SRCH] Button

- Press this button to open chapter or title search window while playing DVD.

[BAND] Button

- Switch to next band alternately.

[SET] Button

- Press this button to open the Audio setting menu in any mode.

[BACK] Button

- Press this button to quit main menu if current screen is main menu.

[▲], [▼], [◀], [▶] Buttons

- Press this button for cursor movement in main menu or Setting mode.
- From the main menu, you can select your desired source or change your settings.
- Press this button for cursor movement in DVD Menu.

[MENU] Button

- Press this button to enter the MAIN MENU or return current resource.

[PIC] Button

- Press and hold this button to change your monitor brightness.

[ENT] Button

- Press to fix the entered data in the Key Pad screen or enter the item the cursor is on.

[TAG] Button

- Press this button to record TAG in HD Radio mode .

[TITLE] Button

- Press to go to the title menu on the DVD.

[ROOT] Button

- Press to go to the root menu on the DVD.

[RPT] Button

- Press to perform chapter repeat / title repeat / repeat off while playing DVD mode.
- Press to perform track repeat/repeat off while playing CD.
- Press to perform repeat track /repeat folder/ repeat off while playing MP3/WMA, or video files on disc.
- Press to perform repeat track /repeat folder/ repeat off while playing MP3/WMA, or video files in USB memory.
- Press to perform repeat one /repeat all/ repeat off in iPod mode.

[◀◀] Buttons

- Short press to preset down in Tuner,SiriusXM modes.
Press and hold to seek down in Tuner mode.
Press and hold to channel up in SiriusXM mode.
- Short press to search track or chapter up in CD/DVD video,USB iPod and BT audio modes.
- Press and hold to progressive fast reverse in CD/ DVD ,USB modes.
- Press and hold to fast backward in iPod mode.

[▶▶] Buttons

- Short press to preset down in Tuner,SiriusXM modes.
Press and hold to seek down in Tuner mode.
Press and hold to channel up in SiriusXM mode.
- Short press to search track or chapter down in CD/ DVD ,USB ,iPod and BT audio modes.
- Press and hold to progressive fast forward in CD/ DVD ,USB modes.
- Press and hold to fast forward in iPod mode.

Functions of Remote Control Buttons

[◀◀], [▶▶] Buttons

- Short press to seek up or seek down in Tuner modes.
- Short press to channel up or channel down in SiriusXM mode.
- Short press to fast-forward or fast-backward in CD/DVD,USB,and iPod modes.

[ZOOM] Button

- Press to turn on and zoom in while playing DVD. You can zoom in up to 3x. (No all DVD disc supports this function).

[AUDIO] Button

- Press to switch the AUDIO channel of the disc while playing DVD.

[SUB-T] Button

- Press to switch next available subtitle while playing DVD.
- Press to display Video menu in iPod mode.

[ANGLE] Button

- Press to switch the different ANGLE while playing DVD. (No all DVD disc supports this function)
- Press to display Audio menu in iPod mode.

[OPEN] Button

- Press this button to OPEN or CLOSE the motorized screen. Please ensure there are no obstructions before starting the operation.

6. MAIN MENU OPERATIONS

Front Zone Source



[Tuner]-Press the button to display the Tuner mode.

[Disc Audio]-Press the button to display the Disc Audio mode.

[SiriusXM]-Press the button to display the SiriusXM mode.

[USB Audio]-Press the button to display the USB Audio mode.

[Pandora]- Press the button to display the Pandora mode.

[iPod Audio]-Press the button to display the iPod Audio mode.



[AUX1]-Press the button to display the AUX1 mode.

[Disc Video]-Press the button to display the Disc Video mode.

[AUX 2]-Press the button to display the AUX 2 mode.

[USB Video]-Press the button to display the USB Video mode.

[Camera]-Press the button to display the Camera mode.

[iPod Video]-Press the button to display the iPod Video mode.



[Navigation]-Press the button to display the Navigation mode.

[Telephone]-Press the button to display the Telephone mode.

[Bluetooth Audio]-Press the button to display the Telephone mode.

[Rear Button]-Press the button to display the Bluetooth Audio mode.

[Setting Button]-Press the button to display the setting menu.

Rear Zone Source



[Rear Disc Video]-Press the button to display the Rear Disc Video mode.

[Rear AUX 1]-Press the button to display the Rear AUX 1 mode

[Rear iPod Video]-Press the button to display the Rear iPod Video mode.

[Rear AUX 2]-Press the button to display the rear AUX 2 mode.

[2-Zone Off]-Press the button to closed the rear activity.

[Front Button]-Press the button to display the front main menu.

[Setting Button]-Press the button to display the setting menu.

Scrolling the menu

Press screen and scrolling to right or left it will switch to next or previous page of mainmenu.

Moving the menu position

1. Press any quadrate icon on mainmenu more than 2 seconds, the icon will float on mainmenu.
2. Scrolling the floating icon to any position you want.

7. DVD SYSTEM

DVD video is a high-quality digital video source that provides crisp and clear images. One 12 cm disc contains either one film or four hours of music.

DVD Video Features

This unit provides the following functions in addition to the high image quality and sound quality of DVD video.

Note:

- The functions described in this section, for example, the recorded language, subtitles, angles, etc. differ depending on the DVD video disc. Refer to the instructions provided with the DVD video.
- Some disc functions may operate differently from described in this manual.

Multi-sound function

DVD video can store up to 8 languages for one film; select the language of your preference.

- The languages stored on the disc are indicated by the icon shown below.



Multi-angle function

A DVD video that is filmed from multiple angles allows you to select the angle of choice.

- The number of recorded angles are indicated by the icon shown below.

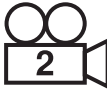

Subpicture (subtitles) function

A DVD video can record subtitles for up to 32 languages and you can select the language of the subtitles you wish to see.

- The number of recorded subtitle languages are indicated by the icon shown below.



Multi-story function

When a DVD video contains more than one story for a film, you can select the story you wish to enjoy. The operation procedures vary with the disc; observe the instructions for selecting a story provided during playback.

Menu screens

Menu can be called up during DVD video playback to perform menu setting.



- Example showing menu display



Discs

Playable discs

This DVD video player can play the following discs.

Playable discs		
 DVD video discs	 Audio CDs	 CD TEXT

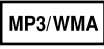
Playable media files
 MP3/WMA

About CD Extra discs

A CD Extra disc is a disc in which a total of two sessions have been recorded. The first session is Audio session and the second session is Data session. Your personally-created CDs with more than second data sessions recorded cannot be played on this DVD video player.

Note:

- When you play a CD Extra disc, only the first session will be recognized.

About playing a CD-R/CD-RW disc (MP3, WMA)

This player can play CD-R/CD-RW discs previously recorded in music CD format (MP3, WMA).

About playing a DVD-R/RW or DVD+R/RW disc

This player cannot play DVD-R/RW and DVD+R/RW discs previously recorded in video CD format.

However, MP3/WMA files recorded on DVD-R/RW and DVD+R/RW discs can be played.

Discs that cannot be played back

This DVD video player cannot play back DVD-Audio, DVD-RAM, Photo CDs, etc.

Note:

- It may also not be possible to play back CDs recorded on a CD-R unit and CD-RW unit. (Cause: disc characteristics, cracks, dust/dirt, dust/dirt on player's lens, etc.)
- If a CD-R or CD-RW disc that has not been finalized is played, it will take a long time to start playing. Also, it may not be possible to play depending on its recording conditions.
- You cannot play SuperAudio CDs Playback of the CD player is not supported even if it is a hybrid disc.

About MP3/WMA playback

This unit can play back CD-R/CD-RW, DVD-R/RW and DVD+R/RW discs on which MP3/WMA music data have been recorded.

For a detailed information, see the section entitled "Listening to MP3/WMA".

Note on region numbers

The DVD video system assigns a region number to DVD video players and DVD discs by sales area. DVD video players sold in the Europe can play back DVD discs with the region number "ALL", "1" or any combination of numbers that also incorporate a "1". The DVD video region number is marked on the disc jacket as shown below.

**About the registered marks, etc.**

- This product incorporates copyright protection technology that is protected by U.S. patents and other intellectual property rights. Use of this copyright protection technology must be authorized by Rovi Corporation, and is intended for home and other limited viewing uses only unless otherwise authorized by Rovi Corporation. Reverse engineering or disassembly is prohibited.
- Use of this product by the customer is restricted to play program materials to which the Rovi copyright protection process has been applied.
- Manufactured under license from Dolby Laboratories. "Dolby", "Pro Logic" and the double-D symbol are trademarks of Dolby Laboratories.
- "Made for iPod," and "Made for iPhone" mean that an electronic accessory has been designed to connect specifically to iPod, or iPhone, respectively, and has been certified by the developer to meet Apple performance standards. Apple is not responsible for the operation of this device or its compliance with safety and regulatory standards. Please note that the use of this accessory with iPod or iPhone may affect wireless performance. iPhone, iPod and iTunes are trademarks of Apple Inc., registered in the U.S. and other countries.
- The Bluetooth® word mark and logos are owned by the Bluetooth® SIG, Inc. and any use of such marks by Clarion Co., Ltd. is under license. Other trademarks and trade names are those of their respective owners.
- SiriusXM™ and all related marks and logos are trademarks of Sirius XM Radio, Inc. All rights reserved.
- HD Radio™, HD Radio Ready™, and the HD Radio Ready logo are proprietary trademarks of iBiquity Digital Corporation. This HD Radio Ready receiver is ready to receive HD Radio broadcasts when connected to the THD400, sold separately.
- Pandora, the Pandora logo and other Pandora marks are trademarks or registered trademarks of Pandora Media, Inc. or its subsidiaries worldwide. "If you have any issues with the Pandora application on your mobile phone, please direct them to pandora-support@pandora.com."

8. DVD VIDEO PLAYER OPERATIONS

Change DVD System Settings

Note: If the set up operation is performed in the middle of DVD video play, the disc will restart from the beginning.

Selecting DVD Set Up Menu

1. Press the **[Setting]** button on the Main Menu to access the Video set up menu.
2. Press **[Video]** button. The video menu is displayed.



Setting up the Screen Size

Press the **[DVD Wide Screen Mode]** button to turn on or turn off the DVD wide screen mode.

The factory default setting is "On".

Note: Not all DVD disc supports this function.

DVD Wide Screen Mode On

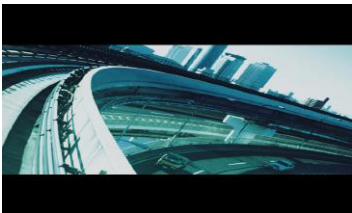

DVD Wide Screen Mode Off

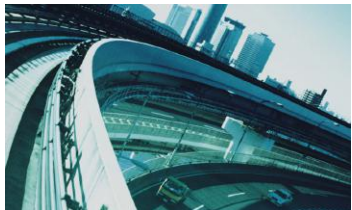

Setting up the password for parental level control

The factory default pass code is "0000".

1. In Main Menu press **[Setting]** button. Press **[Others]** button on the display. Touch the **[Set Password]** ---- and a numerical key pad will appear. Input the old password, and touch the **[OK]** key, or input "4356" to reset password.



Input a new password, and touch the **[OK]** key.

Input the same new password again, and touch the **[OK]** key.

Note: When a disc with view restrictions is inserted, you will be prompted to input this password. The disc will not be viewable until the correct password is entered.

Set rating for parental level control

1. Select Others screen while in Setting mode. Press **[Parental Control]** button. Press the desired rating for level control. Use this table to set the parental level.

Kid Safe	Kid Safe
G	General Audiences
PG	Parental Guidance Suggested
PG-13	Parents Strongly Cautioned
PG-R	Parental Guidance Restricted
R	Restricted
NC-17	No One 17 And Under Admitted
Adult	Only Adult

- The contents that the parental level restricts vary with the country code.

Note: The rating can be selected only under the password unlocked status, and the limits can be set only under the password locked status.

Watching to a disc

1. To load a disc:

Insert the disc into the center of the insertion slot the label side facing up.

CAUTION

For your safety, the driver should not insert or eject a disc, opening the operation panel while driving.

Note:

- Never insert foreign objects into the disc insertion slot.
 - If the disc is not inserted easily, there may be another disc in the mechanism or the unit may require service.
 - 8cm (single play) discs cannot be used.
2. Disc starts playing automatically.

WARNING

Some videos may be recorded at higher than desired volume levels. Increase the volume gradually from the minimal setting after the video has started.

Ejecting a disc

1. To eject a disc press eject  button. The play mode then switches to the Tuner mode.

If the disc is left in the ejected position for 15 seconds, the disc is automatically reloaded. In this case, the play mode will remain in the Tuner mode.

Note: If you force a disc into before auto reloading, it may damage a disc.

Showing DVD Player mode screen

After disc is loaded, the play mode is automatically engaged.

Touch any place of the screen to display DVD Video menu touch the screen again to return the playback screen. The display will return to the playback screen, if you do not touch the screen for 10 seconds.





- 1 - Next page Button
- 2 - Previous Track /Fast Backward Button(long press)
- 3 - Play/Pause Button
- 4 - Next Track/Fast Forward Button(long press)
- 5 - Elapsed playing time
- 6 - Seek bar
- 7 - Total time
- 8 - Menu Button
- 9 - System time
- 10 - Bluetooth status
- 11 - DVD playback info
- 12 - Previous page Button
- 13 - Repeat switching Button
- 14 - Audio Channel switching Button
- 15 - Subtitle switching Button
- 16 - INFO Button
- 17 - Direct chapter or title searching Button



Operate the DVD Player menu

You can select the button items displayed in the DVD menu by directly touching it.

Play/Pause Playback

1. Touch  button to pause during playback.
2. Touch  button again to resume playback.

Skip (Search) a Chapter

1. Press  or  button during playback. Chapters are skipped down or up from current locations, as many times as the button is pressed, and playback starts.

Skip use seek bar

Press the triangle  on seek bar and drag it to any position where you want to start playback.

Fast Forward/Fast Backward

1. Press **[FF]** or **[FB]** button and hold 2 seconds to start fast backward or fast forward during playback. The playback speed starts at 2x, then will increase to 4x, 8x, and 16x. Release the button will continue playing with normal speed.
2. **[◀▶]** button on remote control can also be used to start fast backward or fast forward during playback.

Note:

- No audio is reproduced during fast forward and fast backward operation.
- The fast forward and fast backward speed may differ depending on the disc.

Stop Playback

1. Press the **[■]** button on remote control more than 1 second. Playback is stopped.
2. To resume playback, press the **[▶/||]** button. Playback resumes from start of the disc.

Search with a Chapter/Title Number

You can locate the beginning of a scene using the chapter numbers or title numbers recorded on the DVD Video disc.

1. Showing the DVD Video menu, touch **[Direct]** button. The Key Pad screen appears with the chapter/Title number input mode.

Touching **[Chapter]** button turns the Key Pad to the chapter number input mode.

Touching **[Title]** button turns the Key Pad to the title number input mode.

• Title

A large segment to divide the data area of the disc.

• Chapter

A small segment to divide the data area of the disc.

2. Input the number of the title/chapter that you want to play with the **[0]** to **[9]** key.
3. Touch the **[OK]** button.

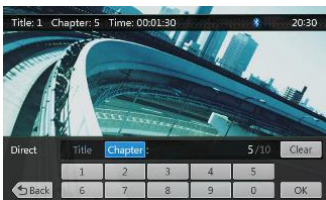

Playback starts from the scene of the input title number or chapter number.

Note:

If the input title/chapter number does not exist or searching with a title/chapter number is not allowed, the screen image will not change.

4. Touch **[Back]** button to close the key pad.

Repeat Playback

This operation plays back chapters recorded on the DVD-Video repeatedly.

1. Showing the DVD Video menu, touch **[Repeat]** button.
2. Touch **[Repeat]** button once for Repeat Chapter , again for Repeat Title.
3. Press **[Repeat]** button again to turn off the repeat playback.

Using the Title Menu

On DVD discs containing two or more titles, you can select from the title menu for playback.

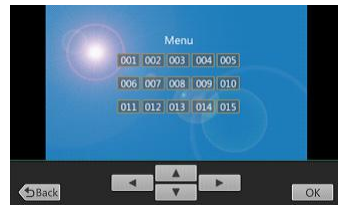

1. Showing the DVD Video menu, touch **[Menu]** button during playback.

The title menu screen appears.

- * Depending on the disc, the title menu may not be called.
2. Touch the title menu screen.
 3. Select the items in the title menu screen by **[Left/Right]** directional buttons.
 - * Depending on the disc, items may not be selected with the directional buttons.
 4. Touch **[OK]** button to fix on the selected item.
 5. Touch **[Back]** button.

Switching Audio

On discs in which two or more audios or audio languages have been recorded, you can switch among the audio languages during playback.

1. Showing the DVD Video menu, touch **[Audio]** button during playback.

- Each time you touch the button, you can switch among audio languages.
- It may take time to switch among audios.
Depending on the disc, up to 8 kinds of audios may be recorded. For details, see the mark of the disc: (8) Indicates that 8 audios have been recorded).

When the power is turned on and when the disc is changed to a new one, the language set as the factory default is selected. If that language has not been recorded on disc the language is specified on the disc.

Depending on the disc, switching may be completely impossible or impossible on some scenes.

Switching Subtitles

On DVD discs in with two or more subtitle languages have been recorded, you can switch among the subtitle languages during playback.

1. Showing the DVD Video menu, touch **[Subtitle]** button to select a subtitle during playback. Each time you touch the key, you can switch among subtitles.

- It may take time to switch among subtitles.
Depending on the disc, up to 32 kinds of subtitles may be recorded. For details, see the mark of the disc: (8) Indicates that 8 kinds of subtitles have been recorded).

Depending on the disc, switching may be completely impossible or impossible on some scenes.

2. To turn off subtitles, repeat touching **[Subtitle]** button until subtitles are turned off.

Switching angles

On DVD discs in with video images have been recorded in two or more angles, you can switch among the angles during playback.

1. Touch **[Angle]** key on the remote control during playback. Each time you touch the key, you can switch among angles.
- It may take time to switch among angles.
- Depending on the disc, up to 9 angles may be recorded. For details, see the mark of the disc: (9) Indicates multi-angle).
- Depending on the disc, angles may switch smoothly or switch with a momentary still image.
- Depending on the disc, switching may be completely impossible or impossible on some scenes.
- Depending on the disc, scenes recorded in two or more angles may be played back.

Displaying the playback status

Touch **[Info]** button on DVD Player mode screen, Playback status is displayed on screen.

Play disc video files

This system can play video files (MP4, etc) stored on disc.

Showing video files Player mode screen

1. After disc with video files is loaded, touch **[DVD Video]** button on MAIN MENU to show video files player mode screen.
2. Touch the screen of the playing video file to display Video files player menu touch the screen again to return the playback screen. The display will return to the playback screen, if you do not touch the screen for 10 seconds.

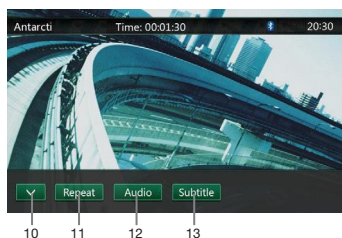



- 1 - Next page Button
- 2 - Previous Track /Fast Backward Button
- 3 - Play/Pause Button
- 4 - Next Track/Fast Forward Button
- 5 - Elapsed playing time /Seek bar
- 6 - List Mode Button
- 7 - System time
- 8 - Bluetooth status
- 9 - Playback info
- 10 - Previous Row Buttons
- 11 - Repeat Button
- 12 - Audio Button
- 13 - Subtitle Button

Operate the Video files Player menu

You can select the button items displayed in the Video files player menu by directly touching it.

Play/Pause Playback

1. Touch  button to pause during playback.
2. Touch  button again to resume playback.

Switch to Previous/next file





1. Press  or  button during playback to play previous /next file

Note: If play more than 2 seconds, press  button will play from start of current track.

Skip using seek bar

Press the triangle on seek bar and drag it to any position where you want to start playback.

Fast Forward /Fast Backward



1. Press  or  button and hold 2 seconds to start fast backward or fast forward during playback. The playback speed starts at 2x, then will increase to 4x, 8x, and 16x. Release the button will continue playback with normal speed.
2.  or  button on remote control can also be used to start fast backward or fast forward during playback.

Note:

No audio is reproduced during fast forward and fast backward operation.

The fast forward and fast backward speed may differ depending on the disc.



Stop Playback

1. Press the  button on remote control more than 1 second. Playback is stopped.
2. To resume playback, press the  button. Playback resumes from current playing time.

Repeat Playback

This operation plays back video files recorded on the disc repeatedly.

The repeat set as the factory default is Repeat all.

1. Showing the video files player menu, touch  button.
2. Touch  button once for Repeat Track, again for Repeat Folder.
3. Press  button again for Repeat All.

Switching Audio

Some video files will have two or more audio channels; you can switch among the audio channels during playback.

1. Touch  button during playback.
 - Each time you touch the button, you can switch among audio languages.
 - It may take time to switch among audios.
- Depending on the disc, switching may be impossible.

Switching Subtitles

Some video files will have two or more subtitles have been recorded; you can switch among these subtitles during playback.

1. Touch the  button to select a subtitle during playback.
 - Each time you touch the key, you can switch among subtitles.
 - It may take time to switch among subtitles.
- Depending on the disc, switching may be impossible.

Video files list

Showing the Video files player menu; touch the  button to display video files list screen.

Video files list operations is almost same as Disc Audio player mode. Please refer to DVD Audio Player Operations.

9. DVD AUDIO PLAYER OPERATIONS

Listening to a disc/Ejecting a disc

Please refer to Disc Video Player Operations -watching to a disc and Ejecting a disc.

Showing CD Player mode screen

- After disc is loaded, the play mode is automatically engaged.
- If disc have been loaded you can touch [Disc Audio] button on main menu to display CD player mode screen.

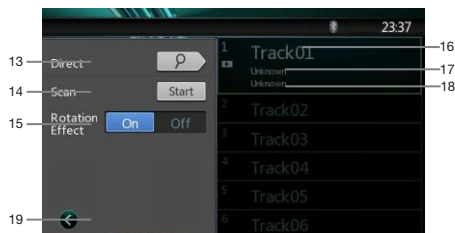
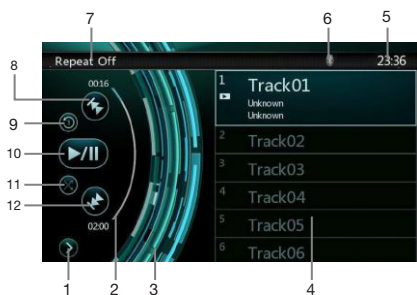

- Open option menu Button
- Elapsed playing time indicator
- Rotation effect
- Audio files or CD tracks.
- System time
- Bluetooth status
- Play back status
- Previous Track /Fast Backward Button
- Repeat Button
- Play/Pause Button
- Random Button
- Next Track/Fast Forward Button
- Direct Searching Button
- Scan Start/Stop Button
- Rotation Effect On/Off Button
- Song Title
- Artist Information
- Album Information
- Close option menu Button

Operate the CD Player menu

You can select the button items displayed in the CD player menu by directly touching it in list.

Play/Pause Playback

- Touch button to pause during playback.
- Touch button again to resume playback.

Switch to Previous/next file or track

Press or button during playback to play previous /next file.

- Pressing button starts playback from the beginning of the next track.
- Pressing button starts playback from the beginning of the current track. When this button is pressed again within 2 seconds, playback starts from the beginning of previous track.

Fast Forward /Fast Backward

- Press or button and hold more than 2 seconds to start fast backward or fast forward during playback. The playback speed starts at 2x, then will increase to 4x, 8x, and 16x. Release the button will continue playback with normal speed.
- [] or [] button on remote control can also be used to start fast backward or fast forward during playback.

Note:

- The fast forward and fast backward speed may differ depending on the disc.

Stop Playback

- Press the button on remote control more than 1 second. Playback is stopped.
- To resume playback, press the button. Playback resumes from current playing time.

Repeat Playback

The repeat set as the factory default is Repeat Track. Touch the button once for Repeat off, again for Repeat Track.

Random Playback









- Touch button to shuffle the tracks during playback.
- Touch this button again to turn off the feature.

Selecting a track on the Track List Screen

This function allows you to select tracks from a displayed list.



- Touch the track title on the display list. The selected track will start playing.
- When the desired track is not displayed, press and flick the track list up or down.
- Touch the desired track title key. The corresponding track is started playback.

Scanning the Tracks



1. Touch  button to show  button.
 2. Touch  button during playback.
 - It will play from next track, and each track will display for 10 seconds.
 - The  button will switch to  button.
 3. Touch  button.
 - It will continue playback from current track.
 -  button will switch to  button.
- * The function will scan all tracks orderly in current folder once. After Scan stopped playback will continue.

Searching with the Track Number

This operation allows searching using the track numbers recorded on the CDs.

1. Touch  Button to show  button.
2. Touch  button .The numerical keypad will appear on the screen.
3. Input the track number that you want to play back with **[0]** to **[9]** key.





Playback starts from the track of the input track number.

- If the input track number does not exist or searching with track number is not allowed, the screen image will not change.
- Touch the  button will close the numerical keypad.
- Touch  Button will close the option window and display playback screen.

Rotation Effect On/Off

This operation allows turn on/turn off rotation effect.

The factory default is On.

1. Touch  Button to show  button
2. Press button  will turn on the Rotation effect.
3. Press button  will turn off the Rotation effect.

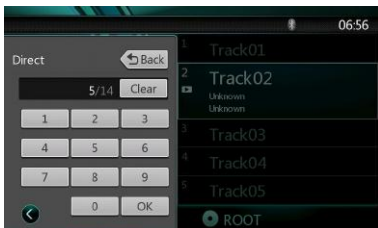

Listening To MP3/WMA

This unit is an ID3 Tag compatible model.

This unit supports the ID3 TAGs of the Version 2.4, 2.3, 1.1 and 1.0.

In displaying, this unit gives priority to the Version 2.3 and 2.4 TAGs.

What is MP3/WMA?

MP3 is an audio compression method and classified into audio layer 3 of MPEG standards.

WMA is an audio compression method developed by Microsoft Corporation.

These audio compression methods have penetrated into PC users and become a standard format.

These features compress the original audio data to about 10 percent of its initial size with a high sound quality. This means that about 10 music CDs can be recorded on a CD-R disc or CD-RW disc to allow a long listening time without having to change CDs.

Note: Some CDs recorded on CD-R/RW mode may not be usable.

Displaying MP3/WMA TAG titles

Tag information such as title, artist and album title can be displayed for MP3/WMA file containing Tag information.

Precautions when creating MP3 disc

• File extensions

1. Always add a file extension “.MP3” or “.mp3” to an MP3 file, and “.WMA” or “.wma” to a WMA file by using single byte letters. If you add a file extension other than specified or forget to add these file extension, the file cannot be played. In addition, if you use upper case and lower case letters (capital and small letters) mixed for file extensions, normal play may not be possible.

2. Files other than MP3/WMA data cannot be played.

Playing files with a format not supported will be skipped, and the scan, random and repeat playback mode may be canceled.

• File and Disc Not Supported

Files and discs with following extensions are not supported: *.AAC, *.DLF, *.M3U, *.PLS, *.MP3 PRO files, files with DRM, open session discs.

• Logical format (File system)

1. When writing an MP3/WMA file on a disc, please select "ISO9660 level 1 or level 2 (without including expansion format)" as the writing software format. Normal playback may not be possible if the disc is recorded on another format.

2. The folder name and file name can be displayed as the title during MP3/WMA play but the title must be within 31 single byte alphabetical letters and numerals for the folder name and file name (including an extension). Entering more letters or numerals than specified may cause an incorrect display.

• Entering File and Folder Names

Names using the code list characters are the only file names and folder names that can be entered and displayed. Using any other character will cause the file and folder names to be displayed incorrectly.

• Electronic Shock Protection

10 seconds for CD-DA (CDA)

45 seconds for MP3 recorded at 44.1 kHz, 128 kbps

90 seconds for WMA recorded at 44.1 kHz, 128 kbps

• Folder structure

1. A disc with a folder having more than 8 hierarchical levels will conflict with the ISO9660 and playback will be impossible.

• Number of files or folders

1. The maximum allowable number of folders is 255 (including root directory); the maximum allowable number of files is 1500 (max. 255 per folder). This represents the maximum number of tracks that can be played back.

2. Tracks are played in the order that they were recorded onto a disc. (Tracks might not always be played in the order displayed on the PC).

- Some noise may occur depending on the type of encoder software used while recording.
- In case of a track recorded at VBR (variable bit rate), the display for the play time of the track may be slightly different from the actual play time. Also, the recommended value of VBR ranges from 32 kbps to 320 kbps.
- After disc selection, the play mode is automatically engaged.

Playing MP3 folders

When selected for play, files and folders (Folder Search, File Search or Folder Select) are accessed in the order in which they were written to the media.

As a result, the order in which they are expected to be played may not match the order in which they are actually played.

You may be able to set the order in which MP3/WMA files are to be played by assigning file names beginning with play sequence numbers such as "01" to "99".

For example, a medium with the following folder/ file hierarchy is subject to Folder Search, File Search or Folder Select.

See the diagram below.

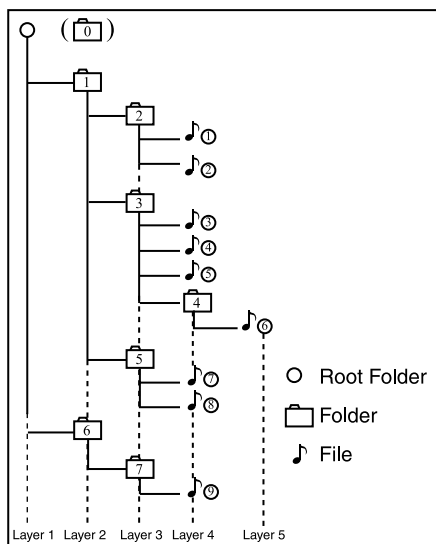

The player will only recognize three folder levels and does not display folders containing other folders. In the example above, the unit will display folders 2, 3, 5 and 7, but 1 and 6 since they do not contain others.

Playback MP3/WMA menu

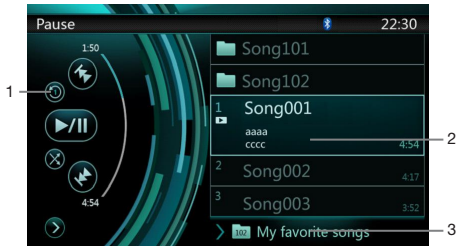

1. Repeat Playback

While playing MP3/WMA touch  button can switch between Repeat Folder, Repeat All and Repeat Track.



2. Folder

Touch the folder title on the display list, the file list will display files and folders in selected folder.

3. Current Folder

- Showing title of current folder.
- The number on the folder symbol is the number of files and folders number in current folder.
- Touch the title of current folder, play list will show files and folders in upper folder.

Stop Playback

1. Press the  button on remote control more than 1 second. Playback is stopped.
2. To resume playback, press the  button. Playback resumes from current playing time.

Other operations about playing MP3/WMA are almost same as CD Player mode.

10. USB AUDIO OPERATIONS

This system can play audio files (MP3/WMA) stored in a USB memory which is recognized as "USB Mass Storage Class device". You can use your USB memory as an audio device by simply copying desired audio files into it.

Note:

- This system will not operate or may operate improperly with some USB memory.
- Files protected with any DRM cannot be played.

Notes on using USB memories

General notes

- When no support files, the file list display nothing.

Notes on the MP3/WMA files

- This system can play the MP3/WMA files stored in the USB memory.
- Set the Sampling Frequency to:
 - For MP3 files:
 - MPEG1 Layer3: 32, 44.1, or 48 kHz
 - MPEG2 Layer3: 32, 44.1, or 48 kHz

For WMA files: 32, 44.1, or 48 kHz

- Set the Bit Rate to:

For MP3 files:

- MPEG1 Layer3: 32 to 320 kbps (VBR)
- MPEG2 Layer3: 32 to 320 kbps (VBR)

For WMA files: 64 or 192 kbps

- Add the following file extension using single byte characters:
 - For MP3 files: ".MP3" or ".mp3"
 - For WMA files: ".WMA" or ".Wma"

Notes on the folder structure

- The folder hierarchy must be within 8 hierarchical levels. Otherwise, playback may be impossible.
- The maximum allowable number of folders is 65535 (including root directory and folders with no MP3/WMA file).
- The maximum allowable number of files in a folder is 65535.
- You can store the MP3 files, WMA files together in a folder.
- The system may become slow if the files or folders exceed the limitation above.

Notes on the Tag titles

The limitations on the Tag titles are same as those in DVD Audio Player mode.

Select USB Audio mode

Connect your USB memory with MP3/WMA files to the USB connector. The system will automatically detect the connected device, and the [USB Audio] button on main menu will be enabled.

- When an USB memory is already connected Touch [USB Audio] button to select the USB Audio mode.

The system changes to the USB Audio mode and starts playback from the previous position or from the beginning.

Note:

If you reconnect the same device that you disconnected last, the system will play back where it left off.

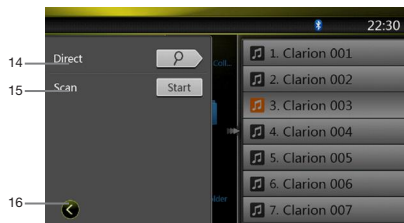



- 1 - Open option menu Button
- 2 - Play/Pause Button
- 3 - Repeat Button
- 4 - Random Button
- 5 - Next Track/Fast Forward Button
- 6 - MP3/WMA files in list
- 7 - Folders in list
- 8 - Folders browse control
- 9 - Playback status info
- 10 - Album Art

- 11 - Current ID3 info area
- 12 - Elapsed playing time indicator/Seek bar
- 13 - Previous Track /Fast Backward (long press)Button
- 14 - Direct Button
- 15 - Scan Button
- 16 - Close option menu Button
- 17 - NextTrack/Fast Forward (long press)Button



Playing MP3/WMA files in USB memory

Play/Pause Playback





1. Touch  button to pause during playback.
2. Touch  button again to resume playback.

Switch to Previous/next file

Press  or  button during playback to play previous /next file.

- Pressing  button starts playback from the beginning of the next track.
- Pressing  button starts playback from the beginning of the current track; when this button is pressed again within about 5 seconds, playback starts from the beginning of previous track.



Fast Forward /Fast Backward

1. Press  or  button and hold more than 2 seconds to start fast backward or fast forward during playback. The playback speed starts at 2x, then will increase to 4x, 8x, and 16x .Release the button will continue playback with normal speed.
2.  or  button on remote control can also be used to start fast backward or fast forward during playback..

Note:

- The fast forward and fast backward speed may differ depending on the audio files.

Stop Playback

1. Press the  button on remote control more than 1 second. Playback is stopped.
2. To resume playback, press the  button. Playback resumes from current playing time.

Repeat Playback

The repeat set as the factory default is Repeat Folder. Touch the  button once for Repeat Track, again for Repeat Folder,Repeat All.

Note: The repeat in all USB files function is not available.

Random Playback

1. Touch  button to Random the tracks in playing folder during playback.
2. Touch this button again to turn off the feature.

Album Art work

If current audio file contains album art image in ID3, the picture will be displayed in this area.

ID3 info area

This area display ID3 info of playing file: song title, artist information, album information, number of current file/total number in current folder, elapsed playing time/total time of current file.

Skip use seek bar

Press  on seek bar and drag it to any position where you want to start playback.

Select a folder on display list

Touch the folder title on the display list, the display list will display files and folders in selected folder.

Selecting a track on the display List

This function allows you to select tracks from a displayed list.





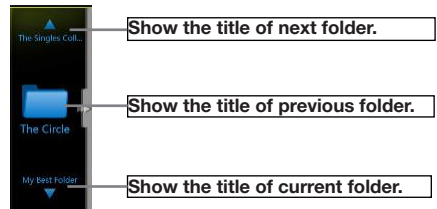



1. Touch the track title on the display list. The selected track will start playing.
2. When the desired track is not displayed, press and flick the track list up or down.
3. Touch the desired track title key. The corresponding track is started playback.

Folders browse control





This area is same as the mouse touch panel of notebook computer. Flick up and down in this area will browse previous or next folder in current folder. Flick left or right will enter this folder or back to the father folder.

Scanning the Tracks



1. Touch  Button to show  button.
 2. Touch  button during playback.
 - It will play from next track, and each track will display for 10s.
 - The  button will switch to  button.
 3. Touch  button.
 - It will continue playback from current track.
 -  button will switch to  button.
- * The function will scan all tracks orderly in current folder once .After Scan stopped playback will continue.

Searching with the Track Number

This operation allows searching using the track numbers in playing folder.

1. Touch  Button to show  button.
2. Touch  button .The numerical keypad will appear on the screen.
3. Input the track number that you want to play back with [0] to [9] key.

Playback starts from the track of the input track number.

- If the input track number does not exist or searching with a track number is not allowed, the screen image will not change.
- Touch  button will close the numerical keypad.
- Touch  Button will close the option window and display playback screen.



11. USB VIDEO OPERATIONS

This system can play USB video files (MP4, etc) stored in an USB memory which is recognized as "USB Mass Storage Class device" You can use your USB memory as an audio device by simply copying desired audio files into it.

Note:

- This system will not operate or may operate improperly with some USB memory.
- Files protected with any DRM cannot be played.

Notes on using USB memories

General notes

When no support files, the file list display nothing.

Notes on the folder structure

The limitations on the folder structure are same as those in USB Audio Player mode.

Notes on the Tag titles

The limitations in DVD Audio Player mode.

Select USB Video mode

Connect your USB memory with video files to the USB connector. The system will automatically detect the connected device, and the [USB Video] button on main menu will be enabled.

• When an USB memory is already connected

Touch [USB Video] button on main menu to select the USB Video mode.

The system changes to the USB Video mode and starts playback from the previous position or from the beginning.

Note: If you reconnect the same device that you disconnected last, the system will play back where it left off.

Playing video files in USB memory

If the video is playing, touch the screen of the playing video to display Operation buttons.

- * The display will return to the playback screen, if you do not touch the screen for 10 seconds.



- 1 - Previous Track Button
- 2 - Play/Pause Button
- 3 - Next Track Button
- 4 - Elapsed playing time indicator/Seek bar
- 5 - Menu Button (Go to list menu mode)
- 6 - Repeat Button
- 7 - System time
- 8 - Bluetooth status
- 9 - Playback info

Play/Pause Playback

1. Touch [Play/Pause] button to Pause playback.
2. Touch [Play/Pause] button to resume playback.

Switch to Previous/next file

Press [Previous] or [Next] button during playback to play previous /next file.

- Pressing [Next] button starts playback from the beginning of the next track.
- Pressing [Previous] button starts playback from the beginning of the current track; when this button is pressed again within about 5 seconds, playback starts from the beginning of previous track.

Repeat Playback

- * The repeat set as the factory default is Repeat Folder.

Touch the [Repeat] button once for Repeat Track, again for Repeat Folder.

Note: The repeat in all USB files function is not available.

Skip use seek bar

Press the [Seek] on seek bar and drag it to any position where you want to start playback.

Switch to USB Video Menu

Press [Menu] button playback will be paused, and the screen will switch to USB Video Menu.

USB Video Menu Operations

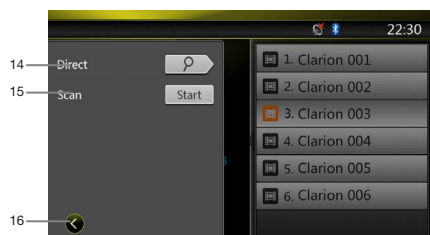

- 1 - Open option menu button
- 2 - Play/Pause Button
- 3 - Repeat Button
- 4 - Random Button
- 5 - Next Track/Fast Forward Button(long press)
- 6 - Video files in list
- 7 - Folders in list
- 8 - Folders area
- 9 - Playback status info
- 10 - Album Art
- 11 - Current file info area
- 12 - Elapsed playing time indicator/Seek bar
- 13 - Previous Track /Fast Backward Button(long press)
- 14 - Direct Button
- 15 - Scan Button
- 16 - Close option menu button

Play/Pause Playback

On USB Video menu screen, playback status is pause.

Touch button to resume playback. The screen will go to video screen automatically.

Switch to Previous/next file

Press or button during playback to play previous /next file.

- Pressing button starts playback from the beginning of the next track.
- Pressing button starts playback from the beginning of the current track; when this button is pressed again within about 5 seconds, playback starts from the beginning of previous track.

Stop Playback

1. Press the button on remote control more than 1 second. Playback is stopped.
2. To resume playback, press the button. Playback resumes from current playing time.

Repeat Playback

* The repeat set as the factory default is Repeat Folder.

Touch the button once for Repeat Track, again for Repeat Folder, Repeat All.

Random Playback

1. Touch button to Random the tracks in playing folder during playback.
2. Touch this button again to turn off the feature.

Current file info area

This area displays info of current video file: file name, number of current file/total number in current folder, Elapsed playing time/total time of current file.

Skip use seek bar

Press on seek bar and drag it to any position where you want to start playback.

Select a folder on display list

This operation is same as this in USB Audio mode.

Selecting a track on the display List

This operation is same as this in USB Audio mode.

Folders area

This operation is same as this in USB Audio mode.

Scanning the Tracks

This operation is same as this in USB Audio mode.

Searching with the Track Number

This operation is same as this in USB Audio mode.

12. iPod/iPhone OPERATIONS

iPod/iPhone can be connected by the special connector cable (CCA-750) separately sold.

Note:

- This system will not operate or may operate improperly with unsupported versions.
- For detailed information on the playable iPod/iPhone models, see our home page: www.clarion.com

Notes on using Apple iPod/iPhone

- Do not connect an iPod/iPhone to this unit with a headphone connected to the iPod/iPhone.
- After the iPod/iPhone has been connected to this unit, the buttons of iPod buttons are disabled for operation in the Music mode. In the Video mode, do not operate the buttons of iPod.
- When in the iPod mode, a special iPod/iPhone control screen is displayed different from the main screens for other modes.
- When in the iPod mode, the screen image input from the AUX terminal is output to the rear monitor.
- When no data is present, the title display will remain blank.
- The iPod/iPhone is used with the equalizer function turned OFF.
- Set the language setting of iPod/iPhone to English before connecting your iPod/iPhone. Some characters of the other languages may not be displayed correctly in this system.

Precautions on battery consumption:

If the iPod/iPhone is connected to this unit when the internal battery of iPod/iPhone has run down, this function may not operate correctly. You must connect the iPod/iPhone after charging the battery if it has run down.

Selecting the iPod Audio mode

Connect your iPod/iPhone to the USB connector via CCA-750 cable. The system will automatically detect the connected device and the iPod Audio button will be enabled for operation on the Main Menu screen.



The playback starts after a while, from where the iPod/iPhone has been paused.

- When iPod/iPhone is already connected Touch the **[iPod Audio]** button on the Main Menu screen. The system changes to the iPod mode, and starts playback from the previous position. Press **[MENU]** button on Operational Panel to return to the Main Menu.

Controlling the iPod/iPhone

iPod audio mode screen

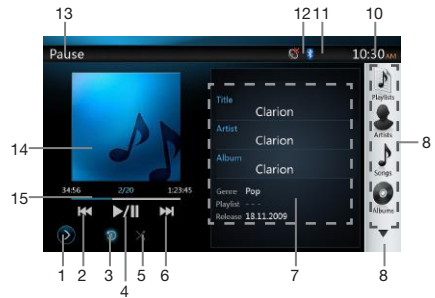

1. [Settings] Settings Button

Displays the Options screen. You can specify play modes and other settings from this screen.

2. [Previous] Previous Track Button

3. [Repeat] Repeat Button

Use to repeat the selected track.

Press once to start a Repeat one. Press again to activate a repeat all. To turn repeat off, press same button again. Repeat symbols are displayed in the info window in the upper left area of the screen.

[Repeat All]: All repeat.

[Repeat One]: 1-Track repeat.

[Repeat Off]: Repeat off.

4. [Play/Pause] Play/Pause Button

Use to control playback and pause.

(1). Touch the key during playback. Playback pauses.

(2). To resume playback touch the key again.

5. [Shuffle] Shuffle Button

Use to switch the shuffle mode on or off. When

enabled, this function performs playback of tracks in random order, regardless of the order in which they are recorded.

[Shuffle Off]: Shuffle Off.

[Shuffle Songs]: Shuffle Songs.

6. Next Track Button

7. ID3 Information

Touch the area of the ID3 Information to display the current play list.

Touch the icon can return to ID3 information display.



8. Next Page [] / Previous Page [] Button

9. Category List

Select different category songs to play. The category is same as the iPod/iPhone.

10. System Time

11. Bluetooth Status

12. MUTE Status

13. Playback Status

14. Art Work

15. Progress bar

iPod audio settings mode screen

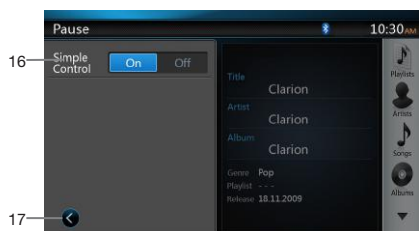

16. Simple Control:

If the Simple Control is set to . The screen will become to Simple Control Mode. It can also display the video of iPod/iPhone regardless it is iPod Audio or iPod Video mode. But only "Previous Track", "Play/Pause" and "Next Track" can be operated. (Refer to 17)

17. Close the Settings Page

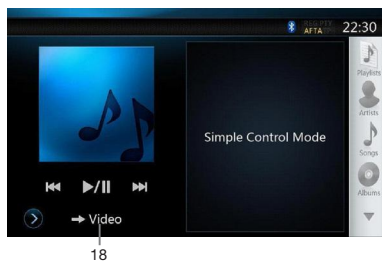

18. Display video of iPod/iPhone.

Follow operation steps to display video of iPod/iPhone in Simple Control Mode.

- Connect the iPod to USB connector via CCA-750 cable.
- Select iPod Audio mode.
- Press the button on iPod audio mode screen to display Settings page.
- Set the Simple Control to "On".
- Press button.
- Set iPod Video settings TV Out to "ON" in iPod.
- Now play video from iPod
- Video of iPod will display on the screen.
- iPhone and iPod Touch are not supported with video output in Simple Mode.

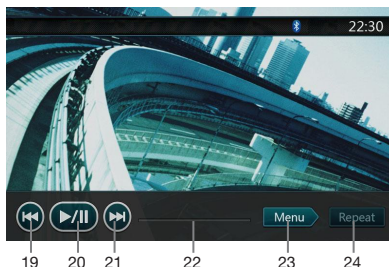

19. Previous files

20. Play or Pause video

21. Next files

22. Progress bar

The "Progress bar" is not available on this screen.

23. Menu:

Press the Menu button can display the Simple Control Mode.

24. Repeat

The "Repeat" Button can't operate on this screen.

iPod Video List mode screen

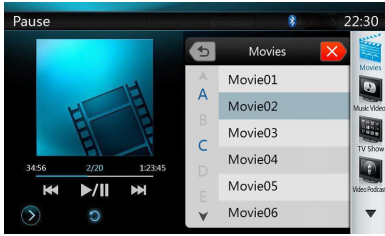

- iPod Video Settings mode screen.

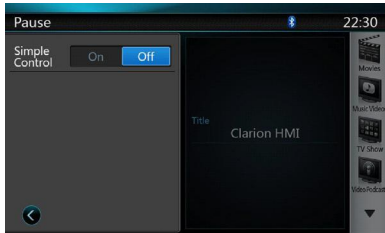

- iPod Video Simple Control Mode Screen

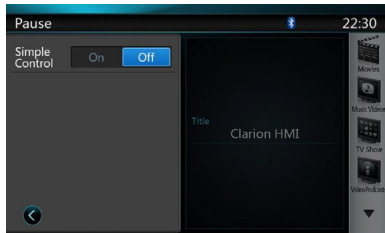

- iPod Video play mode screen.



1. iPod Video Title.
2. Elapsed playing time.
3. **Menu** Menu:

Press the Menu button can display the iPod Video mode screen.

4. **Repeat** Repeat Button:

Use to repeat the selected track.

Press once to start a single Repeat one. Press again to activate a Repeat all. To turn Repeat off, press same button again. Repeat symbols are displayed in the info window in the upper left area of the screen.

In iPod Video mode screen, there are three repeat icons:

: Repeat All.

: Repeat one.

: Repeat off.

Note:

The operation keys in iPod video mode are as same as iPod Audio mode. Please refer to the iPod Audio Mode operation key.

Note:

Video playback is not available on all iPod/ iPhone devices. Please contact your Clarion dealer for details. An optional connection cable or accessory may be required for this feature.

Note:

- "AUDIO ONLY" is displayed when the automobile is moving.
- Image data may not be played back according to the status of the iPod/iPhone
- The volume setting of video data is relatively lower than audio data. Be sure to lower the volume setting before switching to the other mode.
- Do not select the categories with no track registered from the iPod menu screen. The iPod/iPhone may be frozen. If the iPod/iPhone is frozen, reset the iPod/iPhone by following the procedure described in the instruction manual of the iPod/iPhone.
- Audio may be played back slightly out of synchronization with video images.

13. SELECTING THE Pandora MODE

Pandora®, the leading internet radio service, gives people music they love anytime, anywhere, through personalized radio stations available on a wide variety of connected devices.

To listen to Pandora internet radio, you can do as follows:

1. Turn on Pandora function of your iPod.
2. Connect your iPod to the unit.
3. When iPod/iPhone is already connected, touch the [Pandora] icon on the Main Menu screen.

• Pandora mode ID 3 Information Screen

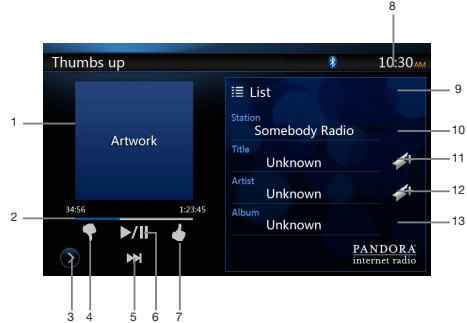

- 1-Art Work
- 2-Progress bar
- 3-[⚙️] Settings Button
- 4-[👎] Thumbs-down
Press this button Thumbs-down current track and play next track.
- 5-[▶️] Next track Button
- 6-[⏸️] Play/Pause Button
Use to control playback and pause.
(1). Touch the key during playback. Playback pauses.
(2). To resume playback touch the key again.
- 7-[👍] Thumbs-up
- 8-System time
- 9-[☰] List Button
Press this button to show List Screen
- 10-Current station name
- 11-Current title.
Touch [👍] icon to store current title to track favorites list.
- 12-Current artist.
Touch [👍] icon to store current artist to artist favorites list.
- 13-Current album name.

• Skipping a track (Pandora mode)

Press [▶️] button during playback, tracks are skipped and starts playback from the beginning of the next track.

Note:

- Some track are not able to be skipped.
- If skip limit has been reached(Skip 6 tracks in 1H),this fuction will not available.

•Track rating

Press [👍] or [👎] button to thumbs-down or Thumbs-up current track, and the button will light.

Note:

- Press [👍] button will skip to next track (skip limit has not been reached).
- Some track is not able to be rated (i.e. audio ads and shared station content). The thumbs buttons will disable.

•Bookmarking

Touch [👍] button to store current title or artist to track favorites list.

Note:

- Some track are not able to be bookmarked (i.e. audio ads). In this case the bookmark buttons will disable.

• Pandora mode Station List

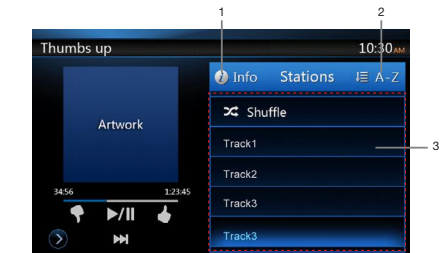



- 1- [Info] button
Press this button to display ID 3 Information Screen.
- 2- [A-Z] button
Press this button to sort the list by first letter,press again to sort the list by date.
- 3- Station list,touch to select station play.
When the desired station is not displayed, press and flick the station list up or down.

• Add New Station

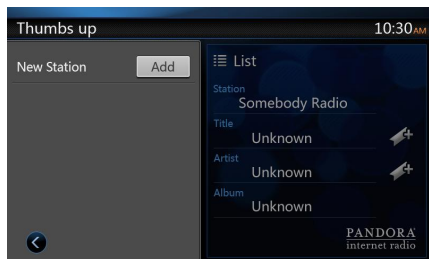
1. Press  button on Pandora mode ID 3 Information Screen to enter Pandora mode Setting screen.



2. Press  button to add a new Station
3. Press  button to close the setting screen

14. Bluetooth AUDIO PLAYER OPERATIONS

Some Bluetooth cellular phones have audio features, and some portable audio players support the Bluetooth feature. These devices will be called as “Bluetooth audio players” in this manual. This system can play audio data stored in a Bluetooth audio player.

Note:

- This system will not operate or may operate improperly with some Bluetooth audio players.
- For detailed information on the playable Bluetooth audio players, see our home page: www.clarion.com

Selecting the Bluetooth Audio mode

1. Press **[MENU]** button on Operational Panel to return to the Main Menu.
2. Touch the **[Bluetooth Audio]** key to select the Bluetooth Audio mode.

The system changes to the Bluetooth mode. If the connection with a Bluetooth audio player has been already established, you may select the Music function.

- When the connection with a Bluetooth audio player has been established, the  icon is displayed at the top of the screen.



Bluetooth audio player settings

Confirming Bluetooth Information and setting Pass Key

You can confirm various information concerning about the Bluetooth Interface features.

1. Touch the **[>]** key to display the information on the screen.

2. When you finish confirming the Bluetooth information, touch the **[<]** key to return to the previous screen.



If you want to change the Pin Code setting of this unit, perform the following steps.

- The factory default setting is “1234”.
3. Touch the text box of the Pin Code item to display the Ten-Key Pad screen.
 4. Enter your desired 4-digit PIN number, and then touch the **[OK]** key.

Note:

MIC Gain is disabled in Bluetooth Audio mode settings.

Registering your Bluetooth audio player (Pairing)

You can register up to 3 Bluetooth audio players.

1. Turn on the power of the Bluetooth audio player you wish to register.
2. Touch the Device key  to display the Device Select screen.



3. Touch the **[+]** key to display the Inquiring Device screen.





4. Touch your desired Device and press the key to register for the Bluetooth audio player.
5. If entering the Pass Key code is prompted on your Bluetooth audio player, enter the Pass Key code set to this unit.
 - You can change the Pass key setting of this unit from the BT Info screen.
 - You also can add the favorite icon to the connected device. There are 10 favorite icons for selection.

When the pairing operation completes, the registered Bluetooth audio player is set as the current device, after selecting the favorite icon, the display return to the device list screen. Press button, the display will return to the Bluetooth audio mode screen.

Note:

- You cannot register the same Bluetooth audio player which is already registered. If you wish to change the Device key registered, once delete the corresponding Bluetooth audio player from the previous Device key, and then register it again to your desired Device key.

• To delete the Bluetooth audio player registration

1. Touch the key to delete the device.

A confirmation screen is displayed.

2. Touch the key to confirm delete.

Selecting the Bluetooth audio player

To change the current Bluetooth audio player to the other device which is already registered, perform the following operation.

1. Touch the Device key to display the Device Select screen.
2. Touch the currently connected device, then press the key to disconnect the active device.
3. Touch the desired Device key you wish to use. Press key to select it as your active device. The corresponding cellular phone is set as current telephone.
 - If the power of the cellular phone is not turned on, turn it on.
 - The cellular phone may prompt to acknowledge the Bluetooth connection or ask to enter the Pass Key code of this unit.

Perform these operations according to the message displayed.

4. Touch the key to return to the previous screen.

Controlling the Bluetooth audio player

Note:

- Occasionally, depending on the environment, playback sounds may be fragmented, or switch noises may be generated.

Playing a music

After the connection with a Bluetooth audio player is established, the play mode is automatically engaged.

- When playback is not started for some devices, touch the key manually.

Pausing playback

1. Touch the key during playback.

Playback pauses.

2. To resume playback, touch the key. Playback resumes.

Skipping a track (searching)

3. Press the or button during playback.

Tracks are skipped, as many as the times the button is pressed, and playback starts.

Stopping playback

4. Press the button during playback.

Tracks are stopped, press the button to playback the first Track.

15. Bluetooth TELEPHONE OPERATIONS

When the connection with your Bluetooth cellular phone is established, the following functions are available on this unit:

- Listening to your telephone calls on the car speakers.
- Answering to an incoming call.
- Making a call using the Ten-Key pad screen.
- Making a call using the Phone Book data in the selected cellular phone.
- Making a call using the History data of the dialed/received calls.

Note:

- Some cellular phones may not be able to transfer the Phone Book data to head unit.
- The Phone Book data transmission may take a long time. The operations of sending calls are disabled during the data transmission.
- You can talk with other party by using the internal microphone. When it is hard to hear for the other party in accordance with the communication condition or the used telephone, please use the optional microphone (RCB-199), and set the Microphone Select setting to "External". The sound will be improved, but noises may still be heard depending on the communication condition.

Select the BT Phone mode

1. Press **[MENU]** button on Operational Panel to return to the Main Menu.
2. Touch the **[Bluetooth Telephone]** key to select the Bluetooth Telephone mode.

The Telephone screen is displayed.

- When no Bluetooth Telephone connected, the icon  is displayed at the top of the screen.



- When the connection with a Bluetooth Telephone has been established, the icon  and signal level indicator are displayed at the top of the screen.



Bluetooth Telephone settings

Confirming Bluetooth Information and setting Pass Key

You can confirm various information concerning the Bluetooth Interface features.

1. Touch the **[>]** key to display the information on the screen.
2. Perform setting for the desired item. See the following sections for detail.
3. When you finish confirming the Bluetooth information, touch the **[<]** key to return to the previous screen.

If you want to change the Pass Key setting of this unit, perform the following steps.

1. Touch the text box of the Pass Key item to display the Ten-Key Pad screen.
- The factory default setting is "1234".
2. Enter your desired 4-digit PIN number, and then touch the **[OK]** key.

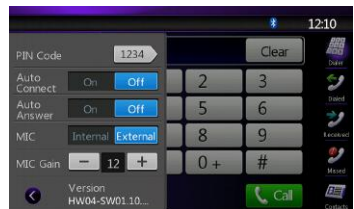

Setting Automatic Connection

The system automatically reconnects the cellular phone after the connection is lost or the system is restarted.

- The factory default setting is "OFF". Touch the **[On]** or **[Off]** key of the Automatic Connection item to set the function ON or OFF.

Setting Automatic Answer

If a call comes in, answer automatically after 5 seconds.

- The factory default setting is "OFF". Touch the **[On]** or **[Off]** key of the Automatic Answer item to set the function ON or OFF.

Selecting Microphone

You can select the microphone to be used.

- The factory default setting is "Internal". Touch the **[Internal]** or **[External]** key of the Microphone Select item to set the function.

Setting Microphone Gain

You can adjust the input level of the microphone in 16 levels.

- The factory default setting is "8".
- Touch the level indicator button of the Microphone Gain item to adjust the input level.

Note:

- The input level of the microphone can be affected by its surroundings. Adjust the level if the person on the other end of the telephone has a reception problem.

Register your cellular phone (Pairing)

You can register up to 3 cellular phones. The registering method is as same as "Registering your Bluetooth audio player".

- Turn on the power of the cellular phone you wish to register.
- Touch the Device key **[Bluetooth]** to display the Device Select screen.



- Touch the **[+]** key to display the Inquiring Device screen.

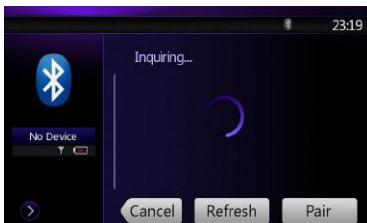

- Touch your desired Cellular key to select the key for the cellular phone to be registered. And press the **[Pair]** key to register for the Bluetooth audio player.
 - You cannot select the Cellular key of which another cellular phone is already registered. Select a blank Cellular key.
 - If entering the Pass Key code is prompted on your cellular phone, enter the Pass Key code set in this unit.
 - You can change the Pass key setting of this unit from the BT Info screen under the Telephone Settings screen.
 - You can also add the favorite icon to the connected device. There are 10 favorite icons for selecting.
- When the pairing operation completes, the registered cellular phone is set as the current telephone, and the display returns to the Telephone screen.

Note:

- You cannot register the same cellular phone which is already registered. If you wish to change the Cellular key registered, once delete the corresponding cellular phone from the current Cellular key, and then register it again to your desired Cellular key.
- To delete the cellular phone registration
 - Touch the **Delete** key to delete the device. A confirmation screen is displayed.
 - Touch the **OK** key to confirm delete.

Select the cellular phone

To change the current cellular phone to the other device which is already registered, perform the following operation.

- Touch the **Bluetooth** key to display the Device Select screen.
 - Touch the currently connected device, then press **Cut** key to disconnect the active device.
 - Touch the desired Device key you wish to use. Press **Connect** key to select it as your active device. The corresponding cellular phone is set as the current telephone.
- If the power of the cellular phone is not turned on, turn it on.
 - The cellular phone may prompt to acknowledge the Bluetooth connection or to enter the Pass Key code of this unit. Perform these operations according to the message displayed.
- Touch the **Back** key to return to the previous screen.

Obtaining the Phone Book data

Sending the Phone Book data from the cellular phone enables you to make a call using the Phone Book function from this unit.

- Perform the Object Push transfer operation of the Phone Book data on the current cellular phone.

For details of the operation, see the operation manual of the cellular phone.

Note:

- Some cellular phones may not be able to transfer the Phone Book data.
- Some cellular phones cannot transfer the Phone Book data when the hands-free mode is set or it is also registered in the Bluetooth mode. In those cases, disable these functions from the cellular phone before performing the Object Push transfer.
- Some cellular phones may transfer Phone Book data automatically.

Telephone operations**Making a call using the Ten-Key pad**

- Touch the **Phone** key to display the Ten-Key pad screen.
- Enter the telephone number by using the Ten-Key pad displayed on the screen.

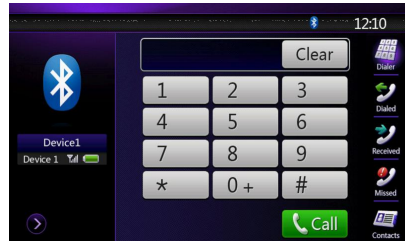

- Touch the **Call** (Send) key to call the entered number.

- The following Telephone Interrupt screen is displayed during phone call.

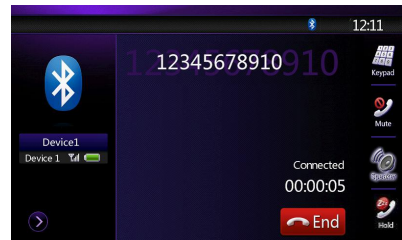

- Touch the **Call** key to talk by using the cellular phone and canceling the hands-free function (Private Mode). To return to the hands-free mode, touch the **Phone** key again.
- Touch the **Mute** key to mute the microphone. Now you can hear the other side, but the other side cannot hear your side.
- Touch the **Call** key to hold the current phone call, now you can answer to the other incoming call. Touch again to talk with previous call.

If during a call with a third-party call, you can keep the current call to answer a third party or hang up the current call to answer a third party. You can also ignore the third-party calls.

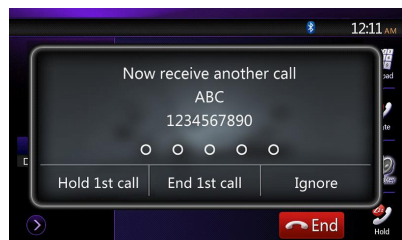

- When the call is finished, touch the  key to hang up.

Note:



- Depending on some special cellular phone, the Telephone Interrupt screen may be closed and the connection with this system may be disconnected when entering the Private mode.

Making a call using the Phone Book

You can use the Phone Book data obtained from the cellular phone to make a call from this unit.



Note:

- Before using this function, the Phone Book data must be sent from the cellular phone.
- Only the Phone Book items with at least one telephone number registered in the captured Phone Book data are displayed on the Phone Book screen.

- Touch the  key to display the Phone Book screen.
- Touch the desired Name key you wish to dial.
 - Flick the list up and down to scroll the list.
- Touch the  key to call the specified number. The Telephone Interrupt screen is displayed, and calling starts.
- When the call is finished, touch the  key to hang up.

Making a call using the History

The system will memorize the Dialed/Received calls record data in the memory. You can confirm it and use it to make a call from this unit.



- Touch the  key. The History List screen is displayed.
 - The items are sorted by Dialed, Missed and Received calls.
 - Flick the list up and down to scroll the list.
- Touch the desired History item key you wish to dial.
- Touch the  key to call the specified number. The Telephone Interrupt screen is displayed, and calling starts.
- When the call is finished, touch the  key to hang up.

Answering to an incoming call

When a call comes in, the following Telephone Interrupt screen appears.



You can answer to the incoming call on this system by the following operation.

- Touch the  key to answer the call.
- When the call is finished, touch the  key to hang up.

16. RADIO OPERATIONS

Listening to the Radio

1. Touch the **[Tuner]** button on the Main menu display. The tuner mode screen is displayed.
2. Press the **[FM1/2/3/AM]** button or touch the **[Band]** key on remote control to select the radio band. Each time the button is pressed, the radio reception band changes in the following order:
FM1->FM2->FM3->AM ->FM1...



1. Preset Scan Button
2. Direct Button
3. Preset List Button
4. Frequencies Display
5. Tune Up
6. Tune Down
7. Band Display
8. LOC/DX Display
9. Bluetooth Display
10. System Time

Seek Tuning

1. Press the **[FM1/2/3/AM]** button to select the radio band (FM or AM).
2. Touch the **[Direct]** key, and then flick the BIG Frequency up and down to search for next available station.
 - When flick the frequency up, the station is searched in the direction of higher frequency.
 - When flick the frequency down, the station is searched in the direction of lower frequency.

Step Tuning

1. Press the **[FM1/2/3/AM]** button to select the radio band (FM or AM).
2. Touch the **[▲]** or **[▼]** key in frequency panel to tune up or down by one step.

Recalling a preset station

1. Press the **[FM1/2/3/AM]** button to select the desired band (FM or AM) on the tuner.
2. Touch the **[Preset]** key, Press the preset station (1 to 6) on preset list.
3. Press the **[>]** key, then press the **[Start]** button to auto search and store the stations.

Manual memory

1. Touch the desired Band key to select the band you wish to store.
2. Tune to a station you want to store using the seek tuning, step tuning, or preset tuning.
3. Touch and hold the desired Preset key you want to store for about 3 seconds.

Auto Store

The Auto Store is a function for storing up to 6 stations that are automatically searched in sequentially. If the number of receivable stations cannot reach to 6, the previous stored station remains.

1. Touch the **[FM1/2/3/AM]** key to select the desired band. (FM or AM)
2. Press the **[>]** key, and then press the **[Start]** key to start the Auto Store.

A beep sounds and the stations with good reception are stored automatically to the preset list.



Preset Scan

The Preset Scan receives the stations stored in the preset memory in order. This function is useful when searching for the desired station in memory.

1. Touch the **[FM1/2/3/AM]** key to select the desired band. (FM or AM)
2. Touch the **[Preset Scan]** key to start the Preset Scan. The unit starts scanning each station for 10 seconds sequentially. But the station stored is not a valid station; the scanning time is only 2 seconds.
3. When the desired station is tuned in, touch the **[Preset Scan]** key again to stay in that station.

LOC/DX Setting

The DX / LOC setting changes the tuner sensitivity in order to separate closely spaced stations. This feature is useful in areas that have many radio stations in close proximity.

1. Touch the **[Local]** key to switch to LOCAL tuner sensitivity.
2. Touch the **[DX]** key to switch to DX tuner sensitivity.

17. HD Radio™ RECEIVER OPERATIONS

This function is available when an HD Radio tuner is connected.

This unit can control the following HD Radio tuner:

- HD Radio Tuner (THD400)

Note:

- Be sure to turn off the ACC power before connecting/disconnecting the HD Radio tuner.
- Not all areas offer HD Radio broadcasts
- HD Radio stations may not always broadcast sub channels
- Volume levels of HD Radio stations may vary. Increase the volume gradually from the minimal setting after the channel is selected. Be sure to lower the volume setting before switching to another mode or channel.

Additional information about HD Radio can be found at www.hdradio.com

Listening to HD Radio

Note: Connect THD400 HD Radio™ black box to activate HD Radio function.

1. Touch the Tuner button on the Main menu display. The HD Radio mode screen will be displayed.
2. Press the **[FM1/2/3/AM]** button or touch the **[Band]** key on remote control to select the radio band. Each time the button is pressed, the radio reception band changes in the following order: FM1, FM2, FM3, AM, FM1...

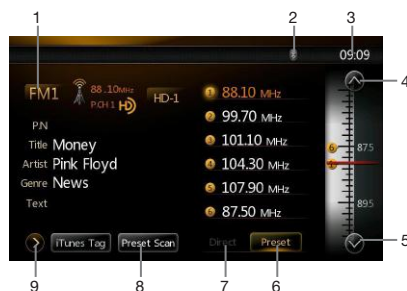

1. Band Display
2. Bluetooth Status Display
3. Time Display
4. Tune Up
5. Tune Down
6. Preset List Button
7. Direct Button
8. reset Scan Button
9. Setting Button

Seek Tuning

1. Press the **[FM1/2/3/AM]** button to select the radio band (FM or AM).
2. Touch the **[Direct]** key, and then flick the BIG Frequency up and down to search for next available station.
 - When flick the frequency up, the station is searched in the direction of higher frequency.
 - When flick the frequency down, the station is searched in the direction of lower frequency.

Step Tuning

1. Press the [FM1/2/3/AM] button to select the radio band (FM or AM).
2. Touch the [▲] or [▼] key in frequency panel to tune up or down by one step.

Recalling a preset station

1. Press the [FM1/2/3/AM] button to select the desired band (FM or AM) on the tuner.
2. Touch the [Preset] key, Press the preset station (1 to 6) on preset list.
3. Press the [▶] key, then press the [Start] button to auto search and store the stations.

Manual memory

1. Touch the desired Band key to select the band you wish to store.
2. Tune to a station you want to store using the seek tuning, step tuning, or preset tuning.
3. Touch and hold the desired Preset key you want to store for about 3 seconds.

Auto Store

The Auto Store is a function for storing up to 6 stations that are automatically searched in sequentially. If the number of receivable stations cannot reach to 6, the previous stored station remains.

1. Touch the [FM1/2/3/AM] key to select the desired band. (FM or AM)
2. Press the [▶] key, and then press the [Start] key to start the Auto Store.

A beep sounds and the stations with good reception are stored automatically to the preset list.

HD Radio Sub channel Function

If the [HD1] key is enabled, please touch the [HD1] key to tune to next available sub channel.

Note: *Not all stations have HD Radio sub channel broadcasts. The [HD1] key is only enabled when current station has sub channel broadcast and signal strength is strong enough.*

iTunes® Tagging Function

A new feature is available to mark songs on HD Radio broadcasts for review and purchase at a later time from the listener's personal computer. This feature is available through HD Radio™ receivers that build in the new "iTunes Tagging" feature.

Now iTunes Tagging system is only available for Apple iPod and iPhone.

Operation:

1. Touch [iTunes Tag] key to store the current music information to memory.
2. You may store up to 64 tags to the memory of head unit.
3. When an iPod/iPhone is connected to the unit, the unit will automatically transfer the tags in memory to the iPod/iPhone

Note:

Not all broadcasted material can be tagged, in this case, the [iTunes Tag] button will be disabled

18. SiriusXM Satellite Radio OPERATIONS

Everything worth listening to is on SiriusXM, getting over 130 channels, including the most commercial-free music, plus the best sports, news, talk and entertainment. A SiriusXM Vehicle Tuner (sold separately) and Subscription are required.

For more information, visit www.siriusxm.com/activateradio, or call 1-866-635-2349.

To activate SiriusXM Canada service go to www.xmradio.ca and click on "ACTIVATE RADIO" in the top right corner, or call 1-877-438-9677

Selecting a Satellite Radio mode

Press the [SiriusXM] button on Main Menu display. The system changes to the SiriusXM Satellite Radio mode. The SiriusXM mode screen is displayed.

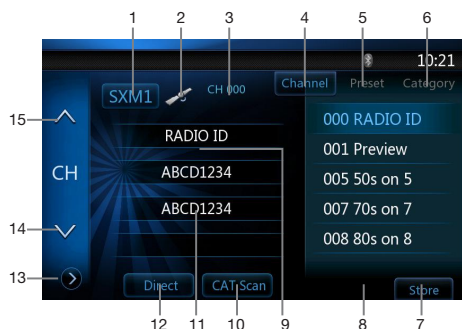

- 1- Band switch Button
- 2- Show signal status
- 3- Current program information
- 4- All program list Button
- 5- Preset List Button
- 6- Program style list Button
- 7- To delete the selected preset programs/Store the program
- 8- Program list
- 9- Current program name
- 10- Category Scan Button
- 11- Current program ID3 information
- 12- Keypad Button
- 13- Setting Button
- 14- Next program Button
- 15- Previous program Button

Displaying the Identification (ID) Code

Before you listen to satellite radio, you must subscribe to the service using the SiriusXM Radio ID number.

Touch the button on the SiriusXM Menu display to enter Settings menu.

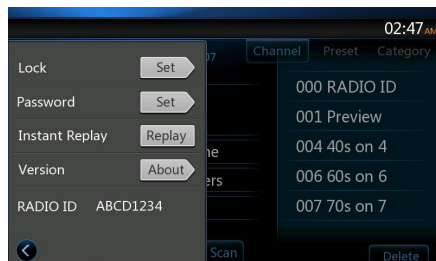

The SiriusXM Radio ID can be found by tuning to Channel 0. In addition, the Radio ID is located on the bottom of the SiriusXM Connect Vehicle Tuner. Please note that the SiriusXM Radio ID does not include the letters I, O, S or F.

Channel Selection

1. Touch the button on the SiriusXM Menu display to enter channel list preview mode. You can select any channels in list directly.
2. Select the channel with and . Only channels that can be received are selected. Channels that are locked and channels not covered by the contract will be skipped. The receiver seeks the next available channel below or above the current channel.

Channel Selection with the channel number

1. Touch the direct access button on the SiriusXM Menu display to enter direct channel selection.
2. Enter the channel number of your desired station by touching the [0] to [9] keys.
If you enter a wrong number, you can cancel it by touching the key.
3. Touch the key. The radio channel you entered will be tuned.

Presets Channel Selection with the channel number

A total of 22 satellite radio stations each band can be stored in the receiver's memory. You can access the presets by pressing the Presets button. This allows you to store your favorite satellite radio stations in the memory for later recall.

1. Touch button and enter the preset menu.
2. When the desired radio station is not displayed, press and glide the track list up or down.

Preset Store

1. Touch and hold the corresponding preset key for more than 2 seconds to save the current channel.
2. Touch the button to save the current channel to the first empty place in presets list.

Deleting a Preset

If current channel is already in presets list, the **Store** key will become to **Delete** key, press **Delete** key to remove current channel from presets list.

Receiving Stations by Category

Satellite Radio allows you to select broadcast channel category (contents).

1. Touch **Category** button to enter category mode.
2. Press and flick the category list up or down.
3. Touch the desired category item key to enter channel lists belonging to this category.
4. Select the desired channel by touching it momentarily on the list.
5. Right flick this channel list to go back to category list.

Parental Control Lock / Unlock

The SiriusXM Parental Control feature allows you to control access to channels that you consider inappropriate for younger listener.

When enabled, the Parental Control feature requires you to enter a passcode to tune to the locked channels.

Information on setting up the passcode, setting up the channels to be locked, and the method to access the locked channels is described below.

1. Touch **Lock** button to enter setting page.
2. Touch **Set** button in Lock item to enter pass code screen, enter the right code to enter lock list.
3. Press and flick the track list up or down.
4. Press and hold the channel item, and it will be locked or unlocked alternately.
5. Touch the channel item, tune to the channel.

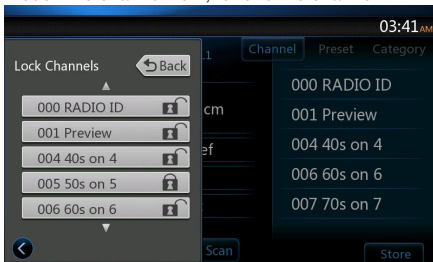

Setting the password

1. Touch **Lock** button to enter setting page.
2. Touch **Set** button in password item to set a new pass code following the screen indicator.

If you enter a wrong number, you can cancel it by touching the **Clear** key.

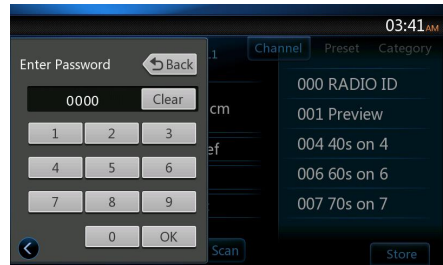

Note:

You must input the correct code to enter lock list. When you try to tune to a locked channel by direct tune keypad, it will display password keypad. Only entering correct code can tune to that channel, otherwise it will go back to the previous channel.

The default pass code is 0000.

SiriusXM Replay™

The Replay feature allows you to pause, rewind, and replay live SiriusXM Satellite Radio content..

1. Touch **Replay** button to enter setting page.
2. Touch **Replay** button in Instant Replay item to enter Instant Replay mode.



- 1- Playback Status
- 2- Previous track/program
Fast Backward (long press)
- 3- Play/Pause Button
- 4- Next track/program
Fast forward (long press)
- 5- Go to Live mode
- 6- remain time
- 7- Buffer usage
- 8- Playback position
- 9- Current track play time / current track total time

19. AUX 1 / AUX 2 OPERATIONS

External peripheral devices, including a game console, camcorder, iPod/iPhone, etc. can be connected to the AUX 1 or AUX 2 connector on the front or back of this unit using the A/V media cables.

Switching to AUX IN / AV IN mode

- Press **[AUX 1]** or **[AUX 2]** button on Main Menu to select desired mode (when unit is connected). If the external device connected to AUX 1 or AUX 2 input have audio signal, the unit will broadcast audio of external device.
- Press **[Menu]** button on Operational Panel to return to the Main Menu.

You cannot directly control external devices connected to AUX 1 or AUX 2 input.



20. CAMERA OPERATIONS

Switching to Camera mode

Press **[Camera]** button on Main Menu to select desired mode.

The LCD will display the external camera video. The screen will display "No Video Signal" menu, if a valid camera is not connect to this head unit.

Press Menu button on Operational Panel to return to the Main Menu.

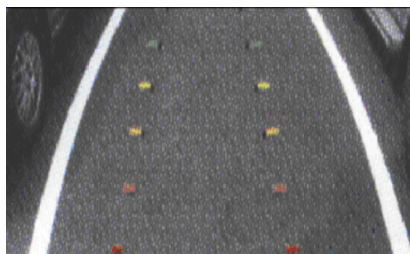
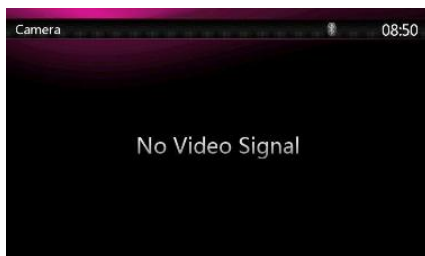

Note:

If the reverse cable is connected correctly to the car, the center unit to switch to camera mode automatically when the car is in reverses.

21. REAR SOURCE OPERATIONS

If rear monitors are installed in the rear seat and connected to the rear zone AV output, passengers in the back seats can watch the DVD/iPod Video/AUX1/AUX2 video separately from front source.



1. Press the button to access the rear source menu.
2. Press the button again to back to front source menu.

Multi-Zone Operation

Independent sources can be played simultaneously on the unit. For example, a FM/AM console can be playback on the front screen while DVD video is available to rear passengers. But now can't select DVD video in front.

Access Rear-Zone

1. Touch the Rear button on Main Menu to access the Rear Source.
2. Use the Multi-Zone Remote Control to access the Rear-Zone and select a source to play.

Exit Rear-Zone

1. Touch the 2-Zone off button to close the Rear Source.
2. Use the Multi-Zone Remote Control to closed

NOTE:

1. If the source is selected as the front, the source in rear can't be selected.
2. If the source is selected as the rear, the source in front can't be selected.
3. Press the Front Button to access the main menu but not close the Rear

DVD Video in Rear



1. : Next Row Buttons
Press the button can display the hidden button.
2. : Previous chapter.
3. : Play or Pause video.
4. : Next chapter.
5. Elapsed playing time indicator.
6. : Menu Button
7. : Front/Rear switching button

If the screen displays Rear Source, press to switch to Front Source.

If the screen displays Front Source, Press to switch to Rear Source.



8. : Audio Channel switching Button.
Use to repeat the Title or Chapter.
Press once to start Repeat Chapter. Press again to activate Repeat Title. To turn Repeat off, press same button again. Repeat symbols are displayed in the info window in the upper left area of the screen.
9. : Audio Channel switching Button
10. : Subtitle switching Button
11. : INFO Button
12. : Direct chapter or title searching Button

DVD Video Rear Source Control Info mode.



Press button to return.

DVD Video Rear Source Control Direct mode.

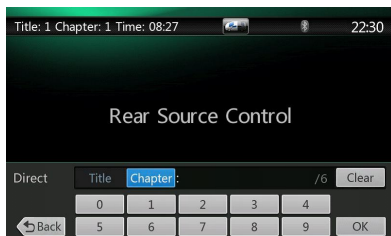

Note: More detail please refer to DVD Video Front source.

AUX 1 in Rear

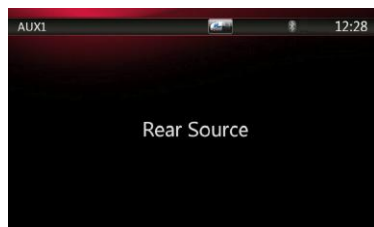

AUX 2 in Rear



iPod Video in Rear

iPod Video Rear Source Control Play Mode



1. : Previous file.
2. : Play or Pause video.
3. : Next file.
4. Elapsed playing time indicator.
5. Menu:
Press the Menu button can display the iPod Video Rear Source mode screen.
6. Repeat Button (Same as iPod function of front source)
7. : Front/Rear button

If the screen displays Rear Source, press to switch to Front Source.

If the screen displays Front Source, Press to switch to Rear Source.

iPod Video Rear Source ID3 Mode



Note:

If the source is selected as the front, the source in rear can't be selected.

If the source is selected as the rear, the source in front can't be selected.

Press the Front Button to access the front main menu but the rear source will keep running.

Remote Control in Rear

Remote Control is always available for the front source, however, it is available for the rear source if the screen displays Rear Source Control of DVD Video or iPod Video.

22. SETTING OPERATIONS

Press **[Setting]** button on the Main menu screen.
The Setting menu screen will be displayed.

General Setup Menu

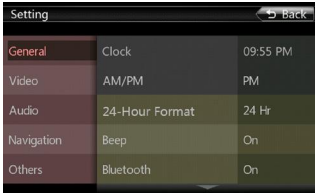

- Clock:** Set system clock.
- AM/PM:** Set AM or PM when current time mode is 12HR mode.
- 24-Hour Format:** Set the time display mode.
- Beep:** Turn on or turn off the beep confirmation sound.
- Bluetooth:** Set the Bluetooth ON or OFF.
- Wallpaper:** Choose the desired wallpaper.



Input Aux Sense: Auxin input switch, including Low, Mid, High.

Dimmer Mode: Select screen dimmer mode. There are three options, Day, Night and Auto.

Tel Speaker: There are two options, Left and Right. For example, if current setting is Left, when BT phone is coming in, only left speaker can hear the phone.

PANDORA: Set PANDORA On or Off.

TFT Auto Open: There are two options, On and Off. If current setting is On, the TFT screen will slide out automatically when the system is power on. If current setting is Off, the TFT screen will always keep the last position when the system is power on.

Camera Audio: There are three options, Off ,On ,Mute. When the car is in reverses, if current setting is Off ,current source will continue play; if current setting is On ,current source will pause and camera audio will play; if current setting is Mute , system mute.

Camera Input Format : There are two options, NTSC and PAL.

Version: Display the software version information.

Note:

- *AM/PM and Clock can be adjusted when set the system time not to be synchronized with GPS local time.*

Video Setup Menu



This menu includes: DVD Wide Screen Mode; Brightness.

DVD Wide Screen Mode: Set the DVD wide screen mode on or off.

Brightness: Set brightness value from 0 to 20.

Audio Setup Menu

Setting		
General	Balance	0
Video	Fader	0
Audio	Select EQ	Off
Navigation	Sub Woofer Ctrl	14
Others	Sub Woofer Phase	Normal

Setting		
General	Sub Woofer Phase	Normal
Video	High Pass Filter	Through
Audio	Low Pass Filter	Through
Navigation	Amp Cancel	Off
Others	Magna Bass EX	Off

This menu includes: Balance, Fader, Select EQ, Sub Woofer Ctrl, Sub Woofer Phase, High Pass Filter, low Pass Filter, Amp Cancel and Magna Bass EX.

Balance: Choose the desired volume for left and right speaker.

Fader: Choose the desired volume for front and rear speaker.

Select EQ: Choose the desired mode: Bass Boost, Impact, Excite, Custom and OFF.

Sub Woofer Ctrl: Choose the desired sub woofer gain from 0 to 14.

Sub Woofer Phase: Choose the sub woofer phase normal or reverse.

High Pass Filter: Choose the high pass filter through/55Hz/85Hz/120Hz.

Low Pass Filter: Choose the low pass filter through/62Hz/95Hz/135Hz.

Amp Cancel: Choose the amplifier audio output on or off.

Magna Bass EX: Choose the loudness on or off.

Navigation Setup Menu

Setting		
General	GPS Time	Ignore
Video	Navi Interrupt	On
Audio	Voice Guidance	On
Navigation	Voice Guidance Mix	On
Others		

This menu includes: GPS Time, Navi Interrupt, and Voice Guidance

GPS Time: Set the system time to be synchronized with GPS local time or not.

Navi Interrupt: There are three choose: On/Popup/Off. "On": The navigation screen will cover to AV screen when reaching some key point. "Popup": When

small turn info window will pop up in the top of the AV screen to indicate the key point. "Off": Turn off this function.

Voice Guidance: Enable or disable the navigation voice guidance.

Voice Guidance Mix: There are two choose: On/Off. "On": The navigation voice guidance will play at the same time and the voice of the current source. "Off": Only the navigation voice guidance. (Voice Guidance On)

Others Setup Menu

Settings		
General	Set Password	Locked
Video	Parental Control	Kid Safe
Audio	Audio Language	English
Navigation	Subtitle Language	English
Others	System Language	US English

Settings		
General	Subtitle Language	English
Video	System Language	US English
Audio	Blinking LED	Off
Navigation	Screen Calibration	No
Others	Factory Default	No

Set password: Set the password for DVD parental control.

Parental control: Set the rating of the age. It contains Kid Safe/G/PG/PG- 13/PG-R/R/NC- 17/Adult.

Audio Language: Set the Language for DVD Audio.

Subtitle Language: Set the Language for DVD subtitle.

System Language: Set the Language for system screen.

Blinking LED: Select the blinking LED On/Off.

Screen Calibrate: The function of it is to select the TS Calibrate YES or NO.

Factory Default: The function is to select to load factory default or not.

Set the Anti-Theft code

1. If your unit is unlocked, hold the **[General]** button more than 2 seconds, then the Anti-Theft setting mode will display. Users can change anti-theft code. Click **[Yes]**, the numerical keypad is displayed. Enter the new password twice, then anti-theft code is set and your unit is secured.

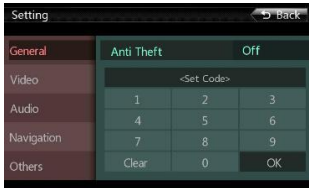

When the Anti-theft is "On", you need enter correct Anti-theft code to turn the unit on. If you enter wrong code three times, the unit is locked, and must be unlocked by the professionals.

2. If your unit is secured, hold the **[General]** more than 2 seconds, then the Anti-Theft setting mode will display. The numerical keypad is displayed, enter the right code to unlock.

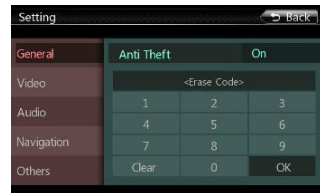

23. TROUBLESHOOTING

GENERAL

Problem	Cause	Measure
Power does not turn on. (No sound is produced.)	Fuse is blown.	Replace with a fuse of the same amperage. If the fuse blows again, consult your store of purchase.
	Incorrect wiring.	Consult your installation center.
Nothing happens when buttons are pressed. Display is not accurate.	The microprocessor has malfunctioned due to noise, etc.	Press the reset button with a thin rod. Note: When the Reset button is pressed, turn off the power. * When the Reset button is pressed, frequencies of radio stations, titles, etc. stored in memory are cleared.
The remote control unit does not work.	Direct rays of the sun fall on the light-receptive part of the remote control unit.	When direct rays of the sun fall on the light-receptive part of the remote control unit, it may not work.
	The battery of the remote control unit is dead or there is no battery in the remote control unit.	Check the battery of the remote control unit.

DVD PLAYER

Problem	Cause	Measure
Disc cannot be loaded.	A disc is already loaded.	Eject the disc before loading the new one.
	There is foreign matter already in the disc slot.	Remove the foreign matter, or consult a service station.
Sound skips or is noisy.	Disc is dirty.	Clean the disc with a soft cloth.
	Disc is heavily scratched or warped.	Replace with a disc in good condition.
Sound is bad directly after power is turned on.	Condensation may form on the internal lens when the car is parked in a humid place.	Let dry for about 1 hour with the power on.
Video images are not displayed.	The parking brake is not engaged.	Check that the parking brake is engaged.
Disc cannot play with the display "PARENTAL VIOLATION" shown.	Feature exceeds set parental level.	Release the view limitation or change the parental level. See the subsection "Setting up the parental level".

USB DEVICE

Problem	Cause	Measure
USB device cannot be inserted.	The USB device has been inserted with wrong direction.	Reversing the connection direction of the USB device, try it again.
	The USB connector is broken.	Replace with a new USB device.
USB device is not recognized.	The USB device is damaged.	Disconnect the USB device and reconnect. If the device is still not recognized, try replacing with a different USB device.
	Connectors are loose.	
No sound heard and no file display on file list	No MP3/WMA file is stored in the USB device.	Store these files properly in the USB device.
Sound skips or is noisy.	MP3/WMA files are not encoded properly.	Use MP3/WMA files encoded properly.
The video of iPod/iPhone image is disturbed	The TV Signal setting of the iPod/iPhone is not set correctly.	Set the TV Signal setting (NTSC/PAL) of the iPod/iPhone correctly.

Bluetooth

Problem	Cause	Measure
Cannot pair the Bluetooth enable device with the car audio system.	The device does not support the profiles required for the system.	Use another device to connect.
	The Bluetooth function of the device is not enabled.	Refer to the user manual of the device for how to enable the function.
The audio quality is poor after connection with a Bluetooth enabled device.	The microphone is not correctly positioned.	Use optional external microphone and adjust the position of it.
	The Bluetooth reception is poor.	Move the device closer to the car audio system or remove any obstacle between the device and the system.

SiriusXM Advisory Messages

Message	Description
Check Tuner	Check the SiriusXM tuner connection on the back of the unit to ensure that its correctly connected.
Check Antenna	Ensure the SiriusXM antenna cable is connected to the SiriusXM tuner correctly. Check the SiriusXM antenna wire for breaks or sharp bends. Replace the antenna if necessary. Load "Factory default" settings on Setting menu. If the message remains, the antenna may have been damaged.
No Signal	The vehicle must be outside, and the antenna must have a clear view of the southern sky.
Channel Not Subscribed	This channel is not included in your SiriusXM subscription plan. Call 1-877-438-9677 to subscribe.
Channel Not Available	This channel is not a valid SiriusXM channel. The channel number has been entered incorrectly, or the channel was removed from the SiriusXM channel lineup.
Channel Locked	The selected channel has been locked by the parental controls, or a mature channel has been selected. A prompt to enter the unlock code will appear. Enter the unlock code as described on page 46.
Subscription Updated	An update to your SiriusXM subscription has been received by the SiriusXM tuner. Press any button to continue.

TV/VTR (When connecting an optional TV tuner, etc.)

Problem	Cause	Measure
The image is not displayed.	The parking brake is not engaged.	Check that the parking brake is engaged.
The display is dark.	The brightness control is too low.	Adjust the brightness properly.
	The operating condition is not good.	The temperature inside the vehicle may be 0 or lower. Set to an appropriate temperature (25 or so) and check it again.
	The headlight of the vehicle is lit	The display is made dark at night to prevent the glare (When the headlight of the vehicle is lit in the daytime, the display gets dark).
When the camera is connected, the image is disturbed.	Improper NTSC/PAL setting	Set the PAL/NTSC properly according to the camera.
There are red, green, and blue points in display.	-----	This is not a failure, but a phenomenon peculiar to a liquid crystal panel (The liquid crystal panel is produced according to technology with very high precision. Note that, though there are effective pixels of 99.99% or more, pixel missing or normally lit pixels account for 0.01%).

24. ERROR DISPLAY

If an error occurs, one of the following displays is displayed.
Take the measures described below to solve the problem.

DVD PLAYER

Display	Cause	Measure
Invalid Disc	A disc is caught inside the DVD deck and is not ejected.	This is a failure of DVD deck's mechanism and consult your store of purchase.
Invalid Disc	A disc cannot be played due to scratches, etc.	Replace with a non-scratched, non-warped disc.
Invalid Disc	A disc is loaded upside- down inside the DVD deck and does not play.	Eject the disc then reload it properly.
PARENTAL VIOLATION	Parental level error	Set the correct Parental level.
Disc Region incorrect	Region code error	Eject the disc, and replace correct region code disc.

If an error display other than the ones described above appears, press the Reset button. If the problem persists, turn off the power and consult your store of purchase.

* When the Reset button is pressed, frequencies of radio stations, titles, etc. stored in memory are cleared.

25. SPECIFICATIONS

FM Tuner

Frequency Range: 87.9 MHz to 107.9 MHz

Usable Sensitivity: 8 dB μ V

50dB Quieting Sensitivity: 14 dB μ V

Alternate Channel Selectivity: 70 dB

Stereo Separation: 25 dB (1 kHz)

Frequency Response: 30 Hz to 14 kHz

AM Tuner

Frequency Range: 530 kHz to 1710 kHz

Usable Sensitivity: 30 dB μ V

DVD Player System

Digital Versatile Disc System with CDDA capable

Usable discs:

DVD video disc, Compact disc

Frequency Response: 20 Hz to 20 kHz

Sound/Noise Ratio: 95 dB (1 W Ref)

Dynamic Range: 95 dB (1 kHz)

Distortion: 0.05%

Video system: NTSC/PAL

Audio/Video Input

Audio input voltage: $\leq 2 V_{rms}$

Video input voltage: $1.0 V_{p-p} @ 75\Omega$

Audio input sensitivity (at 2 V output)

High: 325 mV $_{rms}$

Mid: 650 mV $_{rms}$

Low: 1.3 V $_{rms}$

Audio/Video output

Video output voltage: $1.0 V_{p-p} @ 75\Omega$

Screen Size: 7" wide type

Pixels: 1,152,000

Resolution: 800 x 480 x 3 (RGB)

Bluetooth

Specification: Bluetooth Ver 2.1+EDR

Profile: HFP1.5(Hands Free Profile)

HSP1.0 (Headset Profile)

A2DP (Advanced Audio Distribution Profile)

AVRCP1.2,1.3,1.4 (AV Remote Control Profile)

Power Class: 2

MP3 mode

Bit rate: 32 kbps to 320 kbps

Sampling rate: 32 kHz, 44.1 kHz, 48 kHz

WMA mode

Bit rate: 64 kbps to 192 kbps

Sampling rate: 32 kHz, 44.1 kHz, 48 kHz

USB

Specification: USB 1.1/2.0 (FS)

Playable audio format:

MP3(.mp3): MPEG 2/Audio Layer-3

WMA(.wma): Ver 7/8/9.1/9.2

Playable Video Format

Disc Video: .mp4 (MPEG4/AAC) 720*480

.avi (MPEG4/MP3) 720*480

.mpg (MPEG2/MP3) 720*480

USB Video: .mp4 (MPEG4/AAC) 480*272

.mp4 (H.264/AAC) 480*272

.3gp (MPEG4/AAC) 480*272

.avi (MPEG4/MP3) 480*272

.mpg (MPEG2/MP3) 480*272

General

Power source voltage:

14.4 VDC (10.8 to 15.6 V allowable)

Ground: Negative

Current consumption: 4.0 A @1 W

Auto Antenna Rated Current: 500 mA less

Note:

- Specifications comply with JEITA Standards.
- Specifications and design are subject to change without notice for further improvement.

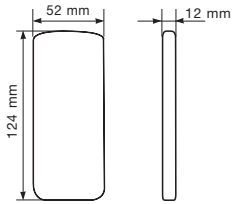

Remote Control dimensions:

Remote Control weight:

1.76 oz. (50g) (including battery)

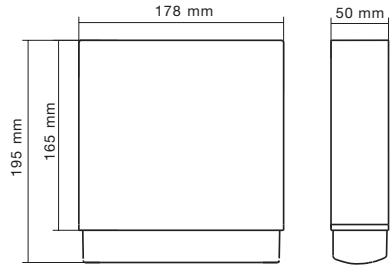

NZ503 dimensions:

NZ503 weight: 5.29 lb. (2.4kg)

Power Output:

19W RMS x 4 Channels at 4Ω
and 1% THD+N

Signal to Noise Ratio:

95dBA (reference: 1W into 4Ω)



26. WIRING AND CONNECTIONS

Note:

- Before installing, be sure to disconnect the negative cable of the car battery.
- In the optional devices, the RCA cables and the Connector cables are separately-sold items.

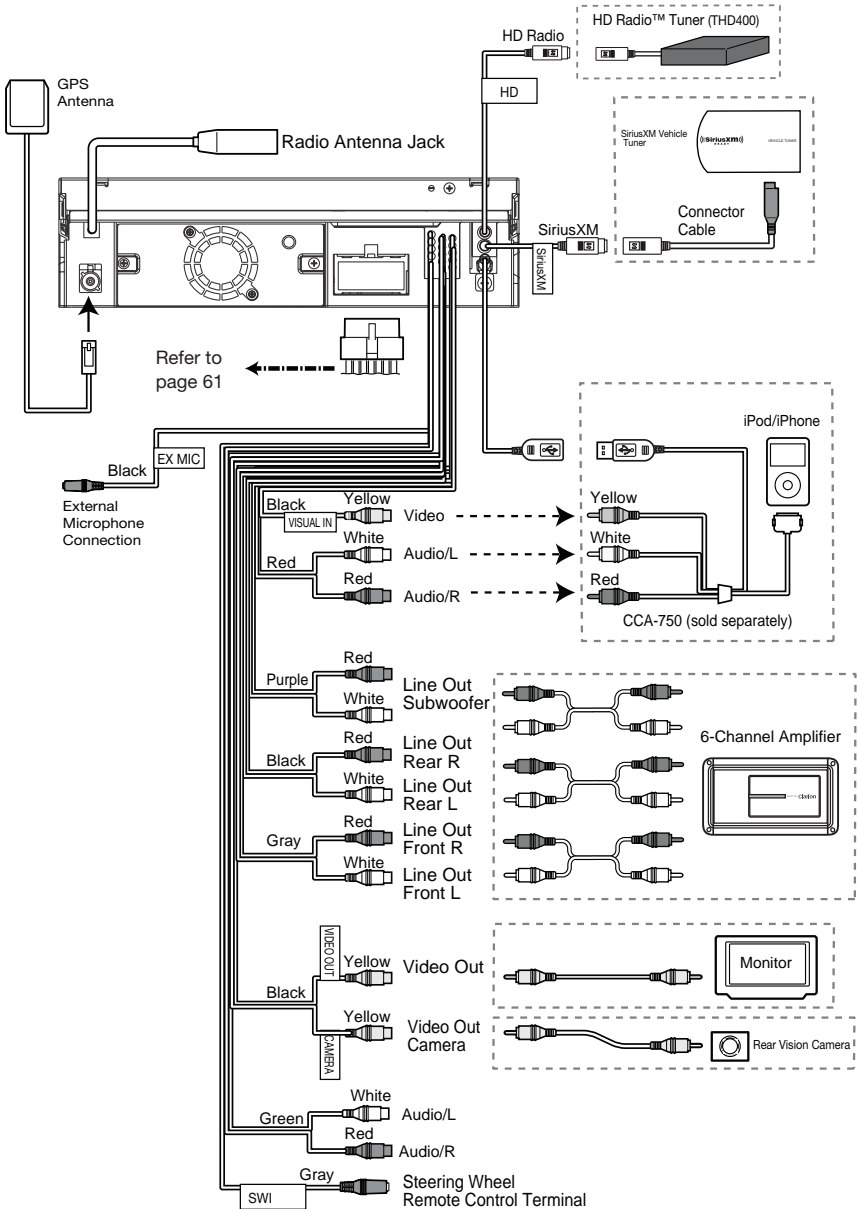

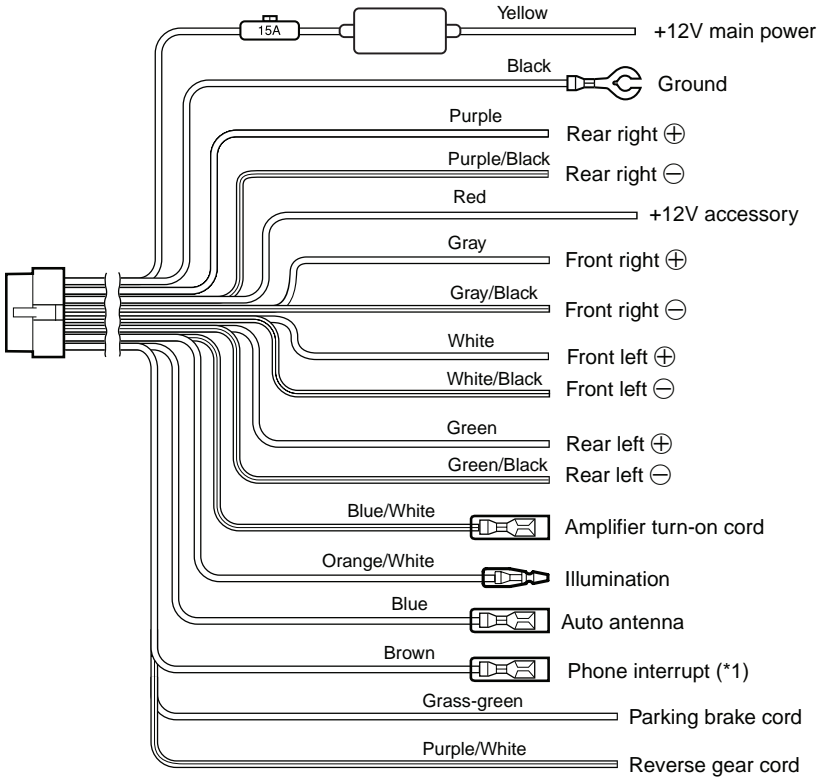
**Note:**

*1: Connecting the PHONE INTERRUPT terminal

The phone interrupt will mute the audio if the lead receives a negative or ground signal.

See next page for how to connect the parking brake cord.

Connecting the parking brake cord

Connect the cord to parking brake lamp ground in the meter panel.

Note:

- Connecting the parking brake cord to lamp ground allows you to watch iPod/iPhone video/DVD video/AV input when the parking brake is engaged.
- When the parking brake cord is not connected, the monitor will not show any video sources.
- If "AUDIO ONLY" appears on the screen just after turning on the ACC power of the car, release the parking brake while confirming safety, and then engage the parking brake again.

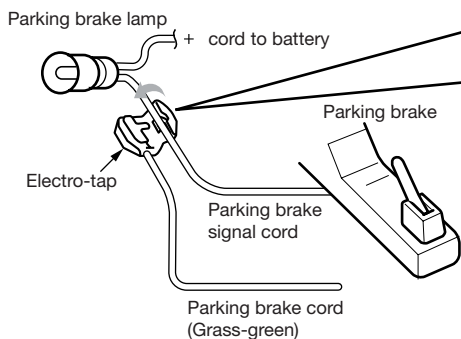

How to attach the electro-tap

1. Place the Parking brake cord at the stopper, and fold it back in the direction of the arrow
2. Pass the Parking brake signal cord through, and fold it back in the direction of the arrow.

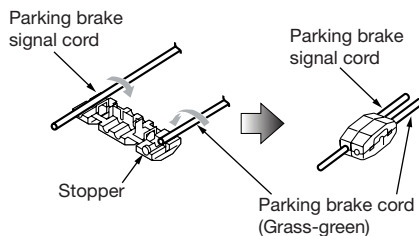

Connecting the accessories

• Connecting to the external amplifier

The external amplifiers can be connected to the 6 channel RCA output connections. Ensure that the connectors are not grounded or shorted to prevent damage to the unit.

• Connecting to iPod/iPhone device

The iPod/iPhone device can be connected to dedicated iPod/iPhone connection on the main unit. For detailed information, refer to the instruction sheet or manual for the iPod/iPhone cable.

Note:

- This unit may not support all functions of all iPod/iPhone devices.
- The iPod/ iPhone connection will charge your iPod/iPhone unless the iPod/iPhone battery is completely depleted. If the specified cord of the cellular phone is connected to the phone interrupt cord of the main unit, the audio mute is activated when cellular phone in use.
- Connecting to SiriusXM Radio Receiver

When SiriusXM Radio Receiver is to be connected, use the dedicated connector. For detailed information, refer to the instruction manual of the SiriusXM-Connect Vehicle Tuner.

Clarion Co., Ltd.

All Rights Reserved. Copyright © 2012: Clarion Co., Ltd.
Printed in China / Imprime au Chiné / Impreso en China