

clarion®

Owner's manual

VX402A
VZ402A

**2-DIN DVD MULTIMEDIA STATION WITH 6.2-inch
TOUCH PANEL CONTROL**
**DVD MULTIMEDIA STATION WITH 7-inch
TOUCH PANEL CONTROL**

Contents

1. FEATURES	3
Expanding Systems.....	3
2. PRECAUTIONS	4
3. CONTROLS	6
Operational Panel.....	6
Functions of Buttons.....	7
Remote Control.....	8
Functions of Remote Control Buttons.....	9
4. CAUTIONS ON HANDLING	11
Operation Panel.....	11
USB Port.....	11
Cleaning.....	11
Handling Discs.....	12
5. DVD VIDEO SYSTEM	13
DVD Video Features.....	13
Discs.....	14
6. OPERATIONS	16
Basic Operations.....	16
DVD Player Operations.....	17
USB Operations.....	24
iPod Operations.....	25
Bluetooth Mode.....	29
Radio Operation.....	33
AUX IN/ AV IN.....	35
Camera in Operations.....	35
Settings Operations.....	36
7. TROUBLESHOOTING	40
GENERAL.....	40
DVD PLAYER.....	40
USB DEVICE.....	41
Bluetooth.....	41
TV/VTR (When connecting an optional TV tuner, etc.).....	42
8. ERROR DISPLAY	43
DVD PLAYER.....	43
9. SPECIFICATIONS	43
10. WIRE CONNECTION GUIDE	45

1. FEATURES

- Built-in Parrot Bluetooth® Handsfree(HFP) and Audio Streaming(A2DP & AVRCP)
- Compatible with iPod® / iPhone® with Album Art



Expanding Systems

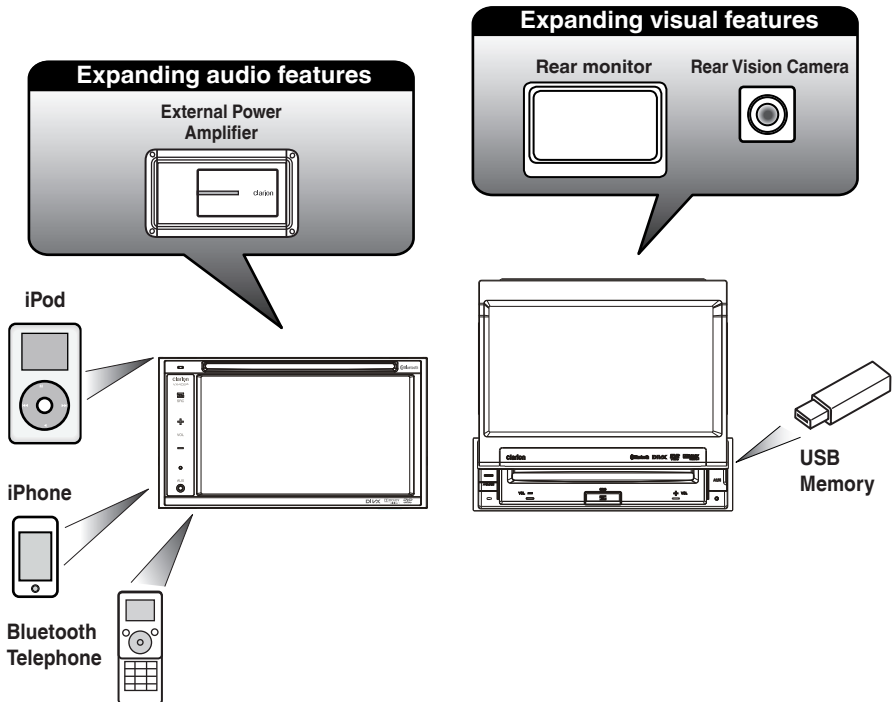

NOTE:

The items listed outside the frames are the commercial products generally sold.

2. PRECAUTIONS

WARNING

- For your safety, the driver should not watch any video sources and/or operate the controls while driving. Please note that watching and operating any video sources while driving are prohibited by law in some countries. Also, while driving, keep the volume to a level at which external sounds can be heard.
- Do not disassemble or modify this unit. It may cause an accident, fire, or electric shock.
- Do not use this unit when a trouble exists, such as no screen content appears or no sound is audible. It may cause an accident, fire, or electric shock. For that case, consult your authorized dealer or a nearest Clarion service center.
- In case of a problem, such as any material has been entered in the unit, the unit gets wet, or smoke or strange smells come out of the unit, etc., stop using this unit immediately, and consult your authorized dealer or a nearest Clarion service center.
Using it in that condition may cause an accident, fire, or electric shock.
- Use a fuse with the same specification only when replacing the fuse.
Using a fuse with a different specification may causes a fire.
- For the installation of this unit or a change in the installation, ask your authorized dealer or a nearest Clarion service center for safety. Professional skills and experiences are required to do so.

1. When the inside of the car is very cold and the player is used soon after switching on the heater, moisture may form on the disc (DVD/CD) or the optical parts of the player and proper playback may not be possible. If moisture forms on the disc (DVD/CD), wipe it off with a soft cloth. If moisture forms on the optical parts of the player, do not use the player for about one hour. The condensation will disappear naturally allowing normal operation.

2. Driving on extremely bumpy roads which cause severe vibration may cause the sound to skip.

3. This unit uses a precision mechanism. Even in the event that trouble arises, never open the case, disassemble the unit, or lubricate the rotating parts.

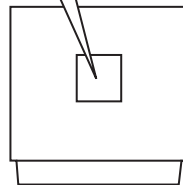
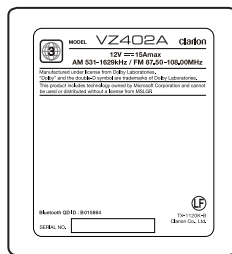

VZ402A

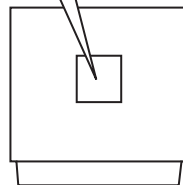
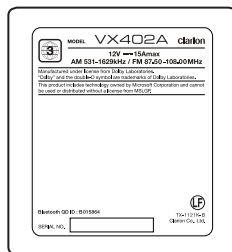

VX402A

3. CONTROLS

Operational Panel

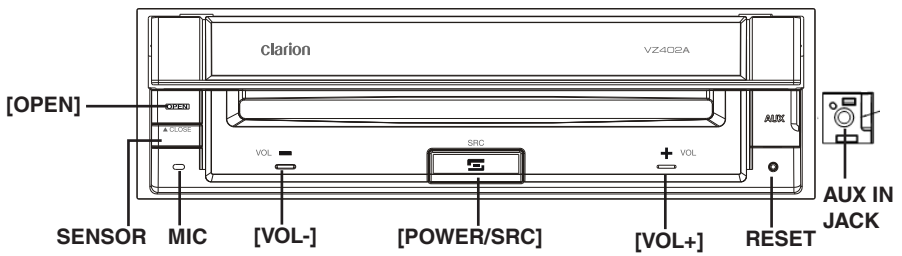
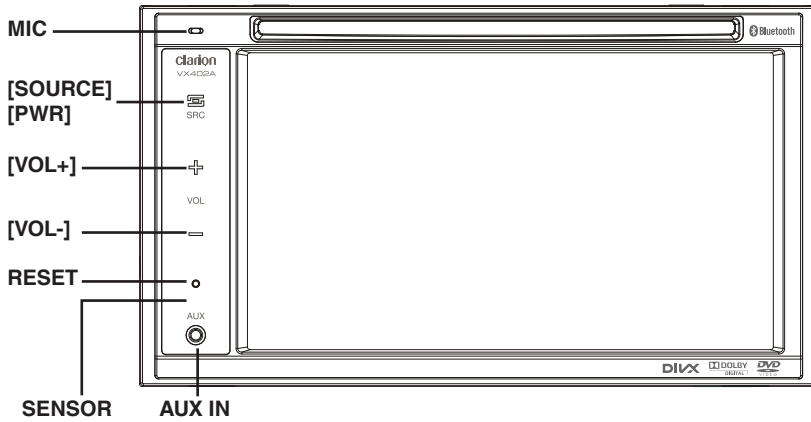

Functions of Buttons

[Power/SRC] Button

- Press this button to turn the unit power on.
- Press this button to select a source.
- Press and hold this button for more than 2 seconds to turn the power off.

[VOL -], [VOL +] Buttons

- Use these buttons to decrease/increase the volume.

[OPEN] [CLOSE] Button (VZ402A)

- Use this button to open/close operation panel.

RESET Button

- Press this button to reset the unit.

SENSOR

- Receiver for the remote control unit (operating range: 30 degree in all directions).

MIC

- Internal microphone for use during Bluetooth phone calls. Sensitivity can be adjusted from the Settings menu.

Remote Control

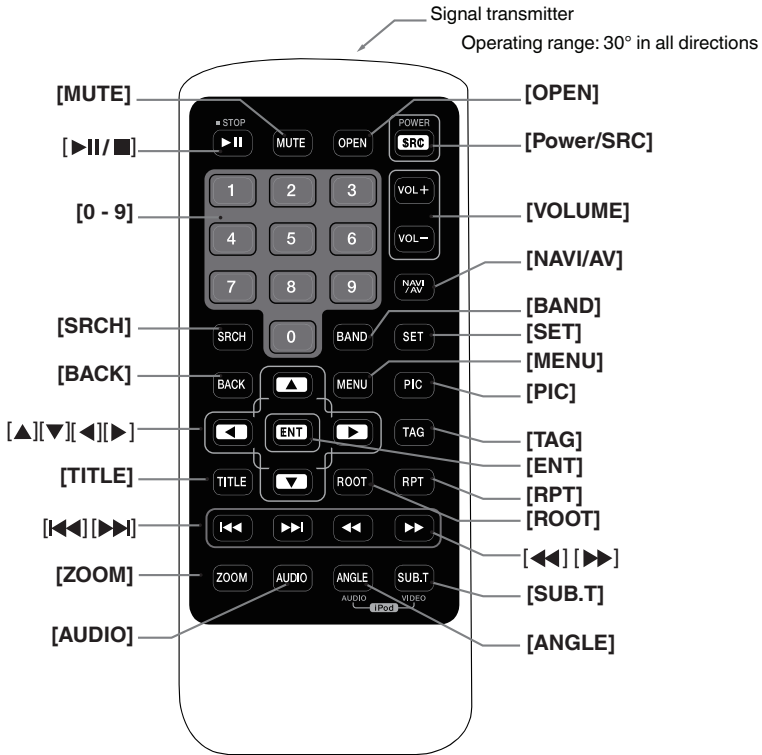

Replacing the batteries

1. Press the retention tab and pull out the battery tray and remove the old battery.
2. Insert the new CR2025 battery and slide the battery tray back in the remote control the same direction that you removed it. Please ensure the tray is inserted in the correct direction.

Note:

Using battery improperly can cause it to explode. Take note of the following points:

- When replacing batteries, replace both batteries with new ones.
- Do not short-circuit, disassemble or heat battery.

- Do not dispose of battery into fire or flames.
- Dispose of spent batteries properly.

Note:

- The wireless remote control operation may not be optimal in direct sunlight.

Functions of Remote Control Buttons

You can use the remote control unit to control the VX402A and VZ402A.

Note:

- The wireless remote control operation may not be optimal in direct sunlight.

▶■ ■ Button

- Press this button to play or pause video and audio media.
- Press this button more than 1 second to stop Video and audio media.

[MUTE] Button

Mute or unmute the speaker.

[OPEN] Button

- Press this button to eject the disc. **(VX402A)**
- Press this button to open/close operation panel. Please ensure there are no obstructions before starting the operation. **(VZ402A)**

[POWER/SRC] Button

- Press this button to power on when the unit is power off.
- Press this button to select a source.
- Press this button more than 1 second to power off when the unit is power on.

[0 - 9] Buttons

- Use in the Key Pad screen to select the radio or DVB-T channels.
- Use to select the track in the track list screen.
- Press to enter DVD video chapters/titles in the Key Pad screen.

[VOLUME] Button

Increase or decrease volume.

[NAVI/AV] Button

This button is not effective.

[SRCH] Button

Press this button to open chapter or title search window while playing DVD.

[BAND] Button

Switch to next band alternately.

[SET] Button

Press this button to open the Audio setting menu in any mode.

[BACK] Button

Press this button to quit main menu if current screen is main menu.
Press this button to exit selection and adjustment menus.

[▲], [▼], [◀], [▶] Buttons

- Press those buttons for cursor movement in main menu or Setting mode.
- Press [▲], [▼] to scroll through the saved presets list in the TUNER mode.
- Press [◀], [▶] to scroll through the page screens

in the TUNER mode.

- Press to select button items on the menu screen of a DVD video.
- Press[▲], [▼]to scroll through the pages screens in the CD and MP3/WMA modes.

[MENU] Button

Press this button to enter the MAIN MENU or return current resource.

[PIC] Button

Press this button to change your monitor brightness.

[ENT] Button

Press to fix the entered data in the Key Pad screen or enter the item the cursor is on.

[TAG] Button

This button is not effective

[TITLE] Button

Press to go to the title menu on the DVD.

[ROOT] Button

Press to go to the root menu on the DVD.

[RPT] Button

- Press to perform repeat chapter / repeat title / repeat off while playing DVD mode.
- Press to perform repeat single / repeat all / repeat off while playing CD.
- Press to perform repeat single / repeat folder / repeat all / repeat off while playing MP3/WMA, or video files on disc.
- Press to perform repeat single / repeat folder / repeat all / repeat off while playing MP3/WMA, or video files in USB memory.
- Press to perform repeat single / repeat all / repeat off in iPod mode.

[◀◀] Button

- Press to seek the next available lower station in Tuner mode.
- Press to select the next lower chapter number in DVD video mode.
- Press to select the next lower in DVD Audio, CD,USB Video, USB Audio iPod Audio, iPod Video mode.
- Press to play from beginning of current track in DVD Audio, CD,USB Video, USB Audio. (In play for 5 seconds)
- Press to play from beginning of current track in iPod Audio, iPod Video mode.(In play for 2 seconds)

Functions of Remote Control Buttons

[▶▶] Button

- Press to seek the next available higher station in Tuner mode.
- Press to select the next higher chapter number in DVD video mode.
- Press to select the next higher track in DVD Audio, USB Video, USB Audio/iPod Audio, iPod Video mode.

[◀◀], [▶▶] Buttons

- Press to manually select the next lower or higher station in Tuner modes.
- Press to perform fast-backward or fast-forward searching, press again to change the speed to 2x, 4x, 8x or 16x in DVD or USB mode.
- Press to perform fast-backward or fast-forward searching in iPod mode.

[ZOOM] Button

Press to turn on and zoom in while playing DVD. You can zoom in up to 3x. (No all DVD disc supports this function)

[AUDIO] Button

Press to switch the AUDIO channel of the disc while playing DVD.

[SUB-T] Button

- Press to switch next available subtitle while playing DVD.
- Press to display Video menu in iPod mode.

[ANGLE] Button

- Press to switch the different ANGLE while playing DVD. (No all DVD disc supports this function)
- Press to display Audio menu in iPod mode.

4. CAUTIONS ON HANDLING

Operation Panel

For a longer service life, be sure to read the following cautions.

- The operation panel will operate properly in a temperature range of 0° to 60° C.
- Do not allow any liquids on the set from drinks, umbrellas etc. Doing so may damage the internal circuitry.
- Do not disassemble or modify the set in any way. Doing so may result in damage.
- Subjecting the operation panel to shocks may result in breakage, deformation or other damage.
- Do not let cigarettes burn the display.
- If a problem should occur, have the set inspected at your store of purchase.
- Do not insert objects or poke in the space between the operation panel and the main unit when the panel is tilted.
- The remote control unit may not work if the remote control sensor is exposed to direct sunlight.
- In extremely cold weather, the display movement may slow down and the display may darken, but this is not a malfunction. The display will work normally when the temperature increases.
- Small black and shiny spots inside the liquid crystal panel are normal for LCD products.

USB Port

- The USB memory stick may stick out when inserted, so it may cause danger during driving. In such cases, you can use a commercial USB extension cable, etc., but use it safely under your own judgement.
- The USB memory sticks must be recognized as "USB mass storage class" to work properly. Some models may not operate correctly.
When the memorized data is lost or damaged by any chance, Clarion shall not be liable for any damage.
When using an USB memory stick, we recommend that you backup your data stored on it before by using a personal computer etc.
- Data files may be broken when using USB memory sticks in the following situation:
When disconnecting the USB memory stick or turning the power off during writing or reading data.
When affected by static electricity or electric noise.
Connect/disconnect the USB memory stick when it is not accessed.
- Some USB memory sticks cannot be inserted to the main unit because of their shape. In such cases, use a commercial USB extension cable to connect them.
- Connecting with the computer is not covered.
- Music files (MP3, WMA, etc.) stored in the USB memory stick can be played back.

Cleaning

- **Cleaning the cabinet**
Use a soft, dry cloth and gently wipe off the dirt. For tough dirt, apply some neutral detergent diluted in water to a soft cloth, wipe off the dirt gently, then wipe again with a dry cloth. Do not use benzene, thinner, car cleaner, etc., as these substances may damage the cabinet or cause the paint to peel. Also, leaving rubber or plastic products in contact with the cabinet for long periods of time may cause stains.
- **Cleaning the liquid crystal panel**
The liquid crystal panel tends to collect dust, so wipe it off occasionally with a soft cloth. The surface is easily scratched, so do not rub it with hard objects.

Handling Discs

Handling

- New discs may have some roughness around the edges. If such discs are used, the player may not work or the sound may skip. Use a ball-point pen or the like to remove any roughness from the edge of the disc.

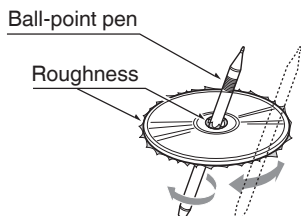

Never stick labels on the surface of the disc or mark the surface with a pencil or pen.

- Never play a disc with any cellophane tape or other glue on it or with peeling off marks. If you try to play such a disc, you may not be able to get it back out of the DVD player or it may damage the DVD player.
- Do not use discs that have large scratches, are misshapen, cracked, etc. Use of such discs may cause misoperation or damage.
- To remove a disc from its storage case, press down on the center of the case and lift the disc out, holding it carefully by the edges.
- Do not use commercially available disc protection sheets or discs equipped with stabilizers, etc. These may damage the disc or cause breakdown of the internal mechanism.

Storage

- Do not expose discs to direct sunlight or any heat source.
- Do not expose discs to excess humidity or dust.
- Do not expose discs to direct heat from heaters.

Cleaning

- To remove fingermarks and dust, use a soft cloth and wipe in a straight line from the center of the disc to the circumference.
- Do not use any solvents, such as commercially available cleaners, anti-static spray, or thinner to clean discs.
- After using special disc cleaner, let the disc dry off well before playing it.

On Discs

- Exercise a good precaution when loading a disc. The operation panel will close automatically when leaving it open for a while.
- Never turn off the power and remove the unit from the car with a disc loaded.

CAUTION

For your safety, the driver should not insert or eject a disc, opening the operation panel while driving.

5. DVD VIDEO SYSTEM

DVD video is a high-quality digital video source that provides crisp and clear images. One 12 cm disc contains either one film or four hours of music.

DVD Video Features

This unit provides the following functions in addition to the high image quality and sound quality of DVD video.

Note:

- The functions described in this section, for example, the recorded language, subtitles, angles, etc. differ depending on the DVD video disc. Refer to the instructions provided with the DVD video.
- Some disc functions may operate differently from described in this manual.

Multi-sound function

DVD video can store up to 8 languages for one film; select the language of your preference.

- The languages stored on the disc are indicated by the icon shown below.



Multi-angle function

A DVD video that is filmed from multiple angles allows you to select the angle of choice.

- The number of recorded angles are indicated by the icon shown below.

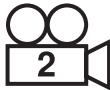

Subpicture (subtitles) function

A DVD video can record subtitles for up to 32 languages and you can select the language of the subtitles you wish to see.

The number of recorded subtitle languages are indicated by the icon shown below.



Multi-story function

When a DVD video contains more than one story for a film, you can select the story you wish to enjoy. The operation procedures vary with the disc; observe the instructions for selecting a story provided during playback.

Menu screens

Menu can be called up during DVD video playback to perform menu setting.

- Example showing menu display

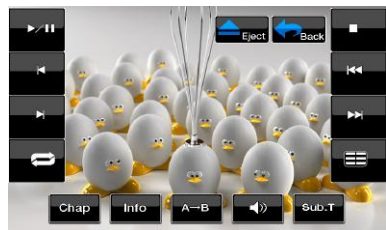

Discs

Playable discs

This DVD video player can play the following discs.

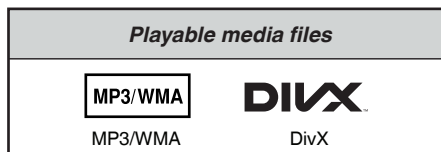
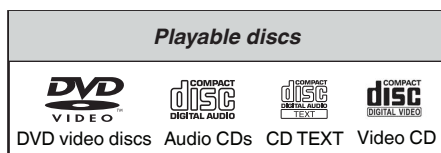

About CD Extra discs

A CD Extra disc is a disc in which a total of two sessions have been recorded. The first session is Audio session and the second session is Data session.

Your personally-created CDs with more than second data sessions recorded cannot be played on this DVD video player.

Note:

- When you play a CD Extra disc, only the first session will be recognized.

About playing a CD-R/CD-RW disc (MP3, WMA)

This player can play CD-R/CD-RW discs previously recorded in music CD format (MP3, WMA).

About playing a DVD-R/RW or DVD+R/RW disc

This player cannot play DVD-R/RW and DVD+R/RW discs previously recorded in video CD format.

However, MP3/WMA files recorded on DVD-R/RW and DVD+R/RW discs can be played.

Discs that cannot be played back

This DVD video player cannot play back DVD-

Audio, DVD-RAM, Photo CDs, etc.

Note:

- It may also not be possible to play back CDs recorded on a CD-R unit and CD-RW unit. (Cause: disc characteristics, cracks, dust/dirt, dust/dirt on player's lens, etc.)
- If a CD-R or CD-RW disc that has not been finalized is played, it will take a long time to start playing. Also, it may not be possible to play depending on its recording conditions.
- You cannot play SuperAudio CDs Playback of the CD player is not supported even if it is a hybrid disc.

About MP3/WMA playback

This unit can play back CD-R/CD-RW, DVD-R/RW and DVD+R/RW discs on which MP3/WMA music data have been recorded.

For a detailed information, see the section entitled "Listening to MP3/WMA".

Note on region numbers

The DVD video system assigns a region number to DVD video players and DVD discs by sales area. DVD video players sold in Asia can play back DVD discs with the region number "ALL", "3" or any combination of numbers that also incorporate a "3".

The DVD video region number is marked on the disc jacket as shown below.



Asia

▲ About the registered marks, etc.

- This product incorporates copyright protection technology that is protected by U.S. patents and other intellectual property rights. Use of this copyright protection technology must be authorized by Rovi Corporation, and is intended for home and other limited viewing uses only unless otherwise authorized by Rovi Corporation.
Reverse engineering or disassembly is prohibited.
- Manufactured under license from Dolby Laboratories. "Dolby", "Pro Logic" and the double-D symbol are trademarks of Dolby Laboratories.
- "Made for iPod," and "Made for iPhone" mean that an electronic accessory has been designed to connect specifically to iPod, or iPhone, respectively, and has been certified by the developer to meet Apple performance standards. Apple is not responsible for the operation of this device or its compliance with safety and regulatory standards. Please note that the use of this accessory with iPod or iPhone may affect wireless performance. iPhone and iPod are trademarks of Apple Inc., registered in the U.S. and other countries.
- The Bluetooth® word mark and logos are owned by the Bluetooth® SIG, Inc. And any use of such marks by Clarion Co.,Ltd. is under license. Other trademarks and trade names are those of their respective owners.
- DivX®, DivX Certified® and associated logos are trademarks of Rovi Corporation or its subsidiaries and are used under license. DivX Certified® to play DivX® video, including premium content. Covered by one or more of the following U.S. patents: 7,295,673; 7,460,668; 7,515,710; 7,519,274 ABOUT DivX VIDEO: DivX® is a digital video format created by DivX, LLC, a subsidiary of Rovi Corporation. This is an official DivXCertified® device that plays DivX video. Visit DivX.com for more information and software tools to convert your files into DivX videos.
ABOUT DivX VIDEO-ON-DEMAND: This DivX Certified® device must be registered in order to play purchased DivX Video-on-Demand (VOD) movies. To obtain your registration code, locate the DivX VOD section in your device setup menu. Go to vod.DivX.com for more information on how to complete your registration.

6. OPERATIONS

Basic Operations

Note:

- Be sure to read this chapter referring to the

CAUTION

- Do not move the operation panel forcibly or apply strong force to the operation panel.
- When the operation panel is operating, be careful not to get your hand or finger caught between the operation panel and main unit or its mechanical parts.
- The driver should not operate the operation panel while driving.



Start the engine.
The power is supplied to this unit.



Press [POWER/
Source] button on the panel to turn on the unit.



Selecting a Source

- Press [Back] button on Screen to show main source menu. Touch the icons on the screen to enter corresponding work mode, such as DVD/CD mode, Tuner mode, USB mode, etc.
- Press [POWER/Source] button on the panel to select a source in any source.
- Press [POWER/SRC] button Remote Control to select a source in any source.

MAIN MENU

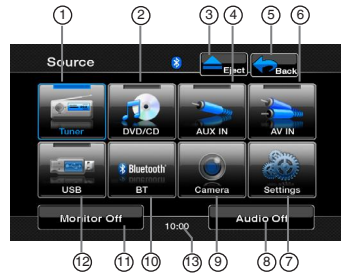

- | | |
|-------------------------|--|
| 1- Display Tuner mode | 10- Display BT mode |
| 2- Display DVD/CD mode | 11- Monitor Off |
| 3- Eject Disc | 12- Display USB/iPod mode |
| 4- Display AUX IN mode | 13- System time, touchto display clock mode. |
| 5- Display current mode | |
| 6- Display AV IN mode | |
| 7- Display Settings | |
| 8- Audio Off | |
| 9- Display Camera mode | |

DVD Player Operations

Change DVD/VCD System Settings

Selecting Setup Menu

1. Press the **[Settings]** button on the Main Menu to access the Video setup menu.
2. Press **[Video]** button. The video menu is displayed.



Setting up the Screen Size

1. Press the **[Aspect Ratio]** button to change the screen size.
2. Touch the desired aspect ratio: **4:3** or **16:9**. The factory default setting is "16:9".

Note: Not all disc support this function.

Setting up the password for parental level control

The factory default pass code is "0000".

1. In **Main Menu** press **[Settings]** button. Press **[Rating]** button on the display. Touch the **[Set Password]** ---- and a numerical key pad will appear.

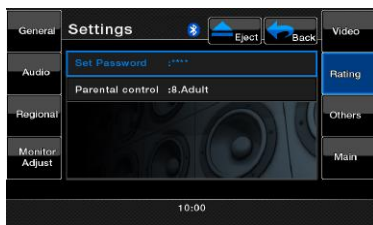

Input a new password and come again. The password is set.

Note: When a disc with view restrictions is inserted, you will be prompted to input this password. The disc will not be viewable until the correct password is entered.

Set rating for parental level control

1. Select **Rating** screen while in **Settings** mode. Press **[Parental Control]** button.

2. Enter right password.
3. Press the desired rating for level control. Use this table to set the parental level.

Kid Safe	Kid Safe
G	General Audiences
PG	Parental Guidance Suggested
PG-13	Parents Strongly Cautioned
PG-R	Parental Guidance Restricted
R	Restricted
NC-17	No One 17 And Under Admitted
Adult	Only Adult

- The contents that the parental level restricts vary with the country code.

Watching to a disc

1. To load a disc:
Insert the disc into the center of the insertion slot the label side facing up.

⚠ CAUTION

For your safety, the driver should not insert or eject a disc, or operate the controls while driving.

⚠ WARNING

Some videos may be recorded at higher than desired volume levels. Increase the volume gradually from the minimal setting after the video has started.

Note:

- Never insert foreign objects into the disc insertion slot.
 - If the disc is not inserted easily, there may be another disc in the mechanism or the unit may require service.
 - 8 cm (single play) discs cannot be used.
2. Disc starts playing automatically.

Ejecting a disc

1. To eject a disc press eject [**▲**] button. The play mode then switches to the Tuner mode. If the disc is left in the ejected position for 15 seconds, the disc is automatically reloaded. In this case, the play mode will remain in the Tuner mode.

Note: If you force a disc into before auto reloading, it may damage a disc.

DVD Player Operations

Showing DVD/VCD Player mode screen

After disc is loaded, the play mode is automatically engaged.

Touch any place of the screen to display DVD/VCD Video menu touch the screen again to return playback screen. The display will return to the playback screen, if you do not touch the screen for 25 seconds.

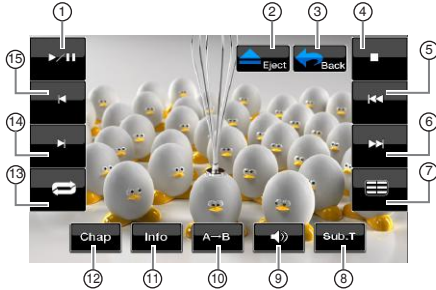

- | | |
|--------------------------|------------------------|
| 1- Play/Pause key | 9- Audio key |
| 2- Eject key | 10- Repeat Segment key |
| 3- Main Menu key | 11- Information key |
| 4- Stop key | 12- Chapter key |
| 5- Previous Playback key | 13- Repeat key |
| 6- Next Playback key | 14- Fast Forward key |
| 7- Title List key | 15- Fast Backward key |
| 8- Subtitle List key | |

Operate the DVD/VCD Player menu

Stop Playback

1. Touch the [■] key. Playback is stopped.
2. To resume playback, press the [▶||] key. Playback resumes from the scene where playback is stopped.

Play/Pause Playback

1. Touch the [▶||] key to pause during playback.
2. Touch the [▶||] key again to resume playback.

Skip (Search) a Chapter

1. Touch the [◀◀] or [▶▶] key during playback. Chapters are skipped down or up from current locations, as many times as the key is pressed, and playback starts.

Fast Forward Fast Backward

1. Touch the [◀◀] or [▶▶] key to start your fast backward or fast forward during playback. The playback speed starts at 2x, then will increase to 4x, 8x, and 16x with each additional press.
 - *No audio is reproduced during fast forward and fast backward operation.
 - *The fast forward and fast backward speed may differ depending on the disc.

Direct Search Options

You can locate the beginning of a scene using the time, chapter numbers or title numbers recorded on the DVD/VCD Video disc.

1. Showing the DVD/VCD PLAYER mode screen, touch the [Chap] key.
2. The Direct Search Option menu appears with the search options that are available:
 - Title
 - A large segment to divide the data area of the disc.
 - Chapter
 - A small segment to divide the data area of the disc.
 - Time
 - A specific time on the disc.
3. Touch the Direct Search method you would like to use.
4. Input the number of the title/chapter/time that you want to play back with the numeric key.
5. Touch the [OK] key to confirm.



Playback starts from the scene of the input title number, time or chapter number.

*If the input title/chapter/time number does not exist or searching with a title/chapter number is not allowed, the screen image will not change.

DVD Player Operations

Repeat Playback

This operation plays back chapters recorded on the DVD/VCD Video repeatedly.

1. Showing the DVD/VCD Player mode screen, touch the **[Repeat]** key for **Repeat Chapter**.
2. Touch the **[Repeat]** key again for **Repeat Title**.
3. Touch the **[Repeat]** key again to turn off the repeat playback.

Repeat A → B

Select the desired passage to play back.

1. Touch the **[A→B]** key to select the Repeat loop starting position.
2. Touch the **[A→B]** key again to select the Repeat loop ending position. The Repeat loop will begin.
3. Touch the **[A→B]** key again to stop replay.

Using the Title Menu

On discs containing two or more titles, you can select from the title menu for playback.

1. Showing the DVD Player mode screen, touch the **[Title]** key during playback. The title menu screen appears.

*Depending on the disc, the title menu cannot be called.

2. Select the desired menu item using the Cursor-Key according to the menu contents.
3. Touch the **[ENT]** key to specify the selected menu item.
4. Touch the **[Back]** key to hide the Key Pad panel.

Switching Key Pad position

When the menu items become difficult to view by the Key Pad buttons, you can touch the **[Left]** or **[Right]** key to move the Key Pad panel to the other side of the screen.

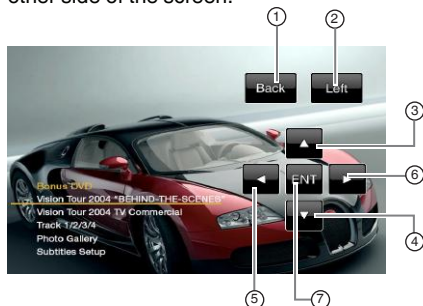

- | | |
|--------------------|---------------------|
| 1- Back key | 5- Select Left key |
| 2- Left key | 6- Select Right key |
| 3- Select Up key | 7- Enter key |
| 4- Select Down key | |

Switching among the languages

On discs in which two or more audios or audio languages have been recorded, you can switch among the audio languages during playback.

1. Touch the **[Audio]** audio key during playback.
 - Each time you touch the key, you can switch among audio languages.
 - It may take time to switch among audios.
- * Depending on the disc, up to 8 audios may be recorded. For details, see the mark of the disc: (8) Indicates that 8 audios have been recorded).
 - * When the power is turned on and when the disc is changed to a new one, the language set as the factory default is selected. If that language has not been recorded, the language specified on the disc.
 - * Depending on the disc, switching may be completely impossible or impossible on some scenes.
2. The DVD/VCD PLAYER mode screen will hide in 3 seconds after your selection is made.

Switching Subtitles

On discs in which two or more subtitle languages have been recorded, you can switch among the subtitle languages during playback.

1. Touch the **[Sub.T]** key during playback. Each time you touch the key, you can switch among subtitles.
 - It may take time to switch among subtitles.
 - * Depending on the disc, up to 32 kinds of subtitles may be recorded. For details, see the mark of the disc: (8) Indicates that 8 kinds of 8 subtitles have been recorded).
 - * Depending on the disc, switching may be completely impossible or impossible on some scenes.
2. The DVD Player mode screen will hide in 3 seconds after your selection is made.
3. To turn off subtitles, repeat touching the **[Sub.T]** key until subtitles are turned off.

DVD Player Operations

Switching angles

On discs in which video images have been recorded in two or more angles, you can switch among the angles during playback.

1. Press the **[ANGLE]** button on the remote control during playback. Each time you press the key, you can switch among angles.

- * It may take time to switch among angles.
- * Depending on the disc, up to 9 angles may be recorded. For details, see the mark of the disc: ( Indicates multi-angle).
- * Depending on the disc, angles may switch smoothly or switch with a momentary still image.
- * Depending on the disc, switching may be completely impossible or impossible on some scenes.
- * Depending on the disc, scenes recorded in two or more angles may be played back.

Displaying the playback status

Touch the **[Info]** key on the DVD/VCD Player mode screen to display the playback status.



MP3/WMA /CD Playback



- | | |
|-----------------------|--|
| 1- Play/Pause key | 9- Fast Forward key |
| 2- Eject key | 10 - Fast Backward key |
| 3- Main Menu key | 11- Media Information |
| 4- Stop key | 12- User (Name, Artist, Album) Information |
| 5- Previous Track key | 13- Track Play number |
| 6- Next Track key | 14- Track Play time |
| 7- Audio Settings key | |
| 8- List key | |

Pausing Playback

1. Touch the **[⏸]** key to pause playback.
2. To resume playback, touch the **[▶]** key again.

Skipping a Track (searching)

Touch the **[⏮]** or **[⏭]** key during playback. Tracks are skipped as many times the key is pressed, and playback starts.

- Pressing the **[⏭]** key starts playback from the beginning of the next track.
- Pressing the **[⏮]** key starts playback from the beginning of the current track. When this key is pressed again within about **5** seconds, playback starts from the beginning of the previous track.

Fast Forward and Fast Backward

1. Touch the **[⏭]** or **[⏮]** key during play back. The media will advance at 2x speed.
2. Touch again to advance to higher speed reversing or forwarding such as 4x, 8x and 16x. Touch once more to resume normal speed playback.

Scanning the Tracks

1. Touch the **[List]** key to display the Disc List screen.
2. Touch the **[Scan]** key to begin previewing the first 10 seconds of each song on the disc.

Searching with the Track Number



This operation allows searching using the track numbers recorded on the CD.

1. Touch the **[List]** key to display the Disc List screen.
2. Touch the **[Key]** key to display the numerical keypad.
3. Input the track number that you want to play back with numerical keypad.
4. Touch the **[OK]** key to confirm.
 - If the input track number does not exist or searching with a track number is not allowed, the unit will return to the List screen

DVD Player Operations

Selecting a track on the Track List Screen

This function allows you to select tracks from a displayed list.

1. Touch the **[List]** key to display the Disc List screen.
2. Touch the track title on the display list. The selected track will start playing.
3. When the desired track is not displayed, touch the  or  key to scroll the track list.
4. Touch the desired track title key in the List display. The corresponding track will start playback.
5. Touch the **[List]** key to return to the main screen.



Stop Playback

1. Touch the  key to stop playback.

Audio Settings

1. Touch the **[Audio Settings]** key to enter Audio menu.

Other various play functions

1. Touch the **[List]** key to display the Disc List screen.
2. Touch the key of the function you want to play
 - Repeat** : Touch once to start a single track repeat. To turn repeat off, press the same key again.
 - Repeat symbols are displayed in the info window above the song list.
 - Shuffle** : Touch the key to shuffle the tracks during playback. Touch the key again to turn off the feature.
 - A shuffle symbol is displayed in the info window above the song list.

LISTENING TO MP3/WMA

This unit is an ID3 Tag compatible model.

This unit supports the ID3 TAGs of the Version 2.4, 2.3, 1.1 and 1.0.

In displaying, this unit gives priority to the Version 2.3 and 2.4 TAGs.

After USB device inserted into USB slot, or disc is loaded, the play mode is automatically engaged.

What is MP3/WMA?

MP3 is an audio compression method and classified into audio layer 3 of MPEG standards. WMA is an audio compression method developed by Microsoft Corporation.

These audio compression methods have penetrated into PC users and become a standard format.

These features compress the original audio data to about 10 percent of its initial size with a high sound quality. This means that about 10 music CDs can be recorded on a CD-R disc or CD-RW disc to allow a long listening time without having to change CDs.

Note:

- Some CDs recorded on CD-R/RW mode may not be usable.

Displaying MP3/WMA TAG titles

Tag information such as title, artist and album title can be displayed for MP3/WMA file containing Tag information.

Precautions when creating MP3 disc

• File extensions

1. Always add a file extension “.MP3” or “.mp3” to an MP3 file, and “.WMA” or “.wma” to a WMA file by using single byte letters. If you add a file extension other than specified or forget to add these file extension, the file cannot be played. In addition, if you use upper case and lower case letters (capital and small letters) mixedly for file extensions, normal play may not be possible.
2. Files other than MP3/WMA data cannot be played. Playing files with a format not supported will be skipped, and the scan, random and repeat playback mode may be canceled.

• File and Disc Not Supported

Files and discs with following extensions are not supported: *.AAC, *.DLF, *.M3U, *.PLS, MP3 PRO files, files with DRM, open session discs.

• Logical format (File system)

1. When writing an MP3/WMA file on a disc, please select “**ISO9660 level 1 or level 2 (without including expansion format)**” as the writing software format. Normal playback may not be possible if the disc is recorded on another format.

DVD Player Operations

2. The folder name and file name can be displayed as the title during MP3/WMA playback but the title must be within 31 single byte alphabetical letters and numerals for the folder name and file name (including an extension). Entering more letters or numerals than specified may cause an incorrect display.

- **Entering File and Folder Names**

Names using the code list characters are the only file names and folder names that can be entered and displayed. Using any other character will cause the file and folder names to be displayed incorrectly.

- **Electronic Shock Protection**

10 seconds for CD-DA (CDA) 45 seconds for MP3 recorded at 44.1 kHz, 128kbps 90 seconds for WMA recorded at 44.1 kHz, 128kbps

- **Folder structure**

A disc with a folder having more than 8 hierarchical levels will conflict with the ISO9660 and playback will be impossible.

- **Number of files or folders**

1. The maximum allowable number of folders is 2 00 (including root directory); the maximum allowable number of files is 1500 (max. 1500 per folder). This represents the maximum number of tracks that can be played back.
 2. Tracks are played in the order that they were recorded onto a disc. (Tracks might not always be played in the order displayed on the PC).
- Some noise may occur depending on the type of encoder software used while recording.
 - In case of a track recorded at VBR (variable bit rate), the display for the play time of the track may be slightly different from the actual play time. Also, the recommended value of VBR ranges from 32 kbps to 320 kbps.
 - After disc selection, the play mode is automatically engaged.

DVD Player Operations

Playing MP3 folders

When selected for play, files and folders (Folder Search, File Search or Folder Select) are accessed in the order in which they were written to the media. As a result, the order in which they are expected to be played may not match the order in which they are actually played.

You may be able to set the order in which MP3/WMA files are to be played by assigning file names beginning with play sequence numbers such as "01" to "99".

For example, a medium with the following folder/file hierarchy is subject to Folder Search, File Search or Folder Select. See the diagram below.

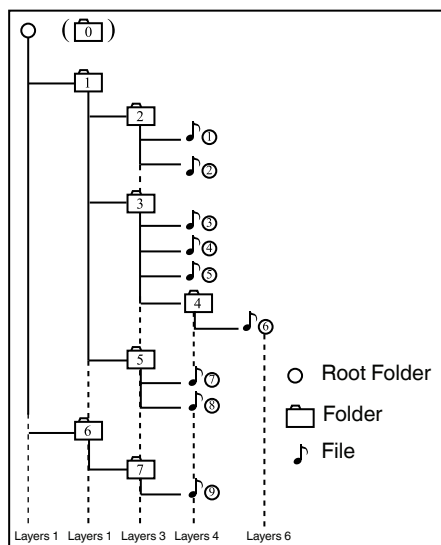

The player will only recognize three folder levels and does not display folders containing other folders. In the example above, the unit will display folders 2, 3, 5, and 7, but not 1 and 6 since they do not contain others.

Playing DivX file

This system can playback DivX movie files recorded on a disc.

- Official DivX[®] Certified product
- Plays all versions of DivX[®] video (including DivX[®] 6) with standard playback of DivX[®] media files.

What is DivX?

DivX is a popular media technology created by DivX, Inc. DivX media files contain highly compressed video with high visual quality that maintains a relatively small file size. DivX files can also include advanced media features like menus, subtitles, and alternate audio tracks. Many DivX media files are available for download online, and you can create your own using your personal content and easy-to-use tools from DivX.com.

USB Operations

This system can play audio files (MP3/WMA) and video files (MP4/AVI/MPG) stored in an USB memory which is recognized as "USB Mass Storage Class device". You can use your USB memory as an audio/video device by simply copying desired audio/video files into it.

Note:

- This system will not operate or may operate improperly with some USB memory.
- Files protected with any DRM cannot be played

Notes on using USB memories

General notes

- When no data is present, the message "NO FILE" will be displayed.

Notes on the MP3/WMA files

- This system can play the MP3/WMA files stored in the USB memory.
- This system can play DivX files stored in the USB memory.
- Set the Sampling Frequency to:
 - For MP3 files:
 - MPEG1 Layer3: 32, 44.1, or 48 kHz
 - MPEG2 Layer3: 16, 22.05, or 24 kHz
 - MPEG2.5 Layer3: 8, 11.025, or 12 kHz
 - For WMA files: 32, 44.1, or 48 kHz

- Set the Bit Rate to:

For MP3 files:

- MPEG1 Layer3: 32 to 320 kbps (VBR)
- MPEG2 Layer3: 16 to 160 kbps (VBR)
- MPEG2.5 Layer3: 16 to 160 kbps (VBR)
- For WMA files: 32, 48, 64, 80, 96, 128, 160, or 192 kbps

- Add the following file extension using single byte characters:

For MP3 files: ".MP3" or ".mp3"

For WMA files: ".WMA" or ".wma"

Notes on the folder structure

- The folder hierarchy must be within 8 hierarchical levels. Otherwise, playback will be impossible.
- The maximum allowable number of folders is 200 (including root directory and folders with no MP3/WMA file).
- The maximum allowable number of files in a folder is 1500.
- The maximum allowable number of files in all folders is 1500.
- You can store the MP3 files, WMA files together in a folder.

Notes on the Tag titles

The limitations on the Tag titles are same as those in the MP3/WMA modes.

Folder representation in the folder list

The limitations on the folder representation are same as those in the MP3/WMA modes.

Selecting the USB Memory Mode

Connect your USB memory to the USB connector. Touch the **[USB]** key on Main Menu screen, the system changes to the USB mode and starts playback.



Playing Back Files in the USB Memory

The operations in the USB Memory mode are same as those in the DVD mode. Please refer MP3/WMA /CD Playback.

iPod Operations

iPod/iPhone can be connected by using the connector cable supplied with the iPod/iPhone, but in this case, you can enjoy its audio sound only. To enjoy video movies stored in the iPod/iPhone with video displaying them on this unit, it is required to use the special connector cable (CCA-750) separately sold.

Note:

- This system will not operate or may operate improperly with unsupported versions.
- For detailed information on the playable iPod/iPhone models, see our home page: www.clarion.com.

Notes on using Apple iPod/iPhone

- Do not connect an iPod/iPhone to this unit with a headphone connected to the iPod/iPhone.
- After the iPod/iPhone has been connected to this unit, the buttons of iPod are disabled for operation in the Music mode.
- In the Video mode, do not operate the buttons of iPod.
- When in the iPod mode, a special iPod/iPhone control screen is displayed different from the main screens for other modes.
- When no data is present, the title display will remain blank.
- The iPod/iPhone is used with the equalizer function turned OFF.
- Set the language setting of iPod/iPhone to English before connecting your iPod/iPhone. Some characters of the other languages may not be displayed correctly in this system.
- **Precautions on battery consumption:**

If the iPod/iPhone is connected to this unit when the internal battery of iPod/iPhone has run down, this function may not operate correctly. You must connect the iPod/iPhone after charging the battery if it has run down.

Selecting the iPod Audio mode

Connect your iPod/iPhone to the USB connector. The system will automatically detect the connected device and the iPod Audio button will be enabled for operation on the Main Menu screen.



When an iPod/iPhone is already connected

Touch the **[iPod]** key on the Main Menu screen. The system changes to the iPod mode, and starts playback from the previous position.

iPod Operations

Operation keys

iPod audio mode screen

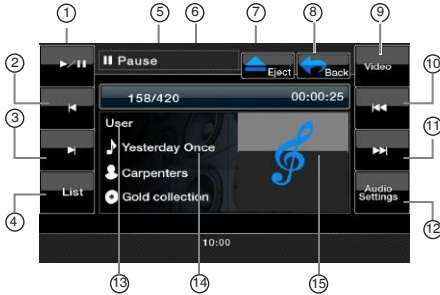

- | | |
|--|---------------------------|
| 1- Play/Pause key | 9- Video/Music key |
| 2- Fast Backward key | 10- Previous Track key |
| 3- Fast Forward key | 11- Next Track key |
| 4- List key | 12- Audio Settings key |
| 5- Playback status info | 13- EQ |
| 6- Song Elapsed playing time indicator | 14- Current ID3 info area |
| 7- Eject key | 15- Art Work |
| 8- Main Menu key | |

[Play/Pause] key

- Use to control playback and pause.
 - Touch the key during playback. Playback pauses.
 - Touch the key again to resume playback.

[Fast Backward] key

- Touch this key to fast backward the track selection.

[Fast Forward] key

- Touch this key to fast forward the track selection.

[List] key

- Touch the List key to display the menu screen to search tracks to be played.

[Video/Music] key

- Touch this key to switch operation mode to the Video mode or Music mode.

[Previous Track] key

- Touch this key to play the previous track.
- Touch this key to play from beginning of current track (In play for 2 seconds)

[Next Track] key

- Touch this key to play the next track.

[Audio Settings] key

- Touch this key to switch to the Audio menu for setting the audio settings.

iPod audio list screen

Touch the **[List]** key to display the menu screen to search tracks to be played.



- | | |
|-------------------------|-----------------------|
| 1- Repeat play key | 5- iPod Menu key |
| 2- Shuffle play key | 6- Simple Control key |
| 3- Back to iPod screen. | 7- Page up key |
| 4- Folders key | 8- Page down key |

[Repeat play] key

- Touch this key to repeat the play of the selected track.

[Shuffle play] key

- Touch this key to shuffle between the tracks.

[Folders] key

- Touch this key to return to the main track search screen.

[iPod Menu] key

- Touch this key to return to the previous menu.

[Simple Control] key

- Touch this key to display Simple Control Mode.

[Page up] key

- Touch this key to scroll up the track list.

[Page down] key

- Touch this key to scroll down the track list.

iPod audio Simple Control screen

Touch the **[Simple Control]** key to display Simple Control Mode.



iPod Operation

- | | |
|--------------------------|--------------------------------|
| 1- Play/Pause key | 7- Video key |
| 2- Fast Backward key | 8- Previous Track key |
| 3- Fast Forward key | 9- Next Track key |
| 4- Playback status info | 10- Back to iPod audio screen. |
| 5- Eject key | |
| 6- Back to main menu key | |

[Play/Pause] key

- Use to control playback and pause.
 - (1). Touch the key during playback. Playback pauses.
 - (2). Touch the key again to resume playback.

[Fast Backward] key

- Touch this key to fast backward the track selection.

[Fast Forward] key

- Touch this key to fast forward the track selection.

[Video] key

- Touch this key to switch operation mode to the Video mode.

[Previous Track] key

- Touch this key to play the previous track.
- Touch this key to play from beginning of current track (In play for 2 seconds)

[Next Track] key

- Touch this key to play the next track.

iPod video mode screen

When you connect an iPod/iPhone with video features by using the optional connector cable for iPod/iPhone with video, you can enjoy the video data and slide show data stored in the iPod/iPhone showing them on the display of this unit (and the rear monitor if connected).

Note:

Do not connect the iPod/iPhone to this unit when a Video Playlists item is selected on the iPod/iPhone.

1. Touch the **[Video]** key on the iPod audio mode menu screen. The iPod play video screen is displayed.
2. Select the type of video you would like to play, by touching the menu. The video playback will start.

Note:

- Video playback is not available on all iPod/iPhone devices. Please contact your Clarion dealer for details. An optional connection cable or accessory may be required for this feature.

3. To stop the video play, touch the screen. iPod play video menu will be displayed.

4. Touch the **[Music]** key to return to the iPod audio menu.

Note:

- "AUDIO ONLY" is displayed when the automobile is moving.
- Image data may not be played back according to the status of the iPod/iPhone.
- The volume setting of video data is relatively lower than audio data. Be sure to lower the volume setting before switching to the other mode.
- Do not select the categories with no track registered from the iPod menu screen. The iPod/iPhone may be frozen. If the iPod/iPhone is frozen, reset the iPod/iPhone by following the procedure described in the instruction manual of the iPod/iPhone.
- Audio may be played back slightly out of synchronization with video images.

iPod Operation

iPod Video List mode screen



- | | |
|--|------------------------|
| 1- Play/Pause key | 7- Back to main menu |
| 2- Repeat play key | 8- Music key |
| 3- Shuffle key | 9- Folders key |
| 4- Back to iPod video list screen | 10- iPod Menu |
| 5- Song Elapsed playing time indicator | 11- Simple Control key |
| 6- Eject key | 12- Page up key |
| | 13- Page down key |

[Play/Paus] key

- Use to control playback and pause.
 - Touch the key during playback. Playback pauses.
 - Touch the key again to resume playback.

[Repeat play] key

- Touch this key to repeat the play of the selected track.

[Shuffle] key

- No function in this mode.

[Video/Music] key

- Touch this key to switch operation mode to the Video mode or Music mode.

[Folders] key

- Touch this key to return to the main track search screen.

[iPod Menu] key

- Touch this key to return to the previous menu.

[Simple Control]key

- Touch this key to display Simple Control Mode.

[Page up] key

- Touch this key to scroll up the track list.

[Page down] key

- Touch this key to scroll down the track list.

iPod Video Simple Control Mode Screen



Bluetooth Mode

Some Bluetooth cellular phones have the audio features, and some portable audio player support the Bluetooth feature. These devices will be called as “Bluetooth audio players” in this manual. This system can play audio data stored in a Bluetooth audio player.

Note:

- This system will not operate or may operate improperly with some Bluetooth audio players.
 - For detailed information on the playable Bluetooth audio players, see our home page: www.clarion.com
- This unit has a Bluetooth indicator (📶) on the top of the screen.

When the Bluetooth function is “OFF”, the indicator is grey.

When the Bluetooth function is “ON” and the phone is not connected, the indicator will blink.

If the phone is connected, the indicator is light up solid.

Selecting the Bluetooth Mode

1. Touch the [📶 Bluetooth] key in the Main Menu screen to access the Bluetooth mode directly. The default setting is OFF.
2. The system changes to the Bluetooth mode.



- | | |
|-----------------------|---------------|
| 1- Audio Transfer key | 5- Keypad key |
| 2- Send key | 6- End key |
| 3- Phone Function key | 7- Music key |
| 4- Cancel key | 8- Settings |

[Audio Transfer] key

While talking, to transfer audio from the unit back to the mobile, touch the key. You can only transfer a call after it has been answered. Touch the key again to transfer the call back to the head unit.

[Send] key

- Touch this key to answer an incoming call or to make a call.

[Phone Function] key

- Touch this key to access the phone book

[Cancel] key

- Touch this key to backspace.

[Keypad] key

- Touch to access the numerical pad channel.

[End] key

- Touch this key to reject an incoming call or to end a call.

[Music] key

- Touch to access the Bluetooth music function.

[Settings] key

- Touch this key to access the Bluetooth Setting.

Registering your Bluetooth Device (Pairing)

You can register up to 1 Bluetooth device.

The required password to pair the phone to the unit is “1234”.

1. Touch the [Settings] key on the screen.
2. Touch the [Pair mode] key on the Settings screen.
3. Touch the [Pairing] key to begin the pairing process.



4. The cellular phone may prompt to acknowledge the Bluetooth connection and to enter the Pass Key code of this unit. Perform these operations according to the message displayed.
5. When the pairing operation is completed, the registered Bluetooth device is set as current. Bluetooth Indicator is light up solid.



Bluetooth Mode

Note:

- You cannot register the same Bluetooth audio player which is already registered doubly.

Controlling the Bluetooth Audio Player

Note:

- Occasionally, depending on the environment, playback sounds may be fragmented, or switch noises may be generated.

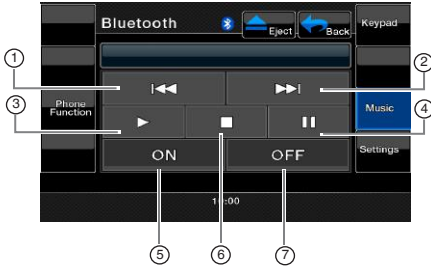

- | | |
|-------------------|--------------|
| 1- [◀▶] key | 2- [▶▶] key |
| 3- [▶] key | 4- [⏸] key |
| 5- [ON] key | 6- [OFF] key |
| 7- [Settings] key | |

Playing Music

After the connection with a Bluetooth audio player is established, the play mode is automatically engaged.

- When playback is not started, touch the [▶]key.

Pausing Playback

- Touch the [⏸]key during playback. Playback pauses.
- To resume playback, touch the [▶]key. Playback resumes.

Skipping a Track (Searching)

- Touch the [◀▶] or [▶▶]key during playback. Tracks are skipped, as many as the times the key is touched, and playback starts.

Note:

- Control functions such as play, pause and track skipping are not available on all devices.

Stop Playback

- Touch the [⏸] key during playback. Playback stops.
- To resume playback, touch the [▶] key. Playback resumes.

[ON]

- Touch this key to connect the music.

[OFF]

- Touch this key to disconnect the music.
- Selecting the BT Phone mode
- Touch the [Back] key to display the Menu screen.
 - Touch the [Bluetooth] key to select the Bluetooth mode.
 - Touch the [Keypad] key to select the BT Phone mode. The Telephone screen is displayed.
 - When the connection with a Bluetooth telephone has been established, the icon and signal level indicator are displayed at the top of the screen.

Selecting the BT Phone mode

- Touch the [Back] key to display the Menu screen.
- Touch the [Bluetooth] key to select the Bluetooth mode.
- Touch the [Keypad] key to select the BT Phone mode. The Telephone screen is displayed.
 - When the connection with a Bluetooth telephone has been established, the icon and signal level indicator are displayed at the top of the screen.



Setting the Telephone Features

- Touch the [Setting] key to display the Telephone Settings screen.



- Perform setting for the desired item. See the following sections for detail.

Bluetooth Mode

Setting Automatic Connection

The system automatically reconnects the cellular phone after the connection is lost or the system is restarted.

- The factory default setting is “Manual”. Touch the **[Manual]** or **[Auto]** key of the Automatic **[Connect]** item to set the function preference

Selecting Microphone

You can select the microphone to be used.

- The factory default setting is “Internal”. Touch the **[External]** or **[Internal]** key of the **[MIC Select]** item to set the function.

Setting Microphone Gain

1. You can adjust the input level of the microphone in 6 levels.

- The factory default setting is “3”.

Note:

- *The input level of the microphone can be affected by its surroundings. Adjust the level when the person on the other end of the telephone has a reception problem.*
2. Touch the level indicator of the **[MIC Gain]** key to adjust the input level.

Note:

- *You can talk with other party by using the internal microphone. When it is hard to hear for the other party in accordance with the communication condition or the used telephone, use the optional microphone (RCB-199), and set the Microphone Select setting to “External”. The sound will be improved, but noises may still be heard depending on the communication condition.*

Telephone operations

Note:

- *For your safety, this system disables the calling functions when the car is moving. Be sure to stop the car and apply the parking brake before making a call.*

Making a Call Using the Ten-Key Pad

1. Touch the **[Keypad]** key to display the Ten-Key pad screen.
2. Enter the telephone number by using the Ten-Key pad displayed on the screen.
3. Touch the **[Send]** key to call the entered number.
 - The following Telephone Interrupt screen is displayed during phone call.



- Touch the **[Audio Transfer]** key to talk using the cellular phone canceling the hands-free function. To return to the hands-free mode, touch the **[Audio Transfer]** key.

4. When the call is finished, touch the **[End]** key to hang up. The display will return to the previous mode screen selected before entering the BT Phone mode.

Note:

- *Depending on the cellular phone, the Telephone Interrupt screen may be closed and the connection with this system may be disconnected when entering the Private mode.*

Obtaining the Phone Book Data

Sending the Phone Book data from the cellular phone enables you to make a call using the Phone Book function from this unit.

1. Perform the Object Push transfer operation of the Phone Book data on the current cellular phone. For details of the operation, see the operation manual of the cellular phone.

Note:

- *Some cellular phones may not be able to transfer the Phone Book data.*
- *The Phone Book data transmission may take a long time. The operations of sending calls are disabled during the data transmission.*
- *Some cellular phones cannot transfer the Phone Book data when the hands-free mode is set or it is also registered in the Bluetooth mode. In those cases, disable these functions from the cellular phone before performing the Object Push transfer.*
- *Some cellular phones may transfer Phone Book data automatically.*

Making a Call Using the Phone Book

You can use the Phone Book data obtained from the cellular phone to make a call from this unit.

Bluetooth Mode

Note:

- Before using this function, the Phone Book data must be sent from the cellular phone
 - Only the Phone Book items with at least one telephone number registered in the captured Phone Book data are displayed on the Phone Book screen.
1. Touch the **[Phone Function]** key to display the Phone Log screen.
 2. Select **[My Phonebook]** or **[SIM Phonebook]** to select your desired phonebook to view.
 3. Touch the desired Name key you wish to dial. Touch the **[▲]** or **[▼]** key to scroll the list. When you touch the alphabet key at the right of the screen, the list scrolls to the item which starts with the specified character.
 4. Touch the desired selection you wish to dial. When the call is finished, touch the **[End]** key to hang up.

Making a Call Using the History

The system will recall the Dialed/Received calls record data in the handset memory. You can confirm it and use it to make a call from this unit.

1. Touch the **[Phone Function]** key. The History List screen is displayed.
2. Select **[Dialed Call]**, **[Received Call]** or **[Missed Call]** key to select your desired call log.
 - Touch the **[▲]** or **[▼]** key to scroll the list.
 - Touch the **[Phone Function]** key to return to the previous screen.
3. Touch the desired History item key you wish to dial. When the call is finished, touch the **[End]** key to hang up.

Answering to an Incoming Call

When a call comes in, the following Telephone Interrupt screen appears.



You can answer to the incoming call on this system by the following operation.

1. Touch the **[Send]** key to answer to the call. When the call is finished, touch the **[End]** key to hang up.

Radio Operation

Listening to the Radio

Touch the Tuner button on the Main menu display. The tuner mode screen is displayed.



Touch the **[Band]** key or touch the **[Band]** button on remote control to select the radio band. Each time the button is pressed, the radio reception band changes in the following order: FM1, FM2, FM3, AM, FM1...

Seek Tuning

1. Touch the **[Band]** key to select the radio band (FM or AM).
2. Touch the **[Seek]** or **[Seek]** key to automatically seek a station.
 - When touching the **[Seek]** key, the station is sought in the direction of higher frequencies.
 - When touching the **[Seek]** key, the station is sought in the direction of lower frequencies.

Manual Tuning

1. Touch the **[BAND]** key to select the radio band (FM or AM).
2. Touch the **[M-Seek]** or **[M-Seek]** key to automatically seek a station.
 - When touching the **[M-Seek]** key, the station is sought in the direction of higher frequencies.
 - When touching the **[M-Seek]** key, the station is sought in the direction of lower frequencies.

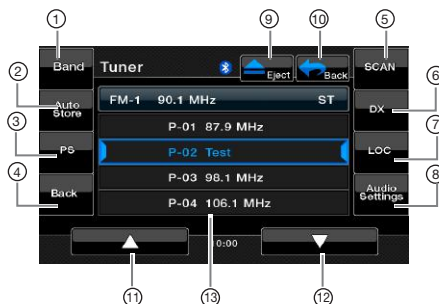

1. Scan preset stations
Auto store preset stations (long press)
2. Program scan
3. Show play mode
4. Scan all stations
5. Key to switch to DX tuner
6. Choose local or distant seeking mode
7. Eject disc
8. Show main menu
9. Previous page
10. Play selected station in preset stations list
11. Next page

Recalling a preset station

There are 2 ways to recall the preset station.

Using the remote control:

1. Touch the **[Band]** button to select the desired band (FM or AM) on the remote control.
2. Touch the preset number (1 to 6) on numeric pad.

Using the tuner unit:



1. Touch the **[Band]** key to select the desired band (FM or AM) on the tuner.
2. Touch the **[List]** key to display the Preset List screen.
3. Touch the preset station (1 to 6) on tuner display.
4. Touch **[▲]** or **[▼]** to select next station up or down the preset list.
5. Touch the **[AS/PS]** button to begin scanning the preset stations.

Manual memory

1. Touch the desired Band key to select the band

Radio Operation

you wish to store in.

2. Tune in the station you wish to store using seek tuning, manual tuning, or preset tuning.
3. Touch and hold the desired Preset key you wish to store the current station for more than 2 seconds.
4. Touch  or  to select next station up or down the preset list.

3. Touch the **[LOC]** key to switch to Local tuner sensitivity.

Auto Store

The Auto Store is a function for storing up to 6 stations that are automatically tuned in sequentially. If 6 receivable stations cannot be received, a previously stored station remains at the memory position.

1. Touch the **[Band]** key to select the desired band. (FM or AM)
2. Touch and hold the **[AS/PS]** key to start the Auto Store function. A beep sounds and the stations with good reception are stored automatically to the preset channels.

Preset Scan

The Preset Scan receives the stations stored in the preset memory in order. This function is useful when searching for the desired station in memory.

1. Touch the **[Band]** key to select the desired band. (FM or AM).
2. Touch the  key to display the Preset List screen.
3. Touch the **[AS/PS]** key to start the Preset Scan. The unit starts scanning each station for 10 seconds sequentially. Presets with a weak signal will be skipped.
4. When the desired station is tuned in, touch the **[PS]** key again to continue receiving that station.

LOC/DX Setting

The DX / LOC setting changes the tuner sensitivity in order to separate closely spaced stations. This feature is useful in areas that have many radio stations in close proximity.

1. Touch the  key to display the Preset List screen.
2. Touch the **[DX]** key to switch to DX tuner sensitivity.

AUX IN/ AV IN

AUX IN/ AV IN

External peripheral devices, including a game console, camcorder, navigation unit, iPod/iPhone, etc. can be connected to the AUX connector on the front or back of this unit using the A/V media cables.

Switching to AUX IN

Press **[AUX IN]** / **[AV IN]** button on Main Menu to select desired mode (when unit is reading). If the external device connected to AUX IN or AV IN input have video/audio signal, the unit will broadcast video/audio of external device.

The screen will display “No Video” menu, there is no video signal.

You cannot directly control external devices connected to AUX IN or AV IN input.

Press  button return to the Main Menu.



Camera in Operations

Switching to Camera mode

Press **[Camera]** button on Main Menu to select desired mode.

The LCD will display the external camera video.

The screen will display “No Video Signal” menu, if a valid camera is not connect to this head unit.

Press  button return to the Main Menu.

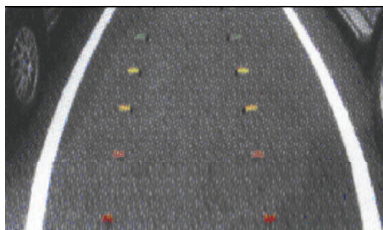

Settings Operations

You can customize the various settings of this unit from the Settings screen. Touch **[Settings]** key on the Main Menu screen. The Setting menu screen will be displayed. Touch the **[Main]** key to return to the Main screen.

General Setup Menu

1. Touch the **[General]** key. The general setting screen appears. The screen includes: Clock, Clock Mode, Radio, and Version.
2. Touch the desired tab key and perform the basic adjustments.

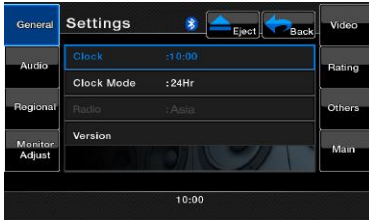

- **Setting the Clock**
Touch this tab to set the time. The keypad will appear for adjustment. Touch the **[OK]** key to save.
- **Setting the Clock Mode**
Touch this tab to change to 12Hr or 24Hr mode.
- **Radio**
Display the current radio area, on not set.
- **Version**
This tab displays the software version of your unit.

Audio Setup Menu

1. Touch the **[Audio]** key to set: Bass Freq, Treble Freq, and Bass Q-Factor.
2. Touch the desired tab key to make the desired audio adjustments.

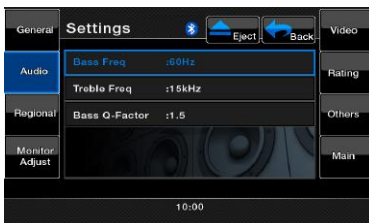

- **Bass Freq**
Select the desired bass center adjustment frequency: 60Hz, 80Hz, 100Hz, and 200Hz.
- **Treble Freq**
Select the desired treble center adjustment frequency: 10 KHz, 12.5KHz, 15KHz, 17.5 KHz

- **Bass Q-Factor**

Select the desired bass Q-Factor: 1.0, 1.25, 1.5, and 2.0.

Regional Setup Menu

1. Touch the **[Regional]** key to set the default subtitle and audio language preferences.
 2. Touch the desired tab key and perform the adjustments.
- Select the desired audio/subtitle language: English, Deutsch, Française, Italiano, Espanol, Svenska, Nederlands, Polish, Greek, Russian, Auto, Off.
 - Select Auto to automatically set the language. Select Off to turn the desired function off.

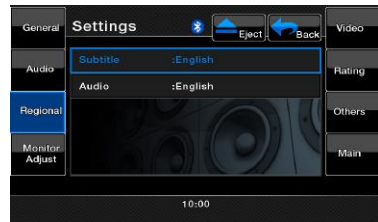

Monitor Adjust Setup Menu

1. Touch the **[Monitor Adjust]** key to set: Touch Screen Calibration, Brightness, TFT Angle and TFT Auto Open.
2. Touch the desired tab key and perform the necessary adjustments.

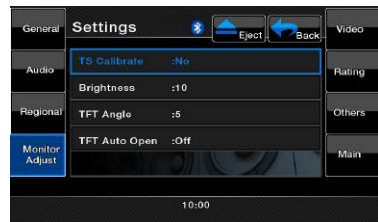

- **Touch Screen Calibration**
This key is to activate the touch screen activation mode, please consult technical support before attempting this process.
- **Brightness**
Set screen brightness value from 0 to 20.
- **TFT Angle (VZ402A)**
Adjust the TFT angle from 0 to 5.

Settings Operations

• TFT Auto Open (VZ402A)

When it is On and the ACC power on, the TFT opens automatically.

Video Setup Menu

1. Touch the **[Video]** key to set: Aux In Sensitivity, Aux In Format, and Aspect Ratio.
2. Touch the desired tab key and perform the adjustments.



• Aux In Input SW

Select the Low, Mid or High for the Aux In input sensitivity level.

• Aux In

Select the video format for Aux In signal. Select from Auto, PAL or NTSC.

• Aspect Ratio

Select the screen area shape: **4:3** or **16:9**.

Rating Setup Menu

1. Touch the **[Rating]** key to set: Password, DVD Parental control rating.
2. Touch the desired tab key and perform the adjustments.



• Password

Refer to Setting up the password for parental level control.

• Parental control

Touch this key to set the age ratings Choose the desired rating:1. Kid Safe 2. G 3. PG 4. PG-13 5. PG-R 6. R 7. NC-17 8. Adult.

Others Setup Menu

1. Touch the key to set: Anti-theft code, Anti-theft, Bluetooth, Tel SP, Blinking, Beep, Reset, DivX

Registration, DivX Deactivation.

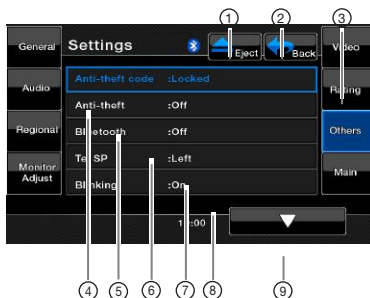

- | | |
|------------------------------------|---|
| 1- Eject disc | 7- Set left/right speaker can play the Bluetooth phone sound. |
| 2- Back to main menu | 8- Blinking on/off |
| 3- Others setup | 9- Page down |
| 4- Anti-theft code | |
| 5- Open Anti-theft function or not | |
| 6- Bluetooth On/Off | |

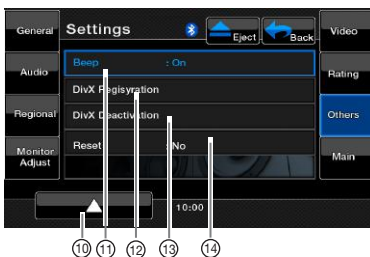

- | |
|-----------------------|
| 10- Page up |
| 11- Beep: On/Off |
| 12- DivX Registration |
| 13- DivX Deactivation |
| 14- Reset |

Settings Operations

2. Touch the desired tab key and perform the adjustments.

- **Anti-theft code**

If your unit is unlocked, touch this tab to change your anti-theft code.

The numerical keypad is displayed, enter the right code to unlock, and it displays “_____”. Touch again and enter the new code twice, then the code is set and your unit is locked. If your unit is unlocked, enter your code. Touch the **[OK]** key to save it.

- **Anti-theft**

Touch this tab to turn On or Off the anti-theft lock function. Turn on the Back up when the Anti-theft is On, you need enter the right Anti-theft code to turn on the unit normally.



If you enter the wrong code for four times, the unit will be locked, and must be unlocked by the professionals.



- **Bluetooth**

Touch this tab to turn On or Off the Bluetooth.

- **Tel SP**

Touch this tab to set the output speaker for the Bluetooth feature. You may select the Left Front speaker or Right Front speaker.

- **Blinking**

Touch this tab to turn the anti-theft blinking indicator On or Off. When the Blinking is On and the ACC power is off, the indicator blinks red.

- **Beep**

Touch this key to turn On or Off the beep sound.

- **DivX Regisyration**

Touch this key to obtain **DivX** registration code.

- **DivX Deactivation**

Touch this key to obtain **DivX** deactivation code.

- **Reset**

Touch this key to reset the unit to default settings except Anti-theft.

Settings Operations

Monitor Off

Touch Monitor Off button on main menu, it will show "Monitor off.....Touch the screen to return" and then the head unit will turn off the TFT screen. Touch any place of the screen, the TFT screen will turn on again.

Audio Off

Touch Audio Off button on main menu to turn on/off the audio of source .

Clock mode

Touch system time on main menu to show clock mode.

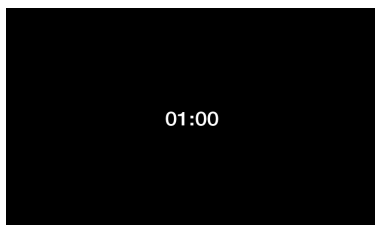

7. TROUBLESHOOTING

GENERAL

Problem	Cause	Measure
Power does not turn on. (No sound is produced.)	Fuse is blown.	Replace with a fuse of the same amperage. If the fuse blows again, consult your store of purchase.
	Incorrect wiring.	Consult your installation center.
Nothing happens when buttons are pressed. Display is not accurate.	The microprocessor has malfunctioned due to noise, etc.	Press the reset button with a thin rod. Note: <i>When the Reset button is pressed, turn off the ACC power.</i> * When the Reset button is pressed, frequencies of radio stations, titles, etc. stored in memory are cleared.
The remote control unit does not work.	Direct rays of the sun fall on the light-receptive part of the remote control unit.	When direct rays of the sun fall on the light-receptive part of the remote control unit, it may not work.
	The battery of the remote control unit is dead or there is no battery in the remote control unit.	Check the battery of the remote control unit.

DVD PLAYER

Problem	Cause	Measure
Disc cannot be loaded.	A disc is already loaded.	Eject the disc before loading the new one.
	There is foreign matter already in the disc slot.	Remove the foreign matter, or consult a service station.
Sound skips or is noisy.	Disc is dirty.	Clean the disc with a soft cloth.
	Disc is heavily scratched or warped.	Replace with a disc in good condition.
Sound is bad directly after power is turned on.	Condensation may form on the internal lens when the car is parked in a humid place.	Let dry for about 1 hour with the power on.
Video images are not displayed.	The parking brake is not engaged.	Check that the parking brake is engaged.
Disc cannot play with the display " PARENTAL VIOLATION " shown.	Feature exceeds set parental level.	Release the view limitation or change the parental level. See the subsection "Setting up the parental level"

USB DEVICE

Problem	Cause	Measure
USB device cannot be inserted.	The USB device has been inserted with wrong direction.	Reversing the connection direction of the USB device, try it again.
	The USB connector is broken.	Replace with a new USB device.
USB device is not recognized.	The USB device is damaged.	Disconnect the USB device and reconnect. If the device is still not recognized, try replacing with a different USB device.
	Connectors are loose.	
No sound heard with the display "NO FILE" shown.	No MP3/WMA file is stored in the USB device.	Store these files properly in the USB device.
Sound skips or is noisy.	MP3/WMA files are not encoded properly.	Use MP3/WMA files encoded properly.
The video image of iPod/iPhone is disturbed.	The TV Signal setting of the iPod/iPhone is not set correctly.	Set the TV Signal setting (NTSC/PAL) of the iPod/iPhone correctly.

Bluetooth

Problem	Cause	Measure
Cannot pair the Bluetooth enable device with the car audio system.	The device does not support the profiles required for the system.	Use another device to connect.
	The Bluetooth function of the device is not enabled.	Refer to the user manual of the device for how to enable the function.
The audio quality is poor after connection with a Bluetooth enabled device.	The microphone is not correctly positioned.	Use optional external microphone and adjust the position of it.
	The Bluetooth reception is poor.	Move the device closer to the car audio system or remove any obstacle between the device and the system.

TV/VTR (When connecting an optional TV tuner, etc.)

Problem	Cause	Measure
The image is not displayed.	The parking brake is not engaged.	Check that the parking brake is engaged.
The display is dark.	The brightness control is too low.	Adjust the brightness properly.
	The operating condition is not good.	The temperature inside the vehicle may be 0°C or lower. Set to an appropriate temperature (25°C or so) and check it again.
	The headlight of the vehicle is lit	The display is made dark at night to prevent the glare (When the headlight of the vehicle is lit in the daytime, the display gets dark).
When the VTR is connected, the image is disturbed.	Improper NTSC/PAL setting	Set the AUTO/PAL/NTSC properly according to the VTR.
There are red, green, and blue points in display.	-----	This is not a failure, but a phenomenon peculiar to a liquid crystal panel (The liquid crystal panel is produced according to technology with very high precision. Note that, though there are effective pixels of 99.99% or more, pixel missing or normally lit pixels account for 0.01%).

8. ERROR DISPLAY

If an error occurs, one of the following displays is displayed.
Take the measures described below to solve the problem.

DVD PLAYER

Display	Cause	Measure
BAD DISC	A disc is caught inside the DVD deck and is not ejected.	This is a failure of DVD deck's mechanism and consult your store of purchase.
BAD DISC	A disc cannot be played due to scratches, etc.	Replace with a non-scratched, non-warped disc.
BAD DISC	A disc is loaded upside- down inside the DVD deck and does not play.	Eject the disc then reload it properly.
PARENTAL VIOLATION	Parental level error	Set the correct Parental level.
Disc Region incorrect	Region code error	Eject the disc, and replace correct region code disc.

If an error display other than the ones described above appears, press the Reset button. If the problem persists, turn off the power and consult your store of purchase.

* When the Reset button is pressed, frequencies of radio stations, titles, etc. stored in memory are cleared.

9. SPECIFICATIONS

FM Tuner

Frequency Range: 87.5 MHz to 108 MHz

Usable Sensitivity: 8 dB μ V

50dB Quieting Sensitivity: 14 dB μ V

Alternate Channel Selectivity: 70 dB

Stereo Separation: 25 dB (1 kHz)

Frequency Response: 30 Hz to 15 kHz

AM Tuner

Frequency Range: 531 kHz to 1,629 kHz

Usable Sensitivity: 28 dB μ V

DVD Player System

Digital Versatile Disc System with CDDA, Video CD capable

Usable discs:

DVD video disc, Compact disc

Frequency Response: 20 Hz to 20 kHz

Sound/Noise Ratio: 87 dbA (1W Ref)

Dynamic Range: 87 dB (1 kHz)

Distortion: 0.05%

Audio/Video Input

Audio input voltage: ≤ 2 Vrms

Video input voltage : 1.0 Vp-p@75 Ω

Audio input sensitivity (at 1V output)

High : 300 mVrms

Mid : 600 mVrms

Low : 1.3 Vrms

Audio/Video output

Video output voltage: 1.0Vp-p @75 Ω

LCD Monitor**VX402A Screen Size:** 6.2" wide type**Pixels:** 1,152,000**Resolution:** 800 x 480 x 3 (RGB)**VZ402A Screen Size:** 7" wide type**Pixels:** 1,152,000**Resolution:** 800 x 480 x 3 (RGB)**Bluetooth****Specification:** Bluetooth Ver 2.1+EDR**Profile:** HFP(Hands Free Profile)

HSP (Headset Profile)

A2DP (Advanced Audio Distribution Profile)

AVRCP (AV Remote Control Profile)

Power Class: 2**MP3 mode****Bit rate:** 32 kbps to 320 kbps**Sampling rate:** 32 kHz, 44.1 kHz, 48 kHz**WMA mode****Bit rate:** 64 kbps to 192 kbps**Sampling rate:** 32 kHz, 44.1 kHz, 48 kHz**USB****Specification:** USB 1.1/2.0 (FS)**Playable audio format:**

MP3 (.mp3): MPEG 2/Audio Layer-3

WMA (.wma): Ver 7/8/9.1/9.2

Playable video format:

.mp4 (MPEG4/AAC) 720*480

.avi (MPEG4/MP3) 720*480

.mpg (MPEG2/MP3) 720*480

General**Power source voltage:**

14.4 V DC (10.8 to 15.6 V allowable)

Ground: Negative**Current consumption:**

4.0 A @1 W

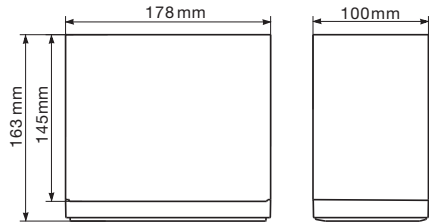
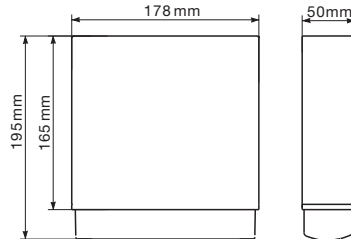
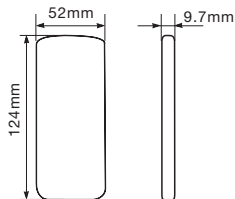
Auto Antenna Rated Current: 500 mA less**VX402A dimensions:****VX402A weight:** 2.4 kg**VZ402A dimensions:****VZ402A weight:** 2.4 kg**Remote Control dimensions:****Remote Control weight:**

50 grams (including battery)

Note:

- Specifications comply with JEITA Standards.
- Specifications and design are subject to change without notice for further improvement.

10. WIRE CONNECTION GUIDE

Note:

- Before installing, be sure to disconnect the negative cable of the car battery.
- In the optional devices, the RCA cables and the Connector cables are separately-sold items.

VX402A

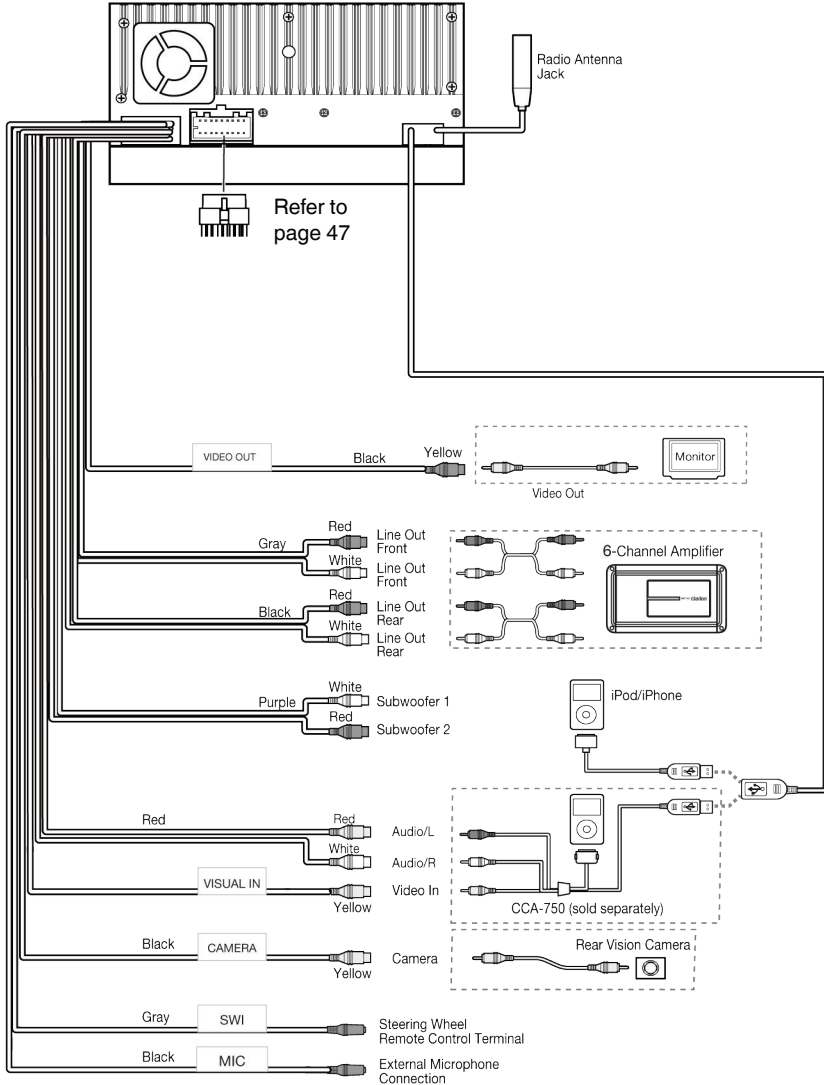

VZ402A

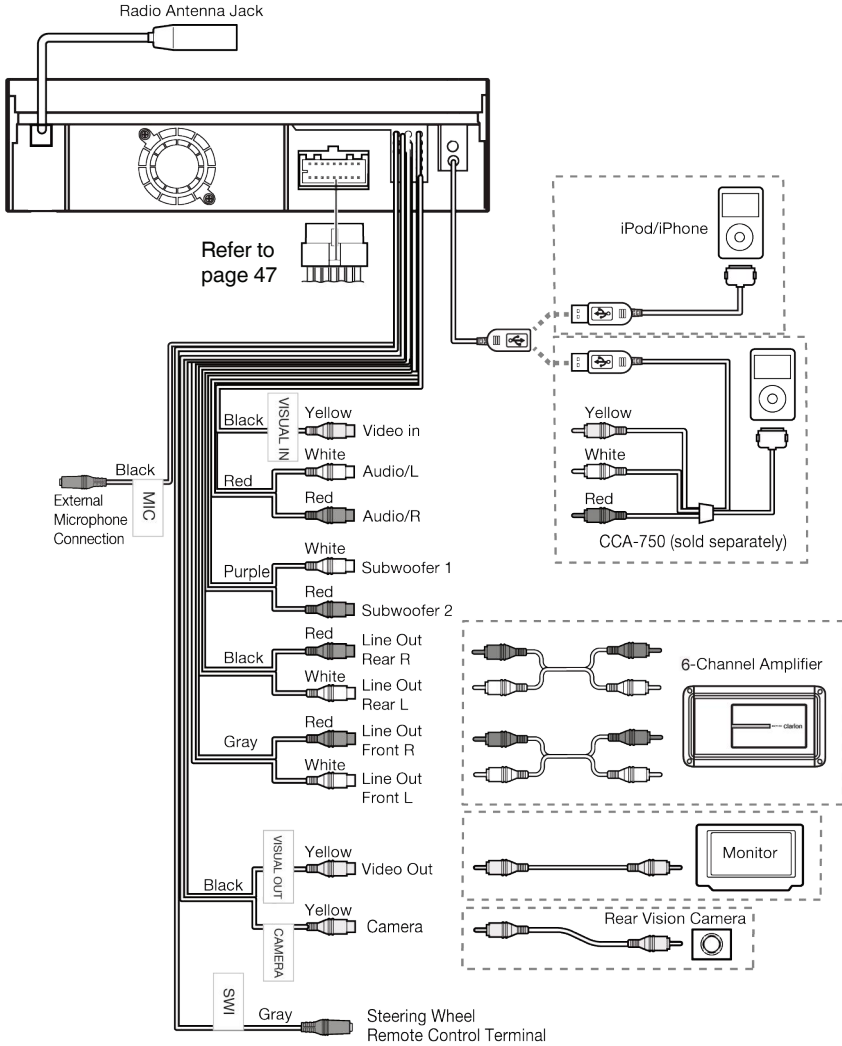

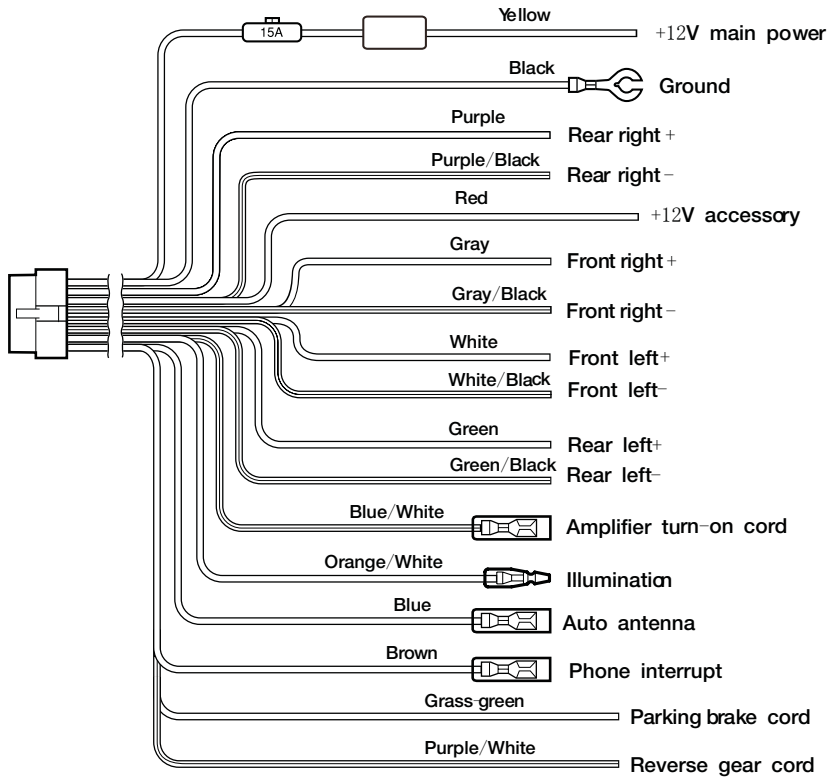

Clarion Co., Ltd.

All Rights Reserved. Copyright © 2012: Clarion Co., Ltd.

VX402A/VZ402A