

# clarion®

Owner's manual

## *XMD1* *XMD2*

AM/FM CD PLAYER  
WITH CD CHANGER CONTROL  
(XMD1 ONLY)

### ■ Contents

1. PRECAUTIONS .....	2
2. FEATURES .....	2
3. CONTROLS .....	3
4. BUTTON TERMINOLOGY .....	3
5. WIRED REMOTE CONTROL UNIT OPERATIONS .....	4
6. HANDLING COMPACT DISCS .....	5
7. OPERATION .....	6
8. TROUBLESHOOTING .....	10
9. ERROR DISPLAYS .....	11
10. SPECIFICATIONS .....	12
Simple Guide .....	13

**C-BUS**  
XMD1/ONLY

COMPACT  
**disc**  
DIGITAL AUDIO

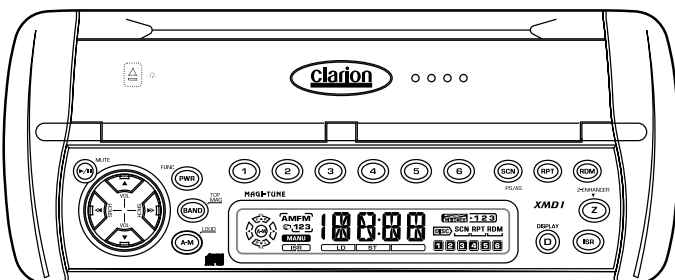

# 1. PRECAUTIONS

1. When it is very cold in the boat and the unit is used soon after switching on the heater, the disc and the optical components may become fogged and not operate properly. Wipe fogged discs with a soft cloth. Fogged optical components will naturally return to normal when the unit is left for about one hour after which it will operate normally.
2. When the boat is traveling in the rough seas the sound may skip as a result of intense vibrations and shock.
3. This unit uses a precision mechanism. Even in the event that trouble arises, never open the case, disassemble the unit, or lubricate the rotating parts.

This equipment has been tested and found to comply with the limits for a Class B digital device, pursuant to Part 15 of the FCC Rules. These limits are designed to provide reasonable protection against harmful interference in a residential installation. This equipment generates, uses, and can radiate radio frequency energy and, if not installed and used in accordance with the instructions, may cause harmful interference to radio communications. However, there is no guarantee that interference will not occur in a particular installation. If this equipment does cause harmful interference to radio or television reception, which can be determined by turning the equipment off and on, the user is encouraged to consult the dealer or an experienced radio/TV technician for help.

## ⚠ CAUTION

USE OF CONTROLS, ADJUSTMENTS, OR PERFORMANCE OF PROCEDURES OTHER THAN THOSE SPECIFIED HEREIN, MAY RESULT IN HAZARDOUS RADIATION EXPOSURE. THE COMPACT DISC PLAYER SHOULD NOT BE ADJUSTED OR REPAIRED BY ANYONE EXCEPT PROPERLY QUALIFIED SERVICE PERSONNEL.

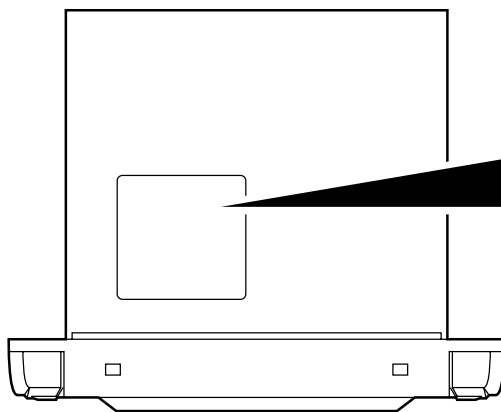

Bottom view of source unit



## INFORMATION FOR USERS:

CHANGES OR MODIFICATIONS TO THIS PRODUCT WILL VOID THE WARRANTY AND WILL VIOLATE FCC APPROVAL.

# 2. FEATURES

- Z-Enhancer with 3 Mode Sound Selector
- MAGI-TUNE<sup>®</sup> FM Reception System
- AM/FM Bands-1 AM, 3 FM/18 FM/6 AM Touchbutton Memory
- 8-Times Oversampling Digital Filter and Dual 1-Bit D/A Converters
- Zero-Bit Detector<sup>™</sup> Mute Circuit
- Repeat/Random Play/Intro Music Scan
- Multi-Color LC Display
- 4-Channel RCA Line Level Output with Fader Control (XMD2 2-Channel RCA)
- 180 W (45 W × 4) Maximum Power Output
- Wire Remote Control
- Water Resistance Escutcheon

## 3.CONTROLS

### Source Unit

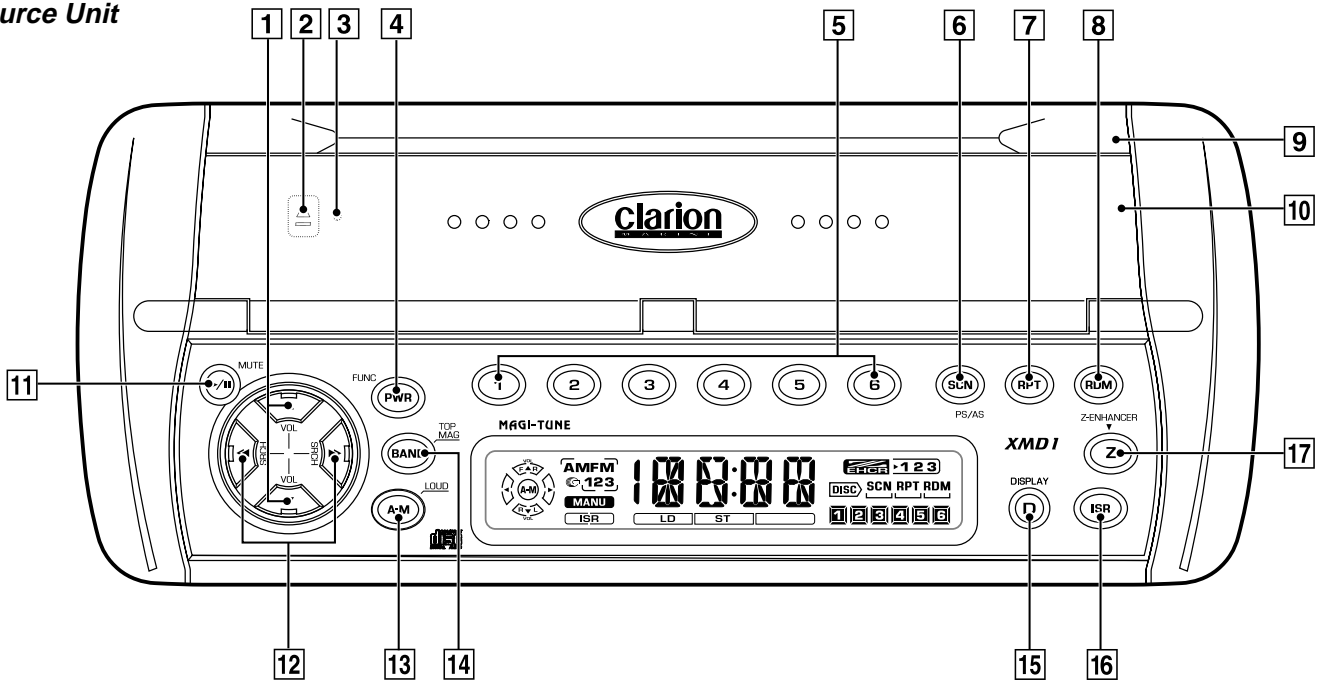

## 4.BUTTON TERMINOLOGY

- |   |   |
|---|---|
| <ul style="list-style-type: none"> <li>1 VOL (Volume) up and Down Button</li> <li>2 Eject (▲) Button</li> <li>3 Reset Button</li> <li>4 Power Button</li> <li>    FUNC (Function) Button</li> <li>5 Preset Buttons (1 to 6)</li> <li>    Direct Button (1 to 6)</li> <li>6 SCN (Scan) Button</li> <li>    PS/AS (Preset Scan/Auto Store) Button</li> <li>7 RPT (Repeat) Button</li> <li>8 RDM (Random) Button</li> <li>9 Hook</li> <li>10 Door</li> </ul> | <ul style="list-style-type: none"> <li>11 Play / Pause (▶/  ) Button</li> <li>    MUTE Button</li> <li>12 SRCH (Search) Left and Right (◀◀ and ▶▶) Button</li> <li>13 A-M (Audio Mode) Button</li> <li>    LOUD (Loudness) Button</li> <li>14 BAND Button</li> <li>    Top (Top Play) Button</li> <li>    MAG (Magazine) Button (Only XMD1)</li> <li>15 D (Display) Button</li> <li>16 ISR (Instant Station Recall) Button</li> <li>17 Z (Z-enhancer) Button</li> </ul> |
|---|---|

# 5. WIRED REMOTE CONTROL UNIT OPERATIONS

■ XMD1/XMD2 following operations are enabled by remote control with the Wired Remote Control Unit M101RC (sold separately).

## WIRED REMOTE CONTROL UNIT

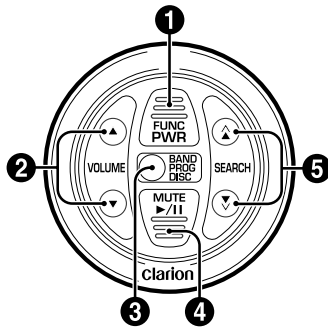

- ❶ PWR (Power) Button  
FUNC (Function) Button
- ❷ VOLUME Up (▲) / Down (▼) Buttons
- ❸ BAND Button [ 📶 ]  
DISC Up Button [ 📀 ]
- ❹ Play/Pause (▶/⏸) Button [ ⏪ ] [ ⏩ ]  
MUTE Button [ 🔇 ]
- ❺ SEARCH Up (▲) / Down (▼) Buttons  
[ 📶 ] : In the Radio Mode  
[ 📀 ] : In the CD Mode  
[ 📀 ] : In the CD Changer Mode

### PWR / FUNC Button ❶

#### Turning on and off the power

Press the PWR button ❶ to turn the power on and press and hold it for 1 second or longer to turn the power off.

### Changing the operation mode

Each time the FUNC button ❶ is pressed, the mode switches in the following order:



#### Notes:

- If the above equipment is not connected, corresponding mode cannot be selected.
- In CD mode, if no CD is loaded in XMD1/XMD2, "DISC" flashes on the display and the radio mode is selected.

### VOLUME Up (▲) / Down (▼) Buttons ❷

#### Adjusting the volume

Press the VOLUME Up button ❷ to increase the volume and press the VOLUME Down button ❷ to decrease the volume.

### BAND / DISC Up Button ❸

#### Changing the band (in the Radio mode)

Each time the BAND button ❸ is pressed, the band switches in the following order:

FM1 → FM2 → FM3 → AM → FM1.....

#### Top function (in CD mode)

Press the button ❸, then the CD will start from the first song (track number 1).

#### Changing the disc (in the CD changer mode) XMD1 only

Each time the DISC Up button ❸ is pressed, the disc switches in the following order:

1 → 2 → 3 → 4 → 5 → 6 → 1.....

## ⚠ CAUTION

Be careful about adjusting the volume, as turning on the power while the volume is raised to its maximum may harm your hearing.

### Play/Pause (▶/⏸) / MUTE Button ❹

#### Pause (in the CD mode or CD changer mode)

Press the Play/Pause button ❹. Playback pauses. To resume playback, press the Play/Pause button ❹ again.

#### Mute (in Radio mode)

Press the MUTE button ❹. The sound is muted immediately. To cancel, press the MUTE button ❹ again.

### SEARCH Up (▲) / Down (▼) Buttons ❺

#### Selecting tracks (in CD changer mode or CD mode)

Press the SEARCH Up button ❺ to start playback from the beginning of the following track. Press the SEARCH Down button ❺ to start playback from the beginning of the current track. If pressed again, the track moves to the previous one.

#### Fast-forward and fast-backward (in CD changer mode or CD mode)

Press and hold the SEARCH Up button ❺ to fast-forward the disc. Press and hold the SEARCH Down button ❺ to fast-backward the disc.

\* Pressing and holding the SEARCH Up/Down buttons for 1 second or longer will move forward or backward 3 times faster than normal play, and pressing and holding it for 3 seconds or longer will do the operation 30 times faster.

#### Changing preset stations (in the Radio mode)

Each time the SEARCH Up/Down buttons ❺ are pressed, the preset station switches in the following order:

1 → 2 → 3 → 4 → 5 → 6 → 1.....

or

6 → 5 → 4 → 3 → 2 → 1 → 6.....

## 6. HANDLING COMPACT DISCS

This unit has been designed specifically for playback of compact discs bearing the  mark. No other discs can be played.

To remove the compact disc from its storage case, press down on the center of the case and lift the disc out, holding it carefully by the edges.

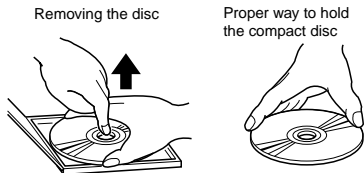

Always handle the compact disc by the edges. Never touch the surface.

To remove fingerprints and dust, use a soft cloth, and wipe in a straight line from the center of the compact disc to the circumference.

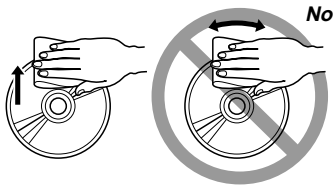

New discs may have some roughness around the edges. The unit may not work or the sound may skip if such discs are used. Use a ball-point pen, etc. to remove roughness from the edge of the disc.

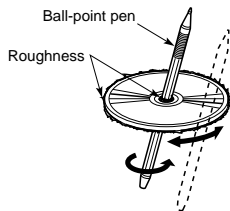

### Note:

- Do not use commercially available CD protection sheets or discs equipped with stabilizers, etc. These may get caught in the internal mechanism and damage the disc.

### Note on Compact Discs

Never stick labels on the surface of the compact disc or mark the surface with a pencil or pen.

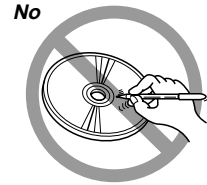

Do not use any solvents such as commercially available cleaners, anti-static spray, or thinner to clean compact discs.

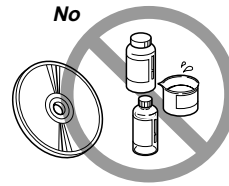

Do not use compact discs that have large scratches, are misshapen, or cracked, etc. Use of such discs will cause misoperation or damage.

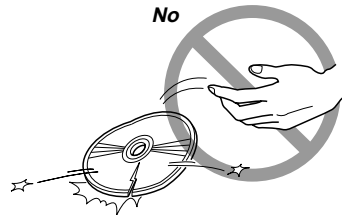

Do not expose compact discs to direct sunlight or any heat source.

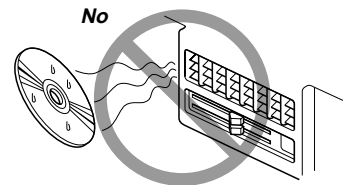

# 7. OPERATION

## Note:

- Be sure to read this chapter referring to the front diagrams of chapter 2. CONTROLS on page 3.

## Basic Operations

### ▲ CAUTION

When this unit is turned on, starting and stopping the engine of a boat with its volume raised to the maximum level may harm your hearing.

Be careful about adjusting the volume.

### IMPORTANT

Door must be totally closed to prevent water go into the set!

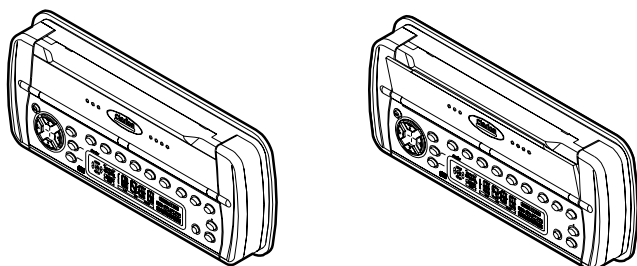

OK

NG

## Turning ON the Power and Adjusting the Volume

- 1) Press the POWER button [4].
  - \* To turn off the power, press the POWER button [4] for 1 second or longer.
- 2) Press the FUNC button [4] and select another operation mode. Every time the FUNC button [4] is pressed, the display changes the operation mode as:  
Radio → CD → CD changer → Radio

## Notes:

- The operation mode not connected to the unit will not be selected.
  - If the CD mode is selected when no disc is inserted, the display flashes "DISC".
- 3) Use the volume button [1] to adjust the volume.
    - ▲: Increases the volume.
    - ▼: Decreases the volume.
    - \* The volume level is from 0 (minimum) to 33 (maximum).

## Audio Mode Adjustments

Press the A-M button [13] to select the adjustment mode. The mode switches as follows each time the A-M button is pressed:

BASS → TREB → BAL → FAD → Previous mode

## Adjusting the Bass

- 1) Press A-M button [13] and select "BASS".
- 2) Press volume button [1] ▲ to emphasize the bass; press ▼ to attenuates the bass.
  - \* The factory default setting is "0". (Adjustment range: -6 to +6)
- 3) When the adjustment is complete, press A-M button [13] several times until the function mode is reached.

## Adjusting the Treble

- 1) Press A-M button [13] and select "TREB".
- 2) Press volume button [1] ▲ to emphasize the treble; press ▼ to attenuates the treble.
  - \* The factory default setting is "0". (Adjustment range: -6 to +6)
- 3) When the adjustment is complete, press A-M button [13] several times until the function mode is reached.

## Adjusting the Balance

- 1) Press A-M button [13] and select "BAL".
- 2) Press the volume ▲ emphasizes the sound from the right speaker; press the volume ▼ emphasizes the sound from the left speaker.
  - \* The factory default setting is "0". (Adjustment range: L9 to R9)
- 3) When the adjustment is complete, press A-M button [13] several times until the function mode is reached.

## Adjusting the Fader

- 1) Press A-M button [13] and select "FAD".
- 2) Press the volume ▲ emphasizes the sound from the front speakers; press the volume ▼ emphasizes the sound from the rear speakers.
  - \* The factory default setting is "0". (Adjustment range: F9 to R9)
- 3) When the adjustment is complete, press A-M button [13] several times until the function mode is reached.

## Setting the Z-enhancer

This unit comes with three types of sound tone effects stored in memory. Select the one you prefer.

\* The factory default setting is "Z-EHCR OFF".

Each time you press Z-EHCR button [17], the tone effect changes in the following order.

"Z-ENHANCER 1" → "Z-ENHANCER 2" → "Z-ENHANCER 3" → "Z-EHCR OFF" → "Z-ENHANCER 1"...

- Z-ENHANCER 1: bass emphasized
- Z-ENHANCER 2: treble emphasized
- Z-ENHANCER 3: bass and treble emphasized
- Z-EHCR OFF: no sound effect

## Loudness Effect

In order to turn on/off the loudness effect, use the LOUD button [13] for 2 seconds or longer. Every time the LOUD button [13] is pressed and held for 2 seconds or longer, the loudness effect switches on and off.

\* When the loudness effect is on, the display will show "LD".

## Switching the Clock Display

Every time the DISP button [15] is pressed, the display will change between the operation mode and the clock display.

## Setting the Clock

- 1) Press the DISP button [15] to display the clock display.
- 2) Press and hold the DISP button [15] for 2 seconds or longer.
- 3) Press the SRCH Left button [12], then set the current hour.
- 4) Press the SRCH Right button [12], then set the current minute.
- 5) Press the DISP button [15], then the clock is set.

## Notes:

- If you select another operation mode while you are setting the clock, the clock setting operation will be canceled.
- If you remove the vehicle's battery for a check or repair, the clock will be reset, so you must set it again.

## Radio Mode Operations

### FM Reception

For enhanced FM performance the **MAGITUNE**® tuner includes signal actuated stereo control and Multipath noise reduction circuits.

### Listening to the Radio

- 1) Press the FUNC button [4] to select the radio mode, then the radio will be on.
- 2) To select a preset band, press the "BAND" button [14], then select one of the preset bands such as FM1, FM2, FM3, or AM. Every time the "BAND" button [14] is pressed, the display will change as: FM1 → FM2 → FM3 → AM → FM1
- 3) Press the SRCH Left/Right button [12], then the station at which there is a broadcast will be selected (Seek selection).

### Mute

Use this function to turn off the sound immediately. Press the MUTE button [11]. The sound turns off and "MUTE" appears on the display. Press the MUTE button again to cancel the mute mode.

### Manual Tuning

- 1) Press the "BAND" button [14], then select FM1, FM2, FM3 or AM.
- 2) Press and hold the "BAND" button [14] for 2 seconds or longer, then the display will show "MANU", which means that a manual selection function is on.
- 3) Press the SRCH Left/Right button [12] and select the right station.

### Seek Tuning

- 1) Press the "BAND" button [14], then select FM1, FM2, FM3 or AM.
- 2) If the "MANU" on the display is on, press and hold the "BAND" button [14] for 2 seconds or longer. When the "MANU" display is off, the Seek Selection function is on.
- 3) Press the SRCH Left/Right button [12], then when it selects the station in which there is a broadcast, it automatically stops.

### Preset Memory Function

Preset Memory Function can store up to 24 stations: six stations for each of FM1, FM2, FM3 and AM.

#### Note:

- When the present memory function is used, all the content of the memory will be erased.

### Manual memory function

- 1) Press the "BAND" button [14], and select the band you want to store in the memory.
- 2) Press the SRCH Left/Right button [12] then select the station you want to store in the memory.
- 3) Press and hold the Preset button [5] for 2 seconds or longer, then the station will be stored in the memory.

### Auto store function (Automatic Station Store)

- 1) Press the "BAND" button [14], then select the band you want to store in the memory.
- 2) Press and hold the AS button [6] for 2 seconds or longer, then the station at which the reception is the strongest will be automatically stored in the memory.

#### Note:

- When the number of stations stored is less than six, the previous content of the memory for each direct button will be retained.

### Preset Scanning (Preset Station Scan)

When the PS button [6] is pressed, the preset memory numbers flash and the stations are tuned in for 7 seconds each in the order in which they were stored. Press the PS button again to cancel the preset scanning mode.

### Instant Station Recall (ISR)

With this function, a specific radio station can be recalled from any mode.

#### ISR memory

- 1) Press the FUNC button [4], then select the radio mode.
- 2) Select the radio station which you want to store in the memory.
- 3) Press and hold the ISR button [16] for 2 seconds or longer.

#### Recalling ISR

Press the ISR button [16] then the display will show "ISR", then the radio station previously memorized will be selected. Press the ISR button [16] again to disengage the unit from the Recalling ISR function.

### Area Change

Use this function when you are using the boat stereo anywhere outside the U.S.

#### Switchable frequency spacing

This boat stereo is initially set to tune in frequency intervals of 10 kHz for AM and 200 kHz for FM, the standard calibrations in the U.S. When using the unit outside the U.S., use the following procedure to switch the frequency range.

The table below lists the frequency specifications for the U.S. and other countries.

		Initial Setting (U.S. standard)	New Setting (outside U.S.)
AM	Frequency spacing	10 kHz	9 kHz
	Frequency range	530 to 1,710 kHz	531 to 1,629 kHz
FM	Frequency spacing	200 kHz	50 kHz
	Frequency range	87.9 to 107.9 MHz	87.5 to 108 MHz

#### Switching the area change Outside U.S. (New Setting)

While pressing the "BAND" button [14], press the SRCH Left button [12], then "outside U.S." will be selected.

#### Inside U.S. standard (Initial Setting)

While pressing the "BAND" button [14], press the SRCH Right button [12], then the "U.S. standard" will be selected.

## CD Mode Operations

### Loading a Disc

Open the door by push up the hook.

Insert the disc into the CD insertion slot with its label side up and completely close the door, then the CD will start playing.

For 5-inch (12 cm) CD

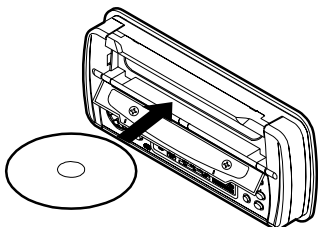

For 3-inch (8 cm) single CD

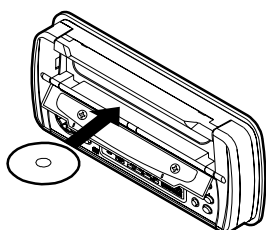

- \* When inserting a single CD (3"(8 cm)), insert it from the center of the slot.
- \* When inserting a single CD (3"(8 cm)), do not connect an adapter.

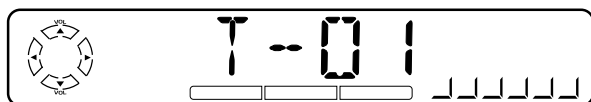

CD MODE OPERATION

- \* Press the DISP button [15], then the display will show the play time.  
Track No. → Play time → Clock → Track No.

#### Notes:

- Some CDs recorded in CD-R mode may not be usable.
- Even when recorded in CD-RW mode, some CDs may not be usable.

### Listening to the Disc already Inserted

Press the FUNC button [4] to select the CD mode, the CD will start playing.

### Stopping (pausing) Playback

Press the Play/Pause button [11].

Press the Play/Pause button [11] again to resume playback.

### Ejecting the CD

Open the door by push up the hook.

Press the Eject button [2], then the CD will be ejected.

#### Note:

- If the ejected CD is left as it is, it will be reloaded after 15 seconds. However, single CDs will not be reloaded, so make sure to remove them.

### Top Function

Press the TOP button [14], then the CD will start playing from the first song (track number 1).

### Selecting Tracks (songs)

Press the SRCH Left/Right button [12].

▶▶ : Playback will start from the next track.

◀◀ : Playback will start from the beginning of the track currently playing. When this button is pressed again, the CD will play from the previous track.

### Fast-Forward and Fast-Backward

Press and hold the SRCH Left/Right button [12].

▶▶ : To fast-forward

◀◀ : To fast-backward

- \* Pressing the SRCH Left/Right button for 1 second or longer will move forward or backward 5 times faster than normal play, and pressing it for 3 seconds or longer will do the operation 30 times faster.

### Scan Play (Intro Music Scan)

Press the SCN button [6], then the display shows "SCN", then the CD will play the first 10 seconds of each track of the whole disc. Press the SCN button [6] again to disengage the unit from scan play.

- \* A scan play will start from the track following the one currently playing.

### Repeat Play

Press the RPT button [7], then the display shows "RPT", then the track currently playing will be played repeatedly. Press the RPT button [7] again to disengage the unit from repeat play.

### Random Play

Press the RDM button [8], then the display will show "RDM", then the entire tracks on the disc will be played at random. Press the RDM button [8] again to disengage the unit from random play.

## CD Changer Mode Operations (Only XMD1)

### Listening to the Disc

Press the FUNC button [4] and select the CD changer mode, then the CD starts playing.

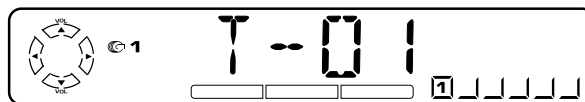

CD CHANGER MODE OPERATION

### Stopping (pausing) Playback

Press the Play/Pause button [11].

Press the Play/Pause button [11] again to resume playback.

### Selection of CDs

Press the Direct button (1 to 6) [5] then select the CD you wish to play.

### Selecting Tracks (songs)

Press the SRCH Left/Right button [12].

▶▶ : Playback will start from the next track.

◀◀ : Playback will start from the beginning of the track currently playing. When this button is pressed again, the CD will play from the previous track.

### Fast-Forward and Fast-Backward

Press and hold the SRCH Left/Right button [12].

▶▶ : To fast-forward

◀◀ : To fast-backward

- \* Pressing the SRCH Left/Right button for 1 second or longer will move forward or backward 5 times faster than normal play, and pressing it for 3 seconds or longer will do the operation 30 times faster.



### ***Scan Play (Intro Music Scan)***

Press the SCN button [6], then the display shows "SCN", then the CD will play the first 10 seconds of all the tracks of all CDs. Press the SCN button [6] again to disengage the unit from scan play.

\* A scan play will start from the track following the one currently playing.

### **Disc scan play**

Press and hold the SCN button [6] for 2 seconds or longer, then the display will show "DISC" and "SCN", and plays the first 10 seconds of the first song of all the CDs in the CD changer.

Press the SCN button [6] again to disengage the unit from disc play.

\* A scan play will start from the first tracks of next CDs following the one currently playing.

### ***Repeat Play***

Press the RPT button [7], then the display shows "RPT", then the track currently playing will be played repeatedly. Press the RPT button [7] again to disengage the unit from repeat play.

### **Disc repeat play**

Press and hold the RPT button [7] for 2 seconds or longer, then the display shows both the "DISC" and "RPT", then the disc currently being played will be played repeatedly.

Press the RPT button [7] again to disengage the unit from disc repeat play.

### ***Random Play***

Press the RDM button [8], then the display will show "RDM", then the entire tracks on the disc will be played at random.

Press the RDM button [8] again to disengage the unit from disc random play.

### **Disc random playback**

Press and hold the RDM button [8] for 2 seconds or longer, then the display will show both the "DISC" and "RDM", then the entire tracks of all the discs in the CD changer will be played at random.

Press the RDM button [8] again to disengage the unit from disc play.

### ***Switching Magazine***

This function can be used only when the connected CD changer can store a multiple number of magazines.

Every time the MAG button [14] is pressed, the next magazine will be selected.

## 8.TROUBLESHOOTING

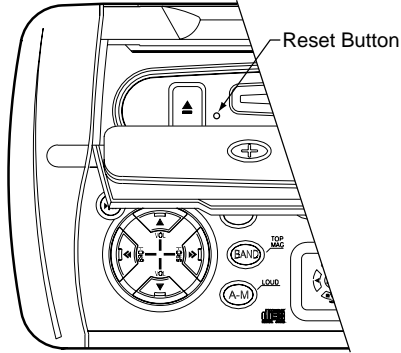
Problem	Cause	Solution
Power does not turn on. (No sound is produced.)	Fuse is blown.	Replace with a fuse of the same amperage. If the fuse blows again, consult your store of purchase.
	Incorrect wiring.	Consult your store of purchase.
Compact disc cannot be loaded.	Another compact disc is already loaded.	Eject the compact disc before loading the new one.
Sound skips or is noisy.	Compact disc is dirty.	Clean the compact disc with a soft cloth.
	Compact disc is heavily scratched or warped.	Replace with a compact disc with no scratches.
Sound is bad directly after power is turned on.	Water droplets may form on the internal lens when the car is parked in a humid place.	Let dry for about 1 hour with the power on.
Nothing happens when buttons are pressed. Display is not accurate.	Microprocessor has malfunctioned due to noise, etc.	Turn off the power, then open the door <b>10</b> by up the hook <b>9</b> . Press the reset button for about 2 seconds with a thin rod. 

## 9. ERROR DISPLAYS

- To protect the system, this unit has been equipped with self diagnostic functions. If a fault arises, a warning is issued by various error displays. Follow the corrective measures and remove the fault.

Error Display	Corrective Measure
Er 2	This error display indicates that a fault has arisen in the mechanism of the source unit or CD changer (for example, the disc cannot be changed or ejected). → Check the source unit and CD changer.
Er 3	This error display indicates that the pickup focus is off because of a scratched disc or some other factor during source unit or CD changer play. → Check the compact disc.
Er 6	This indicates that the CD's TOC (table of contents) cannot be read, for example because the selected disc is upside-down.

## 10. SPECIFICATIONS

### FM Tuner

Frequency Range: 87.9 MHz to 107.9 MHz  
Usable Sensitivity: 11 dBf  
50 dB Quieting Sensitivity: 17 dBf  
Alternate Channel Selectivity: 75 dB  
Stereo Separation (1 kHz): 35 dB  
Frequency Response ( $\pm 3$  dB): 30 Hz to 15 kHz

### AM Tuner

Frequency Range: 530 kHz to 1,710 kHz  
Usable Sensitivity: 25  $\mu$ V

### CD Player

System: Compact disc audio system  
Usable Discs: Compact disc  
Frequency Response: 10 Hz to 20 kHz ( $\pm 1$  dB)  
Signal-to-Noise Ratio: 100 dB (1 kHz) IHF-A  
Dynamic Range: 95 dB (1 kHz)  
Harmonic Distortion: 0.01% (1kHz)

### Audio

Maximum Power Output:  
180 W (45 W  $\times$  4 ch)  
Continuous Average Power Output:  
16 W  $\times$  4, into 4  $\Omega$ , 20 Hz to 20 kHz, 1%THD  
Bass Control Action (30 Hz):  $\pm 13$  dB  
Treble Control Action (10 kHz):  $\pm 10$  dB  
Line Output (CD 1 kHz, 10 k $\Omega$ ): 1.8 V

### General

Power Supply Voltage: 14.4 V DC (10.8 V to 15.6 V allowable), negative ground  
Current Consumption: Less than 15 A  
Speaker Impedance: 4  $\Omega$  (4  $\Omega$  to 8  $\Omega$  allowable)  
Weight: 5.5 lb. (2.5 kg)  
Dimensions:  
7" (178 mm) Width  $\times$  2" (50 mm) Height  $\times$  6" (152 mm) Depth

### Escutcheon section

9" (232 mm) Width  $\times$  4" (94 mm) Height  $\times$  1-1/2" (27 mm) Thickness

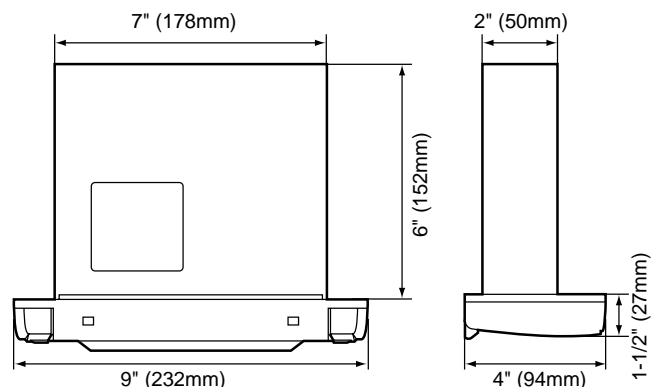

### Notes:

- Specifications comply with EIA Standards.
- Specifications and design are subject to change without notice for further improvement.



Note: Be sure to unfold this page and refer to the front diagram as you read each charters  
SOURCE UNIT

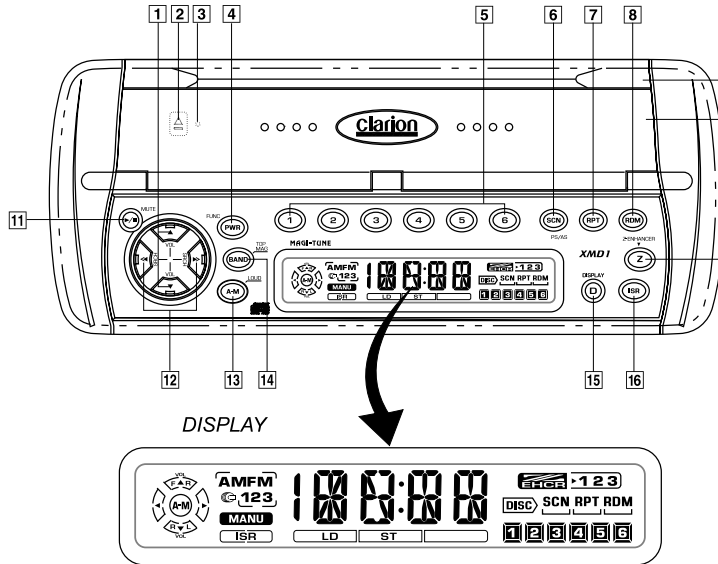

- 1 VOL (Volume) up and Down Button
- 2 Eject (▲) Button
- 3 Reset Button
- 4 Power Button  
FUNC (Function) Button
- 5 Preset Buttons (1 to 6)  
Direct Button (1 to 6)
- 6 SCN (Scan) Button  
PS/AS (Preset Scan/Auto Store) Button
- 7 RPT (Repeat) Button
- 8 RDM (Random) Button
- 9 Hook
- 10 Door
- 11 Play / Pause (⏮/⏭) Button  
MUTE Button
- 12 SRCH (Search) Left and Right (◀ and ▶) Button
- 13 A-M (Audio Mode) Button  
LOUD (Loudness) Button
- 14 BAND Button  
Top (Top Play) Button  
MAG (Magazine) Button
- 15 D (Display) Button
- 16 ISR (Instant Station Recall) Button
- 17 Z (Z-enhancer) Button

**Note: After loading or ejecting CD, make sure the Door 10 is totally close!**

Door open: Push up Hook 9 then Door 10 will open for loading or ejecting CD and using the Reset Button 3.

Button	Mode	Radio	CD	CD Changer (XMD1 only)
4	PWR FUNC	Turns power on and off. When pressed and held for 1 second: Turns power off. Switch between radio, CD and CD Changer.		
14	BAND TOP MAG	Switch reception band	Plays the first track Top play.	The next magazine will be selected. (Multiple number of magazines only)
1	VOLUME	Increases and decreases volume.		
12	SRCH	Seek up or down and stop at the station at which there is a broadcast will be selected.	Moves tracks up and down. When pressed and held for 1 second: Fast - forward/ fast - backward.	Moves tracks up and down. When pressed and held for 1 second: Fast - forward/ fast - backward.
11	PLAY/PAUSE MUTE	Turns mute on and off.	Switches between playback and pause.	Switches between Playback and pause.
13	A - M LOUD	Switches between Bass, Treble, Balance and Fader control. When pressed and held for 2 second Loudness on.		
5	Preset Direct	Recall the station stored before. When pressed and held for 2 seconds: Store the current station.	/	
6	SCN PS/AS	Turns Preset Station on and off. When pressed and held for 2 seconds: Store the Station which the reception is the strongest automatically.	Play the CD first 10 seconds of all tracks.	Play the CD first 10 seconds of all tracks. When pressed and held 2 seconds play all CDs in the CD changer first 10 seconds of each track.
7	RPT	/		Play the current track repeatedly. When pressed and held 2 seconds: The current disc will be played repeatedly.
8	RDM	/		The entire tracks on the disc will be played at random. When pressed and held 2 seconds: The entire tracks of all the discs in the CD changer will be played at random.
16	ISR	The radio station previously memorized will be selected.	/	
17	Z	Select the sound tone effects stored in memory		
15	D	Switch between operation mode and the clock display.		
2	Eject	/		Eject the CD disc

# IMPORTANT

**DOOR MUST BE TOTALLY CLOSED TO PREVENT WATER GO INTO THE SET!**

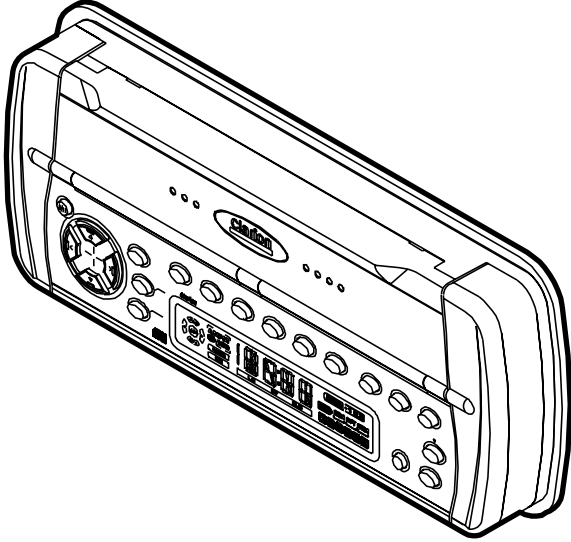

**OK**

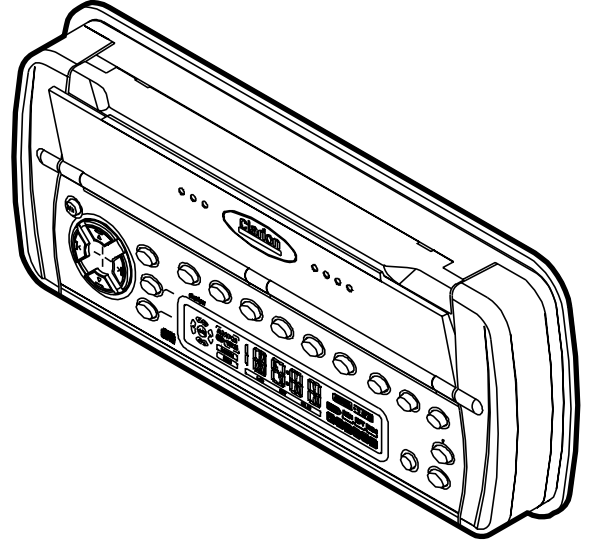

**NG**

**LOADING A DISC  
OPEN THE DOOR BY PUSH THE HOOK.**

For 5-inch (12 cm) CD

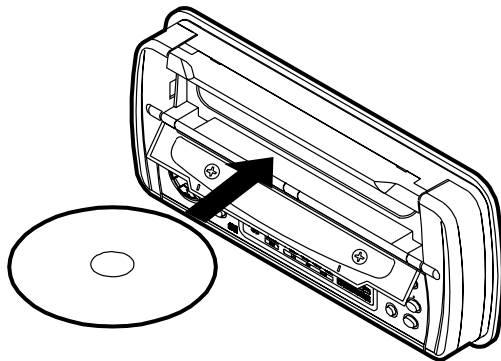

For 3-inch (8 cm) single CD

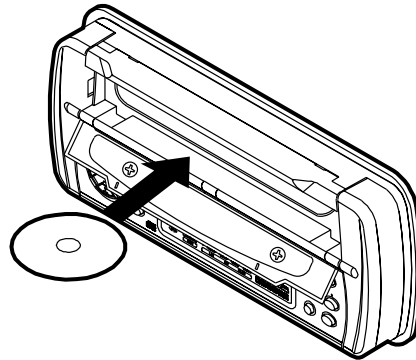

**PRESS THE RESET BUTTON FOR ABOUT 2 SECONDS WITH A THIN ROD.**

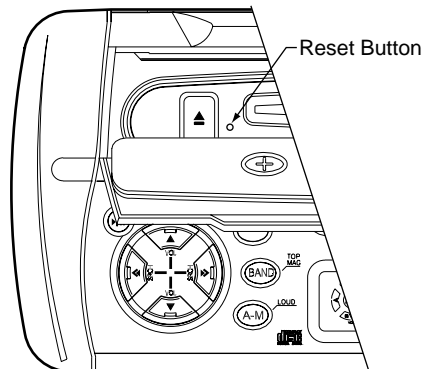



# Clarion Co., Ltd.

---

All Rights Reserved. Copyright © 2000: Clarion Co., Ltd.  
Printed in China

2000/3 (D•C)

PE-2338B / 2339B  
280-7480-00