

# Inspiron 15

## 7000 Series

# Service Manual

Computer Model: Inspiron 7548  
Regulatory Model: P41F  
Regulatory Type: P41F001



# Notes, Cautions, and Warnings

---



**NOTE:** A NOTE indicates important information that helps you make better use of your computer.



**CAUTION:** A CAUTION indicates either potential damage to hardware or loss of data and tells you how to avoid the problem.



**WARNING:** A WARNING indicates a potential for property damage, personal injury, or death.

---

**Copyright © 2014 Dell Inc. All rights reserved.** This product is protected by U.S. and international copyright and intellectual property laws. Dell™ and the Dell logo are trademarks of Dell Inc. in the United States and/or other jurisdictions. All other marks and names mentioned herein may be trademarks of their respective companies.

# Contents

<b>Before Working Inside Your Computer.....</b>	<b>7</b>
Before You Begin .....	7
Safety Instructions.....	7
Recommended Tools.....	8
<b>After Working Inside Your Computer.....</b>	<b>10</b>
<b>Removing the Base Cover.....</b>	<b>11</b>
Procedure.....	11
<b>Replacing the Base Cover.....</b>	<b>13</b>
Procedure.....	13
<b>Removing the Battery.....</b>	<b>14</b>
Prerequisites.....	14
Procedure.....	14
<b>Replacing the Battery.....</b>	<b>16</b>
Procedure.....	16
Post-requisites.....	16
<b>Removing the Hard Drive.....</b>	<b>17</b>
Prerequisites.....	17
Procedure.....	17
<b>Replacing the Hard Drive.....</b>	<b>19</b>
Procedure.....	19
Post-requisites.....	19

<b>Removing the Memory Module(s).....</b>	<b>20</b>
Prerequisites.....	20
Procedure.....	20
<b>Replacing the Memory Module(s).....</b>	<b>22</b>
Procedure.....	22
Post-requisites.....	23
<b>Removing the Wireless Card.....</b>	<b>24</b>
Prerequisites.....	24
Procedure.....	24
<b>Replacing the Wireless Card.....</b>	<b>26</b>
Procedure.....	26
Post-requisites.....	26
<b>Removing the Coin-Cell Battery.....</b>	<b>27</b>
Prerequisites.....	27
Procedure.....	27
<b>Replacing the Coin-Cell Battery.....</b>	<b>29</b>
Procedure.....	29
Post-requisites.....	29
<b>Removing the Power-Adapter Port.....</b>	<b>30</b>
Prerequisites.....	30
Procedure.....	30
<b>Replacing the Power-Adapter Port.....</b>	<b>32</b>
Procedure.....	32
Post-requisites.....	32

<b>Removing the Power-Status Light Board.....</b>	<b>33</b>
Prerequisites.....	33
Procedure.....	33
<b>Replacing the Power-Status Light Board.....</b>	<b>35</b>
Procedure.....	35
Post-requisites.....	35
<b>Removing the Processor Fan.....</b>	<b>36</b>
Prerequisites.....	36
Procedure.....	36
<b>Replacing the Processor Fan.....</b>	<b>38</b>
Procedure.....	38
Post-requisites.....	38
<b>Removing the Video-Card Fan.....</b>	<b>39</b>
Prerequisites.....	39
Procedure.....	39
<b>Replacing the Video-Card Fan.....</b>	<b>42</b>
Procedure.....	42
Post-requisites.....	42
<b>Removing the Heat Sink.....</b>	<b>43</b>
Prerequisites.....	43
Procedure.....	44
<b>Replacing the Heat Sink.....</b>	<b>45</b>
Procedure.....	45
Post-requisites.....	45

<b>Removing the Speakers.....</b>	<b>46</b>
Prerequisites.....	46
Procedure.....	46
<b>Replacing the Speakers.....</b>	<b>48</b>
Procedure.....	48
Post-requisites.....	48
<b>Removing the Display Assembly.....</b>	<b>49</b>
Prerequisites.....	49
Procedure.....	49
<b>Replacing the Display Assembly.....</b>	<b>52</b>
Procedure.....	52
Post-requisites.....	52
<b>Removing the System Board.....</b>	<b>53</b>
Prerequisites.....	53
Procedure.....	54
<b>Replacing the System Board.....</b>	<b>56</b>
Procedure.....	56
Post-requisites.....	56
<b>Removing the Palm Rest and Keyboard.....</b>	<b>57</b>
Procedure.....	57
Procedure.....	57
<b>Replacing the Palm Rest and Keyboard.....</b>	<b>60</b>
Procedure.....	60
Post-requisites.....	60
<b>Flashing the BIOS.....</b>	<b>61</b>



# Before Working Inside Your Computer

---

 **CAUTION:** To avoid damaging the components and cards, handle them by their edges and avoid touching pins and contacts.









 **NOTE:** The images in this document may differ from your computer depending on the configuration you ordered.

## Before You Begin

- 1 Save and close all open files and exit all open applications.
- 2 Shut down your computer.
  - Windows 8.1: On the **Start** screen, click or tap the power icon  → **Shut down**.
  - Windows 7: Click or tap **Start** → **Shut down** .
-  **NOTE:** If you are using a different operating system, see the documentation of your operating system for shut-down instructions.
- 3 Disconnect your computer and all attached devices from their electrical outlets.
- 4 Disconnect all cables such as telephone cables, network cables and so on, from your computer.
- 5 Disconnect all attached devices and peripherals, such as keyboard, mouse, monitor, and so on, from your computer.
- 6 Remove any media card and optical disc from your computer, if applicable.

## Safety Instructions

Use the following safety guidelines to protect your computer from potential damage and ensure your personal safety.

-  **WARNING:** Before working inside your computer, read the safety information that shipped with your computer. For more safety best practices, see the Regulatory Compliance home page at [dell.com/regulatory\\_compliance](http://dell.com/regulatory_compliance).
-  **WARNING:** Disconnect all power sources before opening the computer cover or panels. After you finish working inside the computer, replace all covers, panels, and screws before connecting to the power source.
-  **CAUTION:** To avoid damaging the computer, make sure that the work surface is flat and clean.
-  **CAUTION:** To avoid damaging the components and cards, handle them by their edges and avoid touching pins and contacts.
-  **CAUTION:** You should only perform troubleshooting and repairs as authorized or directed by the Dell technical assistance team. Damage due to servicing that is not authorized by Dell is not covered by your warranty. See the safety instructions that shipped with the product or at [dell.com/regulatory\\_compliance](http://dell.com/regulatory_compliance).
-  **CAUTION:** Before touching anything inside your computer, ground yourself by touching an unpainted metal surface, such as the metal at the back of the computer. While you work, periodically touch an unpainted metal surface to dissipate static electricity, which could harm internal components.
-  **CAUTION:** When you disconnect a cable, pull on its connector or on its pull-tab, not on the cable itself. Some cables have connectors with locking tabs or thumb-screws that you must disengage before disconnecting the cable. When disconnecting cables, keep them evenly aligned to avoid bending any connector pins. When connecting cables, make sure that the ports and connectors are correctly oriented and aligned.
-  **CAUTION:** To disconnect a network cable, first unplug the cable from your computer and then unplug the cable from the network device.
-  **CAUTION:** Press and eject any installed card from the media-card reader.

## Recommended Tools

The procedures in this document may require the following tools:



- Philips screwdriver
- Plastic scribe

# After Working Inside Your Computer

---



**CAUTION: Leaving stray or loose screws inside your computer may severely damage your computer.**

- 1 Replace all screws and make sure that no stray screws remain inside your computer.
- 2 Connect any external devices, peripherals, and cables you removed before working on your computer.
- 3 Replace any media cards, discs, and any other part(s) that you removed before working on your computer.
- 4 Connect your computer and all attached devices to their electrical outlets.
- 5 Turn on your computer.

# Removing the Base Cover

---



**WARNING:** Before working inside your computer, read the safety information that shipped with your computer and follow the steps in [Before Working Inside Your Computer](#). After working inside your computer, follow the instructions in [After Working Inside Your Computer](#). For more safety best practices, see the Regulatory Compliance home page at [dell.com/regulatory\\_compliance](http://dell.com/regulatory_compliance).

## Procedure

- 1 Close the display and turn the computer over.
- 2 Loosen the captive screws that secure the base cover to the palm-rest assembly.
- 3 Remove the screws that secure the base cover to the palm-rest assembly.
- 4 Using a plastic scribe, pry the base cover from the palm-rest assembly.

5 Lift the base cover off the computer.

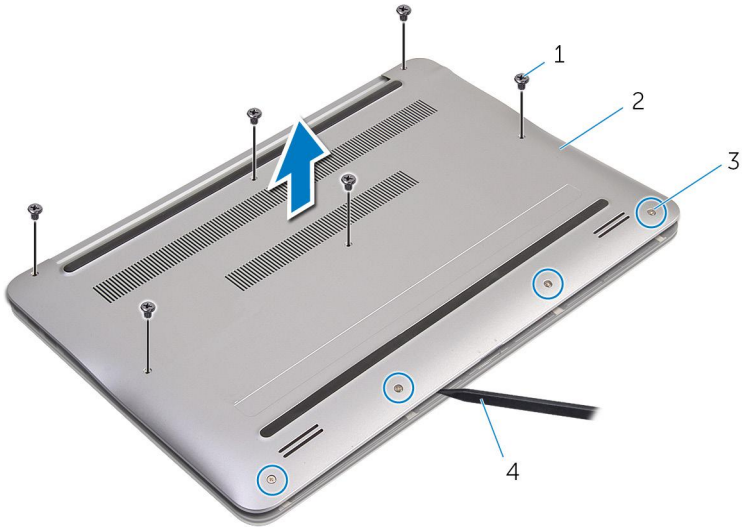

1 screws (6)

2 base cover

3 captive screws (4)

4 plastic scribe

# Replacing the Base Cover

---



**WARNING:** Before working inside your computer, read the safety information that shipped with your computer and follow the steps in [Before Working Inside Your Computer](#). After working inside your computer, follow the instructions in [After Working Inside Your Computer](#). For more safety best practices, see the Regulatory Compliance home page at [dell.com/regulatory\\_compliance](http://dell.com/regulatory_compliance).

## Procedure

- 1 Align the tabs on the base cover with the slots on the palm-rest assembly and snap the base cover into place.
- 2 Replace the screws that secure the base cover to the palm-rest assembly.
- 3 Tighten the captive screws that secure the base cover to the palm-rest assembly.

# Removing the Battery

---

 **WARNING:** Before working inside your computer, read the safety information that shipped with your computer and follow the steps in [Before Working Inside Your Computer](#). After working inside your computer, follow the instructions in [After Working Inside Your Computer](#). For more safety best practices, see the Regulatory Compliance home page at [dell.com/regulatory\\_compliance](http://dell.com/regulatory_compliance).

## Prerequisites

Remove the [base cover](#).

## Procedure

- 1 Remove the screws that secure the battery to the palm-rest assembly.
- 2 Turn the battery over.

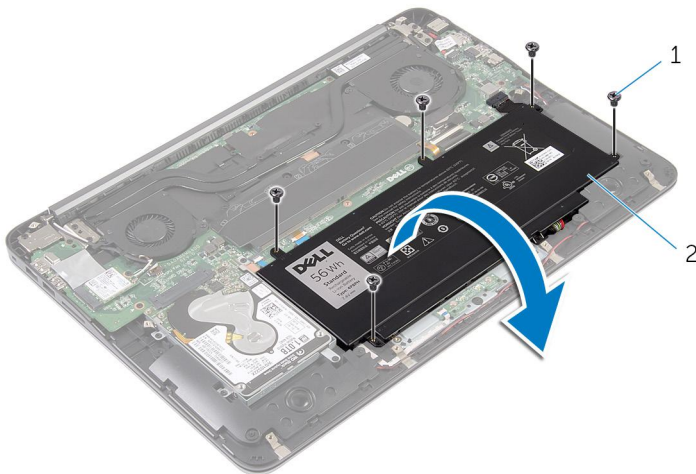

1 screws (5)

2 battery

- 3 Disconnect the battery cable from the battery.

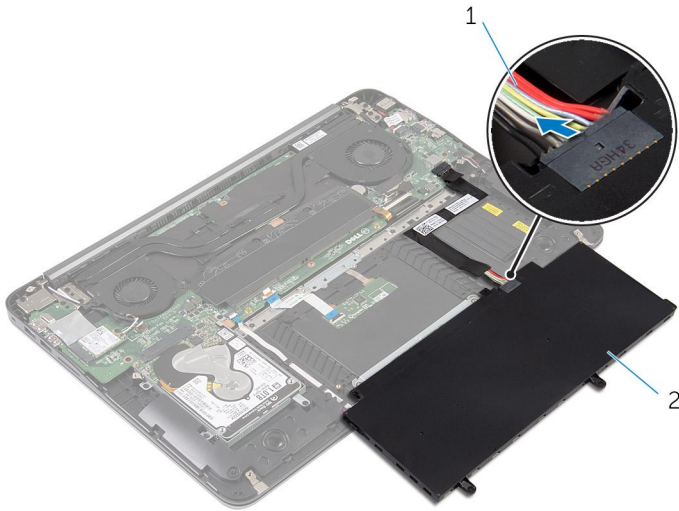

1 battery cable

2 battery

- 4 Turn the computer over, open the display, and press the power button for five seconds to ground the system board.

# Replacing the Battery

---



**WARNING:** Before working inside your computer, read the safety information that shipped with your computer and follow the steps in [Before Working Inside Your Computer](#). After working inside your computer, follow the instructions in [After Working Inside Your Computer](#). For more safety best practices, see the Regulatory Compliance home page at [dell.com/regulatory\\_compliance](http://dell.com/regulatory_compliance).

## Procedure

- 1 Connect the battery cable to the battery.
- 2 Turn the battery over and align the screw holes on the battery with the screw holes on the palm-rest assembly.
- 3 Replace the screws that secure the battery to the palm-rest assembly.



## Post-requisites

Replace the [base cover](#).



# Removing the Hard Drive

---

-  **WARNING:** Before working inside your computer, read the safety information that shipped with your computer and follow the steps in [Before Working Inside Your Computer](#). After working inside your computer, follow the instructions in [After Working Inside Your Computer](#). For more safety best practices, see the Regulatory Compliance home page at [dell.com/regulatory\\_compliance](http://dell.com/regulatory_compliance).
-  **CAUTION:** Hard drives are fragile. Exercise care when handling the hard drive.
-  **CAUTION:** To avoid data loss, do not remove the hard drive while the computer is in sleep or on state.

## Prerequisites

- 1 Remove the [base cover](#).
- 2 Remove the [battery](#).

## Procedure

- 1 Remove the screws that secure the hard-drive assembly to the palm-rest assembly.

- 2** Slide and lift the hard-drive assembly off the palm-rest assembly.

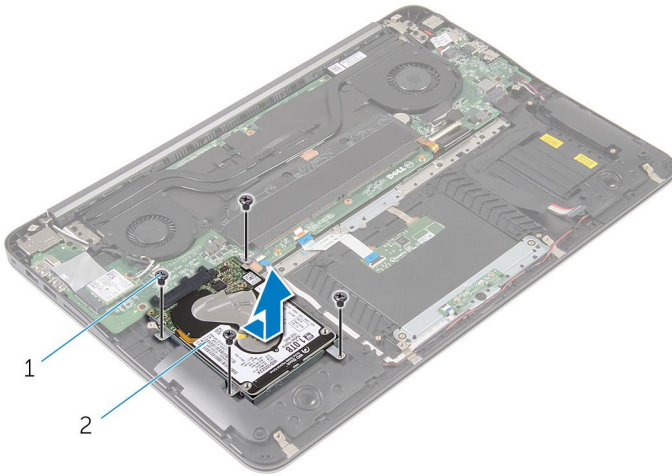

1 screws (4)

2 hard-drive assembly

- 3** Remove the screws that secure the hard-drive bracket to the hard-drive.  
**4** Lift the hard-drive bracket off the hard drive.

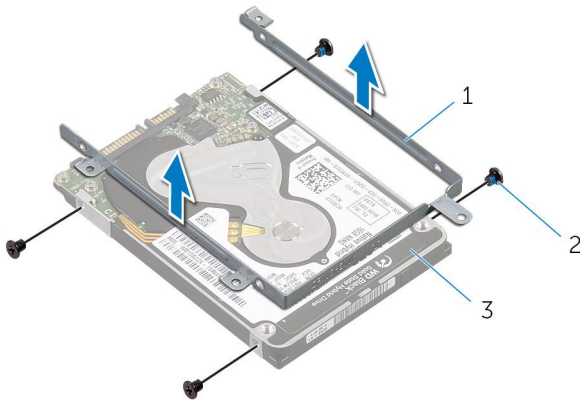

1 hard-drive bracket

2 screws (4)

3 hard drive

# Replacing the Hard Drive

---

 **WARNING:** Before working inside your computer, read the safety information that shipped with your computer and follow the steps in [Before Working Inside Your Computer](#). After working inside your computer, follow the instructions in [After Working Inside Your Computer](#). For more safety best practices, see the Regulatory Compliance home page at [dell.com/regulatory\\_compliance](http://dell.com/regulatory_compliance).

 **CAUTION:** Hard drives are fragile. Exercise care when handling the hard drive.

## Procedure

- 1 Align the screw holes on the hard-drive bracket with the screw holes on the hard drive.
- 2 Replace the screws that secure the hard-drive bracket to the hard-drive.
- 3 Slide the hard-drive assembly into the slot on the palm-rest assembly.
- 4 Replace the screws that secure the hard-drive assembly to the palm-rest assembly.

## Post-requisites

- 1 Replace the [battery](#).
- 2 Replace the [base cover](#).

# Removing the Memory Module(s)

---

-  **WARNING:** Before working inside your computer, read the safety information that shipped with your computer and follow the steps in [Before Working Inside Your Computer](#). After working inside your computer, follow the instructions in [After Working Inside Your Computer](#). For more safety best practices, see the Regulatory Compliance home page at [dell.com/regulatory\\_compliance](http://dell.com/regulatory_compliance).

## Prerequisites

- 1 Remove the [base cover](#).
- 2 Remove the [battery](#).

## Procedure

- 1 Peel off the mylar tape from the memory modules.

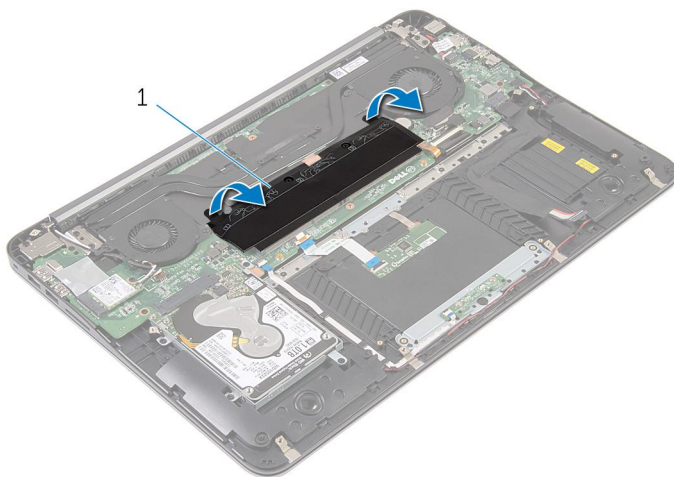

1 mylar tape

- 2 Use your fingertips to carefully spread apart the securing clips on each end of the memory-module slot until the memory module pops up.

**3** Remove the memory module from the memory-module slot.

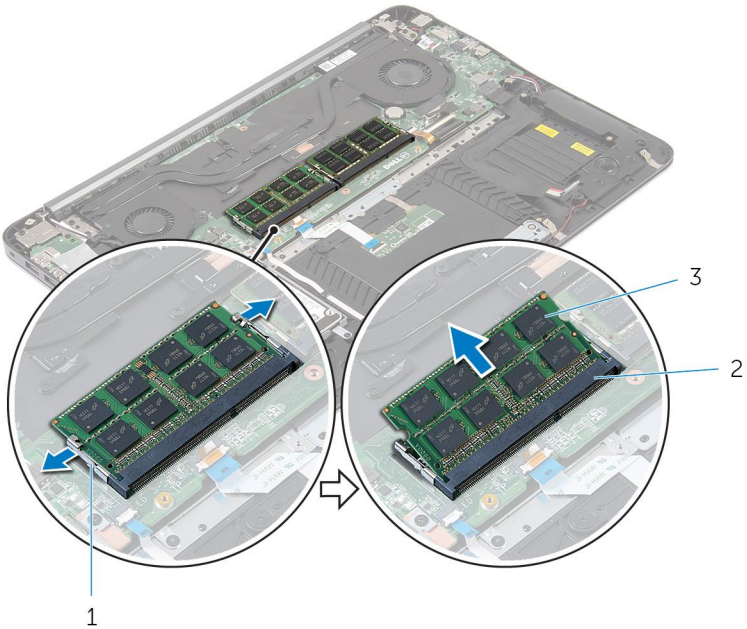

1 securing clips (4)

2 memory-module slot (2)

3 memory modules (2)

# Replacing the Memory Module(s)

---

 **WARNING:** Before working inside your computer, read the safety information that shipped with your computer and follow the steps in [Before Working Inside Your Computer](#). After working inside your computer, follow the instructions in [After Working Inside Your Computer](#). For more safety best practices, see the Regulatory Compliance home page at [dell.com/regulatory\\_compliance](http://dell.com/regulatory_compliance).

## Procedure

- 1 Align the notch on the memory module with the tab on the memory-module slot.

- Slide the memory module firmly into the slot at a 45-degree angle and press the memory module down until it clicks into place.

 **NOTE:** If you do not hear the click, remove the memory module and reinstall it.

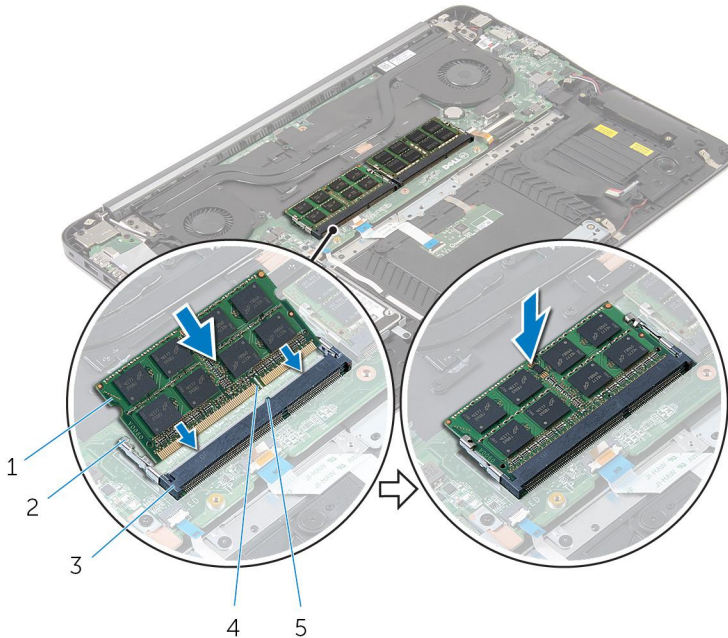

- |   |                        |   |                    |
|---|------------------------|---|--------------------|
| 1 | memory modules (2)     | 2 | securing clips (4) |
| 3 | memory-module slot (2) | 4 | notch              |
| 5 | tab                    |   |                    |

- Adhere the mylar tape over the memory modules.

## Post-requisites

- Replace the [battery](#).
- Replace the [base cover](#).

# Removing the Wireless Card

---



**WARNING:** Before working inside your computer, read the safety information that shipped with your computer and follow the steps in [Before Working Inside Your Computer](#). After working inside your computer, follow the instructions in [After Working Inside Your Computer](#). For more safety best practices, see the Regulatory Compliance home page at [dell.com/regulatory\\_compliance](http://dell.com/regulatory_compliance).

## Prerequisites

- 1 Remove the [base cover](#).
- 2 Remove the [battery](#).

## Procedure

- 1 Disconnect the antenna cables from the wireless card.
- 2 Remove the screw that secures the wireless card to the system board.



**3** Slide and remove the wireless card from the wireless-card slot.

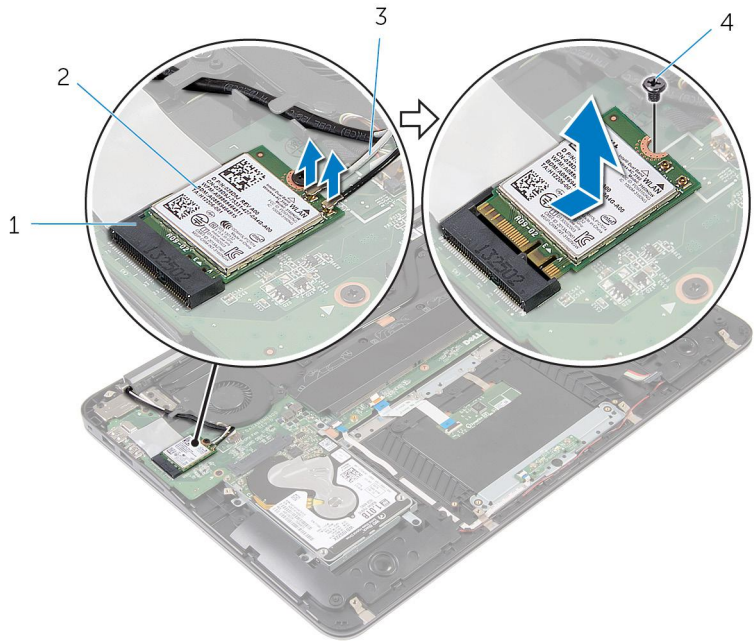

1 wireless-card slot

2 wireless card

3 antenna cables

4 screw

# Replacing the Wireless Card

---

 **WARNING:** Before working inside your computer, read the safety information that shipped with your computer and follow the steps in [Before Working Inside Your Computer](#). After working inside your computer, follow the instructions in [After Working Inside Your Computer](#). For more safety best practices, see the Regulatory Compliance home page at [dell.com/regulatory\\_compliance](http://dell.com/regulatory_compliance).

## Procedure

- 1 Align the notch on the wireless card with the tab on the wireless-card slot.
- 2 Slide the wireless card at an angle into the wireless-card slot.
- 3 Press the other end of the wireless card down and replace the screw that secures the wireless card to the system board.
- 4 Connect the antenna cables to the wireless card.

The following table provides the antenna-cable color scheme for the wireless card supported by your computer:



Connectors on the wireless card	Antenna-cable color
Main (white triangle)	White
Auxiliary (black triangle)	Black

## Post-requisites

- 1 Replace the [battery](#).
- 2 Replace the [base cover](#).

# Removing the Coin-Cell Battery

---

-  **WARNING:** Before working inside your computer, read the safety information that shipped with your computer and follow the steps in [Before Working Inside Your Computer](#). After working inside your computer, follow the instructions in [After Working Inside Your Computer](#). For more safety best practices, see the Regulatory Compliance home page at [dell.com/regulatory\\_compliance](http://dell.com/regulatory_compliance).
-  **CAUTION:** Removing the coin-cell battery resets the BIOS settings to default. It is recommended that you note the BIOS settings before removing the coin-cell battery.

## Prerequisites

- 1 Remove the [base cover](#).
- 2 Remove the [battery](#).

## Procedure

- 1 Lift the mylar tape off the coin-cell battery.

2 Using a plastic scribe, pry the coin-cell battery out of the battery socket.

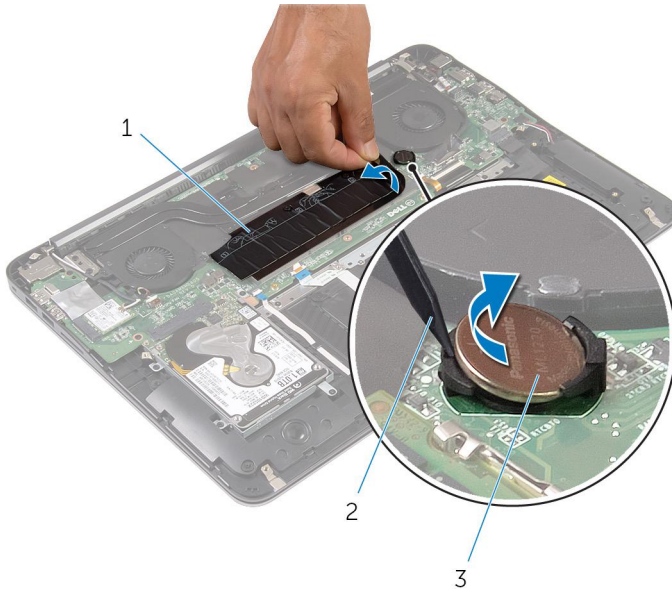

1 mylar tape

2 plastic scribe

3 coin-cell battery

# Replacing the Coin-Cell Battery

---



**WARNING:** Before working inside your computer, read the safety information that shipped with your computer and follow the steps in [Before Working Inside Your Computer](#). After working inside your computer, follow the instructions in [After Working Inside Your Computer](#). For more safety best practices, see the Regulatory Compliance home page at [dell.com/regulatory\\_compliance](http://dell.com/regulatory_compliance).

## Procedure

- 1 With the positive-side facing up, snap the coin-cell battery into the battery socket.
- 2 Adhere the mylar tape over the coin-cell battery.

## Post-requisites

- 1 Replace the [battery](#).
- 2 Replace the [base cover](#).

# Removing the Power-Adapter Port

---



**WARNING:** Before working inside your computer, read the safety information that shipped with your computer and follow the steps in [Before Working Inside Your Computer](#). After working inside your computer, follow the instructions in [After Working Inside Your Computer](#). For more safety best practices, see the Regulatory Compliance home page at [dell.com/regulatory\\_compliance](http://dell.com/regulatory_compliance).

## Prerequisites

- 1 Remove the [base cover](#).
- 2 Remove the [battery](#).

## Procedure

- 1 Disconnect the power-adapter port cable from the system board.

- 2 Using a plastic scribe, pry the power-adaptor port out of the socket on the palm-rest assembly.

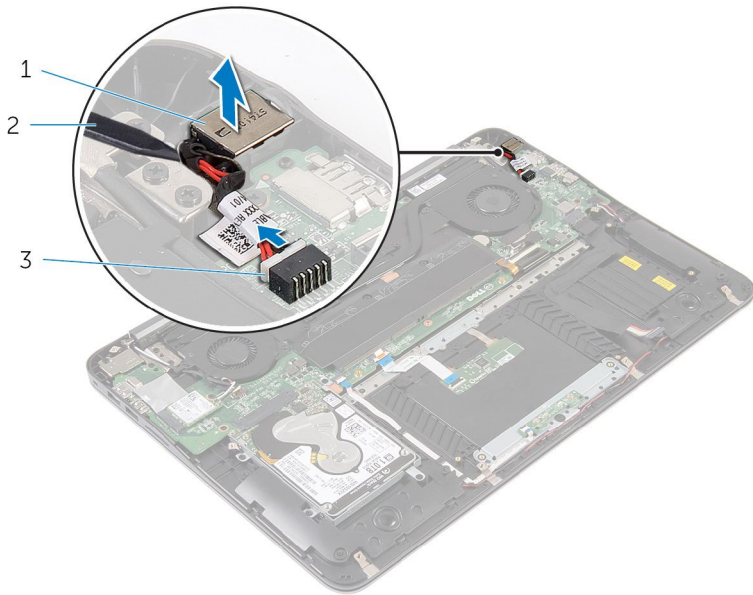

- |   |                          |   |                |
|---|--------------------------|---|----------------|
| 1 | power-adaptor port       | 2 | plastic scribe |
| 3 | power-adaptor port cable |   |                |

# Replacing the Power-Adapter Port

---



**WARNING:** Before working inside your computer, read the safety information that shipped with your computer and follow the steps in [Before Working Inside Your Computer](#). After working inside your computer, follow the instructions in [After Working Inside Your Computer](#). For more safety best practices, see the Regulatory Compliance home page at [dell.com/regulatory\\_compliance](http://dell.com/regulatory_compliance).

## Procedure

- 1 Place the power-adapter port in its socket on the palm-rest assembly.
- 2 Connect the power-adapter port cable to the system board.

## Post-requisites

- 1 Replace the [battery](#).
- 2 Replace the [base cover](#).



# Removing the Power-Status Light Board

---

 **WARNING:** Before working inside your computer, read the safety information that shipped with your computer and follow the steps in [Before Working Inside Your Computer](#). After working inside your computer, follow the instructions in [After Working Inside Your Computer](#). For more safety best practices, see the Regulatory Compliance home page at [dell.com/regulatory\\_compliance](http://dell.com/regulatory_compliance).

## Prerequisites

- 1 Remove the [base cover](#).
- 2 Remove the [battery](#).

## Procedure

- 1 Lift the latch and disconnect the power-light board cable from the power-light board.
- 2 Remove the screws that secure the power-light board to the palm-rest assembly.

**3** Lift the power-light board off the palm-rest assembly.

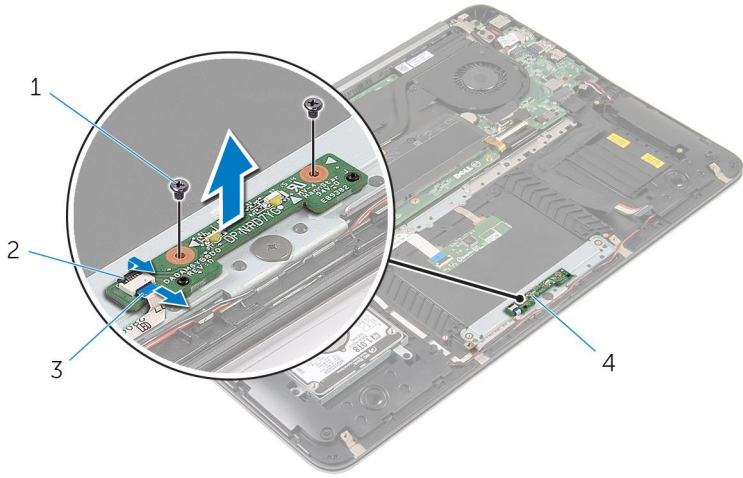

1 screws (2)

2 latch

3 power-light board cable

4 power-light board

# Replacing the Power-Status Light Board

---



**WARNING:** Before working inside your computer, read the safety information that shipped with your computer and follow the steps in [Before Working Inside Your Computer](#). After working inside your computer, follow the instructions in [After Working Inside Your Computer](#). For more safety best practices, see the Regulatory Compliance home page at [dell.com/regulatory\\_compliance](http://dell.com/regulatory_compliance).

## Procedure

- 1 Align the screw holes on the power-light board with the screw holes on the palm-rest assembly.
- 2 Replace the screws that secure the power-light board to the palm-rest assembly.
- 3 Connect the power-light board cable to the power-light board and press down on the latch to secure the cable.

## Post-requisites

- 1 Replace the [battery](#).
- 2 Replace the [base cover](#).

# Removing the Processor Fan

**⚠ WARNING:** Before working inside your computer, read the safety information that shipped with your computer and follow the steps in [Before Working Inside Your Computer](#). After working inside your computer, follow the instructions in [After Working Inside Your Computer](#). For more safety best practices, see the Regulatory Compliance home page at [dell.com/regulatory\\_compliance](http://dell.com/regulatory_compliance).

## Prerequisites

- 1 Remove the [base cover](#).
- 2 Remove the [battery](#).

## Procedure

- 1 Disconnect the display cable from the system board.
- 2 Note the display-cable routing and remove the display cable from the routing guides on the fan.

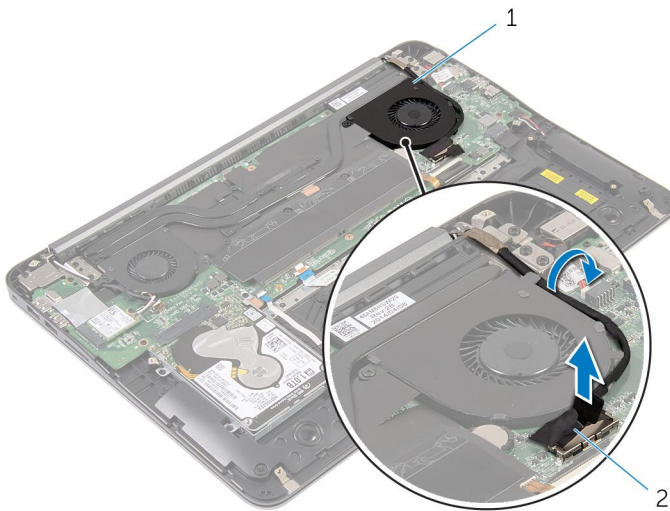

1 processor fan

2 display cable

- 3 Lift the mylar tape and disconnect the processor-fan cable from the system board.
- 4 Remove the screws that secure the processor fan to the system board.
- 5 Lift the processor fan off the system board.

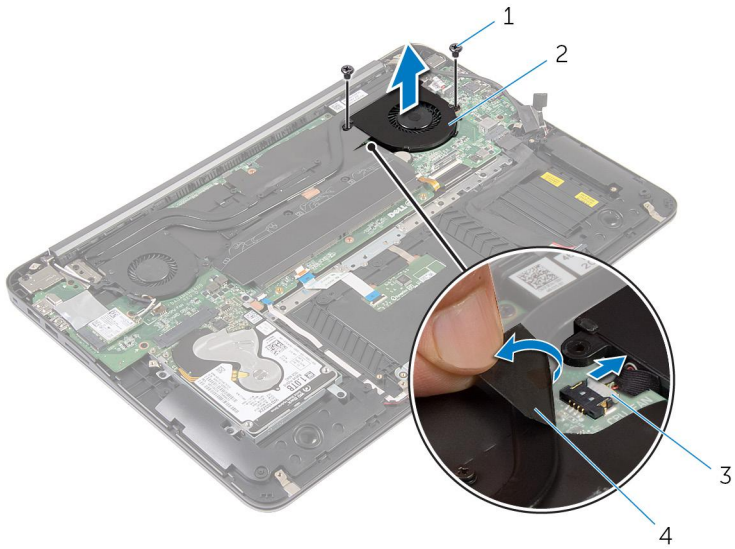

- |   |                     |   |               |
|---|---------------------|---|---------------|
| 1 | screws (2)          | 2 | processor fan |
| 3 | processor-fan cable | 4 | mylar tape    |

# Replacing the Processor Fan

---



**WARNING:** Before working inside your computer, read the safety information that shipped with your computer and follow the steps in [Before Working Inside Your Computer](#). After working inside your computer, follow the instructions in [After Working Inside Your Computer](#). For more safety best practices, see the Regulatory Compliance home page at [dell.com/regulatory\\_compliance](http://dell.com/regulatory_compliance).

## Procedure

- 1 Connect the processor-fan cable to the system board and adhere the mylar tape.
- 2 Align the screw holes on the processor fan with the screw holes on the system board.
- 3 Replace the screws that secure the processor fan to the system board.
- 4 Route the display cable and connect it to the system board.

## Post-requisites

- 1 Replace the [battery](#).
- 2 Replace the [base cover](#).

# Removing the Video-Card Fan

---



**WARNING:** Before working inside your computer, read the safety information that shipped with your computer and follow the steps in [Before Working Inside Your Computer](#). After working inside your computer, follow the instructions in [After Working Inside Your Computer](#). For more safety best practices, see the Regulatory Compliance home page at [dell.com/regulatory\\_compliance](http://dell.com/regulatory_compliance).

## Prerequisites

- 1 Remove the [base cover](#).
- 2 Remove the [battery](#).

## Procedure

- 1 Disconnect the antenna cables from the wireless card.

- 2 Note the antenna-cable routing and remove the antenna cables from the routing guides on the video-card fan.



- 1 video-card fan
- 3 antenna cables

- 2 wireless card

- 3 Disconnect the video-card fan cable from the system board.
- 4 Remove the screws that secure the video-card fan to the system board.



5 Lift the video-card fan off the system board.

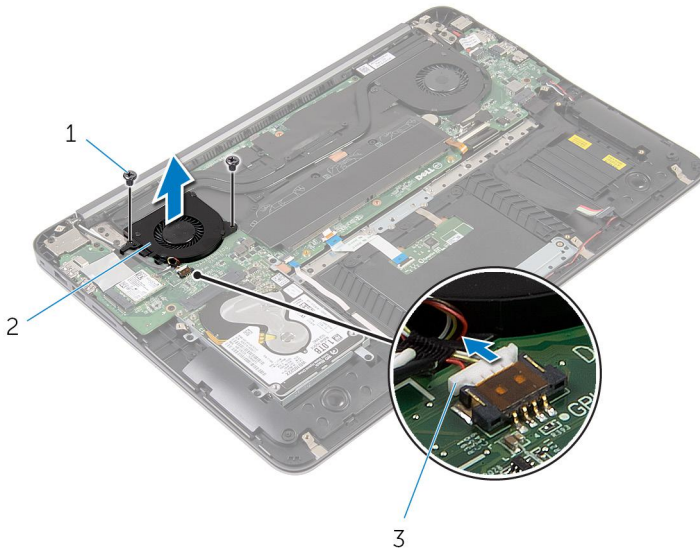

1 screws (2)

2 video-card fan

3 video-card fan cable

# Replacing the Video-Card Fan

---



**WARNING:** Before working inside your computer, read the safety information that shipped with your computer and follow the steps in [Before Working Inside Your Computer](#). After working inside your computer, follow the instructions in [After Working Inside Your Computer](#). For more safety best practices, see the Regulatory Compliance home page at [dell.com/regulatory\\_compliance](http://dell.com/regulatory_compliance).

## Procedure



- 1 Align the screw holes on the video-card fan with the screw holes on the system board.
- 2 Replace the screws that secure the video-card fan to the system board.
- 3 Connect the video-card fan cable to the system board.
- 4 Route the antenna cables and connect them to the wireless card.

## Post-requisites

- 1 Replace the [battery](#).
- 2 Replace the [base cover](#).

# Removing the Heat Sink

---

-  **WARNING:** Before working inside your computer, read the safety information that shipped with your computer and follow the steps in [Before Working Inside Your Computer](#). After working inside your computer, follow the instructions in [After Working Inside Your Computer](#). For more safety best practices, see the Regulatory Compliance home page at [dell.com/regulatory\\_compliance](http://dell.com/regulatory_compliance).
-  **WARNING:** The heat sink may become hot during normal operation. Allow sufficient time for the heat sink to cool before you touch it.
-  **CAUTION:** For maximum cooling of the processor, do not touch the heat transfer areas on the heat sink. The oils in your skin can reduce the heat transfer capability of the thermal grease.

## Prerequisites

- 1 Remove the [base cover](#).
- 2 Remove the [battery](#).

# Procedure

- 1 Peel off the mylar tape from the memory modules.

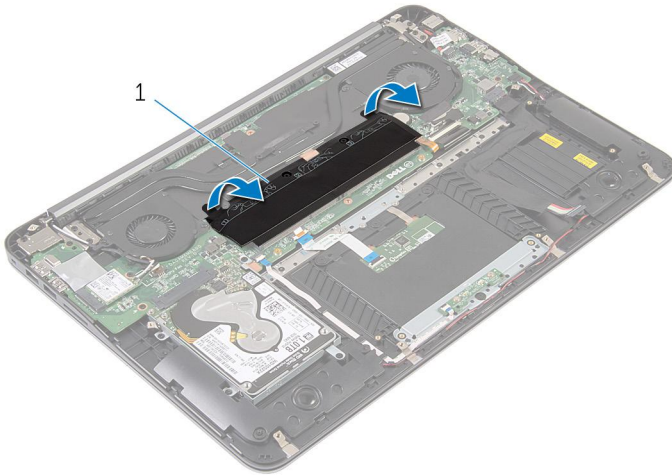

1 mylar tape

- 2 Loosen the captive screws that secure the heat sink to the system board.
- 3 Lift the heat sink off the system board.

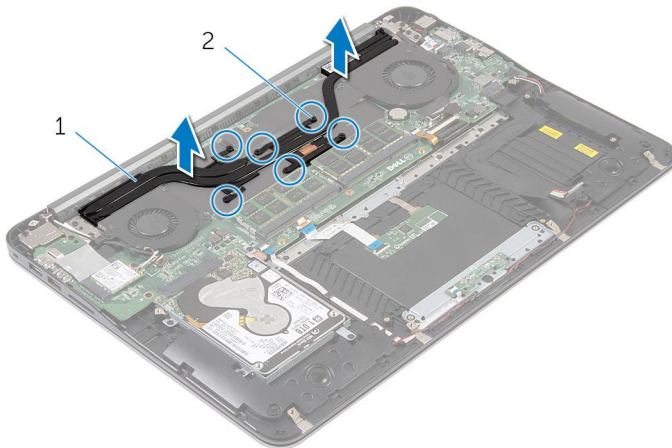



1 heat sink

2 captive screws (6)

# Replacing the Heat Sink

---

 **WARNING:** Before working inside your computer, read the safety information that shipped with your computer and follow the steps in [Before Working Inside Your Computer](#). After working inside your computer, follow the instructions in [After Working Inside Your Computer](#). For more safety best practices, see the Regulatory Compliance home page at [dell.com/regulatory\\_compliance](http://dell.com/regulatory_compliance).

 **CAUTION:** Incorrect alignment of the heat sink can cause damage to the system board and processor.

 **NOTE:** The original thermal grease can be reused if the original system board and heat sink are reinstalled together. If either the system board or the heat sink is replaced, use the thermal pad provided in the kit to make sure that thermal conductivity is achieved.

## Procedure

- 1 Align the captive screws on the heat sink with the screw holes on the system board.
- 2 Tighten the captive screws that secure the heat sink to the system board.
- 3 Adhere the mylar tape over the memory modules.

## Post-requisites

- 1 Replace the [battery](#).
- 2 Replace the [base cover](#).

# Removing the Speakers

---



**WARNING:** Before working inside your computer, read the safety information that shipped with your computer and follow the steps in [Before Working Inside Your Computer](#). After working inside your computer, follow the instructions in [After Working Inside Your Computer](#). For more safety best practices, see the Regulatory Compliance home page at [dell.com/regulatory\\_compliance](http://dell.com/regulatory_compliance).

## Prerequisites

- 1 Remove the [base cover](#).
- 2 Remove the [battery](#).

## Procedure

- 1 Disconnect the speaker cable from the system board.

- 2 Note the speaker-cable routing and lift the speakers, along with the speaker cable, off the palm-rest assembly.

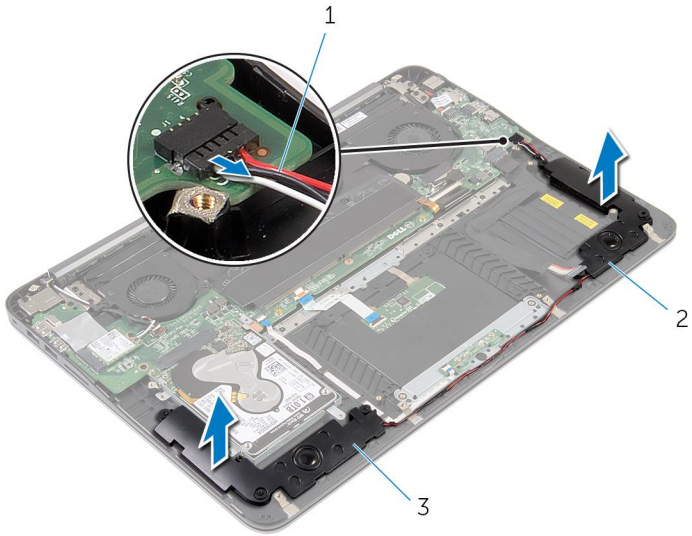

1 speaker cable

2 left speaker

3 right speaker

# Replacing the Speakers

---



**WARNING:** Before working inside your computer, read the safety information that shipped with your computer and follow the steps in [Before Working Inside Your Computer](#). After working inside your computer, follow the instructions in [After Working Inside Your Computer](#). For more safety best practices, see the Regulatory Compliance home page at [dell.com/regulatory\\_compliance](http://dell.com/regulatory_compliance).

## Procedure

- 1 Route the speaker cable and, using the alignment posts on the palm rest, place the speakers in position.
- 2 Connect the speaker cable to the system board.

## Post-requisites

- 1 Replace the [battery](#).
- 2 Replace the [base cover](#).



# Removing the Display Assembly

---



**WARNING:** Before working inside your computer, read the safety information that shipped with your computer and follow the steps in [Before Working Inside Your Computer](#). After working inside your computer, follow the instructions in [After Working Inside Your Computer](#). For more safety best practices, see the Regulatory Compliance home page at [dell.com/regulatory\\_compliance](http://dell.com/regulatory_compliance).

## Prerequisites

- 1 Remove the [base cover](#).
- 2 Remove the [battery](#).

## Procedure

- 1 Disconnect the antenna cables from the wireless card.
- 2 Note the antenna-cable routing and remove them from the routing guides on the video-card fan.
- 3 Disconnect the display cable from the system board.

- 4 Note the display-cable routing and remove the display cable from the routing guides on the processor fan.

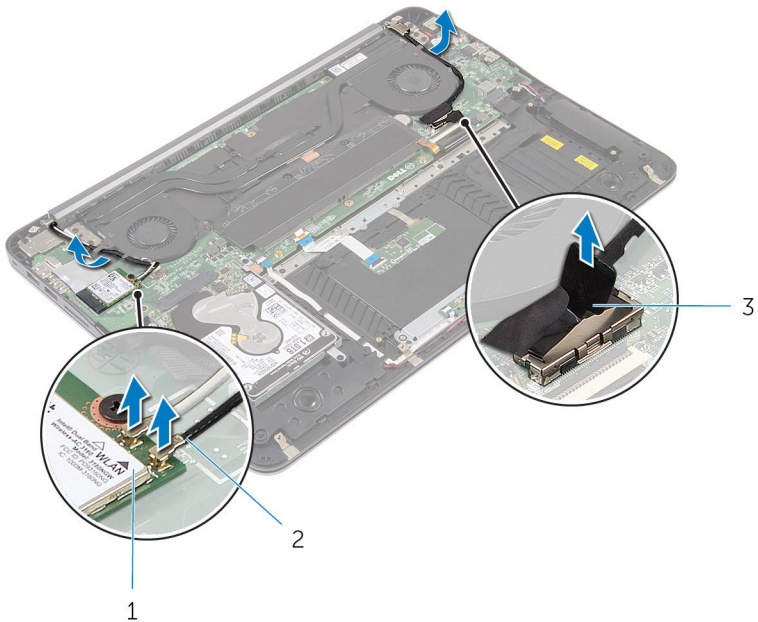

1 wireless card

2 antenna cables

3 display cable

- 5 Open the palm-rest assembly to an angle of 90 degrees.
- 6 Place the computer at the edge of a table with the display hanging over.
- 7 Remove the screws that secure the display assembly to the palm-rest assembly.

**8** Lift the display assembly off the computer.

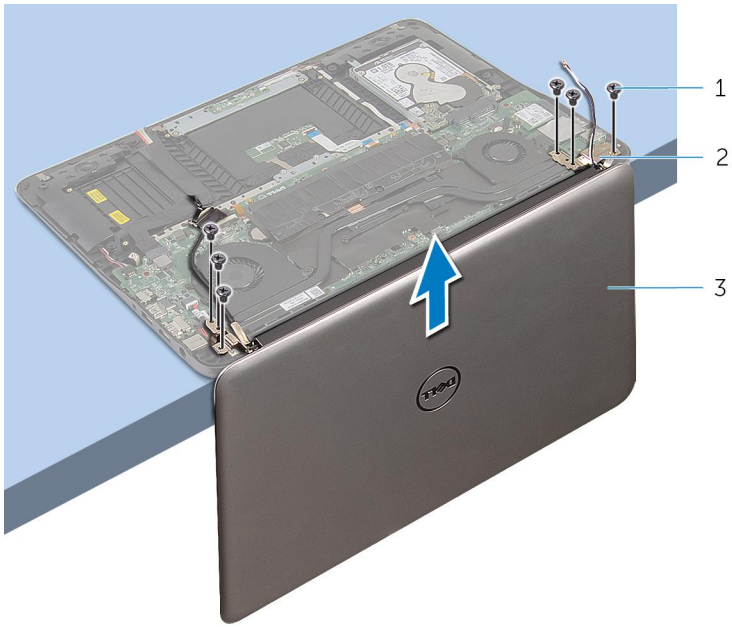

1 screws (6)

2 hinges (2)

3 display assembly

# Replacing the Display Assembly

---



**WARNING:** Before working inside your computer, read the safety information that shipped with your computer and follow the steps in [Before Working Inside Your Computer](#). After working inside your computer, follow the instructions in [After Working Inside Your Computer](#). For more safety best practices, see the Regulatory Compliance home page at [dell.com/regulatory\\_compliance](http://dell.com/regulatory_compliance).

## Procedure

- 1 Place the palm-rest assembly on the edge of a table with the keyboard facing down.
- 2 Align the screw holes on the hinges of the display assembly with the screw holes on the palm-rest assembly.
- 3 Replace the screws that secure the display assembly to the palm-rest assembly.
- 4 Close the display.
- 5 Route the display cable and connect it to the system board
- 6 Route the antenna cables and connect them to the wireless card.

## Post-requisites

- 1 Replace the [battery](#).
- 2 Replace the [base cover](#).

# Removing the System Board

---



**WARNING:** Before working inside your computer, read the safety information that shipped with your computer and follow the steps in [Before Working Inside Your Computer](#). After working inside your computer, follow the instructions in [After Working Inside Your Computer](#). For more safety best practices, see the Regulatory Compliance home page at [dell.com/regulatory\\_compliance](http://dell.com/regulatory_compliance).



**NOTE:** Your computer's Service Tag is stored in the system board. You must enter the Service Tag in the BIOS setup program after you replace the system board.



**NOTE:** Replacing the system board removes any changes you have made to the BIOS using the BIOS setup program. You must make the desired changes again after you replace the system board.



**NOTE:** Before disconnecting the cables from the system board, note the location of the connectors so that you can reconnect them correctly after you replace the system board.

## Prerequisites

- 1 Remove the [base cover](#).
- 2 Remove the [battery](#).
- 3 Remove the [hard drive](#).
- 4 Remove the [video-card fan](#).
- 5 Remove the [processor fan](#).
- 6 Remove the [display assembly](#).

# Procedure

- 1 Disconnect the touch-pad cable, power-light cable, keyboard-backlight cable, keyboard cable, power-adapter port cable, speaker cable and battery cable from the system board.

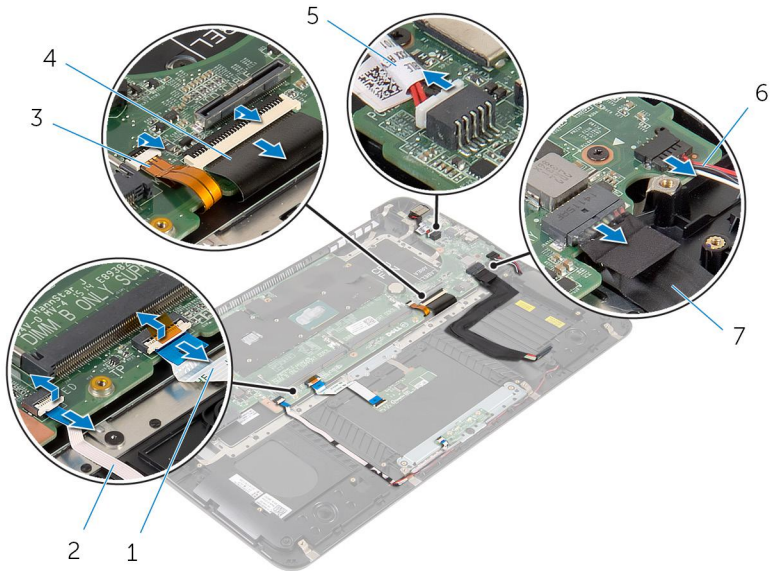

- |                            |                     |
|----------------------------|---------------------|
| 1 touch-pad cable          | 2 power-light cable |
| 3 keyboard-backlight cable | 4 keyboard cable    |
| 5 power-adapter port cable | 6 speaker cable     |
| 7 battery cable            |                     |

- 2 Remove the screws that secure the system board to the palm-rest assembly.

- 3** Starting from the left, gently lift the system board off the palm-rest assembly.

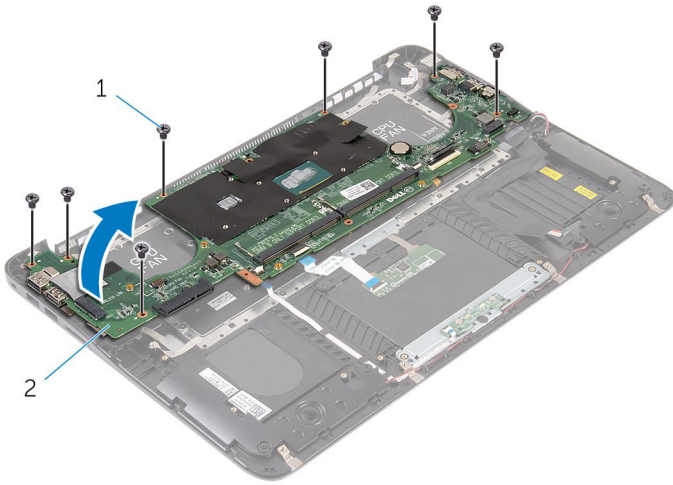

1 screws (7)

2 system board

# Replacing the System Board

---



**WARNING:** Before working inside your computer, read the safety information that shipped with your computer and follow the steps in [Before Working Inside Your Computer](#). After working inside your computer, follow the instructions in [After Working Inside Your Computer](#). For more safety best practices, see the Regulatory Compliance home page at [dell.com/regulatory\\_compliance](http://dell.com/regulatory_compliance).



**NOTE:** Your computer's Service Tag is stored in the system board. You must enter the Service Tag in the BIOS setup program after you replace the system board.



**NOTE:** Replacing the system board removes any changes you have made to the BIOS using the BIOS setup program. You must make the desired changes again after you replace the system board.

## Procedure

- 1 Starting from the right, gently place the system board on the palm-rest assembly.
- 2 Align the screw holes on the system board with the screw holes on the palm-rest assembly.
- 3 Replace the screws that secure the system board to the palm-rest assembly.
- 4 Connect the battery cable, speaker cable, power-adaptor port cable, keyboard cable, keyboard-backlight cable, power-light cable and touch-pad cable to the system board.

## Post-requisites

- 1 Replace the [display assembly](#).
- 2 Replace the [processor fan](#).
- 3 Replace the [video-card fan](#).
- 4 Replace the [hard drive](#).
- 5 Replace the [battery](#).
- 6 Replace the [base cover](#).



# Removing the Palm Rest and Keyboard

---

 **WARNING:** Before working inside your computer, read the safety information that shipped with your computer and follow the steps in [Before Working Inside Your Computer](#). After working inside your computer, follow the instructions in [After Working Inside Your Computer](#). For more safety best practices, see the Regulatory Compliance home page at [dell.com/regulatory\\_compliance](http://dell.com/regulatory_compliance).

## Procedure

- 1 Remove the [base cover](#).
- 2 Remove the [battery](#).
- 3 Remove the [hard drive](#).
- 4 Remove the [wireless card](#).
- 5 Remove the [memory module\(s\)](#).
- 6 Remove the [video-card fan](#).
- 7 Remove the [processor fan](#).
- 8 Remove the [heat sink](#).
- 9 Remove the [display assembly](#).
- 10 Remove the [system board](#).

## Procedure

- 1 Remove the screws that secure the keyboard bracket to the palm-rest assembly.

**2** Lift the keyboard bracket off the palm-rest assembly.

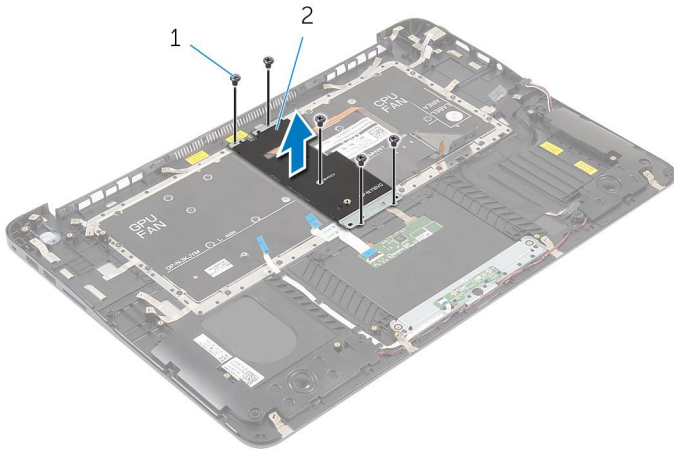

**1** screws (5)

**2** keyboard bracket

**3** Remove the screws that secure the keyboard to the palm-rest assembly.

4 Lift the keyboard off the palm-rest assembly.

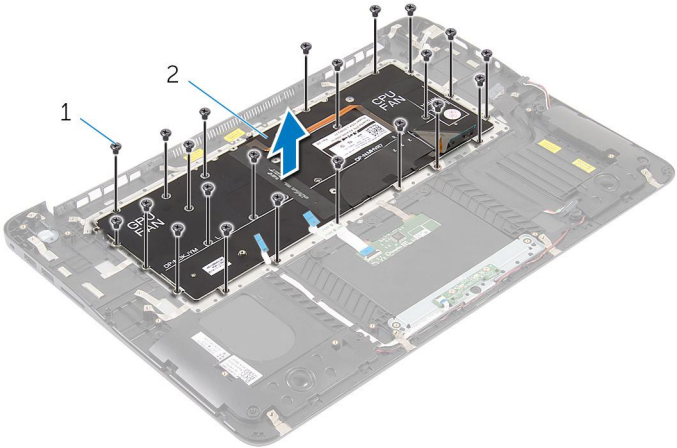

1 screws (22)

2 keyboard



1 keyboard

2 palm-rest assembly

# Replacing the Palm Rest and Keyboard

---



**WARNING:** Before working inside your computer, read the safety information that shipped with your computer and follow the steps in [Before Working Inside Your Computer](#). After working inside your computer, follow the instructions in [After Working Inside Your Computer](#). For more safety best practices, see the Regulatory Compliance home page at [dell.com/regulatory\\_compliance](http://dell.com/regulatory_compliance).

## Procedure

- 1 Align the screw holes on the keyboard with the screw holes on the palm-rest assembly.
- 2 Replace the screws that secure the keyboard to the palm-rest assembly.
- 3 Align the screw holes on the keyboard bracket with the screw holes on the palm-rest assembly.
- 4 Replace the screws that secure the keyboard bracket to the palm-rest assembly.

## Post-requisites

- 1 Replace the [system board](#).
- 2 Replace the [display assembly](#).
- 3 Replace the [heat sink](#).
- 4 Replace the [processor fan](#).
- 5 Replace the [video-card fan](#).
- 6 Replace the [memory module\(s\)](#).
- 7 Replace the [wireless card](#).
- 8 Replace the [hard drive](#).
- 9 Replace the [battery](#).
- 10 Replace the [base cover](#).

# Flashing the BIOS

---

You may need to flash (update) the BIOS when an update is available or when you replace the system board. To flash the BIOS:

- 1 Turn on the computer.
- 2 Go to **dell.com/support**.
- 3 If you have your computer's Service Tag, type your computer's Service Tag and click **Submit**.  
If you do not have your computer's Service Tag, click **Detect My Product** to allow automatic detection of the Service Tag.  
 **NOTE:** If the Service Tag cannot be detected automatically, select your product under the product categories.
- 4 Click **Get Drivers and Downloads**.
- 5 Click **View All Drivers**.
- 6 In the **Operating System** drop-down, select the operating system installed on your computer.
- 7 Click **BIOS**.
- 8 Click **Download File** to download the latest version of the BIOS for your computer.
- 9 On the next page, select **Single-file download** and click **Continue**.
- 10 Save the file and once the download is complete, navigate to the folder where you saved the BIOS update file.
- 11 Double-click the BIOS update file icon and follow the instructions on the screen.