



Dell™ Inspiron™ i1200 and i2200 Service Manual

[Before You Begin](#)
[System Components](#)
[Memory, Optical Drive, Modem, and Mini PCI Card](#)
[Hard Drive](#)
[Keyboard](#)
[Display](#)
[Palm Rest](#)
[Coin-Cell Battery](#)
[Microprocessor Thermal-Cooling Assembly](#)
[Microprocessor Module](#)
[Speakers](#)
[System Board](#)
[Flashing the BIOS](#)
[Base Plastics](#)
[Pinout Assignments for I/O Connectors](#)

-  **NOTE:** A NOTE indicates important information that helps you make better use of your computer.
-  **NOTICE:** A NOTICE indicates either potential damage to hardware or loss of data and tells you how to avoid the problem.
-  **CAUTION:** A CAUTION indicates a potential for property damage, personal injury, or death.

For a complete list of abbreviations and acronyms, see the *Dell Inspiron Help* file. To access the help file:

If you purchased a Dell™ n Series computer, any references in this document to Microsoft® Windows® operating systems are not applicable.

Information in this document is subject to change without notice.
© 2005 Dell Inc. All rights reserved.

Reproduction in any manner whatsoever without the written permission of Dell Inc. is strictly forbidden.

Trademarks used in this text: *Dell*, the *DELL* logo, and *Inspiron* are trademarks of Dell Inc.; *Microsoft* and *Windows* are registered trademarks of Microsoft Corporation.

Other trademarks and trade names may be used in this document to refer to either the entities claiming the marks and names or their products. Dell Inc. disclaims any proprietary interest in trademarks and trade names other than its own.

Model PP10S

June 2005 Rev. A01

[Back to Contents Page](#)

Base Plastics

Dell™ Inspiron™ i1200 and i2200 Service Manual

 **CAUTION:** Before performing the following procedures, read the safety instructions in the *Product Information Guide*.

 **CAUTION:** To prevent static damage to components inside your computer, discharge static electricity from your body before you touch any of your computer's electronic components. You can do so by touching an unpainted metal surface.

1. Follow the instructions in "[Before Working Inside Your Computer](#)."
2. Remove the [hard drive](#).
3. Remove the [optical drive](#).
4. Remove the [memory module](#).
5. Remove the [keyboard](#).
6. Remove the [Mini PCI card](#).
7. Remove the [modem](#).
8. Remove the [display assembly](#).
9. Remove the [palm rest](#).
10. Remove the [microprocessor thermal-cooling assembly](#).
11. Remove the [microprocessor](#).
12. Remove the [speakers](#).
13. Remove the [system board](#).

[Back to Contents Page](#)

Before You Begin

Dell™ Inspiron™ i1200 and i2200 Service Manual

- [Recommended Tools](#)
- [Turning Off Your Computer](#)
- [Before Working Inside Your Computer](#)
- [Computer Orientation](#)
- [Screw Identification](#)

This chapter provides procedures for removing and installing the components in your computer. Unless otherwise noted, each procedure assumes that the following conditions exist:

- 1 You have performed the steps in "[Turning Off Your Computer](#)" and "[Before Working Inside Your Computer](#)."
 - 1 You have read the safety information in the *Product Information Guide*.
 - 1 A component can be replaced by performing the removal procedure in reverse order.
-

Recommended Tools

The procedures in this document may require the following tools:

- 1 Small flat-blade screwdriver
 - 1 Phillips screwdriver
 - 1 Small plastic scribe
 - 1 Hex nut driver
 - 1 Flash BIOS-update program floppy disk or CD
-

Turning Off Your Computer

 **NOTICE:** To avoid losing data, save and close any open files and exit any open programs before you turn off your computer.

1. Shut down the operating system:
 - a. Save and close any open files, exit any open programs, click the **Start** button, and then click **Turn Off Computer**.
 - b. In the **Turn off computer** window, click **Turn off**.

The computer turns off after the operating system shutdown process finishes.

2. Ensure that the computer and any attached devices are turned off. If your computer and attached devices do not automatically turn off when you shut down your operating system, press and hold the power button for 4 seconds.
-

Before Working Inside Your Computer

Use the following safety guidelines to help protect your computer from potential damage and to help ensure your own personal safety.

 **CAUTION:** Before you begin any of the procedures in this section, follow the safety instructions in the *Product Information Guide*.

 **CAUTION:** Handle components and cards with care. Do not touch the components or contacts on a card. Hold a card by its edges or by its metal mounting bracket. Hold a component such as a processor by its edges, not by its pins.

- ➔ **NOTICE:** Only a certified service technician should perform repairs on your computer. Damage due to servicing that is not authorized by Dell is not covered by your warranty.
- ➔ **NOTICE:** When you disconnect a cable, pull on its connector or on its strain-relief loop, not on the cable itself. Some cables have a connector with locking tabs: if you are disconnecting this type of cable, press in on the locking tabs before you disconnect the cable. As you pull connectors apart, keep them evenly aligned to avoid bending any connector pins. Also, before you connect a cable, ensure that both connectors are correctly oriented and aligned.
- ➔ **NOTICE:** To avoid damaging the computer, perform the following steps before you begin working inside the computer.
 1. Ensure that the work surface is flat and clean to prevent the computer cover from being scratched.
 2. [Turn off your computer.](#)
 3. If the computer is connected to a docking device, undock it. See the documentation that came with your docking device for instructions.
- ➔ **NOTICE:** To disconnect a network cable, first unplug the cable from your computer and then unplug it from the network wall jack.
 4. Disconnect any telephone, network, and USB cables from the computer.
 5. Disconnect your computer and all attached devices from their electrical outlets.
- ➔ **NOTICE:** To connect a network cable, first plug the cable into the network wall jack and then plug it into the computer.
 6. [Remove any installed PC Cards](#) from the PC Card slot.
 7. Close the display and turn the computer upside down on a flat work surface.
- ➔ **NOTICE:** To avoid damaging the system board, you must remove the main battery before you service the computer.
 8. Slide and hold the battery-bay latch release on the bottom of the computer, and then remove the battery from the battery bay.



1	battery
2	battery-bay latch release

Computer Orientation









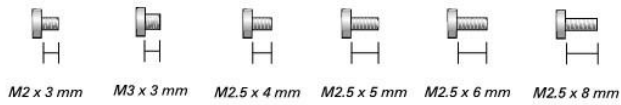





1	front
2	left
3	back
4	right

Screw Identification

When you are removing and replacing components, print this section as a tool to lay out and keep track of the screws. The placemat provides the number of screws and their sizes.



<p>Optical Drive: (1 each)</p>  <p>M2.5 x 8 mm</p>	<p>Hard Drive Door: (2 each)</p>  <p>M3 x 3 mm</p>	<p>Hard Drive: (2 each)</p>  <p>M2 x 3 mm</p>
<p>Modem to System Board: (2 each)</p>  <p>M2 x 3 mm</p>	<p>EMI Shield: (4 each)</p>  <p>M2.5 x 5 mm</p>	<p>Display Assembly to Computer Base: (4 each)</p>  <p>M2.5 x 8 mm</p>
<p>Display Bezel: (6 each)</p>	<p>Display Panel: (8 each)</p>	<p>Top of Palm Rest to Computer Base: (6 each)</p>

 <p>M2.5 x 5 mm</p>	<p>Screw Covers (6 each) Display Bumpers (6 each)</p>  <p>M2 x 3 mm</p>	 <p>M2.5 x 5 mm</p>
<p>Palm Rest to Base Plastics: (8 each)</p>  <p>M2.5 x 8 mm</p>	<p>Palm Rest to Base Plastics in Hard Drive Bay: (2 each)</p>  <p>M2 x 3 mm</p>	<p>System Board to Base Plastics: (4 each, hard drive cage) (2 each, system board)</p>  <p>M2.5 x 5 mm</p>
<p>Speakers to Base Plastics: (2 for each speaker, 4 total)</p>  <p>M2.5 x 5 mm</p>		

Flashing the BIOS

Dell™ Inspiron™ i1200 and i2200 Service Manual

- [Flashing the BIOS From a Floppy Disk or a CD](#)
- [Flashing the BIOS From the Hard Drive](#)

If a BIOS-update program floppy disk or CD is provided with the new system board, flash the BIOS from a floppy disk or a CD. If you do not have a BIOS-update program floppy disk or CD, flash the BIOS from the hard drive.

Flashing the BIOS From a Floppy Disk or a CD

1. Ensure that the AC adapter is plugged in and that the main battery is installed properly.

 **NOTE:** If you use a BIOS-update program CD to flash the BIOS, set up the computer to boot from a CD before inserting the CD.

2. Insert the BIOS-update program floppy disk or CD, and turn on the computer.

Follow the instructions that appear on the screen. The computer continues to boot and updates the new BIOS. When the flash update is complete, the computer will automatically reboot.

3. Press <F2> during POST to enter the system setup program.
 4. Press <Alt> and <F> to reset the computer defaults.
 5. Press <Esc>, select **Save changes and reboot**, and press <Enter> to save configuration changes.
 6. Remove the flash BIOS-update program floppy disk or CD from the drive and restart the computer.
-

Flashing the BIOS From the Hard Drive

1. Ensure that the AC adapter is plugged in, the main battery is properly installed, and a network cable is attached.
2. Boot up the computer.
3. Locate the latest BIOS update file for your computer at support.dell.com.
4. Click **Download Now** to download the file.
5. If the **Export Compliance Disclaimer** window appears, click **Yes, I Accept this Agreement**.

The **File Download** window appears.

6. Click **Save this program to disk** and then click **OK**.

The **Save In** window appears.

7. Click the down arrow to view the **Save In** menu, select **Desktop**, and then click **Save**.

The file downloads to your desktop.

8. Click **Close** if the **Download Complete** window appears.

The file icon appears on your desktop and is titled the same as the downloaded BIOS update file.

9. Double-click the file icon on the desktop and follow the instructions on the screen.

[Back to Contents Page](#)

Coin-Cell Battery

Dell™ Inspiron™ i1200 and i2200 Service Manual

⚠ CAUTION: Before performing the following procedures, read the safety instructions in the *Product Information Guide*.

⚠ CAUTION: To prevent static damage to components inside your computer, discharge static electricity from your body before you touch any of your computer's electronic components. You can do so by touching an unpainted metal surface.

1. Follow the instructions in "[Before Working Inside Your Computer](#)."
2. Remove the [hard drive](#).
3. Remove the [optical drive](#).
4. Remove the [keyboard](#).
5. Remove the [display assembly](#).
6. Remove the [Mini PCI card](#).
7. Remove the [palm rest](#).
8. Locate the coin-cell battery on the system board and use a plastic scribe to gently pry the coin-cell battery out of the connector.



Microprocessor Module

Dell™ Inspiron™ i1200 and i2200 Service Manual

- [Removing the Microprocessor Module](#)
- [Installing the Microprocessor Module](#)

Removing the Microprocessor Module

- ⚠ **CAUTION:** Before performing the following procedures, read the safety instructions in the *Product Information Guide*.
 - ⚠ **CAUTION:** To prevent static damage to components inside your computer, discharge static electricity from your body before you touch any of your computer's electronic components. You can do so by touching an unpainted metal surface.
 - 👉 **NOTICE:** Press and hold the microprocessor down by applying slight pressure to the center of the microprocessor while turning the cam screw to prevent intermittent contact between the cam screw and microprocessor.
 - 👉 **NOTICE:** To avoid damage to the microprocessor, hold the screwdriver so that it is perpendicular to the microprocessor when turning the cam screw.
1. Follow the instructions in "[Before Working Inside Your Computer](#)."
 2. Remove the [keyboard](#).
 3. Remove the [cooling fan](#).
 4. Remove the [microprocessor thermal-cooling assembly](#).
- 👉 **NOTICE:** When removing the microprocessor module, pull the module straight up. Be careful not to bend the pins on the microprocessor module.
5. To loosen the ZIF socket, use a small, flat-blade screwdriver and rotate the ZIF-socket cam screw counterclockwise until it comes to the cam stop.

The ZIF-socket cam screw secures the microprocessor to the system board. Take note of the arrow on the ZIF-socket cam screw.

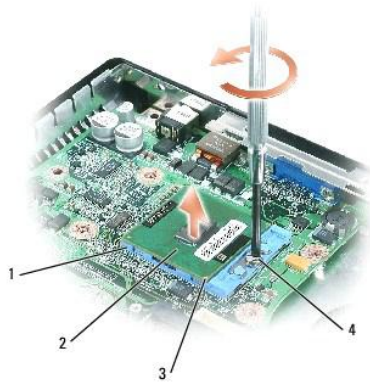

1	ZIF-socket
2	microprocessor module
3	pin-1 corner of microprocessor
4	ZIF-socket cam screw

6. Use a microprocessor extraction tool to remove the microprocessor module.
-

Installing the Microprocessor Module

➡ **NOTICE:** Ensure that the cam lock is in the fully open position before seating the microprocessor module. Seating the microprocessor module properly in the ZIF socket does not require force.

➡ **NOTICE:** A microprocessor module that is not properly seated can result in an intermittent connection or permanent damage to the microprocessor and ZIF socket.

1. Align the pin-1 corner of the microprocessor module so that it points to the triangle on the system board, and insert the microprocessor module into the ZIF socket.

When the microprocessor module is correctly seated, all four corners are aligned at the same height. If one or more corners of the module are higher than the others, the module is not seated correctly.

➡ **NOTICE:** Hold the microprocessor down while turning the cam screw to prevent intermittent contact between the cam screw and microprocessor.

2. Tighten the ZIF socket by turning the cam screw clockwise to secure the microprocessor module to the system board.
3. Wipe the thermal grease off of the microprocessor thermal-cooling assembly with a clean paper towel.
4. Squeeze the contents of the thermal grease packet (provided with the kit) onto the microprocessor thermal-cooling assembly.
5. Replace the [microprocessor thermal-cooling assembly](#).
6. Replace the [cooling fan](#).
7. Replace the [keyboard](#).
8. [Update the BIOS](#) using a flash BIOS-update program CD.

[Back to Contents Page](#)

Display

Dell™ Latitude™ 110L Service Manual

- [Display Assembly](#)
 - [Display Bezel](#)
 - [Display Panel](#)
-

Display Assembly

⚠ CAUTION: Before performing the following procedures, read the safety instructions in the *Product Information Guide*.

⚠ CAUTION: To prevent static damage to components inside your computer, discharge static electricity from your body before you touch any of your computer's electronic components. You can do so by touching an unpainted metal surface.

1. Follow the instructions in "[Before Working Inside Your Computer](#)."
2. Remove the [keyboard](#).
3. Disconnect the display ground wire from the EMI shield by unscrewing the captive screw.

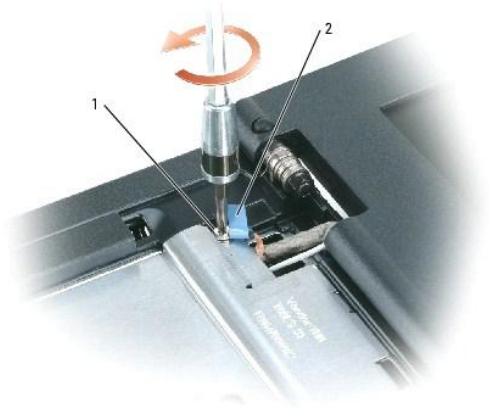

1	captive screw
2	display ground wire

4. Remove the four M2.5 x 5-mm screws (labeled "M2.5x5") that secure the EMI shield to the system board.
5. Pull the EMI shield out of the computer base by rotating the front upwards then lifting to release the retention tabs from the retention-tab slots.



1	M2.5 x 5-mm screws (4)
2	shield retention tabs (3)
3	shield-retention tab slots

6. Disconnect the attached antenna cable from the Mini PCI card.



1	antenna cable
2	metal securing tabs (2)
3	Mini PCI card connector
4	Mini PCI card

7. Close the display.

8. From the bottom of the computer, remove the two M2.5 x 5-mm screws labeled "D."



9. From the back of the computer, remove the two M2.5 x 8-mm screws labeled "D."



10. Pull straight up on the pull-tab that is attached to the display-feed flex cable to disconnect the cable from the system board.



1	display cable
2	system board connector

11. Carefully remove the Mini PCI card antenna cable and the display cables from their routing guides.

12. Lift the display assembly out of the computer base.

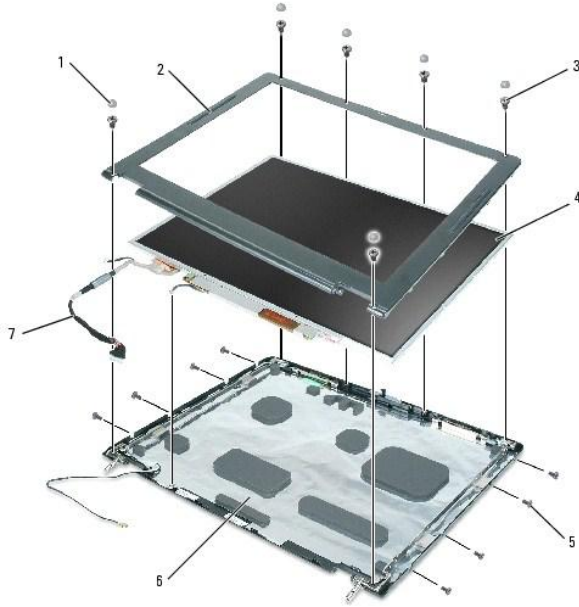

1	screw covers/display bumpers (6)
2	display bezel
3	M2.5 x 5-mm screws (6)
4	display panel
5	M2 x 3-mm screws (8)
6	top cover
7	display-feed flex cable

Display Bezel

⚠ CAUTION: Before performing the following procedures, read the safety instructions in the *Product Information Guide*.

⚠ CAUTION: To prevent static damage to components inside your computer, discharge static electricity from your body before you touch any of your computer's electronic components. You can do so by touching an unpainted metal surface.

1. Follow the instructions in "[Before Working Inside Your Computer](#)."
2. Remove the [display assembly](#).
3. Use a plastic scribe to pry the six screw covers/display bumpers out of the screw holes on the front of the bezel.
4. Remove the six M2.5 x 5-mm screws from the front of the bezel.

👉 NOTICE: Carefully separate the bezel from the top cover to avoid damage to the bezel.

5. Starting at the bottom of the display panel, use your fingers to separate the bezel from the top cover and lift the inside edge of the bezel away from the top cover.
-

Display Panel

Removing the Display Panel

⚠ CAUTION: Before performing the following procedures, read the safety instructions in the *Product Information Guide*.

⚠ CAUTION: To prevent static damage to components inside your computer, discharge static electricity from your body before you touch any of your computer's electronic components. You can do so by touching an unpainted metal surface.

1. Follow the instructions in "[Before Working Inside Your Computer](#)."
2. Remove the [display assembly](#).
3. Remove the [display bezel](#).
4. Remove the four M2 x 3-mm screws from each side of the display panel.
5. Lift the display panel out of the top cover.
6. Press in both sides of the top flex-cable connector, and pull the top flex-cable connector away from the display connector.

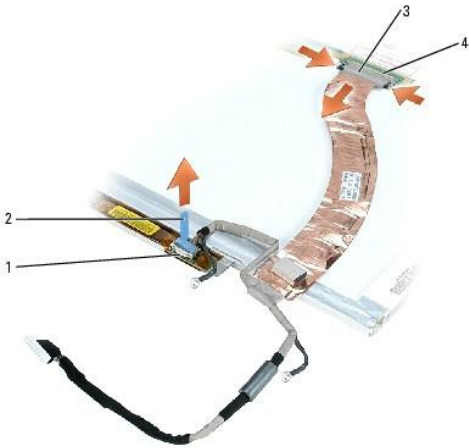

1	inverter connector
2	pull-tab on bottom flex-cable connector
3	top flex-cable connector
4	display connector

7. Use the pull-tab to disconnect the bottom flex-cable connector from the inverter connector.

Installing the Display Panel

1. Connect the top flex-cable connector to the display panel connector.
2. Connect the bottom flex-cable connector to the inverter connector.
3. Lay the display panel into the top cover.
4. Route the display-feed flex cable so that it rests in the notch located in the bottom edge of the top cover.
5. Replace the eight M2 x 3-mm screws that secure the display panel to the top cover.
6. Replace the [display bezel](#).

Hard Drive

Dell™ Inspiron™ i1200 and i2200 Service Manual

- [Removing the Hard Drive](#)
 - [Installing the Hard Drive](#)
-

Removing the Hard Drive

- ⚠ **CAUTION:** If you remove the hard drive from the computer when the drive is hot, do not touch the metal housing of the hard drive.
- ⚠ **CAUTION:** Before working inside your computer, follow the safety instructions located in the *Product Information Guide*.
- 🔍 **NOTICE:** To prevent data loss, [turn off your computer](#) before removing the hard drive. Do not remove the hard drive while the computer is on, in standby mode, or in hibernate mode.
- 🔍 **NOTICE:** Hard drives are extremely fragile; even a slight bump can damage the drive.
- 📌 **NOTE:** Dell does not guarantee compatibility or provide support for hard drives from sources other than Dell.

To replace the hard drive in the hard drive bay:

1. Follow the procedures in "[Before You Begin](#)."
2. Turn the computer over, and remove the hard drive cover screws.
3. Lift the hard drive cover and remove the screws used to secure the hard drive.



- 🔍 **NOTICE:** When the hard drive is not in the computer, store it in protective antistatic packaging. See "Protecting Against Electrostatic Discharge" in the *Product Information Guide*.
 4. A black plastic strap is attached to the hard drive to assist in removal. Grasp the strap and pull straight out to remove the hard drive from computer.
-

Installing the Hard Drive

- ⚠ **CAUTION:** Before you begin any of the procedures in this section, follow the safety instructions in the *Product Information Guide*.
- 📌 **NOTE:** You need the *Operating System* CD to install the Microsoft® Windows® operating system. The *Operating System* CD may not ship in certain countries. See your *Owner's Manual* for more information.

 **NOTE:** You need the *Drivers and Utilities* CD to install the drivers and utilities on the new hard drive. The *Drivers and Utilities* CD is optional and may not ship with your computer. See your *Owner's Manual* for more information.

5. Remove the new drive from its packaging.

Save the original packaging for storing or shipping the hard drive.

 **NOTICE:** Use firm and even pressure to slide the drive into place. If you use excessive force, you may damage the connector.

6. Slide the hard drive into the bay until it is fully seated.
7. Replace and tighten the screws.
8. Install the operating system for your computer, using the *Operating System* CD.
9. Install the drivers and utilities for your computer.

[Back to Contents Page](#)

Keyboard

Dell™ Inspiron™ i1200 and i2200 Service Manual

- [Removing the Keyboard](#)
- [Installing the Keyboard](#)

Removing the Keyboard

⚠ CAUTION: Before working inside your Dell™ computer, read the safety instructions in your *Product Information Guide*.

⚠ CAUTION: To prevent static damage to components inside your computer, discharge static electricity from your body before you touch any of your computer's electronic components. You can do so by touching an unpainted metal surface.

1. Follow the instructions in "[Before Working Inside Your Computer](#)."
2. Facing the back of the computer, use a small plastic scribe to lift the two notched edges on the hinge cover.



1	notched edges (2) on hinge cover
---	----------------------------------

3. Open the display all the way (180 degrees) so that it lies flat against your work surface.
4. Use a small plastic scribe to lift the right edge of the hinge cover.
5. Starting from the right and working toward the left, lift the hinge cover away from the hinges and computer base.

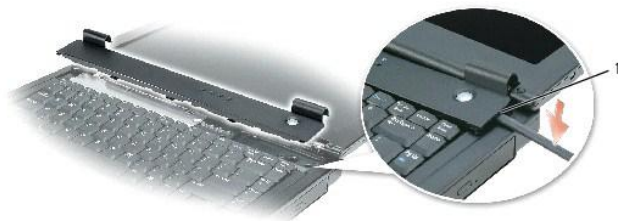

1	right edge of hinge cover
---	---------------------------

➡ **NOTICE:** The keycaps on the keyboard are fragile, easily dislodged, and time-consuming to replace. Be careful when removing and handling the keyboard.

6. Lift the top of the keyboard out of the computer base, and pull the keyboard out at an angle *toward* the display to access the connector.
7. Grasp the interface connector lever near the edge of the keyboard connector, and rotate the lever toward you to raise the interface connector lever.
8. Lift the keyboard flex cable to remove the cable from the interface connector on the system board.



1	keyboard flex-cable
2	interface connector lever
3	keyboard flex-cable connector

9. Remove the keyboard from the computer base.
-

Installing the Keyboard

➡ **NOTICE:** To avoid damage to the connector pins, insert the keyboard connector evenly into the interface connector on the system board, and do not reverse the keyboard connector.

1. Insert the keyboard flex cable into the interface connector on the system board. Ensure that the tabs at the end of the keyboard flex cable are completely seated; they should be beneath the edges of the interface connector.
2. Rotate the interface connector lever away from you, to secure the keyboard flex cable.
3. Insert the securing tabs on the front of the keyboard into their respective slots in the palm rest, and lower the keyboard into the computer base.

Ensure that all securing tabs are engaged before you completely seat the keyboard.

4. Insert the front side of the hinge cover into the notches on the keyboard.
 5. Snap down the hinge cover, and ensure that it is flush with the surrounding plastic.
-

[Back to Contents Page](#)

Palm Rest

Dell™ Inspiron™ i1200 and i2200 Service Manual

- ⚠ CAUTION:** Before performing the following procedures, read the safety instructions in the *Product Information Guide*.
- ⚠ CAUTION:** To prevent static damage to components inside your computer, discharge static electricity from your body before you touch any of your computer's electronic components. You can do so by touching an unpainted metal surface.
1. Follow the instructions in "[Before Working Inside Your Computer](#)."
 2. Remove the [hard drive](#).
 3. [Remove the](#) optical drive.
 4. Remove the [keyboard](#).
 5. Remove the [display assembly](#).
 6. Remove the [Mini PCI card](#).
 7. Turn the computer upside down and remove the eight M2.5 x 8-mm screws (labeled "P") from the bottom of the computer. One of the screws is located in the recess of the hard drive cover.



8. Remove the two M2 x 3-mm screws from the hard drive bay.



9. Turn the computer top-side up and remove the four M2.5 x 5-mm screws (labeled "P") from the top of the palm rest and the remaining two M2.5 x 5-mm screws from near the power button and the activity LEDs.

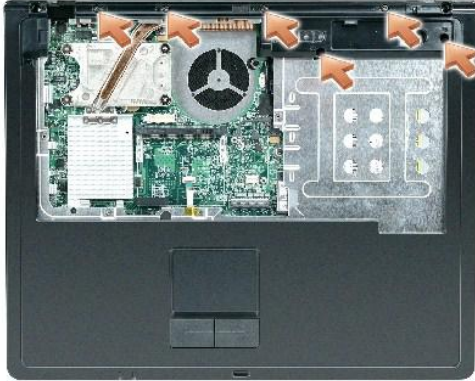

10. Disconnect the touch pad connector from the system board.

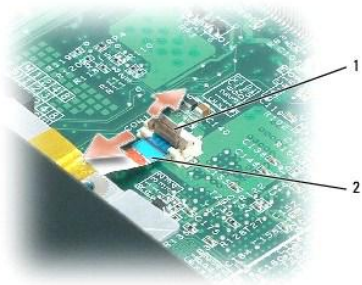

1	connector lever
2	palm rest connector

➡ **NOTICE:** Carefully separate the palm rest from the base plastics to avoid damage to the palm rest.

11. Starting at the back center of the palm rest, use your fingers to separate the palm rest from the base plastics by lifting the inside edge of the palm rest.

[Back to Contents Page](#)

Pinout Assignments for I/O Connectors

Dell™ Inspiron™ i1200 and i2200 Service Manual

● [USB Connector](#)

● [Video Connector](#)

USB Connector

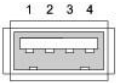

Pin	Signal
1	USB5V+
2	USBP-
3	USBP+
4	GND

Video Connector

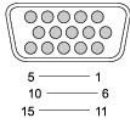

Pin	Signal	Pin	Signal
1	CRT_R	9	5V+
2	CRT_G	10	GND
3	CRT_B	11	MONITOR_DETECT-
4	NC	12	DDC_DATA
5	GND	13	CRT_HS
6	GND	14	CRT_VS
7	GND	15	DDC_CLK
8	GND		

Speakers

Dell™ Inspiron™ i1200 and i2200 Service Manual

- [Removing the Speakers](#)
- [Installing the Speakers](#)

Removing the Speakers

⚠ CAUTION: Before performing the following procedures, read the safety instructions in the *Product Information Guide*.

⚠ CAUTION: To prevent static damage to components inside your computer, discharge static electricity from your body before you touch any of your computer's electronic components. You can do so by touching an unpainted metal surface.

The speakers are located on the left and right corners of the front of the base plastics. Take note of the speaker cable routing so that you can replace the cables properly under or between their routing clips.

1. Follow the instructions in "[Before Working Inside Your Computer](#)."
2. Remove the [hard drive](#).
3. [Remove the](#) optical drive.
4. Remove the [keyboard](#).
5. Remove the [display assembly](#).
6. Remove the [palm rest](#).
7. Disconnect the speaker connector from the system board.

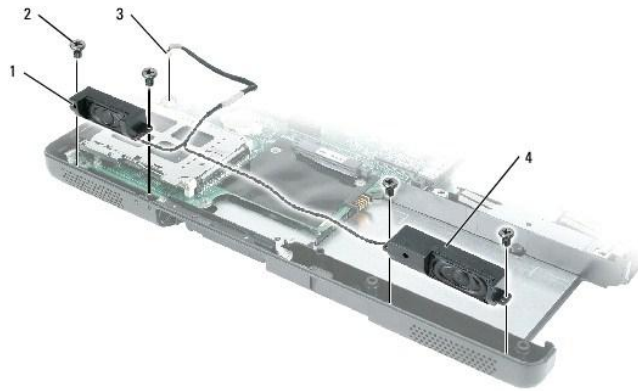

1	left speaker
2	M2.5 x 5-mm screws (4)
3	speaker connector
4	right speaker

➡ NOTICE: Remove the speaker cables from their routing clips with care to avoid damaging the cables.

8. Remove the speaker cables from under or between their routing clips.

➡ NOTICE: Handle the speakers with care to avoid damaging them.

9. Remove the four M2.5 x 5-mm screws from the speaker mounts.
10. Remove the speakers by pulling them straight up and out of the base plastics.

Installing the Speakers

1. Slide the speakers down into the base plastics.

 **NOTICE:** Ensure that the speaker cables are under or between their routing clips.

 **NOTE:** The speakers face out in the base plastics holders.

 **NOTE:** The right speaker cable is longer than the left speaker cable.

2. Route the speaker cables under or between their routing clips.
3. Replace the four M2.5 x 5-mm screws.
4. Connect the speaker connector to the system board.

[Back to Contents Page](#)

System Board

Dell™ Inspiron™ i1200 and i2200 Service Manual

- [Removing the System Board](#)
- [Installing the System Board](#)

Removing the System Board

⚠ CAUTION: Before performing the following procedures, read the safety instructions in the *Product Information Guide*.

⚠ CAUTION: To prevent static damage to components inside your computer, discharge static electricity from your body before you touch any of your computer's electronic components. You can do so by touching an unpainted metal surface.

The system board's BIOS chip contains the Service Tag, which is also visible on a barcode label on the bottom of the computer. The replacement kit for the system board includes a CD that provides a utility for transferring the Service Tag to the replacement system board.

1. Follow the instructions in "[Before Working Inside Your Computer](#)."
2. Remove the [hard drive](#).
3. Remove the [optical drive](#).
4. Remove the [memory module](#).
5. Remove the [keyboard](#).
6. Remove the [Mini PCI card](#).
7. Remove the [modem](#).
8. Remove the [display assembly](#).
9. Remove the [palm rest](#).
10. Remove the [microprocessor thermal-cooling assembly](#).
11. Remove the [microprocessor](#).
12. Remove the [speakers](#).
13. Remove the four M2.5 x 5-mm screws from the hard drive cage and remove the hard drive cage.

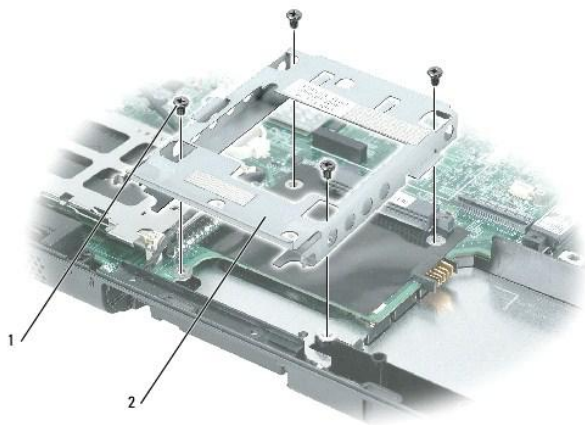

1	M2.5x5-mm screws (4)
2	hard drive cage

14. Remove the two hex nuts that secure the video connector to the base plastics.



1	hex screws (2)
---	----------------

15. Disconnect the display switch connector from the system board.



1	display switch connector
---	--------------------------

16. Remove any cards from the PCMCIA slot.

17. Remove the two M2.5 x 5-mm system board screws and lift the front of the system board out and away from the base plastics.

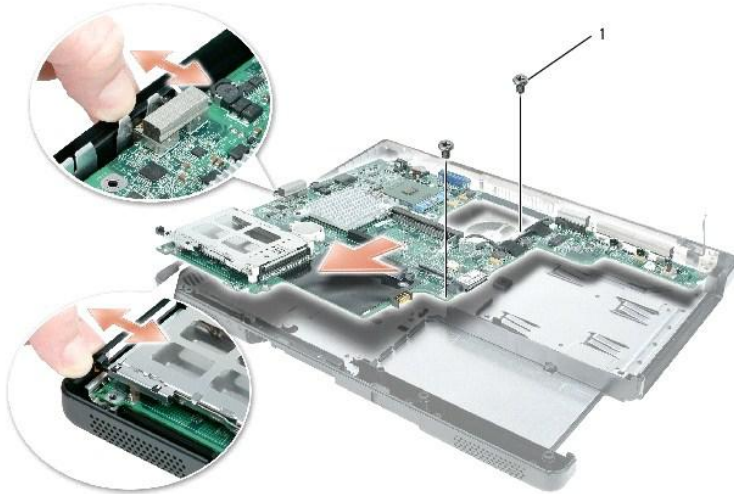

1	M2.5 x 5-mm screws (2)
---	------------------------

Installing the System Board

1. Insert the video connector on the replacement system board through the back of the base plastics.
2. Replace the two hex nuts that secure the video connector to the base plastics.
3. Replace the two M2.5 x 5-mm screws that secure the system board to the base plastics.
4. Replace the four M2.5 x 5-mm screws that secure the hard drive cage to the system board.

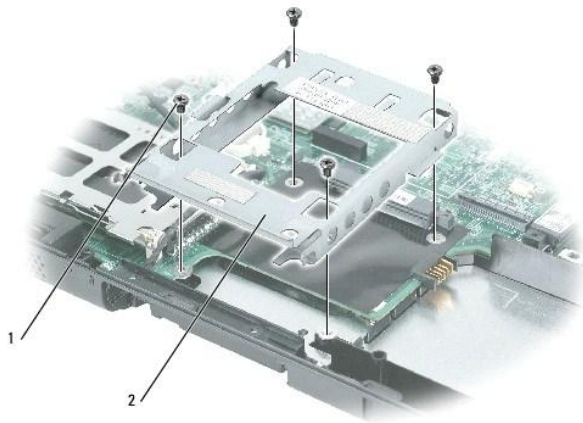



1	M2.5x5-mm screws (4)
2	hard drive cage

5. Replace the [speakers](#).
6. Replace the [microprocessor](#).

NOTICE: Before you replace the microprocessor thermal-cooling assembly, wipe the thermal grease off of the assembly with a clean paper towel. Squeeze the contents of the thermal grease packet (provided with the kit) onto the microprocessor thermal-cooling assembly.

7. Replace the [palm rest](#).
8. Replace the [microprocessor thermal-cooling assembly](#).
9. Replace the [cooling fan](#).
10. Replace the [display assembly](#).
11. Replace the [keyboard](#).
12. Replace the [Mini PCI card](#), [modem](#), and [memory module](#) that you removed from the old system board.
13. Replace the [optical drive](#).
14. Replace the [hard drive](#).
15. Insert the battery into the battery bay.
16. Connect the AC adapter to the computer and to an electrical outlet.

 **NOTICE:** Before turning on the computer, replace all screws and ensure that no stray screws remain inside the computer. Failure to do so may result in damage to the computer.

 **NOTE:** After replacing the system board, enter the computer Service Tag into the BIOS of the replacement system board.

17. Turn on the computer.
18. Insert the CD that accompanied the replacement system board into the appropriate drive, and turn on the computer. Follow the instructions on the screen.

[Back to Contents Page](#)

System Components

Dell™ Inspiron™ i1200 and i2200 Service Manual

⚠ CAUTION: Only a certified service technician should perform repairs on your computer. Damage due to servicing that is not authorized by Dell is not covered by your warranty.

↻ NOTICE: Unless otherwise noted, each procedure in this document assumes that a part can be replaced by performing the removal procedure in reverse order.

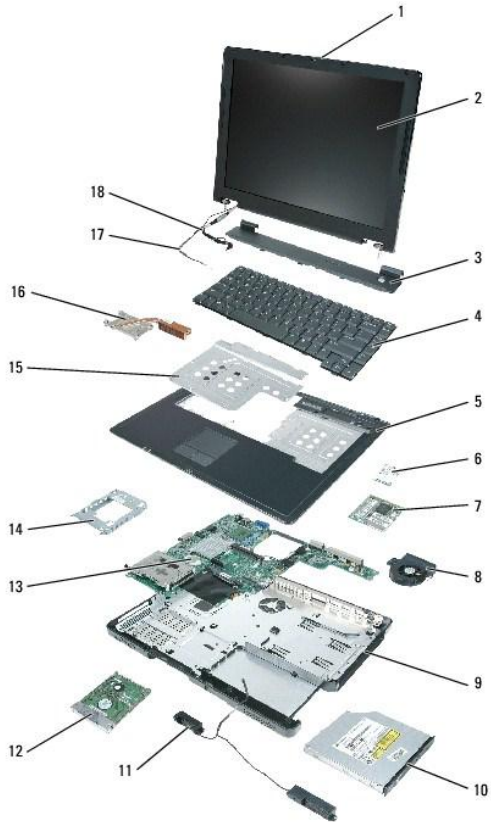

1	display latch	10	optical drive
2	display	11	speakers (2)
3	hinge cover	12	hard drive
4	keyboard	13	coin-cell battery
5	palm rest	14	hard drive cage
6	modem	15	EMI shield
7	EMI shield	16	microprocessor cooling assembly
8	fan	17	antenna cable
9	base plastics	18	display-feed flex cable

Microprocessor Thermal-Cooling Assembly

Dell™ Inspiron™ i1200 and i2200 Service Manual

- [Removing the Cooling Fan](#)
- [Installing the Cooling Fan](#)
- [Removing the Microprocessor Thermal-Cooling Assembly](#)
- [Installing the Microprocessor Thermal-Cooling Assembly](#)

Removing the Cooling Fan

⚠ CAUTION: Before performing the following procedures, read the safety instructions in the *Product Information Guide*.

To prevent static damage to components inside your computer, discharge static electricity from your body before you touch any of your computer's electronic components. You can do so by touching an unpainted metal surface.

1. Follow the instructions in "[Before Working Inside Your Computer](#)."
2. Remove the [keyboard](#).
3. Disconnect the display ground wire from the EMI shield by unscrewing the captive screw.

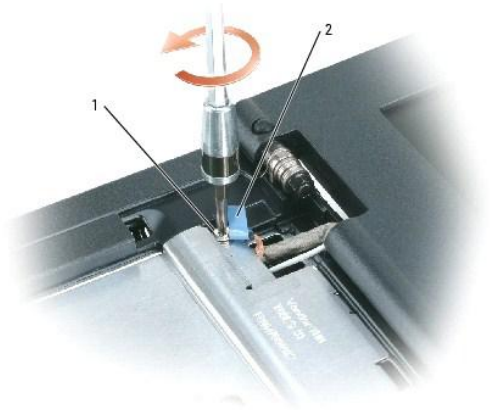

1	captive screw
2	display ground wire

4. Remove the four M2.5 x 5-mm screws (labeled "M2.5x5") that secure the EMI shield to the system board.
5. Pull the EMI shield out of the computer base by rotating the front upwards then lifting to release the retention tabs from the retention-tab slots.



1	M2.5 x 5-mm screws (4)
2	shield retention tabs (3)
3	shield-retention tab slots

6. Disconnect the two M2 x 3-mm screws and the fan power cable from the system board.

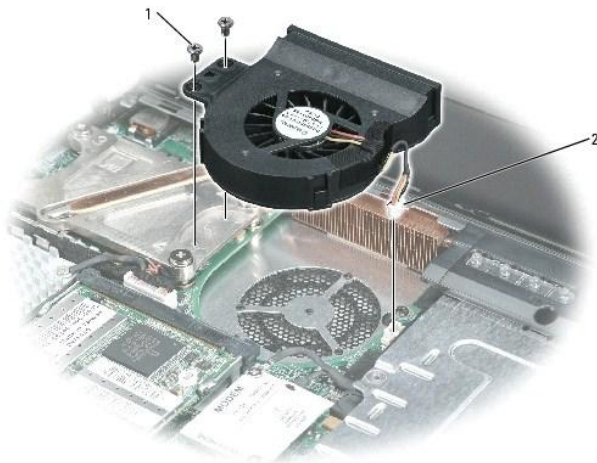

1	M2 x 3-mm screws (2)
2	fan connector

7. Hold the fan by the plastic housing at an angle to lift it out of the system board.

Installing the Cooling Fan

1. Align the cooling fan with the microprocessor thermal-cooling assembly on the system board.
2. Replace the two M2 x 3-mm screws and connect the fan connector to the system board.

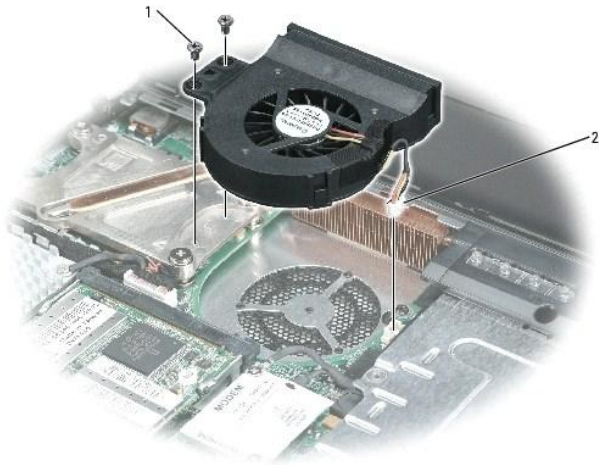

1	M2 x 3-mm screws (2)
2	fan connector

- Align the EMI shield retention tabs with the retention-tab slots on the computer base and rotate the front until it lies flat.
- Replace the four M2.5 x 5-mm screws that secure it to the system board.



1	M2.5 x 5-mm screws (4)
2	shield retention tabs (3)
3	shield-retention tab slots

1	M2.5 x 5-mm screws (4)
---	------------------------

Removing the Microprocessor Thermal-Cooling Assembly

CAUTION: Before performing the following procedures, read the safety instructions in the Product Information Guide.

CAUTION: To prevent static damage to components inside your computer, discharge static electricity from your body before you touch any of your computer's electronic components. You can do so by touching an unpainted metal surface.

1. Follow the instructions in "[Before Working Inside Your Computer.](#)"
2. Remove the [keyboard.](#)
3. Disconnect the display ground wire from the EMI shield by unscrewing the captive screw.

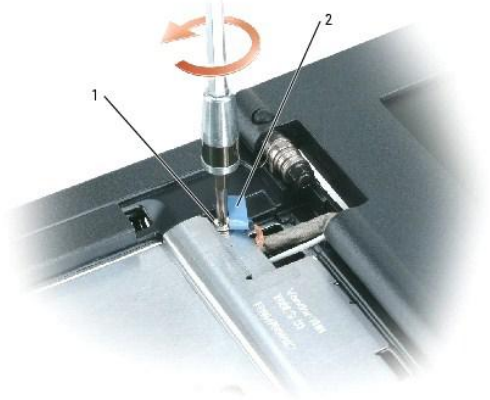

1	captive screw
2	display ground wire

4. Remove the four M2.5 x 5-mm screws (labeled "M2.5x5") that secure the EMI shield to the system board, and pull the EMI shield out of the computer base.



1	M2.5 x 5-mm screws (4)
---	------------------------

5. Remove the [cooling fan.](#)
6. Loosen in consecutive order the four captive screws, labeled "1" through "4," that secure the microprocessor thermal-cooling assembly to the system board.

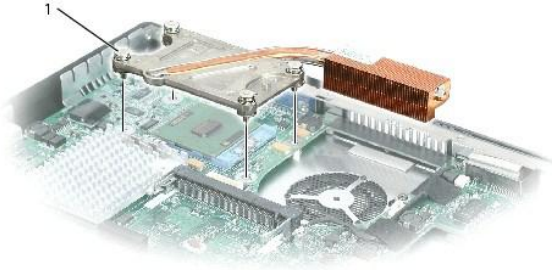

1	captive screws (4)
---	--------------------

7. Pull up the microprocessor thermal-cooling assembly by the pull-tab to lift the assembly out of the system board.
-

Installing the Microprocessor Thermal-Cooling Assembly

NOTICE: Before you install the replacement microprocessor thermal-cooling assembly, remove the mylar that covers the thermal grease on the assembly.

1. *If you are installing a replacement microprocessor thermal-cooling assembly, remove the mylar that covers the thermal grease on the assembly. If you are installing the assembly that you removed in the previous section:*
 - a. Wipe the thermal grease off of the microprocessor thermal-cooling assembly with a clean paper towel.
 - b. Squeeze the contents of the thermal grease packet (provided with the kit) onto the microprocessor thermal-cooling assembly.
2. Place the back of the microprocessor thermal-cooling assembly under the palm rest, and lower the assembly onto the system board.
3. Tighten the four captive screws, labeled "1" through "4," in consecutive order.
4. Replace the [cooling fan](#).
5. Replace the EMI shield and the four M2.5 x 5-mm screws that secure it to the system board.



1	M2.5 x 5-mm screws (4)
---	------------------------

6. Replace the [keyboard](#).
-

[Back to Contents Page](#)

[Back to Contents Page](#)

Dell™ Inspiron™ i1200 and i2200 Service Manual



NOTE: A NOTE indicates important information that helps you make better use of your computer.



NOTICE: A NOTICE indicates either potential damage to hardware or loss of data and tells you how to avoid the problem.



CAUTION: A CAUTION indicates a potential for property damage, personal injury, or death.

For a complete list of abbreviations and acronyms, see the *Dell Inspiron Help* file. To access the help file:

1. Click the **Start** button and click **Help and Support**.
2. Click **User and system guides** and click **User's guides**.
3. Click **Dell Inspiron Help**.

If you purchased a Dell™ n Series computer, any references in this document to Microsoft® Windows® operating systems are not applicable.

Information in this document is subject to change without notice.
© 2005 Dell Inc. All rights reserved.

Reproduction in any manner whatsoever without the written permission of Dell Inc. is strictly forbidden.

Trademarks used in this text: *Dell*, the *DELL* logo, and *Inspiron* are trademarks of Dell Inc.; *Microsoft* and *Windows* are registered trademarks of Microsoft Corporation.

Other trademarks and trade names may be used in this document to refer to either the entities claiming the marks and names or their products. Dell Inc. disclaims any proprietary interest in trademarks and trade names other than its own.

Model PP10S

June 2005 Rev. A01

[Back to Contents Page](#)

Memory, Optical Drive, Modem, and Mini PCI Card

Dell™ Inspiron™ i1200 and i2200 Service Manual

- [Memory](#)
 - [Optical Drive](#)
 - [Modem](#)
 - [Mini PCI Card](#)
-

Memory

Removing the Memory Module

- ⚠ **CAUTION:** Before working inside your Dell™ computer, read the safety instructions in the *Product Information Guide*.
- ⚠ **CAUTION:** To prevent static damage to components inside your computer, discharge static electricity from your body before you touch any of your computer's electronic components. You can do so by touching an unpainted metal surface.
- 📌 **NOTE:** Memory modules purchased from Dell are covered under your computer warranty.

1. Follow the instructions in "[Before Working Inside Your Computer](#)."
2. Loosen the captive screw (labeled "M") in the memory module cover, and lift the cover away from the computer.



1	captive screw
2	memory module cover

3. Use your fingertips to carefully spread apart the securing clips on each end of the memory module connector until the module pops up.
4. Remove the module from the connector.

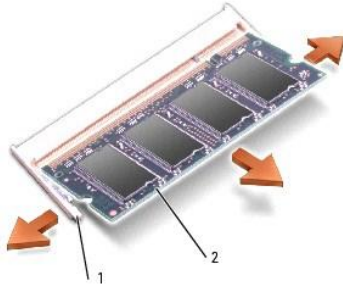

1	securing clips
2	memory module

Installing the Memory Modules

 **NOTE:** If the memory module is not installed properly, the computer may not boot properly. No error message indicates this failure.

1. Align the notch in the module edge connector with the tab in the connector slot.
2. Slide the module firmly into the slot at a 45-degree angle, and rotate the module down until it clicks into place. If you do not feel the click, remove the module and reinstall it.

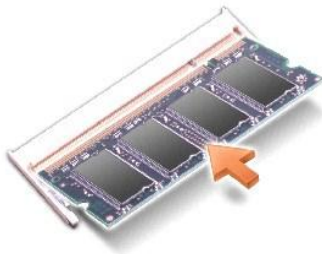

3. Replace the cover and tighten the captive screw.

 **NOTICE:** If the memory module cover is difficult to close, remove the module and reinstall it. Forcing the cover to close may damage your computer.

4. Insert the battery into the battery bay, or connect the AC adapter to your computer and an electrical outlet.
5. Turn on the computer.

As the computer boots, it detects the additional memory and automatically updates the system configuration information.

To confirm the amount of memory installed in the computer, click the **Start** button, click **Help and Support**, and then click **Computer Information**.

Optical Drive

Removing the Optical Drive

 **CAUTION:** Before you perform the following procedures, see the safety instructions in the *Product Information Guide*.

 **CAUTION:** To prevent static damage to components inside your computer, discharge static electricity from your body before you touch any of your computer's electronic components. You can do so by touching an unpainted metal surface.

1. Follow the instructions in "[Before Working Inside Your Computer](#)."

2. Remove the M2.5 x 8-mm screw from the indentation labeled with a lock symbol (🔒).
3. Insert a screwdriver into the indentation and push the notch on the metal tab to release the drive from the bay.



1	notch
2	M2.5 x 8-mm screw labeled "🔒"
3	optical drive

4. Pull the drive out of the bay.

Installing the Optical Drive

1. Slide the new drive into the bay until it snaps securely into place.
2. Replace the M2.5 x 8-mm screw.

Modem

Removing the Modem

⚠ CAUTION: Before you perform the following procedures, see the safety instructions in the *Product Information Guide*.

⚠ CAUTION: To prevent static damage to components inside your computer, discharge static electricity from your body before you touch any of your computer's electronic components. You can do so by touching an unpainted metal surface.

1. Follow the instructions in "[Before Working Inside Your Computer](#)."
2. Turn the computer over and use a small plastic scribe to lift the two notched edges on the back of the hinge cover.



1	hinge cover
2	notched edge

3. Open the display all the way (180 degrees) so that it lies flat against your work surface.
4. Use a small plastic scribe to lift the right edge of the hinge cover.
5. Lift the hinge cover away from the hinges and computer base.



1	hinge cover
2	notched edge

➡ **NOTICE:** The keycaps on the keyboard are fragile, easily dislodged, and time-consuming to replace. Be careful when removing and handling the keyboard.

➡ **NOTICE:** When lifting the keyboard, be careful not to pull the keyboard connection out of the system board.

6. Lift and turn the keyboard over and lay it across the palm rest over the touch pad.
7. Remove the M2 x 3-mm screw securing the modem to the system board, and set it aside.
8. Remove the captive screw from the modem.
9. Pull straight up on the attached pull-tab to lift the modem out of its connector on the system board and disconnect the modem cable.

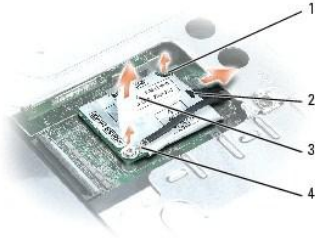

1	M2 x 3-mm screw
2	modem cable
3	pull-tab
4	captive screw

Installing the Modem

1. Connect the modem cable to the modem.

NOTICE: The cable connectors are keyed for correct insertion; do not force the connections.

2. Align the modem with the screw holes, and press the modem onto the connector on the system board.
3. Install the M2 x 3-mm screw to secure the modem to the system board.
4. Replace and tighten the captive screw on the opposite corner of the modem.
5. Being careful not to pull the keyboard connection out of the system board, turn the keyboard back over and insert the securing tabs on the front of the keyboard into their respective slots in the palm rest and lower the keyboard into the computer base.

Ensure that all securing tabs are engaged before trying to completely seat the keyboard.

6. Insert the lower side of the hinge cover into the notches on the keyboard.
7. Snap down the hinge cover, and ensure that it is flush with the palm rest.

Mini PCI Card

Removing the Mini PCI Card

CAUTION: Before working inside your Dell™ computer, read the safety instructions in the *Product Information Guide*.

CAUTION: To prevent static damage to components inside your computer, discharge static electricity from your body before you touch any of your computer's electronic components. You can do so by touching an unpainted metal surface.

NOTE: Depending on the options ordered, the computer may be configured with a single antenna located in the LCD to enhance wireless reception. When replacing the LCD, disconnect this antenna before removing the LCD panel. In some cases, if an internal wireless card was not ordered with the computer, it may not have an antenna in the LCD panel assembly and internal wireless functionality is not enabled.

NOTE: The Inspiron 1200 offers an optional external wireless card to access wireless networks. It does not have an antenna in the LCD panel assembly.

1. Follow the instructions in ["Before Working Inside Your Computer."](#)
2. Remove the [keyboard](#).
3. Disconnect the display ground wire from the EMI shield by unscrewing the captive screw.

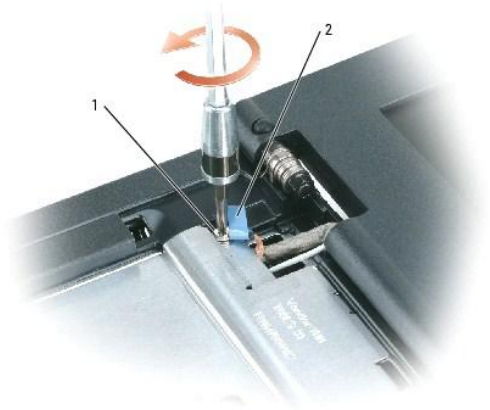

1	captive screw
2	display ground wire

- Remove the four M2.5 x 5-mm screws (labeled "M2.5x5") that secure the EMI shield to the system board.
- Pull the EMI shield out of the computer base by rotating the front upwards then lifting to release the retention tabs from the retention-tab slots.

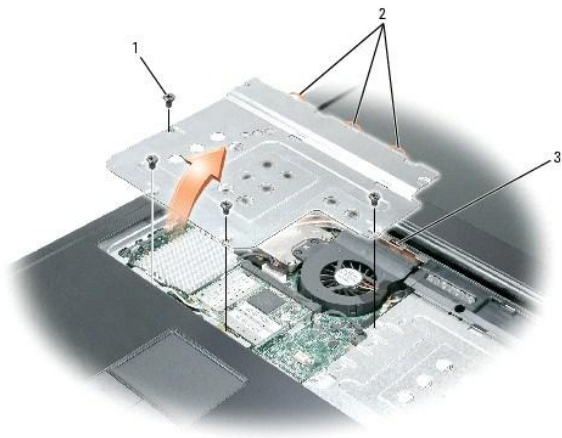

1	M2.5 x 5-mm screws (4)
2	shield retention tabs (3)
3	shield-retention tab slots

- Disconnect the attached antenna cable from the Mini PCI card.



1	antenna cable
2	metal securing tabs (2)
3	Mini PCI card connector
4	Mini PCI card

7. Use your fingertips to carefully spread apart the securing taps on each end of the Mini PCI card connector until the card pops up.
8. Lift the Mini PCI card out of its connector.

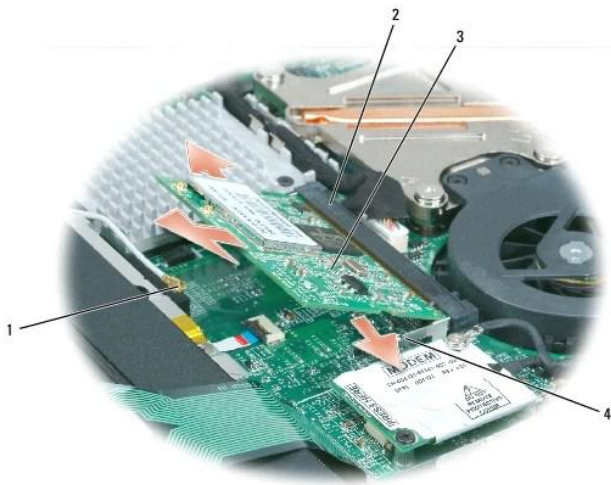

1	antenna cable
2	Mini PCI card connector
3	Mini PCI card
4	metal securing tabs (2)

Installing the Mini PCI Card

- 👉 **NOTICE:** To avoid damaging the Mini PCI card, never place the cable on top of or under the card.

NOTICE: The connectors are keyed to ensure correct insertion. If you feel resistance, check the connectors and realign the card.

1. Align the Mini PCI card with the connector at a 45-degree angle, and press the Mini PCI card into the connector until it clicks.



1	Mini PCI card connector
2	Mini PCI card

2. Connect the antenna cable to the Mini PCI card.

NOTE: To prevent damage to the antenna cable, ensure that the card is not on top of or under the cable.

3. Align the EMI shield retention tabs with the retention-tab slots on the computer base and rotate the front until it lies flat.
4. Replace the four M2.5 x 5-mm screws that secure it to the system board.

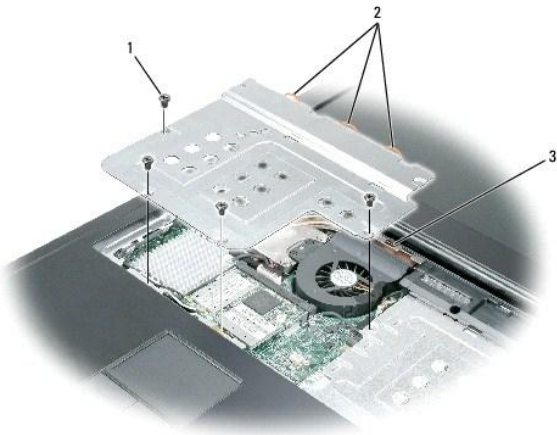

1	M2.5 x 5-mm screws (4)
2	shield retention tabs (3)
3	shield-retention tab slots

5. Replace the [keyboard](#).
-

[Back to Contents Page](#)