

# Dell Latitude 3330 Owner's Manual

Regulatory Model: P18S  
Regulatory Type: P18S002



# Notes, Cautions, and Warnings



**NOTE:** A NOTE indicates important information that helps you make better use of your computer.



**CAUTION:** A CAUTION indicates either potential damage to hardware or loss of data and tells you how to avoid the problem.



**WARNING:** A WARNING indicates a potential for property damage, personal injury, or death.

© 2013 Dell Inc.

Trademarks used in this text: Dell™, the Dell logo, Dell Boomi™, Dell Precision™, OptiPlex™, Latitude™, PowerEdge™, PowerVault™, PowerConnect™, OpenManage™, EqualLogic™, Compellent™, KACE™, FlexAddress™, Force10™ and Vostro™ are trademarks of Dell Inc. Intel®, Pentium®, Xeon®, Core® and Celeron® are registered trademarks of Intel Corporation in the U.S. and other countries. AMD® is a registered trademark and AMD Opteron™, AMD Phenom™ and AMD Sempron™ are trademarks of Advanced Micro Devices, Inc. Microsoft®, Windows®, Windows Server®, Internet Explorer®, MS-DOS®, Windows Vista® and Active Directory® are either trademarks or registered trademarks of Microsoft Corporation in the United States and/or other countries. Red Hat® and Red Hat® Enterprise Linux® are registered trademarks of Red Hat, Inc. in the United States and/or other countries. Novell® and SUSE® are registered trademarks of Novell Inc. in the United States and other countries. Oracle® is a registered trademark of Oracle Corporation and/or its affiliates. Citrix®, Xen®, XenServer® and XenMotion® are either registered trademarks or trademarks of Citrix Systems, Inc. in the United States and/or other countries. VMware®, Virtual SMP®, vMotion®, vCenter® and vSphere® are registered trademarks or trademarks of VMware, Inc. in the United States or other countries. IBM® is a registered trademark of International Business Machines Corporation.

2013 -03

Rev. A00

# Contents

<b>Notes, Cautions, and Warnings.....</b>	<b>2</b>
<b>1 Working on Your Computer.....</b>	<b>5</b>
Before Working Inside Your Computer.....	5
Turning Off Your Computer.....	6
After Working Inside Your Computer.....	7
System Overview.....	7
<b>2 Removing and Installing Components.....</b>	<b>9</b>
Removing the Secure Digital (SD) Card.....	9
Installing The Secure Digital (SD) Card.....	9
Removing The Battery.....	9
Installing The Battery.....	10
Removing The Base Cover.....	10
Installing The Base Cover.....	10
Removing The Memory.....	10
Installing The Memory.....	11
Removing The Hard Drive.....	11
Installing The Hard Drive.....	12
Removing The Display Bezel.....	12
Installing the Display Bezel.....	13
Removing The Camera.....	13
Installing The Camera.....	13
Removing The Display Panel.....	13
Installing The Display Panel.....	14
Removing The Keyboard.....	15
Installing The Keyboard.....	16
Removing The Palmrest.....	16
Installing The Palmrest.....	17
Removing The Wireless Local Area Network (WLAN) Card.....	18
Installing The Wireless Local Area Network (WLAN) Card.....	18
Removing The Display Assembly.....	18
Installing The Display Assembly.....	20
Removing The Coin-Cell Battery.....	21
Installing The Coin-Cell Battery.....	21
Removing The System Board.....	21
Installing The System Board.....	22

Removing The Heat Sink.....	22
Installing The Heat Sink.....	23
Removing The High-Definition Multimedia Interface (HDMI) Board.....	23
Installing The High-Definition Multimedia Interface (HDMI) Board.....	24
Removing The Speakers.....	24
Installing The Speakers.....	25
Removing The Input/Output (I/O) Board.....	25
Installing The Input/Output (I/O) Board.....	26
Removing The Power Connector.....	26
Installing The Power Connector.....	27
System Setup Options.....	27
<b>3 System Setup.....</b>	<b>35</b>
Boot Sequence.....	35
Navigation Keys.....	35
System Setup Options.....	36
Updating the BIOS .....	43
System and Setup Password.....	43
Assigning a System Password and Setup Password.....	44
Deleting or Changing an Existing System and/or Setup Password.....	44
<b>4 Technical Specifications.....</b>	<b>47</b>
<b>5 Contacting Dell.....</b>	<b>53</b>

# Working on Your Computer

## Before Working Inside Your Computer

Use the following safety guidelines to help protect your computer from potential damage and to help to ensure your personal safety. Unless otherwise noted, each procedure included in this document assumes that the following conditions exist:

- You have performed the steps in Working on Your Computer.
- You have read the safety information that shipped with your computer.
- A component can be replaced or--if purchased separately--installed by performing the removal procedure in reverse order.

 **WARNING:** Before working inside your computer, read the safety information that shipped with your computer. For additional safety best practices information, see the Regulatory Compliance Homepage at [www.dell.com/regulatory\\_compliance](http://www.dell.com/regulatory_compliance)

 **CAUTION:** Many repairs may only be done by a certified service technician. You should only perform troubleshooting and simple repairs as authorized in your product documentation, or as directed by the online or telephone service and support team. Damage due to servicing that is not authorized by Dell is not covered by your warranty. Read and follow the safety instructions that came with the product.

 **CAUTION:** To avoid electrostatic discharge, ground yourself by using a wrist grounding strap or by periodically touching an unpainted metal surface, such as a connector on the back of the computer.

 **CAUTION:** Handle components and cards with care. Do not touch the components or contacts on a card. Hold a card by its edges or by its metal mounting bracket. Hold a component such as a processor by its edges, not by its pins.

 **CAUTION:** When you disconnect a cable, pull on its connector or on its pull-tab, not on the cable itself. Some cables have connectors with locking tabs; if you are disconnecting this type of cable, press in on the locking tabs before you disconnect the cable. As you pull connectors apart, keep them evenly aligned to avoid bending any connector pins. Also, before you connect a cable, ensure that both connectors are correctly oriented and aligned.

 **NOTE:** The color of your computer and certain components may appear differently than shown in this document.

To avoid damaging your computer, perform the following steps before you begin working inside the computer.

1. Ensure that your work surface is flat and clean to prevent the computer cover from being scratched.
2. Turn off your computer (see [Turning Off Your Computer](#)).
3. If the computer is connected to a docking device (docked) such as the optional Media Base or Battery Slice, undock it.

 **CAUTION:** To disconnect a network cable, first unplug the cable from your computer and then unplug the cable from the network device.

4. Disconnect all network cables from the computer.
5. Disconnect your computer and all attached devices from their electrical outlets.

6. Close the display and turn the computer upside-down on a flat work surface.

 **NOTE:** To avoid damaging the system board, you must remove the main battery before you service the computer.

7. Remove the main battery.
8. Turn the computer top-side up.
9. Open the display.
10. Press the power button to ground the system board.



 **CAUTION:** To guard against electrical shock, always unplug your computer from the electrical outlet before opening the display.

 **CAUTION:** Before touching anything inside your computer, ground yourself by touching an unpainted metal surface, such as the metal at the back of the computer. While you work, periodically touch an unpainted metal surface to dissipate static electricity, which could harm internal components.

11. Remove any installed ExpressCards or Smart Cards from the appropriate slots.

## Turning Off Your Computer

 **CAUTION:** To avoid losing data, save and close all open files and exit all open programs before you turn off your computer.

1. Shut down the operating system:
  - In Windows 8:
    - \* Using a touch-enabled device:
      - a. Swipe in from the right edge of the screen, opening the Charms menu and select **Settings**.
      - b. Select the  and then select **Shut down**
    - \* Using a mouse:
      - a. Point to upper-right corner of the screen and click **Settings**.
      - b. Click the  and select **Shut down**.
  - In Windows 7:
    1. Click **Start** .
    2. Click **Shut Down**.

or

1. Click **Start** .
2. Click the arrow in the lower-right corner of the **Start** menu as shown below, and then click **Shut**

**Down..**



2. Ensure that the computer and all attached devices are turned off. If your computer and attached devices did not automatically turn off when you shut down your operating system, press and hold the power button for about 4 seconds to turn them off.

## After Working Inside Your Computer

After you complete any replacement procedure, ensure you connect any external devices, cards, and cables before turning on your computer.

**⚠ CAUTION: To avoid damage to the computer, use only the battery designed for this particular Dell computer. Do not use batteries designed for other Dell computers.**

1. Connect any external devices, such as a port replicator, battery slice, or media base, and replace any cards, such as an ExpressCard.
2. Connect any telephone or network cables to your computer.

**⚠ CAUTION: To connect a network cable, first plug the cable into the network device and then plug it into the computer.**

3. Replace the battery.
4. Connect your computer and all attached devices to their electrical outlets.
5. Turn on your computer.

## System Overview

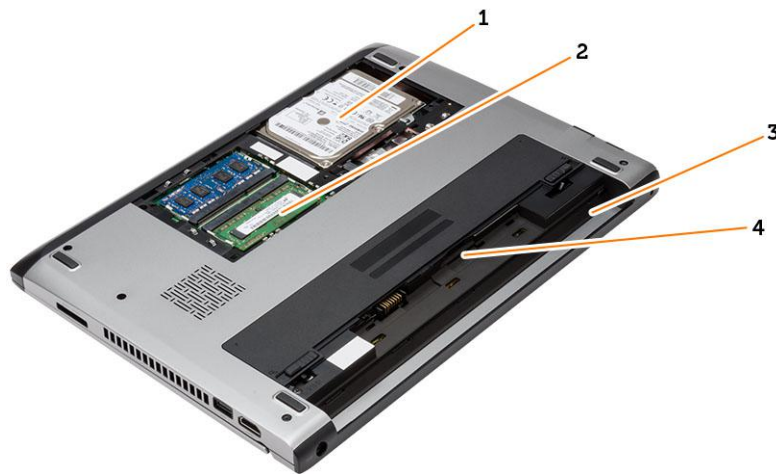

**Figure 1. Inside View — Back**

1. hard drive
2. memory
3. battery bay
4. SIM slot



**Figure 2. Inside view — Front**

- |  |                    |
|--|--------------------|
| 1. Input/Output (I/O) board                | 5. system board    |
| 2. coin-cell battery                       | 6. speaker         |
| 3. wireless local area network (WLAN) card | 7. power connector |
| 4. speaker                                 |                    |



## Removing and Installing Components

This section provides detailed information on how to remove or install the components from your computer.

### Removing the Secure Digital (SD) Card

1. Follow the procedures in *Before Working Inside Your Computer*.
2. Press in on the SD card to release it from the computer.



3. Slide the SD card out of the computer.

### Installing The Secure Digital (SD) Card

1. Slide the SD card into its slot and press until it clicks into place.
2. Follow the procedures in *After Working Inside Your Computer*.

### Removing The Battery

1. Follow the procedures in *Before Working On Your Computer*.
2. Slide the release latches to unlock position, and remove the battery from the computer.



## Installing The Battery

1. Insert the battery into its slot until the battery clicks into place.
2. Follow the procedures in *After Working Inside Your Computer*.

## Removing The Base Cover

1. Follow the procedures in *Before Working On Your Computer*.
2. Remove the battery.
3. Loosen the captive screw that secures the base cover to the computer.

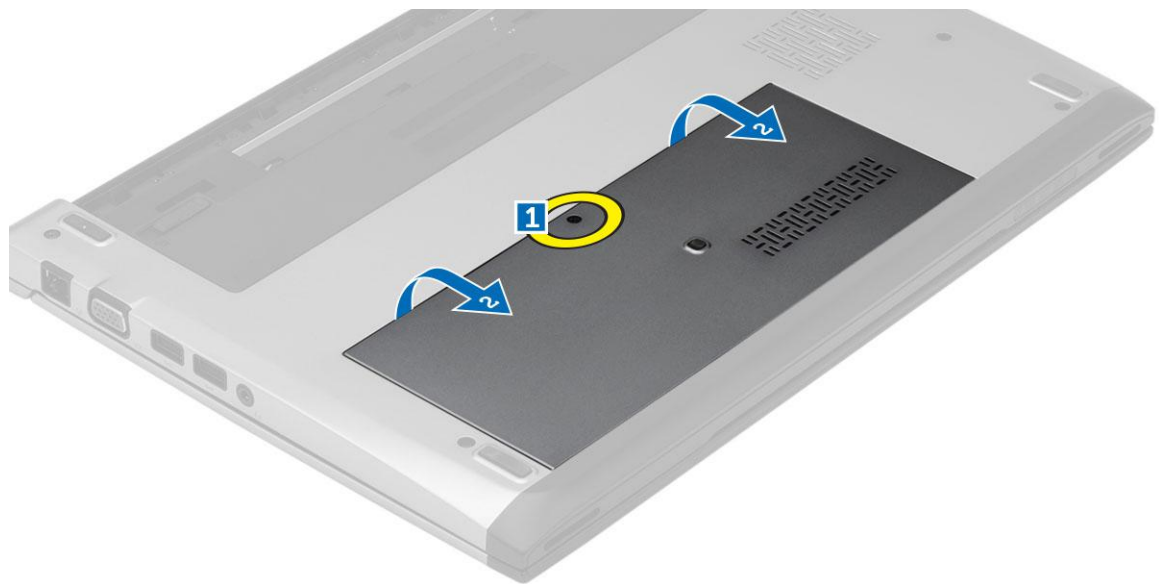

4. Slide the base cover towards the back of the computer. Lift it up and away from the computer.

## Installing The Base Cover

1. Align the edge of the base cover on the computer and slide it on the computer.
2. Tighten the screw to secure the base cover to the computer.
3. Install the battery.
4. Follow the procedures in *After Working Inside Your Computer*.

## Removing The Memory

1. Follow the procedures in *Before Working On Your Computer*.
2. Remove:
  - a) Battery
  - b) Base Cover
3. Pry the retention clips away from the memory module till the memory module pops up.

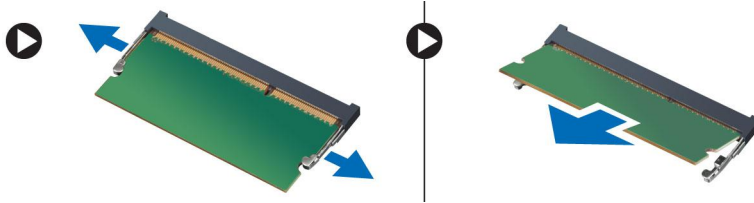

4. Remove the memory module from the computer.

## Installing The Memory

1. Insert the memory module into the memory socket and press until the memory clicks in to its place.
2. Install:
  - a) base cover
  - b) battery
3. Follow the procedures in *After Working Inside Your Computer*.

## Removing The Hard Drive

1. Follow the procedures in *Before Working On Your Computer*.
2. Remove:
  - a) battery
  - b) base cover
3. Remove the screw that secures the hard drive in place.



4. Slide the hard drive module to the left.
5. Carefully pry up and remove the hard drive from the computer.
6. Remove the screws which secure the hard-drive bracket to the hard drive. Separate the hard-drive bracket from the hard drive.

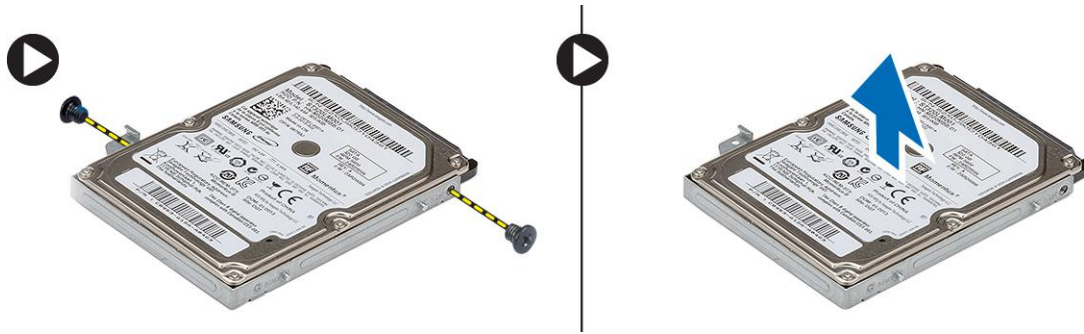

## Installing The Hard Drive

1. Align the hard-drive bracket with the hard drive.
2. Tighten the screws on the hard drive to secure the hard-drive bracket to the hard drive.
3. Slide the hard drive into the bay on the system board.
4. Replace and tighten the screw to secure the hard drive to the computer.
5. Install:
  - a) base cover
  - b) battery
6. Follow the procedures in *After Working Inside Your Computer*.

## Removing The Display Bezel

1. Follow the procedures in *Before Working on Your Computer*.
2. Remove the battery.
3. Gently pry the display bezel inside out to release it from the display assembly.



4. Lift the display bezel and remove it from the display assembly.

## Installing the Display Bezel

1. Align the display bezel with the display assembly.
2. Starting from the top corner, press on the display bezel and work around the entire bezel until it snaps onto the display assembly.
3. Install the battery.
4. Follow the procedures in *After Working Inside Your Computer*.

## Removing The Camera

1. Follow the procedures in *Before Working on Your Computer*.
2. Remove:
  - a) battery
  - b) display bezel
3. Disconnect the camera cable and lift the camera to remove it from the computer.



## Installing The Camera

1. Align the camera on the camera module.
2. Connect the camera cable to the camera module.
3. Install:
  - a) display bezel
  - b) battery
4. Follow the procedures in *After Working Inside Your Computer*.

## Removing The Display Panel

1. Follow the procedures in *Before Working on Your Computer*.
2. Remove:
  - a) battery
  - b) display bezel
3. Remove the screws that secure the display panel to the display assembly.



4. Rotate the display panel over to the keyboard.
5. Peel off the adhesive tape that secures the low-voltage differential signalling (LVDS) connection to the display panel.
6. Disconnect the LVDS cable from the display panel.



7. Remove the display panel from the computer.

## Installing The Display Panel

1. Connect the display cable to the display panel and attach the adhesive tape to secure the connection.
2. Connect the low-voltage differential signalling (LVDS) cable to the display panel.
3. Replace the adhesive tape that secures the LVDS connection to the display panel.
4. Align the display panel in its original position on the display assembly.

5. Tighten the screws to secure the display panel to the display assembly.
6. Install:
  - a) display bezel
  - b) battery
7. Follow the procedures in *After Working Inside Your Computer*.

## Removing The Keyboard

1. Follow the procedures in *Before Working On Your Computer*.
2. Remove the battery.
3. Pry the keyboard using a flat-head screwdriver to remove the keyboard retainers that secure the keyboard to the computer.



4. Flip the keyboard over and lay it on the palmrest.
5. Lift the clip to release the keyboard cable and disconnect it from the system board.



6. Lift the keyboard up and away from the computer.

## Installing The Keyboard

1. Connect the keyboard cable to the system board.
2. Insert the keyboard in its compartment.
3. Press down until the keyboard clicks into place in the computer.
4. Install the battery.
5. Follow the procedures in *After Working Inside Your Computer*.

## Removing The Palmrest

1. Follow the procedures in *Before Working On Your Computer*.
2. Remove:
  - a) battery
  - b) base cover
  - c) keyboard
  - d) hard drive
3. Remove the screws from the bottom of the computer, that secures the palmrest.



4. Remove the screws on the palmrest.



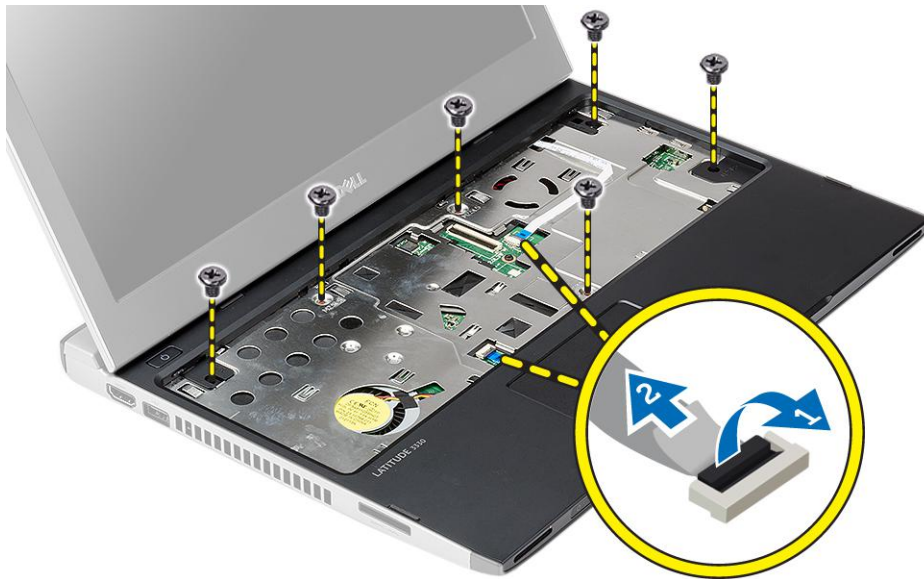

5. Disconnect the following cables:
  - media board
  - touch pad
6. Using a plastic scribe, gently pry the sides of the palmrest and remove it from the computer.

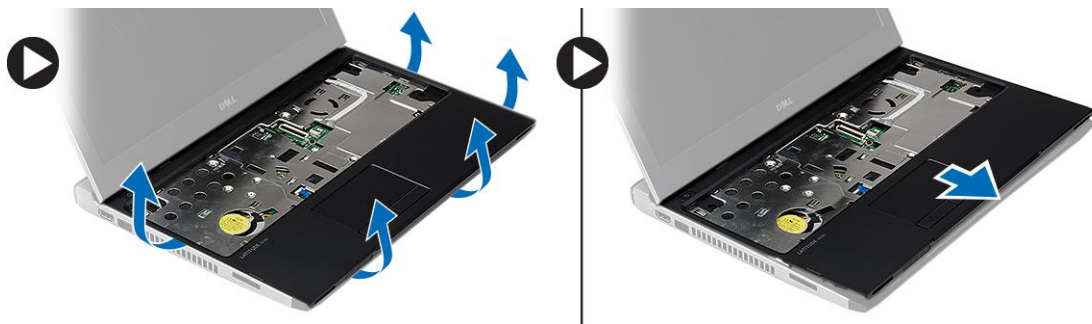

## Installing The Palmrest

1. Align the palmrest to its original position in the computer and gently snap it into place.
2. Connect the following cables to the palmrest:
  - media board
  - touch pad
3. Tighten the screws on the palmrest to secure the palmrest in place.
4. Tighten the screws at the bottom base of the computer that secures the palmrest.
5. Install:
  - a) hard drive
  - b) keyboard
  - c) base cover
  - d) battery
6. Follow the procedures in *After Working Insider Your Computer*.

## Removing The Wireless Local Area Network (WLAN) Card

1. Follow the procedures in *Before Working on Your Computer*.
2. Remove:
  - a) battery
  - b) base cover
  - c) hard drive
  - d) keyboard
  - e) palmrest
3. Disconnect the antenna cables from the WLAN card.

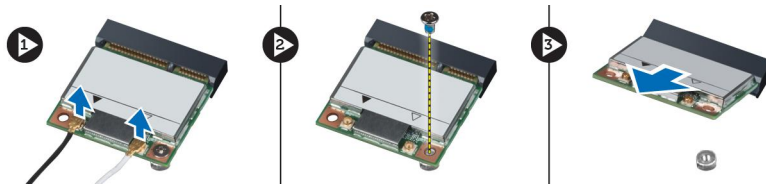

4. Remove the screw that secures the WLAN card.
5. Remove the WLAN card.

## Installing The Wireless Local Area Network (WLAN) Card

1. Insert the WLAN card into its connector.
2. Press the WLAN card down and tighten the screw to secure the WLAN card to the computer.
3. Connect the antenna cables to their respective connectors marked on the WLAN card.
4. Install:
  - a) palmrest
  - b) keyboard
  - c) hard drive
  - d) base cover
  - e) battery
5. Follow the procedures in *After Working Inside Your Computer*.

## Removing The Display Assembly

1. Follow the procedures in *Before Working on Your Computer*.
2. Remove:
  - a) battery
  - b) base cover
  - c) hard drive
  - d) keyboard
  - e) palmrest
3. Remove the screws from the computer base that secures the display assembly.



4. Turn over the computer. Disconnect the WLAN cable and release the cable from the routing channel on the bottom base chassis.



5. Disconnect the display cable from the computer and release it from the routing channel.



6. Remove the screw that secures the right hinge.



7. Carefully lift up the display assembly from the computer base.

## Installing The Display Assembly

1. Align the display assembly to the computer base.
2. Tighten the screw to secure the right hinge in place.
3. Tighten the screws to secure the display assembly to the bottom base chassis.
4. Connect the display cable to the connector on the system board.
5. Route the WLAN cable in its routing channel and connect the cable in the respective modules.
6. Install:
  - a) palmrest

- b) keyboard
- c) hard drive
- d) base cover
- e) battery

7. Follow the procedures in *After Working Inside Your Computer*

## Removing The Coin-Cell Battery

1. Follow the procedures in *Before Working on Your Computer*

2. Remove:

- a) battery
- b) base cover
- c) keyboard
- d) hard drive
- e) palmrest

3. Remove the coin-cell connector from the system board and pry out the coin-cell battery.

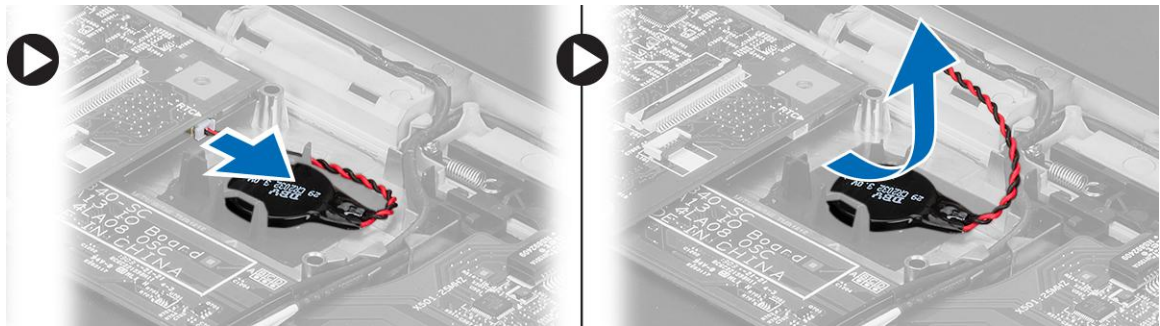

4. Remove the coin-cell battery from the computer.

## Installing The Coin-Cell Battery

1. Insert the coin-cell battery and connect the coin-cell connector to its compartment.

2. Install:

- a) palmrest
- b) hard drive
- c) keyboard
- d) base cover
- e) battery

3. Follow the procedures in *After Working Inside Your Computer*.

## Removing The System Board

1. Follow the procedures in *Before Working on Your Computer*.

2. Remove:

- a) battery
- b) secure digital (SD) card
- c) base cover
- d) keyboard
- e) memory

- f) hard drive
- g) palmrest
- h) coin-cell
- i) display assembly

3. Disconnect the power connector cable from the system board.

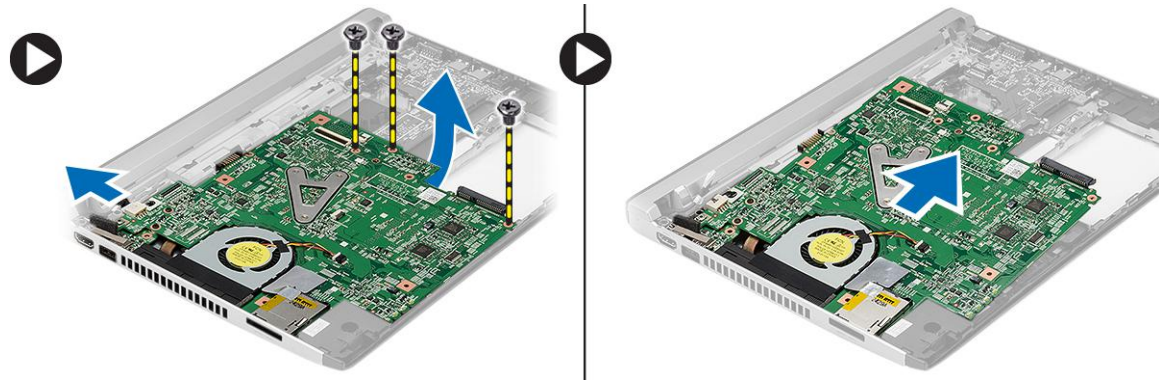

4. Remove the screws that secure the system board to the chassis.
5. Lift up and remove the system board from the chassis.

## Installing The System Board

1. Connect the power connector cable to the system board.
2. Insert the system board into its slot.
3. Tighten the screws to secure the system board to the chassis.
4. Install:
  - a) display assembly
  - b) coin-cell
  - c) palmrest
  - d) memory
  - e) hard drive
  - f) keyboard
  - g) base cover
  - h) secure digital (SD) Card
  - i) battery
5. Follow the procedures in *After Working Inside Your Computer*.

## Removing The Heat Sink

1. Follow the procedures in *Before Working on Your Computer*.
2. Remove:
  - a) battery
  - b) secure digital (SD) card
  - c) base cover
  - d) keyboard
  - e) hard drive
  - f) memory
  - g) palmrest

- h) coin-cell
  - i) system board
  - j) display assembly
3. Disconnect the heat sink cable from the system board.

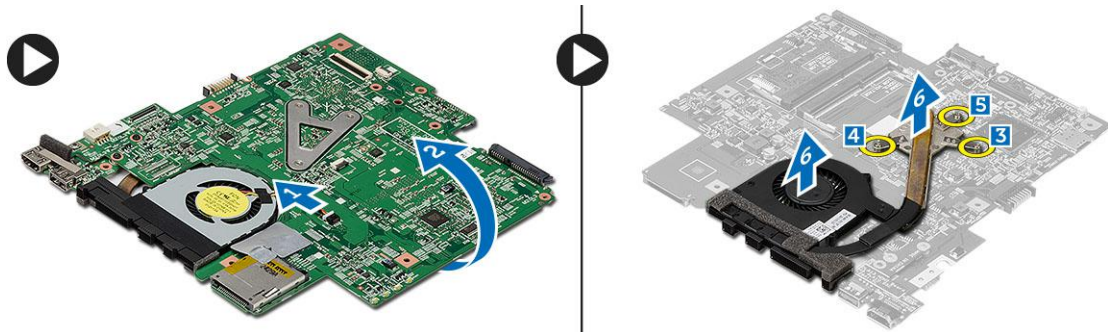

4. Loosen the captive screws that secure the heat sink to the system board.
5. Lift and remove the heat sink from the system board.

## Installing The Heat Sink

1. Insert the heat sink into its compartment.
2. Tighten the captive screws to secure the heat sink in place.
3. Connect the fan cable to the system board.
4. Install:
  - a) display assembly
  - b) system board
  - c) coin-cell
  - d) palmrest
  - e) memory
  - f) hard drive
  - g) keyboard
  - h) base cover
  - i) secure digital (SD) card
  - j) battery
5. Follow the procedures in *After Working Inside Your Computer*.

## Removing The High-Definition Multimedia Interface (HDMI) Board

1. Follow the procedures in *Before Working on Your Computer*.
2. Remove:
  - a) battery
  - b) secure digital (SD) card
  - c) base cover
  - d) keyboard
  - e) hard drive
  - f) memory
  - g) palmrest
  - h) display assembly
  - i) system board

3. Remove the screws that secure the HDMI board to the system board.

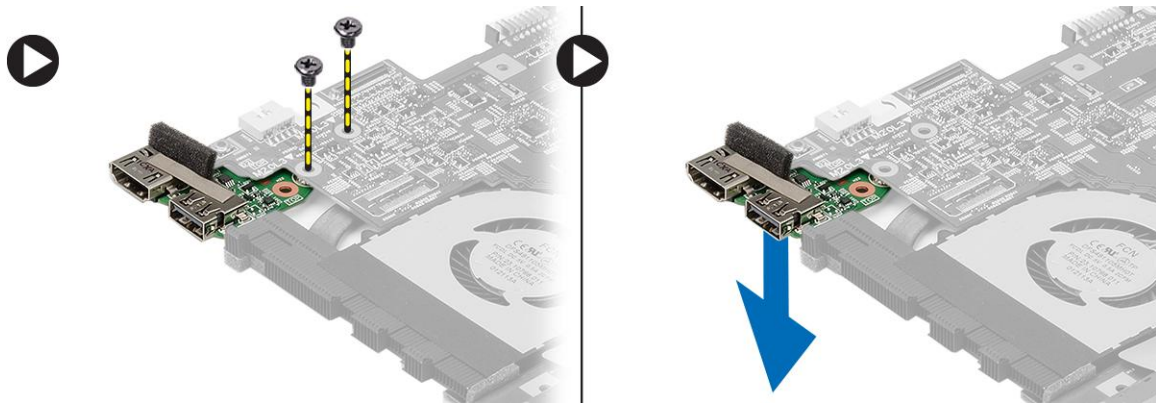

4. Remove the High-Definition Multimedia Interface (HDMI) board from the system board.

## Installing The High-Definition Multimedia Interface (HDMI) Board

1. Replace the HDMI board into its compartment.
2. Install:
  - a) display assembly
  - b) system board
  - c) display assembly
  - d) palmrest
  - e) memory
  - f) hard drive
  - g) keyboard
  - h) base cover
  - i) secure digital (SD) card
  - j) battery
3. Follow the procedures in *After Working Inside Your Computer*.

## Removing The Speakers

1. Follow the procedures in *Before Working on Your Computer*.
2. Remove:
  - a) battery
  - b) secure digital (SD) card
  - c) base cover
  - d) keyboard
  - e) hard drive
  - f) memory
  - g) palmrest
  - h) system board
  - i) coin-cell
3. Disconnect the speaker cable from the I/O board.



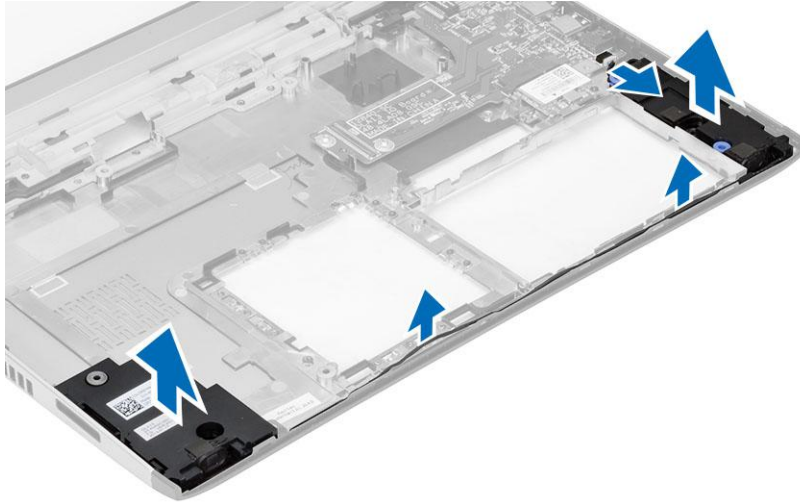

4. Unthread the speaker cable from its holder and remove the speakers from the computer.

## Installing The Speakers

1. Place the speakers in its compartments and route the cable through the channels.
2. Connect the speaker cable to the I/O board.
3. Install:
  - a) coin-cell
  - b) system board
  - c) palmrest
  - d) memory
  - e) hard drive
  - f) keyboard
  - g) base cover
  - h) secure digital (SD) card
  - i) battery
4. Follow the procedures in *After Working Inside Your Computer*.

## Removing The Input/Output (I/O) Board

1. Follow the procedures in *Before Working on Your Computer*.
2. Remove:
  - a) battery
  - b) secure digital (SD) card
  - c) base cover
  - d) hard drive
  - e) memory
  - f) keyboard
  - g) palmrest
  - h) system board
3. Disconnect the speaker cable from the I/O board.
4. Remove the I/O board from the chassis.

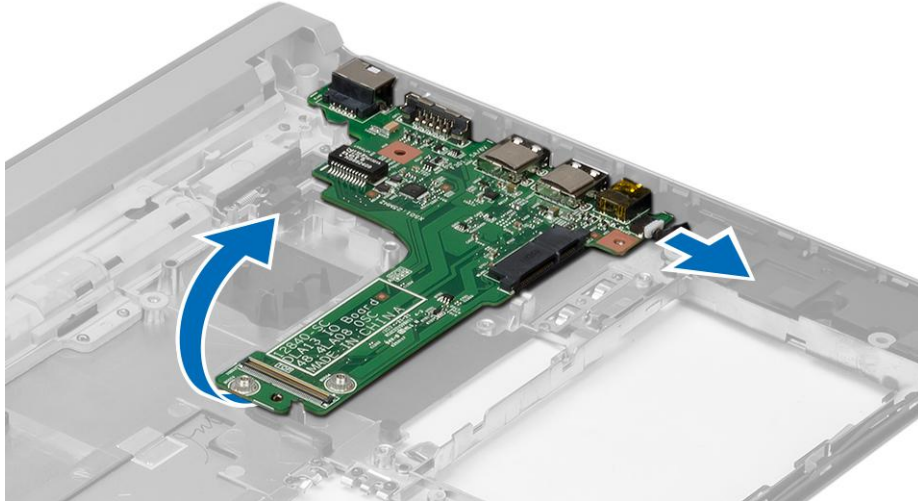

## Installing The Input/Output (I/O) Board

1. Insert the I/O board into its slot.
2. Connect the speaker cable to the I/O board.
3. Install:
  - a) system board
  - b) palmrest
  - c) memory
  - d) hard drive
  - e) keyboard
  - f) base cover
  - g) secure digital (SD) card
  - h) battery
4. Follow the procedures in *After Working Inside Your Computer*.

## Removing The Power Connector

1. Follow the procedures in *Before Working on Your Computer*.
2. Remove:
  - a) battery
  - b) secure digital (SD) card
  - c) base cover
  - d) hard drive
  - e) palmrest
  - f) memory
  - g) keyboard
  - h) display assembly
  - i) system board
3. Remove the screw that secures the power connector port.
4. Lift up and remove the power connector port from the bottom base.

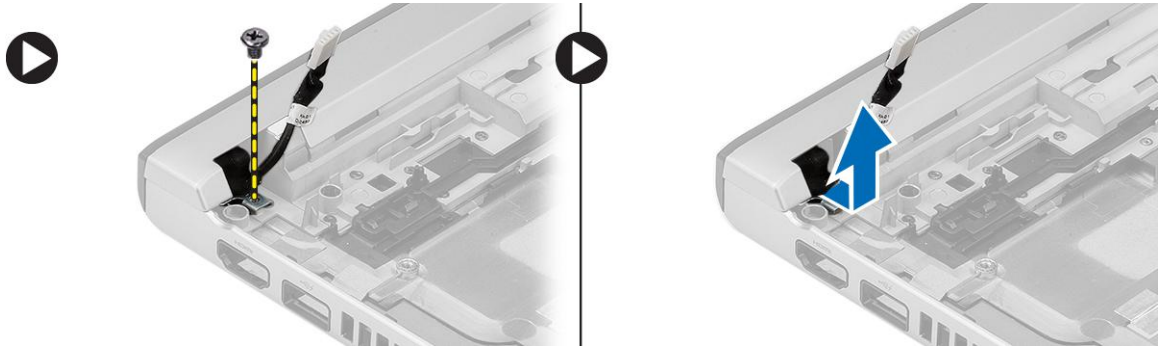

## Installing The Power Connector

1. Replace the power connector port into its compartment.
2. Tighten the screw to secure the power connector port in place.
3. Install:
  - a) system board
  - b) display assembly
  - c) palmrest
  - d) memory
  - e) hard drive
  - f) keyboard
  - g) base cover
  - h) secure digital (SD) card
  - i) battery
4. Follow the procedures in *After Working Inside Your Computer*.

## System Setup Options

 **NOTE:** Depending on your computer and its installed devices, the items listed in this section may or may not appear.

**Table 1. General**

Option	Description
<b>System Information</b>	<p>This section lists the primary hardware features of your computer.</p> <ul style="list-style-type: none"> <li>• System Information</li> <li>• Memory Information</li> <li>• Processor Information</li> <li>• Device Information</li> </ul>
<b>Battery Information</b>	<p>Displays the charge status of the battery.</p>
<b>Boot Sequence</b>	<p>Allows you to change the order in which the computer attempts to find an operating system. All the below options are selected.</p> <ul style="list-style-type: none"> <li>• Diskette Drive</li> <li>• Internal HDD</li> </ul>

Option	Description
	<ul style="list-style-type: none"> <li>• USB Storage Device</li> <li>• CD/DVD/CD-RW Drive</li> <li>• Onboard NIC</li> </ul> <p>You can also choose the Boot List option. The options are:</p> <ul style="list-style-type: none"> <li>• <b>Legacy</b> (Default Setting)</li> <li>• UEFI</li> </ul>
<b>Advanced Boot Options</b>	Allows you to enable the Legacy Option ROMs during the UEFI boot mode.
<b>Date/Time</b>	Allows you to set the date and time.

Table 2. System Configuration





Option	Description
<b>Integrated NIC</b>	<p>Allows you to configure the integrated network controller. The options are:</p> <ul style="list-style-type: none"> <li>• Disabled</li> <li>• Enabled</li> <li>• <b>Enabled w/PXE</b> (Default Setting)</li> </ul>
<b>SATA Operation</b>	<p>Allows you to configure the internal SATA hard-drive controller. The options are:</p> <ul style="list-style-type: none"> <li>• Disabled</li> <li>• ATA</li> <li>• AHCI</li> <li>• <b>RAID On</b> (Default Setting)</li> </ul> <p> <b>NOTE:</b> SATA is configured to support RAID mode.</p>
<b>Drives</b>	<p>Allows you to configure the SATA drives on board. The options are:</p> <ul style="list-style-type: none"> <li>• SATA-0</li> <li>• SATA-1</li> </ul> <p>Default Setting: All drives are enabled.</p>
<b>SMART Reporting</b>	<p>This field controls if the hard drive errors for the integrated drives are reported during system startup. This technology is part of the SMART (Self Monitoring Analysis and Reporting Technology) specification.</p> <ul style="list-style-type: none"> <li>• <b>Enable SMART Reporting</b> - This option is disabled by default.</li> </ul>
<b>USB Configuration</b>	Allows you to define the USB configuration. The options are:

Option	Description
	<ul style="list-style-type: none"> <li>• Enable Boot Support</li> <li>• Enable External USB Port</li> </ul> <p>Default Setting: both the options are enabled.</p>
<b>USB PowerShare</b>	<p>Allows you to configure the behavior of the USB PowerShare feature. The option is disabled by default.</p> <ul style="list-style-type: none"> <li>• Enable USB PowerShare</li> </ul>
<b>Miscellaneous Devices</b>	<p>Allows you enable or disable the various on board devices. The options are:</p> <ul style="list-style-type: none"> <li>• Enable Microphone</li> <li>• Enable Hard Drive Free Fall Protection</li> <li>• Enable Camera</li> <li>• Enable Media Card</li> <li>• Disable Media Card</li> </ul> <p>Default Setting: All devices are enabled</p>

**Table 3. Video**

Option	Description
<b>LCD Brightness</b>	Allows you to set the panel brightness when the ambient sensor is Off.

**Table 4. Security**

Option	Description
<b>Admin Password</b>	<p>Allows you to set, change, or delete the administrator (admin) password.</p> <p> <b>NOTE:</b> You must set the admin password first if an admin password is used with a system password and/or Hard Drive password</p> <p> <b>NOTE:</b> Successful password changes take effect immediately.</p> <p> <b>NOTE:</b> Deleting the admin password automatically deletes the system password and the hard drive password.</p> <p> <b>NOTE:</b> Successful password changes take effect immediately.</p> <p>Default Setting: <b>Not set</b></p>
<b>System Password</b>	<p>Allows you to set, change or delete the system password.</p> <p> <b>NOTE:</b> Successful password changes take effect immediately.</p> <p>Default Setting: <b>Not set</b></p>
<b>Internal HDD-0 Password</b>	<p>Allows you to set, change, or delete the administrator (admin) password.</p> <p>Default Setting: <b>Not set</b></p>
<b>Strong Password</b>	<p>Allows you to enforce the option to always set strong passwords.</p> <p>Default Setting: <b>Enable Strong Password</b> is not selected.</p>
<b>Password Configuration</b>	<p>You can define the length of your password. Min = 4 , Max = 32</p>

Option	Description
<b>Password Bypass</b>	<p>Allows you to enable or disable the permission to bypass the System and the Internal HDD password, when they are set. The options are:</p> <ul style="list-style-type: none"> <li>• <b>Disabled</b> (Default Setting)</li> <li>• Reboot bypass</li> </ul>
<b>Password Change</b>	<p>Allows you to enable the disable permission to the System and Hard Drive passwords when the admin password is set.</p> <p>Default Setting: <b>Allow Non-Admin Password Changes</b> is not selected</p>
<b>Non-Admin Setup Changes</b>	<p>Allows you to determine whether changes to setup option are permitted when an administrator password is set. The option is disabled.</p> <ul style="list-style-type: none"> <li>• Allows Wireless Switch Changes</li> </ul>
<b>TPM Security</b>	<p>Allows you to enable the Trusted Platform Module (TPM) during POST. The options are:</p> <ul style="list-style-type: none"> <li>• TPM Security</li> <li>• TPM ACPI Support</li> <li>• TPM PPI Deprovision Override</li> <li>• Clear</li> <li>• TPM PPI Provision Override</li> <li>• Deactivate (Default setting)</li> <li>• Activate</li> </ul> <p>Default Setting: <b>Enable TPM Security, TPM ACPI Support, TPM PPI Provision Override.</b></p>
<b>Computrace</b>	<p>Allows you to activate or disable the optional Computrace software The options are:</p> <ul style="list-style-type: none"> <li>• <b>Deactivate</b> (Default Setting)</li> <li>• Disable</li> <li>• Activate</li> </ul> <p> <b>NOTE:</b> The Activate and Disable options will permanently activate or disable the feature and no further changes will be allowed</p>
<b>CPU XD Support</b>	<p>Allows you to enable the Execute Disable mode of the processor.</p> <p>Default Setting: <b>Enable CPU XD Support</b></p>
<b>OROM Keyboard Access</b>	<p>Allows you to set access to enter the Option ROM Configuration screens using hotkeys during boot process. The options are:</p> <ul style="list-style-type: none"> <li>• <b>Enable</b> (Default Setting)</li> <li>• One Time Enable</li> <li>• Disable</li> </ul>
<b>Admin Setup Lockout</b>	<p>Allows you to prevent users from entering Setup when an Administrator password is set.</p> <p>Default Setting: <b>Disabled</b></p>

**Table 5. Secure Boot**

Option	Description
Secure Boot Enable	<p>Allows you to enable or disable the secure boot. The options are:</p> <ul style="list-style-type: none"><li>• <b>Disabled</b> (Default Setting)</li><li>• Enabled</li></ul>
Expert Key Management	<p>Allows you to manipulate the security key databases only if the system is in Custom Mode. The <b>Enable Custom Mode</b> option is disabled by default. The options are:</p> <ul style="list-style-type: none"><li>• PK</li><li>• KEK</li><li>• db</li><li>• dbx</li></ul> <p>If you enable the <b>Custom Mode</b>, the relevant options for <b>PK, KEK, db, and dbx</b> appear. The options are:</p> <ul style="list-style-type: none"><li>• <b>Save to File</b>- Saves the key to a user-selected file</li><li>• <b>Replace from File</b>- Replaces the current key with a key from a user-selected file</li><li>• <b>Append from File</b>- Adds a key to the current database from a user-selected file</li><li>• <b>Delete</b>- Deletes the selected key</li><li>• <b>Reset All Keys</b>- Resets to default setting</li><li>• <b>Delete All Keys</b>- Deletes all the keys</li></ul> <p> <b>NOTE:</b> If you disable the Custom Mode, all the changes made will be erased and the keys will restore to default settings.</p>

**Table 6. Performance**

<b>Option</b>	<b>Description</b>
<b>Multi Core Support</b>	<p>This field specifies whether the process will have one or all cores enabled. The performance of some applications will improve with the additional cores. This option is enabled by default. Allows you to enable or disable multi-core support for the processor. The options are:</p> <ul style="list-style-type: none"> <li>• <b>All</b> (Default Setting)</li> <li>• 1</li> <li>• 2</li> </ul>
<b>Intel SpeedStep</b>	<p>Allows you to enable or disable the Intel SpeedStep feature. Default Setting: <b>Enable Intel SpeedStep</b></p>
<b>C States Control</b>	<p>Allows you to enable or disable the additional processor sleep states. Default Setting: <b>Enable C states.</b></p>
<b>Hyper-Thread Control</b>	<p>Allows you to enable or disable the HyperThreading in the processor. Default Setting: <b>Enabled</b></p>

**Table 7. Power Management**

<b>Option</b>	<b>Description</b>
<b>AC Behavior</b>	<p>Allows the computer to power-on automatically, when AC adapter is plugged. The option is disabled.</p> <ul style="list-style-type: none"> <li>• Wake on AC</li> </ul>
<b>Auto On Time</b>	<p>Allows you to set the time at which the computer must turn on automatically. The options are:</p> <ul style="list-style-type: none"> <li>• <b>Disabled</b> (Default Setting)</li> <li>• Every Day</li> <li>• Weekdays</li> <li>• Select Days</li> </ul>
<b>USB Wake Support</b>	<p>Allows you to enable the USB devices to wake the computer from standby mode. The option is disabled</p> <ul style="list-style-type: none"> <li>• Enable USB Wake Support</li> </ul>
<b>Wireless Radio Control</b>	<p>Allows you to control the WLAN and WWAN radio. The options are:</p> <ul style="list-style-type: none"> <li>• Control WLAN radio</li> <li>• Control WWAN radio</li> </ul> <p>Default Setting: both the options are disabled.</p>



Option	Description
<b>Wake on LAN/WLAN</b>	<p>This option allows the computer to power up from the off state when triggered by a special LAN signal. Wake-up from the Standby state is unaffected by this setting and must be enabled in the operating system. This feature only works when the computer is connected to AC power supply.</p> <ul style="list-style-type: none"> <li>• <b>Disabled</b> - Does not allow the system to power on by special LAN signals when it receives a wake-up signal from the LAN or wireless LAN. (Default Setting)</li> <li>• LAN Only - Allows the system to be powered on by special LAN signals.</li> <li>• WLAN Only</li> <li>• LAN or WLAN</li> </ul>
<b>Block Sleep</b>	<p>Allows you to block the computer from entering into the sleep state. Option is disabled by default.</p> <ul style="list-style-type: none"> <li>• Block Sleep (S3)</li> </ul>

**Table 8. POST Behavior**

Option	Description
<b>Adapter Warnings</b>	<p>Allows you to activate the adapter warning messages when certain power adapters are used. The option is enabled by default.</p> <ul style="list-style-type: none"> <li>• Enable Adapter Warnings</li> </ul>
<b>Mouse/Touchpad</b>	<p>Allows you to define how the computer handles the mouse and touchpad input. The options are:</p> <ul style="list-style-type: none"> <li>• Serial Mouse</li> <li>• PS2 Mouse</li> <li>• <b>Touchpad/PS-2 Mouse</b> (Default Setting)</li> </ul>
<b>Fn Key Emulation</b>	<p>Allows you to match the &lt;Scroll Lock&gt; key feature of PS-2 keyboard with the &lt;Fn&gt; key feature in an internal keyboard. The option is enabled by default.</p> <ul style="list-style-type: none"> <li>• Enable Fn Key Emulation</li> </ul>
<b>Fastboot</b>	<p>Allows you to speed up the boot processes. The options are:</p> <ul style="list-style-type: none"> <li>• Minimal</li> <li>• <b>Thorough</b> (Default Setting)</li> <li>• Auto</li> </ul>

**Table 9. Virtualization Support**

Option	Description
<b>Virtualization</b>	<p>This option specifies whether a Virtual Machine Monitor (VMM) can utilize the additional hardware capabilities provided by Intel Virtualization technology.</p> <ul style="list-style-type: none"> <li>• <b>Enable Intel Virtualization Technology</b> - Default Setting.</li> </ul>

**Table 10. Wireless**

Option	Description
<b>Wireless Switch</b>	<p>Allows you to determine which wireless device can be controlled by the wireless switch. The options are:</p> <ul style="list-style-type: none"> <li>• WWAN</li> <li>• WLAN</li> </ul> <p>All options are enabled by default.</p> <p> <b>NOTE:</b> For Windows 8 Operating System, the <b>Wireless Switch</b> option is directly controlled by the OS driver. So, this setting here does not affect the <b>Wireless Switch Behavior</b>.</p>
<b>Wireless Device Enable</b>	<p>Allows you to enable or disable the internal wireless devices. The options are:</p> <ul style="list-style-type: none"> <li>• WWAN</li> <li>• WLAN</li> </ul> <p>All options are enabled by default.</p>

**Table 11. Maintenance**

Option	Description
<b>Service Tag</b>	Displays the service tag of your computer.
<b>Asset Tag</b>	Allows you to create a system asset tag if an asset tag is not already set. This option is not set by default.

**Table 12. System Logs**

Option	Description
<b>BIOS Events</b>	<p>Displays the BIOS event log and allows you to clear the log.</p> <ul style="list-style-type: none"> <li>• Clear Log</li> </ul>
<b>Thermal Events</b>	<p>Displays the Thermal event log and allows you to clear the log.</p> <ul style="list-style-type: none"> <li>• Clear Log</li> </ul>
<b>Power Events</b>	<p>Displays the Power event log and allows you to clear the log.</p> <ul style="list-style-type: none"> <li>• Clear Log</li> </ul>

## System Setup

System Setup enables you to manage your computer hardware and specify BIOS-level options. From the System Setup, you can:



- Change the NVRAM settings after you add or remove hardware
- View the system hardware configuration
- Enable or disable integrated devices
- Set performance and power management thresholds
- Manage your computer security

## Boot Sequence

Boot Sequence allows you to bypass the System Setup-defined boot device order and boot directly to a specific device (for example: optical drive or hard drive). During the Power-on Self Test (POST), when the Dell logo appears, you can:

- Access System Setup by pressing <F2> key
- Bring up the one-time boot menu by pressing <F12> key

The one-time boot menu displays the devices that you can boot from including the diagnostic option. The boot-menu options are:

- Removable Drive (if available)
- STXXXX Drive
  -  **NOTE:** XXX denotes the SATA drive number.
- Optical Drive
- Diagnostics
  -  **NOTE:** Choosing Diagnostics, will display the **ePSA diagnostics** screen.

The boot sequence screen also displays the option to access the System Setup screen.

## Navigation Keys

The following table displays the system setup navigation keys.

 **NOTE:** For most of the system setup options, changes that you make are recorded but do not take effect until you restart the system.

**Table 13. Navigation Keys**

Keys	Navigation
Up arrow	Moves to the previous field.
Down arrow	Moves to the next field.

Keys	Navigation
<Enter>	Allows you to select a value in the selected field (if applicable) or follow the link in the field.
Spacebar	Expands or collapses a drop-down list, if applicable.
<Tab>	Moves to the next focus area.
	 <b>NOTE:</b> For the standard graphics browser only.
<Esc>	Moves to the previous page till you view the main screen. Pressing <Esc> in the main screen displays a message that prompts you to save any unsaved changes and restarts the system.
<F1>	Displays the System Setup help file.

## System Setup Options

 **NOTE:** Depending on your computer and its installed devices, the items listed in this section may or may not appear.

**Table 14. General**

Option	Description
<b>System Information</b>	<p>This section lists the primary hardware features of your computer.</p> <ul style="list-style-type: none"> <li>• System Information</li> <li>• Memory Information</li> <li>• Processor Information</li> <li>• Device Information</li> </ul>
<b>Battery Information</b>	<p>Displays the charge status of the battery.</p>
<b>Boot Sequence</b>	<p>Allows you to change the order in which the computer attempts to find an operating system. All the below options are selected.</p> <ul style="list-style-type: none"> <li>• Diskette Drive</li> <li>• Internal HDD</li> <li>• USB Storage Device</li> <li>• CD/DVD/CD-RW Drive</li> <li>• Onboard NIC</li> </ul> <p>You can also choose the Boot List option. The options are:</p> <ul style="list-style-type: none"> <li>• <b>Legacy</b> (Default Setting)</li> <li>• UEFI</li> </ul>
<b>Advanced Boot Options</b>	<p>Allows you to enable the Legacy Option ROMs during the UEFI boot mode.</p>
<b>Date/Time</b>	<p>Allows you to set the date and time.</p>

**Table 15. System Configuration**





Option	Description
<b>Integrated NIC</b>	Allows you to configure the integrated network controller. The options are: <ul style="list-style-type: none"><li>• Disabled</li><li>• Enabled</li><li>• <b>Enabled w/PXE</b> (Default Setting)</li></ul>
<b>SATA Operation</b>	Allows you to configure the internal SATA hard-drive controller. The options are: <ul style="list-style-type: none"><li>• Disabled</li><li>• ATA</li><li>• AHCI</li><li>• <b>RAID On</b> (Default Setting)</li></ul> <p> <b>NOTE:</b> SATA is configured to support RAID mode.</p>
<b>Drives</b>	Allows you to configure the SATA drives on board. The options are: <ul style="list-style-type: none"><li>• SATA-0</li><li>• SATA-1</li></ul>
<b>SMART Reporting</b>	Default Setting: All drives are enabled. This field controls if the hard drive errors for the integrated drives are reported during system startup. This technology is part of the SMART (Self Monitoring Analysis and Reporting Technology) specification. <ul style="list-style-type: none"><li>• <b>Enable SMART Reporting</b> - This option is disabled by default.</li></ul>
<b>USB Configuration</b>	Allows you to define the USB configuration. The options are: <ul style="list-style-type: none"><li>• Enable Boot Support</li><li>• Enable External USB Port</li></ul>
<b>USB PowerShare</b>	Default Setting: both the options are enabled. Allows you to configure the behavior of the USB PowerShare feature. The option is disabled by default. <ul style="list-style-type: none"><li>• Enable USB PowerShare</li></ul>
<b>Miscellaneous Devices</b>	Allows you enable or disable the various on board devices. The options are: <ul style="list-style-type: none"><li>• Enable Microphone</li><li>• Enable Hard Drive Free Fall Protection</li><li>• Enable Camera</li></ul>

Option	Description
	<ul style="list-style-type: none"> <li>• Enable Media Card</li> <li>• Disable Media Card</li> </ul> <p>Default Setting: All devices are enabled</p>

Table 16. Video

Option	Description
LCD Brightness	Allows you to set the panel brightness when the ambient sensor is Off.

Table 17. Security

Option	Description
<b>Admin Password</b>	<p>Allows you to set, change, or delete the administrator (admin) password.</p> <p> <b>NOTE:</b> You must set the admin password first if an admin password is used with a system password and/or Hard Drive password</p> <p> <b>NOTE:</b> Successful password changes take effect immediately.</p> <p> <b>NOTE:</b> Deleting the admin password automatically deletes the system password and the hard drive password.</p> <p> <b>NOTE:</b> Successful password changes take effect immediately.</p> <p>Default Setting: <b>Not set</b></p>
<b>System Password</b>	<p>Allows you to set, change or delete the system password.</p> <p> <b>NOTE:</b> Successful password changes take effect immediately.</p> <p>Default Setting: <b>Not set</b></p>
<b>Internal HDD-0 Password</b>	<p>Allows you to set, change, or delete the administrator (admin) password.</p> <p>Default Setting: <b>Not set</b></p>
<b>Strong Password</b>	<p>Allows you to enforce the option to always set strong passwords.</p> <p>Default Setting: <b>Enable Strong Password</b> is not selected.</p>
<b>Password Configuration</b>	You can define the length of your password. Min = 4 , Max = 32
<b>Password Bypass</b>	<p>Allows you to enable or disable the permission to bypass the System and the Internal HDD password, when they are set. The options are:</p> <ul style="list-style-type: none"> <li>• <b>Disabled</b> (Default Setting)</li> <li>• Reboot bypass</li> </ul>
<b>Password Change</b>	<p>Allows you to enable the disable permission to the System and Hard Drive passwords when the admin password is set.</p> <p>Default Setting: <b>Allow Non-Admin Password Changes</b> is not selected</p>
<b>Non-Admin Setup Changes</b>	<p>Allows you to determine whether changes to setup option are permitted when an administrator password is set. The option is disabled.</p> <ul style="list-style-type: none"> <li>• Allows Wireless Switch Changes</li> </ul>
<b>TPM Security</b>	<p>Allows you to enable the Trusted Platform Module (TPM) during POST. The options are:</p>

Option	Description
	<ul style="list-style-type: none"> <li>• TPM Security</li> <li>• TPM ACPI Support</li> <li>• TPM PPI Deprovision Override</li> <li>• Clear</li> <li>• TPM PPI Provision Override</li> <li>• Deactivate (Default setting)</li> <li>• Activate</li> </ul> <p>Default Setting: <b>Enable TPM Security, TPM ACPI Support, TPM PPI Provision Override.</b></p>
<b>Computrace</b>	<p>Allows you to activate or disable the optional Computrace software. The options are:</p> <ul style="list-style-type: none"> <li>• <b>Deactivate</b> (Default Setting)</li> <li>• Disable</li> <li>• Activate</li> </ul> <p> <b>NOTE:</b> The Activate and Disable options will permanently activate or disable the feature and no further changes will be allowed</p>
<b>CPU XD Support</b>	<p>Allows you to enable the Execute Disable mode of the processor.</p> <p>Default Setting: <b>Enable CPU XD Support</b></p>
<b>OROM Keyboard Access</b>	<p>Allows you to set access to enter the Option ROM Configuration screens using hotkeys during boot process. The options are:</p> <ul style="list-style-type: none"> <li>• <b>Enable</b> (Default Setting)</li> <li>• One Time Enable</li> <li>• Disable</li> </ul>
<b>Admin Setup Lockout</b>	<p>Allows you to prevent users from entering Setup when an Administrator password is set.</p> <p>Default Setting: <b>Disabled</b></p>

**Table 18. Secure Boot**

Option	Description
Secure Boot Enable	<p>Allows you to enable or disable the secure boot. The options are:</p> <ul style="list-style-type: none"> <li>• <b>Disabled</b> (Default Setting)</li> <li>• Enabled</li> </ul>
Expert Key Management	<p>Allows you to manipulate the security key databases only if the system is in Custom Mode. The <b>Enable Custom Mode</b> option is disabled by default. The options are:</p> <ul style="list-style-type: none"> <li>• PK</li> <li>• KEK</li> <li>• db</li> <li>• dbx</li> </ul>

Option	Description
	<p>If you enable the <b>Custom Mode</b>, the relevant options for <b>PK, KEK, db, and dbx</b> appear. The options are:</p> <ul style="list-style-type: none"> <li>• <b>Save to File</b>- Saves the key to a user-selected file</li> <li>• <b>Replace from File</b>- Replaces the current key with a key from a user-selected file</li> <li>• <b>Append from File</b>- Adds a key to the current database from a user-selected file</li> <li>• <b>Delete</b>- Deletes the selected key</li> <li>• <b>Reset All Keys</b>- Resets to default setting</li> <li>• <b>Delete All Keys</b>- Deletes all the keys</li> </ul> <p> <b>NOTE:</b> If you disable the Custom Mode, all the changes made will be erased and the keys will restore to default settings.</p>

Table 19. Performance

Option	Description
<b>Multi Core Support</b>	<p>This field specifies whether the process will have one or all cores enabled. The performance of some applications will improve with the additional cores. This option is enabled by default. Allows you to enable or disable multi-core support for the processor. The options are:</p> <ul style="list-style-type: none"> <li>• <b>All</b> (Default Setting)</li> <li>• 1</li> <li>• 2</li> </ul>
<b>Intel SpeedStep</b>	<p>Allows you to enable or disable the Intel SpeedStep feature. Default Setting: <b>Enable Intel SpeedStep</b></p>
<b>C States Control</b>	<p>Allows you to enable or disable the additional processor sleep states. Default Setting: <b>Enable C states.</b></p>
<b>Hyper-Thread Control</b>	<p>Allows you to enable or disable the HyperThreading in the processor. Default Setting: <b>Enabled</b></p>

Table 20. Power Management

Option	Description
<b>AC Behavior</b>	<p>Allows the computer to power-on automatically, when AC adapter is plugged. The option is disabled.</p>



Option	Description
	<ul style="list-style-type: none"> <li>Wake on AC</li> </ul>
<b>Auto On Time</b>	<p>Allows you to set the time at which the computer must turn on automatically. The options are:</p> <ul style="list-style-type: none"> <li><b>Disabled</b> (Default Setting)</li> <li>Every Day</li> <li>Weekdays</li> <li>Select Days</li> </ul>
<b>USB Wake Support</b>	<p>Allows you to enable the USB devices to wake the computer from standby mode. The option is disabled</p> <ul style="list-style-type: none"> <li>Enable USB Wake Support</li> </ul>
<b>Wireless Radio Control</b>	<p>Allows you to control the WLAN and WWAN radio. The options are:</p> <ul style="list-style-type: none"> <li>Control WLAN radio</li> <li>Control WWAN radio</li> </ul> <p>Default Setting: both the options are disabled.</p>
<b>Wake on LAN/WLAN</b>	<p>This option allows the computer to power up from the off state when triggered by a special LAN signal. Wake-up from the Standby state is unaffected by this setting and must be enabled in the operating system. This feature only works when the computer is connected to AC power supply.</p> <ul style="list-style-type: none"> <li><b>Disabled</b> - Does not allow the system to power on by special LAN signals when it receives a wake-up signal from the LAN or wireless LAN. (Default Setting)</li> <li>LAN Only - Allows the system to be powered on by special LAN signals.</li> <li>WLAN Only</li> <li>LAN or WLAN</li> </ul>
<b>Block Sleep</b>	<p>Allows you to block the computer from entering into the sleep state. Option is disabled by default.</p> <ul style="list-style-type: none"> <li>Block Sleep (S3)</li> </ul>

**Table 21. POST Behavior**

Option	Description
<b>Adapter Warnings</b>	<p>Allows you to activate the adapter warning messages when certain power adapters are used. The option is enabled by default.</p> <ul style="list-style-type: none"> <li>Enable Adapter Warnings</li> </ul>
<b>Mouse/Touchpad</b>	<p>Allows you to define how the computer handles the mouse and touchpad input. The options are:</p> <ul style="list-style-type: none"> <li>Serial Mouse</li> <li>PS2 Mouse</li> <li><b>Touchpad/PS-2 Mouse</b> (Default Setting)</li> </ul>

Option	Description
<b>Fn Key Emulation</b>	Allows you to match the <Scroll Lock> key feature of PS-2 keyboard with the <Fn> key feature in an internal keyboard. The option is enabled by default. <ul style="list-style-type: none"> <li>• Enable Fn Key Emulation</li> </ul>
<b>Fastboot</b>	Allows you to speed up the boot processes. The options are: <ul style="list-style-type: none"> <li>• Minimal</li> <li>• <b>Thorough</b> (Default Setting)</li> <li>• Auto</li> </ul>

**Table 22. Virtualization Support**

Option	Description
<b>Virtualization</b>	This option specifies whether a Virtual Machine Monitor (VMM) can utilize the additional hardware capabilities provided by Intel Virtualization technology. <ul style="list-style-type: none"> <li>• <b>Enable Intel Virtualization Technology</b> - Default Setting.</li> </ul>

**Table 23. Wireless**

Option	Description
<b>Wireless Switch</b>	Allows you to determine which wireless device can be controlled by the wireless switch. The options are: <ul style="list-style-type: none"> <li>• WWAN</li> <li>• WLAN</li> </ul> <p>All options are enabled by default.</p> <p> <b>NOTE:</b> For Windows 8 Operating System, the <b>Wireless Switch</b> option is directly controlled by the OS driver. So, this setting here does not affect the <b>Wireless Switch Behavior</b>.</p>
<b>Wireless Device Enable</b>	Allows you to enable or disable the internal wireless devices. The options are: <ul style="list-style-type: none"> <li>• WWAN</li> <li>• WLAN</li> </ul> <p>All options are enabled by default.</p>

**Table 24. Maintenance**

Option	Description
<b>Service Tag</b>	Displays the service tag of your computer.
<b>Asset Tag</b>	Allows you to create a system asset tag if an asset tag is not already set. This option is not set by default.



**Table 25. System Logs**

Option	Description
<b>BIOS Events</b>	Displays the BIOS event log and allows you to clear the log.

Option	Description
	<ul style="list-style-type: none"> <li>• Clear Log</li> </ul>
<b>Thermal Events</b>	Displays the Thermal event log and allows you to clear the log. <ul style="list-style-type: none"> <li>• Clear Log</li> </ul>
<b>Power Events</b>	Displays the Power event log and allows you to clear the log. <ul style="list-style-type: none"> <li>• Clear Log</li> </ul>

## Updating the BIOS

It is recommended to update your BIOS (system setup), on replacing the system board or if an update is available. For notebooks, ensure that your computer battery is fully charged and connected to a power outlet

1. Restart the computer.
2. Go to [support.dell.com/support/downloads](http://support.dell.com/support/downloads).
3. If you have your computer's Service Tag or Express Service Code:
  -  **NOTE:** For desktops, the service tag label is available on the front of your computer.
  -  **NOTE:** For notebooks, the service tag label is available on the bottom of your computer.
  -  **NOTE:** For All-In-One Desktops, the service tag label is available at the back of your computer.
  - a) Enter the **Service Tag** or **Express Service Code** and click **Submit**.
  - b) Click **Submit** and proceed to step 5.
4. If you do not have your computer's service tag or express service code, select one of the following:
  - a) **Automatically detect my Service Tag for me**
  - b) **Choose from My Products and Services List**
  - c) **Choose from a list of all Dell products**
5. On the application and drivers screen, under the **Operating System** drop-down list, select **BIOS**.
6. Identify the latest BIOS file and click **Download File**.
7. Select your preferred download method in the **Please select your download method below window**; click **Download Now**.  
The **File Download** window appears.
8. Click **Save** to save the file on your computer.
9. Click **Run** to install the updated BIOS settings on your computer.  
Follow the instructions on the screen.

## System and Setup Password

You can create a system password and a setup password to secure your computer.

Password Type	Description
<b>System password</b>	Password that you must enter to log on to your system.
<b>Setup password</b>	Password that you must enter to access and make changes to the BIOS settings of your computer.

 **CAUTION:** The password features provide a basic level of security for the data on your computer.

 **CAUTION:** Anyone can access the data stored on your computer if it is not locked and left unattended.

 **NOTE:** Your computer is shipped with the system and setup password feature disabled.

## Assigning a System Password and Setup Password

You can assign a new **System Password** and/or **Setup Password** or change an existing **System Password** and/or **Setup Password** only when **Password Status** is **Unlocked**. If the Password Status is **Locked**, you cannot change the System Password.

 **NOTE:** If the password jumper is disabled, the existing System Password and Setup Password is deleted and you need not provide the system password to log on to the computer.

To enter a system setup, press <F2> immediately after a power-on or reboot.

1. In the **System BIOS** or **System Setup** screen, select **System Security** and press <Enter>. The **System Security** screen appears.
2. In the **System Security** screen, verify that **Password Status** is **Unlocked**.
3. Select **System Password**, enter your system password, and press <Enter> or <Tab>. Use the following guidelines to assign the system password:
  - A password can have up to 32 characters.
  - The password can contain the numbers 0 through 9.
  - Only lower case letters are valid, upper case letters are not allowed.
  - Only the following special characters are allowed: space, ("), (+), (,), (-), (.), (/), (:), (|), (\), (|), (^), (&).

Re-enter the system password when prompted.

4. Type the system password that you entered earlier and click **OK**.
5. Select **Setup Password**, type your system password and press <Enter> or <Tab>. A message prompts you to re-type the setup password.
6. Type the setup password that you entered earlier and click **OK**.
7. Press <Esc> and a message prompts you to save the changes.
8. Press <Y> to save the changes. The computer reboots.

## Deleting or Changing an Existing System and/or Setup Password

Ensure that the **Password Status** is **Unlocked** (in the System Setup) before attempting to delete or change the existing System and/or Setup password. You cannot delete or change an existing System or Setup password, if the **Password Status** is **Locked**.

To enter the System Setup, press <F2> immediately after a power-on or reboot.

1. In the **System BIOS** or **System Setup** screen, select **System Security** and press <Enter>. The **System Security** screen is displayed.
2. In the **System Security** screen, verify that **Password Status** is **Unlocked**.
3. Select **System Password**, alter or delete the existing system password and press <Enter> or <Tab>.
4. Select **Setup Password**, alter or delete the existing setup password and press <Enter> or <Tab>.

 **NOTE:** If you change the System and/or Setup password, re-enter the new password when promoted. If you delete the System and/or Setup password, confirm the deletion when promoted.

5. Press <Esc> and a message prompts you to save the changes.
6. Press <Y> to save the changes and exit from the System Setup.  
The computer reboots.



# Technical Specifications

 **NOTE:** Offerings may vary by region. The following specifications are only those required by law to ship with your computer. For more information regarding the configuration of your computer, click **Start** → **Help and Support** and select the option to view information about your computer.

<b>System Information</b>	
Chipset	Intel HM77 Express Chipset
<b>Processor</b>	
Type	<ul style="list-style-type: none"> <li>• Intel IVB ULV 17 W               <ul style="list-style-type: none"> <li>– Intel Celeron</li> <li>– Intel Core i3 series</li> <li>– Intel Core i5 series</li> </ul> </li> <li>• Intel SNB ULV 17 W               <ul style="list-style-type: none"> <li>– Intel Core i3 series</li> </ul> </li> </ul>
<b>Video</b>	
Video type	Integrated on system board
Data bus	Integrated video
Video controller:	
Intel Celeron	Intel HD Graphics
Intel i3 and i5	<ul style="list-style-type: none"> <li>• Intel HD Graphics for Intel Celeron processors</li> <li>• Intel HD 3000 Graphics for 2nd Generation Intel processors</li> <li>• Intel HD 4000 Graphics for 3rd Generation Intel processors</li> </ul>
<b>Memory</b>	
Memory connector	Two SODIMM slots
Memory capacity	2 GB, 4 GB, and 8 GB
Memory type	<ul style="list-style-type: none"> <li>• 1333MHz DDR3 for 2nd Generation Intel processors</li> <li>• 1600MHz DDR3L for 3rd Generation Intel processors</li> </ul>
Minimum memory	2 GB
Maximum memory	8 GB

---

<b>Audio</b>	
Type	Two-channel high definition audio
Controller	IDT 92HD93
Stereo Conversion	24-bit (analog-to-digital and digital-to-analog)
Interface:	
Internal	High-definition audio
External	Microphone-in/stereo headphones combo connector
Speakers	Two (2 W)
Internal speaker amplifier	Two (2 W)
Volume controls	Software program menus, media controls, and keyboard function keys

---

<b>Communications</b>	
Network adapter	10/100/1000 Mbps Ethernet LAN
Wireless	Internal wireless local area network (WLAN), Bluetooth (optional), and 3G Mobile Broadband (optional)

---

<b>Ports and Connectors</b>	
Audio	Audio in / one out combo jack
Video	One VGA connector, one 19-pin HDMI connector
Network adapter	One RJ-45 connector
USB	<ul style="list-style-type: none"> <li>• Two USB-3.0 compliant connectors</li> <li>• One USB-2.0 (1) PowerShare connector</li> </ul>
Memory card reader	One Multi-Media card reader: (SD-XC, plus legacy - SD, SDIO, MMC, Mini-MMC, MMC+ (supported in MMC compatibility mode only), Hi-Density SD, Hi-capacity SD)

---

<b>Display</b>	
Type	HD WLED Anti-Glare
Size	13.30 inches
Active area (X/Y)	293.42 mm x 164.97 mm
Dimensions:	
Height	188.75 mm (7.43 inches)
Width	314.10 mm (12.36 inches)
Z-height	3.60 mm (0.14 inch)
Diagonal	337.82 mm (13.30 inches)
Maximum resolution	1366 x 768 pixels at 262 K colors
Maximum Brightness	220 nits



---

**Display**

---

Refresh rate	60 Hz
Operating Angle	0° (closed) to 135°
Minimum Viewing Angles:	
Horizontal	40/45 @ CR >= 10
Vertical	15/20 @ CR >= 10
Pixel pitch	0.2148 mm x 0.2148 mm

---

**Keyboard**

---

Number of keys	<ul style="list-style-type: none"><li>• United States and Canada: 86 keys</li><li>• Europe and Brazil: 87 keys</li><li>• Japan: 90 keys</li></ul>
----------------	---

---

**Touchpad**

---

Active Area:	
X-axis	81.00 mm (3.18 inches)
Y-axis	41.00 mm (1.61 inches)

---

**Battery**

---

Type	<ul style="list-style-type: none"><li>• 4-cell lithium ion (3.0 Ahr)</li><li>• 6-cell lithium ion (3.0 Ahr)</li></ul>
------	---

## Dimensions:

## Depth:

4-cell and 6-cell	48.79 mm (1.92 inches)
-------------------	------------------------

## Height:

4-cell	20.25 mm (0.80 inch)
6-cell	30.20 mm (1.18 inches)

## Width:

4-cell and 6-cell	269.50 mm (10.61 inches)
-------------------	--------------------------

## Weight:

4-cell	245.00 g (0.54 lb)
6-cell	370.00 g (0.81 lb)

## Voltage:

4-cell	14.80 V
6-cell	11.10 V

Approximate charge time for a 4-cell and 6-cell battery with computer off	4 hours
---	---------

---

**Battery**

---

## Temperature range:

Operating	0 °C to 35 °C (32 °F to 95 °F)
Non-operating	-40 °C to 65 °C (-40 °F to 149 °F)

Coin-cell battery 3 V CR2032 lithium ion

---

**AC Adapter**

---

Type	65 W and 90 W
Input voltage	100 VAC to 240 VAC
Input current (maximum)	1.50 A, 1.60 A, and 1.70 A
Input frequency	50 Hz to 60 Hz
Output power	65 W and 90 W
Output current	
60 W	4.43 A (maximum at 4-second pulse), 3.34 A (continuous)
90 W	4.62 A
Rated output voltage	19.50 VDC (+/- 1.0 VDC)
Dimensions:	
Height	29.00 mm (1.14 inches)
Width	46.50 mm (1.83 inches)
Depth	107.00 mm (4.21 inches)
Temperature range:	
Operating	0 °C to 40 °C (32 °F to 104 °F)
Non Operating	-40 °C to 70 °C (-40 °F to 158 °F)

---

**Physical**

---

Height (with a WLED panel)	21 mm to 32.00 mm (0.83 inch to 1.25 inches)
Width	329.30 mm (12.96 inches)
Depth	237.65 mm (9.35 inches)
Weight (Minimum)	1.55 kg (3.43 lb)

---

**Environmental**

---

## Temperature range:

Operating	0 °C to 35 °C (32 °F to 95 °F)
Storage	-40 °C to 65 °C (-40 °F to 149 °F)

## Relative humidity (maximum):

Operating	10 % to 90 % (noncondensing)
Storage	5 % to 95 % (noncondensing)

---

**Environmental**

---

## Altitude (maximum):

Operating	-15.2 m to 3048 m (-50 to 10,000 ft) 0° to 35°C
-----------	--

Non-Operating	-15.20 m to 10,668 m (-50 ft to 35,000 ft)
---------------	--

## Maximum vibration:

Operating	0.66 Grms (2 Hz - 600 Hz)
-----------	---------------------------

Storage	1.30 Grms (2 Hz - 600 Hz)
---------	---------------------------

## Maximum shock:

Operating	110 G
-----------	-------

Storage	160 G
---------	-------

## Airborne contaminant level

	G1 or lower as defined by ISA-S71.04-1985
--	---



## Contacting Dell

 **NOTE:** If you do not have an active Internet connection, you can find contact information on your purchase invoice, packing slip, bill, or Dell product catalog.

Dell provides several online and telephone-based support and service options. Availability varies by country and product, and some services may not be available in your area. To contact Dell for sales, technical support, or customer service issues:

1. Visit [dell.com/support](https://dell.com/support)
2. Select your support category.
3. Verify your country or region in the Choose a Country/Region drop-down menu at the top of page.
4. Select the appropriate service or support link based on your need.