

Dell™ Latitude™ C400 Service Manual

[Before You Begin](#)

[System Components](#)

[Keyboard](#)

[Memory Module and Modem Daughter Card](#)

[Hard Drive](#)

[Wireless Network Adapter](#)

[Display Assembly and Display Latch](#)

[Palm Rest](#)

[Cooling Fan](#)

[Reserve Battery](#)

[Flashing the BIOS](#)

[Audio Board](#)

[System Board](#)

[Battery Latch](#)

[Pin Assignments for I/O Connectors](#)

Notes, Notices, and Cautions



NOTE: A NOTE indicates important information that helps you make better use of your computer.



NOTICE: A NOTICE indicates either potential damage to hardware or loss of data and tells you how to avoid the problem.



CAUTION: A CAUTION indicates a potential for property damage, personal injury, or death.

Information in this document is subject to change without notice.

© 2001 Dell Computer Corporation. All rights reserved.

Reproduction in any manner whatsoever without the written permission of Dell Computer Corporation is strictly forbidden.

Trademarks used in this text: *Dell*, the *DELL* logo, and *Latitude* are trademarks of Dell Computer Corporation; *Intel* is a registered trademark of Intel Corporation; *Microsoft* and *Windows* are registered trademarks of Microsoft Corporation.

Other trademarks and trade names may be used in this document to refer to either the entities claiming the marks and names or their products. Dell Computer Corporation disclaims any proprietary interest in trademarks and trade names other than its own.

October 2001 Rev. A00

Before You Begin

Dell™ Latitude™ C400 Service Manual

- [Preparing to Work Inside the Computer](#)
 - [Recommended Tools](#)
 - [Screw Identification](#)
-

Preparing to Work Inside the Computer

 **NOTICE:** Only a certified service technician should perform repairs on your computer. Damage due to servicing that is not authorized by Dell is not covered by your warranty.

 **NOTICE:** To avoid damaging the computer, perform the following steps before you begin working inside the computer.

1. Make sure that the work surface is clean to prevent scratching the computer cover.
2. Save any work in progress and close all open application programs.
3. Turn off the computer and all attached devices.

 **NOTE:** Make sure the computer is turned off and not in suspend-to-disk or hibernate mode. If you cannot shut down the computer using the computer's operating system, press and hold the power button for 4 seconds.

4. Make sure the computer is undocked.
5. Disconnect the computer from the electrical outlet.
6. To avoid possible damage to the system board, wait 10 to 20 seconds and then disconnect any attached devices.
7. Disconnect all other external cables from the computer, including the IDE modular bay cable (if connected).
8. Remove any installed PC Cards or plastic blanks from the PC Card slot.
9. Close the display and turn the computer upside down on a flat work surface.

 **NOTICE:** To avoid damaging the system board, you must remove the battery before you service the computer.

10. Remove the battery from the battery bay.
 11. To dissipate any static electricity while you work, use a wrist grounding strap or periodically touch an unpainted metal surface.
 12. Handle components and cards with care. Do not touch the components or contacts on a card. Hold a card by its edges or by its metal mounting bracket. Hold internal components by their edges, not by their pins.
-

Recommended Tools

The procedures in this manual require the following tools:

- #1 magnetized Phillips screwdriver
- Small flat-blade screwdriver

- 5-mm nut driver
- 7-mm nut driver
- Needle-nose pliers
- Flash BIOS update program floppy disk or CD

Computer Orientation



1	back
2	right
3	front
4	left

Screw Identification

When you are removing and replacing components, photocopy the placemat as a tool to lay out and keep track of the screws. The placemat provides the number of screws and their sizes.

Screw Identification

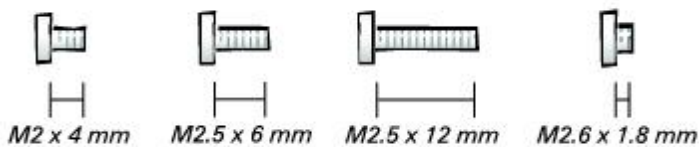

NOTICE: When reinstalling a screw, you must use a screw of the correct diameter and length. Make sure that the screw is properly aligned with its corresponding hole, and avoid overtightening.

Hard Drive Door:

(1 each)



M2.5 x 12 mm

Modem Daughter Card:

(1 each)



M2 x 4 mm

Keyboard:

(4 each)



M2 x 4 mm

Display Assembly:

(2 each)



M2.5 x 6 mm

(2 each)



M2.5 x 12 mm

Display Bezel:

(6 each)



M2 x 4 mm

Palm Rest to Bottom Case:

(6 each: 4 to each side of battery bay; 2 by service tag)

(4 each)

(2 each)



M2.5 x 6 mm



M2.6 x 1.8 mm



M2 x 4 mm

Rubber screw covers: 6 each

Critical Component Shield:

(6 each)



M2 x 4 mm

Palm Rest to System Board:

(6 each)



M2.5 x 6 mm

Cooling Fan:

(3 each)

Audio Board:

(2 each)



M2.5 x 6 mm



M2 x 4 mm

System Board:

(1 each)



M2 x 4 mm

Guide pins: 2 each
5-mm hex nuts: 4 each
7-mm hex nuts: 2 each

[Back to Contents Page](#)

System Components

Dell™ Latitude™ C400 Service Manual

➡ **NOTICE:** Only a certified service technician should perform repairs on your computer. Damage due to servicing that is not authorized by Dell is not covered by your warranty.

➡ **NOTICE:** Unless otherwise noted, each procedure in this manual assumes that a part can be replaced by performing the removal procedure in reverse order.

System Components

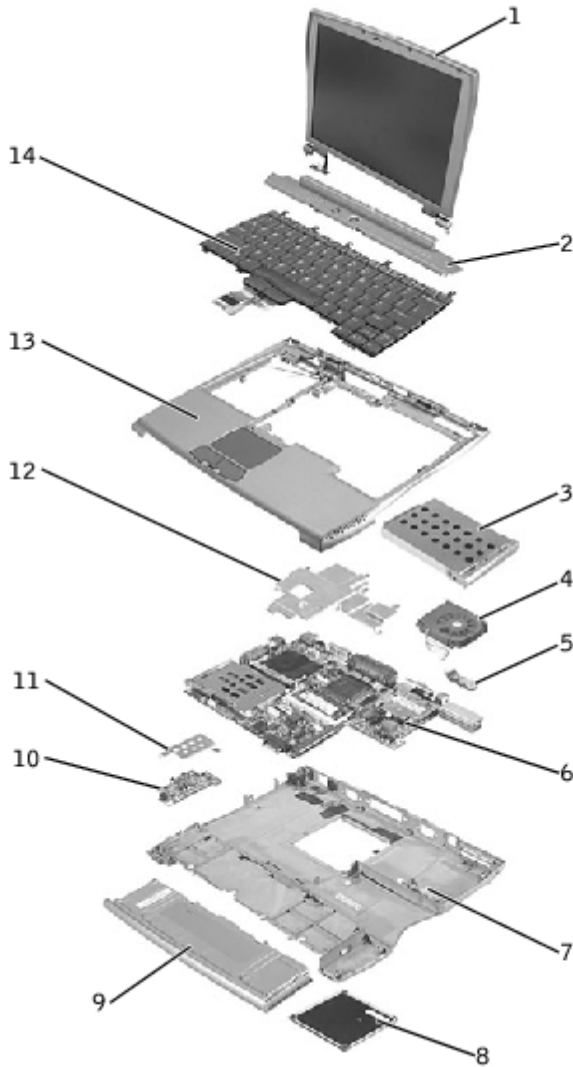

1	display	8	memory module/modem cover
2	center cover	9	battery
3	hard drive	10	audio card
4	cooling fan	11	audio card shield
5	reserve battery	12	critical component shield
6	system board	13	palm rest
7	bottom case	14	keyboard

[Back to Contents Page](#)

Keyboard

Dell™ Latitude™ C400 Service Manual

[Removing the Keyboard](#)

[Replacing the Keyboard](#)

Removing the Keyboard

- ➔ **NOTICE:** Disconnect the computer and any attached devices from electrical outlets, and remove any installed batteries.
- ➔ **NOTICE:** To avoid ESD, ground yourself by using a wrist grounding strap or by touching an unpainted metal surface on the computer.
- ➔ **NOTICE:** Read "[Preparing to Work Inside the Computer](#)" before performing the following procedure.

1. Remove the [hard drive](#).

- ➔ **NOTICE:** The key caps on the keyboard are fragile, easily dislodged, and time-consuming to replace. Be careful when removing and handling the keyboard.

2. Turn the computer right-side up and remove the center cover.

Center Cover Removal

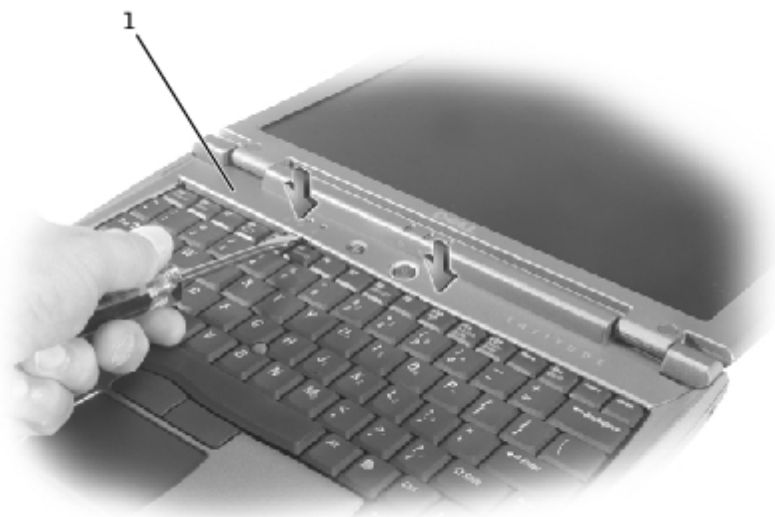

1 center cover

- a. Open the computer all the way (180 degrees) so that it lies flat against your work surface.
- b. Press and hold down the <F4> and <F5> keys to reveal the left release slot of the center cover.

 **NOTE:** To protect the keycaps, it may be helpful to place a straightedge (such as a short ruler) across the first

row or two of keycaps, and press on the straightedge instead of on the keycaps themselves.

- c. Insert a flat-blade screwdriver into the slot. While holding the screwdriver, make your hand into a fist, brace your knuckles against the keyboard, and pry up the center cover.
- d. Repeat steps b and c for the right release slot, located behind the <F9> and <F10> keys.
- e. Lift the center cover up and away from the bottom case.

3. Remove the four M2 x 4-mm screws that secure the back edge of the keyboard.

Keyboard Screws

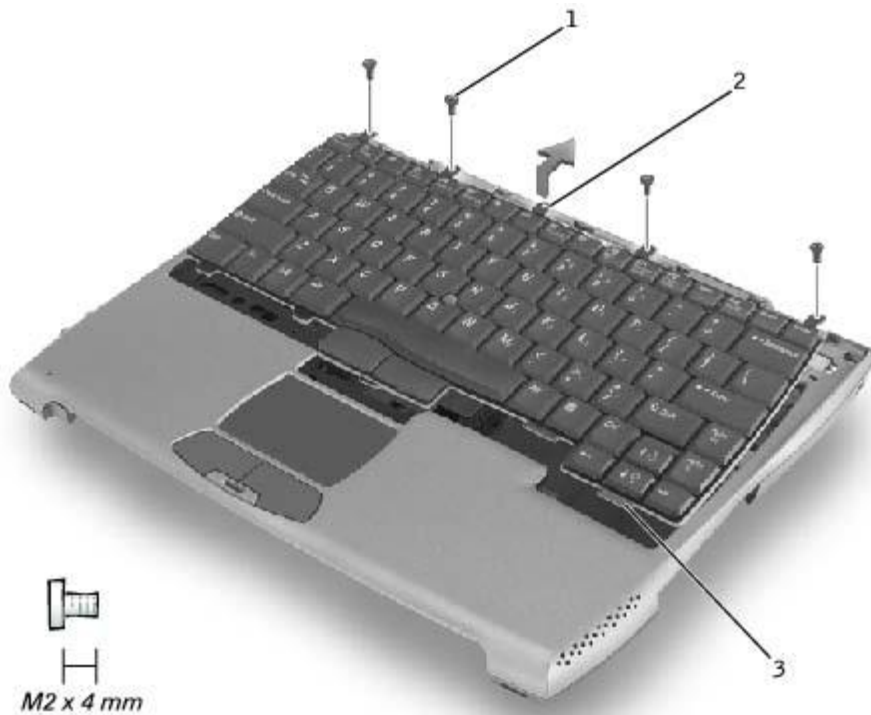

1	M2 x 4-mm screws (4)
2	keyboard locator tab
3	keyboard securing tabs (5)

4. Pry up the keyboard locator tab, lift the back edge of the keyboard slightly, and then pull the keyboard a small distance toward the back of the computer to release the five securing tabs located across the front edge of the keyboard.
5. Rotate the keyboard toward the front of the computer and place it face-down on the palm rest.

NOTICE: Do not pull on the keyboard flex cable.

Keyboard Removal

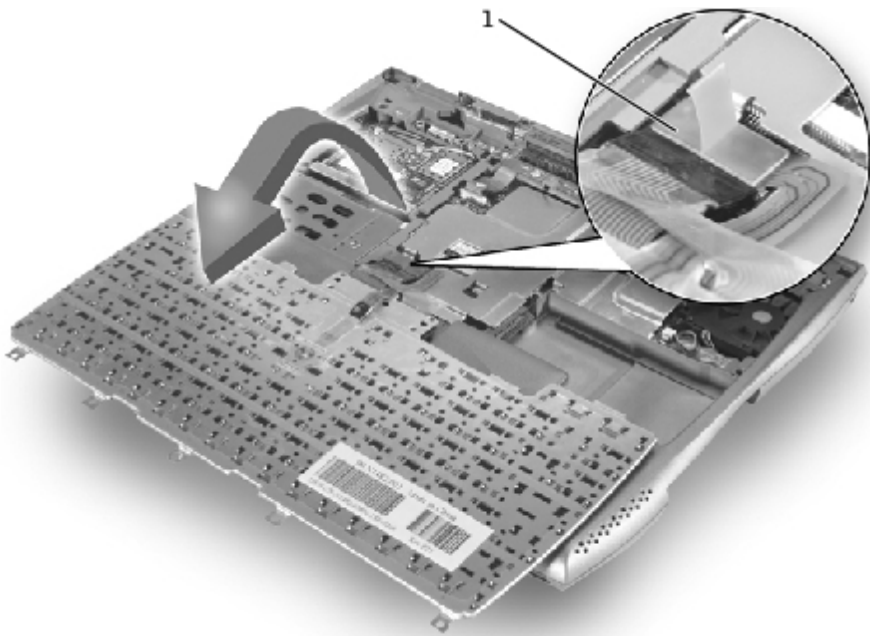

1 keyboard flex cable

6. Use the pull tab to pull the keyboard flex cable up from its connector on the system board.

The keyboard is now disconnected from the bottom case.

Replacing the Keyboard

1. Replace the [hard drive](#).
2. Place the keyboard face-down on the palm rest, with the keyboard flex cable pointing toward the back of the computer.

NOTICE: To avoid damage to the connector pins, press the keyboard flex cable connector evenly into the interface connector on the system board, and do not reverse the keyboard connector.

3. Connect the keyboard flex cable to its interface connector on the system board.

To aid with proper flex cable connection, a white locator line has been added near the end of the flex cable. Press the cable into the connector until the white line disappears and hold it steady while you snap the flex cable connector down. (The white line may reappear after the connector is closed; this should not indicate a problem with the connection.)

NOTICE: Position the keyboard flex cable so that it is not pinched when you replace the keyboard in the bottom case.

Keyboard Replacement



1	keyboard securing tabs (5)
---	----------------------------

4. Carefully rotate the keyboard back and fit it into the bottom case.

Ensure that all five securing tabs are engaged in their respective slots before trying to completely seat the keyboard. Fitting the tabs to the slots may be easiest when viewed from above and slightly behind the front edge of the keyboard. Press down on the left and right <ALT> keys to help control tab/slot alignment.

When the keyboard appears to be completely seated, confirm that the front edge of the keyboard is aligned with the edge of the palm rest before proceeding.

5. Replace the four M2 x 4-mm screws at the back of the keyboard.
6. Replace the center cover.

Memory Module and Modem Daughter Card

Dell™ Latitude™ C400 Service Manual

- [Removing the Memory Module/Modem Cover](#)
 - [Removing the Memory Modules](#)
 - [Replacing the Memory Modules](#)
 - [Removing the Modem Daughter Card](#)
 - [Replacing the Modem Daughter Card](#)
-

Removing the Memory Module/Modem Cover

 **NOTE:** This procedure covers removing and replacing the memory module located under the memory module/modem cover on the bottom of the computer. A second memory module resides on the upper surface of the system board under the critical component shield. To replace the memory module under the critical component shield, perform the procedure for [removing the palm rest](#) up to and including removal of the critical component shield. Then replace the memory module.

- ➔ **NOTICE:** Disconnect the computer and any attached devices from electrical outlets, and remove any installed batteries.
- ➔ **NOTICE:** To avoid ESD, ground yourself by using a wrist grounding strap or by touching an unpainted metal surface on the computer.
- ➔ **NOTICE:** Read "[Preparing to Work Inside the Computer](#)" before performing the following procedure.

1. Turn the computer over, and use a #1 Phillips screwdriver to release the two captive screws from the memory module/modem cover.
2. Place your finger under the cover at the indentation, rotate the cover open, and remove it.

Memory Module/Modem Cover



Removing the Memory Modules

- ➔ **NOTICE:** Disconnect the computer and any attached devices from electrical outlets, and remove the battery.
- ➔ **NOTICE:** To avoid ESD, ground yourself by using a wrist grounding strap or by touching an unpainted metal surface on the computer.
- ➔ **NOTICE:** Read "[Preparing to Work Inside the Computer](#)" before performing the following procedure.

1. Remove the [memory module/modem cover](#).

- ➔ **NOTICE:** To prevent damage to the memory module connector, do not use tools to spread the inner metal tabs that secure the memory module.

2. Use your fingertips to carefully spread apart the inner tabs on each end of the memory module socket.

The module should pop up.

Memory Module Removal

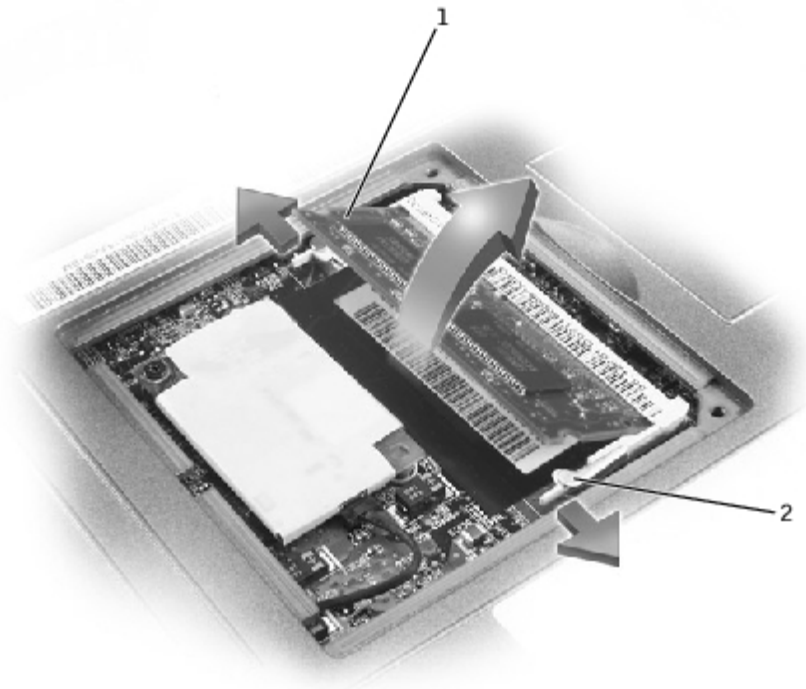

1	memory module socket
2	inner tabs (2)

3. Lift the memory module out of its socket.

Replacing the Memory Modules

- ✎ **NOTE:** Memory modules are keyed, or designed to fit into their sockets, in only one direction.

➔ **NOTICE:** The memory module must be inserted at a 45-degree angle to avoid damaging the connector.

1. Align the notch in the memory module with the slot in the center of the socket.
2. Slide the edge connector of the module firmly into the socket at a 45-degree angle, and rotate the module down until you hear a click. If you do not hear the click, remove the module and reinstall it.
3. Replace the cover and tighten the two captive screws.

Removing the Modem Daughter Card

➔ **NOTICE:** Disconnect the computer and any attached devices from electrical outlets, and remove the battery.

➔ **NOTICE:** To avoid ESD, ground yourself by using a wrist grounding strap or by touching an unpainted metal surface on the computer.

➔ **NOTICE:** Read "[Preparing to Work Inside the Computer](#)" before performing the following procedure.

1. Turn the computer over, and remove the [memory module/modem cover](#).
2. Remove the M2 x 4-mm screw that secures the modem daughter card to the system board.

➔ **NOTICE:** Do not pull on the modem cable. Pull from the modem connector to disconnect the cable.

3. Use the pull tab to pull the modem daughter card straight up out of its connector.
4. Disconnect the modem cable from the modem daughter card.

Modem Daughter Card Removal

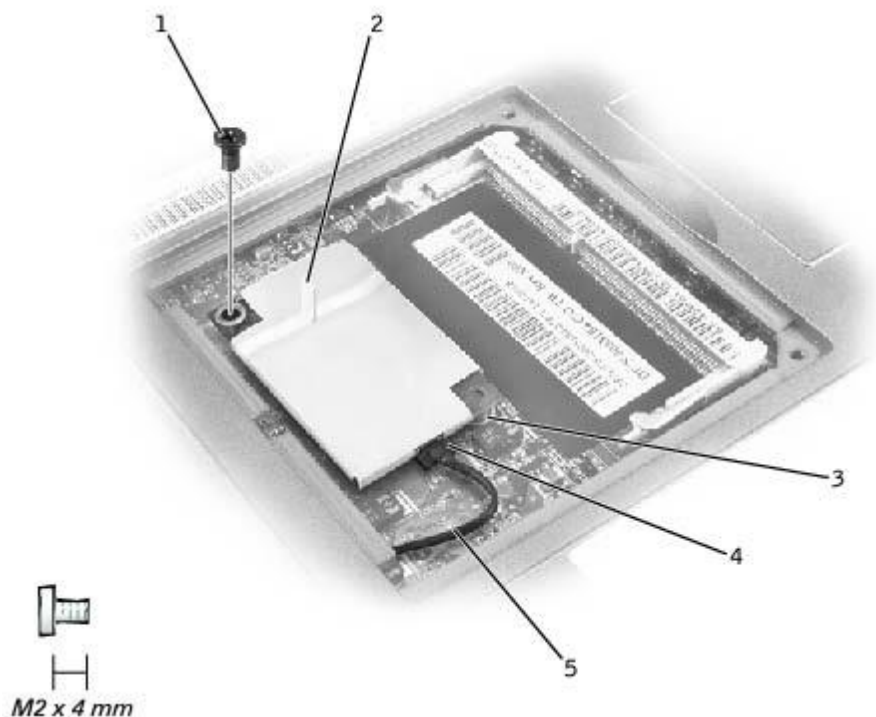

1	M2 x 4-mm screw (1)
---	---------------------

2	pull tab
3	boss
4	modem connector
5	modem cable

Replacing the Modem Daughter Card

1. Connect the modem cable to the modem daughter card.

 **NOTICE:** The connectors are keyed for correct insertion; do not force the connections.

2. Using the screw hole and the boss at the opposite corner of the daughter card to align the card, press the card into its connector on the system board.
 3. Install the M2 x 4-mm screw that secures the modem to the system board.
 4. Replace the [memory module/modem cover](#) and tighten the two captive screws.
-

[Back to Contents Page](#)

Hard Drive

Dell™ Latitude™ C400 Service Manual

- [Removing the Hard Drive](#)
- [Replacing the Hard Drive](#)

Removing the Hard Drive

1. Save and close any open files, exit any open programs, and shut down the computer.

- ➡ **NOTICE:** Disconnect the computer and any attached devices from electrical outlets, and remove the battery.
- ➡ **NOTICE:** The hard drive is very sensitive to shock. Handle the hard drive by its edges (do not squeeze the top of the hard drive case), and avoid dropping it.
- ➡ **NOTICE:** Read "[Preparing to Work Inside the Computer](#)" before performing the following procedure.
- ➡ **NOTICE:** To prevent data loss, turn off your computer before removing the hard drive. Do not remove the hard drive while the computer is on, in standby mode or in hibernate mode.
- ⚠ **CAUTION:** If you remove the hard drive from the computer when the drive is hot, *do not touch* the metal housing of the hard drive.

2. Ground yourself by touching a metal connector on the back of the computer.
3. Turn the computer over. Remove the M2.5 x 12-mm screw from the hard drive door.

Hard Drive Removal

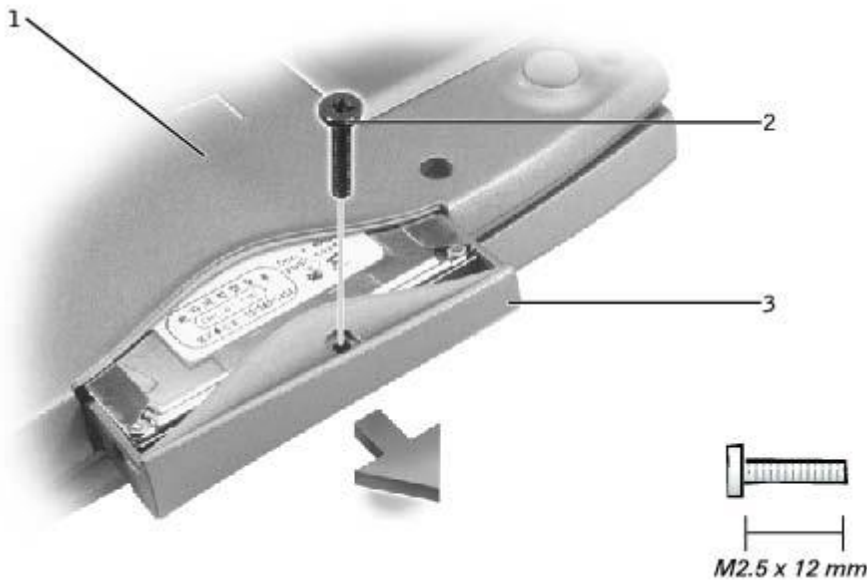

1	bottom of computer
2	M2.5 x 12-mm screw (1)
3	hard drive door

-
4. Slide the hard drive straight out of the computer.
-

Replacing the Hard Drive

 **NOTICE:** Use firm and even pressure to slide the hard drive into place. If you force the hard drive into place using excessive force, you may damage the connector.

1. Push the hard drive into the drive bay until it is fully seated in the bay.
 2. Replace the M2.5 x 12-mm screw in the hard drive door.
-

[Back to Contents Page](#)



Wireless Network Adapter

Dell™ Latitude™ C400 Service Manual

[Removing the Wireless Network Adapter](#)

[Replacing the Wireless Network Adapter](#)

Removing the Wireless Network Adapter

-  **NOTICE:** Disconnect the computer and any attached devices from electrical outlets, and remove any installed batteries.
-  **NOTICE:** To avoid ESD, ground yourself by using a wrist grounding strap or by touching an unpainted metal surface on the computer.
-  **NOTICE:** Read "[Preparing to Work Inside the Computer](#)" before performing the following procedure.

1. Remove the [hard drive](#).
2. Remove the [keyboard](#).

Wireless Network Adapter

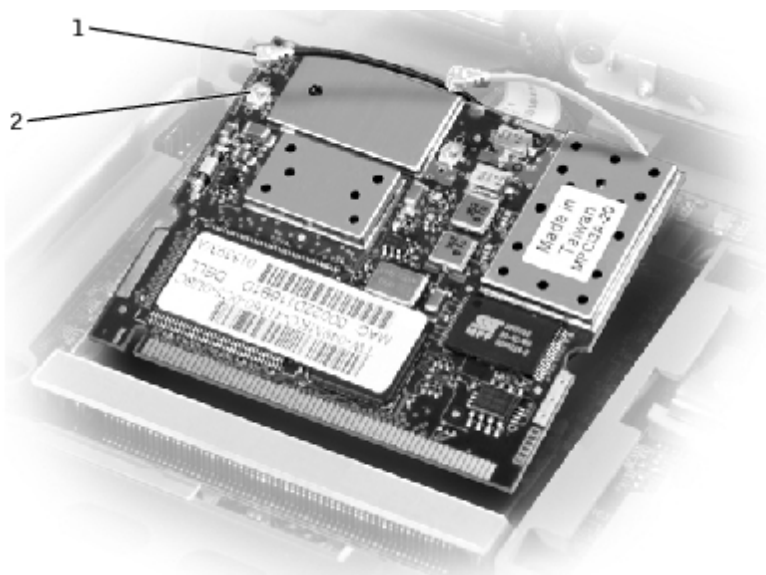

1	wireless cables (2)
2	wireless cable connectors (2)

3. Disconnect the two wireless cables from the wireless card.
4. Spread the two metal securing tabs apart, and pull the card from its socket.

Replacing the Wireless Network Adapter

The wireless card is keyed to the connector. Make sure the card is fully seated in the socket before attempting to pivot it

down into place.

[Back to Contents Page](#)

Display Assembly and Display Latch

Dell™ Latitude™ C400 Service Manual

- [Removing the Display Assembly](#)
- [Replacing the Display Latch](#)

Removing the Display Assembly

- ➔ **NOTICE:** You must remove the display assembly before you remove the palm rest.
- ➔ **NOTICE:** Disconnect the computer and any attached devices from electrical outlets, and remove any installed batteries.
- ➔ **NOTICE:** To avoid ESD, ground yourself by using a wrist grounding strap or by touching an unpainted metal surface on the computer.
- ➔ **NOTICE:** Read "[Preparing to Work Inside the Computer](#)" before performing the following procedure.

1. Remove the battery.
2. Remove the [hard drive](#).
3. Remove the [center cover](#).
4. Close the display.
5. Turn the computer over and remove the two M2.5 x 6-mm screws at the bottom back corners of the computer.

Display Screws



- | | |
|---|------------------------|
| 1 | M2.5 x 6-mm screws (2) |
|---|------------------------|

6. Turn the computer right-side up and open the display 180 degrees.

Display Assembly

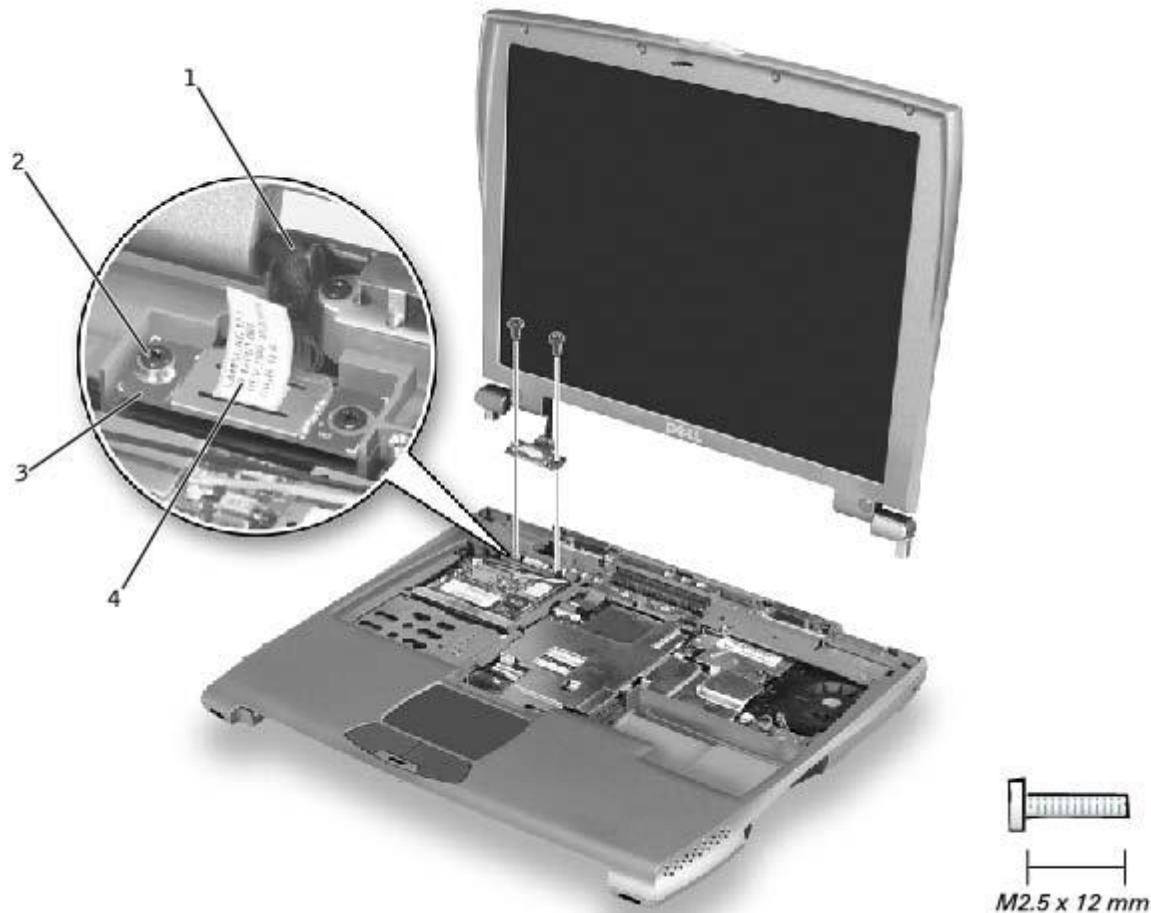

1	display-feed flex cable
2	M2.5 x 12-mm screws (2)
3	display-feed flex cable hold-down board
4	pull tab

7. Remove the two M2.5 x 12-mm screws from the display-feed flex cable hold-down board.
8. Use the pull tab to disconnect the display-feed flex cable from its connector on the system board.
9. Move the display assembly to an upright position and pull it up out of the computer.

Replacing the Display Latch

- ➡ **NOTICE:** Disconnect the computer and any attached devices from electrical outlets, and remove any installed batteries.
- ➡ **NOTICE:** To avoid ESD, ground yourself by using a wrist grounding strap or by touching an unpainted metal surface on the computer.
- ➡ **NOTICE:** Read "[Preparing to Work Inside the Computer](#)" before performing the following procedure.

To replace the display latch, you must replace the whole bezel.

1. Remove the battery.
2. Remove the [hard drive](#).
3. Open the display 180 degrees, and remove the six rubber screw covers and the six M2 x 4-mm screws that secure the bezel.

Bezel Removal

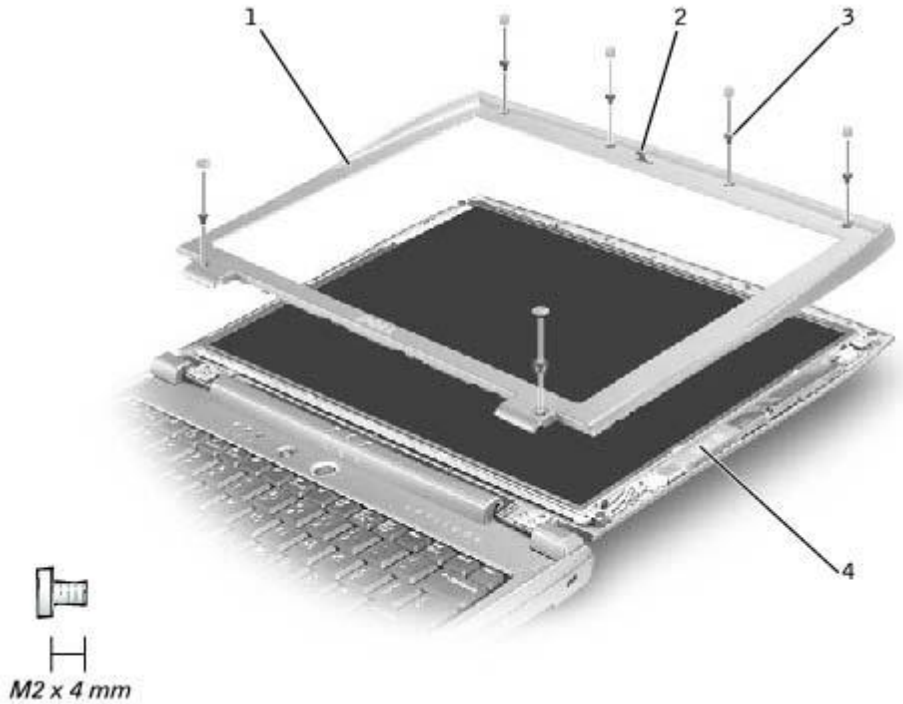

1	bezel
2	display latch
3	M2 x 4-mm screw (6)
4	display assembly

4. Use a small flat-blade screwdriver to carefully pry around the perimeter of the bezel until the bezel separates from the display assembly.
5. Install the new bezel.

Palm Rest

Dell™ Latitude™ C400 Service Manual

[Removing the Palm Rest](#)

[Replacing the Palm Rest](#)

Removing the Palm Rest

- ➔ **NOTICE:** Disconnect the computer and any attached devices from electrical outlets, and remove any installed batteries.
 - ➔ **NOTICE:** To avoid ESD, ground yourself by using a wrist grounding strap or by touching an unpainted metal surface on the computer.
 - ➔ **NOTICE:** Read "[Preparing to Work Inside the Computer](#)" before performing the following procedure.
1. Remove the [hard drive](#).
 2. Remove the [keyboard](#).
-
- ➔ **NOTICE:** You must remove the display assembly before you remove the palm rest; the display hinges pass through the back of the palm rest.
3. Remove the [display assembly](#).
 4. Turn the computer over and remove the four M2.5 x 6-mm screws (two screws to each side of the battery bay).

Palm-Rest Screws on Bottom of Computer

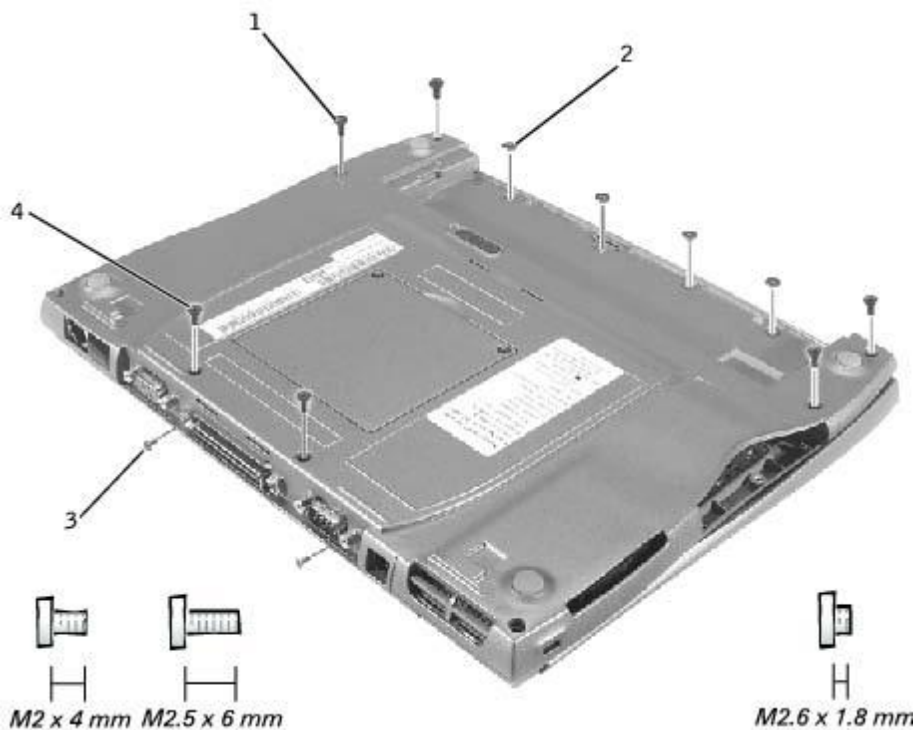

1	M2.5 x 6-mm screws (4)
2	M2.6 x 1.8-mm screws (4)
3	M2 x 4-mm screws (2)
4	M2.5 x 6-mm screws (2)

- Remove the four M2.6 x 1.8-mm screws located inside the battery bay.
- Remove the two M2.5 x 6-mm screws located near the service tag at the back edge of the computer.
- Turn the computer over and remove the two M2 x 4-mm screws located above the serial, docking, and video connectors on the back panel.

Critical Component Shield

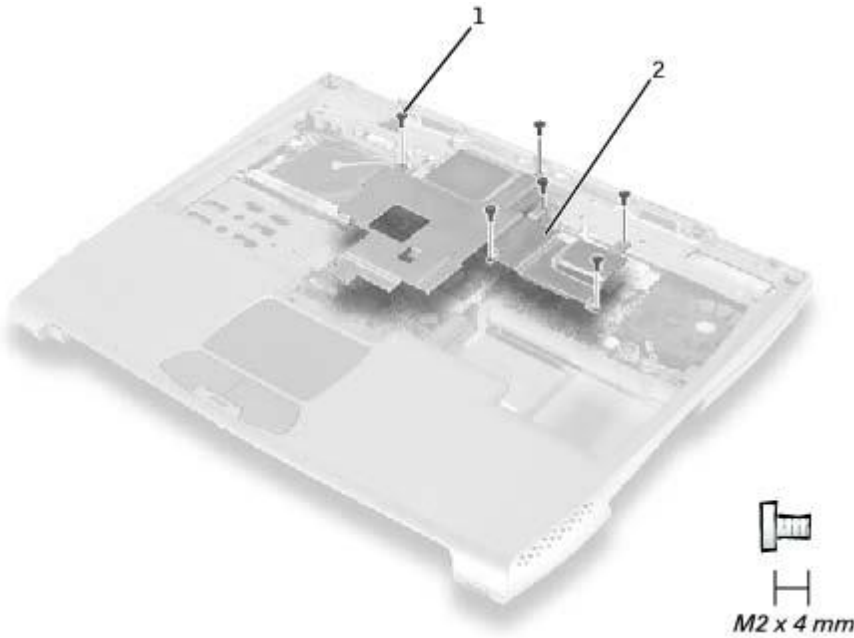

1	M2 x 4-mm screws (6) (one screw may be captive)
2	critical component shield

- Remove the six M2 x 4-mm screws (one of which may be captive) that secure the critical component shield to the system board, and lift the shield away.

 **NOTE:** At this point, the memory module under the critical component shield can be replaced.

Palm Rest Removal

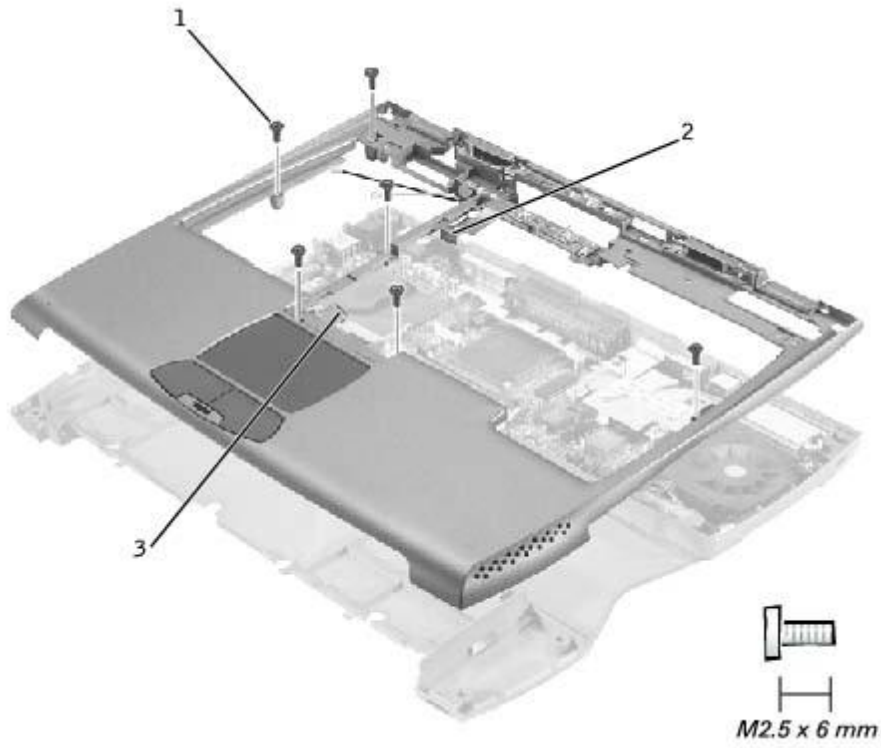

1	M2.5 x 6-mm screws (6)
2	LED cable
3	palm-rest flex cable

9. Remove the six M2.5 x 6-mm screws that secure the palm rest to the system board.
10. Disconnect the LED and palm-rest flex cables.
11. If a Mini PCI wireless card is installed, [disconnect the two wireless cables](#) from the card.
12. Lift the palm rest away.

Replacing the Palm Rest

To aid with proper flex cable connection, a white locator line has been added near the ends of the flex cables. When replacing the LED and palm-rest flex cables, press the cable into the connector until the white line disappears and hold it steady while you snap the flex cable connector down. (The white line may reappear after the connector is closed; this should not indicate a problem with the connection.)

[Back to Contents Page](#)

Cooling Fan

Dell™ Latitude™ C400 Service Manual

[Removing the Cooling Fan](#)

Removing the Cooling Fan

- ➔ **NOTICE:** Disconnect the computer and any attached devices from electrical outlets, and remove any installed batteries.
 - ➔ **NOTICE:** To avoid ESD, ground yourself by using a wrist grounding strap or by touching an unpainted metal surface on the computer.
 - ➔ **NOTICE:** Read "[Preparing to Work Inside the Computer](#)" before performing the following procedure.
1. Remove the [hard drive](#).
 2. Remove the [keyboard](#).
 3. Remove the [display assembly](#).
 4. Remove the [palm rest](#).

Cooling Fan Removal

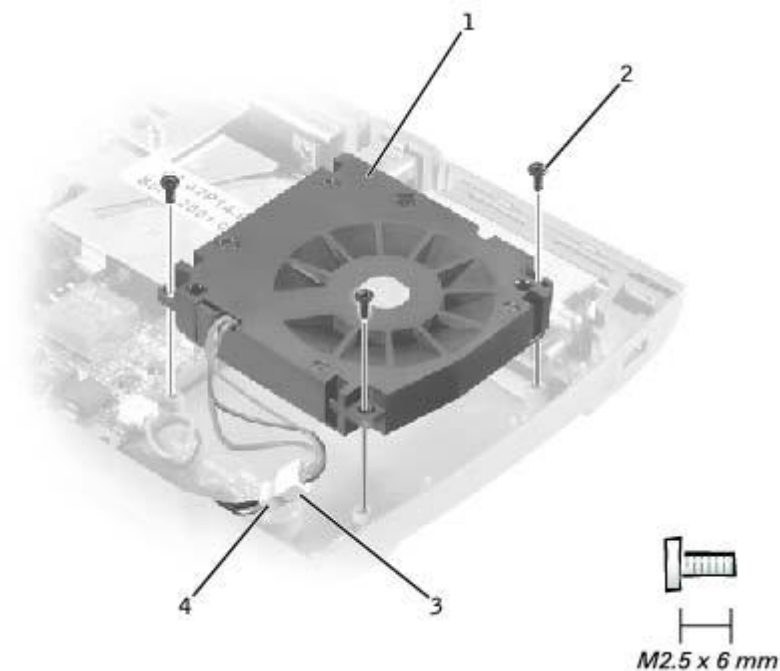

1	cooling fan
2	M2.5 x 6-mm screws (3)
3	fan cable
4	fan extender cable

5. Remove the fan cable from the fan extender cable that runs under the system board.
 6. Remove the three M2.5 x 6-mm screws that secure the cooling fan.
 7. Lift out the cooling fan.
-

[Back to Contents Page](#)

Reserve Battery

Dell™ Latitude™ C400 Service Manual

- [Removing the Reserve Battery](#)
- [Replacing the Reserve Battery](#)

Removing the Reserve Battery

- ➔ **NOTICE:** The reserve battery provides power to the computer's RTC and NVRAM when the computer is turned off. Removing the battery causes the computer to lose the date and time information as well as all user-specified parameters in the BIOS. If possible, make a copy of this information before you remove the reserve battery.
 - ➔ **NOTICE:** Disconnect the computer and any attached devices from electrical outlets, and remove any installed batteries.
 - ➔ **NOTICE:** To avoid ESD, ground yourself by using a wrist grounding strap or by touching an unpainted metal surface on the computer.
 - ➔ **NOTICE:** Read "[Preparing to Work Inside the Computer](#)" before performing the following procedure.
1. Remove the [hard drive](#).
 2. Remove the [keyboard](#).
 3. Remove the [display assembly](#).
 4. Remove the [palm rest](#).

Reserve Battery Removal

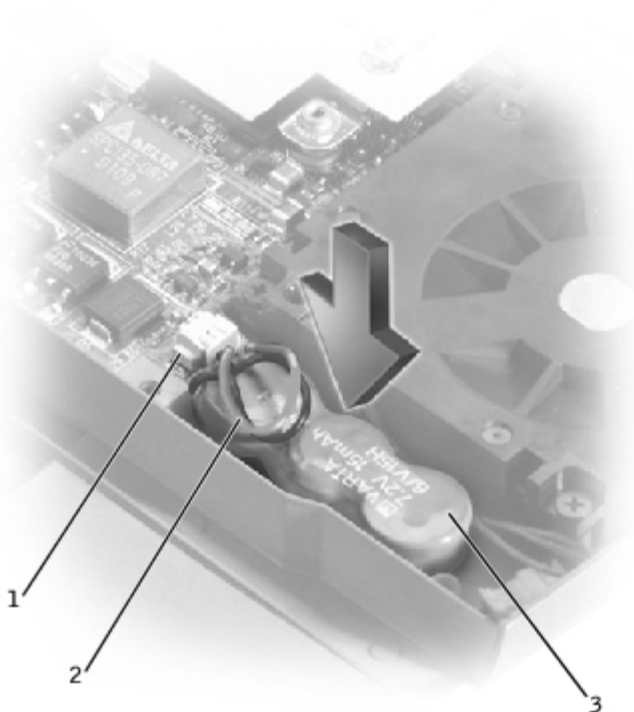

1	reserve battery connector on system board
2	reserve battery cable
3	reserve battery

5. Disconnect the reserve battery cable from the system board connector.
 6. Pry the reserve battery free from the system board. The reserve battery is attached to the system board with a piece of adhesive tape.
 7. Remove any remnants of the adhesive tape from the system board.
-

Replacing the Reserve Battery

1. Connect the reserve battery cable to the system board connector.
 2. Press the reserve battery into place on the system board.
 3. Update the BIOS using a flash BIOS update program floppy disk or CD. For instructions on how to flash the BIOS, see "[Flashing the BIOS](#)."
-

[Back to Contents Page](#)

Flashing the BIOS

Dell™ Latitude™ C400 Service Manual

Perform the following steps to update the BIOS:

1. Make sure that the AC adapter is plugged in and that the main battery is installed properly.
2. Turn on the computer. The following error message appears:

```
System hardware failures: #0010
```

```
Strike the F1 key to shutdown
```

3. Instead of pressing <F1>, insert the Flash BIOS update floppy disk or CD into the appropriate drive and press <F6>, and then press <F4>. The computer displays the following message on the screen:

```
Failure override
```

```
Processor update failure. Reload current BIOS
```

```
Strike the F1 key to continue, F2 to run the setup utility.
```

4. Press <F1>. The computer continues to boot and updates the new BIOS.
5. Press <F2> to enter the system setup program and reset the boot sequence with the appropriate drive, if required.
6. Press <ESC> to exit the system setup program.
7. Remove the Flash BIOS update floppy disk or CD from the drive and restart the computer.



Audio Board

Dell™ Latitude™ C400 Service Manual

[Removing the Audio Board](#)

[Replacing the Audio Board](#)

Removing the Audio Board

-  **NOTICE:** Disconnect the computer and any attached devices from electrical outlets, and remove any installed batteries.
 -  **NOTICE:** To avoid ESD, ground yourself by using a wrist grounding strap or by touching an unpainted metal surface on the computer.
 -  **NOTICE:** Read "[Preparing to Work Inside the Computer](#)" before performing the following procedure.
1. Remove the [hard drive](#).
 2. Remove the [keyboard](#).
 3. Remove the [display assembly](#).
 4. Remove the [palm rest](#).

Audio Board Removal

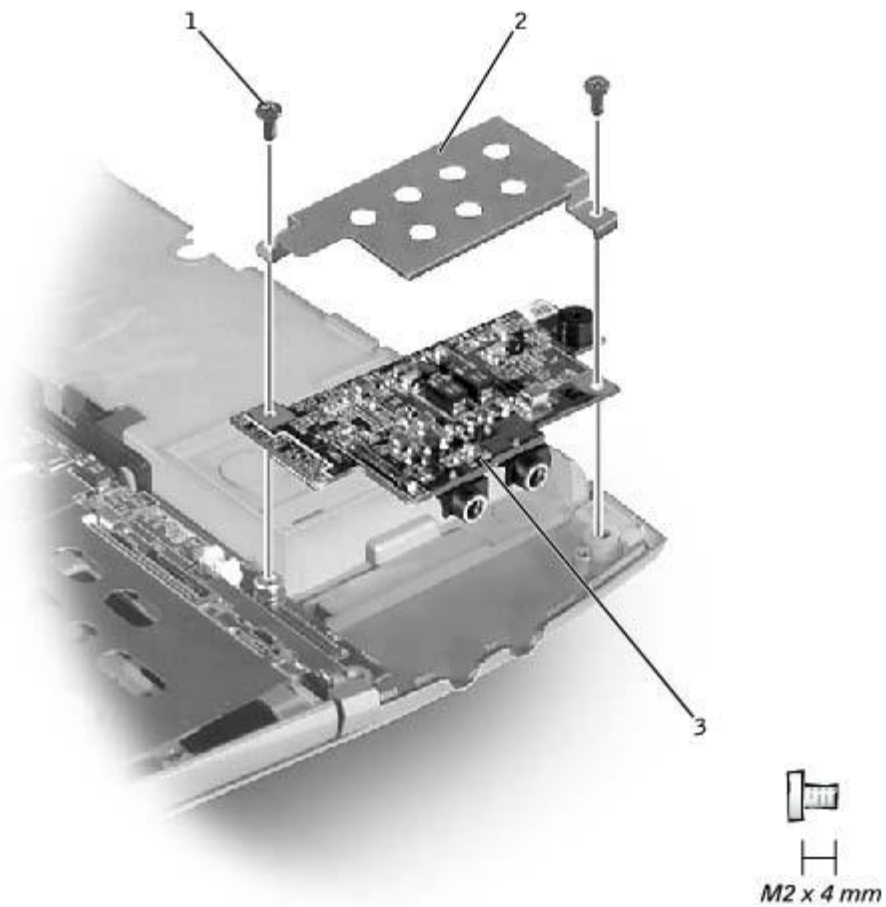

1	M2 x 4-mm screws (2)
2	audio board shield
3	audio board

5. Remove the two M2 x 4-mm screws from the audio board shield, and remove the shield.
6. Pull the audio board up out of its connector.

Replacing the Audio Board

The audio board can be easily misaligned. When replacing it, first align the two screw holes in the board with the holes in the bosses. Then, as you press the audio board into the connector, sight sideways between the audio board and the system board to ensure that all pins on the audio board connector are headed correctly into the system board connector.

[Back to Contents Page](#)

System Board



Dell™ Latitude™ C400 Service Manual

[Removing the System Board](#)

[Replacing the System Board](#)

Removing the System Board

The system board's BIOS chip contains the service tag sequence, which is also visible on a barcode label on the bottom of the computer. The replacement kit for the system board may include a CD that provides a utility for transferring the service tag sequence to the replacement system board.

-  **NOTICE:** Disconnect the computer and any attached devices from electrical outlets, and remove any installed batteries.
-  **NOTICE:** To avoid ESD, ground yourself by using a wrist grounding strap or by touching an unpainted metal surface on the computer.
-  **NOTICE:** Read "[Preparing to Work Inside the Computer](#)" before performing the following procedure.

1. Remove the PC Card or plastic blank, if present, from the PC Card slot.
2. Remove the [hard drive](#).
3. Remove the [keyboard](#).
4. Remove the [display assembly](#).
5. Remove the [palm rest](#).
6. Remove the [wireless network adapter](#), if present.
7. Remove the [modem daughter card](#), if present.
8. Remove all installed [memory modules](#).
9. Remove the [audio board](#).

System Board Removal

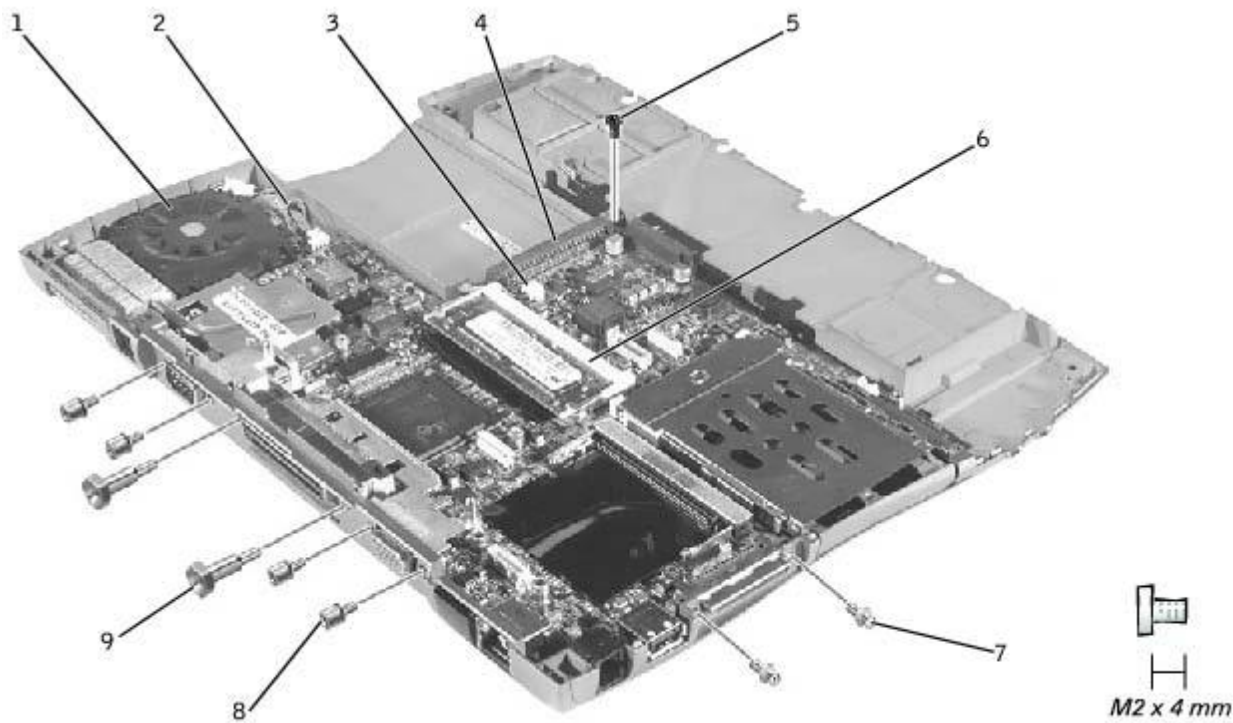

1	fan
2	reserve battery cable
3	connector for fan extender cable
4	hard-drive connector
5	M2 x 4-mm screw (1)
6	memory module socket
7	guide pins (2)
8	5-mm hex nuts (4)
9	7-mm hex nuts (2)

10. Remove the four 5-mm hex nuts near each end of the serial and video connectors.
11. Use a flat-blade screwdriver to remove the two 7-mm hex nuts near each end of the docking connector.
12. Remove the two guide pins from the IDE connector.
13. Disconnect the cooling fan from the fan extender cable.
14. Disconnect the fan extender cable from the connector beside the internal memory socket.
15. Disconnect the reserve battery cable from the system board.
16. Remove the M2 x 4-mm screw that secures the right front corner of the system board.
17. Disengage the system board from the back panel.

Replacing the System Board

While replacing the system board, pull the fan extender cable aside to avoid trapping it beneath the system board. After replacing the system board, route the cable between the hard-drive connector and the internal memory socket.

After you have replaced the system board, insert the floppy disk or CD that accompanied the replacement system board into the appropriate drive, and turn on the computer. Follow the instructions on the screen.



NOTE: After replacing the system board, be sure to enter the computer's service tag sequence into the BIOS of the replacement system board.

[Back to Contents Page](#)



Battery Latch

Dell™ Latitude™ C400 Service Manual

[Removing the Battery Latch](#)

[Replacing the Battery Latch](#)

Removing the Battery Latch

-  **NOTICE:** Disconnect the computer and any attached devices from electrical outlets, and remove any installed batteries.
 -  **NOTICE:** To avoid ESD, ground yourself by using a wrist grounding strap or by touching an unpainted metal surface on the computer.
 -  **NOTICE:** Read "[Preparing to Work Inside the Computer](#)" before performing the following procedure.
1. Remove the PC Card or plastic blank, if present, from the PC Card slot.
 2. Remove the [hard drive](#).
 3. Remove the [keyboard](#).
 4. Remove the [display assembly](#).
 5. Remove the [palm rest](#).
 6. Remove the [wireless network adapter](#), if present.
 7. Remove the [modem daughter card](#), if present.
 8. Remove all installed [memory modules](#).
 9. Remove the [audio board](#).
 10. Remove the [system board](#).

Battery Latch Removal

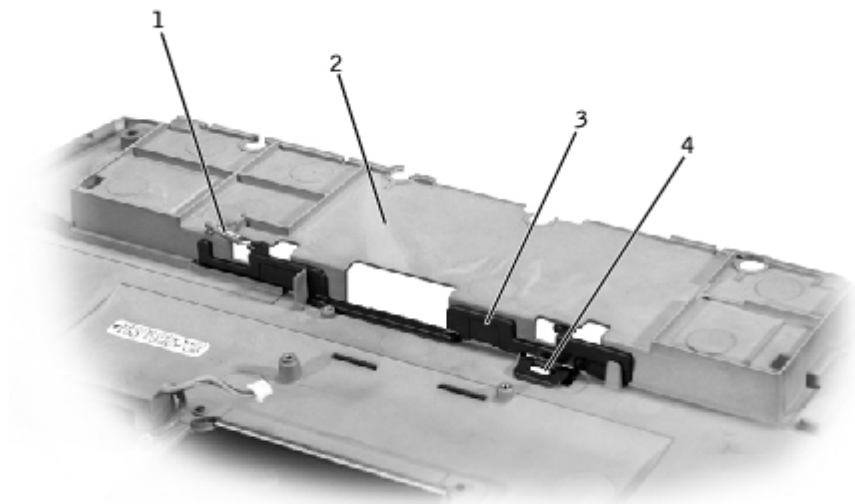

1	tension spring
2	bottom case
3	battery latch
4	battery release-button tabs

NOTICE: The tabs on the release button are plastic. When squeezing the tabs, be careful not to break them.

11. On the inside of the bottom case, use needle-nose pliers to gently squeeze the two release-button tabs together and push the tabs down through the hole, catching the release button on the outside of the bottom case.
12. To remove the battery latch, unhook the small tension spring located on the metal post next to the hard drive.

Replacing the Battery Latch

1. With the inside of the bottom case facing up, place the battery latch in position.
2. Turn the bottom case over and align the slot in the battery latch with the release-button slot in the bottom case.
3. Holding the battery latch in place, press the release-button tabs through the underside of the bottom case and into the battery latch until the tabs snap into place.
4. Replace the tension spring.

[Back to Contents Page](#)

Pin Assignments for I/O Connectors

Dell™ Latitude™ C400 Service Manual

- [Serial Connector](#)
 - [Docking Connector](#)
 - [Video Connector](#)
- [USB Connector](#)
 - [IDE Module Bay Connector](#)

Serial Connector



Pin	Signal
1	DCD
2	RXDA
3	TXDA
4	DTR
5	GND
6	DSR
7	RTS
8	CTS
9	RI

Docking Connector

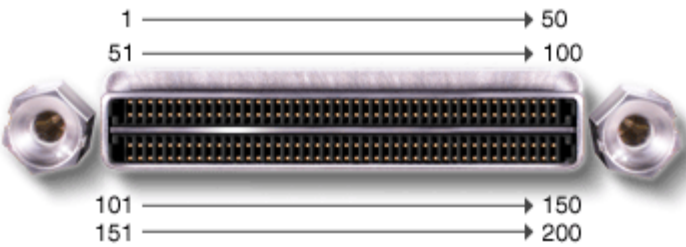

Pin	Signal
1	STRB#/5V
2	PD0
3	PD1
4	PD2
5	PD3
6	PD4
7	PD5

Pin	Signal
51	HSYNC
52	VSYNC
53	GND
54	DOCKED
55	USB_VD1+
56	USB_VD1-
57	GND

Pin	Signal
101	VGA_GRN
102	GND
103	VGA_RED
104	GND
105	VGA_BLU
106	DOCK_SD/MODE
107	D_IRTX

Pin	Signal
151	GND
152	CLK_SPCI
153	GND
154	SAD0
155	SAD1
156	SAD2
157	SAD3

8	PD6
9	PD7
10	GND
11	DOCK_SPKR
12	DOCK_MIC
13	DOCK_LINE
14	DOCK_CDROM
15	GND
16	NC
17	POWER_SW#
18	QPCIEN#
19	S1.6M_EN#
20	DFDD/LPT#
21	GND
22	NC
23	NC
24	D_ACTLED
25	D_PWRLED
26	DOCK_PWR_SRC
27	DOCK_PWR_SRC
28	DOCK_PWR_SRC
29	GND
30	+5VDOCK
31	+5VDOCK
32	+5VDOCK
33	+5VDOCK
34	+5VDOCK
35	GND
36	DOCK_PWR_SRC
37	DOCK_PWR_SRC
38	DOCK_PWR_SRC
39	DOCK_PWR_SRC
40	GND
41	DOCK_+DC_IN
42	DOCK_+DC_IN
43	DOCK_+DC_IN
44	DOCK_+DC_IN
45	DOCK_+DC_IN
46	DOCK_+DC_IN
47	DOCK_+DC_IN

58	USB_VD2+
59	USB_VD2-
60	DOCKOC1#
61	RUN_ON#
62	GND
63	NC
64	DOCK_SCLK
65	DOCK_LRCK
66	DOCK_MCLK
67	GND
68	+12V
69	AFD#
70	ERROR#
71	ACK#
72	GND
73	INIT#
74	SLCT_IN#
75	BUSY
76	PE
77	SLCT
78	GND
79	DAT_SMB
80	DCLK_SMB
81	SMB_INIT#
82	GND
83	DAT_DOCKSM1
84	CLK_DOCKSM1
85	DAT_DOCKKBD
86	CLK_DOCKKBD
87	GND
88	RIO
89	CTS0
90	RTS0
91	DSR0
92	GND
93	DTR0
94	TXD0#
95	RXD0#
96	DCD0
97	NC

108	D_IRRX
109	GND
110	SPIRQB#
111	SPIRQC#
112	DAT_DDC2
113	CLK_DDC2
114	SPAR
115	SPME#
116	GND
117	SSERR#
118	SPERR#
119	SLOCK#
120	SSTOP#
121	GND
122	SDEVSEL#
123	STRDY#
124	SIRDY#
125	SFRAME#
126	SCLKRUN#
127	GND
128	SGNTA#
129	SREQA#
130	SGNT0#
131	SREQ0#
132	SPCIRST#
133	SH1SEL#
134	GND
135	SWRPR#
136	SDSKCHG#/DRQ
137	SDIR#
138	STRK0#
139	SSTEP#
140	SDRV1#
141	GND
142	SMTR1#
143	SWRDATA#
144	SWGATE#
145	SRDATA#
146	SINDEX#
147	GND

158	SAD4
159	SAD5
160	SAD6
161	GND
162	SAD7
163	SAD8
164	SC/BE0#
165	SAD9
166	SAD10
167	SAD11
168	SAD12
169	GND
170	SAD13
171	SAD14
172	SAD15
173	SAD16
174	SC/BE1#
175	CD/BE2#
176	GND
177	SAD17
178	SAD18
179	SAD19
180	SAD20
181	SAD21
182	GND
183	SAD22
184	SAD23
185	SAD24
186	SC/BE3#
187	SAD25
188	GND
189	SAD26
190	SAD27
191	SAD28
192	SAD29
193	SAD30
194	SAD31
195	GND
196	NC
197	NC

48	DOCK_+DC_IN
49	GND
50	LOW_PWR

98	+5VSUS
99	NC
100	NC

148	NC
149	+5VALW
150	NC

198	NC
199	NC
200	GND

Video Connector



5 4 3 2 1
10 9 8 7 6
15 14 13 12 11

Pin	Signal
1	RED
2	GREEN
3	BLUE
4	NC
5	GND
6	GND
7	GND
8	GND

Pin	Signal
9	CRT_VCC
10	GND
11	NC
12	DAT_DDC2
13	HSYNC
14	VSYNC
15	CLK_DDC2

USB Connector



Pin	Signal
1	VCC
2	-DATA
3	+DATA
4	GROUND

IDE Module Bay Connector

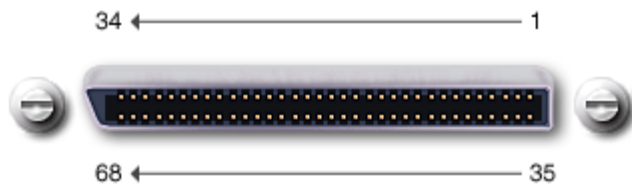

Pin	Signal	Pin	Signal
1	BAY_MODPRES#	35	WGATE#
2	HDSEL#	36	GND
3	RDATA#	37	MTR0#
4	WRPRT#	38	STEP#
5	WRDATA#	39	DRV0#
6	INDEX#	40	GND
7	DSKCHG#	41	DIR#
8	1D6M_EN#	42	TRKO#
9	SIDE_IOW#	43	BAY_CD_FDD#
10	SIDED15	44	GND
11	SIDED12	45	SIDED1
12	SIDED9	46	SIDED4
13	SIDE_CS3#	47	SIDED7
14	SIDE_CS1#	48	GND
15	+5VMOD	49	SIDEIORDY
16	IRQ15	50	GND
17	+5VMOD	51	SIDE_DREQ
18	SIDED0	52	GND
19	+5VMOD	53	SIDED13
20	SIDED3	54	SIDED10
21	+5VMOD	55	IDE_RST_MOD_5V#
22	SIDED6	56	GND
23	+5VMOD	57	SIDEACT#
24	SIDE_A2	58	SIDE_A1
25	+5VMOD	59	SIDE_A0
26	SIDE_DACK#	60	GND
27	+5VMOD	61	SIDE_CSEL_SEC#
28	SIDE_IOR#	62	SIDED2
29	+5VMOD	63	SIDED5
30	SIDED14	64	GND
31	+5VMOD	65	SIDED8
32	SIDED11	66	MOD_CL_L
33	+5VMOD	67	CDGND
34	MOD_CD_R	68	BAY_MODPRES#