

Precision 5540

Service Manual



Notes, cautions, and warnings

 **NOTE:** A NOTE indicates important information that helps you make better use of your product.

 **CAUTION:** A CAUTION indicates either potential damage to hardware or loss of data and tells you how to avoid the problem.

 **WARNING:** A WARNING indicates a potential for property damage, personal injury, or death.

Chapter 1: Working on your computer	5
Safety instructions.....	5
Before working inside your computer.....	5
Safety precautions.....	6
Electrostatic discharge—ESD protection.....	6
ESD field service kit	7
Transporting sensitive components.....	8
After working inside your computer.....	8
Chapter 2: Technology and components	9
Power supply specifications.....	9
Power adapter.....	9
Video specifications.....	9
Audio specifications.....	10
Memory	10
Display specifications.....	10
Keyboard specifications.....	12
Battery.....	12
Storage specifications.....	13
USB Type-C.....	13
USB features.....	14
Chapter 3: Major components of your system	16
Chapter 4: Disassembly and reassembly	18
Disassembly and reassembly.....	18
Base cover.....	18
Battery.....	19
PCIe Solid State Drive (SSD).....	20
Hard drive.....	22
Speaker.....	24
WLAN card.....	25
Memory modules.....	26
System fan.....	27
Heat sink assembly.....	29
Power connector port.....	31
System board.....	31
Audio board.....	34
Coin-cell battery.....	36
Power button.....	37
Power button with fingerprint reader -optional.....	38
Display Assembly.....	40
Antenna cover.....	41
Keyboard lattice and Keyboard.....	43

Palm rest.....	45
Chapter 5: Troubleshooting.....	49
Handling swollen Lithium-ion batteries.....	49
Enhanced Pre-Boot System Assessment — ePSA diagnostics.....	49
Running the ePSA Diagnostics.....	50
Built-in self-test (BIST).....	50
M-BIST.....	50
LCD Power rail test (L-BIST).....	51
LCD Built-in Self Test (BIST).....	51
Beep codes.....	52
Recovering the operating system.....	52
Real-Time Clock (RTC Reset).....	52
Backup media and recovery options.....	52
WiFi power cycle.....	52
Drain residual flea power (perform hard reset).....	53
Chapter 6: Getting help.....	54
Contacting Dell.....	54

Working on your computer

Safety instructions

Prerequisites

Use the following safety guidelines to protect your computer from potential damage and to ensure your personal safety. Unless otherwise noted, each procedure included in this document assumes that the following conditions exist:

- You have read the safety information that shipped with your computer.
- A component can be replaced or, if purchased separately, installed by performing the removal procedure in reverse order.

About this task

 **NOTE:** Disconnect all power sources before opening the computer cover or panels. After you finish working inside the computer, replace all covers, panels, and screws before connecting to the power source.

 **WARNING:** Before working inside your computer, read the safety information that shipped with your computer. For additional safety best practices information, see the [Regulatory Compliance Homepage](#)

 **CAUTION:** Many repairs may only be done by a certified service technician. You should only perform troubleshooting and simple repairs as authorized in your product documentation, or as directed by the online or telephone service and support team. Damage due to servicing that is not authorized by Dell is not covered by your warranty. Read and follow the safety instructions that came with the product.

 **CAUTION:** To avoid electrostatic discharge, ground yourself by using a wrist grounding strap or by periodically touching an unpainted metal surface at the same time as touching a connector on the back of the computer.

 **CAUTION:** Handle components and cards with care. Do not touch the components or contacts on a card. Hold a card by its edges or by its metal mounting bracket. Hold a component such as a processor by its edges, not by its pins.

 **CAUTION:** When you disconnect a cable, pull on its connector or on its pull-tab, not on the cable itself. Some cables have connectors with locking tabs; if you are disconnecting this type of cable, press in on the locking tabs before you disconnect the cable. As you pull connectors apart, keep them evenly aligned to avoid bending any connector pins. Also, before you connect a cable, ensure that both connectors are correctly oriented and aligned.

 **NOTE:** The color of your computer and certain components may appear differently than shown in this document.

Before working inside your computer

Steps

1. Ensure that your work surface is flat and clean to prevent the computer cover from being scratched.
2. Turn off your computer.
3. Disconnect all network cables from the computer (if available).

 **CAUTION:** If your computer has an RJ45 port, disconnect the network cable by first unplugging the cable from your computer.

4. Disconnect your computer and all attached devices from their electrical outlets.
5. Open the display.
6. Press and hold the power button for few seconds, to ground the system board.

 **CAUTION:** To guard against electrical shock unplug your computer from the electrical outlet before performing Step # 8.

 **CAUTION:** To avoid electrostatic discharge, ground yourself by using a wrist grounding strap or by periodically touching an unpainted metal surface at the same time as touching a connector on the back of the computer.

7. Remove any installed ExpressCards or Smart Cards from the appropriate slots.

Safety precautions

The safety precautions chapter details the primary steps to be taken before performing any disassembly instructions.

Observe the following safety precautions before you perform any installation or break/fix procedures involving disassembly or reassembly:

- Turn off the system and all attached peripherals.
- Disconnect the system and all attached peripherals from AC power.
- Disconnect all network cables, telephone, and telecommunications lines from the system.
- Use an ESD field service kit when working inside any to avoid electrostatic discharge (ESD) damage.
- After removing any system component, carefully place the removed component on an anti-static mat.
- Wear shoes with non-conductive rubber soles to reduce the chance of getting electrocuted.

Standby power

Dell products with standby power must be unplugged before you open the case. Systems that incorporate standby power are essentially powered while turned off. The internal power enables the system to be remotely turned on (wake on LAN) and suspended into a sleep mode and has other advanced power management features.

Unplugging, pressing and holding the power button for 15 seconds should discharge residual power in the system board.

Bonding

Bonding is a method for connecting two or more grounding conductors to the same electrical potential. This is done through the use of a field service electrostatic discharge (ESD) kit. When connecting a bonding wire, ensure that it is connected to bare metal and never to a painted or non-metal surface. The wrist strap should be secure and in full contact with your skin, and ensure that you remove all jewelry such as watches, bracelets, or rings prior to bonding yourself and the equipment.

Electrostatic discharge—ESD protection

ESD is a major concern when you handle electronic components, especially sensitive components such as expansion cards, processors, memory DIMMs, and system boards. Very slight charges can damage circuits in ways that may not be obvious, such as intermittent problems or a shortened product life span. As the industry pushes for lower power requirements and increased density, ESD protection is an increasing concern.

Due to the increased density of semiconductors used in recent Dell products, the sensitivity to static damage is now higher than in previous Dell products. For this reason, some previously approved methods of handling parts are no longer applicable.

Two recognized types of ESD damage are catastrophic and intermittent failures.

- **Catastrophic** – Catastrophic failures represent approximately 20 percent of ESD-related failures. The damage causes an immediate and complete loss of device functionality. An example of catastrophic failure is a memory DIMM that has received a static shock and immediately generates a "No POST/No Video" symptom with a beep code emitted for missing or nonfunctional memory.
- **Intermittent** – Intermittent failures represent approximately 80 percent of ESD-related failures. The high rate of intermittent failures means that most of the time when damage occurs, it is not immediately recognizable. The DIMM receives a static shock, but the tracing is merely weakened and does not immediately produce outward symptoms related to the damage. The weakened trace may take weeks or months to melt, and in the meantime may cause degradation of memory integrity, intermittent memory errors, etc.

The more difficult type of damage to recognize and troubleshoot is the intermittent (also called latent or "walking wounded") failure.

Perform the following steps to prevent ESD damage:

- Use a wired ESD wrist strap that is properly grounded. The use of wireless anti-static straps is no longer allowed; they do not provide adequate protection. Touching the chassis before handling parts does not ensure adequate ESD protection on parts with increased sensitivity to ESD damage.
- Handle all static-sensitive components in a static-safe area. If possible, use anti-static floor pads and workbench pads.
- When unpacking a static-sensitive component from its shipping carton, do not remove the component from the anti-static packing material until you are ready to install the component. Before unwrapping the anti-static packaging, ensure that you discharge static electricity from your body.
- Before transporting a static-sensitive component, place it in an anti-static container or packaging.

ESD field service kit

The unmonitored Field Service kit is the most commonly used service kit. Each Field Service kit includes three main components: anti-static mat, wrist strap, and bonding wire.

Components of an ESD field service kit

The components of an ESD field service kit are:

- **Anti-Static Mat** – The anti-static mat is dissipative and parts can be placed on it during service procedures. When using an anti-static mat, your wrist strap should be snug and the bonding wire should be connected to the mat and to any bare metal on the system being worked on. Once deployed properly, service parts can be removed from the ESD bag and placed directly on the mat. ESD-sensitive items are safe in your hand, on the ESD mat, in the system, or inside a bag.
- **Wrist Strap and Bonding Wire** – The wrist strap and bonding wire can be either directly connected between your wrist and bare metal on the hardware if the ESD mat is not required, or connected to the anti-static mat to protect hardware that is temporarily placed on the mat. The physical connection of the wrist strap and bonding wire between your skin, the ESD mat, and the hardware is known as bonding. Use only Field Service kits with a wrist strap, mat, and bonding wire. Never use wireless wrist straps. Always be aware that the internal wires of a wrist strap are prone to damage from normal wear and tear, and must be checked regularly with a wrist strap tester in order to avoid accidental ESD hardware damage. It is recommended to test the wrist strap and bonding wire at least once per week.
- **ESD Wrist Strap Tester** – The wires inside of an ESD strap are prone to damage over time. When using an unmonitored kit, it is a best practice to regularly test the strap prior to each service call, and at a minimum, test once per week. A wrist strap tester is the best method for doing this test. If you do not have your own wrist strap tester, check with your regional office to find out if they have one. To perform the test, plug the wrist-strap's bonding-wire into the tester while it is strapped to your wrist and push the button to test. A green LED is lit if the test is successful; a red LED is lit and an alarm sounds if the test fails.
- **Insulator Elements** – It is critical to keep ESD sensitive devices, such as plastic heat sink casings, away from internal parts that are insulators and often highly charged.
- **Working Environment** – Before deploying the ESD Field Service kit, assess the situation at the customer location. For example, deploying the kit for a server environment is different than for a desktop or portable environment. Servers are typically installed in a rack within a data center; desktops or portables are typically placed on office desks or cubicles. Always look for a large open flat work area that is free of clutter and large enough to deploy the ESD kit with additional space to accommodate the type of system that is being repaired. The workspace should also be free of insulators that can cause an ESD event. On the work area, insulators such as Styrofoam and other plastics should always be moved at least 12 inches or 30 centimeters away from sensitive parts before physically handling any hardware components
- **ESD Packaging** – All ESD-sensitive devices must be shipped and received in static-safe packaging. Metal, static-shielded bags are preferred. However, you should always return the damaged part using the same ESD bag and packaging that the new part arrived in. The ESD bag should be folded over and taped shut and all the same foam packing material should be used in the original box that the new part arrived in. ESD-sensitive devices should be removed from packaging only at an ESD-protected work surface, and parts should never be placed on top of the ESD bag because only the inside of the bag is shielded. Always place parts in your hand, on the ESD mat, in the system, or inside an anti-static bag.
- **Transporting Sensitive Components** – When transporting ESD sensitive components such as replacement parts or parts to be returned to Dell, it is critical to place these parts in anti-static bags for safe transport.

ESD protection summary

It is recommended that all field service technicians use the traditional wired ESD grounding wrist strap and protective anti-static mat at all times when servicing Dell products. In addition, it is critical that technicians keep sensitive parts separate from all insulator parts while performing service and that they use anti-static bags for transporting sensitive components.

Transporting sensitive components

When transporting ESD sensitive components such as replacement parts or parts to be returned to Dell, it is critical to place these parts in anti-static bags for safe transport.

Lifting equipment

Adhere to the following guidelines when lifting heavy weight equipment:

 **CAUTION: Do not lift greater than 50 pounds. Always obtain additional resources or use a mechanical lifting device.**

1. Get a firm balanced footing. Keep your feet apart for a stable base, and point your toes out.
2. Tighten stomach muscles. Abdominal muscles support your spine when you lift, offsetting the force of the load.
3. Lift with your legs, not your back.
4. Keep the load close. The closer it is to your spine, the less force it exerts on your back.
5. Keep your back upright, whether lifting or setting down the load. Do not add the weight of your body to the load. Avoid twisting your body and back.
6. Follow the same techniques in reverse to set the load down.

After working inside your computer

About this task

After you complete any replacement procedure, ensure that you connect any external devices, cards, and cables before turning on your computer.

 **CAUTION: To avoid damage to the computer, use only the battery designed for this particular Dell computer. Do not use batteries designed for other Dell computers.**

Steps

1. Connect any external devices, such as a port replicator or media base, and replace any cards, such as an ExpressCard.
2. Connect any telephone or network cables to your computer.

 **CAUTION: To connect a network cable, first plug the cable into the network device and then plug it into the computer.**

3. Connect your computer and all attached devices to their electrical outlets.
4. Turn on your computer.

Technology and components

This chapter details the technology and components available in the system.

Power supply specifications

Table 1. Power supply

Features	Specification
Input Voltage	100 – 240 VAC
Input frequency	50 – 60 Hz
Type	130 W AC Adapter

Power adapter

Table 2. Power adapter specifications

Features	Specification
Type	130W adapter
Input Voltage	100 to 240 VAC
Adapter size	Height:22 mm (0.86 inches) Width:66 mm (2.59 inches) Depth:143 mm (5.62 inches)
Input frequency	50 Hz to 60 Hz
Output current	130 W - 6.67 A (continuous)
Rated output voltage	19.5 VDC
Temperature range (Operating)	0° to 40° C (32° to 104° F)
Temperature range (Non-Operating)	40° to 70° C (-40° to 158° F)

Video specifications

Table 3. Video

Controller	Type	CPU Dependency	Graphics memory type	Capacity	External display support
Integrated Intel UHD 630	GFX	Intel HD GFX	Integrated	Shared system memory	HDMI 2.0

Table 3. Video (continued)

Controller	Type	CPU Dependency	Graphics memory type	Capacity	External display support
Nvidia Quadro T1000 w/4GB GDDR5	Discrete	Intel Xeon E-2276M	GDDR5	4 GB	HDMI 2.0
Nvidia Quadro T2000 w/4GB GDDR5	Discrete	Intel Xeon E-2276M	GDDR5	4 GB	HDMI 2.0

Audio specifications

Table 4. Audio specifications

Features	Specification
Controller	Waves MaxxAudio Pro
Type	Integrated
Interface	<ul style="list-style-type: none"> High-quality speakers Dual-array microphones

Memory

Table 5. Memory specifications

Memory type	2x DDR4 SoDIMM
Memory capacity per slot	up to 32 GB
Memory speed	2666 MHz
Minimum memory	8 GB
Maximum memory	64 GB
DIMM configurations	<ul style="list-style-type: none"> 8 GB x 1 4 GB x 2 16 GB x 1 8 GB x 2 16 GB x 2 32 GB x2

Display specifications

Table 6. Display specifications

Features	Specification
Type	<ul style="list-style-type: none"> UltraSharp FHD IGZO4, 1920x1080, AG, NT, W/Prem Panel Guar, 100% sRGB color gamut, Titan Gray. UltraSharp FHD IGZO4, 1920x1080, AG, NT, w/Prem Panel Guar, 100% sRGB color gamut, Platinum Silver.

Table 6. Display specifications (continued)

Features	Specification
	<p>15.6" Ultrasharp UHD IGZO4, 3840x2160, Touch, w/Prem Panel Guar, 100% Adobe color gamut, Titan Gray.</p> <p>15.6" Ultrasharp UHD IGZO4, 3840x2160, Touch, w/Prem Panel Guar, 100% Adobe color gamut, Platinum Silver.</p> <p>15.6" Ultrasharp OLED UHD, 3840x2160, non-touch, w/Prem Panel Guar, 100% DCI-P3 color gamut, Titan Gray</p> <ul style="list-style-type: none"> ● 15.6" Ultrasharp OLED UHD, 3840x2160, non-touch, w/Prem Panel Guar, 100% DCI-P3 color gamut, Platinum Silver. ● OLED Panel <p>Active Matrix Organic Light Emitting Diode (AMOLED) panel</p> <p>Color Depth: 8 bit+2 bit FRC</p> <p>Color Gamut: DCI-P3 Typ.100%</p> <p>Response Time: 1ms</p> <p>Interface type: eDP1.4b + PSR2 (4lane)</p> <p>Polarizer type: Anti Glare</p> <p>Display Mode: Wide view angle: 80/80/80/80 for U/D/L/R (Min)</p>
Height (Active area)	<ul style="list-style-type: none"> ● FHD - 194.5 mm (7.66 inches) ● UHD - 194.5 mm (7.66 inches)
Width (Active area)	<ul style="list-style-type: none"> ● FHD - 345.6 mm (13.61 inches) ● UHD - 345.6 mm (13.55 inches)
Diagonal	<ul style="list-style-type: none"> ● FHD - 396.52 mm (15.61 inches) ● UHD - 396.52 mm (15.61 inches)
Megapixels	<ul style="list-style-type: none"> ● FHD - 2.07 ● UHD - 8.29
Pixels Per Inch (PPI)	<ul style="list-style-type: none"> ● FHD - 141 ● UHD - 282 ● UHD - 3840 x 2160
Contrast ratio	<ul style="list-style-type: none"> ● FHD - 1500:1 ● UHD - 1500:1 ● OLED - 100,000:1
Refresh rate	60 Hz
Horizontal viewing angle (min)	+/- 89 degrees
Vertical viewing angle (min)	+/- 89 degrees
Pixel pitch	<ul style="list-style-type: none"> ● FHD - 0.18 mm ● UHD - 0.09 mm
Power consumption (max)	<ul style="list-style-type: none"> ● 4.22 W (FHD 100% sRGB color gamut) ● 9.23 W (UHD Adobe 100% color gamut) ● 4.3 W (OLED UHD 100% color gamut, Titan Gray) ● 14.8 (OLED UHD 100% color gamut, Platinum Silver)

Keyboard specifications

Table 7. Keyboard specifications

Features	Specification
Number of keys	<ul style="list-style-type: none"> 80 (U.S. and Canada) 81 (Europe) 84 (Japan)
Size	Full sized <ul style="list-style-type: none"> X= 19.05 mm key pitch Y= 18.05 mm key pitch
Backlit keyboard	Easy enable/disable via hotkey <Fn+F10 Key> variable brightness levels
Layout	QWERTY

Battery

 **NOTE:** 97 WHr battery is not available with the 2.5 inch drives.

Table 8. Battery specifications

Features	Specifications
Type	<ul style="list-style-type: none"> 56 WHr lithium-ion polymer 3 cell battery 97 WHr lithium-ion polymer 6 cell battery
Dimension	<ol style="list-style-type: none"> 56 WHr lithium-ion polymer <ul style="list-style-type: none"> Length: 223.2 mm (8.79 inch) Width: 71.8 mm (2.83 inch) Height: 7.2 mm (0.28 inch) Weight: 250.00 g (0.55 lb) 97 WHr lithium-ion polymer <ul style="list-style-type: none"> Length: 332 mm (13.07 inch) Width: 96.0 mm (3.78 inch) Height: 7.7 mm (0.30 inch) Weight: 450.00 g (0.992 lb)
Weight (maximum)	450.00 g (0.992 lb)
Voltage	<ul style="list-style-type: none"> 56 WHr - 11.4 VDC 97 WHr - 11.4 VDC
Life span	300 discharge/recharge cycles
Charging time when the computer is off (approximate)	4 hours
Operating time	Varies depending on operating conditions and can significantly reduce under certain power-intensive conditions
Temperature range: Operating	0°C to 35°C (32°F to 95°F)
Temperature range: Storage	-40°C to 65°C (-40°F to 149°F)

Table 8. Battery specifications (continued)

Features	Specifications
Coin-cell battery	ML1220

Storage specifications

NOTE: The 2.5 inches drives are not available with the 97 WHr battery and are available only on 3 Cell 56 WHr battery configurations

Table 9. Storage specifications

Storage specifications
2.5" 7mm 500GB 7200RPM SATA Hard Drive
2.5" 7mm 500GB 7200RPM SATA FIPS Hard Drive
2.5" 7mm 1TB 7200RPM SATA Hard Drive
2.5" 7mm 2TB 5400RPM SATA Hard Drive
256GB M.2 NVMe PCIe SSD Class 40
512GB M.2 NVMe PCIe SSD Class 40
1TB M.2 NVMe PCIe SSD Class 40
2TB M.2 NVMe PCIe SSD Class 40
512GB M.2 NVMe PCIe SED SSD Class 40
1TB M.2 NVMe PCIe SED SSD Class 40
512GB M.2 NVMe PCIe SSD Class 50
1TB M.2 NVMe PCIe SSD Class 50

USB Type-C

USB Type-C is a new, tiny physical connector. The connector itself can support various exciting new USB standard like USB 3.1 and USB power delivery (USB PD).

Alternate Mode

USB Type-C is a new connector standard that's very small. It's about a third the size of an old USB Type-A plug. This is a single connector standard that every device should be able to use. USB Type-C ports can support a variety of different protocols using "alternate modes," which allows you to have adapters that can output HDMI, VGA, DisplayPort, or other types of connections from that single USB port

USB Power Delivery

The USB PD specification is also closely intertwined with USB Type-C. Currently, smartphones, tablets, and other mobile devices often use a USB connection to charge. A USB 2.0 connection provides up to 2.5 watts of power — that'll charge your phone, but that's about it. A laptop might require up to 60 watts, for example. The USB Power Delivery specification ups this

power delivery to 100 watts. It's bi-directional, so a device can either send or receive power. And this power can be transferred at the same time the device is transmitting data across the connection.

This could spell the end of all those proprietary laptop charging cables, with everything charging via a standard USB connection. You could charge your laptop from one of those portable battery packs you charge your smartphones and other portable devices from today. You could plug your laptop into an external display connected to a power cable, and that external display would charge your laptop as you used it as an external display — all via the one little USB Type-C connection. To use this, the device and the cable have to support USB Power Delivery. Just having a USB Type-C connection doesn't necessarily mean they do.

USB Type-C and USB 3.1

USB 3.1 is a new USB standard. USB 3's theoretical bandwidth is 5 Gbps, while USB 3.1 Gen2 is 10Gbps. That's double the bandwidth, as fast as a first-generation Thunderbolt connector. USB Type-C isn't the same thing as USB 3.1. USB Type-C is just a connector shape, and the underlying technology could just be USB 2 or USB 3.0. In fact, Nokia's N1 Android tablet uses a USB Type-C connector, but underneath it's all USB 2.0 — not even USB 3.0. However, these technologies are closely related.

USB features

Universal Serial Bus, or USB, was introduced in 1996. It dramatically simplified the connection between host computers and peripheral devices like mice, keyboards, external drivers, and printers.

Let's take a quick look on the USB evolution referencing to the table below.

Table 10. USB evolution

Type	Data Transfer Rate	Category	Introduction Year
USB 2.0	480 Mbps	High Speed	2000
USB 3.0/USB 3.1 Gen 1	5 Gbps	Super Speed	2010
USB 3.1 Gen 2	10 Gbps	Super Speed	2013

USB 3.0/USB 3.1 Gen 1 (SuperSpeed USB)

For years, the USB 2.0 has been firmly entrenched as the de facto interface standard in the PC world with about 6 billion devices sold, and yet the need for more speed grows by ever faster computing hardware and ever greater bandwidth demands. The USB 3.0/USB 3.1 Gen 1 finally has the answer to the consumers' demands with a theoretically 10 times faster than its predecessor. In a nutshell, USB 3.1 Gen 1 features are as follows:

- Higher transfer rates (up to 5 Gbps)
- Increased maximum bus power and increased device current draw to better accommodate power-hungry devices
- New power management features
- Full-duplex data transfers and support for new transfer types
- Backward USB 2.0 compatibility
- New connectors and cable

The topics below cover some of the most commonly asked questions regarding USB 3.0/USB 3.1 Gen 1.



Speed

Currently, there are 3 speed modes defined by the latest USB 3.0/USB 3.1 Gen 1 specification. They are Super-Speed, Hi-Speed and Full-Speed. The new SuperSpeed mode has a transfer rate of 4.8Gbps. While the specification retains Hi-Speed, and Full-Speed USB mode, commonly known as USB 2.0 and 1.1 respectively, the slower modes still operate at 480Mbps and 12Mbps respectively and are kept to maintain backward compatibility.

USB 3.0/USB 3.1 Gen 1 achieves the much higher performance by the technical changes below:

- An additional physical bus that is added in parallel with the existing USB 2.0 bus (refer to the picture below).
- USB 2.0 previously had four wires (power, ground, and a pair for differential data); USB 3.0/USB 3.1 Gen 1 adds four more for two pairs of differential signals (receive and transmit) for a combined total of eight connections in the connectors and cabling.
- USB 3.0/USB 3.1 Gen 1 utilizes the bidirectional data interface, rather than USB 2.0's half-duplex arrangement. This gives a 10-fold increase in theoretical bandwidth.

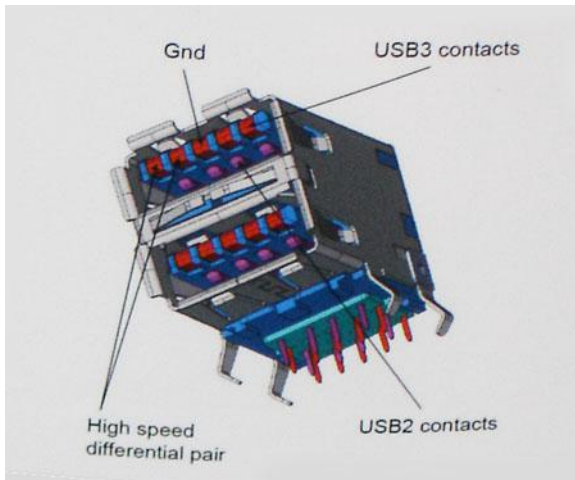

With today's ever increasing demands placed on data transfers with high-definition video content, terabyte storage devices, high megapixel count digital cameras etc., USB 2.0 may not be fast enough. Furthermore, no USB 2.0 connection could ever come close to the 480Mbps theoretical maximum throughput, making data transfer at around 320Mbps (40MB/s) — the actual real-world maximum. Similarly, USB 3.0/USB 3.1 Gen 1 connections will never achieve 4.8Gbps. We will likely see a real-world maximum rate of 400MB/s with overheads. At this speed, USB 3.0/USB 3.1 Gen 1 is a 10x improvement over USB 2.0.

Applications

USB 3.0/USB 3.1 Gen 1 opens up the laneways and provides more headroom for devices to deliver a better overall experience. Where USB video was barely tolerable previously (both from a maximum resolution, latency, and video compression perspective), it's easy to imagine that with 5-10 times the bandwidth available, USB video solutions should work that much better. Single-link DVI requires almost 2Gbps throughput. Where 480Mbps was limiting, 5Gbps is more than promising. With its promised 4.8Gbps speed, the standard will find its way into some products that previously weren't USB territory, like external RAID storage systems.

Listed below are some of the available SuperSpeed USB 3.0/USB 3.1 Gen 1 products:

- External Desktop USB 3.0/USB 3.1 Gen 1 Hard Drives
- Portable USB 3.0/USB 3.1 Gen 1 Hard Drives
- USB 3.0/USB 3.1 Gen 1 Drive Docks & Adapters
- USB 3.0/USB 3.1 Gen 1 Flash Drives & Readers
- USB 3.0/USB 3.1 Gen 1 Solid-state Drives
- USB 3.0/USB 3.1 Gen 1 RAIDs
- Optical Media Drives
- Multimedia Devices
- Networking
- USB 3.0/USB 3.1 Gen 1 Adapter Cards & Hubs

Compatibility

The good news is that USB 3.0/USB 3.1 Gen 1 has been carefully planned from the start to peacefully co-exist with USB 2.0. First of all, while USB 3.0/USB 3.1 Gen 1 specifies new physical connections and thus new cables to take advantage of the higher speed capability of the new protocol, the connector itself remains the same rectangular shape with the four USB 2.0 contacts in the exact same location as before. Five new connections to carry receive and transmitted data independently are present on USB 3.0/USB 3.1 Gen 1 cables and only come into contact when connected to a proper SuperSpeed USB connection.

Major components of your system

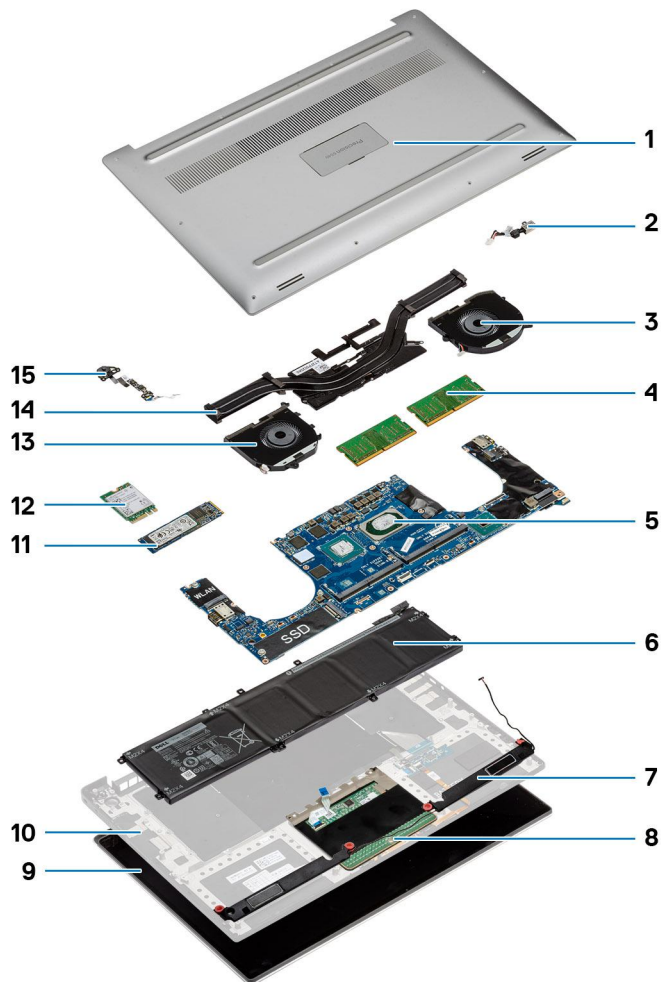

1. Base cover
2. Power connector port
3. System fan
4. Memory modules
5. System board
6. Battery
7. Speaker
8. Touchpad
9. Display Assembly
10. Palmrest Assembly
11. PCIe Solid State Drive (SSD)
12. WLAN card
13. System fan
14. Heatsink assembly
15. Power button

 **NOTE:** Dell provides a list of components and their part numbers for the original system configuration purchased. These parts are available according to warranty coverages purchased by the customer. Contact your Dell sales representative for purchase options.

Disassembly and reassembly

Disassembly and reassembly

Base cover

Installing the Base Cover

Steps

1. Place the base cover on the computer and snap it in place.
2. Tighten the M2x3 T5 (10), M2x8 (2) screws to secure the base cover to the computer.

i **NOTE:** Ensure you use a Torx #5 screwdriver for the base screws and a Philips screwdriver for the two M2x8 system badge screws.

3. Turn the system badge flap over and snap it in place.
4. Follow the procedures in [After Working Inside Your Computer](#).

Removing the Base Cover

Steps

1. Follow the procedures in [Before Working Inside Your Computer](#).
2. Close the display and turn the computer over.
3. Turn the system badge flap over and then remove the M2x3 T5 (10), M2x8.5 (2) screws that secure the base cover to the computer [1,2].

i **NOTE:** Use a Torx #5 screwdriver for the base screws and a Philips screwdriver for the two M2x8.5 screws inside the badge flap.

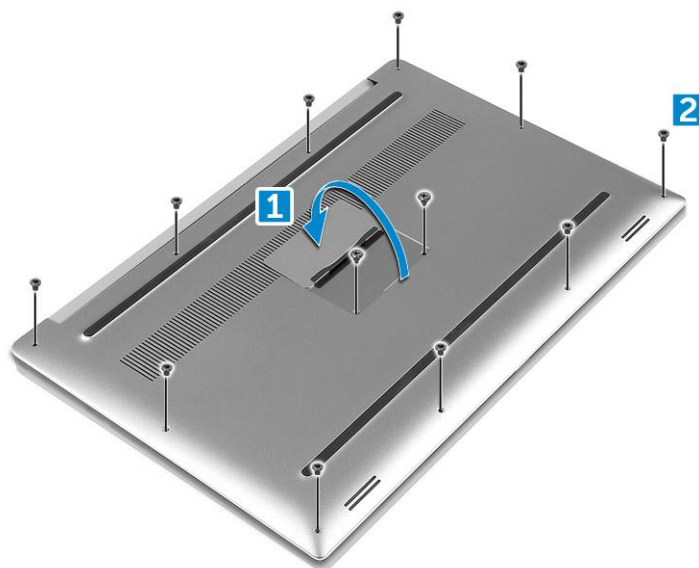

4. Pry the edges of the base cover and lift it to remove it from the computer.

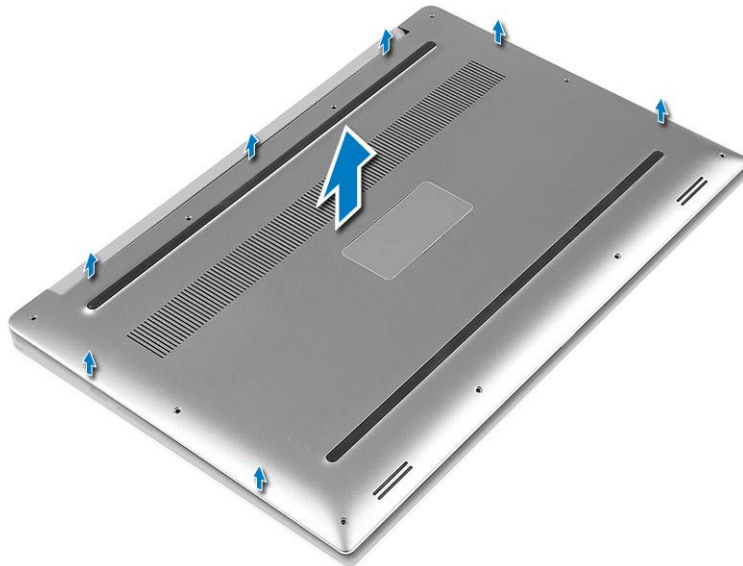

Battery

Lithium-ion battery precautions

⚠ CAUTION:

- Exercise caution when handling Lithium-ion batteries.
- Discharge the battery as much as possible before removing it from the system. This can be done by disconnecting the AC adapter from the system to allow the battery to drain.
- Do not crush, drop, mutilate, or penetrate the battery with foreign objects.
- Do not expose the battery to high temperatures, or disassemble battery packs and cells.
- Do not apply pressure to the surface of the battery.
- Do not bend the battery.
- Do not use tools of any kind to pry on or against the battery.
- Ensure any screws during the servicing of this product are not lost or misplaced, to prevent accidental puncture or damage to the battery and other system components.
- If the battery gets stuck inside your computer as a result of swelling, do not try to release it as puncturing, bending, or crushing a lithium-ion battery can be dangerous. In such an instance, contact Dell technical support for assistance. See www.dell.com/contactdell.
- Always purchase genuine batteries from www.dell.com or authorized Dell partners and resellers.

Removing the Battery

About this task

i **NOTE:** Discharge the battery as much as possible before removing from the system. This can be done by disconnecting the A/C adapter from the system (while the system is turned on) to allow the system to drain the battery.

i **NOTE:** System shipped with 3-Cell battery has 4 screws, the hard drive will be part of the configuration (Optional).

Steps

1. Follow the procedures in [Before Working Inside Your Computer](#).
2. Remove the [base cover](#)
3. Perform the following steps to remove the battery:

- a. Disconnect the battery cable from the system board [1].
 - b. Remove the M2x4 (7) screws that secure the battery to the computer [2].
 - c. Lift the battery off the computer [3].
- **Do not** apply pressure to the surface of the battery
 - **Do not** bend
 - **Do not** use tools of any kind to pry on or against the battery
 - If a battery cannot be removed within the constraints above, please contact Dell technical support

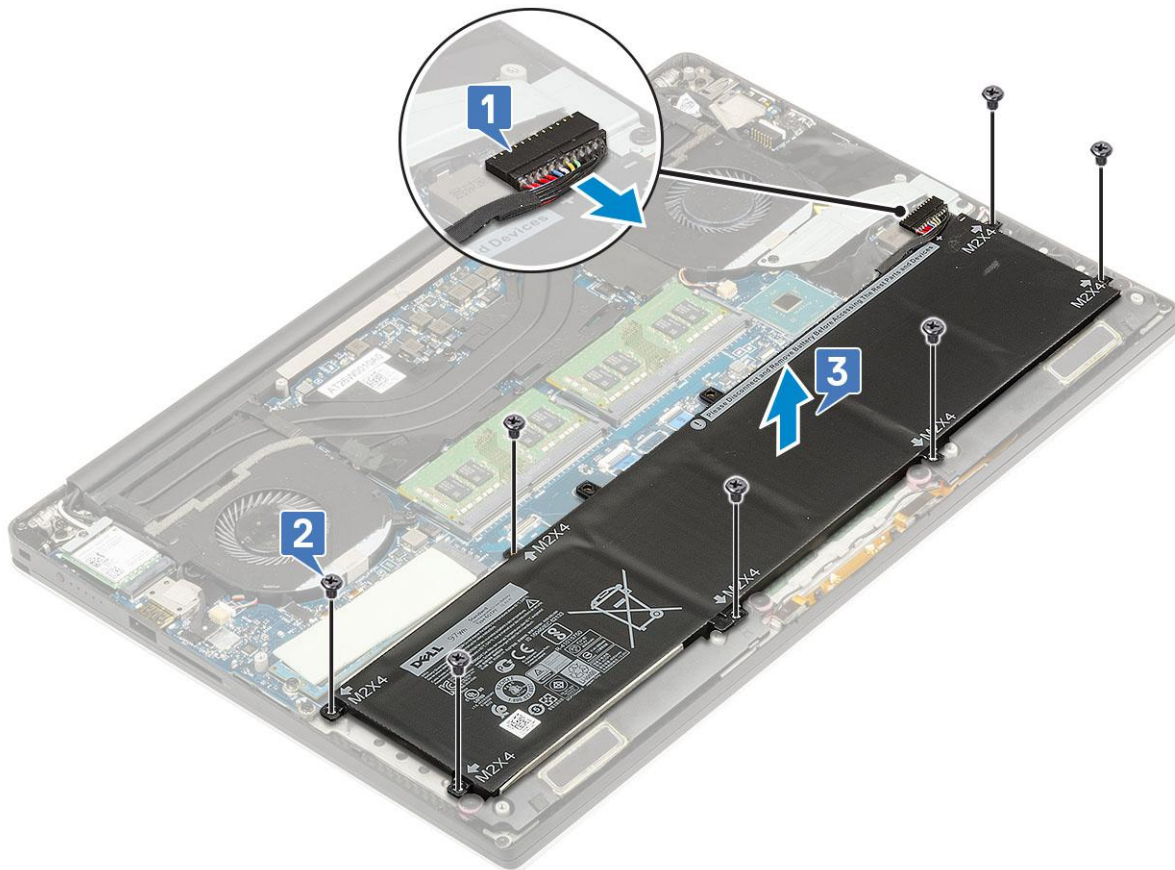

Installing the Battery

Steps

1. Place and align the battery in the battery bay.
2. Tighten the M2x4 (7) screws that secure the battery to the computer.
3. Connect the battery cable to the system board.
4. Install the base cover.
5. Follow the procedures in [After Working Inside Your Computer](#).

PCIe Solid State Drive (SSD)

Removing M.2 Solid State Drive -SSD

Steps

1. Follow the procedures in [Before Working Inside Your Computer](#)
2. Remove the:
 - a. [base cover](#)

b. battery

3. Remove the M2x3 (1) screw that secures the M.2 solid-state drive (SSD) to the system board [1].
4. Lift the M.2 solid-state drive (SSD) from the system board [2].

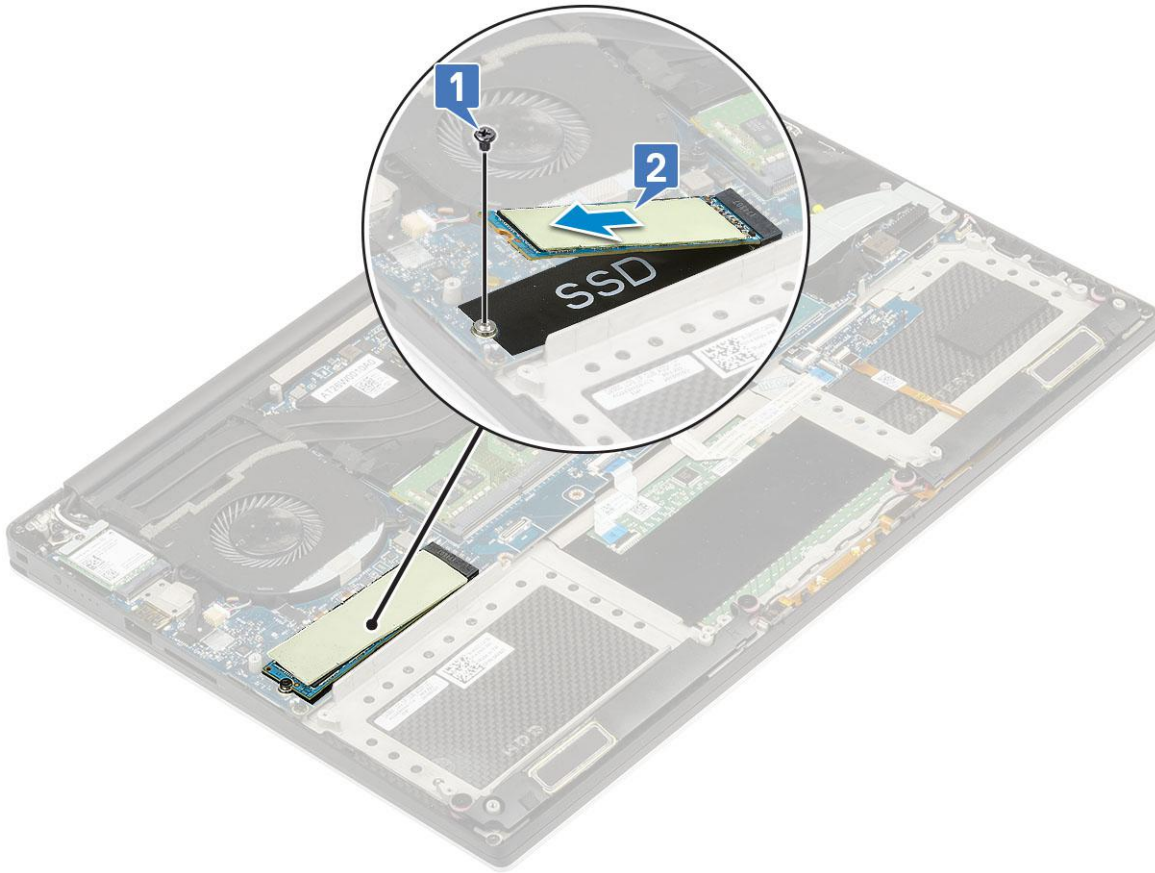

5. Pull the SSD card thermal pad to access the bare SSD card.

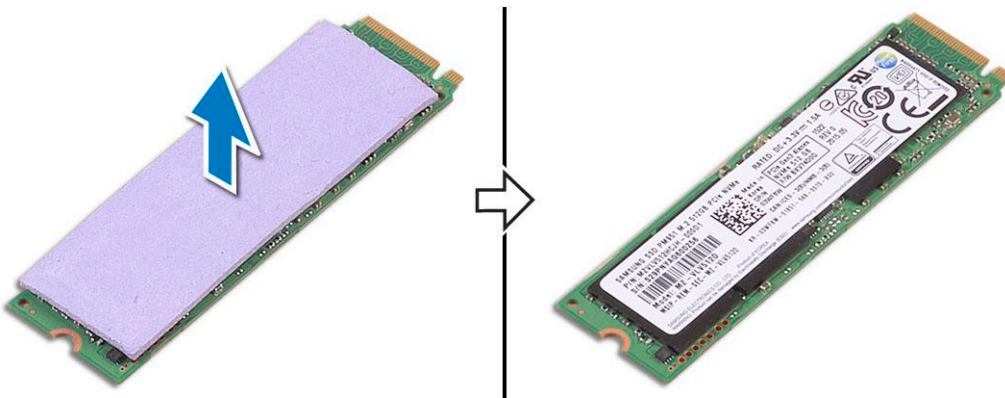

Installing M.2 Solid State Drive -SSD

Steps

1. Adhere the thermal pad to the M.2 solid-state drive.
(i) NOTE: The thermal pad is applicable only for a PCIe SSD card.
2. Slide the M.2 solid-state drive at an angle into the solid-state drive slot.

3. Press the other end of the solid-state drive down and replace the M2x3 (1) screw that secures the solid-state drive to the system board.
4. Install the:
 - a. [battery](#)
 - b. [base cover](#)
5. Follow the procedures in [After Working Inside Your Computer](#).

Hard drive

Removing 2.5 inch Hard Drive -optional

Steps

1. Follow the procedures in [Before Working Inside Your Computer](#).
2. Remove the:
 - a. [base cover](#)
 - b. [battery](#)

 **NOTE:** System shipped with 3-Cell battery, the hard drive will be part of the configuration (Optional).
3. Perform the following steps to remove the hard-drive bracket from the computer:
 - a. Remove the M2x4 (4) screws securing the hard-drive bracket to the computer [1].
 - b. Lift the hard-drive cage [2] off the hard drive assembly [3].

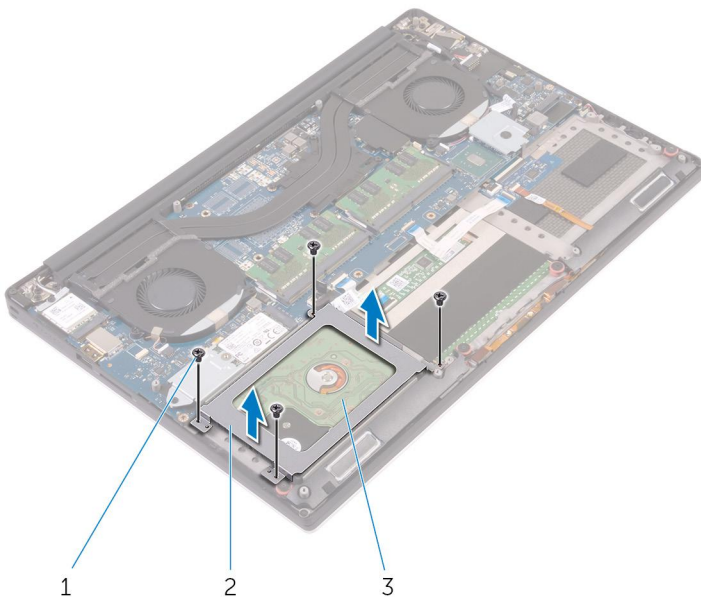

4. Perform the following steps to remove the hard-drive:
 - a. Disconnect the hard-drive cable from the system board [1].
 - b. Lift the hard drive off the palm rest assembly [2].

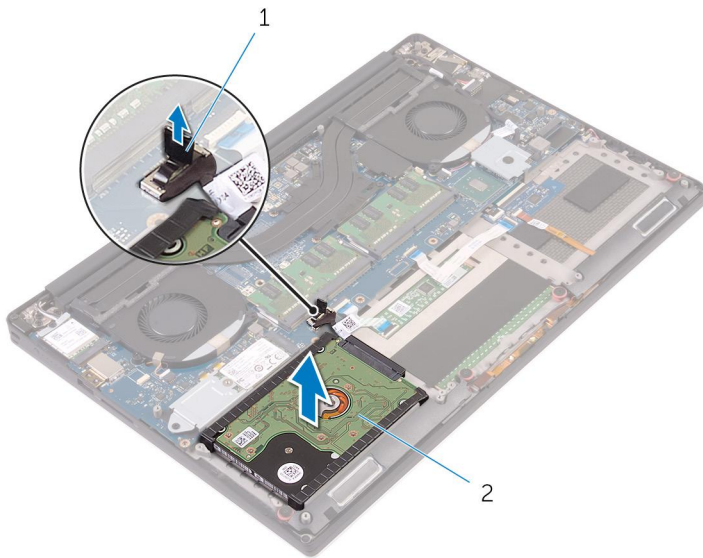

5. Disconnect the hard drive interposer from the hard drive assembly and then remove the hard drive covers away from the hard drive [1,2].

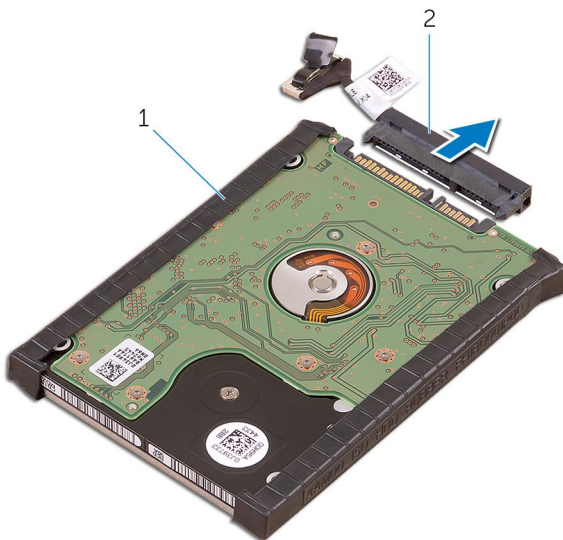

Installing the Hard Drive -optional

Steps

1. Replace the hard-drive covers on the hard drive.
2. Connect the hard-drive interposer to the hard-drive assembly.
3. Place the hard-drive assembly on the palm-rest assembly.
4. Connect the hard-drive cable to the system board.
5. Align the screw holes on the hard-drive cage with the screw holes on the hard-drive assembly.
6. Replace the M2x4 (4) screws that secure the hard-drive cage to the palm-rest assembly.
7. Install the:
 - a. [battery](#)
 - b. [base cover](#)
8. Follow the procedures in [After Working Inside Your Computer](#).

Speaker

Removing the Speakers

Steps

1. Follow the procedures in *Before Working Inside Your Computer*.
2. Remove the:
 - a. [base cover](#)
 - b. [battery](#)
3. Perform the following steps to remove the speaker:
 - a. Disconnect the speaker cable from the system board [1].
 - b. Remove the M2x2 (4) screws that secure the speakers to the computer [2].
 - c. Lift the speakers, along with the speaker cable, off the computer [3].

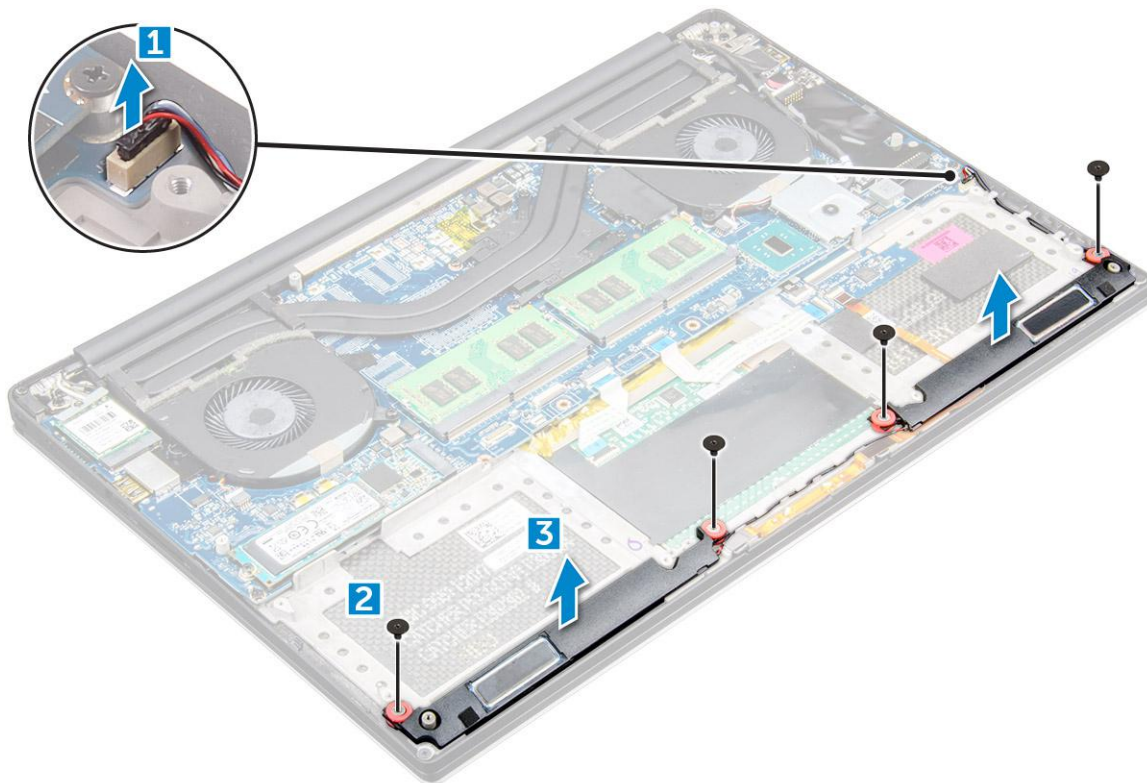

Installing the Speakers

Steps

1. Using the alignment posts, place the speakers on the palm-rest assembly.
2. Replace the M2x2 (4) screws that secure the speakers to the palm-rest assembly.
3. Route the speaker cables through the routing guides on the palm-rest assembly.
4. Connect the speaker cable to the system board.
5. Install the:
 - a. [battery](#)
 - b. [base cover](#)
6. Follow the procedures in *After Working Inside Your Computer*.

WLAN card

Removing the WLAN Card

Steps

1. Follow the procedures in *Before Working Inside Your Computer*.
2. Remove the:
 - a. base cover
 - b. battery
3. Perform the following steps to remove the WLAN card:
 - a. Remove the captive screw to release the bracket that secures the WLAN card to the computer [1] and lift the bracket away from the computer [2].
 - b. Disconnect the antenna cables from the WLAN card [3].
 - c. Slide and remove the WLAN card from its connector on the board [4].

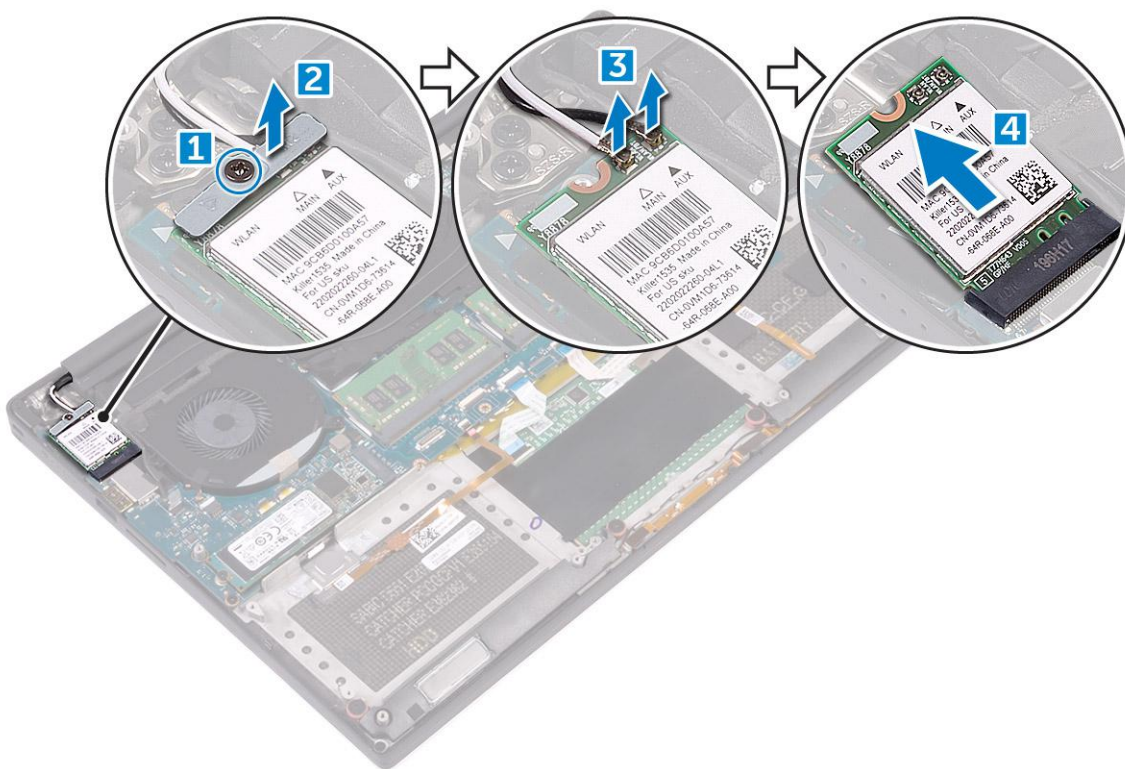

Installing the WLAN Card

Steps

1. Align the notch on the WLAN card with the tab on the WLAN-card connector on the system board.
2. Align the bracket which secures the WLAN card to the palmrest assembly.
3. Connect the antenna cables to the WLAN card.

CAUTION: To avoid damage to the WLAN card, do not place any cables under it.

NOTE: The color of the antenna cables is visible near the tip of the cables. The antenna-cable color scheme for the WLAN card supported by your computer is as follows:

Table 11. Antenna-Cable Color Scheme for the WLAN Card

Connectors on the WLAN card	Antenna-cable color
Main (white triangle)	white
Auxiliary (black triangle)	black
Multiple input, multiple output (grey triangle)	Grey (optional)

4. Tighten the captive screw to secure the bracket and the WLAN card to the palmrest assembly.
5. Install the:
 - a. [Battery](#)
 - b. [Base cover](#)
6. Follow the procedures in [After Working Inside Your Computer](#)

Memory modules

Removing the Memory Modules

Steps

1. Follow the procedures in [Before Working Inside Your Computer](#).
2. Remove the:
 - a. [base cover](#)
 - b. [battery](#)
3. Pry the securing clips away from the memory module until it pops-up [1]. Then, remove the memory module from its connector on the system board [2].

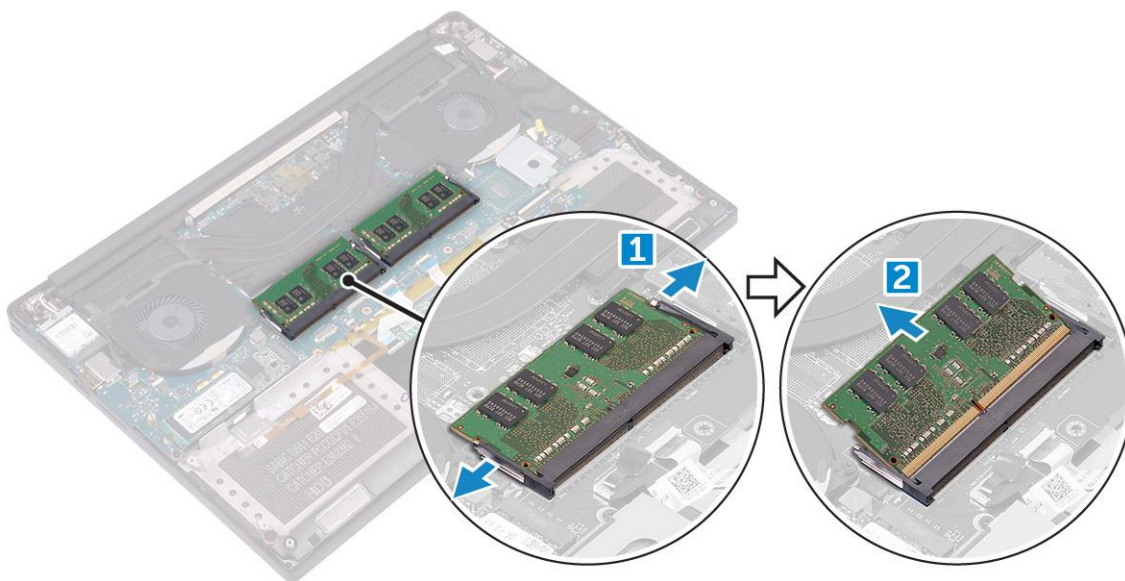

Installing the Memory Modules

Steps

1. Insert the memory module into the memory socket.
2. Press the memory module down until it clicks into place.
NOTE: If you do not hear the click, remove the memory module and re-install it.
3. Install the:

- a. Battery
 - b. Base cover
4. Follow the procedures in [After Working Inside Your Computer](#).

System fan

Removing the Fans

Steps

1. Follow the procedures in [Before Working Inside Your Computer](#).
2. Remove the:
 - a. base cover
 - b. battery
3. Perform the following steps to remove the left video-card fan:
 - a. Release the Mylar tape that secures the cable to the system board [1].
 - b. Disconnect the fan cable from the system board [2]
 - c. Remove the M2x4 (2) screws that secure the fan to the system board [3].
 - d. Lift the fan away from the computer [4]

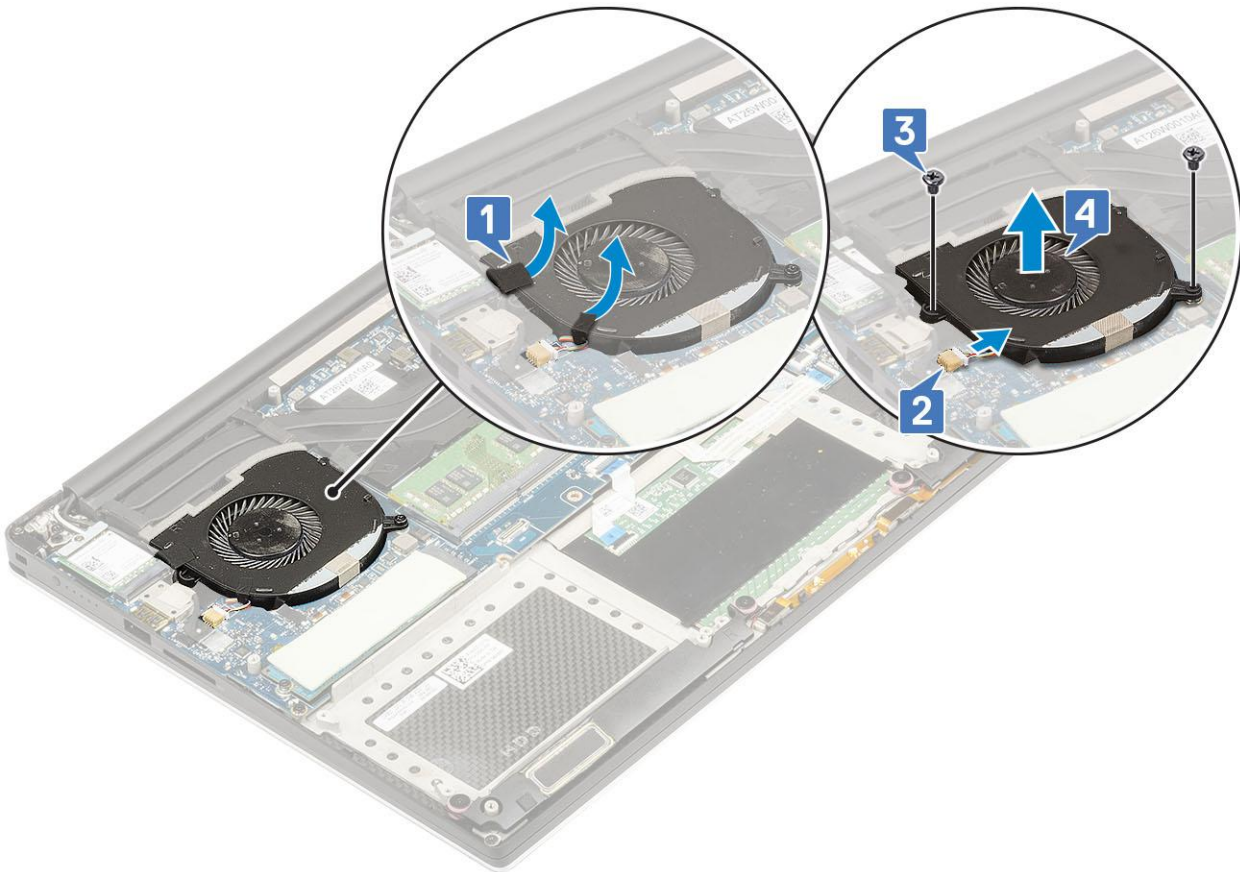

4. Perform the following steps to remove the right system fan:
 - a. Remove the M2x4 (2) screws and lift the metal bracket that holds the left video-card fan to the system board [1].
 - b. Lift the metal bracket that secures the DisplayPort over Type-C [2].

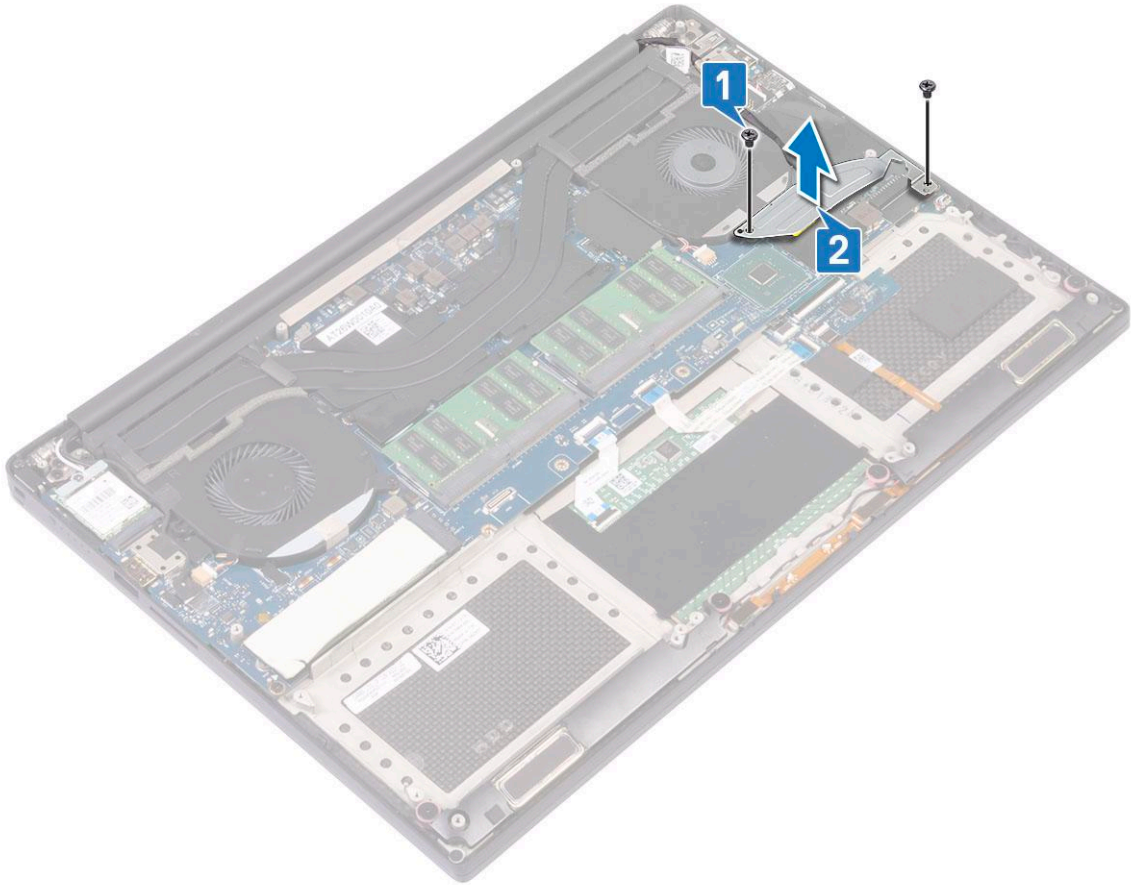

- c. Disconnect the display cable from the system board [1].
- d. Un-route the display cable from the restraints [2]
- e. Disconnect the system fan cable from the system board [3].
- f. Remove the M2x4 (2) screws that secure the system fan to the system board [4].
- g. Lift the fan away from the laptop [5].

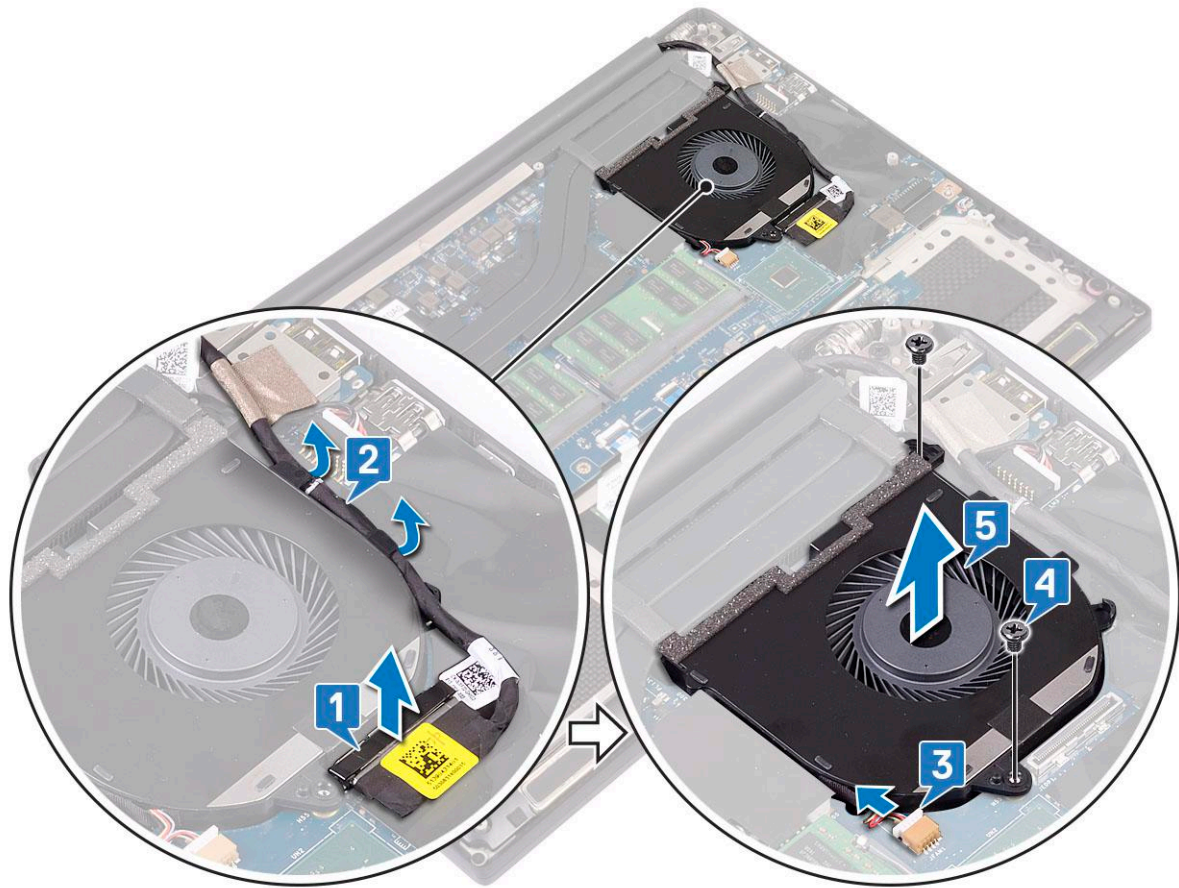

Installing the Fans

Steps

1. Perform the following steps to install the system fan:
 - a. Align the screw holes on the left fan with the screw holes on the palm-rest assembly.
 - b. Connect the left fan cable to the system board.
 - c. Route the display cable through the routing guides on the left fan.
 - d. Replace the M2x4 (2) screws that secure the left fan to the system board.
 - e. Align the right fan to the system board.
 - f. Route the touch-screen cable through the routing guides on the right fan.
 - g. Connect the touch-screen cable to the system board.
 - h. Connect the fan cable to the connector to the system board.
 - i. Replace the Mylar tape that secures the cable to the system board
 - j. Align the metal brackets that secure touch-screen cable and DisplayPort Over Type-C cable.
 - k. Replace the M2x4 (2) screws that secure the metal brackets and right fan to the system board.
 - a. Install the [Base cover](#)
2. Follow the procedures in [After Working Inside Your Computer](#).

Heat sink assembly

Removing the Heatsink

Steps

1. Follow the procedures in [Before Working Inside Your Computer](#).

2. Remove the:

CAUTION: The heat sink may become hot during normal operation. Allow sufficient time for the heat sink to cool before you touch.

NOTE: The Heatsink removal screw may vary depending upon the type of Heatsink installed.

- a. base cover
- b. battery

3. Remove the M2x3 (5) screws that secure the heatsink to the system board.

NOTE: Ensure to remove the screws in the order (1,2,3,4,5). See the printed image number order on the top of heatsink.

4. Lift the heatsink away from the system board [2].

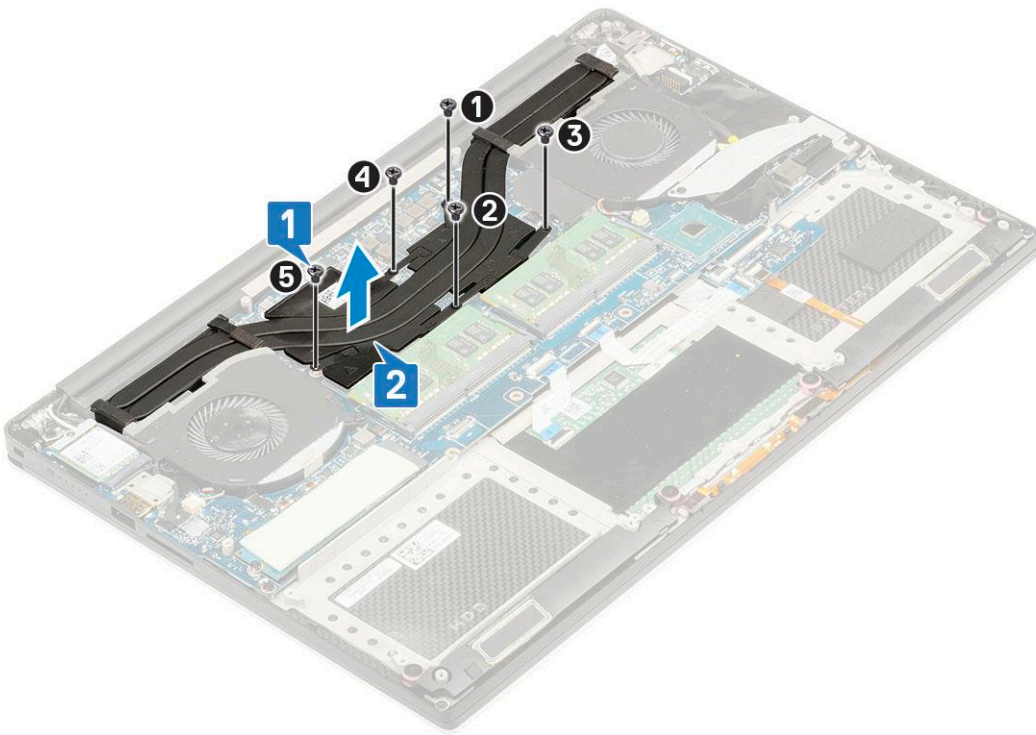

Installing the Heatsink

Steps

1. Align the heatsink with the screw holes on the system board.

2. Replace the M2x3 (5) screws to secure the heatsink to the system board.

NOTE: Ensure to replace the screws in the order (1,2,3,4,5). See the printed image number order on the top of heatsink

3. Install the:

- a. Battery
- b. Base cover

4. Follow the procedures in [After Working Inside Your Computer](#)

Power connector port

Removing the DC-in Connector

Steps

1. Follow the procedures in *Before Working Inside Your Computer*.
2. Remove the:
 - a. [base cover](#)
 - b. [battery](#)
3. Perform the following steps to remove the I/O board:
 - a. Disconnect the DC-in cable from the connector to the system board [1].
 - b. Remove the M2x3 screw that secures the DC-in connector to the computer [2].
 - c. Lift the DC-in connector from the computer [3].

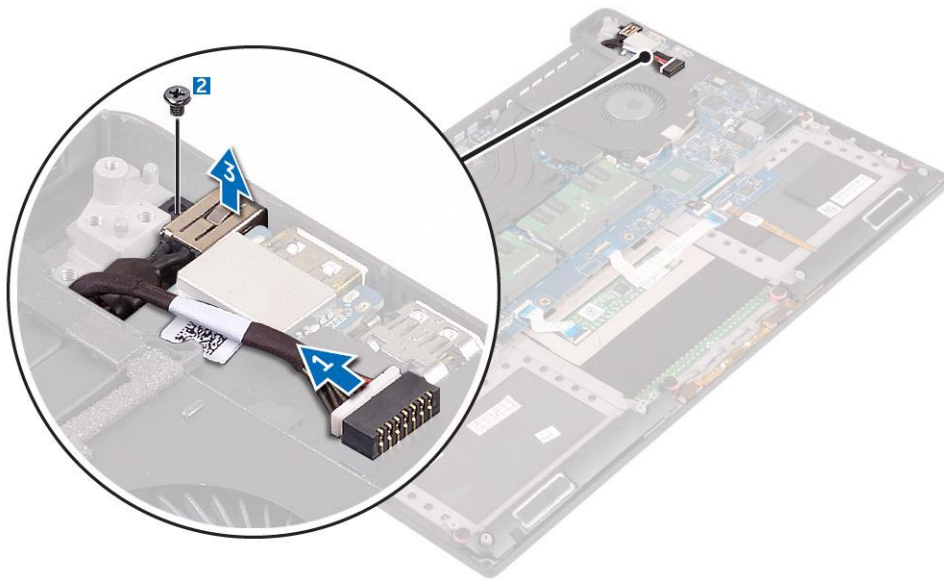

Installing the DC-in Adapter Port

Steps

1. Place the DC-in adapter port into the slot on the palm-rest assembly.
2. Route the power-adapter port cable through its routing guides on the palm-rest assembly.
3. Replace the M2x3 screw that secures the power-adapter port to the palm-rest assembly.
4. Connect the power-adapter port cable to the system board.
5. Install the:
 - a. [Battery](#)
 - b. [Base cover](#)
6. Follow the procedures in *After Working Inside Your Computer*.

System board

Removing the System Board

Steps

1. Follow the procedures in *Before Working Inside Your Computer*.

2. Remove the:
 - a. base cover
 - b. battery
 - c. fans
 - d. heatsink assembly
 - e. WLAN
 - f. hard drive (optional)
 - g. keyboard
 - h. SSD
 - i. memory modules

i **NOTE:** Your computer's Service Tag is located under the system badge flap. You must enter the Service Tag in the BIOS after you replace the system board.

i **NOTE:** Before disconnecting the cables from the system board, note the location of the connectors so that you can re-connect them correctly after you replace the system board.

3. To remove the system board:
 - a. Lift the latch and disconnect the touchpad cable [1].
 - b. Lift the latch and disconnect the keyboard controller board cable [2].
 - c. Disconnect the power connector port cable from the system board [3].
 - d. Disconnect the speaker cable from the connector from the system board [4].
 - e. Peel the adhesive tape and lift the latch to remove the fingerprint cable [5]
 - f. Lift the plastic lever and disconnect the display touchscreen cable [6]
 - g. Peel the adhesive tape to release the touch screen cable.

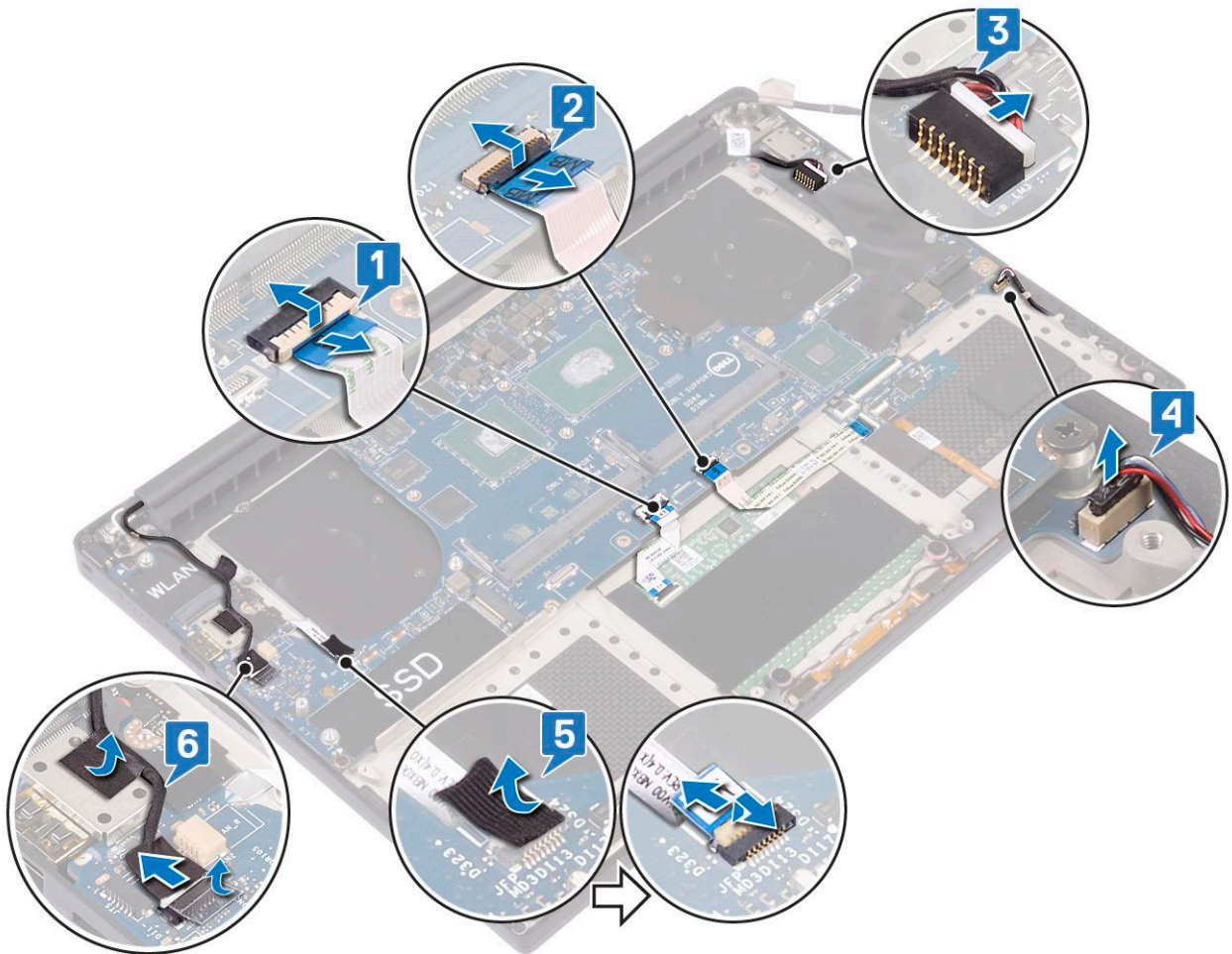

4. Perform the following steps to remove the system board from the chassis:
 - a. Remove the M2x4 (4) screws that secure the system board to the computer [1].

b. Lift the system board from the computer [2].

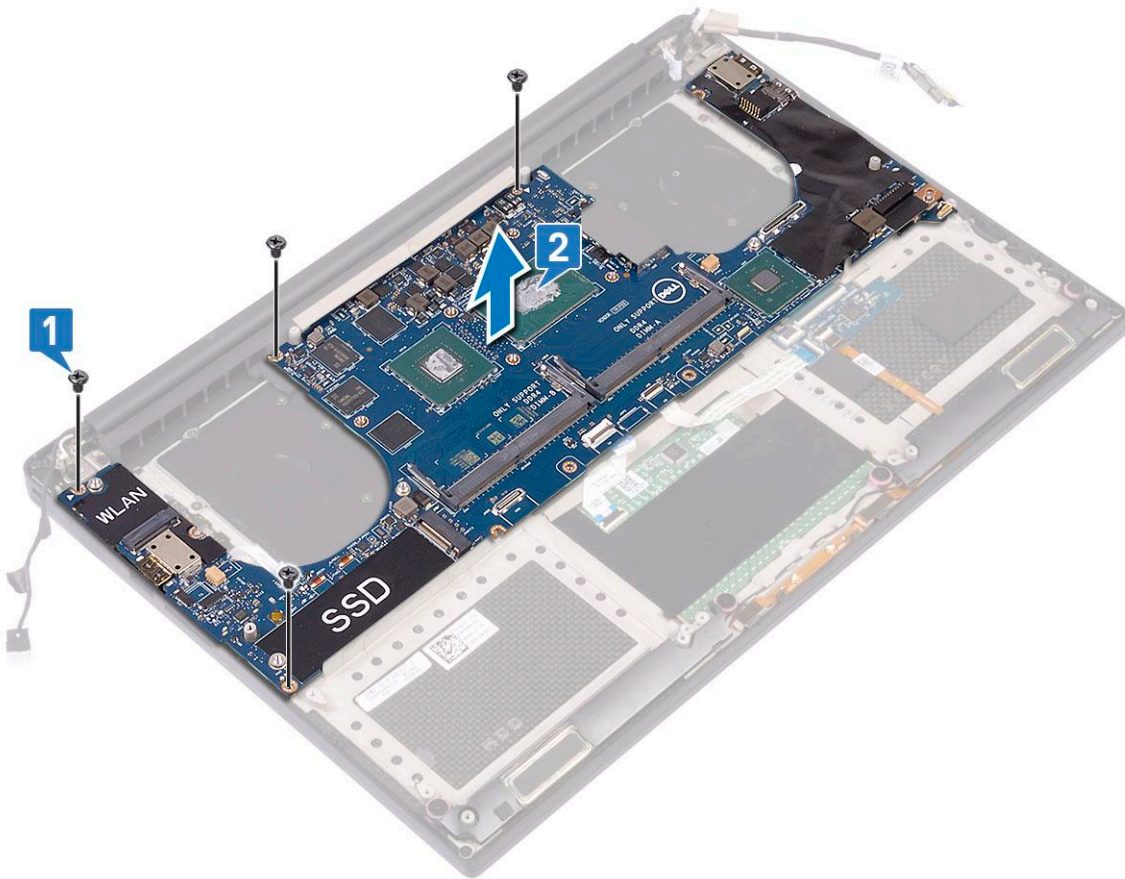

Installing the System Board

Steps

1. Hold the system board at the center. Avoid holding the system board by the "neck" area to avoid damaging it.
2. Replace the M2x4 (4) screws that secure the system board to the palm-rest assembly.
3. Angle the system board onto the palm-rest assembly with the SD-card slot side. Angling it this way while mounting the system board gives sufficient clearance as the audio daughter-board is beneath the other side of the system board.



4. Connect the power-adaptor port cable, speaker cable, keyboard-control board cable, touchpad cable, and touch-screen cable to the system board.
5. Connect the display cable to the system board.
6. Align the display-cable bracket with the screw hole on the system board and replace the screw (2).
7. Install the:
 - a. [Memory](#)
 - b. [SSD](#)
 - c. [Keyboard](#)
 - d. [Heatsink assembly](#)
 - e. [Fans](#)
 - f. [Hard drive\(optional\)](#)
 - g. [WLAN card](#)
 - h. [Battery](#)
 - i. [Base cover](#)
8. Follow the procedures in [After Working Inside Your Computer](#).

Audio board

Removing Audio board

Steps

1. Follow the procedures in [Before Working Inside Your Computer](#).
2. Remove the:
 - a. [base cover](#)
 - b. [battery](#)
 - c. [WLAN card](#)
 - d. [hard drive](#)
 - e. [fans](#)
 - f. [heatsink assembly](#)
 - g. [memory modules](#)
 - h. [system board](#)
3. Perform the following steps to remove the audio board:
 - a. Turn the system board over.

- b. Remove the M2x3 (2) screws that secure the audio board to the system board [1].
- c. Lift up the audio board [2].

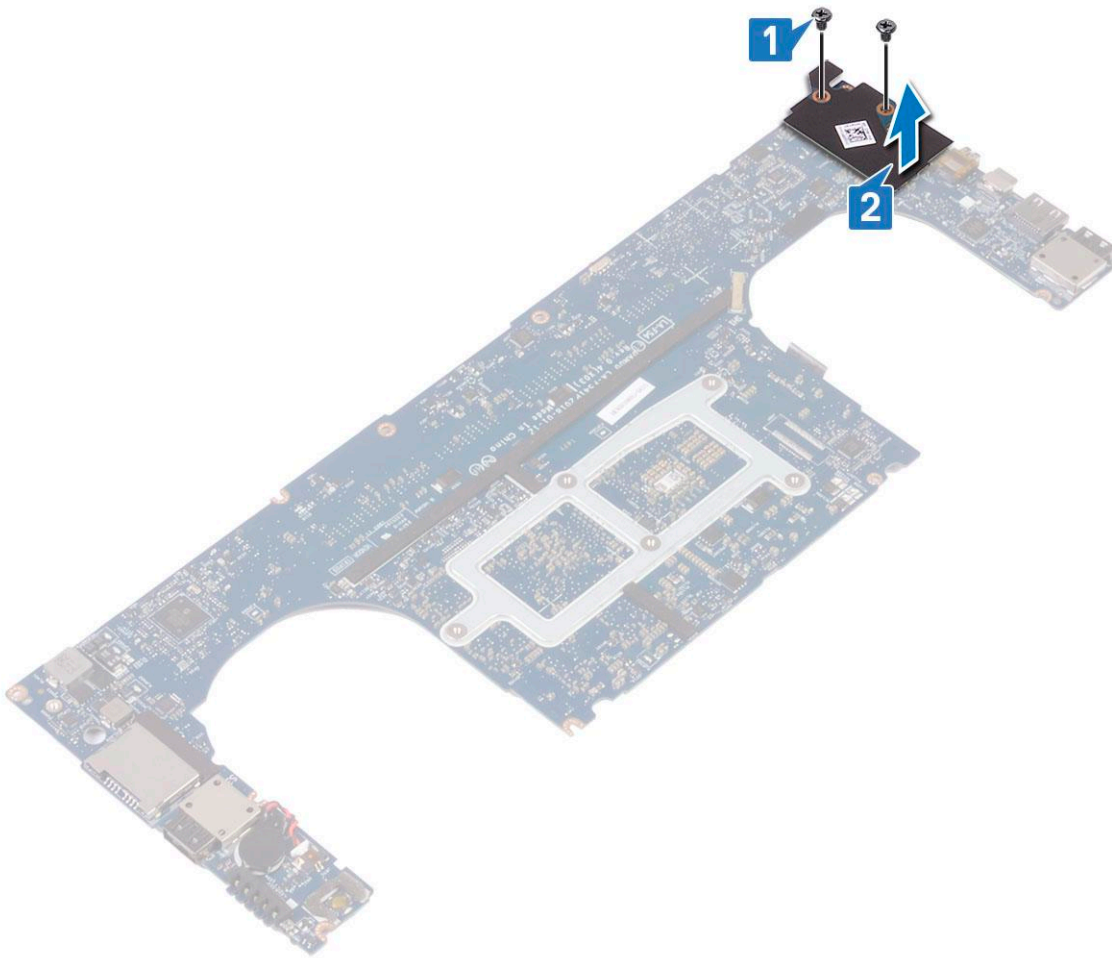

Installing audio board

Steps

1. Align the audio port in the slot of the system board.
2. Replace the M2x3 (2) screws to secure the audio board to the system board.
3. Turn the system board over.
4. Install the:
 - a. [System Board](#)
 - b. [Memory](#)
 - c. [Heatsink assembly](#)
 - d. [Fans](#)
 - e. [Hard drive](#)
 - f. [WLAN card](#)
 - g. [Battery](#)
 - h. [Base cover](#)
5. Follow the procedures in [After Working Inside Your Computer](#).

Coin-cell battery

Removing the Coin-Cell Battery

Steps

1. Follow the procedures in [Before Working Inside Your Computer](#).

 **CAUTION:** Removing the coin-cell battery re-sets the BIOS settings to default. It is recommended that you note the BIOS settings before removing the coin-cell battery.

2. Remove the:
 - a. base cover
 - b. battery
 - c. WLAN card
 - d. hard drive
 - e. fans
 - f. heatsink assembly
 - g. memory modules
 - h. system board
3. Perform the following steps to remove the coin-cell battery:
 - a. Turn the system board over.
 - b. Disconnect the coin-cell battery cable from the system board [1].
 - c. Lift up the coin-cell battery [2].

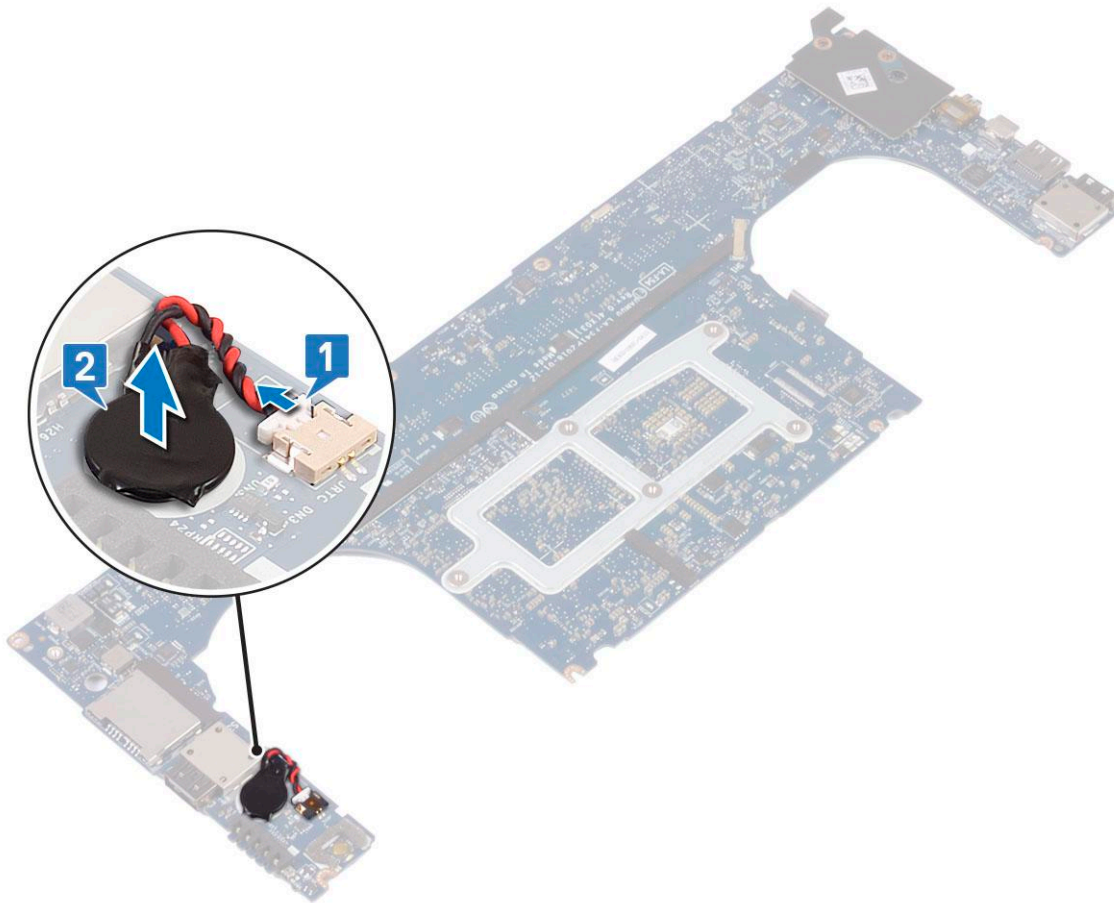

Installing the Coin-Cell Battery

Steps

1. Replace the coin-cell battery in its slot in the computer.
2. Connect the coin-cell battery cable to the system board.
3. Turn the system board over.
4. Install the:
 - a. [System Board](#)
 - b. [Memory](#)
 - c. [Heatsink assembly](#)
 - d. [Fans](#)
 - e. [Hard drive](#)
 - f. [WLAN card](#)
 - g. [Battery](#)
 - h. [Base cover](#)
5. Follow the procedures in [After Working Inside Your Computer](#).

Power button

Removing power button

Steps

1. Follow the procedures in [Before Working Inside Your Computer](#).
 2. Remove the:
 - a. [base cover](#)
 - b. [battery](#)
 - c. System board
 3. Perform the following steps to remove the power button:
 - a. Remove the M1.6x3 (2) screws that secure the power button module to the system board [1].
 - b. Lift the power button away from the system chassis [2].
- NOTE:** There are two power button options:
- Power button function with light indicator.
 - Power button with fingerprint reader function without light indicator. (optional)

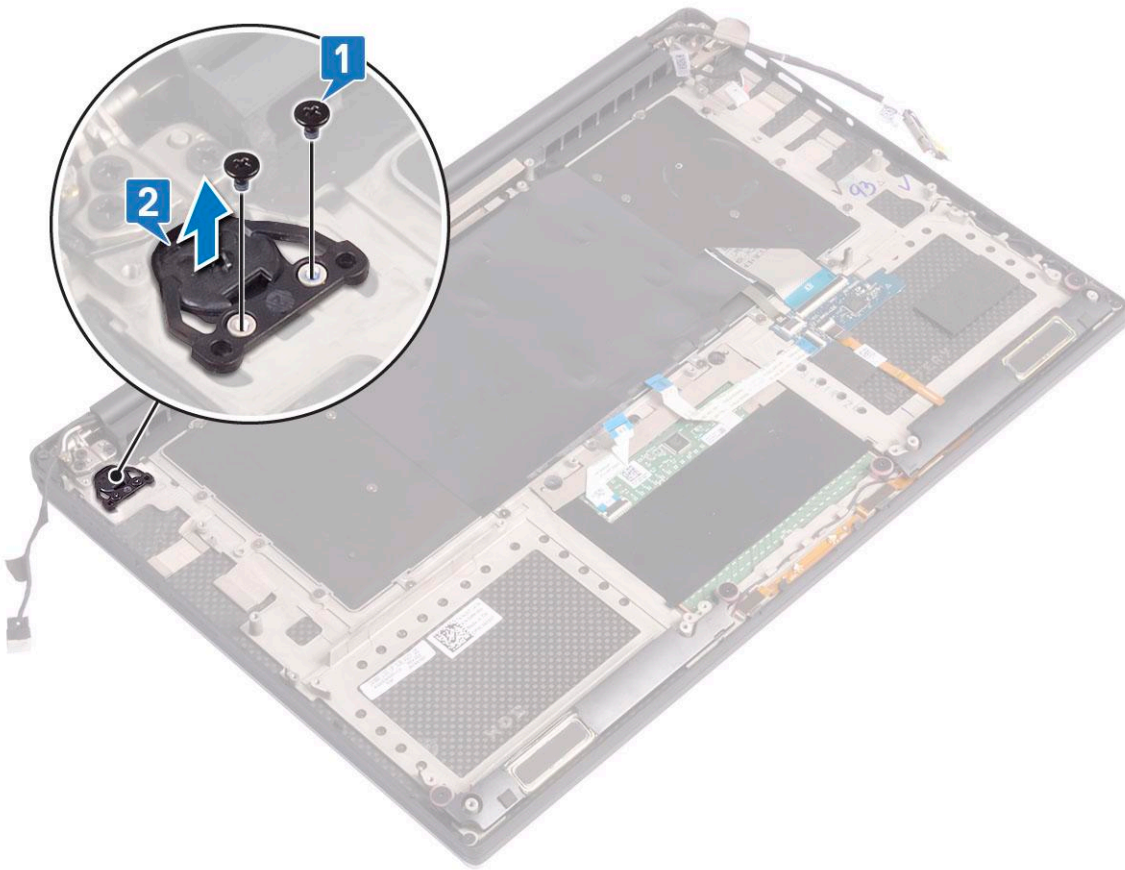

Installing power button

Steps

1. Align the power button into the slot on the system chassis.
2. Replace the M1.6x3 (2) screws that secure the power button to the system board.
3. Install the:
 - a. [Battery](#)
 - b. [Base cover](#)
4. Follow the procedures in [After Working Inside Your Computer](#).

Power button with fingerprint reader -optional

Removing power button with fingerprint reader

Steps

1. Follow the procedures in [Before Working Inside Your Computer](#).
2. Remove the:
 - a. [base cover](#)
 - b. [battery](#)
3. Perform the following steps to remove the power button:
 - a. Remove the M1.6x3 (2) screws that secure the power button to the system board [1].
 - i** **NOTE:** There are two power button options:
 - Power button function with light indicator.

- Power button with fingerprint reader function without light indicator (optional).

- Release the Mylar tape that secures the power button board to the system chassis [2].
- Remove the M1.6x1.5 (1) screw that secures the power button board to the system chassis [3].
- Disconnect and release the adhesive data cable from the system chassis [4].
- Lift the power button board away from the system chassis [5].

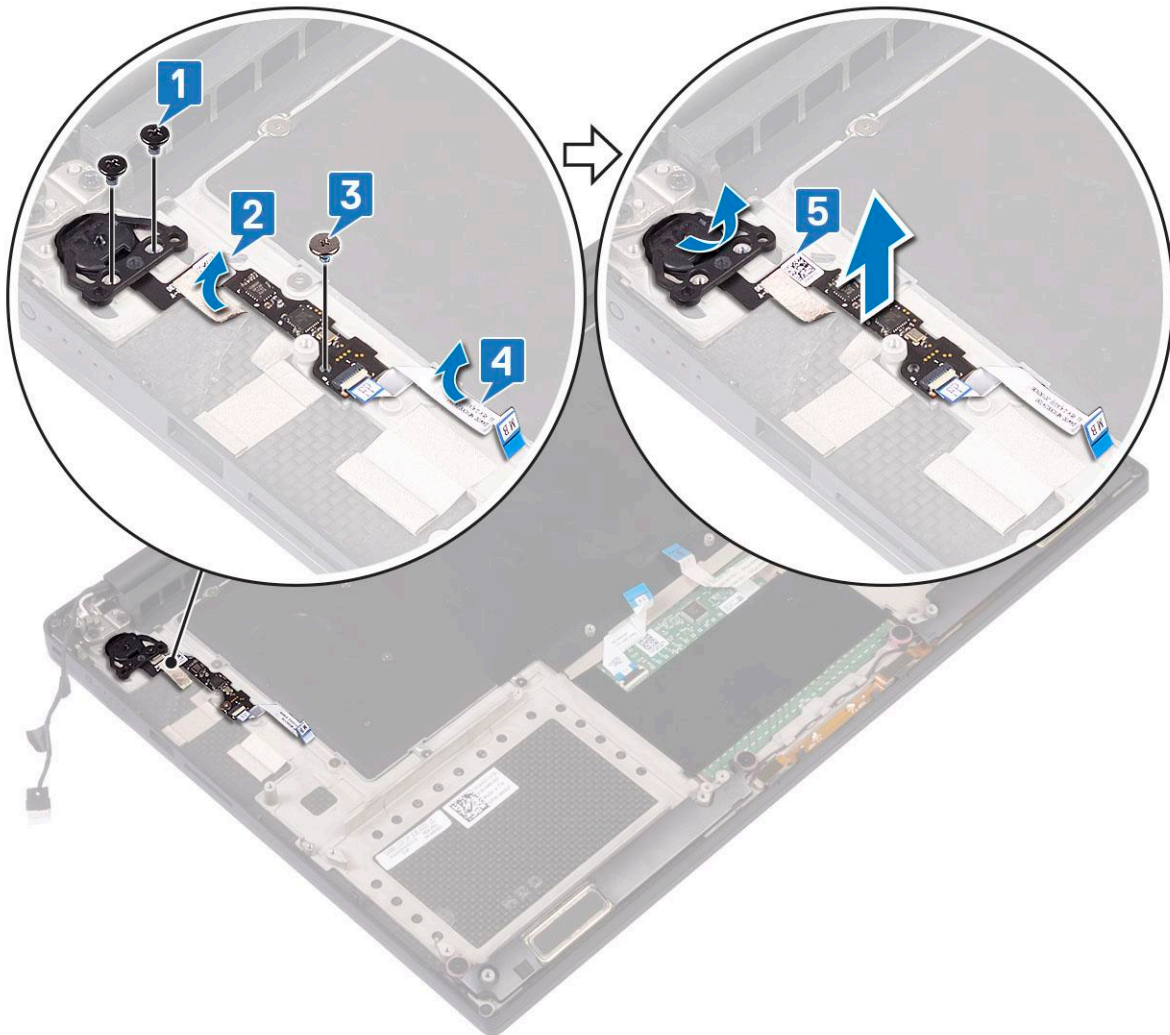

Installing power button with fingerprint reader

Steps

- Place the power button into the slot on the system chassis.

NOTE: There are two power button options:

- Power button function with light indicator.
- Power button with fingerprint reader function without light indicator (optional).

- Connect the adhesive data cable to the system chassis .
- Replace the M2x3 screw that secures the power button board to the system chassis.
- Replace the Mylar tape that secures the power button board to the system chassis.
- Replace the M2x4 (2) screws that secure the power button to the system board.
- Install the:
 - Battery
 - Base cover

7. Follow the procedures in [After Working Inside Your Computer](#).

Display Assembly

Removing the Display Assembly

Steps

1. Follow the procedures in [Before Working Inside Your Computer](#).
2. Remove the:
 - a. [base cover](#)
 - b. [battery](#)
3. Perform the following steps:
 - a. Release the Mylar tape that secures the display cable to the system board [1].
 - b. Lift the latch and disconnect the display cable from the connector on the system board [2].
 - c. Release the Mylar tape that secures the display cable to the system board [3].
 - d. Remove the M2x4 (2) screws and lift the metal bracket that holds the left video-card fan to the system board [4].
 - e. Un-route the display cable from the restraints clips [5]
 - f. Disconnect the display cable from the system board [6].

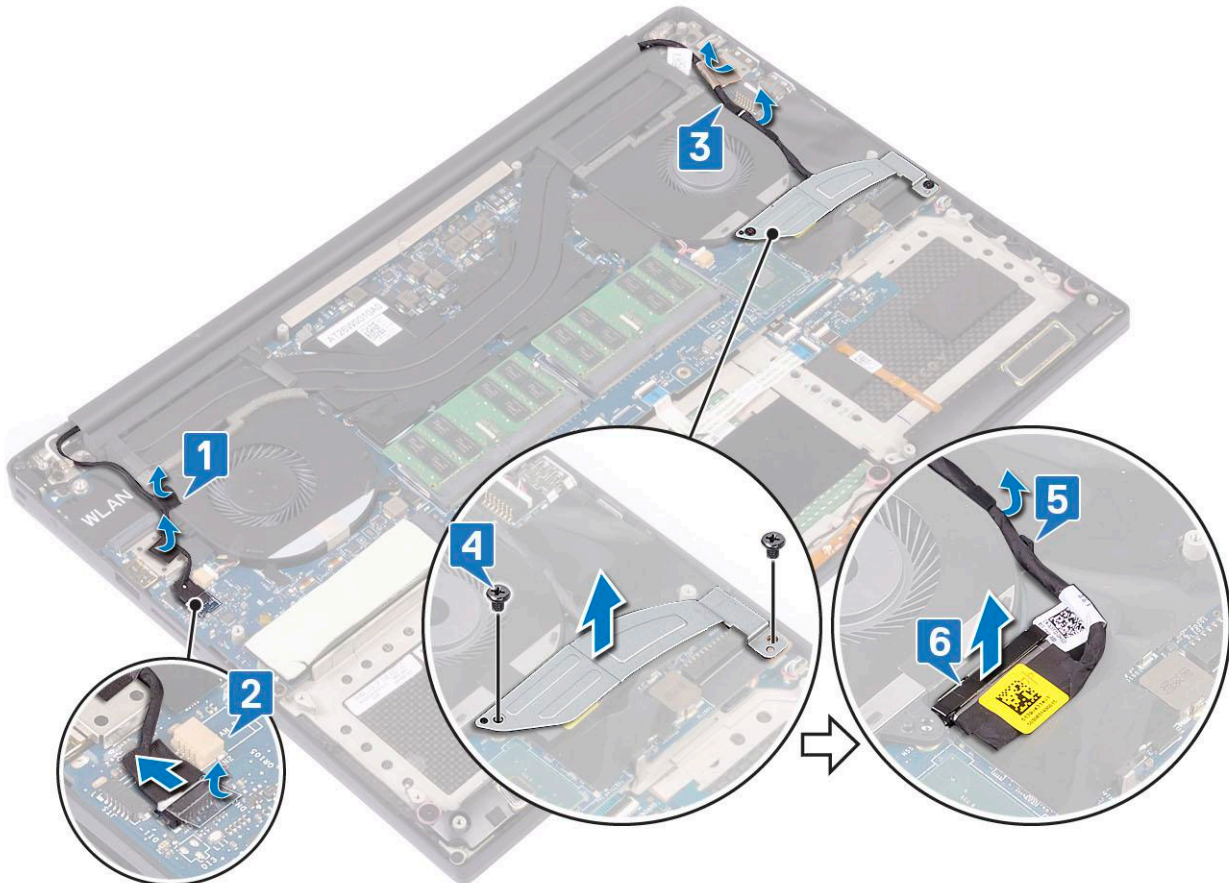

4. To remove the display assembly:
 - a. Place the computer at the edge of a flat surface and remove the M2.5x5 (6) screws securing the display assembly to the system chassis [1].
 - b. Lift the display assembly away from the system chassis [2].



Installing the Display Assembly

Steps

1. Place the palm-rest assembly at the edge of the table with the speakers facing away from the edge.
2. Align the screw holes on the palm-rest assembly with the screw holes on the display hinges.
3. Replace the M2.5 x 5 (6) screws that secure the display hinges to the palm-rest assembly.
4. Route the touchscreen cable through the routing guides on the fan.
5. Connect the touchscreen cable and display cable to the system board.
6. Replace the screw (2) that secures the display-cable bracket to the system board.
7. Install the:
 - a. [Battery](#)
 - b. [Base cover](#)
8. Follow the procedures in [After Working Inside Your Computer](#)

Antenna cover

Removing antenna

Steps

1. Follow the procedures in [Before Working Inside Your Computer](#).

2. Remove the:
 - a. [base cover](#)
 - b. [battery](#)
 - c. [WLAN card](#)
 - d. [display assembly](#)
3. Gently place the system on a flat surface .
4. Rotate the hinges to angle 45° to release the antenna cable.

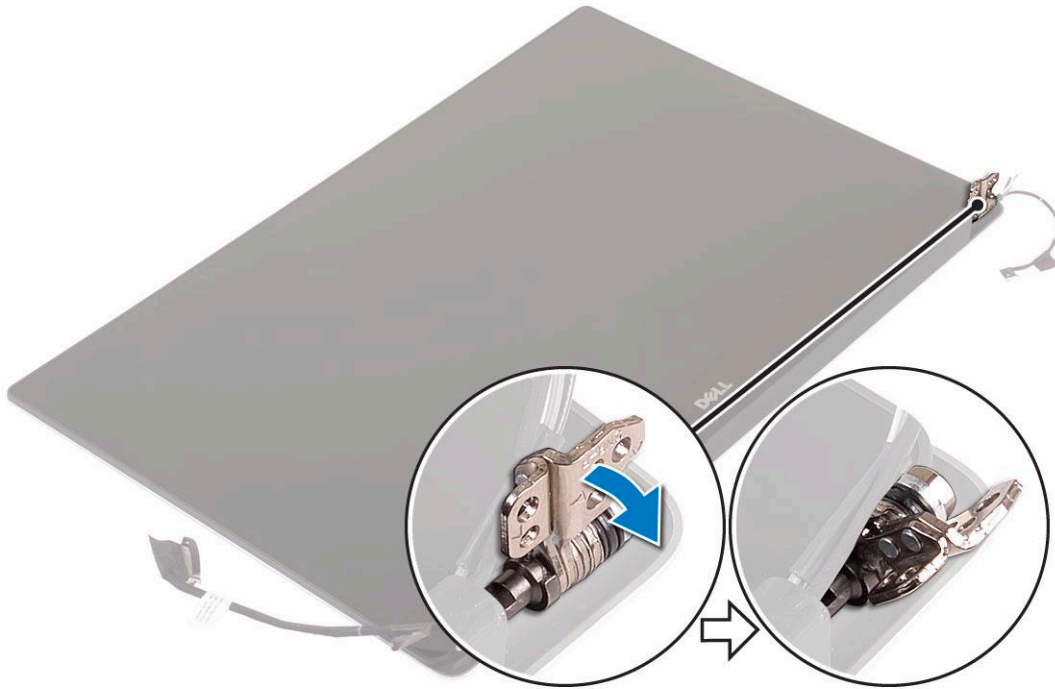

5. Slide and lift the antenna cover away from the display assembly.



6. To remove the antenna module:
 - a. Remove the copper tapes that secure the antenna module [1].

- b. Remove the M2x4 (4) screws and lift the metal brackets that secure the antenna cable [2,3].

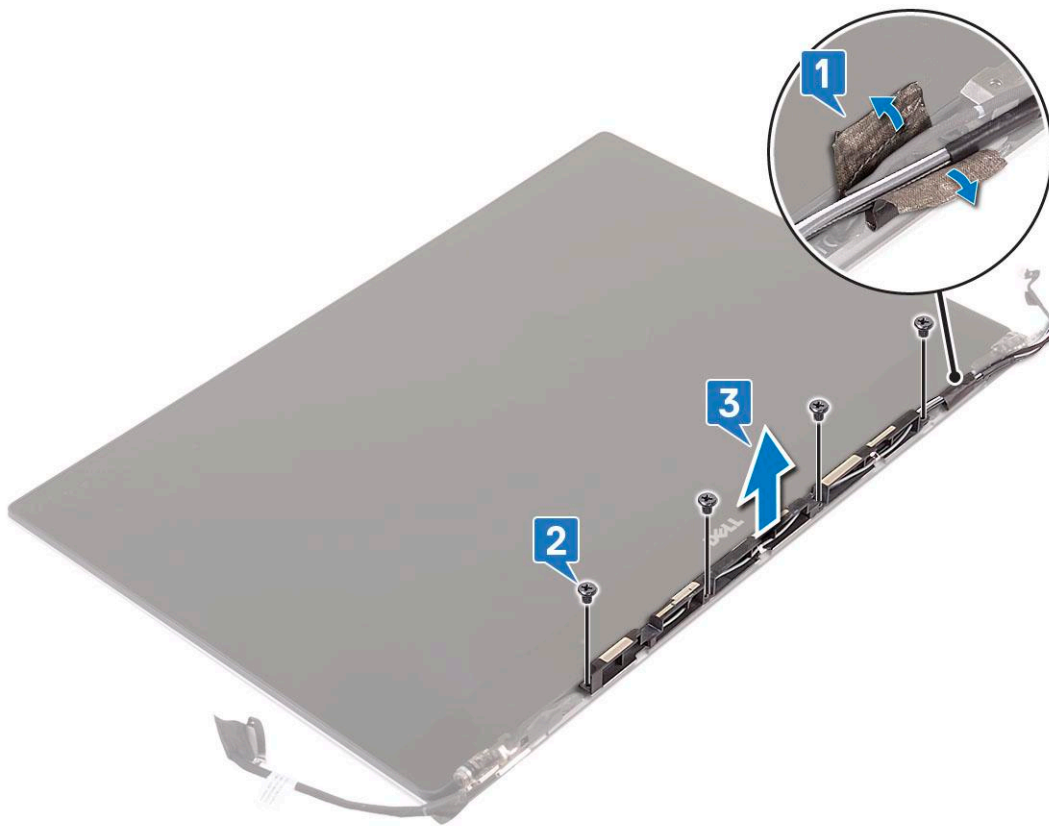

Installing the antenna cover

Steps

1. Replace the antenna cover on the display assembly.
2. Turn the display hinges to the normal position.
3. Install the:
 - a. [Display assembly](#)
 - b. [WLAN card](#)
 - c. [Battery](#)
 - d. [Base cover](#)
4. Follow the procedures in [After Working Inside Your Computer](#).

Keyboard lattice and Keyboard

Removing the Keyboard

Steps

1. Follow the procedures in [Before Working Inside Your Computer](#).
2. Remove the:
 - a. [base cover](#)
 - b. [battery](#)
 - c. [fans](#)
 - d. [heatsink assembly](#)
 - e. [SSD](#)

- f. memory modules
- g. system board

3. Perform the following steps to disconnect the keyboard and backlight connectors from the computer.
 - a. Lift up the latch [1] and the disconnect the cables from the connectors [2].
 - b. Peel back the screw shields [3].

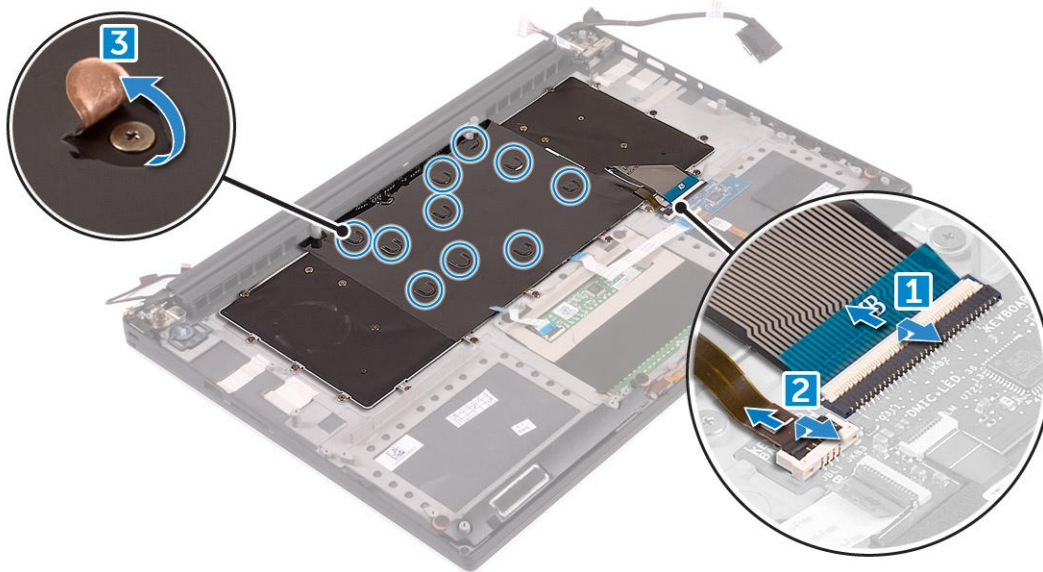

4. Un-route the Keyboard cable [1] and then remove the M1.6 x 1.5 (31) screws that secure the keyboard to the computer [2].

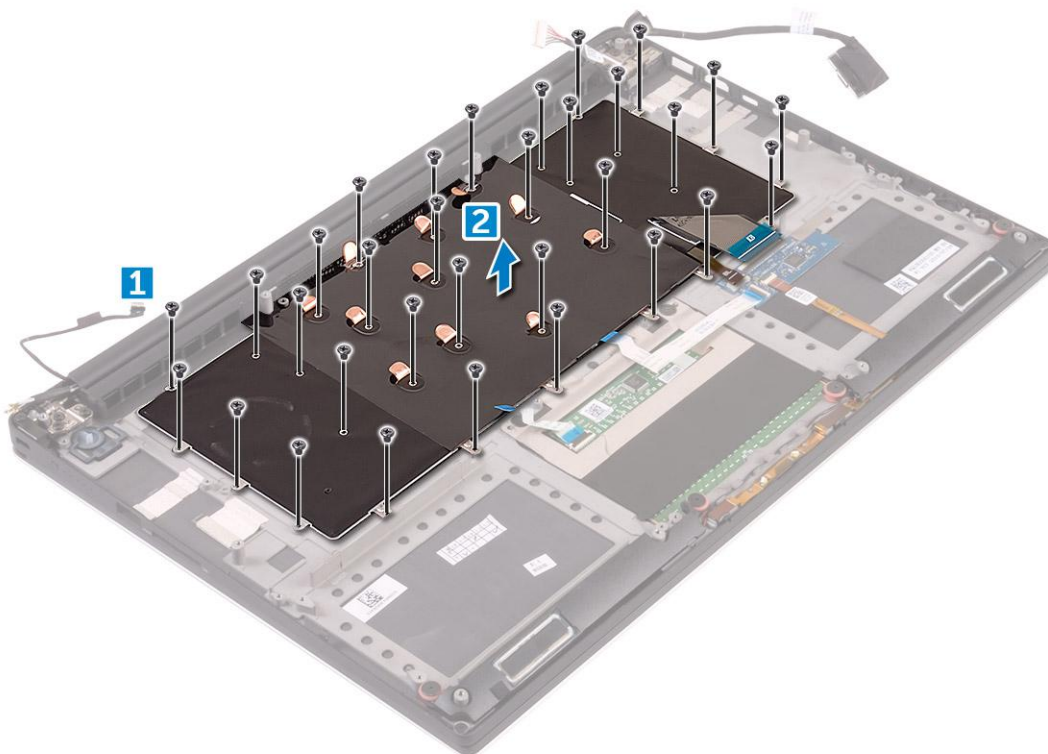

5. Disconnect the cable from the connector on the system board.
6. Remove the screw (2) that secures the keyboard pad to the system board.
7. Lift and remove the keyboard from the system chassis.

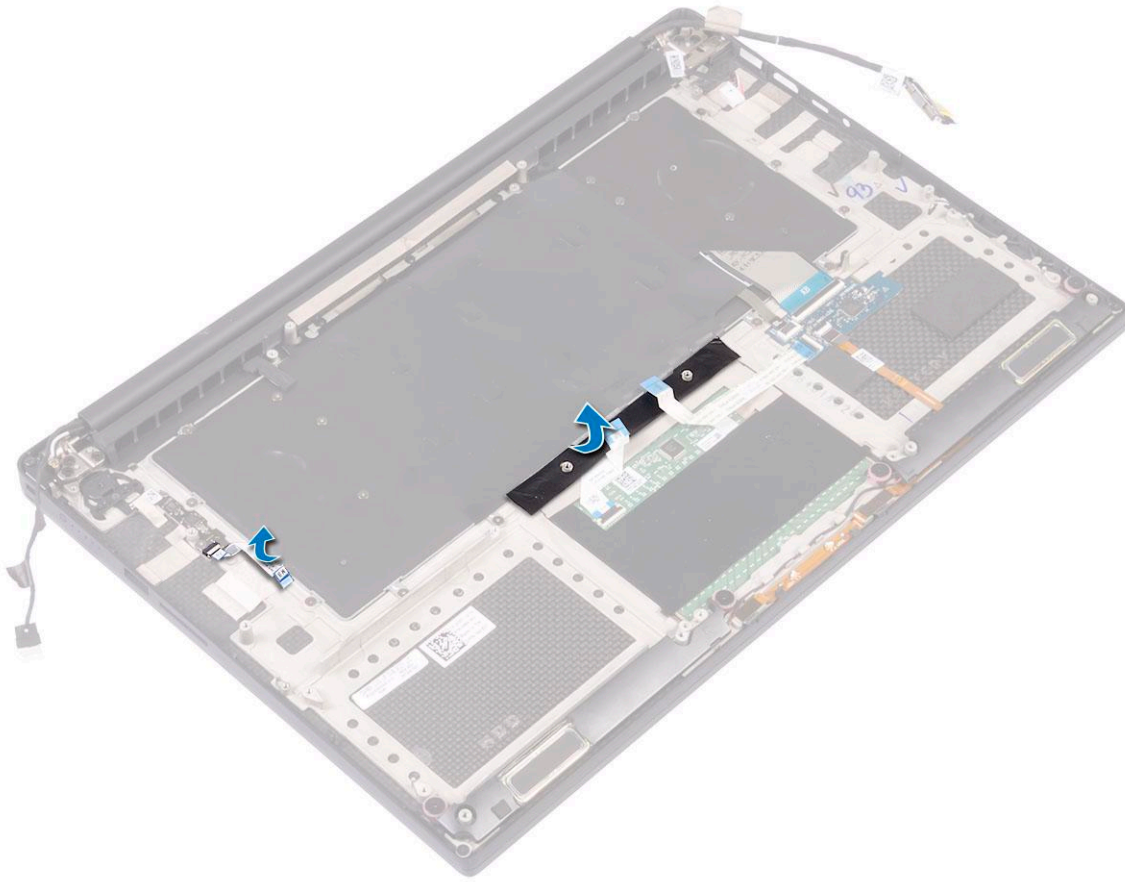

Installing the Keyboard

Steps

1. Adhere the Mylar to the keyboard.
2. Align the screw holes on the keyboard with the screw holes on the palm-rest assembly.
3. Replace the M1.6 x 1.5 (31) screws that secure the keyboard to the palm-rest assembly.
4. Adhere the Mylar to the screws that secure the keyboard to the palm-rest assembly.
5. Connect the keyboard cable and keyboard-backlight cable to the keyboard-controls board.
6. Install the:
 - a. [System Board](#)
 - b. [Hard drive](#)
 - c. [Base cover](#)
7. Follow the procedures in [After Working Inside Your Computer](#).

Palm rest

Removing the Palm rest Assembly

Steps

1. Follow the procedures in [Before Working Inside Your Computer](#).
2. Remove the:
 - a. [base cover](#)
 - b. [battery](#)
 - c. [WLAN card](#)

- d. hard drive
 - e. fans
 - f. speakers
 - g. heatsink assembly
 - h. memory modules
 - i. system board
 - j. display assembly
 - k. power connector port
 - l. keyboard
3. After performing the above steps, we are left with the palm rest assembly.

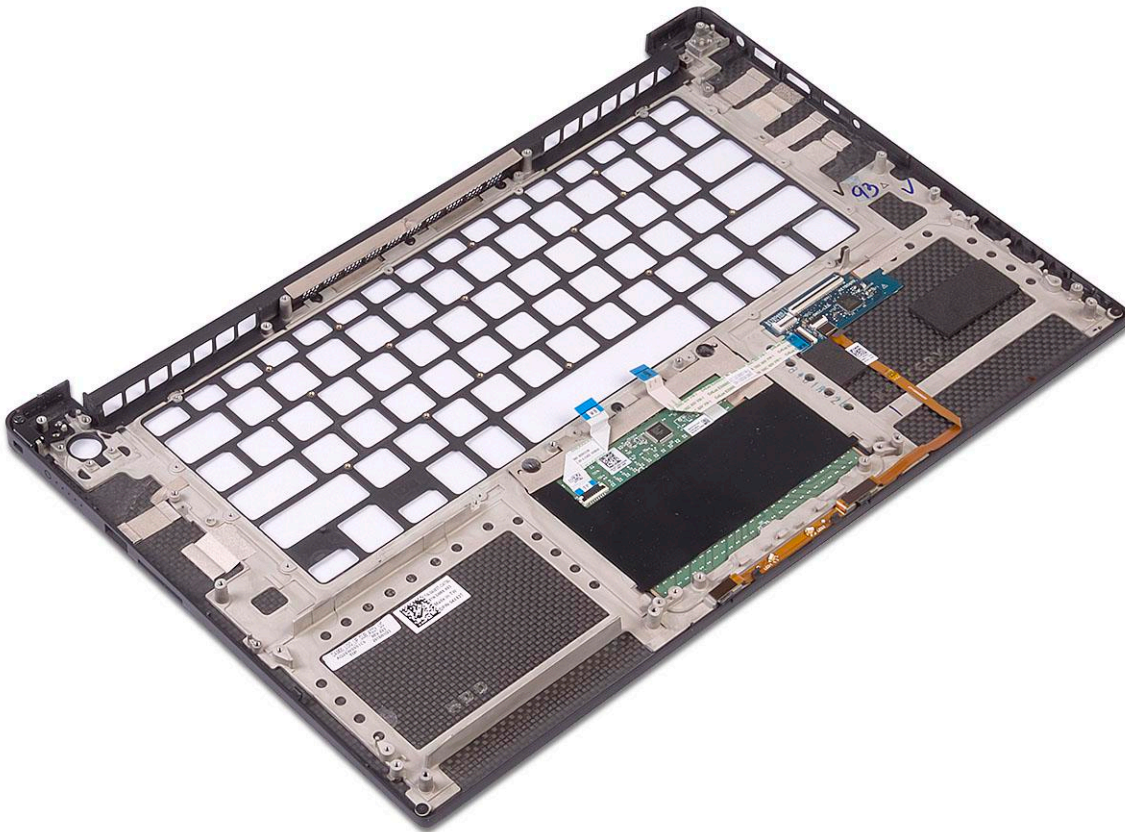

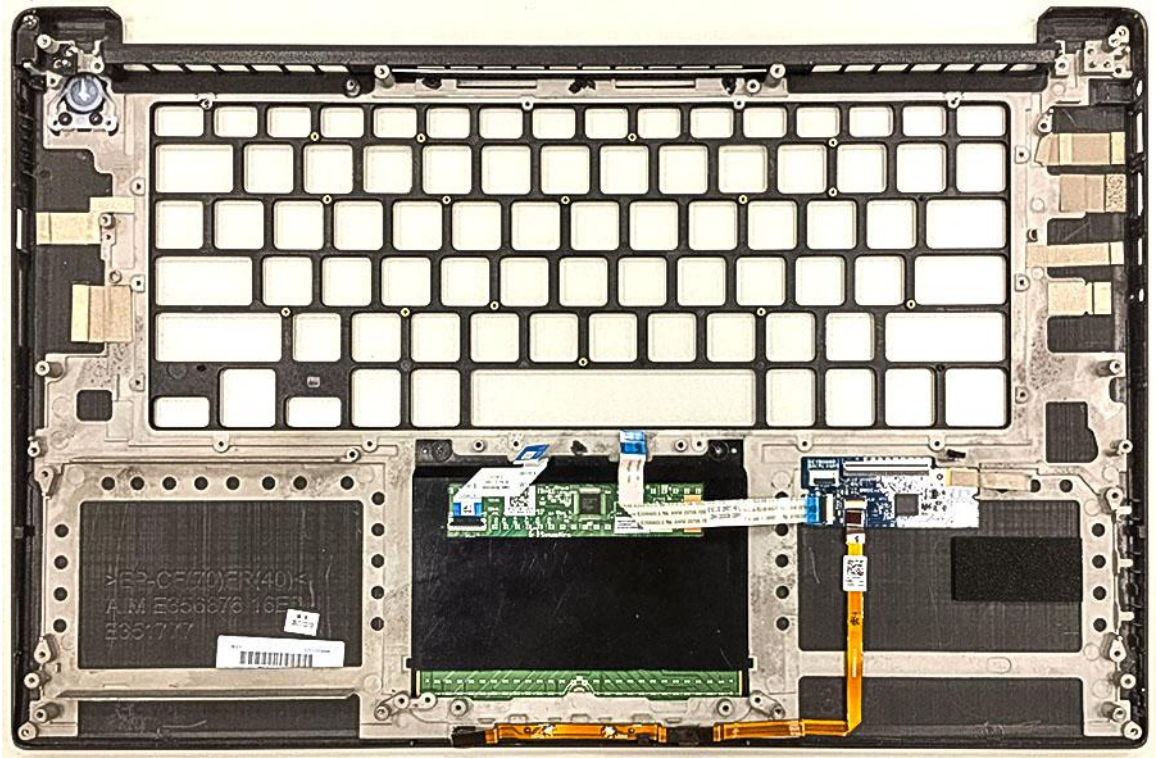

Figure 1. Power button with light indicator

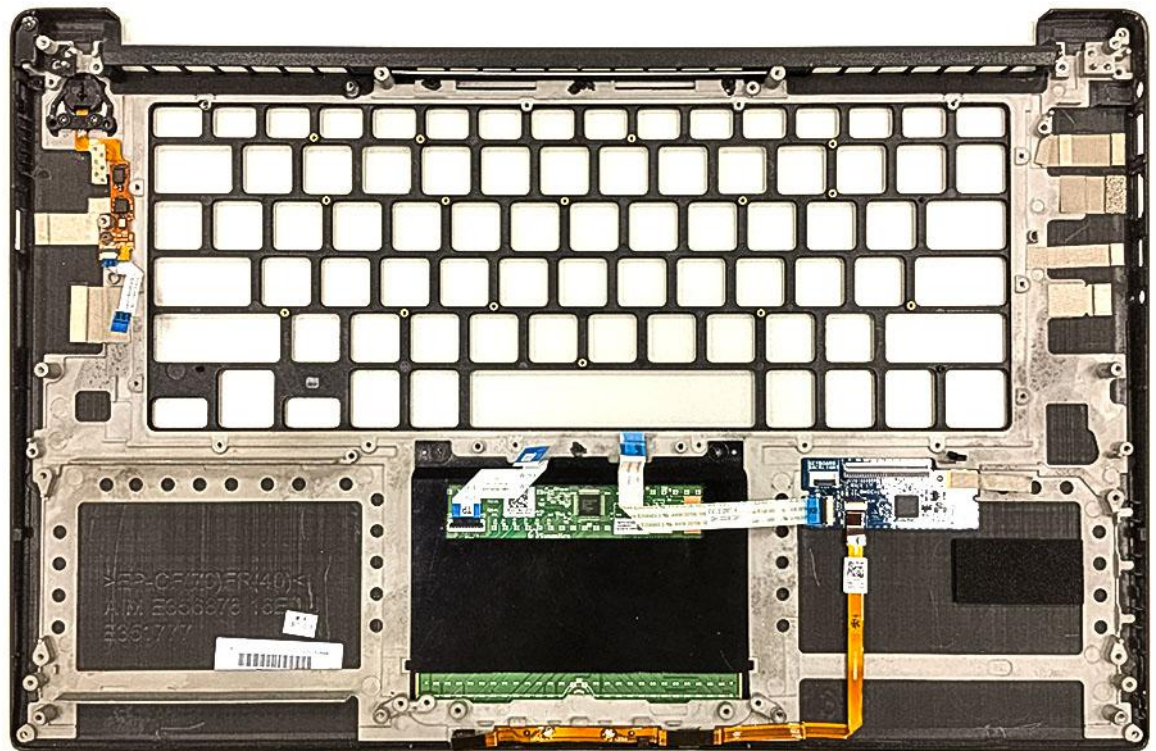

Figure 2. Fingerprint reader function without light indicator

Installing the Palm rest Assembly

Steps

1. Align the palm rest assembly on the display assembly.
2. Tighten the screws to secure the display hinges to the palm rest assembly.
3. Press down on the palm rest assembly to close the display.
4. Install the:
 - a. keyboard
 - b. system board
 - c. power connector port
 - d. display assembly
 - e. fans
 - f. heatsink assembly
 - g. speakers
 - h. WLAN card
 - i. hard drive(optional)
 - j. memory modules
 - k. battery
 - l. base cover
5. Follow the procedures in [After Working Inside Your Computer](#)

Troubleshooting

Handling swollen Lithium-ion batteries

Like most laptops, Dell laptops use lithium-ion batteries. One type of lithium-ion battery is the lithium-ion polymer battery. Lithium-ion polymer batteries have increased in popularity in recent years and have become standard in the electronics industry due to customer preferences for a slim form factor (especially with newer ultra-thin laptops) and long battery life. Inherent to lithium-ion polymer battery technology is the potential for swelling of the battery cells.

Swollen battery may impact the performance of the laptop. To prevent possible further damage to the device enclosure or internal components leading to malfunction, discontinue the use of the laptop and discharge it by disconnecting the AC adapter and letting the battery drain.

Swollen batteries should not be used and should be replaced and disposed of properly. We recommend contacting Dell product support for options to replace a swollen battery under the terms of the applicable warranty or service contract, including options for replacement by a Dell authorized service technician.

The guidelines for handling and replacing Lithium-ion batteries are as follows:

- Exercise caution when handling Lithium-ion batteries.
- Discharge the battery before removing it from the system. To discharge the battery, unplug the AC adapter from the system and operate the system only on battery power. When the system will no longer power on when the power button is pressed, the battery is fully discharged.
- Do not crush, drop, mutilate, or penetrate the battery with foreign objects.
- Do not expose the battery to high temperatures, or disassemble battery packs and cells.
- Do not apply pressure to the surface of the battery.
- Do not bend the battery.
- Do not use tools of any type to pry on or against the battery.
- If a battery gets stuck in a device as a result of swelling, do not try to free it as puncturing, bending, or crushing a battery can be dangerous.
- Do not attempt to reassemble a damaged or swollen battery into a laptop.
- Swollen batteries that are covered under warranty should be returned to Dell in an approved shipping container (provided by Dell)—this is to comply with transportation regulations. Swollen batteries that are not covered under warranty should be disposed of at an approved recycling center. Contact Dell product support at <https://www.dell.com/support> for assistance and further instructions.
- Using a non-Dell or incompatible battery may increase the risk of fire or explosion. Replace the battery only with a compatible battery purchased from Dell that is designed to work with your Dell computer. Do not use a battery from other computers with your computer. Always purchase genuine batteries from <https://www.dell.com> or otherwise directly from Dell.

Lithium-ion batteries can swell for various reasons such as age, number of charge cycles, or exposure to high heat. For more information on how to improve the performance and lifespan of the laptop battery and to minimize the possibility of occurrence of the issue, see [Dell Laptop Battery - Frequently Asked Questions](#).

Enhanced Pre-Boot System Assessment — ePSA diagnostics

About this task

The ePSA diagnostics (also known as system diagnostics) performs a complete check of your hardware. The ePSA is embedded with the BIOS and is launched by the BIOS internally. The embedded system diagnostics provides a set of options for particular devices or device groups allowing you to:

The ePSA diagnostics can be initiated by the FN+PWR buttons while powering on the computer.

- Run tests automatically or in an interactive mode

- Repeat tests
- Display or save test results
- Run thorough tests to introduce additional test options to provide extra information about the failed device(s)
- View status messages that inform you if tests are completed successfully
- View error messages that inform you of problems encountered during testing

i **NOTE:** Some tests for specific devices require user interaction. Always ensure that you are present at the computer terminal when the diagnostic tests are performed.

Running the ePSA Diagnostics

About this task

Invoke diagnostics boot by either of the methods that are suggested below:

Steps

1. Power on the computer.
2. As the computer boots, press the F12 key when the Dell logo is displayed.
3. In the boot menu screen, use Up/Down arrow key to select the **Diagnostics** option and then press **Enter**.

i **NOTE:** The **Enhanced Pre-boot System Assessment** window displays, listing all devices detected in the computer. The diagnostics starts running the tests on all the detected devices.
4. Press the arrow in the lower-right corner to go to the page listing. The detected items are listed and tested.
5. To run a diagnostic test on a specific device, press Esc and click **Yes** to stop the diagnostic test.
6. Select the device from the left pane and click **Run Tests**.
7. If there are any issues, error codes are displayed. Note the error code and contact Dell.

Built-in self-test (BIST)

M-BIST

M-BIST (Built In Self-Test) is the system board's built-in self-test diagnostics tool that improves the diagnostics accuracy of system board embedded controller (EC) failures.

i **NOTE:** M-BIST can be manually initiated before POST (Power On Self Test).

How to run M-BIST

i **NOTE:** M-BIST must be initiated on the system from a power-off state either connected to AC power or with battery only.

1. Press and hold both the **M** key on the keyboard and the **power button** to initiate M-BIST.
2. With both the **M** key and the **power button** held down, the battery indicator LED may exhibit two states:
 - a. OFF: No fault detected with the system board
 - b. AMBER: Indicates a problem with the system board
3. If there is a failure with the system board, the battery status LED will flash one of the following error codes for 30 seconds:

Table 12. LED error codes

Blinking Pattern		Possible Problem
Amber	White	
2	1	CPU Failure

Table 12. LED error codes (continued)

Blinking Pattern		Possible Problem
Amber	White	
2	8	LCD Power Rail Failure
1	1	TPM Detection Failure
2	4	Unrecoverable SPI Failure

4. If there is no failure with the system board, the LCD will cycle through the solid color screens described in the LCD-BIST section for 30 seconds and then power off.

LCD Power rail test (L-BIST)

L-BIST is an enhancement to the single LED error code diagnostics and is automatically initiated during POST. L-BIST will check the LCD power rail. If there is no power being supplied to the LCD (i.e., the L-BIST circuit fails), the battery status LED will flash either an error code [2,8] or an error code [2,7].

 **NOTE:** If L-BIST fails, LCD-BIST cannot function as no power will be supplied to the LCD.

How to invoke L-BIST Test:

1. Press the power button to start the system.
2. If the system does not start up normally, look at the battery status LED:
 - If the battery status LED flashes an error code [2,7], the display cable may not be connected properly.
 - If the battery status LED flashes an error code [2,8], there is a failure on the LCD power rail of the system board, hence there is no power supplied to the LCD.
3. For cases, when a [2,7] error code is shown, check to see if the display cable is properly connected.
4. For cases when a [2,8] error code is shown, replace the system board.

LCD Built-in Self Test (BIST)

Dell laptops have a built-in diagnostic tool that helps you determine if the screen abnormality you are experiencing is an inherent problem with the LCD (screen) of the Dell laptop or with the video card (GPU) and PC settings.

When you notice screen abnormalities like flickering, distortion, clarity issues, fuzzy or blurry image, horizontal or vertical lines, color fade etc., it is always a good practice to isolate the LCD (screen) by running the Built-In Self Test (BIST).

How to invoke LCD BIST Test

1. Power off the Dell laptop.
2. Disconnect any peripherals that are connected to the laptop. Connect only the AC adapter (charger) to the laptop.
3. Ensure that the LCD (screen) is clean (no dust particles on the surface of the screen).
4. Press and hold **D** key and **Power on** the laptop to enter LCD built-in self test (BIST) mode. Continue to hold the D key, until the system boots up.
5. The screen will display solid colors and change colors on the entire screen to white, black, red, green, and blue twice.
6. Then it will display the colors white, black and red.
7. Carefully inspect the screen for abnormalities (any lines, fuzzy color or distortion on the screen).
8. At the end of the last solid color (red), the system will shut down.

 **NOTE:** Dell SupportAssist Pre-boot diagnostics upon launch, initiates an LCD BIST first, expecting a user intervention confirm functionality of the LCD.

Beep codes

NOTE: Some notebook systems use a sequence of audible beeps to give an indication as to possible failed hardware components. Please see [000132041](#) table to help troubleshoot your computer for more information on how to diagnose and troubleshoot these codes.

Recovering the operating system

When your computer is unable to boot to the operating system even after repeated attempts, it automatically starts Dell SupportAssist OS Recovery.

Dell SupportAssist OS Recovery is a standalone tool that is preinstalled in all Dell computers installed with Windows operating system. It consists of tools to diagnose and troubleshoot issues that may occur before your computer boots to the operating system. It enables you to diagnose hardware issues, repair your computer, back up your files, or restore your computer to its factory state.

You can also download it from the Dell Support website to troubleshoot and fix your computer when it fails to boot into their primary operating system due to software or hardware failures.

For more information about the Dell SupportAssist OS Recovery, see *Dell SupportAssist OS Recovery User's Guide* at www.dell.com/serviceabilitytools. Click **SupportAssist** and then, click **SupportAssist OS Recovery**.

Real-Time Clock (RTC Reset)

The Real Time Clock (RTC) reset function allows you or the service technician to recover Dell systems from No POST/No Power/No Boot situations. The legacy jumper enabled RTC reset has been retired on these models.

Start the RTC reset with the system powered off and connected to AC power. Press and hold the power button for 20 seconds. The system RTC Reset occurs after you release the power button.

Backup media and recovery options

It is recommended to create a recovery drive to troubleshoot and fix problems that may occur with Windows. Dell proposes multiple options for recovering Windows operating system on your Dell PC. For more information, see [Dell Windows Backup Media and Recovery Options](#).

WiFi power cycle

About this task

If your computer is unable to access the internet due to WiFi connectivity issues a WiFi power cycle procedure may be performed. The following procedure provides the instructions on how to conduct a WiFi power cycle:

NOTE: Some ISPs (Internet Service Providers) provide a modem/router combo device.

Steps

1. Turn off your computer.
2. Turn off the modem.
3. Turn off the wireless router.
4. Wait for 30 seconds.
5. Turn on the wireless router.
6. Turn on the modem.
7. Turn on your computer.

Drain residual flea power (perform hard reset)

About this task

Flea power is the residual static electricity that remains in the computer even after it has been powered off and the battery is removed.

For your safety, and to protect the sensitive electronic components in your computer, you are requested to drain residual flea power before removing or replacing any components in your computer.

Draining residual flea power, also known as a performing a "hard reset", is also a common troubleshooting step if your computer does not power on or boot into the operating system.

To drain residual flea power (perform a hard reset)

Steps

1. Turn off your computer.
2. Disconnect the power adapter from your computer.
3. Remove the base cover.
4. Remove the battery.
5. Press and hold the power button for 20 seconds to drain the flea power.
6. Install the battery.
7. Install the base cover.
8. Connect the power adapter to your computer.
9. Turn on your computer.



NOTE: For more information about performing a hard reset, see the knowledge base article [000130881](https://www.dell.com/support) at www.dell.com/support.

Getting help

Contacting Dell

Prerequisites

 **NOTE:** If you do not have an active Internet connection, you can find contact information on your purchase invoice, packing slip, bill, or Dell product catalog.

About this task

Dell provides several online and telephone-based support and service options. Availability varies by country and product, and some services may not be available in your area. To contact Dell for sales, technical support, or customer service issues:

Steps

1. Go to **Dell.com/support**.
2. Select your support category.
3. Verify your country or region in the **Choose a Country/Region** drop-down list at the bottom of the page.
4. Select the appropriate service or support link based on your need.