



# Dell™ Studio 1535/1536/1537 Service Manual

[Before You Begin](#)  
[Base Cover](#)  
[Coin-Cell Battery](#)  
[Memory](#)  
[Hard Drive](#)  
[Processor Thermal-Cooling Assembly](#)  
[Processor Module](#)  
[Center Control Cover](#)  
[Keyboard](#)  
[Wireless Mini-Card](#)  
[Display](#)  
[Camera](#)  
[Palm Rest](#)  
[Speaker Assembly](#)  
[Optical Drive](#)  
[USB/Audio Board](#)  
[Microphone](#)  
[System Board Assembly](#)  
[Battery Latch Assembly](#)  
[Flashing the BIOS](#)

---

## Notes, Notices, and Cautions

-  **NOTE:** A NOTE indicates important information that helps you make better use of your computer.
-  **NOTICE:** A NOTICE indicates either potential damage to hardware or loss of data and tells you how to avoid the problem.
-  **CAUTION:** A CAUTION indicates potential for property damage, personal injury, or death.

If you purchased a Dell™ n Series computer, any references in this document to Microsoft® Windows® operating systems are not applicable.

---

Information in this document is subject to change without notice.  
© 2008 Dell Inc. All rights reserved.

Reproduction in any manner whatsoever without the written permission of Dell Inc. is strictly forbidden.

Trademarks used in this text: *Dell* and the *DELL* logo are trademarks of Dell Inc.; *Microsoft*, *Windows*, and *Windows Vista* are either trademarks or registered trademarks of Microsoft Corporation in the United States and/or other countries; *Bluetooth* is a registered trademark owned by Bluetooth SIG, Inc. and is used by Dell under license.



Other trademarks and trade names may be used in this document to refer to either the entities claiming the marks and names or their products. Dell Inc. disclaims any proprietary interest in trademarks and trade names other than its own.

Model: PP33L

August 2008 Rev. A01

## Base Cover

### Dell™ Studio 1535/1536/1537 Service Manual

-  **CAUTION:** Before working inside your computer, follow the safety instructions that shipped with your computer.
-  **CAUTION:** Before performing this procedures, turn off the computer, disconnect the AC adapter from the electrical outlet and the computer, disconnect the modem from the wall connector and the computer, and remove any other external cables from the computer.
-  **NOTICE:** To avoid electrostatic discharge, ground yourself by using a wrist grounding strap or by periodically touching an unpainted metal surface (such as a connector on the back of the computer).

### Removing the Base Cover

1. Ensure that the computer is turned off.
2. Remove the battery (see [Before Working Inside Your Computer](#)).
3. Loosen the seven captive screws on the base cover and lift the cover off the computer at an angle as shown in the figure.

-  **CAUTION:** Do not touch the processor thermal-cooling assembly. Processor components should be removed only by trained support personnel.

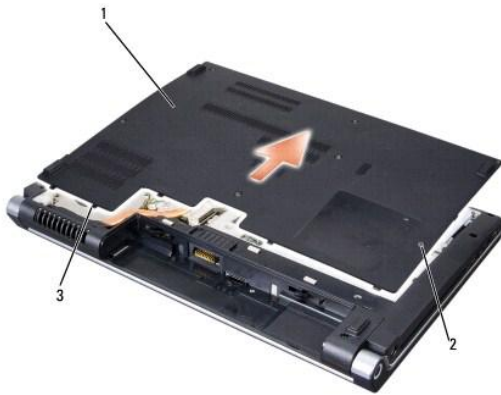

1	base cover	2	captive screws (7)
3	tabs		

### Replacing the Base Cover

1. Align the tabs on the base cover to the bottom of the computer.
2. Replace and tighten the seven captive screws on the base cover.
3. Slide the battery into the battery bay until it clicks into place.

[Back to Contents Page](#)

## Before You Begin

### Dell™ Studio 1535/1536/1537 Service Manual

- [Recommended Tools](#)
- [Before Working Inside Your Computer](#)

This document provides procedures for removing and installing the components in your computer. Unless otherwise noted, each procedure assumes that:

- 1 You have performed the steps in [Before Working Inside Your Computer](#).
- 1 You have read the safety information that shipped with your computer.
- 1 When replacing a component, you have already removed the original component, if installed.

---

## Recommended Tools



The procedures in this document may require the following tools:

- 1 Small flat-blade screwdriver
- 1 Phillips screwdriver
- 1 Small plastic scribe
- 1 Flash BIOS update media (see the Dell Support website at [support.dell.com](http://support.dell.com))

---

## Before Working Inside Your Computer

Use the following safety guidelines to help protect your computer from potential damage and to help ensure your own personal safety.

- ⚠ **CAUTION:** Before you begin any of the procedures in this section, follow the safety instructions that shipped with your computer.
  - 🔧 **NOTICE:** Only a certified service technician should perform repairs on your computer. Damage due to servicing that is not authorized by Dell is not covered by your warranty.
  - 🔧 **NOTICE:** To avoid electrostatic discharge, ground yourself by using a wrist grounding strap or by periodically touching an unpainted metal surface, such as a connector on the back of the computer.
  - 🔧 **NOTICE:** Handle components and cards with care. Do not touch the components or contacts on a card. Hold a card by its edges or by its metal mounting bracket. Hold a component such as a processor by its edges, not by its pins.
  - 🔧 **NOTICE:** When disconnecting a cable, pull on the cable's connector or on its strain-relief loop, not on the cable itself. For cable connectors with locking tabs, press inward on the locking tabs to release the connector. When connecting a cable, ensure that the connectors are correctly oriented and aligned to avoid damage to the connector and/or the connector's pins.
1. Ensure that the work surface is flat and clean to prevent the computer cover from being scratched.
  2. Click **Start** , click the arrow , and then click **Shut Down**.  
The computer turns off after the operating system shutdown process finishes.
  3. Disconnect your computer and all attached devices from their electrical outlets.
  - 🔧 **NOTICE:** To disconnect a network cable, first unplug the cable from your computer, and then unplug it from the network wall jack.
  4. Disconnect any telephone or network cables from the computer.
  5. Press and eject any installed cards from the ExpressCard slot and the 8-in-1 memory card reader.
  - 🔧 **NOTICE:** To help prevent damage to the system board, you must remove the battery from the battery bay before you service the computer.
  - 🔧 **NOTICE:** To avoid damage to the computer, use only the battery designed for this particular Dell computer. Do not use batteries designed for other Dell computers.
  6. Turn the computer over.
  7. Slide the battery release latch until it clicks into place.
  8. Slide the battery out of the battery bay.

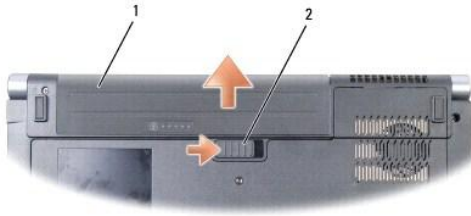

1	battery	2	battery release latch
---	---------	---	-----------------------

9. Turn the computer top side up, open the display, and press the power button to ground the system board.

---

[Back to Contents Page](#)

## Flashing the BIOS

### Dell™ Studio 1535/1536/1537 Service Manual

If a BIOS-update program CD is provided with a new system board, flash the BIOS from the CD. If you do not have a BIOS-update program CD, flash the BIOS from the hard drive.

### Flashing the BIOS From a CD

 **NOTICE:** Plug the AC adapter into a known, good power source to prevent loss of power. Failure to do so may cause system damage.

1. Ensure that the AC adapter is plugged in and that the main battery is installed properly.

 **NOTE:** If you use the BIOS-update program CD to flash the BIOS, press <F12> before inserting the CD so that you can set up the computer to boot from a CD for one time only. Otherwise, you must enter the system setup program to change the default boot order.

2. Insert the BIOS-update program CD and turn on the computer.

 **NOTICE:** Do not interrupt this process once it begins. Doing so may cause system damage.

Follow the instructions that appear on the screen. The computer continues to boot and updates the new BIOS. When the flash update is complete, the computer will automatically reboot.

3. Press <F2> during POST to enter the system setup program.
4. Press <Alt> and <F> to reset the computer defaults.
5. Press <Esc>, select **Save/Exit**, and press <Enter> to save configuration changes.
6. Remove the flash BIOS-update program CD from the drive and restart the computer.

### Flashing the BIOS From the Hard Drive

 **NOTICE:** Plug the AC adapter into a known, good power source to prevent loss of power. Failure to do so may cause system damage.

1. Ensure that the AC adapter is plugged in, the main battery is properly installed, and a network cable is attached.
2. Turn on the computer.
3. Locate the latest BIOS update file for your computer at [support.dell.com](http://support.dell.com).
4. Click **Download Now** to download the file.
5. If the **Export Compliance Disclaimer** window appears, click **Yes, I Accept this Agreement**.

The **File Download** window appears.

6. Click **Save this program to disk**, and then click **OK**.

The **Save In** window appears.

7. Click the down arrow to view the **Save In** menu, select **Desktop**, and then click **Save**.

The file downloads to your desktop.

8. Click **Close** if the **Download Complete** window appears.

The file icon appears on your desktop and is titled the same as the downloaded BIOS update file.

 **NOTICE:** Do not interrupt this process once it begins. Doing so may cause system damage.



9. Double-click the file icon on the desktop and follow the instructions on the screen.

---

[Back to Contents Page](#)

## USB/Audio Board

### Dell™ Studio 1535/1536/1537 Service Manual

-  **CAUTION:** Before you begin any of the procedures in this section, follow the safety instructions that shipped with your computer.
-  **NOTICE:** To avoid electrostatic discharge, ground yourself by using a wrist grounding strap or by periodically touching an unpainted metal surface (such as a connector on the back of the computer).
-  **NOTICE:** To help prevent damage to the system board, you must remove the battery from the battery bay before you begin working inside the computer.

### Removing the USB/Audio Board

1. Follow the procedures in [Before You Begin](#).
2. Remove the optical drive (see [Removing the Optical Drive](#)).
3. Disconnect the two cables of the USB/Audio board from the connectors on the system board.
4. Remove the adhesive tapes from the cables securing it to the system board.
5. Remove the screw securing the USB/Audio board to the computer base cover and remove the board.





1	USB board	2	USB/Audio cables
---	-----------	---	------------------

### Replacing the USB/Audio Board

1. Connect the USB/Audio board cables to the system board connectors.
2. Place the USB/Audio board in position and replace and tighten the screw to secure the board.
3. Replace the optical drive (see [Replacing the Optical Drive](#)).

## Camera

### Dell™ Studio 1535/1536/1537 Service Manual

-  **CAUTION:** Before working inside your computer, follow the safety instructions that shipped with your computer.
-  **CAUTION:** Before performing this procedures, turn off the computer, disconnect the AC adapter from the electrical outlet and the computer, disconnect the modem from the wall connector and the computer, and remove any other external cables from the computer.
-  **NOTICE:** To avoid electrostatic discharge, ground yourself by using a wrist grounding strap or by periodically touching an unpainted metal surface (such as a connector on the back of the computer).

### Removing the Camera Module

1. Follow the instructions in [Before You Begin](#).
2. Remove the display bezel (see [Removing the Display Bezel](#)).
3. Loosen the two screws connecting the camera to the display cover.
4. Disconnect the camera cable and take out the camera module.

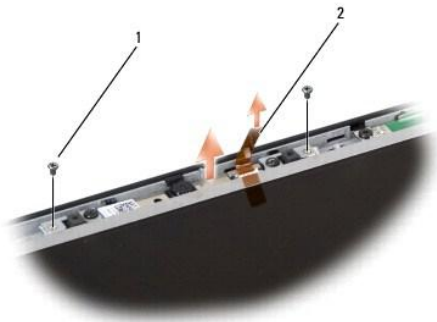

1	screws (2)	2	camera cable
---	------------	---	--------------



### Replacing the Camera Module

1. Follow the instructions in [Before You Begin](#).
2. Replace and tighten the two screws securing the camera to the display cover.
3. Connect the camera cable to the connector.
4. Replace the display bezel (see [Replacing the Display Bezel](#)).



## Center Control Cover

Dell™ Studio 1535/1536/1537 Service Manual

-  **CAUTION:** Before you begin any of the procedures in this section, follow the safety instructions that shipped with your computer.
-  **NOTICE:** To avoid electrostatic discharge, ground yourself by using a wrist grounding strap or by periodically touching an unpainted metal surface (such as a connector on the back of the computer).
-  **NOTICE:** To help prevent damage to the system board, you must remove the battery from the battery bay before you begin working inside the computer.

### Removing the Center Control Cover

1. Follow the procedures in [Before You Begin](#).
2. Remove the two screws securing the center control cover from the battery bay.



3. Turn the computer over and open the display as far as possible.
  4. Pry out the center control cover with your fingers starting from the battery bay location at the back of the system.
-  **NOTICE:** To avoid damage to the data cable connected to the system board, ensure that you do not pull hard when you are lifting the center control cover.
5. Ease the center control cover up.



1	center control cover
---	----------------------

6. Remove the keyboard surround by easing it out using a scribe (see [Removing the Keyboard](#)).
  7. Remove the two screws from the top of the keyboard.
-  **NOTICE:** The key caps on the keyboard are fragile, easily dislodged, and time-consuming to replace. Be careful when removing and handling the keyboard.

8. Lift the keyboard and hold it up and slightly forward to access the media control buttons connector on the system board.

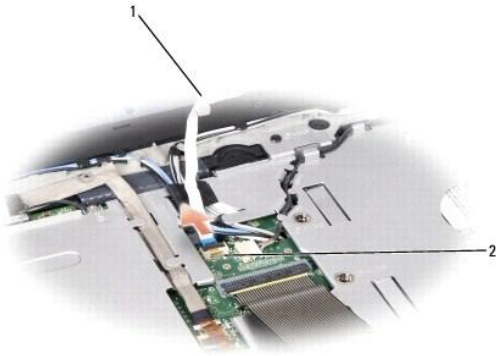

1	media control buttons cable	2	media control buttons connector
---	-----------------------------	---	---------------------------------

9. Disconnect the media control buttons cable from the connector on the system board.

## Replacing the Center Control Cover

1. Follow the procedures in [Before You Begin](#).
2. Reconnect the media control buttons cable to the connector below the keyboard on the system board.
3. Align the tabs along the bottom of the keyboard and slide them under the palm rest.
4. Replace the keyboard surround.
5. Press on the corner edges near the top to snap the keyboard into place.
6. Replace the two screws on the top of the keyboard.
7. Slide the center control cover into the keyboard surround and press at both the edges of the cover until it snaps into place.
8. In the battery bay, replace the two screws that secure the center control cover.

---

[Back to Contents Page](#)

## Coin-Cell Battery

Dell™ Studio 1535/1536/1537 Service Manual

### Removing the Coin-Cell Battery

**⚠ CAUTION:** Before you begin any of the procedures in this section, follow the safety instructions that shipped with your computer.

1. Follow the instructions in [Before You Begin](#).
2. Remove the base cover (see [Removing the Base Cover](#)).
3. Use a plastic scribe to pry up the coin-cell battery from the slot.



1	coin-cell battery	2	slot
---	-------------------	---	------

### Replacing the Coin-Cell Battery

**⚠ CAUTION:** Before you begin the following procedure, follow the safety instructions that shipped with your computer.

1. Follow the instructions in [Before You Begin](#).
2. Hold the coin-cell battery with the positive side up.
3. Slide the coin-cell battery into the slot and gently press until it snaps to the slot.

## Processor Module

Dell™ Studio 1535/1536/1537 Service Manual

### Removing the Processor Module

**⚠ CAUTION:** Before you begin the following procedure, follow the safety instructions that shipped with your computer.

1. Follow the instructions in [Before You Begin](#).
2. Remove the processor thermal-cooling assembly (see [Removing the Processor Thermal-Cooling Assembly](#)).

**➡ NOTICE:** To avoid damage to the processor, hold the screwdriver so that it is perpendicular to the processor when turning the cam screw.

3. To loosen the ZIF socket, use a small, flat-blade screwdriver and rotate the ZIF-socket cam screw counterclockwise until it comes to the cam stop.

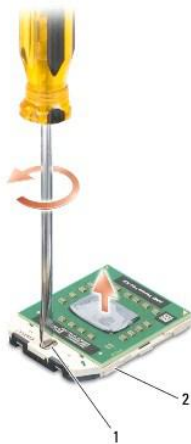

1	ZIF-socket cam screw	2	ZIF socket
---	----------------------	---	------------

**➡ NOTICE:** To ensure maximum cooling for the processor, do not touch the heat transfer areas on the processor thermal-cooling assembly. The oils in your skin can reduce the heat transfer capability of the thermal pads.

**➡ NOTICE:** When removing the processor module, pull the module straight up. Be careful not to bend the pins on the processor module.

4. Lift the processor module from the ZIF socket.

### Replacing the Processor Module

**⚠ CAUTION:** Before you begin the following procedure, follow the safety instructions that shipped with your computer.

**➡ NOTICE:** Do not touch the processor die. Press and hold the processor down on the substrate on which the die is mounted while turning the cam screw to prevent intermittent contact between the cam screw and processor.

**➡ NOTICE:** Ensure that the cam lock is in the fully open position before seating the processor module. Seating the processor module properly in the ZIF socket does not require force. A processor module that is not properly seated can result in an intermittent connection or permanent damage to the microprocessor and ZIF socket.

**🔧 NOTE:** If a new processor is installed, you will receive a new thermal-cooling assembly, which will include an affixed thermal pad, or you will receive a new thermal pad along with documentation to illustrate proper installation.

1. Follow the instructions in [Before You Begin](#).
2. Align the pin-1 corner of the processor module with the pin-1 corner of the ZIF socket, then insert the processor module.

**NOTE:** The pin-1 corner of the processor module has a triangle that aligns with the triangle on the pin-1 corner of the ZIF socket.

When the processor module is properly seated, all four corners are aligned at the same height. If one or more corners of the module are higher than the others, the module is not seated properly.



1	ZIF-socket cam screw	2	ZIF socket
3	pin-1 corner		

**NOTE:** To avoid damage to the processor, hold the screwdriver so that it is perpendicular to the processor when turning the cam screw.

3. Tighten the ZIF socket by turning the cam screw clockwise to secure the processor module to the system board.
4. Replace the processor thermal-cooling assembly (see [Replacing the Processor Thermal-Cooling Assembly](#)).
5. Replace the base cover (see [Replacing the Base Cover](#)).

---

[Back to Contents Page](#)

## Processor Thermal-Cooling Assembly

Dell™ Studio 1535/1536/1537 Service Manual

### Removing the Processor Thermal-Cooling Assembly

**⚠ CAUTION:** Before you begin the following procedure, follow the safety instructions that shipped with your computer.

1. Follow the instructions in [Before You Begin](#).
2. Turn the computer over and remove the base cover (see [Removing the Base Cover](#)).
3. In sequential order (indicated on the thermal-cooling assembly), loosen the four captive screws on the thermal-cooling assembly processor cover.
4. Loosen the two captive screws on the thermal-cooling assembly sink.
5. Disconnect the thermal-cooling assembly fan cable from the connector on the system board.
6. Remove the screw from the thermal-cooling assembly fan and take out the thermal-cooling assembly.



1	thermal-cooling assembly sink	2	fan cable
3	thermal-cooling assembly processor cover	4	thermal-cooling assembly fan

### Replacing the Processor Thermal-Cooling Assembly

**⚠ CAUTION:** Before you begin the following procedure, follow the safety instructions that shipped with your computer.

1. Align the four captive screws on the processor thermal-cooling assembly processor cover with the screw holes on the system board and tighten the screws in sequential order.
2. Tighten the two captive screws securing the thermal-cooling assembly sink to the system board.
3. Replace and tighten the screw to secure the thermal-cooling assembly fan to the system board.
4. Connect the thermal-cooling assembly fan cable to the system board.
5. Replace the base cover (see [Replacing the Base Cover](#)).



[Back to Contents Page](#)

## Display

Dell™ Studio 1535/1536/1537 Service Manual

- [Display Assembly](#)
  - [Display Bezel](#)
  - [Display Panel](#)
  - [Display Inverter](#)
  - [Display Hinges](#)
- 

### Display Assembly

#### Removing the Display Assembly

**⚠ CAUTION:** Before you begin the following procedure, follow the safety instructions that shipped with your computer.

1. Follow the instructions in [Before You Begin](#).
2. Remove the base cover (see [Removing the Base Cover](#)).
3. Disconnect the antenna cables from the Mini-Card.
4. Lift the antenna cables from the securing tabs and release them from the routing channel.

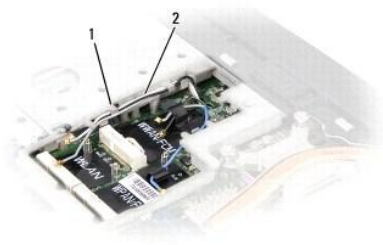

1	securing tabs	2	antenna cables
---	---------------	---	----------------

5. Remove the two screws securing the display assembly from the bottom of the computer.



6. Remove the center control cover (see [Removing the Center Control Cover](#)).
7. Remove the keyboard (see [Removing the Keyboard](#)).



8. Disconnect the display data cable from the connector on the system board, loosen the captive screw, and release the cable from the securing plastic tabs.
9. Disconnect the camera cable from the system board, loosen the captive screw, and release it from the securing plastic tabs.
10. Disconnect the display power cable from the connector on the system board and release it from the securing plastic tabs.

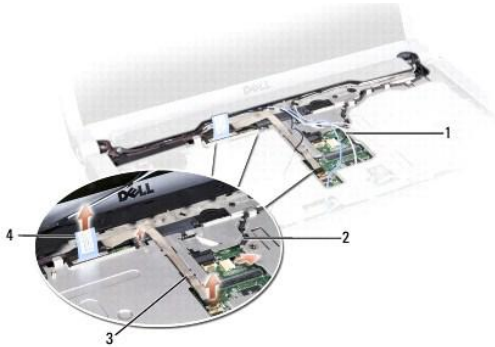

1	antenna cables	2	display power cable
3	camera cable	4	display data cable

11. Pull the antenna cables from the routing hole and release them from the routing channel.
12. Remove the two screws from the display assembly hinges.



1	hinge screws (2)
---	------------------

13. Lift the display assembly out of the computer.

## Replacing the Display Assembly

**CAUTION:** Before you begin the following procedure, follow the safety instructions that shipped with your computer.

1. Follow the instructions in [Before You Begin](#).
2. Align the display hinges with the holes in the base of the computer and then lower the display into place.
3. Replace and tighten the two display assembly hinge screws.
4. Slide the antenna cables through the routing hole to the base of the computer.
5. Connect the display power cable to the connectors on the system board.
6. Connect the display data and camera cables to the connector on the system board and tighten the captive screws to secure the cables.

**NOTE:** Ensure that the display and camera cables are properly routed and secured beneath the plastic tabs.

7. Replace the keyboard (see [Replacing the Keyboard](#)).
  8. Replace the center control cover (see [Replacing the Center Control Cover](#)).
  9. Close the display and turn the computer over.
  10. Replace and tighten the two screws securing the display assembly to the bottom of the computer.
  11. Replace the Mini-Card and connect the antenna cables to it (see [Replacing the Mini-Card](#)).
  12. Replace the base cover (see [Replacing the Base Cover](#)).
- 

## Display Bezel

### Removing the Display Bezel

**⚠ CAUTION:** Before you begin the following procedure, follow the safety instructions that shipped with your computer.

**⚠ CAUTION:** The following instructions are not applicable to Edge-to-Edge display panels, which should not be disassembled.

1. Follow the instructions in [Before You Begin](#).
2. Remove the display assembly (see [Removing the Display Assembly](#)).

**🔍 NOTICE:** Removal of the bezel from the display bottom cover requires extreme care to avoid damage to the bezel and the display panel.

3. Gently push the display bezel outwards on each of the four sides to release the bezel from the display panel.



1 display bezel

**🔍 NOTE:** In some computers, the display bezel might have double-sided tape on both ends. To reuse the tape, carefully remove the bezel.

### Replacing the Display Bezel

**⚠ CAUTION:** Before you begin the following procedure, follow the safety instructions that shipped with your computer.

1. Follow the instructions in [Before You Begin](#).
  2. Starting at any corner, use your fingers to gently snap the bezel into place to secure it to the display panel.
  3. Replace the display assembly (see [Replacing the Display Assembly](#)).
-

## Display Panel

### Removing the Display Panel

**⚠ CAUTION:** Before you begin the following procedure, follow the safety instructions that shipped with your computer.

**⚠ CAUTION:** The following instructions are not applicable to Edge-to-Edge display panels, which should not be disassembled.

1. Follow the instructions in [Before You Begin](#).
2. Remove the display assembly (see [Removing the Display Assembly](#)).
3. Remove the display bezel (see [Removing the Display Bezel](#)).
4. Remove the four screws securing the display panel to the cover.

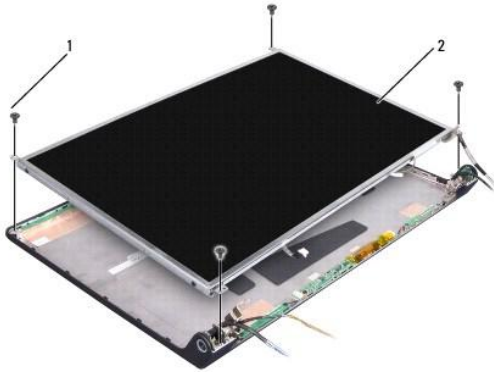

1	screws (4)	2	display panel
---	------------	---	---------------

5. Disconnect the cables from the connectors on each end of the inverter.

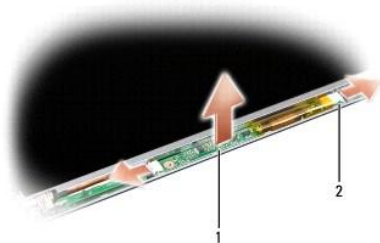

1	inverter	2	connectors (2)
---	----------	---	----------------

6. Lift the display panel out of the display cover.
7. Remove the four screws (two on each side of the display panel) securing the brackets to the display panel and remove the brackets.

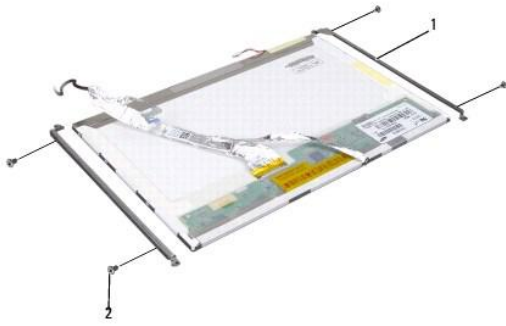

1	display panel bracket (2)	2	screws (4)
---	---------------------------	---	------------

8. Turn over the display panel and remove the conductive tape on the display board.
9. Disconnect the display cable from the display board.

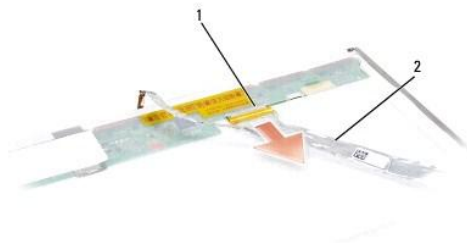

1	display cable connector	2	display cable
---	-------------------------	---	---------------

## Replacing the Display Panel

**⚠ CAUTION:** Before you begin the following procedure, follow the safety instructions that shipped with your computer.

1. Follow the instructions in [Before You Begin](#).
2. Replace the four screws (two on each side of the display panel) to secure the display brackets to the display panel.
3. Connect the display cable to the board at the back of the display panel.
4. Connect the power cables to the connectors on both ends of the inverter.
5. Align the screw holes on the display bracket with the corresponding screw holes and guide pins on the top cover and gently lower the display panel into place.
6. Replace the four screws that secure the display panel to the cover.
7. Replace the display bezel (see [Replacing the Display Bezel](#)).
8. Replace the display assembly (see [Replacing the Display Assembly](#)).

9. Replace the keyboard (see [Replacing the Keyboard](#)).
  10. Replace the center control cover (see [Replacing the Center Control Cover](#)).
- 

## Display Inverter

### Removing the Display Inverter

**⚠ CAUTION:** Before you begin the following procedure, follow the safety instructions that shipped with your computer.

1. Follow the instructions in [Before You Begin](#).
2. Remove the display assembly. See [Removing the Display Assembly](#).
3. Remove the display panel without removing the display bracket (See [Removing the Display Panel](#)).
4. Pry out the inverter from the securing plastic tabs.

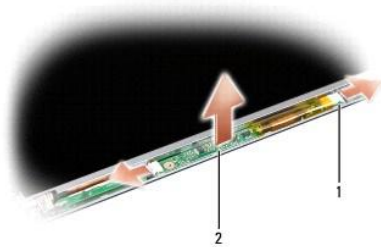

1	inverter	2	connectors (2)
---	----------	---	----------------

### Replacing the Display Inverter

**⚠ CAUTION:** Before you begin the following procedure, follow the safety instructions that shipped with your computer.

1. Follow the instructions in [Before You Begin](#).
  2. Align the holes on the inverter with the tabs on the display cover and place it in position.
  3. Replace the display panel. See [Replacing the Display Panel](#).
  4. Replace the display assembly. See [Replacing the Display Assembly](#).
- 

## Display Hinges

### Removing the Display Hinges

**⚠ CAUTION:** Before you begin the following procedure, follow the safety instructions that shipped with your computer.

1. Follow the instructions in [Before You Begin](#).
2. Remove the display assembly. See [Removing the Display Assembly](#).

3. Remove the display panel without removing the display bracket. See [Removing the Display Panel](#).
4. Remove the four screws (two on each side) securing the display hinges to the display cover.
5. Remove the display hinges.

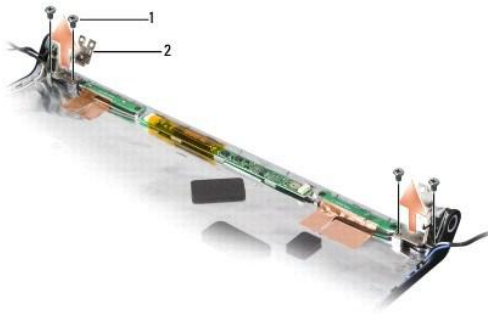

1	screws (4)	2	hinges (2)
---	------------	---	------------

## Replacing the Display Hinges

**⚠ CAUTION:** Before you begin the following procedure, follow the safety instructions that shipped with your computer.





1. Follow the instructions in [Before You Begin](#).
2. Align the holes on the hinges with the holes on the display cover and replace the screws on the hinges.
3. Replace the display panel. See [Replacing the Display Panel](#).
4. Replace the display assembly. See [Replacing the Display Assembly](#).

---

[Back to Contents Page](#)

## Hard Drive

### Dell™ Studio 1535/1536/1537 Service Manual

-  **CAUTION:** Before you begin any of the procedures in this section, follow the safety instructions that shipped with your computer.
-  **CAUTION:** Do not touch the metal housing of the hard drive if you remove the hard drive from the computer while the drive is hot.
-  **NOTICE:** To prevent data loss, turn off your computer before removing the hard drive. Do not remove the hard drive while the computer is on or in the Sleep state.
-  **NOTICE:** Hard drives are extremely fragile. Exercise care when handling the hard drive.
-  **NOTE:** Dell does not guarantee compatibility or provide support for hard drives obtained from sources other than Dell.

### Removing the Hard Drive

1. Follow the procedures in [Before You Begin](#).
2. Turn the computer over and remove the base cover (see [Removing the Base Cover](#)).
3. Remove the four screws securing the hard drive assembly to the computer.
4. Pull the hard drive cable pull-tab to disconnect the cable from the system board connector.
5. Pull on the hard drive pull-tab to lift the hard drive assembly from the bay.

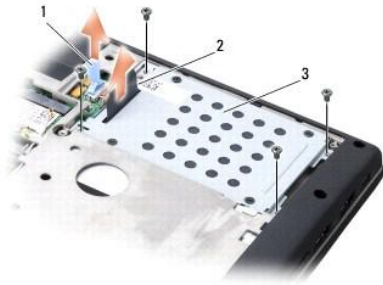

1	hard drive cable pull-tab	2	hard drive pull-tab
3	hard drive assembly		

6. Remove the four M3 x 3-mm screws securing the hard drive cage to the hard drive.
7. Lift the hard drive cage off the hard drive.

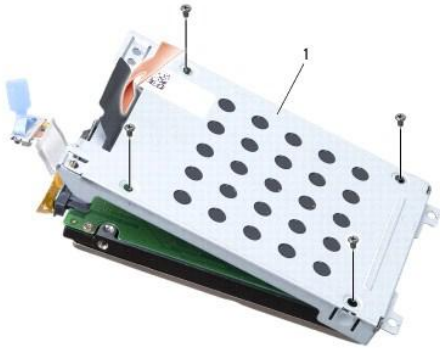

1 hard drive cage

➔ **NOTICE:** Do not disconnect the hard drive cable from the hard drive connector using the pull tab.

8. Disconnect the hard drive cable from the connector on the hard drive..



➔ **NOTICE:** When the hard drive is not in the computer, store it in protective antistatic packaging. For more information, see "Protecting Against Electrostatic Discharge" in the safety information that shipped with your computer.

## Replacing the Hard Drive

1. Follow the instructions in [Before You Begin](#).
2. Connect the hard drive cable to the connector on the hard drive.
3. Replace the hard drive cage and tighten the four screws to secure the cage to the hard drive.
4. Place the hard drive assembly in the hard drive bay and replace the four screws to secure the hard drive assembly.
5. Connect the hard drive cable to the system board connector.
6. Replace the base cover (see [Replacing the Base Cover](#)).
7. Install the operating system for your computer, as needed (see "Restoring Your Operating System" in your *Quick Reference Guide*).
8. Install the drivers and utilities for your computer, as needed (see "Reinstalling Drivers and Utilities" in your *Quick Reference Guide*).



---

[Back to Contents Page](#)



## Keyboard

### Dell™ Studio 1535/1536/1537 Service Manual



-  **CAUTION:** Before you begin any of the procedures in this section, follow the safety instructions that shipped with your computer.
-  **NOTICE:** To avoid electrostatic discharge, ground yourself by using a wrist grounding strap or by periodically touching an unpainted metal surface (such as a connector on the back of the computer).
-  **NOTICE:** To help prevent damage to the system board, you must remove the battery from the battery bay before you begin working inside the computer.

### Removing the Keyboard

1. Follow the procedures in [Before You Begin](#).
2. Remove the center control cover (see [Removing the Center Control Cover](#)).
3. Remove the keyboard surround by easing it out using a plastic scribe.



1	plastic scribe	2	keyboard
3	keyboard surround		

4. Remove the two screws at the top of the keyboard.
-  **NOTICE:** The key caps on the keyboard are fragile, easily dislodged, and time-consuming to replace. Be careful when removing and handling the keyboard.
5. Lift the keyboard and hold it to access the keyboard connector.
  6. Disconnect the keyboard cable from the keyboard connector on the system board by rotating the keyboard connector latch towards the front of the computer.
  7. Slide the keyboard cable out of the keyboard connector.
-  **NOTE:** If you have the backlit keyboard (optional), there would be an additional cable that needs to be disconnected.



1	screws (2)	2	keyboard connetor latch
3	keyboard tabs	4	palm rest slot

## Replacing the Keyboard

1. Follow the procedures in [Before You Begin](#).
2. Slide the keyboard cable into the keyboard connector.
3. Rotate the keyboard connector latch to secure the cable.
4. Align the tabs along the bottom of the keyboard and slide them into the slots of the palm rest.
5. Press on the corner edges near the top to snap the keyboard into place.
6. Replace the two screws on the top of the keyboard.
7. Replace the keyboard surround.
8. Replace the center control cover (see [Replacing the Center Control Cover](#)).

---

[Back to Contents Page](#)

## Battery Latch Assembly

Dell™ Studio 1535/1536/1537 Service Manual

### Removing the Battery Latch Assembly

**⚠ CAUTION:** Before you begin the following procedure, follow the safety instructions that shipped with your computer.

1. Follow the instructions in [Before You Begin](#).
2. Remove the base cover (see [Removing the Base Cover](#)).
3. Remove all memory modules (see [Removing Memory Module\(s\)](#)).
4. Remove the hard drive (see [Removing the Hard Drive](#)).
5. Remove Mini-Card (see [Removing the Mini-Card](#)).
6. Remove the processor thermal-cooling assembly (see [Removing the Processor Thermal-Cooling Assembly](#)).
7. Remove the processor (see [Removing the Processor Module](#)).
8. Remove the center control cover (see [Removing the Center Control Cover](#)).
9. Remove the keyboard (see [Removing the Keyboard](#)).
10. Remove the display assembly (see [Removing the Display Assembly](#)).
11. Remove the palm rest (see [Removing the Palm Rest](#)).
12. Remove the optical drive (see [Removing the Optical Drive](#)).
13. Remove the system board (see [Removing the System Board Assembly](#)).
14. Remove the latch spring.

**🔄 NOTICE:** Before you remove the latch button, observe the orientation of the latch to ensure proper installation when the latch is replaced.

15. Remove the screw from the battery latch and take the latch out from the computer base.



1	screw	2	spring
3	battery latch assembly		

### Replacing the Battery Latch Assembly

 **CAUTION:** Before you begin the following procedure, follow the safety instructions that shipped with your computer.

 **NOTICE:** Ensure the battery latch assembly is properly oriented. The indent for the screw should face up when installing the assembly.

1. Slide the battery latch assembly into place.
2. Replace and tighten the screw securing the battery latch to the computer cover.
3. Follow the steps in [Removing the Battery Latch Assembly](#) in the reverse order.

---

[Back to Contents Page](#)

## Memory

### Dell™ Studio 1535/1536/1537 Service Manual

**CAUTION:** Before you begin any of the procedures in this section, follow the safety instructions that shipped with your computer.

You can increase your computer memory by installing memory modules on the system board. See "Specifications" in your *Quick Reference Guide* for information on the memory supported by your computer. Install only memory modules that are intended for your computer.

**NOTE:** Memory modules purchased from Dell™ are covered under your computer warranty.

Your computer has two user-accessible SODIMM sockets, DIMM A and DIMM B, accessed from the bottom of the computer.

**NOTE:** If you need to install memory modules in two connectors, install a memory module in the connector labeled "DIMM A" before you install a module in the connector labeled "DIMM B."

## Removing Memory Module(s)

The memory modules are located under the base cover on the computer.

1. Follow the procedures in [Before You Begin](#).
2. Turn the computer over and remove the base cover (see [Removing the Base Cover](#)).

**NOTE:** To prevent damage to the memory module connector, do not use tools to spread the memory module securing clips.

**NOTE:** To avoid electrostatic discharge, ground yourself by using a wrist grounding strap or by periodically touching an unpainted metal surface (such as a connector on the back of the computer).

3. Use your fingertips to carefully spread apart the securing clips on each end of the memory module connector until the module pops up.
4. Remove the module from the connector.

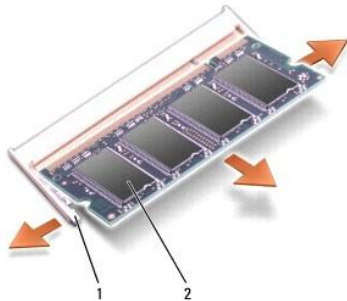

1	securing clips (2)	2	memory module
---	--------------------	---	---------------

## Replacing Memory Module(s)

**NOTE:** To avoid electrostatic discharge, ground yourself by using a wrist grounding strap or by periodically touching an unpainted metal surface (such as a connector on the back of the computer).

1. Align the notch in the module edge connector with the tab in the connector slot.
2. Slide the module firmly into the slot at a 45-degree angle, and rotate the module down until it clicks into place. If you do not hear the click, remove the module and reinstall it.

**NOTE:** If the memory module is not installed properly, the computer may not boot. No error message indicates this failure.

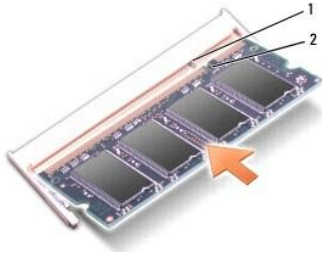

1	tab	2	notch
---	-----	---	-------

**NOTICE:** If the base cover is difficult to close, remove the module and reinstall it. Forcing the base cover to close may damage your computer.

3. Replace the base cover (see [Replacing the Base Cover](#)).
4. Slide the battery into the battery bay until it clicks into place, or connect the AC adapter to your computer and an electrical outlet.
5. Turn on the computer.

As the computer boots, it detects the additional memory and automatically updates the system configuration information.



To confirm the amount of memory installed in the computer, click **Start** → **Help and Support** → **Dell System Information**.

---

[Back to Contents Page](#)

## Microphone

### Dell™ Studio 1535/1536/1537 Service Manual

-  **CAUTION:** Before you begin any of the procedures in this section, follow the safety instructions that shipped with your computer.
-  **NOTICE:** To avoid electrostatic discharge, ground yourself by using a wrist grounding strap or by periodically touching an unpainted metal surface (such as a connector on the back of the computer).
-  **NOTICE:** To help prevent damage to the system board, you must remove the battery from the battery bay before you begin working inside the computer.

### Removing the Microphone Module

 **NOTE:** The analog microphone is not present if you have ordered the optional camera. Instead, you will have digital array microphones with the camera.

1. Follow the procedures in [Before You Begin](#).
2. Remove the palm rest. See [Removing the Palm Rest](#).
3. Disconnect the microphone cable from the system board and remove the microphone module.



1	Microphone connector	2	Microphone module
---	----------------------	---	-------------------

### Replacing the Microphone Module

1. Connect the USB/Audio board cables to the system board.
2. Connect the microphone cable to the connector on the system board.
3. Replace the palm rest (see [Replacing the Palm Rest](#)).

## Wireless Mini-Card

### Dell™ Studio 1535/1536/1537 Service Manual

**CAUTION:** Before you begin any of the procedures in this section, follow the safety instructions that shipped with your computer.

**NOTICE:** To help prevent damage to the system board, you must remove the battery from the battery bay before you begin working inside the computer.

Your computer supports three Mini-Card slots:

- 1 Two Full Mini-Card slots – for WWAN, WPAN, UWB, Bluetooth
- 1 One Half Mini-Card slot – for WLAN

**NOTE:** Depending on the configuration of your system, one or more of the Mini-Cards might not be present.

The types of Mini-Cards supported are:

- 1 Wireless Local Area Network (WLAN) — Half Mini-Card
- 1 Ultra Wide Band (UWB) — Full Mini-Card
- 1 Mobile broadband or Wireless Wide Area Network (WWAN) — Full Mini-Card
- 1 Wireless Personal Area Network (WPAN) or Internal Card with Bluetooth® Wireless Technology — Full Mini-Card

**NOTE:** Your computer can only support two Full Mini-Cards and one Half Mini-Card at a time.

**NOTE:** The WLAN slot supports a half Mini-Card.

## Removing the Mini-Card

1. Follow the instructions in [Before You Begin](#).
2. Remove the base cover (see [Removing the Base Cover](#)).

**NOTICE:** When you disconnect a cable, pull on its connector or on its pull-tab, not on the cable itself. Some cables have connectors with locking tabs; if you are disconnecting this type of cable, press in on the locking tabs before you disconnect the cable. As you pull connectors apart, keep them evenly aligned to avoid bending any connector pins. Also, before you connect a cable, ensure that both connectors are correctly oriented and aligned.

3. Disconnect the antenna cables from the Mini-Card.

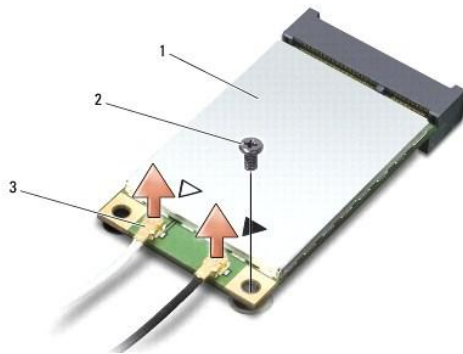

1	WWAN/WLAN Mini-Card	2	M2 x 3-mm securing screw	3	antenna cable connectors (2)
---	---------------------	---	--------------------------	---	------------------------------

**NOTE:** If you are removing a WPAN/UWB Mini-Card, disconnect the blue antenna cable from the Mini-Card.

4. Remove the securing screw that connects the Mini-Card to the system board.
5. Lift the Mini-Card out of the system board connector.



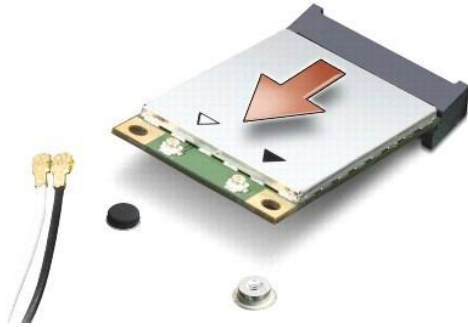

➔ **NOTICE:** When the Mini-Card is not in the computer, store it in protective antistatic packaging. For more information, see "Protecting Against Electrostatic Discharge" in the safety information that shipped with your computer.

## Replacing the Mini-Card

➔ **NOTICE:** Install the UWB Mini-Card in the WWAN or WPAN slot. Do not install a UWB Mini-Card in the WLAN card slot. Doing so may cause damage to your computer.

1. Follow the instructions in [Before You Begin](#).
2. Remove the new Mini-Card from its packaging.

➔ **NOTICE:** Use firm and even pressure to slide the card into place. If you use excessive force, you may damage the connector.

3. Insert the Mini-Card connector at a 45-degree angle into the appropriate system board connector. For example, the WLAN card connector is labeled **WLAN** and so on.
4. Press the other end of the Mini-Card down into the slot and replace the securing screw.
5. Connect the appropriate antenna cables to the Mini-Card you are installing. The following table provides the antenna cable color scheme for each Mini-Card supported by your computer.

Connectors on the Mini-Card	Antenna Cable Color Scheme
<b>WWAN (2 antenna cables)</b>	
Main WWAN (white triangle)	white with gray stripe
Auxiliary WWAN (black triangle)	black with gray stripe
<b>WLAN (2 or 3 antenna cables)</b>	
Main WLAN (white triangle)	white
Auxiliary WLAN (black triangle)	black
MIMO WLAN (*gray triangle)	gray
<b>WPAN (one antenna cable)</b>	
WPAN	blue
* The MIMO WLAN is optional and may not be available in all computers.	

📌 **NOTE:** The gray antenna cable may not be available in all computers. The presence of the gray antenna cable in your Mini-Card compartment depends upon the type of display.

6. Secure the unused antenna cables in the protective mylar sleeve.
7. Replace the base cover and tighten the captive screws.
8. Slide the battery into the bay until it clicks into place.
9. Install the drivers and utilities for your computer, as required. For more information, see the *Dell Technology Guide*.

📌 **NOTE:** If you are installing a communication card from a source other than Dell, you must install the appropriate drivers and utilities. For more information, see the *Dell Technology Guide*.

[Back to Contents Page](#)

[Back to Contents Page](#)

## Optical Drive

Dell™ Studio 1535/1536/1537 Service Manual

### Removing the Optical Drive

1. Follow the procedures in [Before You Begin](#).
2. Remove the palm rest (see [Removing the Palm Rest](#)).
3. Remove the three screws on the optical drive and take out the optical drive from the bay.



1	optical drive	3	screws (3)
---	---------------	---	------------

### Replacing the Optical Drive

1. Connect the optical drive connector to the system board.
2. Replace and tighten the three screws on the optical drive.
3. Replace the palm rest (see [Replacing the Palm Rest](#)).

### Removing the Optical Drive Interposer

1. Follow the procedures in [Before You Begin](#).
2. Remove the palm rest (see [Removing the Palm Rest](#)).
3. Remove the three screws on the optical drive and take out the optical drive from the bay.
4. Pull out the optical drive interposer to remove it.



1	optical drive	2	optical drive interposer
---	---------------	---	--------------------------

---

[Back to Contents Page](#)

## Palm Rest

Dell™ Studio 1535/1536/1537 Service Manual

### Removing the Palm Rest

**⚠ CAUTION:** Before you begin the following procedure, follow the safety instructions that shipped with your computer.

1. Follow the instructions in [Before You Begin](#).
2. Remove the base cover (see [Removing the Base Cover](#)).
3. Remove the eight screws from the bottom of the computer.



4. Remove all Mini-Cards (see [Removing the Mini-Card](#)).
5. Press and remove any ExpressCard or media card.
6. Remove the display assembly (see [Removing the Display Assembly](#)).
7. Remove the eight screws on the palm rest.
8. Remove the touch pad, fingerprint reader, and speaker connectors from the system board.

**ⓘ NOTICE:** Do not use force to separate the palm rest from the computer. If you encounter resistance, gently flex or apply pressure to the palm rest, or move along the edge, working away from the area of resistance, until the palm rest is free.

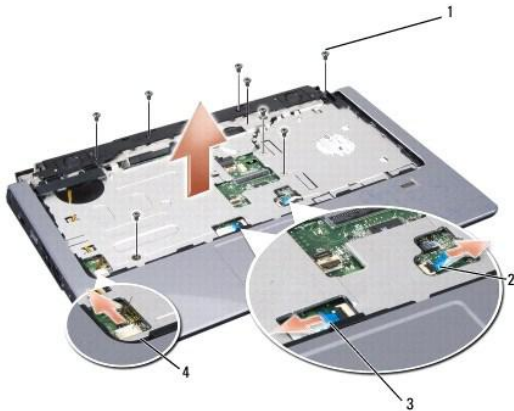

1	screws (8)	2	fingerprint reader connector
3	touch pad connector	4	speaker connector

9. Moving from left to right, carefully lift the palm rest along the rear edge, near the hinge brackets, then gently lift the palm rest to remove it from the computer.

## Replacing the Palm Rest

 **CAUTION:** Before you begin the following procedure, follow the safety instructions that shipped with your computer.

1. Align the palm rest with the base of the computer and gently snap it into place.
2. Connect the touch pad, fingerprint reader, and speaker connectors to the system board.
3. Replace the eight screws on the palm rest.
4. Replace the display assembly (see [Replacing the Display Assembly](#)).
5. Replace the mini cards (see [Replacing the Mini-Card](#)).
6. Replace the eight screws at the bottom of the computer.
7. Replace the base cover (see [Replacing the Base Cover](#)).

---

[Back to Contents Page](#)

## Speaker Assembly

Dell™ Studio 1535/1536/1537 Service Manual

### Removing the Speaker Assembly

**⚠ CAUTION:** Before you begin the following procedure, follow the safety instructions that shipped with your computer.

1. Follow the instructions in [Before You Begin](#).
2. Remove the palm rest (see [Removing the Palm Rest](#)).
3. Remove the four screws (two on each side) on the speakers.
4. Release the speaker cable from the securing tabs on the palm rest and take out the speaker assembly.



1	screws (4)	2	speaker cable
---	------------	---	---------------

### Replacing the Speaker Assembly

**⚠ CAUTION:** Before you begin the following procedure, follow the safety instructions that shipped with your computer.

1. Replace and tighten the four screws securing the speaker assembly to the palm rest.
2. Route the speaker cables carefully through the securing tabs on the palm rest.
3. Replace the palm rest (see [Replacing the Palm Rest](#)).

[Back to Contents Page](#)

## System Board Assembly

### Dell™ Studio 1535/1536/1537 Service Manual

The BIOS chip in the system board contains the Service Tag, which is also visible on a barcode label on the bottom of the computer. The replacement kit for the system board includes media that provides a utility for transferring the Service Tag to the replacement system board.

## Removing the System Board Assembly

**⚠ CAUTION:** Before you begin the following procedure, follow the safety instructions that shipped with your computer.

1. Follow the instructions in [Before You Begin](#).
2. Remove memory module(s) (see [Removing Memory Module\(s\)](#)).
3. Remove the hard drive (see [Removing the Hard Drive](#)).
4. Remove the Mini-Card (see [Removing the Mini-Card](#)).
5. Remove the processor thermal-cooling assembly (see [Removing the Processor Thermal-Cooling Assembly](#)).
6. Remove the processor (see [Removing the Processor Module](#)).
7. Remove the center control cover (see [Removing the Center Control Cover](#)).
8. Remove the keyboard (see [Removing the Keyboard](#)).
9. Remove the display assembly (see [Removing the Display Assembly](#)).
10. Remove the palm rest (see [Removing the Palm Rest](#)).
11. Remove the optical drive (see [Removing the Optical Drive](#)).

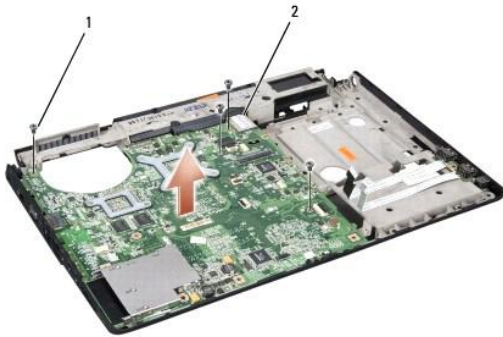

1	screws (4)	2	system board connector
---	------------	---	------------------------

12. Remove the four screws from the top of the system board.
13. Disconnect the system board cable and remove the system board.

**NOTE:** Depending on your system configuration, the number of screws shown here may be greater than the number of screws present in your computer.

## Replacing the System Board Assembly



 **CAUTION:** Before you begin the following procedure, follow the safety instructions that shipped with your computer.

 **NOTICE:** Ensure that any loose cables do not get caught beneath the system board.

1. Replace the system board in position.
  2. Replace the four screws on the top of the system board.
  3. Connect the system board cable.
  4. Follow the steps in [Removing the System Board Assembly](#) in reverse order.
- 



[Back to Contents Page](#)

[Back to Contents Page](#)

## Dell™ Studio 1535/1536/1537 Service Manual

---

### Notes, Notices, and Cautions

-  **NOTE:** A NOTE indicates important information that helps you make better use of your computer.
-  **NOTICE:** A NOTICE indicates either potential damage to hardware or loss of data and tells you how to avoid the problem.
-  **CAUTION:** A CAUTION indicates potential for property damage, personal injury, or death.

If you purchased a Dell™ n Series computer, any references in this document to Microsoft® Windows® operating systems are not applicable.

---

Information in this document is subject to change without notice.  
© 2008 Dell Inc. All rights reserved.

Reproduction in any manner whatsoever without the written permission of Dell Inc. is strictly forbidden.

Trademarks used in this text: *Dell* and the *DELL* logo are trademarks of Dell Inc.; *Microsoft*, *Windows*, and *Windows Vista* are either trademarks or registered trademarks of Microsoft Corporation in the United States and/or other countries; *Bluetooth* is a registered trademark owned by Bluetooth SIG, Inc. and is used by Dell under license.

Other trademarks and trade names may be used in this document to refer to either the entities claiming the marks and names or their products. Dell Inc. disclaims any proprietary interest in trademarks and trade names other than its own.

August 2008 Rev. A01

---

[Back to Contents Page](#)