

Dell™ XPS™ 420 Owner's Manual

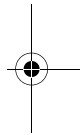

Model DC01L

www.dell.com | support.dell.com

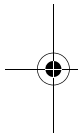
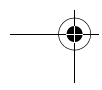
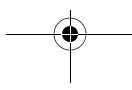

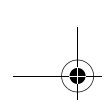

Notes, Notices, and Cautions



NOTE: A NOTE indicates important information that helps you make better use of your computer.



NOTICE: A NOTICE indicates either potential damage to hardware or loss of data and tells you how to avoid the problem.



CAUTION: A CAUTION indicates a potential for property damage, personal injury, or death.

If you purchased a Dell™ n Series computer, any references in this document to Microsoft® Windows® operating systems are not applicable.

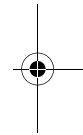
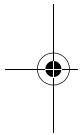

Information in this document is subject to change without notice.

© 2007 Dell Inc. All rights reserved.

Reproduction in any manner whatsoever without the written permission of Dell Inc. is strictly forbidden.

Trademarks used in this text: *Dell*, the *DELL* logo, *XPS*, *Dell TravelLite*, the Dell Media *Xcelerator*, *Yours Is Here*, and *StrikeZone* are trademarks of Dell Inc.; *Intel*, *Pentium*, *Intel Core 2 Extreme*, *Intel Core 2 Duo*, *Intel Core 2 Quad*, *Intel SpeedStep*, and *Intel ViiV* are either trademarks or registered trademarks of Intel Corporation; *Microsoft*, *Windows*, *Windows Vista*, *Outlook*, *SideShow*, and the *Windows Vista Start* button are either trademarks or registered trademarks of Microsoft Corporation in the United States and/or other countries; *Blu-ray Disc* is a trademark of the Blu-ray Disc Association; *Bluetooth* is a registered trademark owned by Bluetooth SIG, Inc. and is used by Dell under license.

Other trademarks and trade names may be used in this document to refer to either the entities claiming the marks and names or their products. Dell Inc. disclaims any proprietary interest in trademarks and trade names other than its own.

Model DC01L

November 2007

P/N GX404

Rev. A01

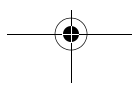

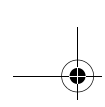

Contents

Finding Information 11

1 Setting Up and Using Your Computer . . . 15

Front and Back View of the Computer 15

Front View 15

Front I/O Connectors 18

Back View 19

Back I/O Connectors 20

Installing Your Computer in an Enclosure 22

Connecting Monitors 24

Connecting a Monitor (Without an Adapter) 25

Connecting a Monitor (With an Adapter) 26

Connecting Two or More Monitors 28

Connecting a TV 29

Changing the Display Settings 30

About Your RAID Configuration 30

RAID Level 0 Configuration 30

RAID Level 1 Configuration 31

Configuring Your Computer for RAID 32

Using the Intel® RAID Option ROM Utility 33

Using the Intel® Application Accelerator 36

Dell DataSafe (Optional) 41

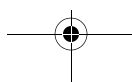
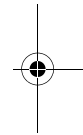
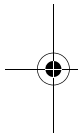

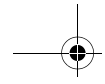

Intel® Viiv™ Technology (Optional)	41
Using Intel Viiv Quick Resume Technology (QRT)	41
Enabling the QRT Feature in System Setup	42
Enabling the QRT Feature in the Operating System	42
Using Multimedia	42
Playing CDs or DVDs	42
Copying Media	44
How to Copy a CD or DVD	44
How to Copy a Blu-ray Disc™ (BD) Media	45
Using Blank CDs and DVDs	45
Helpful Tips	46
Using a Media Card Reader	47
Understanding the Media Xcelerator™ (Optional)	49
Understanding Windows® SideShow™ and the LCD display	50
Configuring the LCD display	51
Adding Gadgets To LCD Display Menu	51
Setting Up a Printer	52
Printer Cable	52
Connecting a USB Printer	52
Connecting to the Internet	54
Setting Up Your Internet Connection	54
Network Setup Wizard	55
Transferring Information to a New Computer	56

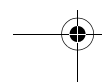
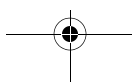
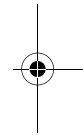
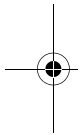

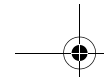

Power Management Options in Windows Vista	56
Sleep Mode	56
Hybrid Sleep	56
Hibernate Mode	57
Configuring Power Management Settings	57
2 Optimizing for Greater Performance	59
Understanding Intel™ SpeedStep® Technology	59
3 Troubleshooting	61
Solving Problems	61
Coin-Cell Battery Problems	61
Drive Problems	62
E-Mail, Modem, and Internet Problems	63
Error Messages	64
IEEE 1394a Device Problems	65
Keyboard Problems	65
Lockups and Software Problems	66
Memory Problems	68
Mouse Problems	68
Network Problems	69
Power Problems	69
Printer Problems	71
Scanner Problems	71
Sound and Speaker Problems	72
Video and Monitor Problems	73
Power Lights	75
Diagnostic Lights	76
Beep Codes	81

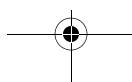
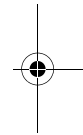
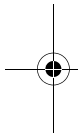

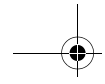

System Messages 83

Dell Diagnostics 86

When to Use Dell Diagnostics 86

Starting Dell Diagnostics From Your
Hard Drive 87

Starting Dell Diagnostics From the Drivers and
Utilities Media 88

Dell Diagnostics Main Menu 88

Drivers 90

What Is a Driver? 90

Identifying Drivers 91

Reinstalling Drivers and Utilities 91

Using Windows Device Driver Rollback 91

Using the Drivers and Utilities Media 92

**Troubleshooting Software and Hardware Problems
in the Microsoft Windows Vista™ Operating
System 93**

Restoring Your Operating System 94

Using Microsoft Windows System Restore 94

Using Dell Factory Image Restore 95

Using the Operating System Media 96

Troubleshooting LCD Display Problems 98

4 Removing and Installing Parts 99

Before You Begin 99

Recommended Tools 99

Turning Off Your Computer 99

Before Working Inside Your Computer 100

Removing the Computer Cover 101

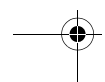
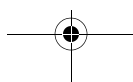

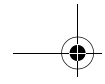

Inside View of Your Computer	102
System Board Components	103
Memory	104
Memory Overview	104
Installing Memory	106
Removing Memory	108
Cards	109
PCI Cards	109
PCI Express Cards	115
Drive Panels	124
Removing the Drive Panel	124
Removing the Drive-Panel Insert	125
Replacing the Drive-Panel Insert	126
Replacing the Drive Panel	127
Drives	128
General Installation Guidelines	128
Hard Drive	129
Removing a Hard Drive	129
Installing a Hard Drive	130
Adding a Second Hard Drive	132
Installing a Hard Drive in the FlexBay	134
Removing a Hard Drive From the FlexBay	135
Floppy Drive	136
Removing a Floppy Drive	136
Installing a Floppy Drive	138
Media Card Reader	140
Removing a Media Card Reader	140
Installing a Media Card Reader	142

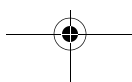
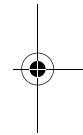
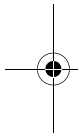

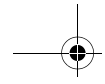

CD/DVD Drive	144
Removing a CD/DVD Drive	144
Installing a CD/DVD Drive	146
Processor Airflow Shroud	148
Removing the Processor Airflow Shroud Assembly	148
Installing the Processor Airflow Shroud Assembly	149
Fans	149
Removing the Processor Fan Cage	149
Installing the Processor Fan Cage	150
Removing the Processor Fan	151
Installing the Processor Fan	152
Removing the Card Fan	152
Installing the Card Fan	154
Processor	154
Removing the Processor	154
Installing the Processor	155
System Board	157
Removing the System Board	157
Installing the System Board	158
Power Supply	160
Power Supply (PSU) DC Connector Pin Assignments	160
Removing the Power Supply	165
Installing the Power Supply	166
Front I/O Panel	167
Front I/O-Panel Components	167
Removing the Front I/O Panel	168
Installing the Front I/O Panel	169

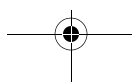
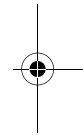
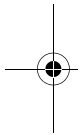

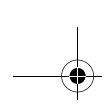

Coin-Cell Battery 170
 Replacing the Coin-Cell Battery 170

Replacing the Computer Cover 172

A Appendix 173

Specifications 173

System Setup 178
 Overview 178
 Entering System Setup 179
 System Setup Options 180
 Boot Sequence 186

Clearing Forgotten Passwords 188

Clearing CMOS Settings 190

Cleaning Your Computer 191
 Computer, Keyboard, and Monitor 191
 Mouse 191
 Floppy Drive 192
 CDs and DVDs 192

FCC Notices (U.S. Only) 193

Class A 193
 Class B 194
 FCC Identification Information 194

Getting Help 195

Obtaining Assistance 195
 Technical Support and Customer Service 196
 DellConnect 196
 Online Services 196

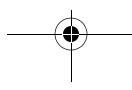
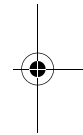
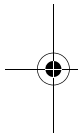

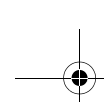

AutoTech Service	197
Automated Order-Status Service	197
Problems With Your Order	197
Product Information	197
Returning Items for Warranty Repair or Credit	198
Before You Call	198
Contacting Dell	200

Glossary	201
--------------------	-----

Index	219
-----------------	-----

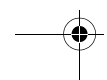
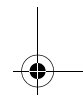
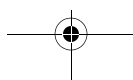
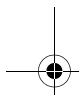
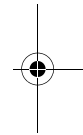
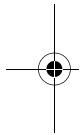



Finding Information

 **NOTE:** Some features or media may be optional and may not ship with your computer. Some features or media may not be available in certain countries.

 **NOTE:** Additional information may ship with your computer.

What Are You Looking For?	Find It Here
<ul style="list-style-type: none"> • A diagnostic program for my computer • Drivers for my computer • My device documentation • Desktop System Software (DSS) 	<p>Drivers and Utilities Media</p> <p>Documentation and drivers are already installed on your computer. You can use the <i>Drivers and Utilities</i> media to reinstall drivers (see "Reinstalling Drivers and Utilities" on page 91), access your documentation, or run the Dell Diagnostics (see "Dell Diagnostics" on page 86).</p> <p>Readme files may also be included on your media to provide last-minute updates about technical changes to your computer or advanced technical reference material for technicians and experienced users.</p>

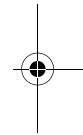
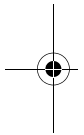

NOTE: Drivers and documentation updates can be found at support.dell.com.

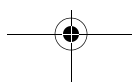

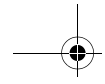

What Are You Looking For?

- Warranty information
- Terms and Conditions (U.S. only)
- Safety instructions
- Regulatory information
- Ergonomics information
- End User License Agreement

Find It Here**Dell™ Product Information Guide**

- How to set up my computer

Setup Diagram

- Service Tag and Express Service Code
- Microsoft Windows License Label

Service Tag and Microsoft Windows Product Key

These labels are located on your computer.

- Use the Service Tag to identify your computer when you use support.dell.com or contact support.



- Enter the Express Service Code to direct your call when contacting support.

NOTE: As an increased security measure, the newly designed Microsoft Windows license label incorporates a missing portion or "hole" to discourage removal of the label.

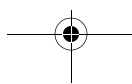

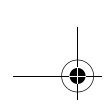

What Are You Looking For?

- Solutions — Troubleshooting hints and tips, articles from technicians, online courses, and frequently asked questions
- Community — Online discussion with other Dell customers
- Upgrades — Upgrade information for components, such as the memory, hard drive, and operating system
- Customer Care — Contact information, service call and order status, and warranty and repair information
- Service and Support — Service call status, support history, service contract, and online discussions with support
- Reference — Computer documentation, details on my computer configuration, product specifications, and white papers
- Downloads — Certified drivers, patches, and software updates
- Desktop System Software (DSS) — If you reinstall the operating system on your computer, you should also reinstall the DSS utility. DSS automatically detects your computer and operating system and installs the updates appropriate for your configuration, providing critical updates for your operating system and support for Dell™ 3.5-inch USB floppy drives, Intel® Pentium® M processors, optical drives, and USB devices. DSS is necessary for correct operation of your Dell computer.

Find It Here

Dell Support Website — support.dell.com

NOTE: Select your region or business segment to view the appropriate support site.

To download Desktop System Software:

- 1** Go to support.dell.com, select your business segment, and then enter your Service Tag or product model.
- 2** Select **Drivers & Downloads**, and then click **Go**.
- 3** Select your operating system and language, and then search for the keyword *Desktop System Software*.

NOTE: The support.dell.com user interface may vary depending on your selections.

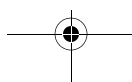

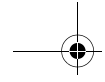

What Are You Looking For?

- How to use your Windows™ operating system
- How to work with programs and files
- How to personalize my desktop

Find It Here**Windows Help and Support**

- 1** To access Windows Help and Support:
 - In Windows Vista™, click the Windows Vista Start button™  and click **Help and Support**.
- 2** Type a word or phrase that describes your problem, and then click the arrow icon.
- 3** Click the topic that describes your problem.
- 4** Follow the instructions on the screen.

- How to reinstall my operating system

Operating System Media

The operating system is already installed on your computer. To reinstall your operating system, use the *Operating System* (see "Restoring Your Operating System" on page 94).



After you reinstall the operating system, use the *Drivers and Utilities* media to reinstall drivers for the devices that came with your computer.

The operating system product key label is located on your computer.

NOTE: The color of your *Operating System* CD varies according to the operating system you ordered.

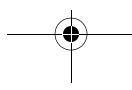



1



Setting Up and Using Your Computer

Front and Back View of the Computer

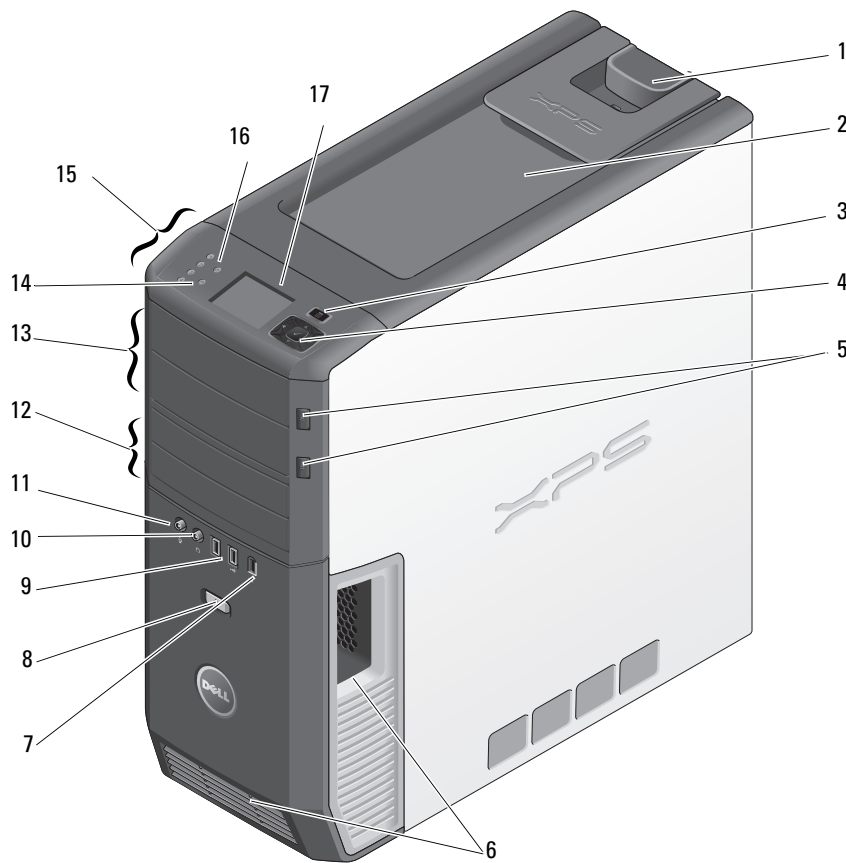
Front View

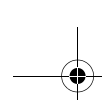



1	cover release latch	Use this latch to remove the cover (see "Removing the Computer Cover" on page 101).
2	storage space	Use to stack CDs, place a digital camera while transferring images to system and so on.
3	LCD display menu	Use to scroll through the different menu options available on LCD display.
4	LCD navigation buttons	Use to navigate the menu options on LCD display. Use the buttons to scroll up and down, navigate options on left and right, or select.
5	optical drive tray eject button (2)	Use to eject the drive tray of an optical drive. NOTE: The self-tending doors on the optical drive open automatically when the eject button is pressed.
6	vents	For adequate cooling, do not block any of the vents.  NOTICE: Ensure that there is a minimum of two inches of space between all vents and any object near the vents.  NOTICE: Keep the vent area clean and dust-free to ensure that the system is adequately ventilated. Use only a dry cloth to clean the vent area to avoid water damage to the system.
7	IEEE 1394 connector	Use the IEEE 1394 connector for high-speed data devices such as digital video cameras and external storage devices.
8	power button	Press to turn on the computer.  NOTICE: To avoid losing data, do not use the power button to turn off the computer. Instead, perform an operating system shutdown. NOTE: The power button can also be used to wake the system or to place it into a power-saving state (see "Power Management Options in Windows Vista" on page 56).

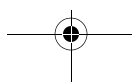
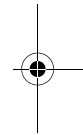
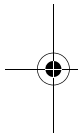

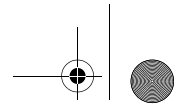

9	USB connectors (2)	Use the front USB connectors for devices that you connect occasionally, such as flash memory keys, cameras, or bootable USB devices. For more information on booting to a USB device, see "System Setup" on page 178. NOTE: It is recommended that you use the back USB connectors for devices that typically remain connected, such as printers and keyboards.
10	headphone connector	Use the headphone connector to attach headphones and most kinds of speakers.
11	microphone connector	Use the microphone connector to attach a personal computer microphone for voice or musical input into a sound or telephony program.
12	3.5-inch flexbays (2)	Can hold an optional Media Card Reader, audio input, video input, output device with or without a graphics accelerator device, floppy drive or an additional hard drive.
13	5.25-inch drive bays (2)	Can hold CD-RW/DVD, audio or video input or output with or without graphics accelerator device, DVD-RW or Blu-ray Disc™.
14	hard-drive activity light	The hard drive light is on when the computer reads data from or writes data to the hard drive. The light may also be on when a device such as your CD player is operating.
15	diagnostic lights(4)	Use the sequence of these diagnostics lights to help troubleshoot a problem with your computer (see "Dell Diagnostics" on page 86).
16	network indicator light	The network link light is on when a good connection exists between a network and the computer.
17	LCD display	Displays a "Now playing" screen for audio and video applications. Allows you to navigate, select, and launch devices available on your system.

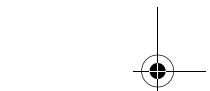
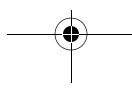
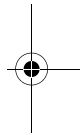
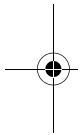

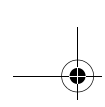

Front I/O Connectors

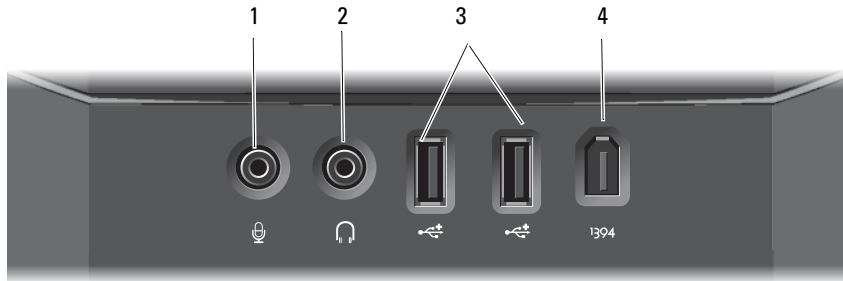

1	microphone connector	Use the microphone connector to attach a personal computer microphone for voice or musical input into a sound or telephony program.
2	headphone connector	Use the headphone connector to attach headphones.
3	USB connectors (2)	Use the front USB connectors for devices that you connect occasionally, such as flash memory keys, cameras, or bootable USB devices. For more information on bootable USB devices see "Boot Sequence" on page 186. It is recommended that you use the back USB connectors for devices that typically remain connected, such as printers and keyboards.
4	IEEE 1394 connector	Use the IEEE 1394 connector for high-speed data devices such as digital video cameras and external storage devices.

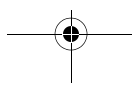
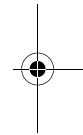
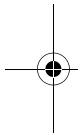

Back View

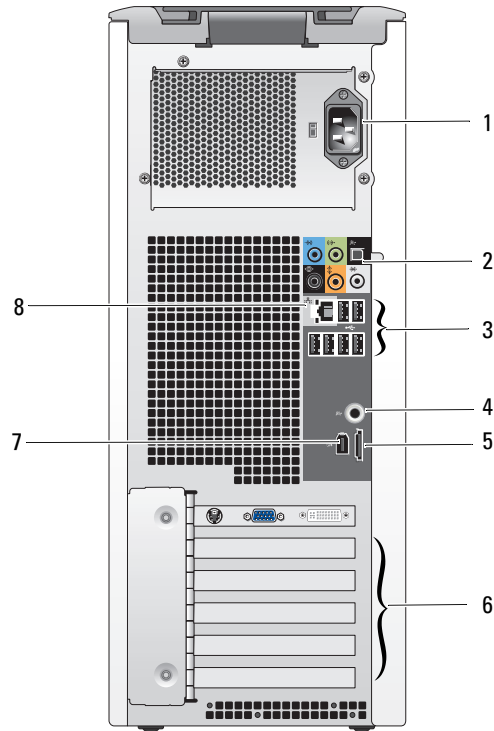

1	power connector	Insert the power cable. The appearance of this connector may differ from what is pictured.
2	audio connectors	Connect appropriate audio devices (see "Back I/O Connectors" on page 20).
3	USB connectors	Recommended for devices that typically remain connected, such as printers and keyboards.
4	S/PDIF (RCA)	Connects to external digital stereo speakers.
5	eSATA	Use it to connect to additional storage devices.



6	card slots	Access connectors for any installed PCI or PCI Express cards. NOTE: Some connector slots support full-length cards.
7	IEEE 1394	Use the IEEE 1394 connector for high-speed data devices such as digital video cameras and external storage devices.
8	network adapter connector	 NOTICE: Do not plug a telephone cable into the network connector. Use the network adapter connector to attach your computer to a network or broadband device.

Back I/O Connectors

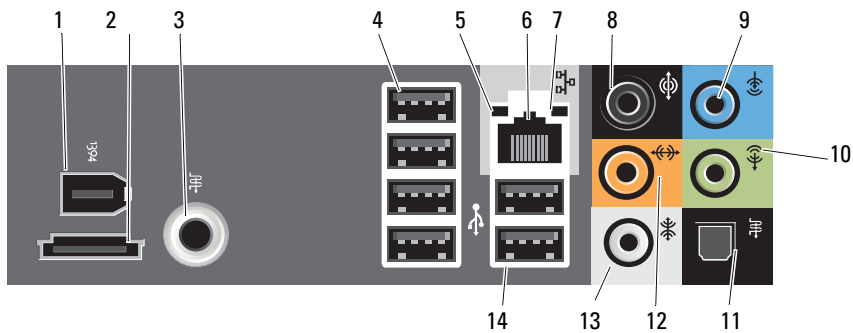

1	IEEE 1394	Use the IEEE 1394 connector for high-speed data devices such as digital video cameras and external storage devices.
2	eSATA	Use this connector to connect to external SATA storage devices.
3	S/PDIF (RCA)	Connects to external digital stereo speakers.
4	USB connectors (4) (rear quad)	Use the back, rear-quad USB connectors for devices that typically remain connected, such as printers and keyboards. NOTE: It is recommended that you use the front USB connectors for devices that you connect occasionally, such as joysticks, cameras, or bootable USB devices.

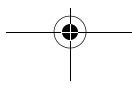

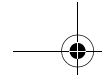

-
- 5 link integrity light
 - Green — A good connection exists between a 10-Mbps network and the computer.
 - Orange — A good connection exists between a 100-Mbps network and the computer.
 - Yellow — A good connection exists between a 1000-Mbps (1-Gbps) network and the computer.
 - Off — The computer is not detecting a physical connection to the network.
-

6 network adapter connector  **NOTICE:** Do not plug a telephone cable into the network adapter connector.

Use the network adapter connector to attach your computer to a network or broadband device. Connect one end of a network cable to either a network jack or your network or broadband device, and then connect the other end of the network cable to the network adapter connector on your computer. A click indicates that the network cable has been securely attached.

On computers with an additional network connector card, use the connectors on the card and on the back of the computer when setting up multiple network connections (such as a separate intra- and extranet).

NOTE: It is recommended that you use Category 5 wiring and connectors for your network. If you must use Category 3 wiring, force the network speed to 10 Mbps to ensure reliable operation.

-
- 7 network activity light Flashes a yellow light when the computer is transmitting or receiving network data. A high volume of network traffic may make this light appear to be in a steady "on" state.
-

- 8 surround sound connector Use the (black) surround sound connector to attach multichannel-capable speakers.
On computers with a sound card, use the connector on the card.
-

- 9 line-in connector Use the (blue) line-in connector to attach a record/playback device such as a cassette player, CD player, or VCR.
On computers with a sound card, use the connector on the card.
-

- 10 line-out/headphone connector Use the (green) line-out connector to attach headphones and most speakers with integrated amplifiers.
On computers with a sound card, use the connector on the card.
-

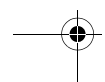
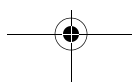

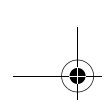

11 S/PDIF (optical) connector	Use the S/PDIF optical connector to transmit digital audio without going through an analog audio conversion process. On computers with a sound card, use the connector on the card.
12 center/subwoofer LFE connector	Use the (orange) center/subwoofer connector to attach a center speaker or a single subwoofer. On computers with a sound card, use the connector on the card. NOTE: The LFE (Low Frequency Effects) Audio channel, found in digital surround sound audio schemes, carries only low frequency information of 80 Hz and below. The LFE channel drives a subwoofer to provide extremely low bass extension. Systems not using subwoofers can shunt the LFE information to the main speakers in the surround sound setup.
13 side surround sound connector	Use the (gray) side surround sound connector to attach multichannel-capable speakers. The side-surround output provides enhanced surround audio for computers with 7.1 speakers. On computers with a sound card, use the connector on the card.
14 USB 2.0 connectors (2) (rear dual)	Use the back, rear-dual USB connectors for devices that typically remain connected, such as printers and keyboards. NOTE: It is recommended that you use the front USB connectors for devices that you connect occasionally, such as joysticks, cameras, or bootable USB devices.

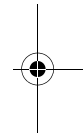
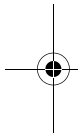

Installing Your Computer in an Enclosure

Installing your computer in an enclosure can restrict the airflow and impact your computer's performance, possibly causing it to overheat. Follow the guidelines below when installing your computer in an enclosure:

-  **NOTICE:** The operating temperature specifications indicated in your Owner's Manual reflect the maximum ambient operating temperature. The room's ambient temperature needs to be a consideration when installing your computer in an enclosure. For example, if the ambient room temperature is at 25° C (77° F), depending on your computer's specifications, you only have 5° to 10° C (9° to 18° F) temperature margin before you reach your computer's maximum operating temperature. For details about your computer's specifications, see "Specifications" on page 173.

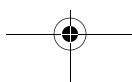



- Leave a 10.2 centimeter (4 inch) minimum clearance on all vented sides of the computer to permit the airflow required for proper ventilation.
- If your enclosure has doors, they need to be of a type that allows at least 30% airflow through the enclosure (front and back).

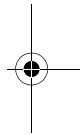
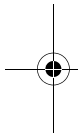
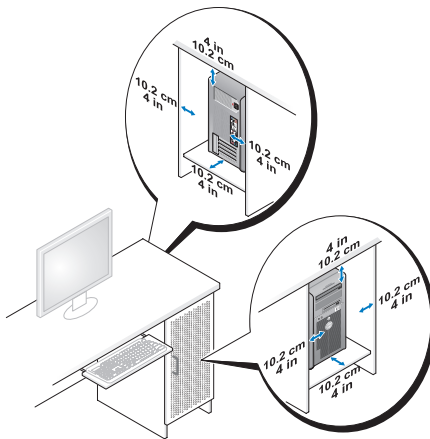

- If your computer is installed in a corner on a desk or under a desk, leave at least 5.1 centimeters (2 inch) of clearance from the back of the computer to the wall to permit the airflow required for proper ventilation.

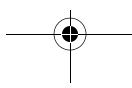
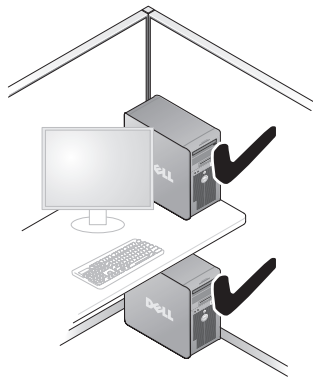

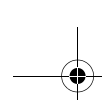

- Do not install your computer in an enclosure that does not allow airflow. Restricting the airflow impacts your computer's performance, possibly causing it to overheat.

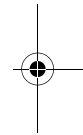
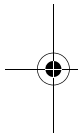

Connecting Monitors



CAUTION: Before you perform any of the procedures in this section, follow the safety instructions in the *Product Information Guide*.



CAUTION: To reduce the risk of fire, electric shock, or injury, do not overload an electrical outlet, power strip, or convenience receptacle. The total ampere rating of all products plugged into an electrical outlet, power strip, or other receptacle should not exceed 80 percent of the branch circuit rating.



NOTE: Your video card has three different ports: a DVI (White) port, a DVI-I (Black) port, and a VGA (Blue) port.

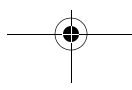

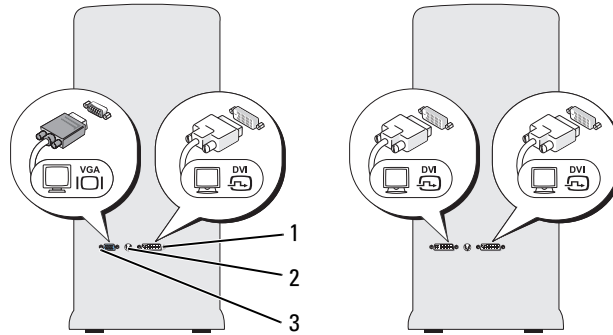

- 1 DVI (white) connector 2 TV-OUT connector 3 VGA (blue) connector

Connecting a Monitor (Without an Adapter)

⚠ CAUTION: Before you perform any of the procedures in this section, follow the safety instructions in the *Product Information Guide*.

- 1 Save and close all open files and exit all open programs.
- 2 Shut down the operating system:
 - In Windows Vista™, click the Windows Vista Start button™  click the arrow in the lower-right corner of the Start menu as shown below, and then click **Shut Down**.



The computer turns off after the operating system shutdown process is complete.

- 3 Ensure that the computer and all attached devices are turned off. If your computer and attached devices did not automatically turn off when you shut down your operating system, press and hold the power button for about 4 seconds to turn them off. Disconnect the computer and all attached devices from their electrical outlets.

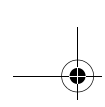

- 4 Connect the DVI or VGA connector of your monitor to the appropriate connector on the back of the computer:

To connect a monitor with a DVI connector, use the (white) DVI port on your computer.

To connect a monitor with a VGA connector, use the (blue) VGA port on your computer.

 **NOTE:** To connect a monitor with a VGA connector to the DVI-I (black) port on your computer, use a dongle.

Connecting a Monitor (With an Adapter)



CAUTION: Before you perform any of the procedures in this section, follow the safety instructions in the *Product Information Guide*.



NOTE: In order to connect a monitor with a VGA connector to the DVI port on the back of your computer, a DVI-to-VGA adapter is required.

- 1 Save and close all open files and exit all open programs.
- 2 Shut down the operating system:
 - In Windows Vista, click **Start** , click the arrow in the lower-right corner of the Start menu as shown below, and then click **Shut Down**.



The computer turns off after the operating system shutdown process is complete.

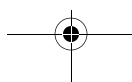
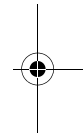
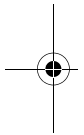

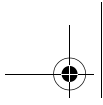

- 3** Ensure that the computer and all attached devices are turned off. If your computer and attached devices did not automatically turn off when you shut down your operating system, press and hold the power button for about 4 seconds to turn them off.
- 4** Connect the DVI-to-VGA adapter to the VGA connector on your monitor, and then connect the other end of the adapter to the (white) DVI port on the back of the computer.

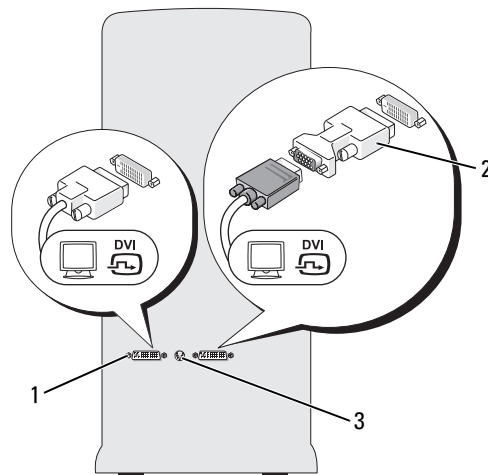

- 1 DVI (white) connector 2 DVI-to-VGA adapter 3 TV-OUT connector (optional)

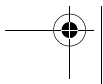

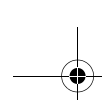

Connecting Two or More Monitors



CAUTION: Before you perform any of the procedures in this section, follow the safety instructions in the *Product Information Guide*.



NOTE: Your video card has one DVI (white) port, one DVI-I (black) port, and one VGA (blue) port.

- 1 Save and close all open files and exit all open programs.
- 2 Shut down the operating system:
 - In Windows Vista, click **Start** , click the arrow in the lower-right corner of the Start menu as shown below, and then click **Shut Down**.



The computer turns off after the operating system shutdown process is complete.

- 3 Ensure that the computer and all attached devices are turned off. If your computer and attached devices did not automatically turn off when you shut down your operating system, press and hold the power button for about 4 seconds to turn them off.
- 4 Connect two or more monitors to the appropriate DVI or VGA ports on the back of the computer.



NOTE: In order to connect a monitor with a VGA connector to the DVI port on the back of your computer, a DVI-to-VGA adapter is required.

To connect two or more monitors directly to the DVI or VGA ports on your computer, see "Connecting a Monitor (Without an Adapter)" on page 25.

To connect the VGA connectors of one or more monitors to the DVI port(s) on your computer, see "Connecting a Monitor (With an Adapter)" on page 26.



NOTE: To connect a monitor with a VGA connector to the DVI-I (black) port on your computer, use a dongle.

- 5 Change the display settings to support multiple monitors (see "Changing the Display Settings" on page 30).

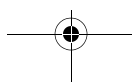

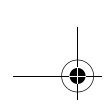

Connecting a TV



CAUTION: Before you perform any of the procedures in this section, follow the safety instructions in the *Product Information Guide*.



NOTE: If you are connecting a TV to your computer, you may connect only one monitor (VGA or DVI) in addition to the TV.



NOTE: See the documentation that came with your TV to ensure that you properly configure and connect the TV.

To connect a TV to your computer, an S-video cable is required. If you do not have an S-video cable, you may purchase one at most consumer electronics stores. An S-video cable is not included with your computer.

- 1 Save and close all open files and exit all open programs.
- 2 Shut down the operating system:
 - In Windows Vista, click **Start** , click the arrow in the lower-right corner of the Start menu as shown below, and then click **Shut Down**.



The computer turns off after the operating system shutdown process is complete.

- 3 Ensure that the computer and all attached devices are turned off. If your computer and attached devices did not automatically turn off when you shut down your operating system, press and hold the power button for about 4 seconds to turn them off.
- 4 Disconnect the computer and all attached devices from their electrical outlets.
- 5 Connect one end of the S-video cable to the TV-OUT connector on the back of the computer.
- 6 Connect the other end of the S-video cable to the S-video input connector on your TV.
- 7 Connect one monitor, as needed, with a DVI or VGA connector as described in "Connecting Monitors" on page 24.

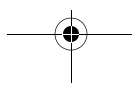
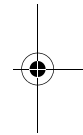
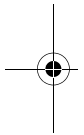

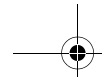

Changing the Display Settings

- 1 After you connect the monitor(s) or TV, turn on the computer.
The Microsoft® Windows® desktop displays on the primary monitor.
- 2 Enable extended desktop mode in the display settings. In extended desktop mode, you can drag objects from one screen to the other, effectively doubling the amount of viewable work space.

About Your RAID Configuration

This section provides an overview of the RAID configuration you may have selected when you purchased your computer. There are several RAID configurations available in the computer industry for different types of uses. Your computer supports RAID level 0 and RAID level 1. A RAID level 0 configuration is recommended for high-performance programs or gaming, and a RAID level 1 configuration is recommended for users who require a high level of data integrity. For example, those in the digital photography and audio industries.

 **NOTE:** RAID levels do not represent a hierarchy. A RAID level 1 configuration is not inherently better or worse than a RAID level 0 configuration.

The drives in a RAID configuration should be the same size in order to ensure that the larger drive does not contain unallocated (and therefore unusable) space.

RAID Level 0 Configuration

 **NOTICE:** Because RAID level 0 configurations provide no data redundancy, a failure of one drive results in the loss of all data (the data on the remaining drive is also inaccessible). Therefore, ensure that you perform regular backups when you use a RAID level 0 configuration.

A RAID level 0 configuration uses a storage technique known as data striping to provide a high data access rate. Data striping is a method of writing consecutive segments, or stripes, of data sequentially across the physical drives to create a large virtual drive. Data striping allows one of the drives to read data while the other drive is searching for and reading the next block.

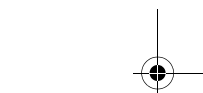
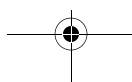

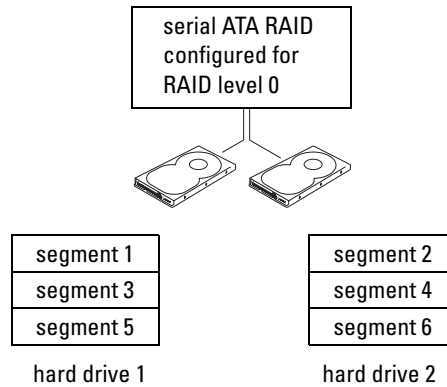

Another advantage of a RAID level 0 configuration is that it utilizes the full storage capacities of the drives. For example, two 120-GB drives combine to provide 240 GB of hard drive space on which to store data.

 **NOTE:** In a RAID level 0 configuration, the size of the configuration is equal to the size of the smallest drive multiplied by the number of drives in the configuration.

RAID Level 1 Configuration

A RAID level 1 configuration uses a data-redundancy storage technique known as mirroring to enhance data integrity. When data is written to the primary drive, the data is also duplicated, or mirrored, on the second drive in the configuration. RAID level 1 sacrifices high data-access rates for its data redundancy advantages.



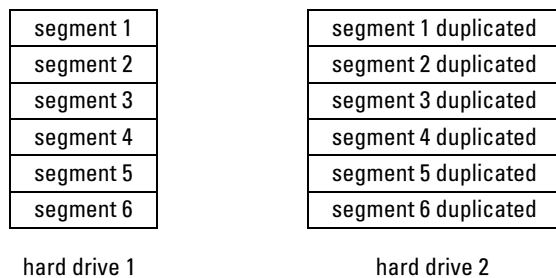
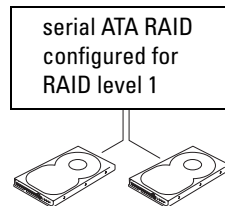

If a drive failure occurs, subsequent read and write operations are directed to the surviving drive. A replacement drive can then be rebuilt using the data from the surviving drive.

NOTE: In a RAID level 1 configuration, the size of the configuration is equal to the size of the smallest drive in the configuration.

Configuring Your Computer for RAID

Your computer can be configured for RAID, even if you did not select a RAID configuration when the computer was purchased. You must have at least two hard drives installed in your computer to set up a RAID configuration. For an explanation of RAID levels, see "About Your RAID Configuration" on page 30. For instructions on how to install a hard drive, see "Installing a Hard Drive" on page 130.

You can use one of two methods to configure RAID hard drive volumes. The first method uses the Intel® RAID Option ROM utility and is performed *before* you install the operating system onto the hard drive. The second method uses the Intel® Application Accelerator and is performed *after* you have installed the operating system.

Both methods require that you set your computer to RAID-enabled mode before beginning any of the RAID configuration procedures in this document.



Setting Your Computer to RAID-Enabled Mode

 **NOTICE:** Back up any data you want to keep before entering the RAID-Enabled mode. The RAID configuration procedure can result in loss of all data from the hard drives.

- 1 Enter system setup (see "Entering System Setup" on page 179).
- 2 Press the up- and down-arrow keys to highlight **Drives**, then press <Enter>.
- 3 Press the up- and down-arrow keys to highlight **SATA Operation**, then press <Enter>.
- 4 Press the left- and right-arrow keys to highlight **RAID On**, press <Enter>, and then press <Esc>.

 **NOTE:** For more information about RAID options, see "System Setup Options" on page 180.

- 5 Press the left- and right-arrow keys to highlight **Save/Exit**, and then press <Enter> to exit system setup and resume the boot process.

Using the Intel® RAID Option ROM Utility

 **NOTE:** Hard drives of any size may be used to create a RAID configuration using the Intel RAID Option ROM utility. Ideally, however, the drives should be of equal size to avoid unallocated or unused space. For an explanation of RAID levels, see "About Your RAID Configuration" on page 30.

Creating a RAID Level 0 Configuration

 **NOTICE:** The following procedure will result in the loss of all data on your hard drives. Back up any data you want to keep before continuing.

 **NOTE:** Use the following procedure only if you are reinstalling your operating system. Do not use the following procedure to migrate an existing storage configuration to RAID level 0 configuration.

- 1 Set your computer to RAID-enabled mode (see "Setting Your Computer to RAID-Enabled Mode" on page 33).
- 2 Press <Ctrl><I> when you are prompted to enter the Intel® RAID Option ROM utility.
- 3 Press the up- and down-arrow keys to highlight **Create RAID Volume**, then press <Enter>.
- 4 Enter a RAID volume name or accept the default name, then press <Enter>.

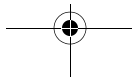

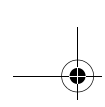

- 5 Press the up- and down-arrow keys to select **RAID0 (Stripe)**, then press <Enter>.
- 6 If there are more than two hard drives available, press the up- and down-arrow keys and spacebar to select the two or three drives you want to use to make up your configuration, then press <Enter>.
-  **NOTE:** Select the strip size closest to the size of the average file you want to store on the RAID volume. If you do not know the average file size, choose 128 KB as your strip size.
- 7 Press the up- and down-arrow keys to change the strip size, then press <Enter>.
- 8 Select the desired capacity for the volume, then press <Enter>.
The default value is the maximum available size.
- 9 Press <Enter> to create the volume.
- 10 Press <Y> to confirm that you want to create the RAID volume.
- 11 Confirm that the correct volume configuration is displayed on the main Intel® RAID Option ROM utility screen.
- 12 Press the up- and down-arrow keys to select **Exit**, and then press <Enter>.
- 13 Install the operating system. See "Reinstalling Windows Vista" on page 97.

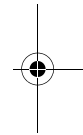
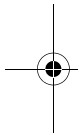

Creating a RAID Level 1 Configuration

- 1 Set your computer to RAID-enabled mode (see "Setting Your Computer to RAID-Enabled Mode" on page 33).
- 2 Press <Ctrl><I> when you are prompted to enter the Intel RAID Option ROM utility.
- 3 Use the up- and down-arrow keys to highlight **Create RAID Volume**, then press <Enter>.
- 4 Enter a RAID volume name or accept the default name, then press <Enter>.
- 5 Use the up- and down-arrow keys to select **RAID1 (Mirror)**, then press <Enter>.
- 6 If there are more than two hard drives available, press the up- and down-arrow keys and spacebar to select the two drives you want to use to make up your volume, then press <Enter>.

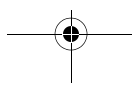



- 7 Select the desired capacity for the volume, then press <Enter>.
The default value is the maximum available size.
- 8 Press <Enter> to create the volume.
- 9 Press <Y> to confirm that you want to create the RAID volume.
- 10 Confirm that the correct volume configuration is displayed on the main Intel RAID Option ROM utility screen.
- 11 Use the up- and down-arrow keys to select **Exit**, and then press <Enter>.
- 12 Install the operating system (see "Reinstalling Windows Vista" on page 97).

Deleting a RAID Volume



NOTICE: The following procedure will result in the loss of all data on the hard drives in your RAID configuration. Back up any data you want to keep before continuing.



NOTICE: If your computer currently boots to RAID and you delete the RAID volume in the Intel RAID Option ROM utility, your computer will become unbootable.

- 1 Press <Ctrl><I> when you are prompted to enter the Intel RAID Option ROM utility.
- 2 Use the up- and down-arrow keys to highlight **Delete RAID Volume**, then press <Enter>.
- 3 Use the up- and down-arrow keys to highlight the RAID volume you want to delete, then press <Delete>.
- 4 Press <Y> to confirm the deletion of the RAID volume.
- 5 Press <Esc> to exit the Intel RAID Option ROM utility.

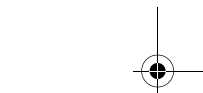
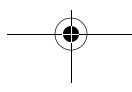
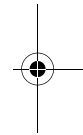
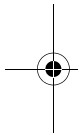

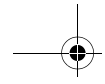

Using the Intel® Application Accelerator

If you already have one hard drive with the operating system installed on it, and you want to add a second hard drive then reconfigure both drives into a RAID volume without losing the existing operating system or data, use the migrating option (see "Migrating to a RAID Level 0 Configuration" on page 38 or "Migrating to a RAID Level 1 Configuration" on page 39). Create a RAID level 0 volume or RAID level 1 volume only when:

- You are adding two new drives to an existing single-drive computer (with the operating system installed on the single drive), and you want to configure the two new drives into a RAID volume.
- You already have a two-hard drive computer configured into a volume, but you still have some space left on the volume that you want to designate as a second RAID volume.

Creating a RAID Level 0 Configuration



NOTICE: The following procedure will result in the loss of all data on the hard drives in your RAID configuration. Back up any data you want to keep before continuing.

- 1 Set your computer to RAID-enabled mode (see "Setting Your Computer to RAID-Enabled Mode" on page 33).
- 2 Click **Start** and point to **Programs**→**Intel(R) Application Accelerator**→**Intel Matrix Storage Manager** to launch the Intel® Storage Utility.



NOTE: If you do not see an **Actions** menu option, you have not yet set your computer to RAID-enabled mode (see "Setting Your Computer to RAID-Enabled Mode" on page 33).

- 3 On the **Actions** menu, select **Create RAID Volume** to launch the Create RAID Volume Wizard, then click **Next**.
- 4 On the **Select Volume Location** screen, click the first hard drive you want to include in your RAID level 0 volume, then click the right arrow.
- 5 Click to add a second hard drive, then click **Next**.

To add a third hard drive in your RAID level 0 volume, click the right arrow and click on the third drive until three drives appear in the **Selected** window, and then click **Next**.

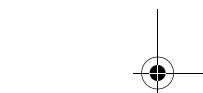
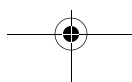



- 6 In the **Specify Volume Size** window, click the **Volume Size** desired, then click **Next**.
- 7 Click **Finish** to create the volume, or click **Back** to make changes.

Creating a RAID Level 1 Configuration

 **NOTICE:** The following procedure will result in the loss of all data on the hard drives in your RAID configuration. Back up any data you want to keep before continuing.

- 1 Set your computer to RAID-enabled mode (see "Setting Your Computer to RAID-Enabled Mode" on page 33).
- 2 Click the **Start** button and point to **Programs**→**Intel(R) Application Accelerator**→**Intel Matrix Storage Manager** to launch the Intel® Storage Utility.

 **NOTE:** If you do not see an **Actions** menu option, you have not yet set your computer to RAID-enabled mode (see "Setting Your Computer to RAID-Enabled Mode" on page 33).

- 3 On the **Actions** menu, select **Create RAID Volume** to launch the Create RAID Volume Wizard.
- 4 Click **Next** at the first screen.
- 5 Confirm the volume name, select **RAID 1** as the RAID level, and then click **Next** to continue.
- 6 On the **Select Volume Location** screen, click the first hard drive you want to use to create your RAID level 0 volume, then click the right arrow. Click to add a second hard drive until two drives appear in the **Selected** window, and then click **Next**.
- 7 In the **Specify Volume Size** window, select the **Volume Size** desired, then click **Next**.
- 8 Click **Finish** to create the volume, or click **Back** to make changes.
- 9 Follow Microsoft Windows procedures for creating a partition on the new RAID volume.

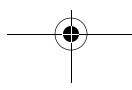
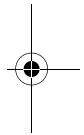
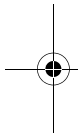

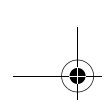

Deleting a RAID Volume



NOTE: While this procedure deletes the RAID 1 volume, it also splits the RAID 1 volume into two non-RAID hard drives with a partition, and leaves any existing data files intact. Deleting a RAID 0 volume, however, destroys all data on the volume.

- 1 Click the **Start** button and point to **Programs**→**Intel(R) Application Accelerator**→**Intel Matrix Storage Manager** to launch the Intel® Storage Utility.
- 2 Right-click the **Volume** icon of the RAID volume you want to delete, then select **Delete Volume**.
- 3 On the **Delete RAID Volume Wizard** screen, click **Next**.
- 4 Highlight the RAID volume you want to delete in the **Available** box, click the right-arrow button to move the highlighted RAID volume into the **Selected** box, and then click **Next**.
- 5 Click **Finish** to delete the volume.



Migrating to a RAID Level 0 Configuration

- 1 Set your computer to RAID-enabled mode (see "Setting Your Computer to RAID-Enabled Mode" on page 33).
- 2 Click the **Start** button and point to **All Programs**→**Intel(R) Application Accelerator**→**Intel Matrix Storage Manager** to launch the Intel® Storage Utility.
 **NOTE:** If you do not see an **Actions** menu option, you have not yet set your computer to RAID-enabled mode (see "Setting Your Computer to RAID-Enabled Mode" on page 33).
- 3 On the **Actions** menu, select **Create RAID Volume From Existing Hard Drive** to launch the Migration Wizard.
- 4 Click **Next** on the Migration Wizard screen.
- 5 Enter a RAID volume name or accept the default name.
- 6 From the drop-down box, select **RAID 0** as the RAID level.
- 7 Select the appropriate strip size from the drop-down box, and then click **Next**.



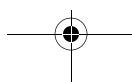

NOTE: Select the strip size closest to the size of the average file you want to store on the RAID volume. If you do not know the average file size, choose 128 KB as your strip size.



- 8 On the **Select Source Hard Drive** screen, double-click the hard drive from which you want to migrate, and click **Next**.
 -  **NOTE:** The source hard drive should be the hard drive containing the data or operating system files that you want to keep on the RAID volume.
- 9 On the **Select Member Hard Drive** screen, double-click the hard drive(s) to select the member drive(s) to span the stripe array, then click **Next**.
- 10 On the **Specify Volume Size** screen, select the **Volume Size** you want, then click **Next**.
 -  **NOTICE:** The next step will result in the loss of all data on the member drive.
- 11 Click **Finish** to start migrating, or click **Back** to make changes. You can use your computer normally during the migration process.

Migrating to a RAID Level 1 Configuration

- 1 Set your computer to RAID-enabled mode (see "Setting Your Computer to RAID-Enabled Mode" on page 33).
- 2 Click the **Start** button and point to **All Programs**→**Intel(R) Application Accelerator**→**Intel Matrix Storage Manager** to launch the Intel® Storage Utility.
 -  **NOTE:** If you do not see an **Actions** menu option, you have not yet set your computer to RAID-enabled mode (see "Setting Your Computer to RAID-Enabled Mode" on page 33).
- 3 On the **Actions** menu, click **Create RAID Volume From Existing Hard Drive** to launch the Migration Wizard.
- 4 Click **Next** on the first Migration Wizard screen.
- 5 Enter a RAID volume name or accept the default name.
- 6 From the drop-down box, select **RAID 1** as the RAID level.
- 7 On the **Select Source Hard Drive** screen, double-click the hard drive from which you want to migrate, and click **Next**.
 -  **NOTE:** The source hard drive should be the hard drive containing the data or operating system files that you want to keep on the RAID volume.
- 8 On the **Select Member Hard Drive** screen, double-click the hard drive to select the member drive that you want to act as the mirror in the configuration, then click **Next**.

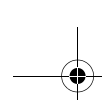

9 On the **Specify Volume Size** screen, select the volume size you want, then click **Next**.

 **NOTICE:** The next step will result in the loss of all data on the member drive.

10 Click **Finish** to start migrating, or click **Back** to make changes. You can use your computer normally during migration process.

Creating a Spare Hard Drive

A spare hard drive may be created with a RAID level 1 configuration. The spare hard drive will not be recognized by the operating system, but you will be able to see the spare drive from within Disk Manager or the Intel RAID Option ROM utility. When a member of the RAID level 1 configuration fails, the computer automatically rebuilds the mirror configuration using the spare hard drive as the failed member's replacement.

To mark a drive as a spare hard drive:

- 1 Click the **Start** button and point to **Programs→Intel(R) Application Accelerator→Intel Matrix Storage Manager** to launch the Intel® Storage Utility.
- 2 Right-click the hard drive you want to mark as a spare hard drive.
- 3 Click **Mark as Spare**.

To remove a drive as a spare hard drive:

- 1 Right-click the spare hard drive icon.
- 2 Click **Reset Hard Drive to Non-RAID**.

Rebuilding a Degraded RAID Level 1 Configuration

If your computer does not have a spare hard drive, and the computer has reported a degraded RAID level 1 volume, you can manually rebuild the computer's redundancy mirror to a new hard drive by performing the following steps:

- 1 Click the **Start** button and point to **Programs→Intel(R) Application Accelerator→Intel Matrix Storage Manager** to launch the Intel® Storage Utility.
- 2 Right-click the available hard drive to which you want to rebuild the RAID level 1 volume, then click **Rebuild to this Disk**.

You can use your computer while the computer is rebuilding the RAID level 1 volume.

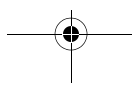



Dell DataSafe (Optional)

Dell DataSafe is a solution to help you protect your data against unfortunate events such as data loss from system crashes, hard drive failures, software corruption, viruses, and other accidents. Using Intel technology, your computer has a robust level of data protection out of the factory. With Dell DataSafe, you will have a selected area on your system that automatically stores periodic copies of your computer's hard drive data. Not only does Dell DataSafe help you to store and protect your valuable data such as photos, music, videos, files, and more, it also helps restore your computer and your data in the event of a failure. The included software can give you the power to roll back your system to a healthy state after a system problem, easily retrieve deleted files, and recover individual files or an entire hard drive, and the Intel Matrix Storage Console (RAID) allows for continued functionality in the case of a single hard drive failure.

Intel® Viiv™ Technology (Optional)

Intel Viiv technology is a technology aimed at the digital home enthusiast that includes:

- A BIOS that supports Intel Quick Resume Technology
- Device drivers

This technology allows the user's system to quickly return to an active state after non-use.

Using Intel Viiv Quick Resume Technology (QRT)

When running in the Intel Viiv QRT mode, your power button is used as a quick on/off feature. Pressing the power button once causes the display to go blank and the audio to mute. In this mode, the computer is still operating as indicated by the power button indicator and diagnostic lights 1, 2, and 4 being lit. Also, you may notice that the hard drive indicator may blink when the hard drive is being accessed by an external device.

To resume normal computer operation, briefly press the power button, press any key on the keyboard or move the mouse.

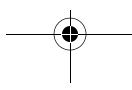
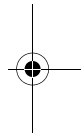
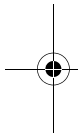

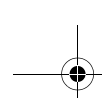

Enabling the QRT Feature in System Setup

The QRT drivers must be installed before the Quick Resume feature becomes active. The QRT drivers are installed when this option is ordered. Also, Quick Resume is enabled in system setup when this feature is ordered.



- 1 Enter system setup (see "Entering System Setup" on page 179).
- 2 Press the arrow keys to highlight the **Power Management** menu option, then press <Enter> to access the menu.
- 3 Press the up- and down-arrow keys to highlight the **Quick Resume** option, then press <Enter> to access the menu.
- 4 Press the left- and right-arrow keys to highlight the **On** option, and then press <Enter> to enable the Quick Resume feature.

Enabling the QRT Feature in the Operating System

- 1 Click the **Start**  button, then click **Control Panel**.
- 2 Click the **Away** tab.
- 3 Ensure that the check boxes for **Enable away mode** and **Options** are checked.
- 4 Click the **Advanced** tab.
- 5 From the **When I press the power button on my computer** drop-down menu, select **Do Nothing**.
- 6 From the **When I press the sleep button on my computer** drop-down menu, select **Do Nothing**.

Using Multimedia

Playing CDs or DVDs

-  **NOTICE:** Do not press down on the CD/DVD tray when you open or close it. Keep the tray closed when you are not using the drive.
 -  **NOTICE:** Do not move the computer while playing CDs or DVDs.
- 1 Press the eject button on the right corner of the drive.
 - 2 Place the disc, label side up, in the center of the tray.
 - 3 Press the eject button or gently push in the tray.

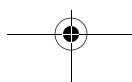

















To format CDs for storing data, to create music CDs, or to copy CDs, see the CD software that came with your computer.

 **NOTE:** Ensure that you follow all copyright laws when you create media.

A CD player includes the following basic buttons:

-
-  Play
 -  Move backward within the current track
 -  Pause
 -  Move forward within the current track
 -  Stop
 -  Go to the previous track
 -  Eject
 -  Go to the next track
-

A DVD player includes the following basic buttons:

-
-  Stop
 -  Restart the current chapter
 -  Play
 -  Fast forward
 -  Pause
 -  Fast reverse
 -  Advance a single frame while in pause mode

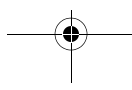

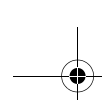

Go to the next title or chapter



Continuously play the current title or chapter



Go to the previous title or chapter



Eject

These controls may not exist on all players in the system. For more information on playing CDs, DVDs, or BDs, click **Help** on the CD or DVD player (if available).

Copying Media

This section applies only to computers that have a DVD+/-RW drive or a BD-RE drive.



NOTE: Ensure that you observe all copyright laws when copying media.



NOTE: The types of optical drives offered by Dell may vary by country.

The following instructions explain how to make a copy of a CD or a DVD using Roxio Creator Plus, and a BD using CyberLink Power DVD 7.0.

The DVD drives and BD drives installed in Dell computers do not support HD-DVD media.

How to Copy a CD or DVD

The following instructions explain how to make an exact copy of a CD or DVD using Roxio Creator Plus - Dell Edition. You can also use Roxio Creator Plus for other purposes, such as creating music CDs from audio files stored on your computer or backing up important data. For help, open Roxio Creator Plus, and then click the question mark icon in the upper-right corner of the window.



NOTE: CD-RW/DVD combo drives cannot write to DVD media. If you have a CD-RW/DVD combo drive and you experience recording problems, check for available software patches on the Sonic Support website at sonic.com.

The DVD-writable drives installed in Dell™ computers can write to and read DVD+/-R, DVD+/-RW and DVD+R DL (dual layer) media, but cannot write to and may not read DVD-RAM or DVD-R DL media.

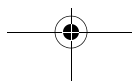

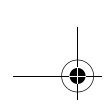

NOTE: Most commercial DVDs have copyright protection and cannot be copied using Roxio Creator Plus.

- 1 Open Roxio Creator Plus.
- 2 Under the **Copy** tab, click **Disc Copy**.
- 3 To copy the CD or DVD:
 - *If you have one CD/DVD drive*, ensure that the settings are correct, and then click **Disc Copy**. The computer reads your source CD or DVD and copies the data to a temporary folder on your computer hard drive. When prompted, insert a blank CD or DVD into the drive and click **OK**.
 - *If you have two CD/DVD drives*, select the drive into which you have inserted your source CD or DVD, and then click **Disc Copy**. The computer copies the data from the source CD or DVD to the blank CD or DVD.

Once you have finished copying the source CD or DVD, the CD or DVD that you have created automatically ejects.

How to Copy a Blu-ray Disc™ (BD) Media

For information on how to use the BD media, refer to the manual that accompanies the product.

Using Blank CDs and DVDs

CD-RW drives can write to CD recording media only (including high-speed CD-RW media) while DVD-writable drives can write to both CD and DVD recording media.

Use blank CD-Rs to record music or permanently store data files. After the maximum storage capacity of a CD-R is reached, you cannot write to that CD-R again (see the Sonic documentation for more information). Use blank CD-RWs if you plan to erase, rewrite, or update information on the CD later.

Blank DVD+/-Rs can be used to permanently store large amounts of data. After you create a DVD+/-R disc, you may not be able to write to that disc again if the disc is *finalized* or *closed* during the final stage of the disc creation process. Use blank DVD+/-RWs if you plan to erase, rewrite, or update information on the disc later.

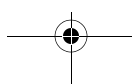

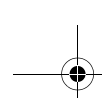
**CD-Writable Drives**

Media Type	Read	Write	Rewritable
CD-R	Yes	Yes	No
CD-RW	Yes	Yes	Yes

DVD-Writable Drives

Media Type	Read	Write	Rewritable
CD-R	Yes	Yes	No
CD-RW	Yes	Yes	Yes
DVD+R	Yes	Yes	No
DVD-R	Yes	Yes	No
DVD+RW	Yes	Yes	Yes
DVD-RW	Yes	Yes	Yes
DVD+R DL	Yes	Yes	No
DVD-R DL	Maybe	No	No

Helpful Tips

- Use Microsoft® Windows® Explorer to drag and drop files to a CD-R or CD-RW only after you start Roxio Creator Plus and open a Creator project.
- Use CD-Rs to burn music CDs that you want to play in regular stereos. CD-RWs may not play in many home or car stereos.
- You cannot create audio DVDs with Roxio Creator Plus.
- Music MP3 files can be played only on MP3 players or on computers that have MP3 software installed.
- Commercially available DVD players used in home theater systems may not support all available DVD formats. For a list of formats supported by your DVD player, see the documentation provided with your DVD player or contact the manufacturer.
- Do not burn a blank CD-R or CD-RW to its maximum capacity; for example, do not copy a 650-MB file to a blank 650-MB CD. The CD-RW drive needs 1–2 MB of blank space to finalize the recording.

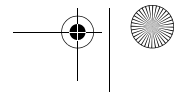
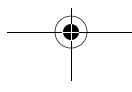

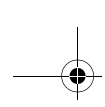

- Use a blank CD-RW to practice CD recording until you are familiar with CD recording techniques. If you make a mistake, you can erase the data on the CD-RW and try again. You can also use blank CD-RWs to test music file projects before you record the project permanently to a blank CD-R.
- See the Sonic website at sonic.com for additional information.

Using a Media Card Reader

 **CAUTION:** Before you perform any of the procedures in this section, follow the safety instructions in the *Product Information Guide*.

Use the media card reader to transfer data directly to your computer.

The media card reader supports the following memory types:

- xD-Picture card
- SmartMedia card (SMC)
- CompactFlash card Type I and II (CF I/II)
- MicroDrive card
- SecureDigital card (SD)
- MiniSD card
- MultiMediaCard (MMC)
- Reduced-size MultiMediaCard (RS-MMC)
- Memory Stick (MS/MS Pro/MS Duo/MS Pro Duo)

For information on installing a media card reader, see "Installing a Media Card Reader" on page 142.

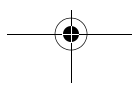
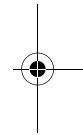
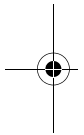

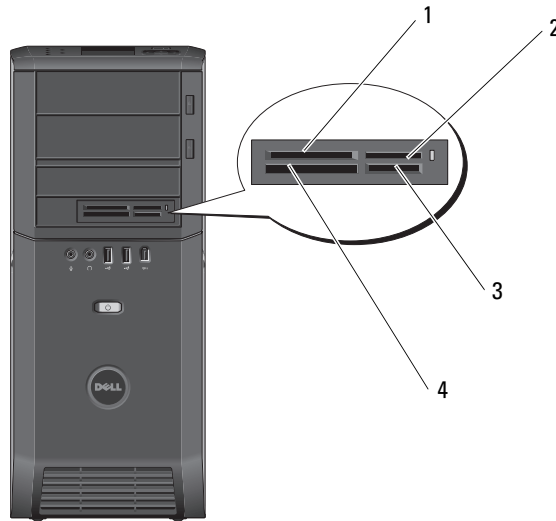

- | | | | |
|---|--|---|---|
| 1 | xD-Picture card and SmartMedia Card (SMC) | 2 | Memory Stick (MS/MS Pro/MS Duo/MS Pro Duo) |
| 3 | Secure Digital card (SD/miniSD)/MultiMedia-Card (MMC/RS-MMC) | 4 | CompactFlash card Type I and II (CF I/II) and MicroDrive card |

- 1 Inspect the media card to determine the proper orientation for insertion.
- 2 Slide the media card into the appropriate slot of the media card reader until it is completely seated in the connector.

If you encounter resistance, remove the card, check for proper orientation, and then try again.

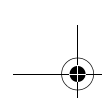

Understanding the Media Xcelerator™ (Optional)

The Dell Media Xcelerator™ is an internal USB 2.0 bus-powered device that increases the speed and performance of MPEG transcoding and transrating for various 3rd party applications supporting the Sonic DVD engine.

The Xcelerator™ device enables faster format conversion and facilitates resolution changes to MPEG-2 and DVD video streams. The device will allow MPEG2 or DVD based format conversions and fit to disk operations to be completed in significantly less time. A built-in, dedicated processor ensures significantly improved system availability and speed. The Xcelerator also supports MPEG-2 and DVD format stream conversion to low bit-rate MPEG-4 formats for portable video devices.

Features supported include:

- Improved system availability through CPU offloading to Xcelerator.
- Quicker DVD creation with improved fit to disk capability.
- Transcode High Definition MPEG-2 video clips to MPEG-2 or MPEG-4 standard definition
- Faster conversions of movies into PC or PMP formats
- Transrate MPEG-2 video clips to a lower bit rate to fit onto a DVD, CD, or other media
- Higher transcoded video quality at similar bit rates

For more information on the Xcelerator, see the *Dell Media Xcelerator™ User's Guide* available on the **Help and Support Center** on your system, or the Dell Support website at support.dell.com.

To access Help and Support Center, click **Start→Help and Support**.



NOTE: The Dell Media Xcelerator is an optional feature and will not be present on your system if you did not order it.

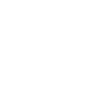
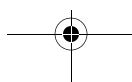
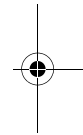
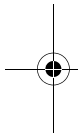

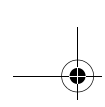

Understanding Windows® SideShow™ and the LCD display

Your LCD display device is located at the top of the system.

Powered by Windows Sideshow technology, the LCD display device is designed to provide quick access to information available on a computer running Windows Vista.

SideShow technology uses gadgets, which are add-in programs, to extend information from the computer onto devices such as the LCD display. Gadgets allow you to view information from your computer regardless of whether it is on, off, or sleeping.

Some of the default gadgets available on the LCD allow you to browse web pictures, view photos stored on your system, play or browse audio and video files, set reminders and alarms, monitor PC settings, and set a real-time countdown clock.

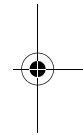
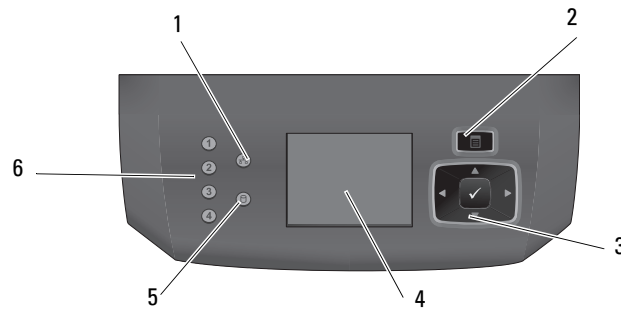
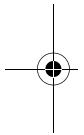

- | | | | | | |
|---|-------------------------|---|---------------------------|---|----------------------------------|
| 1 | network indicator light | 2 | menu button | 3 | navigation and selection buttons |
| 4 | LCD display screen | 5 | hard-drive activity light | 6 | diagnostic lights (4 nos) |

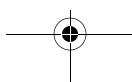



Configuring the LCD display

The LCD display is configured to start whenever your system is powered on. However, the default configuration can be modified by the user.

To disable LCD Display

- 1 Enter system setup (see "Entering System Setup" on page 179).



NOTE: The system setup screen displays current or changeable configuration information for your computer.

- 2 On the system setup screen navigate to LCD display and change settings to Off.
- 3 Exit setup.



NOTE: The LCD display remains inactive when the system is next powered on.

To enable LCD Display

- 1 Enter system setup (see "Entering System Setup" on page 179).



NOTE: The screen displays current or changeable configuration information for your computer.

- 2 On the system setup screen navigate to LCD display and change settings to On.
- 3 Exit setup.



NOTE: The LCD display simultaneously starts when the system is next powered on.

Adding Gadgets To LCD Display Menu

The LCD display menu includes a list of all the gadgets shipped with your system. It also allows you to remove existing gadgets from the list or add them back. All the gadgets available on the LCD display can be viewed with the help of the Menu button and activated with the help of the Navigation buttons.

To add new gadgets to the LCD display

- 1 On your computer, go to **Start**→**Control Panel**→**Windows Sideshow**. A dialog with the list of all gadgets opens.
- 2 Check the boxes for all gadgets you want to add to the LCD display menu.
- 3 Click Save.

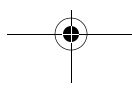
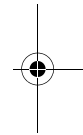
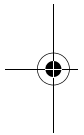

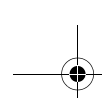

Setting Up a Printer

 **NOTICE:** Complete the operating system setup before you connect a printer to the computer.

See the documentation that came with the printer for setup information, including how to:

- Obtain and install updated drivers.
- Connect the printer to the computer.
- Load paper and install the toner or ink cartridge.

For technical assistance, refer to the printer owner's manual or contact the printer manufacturer.

Printer Cable

Your printer connects to your computer with either a USB cable or a parallel cable. Your printer may not come with a printer cable, so if you purchase a cable separately, ensure that it is compatible with your printer and computer. If you purchased a printer cable at the same time you purchased your computer, the cable may arrive in the computer's shipping box.

Connecting a USB Printer

 **NOTE:** You can connect USB devices while the computer is turned on.

- 1 Complete the operating system setup if you have not already done so.
- 2 Attach the USB printer cable to the USB connectors on the computer and the printer. The USB connectors fit only one way.

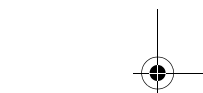
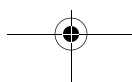

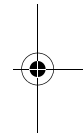
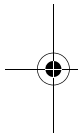
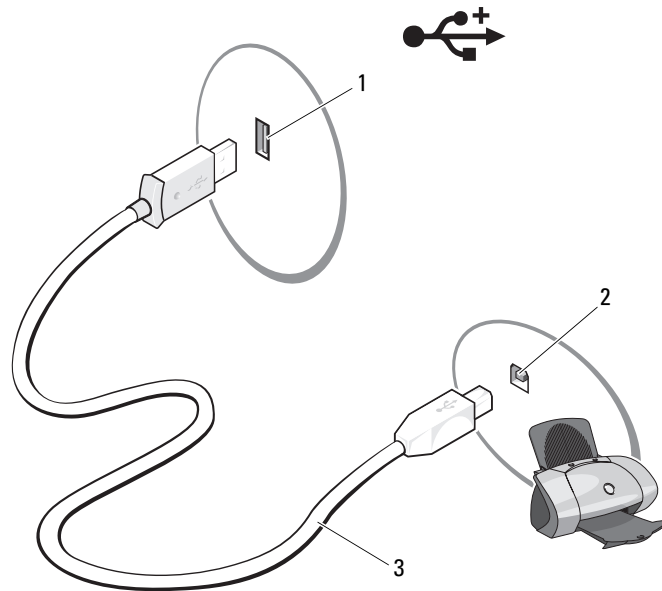
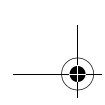

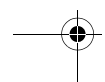
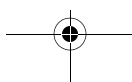

- 1 USB connector on computer 2 USB connector on printer 3 USB printer cable

- 3 Turn on the printer and then turn on the computer.
- 4 Your operating system includes a printer wizard to help you install the printer driver:
Click the Windows Vista Start button™  and click **Network → Add a printer** to start the **Add Printer Wizard**.
- 5 Install the printer driver if necessary. See "Reinstalling Drivers and Utilities" on page 91 and the documentation that came with your printer.

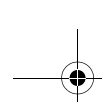



Connecting to the Internet

 **NOTE:** ISPs and ISP offerings vary by country.

To connect to the Internet, you need a modem or network connection and an Internet service provider (ISP). Your ISP will offer one or more of the following Internet connection options:

- DSL connections that provide high-speed Internet access through your existing telephone line or cellular telephone service. With a DSL connection, you can access the Internet and use your telephone on the same line simultaneously.
- Cable modem connections that provide high-speed Internet access through your local cable TV line.
- Satellite modem connections that provide high-speed Internet access through a satellite television system.
- Dial-up connections that provide Internet access through a telephone line. Dial-up connections are considerably slower than DSL and cable (or satellite) modem connections.
- Wireless LAN connections that provide Internet access using Bluetooth® wireless technology.

If you are using a dial-up connection, connect a telephone line to the modem connector on your computer and to the telephone wall jack before you set up your Internet connection. If you are using a DSL or cable/satellite modem connection, contact your ISP or cellular telephone service for setup instructions.

Setting Up Your Internet Connection

To set up an Internet connection with a provided ISP desktop shortcut:

- 1 Save and close any open files, and exit any open programs.
- 2 Double-click the ISP icon on the Microsoft® Windows® desktop.
- 3 Follow the instructions on the screen to complete the setup.

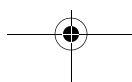

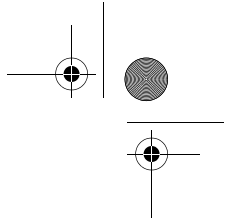



If you do not have an ISP icon on your desktop or if you want to set up an Internet connection with a different ISP, perform the steps in the following section.

 **NOTE:** If you are having problems connecting to the Internet, see "E-Mail, Modem, and Internet Problems" on page 63. If you cannot connect to the Internet but have successfully connected in the past, the ISP might have a service outage. Contact your ISP to check the service status, or try connecting again later.

Windows Vista™

 **NOTE:** Have your ISP information ready. If you do not have an ISP, the **Connect to the Internet** wizard can help you get one.

- 1 Save and close any open files, and exit any open programs.
- 2 Click the Windows Vista Start button™  and click **Control Panel**.
- 3 Under **Network and Internet**, click **Connect to the Internet**.
The **Connect to the Internet** window appears.
- 4 Click either **Broadband (PPPoE)** or **Dial-up**, depending on how you want to connect:
 - Choose **Broadband** if you will use a DSL, satellite modem, cable TV modem, or Bluetooth wireless technology connection.
 - Choose **Dial-up** if you will use a dial-up modem or ISDN.

 **NOTE:** If you do not know which type of connection to select, click **Help me choose** or **contact your ISP**.

- 5 Follow the instructions on the screen and use the setup information provided by your ISP to complete the setup.

Network Setup Wizard

The Microsoft Windows operating system provides a **Network Setup Wizard** to guide you through the process of sharing files, printers, or an Internet connection between computers in a home or small office.

- 1 Click **Start**  and then click **Connect to** → **Set up a connection or network**.
- 2 Select an option under **Choose a connection option**.
- 3 Click **Next**, and then follow the instructions in the wizard.

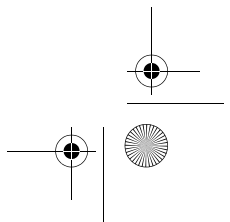

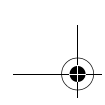

Transferring Information to a New Computer

You can use your operating system "wizards" to help you transfer files and other data from one computer to another—for example, from an *old* computer to a *new* computer. For instructions, see the following section that corresponds to the operating system your computer is running.

- 1 Click **Start**  → **Transfer files and settings** → **Start Windows Easy Transfer**.
- 2 In the **User Account Control** dialog box, click **Continue**.
- 3 Click **Start a new transfer** or **Continue a transfer in progress**.
- 4 Follow the instructions provided on the screen by the **Windows Easy Transfer** wizard.

Power Management Options in Windows Vista

The Microsoft Vista power management features can reduce the amount of electricity your computer uses when it is on and you are not using it. You can reduce power to just the monitor or the hard drive; or you can use sleep mode or hibernate mode to reduce power to the entire computer. When the computer exits from a power conservation mode, it returns to the operating state it was in prior to entering the mode.

Sleep Mode

Sleep mode conserves power by turning off the display and the hard drive after a predetermined period of inactivity (a time-out). When the computer exits sleep mode, it returns to the same operating state it was in before entering sleep mode.

To enter sleep mode in Windows Vista, click **Start** , click the arrow in the lower-right corner of the Start menu, and then click **Sleep**.

To exit sleep mode, press a key on the keyboard or move the mouse.

Hybrid Sleep

Hybrid Sleep emulates the Sleep Mode but stores info in RAM to hard drive so that there is no loss of data in case of power loss.

Hybrid Sleep is enabled on your system by default.

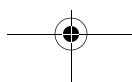

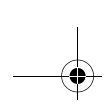

Hibernate Mode

Hibernate mode conserves power by copying system data to a reserved area on the hard drive and then completely turning off the computer. When the computer exits hibernate mode, it returns to the same operating state it was in before entering hibernate mode.

To manually enter hibernate mode in Windows Vista, click **Start** , click the arrow in the lower-right corner of the Start menu, and then click **Hibernate**.



NOTE: If Hybrid Sleep is ON then Hibernate will no longer appear on the shutdown menu in Vista.

- To enable hibernation, click **Start**→open **Search** box and type `powercfg.exe /hibernate ON`→press **Ctrl+Shift+Enter**.
- To disable hibernation, click **Start**→open **Search** box and type `powercfg.exe /hibernate Off`→press **Ctrl+Shift+Enter**.

Configuring Power Management Settings

You can use the Windows Power Options Properties to configure the power management settings on your computer.

To access Power Options Properties, click **Start** →**Control Panel**→**System and Maintenance**→**Power Options**.

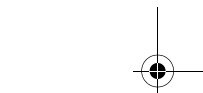
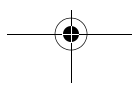
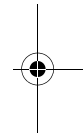
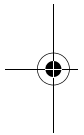

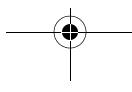
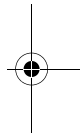
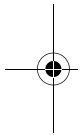
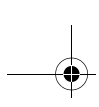



2

Optimizing for Greater Performance

Understanding Intel™ SpeedStep® Technology

SpeedStep technology controls your computer's processor performance automatically, dynamically adjusting the operating frequency and voltage, according to the task at hand. When an application does not require full performance, significant amounts of power can be saved. Performance is designed to still be responsive, with maximum processor performance being delivered when required, and automatic power savings when possible.

Windows Vista™ automatically sets Intel Speedstep technologies in the **Dell Recommended**, **Balanced**, and **Power Saver** power plans. It is disabled in the **High Performance** power plan.

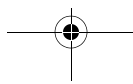

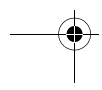
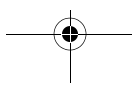
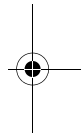
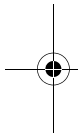
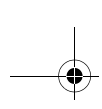

3

Troubleshooting

Solving Problems

Follow these tips when you troubleshoot your computer:

- If you added or removed a part before the problem started, review the installation procedures and ensure that the part is correctly installed.
- If a peripheral device does not work, ensure that the device is properly connected.
- If an error message appears on the screen, write down the exact message. This message may help support personnel diagnose and fix the problem(s).
- If an error message occurs in a program, see the program's documentation.

 **NOTE:** The procedures in this document were written for the Windows default view, so they may not apply if you set your Dell™ computer to the Windows Classic view.

Coin-Cell Battery Problems

 **CAUTION:** There is a danger of a new coin battery exploding if it is incorrectly installed. Replace the coin battery only with the same or equivalent type recommended by the manufacturer. Discard used batteries according to the manufacturer's instructions.

 **CAUTION:** Before you begin any of the procedures in this section, follow the safety instructions in the *Product Information Guide*.

REPLACE THE COIN-CELL BATTERY — If you have to repeatedly reset time and date information after turning on the computer, or if an incorrect time or date displays during start-up, replace the battery (see "Replacing the Coin-Cell Battery" on page 170). If the battery still does not work properly, contact Dell (see "Contacting Dell" on page 200).

Drive Problems

 **CAUTION:** Before you begin any of the procedures in this section, follow the safety instructions in the *Product Information Guide*.

ENSURE THAT MICROSOFT® WINDOWS® RECOGNIZES THE DRIVE —

- Click the Windows Vista Start button™  and click **Computer**.

If the drive is not listed, perform a full scan with your antivirus software to check for and remove viruses. Viruses can sometimes prevent Windows from recognizing the drive.

TEST THE DRIVE —

- Insert another disc to eliminate the possibility that the original drive is defective.
- Insert a bootable floppy disk and restart the computer.

CLEAN THE DRIVE OR DISK — See "Cleaning Your Computer" on page 191.

CHECK THE CABLE CONNECTIONS

RUN THE HARDWARE TROUBLESHOOTER — See "Troubleshooting Software and Hardware Problems in the Microsoft Windows Vista™ Operating System" on page 93.

RUN THE DELL DIAGNOSTICS — See "Dell Diagnostics" on page 86.

Optical drive problems

 **NOTE:** High-speed optical drive vibration is normal and may cause noise, which does not indicate a defect in the drive or the media.

 **NOTE:** Because of different regions worldwide and different disc formats, not all DVD titles work in all DVD drives.

ADJUST THE WINDOWS VOLUME CONTROL —

- Click the speaker icon in the lower-right corner of your screen.
- Ensure that the volume is turned up by clicking the slider and dragging it up.
- Ensure that the sound is not muted by clicking any boxes that are checked.

CHECK THE SPEAKERS AND SUBWOOFER — See "Sound and Speaker Problems" on page 72.

Problems writing to an optical drive

CLOSE OTHER PROGRAMS — The optical drive must receive a steady stream of data during the writing process. If the stream is interrupted, an error occurs. Try closing all programs before you write to the optical.

TURN OFF STANDBY MODE IN WINDOWS BEFORE WRITING TO A DISC — See "Configuring Power Management Settings" on page 57 or search for the keyword *standby* in Windows Help and Support for information on power management modes.

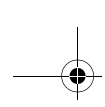

Hard drive problems

RUN CHECK DISK —

- 1 Click Windows Vista **Start**  and click **Computer**.
- 2 Right-click **Local Disk C:**.
- 3 Click **Properties** → **Tools** → **Check Now**.

The **User Account Control** window may appear. If you are an administrator on the computer, click **Continue**; otherwise, contact your administrator to continue the desired action.

- 4 Follow the instructions on the screen.

E-Mail, Modem, and Internet Problems



CAUTION: Before you begin any of the procedures in this section, follow the safety instructions in the *Product Information Guide*.



NOTE: Connect the modem to an analog telephone jack only. The modem does not operate while it is connected to a digital telephone network.



NOTE: Do not plug a telephone cable into the network adapter connector (see "Back I/O Connectors" on page 20).

CHECK THE MICROSOFT OUTLOOK® EXPRESS SECURITY SETTINGS — If you cannot open your e-mail attachments:

- 1 In Outlook Express, click **Tools** → **Options** → **Security**.
- 2 Click **Do not allow attachments** to remove the checkmark, as needed.

CHECK THE TELEPHONE LINE CONNECTION

CHECK THE TELEPHONE JACK

CONNECT THE MODEM DIRECTLY TO THE TELEPHONE WALL JACK

USE A DIFFERENT TELEPHONE LINE —

- Verify that the telephone line is connected to the jack on the modem (the jack has either a green label or a connector-shaped icon next to it).
- Ensure that you hear a click when you insert the telephone line connector into the modem.
- Disconnect the telephone line from the modem and connect it to a telephone, then listen for a dial tone.
- If you have other telephone devices sharing the line, such as an answering machine, fax machine, surge protector, or line splitter, bypass them and use the telephone to connect the modem directly to the telephone wall jack. If you are using a line that is 3 meters (10 feet) or more in length, try a shorter one.

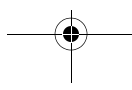

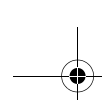

RUN THE MODEM DIAGNOSTIC TOOL —

- 1 Click **Start**  → **All Programs** → **Modem Diagnostic Tool**.
- 2 Follow the instructions on the screen to identify and resolve modem problems. Modem diagnostics are not available on all computers.

VERIFY THAT THE MODEM IS COMMUNICATING WITH WINDOWS —

- 1 Click **Start**  → **Control Panel** → **Hardware and Sound** → **Phone and Modem Options** → **Modems**.
- 2 Click the COM port for your modem → **Properties** → **Diagnostics** → **Query Modem** to verify that the modem is communicating with Windows.

If all commands receive responses, the modem is operating properly.

ENSURE THAT YOU ARE CONNECTED TO THE INTERNET — Ensure that you have subscribed to an Internet provider. With the Outlook Express e-mail program open, click **File**. If **Work Offline** has a checkmark next to it, click the checkmark to remove it and connect to the Internet. For help, contact your Internet service provider.

Error Messages



CAUTION: Before you begin any of the procedures in this section, follow the safety instructions in the *Product Information Guide*.

If the error message is not listed, see the documentation for the operating system or the program that was running when the message appeared.

A FILENAME CANNOT CONTAIN ANY OF THE FOLLOWING CHARACTERS: \ / : * ? " < > | — Do not use these characters in filenames.

A REQUIRED .DLL FILE WAS NOT FOUND — The program that you are trying to open is missing an essential file. To remove and then reinstall the program:

- 1 Click **Start**  → **Control Panel** → **Programs** → **Programs and Features**.
- 2 Select the program you want to remove.
- 3 Click **Uninstall**.
- 4 See the program documentation for installation instructions.

drive letter: \ IS NOT ACCESSIBLE. THE DEVICE IS NOT READY — The drive cannot read the disk. Insert a disk into the drive and try again.

INSERT BOOTABLE MEDIA — Insert a bootable floppy disk, CD, or DVD.

NON-SYSTEM DISK ERROR — Remove the floppy disk from the floppy drive and restart your computer.

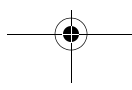



NOT ENOUGH MEMORY OR RESOURCES. CLOSE SOME PROGRAMS AND TRY

AGAIN — Close all windows and open the program that you want to use. In some cases, you may have to restart your computer to restore computer resources. If so, run the program that you want to use first.

OPERATING SYSTEM NOT FOUND — Ensure that there is no non-bootable floppy or USB key attached during system power on.

IEEE 1394a Device Problems

 **CAUTION:** Before you begin any of the procedures in this section, follow the safety instructions in the *Product Information Guide*.

 **NOTE:** Your computer supports only IEEE 1394a standard.

ENSURE THAT THE CABLE FOR THE IEEE 1394A DEVICE IS PROPERLY INSERTED INTO THE DEVICE AND INTO THE CONNECTOR ON THE COMPUTER

ENSURE THAT THE IEEE 1394A DEVICE IS ENABLED IN SYSTEM SETUP — See "System Setup Options" on page 180.

ENSURE THAT THE IEEE 1394A DEVICE IS RECOGNIZED BY WINDOWS —

- 1 Click Start  →Control Panel→Hardware and Sound.
- 2 Click Device Manager.

If your IEEE 1394a device is listed, Windows recognizes the device.

IF YOU HAVE PROBLEMS WITH A DELL IEEE 1394A DEVICE — Contact Dell (see "Contacting Dell" on page 200).

IF YOU HAVE PROBLEMS WITH AN IEEE 1394A DEVICE NOT PROVIDED BY DELL — Contact the IEEE 1394a device manufacturer.

Keyboard Problems

 **CAUTION:** Before you begin any of the procedures in this section, follow the safety instructions in the *Product Information Guide*.

CHECK THE KEYBOARD CABLE —

- Ensure that the keyboard cable is firmly connected to the computer.
- Shut down the computer (see "Before Working Inside Your Computer" on page 100), reconnect the keyboard cable as shown on the setup diagram for your computer, and then restart the computer.
- Ensure that the cable is not damaged or frayed and check cable connectors for bent or broken pins. Straighten any bent pins.
- Remove any keyboard extension cables and connect the keyboard directly to the computer.



TEST THE KEYBOARD — Connect a properly working keyboard to the computer, then try using the keyboard.

WORKING WITH AN USB KEYBOARD — During the first system boot, the operating system takes time to configure the USB keyboard. Reboot the system to configure the keyboard faster.

USB KEYBOARD OR MOUSE FAILURE — Connect the device to a different USB port and check if it starts working.

RUN THE HARDWARE TROUBLESHOOTER — See "Troubleshooting Software and Hardware Problems in the Microsoft Windows Vista™ Operating System" on page 93.

Lockups and Software Problems



CAUTION: Before you begin any of the procedures in this section, follow the safety instructions in the *Product Information Guide*.

The computer does not start up

CHECK THE DIAGNOSTIC LIGHTS — See "Diagnostic Lights" on page 76.

ENSURE THAT THE POWER CABLE IS FIRMLY CONNECTED TO THE COMPUTER AND TO THE ELECTRICAL OUTLET

The computer stops responding



NOTICE: You may lose data if you are unable to perform an operating system shutdown.

TURN THE COMPUTER OFF — If you are unable to get a response by pressing a key on your keyboard or moving your mouse, press and hold the power button for at least 8 to 10 seconds (until the computer turns off), and then restart your computer.

A program stops responding

END THE PROGRAM —

- 1 Press <Ctrl><Shift><Esc> simultaneously to access the Task Manager.
- 2 Click the Applications tab.
- 3 Click to select the program that is no longer responding.
- 4 Click End Task.





A program crashes repeatedly



NOTE: Most software includes installation instructions in its documentation or on a floppy disk, CD, or DVD.

CHECK THE SOFTWARE DOCUMENTATION — If necessary, uninstall and then reinstall the program.

A program is designed for an earlier Windows operating system

RUN THE PROGRAM COMPATIBILITY WIZARD —

The Program Compatibility Wizard configures a program so that it runs in an environment similar to non-Windows Vista operating system environments.

- 1 Click **Start**  → **Control Panel** → **Programs** → **Use an older program with this version of Windows**.
- 2 In the welcome screen, click **Next**.
- 3 Follow the instructions on the screen.

A solid blue screen appears

TURN THE COMPUTER OFF — If you are unable to get a response by pressing a key on your keyboard or moving your mouse, press and hold the power button for at least 8 to 10 seconds (until the computer turns off), and then restart your computer.

Other software problems

CHECK THE SOFTWARE DOCUMENTATION OR CONTACT THE SOFTWARE MANUFACTURER FOR TROUBLESHOOTING INFORMATION —

- Ensure that the program is compatible with the operating system installed on your computer.
- Ensure that your computer meets the minimum hardware requirements needed to run the software. See the software documentation for information.
- Ensure that the program is installed and configured properly.
- Verify that the device drivers do not conflict with the program.
- If necessary, uninstall and then reinstall the program.

BACK UP YOUR FILES IMMEDIATELY

USE A VIRUS-SCANNING PROGRAM TO CHECK THE HARD DRIVE, FLOPPY DISKS, CDS, OR DVDs

SAVE AND CLOSE ANY OPEN FILES OR PROGRAMS AND SHUT DOWN YOUR COMPUTER THROUGH THE START MENU

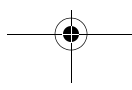
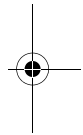
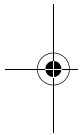



Memory Problems



CAUTION: Before you begin any of the procedures in this section, follow the safety instructions in the *Product Information Guide*.

IF YOU RECEIVE AN INSUFFICIENT MEMORY MESSAGE —

- Save and close any open files and exit any open programs you are not using to see if that resolves the problem.
- See the software documentation for minimum memory requirements. If necessary, install additional memory (see "Installing Memory" on page 106).
- Reseat the memory modules (see "Memory" on page 104) to ensure that your computer is successfully communicating with the memory.
- Run the Dell Diagnostics (see "Dell Diagnostics" on page 86).

IF YOU EXPERIENCE OTHER MEMORY PROBLEMS —

- Reseat the memory modules (see "Memory" on page 104) to ensure that your computer is successfully communicating with the memory.
- Ensure that you are following the memory installation guidelines (see "Installing Memory" on page 106).
- Ensure that the memory you are using is supported by your computer. For more information about the type of memory supported by your computer, see "Memory" on page 104.
- Run the Dell Diagnostics (see "Dell Diagnostics" on page 86).

Mouse Problems



CAUTION: Before you begin any of the procedures in this section, follow the safety instructions in the *Product Information Guide*.

CHECK THE MOUSE CABLE —

- Ensure that the cable is not damaged or frayed and check cable connectors for bent or broken pins. Straighten any bent pins.
- Remove any mouse extension cables, and connect the mouse directly to the computer.
- Verify that the mouse cable is connected as shown on the setup diagram for your computer.

RESTART THE COMPUTER —

- 1 Simultaneously press <Ctrl><Esc> to display the **Start** menu.
- 2 Press <u>, press the up- and down-arrow keys to highlight **Shut down** or **Turn Off**, and then press <Enter>.

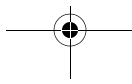

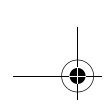

3 After the computer turns off, reconnect the mouse cable as shown on the setup diagram.

4 Turn on the computer.

TEST THE MOUSE — Connect a properly working mouse to the computer, then try using the mouse.

CHECK THE MOUSE SETTINGS —

1 Click Start  →Control Panel→Hardware and Sound→Mouse.

2 Adjust the settings as needed.

REINSTALL THE MOUSE DRIVER — See "Drivers" on page 90.

RUN THE HARDWARE TROUBLESHOOTER — See "Troubleshooting Software and Hardware Problems in the Microsoft Windows Vista™ Operating System" on page 93.

Network Problems

 **CAUTION:** Before you begin any of the procedures in this section, follow the safety instructions in the *Product Information Guide*.

CHECK THE NETWORK CABLE CONNECTOR — Ensure that the network cable is firmly inserted into the network connector on the back of the computer and the network jack.

CHECK THE NETWORK LIGHTS ON THE BACK OF THE COMPUTER — If the link integrity light is off (see "Controls and Lights" on page 176), no network communication is occurring. Replace the network cable.

RESTART THE COMPUTER AND LOG ON TO THE NETWORK AGAIN

CHECK YOUR NETWORK SETTINGS — Contact your network administrator or the person who set up your network to verify that your network settings are correct and that the network is functioning.

RUN THE HARDWARE TROUBLESHOOTER — See "Troubleshooting Software and Hardware Problems in the Microsoft Windows Vista™ Operating System" on page 93.

Power Problems

 **CAUTION:** Before you begin any of the procedures in this section, follow the safety instructions in the *Product Information Guide*.

IF THE POWER LIGHT IS BLUE AND THE COMPUTER IS NOT RESPONDING — See "Diagnostic Lights" on page 76.

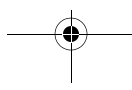

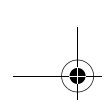

IF THE POWER LIGHT IS BLINKING BLUE —

- The computer is in standby mode. Press a key on the keyboard, move the mouse, or press the power button to resume normal operation.
- USB keyboard and mouse wake up the system if these devices are configured as wake up devices in the operating system devices properties. Otherwise, press the power button.

IF THE POWER LIGHT IS OFF — The computer is either turned off or is not receiving power.

- Reseat the power cable in the power connector on the back of the computer and the electrical outlet.
- Bypass power strips, power extension cables, and other power protection devices to verify that the computer turns on properly.
- Ensure that any power strips being used are plugged into an electrical outlet and are turned on.
- Ensure that the electrical outlet is working by testing it with another device, such as a lamp.
- Ensure that the main power cable and front panel cable are securely connected to the system board (see "System Board Components" on page 103).

IF THE POWER LIGHT IS BLINKING AMBER — The computer is receiving electrical power, but an internal power problem may exist.

- Ensure that the voltage selection switch is set to match the AC power at your location (if applicable).
- Ensure that all components and cables are properly installed and securely connected to the system board (see "System Board Components" on page 103).

IF THE POWER LIGHT IS STEADY AMBER — A device may be malfunctioning or incorrectly installed.

- Remove and then reinstall all memory modules (see "Memory" on page 104).
- Remove and then reinstall any expansion cards, including graphics cards (see "Removing a PCI Express Card" on page 121).

IF THE POWER LIGHT FLASHES AMBER AND THEN GOES OFF — It can be an internal power problem.

- Ensure that the processor power cable is securely connected to the system board power connector (12VPOWER). (See "System Board Components" on page 103).

ELIMINATE INTERFERENCE — Some possible causes of interference are:

- Power, keyboard, and mouse extension cables
- Too many devices connected to the same power strip
- Multiple power strips connected to the same electrical outlet

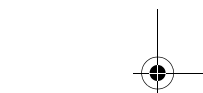
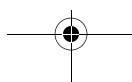

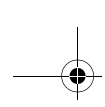

Printer Problems



CAUTION: Before you begin any of the procedures in this section, follow the safety instructions in the *Product Information Guide*.



NOTE: If you need technical assistance for your printer, contact the printer's manufacturer.

CHECK THE PRINTER DOCUMENTATION — See the printer documentation for setup and troubleshooting information.

ENSURE THAT THE PRINTER IS TURNED ON

CHECK THE PRINTER CABLE CONNECTIONS —

- See the printer documentation for cable connection information.
- Ensure that the printer cables are securely connected to the printer and the computer.

TEST THE ELECTRICAL OUTLET — Ensure that the electrical outlet is working by testing it with another device, such as a lamp.

VERIFY THAT THE PRINTER IS RECOGNIZED BY WINDOWS —

- 1 Click Start  →Control Panel→Hardware and Sound→Printer.
- 2 If the printer is listed, right-click the printer icon.
- 3 Click Properties and click Ports.
- 4 Adjust the settings, as needed.

REINSTALL THE PRINTER DRIVER — **SEE THE PRINTER DOCUMENTATION FOR INFORMATION ON REINSTALLING THE PRINTER DRIVER.** — **Scanner Problems**



CAUTION: Before you begin any of the procedures in this section, follow the safety instructions in the *Product Information Guide*.



NOTE: If you need technical assistance for your scanner, contact the scanner's manufacturer.

CHECK THE SCANNER DOCUMENTATION — See the scanner documentation for setup and troubleshooting information.

UNLOCK THE SCANNER — Ensure that your scanner is unlocked (if the scanner has a locking tab or button).

RESTART THE COMPUTER AND TRY THE SCANNER AGAIN

CHECK THE CABLE CONNECTIONS —

- See the scanner documentation for information on cable connections.
- Ensure that the scanner cables are securely connected to the scanner and the computer.

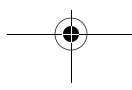
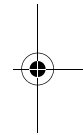
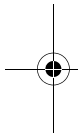

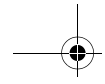

VERIFY THAT THE SCANNER IS RECOGNIZED BY MICROSOFT WINDOWS —

- 1 Click **Start**  → **Control Panel** → **Hardware and Sound** → **Scanners and Cameras**.
- 2 If the scanner is listed, Windows recognizes the scanner.

REINSTALL THE SCANNER DRIVER — See the scanner documentation for instructions.

Sound and Speaker Problems



CAUTION: Before you begin any of the procedures in this section, follow the safety instructions in the *Product Information Guide*.

No sound from speakers



NOTE: The volume control in MP3 and other media players may override the Windows volume setting. Always check to ensure that the volume on the media player(s) has not been turned down or off.

CHECK THE SPEAKER CABLE CONNECTIONS — Ensure that the speakers are connected as shown on the setup diagram supplied with the speakers. If you purchased a sound card, ensure that the speakers are connected to the card.

ENSURE THAT THE SUBWOOFER AND THE SPEAKERS ARE TURNED ON — See the setup diagram supplied with the speakers. If your speakers have volume controls, adjust the volume, bass, or treble to eliminate distortion.

ADJUST THE WINDOWS VOLUME CONTROL — Click or double-click the speaker icon in the lower-right corner of your screen. Ensure that the volume is turned up and that the sound is not muted.

DISCONNECT HEADPHONES FROM THE HEADPHONE CONNECTOR — Sound from the speakers is automatically disabled when headphones are connected to the computer's front-panel headphone connector.

TEST THE ELECTRICAL OUTLET — Ensure that the electrical outlet is working by testing it with another device, such as a lamp.

ELIMINATE POSSIBLE INTERFERENCE — Turn off nearby fans, fluorescent lights, or halogen lamps to check for interference.

RUN THE SPEAKER DIAGNOSTICS

REINSTALL THE SOUND DRIVER — See "Drivers" on page 90.

RUN THE HARDWARE TROUBLESHOOTER — See "Troubleshooting Software and Hardware Problems in the Microsoft Windows Vista™ Operating System" on page 93.

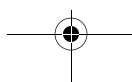





No sound from headphones

CHECK THE HEADPHONE CABLE CONNECTION — Ensure that the headphone cable is securely inserted into the headphone connector (see "Front and Back View of the Computer" on page 15).

ADJUST THE WINDOWS VOLUME CONTROL — Click or double-click the speaker icon in the lower-right corner of your screen. Ensure that the volume is turned up and that the sound is not muted.

Video and Monitor Problems

 **CAUTION:** Before you begin any of the procedures in this section, follow the safety instructions in the *Product Information Guide*.

 **NOTICE:** If your computer came with a PCI graphics card installed, removal of the card is not necessary when installing additional graphics cards; however, the card is required for troubleshooting purposes. If you remove the card, store it in a safe and secure location. For information about your graphics card, go to support.dell.com.

The screen is blank

 **NOTE:** For troubleshooting procedures, see the monitor's documentation.

The screen is difficult to read

CHECK THE MONITOR CABLE CONNECTION —

- Ensure that the monitor cable is connected to the correct graphics card (for dual graphics card configurations).
- If you are using the optional DVI-to-VGA adapter, ensure that the adapter is correctly attached to the graphics card and monitor.
- Ensure that the monitor cable is connected as shown on the setup diagram for your computer.
- Remove any video extension cables and connect the monitor directly to the computer.
- Swap the computer and monitor power cables to determine if the monitor's power cable is defective.
- Check the connectors for bent or broken pins (it is normal for monitor cable connectors to have missing pins).

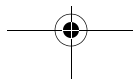

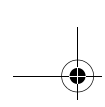

CHECK THE MONITOR POWER LIGHT —

- If the power light is lit or blinking, the monitor has power.
- If the power light is off, firmly press the button to ensure that the monitor is turned on.
- If the power light is blinking, press a key on the keyboard or move the mouse to resume normal operation.

TEST THE ELECTRICAL OUTLET — Ensure that the electrical outlet is working by testing it with another device, such as a lamp.

CHECK THE DIAGNOSTIC LIGHTS — See "Diagnostic Lights" on page 76.

CHECK THE MONITOR SETTINGS — See the monitor documentation for instructions on adjusting the contrast and brightness, demagnetizing (degaussing) the monitor, and running the monitor self-test.

MOVE THE SUBWOOFER AWAY FROM THE MONITOR — If your speaker system includes a subwoofer, ensure that the subwoofer is positioned at least 60 centimeters (2 feet) away from the monitor.

MOVE THE MONITOR AWAY FROM EXTERNAL POWER SOURCES — Fans, fluorescent lights, halogen lamps, and other electrical devices can cause the screen image to appear shaky. Turn off nearby devices to check for interference.

ROTATE THE MONITOR TO ELIMINATE SUNLIGHT GLARE AND POSSIBLE INTERFERENCE

ADJUST THE WINDOWS DISPLAY SETTINGS —

- 1 Click Start  → Control Panel → Hardware and Sound → Personalization → Display Settings.
- 2 Adjust Resolution and Colors settings, as needed.

3D image quality is poor

CHECK THE GRAPHICS CARD POWER CABLE CONNECTION — Ensure that the power cable for the graphics card(s) is correctly attached to the card.

CHECK THE MONITOR SETTINGS — See the monitor documentation for instructions on adjusting the contrast and brightness, demagnetizing (degaussing) the monitor, and running the monitor self-test.

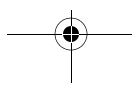



Power Lights

 **CAUTION:** Before you begin any of the procedures in this section, follow the safety instructions in the *Product Information Guide*.

The power button light located on the front of the computer illuminates and blinks or remains solid to indicate different states:

- If the power light is blue and the computer is not responding, see "Diagnostic Lights" on page 76.
- If the power light is blinking blue, the computer is in standby mode. Press a key on the keyboard, move the mouse, or press the power button to resume normal operation.
- If the power light is off, the computer is either turned off or is not receiving power.
 - Reseat the power cable into both the power connector on the back of the computer and the electrical outlet.
 - If the computer is plugged into a power strip, ensure that the power strip is plugged into an electrical outlet and that the power strip is turned on.
 - Bypass power protection devices, power strips, and power extension cables to verify that the computer turns on properly.
 - Ensure that the electrical outlet is working by testing it with another device, such as a lamp.
 - Ensure that the main power cable and front panel cable are securely connected to the system board (see "System Board Components" on page 103).
- If the power light is blinking amber, the computer is receiving electrical power, but an internal power problem might exist.
 - Ensure that the voltage selection switch is set to match the AC power at your location, if applicable.
 - Ensure that the processor power cable is securely connected to the system board (see "System Board Components" on page 103).

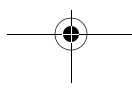
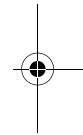
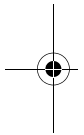

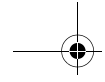









- If the power light is steady amber, a device may be malfunctioning or incorrectly installed.
 - Remove and then reinstall the memory modules (see "Memory" on page 104).
 - Remove and then reinstall any cards (see "Cards" on page 109).
- Eliminate interference. Some possible causes of interference are:
 - Power, keyboard, and mouse extension cables
 - Too many devices on a power strip
 - Multiple power strips connected to the same electrical outlet

Diagnostic Lights

 **CAUTION:** Before you begin any of the procedures in this section, follow the safety instructions in the *Product Information Guide*.

To help troubleshoot a problem, your computer has four blue lights labeled 1, 2, 3, and 4 on the top bezel (see "Front View" on page 15). When the computer starts normally, the lights flash before turning off. If the computer malfunctions, the sequence of the lights help to identify the problem.

 **NOTE:** After the computer completes POST, all four lights turn off before booting to the operating system.

Light Pattern	Problem Description	Suggested Resolution
   	<p>The computer is in a normal <i>off</i> condition or a possible pre-BIOS failure has occurred.</p> <p>The diagnostic lights are not lit after the system successfully boots to the operating system.</p>	<ul style="list-style-type: none"> • Plug the computer into a working electrical outlet (see "Power Problems" on page 69). • If the problem persists, contact Dell (see "Contacting Dell" on page 200).
   	<p>A possible processor failure has occurred.</p>	<ul style="list-style-type: none"> • Reseat the processor (see "Processor" on page 154). • If the problem persists, contact Dell (see "Contacting Dell" on page 200).

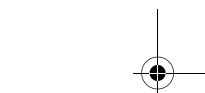
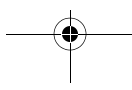





Light Pattern	Problem Description	Suggested Resolution
① ② ③ ④	Memory modules are detected, but a memory failure has occurred.	<ul style="list-style-type: none"> • If two or more memory modules are installed, remove the modules (see "Removing Memory" on page 108), then reinstall one module (see "Installing Memory" on page 106) and restart the computer. If the computer starts normally, continue to install additional memory modules (one at a time) until you have identified a faulty module or reinstalled all modules without error. • If available, install working memory of the same type into your computer (see "Installing Memory" on page 106). • If the problem persists, contact Dell (see "Contacting Dell" on page 200).
① ② ③ ④	A possible graphics card failure has occurred.	<ul style="list-style-type: none"> • Reseat any installed graphics cards (see "Cards" on page 109). • If available, install a working graphics card into your computer. • If the problem persists, contact Dell (see "Contacting Dell" on page 200).
① ② ③ ④	A possible floppy drive or hard drive failure has occurred.	Reseat all power and data cables.
① ② ③ ④	A possible USB failure has occurred.	Reinstall all USB devices and check all cable connections.







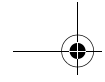

Light Pattern	Problem Description	Suggested Resolution
	<p>No memory modules are detected.</p>	<ul style="list-style-type: none"> • If two or more memory modules are installed, remove the modules (see "Removing Memory" on page 108), then reinstall one module (see "Installing Memory" on page 106) and restart the computer. If the computer starts normally, continue to install additional memory modules (one at a time) until you have identified a faulty module or reinstalled all modules without error. • If available, install working memory of the same type into your computer (see "Installing Memory" on page 106). • If the problem persists, contact Dell (see "Contacting Dell" on page 200).
	<p>Memory modules are detected, but a memory configuration or compatibility error has occurred.</p>	<ul style="list-style-type: none"> • Ensure that no special requirements for memory module/connector placement exist (see "Memory" on page 104). • Ensure that the memory you are using is supported by your computer (see "Memory" on page 173). • If the problem persists, contact Dell (see "Contacting Dell" on page 200).





Light Pattern	Problem Description	Suggested Resolution
   	A possible expansion card failure has occurred.	<ol style="list-style-type: none"><li data-bbox="894 499 1221 701">1 Determine if a conflict exists by removing an expansion card (not a graphics card) and restarting the computer (see "Removing a PCI Card" on page 114 and "Removing a PCI Express Card" on page 121).<li data-bbox="894 709 1221 821">2 If the problem persists, reinstall the card you removed, then remove a different card and restart the computer.<li data-bbox="894 829 1221 1150">3 Repeat this process for each expansion card installed. If the computer starts normally, troubleshoot the last card removed from the computer for resource conflicts (see "Troubleshooting Software and Hardware Problems in the Microsoft Windows Vista™ Operating System" on page 93).<li data-bbox="894 1159 1221 1245">4 If the problem persists, contact Dell (see "Contacting Dell" on page 200).

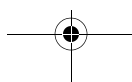
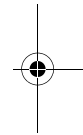
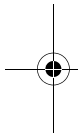

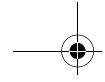

Light Pattern	Problem Description	Suggested Resolution
	<p>Another failure has occurred.</p>	<ul style="list-style-type: none"> • Ensure that all hard drive and optical drive cables are properly connected to the system board (see "System Board Components" on page 103). • If there is an error message on the screen identifying a problem with a device (such as the floppy drive or hard drive), check the device to make sure it is functioning properly. • If the operating system is attempting to boot from a device (such as the floppy drive or optical drive), check system setup (see "System Setup" on page 178) to ensure the boot sequence is correct for the devices installed on your computer. • If the problem persists, contact Dell (see "Contacting Dell" on page 200).

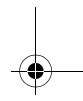
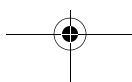
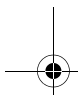
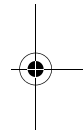
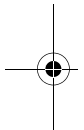

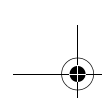

Beep Codes

Your computer might emit a series of beeps during start-up if the monitor cannot display errors or problems. This series of beeps, called a beep code, identifies a problem. For example, beep code 1-3-1 (one possible beep code) consists of one beep, a burst of three beeps, and then one beep. This beep code tells you that the computer encountered a memory problem.

Reseating the memory modules may correct the following beep code errors. If the problem persists, contact Dell (see "Contacting Dell" on page 200) for instructions on obtaining technical assistance.

Code	Cause
1-3-1 through 2-4-4	Memory not being properly identified or used
4-3-1	Memory failure above address 0FFFFh

If you experience any of the following beep code errors, see "Contacting Dell" on page 200 for instructions on obtaining technical assistance.

Code	Cause
1-1-2	Microprocessor register failure
1-1-3	NVRAM read/write failure
1-1-4	ROM BIOS checksum failure
1-2-1	Programmable interval timer failure
1-2-2	DMA initialization failure
1-2-3	DMA page register read/write failure
1-3	Video Memory Test failure
1-3-1 through 2-4-4	Memory not being properly identified or used
3-1-1	Slave DMA register failure
3-1-2	Master DMA register failure
3-1-3	Master interrupt mask register failure
3-1-4	Slave interrupt mask register failure
3-2-2	Interrupt vector loading failure

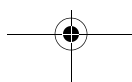

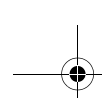

Code	Cause
3-2-4	Keyboard Controller Test failure
3-3-1	NVRAM power loss
3-3-2	Invalid NVRAM configuration
3-3-4	Video Memory Test failure
3-4-1	Screen initialization failure
3-4-2	Screen retrace failure
3-4-3	Search for video ROM failure
4-2-1	No timer tick
4-2-2	Shutdown failure
4-2-3	Gate A20 failure
4-2-4	Unexpected interrupt in protected mode
4-3-1	Memory failure above address 0FFFFh
4-3-3	Timer-chip counter 2 failure
4-3-4	Time-of-day clock stopped
4-4-1	Serial or parallel port test failure
4-4-2	Failure to decompress code to shadowed memory
4-4-3	Math-coprocessor test failure
4-4-4	Cache test failure

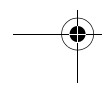
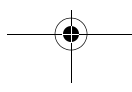
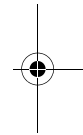
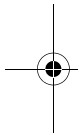



System Messages

 **NOTE:** If the message you received is not listed in the table, see the documentation for either the operating system or the program that was running when the message appeared.

Message	Possible Cause	Corrective Action
8042 Gate-A20 error	The keyboard controller failed its test.	If you receive this message after you make changes in the system setup program, enter the system setup program and restore the original value(s).
Address Line Short!	An error in the address decoding circuitry in the memory has occurred.	Reseat the memory modules (see "Memory" on page 104).
C: Drive Error C: Drive Failure	The hard drive is not working or is not configured correctly.	Ensure that the hard drive is installed correctly in the computer (see "Drives" on page 128) and defined correctly in the system setup program (see "System Setup" on page 178).
Cache Memory Bad, Do Not Enable Cache	The cache memory is not operating.	See "Contacting Dell" on page 200 for instructions on obtaining technical assistance.
CH-2 Timer Error	An error is occurring on the timer on the system board.	See "Contacting Dell" on page 200 for instructions on obtaining technical assistance.

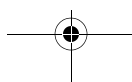
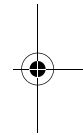
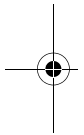

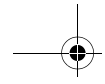

Message	Possible Cause	Corrective Action
CMOS Battery State Low	The system configuration information in the system setup program is incorrect or the battery charge may be low.	Enter the system setup program (see "Entering System Setup" on page 179), verify the system configuration, and then restart the computer.
CMOS Checksum Failure		
CMOS System Options Not Set		
CMOS Display Type Mismatch		
CMOS Memory Size Mismatch		
CMOS Time and Date Not Set		
Diskette Boot Failure	Drive A or B is present but has failed the BIOS POST.	Ensure that the drive is installed correctly in the computer (see "Drives" on page 128) and defined correctly in the system setup program (see "System Setup" on page 178). Check the interface cable at both ends.
DMA Error	Error in the DMA controller on the system board.	The keyboard or system board may need to be replaced.
DMA 1 Error		
DMA 2 Error		

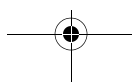
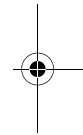
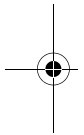

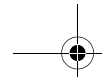

Message	Possible Cause	Corrective Action
FDD Controller Failure HDD Controller Failure	The BIOS cannot communicate with the floppy drive or hard drive controller.	Ensure that the floppy drive or the hard drive is installed correctly in the computer (see "Drives" on page 128) and defined correctly in the system setup program (see "System Setup" on page 178). Check the interface cable at both ends.
INTR1 Error INTR2 Error	An interrupt channel on the system board failed to POST.	The keyboard or system board may need to be replaced.
Invalid Boot Diskette	The operating system cannot be located on drive A or drive C.	Enter the system setup program (see "System Setup" on page 178) and confirm that drive A or drive C is properly identified.
Keyboard Error	The BIOS has detected a stuck key.	Ensure that nothing is resting on the keyboard; if a key appears to be stuck, carefully pry it up. If the problem persists, you may need to replace the keyboard.

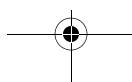
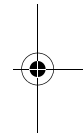
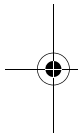

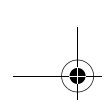

Message	Possible Cause	Corrective Action
KB/Interface Error	An error occurred with the keyboard connector.	Ensure that nothing is resting on the keyboard; if a key appears to be stuck, carefully pry it up. If the problem persists, you may need to replace the keyboard.
No ROM Basic	The operating system cannot be located on drive A or drive C.	Enter the system setup program (see "Entering System Setup" on page 179) and confirm that drive A or drive C is properly identified.

Dell Diagnostics

 **CAUTION:** Before you begin any of the procedures in this section, follow the safety instructions in the *Product Information Guide*.

When to Use Dell Diagnostics

If you experience a problem with your computer, perform the checks in "Solving Problems" on page 61 and run Dell Diagnostics before you contact Dell for technical assistance.

 **NOTE:** Dell Diagnostics only operate on Dell computers.

It is recommended that you print these procedures before you begin.

Start Dell Diagnostics from your hard drive or from the *Drivers and Utilities* media.

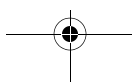
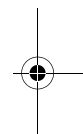
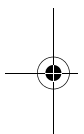

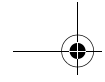

Starting Dell Diagnostics From Your Hard Drive

- 1 Ensure that the computer is connected to an electrical outlet that is known to be working properly.
- 2 Turn on (or restart) your computer.
- 3 When the DELL™ logo appears, press <F12> immediately. Select **Diagnostics** from the boot menu and press <Enter>.



NOTE: If you wait too long and the operating system logo appears, continue to wait until you see the Microsoft® Windows® desktop, then shut down your computer and try again.



NOTE: If you see a message stating that no diagnostics utility partition has been found, run the Dell Diagnostics from the *Drivers and Utilities* media (see "Starting Dell Diagnostics From the Drivers and Utilities Media" on page 88).

- 4 Press any key to start the Dell Diagnostics from the diagnostics utility partition on your hard drive.



NOTE: The Quickboot feature changes the boot sequence for the current boot only. Upon restart, the computer boots according to the boot sequence specified in system setup.

- 5 At the Dell Diagnostics **Main Menu**, left-click with the mouse, or press <Tab> and then <Enter>, to select the test you want to run (see "Dell Diagnostics Main Menu" on page 88).



NOTE: Write down any error codes and problem descriptions exactly as they appear and follow the instructions on the screen.

- 6 After all tests have completed, close the test window to return to the Dell Diagnostics **Main Menu**.
- 7 Close the **Main Menu** window to exit Dell Diagnostics and restart the computer.

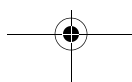
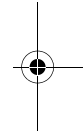
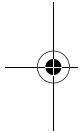

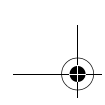

Starting Dell Diagnostics From the Drivers and Utilities Media

- 1 Insert the *Drivers and Utilities* media.
- 2 Shut down and restart the computer.

When the DELL logo appears, press <F12> immediately.



NOTE: If you wait too long and the operating system logo appears, continue to wait until you see the Microsoft® Windows® desktop; then, shut down your computer and try again.



NOTE: The next steps change the boot sequence for one time only. On the next start-up, the computer boots according to the devices specified in the system setup program.

- 3 When the boot device list appears, highlight CD/DVD/CD-RW and press <Enter>.
- 4 Select the **Boot from CD-ROM** option from the menu that appears and press <Enter>.
- 5 Type 1 to start the CD menu and press <Enter> to proceed.
- 6 Select **Run the 32 Bit Dell Diagnostics** from the numbered list. If multiple versions are listed, select the version appropriate for your computer.
- 7 When the Dell Diagnostics **Main Menu** appears, select the test you want to run.



NOTE: Write down any error codes and problem descriptions exactly as they appear and follow the instructions on the screen.

Dell Diagnostics Main Menu

- 1 After the Dell Diagnostics loads and the **Main Menu** screen appears, click the button for the option you want.



NOTE: It is recommended that you select **Test System** to run a complete test on your computer.

Option	Function
Test Memory	Run the stand-alone memory test
Test System	Run System Diagnostics
Exit	Exit the Diagnostics

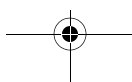

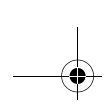

2 After you have selected the **Test System** option from the main menu, the following menu appears:



NOTE: It is recommended that you select **Extended Test** from the menu below to run a more thorough check of devices in the computer.

Option	Function
Express Test	Performs a quick test of system devices. The test typically takes 10 to 20 minutes and requires no interaction on your part. Run Express Test first to increase the possibility of tracing the problem quickly.
Extended Test	Performs a thorough check of system devices. The test typically takes an hour or more.
Custom Test	Use to test a specific device or customize the tests to be run.
Symptom Tree	This option allows you to select tests based on a symptom of the problem you are having. This option lists the most common symptoms.
Built in Self Test	Performs a thorough check on all LCD display related functions. Based on the test results a green Passed or red Failed message appears on screen. For items listed in red, note down the error code and problem description and contact Dell.

3 If a problem is encountered during a test, a message appears with an error code and a description of the problem. Write down the error code and problem description and see "Contacting Dell" on page 200



NOTE: The Service Tag for your computer is located at the top of each test screen. If you contact Dell, technical support will ask for your Service Tag.

4 If you run a test from the **Custom Test** or **Symptom Tree** option, click the applicable tab described in the following table for more information.

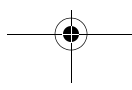



Tab	Function
Results	Displays the results of the test and any error conditions encountered.
Errors	Displays error conditions encountered, error codes, and the problem description.
Help	Describes the test and any requirements for running the test.
Configuration	Displays your hardware configuration for the selected device. NOTE: The Dell Diagnostics obtains configuration information for all devices from system setup, memory, and various internal tests, and it displays the information in the device list in the left pane of the screen. The device list may not display the names of all the components installed on your computer or all devices attached to your computer.
Parameters	Allows you to customize the test, if applicable, by changing the test settings.

- 5 When the tests are complete, close the test screen to return to the **Main Menu** screen. To exit the Dell Diagnostics and restart the computer, close the **Main Menu** screen.
- 6 Remove the Dell *Drivers and Utilities* media.

Drivers

What Is a Driver?

A driver is a program that controls a device such as a printer, mouse, or keyboard. All devices require a driver program.

A driver acts like a translator between the device and any other programs that use the device. Each device has its own set of specialized commands that only its driver recognizes.

Dell ships your computer to you with required drivers already installed—no further installation or configuration is needed.



NOTICE: The *Drivers and Utilities* media may contain drivers for operating systems that are not on your computer. Ensure that you are installing software appropriate for your operating system.

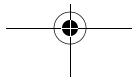

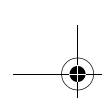



Many drivers, such as the keyboard driver, come with your Microsoft Windows operating system. You may need to install drivers if you:

- Upgrade your operating system.
- Reinstall your operating system.
- Connect or install a new device.

Identifying Drivers

If you experience a problem with any device, identify whether the driver is the source of your problem and, if necessary, update the driver.

- 1 Click the Windows Vista Start button™ , and right-click **Computer**.
- 2 Click **Properties**→**Device Manager**.

 **NOTE:** The **User Account Control** window may appear. If you are an administrator on the computer, click **Continue**; otherwise, contact your administrator to continue.

- 3 Scroll down the list to see if any device has an exclamation point (a yellow circle with a [!]) on the device icon.

If an exclamation point is next to the device name, you may need to reinstall the driver or install a new driver (see "Reinstalling Drivers and Utilities" on page 91).

Reinstalling Drivers and Utilities

 **NOTICE:** The Dell Support website at support.dell.com and your *Drivers and Utilities* media provide approved drivers for Dell™ computers. If you install drivers obtained from other sources, your computer might not work correctly.

Using Windows Device Driver Rollback

If a problem occurs on your computer after you install or update a driver, use Windows Device Driver Rollback to replace the driver with the previously installed version.

- 1 Click the Windows Vista Start button™ , and right-click **Computer**.
- 2 Click **Properties**→**Device Manager**.

 **NOTE:** The **User Account Control** window may appear. If you are an administrator on the computer, click **Continue**; otherwise, contact your administrator to enter the Device Manager.

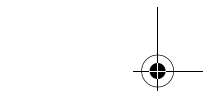
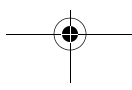

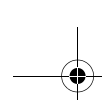

- 3 Right-click the device for which the new driver was installed and click **Properties**.
- 4 Click **Drivers** and click **Roll Back Driver**.

If Device Driver Rollback does not resolve the problem, then use System Restore (see "Restoring Your Operating System" on page 94) to return your computer to the operating state that existed before you installed the driver.

Using the Drivers and Utilities Media

If using Device Driver Rollback or System Restore does not resolve the problem, then reinstall the driver from the *Drivers and Utilities* media.

- 1 With the Windows desktop displayed, insert the *Drivers and Utilities* media.
If this is your first time to use the *Drivers and Utilities* media, go to step 2. If not, go to step 5.
- 2 When the *Drivers and Utilities* installation program starts, follow the prompts on the screen.
- 3 When the **InstallShield Wizard Complete** window appears, remove the *Drivers and Utilities* media and click **Finish** to restart the computer.
- 4 When you see the Windows desktop, reinsert the *Drivers and Utilities* media.
- 5 At the **Welcome Dell System Owner** screen, click **Next**.



NOTE: The *Drivers and Utilities* media displays drivers only for hardware that came installed in your computer. If you installed additional hardware, the drivers for the new hardware might not be displayed by the *Drivers and Utilities* media. If those drivers are not displayed, exit the *Drivers and Utilities* media program. For drivers information, see the documentation that came with the device.

A message appears, stating that the Drivers and Utilities media is detecting hardware in your computer.

The drivers that are used by your computer are automatically displayed in the **My Drivers—The Drivers and Utilities media has identified these components in your system** window.

- 6 Click the driver that you want to reinstall and follow the instructions on the screen.

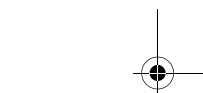
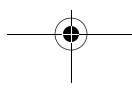
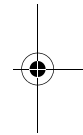
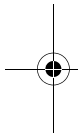

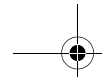

If a particular driver is not listed, that driver is not required by your operating system.



NOTE: It is recommended, for optimized performance, that you install the hardware drivers in the following order:

- Desktop System Software
- Chipset or SMBus driver
- Processor Driver (if applicable)
- Video
- Audio (sound)
- Input Drivers (keyboard/mouse)
- Modem (Desktop computers have a separate CD for the modem)
- Network Card

Troubleshooting Software and Hardware Problems in the Microsoft Windows Vista™ Operating System

If a device is either not detected during the operating system setup or is detected but incorrectly configured, you can use the Hardware Troubleshooter to resolve the incompatibility.

To start the Hardware Troubleshooter:

- 1 Click the Windows Vista Start button™ , and click **Help and Support**.
- 2 Type `hardware troubleshooter` in the search field and press <Enter> to start the search.
- 3 In the search results, select the option that best describes the problem and follow the remaining troubleshooting steps.

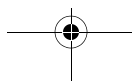

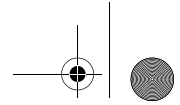

Restoring Your Operating System

You can restore your operating system in the following ways:

- System Restore returns your computer to an earlier operating state without affecting data files. Use System Restore as the first solution for restoring your operating system and preserving data files.
- Dell Factory Image Restore (available in Windows Vista) restores your hard drive to the operating state it was in when you purchased the computer. It permanently deletes all data on the hard drive and removes any programs installed after you received the computer. Use Dell Factory Image Restore only if System Restore did not resolve your operating system problem.
- If you received an *Operating System* disc with your computer, you can use it to restore your operating system. However, using the *Operating System* disc also deletes all data on the hard drive. Use the disc *only* if System Restore did not resolve your operating system problem.

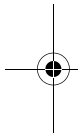

Using Microsoft Windows System Restore

The Windows operating systems provide a System Restore option which allows you to return your computer to an earlier operating state (without affecting data files) if changes to the hardware, software, or other system settings have left the computer in an undesirable operating state. Any changes that System Restore makes to your computer are completely reversible.





NOTICE: Make regular backups of your data files. System Restore does not monitor your data files or recover them.



NOTE: The procedures in this document were written for the Windows default view, so they may not apply if you set your Dell™ computer to the Windows Classic view.

Starting System Restore

- 1 Click Start .
- 2 In the Start Search box, type `System Restore` and press <Enter>.
 -  **NOTE:** The User Account Control window may appear. If you are an administrator on the computer, click **Continue**; otherwise, contact your administrator to continue the desired action.
- 3 Click **Next** and follow the remaining prompts on the screen.

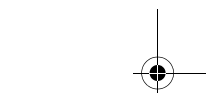
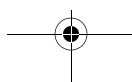
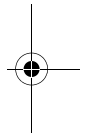





In the event that System Restore did not resolve the issue, you may undo the last system restore.

Undoing the Last System Restore

 **NOTICE:** Before you undo the last system restore, save and close all open files and exit any open programs. Do not alter, open, or delete any files or programs until the system restoration is complete.

- 1 Click **Start** .
- 2 In the Start Search box, type **System Restore** and press <Enter>.
- 3 Click **Undo my last restoration** and click **Next**.

Using Dell Factory Image Restore

 **NOTICE:** Using Dell Factory Image Restore permanently deletes all data on the hard drive and removes any programs or drivers installed after you received your computer. If possible, back up the data before using these options. Use Dell Factory Image Restore only if System Restore did not resolve your operating system problem.

 **NOTE:** Dell Factory Image Restore may not be available in certain countries or on certain computers.

Use Dell Factory Image Restore (Windows Vista) only as the last method to restore your operating system. This option restore your hard drive to the operating state it was in when you purchased the computer. Any programs or files added since you received your computer—including data files—are permanently deleted from the hard drive. Data files include documents, spreadsheets, e-mail messages, digital photos, music files, and so on. If possible, back up all data before using Factory Image Restore.

Windows Vista: Dell Factory Image Restore

Using Factory Image Restore:

- 1 Turn on the computer. When the Dell logo appears, press <F8> several times to access the Vista Advanced Boot Options Window.
- 2 Select **Repair Your Computer**.
The System Recovery Options window appears.
- 3 Select a keyboard layout and click **Next**.

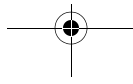

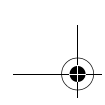

4 To access the recovery options, log on as a local user. To access the command prompt, type `administrator` in the User name field, then click **OK**.

5 Click **Dell Factory Image Restore**.



NOTE: Depending upon your configuration, you may need to select **Dell Factory Tools**, then **Dell Factory Image Restore**.

The Dell Factory Image Restore welcome screen appears.

6 Click **Next**.

The Confirm Data Deletion screen appears.



NOTICE: If you do not want to proceed with Factory Image Restore, click **Cancel**.

7 Click the checkbox to confirm that you want to continue reformatting the hard drive and restoring the system software to the factory condition, then click **Next**.

The restore process begins and may take five or more minutes to complete. A message appears when the operating system and factory-installed applications have been restored to factory condition.

8 Click **Finish** to reboot the system.

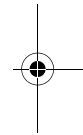
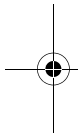

Using the Operating System Media

Before You Begin

If you are considering reinstalling the Windows operating system to correct a problem with a newly installed driver, first try using Windows Device Driver Rollback. See "Using Windows Device Driver Rollback" on page 91. If Device Driver Rollback does not resolve the problem, then use System Restore to return your operating system to the operating state it was in before you installed the new device driver. See "Using Microsoft Windows System Restore" on page 94.



NOTICE: Before performing the installation, back up all data files on your primary hard drive. For conventional hard drive configurations, the primary hard drive is the first drive detected by the computer.

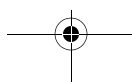



To reinstall Windows, you need the following items:

- Dell™ *Operating System* media
- Dell *Drivers and Utilities* media



NOTE: The Dell *Drivers and Utilities* media contains drivers that were installed during the assembly of the computer. Use the Dell *Drivers and Utilities* media to load any required drivers. Depending on the region from which you ordered your computer, or whether you requested the media, the Dell *Drivers and Utilities* media and *Operating System* media may not ship with your computer.

Reinstalling Windows Vista

The reinstallation process can take 1 to 2 hours to complete. After you reinstall the operating system, you must also reinstall the device drivers, virus protection program, and other software.

- 1 Save and close any open files and exit any open programs.
- 2 Insert the *Operating System* disc.
- 3 Click **Exit** if the **Install Windows** message appears.
- 4 Restart the computer.

When the DELL logo appears, press <F12> immediately.



NOTE: If you wait too long and the operating system logo appears, continue to wait until you see the Microsoft® Windows® desktop; then, shut down your computer and try again.



NOTE: The next steps change the boot sequence for one time only. On the next start-up, the computer boots according to the devices specified in the system setup program.

- 5 When the boot device list appears, highlight **CD/DVD/CD-RW Drive** and press <Enter>.
- 6 Press any key to **Boot from CD-ROM**.
- 7 Follow the instructions on the screen to complete the installation.

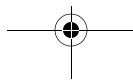

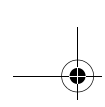

Troubleshooting LCD Display Problems

LCD display includes a built in self-test which allows the user to diagnose and troubleshoot any issues related to the application.

To run the Built-in Self-Test

- 1 Ensure that the system is switched off.
- 2 Press and hold the menu button (see "Understanding Windows® SideShow™ and the LCD display" on page 50).
- 3 Power the system on. Release the menu button.
- 4 The system enters diagnostic test menu.
- 5 Select **Run All Test**.
- 6 When all the tests are completed, the screen displays a Passed (displayed in Green) or Failed (displayed in Red) message.
- 7 Note down the error code and the Failed message description and contact Dell (see "Contacting Dell" on page 200).

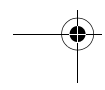
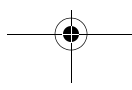
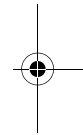
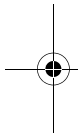

4

Removing and Installing Parts

Before You Begin

This chapter provides procedures for removing and installing the components in your computer. Unless otherwise noted, each procedure assumes that the following conditions exist:

- You have performed the steps in "Turning Off Your Computer" on page 99 and "Before Working Inside Your Computer" on page 100.
- You have read the safety information in your Dell™ *Product Information Guide*.
- A component can be replaced or—if purchased separately—installed by performing the removal procedure in reverse order.

Recommended Tools

The procedures in this document may require the following tools:

- Small flat-blade screwdriver
- Small Phillips screwdriver
- Small plastic scribe

Turning Off Your Computer

 **NOTICE:** To avoid losing data, save any work in progress and exit all open programs before turning off your computer.

- 1 Shut down the operating system:
 - a Save and close all open files and exit all open programs.
 - b In Microsoft® Windows Vista™, click the Windows Vista Start button™,  in the lower-left corner of the desktop, click the arrow in the lower-right corner of the Start menu as shown below, and then click **Shut Down**.





The computer turns off after the operating system shutdown process is complete.





Before Working Inside Your Computer

Use the following safety guidelines to help protect your computer from potential damage and to help ensure your own personal safety.

 **CAUTION:** Before you perform any of the procedures in this section, follow the safety instructions in the *Product Information Guide*.

 **CAUTION:** When working inside the computer, be aware that the processor heat-sink assembly, power supply, graphics card, and other components may be very hot during normal operation. Be sure that they have sufficient time to cool before you touch them.

 **NOTICE:** Handle components and cards with care. Do not touch the components or contacts on a card. Hold a card by its edges or by its metal mounting bracket. Hold a component such as a processor by its edges, not by its pins.

 **NOTICE:** Only a certified service technician should perform repairs on your computer. Damage due to servicing that is not authorized by Dell is not covered by your warranty.

 **NOTICE:** When you disconnect a cable, pull on its connector or on its strain-relief loop, not on the cable itself. Some cables have a connector with locking tabs; if you are disconnecting this type of cable, press in on the locking tabs before you disconnect the cable. As you pull connectors apart, keep them evenly aligned to avoid bending any connector pins. Also, before you connect a cable, ensure that both connectors are correctly oriented and aligned.

 **NOTICE:** To avoid damaging the computer, perform the following steps before you begin working inside the computer.

- 1 Ensure that the work surface is flat and clean to prevent the computer cover from being scratched.
- 2 Turn off your computer (see "Turning Off Your Computer" on page 99).

 **NOTICE:** To disconnect a network cable, first unplug the cable from your computer and then unplug it from the network wall jack.

- 3 Disconnect all telephone or network cables from the computer.
- 4 Disconnect your computer and all attached devices from their electrical outlets, and then press the power button to ground the system board.

 **NOTICE:** Before touching anything inside your computer, ground yourself by touching an unpainted metal surface, such as the metal at the back of the computer. While you work, periodically touch an unpainted metal surface to dissipate any static electricity that could harm internal components.



Removing the Computer Cover

- ⚠ CAUTION:** Before you perform any of the procedures in this section, follow the safety instructions in the *Product Information Guide*.
 - ⚠ CAUTION:** To guard against electrical shock, always unplug your computer from the electrical outlet before removing the cover.
 - ➡ NOTICE:** Before touching anything inside your computer, ground yourself by touching an unpainted metal surface, such as the metal at the back of the computer. While you work, periodically touch an unpainted metal surface to dissipate any static electricity that could harm internal components.
- 1 Follow the procedures in "Before You Begin" on page 99.
 - 2 If you have installed a security cable, remove it from the security cable slot.
 - ➡ NOTICE:** Ensure that sufficient space exists to support the removed cover—at least 30 cm (1 ft) of desk top space.
 - ➡ NOTICE:** Ensure that you are working on a level, protected surface to avoid scratching either the computer or the surface on which it is resting.
- 3 Lay your computer on its side with the computer cover facing up.
 - 4 Pull back the cover release latch on the top panel.

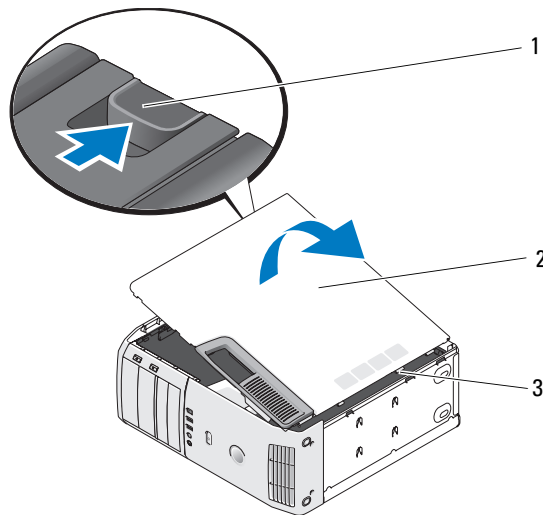

1 cover release latch 2 computer cover 3 hinge tabs (3)

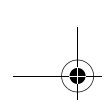

- 5 Locate the three hinge tabs on the bottom edge of the computer.
- 6 Grip the sides of the computer cover and pivot the cover up.
- 7 Lift the cover away and set it aside in a secure location.

Inside View of Your Computer

CAUTION: Before you perform any of the procedures in this section, follow the safety instructions in the *Product Information Guide*.

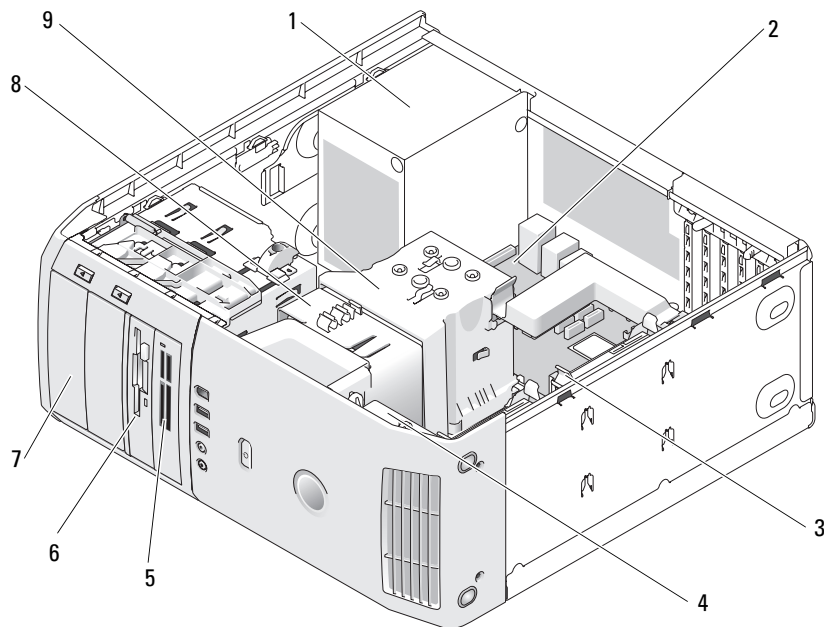

- | | | |
|-----------------------|--------------------------------|--|
| 1 power supply | 2 system board | 3 hard drive (2) |
| 4 card fan | 5 media card reader (optional) | 6 floppy drive (optional) |
| 7 CD or DVD drive (2) | 8 processor fan | 9 processor airflow shroud and processor (processor is below the processor shroud and heat sink) |

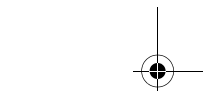
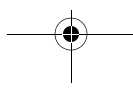

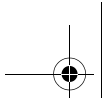

System Board Components

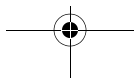
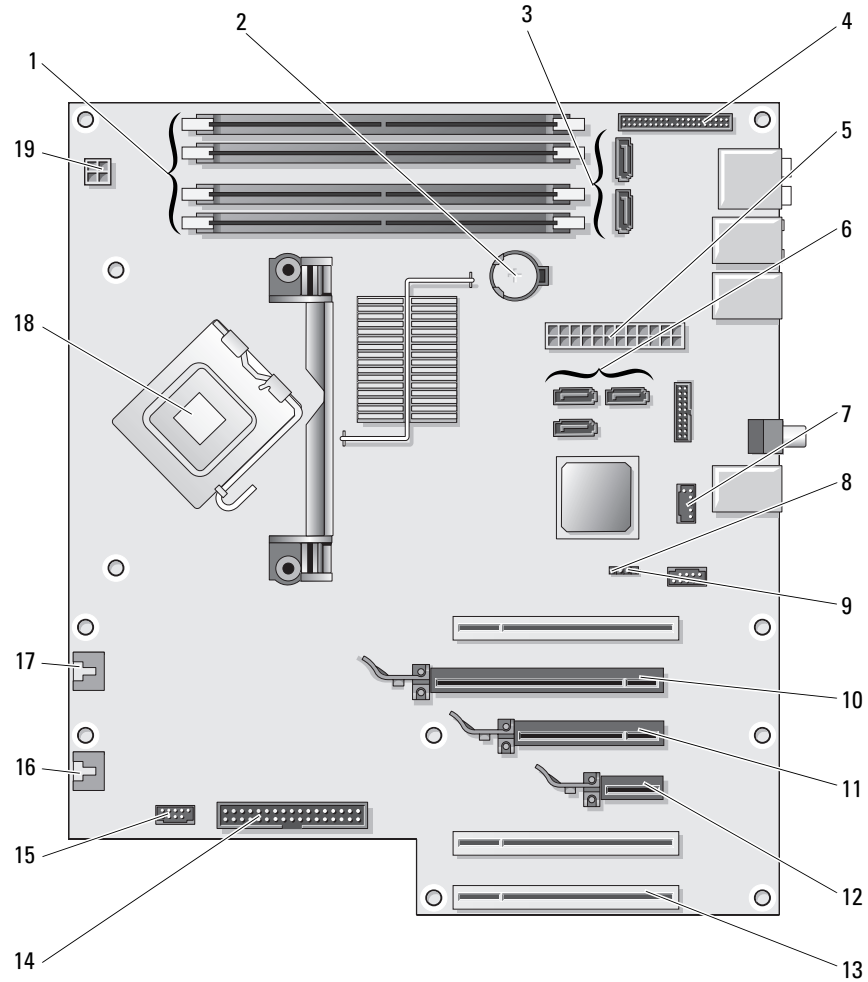

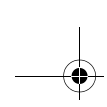

- | | | | | | |
|----|---|----|---|----|---|
| 1 | memory module connectors (1, 2, 3, 4) | 2 | battery socket (BATTERY) | 3 | SATA Connectors (2) (SATA0, SATA1) |
| 4 | front panel I/O connector | 5 | main power connector (POWER) | 6 | SATA connectors (3) (SATA2, SATA3, SATA4) |
| 7 | FlexBay USB connector (9 pins) | 8 | clear CMOS jumper (RTCRST) | 9 | password jumper (PSWD) |
| 10 | PCI Express x16 card connector | 11 | PCI Express x8 card connector (x4 electrical) | 12 | PCI Express x1 card connector |
| 13 | PCI card connectors | 14 | floppy drive connector (FLOPPY) | 15 | internal USB connector connecting to FlexBay device |
| 16 | rear fan connector or card cage fan connector (FAN_CARD_CAGE) | 17 | Processor fan connector (FAN_CPU) | 18 | processor connector |
| 19 | processor power connector (12VPOWER) | | | | |

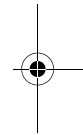
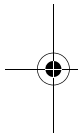

Memory

You can increase your computer memory by installing memory modules on the system board.

Memory Overview

- Memory modules should be installed in *pairs of matched memory size, speed, and technology*. If the memory modules are not installed in matched pairs, the computer will continue to operate, but with a slight reduction in performance. See the label in the upper-right corner of the module to determine the module's capacity.

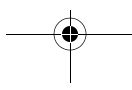

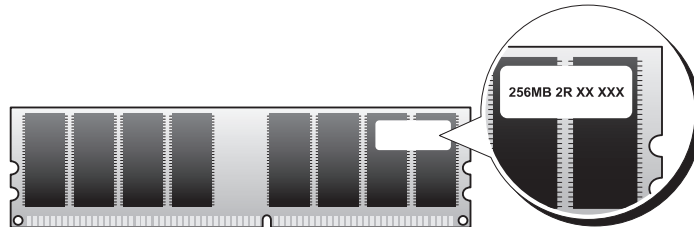

NOTE: Always install memory modules in the order indicated on the system board.

The recommended memory configurations are:

- A pair of matched memory modules installed in connectors DIMM_1 and DIMM_2

or

- A pair of matched memory modules installed in connectors DIMM_1 and DIMM_2 and another matched pair installed in connectors DIMM_3 and DIMM_4
- If you install mixed pairs of DDR2 667-MHz (PC2-5300) and DDR2 800-MHz (PC2-6400) memory, the modules function at the slowest speed installed.
- Be sure to install a single memory module in the DIMM_1 connector, the connector closest to the processor, before you install modules in the other connectors.

NOTE: If you remove your original memory modules from the computer during a memory upgrade, keep them separate from any new modules that you may have, even if you purchased the new modules from Dell. If possible, *do not* pair an original memory module with a new memory module. Otherwise, your computer may not start properly. You should install your original memory modules in pairs either in connectors DIMM_1 and DIMM_2 or connectors DIMM_3 and DIMM_4.

NOTE: Memory purchased from Dell is covered under your computer warranty.

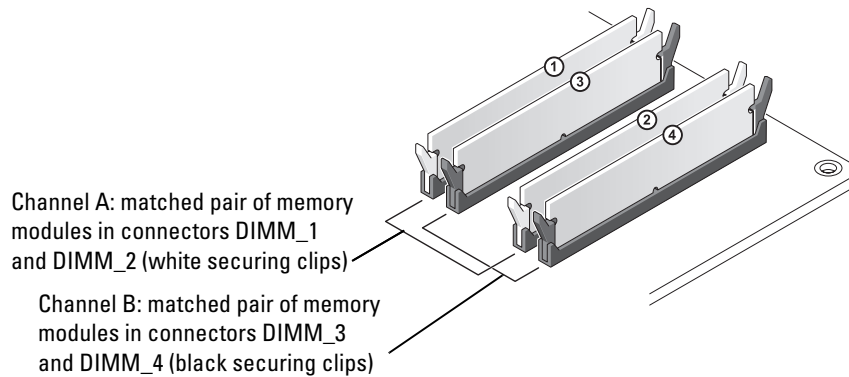

Addressing Memory With 8-GB Configurations

Your computer supports a maximum of 8 GB of memory when you use four 2-GB DIMMs. However, the amount of memory available to the operating system is less than 8 GB. This is because certain components within the computer require address space in the 8-GB range; and any address space reserved for these components cannot be used by computer memory.

NOTE: 8 GB memory is available only if you ordered an operating system that supports 64 bits. If you ordered a system that supports only 32 bits then the memory available is 4 GB.

Installing Memory

CAUTION: Before you perform any of the procedures in this section, follow the safety instructions in the *Product Information Guide*.

NOTICE: To prevent static damage to components inside your computer, discharge static electricity from your body before you touch any of your computer's electronic components. You can do so by touching an unpainted metal surface on the computer.

- 1 Follow the procedures in "Before You Begin" on page 99.
- 2 Remove the computer cover (see "Removing the Computer Cover" on page 101).
- 3 Lay the computer on its side so that the system board is on the bottom of the inside of the computer.
- 4 Press out the securing clip at each end of the memory module connector.

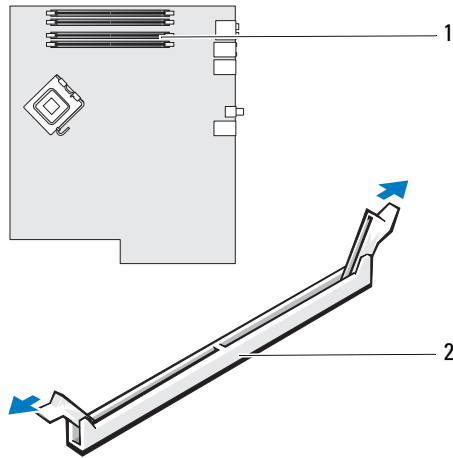
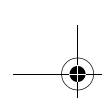

1 memory slot on system board 2 memory slot

- 5** Align the notch on the bottom of the module with the crossbar in the connector.

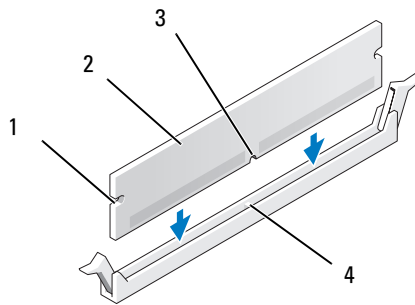

1 cutouts (2) 2 memory module
3 notch 4 crossbar

➔ NOTICE: To avoid damage to the memory module, press the module straight down into the connector while you apply equal force to each end of the module.

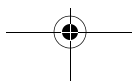



- 6 Insert the module into the connector until the module snaps into position. If you insert the module correctly, the securing clips snap into the cutouts at each end of the module.

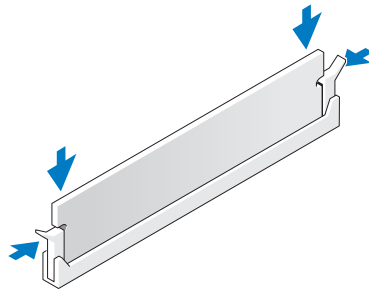

- 7 Replace the computer cover.
- ➔ NOTICE:** To connect a network cable, first plug the cable into the network wall jack and then plug it into the computer.
- 8 Connect your computer and devices to electrical outlets, and then turn them on.
 - 9 Right-click the **My Computer** icon, then click **Properties**.
 - 10 Click the **General** tab.
 - 11 To verify that the memory is installed correctly, check the amount of memory (RAM) listed.

Removing Memory



CAUTION: Before you perform any of the procedures in this section, follow the safety instructions in the *Product Information Guide*.



NOTICE: To prevent static damage to components inside your computer, discharge static electricity from your body before you touch any of your computer's electronic components. You can do so by touching an unpainted metal surface on the computer.

- 1 Follow the procedures in "Before You Begin" on page 99.
- 2 Remove the computer cover (see "Removing the Computer Cover" on page 101).

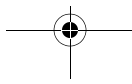



- 3 Press out the securing clip at each end of the memory module connector.
- 4 Grasp the module and pull up.
If the module is difficult to remove, gently ease the module back and forth to remove it from the connector.

Cards

 **CAUTION:** Before you perform any of the procedures in this section, follow the safety instructions in the *Product Information Guide*.

 **NOTICE:** To prevent static damage to components inside your computer, discharge static electricity from your body before you touch any of your computer's electronic components. You can do so by touching an unpainted metal surface on the computer.

Your Dell™ computer provides the following slots for PCI and PCI Express cards:

- Three PCI card slots
- One PCI Express x1 card slot
- One PCI Express x16 card slot
- One PCI Express x8 card slot (electrically configured as an x4)



PCI Cards

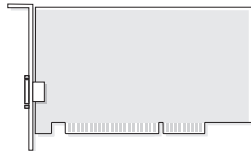

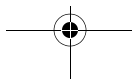

- If you are installing or replacing a PCI card, follow the procedures in the next section.
- If you are removing but not replacing a PCI card, see "Removing a PCI Card" on page 114.
- If you are replacing a PCI card, remove the current driver for the card from the operating system.
- If you are installing or replacing a PCI Express card, see "Installing a PCI Express Card" on page 116.
- If you are removing but not replacing a PCI Express card, see "Removing a PCI Express Card" on page 121.

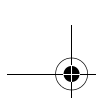



Installing a PCI Card

 **NOTE:** Dell offers an optional customer kit for Audigy II and IEEE 1394 PCI add-in cards that includes a front-mounted IEEE 1394 connector.

 **NOTE:** The PCI connector adjacent to the hard drive can accommodate a card 5.5 inches in length. In order to accommodate a longer card (upto 10.5 inches) remove the hard-drive bracket.

- 1 Follow the procedures in "Before You Begin" on page 99.
- 2 Remove the computer cover (see "Removing the Computer Cover" on page 101).

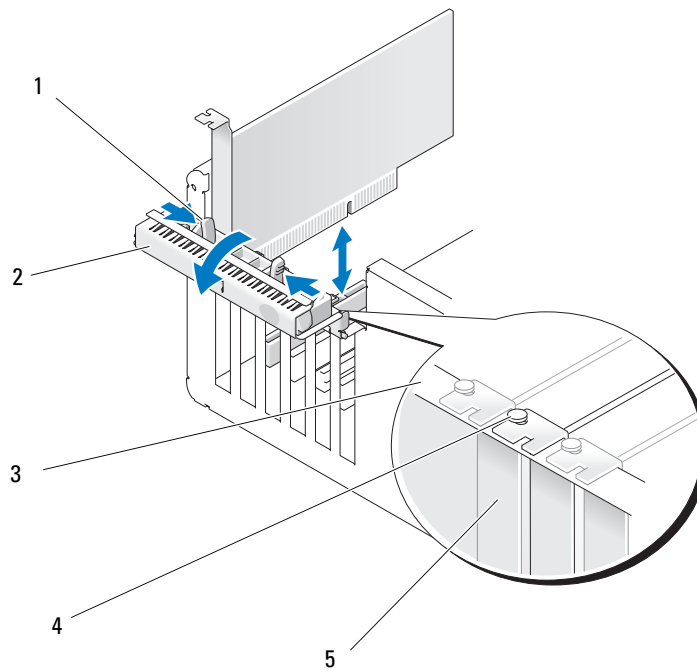

- | | | | | | |
|---|------------------|---|---------------------|---|---------------|
| 1 | release tabs (2) | 2 | card retention door | 3 | alignment bar |
| 4 | alignment guide | 5 | filler bracket | | |

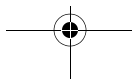

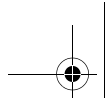

- 3 Push the two release tabs on the card retention door from the inside to pivot the door open. Because the door is hinged, it will remain in the open position.

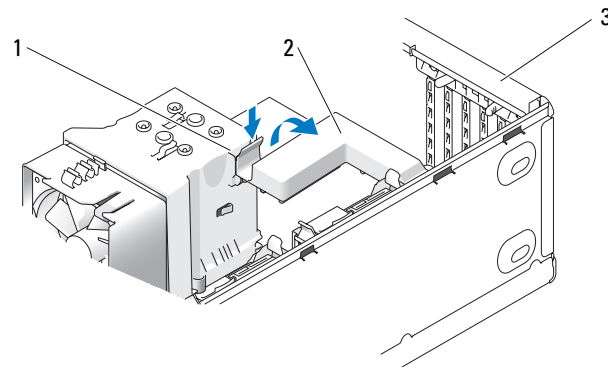

1 release tab 2 card retention mechanism 3 card retention door

- 4 If your computer includes a card retention mechanism to secure the x16 card, press the release tab downward gently and then pivot the mechanism upward to access the card slots.
- 5 If you are installing a new card, remove the filler bracket to create a card-slot opening. Then continue with step 7.
- 6 If you are replacing a card that is already installed in the computer, remove the card.

If necessary, disconnect any cables connected to the card. Grasp the card by its top corners, and ease it out of its connector.

- 7 Prepare the card for installation.
See the documentation that came with the card for information on configuring the card, making internal connections, or otherwise customizing it for your computer.

⚠ CAUTION: Some network adapters automatically start the computer when they are connected to a network. To guard against electrical shock, be sure to unplug your computer from its electrical outlet before installing any cards.

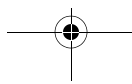



- 8** Place the card in the connector and press down firmly. Ensure that the card is fully seated in the slot.

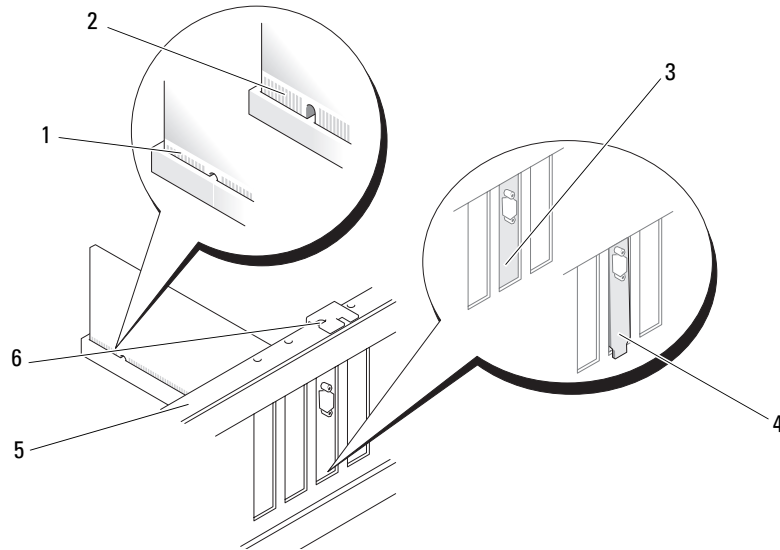

- | | | | | | |
|---|--------------------------------|---|-----------------------|---|---------------------|
| 1 | fully seated card | 2 | not fully seated card | 3 | bracket within slot |
| 4 | bracket caught outside of slot | 5 | alignment bar | 6 | alignment guide |

- 9** Before you close the card retention door, ensure that:
- The tops of all cards and filler brackets are flush with the alignment bar.
 - The notch in the top of the card or filler bracket fits around the alignment guide.

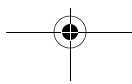

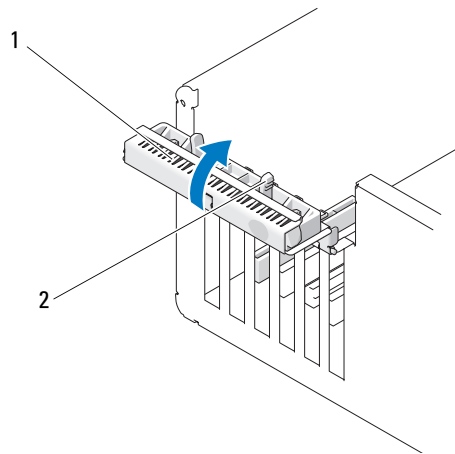

1 card retention door 2 release tabs (2)

10 Close the card retention door by snapping it into place to secure the card(s).

➡ NOTICE: Do not route card cables over or behind the cards. Cables routed over the cards can prevent the computer cover from closing properly or cause damage to the equipment.

11 Connect any cables that should be attached to the card.

See the documentation for the card for information about the card cable connections.

➡ NOTICE: To connect a network cable, first plug the cable into the network device and then plug the cable into the computer.

12 If you replaced a card that was already installed in the computer and you removed the retention mechanism, reinstall the retention mechanism.

13 Before replacing the card retention mechanism, ensure that:

- The tops of all cards and filler brackets are flush with the alignment bar.
- The notch in the top of the card or filler bracket fits around the alignment guide.

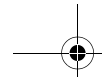

14 Snap the card retention mechanism into place, securing the PCI card.

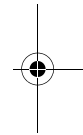
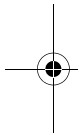

- 15 Replace the computer cover, reconnect the computer and devices to electrical outlets, and then turn them on.
- 16 If you installed a sound card:
 - a Enter system setup, select **Integrated Audio Controller**, and then change the setting to **Off**.
 - b Connect external audio devices to the sound card connectors. Do not connect external audio devices to the integrated microphone, speaker/headphone, or line-in connectors on the back panel.
- 17 If you installed an add-in network adapter and want to disable the integrated network adapter:
 - a Enter system setup, select **Integrated NIC Controller**, and then change the setting to **Off**.
 - b Connect the network cable to the add-in network adapter connectors. Do not connect the network cable to the integrated connector on the back panel.
- 18 Install any drivers required for the card as described in the card documentation.



Removing a PCI Card

- 1 Follow the procedures in "Before You Begin" on page 99.
 - 2 Remove the computer cover (see "Removing the Computer Cover" on page 101).
 - 3 If you are removing the card permanently, install a filler bracket in the empty card-slot opening.
If you need a filler bracket, contact Dell (see "Contacting Dell" on page 200).
-  **NOTICE:** To connect a network cable, first plug the cable into the network device and then plug the cable into the computer.
-  **NOTE:** Installing filler brackets over empty card-slot openings is necessary to maintain FCC certification of the computer. The brackets also keep dust and dirt out of your computer.
- 4 Replace the computer cover, reconnect the computer and devices to electrical outlets, and then turn them on.
 - 5 Remove the card driver from the operating system.

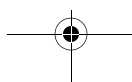



- 6** If you removed a sound card:
 - a** Enter system setup, select **Integrated Audio Controller**, and then change the setting to **On**.
 - b** Connect external audio devices to the audio connectors on the back panel of the computer.
- 7** If you removed an add-in network connector:
 - a** Enter system setup, select **Integrated NIC Controller**, and then change the setting to **On**.
 - b** Connect the network cable to the integrated connector on the back panel of the computer.

PCI Express Cards

Your computer supports:

- One PCI Express x1 card
- One PCI Express x16 card
- One PCI Express x4 card (an x8 card electrically configured as x4)

If you are installing or replacing a PCI Express card, follow the procedures in the next section. If you are removing but not replacing a card, see "Removing a PCI Express Card" on page 121.

If you are replacing a card, remove the current driver for the card from the operating system.

If you are installing or replacing a PCI Express card, see "Installing a PCI Express Card" on page 116.

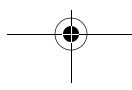
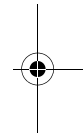
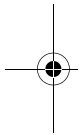

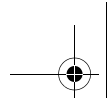

Installing a PCI Express Card

- 1 Follow the procedures in "Before You Begin" on page 99.

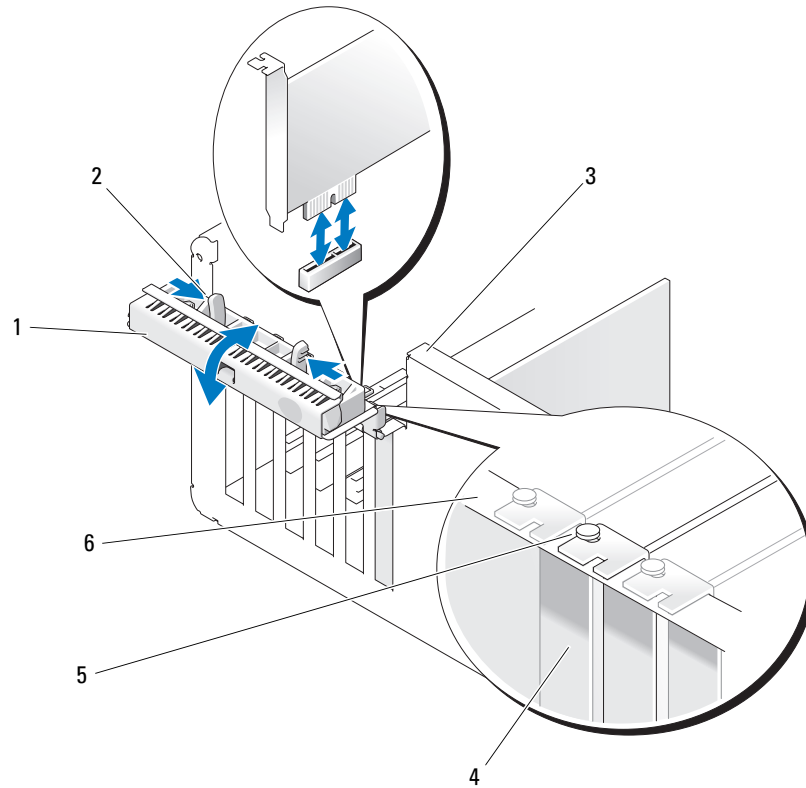

- | | | | | | |
|---|---------------------|---|------------------|---|---|
| 1 | card retention door | 2 | release tabs (2) | 3 | lever on chassis wall (may not be present on all computers) |
| 4 | filler bracket | 5 | alignment guide | 6 | alignment bar |

- 2 If present on your computer, rotate the lever on the chassis wall upward.
- 3 Push the two release tabs on the card retention door toward each other and pivot the door open. Because the door is captive, it will remain in the open position.

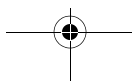

- 4 If your computer includes a card retention mechanism to secure the x16 card, press the release tab downward gently and then pivot the mechanism upward to access the card slots.

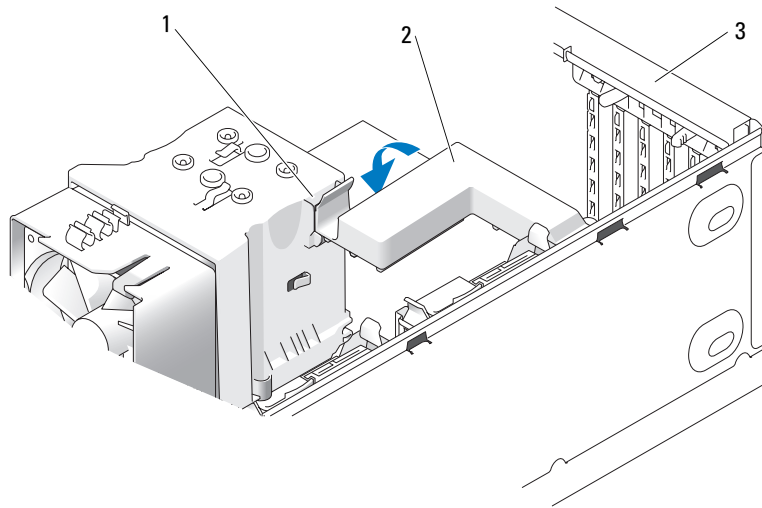

1 release tab 2 card retention mechanism 3 card retention door

- 5 If you are installing a new card, remove the filler bracket to create a card-slot opening. Then continue with step 7.
- 6 If you are replacing a card that is already installed in the computer, remove the existing card.
If necessary, disconnect any cables connected to the card. If your card includes a retention mechanism, remove the top of the retention mechanism by pressing the tab and pulling up on the top.



- 7 Pull the securing tab, grasp the card by its top corners, and then ease it out of its connector.

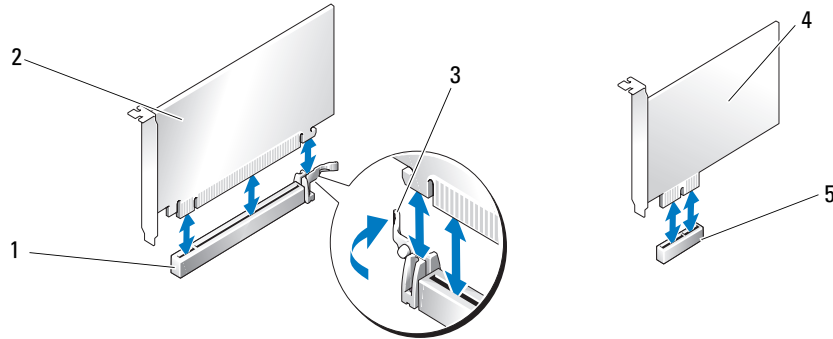

- 1 PCI Express x16 card slot 2 PCI Express x16 card 3 securing tab
- 4 PCI Express x1 card 5 PCI Express x1 card slot

- 8 Prepare the card for installation.

See the documentation that came with the card for information on configuring the card, making internal connections, or otherwise customizing it for your computer.



CAUTION: Some network adapters automatically start the computer when they are connected to a network. To guard against electrical shock, be sure to unplug your computer from its electrical outlet before installing any cards.

- 9 If you are installing the card into the x16 card connector, position the card so that the securing slot is aligned with the securing tab.



NOTICE: Ensure that you release the securing tab to seat the card. If the card is not installed correctly, you may damage the system board.

- 10 Place the card in the connector and press down firmly. Ensure that the card is fully seated in the slot.

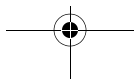

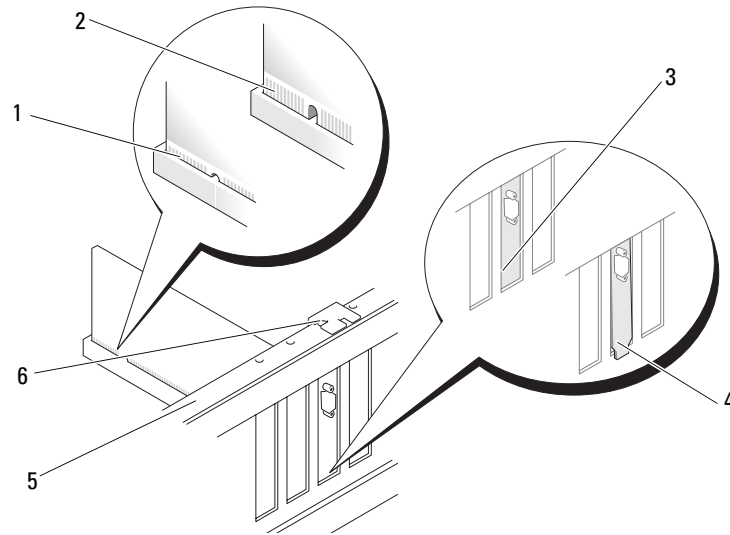
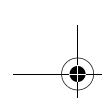

- 1 fully seated card 2 not fully seated card 3 bracket within slot
4 bracket caught outside of slot 5 alignment bar 6 alignment guide

11 Ensure that:

- The tops of all cards and filler brackets are flush with the alignment bar.
- The notch in the top of the card or filler bracket fits around the alignment guide.

- 12** If you removed a card retention mechanism, snap it into place, securing the PCI Express card.

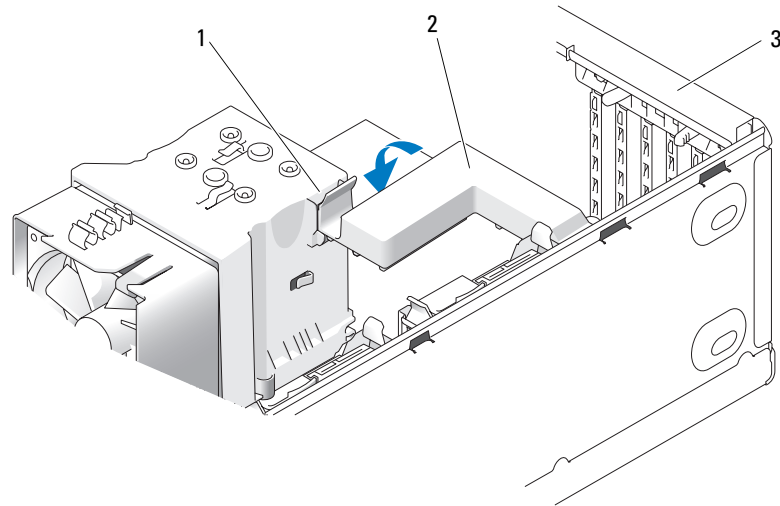

1 release tab 2 card retention mechanism 3 card retention door

➔ **NOTICE:** Do not route card cables over or behind the cards. Cables routed over the cards can prevent the computer cover from closing properly or cause damage to the equipment.

➔ **NOTICE:** To connect a network cable, first plug the cable into the network device and then plug the cable into the computer.

13 Replace the computer cover, reconnect the computer and devices to electrical outlets, and then turn them on.

14 If you installed a sound card:

- a** Enter system setup, select **Integrated Audio Controller**, and then change the setting to **Off**.
- b** Connect external audio devices to the sound card's connectors. Do not connect external audio devices to the integrated microphone, speaker/headphone, or line-in connectors on the back panel.



- 15** If you installed an add-in network adapter and want to disable the integrated network adapter:
 - a** Enter system setup, select **Integrated NIC Controller**, and then change the setting to **Off**.
 - b** Connect the network cable to the add-in network adapter's connectors. Do not connect the network cable to the integrated connector on the back panel.
- 16** Install any drivers required for the card as described in the card documentation.

Removing a PCI Express Card

- 1** Follow the procedures in "Before You Begin" on page 99.
- 2** Remove the computer cover (see "Removing the Computer Cover" on page 101).

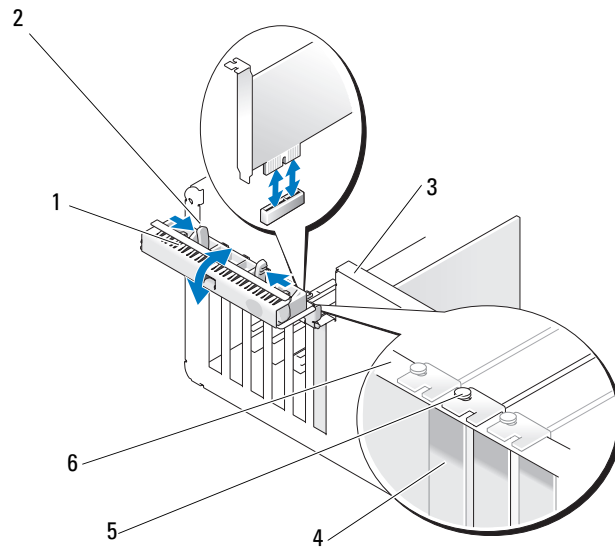

- | | | |
|-----------------------|--------------------|---|
| 1 card retention door | 2 release tabs (2) | 3 lever on chassis wall (may not be present on all computers) |
| 4 filler bracket | 5 alignment guide | 6 alignment bar |

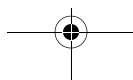

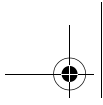

- 3 If present on your computer, rotate the lever on the chassis wall upward.
- 4 Push the two release tabs on the card retention door toward each other and pivot the door open. Because the door is hinged, it will remain in the open position.

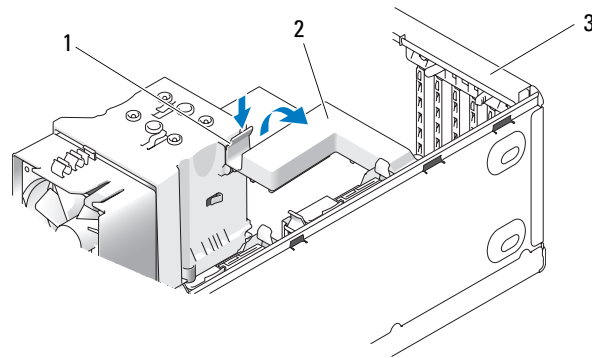

1 release tab 2 card retention mechanism 3 card retention door

- 5 If your computer includes a card retention mechanism to secure the x16 card, press the release tab downward gently and then pivot the mechanism upward to access the card slots.

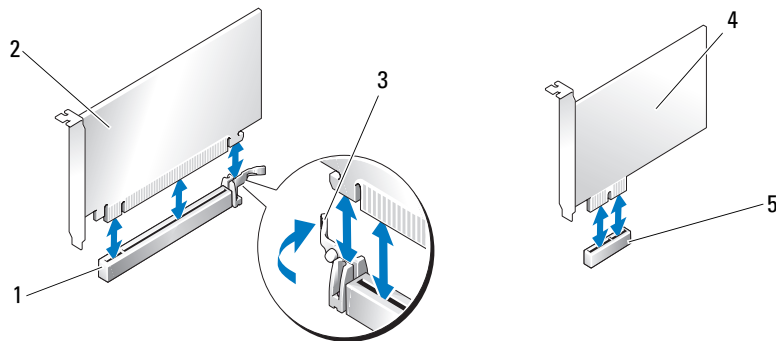

1 PCI Express x16 card slot 2 PCI Express x16 card 3 securing tab
 4 PCI Express x1 card 5 PCI Express x1 card slot





➔ **NOTICE:** Ensure that you release the securing tab to unseat the card. If the card is not removed correctly, the system board may be damaged.

6 Release the securing tab on the card slot to unseat the card.

7 If you are removing the card permanently, install a filler bracket in the empty card-slot opening.

If you need a filler bracket, contact Dell (see "Contacting Dell" on page 200).

 **NOTE:** Installing filler brackets over empty card-slot openings is necessary to maintain FCC certification of the computer. The brackets also keep dust and dirt out of your computer.

8 Reseat the card retention mechanism in the tabs and pivot downward to snap it into place.

9 Close the card retention door to snap it into place, securing the card(s).

➔ **NOTICE:** To connect a network cable, first plug the cable into the network device and then plug the cable into the computer.

 **NOTE:** For full-length PCI-E cards, if a "piano" bracket is present on your computer you need to rotate it down into place.

10 Replace the computer cover, reconnect the computer and devices to electrical outlets, and then turn them on.

11 Remove the card driver from the operating system.

12 If you removed a sound card:

a Enter system setup, select **Integrated Audio Controller**, and then change the setting to **On**.

b Connect external audio devices to the integrated audio connectors on the back panel of the computer.

13 If you removed an add-in network connector:

a Enter system setup, select **Integrated NIC Controller**, and then change the setting to **On**.

b Connect the network cable to the integrated connector on the back panel of the computer.

 **NOTE:** Install any drivers required for the card as described in the card documentation.

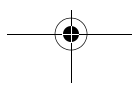
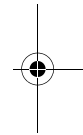
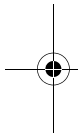

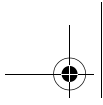

Drive Panels



CAUTION: Before you perform any of the procedures in this section, follow the safety instructions in the *Product Information Guide*.



CAUTION: To guard against electrical shock, always unplug your computer from the electrical outlet before removing the cover.

Removing the Drive Panel

- 1 Follow the procedures in "Before You Begin" on page 99.
- 2 Remove the computer cover (see "Removing the Computer Cover" on page 101).

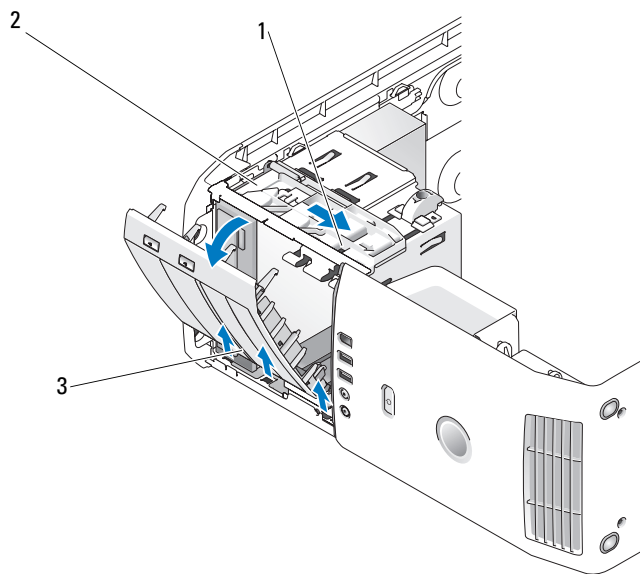

1 sliding plate lever 2 sliding plate 3 drive panel

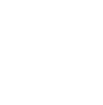



- 3 Grasping the lever on the sliding plate, pull the sliding plate downward and hold in place.



NOTE: The sliding plate secures and releases the drive panel and helps to secure the drives. Push from the inside and pivot the drive panel to the left to release the panel from its side hinges.

- 4 The drive panel clicks open, gently ease it out and set it aside in a secure location.

Removing the Drive-Panel Insert

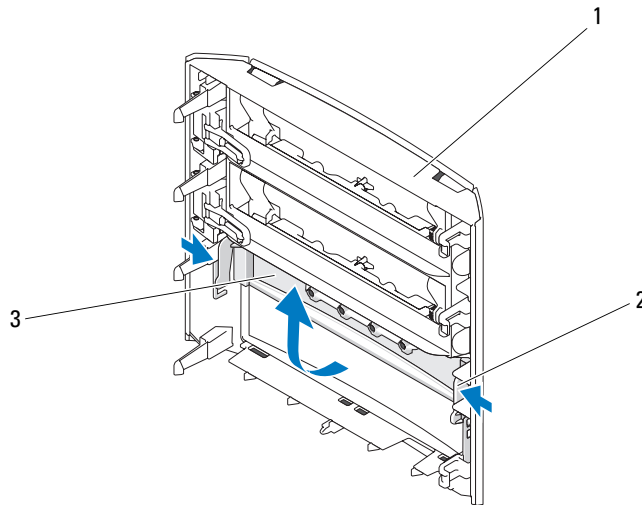

1 drive panel 2 drive-panel insert tab 3 drive-panel insert

- 1 Remove the drive panel, see "Removing the Drive Panel" on page 124.
- 2 Turn the drive panel around to find and hold both outer edges of the drive panel insert tab, pull inwards to ease it out of the latches that hold it in place.
- 3 Set the drive-panel insert aside in a secure location.

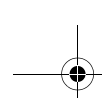

Replacing the Drive-Panel Insert

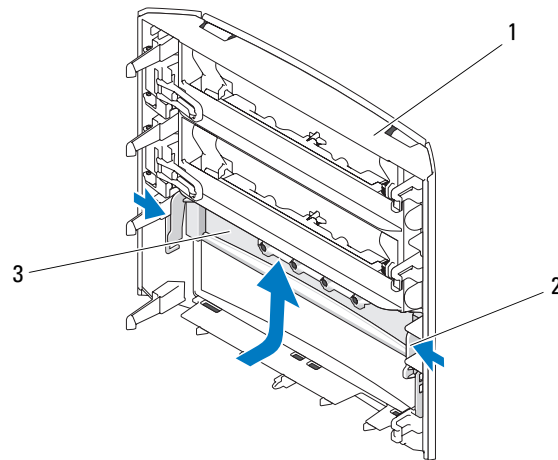

1 drive panel 2 drive-panel insert tab 3 drive-panel insert

- 1 Align the notches on the drive-panel insert to the corresponding slots on the drive panel and snap into place.
- 2 Ensure that the drive-panel insert is correctly seated in the drive panel.

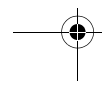
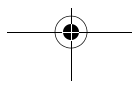
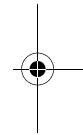
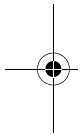



Replacing the Drive Panel

- 1 Follow the procedures in "Before You Begin" on page 99.
- 2 Remove the computer cover (see "Removing the Computer Cover" on page 101).

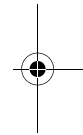
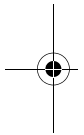
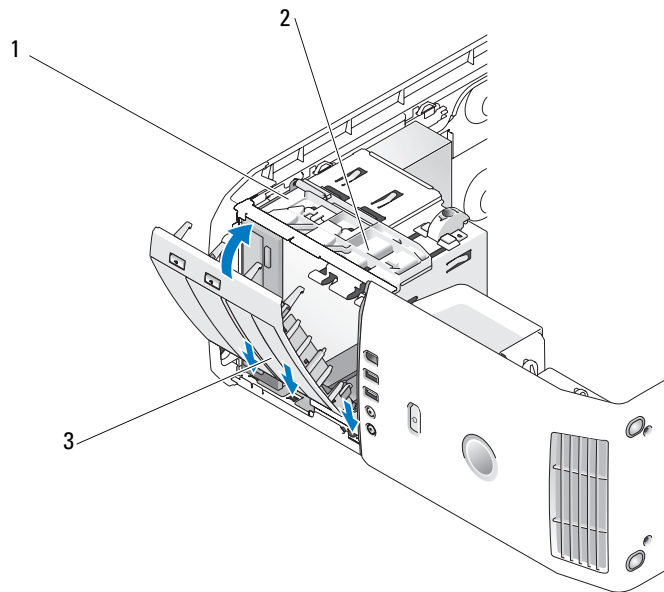

1 sliding plate 2 sliding plate lever 3 drive panel

- 3 Align the drive panel tabs with the side-door hinges.
- 4 Rotate the drive panel toward the computer until the sliding plate lever clicks into place and the drive panel snaps into place on the front panel.
- 5 Replace the computer cover (see "Replacing the Computer Cover" on page 172).

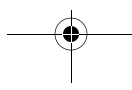



Drives

Your computer supports:

- Two hard drives (Serial ATA)
- Two FlexBay drives (can contain an optional floppy drive, an optional Media Card Reader, or an optional hard drive).
- Two CD or DVD drives

General Installation Guidelines

Connect the hard drives to the connectors labeled "SATA0" and "SATA1", starting with SATA0. Connect CD/DVD drives to the connectors labeled "SATA2", "SATA3", or "SATA4", starting with "SATA2".

Serial ATA hard drives and CD/DVD drives are connected to the connectors labeled "SATA0" to "SATA4" on the system board.

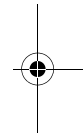
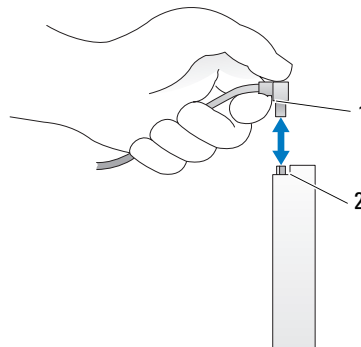
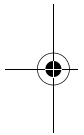

- 1 interface cable
- 2 interface connector

When connecting and disconnecting a serial ATA cable, hold the cable by the connector at each end.



NOTE: It is recommended that you connect the hard drive to the connector labeled SATA0 on the system board. Connect additional hard drives to connectors labeled SATA1 and SATA2. Connect the CD/DVD drives to connectors adjacent to where the hard drive is connected.

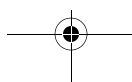

Hard Drive

- !** **CAUTION:** Before you perform any of the procedures in this section, follow the safety instructions in the *Product Information Guide*.
- !** **CAUTION:** To guard against electrical shock, always unplug your computer from the electrical outlet before opening the cover.
- ➡** **NOTICE:** To avoid damage to the drive, do not set it on a hard surface. Instead, set the drive on a surface, such as a foam pad, that will sufficiently cushion it.
- ➡** **NOTICE:** If you are replacing a hard drive that contains data, back up your files before you begin this procedure

Removing a Hard Drive

- 1 Follow the procedures in "Before You Begin" on page 99.
- 2 Remove the computer cover (see "Removing the Computer Cover" on page 101).
- 3 Disconnect the power and hard drive cables from the drive.

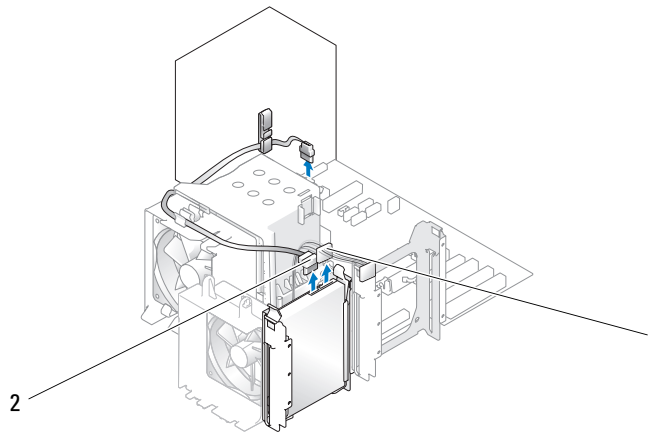

1 power cable 2 hard drive cable

- 4 Press in on the tabs on each side of the drive and slide the drive up and out.

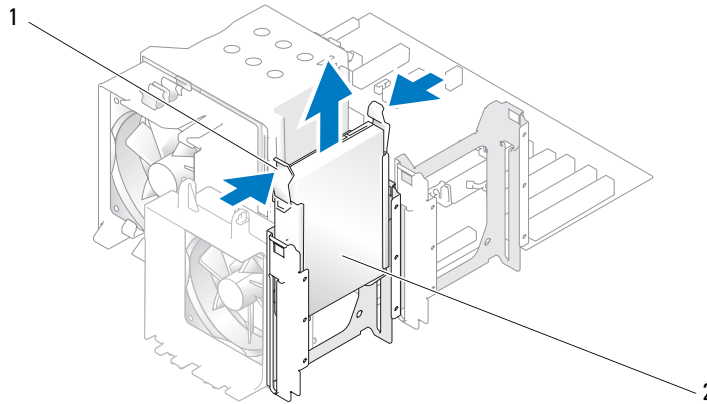

1 tabs (2) 2 hard drive

- 5 Replace the computer cover (see "Replacing the Computer Cover" on page 172).
- 6 If removing this drive changes the drive configuration, then be sure to reflect these changes in the BIOS. When you restart your computer, enter system setup (see "System Setup" on page 178). On the setup screen go to the "Drives" section and set the SATA ports (SATA 0 through 4) to the correct configuration.

Installing a Hard Drive

NOTE: It is recommended that you connect the hard drive to the connector labeled SATA0 on the system board. Connect additional hard drives to connectors labeled SATA1 and SATA2.

- 1 Follow the procedures in "Before You Begin" on page 99.
- 2 Remove the computer cover (see "Removing the Computer Cover" on page 101).
- 3 Unpack the replacement hard drive, and prepare it for installation.
- 4 Check the documentation for the drive to verify that the drive is configured for your computer.



- 5 If your replacement hard drive does not have the hard-drive bracket attached, remove the bracket from the old hard drive by unsnapping it from the drive.
- 6 Snap the hard-drive bracket onto the replacement hard drive.
- 7 Install the hard drive into the computer by sliding the drive into place.

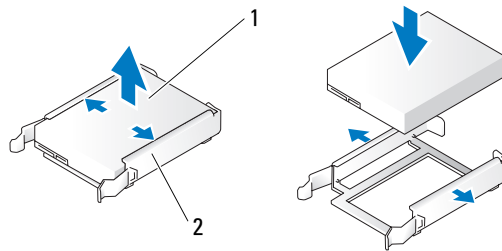

1 hard drive 2 hard-drive bracket

- 8 Connect the power and hard drive cables to the hard drive.

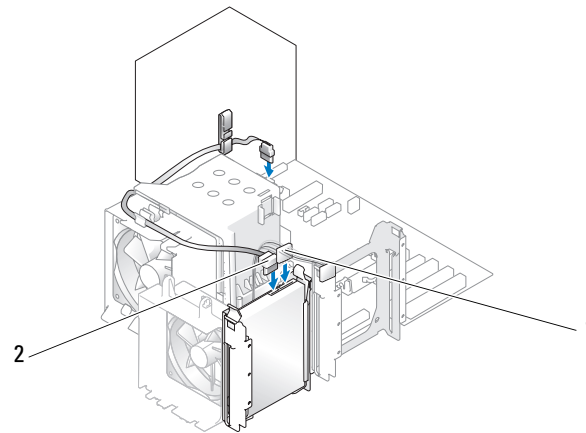

1 power cable 2 hard drive cable

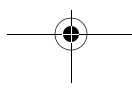

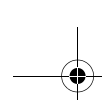

- 9 Check all connectors to be certain that they are properly cabled and firmly seated.
- 10 Replace the computer cover (see "Replacing the Computer Cover" on page 172).
-  **NOTICE:** To connect a network cable, first plug the cable in to the network wall jack and then plug the cable into the computer.
- 11 Connect your computer and devices to electrical outlets, and then turn them on.
- 12 If installing this drive changes the drive configuration, then be sure to reflect these changes in the BIOS. When you restart your computer, enter system setup (see "System Setup" on page 178). On the setup screen go to the "Drives" section and set the SATA ports (SATA 0 through 4) to the correct configuration.
- 13 See the documentation that came with the hard drive for instructions about installing any software required for the operation of the hard drive.

Adding a Second Hard Drive



CAUTION: Before you perform any of the procedures in this section, follow the safety instructions in the *Product Information Guide*.



CAUTION: To guard against electrical shock, always unplug your computer from the electrical outlet before opening the cover.



NOTICE: To avoid damage to the drive, do not set it on a hard surface. Instead, set the drive on a surface, such as a foam pad, that will sufficiently cushion it.



NOTE: It is recommended that you connect the primary hard drive on your system to the connector labeled SATA0 on the system board. Connect additional hard drives to connectors labeled SATA1 and SATA2.

- 1 Check the documentation for the drive to verify that it is configured for your computer.
- 2 Follow the procedures in "Before You Begin" on page 99.
- 3 Remove the computer cover (see "Removing the Computer Cover" on page 101).
- 4 Press in on the tabs on each side of the hard-drive bracket in the empty drive bay and slide the bracket up and out.

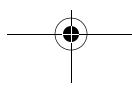

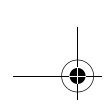

- 5 Snap the hard-drive bracket onto the new hard drive.
- ➔ **NOTICE:** Do not install any drive into the lower hard-drive bay until you have removed the hard-drive bracket from the inside of the hard drive bay.
- 6 Slide the new hard drive into the empty bay and click it into place.

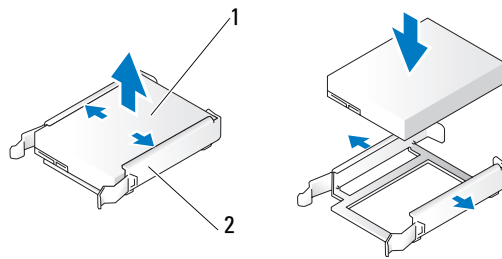

1 hard drive 2 hard-drive bracket

- 7 Connect the power and hard drive cables to the drive.

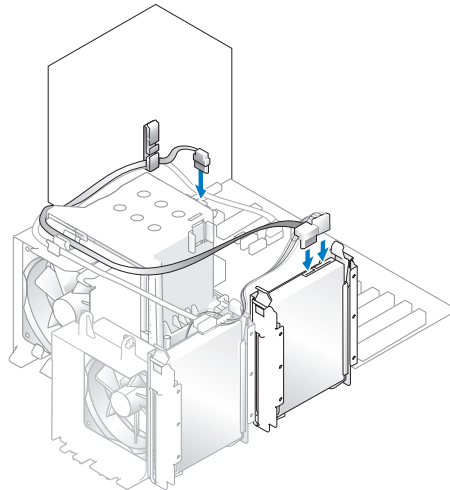

- 8 Check all connectors to be certain that they are properly cabled and firmly seated.

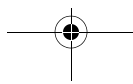

- 9 Replace the computer cover ("Replacing the Computer Cover" on page 172).
- ➔ **NOTICE:** To connect a network cable, first plug the cable into the network wall jack and then plug it into the computer.
- 10 Connect your computer and devices to electrical outlets, and then turn them on.
- 11 When you restart your computer, enter system setup (see "System Setup" on page 178). Then, go to the "Drives" section of the BIOS and under SATA 0 through 4, set the SATA port to "ON" for the hard drive you just installed. This enables the drive.

See the documentation that came with the drive for instructions on installing any software required for drive operation.

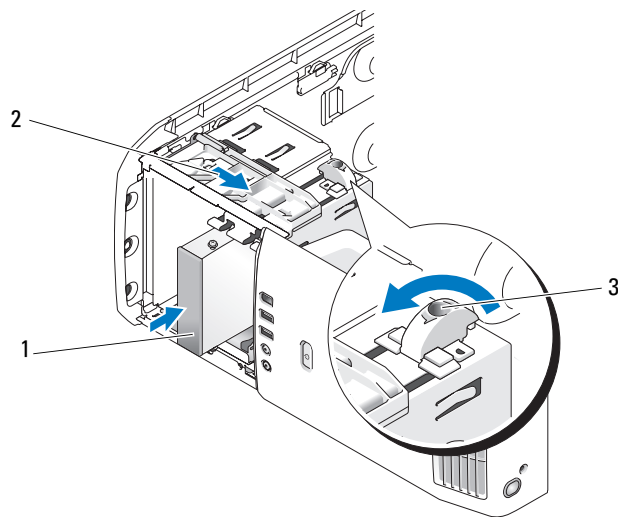

Installing a Hard Drive in the FlexBay

The top FlexBay drive on your system can hold an additional hard drive.



- 1 hard drive 2 sliding plate lever 3 flexbay knob (the default position)

- 1 Follow the procedures in "Before You Begin" on page 99.
- 2 Remove the computer cover (see "Removing the Computer Cover" on page 101).

- 3 Remove the drive panel (see "Removing the Drive Panel" on page 124).
 - 4 Remove the shoulder screws from the inside of the drive-panel insert and attach the screws to the new drive (see "Removing the Drive-Panel Insert" on page 125).
 - 5 Turn the FlexBay knob on the cage at 90 degrees, in the anti-clockwise direction.
-  **NOTICE:** Ensure the FlexBay knob is turned in the anticlockwise direction. Failure to heed can result in the knob being broken.
-  **NOTE:** Turning the FlexBay knob once opens up the drive space to accommodate a larger device like a hard drive. The knob at this stage is in a horizontal position.
- 6 Pull the sliding plate lever down and hold in place.
 - 7 Slide the hard drive into the flex bay drive until the sliding plate clicks into place and the drive snaps into position.
 - 8 Attach the power and hard drive cables to the hard drive.
 - 9 Replace the computer cover (see "Replacing the Computer Cover" on page 172).

Removing a Hard Drive From the FlexBay

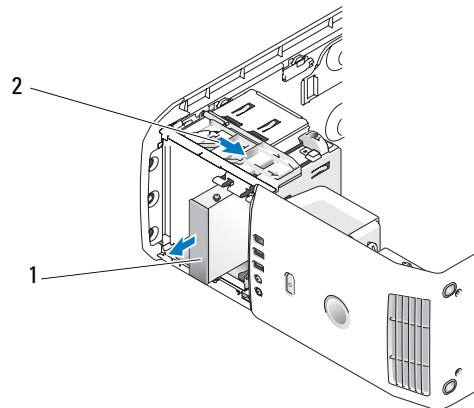

1 hard drive 2 sliding plate lever

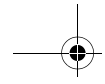

- 1 Follow the procedures in "Before You Begin" on page 99.
 - 2 Remove the computer cover (see "Removing the Computer Cover" on page 101).
 - 3 Disconnect the power and hard-drive cables from the back of the drive.
 - 4 Pull the sliding plate down and hold in place.
 - 5 Slide the hard drive out of the FlexBay.
-  **NOTICE:** Ensure the FlexBay knob is turned in the anticlockwise direction. Failure to heed can result in the knob being broken.
- 6 Turn the FlexBay knob to its default position. Refer to the illustration on "Installing a Hard Drive in the FlexBay" on page 134 to note the default FlexBay knob position.

Floppy Drive



CAUTION: Before you perform any of the procedures in this section, follow the safety instructions in the *Product Information Guide*.



CAUTION: To guard against electrical shock, always unplug your computer from the electrical outlet before opening the cover.



NOTE: If you are adding a floppy drive, see "Installing a Floppy Drive" on page 138.

Removing a Floppy Drive

- 1 Follow the procedures in "Before You Begin" on page 99.
- 2 Remove the computer cover (see "Removing the Computer Cover" on page 101).
- 3 Remove the drive panel (see "Removing the Drive Panel" on page 124).
- 4 Disconnect the power and floppy-drive cables from the back of the floppy drive.
- 5 Unhook floppy-drive cable from the clips on the processor airflow shroud. Disconnect the other end of the floppy-drive cable from the system board. Remove the floppy-drive cable from the computer.

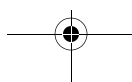

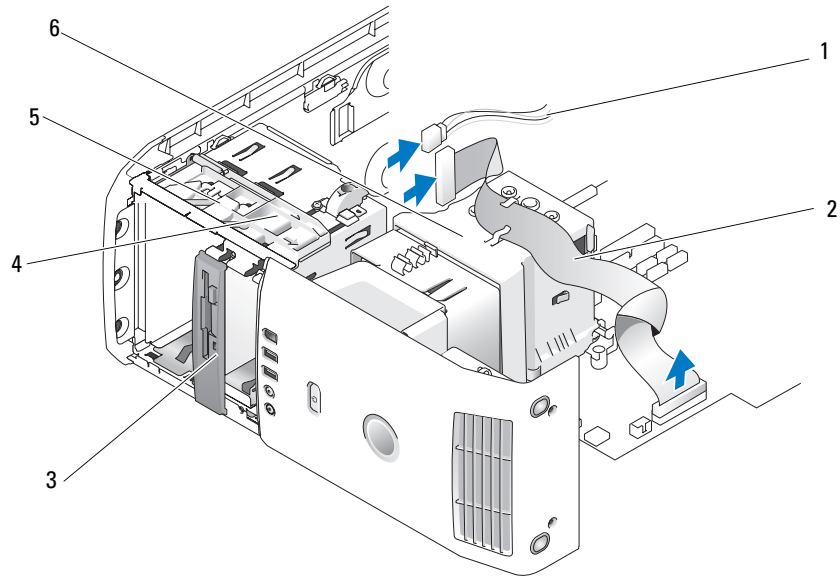

- | | | |
|-----------------------|----------------------|----------------------------|
| 1 power cable | 2 floppy-drive cable | 3 floppy drive |
| 4 sliding plate lever | 5 sliding plate | 6 processor airflow shroud |

- 6 Pull the sliding plate down and hold in place.
- 7 Slide the floppy drive out of the floppy drive bay.

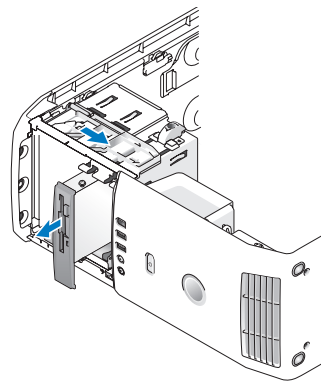

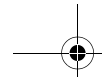

- 8 If you are not replacing the drive, replace the drive-panel insert (see "Replacing the Drive-Panel Insert" on page 126).
- 9 Replace the drive panel (see "Replacing the Drive Panel" on page 127).
- 10 Replace the computer cover (see "Replacing the Computer Cover" on page 172).
- 11 If you are not replacing the drive, then ensure that these changes are reflected in the BIOS. When you restart your computer, enter system setup (see "System Setup" on page 178). On the setup screen go to the "Drives" section and under `Diskette Drive` set the value to "none".

Installing a Floppy Drive

- 1 Follow the procedures in "Before You Begin" on page 99.
- 2 Remove the computer cover (see "Removing the Computer Cover" on page 101).
- 3 Lay the computer on its side so that the system board is on the bottom of the inside of the computer.
- 4 Remove the drive panel (see "Removing the Drive Panel" on page 124).
- 5 If installing a new floppy drive, remove the drive panel insert (see "Removing the Drive-Panel Insert" on page 125).
- 6 If you are installing a new floppy drive, remove the shoulder screws from the inside of the drive-panel insert and attach the screws to the new drive. See "Removing the Drive-Panel Insert" on page 125.

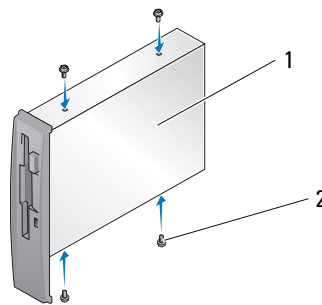
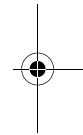
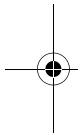

1 floppy drive 2 shoulder screws (4)

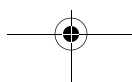

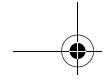

- 7 Slide the floppy drive into the floppy drive bay until the sliding plate clicks into place and the drive snaps into position.
- 8 Attach the power and floppy-drive cables to the floppy drive.
- 9 Check all cable connections, and fold cables out of the way to provide airflow for the fan and cooling vents.
- 10 Replace the computer cover (see "Replacing the Computer Cover" on page 172).

 **NOTICE:** To connect a network cable, first plug the cable in to the network wall jack and then plug it in to the computer.

- 11 Connect your computer and devices to their electrical outlets, and then turn them on.

- 12 When you restart your computer, enter system setup (see "System Setup" on page 178). On the setup screen go to the "Drives" section and under `Diskette Drive` set the value to "Internal only".

See the documentation that came with the floppy drive for instructions on installing any software required for the operation of the drive.

- 13 Verify that your computer works correctly by running the Dell Diagnostics (see "Dell Diagnostics" on page 86).

 **NOTICE:** Ensure the FlexBay knob is turned in the anticlockwise direction. Failure to heed can result in the knob being broken.

 **NOTE:** If you have already installed an additional hard drive in the FlexBay and you want to replace it with a floppy drive, ensure that the FlexBay knob is rotated, anti clockwise, back to its default vertical position, see the illustration for "Installing a Hard Drive in the FlexBay" on page 134.

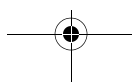
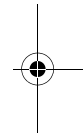
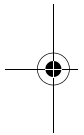

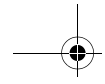



Media Card Reader

For information on using the Media Card Reader, see "Using a Media Card Reader" on page 47.

Removing a Media Card Reader

 **CAUTION:** Before you perform any of the procedures in this section, follow the safety instructions in the *Product Information Guide*.

 **NOTICE:** To prevent static damage to components inside your computer, discharge static electricity from your body before you touch any of your computer's electronic components. You can do so by touching an unpainted metal surface on the computer chassis.

- 1 Follow the procedures in "Before You Begin" on page 99.
- 2 Lay the computer on its side so that the system board is on the bottom of the inside of the computer.
- 3 Remove the computer cover (see "Removing the Computer Cover" on page 101).
- 4 Remove the drive panel (see "Removing the Drive Panel" on page 124).

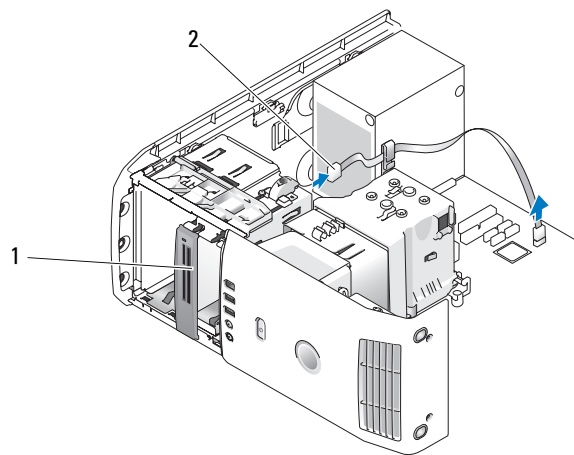

1 Media Card Reader (not present on all computers) 2 USB cable

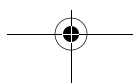



- 5 Disconnect the USB cable on the back of the Media Card Reader. Disconnect the other end of the cable from the USB connector on the system board (see "System Board Components" on page 103). Remove the cable from any clips and lift out of the computer.

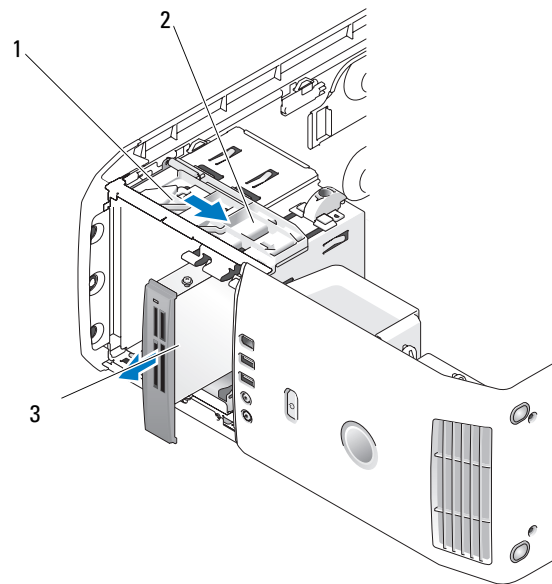

1 sliding plate 2 sliding plate lever 3 Media Card Reader (not present on all computers)

- 6 Pull the sliding plate towards the bottom of the system and hold; then, slide the drive out through the front of the computer.
- 7 Replace the drive panel insert (see "Replacing the Drive-Panel Insert" on page 126).
- 8 Replace the drive panel (see "Replacing the Drive Panel" on page 127).
- 9 Replace the computer cover (see "Replacing the Computer Cover" on page 172).
- 10 Turn on the system and enter system setup (see "System Setup" on page 178). Set the `USB for FlexBay` value to `OFF`.

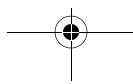



Installing a Media Card Reader



CAUTION: Before you perform any of the procedures in this section, follow the safety instructions in the *Product Information Guide*.



NOTICE: To prevent static damage to components inside your computer, discharge static electricity from your body before you touch any of your computer's electronic components. You can do so by touching an unpainted metal surface on the computer chassis.



NOTICE: Ensure the FlexBay knob is turned in the anticlockwise direction. Failure to heed can result in the knob being broken.



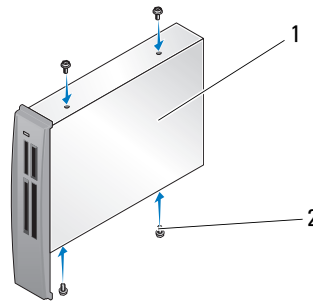

NOTE: If you have already installed an additional hard drive in the FlexBay and you want to replace it with a media card reader, ensure that the FlexBay knob is rotated, anti clockwise, back to its default vertical position, see the illustration for "Installing a Hard Drive in the FlexBay" on page 134.

- 1 Follow the procedures in "Before You Begin" on page 99.
- 2 Lay the computer on its side so that the system board is on the bottom of the inside of the computer.
- 3 Remove the computer cover (see "Removing the Computer Cover" on page 101).
- 4 Remove the drive panel (see "Removing the Drive Panel" on page 124).
- 5 Remove the drive panel insert (see "Removing the Drive-Panel Insert" on page 125).
- 6 Remove the Media Card Reader from its packaging.
- 7 Remove the shoulder screws from the inside of the drive-panel insert and attach the screws to the new drive.

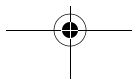

1 Media Card Reader 2 screws (4)



- 8 Gently slide the drive into place till it clicks in securely.
-  **NOTE:** Ensure that the Media Card Reader is installed before connecting the USB cable.
- 9 Connect the USB cable to the back of the Media Card Reader and to the USB connector on the system board (see "System Board Components" on page 103).

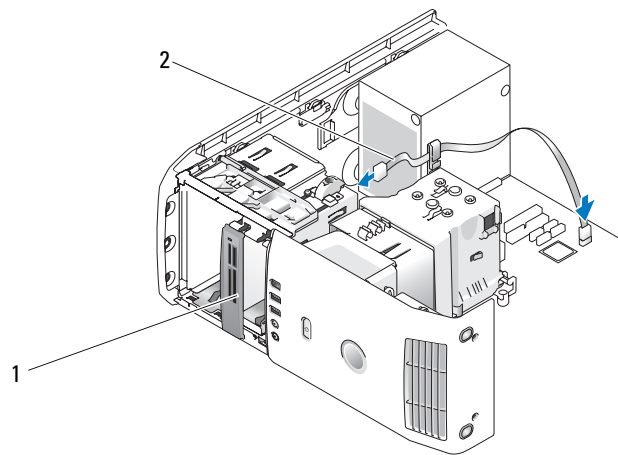

1 Media Card Reader (optional) 2 USB cable

- 10 Route the USB cable through the cable routing clip.
- 11 Replace the drive panel (see "Replacing the Drive Panel" on page 127).
- 12 Replace the computer cover (see "Replacing the Computer Cover" on page 172).
- 13 Turn on the system and enter system setup (see "System Setup" on page 178). Set the `USB for FlexBay` value to `ON`.

CD/DVD Drive

⚠ CAUTION: Before you perform any of the procedures in this section, follow the safety instructions in the *Product Information Guide*.

⚠ CAUTION: To guard against electrical shock, always unplug your computer from the electrical outlet before opening the cover.

Removing a CD/DVD Drive

- 1 Follow the procedures in "Before You Begin" on page 99.
- 2 Remove the computer cover (see "Removing the Computer Cover" on page 101).
- 3 Remove the drive panel (see "Removing the Drive Panel" on page 124).
- 4 Disconnect the power cable from the back of the drive and the CD/DVD drive cable from the back of the drive and the system board.

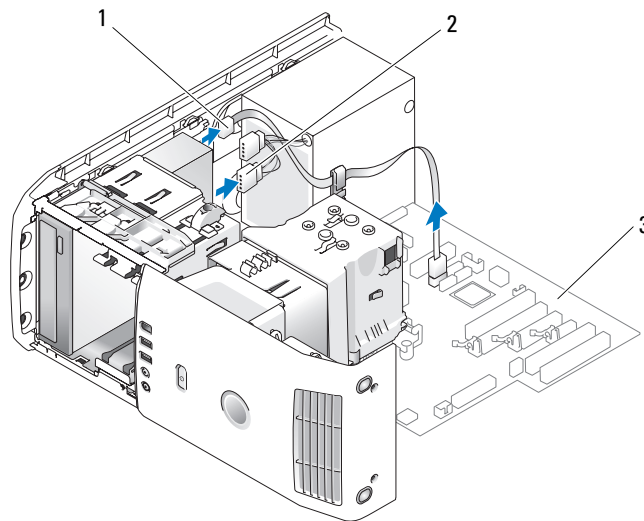

1 CD/DVD drive cable 2 power cable 3 system board

- 5 Slide the drive release mechanism to the right to release the shoulder screw and slide the drive out to remove it from the drive bay.

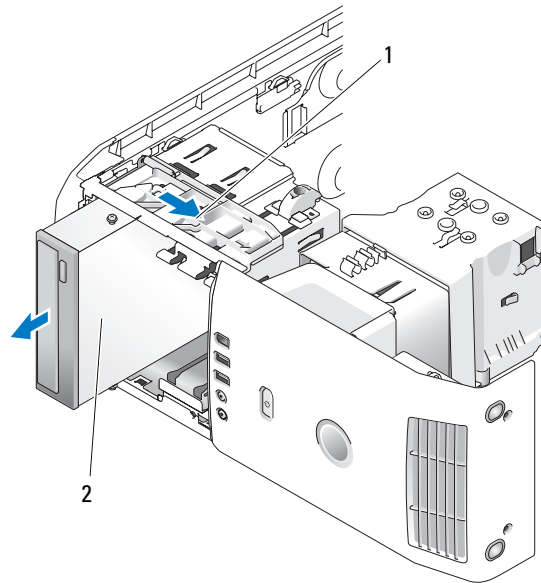

1 sliding plate 2 CD drive

- 6 If you are not replacing the drive, replace the drive panel insert (see "Replacing the Drive-Panel Insert" on page 126).
- 7 Replace the drive panel (see "Replacing the Drive Panel" on page 127).
- 8 Replace the computer cover (see "Replacing the Computer Cover" on page 172).
- 9 If you are removing and not replacing this drive, then be sure to disable the drive in the BIOS. When you restart your computer, enter system setup (see "System Setup" on page 178). On the setup screen go to the "Drives" section and under SATA 0 through 4, set the SATA ports to the correct configuration.



Installing a CD/DVD Drive

- 1 Follow the procedures in "Before You Begin" on page 99.
- 2 Remove the computer cover (see "Removing the Computer Cover" on page 101).
- 3 If you are installing a new drive, unpack the drive and prepare it for installation.
Check the documentation that accompanied the drive to verify that the drive is configured for your computer.
- 4 If you are installing a new drive, remove the drive panel insert (see "Removing the Drive-Panel Insert" on page 125).
- 5 Remove three shoulder screws from the inside of the drive-panel insert and attach the screws to the new drive.

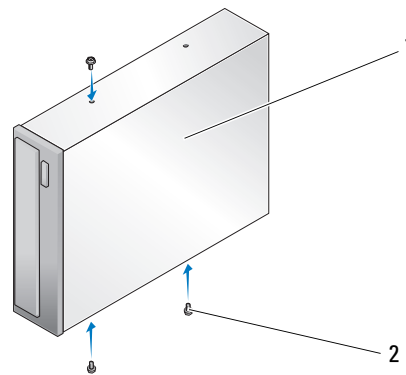

1 CD/DVD drive 2 shoulder screws (3)

- 6 Slide the drive into the drive bay until the drive clicks into position.
- 7 Connect the power cable to the drive and the CD/DVD cable to the drive and system board. To locate the systemboard connectors see "System Board Components" on page 103.

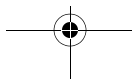

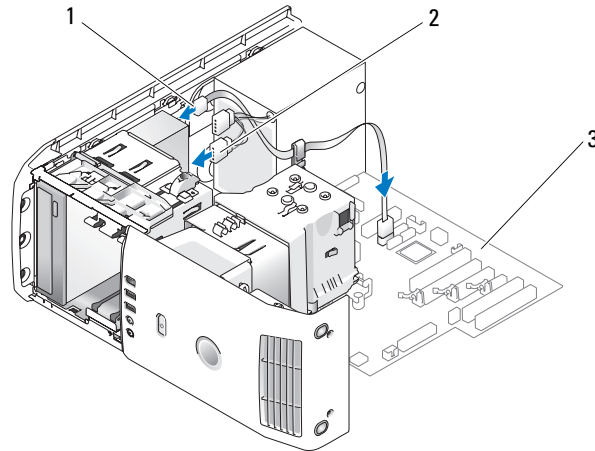

1 CD/DVD cable 2 power cable 3 system board

- 8 Check all cable connections, and fold cables out of the way to provide airflow for the fan and cooling vents.
- 9 Replace the drive panel (see "Replacing the Drive Panel" on page 127).
- 10 Replace the computer cover (See "Replacing the Computer Cover" on page 172).
- ➔ **NOTICE:** To connect a network cable, first plug the cable in to the network wall jack and then plug it in to the computer.
- 11 Connect your computer and devices to their electrical outlets, and then turn them on.
- 12 When you restart your computer, enter system setup (see "System Setup" on page 178). On the setup screen go to the "Drives" section and under SATA 0 through 4, enable the SATA port for this drive.
See the documentation that came with the drive for instructions on installing any software required for drive operation.
- 13 Verify that your computer works correctly by running the Dell Diagnostics (see "Dell Diagnostics" on page 86).

Processor Airflow Shroud

⚠ CAUTION: Before you perform this procedure, follow the safety instructions located in the *Product Information Guide*.

Removing the Processor Airflow Shroud Assembly

- 1 Follow the procedures in "Before You Begin" on page 99.
- 2 Remove the computer cover (see "Removing the Computer Cover" on page 101).

⚠ CAUTION: The processor heat sink can get very hot during normal operation. Be sure that the heat sink has had sufficient time to cool before you touch it.

- 3 Disconnect the fan cable from the FAN_CPU connector on the system board (see "System Board Components" on page 103).

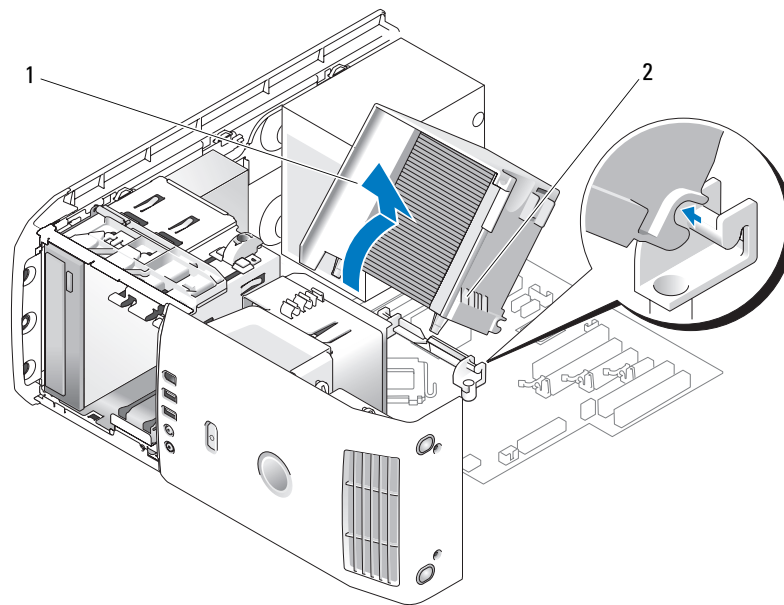

1 processor airflow shroud 2 captive screws (2)

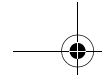

➔ **NOTICE:** The processor heat sink is attached to the processor airflow shroud. When you remove the airflow shroud, lay it upside down or on its side to avoid damaging the heat sink thermal interface.

- 4 Loosen the captive screws securing the processor airflow shroud to the chassis, then pivot the shroud forward and ease it out of the hinges.
- 5 Lift the processor airflow shroud out of the computer, and set it aside.

Installing the Processor Airflow Shroud Assembly

- 1 Follow the procedures in "Before You Begin" on page 99.
- 2 Remove the computer cover (see "Removing the Computer Cover" on page 101).
- 3 Align the hinge slots on the processor airflow shroud with the hinge guides on the system board.
- 4 Align the other side of the processor airflow shroud towards the fan, and then tighten the two captive screws.
- 5 Connect the fan cable to the FAN_CPU connector on the system board (see "System Board Components" on page 103).
- 6 Replace the computer cover (see "Replacing the Computer Cover" on page 172).

➔ **NOTICE:** To connect a network cable, first plug the cable into the network port or device and then plug it into the computer.

- 7 Connect your computer and devices to electrical outlets, and turn them on.

Fans

Removing the Processor Fan Cage

- 1 Follow the procedures in "Before You Begin" on page 99.
- 2 Remove the computer cover (see "Removing the Computer Cover" on page 101).
- 3 Disconnect the fan cable from the FAN_CPU connector on the system board (see "System Board Components" on page 103).
- 4 Remove the processor airflow shroud (see "Removing the Processor Airflow Shroud Assembly" on page 148).

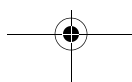

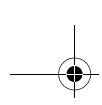

- 5 Lift and hold the release tab present on the bottom of the fan cage, press down on the top of the cage and slide it towards the back of the system to dislodge the tabs from the grooves that hold them down.
- 6 Ease the cage out of the housing.

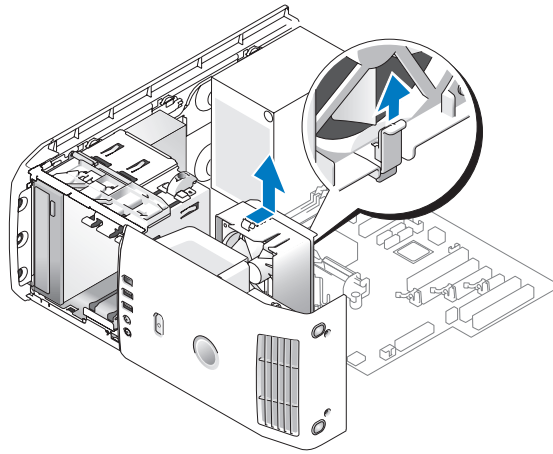

Installing the Processor Fan Cage

- 1 Follow the procedures in "Before You Begin" on page 99.
- 2 Remove the computer cover (see "Removing the Computer Cover" on page 101).
- 3 Remove the processor airflow shroud, if you have not already removed it. (see "Removing the Processor Airflow Shroud Assembly" on page 148).
- 4 With the fan power cable oriented downward, insert the tabs along the bottom of the fan cage into the corresponding slots on the cage housing, gently slide the fan cage towards the front of the system until it snaps into place.
- 5 Connect the fan cable to the FAN_CPU connector on the system board (see "System Board Components" on page 103).
- 6 Replace the processor airflow shroud (see "Installing the Processor Airflow Shroud Assembly" on page 149).
- 7 Replace the computer cover (see "Replacing the Computer Cover" on page 172).

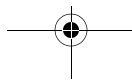

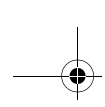

Removing the Processor Fan

- 1 Follow the procedures in "Before You Begin" on page 99.
- 2 Remove the computer cover (see "Removing the Computer Cover" on page 101).
- 3 Disconnect the fan cable from the FAN_CPU connector on the system board (see "System Board Components" on page 103).
- 4 Remove the processor airflow shroud (see "Removing the Processor Airflow Shroud Assembly" on page 148).
- 5 Remove the processor fan cage from the cage housing (see "Removing the Processor Fan Cage" on page 149).
- 6 Carefully pull on the two bottom corners of the fan to detach the four rubber grommets securing the fan to the processor airflow shroud.

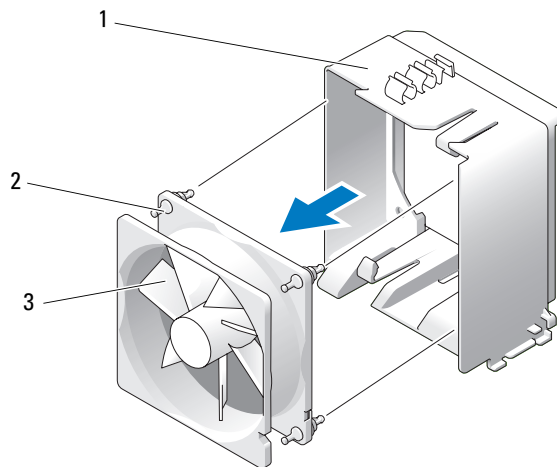

1 fan cage 2 rubber grommet (4) 3 Processor fan

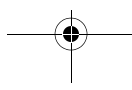
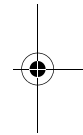
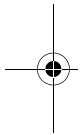

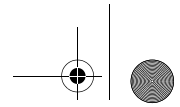

Installing the Processor Fan

- 1 With the fan power cable oriented downward, align the rubber grommets in the fan with the holes in each corner of the processor airflow shroud, then pull the grommets through until they snap into place.



NOTE: Airflow direction and orientation are shown on the side of the fan.

- 2 Replace the processor fan cage into the cage housing (see "Installing the Processor Fan Cage" on page 150).
- 3 Replace the processor airflow shroud (see "Installing the Processor Airflow Shroud Assembly" on page 149).
- 4 Connect the fan cable to the FAN_CPU connector on the system board (see "System Board Components" on page 103).
- 5 Replace the computer cover (see "Replacing the Computer Cover" on page 172).



NOTICE: To connect a network cable, first plug the cable into the network port or device and then plug it into your computer.

- 6 Connect your computer and devices to electrical outlets, and then turn them on.

Removing the Card Fan

- 1 Follow the procedures in "Before You Begin" on page 99.
- 2 Remove the computer cover (see "Removing the Computer Cover" on page 101).
- 3 Remove any full-length expansion cards (see "Removing a PCI Express Card" on page 121 and "Removing a PCI Card" on page 114).
- 4 Disconnect the fan cable from the FAN_CARD_CAGE connector on the system board (see "System Board Components" on page 103).
- 5 Lift and hold the tab present at the bottom of the fan cage. Pressing the top of the cage slide it towards the back of the system, then gently ease the cage out of the groove.

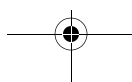

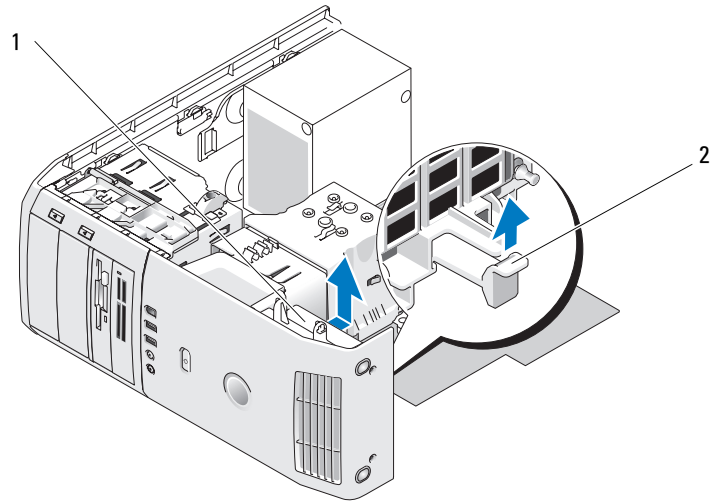

1 fan cage 2 tab

- 6** One by one, carefully pull on each corner of the fan to detach the four rubber grommets securing the fan to the fan cage.

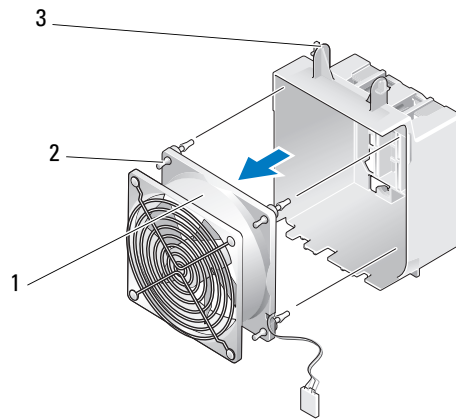

1 card fan 2 rubber grommet (4) 3 card fan cage



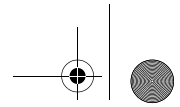



Installing the Card Fan

 **NOTICE:** Ensure the fan cable is correctly routed through the opening in the lower-right corner of the fan cage.

- 1 With the fan power cable oriented downward, align the rubber grommets in the fan with the holes in each corner of the fan cage, then pull the grommets through until they snap into place.

 **NOTE:** Airflow direction and orientation are shown on the side of the fan. Insert the tabs along the bottom of the fan cage into the corresponding slots on the cage housing, then rotate the fan cage forward until it snaps into place.

- 2 Connect the fan cable to the FAN_CARD_CAGE connector on the system board (see "System Board Components" on page 103).
- 3 Replace any expansion cards that you removed (see "Installing a PCI Card" on page 110 and "Installing a PCI Express Card" on page 116).
- 4 Replace the computer cover (see "Replacing the Computer Cover" on page 172).

 **NOTICE:** To connect a network cable, first plug the cable into the network port or device and then plug it into your computer.

- 5 Connect your computer and devices to electrical outlets, and then turn them on.

Processor

 **CAUTION:** Before you begin any of the procedures in this section, follow the safety instructions in the *Product Information Guide*.

 **NOTICE:** Do not perform the following steps unless you are familiar with hardware removal and replacement. Performing these steps incorrectly could damage your system board.

Removing the Processor

- 1 Follow the procedures in "Before You Begin" on page 99.
- 2 Remove the computer cover (see "Removing the Computer Cover" on page 101).
- 3 Disconnect the power cables from the POWER and 12VPOWER connectors (see "System Board Components" on page 103) on the system board.

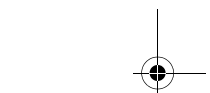
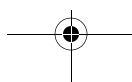

- 4 Remove the airflow shroud (see "Removing the Processor Airflow Shroud Assembly" on page 148).
- 5 Push down and out on the socket release lever.
- 6 Lift the socket release lever and open the processor cover.

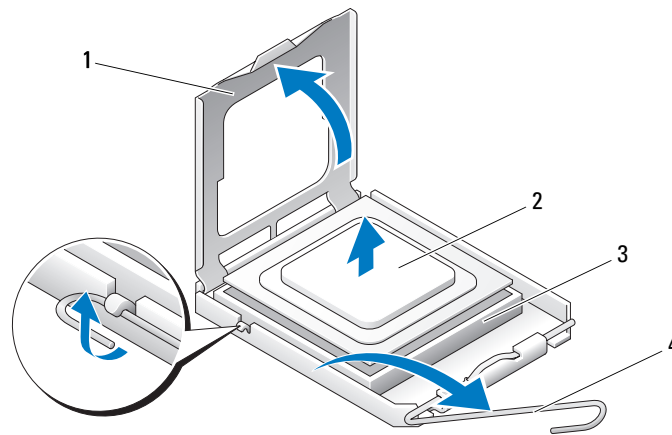

- | | | | |
|---|-----------------|---|----------------------|
| 1 | processor cover | 2 | processor |
| 3 | socket | 4 | socket release lever |

- 7 Remove the processor from the socket.
Leave the release lever extended in the release position so that the socket is ready for the new processor.

Installing the Processor

- ➔ **NOTICE:** Ground yourself by touching an unpainted metal surface on the back of the computer.
- 1 Unpack the new processor.
- ➔ **NOTICE:** You must position the processor correctly in the socket to avoid permanent damage to the processor and the computer when you turn on the computer.
- 2 If the release lever on the socket is not fully extended, move it to that position.

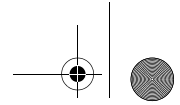

- 3 Align the pin-1 corner of the processor and socket.

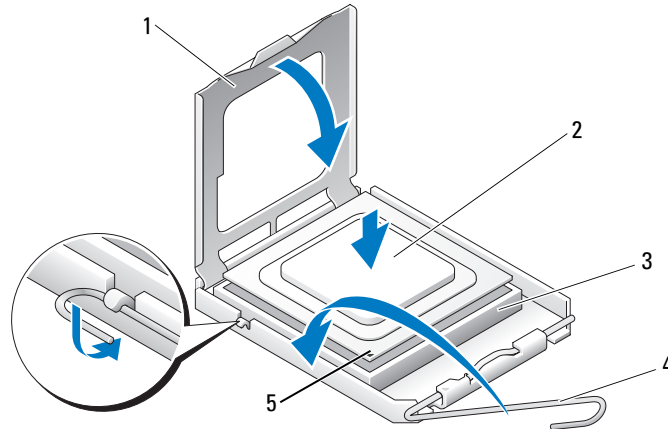

- | | | |
|------------------------|--------------------------|----------|
| 1 processor cover | 2 processor | 3 socket |
| 4 socket release lever | 5 socket pin-1 indicator | |

- NOTICE:** Socket pins are delicate. To avoid damage, ensure that the processor is aligned properly with the socket, and do not use excessive force when you install the processor. Be careful not to touch or bend the pins on the system board.
- 4 Set the processor lightly in the socket and ensure that the processor is level in the socket. When the processor is positioned correctly, press it with minimal pressure to seat it.
 - 5 When the processor is fully seated in the socket, close the processor cover.
 - 6 Pivot the socket release lever back toward the socket and snap it into place to secure the processor.
 - 7 Replace the processor airflow shroud (see "Installing the Processor Airflow Shroud Assembly" on page 149).
 - 8 Reconnect the power cables to the POWER and 12VPOWER connectors (see "System Board Components" on page 103) on the system board.

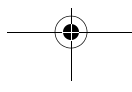

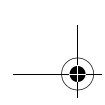

- 9 Close the computer cover (see "Replacing the Computer Cover" on page 172).
- ➔ **NOTICE:** To connect a network cable, first plug the cable into the network port or device and then plug it into the computer.
- 10 Connect your computer and devices to electrical outlets, and turn them on.

System Board

 **CAUTION:** Before you begin any of the procedures in this section, follow the safety instructions in the *Product Information Guide*

Removing the System Board

- ➔ **NOTICE:** The system board and metal tray are connected and are removed as one piece.
- 1 Follow the procedures in "Before You Begin" on page 99.
- 2 Remove the computer cover (see "Removing the Computer Cover" on page 101).
- 3 Remove any full-length expansion cards (see "Removing a PCI Card" on page 114 and "Removing a PCI Express Card" on page 121).
- 4 Remove the two screws securing the card fan assembly, then remove the processor airflow shroud (see "Removing the Processor Airflow Shroud Assembly" on page 148) and the Processor fan assembly (see "Removing the Processor Fan Cage" on page 149 and "Removing the Processor Fan" on page 151).
- 5 Remove the card fan assembly (see "Removing the Card Fan" on page 152).
- 6 Remove any additional components that may restrict access to the system board.
- 7 Disconnect all cables from the system board.
- ➔ **NOTICE:** If you are replacing the system board, visually compare the replacement system board to the existing system board to make sure that you have the correct part.
- 8 Remove the eight screws securing the system board assembly to the chassis, slide the system board assembly towards the front of the computer and lift it up and out.

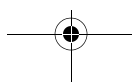
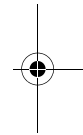
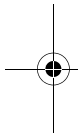

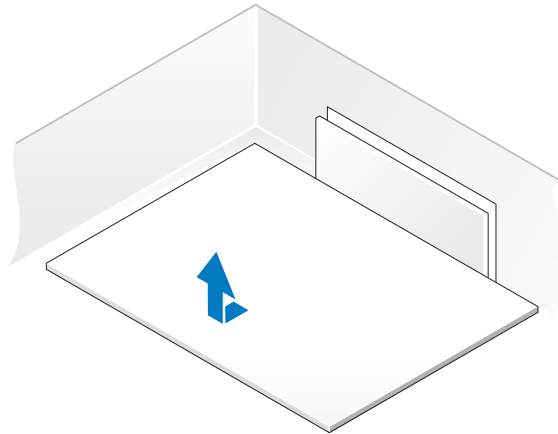
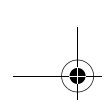

Installing the System Board



NOTICE: The system board and metal tray are connected and are installed as one piece.



NOTICE: If you are replacing the system board, visually compare the replacement system board to the existing system board to make sure that you have the correct part.



NOTE: Some components and connectors on replacement system boards may be in different locations than corresponding connectors on the existing system board.



NOTE: Jumper settings on replacement system boards are preset at the factory.

- 1 Transfer components from the existing system board to the replacement system board, if applicable.
- 2 Orient the system board assembly by aligning the notches on the bottom of the assembly with the tabs on the computer.
- 3 Slide the system board assembly toward the back of the computer until the assembly clicks into place.
- 4 Replace the eight screws to secure the system board assembly to the chassis.
- 5 Replace any expansion cards that you removed (see "Installing a PCI Card" on page 110 and "Installing a PCI Express Card" on page 116).

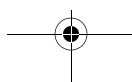

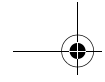

- 6 Replace the processor airflow shroud (see "Installing the Processor Airflow Shroud Assembly" on page 149) and the Processor Fan assembly (see "Installing the Processor Fan Cage" on page 150 and "Installing the Processor Fan" on page 152).
- 7 Replace the card fan assembly (see "Installing the Card Fan" on page 154).
- 8 Replace any additional components that you removed from the system board.
- 9 Reconnect all cables to the system board.
- 10 Replace the computer cover (see "Replacing the Computer Cover" on page 172).
- ➔ **NOTICE:** To connect a network cable, first plug the cable into the network port or device and then plug it into your computer.
- 11 Connect your computer and devices to electrical outlets, and then turn them on.
- 12 Flash the system BIOS, as needed.



NOTE: For information on flashing the system BIOS, see support.dell.com.

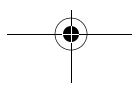
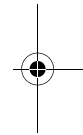
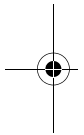

Power Supply

⚠ CAUTION: Before you begin any of the procedures in this section, follow the safety instructions in the *Product Information Guide*.

Power Supply (PSU) DC Connector Pin Assignments

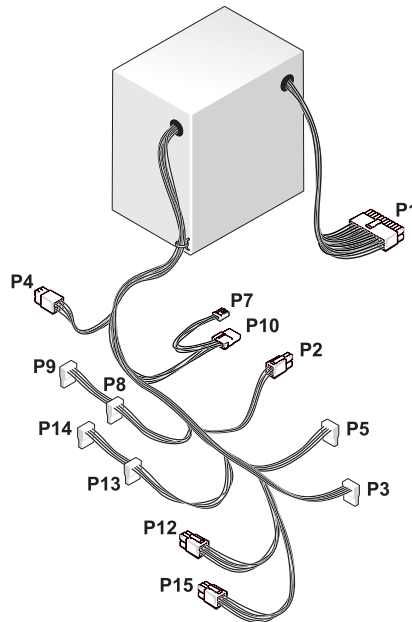

DC Power Connector P1

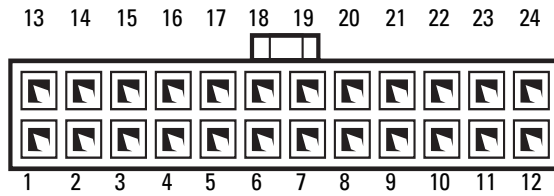

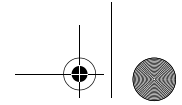

375-W Power Supply			425-W Power Supply	
Pin Number	Signal name	18-AWG Wire Color	Signal name	18-AWG Wire Color
1	+3.3VDC	Orange	+3.3 VDC	Orange
2	+3.3 VDC	Orange	+3.3 VDC	Orange
3	COM	Black	COM	Black
4	+5 VDC	Red	+5 VDC	Red
5	COM	Black	COM	Black
6	+5 VDC	Red	+5 VDC	Red
7	COM	Black	COM	Black
8	POK	Gray	POK	Gray
9	+5 VFP	Purple	+5 VFP	Purple
10	+12 VBDC	White	+12 VB DC	White
11	+12 VB DC	White	+12 VB DC	White
12	+3.3 VDC	Orange	+3.3 VDC	Orange
13	+3.3 VDC/SE [†]	Orange	+3.3 VDC/SE [†]	Orange
14	-12 VDC	Blue	-12 VDC	Blue
15	COM	Black	COM	Black
16	PS_ON	Green	PS_ON	Green
17	COM	Black	COM	Black
18	COM	Black	COM	Black
19	COM	Black	COM	Black
20	N/C	N/C	N/C	N/C
21	+5 VDC	Red	+5 VDC	Red
22	+5 VDC	Red	+5 VDC	Red
23	+5 VDC	Red	+5 VDC	Red
24	COM	Black	COM	Black

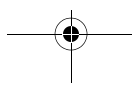
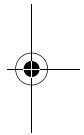
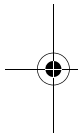

DC Power Connector P2



Pin Number	375-W Power Supply		425-W Power Supply	
	Signal name	18-AWG Wire Color	Signal name	18-AWG Wire Color
1	COM	Black	COM	Black
2	COM	Black	COM	Black
3	+12 VA DC	Yellow	+12 VA DC	Yellow
4	+12 VA DC	Yellow	+12 VA DC	Yellow

DC Power Connector P3 and P5

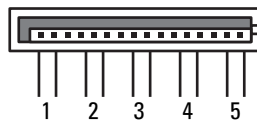

Pin Number	375-W Power Supply		425-W Power Supply	
	Signal name	18-AWG Wire Color	Signal name	18-AWG Wire Color
1	+3.3V DC	Orange	+3.3V DC	Orange
2	COM	Black	COM	Black
3	+5 V DC	Red	+5 V DC	Red
4	COM	Black	COM	Black
5	+12 VA DC	Yellow	+12 VA DC	Yellow



DC Power Connector P7

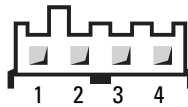

Pin Number	375-W Power Supply		425-W Power Supply	
	Signal name	18-AWG Wire Color	Signal name	18-AWG Wire Color
1	+5 V DC	Red	+5 V DC	Red
2	COM	Black	COM	Black
3	COM	Black	COM	Black
4	+12 VADC	Yellow	+12 VADC	Yellow

DC Power Connectors P8, P9, P13, and P14

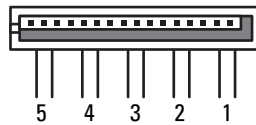

Pin Number	375-W Power Supply		425-W Power Supply	
	Signal name	18-AWG Wire Color	Signal name	18-AWG Wire Color
1	+3.3 VDC	Orange	+3.3 VDC	Orange
2	COM	Black	COM	Black
3	+5 VDC	Red	+5 VDC	Red
4	COM	Black	COM	Black
5	+12 VA DC	White	+12 VB DC	White

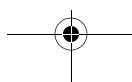

DC Power Connectors P10

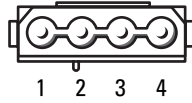

Pin Number	375-W Power Supply		425-W Power Supply	
	Signal name	18-AWG Wire Color	Signal name	18-AWG Wire Color
1	+12 VA DC	Yellow	+12 VB DC	White
2	COM	Black	COM	Black
3	COM	Black	COM	Black
4	+5 V DC	Red	+5 V DC	Red

DC Power Connectors P12

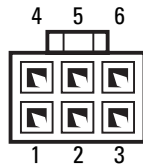

Pin Number	375-W Power Supply		425-W Power Supply	
	Signal name	18-AWG Wire Color	Signal name	18-AWG Wire Color
1	+12 VB DC	White	+12 VC DC	Blue/White
2	+12 VB DC	White	+12 VC DC	Blue/White
3	+12 VB DC	White	+12 VC DC	Blue/White
4	COM	Black	COM	Black
5	COM	Black	COM	Black
6	COM	Black	COM	Black

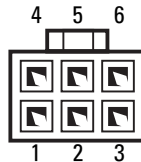

DC Power Connector P15 (For 425-W PSU Only)



Pin Number	Signal Name	18-AWG Wire Color
1	+12 VC DC	Blue/White
2	+12 VC DC	Blue/White
3	+12 VC DC	Blue/White
4	COM	Black
5	COM	Black
6	COM	Black

 **NOTE:** The P15 connector is intended for use with the PCI Express graphics cards whose power requirements exceed 75 watts.

Removing the Power Supply

- 1 Follow the procedures in "Before You Begin" on page 99.
- 2 Remove the computer cover (see "Removing the Computer Cover" on page 101).
-  **NOTICE:** Note the location and ID of each power connector before disconnecting the power supply cables.
- 3 Follow the DC power cables that stem from the power supply and disconnect each connected power cable.
 -  **NOTE:** Note the routing of the power cable bundles as you disconnect them. You must route these cables properly when you replace them to prevent them from being pinched or crimped.
- 4 Remove the four screws that attach the power supply assembly to the back of the chassis.

- 5 Press and hold the metal release tab at the bottom of the power supply unit, push the power supply towards the front of the computer to free it from the securing tabs on the computer chassis.
- 6 Gather the power supply bundles that stem from the power supply, for easy removal and lift it out of the computer.

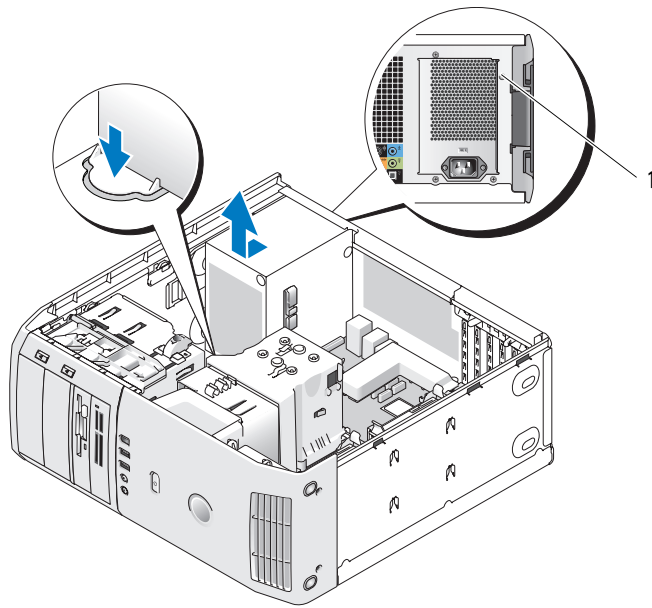

1 power supply screws (4)

Installing the Power Supply

- 1 Seat the power supply unit into place, ensuring that the slot bottom of unit is aligned to tabs on the chassis, then slide it towards the back of the system till it snaps into place.
- 2 Replace the four screws that secure the power supply to the back of the computer chassis.
- 3 Reattach each of the DC power cables that were previously connected, carefully rerouting them as you found them.



4 Replace the computer cover (see "Replacing the Computer Cover" on page 172).

➔ NOTICE: To connect a network cable, first plug the cable into the network port or device and then plug it into the computer.

5 Connect your computer and devices to electrical outlets, and then turn them on.

Front I/O Panel

Front I/O-Panel Components

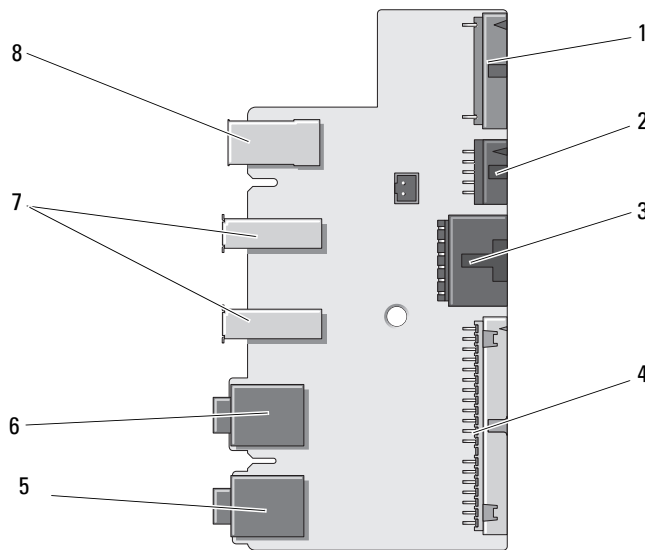

- | | | |
|-----------------------------------|----------------------------|---------------------------|
| 1 add-in audio internal connector | 2 1394a internal connector | 3 power button connector |
| 4 front I/O connector | 5 microphone-in connector | 6 headphone-out connector |
| 7 USB external ports (2) | 8 1394a external port | |

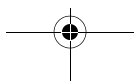

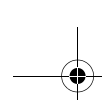

Removing the Front I/O Panel



CAUTION: Before you begin any of the procedures in this section, follow the safety instructions in the *Product Information Guide*.

- 1 Follow the procedures in "Before You Begin" on page 99.
- 2 Remove the computer cover (see "Removing the Computer Cover" on page 101).
-  **NOTICE:** Carefully note the routing of each cable before you disconnect it, so that you are sure to re-route cables correctly. An incorrectly routed or a disconnected cable could lead to computer problems.
- 3 Remove the front plastic bezel. The bezel has two screws on the bottom of the chassis which need to be removed. There are also six snap features that secure the bezel to the front metal wall that must be removed.
- 4 Remove the processor airflow shroud (see "Removing the Processor Airflow Shroud Assembly" on page 148).
- 5 Remove the Processor fan assembly (see "Removing the Processor Fan Cage" on page 149 and "Removing the Processor Fan" on page 151) and the card fan (see "Removing the Card Fan" on page 152).
- 6 Disconnect the control-panel cable from the I/O panel connector by pulling the cable loop.
- 7 Disconnect the power panel cable, 1394 cable, and audio cable (if it exists) so that the entire front I/O panel is free from all cables.

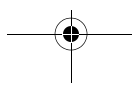
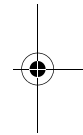
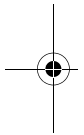

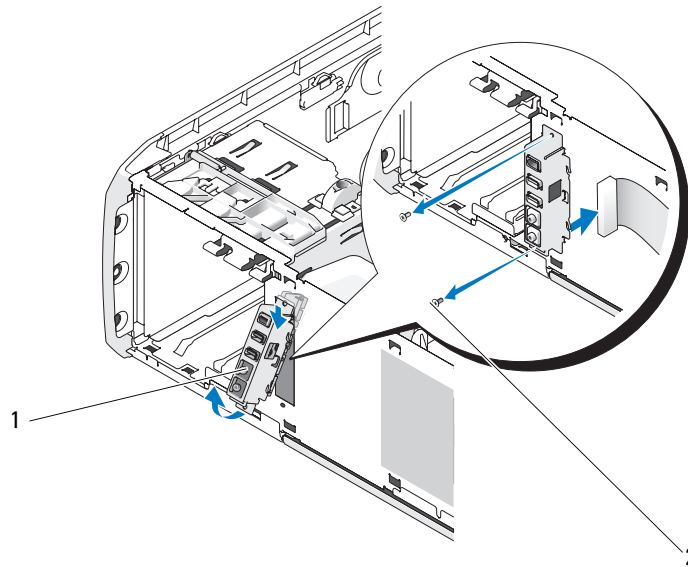

1 Front I/O panel

2 mounting screws (2)

- 8 Remove the two screws that hold the I/O panel assembly to the front of the chassis.
- 9 Gently ease out the lower end of the I/O assembly first from its groove on the chassis followed by the upper end.

Installing the Front I/O Panel

⚠ CAUTION: Before you begin any of the procedures in this section, follow the safety instructions in the *Product Information Guide*.

➡ NOTICE: Ensure that you replace all cables originally attached to the I/O panel or you computer may not function properly.

- 1 Follow the procedures in "Before You Begin" on page 99.
- 2 Remove the computer cover (see "Removing the Computer Cover" on page 101).

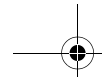

- 3 Align the screw holes on the I/O panel with the screw holes on the chassis, and replace the two screws.
- 4 Reconnect the cable that attaches the power button to the I/O panel.
- 5 Reconnect the 1394 cable, and audio cable (if it exists and you had removed it).
- 6 Reconnect the control-panel cable to the I/O panel connector.
- 7 Replace the front bezel by aligning the six tabs on the corresponding slots on the front chassis and snapping it back into place. Replace the two screws that secure the bezel to the bottom of the chassis.
- 8 Replace the processor airflow shroud (see "Installing the Processor Airflow Shroud Assembly" on page 149) and the Processor fan assembly (see "Installing the Processor Fan Cage" on page 150 and "Installing the Processor Fan" on page 152).
- 9 Connect the card fan assembly (see "Installing the Card Fan" on page 154) to the system board.
- 10 Replace the computer cover (see "Replacing the Computer Cover" on page 172).

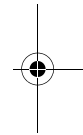
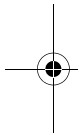

Coin-Cell Battery

Replacing the Coin-Cell Battery



CAUTION: Before you perform any of the procedures in this section, follow the safety instructions in the *Product Information Guide*.



NOTICE: To prevent static damage to components inside your computer, discharge static electricity from your body before you touch any of your computer's electronic components. You can do so by touching an unpainted metal surface on the computer.

A coin-cell battery maintains computer configuration, date, and time information. The battery can last several years. If you have to repeatedly reset time and date information after turning on the computer, replace the battery.



CAUTION: A new battery can explode if it is incorrectly installed. Replace the battery only with the same or equivalent type recommended by the manufacturer. Discard used batteries according to the manufacturer's instructions.

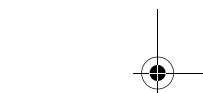
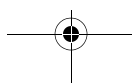



To replace the battery:

- 1 Enter the system setup program and record the values for all the screens (see "Entering System Setup" on page 179) so that you can restore the correct settings after installing the new battery.
 - 2 Follow the procedures in "Before You Begin" on page 99.
 - 3 Remove the computer cover (see "Removing the Computer Cover" on page 101).
 - 4 Locate the battery socket (see "System Board Components" on page 103).
- ➔ NOTICE:** If you pry the battery out of its socket with a blunt object, be careful not to touch the system board with the object. Ensure that the object is inserted between the battery and the socket before you attempt to pry out the battery. Otherwise, you may damage the system board by prying off the socket or by breaking circuit traces on the system board.
- 5 Remove the battery by carefully prying it out of its socket with your fingers or with a blunt, nonconducting object, such as a plastic screwdriver.
 - 6 Insert the new battery into the socket with the side labeled "+" facing up, and then snap the battery into place.
 - 7 Replace the computer cover. (see "Replacing the Computer Cover" on page 172).

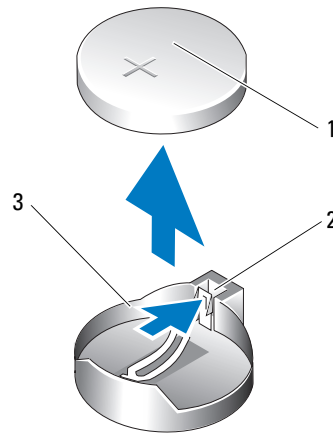

1 coin-cell battery 2 tab 3 battery socket





- ➔ **NOTICE:** To connect a network cable, first plug the cable into the network device and then plug it into the computer.
- 8 Connect your computer and devices to electrical outlets, and then turn them on.
- 9 Enter system setup and restore the settings you recorded in step 1 (see "Entering System Setup" on page 179).
- 10 Properly dispose of the old battery. See the *Product Information Guide* for battery disposal information.

Replacing the Computer Cover

 **CAUTION:** Before you perform any of the procedures in this section, follow the safety instructions in the *Product Information Guide*.

- 1 Ensure that all cables are connected, and fold cables out of the way.
Gently pull the power cables toward you so that they do not get caught underneath the drives.
- 2 Ensure that no tools or extra parts are left inside the computer.
- 3 Lower the cover into place:
 - a Pivot the cover down.
 - b Press down on the right side of the cover until it closes.
 - c Press down on the left side of the cover until it closes.
- 4 Ensure that both sides of the cover are locked. If not, repeat all of step 3.

- ➔ **NOTICE:** To connect a network cable, first plug the cable into the network wall jack and then plug it into the computer.
- 5 Connect your computer and devices to electrical outlets, and then turn them on.

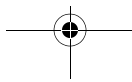

A

Appendix

Specifications

Processor

Processor type	Intel® Core™ 2 Duo Intel® Core™ 2 Extreme (dual-core processor) Intel® Core™ 2 Quad (quad-core processor)
Level 2 (L2) Cache	Intel® Core™ 2 Duo - 2 MB or 4 MB Intel® Core™ 2 Extreme - 4 MB or 8 MB Intel® Core™ 2 Quad - 8 MB

Memory

Type	dual-channel 667 and 800-MHz DDR2
Memory connectors	four
Memory capacities	512 MB, 1 GB, and 2 GB
Minimum memory	1 GB
Maximum memory	8 GB

NOTE: See "Addressing Memory With 8-GB Configurations" on page 106 to verify the amount of memory available to the operating system. 8 GB memory is available only if you ordered an operating system that supports 64 bits.

Computer Information

Chipset	Intel® X38 Express Chipset/ ICH9R
DMA channels	five
Interrupt levels	24
BIOS chip (EEPROM)	8 Mb

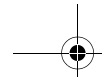

Computer Information (continued)

Memory speed	667/800 MHz
NIC	Integrated Gigabit Ethernet 10/100/1000
System clock	800/1066/1333 MHz (depending on processor)

Video

Type	PCI Express Gen2 x16
------	----------------------

Audio

Type	HDA 7.1 channel
------	-----------------

Expansion Bus

Bus type	PCI Express x1, x8, and x16 PCI 32-bit (PCI specification 2.3)
----------	---

PCI

Connectors	three
Connector size	124 pins
Connector data width (maximum)	32 bit, version 2.3
Bus speed	33 MHz

PCI Express

Connector	one x1
Connector size	36 pins
Connector data width (maximum)	1 PCI Express lane
Bus throughput	1 GB/s

PCI Express

Connector	one x16
Connector size	164 pins
Connector data width (maximum)	16 PCI Express lanes

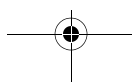
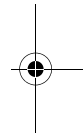
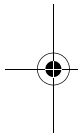

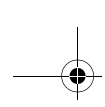

Expansion Bus (continued)

Bus throughput	16 GB/s
PCI Express	
Connector	one x8 (electrically configured for an x4 card)
Connector size	98 pins
Connector data width (maximum)	8 PCI Express lanes
Bus throughput	2 GB/s

Drives

Available devices	Serial ATA drive, floppy drive, memory devices, Blu-ray Disc™ drive, DVD drive, DVD-RW drive, CD-RW/DVD combo drive, media card reader, and Media Xcelerator(optional).
Externally accessible:	two 3.5-inch flexbays two 5.25-inch drive bays
Internally accessible:	two 5.25-inch drive bays two 3.5 HDD bays

Connectors

External connectors:

IEEE 1394a	front and back-panel 6-pin serial connectors
Network adapter	RJ45 connector
USB	two front-panel and six back-panel connectors
eSerial ATA	one
Audio	seven back-panel connectors for line-in, line-out, surround, side surround, center/subwoofer Low Frequency Effects (LFE) channel, and S/PDIF (optical and RCA); two front-panel connectors for headphones/microphone

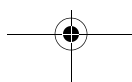

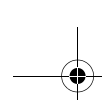

Connectors (continued)

System board connectors:

Serial ATA	five 7-pin connectors
FlexBay	2 port USB header
uDOC	1 port USB header
LCD	Dell proprietary USB based LCD header
Fan	two 5-pin connectors
PCI	three 124-pin connectors
PCI Express x1	36-pin connector
PCI Express x16	164-pin connector
PCI Express x4/x8	98-pin connector

Controls and Lights

Power control	push button
Power light	blue light — Blinking blue in sleep state; solid blue for power-on state. amber light — Blinking amber indicates a problem with an installed device; solid amber indicates an internal power problem.
Hard-drive access light	blue light — Blinking blue denoting hard drive activity state.
Network activity light (front panel)	solid blue indicates network connection.
Link integrity light (on integrated network adapter)	green light — A good connection exists between a 10-Mbps network and the computer. orange light — A good connection exists between a 100-Mbps network and the computer. yellow light — A good connection exists between a 1-GB (1000-Mbps) network and the computer. off (no light) — The computer is not detecting a physical connection to the network.

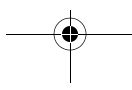
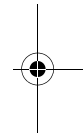
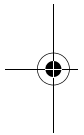

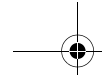

Controls and Lights *(continued)*

Activity light (on integrated network adapter)	yellow blinking light when there is activity on the network; if there is not any network activity, the light will be off
Diagnostic lights	four blue lights on the top bezel (see "Diagnostic Lights" on page 76)
Standby power light	AUX_PWR_LED on the system board

Power

DC power supply:  **CAUTION: To reduce the risk of fire, electric shock, or injury, do not overload an electrical outlet, power strip, or convenience receptacle. The total ampere rating of all products plugged into an electrical outlet, power strip, or other receptacle should not exceed 80 percent of the branch circuit rating.**

Wattage	375 W or 425 W
Voltage (see the safety instructions located in the <i>Product Information Guide</i>)	115 V to 230 V

Backup battery 3-V CR2032 lithium coin cell

Physical

Height	45.03 cm (17.08 in)
Width	187 cm (7.04 in)
Depth	450 cm (17.7 in)
Weight	12.7 kg

Environmental

Temperature:	
Operating	10° to 35°C (50° to 95°F)
Storage	-40° to 65°C (-40° to 149°F)
Relative humidity	20% to 80% (noncondensing)

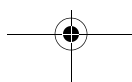

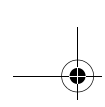

Environmental *(continued)*

Maximum vibration:

Operating	0.25 G at 3 to 200 Hz at 0.5 octave/min
Storage	0.5 G at 3 to 200 Hz at 1 octave/min

Maximum shock:

Operating	bottom half-sine pulse with a change in velocity of 20 inches/sec (50.8 cm/sec)
Storage	27-G faired square wave with a velocity change of 200 inches/sec (508 cm/sec)

Altitude:

Operating	-15.2 to 3048 m (-50 to 10,000 ft)
Storage	-15.2 to 10,668 m (-50 to 35,000 ft)

System Setup

Overview

Use system setup as follows:

- To change the system configuration information after you add, change, or remove any hardware in your computer
- To set or change a user-selectable option such as the user password
- To read the current amount of memory or set the type of hard drive installed

Before you use system setup, it is recommended that you write down the system setup screen information for future reference.

 **NOTICE:** Do not change the settings in system setup unless you are an expert computer user. Certain changes can cause your computer to work incorrectly.

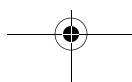

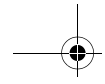

Entering System Setup

- 1 Turn on (or restart) your computer.
- 2 When the DELL logo appears, press <F2> immediately.



NOTE: Keyboard failure may result when a key on the keyboard is held down for extended periods of time. To avoid possible keyboard failure, press and release <F2> in even intervals until the system setup screen appears.

If you wait too long and the operating system logo appears, continue to wait until you see the Microsoft® Windows® desktop, then shut down your computer and try again.

System Setup Screens

The system setup screen displays current or changeable configuration information for your computer. Information on the screen is divided into three areas: the options list, the active options field, and key functions.

<p>Options List — This field appears on the left side of the system setup window. The field is a scrollable list containing features that define the configuration of your computer, including installed hardware, power conservation, and security features.</p> <p>Scroll up and down the list with the up- and down-arrow keys. As an option is highlighted, the Options Field displays more information about that option and the option's current and available settings.</p>	<p>Options Field — This field appears on the right side of the system setup window and contains information about each option listed in the Options List. In this field you can view information about your computer and make changes to your current settings.</p> <p>Press the left- and right-arrow keys to highlight an option. Press <Enter> to make that selection active and return to the Options List.</p> <p>NOTE: Not all settings listed in the Options Field are changeable.</p>
	<p>Key Functions — This field appears below the Options Field and lists keys and their functions within the active system setup field.</p>

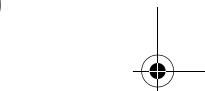
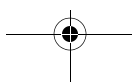
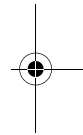
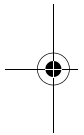

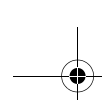

System Setup Options



NOTE: Depending on your computer and installed devices, the items listed in this section may not appear, or may not appear exactly as listed.

System

System Info	Lists system information, such as the computer name, the BIOS version number and date, the system service tag, express service code and asset tag, and other system-specific information.
Processor Info	Identifies the processor type, clock speed, bus speed, L2 cache, L3 cache, ID, and whether the processor is multiple core capable, supports Hyper-Threading and supports 64-bit technology.
Memory Info	Identifies the memory type, speed, and channel mode (dual or single) by DIMM slot location.
PCI Info	Indicates the expansion card type by slot location.
Date/Time	Displays current date and time settings.
Boot Sequence	The computer attempts to boot from the sequence of devices specified in this list.

NOTE: If you insert a boot device and restart the computer, this option appears in the system setup menu. To boot from a USB memory device, for example, select the USB device and move it so that it becomes the first device in the boot sequence.

Drives

Diskette Drive (Internal default)	Enables and disables the floppy drive attached to the DSKT connector on the system board and sets read permissions for the drive. <ul style="list-style-type: none"> • Off — All floppy drives are disabled. • USB — USB floppy drives are enabled • Internal — The integrated floppy drive is enabled. • Read Only — The integrated floppy drive is enabled with read-only access.
--------------------------------------	---

NOTE: Operating systems with USB support will recognize USB floppy drives regardless of this setting.

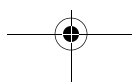

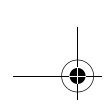

SATA Drives 0 through 4 (On default)	<p>Enables or disables drives attached to the SATA connectors on the system board.</p> <ul style="list-style-type: none"> • Off — A device attached to the interface is not usable. • On — A device attached to the interface is usable. • RAID On - A device attached to the interface is configured for RAID (see "About Your RAID Configuration" on page 30).
SMART Reporting (Off default)	<p>Determines whether hard-drive errors for internal drives are reported during system startup.</p> <ul style="list-style-type: none"> • Off — Errors are not reported. • On — Errors are reported.

Onboard Devices

Integrated NIC (On default)	<p>Enables or disables the integrated network interface controller (NIC).</p> <ul style="list-style-type: none"> • Off — The integrated NIC is disabled. • On — The integrated NIC is enabled. • On w/PXE — The integrated NIC is on (with PXE enabled). <p>NOTE: PXE is required only if you are booting to an operating system located on another computer. If a boot routine is not available from the remote system, the computer attempts to boot from the next device listed in the boot sequence.</p>
Integrated Audio (On default)	<p>Enables or disables the onboard audio controller.</p> <ul style="list-style-type: none"> • Off — Integrated audio is disabled. • On — Integrated audio is enabled.
USB Controller (On default)	<p>Enables or disables the internal USB controller. Set to On (default) so that USB devices will be detected and supported in the operating system.</p> <ul style="list-style-type: none"> • Off — The USB controller is disabled. • On — The USB controller is enabled. • No Boot — The USB controller is enabled; however, the BIOS will not recognize USB storage devices. <p>NOTE: Operating systems with USB support will recognize USB storage devices regardless of the No Boot setting.</p>

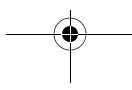

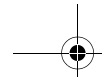

1394 Controller (On default)	<p>Enables or disables the integrated IEEE 1394 controller.</p> <ul style="list-style-type: none"> • Off — The 1394 controller is disabled. • On — The 1394 controller is enabled.
LCD Display (On default)	<p>Enables or disables the LCD display on the top bezel.</p> <ul style="list-style-type: none"> • Off — The LCD device is disabled. • On — The LCD device is enabled. <p>NOTE: When the LCD display is set to On, it starts whenever the system is powered on.</p>

Performance

Multiple CPU Core (On default)	<p>Specifies whether the processor has more than one core enabled.</p> <ul style="list-style-type: none"> • Off — Multiple CPU core technology is disabled. • On — Multiple CPU core technology is enabled. <p>NOTE: The performance of some applications may improve with an additional core enabled.</p>
-----------------------------------	---

Advanced	<p>Displays processor type and current BIOS settings for processor clock speed, processor multiplier, front side bus (FSB) clock, and CPU core voltage. These settings may have been set by performance tuning applications or may change depending on settings in performance applications that you have installed.</p> <p>For systems with Intel Extreme processors, the following fields are adjustable through the BIOS:</p> <ul style="list-style-type: none"> • Processor Clock Speed: Adjusts the multiplier of the processor. For processors that cannot be overclocked, this field reports the current settings and cannot be changed. • Performance Application Support: Enables software applications to display and modify key system parameters to tune system performance. These applications are not installed or supported by Dell. The default is Off. <p>NOTE: Pressing <Alt><F> returns your system to the factory defaults including RAID settings.</p>
----------	--

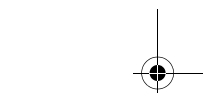
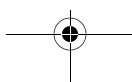

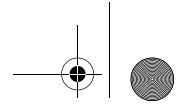

SpeedStep (Off default)	Specifies whether Enhanced Intel SpeedStep [®] technology is enabled for all supported processors in the system. <ul style="list-style-type: none">• Off — Disable Enhanced SpeedStep technology• On — Enable Enhanced SpeedStep technology
----------------------------	---

HDD Acoustic Mode (Bypass default)	Determines the acoustic mode at which the hard drive operates. <ul style="list-style-type: none">• Bypass — Do nothing (needed for older drives).• Quiet — The hard drive operates at a slower, but quieter speed.• Suggested — Allow the hard drive manufacturer to select the mode.• Performance — The hard drive operates at a faster, but possibly noisier speed.
---------------------------------------	--

NOTE: Switching to performance mode may cause an increase in noise produced by the drive, but does not affect the drive's performance.

NOTE: Changing the acoustics setting does not alter your hard drive image.

Security

Admin Password (Not Set default)	Used to prohibit an unauthorized user from changing any configuration settings in the system setup.
-------------------------------------	---

System Password (Not Set default)	Used to prohibit an unauthorized user from booting to the operating system.
--------------------------------------	---

Password Changes (Unlocked default)	This option locks the system password field with the administrator (admin) password. <p>NOTE: When the system password field is locked, you can no longer disable password security by pressing <Ctrl><Enter> when the computer starts.</p>
--	--

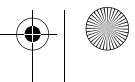
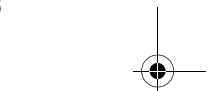
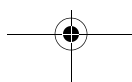

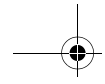

Execute Disable (On default)	Enables or disables Execute Disable Memory Protection technology. <ul style="list-style-type: none"> • Off — Execute Disable Memory Protection technology is disabled. • On — Execute Disable Memory Protection technology is enabled.
---------------------------------	--

Power Management

AC Recovery (Off default)	Specifies how the computer will behave when AC power is restored after an AC power loss. <ul style="list-style-type: none"> • Off — The system stays off after AC power is restored. • On — The system powers on after AC power is restored. • Last — The system returns to the previous state after AC power is restored.
------------------------------	--

Auto Power On (Off default)	Disables or selects when to automatically turn on the computer. <ul style="list-style-type: none"> • Off — Do not use the Auto Power Time. • Everyday — Turn the computer on every day at the time set in Auto Power Time. • Weekdays — Turn the computer on Monday through Friday at the time set in Auto Power Time.
--------------------------------	---

NOTE: This feature does not work if you turn off your computer using a power strip or surge protector.

Auto Power Time	Specifies the time to automatically turn on the computer. Change the time to automatically turn on the computer by pressing the up- or down-arrow key to increase or decrease the numbers, or type the numbers in the appropriate time field.
-----------------	--

NOTE: This feature does not work if you turn off your computer using a power strip or surge protector.

Low Power Mode (Off default)	Specifies how aggressive the system is at conserving power while in hibernate mode or turned off. <ul style="list-style-type: none"> • Off — Add more functionality. • On — Conserve more power.
---------------------------------	--

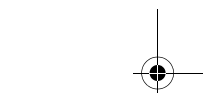
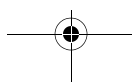

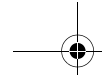

Suspend Mode (S3 default)	<p>Specifies the power management suspend mode.</p> <ul style="list-style-type: none"> • S1 — The computer resumes more quickly from sleep mode. • S3 — The computer conserves more power when not in use (system memory remains active).
------------------------------	---

Quick Resume	<p>This feature enables/disables the Intel® Viiv™ Quick Resume Technology.</p> <p>The default setting is Off.</p>
--------------	--

Maintenance

Service Tag	Displays the system service tag.
-------------	----------------------------------

SERR Message (On default)	<p>Controls the SERR message mechanism. Some graphics cards require that the SERR Message mechanism be disabled.</p> <ul style="list-style-type: none"> • Off — Do not use the SERR message mechanism. • On — Use the SERR message mechanism.
------------------------------	---

Load Defaults	<p>This setting restores the computer's factory-installed default settings.</p> <ul style="list-style-type: none"> • Cancel — Do not restore factory-installed default settings. • Continue — Restore factory-installed default settings.
---------------	---

Event Log	<p>Displays the system event log.</p> <ul style="list-style-type: none"> • Mark all entries — Mark all event log entries as read (R). • Clear log — Clear all event log entries. <p>NOTE: Once an event log entry is marked as read (R) that entry cannot be marked as unread (U).</p>
-----------	---

POST Behavior

Fastboot (On default)	<p>Enables or disables the option to speed up the boot process by skipping certain configurations and tests.</p> <ul style="list-style-type: none"> • Off — Do not skip any steps in the boot process. • On — Boot quickly.
--------------------------	---

Numlock Key (On default)	<p>Enables or disables the numerical and mathematical features of the rightmost bank of keys on the keyboard.</p> <ul style="list-style-type: none"> • Off — Right keypad keys function as arrows. • On — Right keypad keys function as numbers.
-----------------------------	--

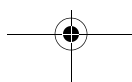

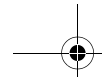

POST Hotkeys (Setup & Boot Menu default)	Specifies the function keys to display on the screen when the computer starts. <ul style="list-style-type: none"> • Setup & Boot Menu — Display both messages (F2=Setup and F12=Boot Menu). • Setup — Display the setup message only (F2=Setup). • Boot Menu — Display the Quickboot message only (F12=Boot Menu). • None — Neither message is displayed.
<hr/>	
Keyboard Errors (Report default)	Enables or disables keyboard error reporting when the computer starts. <ul style="list-style-type: none"> • Report — Display any keyboard errors. • Do not report — Do not display any keyboard errors.

Boot Sequence

This feature allows you to set the order in which the BIOS will search devices when trying to find an operating system.



NOTICE: If you modify any boot sequence settings, save the new settings to avoid losing the changes.

Option Settings



NOTE: The computer attempts to boot from all bootable devices, but if no bootable device is found, the computer generates an error message that states `No boot device available`. Press the <F1> key to retry the boot, or press the <F2> key to enter the setup utility.

- **Onboard or USB Floppy Drive** — The computer attempts to boot from the floppy drive. If there is no floppy in the drive or there is no floppy drive installed, the computer attempts to boot from the next bootable device in the sequence.



NOTE: If there is a non-bootable floppy in the drive, the computer generates an error message. Follow the on-screen instructions to retry the boot.

- **Onboard SATA Hard Drive** — The computer attempts to boot from the primary hard drive. If no operating system is on the drive, the computer attempts to boot from the next bootable device.

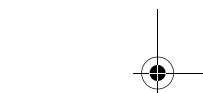
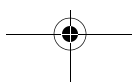



- **Onboard or USB CD-ROM Drive** — The computer attempts to boot from the CD drive. If no CD is in the drive, or if the CD has no operating system, the computer attempts to boot from the next bootable device.
- **USB Device** — Insert the memory device into a USB port and restart the computer. When **F12 = Boot Menu** appears in the upper-right corner of the screen, press <F12>. The BIOS detects the device and adds the USB option to the boot menu.



NOTE: To boot to a USB device, the device must be bootable. To ensure that your device is bootable, check the device documentation.

Changing Boot Sequence for the Current Boot

You can use this feature, for example, to restart your computer to a USB device such as a floppy drive, memory key, or CD-RW drive.



NOTE: If you are booting to a USB floppy drive, you must first set the floppy drive to **OFF** in system setup (see "System Setup Options" on page 180).

- 1 If you are booting to a USB device, connect the USB device to a USB connector (see "Front View" on page 15).
- 2 Turn on (or restart) your computer.
- 3 When **F2 = Setup**, **F12 = Boot Menu** appears in the upper-right corner of the screen, press <F12>.

If you wait too long and the operating system logo appears, continue to wait until you see the Microsoft Windows desktop, then shut down your computer (see "Before You Begin" on page 99) and try again.

The **Boot Device Menu** appears, listing all available boot devices. Each device has a number next to it.

- 4 At the bottom of the menu, enter the number of the device that is to be used for the current boot only.

For example, if you are booting to a USB memory key, highlight **USB Device** and press <Enter>.



NOTE: To boot to a USB device, the device must be bootable. To make sure your device is bootable, check the device documentation.

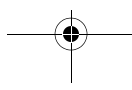
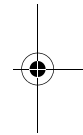
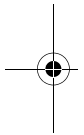

Changing Boot Sequence for Future Boots

- 1 Enter system setup (see "Entering System Setup" on page 179).
- 2 Use the arrow keys to highlight the **Boot Sequence** menu option and press <Enter> to access the menu.
NOTE: Write down your current boot sequence in case you want to restore it.
- 3 Press the up- and down-arrow keys to move through the list of devices.
- 4 Press the spacebar to enable or disable a device (enabled devices have a checkmark).
- 5 Press plus (+) or minus (-) to move a selected device up or down the list.

Clearing Forgotten Passwords

CAUTION: Before you begin any of the procedures in this section, follow the safety instructions in the *Product Information Guide*.

NOTICE: This process erases both the system and setup passwords.

- 1 Follow the procedures in "Before You Begin" on page 99.
- 2 Remove the computer cover (see "Removing the Computer Cover" on page 101).

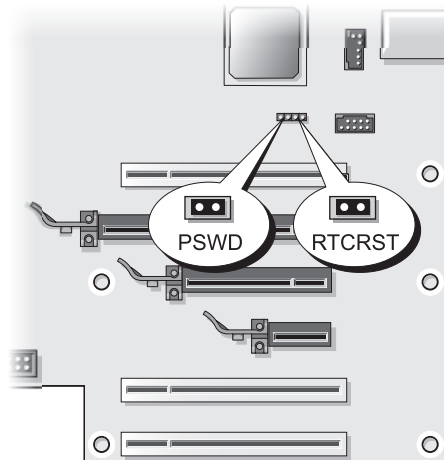

- 3 Locate the RTCRST_PSWD jumper on the system board (see "System Board Components" on page 103), then remove the jumper plug (located on pins three and four) and set the plug aside.
- 4 Close the computer cover.
- 5 Connect your keyboard and mouse, then connect your computer and monitor to electrical outlets and turn them on.
- 6 After the Microsoft® Windows® desktop appears on your computer, turn the computer off:
 - a Save and close all open files and exit all open programs.
 - b Shut down the operating system:
 - In Windows Vista, click **Start** , click the arrow in the lower-right corner of the Start menu as shown below, and then click **Shut Down**.



The computer turns off after the operating system shutdown process is complete.

 **NOTE:** Ensure that the computer is off and not in a power management mode. If you cannot shut down the computer using the operating system, press and hold the power button for 4 seconds.

- 7 Disconnect the keyboard and mouse, then disconnect the computer and monitor from their electrical outlets.
- 8 Press the power button on the computer to ground the system board.
- 9 Open the computer cover (see "Removing the Computer Cover" on page 101).
-  **NOTICE:** The password jumper plug must be reinstalled on the password jumper pins in order to enable the password feature.
- 10 Locate pins three and four of the RTCRST_PSWD jumper on the system board (see "System Board Components" on page 103), and then reinstall the jumper plug to enable the password feature.

- 11 Replace the computer cover (see "Replacing the Computer Cover" on page 172).
- ➔ **NOTICE:** To connect a network cable, first plug the cable into the network wall jack and then plug it into the computer.
- 12 Connect your computer and devices to electrical outlets, and then turn them on.
- ✍ **NOTE:** In system setup (see "Entering System Setup" on page 179), both system and administrator password options appear as **Not Set**. The password feature is enabled but a password is not assigned.

Clearing CMOS Settings

 **CAUTION:** Before you begin any of the procedures in this section, follow the safety instructions in the *Product Information Guide*.

✍ **NOTE:** This procedure clears and resets system and setup passwords.

- 1 Follow the procedures in "Before You Begin" on page 99.
- 2 Remove the computer cover (see "Removing the Computer Cover" on page 101).
- 3 Locate the RTCRST_PSWD jumper on the system board (see "System Board Components" on page 103).
- 4 Remove the password jumper plug (located on pins three and four), then place the plug on the CMOS jumper pins (pins one and two) and wait approximately 5 seconds.
- ➔ **NOTICE:** The password jumper plug must be reinstalled on the password jumper pins in order to enable the password feature.
- 5 Remove the jumper plug from the RTCRST_PSWD jumper, and then reinstall the plug on the pins three and four to enable the password feature.
- 6 Close the computer cover (see "Replacing the Computer Cover" on page 172).
- ➔ **NOTICE:** To connect a network cable, first plug the cable into the network wall jack and then plug it into the computer.
- 7 Connect your computer and devices to electrical outlets, and then turn them on.



Cleaning Your Computer

 **CAUTION:** Before you begin any of the procedures in this section, follow the safety instructions in the *Product Information Guide*.

Computer, Keyboard, and Monitor

 **CAUTION:** Before you clean your computer, disconnect the computer from the electrical outlet. Do not use liquid or aerosol cleaners, which may contain flammable substances.

 **NOTE:** It is recommended that you use the wipedown cloth, included as part of the accessories, to wipe your system without scratching the glossy exterior.

- Use a can of compressed air to remove dust from between the keys on the keyboard.

 **NOTICE:** Do not wipe the display screen with any soap or alcohol solution. Doing so may damage the antiglare coating.

 **NOTICE:** To avoid damaging the computer or display, do not spray cleaning solution directly onto the display. Only use products specifically designed for cleaning displays, and follow the instructions that are included with the product.

- To clean your monitor screen, lightly dampen a soft, clean cloth with water. If possible, use a special screen-cleaning tissue or solution suitable for the monitor's antistatic coating.
- Wipe the keyboard, computer, and plastic part of the monitor with a soft cleaning cloth moistened with water.

Do not soak the cloth or let water drip inside your computer or keyboard.

Mouse

If your screen cursor skips or moves abnormally, clean the mouse. To clean a non-optical mouse:

- 1 Turn the retainer ring on the underside of your mouse counterclockwise, and then remove the ball.
- 2 Wipe the ball with a clean, lint-free cloth.
- 3 Blow carefully into the ball cage to dislodge dust and lint.
- 4 If the rollers inside the ball cage are dirty, clean the rollers with a cotton swab moistened lightly with isopropyl alcohol.

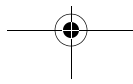



- 5 Recenter the rollers in their channels if they are misaligned. Ensure that fluff from the swab is not left on the rollers.
- 6 Replace the ball and retainer ring, and turn the retainer ring clockwise until it clicks into place.

Floppy Drive

-  **NOTICE:** Do not attempt to clean drive heads with a swab. The heads may become misaligned and prevent the drive from operating.

Clean your floppy drive using a commercially available cleaning kit. These kits contain pretreated floppy disks to remove contaminants that accumulate during normal operation.

CDs and DVDs

-  **NOTICE:** Always use compressed air to clean the lens in the optical drive, and follow the instructions that come with the compressed air. Never touch the lens in the drive.

If you notice problems, such as skipping, with the playback quality of your discs, try cleaning the discs.

- 1 Hold the disc by its outer edge. You can also touch the inside edge of the center hole.
-  **NOTICE:** To avoid damaging the surface, do not wipe in a circular motion around the disc.
- 2 With a soft, lint-free cloth, gently wipe the bottom of the disc (the unlabeled side) in a straight line from the center to the outer edge of the disc.

For stubborn dirt, try using water or a diluted solution of water and mild soap. You can also purchase commercial products that clean discs and provide some protection from dust, fingerprints, and scratches. Cleaning products for CDs are safe to use on DVDs.

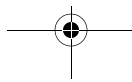

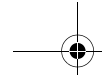

FCC Notices (U.S. Only)

Most Dell computer systems are classified by the Federal Communications Commission (FCC) as Class B digital devices. To determine which classification applies to your computer system, examine all FCC registration labels located on the bottom, side, or back panel of your computer, on card-mounting brackets, and on the cards themselves. If any one of the labels carries a Class A rating, your entire system is considered to be a Class A digital device. If *all* labels carry an FCC Class B rating as distinguished by either an FCC ID number or the FCC logo, (**FC**), your system is considered to be a Class B digital device.

Once you have determined your system's FCC classification, read the appropriate FCC notice. Note that FCC regulations provide that changes or modifications not expressly approved by Dell could void your authority to operate this equipment.

This device complies with Part 15 of the FCC Rules. Operation is subject to the following two conditions:

- 1 This device may not cause harmful interference.
- 2 This device must accept any interference received, including interference that may cause undesired operation.

Class A

This equipment has been tested and found to comply with the limits for a Class A digital device pursuant to Part 15 of the FCC Rules. These limits are designed to provide reasonable protection against harmful interference when the equipment is operated in a commercial environment. This equipment generates, uses, and can radiate radio frequency energy and, if not installed and used in accordance with the manufacturer's instruction manual, may cause harmful interference with radio communications. Operation of this equipment in a residential area is likely to cause harmful interference, in which case you will be required to correct the interference at your own expense.

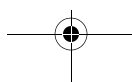
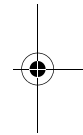
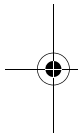

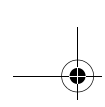

Class B

This equipment has been tested and found to comply with the limits for a Class B digital device pursuant to Part 15 of the FCC Rules. These limits are designed to provide reasonable protection against harmful interference in a residential installation. This equipment generates, uses, and can radiate radio frequency energy and, if not installed and used in accordance with the manufacturer's instruction manual, may cause interference with radio communications. However, there is no guarantee that interference will not occur in a particular installation. If this equipment does cause harmful interference to radio or television reception, which can be determined by turning the equipment off and on, you are encouraged to try to correct the interference by one or more of the following measures:

- Reorient or relocate the receiving antenna.
- Increase the separation between the equipment and the receiver.
- Connect the equipment into an outlet on a circuit different from that to which the receiver is connected.
- Consult the dealer or an experienced radio/television technician for help.

FCC Identification Information

The following information is provided on the device or devices covered in this document in compliance with FCC regulations:

- Product name: Dell™ XPS™ 420
- Model number: DC01L

Company name:

Dell Inc.
One Dell Way
Round Rock, Texas 78682 USA
512-338-4400

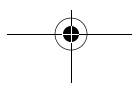

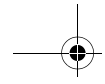

Getting Help

Obtaining Assistance

 **CAUTION:** If you need to remove the computer cover, first disconnect the computer power and modem cables from all electrical outlets.

If you experience a problem with your computer, you can complete the following steps to diagnose and troubleshoot the problem:

- 1 See "Troubleshooting" on page 61 for information and procedures that pertain to the problem your computer is experiencing.
- 2 See "Dell Diagnostics" on page 86 for procedures on how to run Dell Diagnostics.
- 3 Fill out the "Diagnostics Checklist" on page 199.
- 4 Use Dell's extensive suite of online services available at Dell Support (support.dell.com) for help with installation and troubleshooting procedures. See "Online Services" on page 196 for a more extensive list of Dell Support online.
- 5 If the preceding steps have not resolved the problem, see "Contacting Dell" on page 200.

 **NOTE:** Call Dell Support from a telephone near or at the computer so that the support staff can assist you with any necessary procedures.

 **NOTE:** Dell's Express Service Code system may not be available in all countries.

When prompted by Dell's automated telephone system, enter your Express Service Code to route the call directly to the proper support personnel. If you do not have an Express Service Code, open the **Dell Accessories** folder, double-click the **Express Service Code** icon, and follow the directions.

For instructions on using the Dell Support, see "Technical Support and Customer Service" on page 196.

 **NOTE:** Some of the following services are not always available in all locations outside the continental U.S. Call your local Dell representative for information on availability.

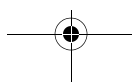
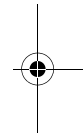
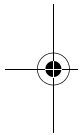



Technical Support and Customer Service

Dell's support service is available to answer your questions about Dell™ hardware. Our support staff uses computer-based diagnostics to provide fast, accurate answers.

To contact Dell's support service, see "Before You Call" on page 198, and then see the contact information for your region or go to support.dell.com.

DellConnect

DellConnect is a simple online access tool that allows a Dell service and support associate to access your computer through a broadband connection, diagnose your problem and repair it all under your supervision. For more information, go to support.dell.com and click DellConnect.

Online Services

You can learn about Dell products and services on the following websites:

www.dell.com

www.dell.com/ap (Asian/Pacific countries only)

www.dell.com/jp (Japan only)

www.euro.dell.com (Europe only)

www.dell.com/la (Latin American and Caribbean countries)

www.dell.ca (Canada only)

You can access Dell Support through the following websites and e-mail addresses:

- Dell Support websites

support.dell.com

support.jp.dell.com (Japan only)

support.euro.dell.com (Europe only)

- Dell Support e-mail addresses

mobile_support@us.dell.com

support@us.dell.com

la-techsupport@dell.com (Latin America and Caribbean countries only)

apsupport@dell.com (Asian/Pacific countries only)

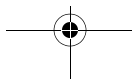

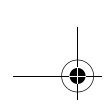

- Dell Marketing and Sales e-mail addresses
apmarketing@dell.com (Asian/Pacific countries only)
sales_canada@dell.com (Canada only)
- Anonymous file transfer protocol (FTP)
ftp.dell.com
Log in as user: anonymous, and use your e-mail address as your password.

AutoTech Service

Dell's automated support service—AutoTech—provides recorded answers to the questions most frequently asked by Dell customers about their portable and desktop computers.

When you call AutoTech, use your touch-tone telephone to select the subjects that correspond to your questions. For the telephone number to call for your region, see "Contacting Dell" on page 200.

Automated Order-Status Service

To check on the status of any Dell products that you have ordered, you can go to support.dell.com, or you can call the automated order-status service. A recording prompts you for the information needed to locate and report on your order. For the telephone number to call for your region, see "Contacting Dell" on page 200.

Problems With Your Order

If you have a problem with your order, such as missing parts, wrong parts, or incorrect billing, contact Dell for customer assistance. Have your invoice or packing slip handy when you call. For the telephone number to call for your region, see "Contacting Dell" on page 200.

Product Information

If you need information about additional products available from Dell, or if you would like to place an order, visit the Dell website at www.dell.com. For the telephone number to call for your region or to speak to a sales specialist, see the "Contacting Dell" on page 200.

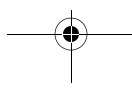



Returning Items for Warranty Repair or Credit

Prepare all items being returned, whether for repair or credit, as follows:

- 1 Call Dell to obtain a Return Material Authorization Number, and write it clearly and prominently on the outside of the box.
For the telephone number to call for your region, see "Contacting Dell" on page 200.
- 2 Include a copy of the invoice and a letter describing the reason for the return.
- 3 Include a copy of the Diagnostics Checklist (see "Diagnostics Checklist" on page 199), indicating the tests that you have run and any error messages reported by the Dell Diagnostics (see "Dell Diagnostics" on page 86).
- 4 Include any accessories that belong with the item(s) being returned (power cables, software floppy disks, guides, and so on) if the return is for credit.
- 5 Pack the equipment to be returned in the original (or equivalent) packing materials.

You are responsible for paying shipping expenses. You are also responsible for insuring any product returned, and you assume the risk of loss during shipment to Dell. Collect On Delivery (C.O.D.) packages are not accepted.

Returns that are missing any of the preceding requirements will be refused at Dell's receiving dock and returned to you.

Before You Call



NOTE: Have your Express Service Code ready when you call. The code helps Dell's automated-support telephone system direct your call more efficiently. You may also be asked for your Service Tag (located on the back or bottom of your computer).

Remember to fill out the Diagnostics Checklist (see "Diagnostics Checklist" on page 199). If possible, turn on your computer before you call Dell for assistance and call from a telephone at or near the computer. You may be asked to type some commands at the keyboard, relay detailed information during operations, or try other troubleshooting steps possible only at the computer itself. Ensure that the computer documentation is available.



CAUTION: Before working inside your computer, follow the safety instructions in your *Product Information Guide*.

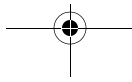

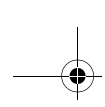

Diagnostics Checklist

Name:

Date:

Address:

Phone number:

Service Tag (bar code on the back or bottom of the computer):

Express Service Code:

Return Material Authorization Number (if provided by Dell support technician):

Operating system and version:

Devices:

Expansion cards:

Are you connected to a network? Yes No

Network, version, and network adapter:

Programs and versions:

See your operating system documentation to determine the contents of the system's start-up files. If the computer is connected to a printer, print each file. Otherwise, record the contents of each file before calling Dell.

Error message, beep code, or diagnostic code:

Description of problem and troubleshooting procedures you performed:

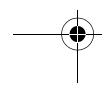
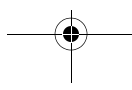
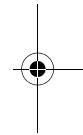
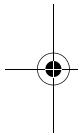

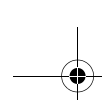

Contacting Dell

 **NOTE:** If you do not have an active Internet connection, you can find contact information on your purchase invoice, packing slip, bill, or Dell product catalog.

Dell provides several online and telephone-based support and service options. Availability varies by country and product, and some services may not be available in your area. To contact Dell for sales, technical support, or customer service issues:

- 1 Visit support.dell.com.
- 2 Verify your country or region in the **Choose A Country/Region** drop-down menu at the bottom of the page.
- 3 Click **Contact Us** on the left side of the page.
- 4 Select the appropriate service or support link based on your need.

Choose the method of contacting Dell that is convenient for you.

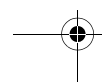
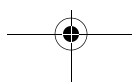
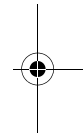
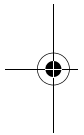

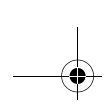

Glossary

Terms in this Glossary are provided for informational purposes only and may or may not describe features included with your particular computer.

A

AC — alternating current — The form of electricity that powers your computer when you plug the AC adapter power cable in to an electrical outlet.

ACPI — advanced configuration and power interface — A power management specification that enables Microsoft® Windows® operating systems to put a computer in standby or hibernate mode to conserve the amount of electrical power allocated to each device attached to the computer.

AGP — accelerated graphics port — A dedicated graphics port that allows system memory to be used for video-related tasks. AGP delivers a smooth, true-color video image because of the faster interface between the video circuitry and the computer memory.

AHCI — Advanced Host Controller Interface — An interface for a SATA hard drive Host Controller which allows the storage driver to enable technologies such as Native Command Queuing (NCQ) and hot plug.

ALS — ambient light sensor — A feature that helps to control display brightness.

antivirus software — A program designed to identify, quarantine, and/or delete viruses from your computer.

ASF — alert standards format — A standard to define a mechanism for reporting hardware and software alerts to a management console. ASF is designed to be platform- and operating system-independent.

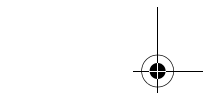
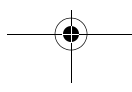
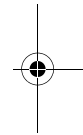
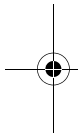

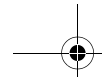

B

battery life span — The length of time (years) during which a portable computer battery is able to be depleted and recharged.

battery operating time — The length of time (minutes or hours) that a portable computer battery powers the computer.

BIOS — basic input/output system — A program (or utility) that serves as an interface between the computer hardware and the operating system. Unless you understand what effect these settings have on the computer, do not change them. Also referred to as *system setup*.

bit — The smallest unit of data interpreted by your computer.

Blu-ray Disc™ (BD)— An optical storage technology offering storage capacity of up to 50 GB, full 1080p video resolution (HDTV required), and as many as 7.1 channels of native, uncompressed surround sound.

Bluetooth® wireless technology — A wireless technology standard for short-range (9 m [29 feet]) networking devices that allows for enabled devices to automatically recognize each other.

boot sequence — Specifies the order of the devices from which the computer attempts to boot.

bootable media — A CD, DVD, or floppy disk that you can use to start your computer. In case your hard drive is damaged or your computer has a virus, ensure that you always have a bootable CD, DVD, or floppy disk available. Your *Drivers and Utilities* media is an example of bootable media.

bps — bits per second — The standard unit for measuring data transmission speed.

BTU — British thermal unit — A measurement of heat output.

bus — A communication pathway between the components in your computer.

bus speed — The speed, given in MHz, that indicates how fast a bus can transfer information.

byte — The basic data unit used by your computer. A byte is usually equal to 8 bits.

C

C — Celsius — A temperature measurement scale where 0° is the freezing point and 100° is the boiling point of water.

cache — A special high-speed storage mechanism which can be either a reserved section of main memory or an independent high-speed storage device. The cache enhances the efficiency of many processor operations.

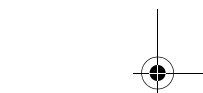
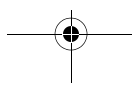

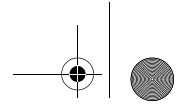

L1 cache — Primary cache stored inside the processor.

L2 cache — Secondary cache which can either be external to the processor or incorporated into the processor architecture.

carnet — An international customs document that facilitates temporary imports into foreign countries. Also known as a *merchandise passport*.

CD-R — CD recordable — A recordable version of a CD. Data can be recorded only once onto a CD-R. Once recorded, the data cannot be erased or written over.

CD-RW — CD rewritable — A rewritable version of a CD. Data can be written to a CD-RW disc, and then erased and written over (rewritten).

CD-RW drive — A drive that can read CDs and write to CD-RW (rewritable CDs) and CD-R (recordable CDs) discs. You can write to CD-RW discs multiple times, but you can write to CD-R discs only once.

CD-RW/DVD drive — A drive, sometimes referred to as a combo drive, that can read CDs and DVDs and write to CD-RW (rewritable CDs) and CD-R (recordable CDs) discs. You can write to CD-RW discs multiple times, but you can write to CD-R discs only once.

clock speed — The speed, given in MHz, that indicates how fast computer components that are connected to the system bus operate.

CMOS — A type of electronic circuit. Computers use a small amount of battery-powered CMOS memory to hold date, time, and system setup options.

COA — Certificate of Authenticity — The Windows alpha-numeric code located on a sticker on your computer. Also referred to as the *Product Key* or *Product ID*.

Control Panel — A Windows utility that allows you to modify operating system and hardware settings, such as display settings.

controller — A chip that controls the transfer of data between the processor and memory or between the processor and devices.

CRIMM — continuity rambus in-line memory module — A special module that has no memory chips and is used to fill unused RIMM slots.

cursor — The marker on a display or screen that shows where the next keyboard, touch pad, or mouse action will occur. It often is a blinking solid line, an underline character, or a small arrow.

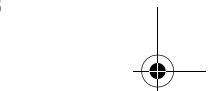
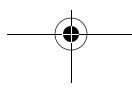
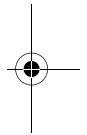
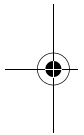

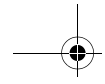

D

DDR SDRAM — double-data-rate SDRAM — A type of SDRAM that doubles the data burst cycle, improving system performance.

DDR2 SDRAM — double-data-rate 2 SDRAM — A type of DDR SDRAM that uses a 4-bit prefetch and other architectural changes to boost memory speed to over 400 MHz.

device — Hardware such as a disk drive, printer, or keyboard that is installed in or connected to your computer.

device driver — See *driver*.

DIMM — dual in-line memory module — A circuit board with memory chips that connects to a memory module on the system board.

DIN connector — A round, six-pin connector that conforms to DIN (Deutsche Industrie-Norm) standards; it is typically used to connect PS/2 keyboard or mouse cable connectors.

disk striping — A technique for spreading data over multiple disk drives. Disk striping can speed up operations that retrieve data from disk storage. Computers that use disk striping generally allow the user to select the data unit size or stripe width.

DMA — direct memory access — A channel that allows certain types of data transfer between RAM and a device to bypass the processor.

docking device — See *APR*.

DMTF — Distributed Management Task Force — A consortium of hardware and software companies who develop management standards for distributed desktop, network, enterprise, and Internet environments.

domain — A group of computers, programs, and devices on a network that are administered as a unit with common rules and procedures for use by a specific group of users. A user logs on to the domain to gain access to the resources.

DRAM — dynamic random-access memory — Memory that stores information in integrated circuits containing capacitors.

driver — Software that allows the operating system to control a device such as a printer. Many devices do not work properly if the correct driver is not installed in the computer.

DSL — Digital Subscriber Line — A technology that provides a constant, high-speed Internet connection through an analog telephone line.

dual-core — A technology in which two physical computational units exist inside a single processor package, thereby increasing computing efficiency and multi-tasking ability.

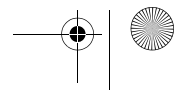
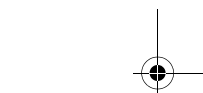
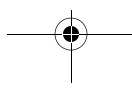

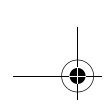

dual display mode — A display setting that allows you to use a second monitor as an extension of your display. Also referred to as *extended display mode*.

DVD-R — DVD recordable — A recordable version of a DVD. Data can be recorded only once onto a DVD-R. Once recorded, the data cannot be erased or written over.

DVD+RW — DVD rewritable — A rewritable version of a DVD. Data can be written to a DVD+RW disc, and then erased and written over (rewritten). (DVD+RW technology is different from DVD-RW technology.)

DVD+RW drive — drive that can read DVDs and most CD media and write to DVD+RW (rewritable DVDs) discs.

DVI — digital video interface — A standard for digital transmission between a computer and a digital video display.

E

ECC — error checking and correction — A type of memory that includes special circuitry for testing the accuracy of data as it passes in and out of memory.

ECP — extended capabilities port — A parallel connector design that provides improved bidirectional data transmission. Similar to EPP, ECP uses direct memory access to transfer data and often improves performance.

EIDE — enhanced integrated device electronics — An improved version of the IDE interface for hard drives and CD drives.

EMI — electromagnetic interference — Electrical interference caused by electromagnetic radiation.

ENERGY STAR® — Environmental Protection Agency requirements that decrease the overall consumption of electricity.

EPP — enhanced parallel port — A parallel connector design that provides bidirectional data transmission.

ESD — electrostatic discharge — A rapid discharge of static electricity. ESD can damage integrated circuits found in computer and communications equipment.

expansion card — A circuit board that installs in an expansion slot on the system board in some computers, expanding the capabilities of the computer. Examples include video, modem, and sound cards.

expansion slot — A connector on the system board (in some computers) where you insert an expansion card, connecting it to the system bus.

ExpressCard — A removable I/O card adhering to the PCMCIA standard. Modems and network adapters are common types of ExpressCards. ExpressCards support both the PCI Express and USB 2.0 standard.

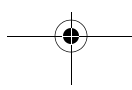
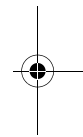
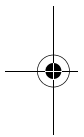

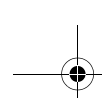

Express Service Code — A numeric code located on a sticker on your Dell™ computer. Use the Express Service Code when contacting Dell for assistance. Express Service Code service may not be available in some countries.

extended display mode — A display setting that allows you to use a second monitor as an extension of your display. Also referred to as *dual display mode*.

extended PC Card — A PC Card that extends beyond the edge of the PC Card slot when installed.

F

Fahrenheit — A temperature measurement scale where 32° is the freezing point and 212° is the boiling point of water.

FBD — fully-buffered DIMM — A DIMM with DDR2 DRAM chips and an Advanced Memory Buffer (AMB) that speeds communication between the DDR2 SDRAM chips and the system.

FCC — Federal Communications Commission — A U.S. agency responsible for enforcing communications-related regulations that state how much radiation computers and other electronic equipment can emit.

fingerprint reader — A strip sensor that uses your unique fingerprint to authenticate your user identity to help secure your computer.

folder — A term used to describe space on a disk or drive where files are organized and grouped. Files in a folder can be viewed and ordered in various ways, such as alphabetically, by date, and by size.

format — The process that prepares a drive or disk for file storage. When a drive or disk is formatted, the existing information on it is lost.

FSB — front side bus — The data path and physical interface between the processor and RAM.

FTP — file transfer protocol — A standard Internet protocol used to exchange files between computers connected to the Internet.

G

G — gravity — A measurement of weight and force.

GB — gigabyte — A measurement of data storage that equals 1024 MB (1,073,741,824 bytes). When used to refer to hard drive storage, the term is often rounded to 1,000,000,000 bytes.

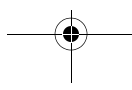
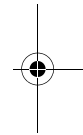
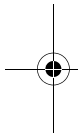

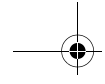

GHz — gigahertz — A measurement of frequency that equals one thousand million Hz, or one thousand MHz. The speeds for computer processors, buses, and interfaces are often measured in GHz.

graphics mode — A video mode that can be defined as x horizontal pixels by y vertical pixels by z colors. Graphics modes can display an unlimited variety of shapes and fonts.

GUI — graphical user interface — Software that interacts with the user by means of menus, windows, and icons. Most programs that operate on the Windows operating systems are GUIs.

H

hard drive — A drive that reads and writes data on a hard disk. The terms hard drive and hard disk are often used interchangeably.

heat sink — A metal plate on some processors that helps dissipate heat.

hibernate mode — A power management mode that saves everything in memory to a reserved space on the hard drive and then turns off the computer. When you restart the computer, the memory information that was saved to the hard drive is automatically restored.

HTTP — hypertext transfer protocol — A protocol for exchanging files between computers connected to the Internet.

Hyper-Threading — Hyper-Threading is an Intel technology that can enhance overall computer performance by allowing one physical processor to function as two logical processors, capable of performing certain tasks simultaneously.

Hz — hertz — A unit of frequency measurement that equals 1 cycle per second. Computers and electronic devices are often measured in kilohertz (kHz), megahertz (MHz), gigahertz (GHz), or terahertz (THz).

I

IC — integrated circuit — A semiconductor wafer, or chip, on which thousands or millions of tiny electronic components are fabricated for use in computer, audio, and video equipment.

IDE — integrated device electronics — An interface for mass storage devices in which the controller is integrated into the hard drive or CD drive.

IEEE 1394 — Institute of Electrical and Electronics Engineers, Inc. — A high-performance serial bus used to connect IEEE 1394-compatible devices, such as digital cameras and DVD players, to the computer.

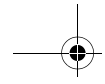

infrared sensor — A port that allows you to transfer data between the computer and infrared-compatible devices without using a cable connection.

integrated — Usually refers to components that are physically located on the computer's system board. Also referred to as *built-in*.

I/O — input/output — An operation or device that enters and extracts data from your computer. Keyboards and printers are I/O devices.

I/O address — An address in RAM that is associated with a specific device (such as a serial connector, parallel connector, or expansion slot) and allows the processor to communicate with that device.

IrDA — Infrared Data Association — The organization that creates international standards for infrared communications.

IRQ — interrupt request — An electronic pathway assigned to a specific device so that the device can communicate with the processor. Each device connection must be assigned an IRQ. Although two devices can share the same IRQ assignment, you cannot operate both devices simultaneously.

ISP — Internet service provider — A company that allows you to access its host server to connect directly to the Internet, send and receive e-mail, and access websites. The ISP typically provides you with a software package, user name, and access phone numbers for a fee.

K

Kb — kilobit — A unit of data that equals 1024 bits. A measurement of the capacity of memory integrated circuits.

KB — kilobyte — A unit of data that equals 1024 bytes but is often referred to as 1000 bytes.

key combination — A command requiring you to press multiple keys at the same time.

kHz — kilohertz — A measurement of frequency that equals 1000 Hz.

L

LAN — local area network — A computer network covering a small area. A LAN usually is confined to a building or a few nearby buildings. A LAN can be connected to another LAN over any distance through telephone lines and radio waves to form a wide area network (WAN).

LCD — liquid crystal display — The technology used by portable computer and flat-panel displays.

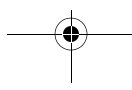

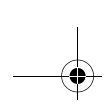

LED — light-emitting diode — An electronic component that emits light to indicate the status of the computer.

local bus — A data bus that provides a fast throughput for devices to the processor.

LPT — line print terminal — The designation for a parallel connection to a printer or other parallel device.

M

Mb — megabit — A measurement of memory chip capacity that equals 1024 Kb.

Mbps — megabits per second — One million bits per second. This measurement is typically used for transmission speeds for networks and modems.

MB — megabyte — A measurement of data storage that equals 1,048,576 bytes. 1 MB equals 1024 KB. When used to refer to hard drive storage, the term is often rounded to 1,000,000 bytes.

MB/sec — megabytes per second — One million bytes per second. This measurement is typically used for data transfer ratings.

media bay — A bay that supports devices such as optical drives, a second battery, or a Dell TravelLite™ module.

memory — A temporary data storage area inside your computer. Because the data in memory is not permanent, it is recommended that you frequently save your files while you are working on them, and always save your files before you shut down the computer. Your computer can contain several different forms of memory, such as RAM, ROM, and video memory. Frequently, the word memory is used as a synonym for RAM.

memory address — A specific location where data is temporarily stored in RAM.

memory mapping — The process by which the computer assigns memory addresses to physical locations at start-up. Devices and software can then identify information that the processor can access.

memory module — A small circuit board containing memory chips, which connects to the system board.

MHz — megahertz — A measure of frequency that equals 1 million cycles per second. The speeds for computer processors, buses, and interfaces are often measured in MHz.

Mini PCI — A standard for integrated peripheral devices with an emphasis on communications such as modems and NICs. A Mini PCI card is a small external card that is functionally equivalent to a standard PCI expansion card.

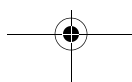
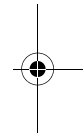
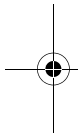

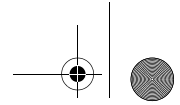

Mini-Card — A small card designed for integrated peripherals, such as communication NICs. The Mini-Card is functionally equivalent to a standard PCI expansion card.

modem — A device that allows your computer to communicate with other computers over analog telephone lines. Three types of modems include: external, PC Card, and internal. You typically use your modem to connect to the Internet and exchange e-mail.

module bay — See *media bay*.

MP — megapixel — A measure of image resolution used for digital cameras.

ms — millisecond — A measure of time that equals one thousandth of a second. Access times of storage devices are often measured in ms.

N

network adapter — A chip that provides network capabilities. A computer may include a network adapter on its system board, or it may contain a PC Card with an adapter on it. A network adapter is also referred to as a *NIC* (network interface controller).

NIC — See *network adapter*.

notification area — The section of the Windows taskbar that contains icons for providing quick access to programs and computer functions, such as the clock, volume control, and print status. Also referred to as *system tray*.

ns — nanosecond — A measure of time that equals one billionth of a second.

NVRAM — nonvolatile random access memory — A type of memory that stores data when the computer is turned off or loses its external power source. NVRAM is used for maintaining computer configuration information such as date, time, and other system setup options that you can set.

O

optical drive — A drive that uses optical technology to read or write data from CDs, DVDs, or DVD+RWs. Example of optical drives include CD drives, DVD drives, CD-RW drives, and CD-RW/DVD combo drives.

P

parallel connector — An I/O port often used to connect a parallel printer to your computer. Also referred to as an *LPT port*.

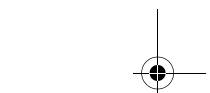
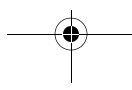

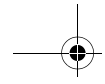

partition — A physical storage area on a hard drive that is assigned to one or more logical storage areas known as logical drives. Each partition can contain multiple logical drives.

PC Card — A removable I/O card adhering to the PCMCIA standard. Modems and network adapters are common types of PC Cards.

PCI — peripheral component interconnect — PCI is a local bus that supports 32- and 64-bit data paths, providing a high-speed data path between the processor and devices such as video, drives, and networks.

PCI Express — A modification to the PCI interface that boosts the data transfer rate between the processor and the devices attached to it. PCI Express can transfer data at speeds from 250 MB/sec to 4 GB/sec. If the PCI Express chip set and the device are capable of different speeds, they will operate at the slower speed.

PCMCIA — Personal Computer Memory Card International Association — The organization that establishes standards for PC Cards.

PIO — programmed input/output — A method of transferring data between two devices through the processor as part of the data path.

pixel — A single point on a display screen. Pixels are arranged in rows and columns to create an image. A video resolution, such as 800 x 600, is expressed as the number of pixels across by the number of pixels up and down.

Plug-and-Play — The ability of the computer to automatically configure devices. Plug and Play provides automatic installation, configuration, and compatibility with existing hardware if the BIOS, operating system, and all devices are Plug and Play compliant.

POST — Power-On Self-Test — Diagnostics programs, loaded automatically by the BIOS, that perform basic tests on the major computer components, such as memory, hard drives, and video. If no problems are detected during POST, the computer continues the start-up.

processor — A computer chip that interprets and executes program instructions. Sometimes the processor is referred to as the CPU (central processing unit).

PS/2 — personal system/2 — A type of connector for attaching a PS/2-compatible keyboard, mouse, or keypad.

PXE — pre-boot execution environment — A WfM (Wired for Management) standard that allows networked computers that do not have an operating system to be configured and started remotely.

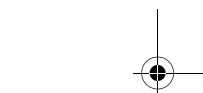
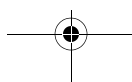
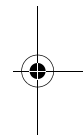
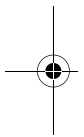

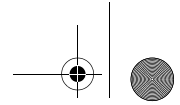

R

RAID — redundant array of independent disks — A method of providing data redundancy. Some common implementations of RAID include RAID 0, RAID 1, RAID 5, RAID 10, and RAID 50.

RAM — random-access memory — The primary temporary storage area for program instructions and data. Any information stored in RAM is lost when you shut down your computer.

readme file — A text file included with a software package or hardware product. Typically, readme files provide installation information and describe new product enhancements or corrections that have not yet been documented.

read-only — Data and/or files you can view but cannot edit or delete. A file can have read-only status if:

- It resides on a physically write-protected floppy disk, CD, or DVD.
- It is located on a network in a directory and the system administrator has assigned rights only to specific individuals.

refresh rate — The frequency, measured in Hz, at which your screen's horizontal lines are recharged (sometimes also referred to as its *vertical frequency*). The higher the refresh rate, the less video flicker can be seen by the human eye.

resolution — The sharpness and clarity of an image produced by a printer or displayed on a monitor. The higher the resolution, the sharper the image.

RFI — radio frequency interference — Interference that is generated at typical radio frequencies, in the range of 10 kHz to 100,000 MHz. Radio frequencies are at the lower end of the electromagnetic frequency spectrum and are more likely to have interference than the higher frequency radiations, such as infrared and light.

ROM — read-only memory — Memory that stores data and programs that cannot be deleted or written to by the computer. ROM, unlike RAM, retains its contents after you shut down your computer. Some programs essential to the operation of your computer reside in ROM.

RPM — revolutions per minute — The number of rotations that occur per minute. Hard drive speed is often measured in rpm.

RTC — real time clock — Battery-powered clock on the system board that keeps the date and time after you shut down the computer.

RTCST — real-time clock reset — A jumper on the system board of some computers that can often be used for troubleshooting problems.

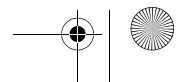
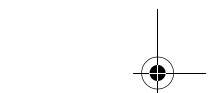
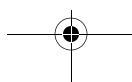

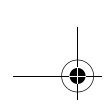

S

SAS — serial attached SCSI — A faster, serial version of the SCSI interface (as opposed to the original SCSI parallel architecture).

SATA — serial ATA — A faster, serial version of the ATA (IDE) interface.

ScanDisk — A Microsoft utility that checks files, folders, and the hard disk's surface for errors. ScanDisk often runs when you restart the computer after it has stopped responding.

SCSI — small computer system interface — A high-speed interface used to connect devices to a computer, such as hard drives, CD drives, printers, and scanners. The SCSI can connect many devices using a single controller. Each device is accessed by an individual identification number on the SCSI controller bus.

SDRAM — synchronous dynamic random-access memory — A type of DRAM that is synchronized with the optimal clock speed of the processor.

serial connector — An I/O port often used to connect devices such as a handheld digital device or digital camera to your computer.

Service Tag — A bar code label on your computer that identifies your computer when you access Dell Support at support.dell.com or when you call Dell for customer service or technical support.

setup program — A program that is used to install and configure hardware and software. The **setup.exe** or **install.exe** program comes with most Windows software packages. *Setup program* differs from *system setup*.

shortcut — An icon that provides quick access to frequently used programs, files, folders, and drives. When you place a shortcut on your Windows desktop and double-click the icon, you can open its corresponding folder or file without having to find it first. Shortcut icons do not change the location of files. If you delete a shortcut, the original file is not affected. Also, you can rename a shortcut icon.

SIM — Subscriber Identity Module — A SIM card contains a microchip that encrypts voice and data transmissions. SIM cards can be used in phones or portable computers.

smart card — A card that is embedded with a processor and a memory chip. Smart cards can be used to authenticate a user on computers equipped for smart cards.

S/PDIF — Sony/Philips Digital Interface — An audio transfer file format that allows the transfer of audio from one file to another without converting it to and from an analog format, which could degrade the quality of the file.

standby mode — A power management mode that shuts down all unnecessary computer operations to save energy.

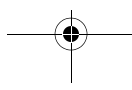
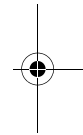
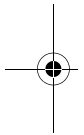

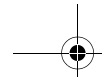

StrikeZone™ — Reinforced area of the platform base that protects the hard drive by acting as a dampening device when a computer experiences resonating shock or is dropped (whether the computer is on or off).

surge protectors — Prevent voltage spikes, such as those that may occur during an electrical storm, from entering the computer through the electrical outlet. Surge protectors do not protect against lightning strikes or against brownouts, which occur when the voltage drops more than 20 percent below the normal AC-line voltage level.

Network connections cannot be protected by surge protectors. Always disconnect the network cable from the network connector during electrical storms.

SVGA — super-video graphics array — A video standard for video cards and controllers. Typical SVGA resolutions are 800 x 600 and 1024 x 768.

The number of colors and resolution that a program displays depends on the capabilities of the monitor, the video controller and its drivers, and the amount of video memory installed in the computer.

S-video TV-out — A connector used to attach a TV or digital audio device to the computer.

SXGA — super-extended graphics array — A video standard for video cards and controllers that supports resolutions up to 1280 x 1024.

SXGA+ — super-extended graphics array plus — A video standard for video cards and controllers that supports resolutions up to 1400 x 1050.

system board — The main circuit board in your computer. Also known as the *motherboard*.

system setup — A utility that serves as an interface between the computer hardware and the operating system. System setup allows you to configure user-selectable options in the BIOS, such as date and time or system password. Unless you understand what effect the settings have on the computer, do not change the settings for this program.

T

TAPI — telephony application programming interface — Enables Windows programs to operate with a wide variety of telephony devices, including voice, data, fax, and video.

text editor — A program used to create and edit files that contain only text; for example, Windows Notepad uses a text editor. Text editors do not usually provide word wrap or formatting functionality (the option to underline, change fonts, and so on).

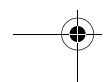
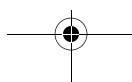

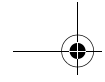

TPM — trusted platform module — A hardware-based security feature that when combined with security software enhances network and computer security by enabling features such as file and e-mail protection.

travel module — A plastic device designed to fit inside the module bay of a portable computer to reduce the weight of the computer.

U

UAC — user account control— Microsoft Windows Vista™ security feature that, when enabled, provides an added layer of security between user accounts and access to operating system settings.

UMA — unified memory allocation — System memory dynamically allocated to video.

UPS — uninterruptible power supply — A backup power source used when the electrical power fails or drops to an unacceptable voltage level. A UPS keeps a computer running for a limited amount of time when there is no electrical power. UPS systems typically provide surge suppression and may also provide voltage regulation. Small UPS systems provide battery power for a few minutes to enable you to shut down your computer.

USB — universal serial bus — A hardware interface for a low-speed device such as a USB-compatible keyboard, mouse, joystick, scanner, set of speakers, printer, broadband devices (DSL and cable modems), imaging devices, or storage devices. Devices are plugged directly in to a 4-pin socket on your computer or in to a multi-port hub that plugs in to your computer. USB devices can be connected and disconnected while the computer is turned on, and they can also be daisy-chained together.

UTP — unshielded twisted pair — Describes a type of cable used in most telephone networks and some computer networks. Pairs of unshielded wires are twisted to protect against electromagnetic interference, rather than relying on a metal sheath around each pair of wires to protect against interference.

UXGA — ultra extended graphics array — A video standard for video cards and controllers that supports resolutions up to 1600 x 1200.

V

video controller — The circuitry on a video card or on the system board (in computers with an integrated video controller) that provides the video capabilities—in combination with the monitor—for your computer.

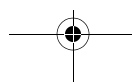
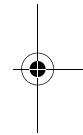
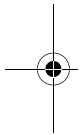

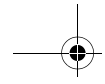

video memory — Memory that consists of memory chips dedicated to video functions. Video memory is usually faster than system memory. The amount of video memory installed primarily influences the number of colors that a program can display.

video mode — A mode that describes how text and graphics are displayed on a monitor. Graphics-based software, such as Windows operating systems, displays in video modes that can be defined as x horizontal pixels by y vertical pixels by z colors. Character-based software, such as text editors, displays in video modes that can be defined as x columns by y rows of characters.

video resolution — See *resolution*.

virus — A program that is designed to inconvenience you or to destroy data stored on your computer. A virus program moves from one computer to another through an infected disk, software downloaded from the Internet, or e-mail attachments. When an infected program starts, its embedded virus also starts.

A common type of virus is a boot virus, which is stored in the boot sectors of a floppy disk. If the floppy disk is left in the drive when the computer is shut down and then turned on, the computer is infected when it reads the boot sectors of the floppy disk expecting to find the operating system. If the computer is infected, the boot virus may replicate itself onto all the floppy disks that are read or written in that computer until the virus is eradicated.

V — volt — The measurement of electric potential or electromotive force. One V appears across a resistance of 1 ohm when a current of 1 ampere flows through that resistance.

W

W — watt — The measurement of electrical power. One W is 1 ampere of current flowing at 1 volt.

W_h — watt-hour — A unit of measure commonly used to indicate the approximate capacity of a battery. For example, a 66-W_h battery can supply 66 W of power for 1 hour or 33 W for 2 hours.

wallpaper — The background pattern or picture on the Windows desktop. Change your wallpaper through the Windows Control Panel. You can also scan in your favorite picture and make it wallpaper.

WLAN — wireless local area network. A series of interconnected computers that communicate with each other over the air waves using access points or wireless routers to provide Internet access.

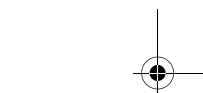
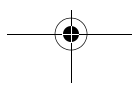

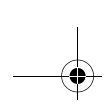

write-protected — Files or media that cannot be changed. Use write-protection when you want to protect data from being changed or destroyed. To write-protect a 3.5-inch floppy disk, slide its write-protect tab to the open position.

WWAN — wireless wide area network. A wireless high-speed data network using cellular technology and covering a much larger geographic area than WLAN.

WXGA — wide-aspect extended graphics array — A video standard for video cards and controllers that supports resolutions up to 1280 x 800."

X

XGA — extended graphics array — A video standard for video cards and controllers that supports resolutions up to 1024 x 768.

Z

ZIF — zero insertion force — A type of socket or connector that allows a computer chip to be installed or removed with no stress applied to either the chip or its socket.

Zip — A popular data compression format. Files that have been compressed with the Zip format are called Zip files and usually have a filename extension of **.zip**. A special kind of zipped file is a self-extracting file, which has a filename extension of **.exe**. You can unzip a self-extracting file by double-clicking it.

Zip drive — A high-capacity floppy drive developed by Iomega Corporation that uses 3.5-inch removable disks called Zip disks. Zip disks are slightly larger than regular floppy disks, about twice as thick, and hold up to 100 MB of data.

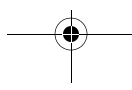
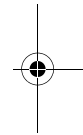
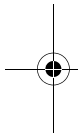

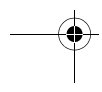
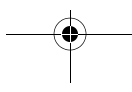
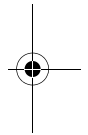
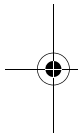
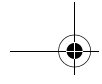

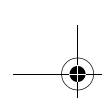

Index

A

audio. *See sound*

B

battery

- problems, 61
- replacing, 170

beep codes, 81

BIOS, 178

boot sequence

- about, 186
- changing, 187-188
- option settings, 186

booting

- to a USB device, 187

C

cards

- installing PCI Express, 116
- PCI Express, 115
- removing PCI, 114
- removing PCI Express, 121
- slots, 20

CD-RW drive

- problems, 62

CDs

- playing, 42

Check Disk, 63

cleaning your computer, 191

CMOS settings

- clearing, 190

computer

- beep codes, 81
- components inside, 102
- crashes, 66-67
- inside view, 102
- stops responding, 66

conflicts

- software and hardware incompatibilities, 93

connectors

- headphone, 18
- IEEE, 16, 18
- network adapter, 21
- power, 19
- USB, 18

contacting Dell, 200

copying CDs

- helpful tips, 46
- how to, 44-45

copying DVDs

- helpful tips, 46
- how to, 44-45

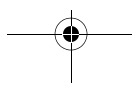
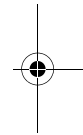
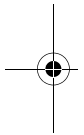

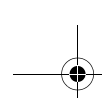

cover
replacing, 172
CPU overclocking, 59

D

Dell
contacting, 193, 200
support site, 13
Dell Diagnostics, 86
Dell Premier Support website, 12
DellConnect, 196
Device Driver Rollback, 91
diagnostic lights, 76
diagnostics
beep codes, 81
Dell, 86
lights, 76
display. See *monitor*
documentation
End User License Agreement, 12
ergonomics, 12
online, 13
Product Information Guide, 12
regulatory, 12
safety, 12
warranty, 12
drive panel, 124
removing, 124
replacing, 127

drive-panel insert
removing, 125
replacing, 126
drivers
about, 90
identifying, 91
reinstalling, 91
Drivers and Utilities Media, 92
drives
problems, 62
RAID, 30
dual graphics technology, 59
dual monitors, 25
DVDs
playing, 42

E

e-mail
problems, 63
End User License Agreement, 12
ergonomics information, 12
error messages
beep codes, 81
diagnostic lights, 76
problems, 64
system, 83

F

Factory Image Restore, 95

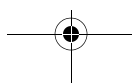
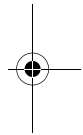
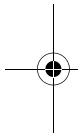

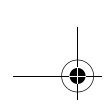

G

Graphics
Dual Graphics, 59

H

hard drive
problems, 63

hardware
beep codes, 81
conflicts, 93
Dell Diagnostics, 86
drives, RAID configuration, 30

Hardware Troubleshooter, 93

headphone
connector, 18

Help and Support, 14

hibernate mode, 57

I

IEEE
connectors, 16, 18

IEEE 1394
problems, 65

installing parts
before you begin, 99
recommended tools, 99
turning off your computer, 99

Internet
problems, 63

Internet connection
about, 54
options, 54
setting up, 54

IRQ conflicts, 93

K

keyboard
problems, 65

L

labels
Microsoft Windows, 12
Service Tag, 12

lights
diagnostic, 76
front of computer, 76
link integrity, 21
network, 21
network activity, 21

M

media
operating system, 14

Media Card Reader
installing, 140, 142
removing, 140

media card reader
using, 47

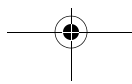

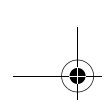

memory
 problems, 68

messages
 error, 64
 system, 83

Microsoft Windows label, 12

modem
 problems, 63

monitor
 blank, 73
 clone mode, 30
 connect DVI, 24, 26
 connect TV, 24
 connect VGA, 24-26
 connecting, 24
 connecting two, 25-26
 display settings, 30
 dual monitors, 24
 extended desktop mode, 30
 hard to read, 73
 problems, 73

motherboard. See *system board*

mouse
 problems, 68

N

network
 connector, 21
 Network Setup Wizard, 55
 problems, 69

Network Setup Wizard, 55

O

operating system
 media, 14, 96
 reinstalling, 14
 reinstalling Windows Vista, 94
 reinstalling Windows XP, 94

optical drive
 problems, 62

overclocking, 59, 182

P

password
 clearing, 188
 jumper, 188

PCI cards
 removing, 114

PCI Express cards
 installing, 116
 removing, 121

performance, 59

phone numbers, 200

playing CDs, 42

playing DVDs, 42

power
 connector, 19
 hibernate mode, 57
 problems, 69
 sleep mode, 56

power light, 75
 conditions, 69

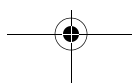

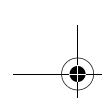

printer

- cable, 52
- connecting, 52
- problems, 71
- setting up, 52
- USB, 52

problems

- battery, 61
- beep codes, 81
- blue screen, 67
- CD-RW drive, 62
- computer crashes, 66-67
- computer stops responding, 66
- conflicts, 93
- Dell Diagnostics, 86
- diagnostic lights, 76
- drives, 62
- e-mail, 63
- error messages, 64
- general, 66
- hard drive, 63
- IEEE 1394, 65
- Internet, 63
- keyboard, 65
- memory, 68
- modem, 63
- monitor hard to read, 73
- monitor is blank, 73
- mouse, 68
- network, 69
- optical drive, 62
- power, 69
- power light conditions, 69
- printer, 71
- program crashes, 67

problems (*continued*)

- program stops responding, 66
- restore to previous state, 94
- scanner, 71
- screen hard to read, 73
- screen is blank, 73
- software, 66-67
- sound and speakers, 72
- video and monitor, 73
- volume adjusting, 72

processor

- type, 173

Product Information Guide, 12

R

RAID

- configuring, 30

regulatory information, 12

reinstalling

- Windows Vista, 94
- Windows XP, 94

S

safety instructions, 12

Scalable Link Interface
technology, 59

scanner

- problems, 71-72

screen. *See monitor*

Service Tag, 12

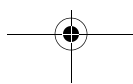
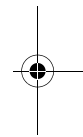
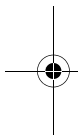

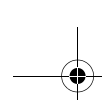

settings
system setup, 178

sleep mode
about, 56

SLI
See *Scalable Link Interface
technology*

software
conflicts, 93
problems, 66-67

sound
problems, 72
volume, 72

speaker
problems, 72
volume, 72

specifications
computer information, 173
connectors, 175
controls and lights, 176
drives, 175
environmental, 177
expansion bus, 174
memory, 173
physical, 177
power, 177
processor, 173
technical, 173
video, 174

support
contacting Dell, 193, 200

support website, 13

system board, 103

system messages, 83

System Restore, 94

system setup, 178
entering, 179
options, 180
screens, 179

T

telephone numbers, 200

troubleshooting
conflicts, 93
Dell Diagnostics, 86
diagnostic lights, 76
Hardware Troubleshooter, 93
Help and Support, 14
restore to previous state, 94

TV
connect to computer, 24

U

USB
booting to devices, 187
connectors, 18

V

video
problems, 73

volume
adjusting, 72

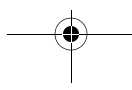

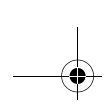

W

warranty information, 12

Windows Vista

Factory Image Restore, 95

Help and Support, 14

hibernate mode, 57

Network Setup Wizard, 55

reinstalling, 14, 94

sleep mode, 56

System Restore, 94

Windows XP

Hardware Troubleshooter, 93

Help and Support, 14

Network Setup Wizard, 55

reinstalling, 14, 94

System Restore, 94

wizards

Network Setup Wizard, 55

