

DENON

AV SURROUND RECEIVER

AVR-1707

OPERATING INSTRUCTIONS

☐ SAFETY PRECAUTIONS



CAUTION
RISK OF ELECTRIC SHOCK
DO NOT OPEN



CAUTION:
TO REDUCE THE RISK OF ELECTRIC SHOCK, DO NOT REMOVE COVER (OR BACK). NO USER-SERVICEABLE PARTS INSIDE. REFER SERVICING TO QUALIFIED SERVICE PERSONNEL.



The lightning flash with arrowhead symbol, within an equilateral triangle, is intended to alert the user to the presence of uninsulated "dangerous voltage" within the product's enclosure that may be of sufficient magnitude to constitute a risk of electric shock to persons.



The exclamation point within an equilateral triangle is intended to alert the user to the presence of important operating and maintenance (servicing) instructions in the literature accompanying the appliance.

WARNING:
TO REDUCE THE RISK OF FIRE OR ELECTRIC SHOCK, DO NOT EXPOSE THIS APPLIANCE TO RAIN OR MOISTURE.

SAFETY INSTRUCTIONS

1. Read Instructions – All the safety and operating instructions should be read before the product is operated.
2. Retain Instructions – The safety and operating instructions should be retained for future reference.
3. Heed Warnings – All warnings on the product and in the operating instructions should be adhered to.
4. Follow Instructions – All operating and use instructions should be followed.
5. Cleaning – Unplug this product from the wall outlet before cleaning. Do not use liquid cleaners or aerosol cleaners.
6. Attachments – Do not use attachments not recommended by the product manufacturer as they may cause hazards.
7. Water and Moisture – Do not use this product near water – for example, near a bath tub, wash bowl, kitchen sink, or laundry tub; in a wet basement; or near a swimming pool; and the like.
8. Accessories – Do not place this product on an unstable cart, stand, tripod, bracket, or table. The product may fall, causing serious injury to a child or adult, and serious damage to the product. Use only with a cart, stand, tripod, bracket, or table recommended by the manufacturer, or sold with the product. Any mounting of the product should follow the manufacturer's instructions, and should use a mounting accessory recommended by the manufacturer.
9. A product and cart combination should be moved with care. Quick stops, excessive force, and uneven surfaces may cause the product and cart combination to overturn.
10. Ventilation – Slots and openings in the cabinet are provided for ventilation and to ensure reliable operation of the product and to protect it from overheating, and these openings must not be blocked or covered. The openings should never be blocked by placing the product on a bed, sofa, rug, or other similar surface. This product should not be placed in a built-in installation such as a bookcase or rack unless proper ventilation is provided or the manufacturer's instructions have been adhered to.
11. Power Sources – This product should be operated only from the type of power source indicated on the marking label. If you are not sure of the type of power supply to your home, consult your product dealer or local power company. For products intended to operate from battery power, or other sources, refer to the operating instructions.
12. Grounding or Polarization – This product may be equipped with a polarized alternating-current line plug (a plug having one blade wider than the other). This plug will fit into the power outlet only one way. This is a safety feature. If you are unable to insert the plug fully into the outlet, try reversing the plug. If the plug should still fail to fit, contact your electrician to replace your obsolete outlet. Do not defeat the safety purpose of the polarized plug.



13. Power-Cord Protection – Power-supply cords should be routed so that they are not likely to be walked on or pinched by items placed upon or against them, paying particular attention to cords at plugs, convenience receptacles, and the point where they exit from the product.
15. Outdoor Antenna Grounding – If an outside antenna or cable system is connected to the product, be sure the antenna or cable system is grounded so as to provide some protection against voltage surges and built-up static charges. Article 810 of the National Electrical Code, ANSI/NFPA 70, provides information with regard to proper grounding of the mast and supporting structure, grounding of the lead-in wire to an antenna discharge unit, size of grounding conductors, location of antenna-discharge unit, connection to grounding electrodes, and requirements for the grounding electrode. See Figure A.
16. Lightning – For added protection for this product during a lightning storm, or when it is left unattended and unused for long periods of time, unplug it from the wall outlet and disconnect the antenna or cable system. This will prevent damage to the product due to lightning and power-line surges.
17. Power Lines – An outside antenna system should not be located in the vicinity of overhead power lines or other electric light or power circuits, or where it can fall into such power lines or circuits. When installing an outside antenna system, extreme care should be taken to keep from touching such power lines or circuits as contact with them might be fatal.
18. Overloading – Do not overload wall outlets, extension cords, or integral convenience receptacles as this can result in a risk of fire or electric shock.
19. Object and Liquid Entry – Never push objects of any kind into this product through openings as they may touch dangerous voltage points or short-out parts that could result in a fire or electric shock. Never spill liquid of any kind on the product.
20. Servicing – Do not attempt to service this product yourself as opening or removing covers may expose you to dangerous voltage or other hazards. Refer all servicing to qualified service personnel.
21. Damage Requiring Service – Unplug this product from the wall outlet and refer servicing to qualified service personnel under the following conditions:
 - a) When the power-supply cord or plug is damaged,
 - b) If liquid has been spilled, or objects have fallen into the product,
 - c) If the product has been exposed to rain or water,
 - d) If the product does not operate normally by following the operating instructions. Adjust only those controls that are covered by the operating instructions as an improper adjustment of other controls may result in damage and will often require extensive work by a qualified technician to restore the product to its normal operation,
 - e) If the product has been dropped or damaged in any way, and
 - f) When the product exhibits a distinct change in performance – this indicates a need for service.
22. Replacement Parts – When replacement parts are required, be sure the service technician has used replacement parts specified by the manufacturer or have the same characteristics as the original part. Unauthorized substitutions may result in fire, electric shock, or other hazards.
23. Safety Check – Upon completion of any service or repairs to this product, ask the service technician to perform safety checks to determine that the product is in proper operating condition.
24. Wall or Ceiling Mounting – The product should be mounted to a wall or ceiling only as recommended by the manufacturer.
25. Heat – The product should be situated away from heat sources such as radiators, heat registers, stoves, or other products (including amplifiers) that produce heat.

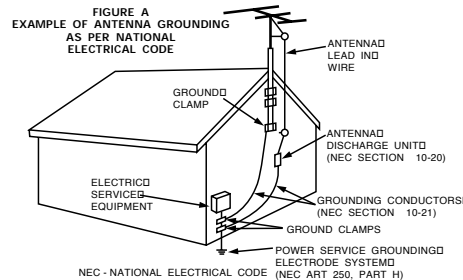

FCC INFORMATION (For US customers)

1. PRODUCT

This product complies with Part 15 of the FCC Rules. Operation is subject to the following two conditions: (1) this product may not cause harmful interference, and (2) this product must accept any interference received, including interference that may cause undesired operation.

2. IMPORTANT NOTICE: DO NOT MODIFY THIS PRODUCT

This product, when installed as indicated in the instructions contained in this manual, meets FCC requirements. Modification not expressly approved by DENON may void your authority, granted by the FCC, to use the product.

3. NOTE

This product has been tested and found to comply with the limits for a Class B digital device, pursuant to Part 15 of the FCC Rules. These limits are designed to provide reasonable protection against harmful interference in a residential installation.







This product generates, uses and can radiate radio frequency energy and, if not installed and used in accordance with the instructions, may cause harmful interference to radio communications. However, there is no guarantee that interference will not occur in a particular installation. If this product does cause harmful interference to radio or television reception, which can be determined by turning the product OFF and ON, the user is encouraged to try to correct the interference by one or more of the following measures:

- Reorient or relocate the receiving antenna.
- Increase the separation between the equipment and receiver.
- Connect the product into an outlet on a circuit different from that to which the receiver is connected.
- Consult the local retailer authorized to distribute this type of product or an experienced radio/TV technician for help.

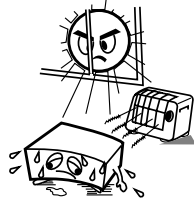
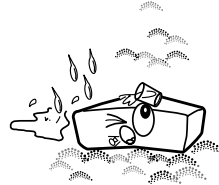
This Class B apparatus complies with Canadian ICES-003.

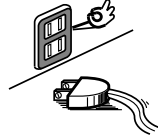
Cet appareil numérique de la classe B est conforme à la norme NMB-003 du Canada.

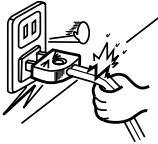
NOTE ON USE

 <ul style="list-style-type: none"> • Avoid high temperatures. Allow for sufficient heat dispersion when installed in a rack. 	 <ul style="list-style-type: none"> • Keep the apparatus free from moisture, water, and dust. 	 <ul style="list-style-type: none"> • Do not let foreign objects into the apparatus.
	 <ul style="list-style-type: none"> • Unplug the power cord when not using the apparatus for long periods of time. 	 <ul style="list-style-type: none"> • Do not let insecticides, benzene, and thinner come in contact with the apparatus.
 <ul style="list-style-type: none"> • Handle the power cord carefully. Hold the plug when unplugging the cord. 	 <p>* (For apparatuses with ventilation holes)</p> <ul style="list-style-type: none"> • Do not obstruct the ventilation holes. 	 <ul style="list-style-type: none"> • Never disassemble or modify the apparatus in any way.

Thank you for choosing the DENON AVR-1707 AV Surround Receiver. This remarkable component has been engineered to provide superb surround sound listening with home theater sources such as DVD, as well as providing outstanding high fidelity reproduction of your favorite music sources.

As this product is provided with an immense array of features, we recommend that before you begin hookup and operation that you review the contents of this manual before proceeding.

Contents

Getting Started

Accessories	2
Before using	2
Cautions on installation	3
About the remote control unit	3
Inserting the batteries	3
Operating range of the remote control unit	3
Part names and functions	
Front panel	4
Display	4
Rear panel	5
Remote control unit	5, 6

Easy Setup Procedure

Easy to setup flow	7
Speaker layout [Basic layout]	7
Speaker connections	8
Connecting a DVD player and monitor	9
Auto Setup	
① Connecting a microphone	10
② Before performing the Auto Setup procedure	10
③ Switching the front speaker	10
④ Starting Auto Setup	11
Error messages	12

Connecting Other Sources

Cable indications	13
The video conversion function	13
Connecting a TV/DBS tuner	14
Connecting a video camera or video game	14
Connecting the external inputs (EXT. IN) terminals	14
Connecting a CD player	15
Connecting a tape deck, CD recorder or MD recorder	15
Connecting a VCR	15
Connecting the antenna terminals	16
Connecting the XM terminal	16
Connecting the iPod®	17
Connecting the MULTI ZONE terminals	
Connecting a room-to-room remote control unit	17
ZONE2 speaker out connections	18
Connecting the power supply cord	18

Basic Operation

Playing the input source	19
Turning the sound off temporarily (MUTING)	20
Listening over headphones	20
Switching the front speakers	20
Checking the currently playing program source, etc.	20
Switching the brightness of the display	20
Using the surround modes	
Types of surround modes and their features	20, 21
Selecting the play mode (DIRECT/STEREO)	21
Selecting the Dolby Digital and DTS Surround mode (only with digital input)	22
Selecting the Dolby Pro Logic IIx (Pro Logic II) mode	23
Selecting the DTS NEO:6 mode	24
Selecting the NEURAL SURROUND mode	24
Surround modes and parameters	25 ~ 27

Using the DENON original surround modes

Types of surround modes and their features	28
Selecting the DSP surround simulation	29
Setting the tone control	30
Adjusting the speaker volume	30
Listening to the radio	
Auto preset memory	30
Auto tuning	31
Manual tuning	31
Preset memory	31
Recalling preset stations	31
XM Satellite Radio	32
Checking the XM signal strength and Radio ID	32
Channel selection	32
Category search	32

Advanced Operation

Night mode	33
User mode function	
Storing the settings in the memory	33
Calling the settings out	33
Combining the currently playing sound with the desired image (VIDEO SELECT function)	33
Personal memory plus function	33
Playing the iPod®	34
Listening to music in the Browse mode	34
Viewing still pictures and videos (only for iPods equipped with the slideshow / video function)	35
Disconnecting the iPod	35
Multi zone music entertainment system	36
Remote control unit operations during multi-source playback (selecting the source)	36
Recording the program source (recording the source currently being monitored)	37
About the memory functions	37
Initialization of the microprocessor (Reset)	37

Advanced Setup – Part 1

System setup items and default values	38, 39
Navigating through the System Setup items	40
About the front display	40
Input Setup	
Setting the Digital In Assignment	41
Setting the iPod Assignment	41
Setting the Component In Assignment	41
Setting the Video Convert	42
Setting the Audio Delay	42
Setting the EXT. IN Subwoofer Level	42
Setting the Auto Preset Memory	43
Option Setup	
Setting the Power Amplifier Assignment	43
Setting the Volume Control	44
Setting the 2ch Direct/Stereo Custom	44
Setting the Auto Surround Mode	45

Advanced Setup – Part 2

Speaker Setup	
Setting the Speaker Configuration	45, 46
Setting the Subwoofer Mode Setup	46
Setting the Distance	46, 47
Setting the Crossover Frequency	47
Setting the Test Tone	47

Operating the remote control unit

Operating DENON audio components	48
Setting the preset memory function	48
Operating a component stored in the preset memory	49 ~ 51
Setting the punch through function	52

Additional Information	53, 54
-------------------------------	--------

Troubleshooting	55, 56
------------------------	--------

Specifications	56
-----------------------	----

List of preset codes	End of this manual
----------------------	--------------------

Getting Started

Accessories

Check that the following parts are attached in addition to the main unit:

① Operating instructions	1
② Warranty (for North America model only)	1
③ Service station list	1
④ Remote control unit (RC-1048)	1
⑤ R6P/AA batteries	2
⑥ AM loop antenna	1
⑦ FM indoor antenna	1
⑧ Setup microphone (DM-S205) (Approx. 23-5/8 ft / 6 m)	1

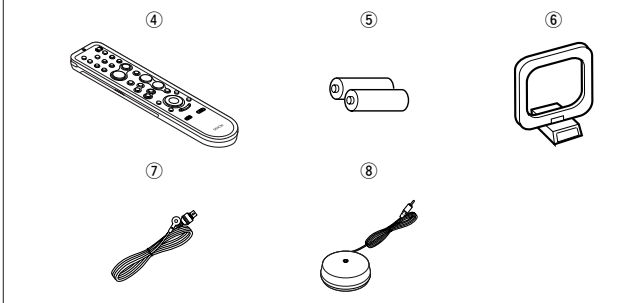
**Before using**

Pay attention to the following before using this unit:

- **Moving the unit.**

To prevent short-circuits or damaged wires in the connection cables, always unplug the power supply cord and disconnect the connection cables between all other audio components when moving the unit.

- **Cautions on using mobile phones.**

Using a mobile phone near this unit may result in noise. If so, move the mobile phone away from this unit when it is in use.

- **Before turning the power operation button on.**

Check once again that all connections are correct and that there are not problems with the connection cables. Always set the power operation button to the standby position before connecting and disconnecting connection cables.

- **Store these instructions in a safe place.**

After reading, store this instructions along with the warranty card in a safe place.

- **Whenever the power operation button is in the STANDBY state, the unit is still connected to AC line voltage.**

Please be sure to turn off the power operation button or unplug the cord when you leave home for, say, a vacation.

- **Note that the illustrations in these instructions may differ from the actual unit for explanation purposes.**

Getting Started

Cautions on installation

Note:
For heat dispersal, do not install this unit in a confined space such as a bookcase or similar enclosure.

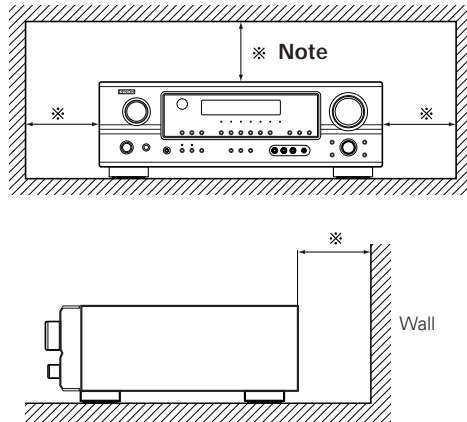

About the remote control unit

In addition to controlling the AVR-1707, the attached remote control unit (RC-1048) can also be used to control the following products:

- ① DENON component products
- ② Component products other than DENON:
 - Set using the preset memory function (➔ page 48).

Inserting the batteries

- ① Remove the remote control unit's rear cover.
- ② Set two R6P/AA batteries in the battery compartment in the indicated direction.

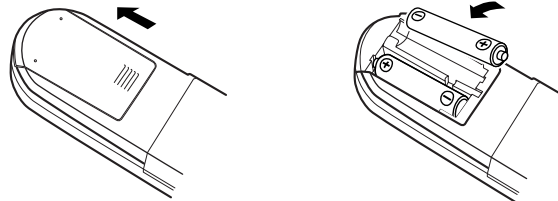

- ③ Put the rear cover back on.

Notes on batteries:

- Replace the batteries with new ones if the set does not operate even when the remote control unit is operated nearby the unit. (The attached batteries are only for verifying operation.)
- When inserting the batteries, be sure to do so in the proper direction, following the "⊕" and "⊖" marks in the battery compartment.
- To prevent damage or leakage of battery fluid:
 - Do not use a new battery together with an old one.
 - Do not use two different types of batteries.
 - Do not short-circuit, disassemble, heat or dispose of batteries in flames.
- Remove the batteries from the remote control unit when you do not plan to use it for an extended period of time.
- If the battery fluid should leak, carefully wipe the fluid off the inside of the battery compartment and insert new batteries.
- Remove the batteries from the remote if it will not be in use for long periods.

Getting Started

Operating range of the remote control unit

- Point the remote control unit at the remote sensor when operating it.
- The remote control unit can be used from a distance of approximately 23 feet/7 meters, at a horizontal angle of up to 30° with respect to the sensor.

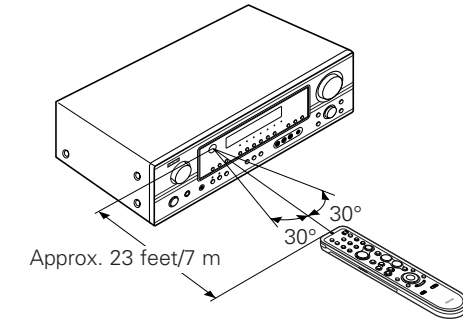

NOTE:

- It may be difficult to operate the remote control unit if the remote sensor is exposed to direct sunlight or strong artificial light.

Getting Started

Part names and functions

For details on the functions of these parts, refer to the pages given in parentheses ().

Front panel

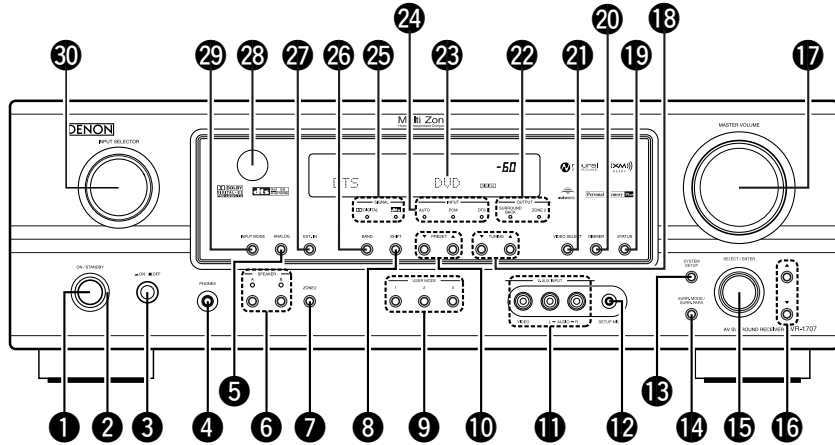

- 1 Power operation button (ON/STANDBY)(10)
- 2 Power indicator(10)
- 3 Power switch(10, 37)
- 4 Headphones jack (PHONES)(20)
- 5 ANALOG button(19)
- 6 SPEAKER buttons(10, 37)
- 7 ZONE2 button(36)
- 8 SHIFT button(31)
- 9 USER MODE buttons(33)
- 10 PRESET buttons(30, 31)

- 11 V. AUX INPUT terminals
Remove the cap covering the terminals when you want to use them.

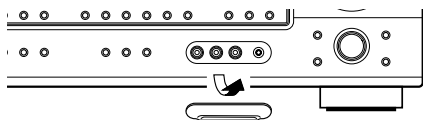

- 12 SETUP MIC jack(10)
- 13 SYSTEM SETUP button(40)
- 14 SURR. MODE/SURR. PARA button(22, 29)
- 15 SELECT/ENTER knob(29, 40)



• The **SELECT/ENTER** knob on the main unit operates in the same way as the Cursor buttons (◀ and ▶) on the remote control unit.



- The control functions in the same way as the Cursor ◀ button when turned counterclockwise, as the Cursor ▶ button when turned clockwise.
- The control functions in the same way as the **ENTER** button when pressed the knob.

- 16 Cursor buttons (Δ, ▽)(22, 40)
- 17 MASTER VOLUME control knob(19)
- 18 TUNING buttons (▲, ▼)(31)
- 19 STATUS button(20)
- 20 DIMMER button(20)
- 21 VIDEO SELECT button(33)
- 22 OUTPUT indicators(22, 36)
- 23 Display

- 24 INPUT mode indicators(19)
- 25 SIGNAL indicators(22)
- 26 BAND button(31)
- 27 EXT. IN button(19)
- 28 Remote control sensor(3)
- 29 INPUT MODE button(19)
- 30 INPUT SELECTOR knob(19)

Getting Started

Display

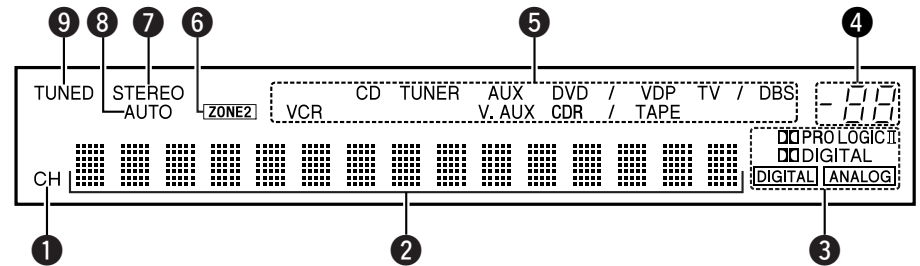

- 1 Signal channel indicator
Lights when the preset channel is displayed at 2.
- 2 Information display
- 3 Input signal indicators
- 4 Master volume indicator
This displays the volume level.
The Setup item number is displayed in System Setup.
- 5 Input mode indicators
- 6 ZONE2 indicator
ZONE2 mode is selected in Power Amplifier Assignment.

- 7 STEREO indicator
This lights when an FM stereo broadcast has been received.
- 8 AUTO indicator
This lights when the broadcast station is selected in the AUTO tuning mode.
- 9 TUNED indicator
This lights when an FM/AM broadcast has been received.

Rear panel

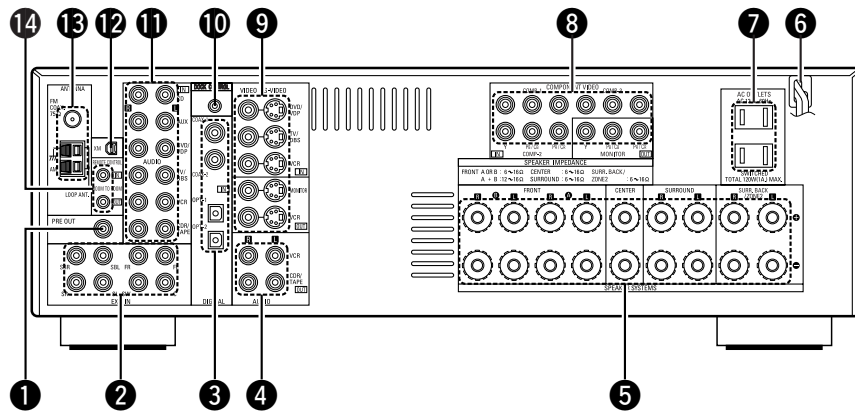

- 1 PRE OUT terminal.....(8)
- 2 EXT. IN terminals.....(14)
- 3 DIGITAL terminals
(Optical/Coaxial).....(9, 15)
- 4 AUDIO OUT terminals.....(9, 15)
- 5 Speaker terminals.....(8, 18, 43)
- 6 Power supply cord.....(18)
- 7 AC outlets.....(18)
- 8 COMPONENT VIDEO terminals.....(9)
- 9 VIDEO/S-VIDEO terminals.....(9)
- 10 DOCK CONTROL jack.....(17)
- 11 AUDIO IN terminals.....(9)
- 12 XM terminal.....(16)
- 13 ANTENNA terminals.....(16)
- 14 REMOTE CONTROL jacks.....(17)

Remote control unit

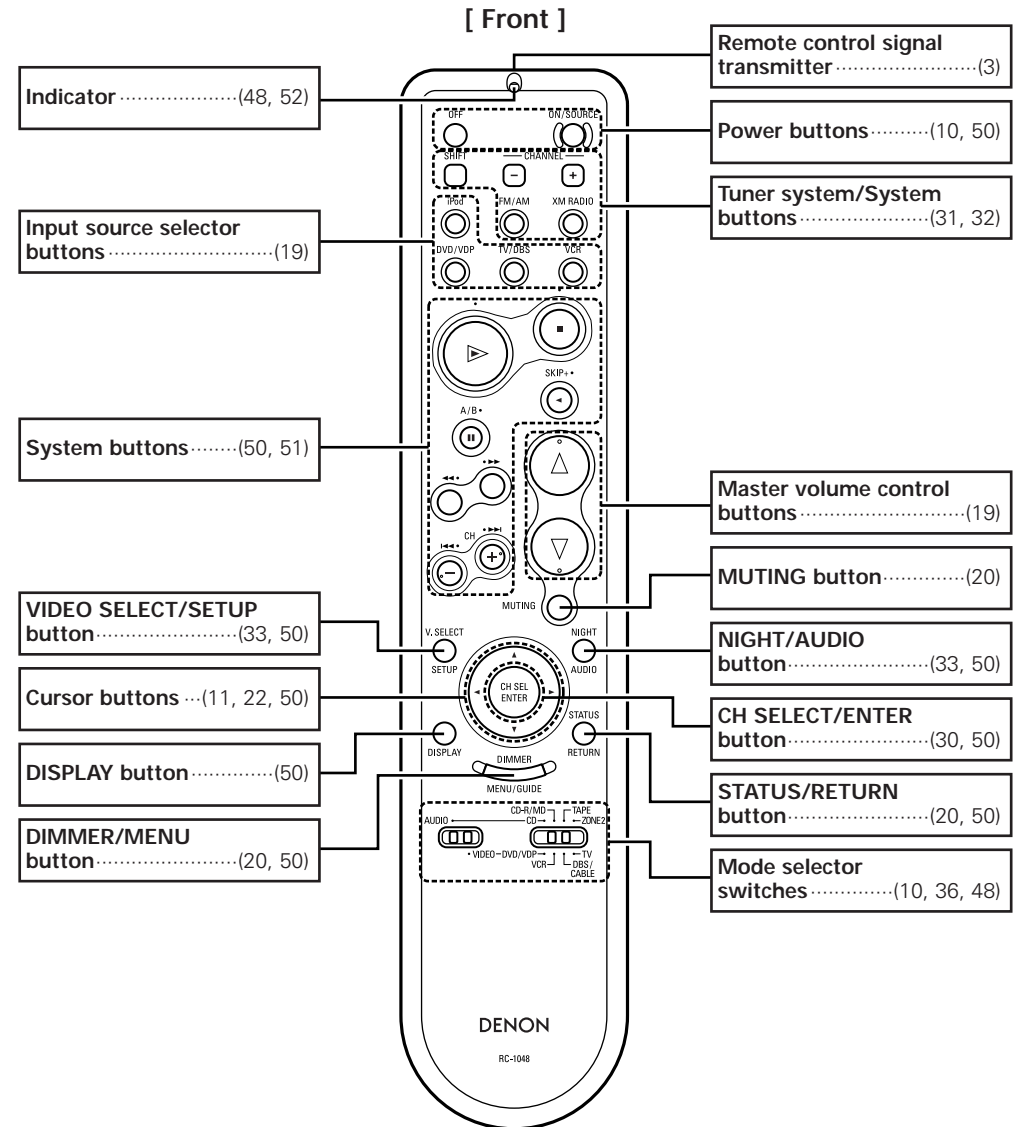

[Rear]

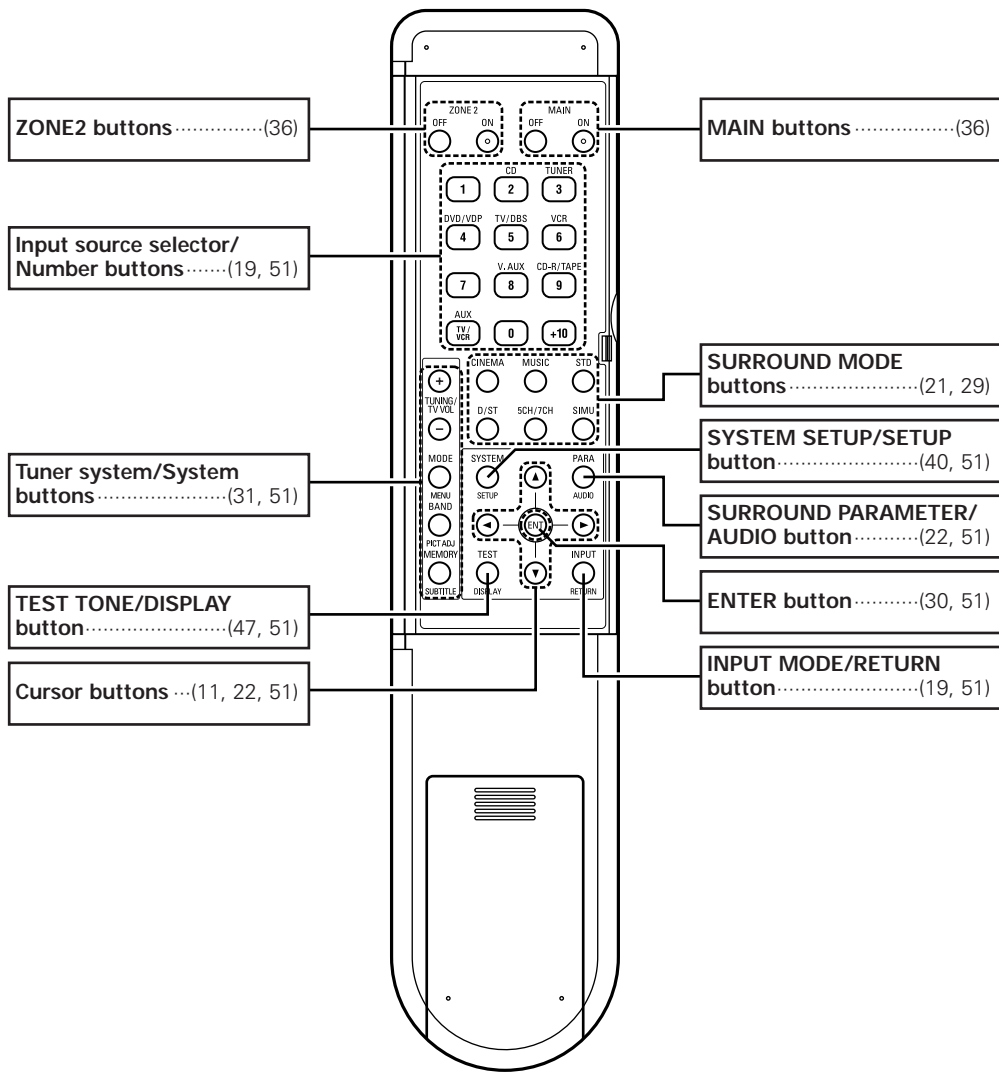

NOTE:

- If buttons on the front or rear are pressed strongly, the button on the opposite side will be activated too.

Easy Setup Procedure

- This section contains the basic steps necessary to configure the AVR-1707 according to your listening room environment and the source equipment and loudspeakers you are using.
- To set the sound field manually (🔧 page 45).

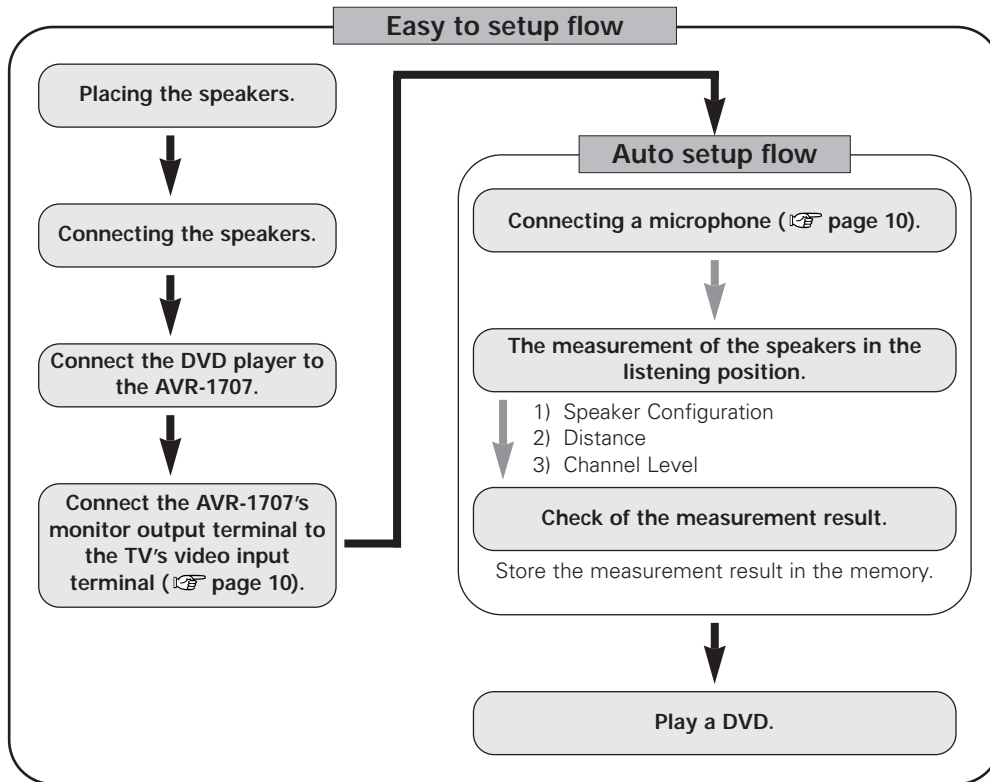

Speaker layout [Basic layout]

Example of basic layout with eight speakers and a monitor.

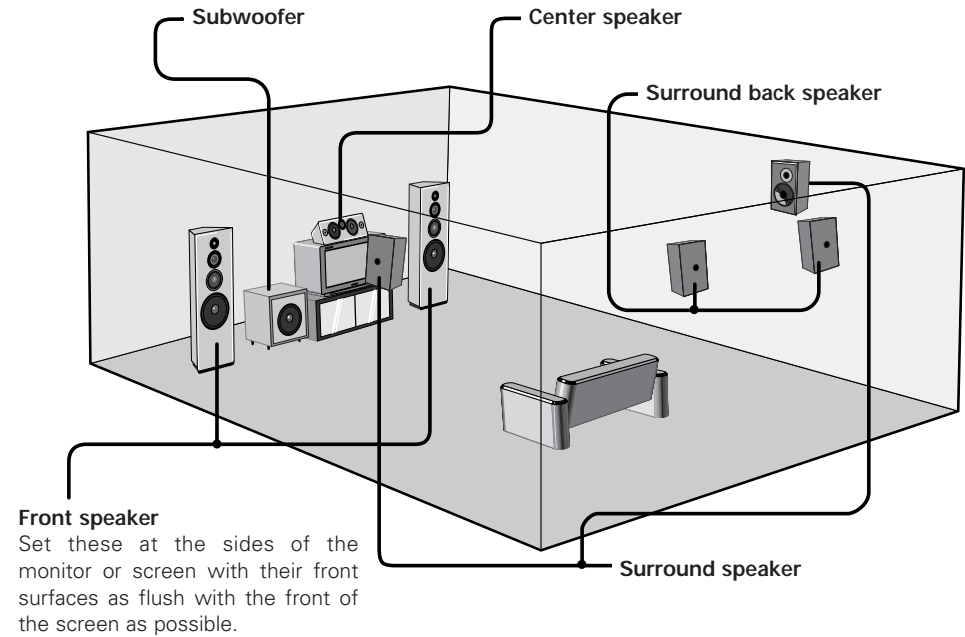

Easy Setup Procedure

Speaker connections

Connect the speaker terminals with the speakers making sure that like polarities are matched (⊕ with ⊕, ⊖ with ⊖).

NOTE:
When making connections, take care that none of the individual conductors of the speaker cable come in contact with adjacent terminals, with other speaker cable conductors, or with the rear panel and screws.
NEVER touch the speaker terminals when the power is on. Doing so could result in electric shocks.

Connecting the speaker cables

1. Loosen by turning counterclockwise.
 2. Insert the cable.
 3. Tighten by turning clockwise.
- Either tightly twist or terminate the core wires.

Connecting banana plugs

Turn clockwise to tighten, then insert the banana plug.

Speaker impedance

Speaker	Impedance
Front A, B	6 ~ 16 Ω/ohms
Front A+B	12 ~ 16 Ω/ohms
Center	6 ~ 16 Ω/ohms
Surround	
Surround back / ZONE2	

Note on speaker impedance

When using speakers with an impedance below the designated value (for example 4 Ω/ohms), playing for long periods of time with the volume high could cause the temperature to rise, activating the protection circuit. When the protection circuit is activated, the output to the speakers is cut off and the power indicator blinks. If this happens, unplug the power cord, wait for the set to cool off and improve ventilation around the unit. Also check the wiring of the input cables and the speaker cables. After doing this, plug the power cord back in and turn the unit's power back on. If the protection circuit is activated again even though there are no problems with the wiring or the ventilation around the unit, switch off the power and contact a DENON service center.

Easy Setup Procedure

Connections

- With the AVR-1707, up to ten speakers can be connected for surround playback.
- When making connections, also refer to the operating instructions of the other components.

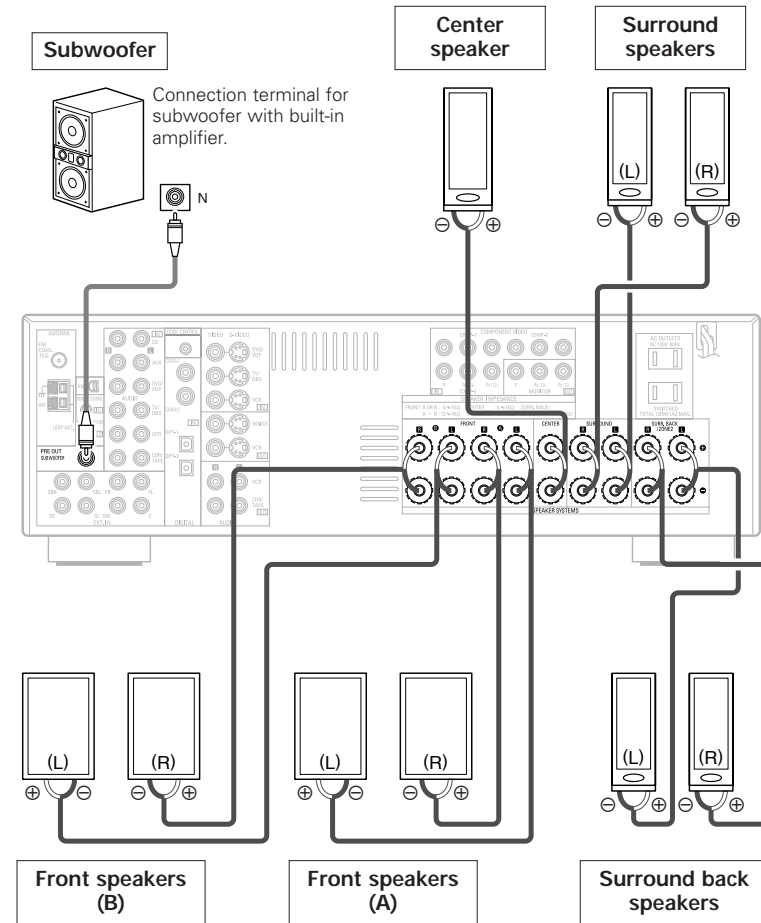

When using only one surround back speaker, connect it to the left channel.

Easy Setup Procedure

Connecting a DVD player and monitor

- To connect the video output from the DVD player to the AVR-1707, you only need to choose one connection type. For more information about the video up conversion function (🔗 page 13).
- To connect the digital audio output from the DVD player, you can choose from either the coaxial or optical connections. If you choose to use the coaxial connection, it needs to be assigned. For more information about Digital Input Assignment (🔗 page 41).

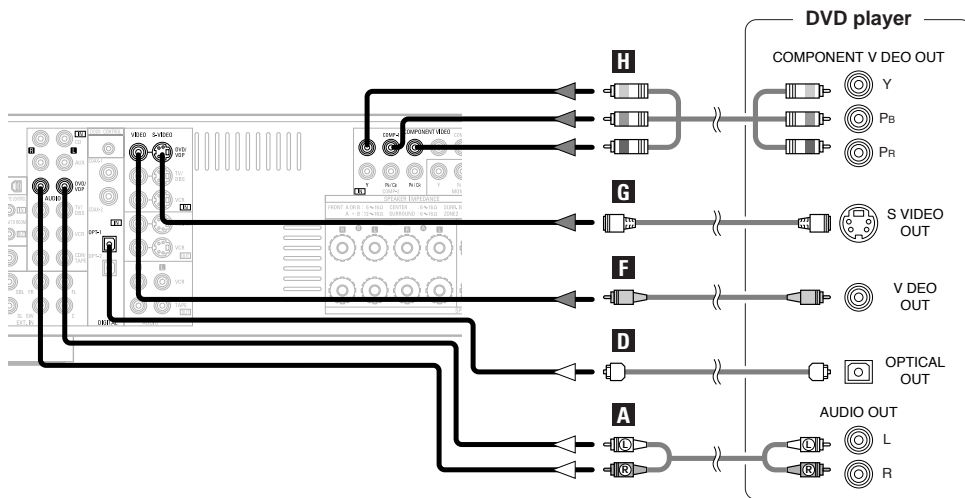

※ Audio signal flow is shown with white arrows, video signal flow is shown with gray arrows.



- Connect a non-DVD video disc player (such as a laser disc, VCD/SVCD, or future high definition disc player) to the DVD/VDP terminals in the same way.

Easy Setup Procedure

- For best picture quality (especially with progressive DVD and other high definition sources), choose the component video connection to your monitor. S-Video and composite video outputs are also provided if your monitor does not have component video inputs.

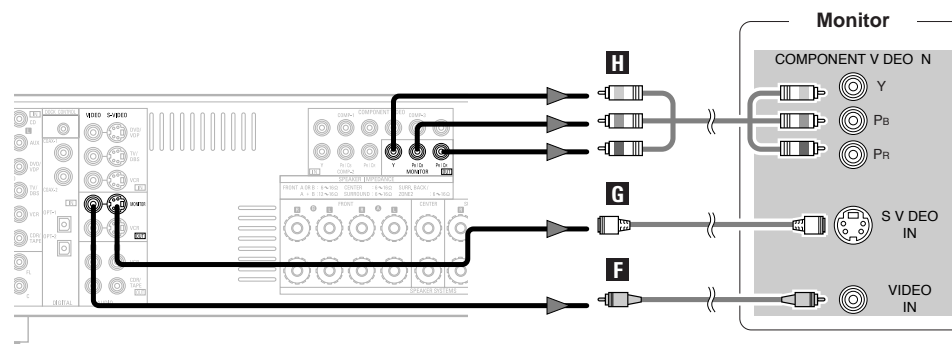

- The component video input and/or output terminals may be labelled differently on some monitors or video components. Check the owner's manuals for other components for further information.

Easy Setup Procedure

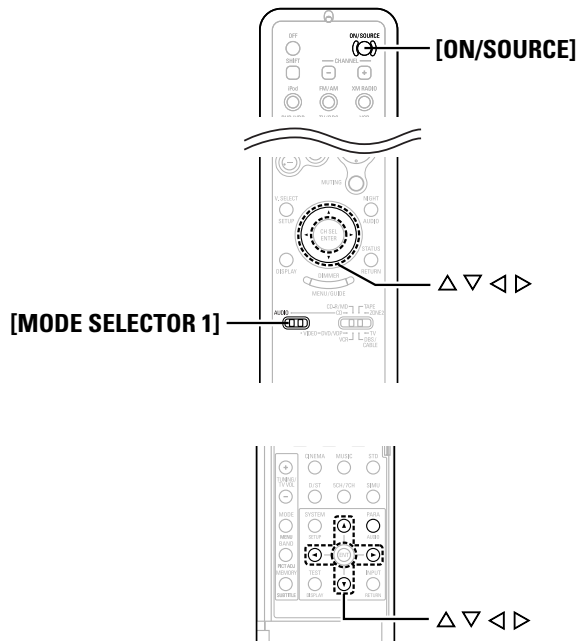
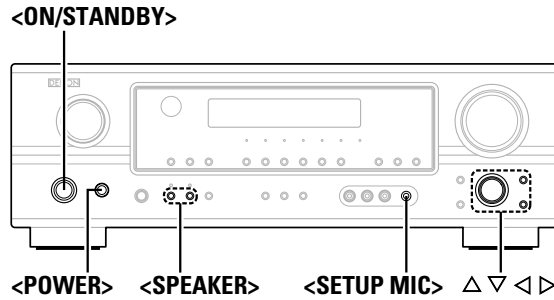

About the button names in this explanation
 < > : Buttons on the main unit
 [] : Buttons on the remote control unit
Button name only :
 Buttons on the main unit and remote control unit

Auto Setup

The AVR-1707's auto setup use the attached microphone to measure the acoustic properties in the room and automatically make the optimum settings.



- To make the sound field settings manually (page 45).

① Connecting a microphone

1 Connect the attached setup microphone to <SETUP MIC>.

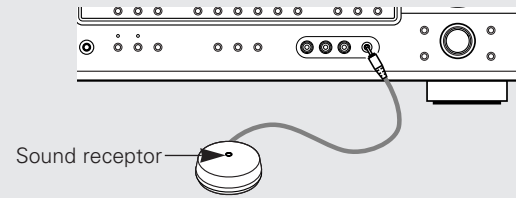

2 Mount the setup microphone on a camera tripod, etc., and set with the receptor pointing towards the ceiling.

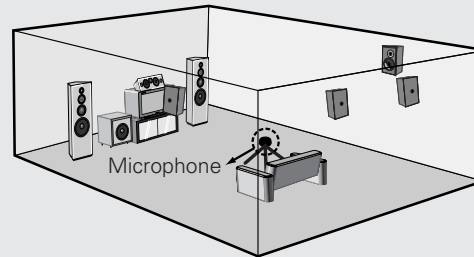

- ※ Place the setup microphone's sound receptor at the height of the ears in the listening position.
- ※ It is not possible to measure properly if there are any obstacles between the speakers and microphone. Check that there are no obstacles.

Easy Setup Procedure

② Before performing the Auto Setup procedure

1 Turn on your subwoofer.

- ※ Set the volume to halfway and set the crossover frequency to the maximum or Low pass filter off if your subwoofer can adjust the output volume and the crossover frequency.
- ※ Some subwoofers have a standby mode. Be sure to turn this function off before performing the Auto Setup procedure.

2 Turn on your monitor.

3 Press <POWER>.

- ON:
The power indicator lights red.
- OFF:
The power turns off and the indicator is off.

4 Press <ON/STANDBY> or [ON/SOURCE].
 • The power indicator blinks green and the power turns on.

5 Set [MODE SELECTOR 1] to "AUDIO".



- Auto Setup mode is not displayed when using headphones.

③ Switching the front speaker

Press <SPEAKER> to select the front speaker (Front A, Front B or Front A+B).

Easy Setup Procedure

④ Starting Auto Setup

1 Press \triangleleft to start the Auto Setup.

- Start the measurements.

※ Measurement of each channel is performed as follows:

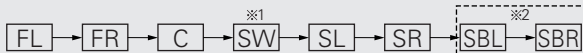

※1: The subwoofer speaker is measured twice.

※2: Not displayed when "ZONE2" is set at "Setting the Power Amplifier Assignment" (page 43).

After each channel is measured, "Calculating" appears. The display switches to the speaker check display automatically.

Measure:FL <Ccl

Calculating

Speaker:3/4/.1

Check the results of the speaker detection

Example: 7.1-channel systems

Speaker:3/4/.1

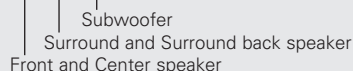

2 Press \triangle ∇ to select "Store", then press \triangleleft .

Store:

Store the checked measurement values.
All parameters are stored.

Retry:

Measure again.

Cancel:

Cancel the checked measurement values.

3 Disconnect the setup mic to finish Auto Setup.

1 Auto Set <Start

2 Setup <Store

Storing



- When measurements have been made using the measurement microphone, speakers with a built-in filter such as subwoofers might be set with a value that differs from the physical distance because of the internal electrical delay.

NOTE:

- Do not change the speaker connections or subwoofer volume after making the measurements.
- Do not turn off the power while the data is being stored.

Easy Setup Procedure

Cautions during measurements:

- Loud test tones are output during the measurements. Be careful for example when small children are nearby.
- Proper measurements may not be possible if there are obstacles between the speaker and the setup microphone.
- During the measurements, do not stand between or near the speakers and setup microphone.
- To avoid influencing the measurements, turn off the power of air-conditioners or any other equipment producing sound in the room. Perform the measurements with the room as quiet as possible.
- Measurement is cancelled when **VOLUME** is operated while the Auto Setup is performed.

About automatic retry

To confirm the results of the measurements, remeasurement is automatically performed.

Remeasurement is performed up to two times. During this time, "Retry1" or "Retry2" is displayed on the display.

Overload Retry1

Easy Setup Procedure

Error messages

An error message is displayed if the measurements could not be completed automatically due to the speaker layout, the measuring environment, etc. Please check the following matters, reset the pertinent items, and measure again.

Be sure to turn off the AVR-1707's power before checking the speaker connections.

Press Δ ∇ to select the items, then press \triangleleft .

Easy Setup Procedure

Example	Cause	Measures
<div style="border: 1px solid black; padding: 2px; margin-bottom: 2px;">Caution:SP None</div> <div style="border: 1px solid black; padding: 2px;">FL</div>	① The speakers required for producing suitable reproduction have not been detected.	<ul style="list-style-type: none"> • Check that the pertinent speakers are properly connected.
<div style="border: 1px solid black; padding: 2px; margin-bottom: 2px;">Caution :Phase</div> <div style="border: 1px solid black; padding: 2px;">FL/R</div>	② The speaker polarity is connected in reverse.	<ul style="list-style-type: none"> • Check the polarity of the pertinent speakers. • For some speakers, the screen below may be displayed even though the speakers are properly connected. If so, select "Skip\triangleleft".
<div style="border: 1px solid black; padding: 2px; margin-bottom: 2px;">Caution</div> <div style="border: 1px solid black; padding: 2px;">Overload <Exit</div>	③ When accurate measurements cannot be made due to the input level of the microphone being too high.	<ul style="list-style-type: none"> • Set up the speakers so that their position is farther away from the listening position. • Lower the volume of the subwoofer speaker.

Connecting Other Sources

Cable indications

The hookup diagrams on the subsequent pages assume the use of the following optional connection cables (not supplied).

Audio cable	Video cable
<p>A Analog connections (Stereo)</p> <p>(White) (Red) </p> <p style="text-align: center;">Pin-plug cable</p>	<p>F Video connections</p> <p>(Yellow) </p> <p style="text-align: center;">Video cable (75 Ω/ohms video pin-plug cable)</p>
<p>B Analog connections (Monaural, for subwoofer)</p> <p></p> <p style="text-align: center;">Pin-plug cable</p>	<p>G S-Video connections</p> <p></p> <p style="text-align: center;">S-Video cable</p>
<p>C Digital connections (Coaxial)</p> <p>(Orange) </p> <p style="text-align: center;">Coaxial cable (75 Ω/ohms pin-plug cable)</p>	<p>H Component video connections</p> <p>(Green) (Y)</p> <p>(Blue) (Pb/Cb)</p> <p>(Red) (Pr/Cr)</p> <p style="text-align: center;">Component video cable</p>
<p>D Digital connections (Optical)</p> <p></p> <p style="text-align: center;">Optical fiber cable</p>	<p style="text-align: center;">Signal direction</p> <p>Audio signal </p> <p>Video signal </p>
<p>E Speaker connections</p> <p></p> <p style="text-align: center;">Speaker cable</p>	

NOTE:

- Do not plug in the power supply cord until all connections have been completed.
- When making connections, also refer to the operating instructions of the other components.
- Be sure to connect the left and right channels properly (left with left, right with right).
- Do not bundle power cords together with speaker cables. Doing so could result in humming or noise.

The video conversion function

With the AVR-1707, the Video signal and the S-Video signal which were inputted are mutually converted. And also the Video signal and the S-Video signal which were inputted are converted into a higher quality.

The flow of the video signals.

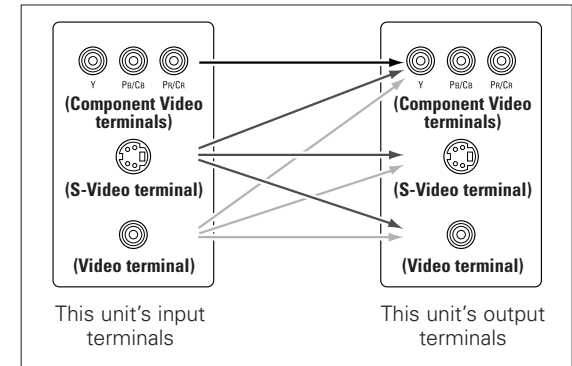

Connecting Other Sources

Connecting a TV/DBS tuner

- For best picture quality choose the component video connection to your TV or DBS tuner. S-Video and composite video outputs are also provided.
- To connect the digital audio output from the TV or DBS tuner, you can choose from either the coaxial or optical connections. If you choose to use the coaxial connection, it needs to be assigned. For more information about Digital Input Assignment (page 41).

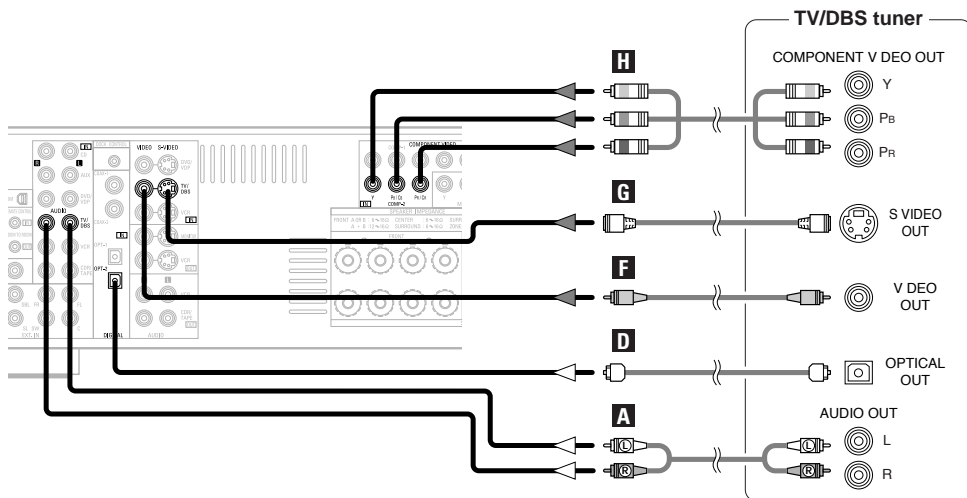

Connecting a video camera or video game

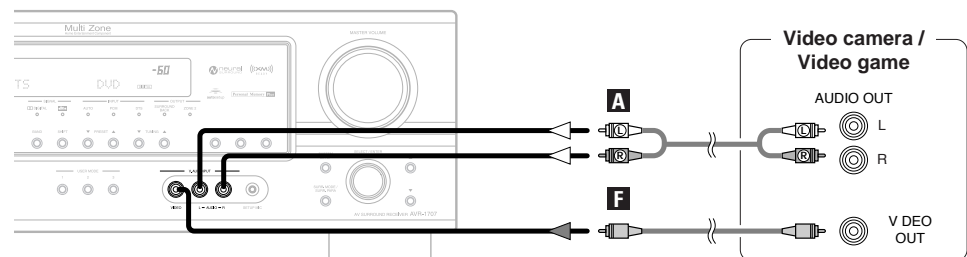

Connecting Other Sources

Connecting the external inputs (EXT. IN) terminals

- These terminals are for inputting multi-channel audio signals from an outboard decoder, or a component with a different type of multi-channel decoder, such as a DVD-Audio player, or a multi-channel Super Audio CD player, or other future multi-channel sound format decoder.
- The video signal connection is the same as that for a DVD player (page 9).
- For instructions on playback using the external input (EXT. IN) terminals (page 19).

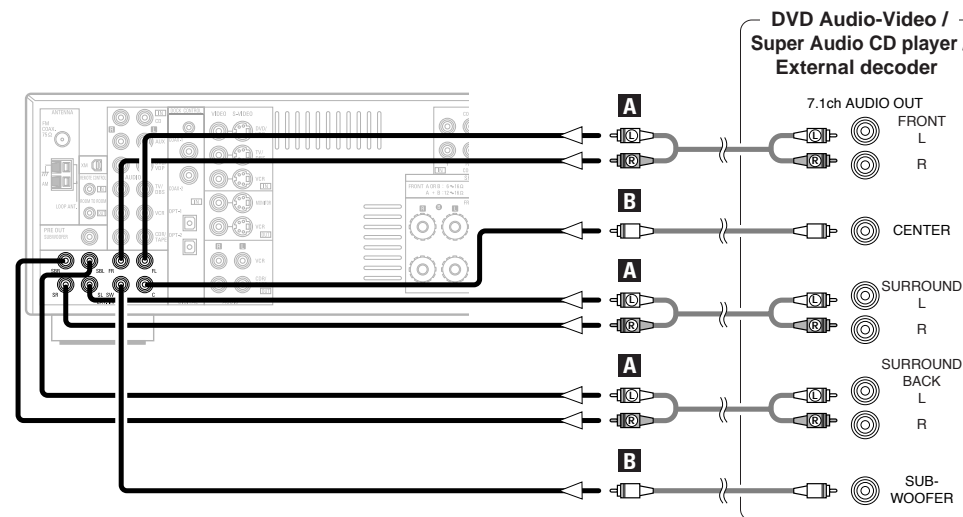

- With discs on which special copyright protection measures have been taken, however, the digital signals may not be output from the DVD player. In this case, connect the DVD player's analog multi-channel output to the AVR-1707's EXT. IN terminals for playback. Also refer to your DVD player's operating instructions.

Connecting Other Sources

Connecting a CD player

To connect the digital audio output from the CD player, you can choose from either the coaxial or optical connections. If you choose to use the optical connection, it needs to be assigned. For more information about Digital Input Assignment (see page 41).

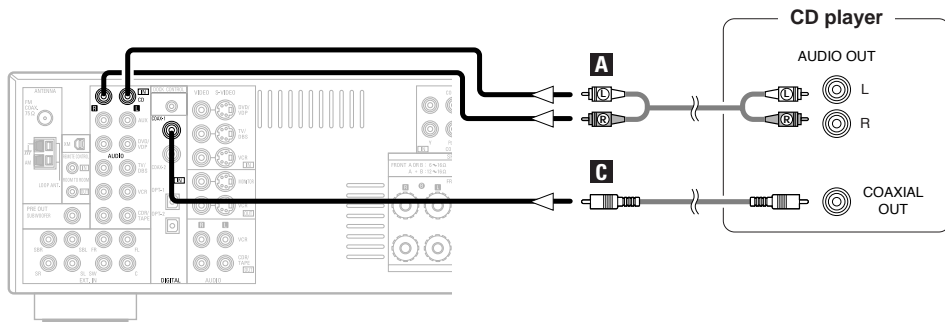

Connecting a tape deck, CD recorder or MD recorder

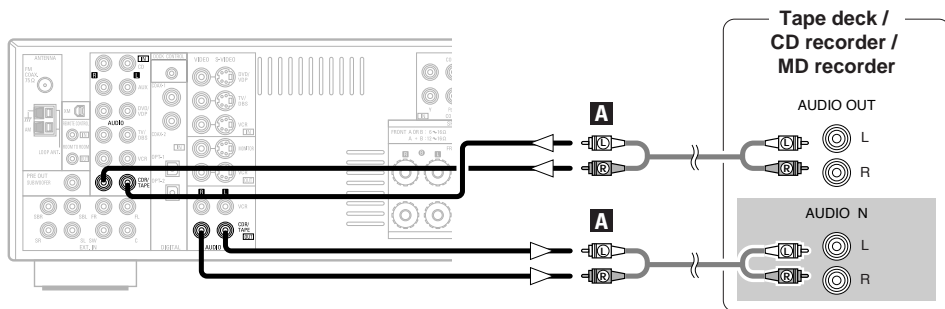

Connecting Other Sources

Connecting a VCR

- For best picture quality choose the component video connection to your VCR. S-Video and composite video outputs are also provided.
- If you wish to perform analog dubbing from a digital source, such as a DVD recorder to an analog recorder such as a cassette deck, you will need to connect the analog inputs and outputs as shown below, in addition to the digital audio connections.

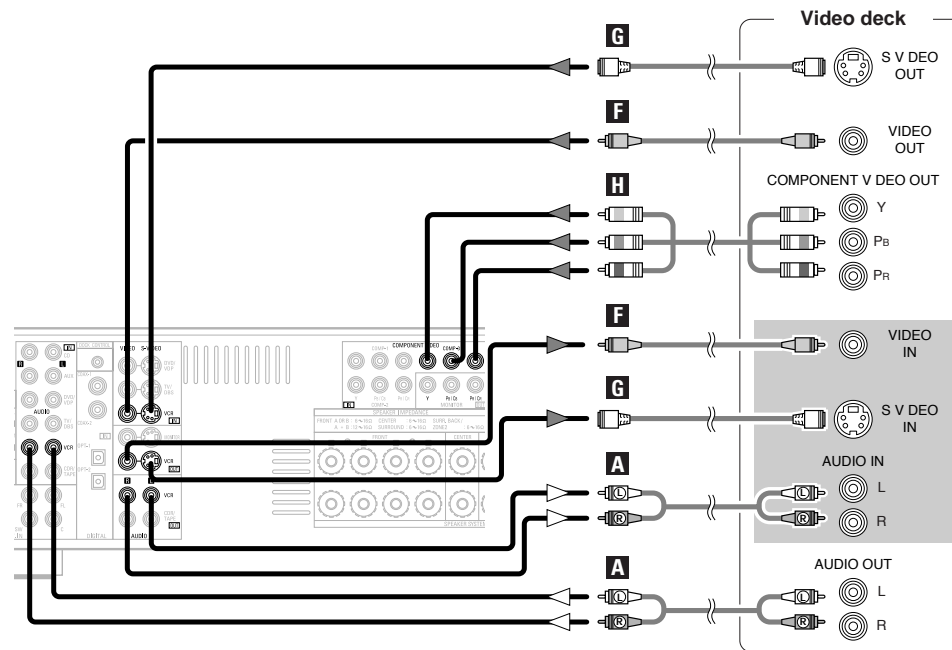

- When recording to a VCR, it is necessary that the type of cable used with the playback source equipment be the same type that is connected to the AVR-1707 VCR OUTPUT terminal.

Example: VCR IN → S-Video cable : VCR OUT → S-Video cable
 VCR IN → Video cable : VCR OUT → Video cable

Connecting Other Sources

Connecting the antenna terminals

An FM antenna cable plug can be connected directly.

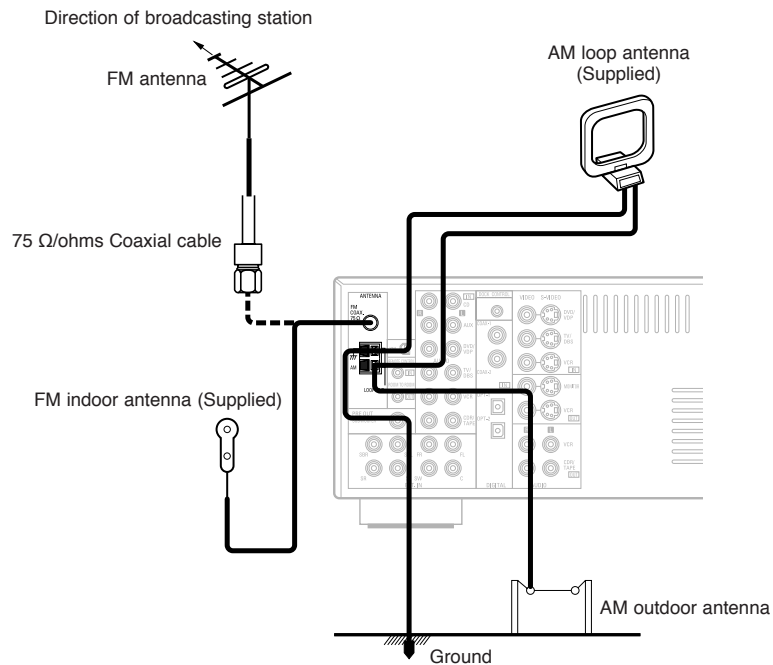

AM loop antenna assembly

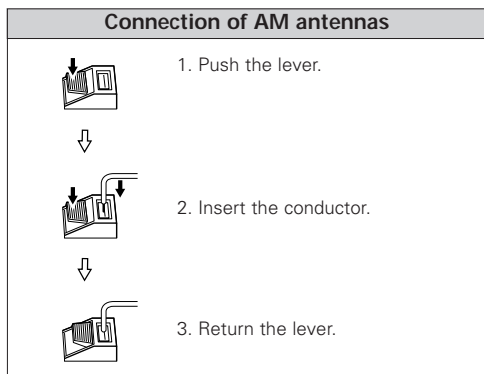
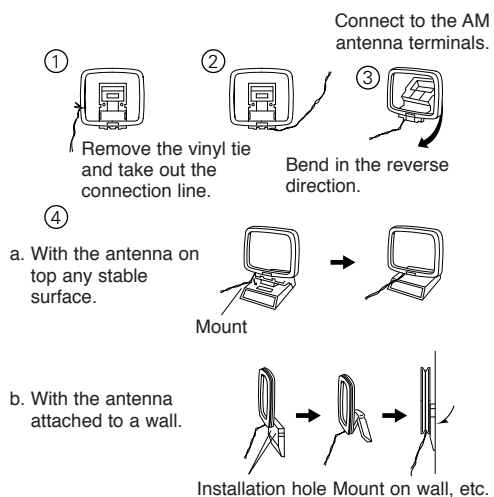

Connecting Other Sources

NOTE:

- Do not connect two FM antennas simultaneously.
- Even if an external AM antenna is used, do not disconnect the AM loop antenna.
- Make sure the AM loop antenna lead terminals do not touch metal parts of the panel.

Note to CATV system installer:

This reminder is provided to call the CATV system installer's attention to Article 820-40 of the NEC which provides guidelines for proper grounding and, in particular, specifies that the cable ground shall be connected to the grounding system of the building, as close to the point of cable entry as practical.

Connecting the XM terminal

- AVR-1707 is the XM Ready® receiver. You can receive XM® Satellite Radio by connecting to the XM Passport System (sold separately) and subscribing to the XM service.
 - Plug the XM Passport System into XM terminal on the rear panel.
 - Position the XM Passport System near a south-facing window to receive the best signal. For details, see "XM Satellite Radio" (page 32).
- When making connections, also refer to the operating instructions of the XM Passport System.

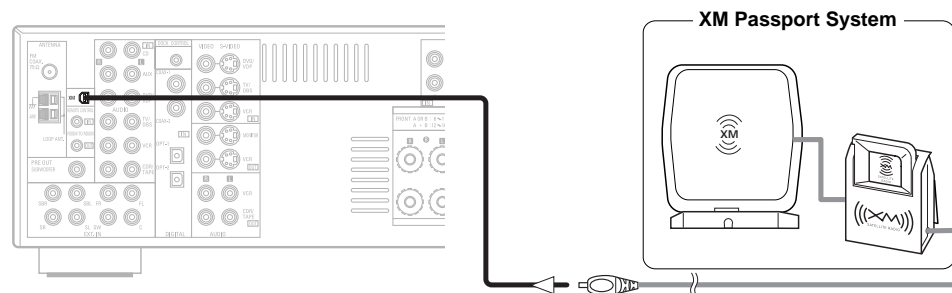

NOTE:

- Keep the power supply cord unplugged until the XM Passport System connection has been completed.

- The XM name and related logo are registered trademarks of XM Satellite Radio Inc. All rights reserved.
- XM Ready is a registered trademark of XM Satellite Radio Inc. All rights reserved.

Connecting Other Sources

Connecting the iPod®

When using an iPod, you must connect the Control Dock for iPod (ASD-1R, sold separately) and the DOCK CONTROL jack on the AVR-1707 with a mini-jack and assign the iPod to any AUDIO and/or S-VIDEO terminal(s).

The diagram below shows an example of connections for when the iPod is assigned to the DVD/VDP terminal.

- ※ For instructions on assigning the iPod to a specific terminal, see "Setting the iPod Assignment" (page 41).
- ※ For instructions on playing the iPod, see "Playing the iPod" (page 34, 35).

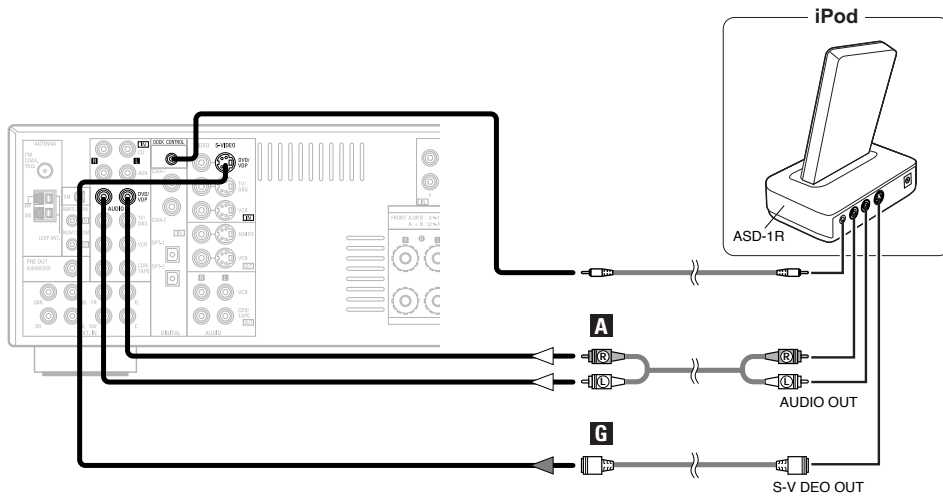

- The optional standard Dock Control for iPod is DENON ASD-1R sold separately.

Connecting Other Sources

Connecting the MULTI ZONE terminals

- ※ For instructions on operations using the MULTI ZONE functions (page 36).

Connecting a room-to-room remote control unit

When a sold separately room-to-room remote control unit (DENON RC-616, 617 or 618) is wired and connected between the MAIN ZONE and ZONE2, the remote-controllable devices in the MAIN ZONE can be controlled from ZONE2 using the remote control unit.

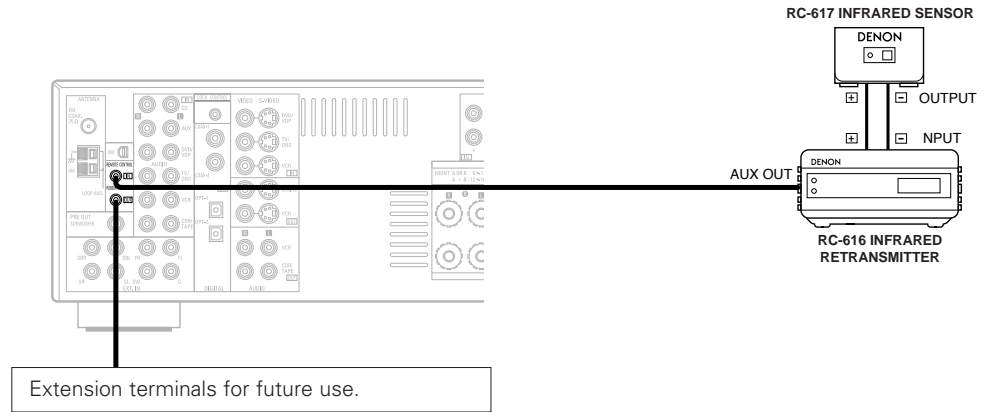

NOTE:

- For instructions on installation and operation of separately sold devices, refer to the devices' operating instructions.

Connecting Other Sources

ZONE2 speaker out connections

- When the surround back's power amplifier is assigned to the ZONE2 output channel at Power Amplifier Assignment mode, the surround back speaker terminals can be used as the ZONE2 speaker out terminals (see page 36).
- The connections diagram below is an example for when the surround back speaker is assigned to the ZONE2 stereo 2 channel. In this case, surround back speaker out can not be used for MAIN ZONE.

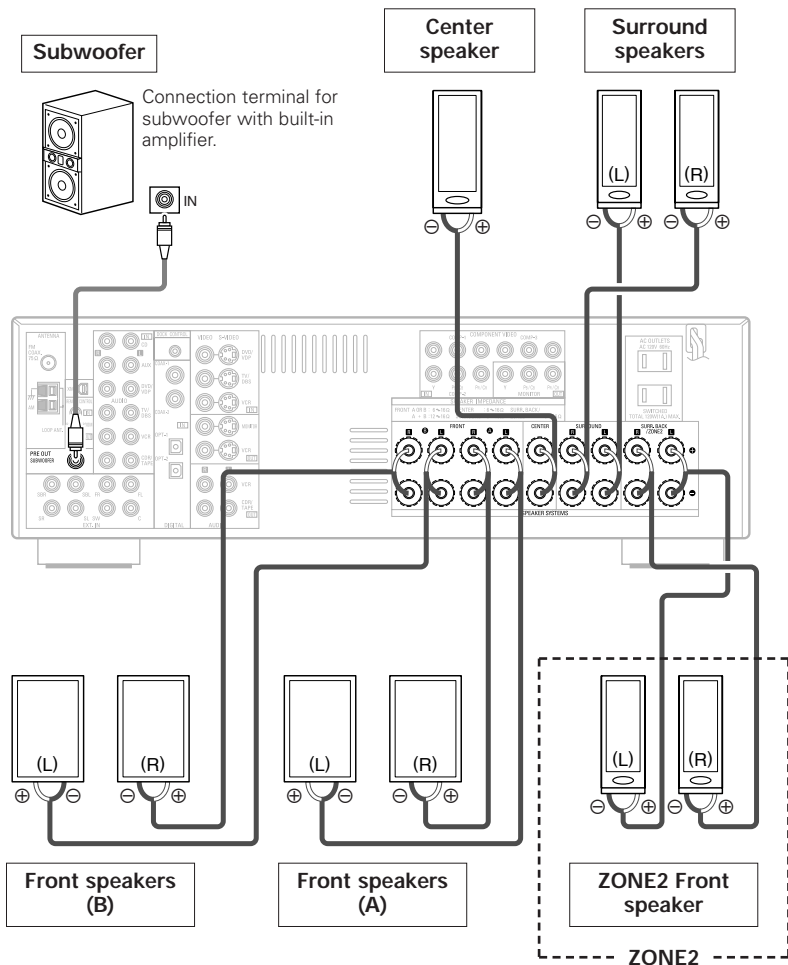

Connecting Other Sources

Connecting the power supply cord

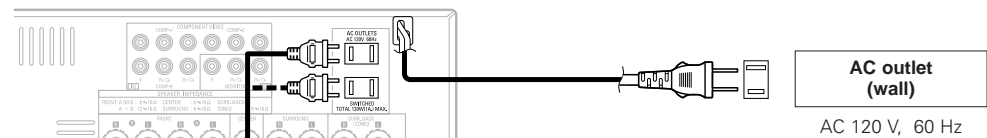

AC OUTLETS

- **SWITCHED** (total capacity – 120 W (1A.))
The power to the outlet is turned on and off in conjunction with the **POWER** switch on the main unit, and when the power is switched between on and standby from the remote control unit.
No power is supplied from this outlet when this unit's power is at standby. Never connect equipment whose total power consumption exceeds 120 W (1A.).

NOTE:

- Insert the plugs securely. Incomplete connections will result in the generation of noise.
- Only use the AC OUTLETS for audio equipment. Never use it for hair driers, monitors or other electrical appliances.

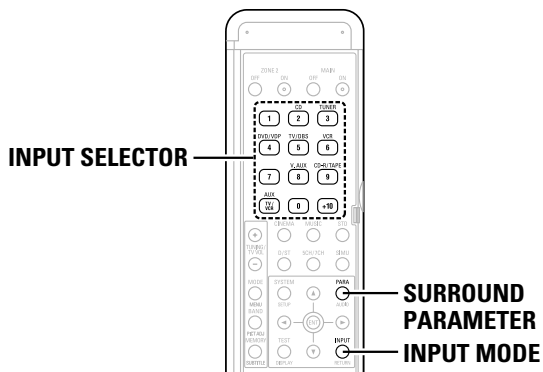
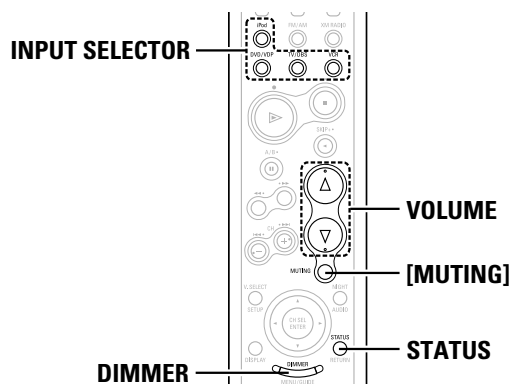
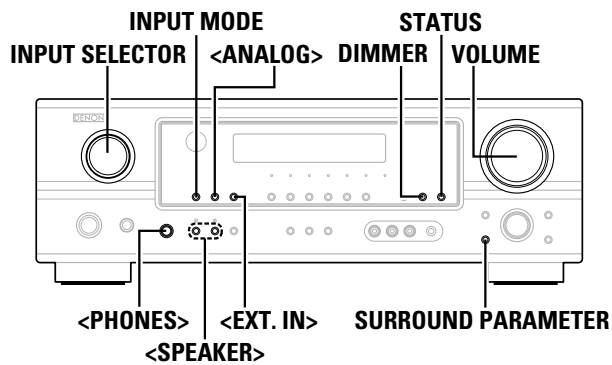

About the button names in this explanation
 < > : Buttons on the main unit
 [] : Buttons on the remote control unit
Button name only :
 Buttons on the main unit and remote control unit

Basic Operation

Playing the input source

1 Use **INPUT SELECTOR** to select the input source you want to play.

2 Press **INPUT MODE**.

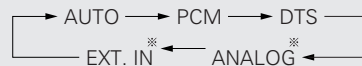

※ Press <ANALOG> to select "ANALOG", <EXT. IN> to select "EXT. IN".

AUTO (All auto mode):

The type of input signal is detected and the AVR-1707's surround mode is switched automatically. Can be selected for sources for which the Digital In Assignment mode (page 41) is made. The mode switches automatically to DTS/ Dolby Digital/ PCM. The input switches to the analog input terminals if no digital signals are being input.

- The INPUT mode indicator lights.

PCM (exclusive PCM signal playback mode) and DTS (exclusive DTS signal playback mode):

Played when the various signals are input. Noise may be generated when a mode different from the input signal is set.

- The INPUT mode indicator lights.

ANALOG (exclusive analog audio signal playback mode) and EXT. IN (External decoder input terminal selection mode):

The signals input to the various input terminals are played.

- ※ To lower the subwoofer channel level in the EXT. IN mode, press **SURROUND PARAMETER** and select "SW. ATT". For some players the playback level of the SW channel may seem strong. If so, set to "ON".

3 Start playback on the selected component.

- ※ For operating instructions, refer to the component's manual.

4 Use **VOLUME** to adjust the volume.

- The volume level is displayed on the master volume level display.

- ※ The volume can be adjusted between the range of -80 ~ 0 ~ 18 dB. Depending on the channel level settings and the different surround mode settings and when in the down-mix mode, it may not be possible to adjust the volume to 18 dB.



- Canceling the EXT. IN mode:
Press **INPUT MODE** or <ANALOG> to switch to the desired input mode.
- To use the EXT. IN mode together with a picture, select the input source to which the video signal is connected first, then set the input mode.
- The "DIGITAL" indicator lights when digital signals are being input properly. If the "DIGITAL" indicator does not light, check whether the "Digital In Assign" (page 41) and connections are correct.

NOTE:

- When the input mode is set to the external input (EXT. IN), the surround mode cannot be set.
- In play modes other than the external input mode, the signals connected to these terminals cannot be played.

Cautions when playing DTS sources:

- For DTS sources, be sure to connect the device to the digital input terminal and set "AUTO" or "DTS" for the input source. Noise will be generated if you play in the "ANALOG" or "PCM" mode.
- When playing DTS signals in the "AUTO" mode, noise may be generated when you first start playing and during searching. If so, play in the "DTS" mode.

Basic Operation

Turning the sound off temporarily (MUTING)

Press **[MUTING]**.

※ You can adjust the muting level (🔊 page 44).



• Canceling MUTING mode:

To cancel the muting mode, either press **[MUTING]** or adjust the volume.

Listening over headphones

Connect the headphones to **<PHONES>**.

• No sound is produced from the speakers automatically.

NOTE:

• To prevent hearing loss, be careful not to raise the volume level excessively when using headphones.

Switching the front speakers

Press **<SPEAKER>** to turn the corresponding speaker pair on.

※ The front speaker A, B setting can be also be changed with **<SPEAKER>**.

Checking the currently playing program source, etc.

Press **STATUS**.

• The current program source and various settings are indicated on the display.

Switching the brightness of the display

Press **DIMMER**.

※ The brightness of the display can be adjusted in 3 steps. The display can also be turned off.

Basic Operation

Using the surround modes

Types of surround modes and their features

The AVR-1707 is equipped with many surround modes. We recommend using the surround modes as described below in order to achieve the maximum effect for the specific signal source.

※  is a 6.1-channel/7.1-channel surround mode.

Sources recorded in Dolby Digital EX

DOLBY DIGITAL EX / +PLIIx* (🔊 page 22)

• This mode is optimized for playing sources recorded in Dolby Digital EX.

Sources recorded in DTS-ES

DTS-ES DSCRT 6.1 / MTRX 6.1, +PLIIx* (🔊 page 22)

• This is the optimum mode for playing sources recorded in DTS-ES.

Dolby Digital or DTS Surround (5.1 ch sources)
2 ch sources recorded in Dolby Surround

**DOLBY DIGITAL / DOLBY DIGITAL+PLIIx* /
DTS SURROUND / DTS 96/24 / DTS+PLIIx* /
DTS+NEO:6** (🔊 page 22)

• This mode is optimized for playing 5.1-channel or 7.1-channel music.
• For Dolby Surround recording sources, Dolby Pro Logic II playback is conducted.

2-channel sources recorded in XM HD Surround

NEURAL SURROUND (🔊 page 24)

• This is the optimum mode for playing sources recorded in XM HD Surround.

Basic Operation

Sources recorded in stereo
Sources recorded in monaural

DIRECT / STEREO

- Effective for achieving pure playback.
- If there is no need for tone control or distribution of the low frequencies in function of the speaker configuration, select the DIRECT mode to achieve the best sound quality.

DENON Original Surround Modes (page 28, 29)

- Select these for 7.1-channel playback with sources recorded in stereo or monaural.
- The effects are different for each of the surround modes. Select the one most suited for the source being used.

DTS NEO:6 (page 24)

- This is a surround mode for playing 6.1- or 7.1-channel stereo sources developed by Digital Theater Systems.
- One of 2 playing modes, MUSIC (for music sources) or CINEMA (for movie sources), can be selected according to your preferences.

DOLBY PRO LOGIC IIx* (page 23)

- Developed by Dolby Laboratories, this surround mode provides 7.1-channel surround sound with conventional stereo (2-channel) sources.
- Select CINEMA mode for movie surround soundtracks, MUSIC for music sources, and GAME for 2-channel game box audio sources.



- Surround modes marked with an asterisk (*) cannot be used when the surround back speaker is set to "NONE".
- The "+PLIIx Cinema" mode cannot be selected when only one surround back speaker is being used.

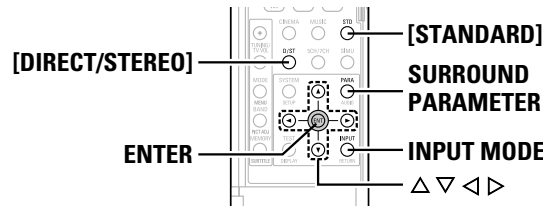
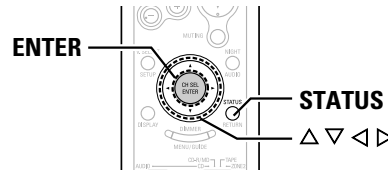
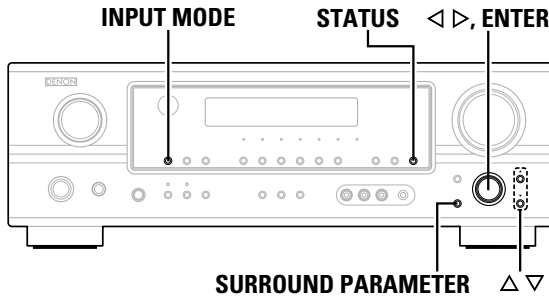

About the button names in this explanation
 < > : Buttons on the main unit
 [] : Buttons on the remote control unit
Button name only :
 Buttons on the main unit and remote control unit

Basic Operation

Selecting the play mode (DIRECT/STEREO)

The AVR-1707 is equipped with two 2-channel playback modes exclusively for music. Select the mode to suit your tastes.

DIRECT mode

This mode is for playing with high quality sound. The audio signals are transmitted directly, without passing through the tone circuits, etc.

Press [DIRECT/STEREO] to select "DIRECT".

DIRECT ←→ STEREO

STEREO mode

Use this mode to adjust the tone and achieve the desired sound.

Press [DIRECT/STEREO] to select "STEREO".



Basic Operation

Selecting the Dolby Digital and DTS Surround mode (only with digital input)

1 Select an input source for which digital (COAXIAL or OPTICAL) is set (☞ page 41).

2 Press **INPUT MODE** to select "AUTO".

3 Press **[STANDARD]** to select "STANDARD (Dolby/DTS Surround)".

4 Play a program source with the ,  mark.
• "DIGITAL" or "DTS" lights, depending on the source.

5 Press **SURROUND PARAMETER**.

6 Press Δ ∇ to select the item, then press \triangleleft \triangleright to set.

※ The parameter switches as shown below each time the button is pressed.

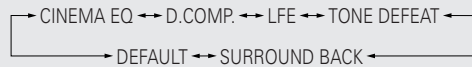

※ If you do want the bass and treble to be adjusted, turn off the tone defeat mode.

CINEMA EQ.:

Use this if movie dialogues sound harsh to lower the treble sound.

- ※ Effective source / mode
Dolby Pro Logic IIx / Dolby Pro Logic / Dolby Digital /
DTS Surround / DTS NEO:6 / NEURAL SURROUND

D.COMP.:

The dynamic range is compressed. Select one of 4 modes: "OFF", "LOW", "MID" (middle) or "HIGH".

- ※ Effective source / mode
Dolby Digital /
DTS (For DTS sources, only displayed for compatible software.)

LFE:

To play the various types of software properly, we recommend setting to the values shown below.

- To play Dolby Digital software: "0 dB"
- To play DTS movie software: "0 dB"
- To play DTS music software: "-10 dB"

TONE:

Adjust the tone control.

- ※ Can be set in surround modes other than direct mode.
- ※ Can be set separately for the different surround modes.
(Adjusted together for the Dolby/DTS SURROUND modes.)

SB CH OUT:

Select the play mode or surround back channel playback method.
• The surround back indicator lights.

(1) For multi-channel sources

- **SB OFF (OFF):**
Not played.
- **NON MTRX:**
Surround channel signal played.
- **MTRX ON:**
Surround channel signal played with digital matrix processing.
- **ES MTRX:**
DTS signal played with digital matrix processing.
- **ES DSCRT:**
Signal included in DTS-ES discrete 6.1-channel sources played.
- **PLIIx CINEMA:**
Decoded in Dolby Pro Logic IIx Cinema mode, surround back signal played.
※ Set the surround back speaker to "2sp" at Speaker Configuration mode (☞ page 45, 46).
- **PLIIx MUSIC:**
Decoded in Dolby Pro Logic IIx Music mode, surround back signal played.
※ Set the surround back speaker to "1sp" or "2sp" at Speaker Configuration mode (☞ page 45, 46).

Basic Operation

(2) For 2-channel sources

- **OFF:** Not played.
- **ON:** Surround channel signal played.

7 Press **ENTER** or **SURROUND PARAMETER**.



- Select "DEFAULT Y/N" and press \triangleleft to reset all the settings.

Dialog normalization function

This operates automatically when playing Dolby Digital sources. This is a function for automatically correcting the standard signal level for different program sources. The correction value can be checked by pressing **STATUS**.

Offset -4dB

The numbers are the correction value when corrected to the standard level.

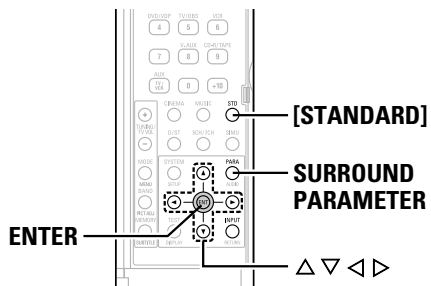
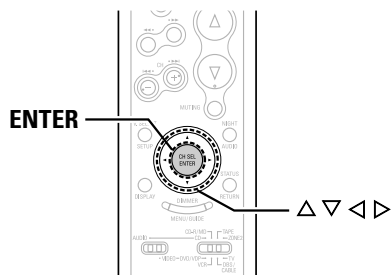
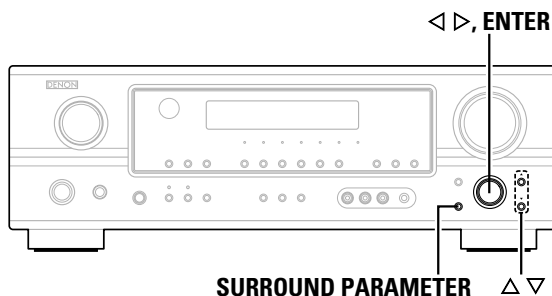

About the button names in this explanation

- < > : Buttons on the main unit
- [] : Buttons on the remote control unit

Button name only :

Buttons on the main unit and remote control unit

Selecting the Dolby Pro Logic IIx (Pro Logic II) mode

It is possible to play analog input signals and digital input signals (2-channels) in the surround mode. This mode is optimal for playing program sources recorded in Dolby Surround.

1 Press [STANDARD] to select “DOLBY PLIIx”.

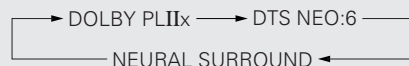

2 Play a program source.

3 Press SURROUND PARAMETER.

4 Press < > to select the play mode.

CINEMA:

This mode is suited for playing movie sources recorded in Dolby Surround and general sources recorded in stereo.

MUSIC:

This mode is suited for playing stereo music signals in the surround mode. With music signals, the sound field expansion differs according to the type of music, the recording conditions (live/studio), etc.. Because of this, the MUSIC mode offers a number of optional parameters for further adjusting the sound field.

GAME:

This mode is optimum for games. The GAME mode can only be used for 2-channel audio sources.

PL:

This mode is compatible with conventional Dolby Pro Logic sources.

5 Press Δ ∇ to select the item, then press < > to set.

* The mode switches as shown below each time the button is pressed.

• **When the Cinema mode:**

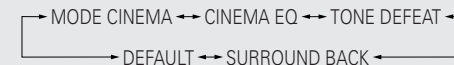

• **When the Music mode:**

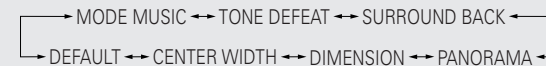

• **When the Game mode:**

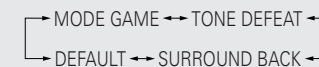

• **When the Dolby Pro Logic mode:**

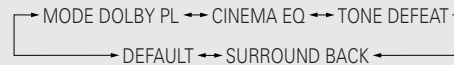

* If you do want the bass and treble to be adjusted, turn off the tone defeat mode.

When “Music” mode is selected:

PANORAMA:

This is effective when the surround effect seems weak.

DIMENSION:

This shifts the center of the sound field image to the front or surround side. This compensates for when the sound field image seems unbalanced. (0 to 6, default : 3)

CENTER WIDTH:

A natural expansion to the front can be achieved by adjusting the center signal’s output balance between the center and front channels. (0 to 7, default : 3)

6 Press ENTER or SURROUND PARAMETER.

Basic Operation

Selecting the DTS NEO:6 mode

It is possible to play analog input signals and digital input signals (2-channels) in the surround mode.

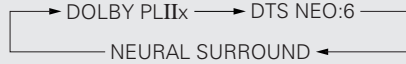
1 Press [STANDARD] to select "DTS NEO:6".

2 Play a program source.

3 Press SURROUND PARAMETER.

4 Press ◀▶ to select the play mode.
CINEMA:

This mode is optimum for playing movies. Decoding is performed with emphasis on separation performance to achieve the same atmosphere with 2-channel sources as with 6.1-channel sources.

MUSIC:

This mode is suited mainly for playing music.

5 Press △▽ to select the item, then press ◀▶ to set.

* The mode switches as shown below each time the button is pressed.

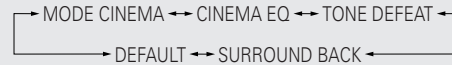
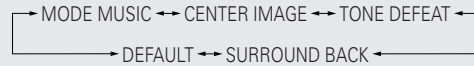
• When the Cinema mode:

• When the Music mode:

* If you do want the bass and treble to be adjusted, turn off the tone defeat mode.

When "Music" mode is selected:

CNTR. IMAGE:

The expansion of the center channel can be adjusted. (0.0 to 1.0, default : 0.3)

6 Press ENTER or SURROUND PARAMETER.

Basic Operation

Selecting the NEURAL SURROUND mode

It is possible to play analog input signals and digital input signals (2-channels) in the surround mode.

This is the optimum mode for playing sources recorded in XM HD Surround (▶ page 32).

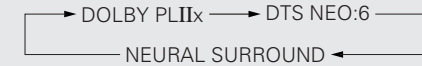
1 Press [STANDARD] to select "NEURAL SURROUND".

2 Play a program source.

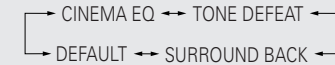
3 Press SURROUND PARAMETER.

4 Press △▽ to select the item, then press ◀▶ to set.

5 Press ENTER or SURROUND PARAMETER.

Surround modes and parameters

Surround Mode	Signals and adjustability in the different modes																			
	Channel output					Parameter (default values are shown in parentheses)														
	FRONT L/R	CENTER	SURROUND L/R	SURROUND BACK L/R	SUB-WOOFER	D. COMP *1	LFE *2	SB CH OUT	TONE CONTROL	CINEMA EQ.	MODE	ROOM SIZE	EFFECT LEVEL	Dolby Digital NIGHT mode	DELAY TIME	PRO LOGIC II/IIx MUSIC MODE only			NEO:6 MUSIC MODE only	EXT. IN only
															PANORAMA	DIMENSION	CENTER WIDTH	CENTER IMAGE	SW ATT	
STEREO	○	×	×	×	⊗	○ (OFF)	○ (0 dB)	×	○ (0 dB)	×	×	×	×	○ (OFF)	×	×	×	×	×	×
EXT. IN	○	⊗	⊗	⊗	⊗	×	×	×	×	×	×	×	×	×	×	×	×	×	×	○
DOLBY PRO LOGIC IIx	○	⊗	⊗	⊗	⊗	○ (OFF)	×	○	○ (0 dB)	○ (NOTE2)	○ (CINEMA)	×	×	○ (OFF)	×	○ (OFF)	○ (3)	○ (3)	×	×
DOLBY PRO LOGIC II	○	⊗	⊗	×	⊗	○ (OFF)	×	○	○ (0 dB)	○ (NOTE3)	○ (CINEMA)	×	×	○ (OFF)	×	○ (OFF)	○ (3)	○ (3)	×	×
DTS NEO:6	○	⊗	⊗	⊗	⊗	○ (OFF)	×	○	○ (0 dB)	○ (NOTE2)	○ (CINEMA)	×	×	○ (OFF)	×	×	×	×	○ (0.3)	×
DOLBY DIGITAL	○	⊗	⊗	⊗	⊗	○ (OFF)	○ (0 dB)	○	○ (0 dB)	○ (OFF)	×	×	×	○ (OFF)	×	×	×	×	×	×
DTS SURROUND	○	⊗	⊗	⊗	⊗	○ (OFF)	○ (0 dB)	○	○ (0 dB)	○ (OFF)	×	×	×	×	×	×	×	×	×	×
NEURAL SURROUND	○	⊗	⊗	⊗	⊗	×	×	○	○	×	×	×	×	×	×	×	×	×	×	×
5CH/7CH STEREO	○	⊗	⊗	⊗	⊗	○ (OFF)	○ (0 dB)	○	○ (0 dB)	×	×	×	×	○ (OFF)	×	×	×	×	×	×
MONO MOVIE	○	⊗	⊗	⊗	⊗	○ (OFF)	○ (0 dB)	○	○ (0 dB)	×	×	○ (Medium)	○ (10)	○ (OFF)	×	×	×	×	×	×
ROCK ARENA	○	⊗	⊗	⊗	⊗	○ (OFF)	○ (0 dB)	○	○ (NOTE1)	×	×	○ (Medium)	○ (10)	○ (OFF)	×	×	×	×	×	×
JAZZ CLUB	○	⊗	⊗	⊗	⊗	○ (OFF)	○ (0 dB)	○	○ (0 dB)	×	×	○ (Medium)	○ (10)	○ (OFF)	×	×	×	×	×	×
VIDEO GAME	○	⊗	⊗	⊗	⊗	○ (OFF)	○ (0 dB)	○	○ (0 dB)	×	×	○ (Medium)	○ (10)	○ (OFF)	×	×	×	×	×	×
MATRIX	○	⊗	⊗	⊗	⊗	○ (OFF)	○ (0 dB)	○	○ (0 dB)	×	×	×	×	○ (OFF)	○ (30 msec)	×	×	×	×	×
VIRTUAL	○	×	×	×	⊗	○ (OFF)	○ (0 dB)	×	○ (0 dB)	×	×	×	×	○ (OFF)	×	×	×	×	×	×

○ : Signal
 × : No signal
 ⊗ : Turned on or off by speaker configuration setting

○ : Adjustable
 × : Not adjustable
 NOTE1 : BASS +6 dB, TREBLE +4 dB
 NOTE2 : This parameter is available when the "MODE" is set to "CINEMA".
 NOTE3 : This parameter is available when the "MODE" is set to "CINEMA" or "PL".
 *1: When playing Dolby Digital and DTS signals.
 *2: When playing Dolby Digital, DTS, DVD-Audio and Super Audio CD.

○ : Signal
 × : No signal

○ : Adjustable
 × : Not adjustable

Basic Operation

Basic Operation

□ Differences in surround mode names depending on the input signals

Button	Surround Mode	Note	Input signals													
			ANALOG	LINEAR PCM	DTS				DOLBY DIGITAL					DVD-AUDIO		
					DTS ES DSCRT (With Flag)	DTS ES MTRX (With Flag)	DTS (5.1ch)	DTS 96/24	DOLBY DIGITAL EX (With Flag)	DOLBY DIGITAL EX (With no Flag)	DOLBY DIGITAL (5.1ch)	DOLBY DIGITAL (3, 4, 5ch)	DOLBY DIGITAL (2ch)	DVD-Audio (multi ch)	DVD-Audio (2ch)	176.4/192kHz
STANDARD																
DTS SURROUND																
	DTS ES DSCRT6.1	*1	X	X	●	X	X	X	X	X	X	X	X	X	X	X
	DTS ES MTRX6.1	*1	X	X	X	●	X	X	X	X	X	X	X	X	X	X
	DTS SURROUND		X	X	○	○	●	X	X	X	X	X	X	X	X	X
	DTS 96/24		X	X	X	X	●	X	X	X	X	X	X	X	X	X
	DTS + PLIIx CINEMA	*2	X	X	○	○	○	○	X	X	X	X	X	X	X	X
	DTS + PLIIx MUSIC	*1	X	X	○	○	○	○	X	X	X	X	X	X	X	X
	DTS + NEO:6	*1	X	X	X	○	○	○	X	X	X	X	X	X	X	X
	DTS NEO:6 CINEMA		○	○	X	X	X	X	X	X	X	X	○	X	○	X
	DTS NEO:6 MUSIC		○	○	X	X	X	X	X	X	X	X	○	X	○	X
DOLBY SURROUND																
	DOLBY DIGITAL EX	*1	X	X	X	X	X	X	○	○	○	○	X	X	X	X
	DOLBY DIGITAL		X	X	X	X	X	X	○	●	●	●	X	X	X	X
	DOLBY DIGITAL+PLIIx CINEMA	*2	X	X	X	X	X	X	●	○	○	○	X	X	X	X
	DOLBY DIGITAL+PLIIx MUSIC	*1	X	X	X	X	X	X	○	○	○	○	X	X	X	X
	DOLBY PRO LOGIC IIx CINEMA		○	○	X	X	X	X	X	X	X	X	●	X	○	X
	DOLBY PRO LOGIC IIx MUSIC		○	○	X	X	X	X	X	X	X	X	○	X	○	X
	DOLBY PRO LOGIC IIx GAME		○	○	X	X	X	X	X	X	X	X	○	X	○	X
	DOLBY PRO LOGIC II CINEMA		○	○	X	X	X	X	X	X	X	X	○	X	○	X
	DOLBY PRO LOGIC II MUSIC		○	○	X	X	X	X	X	X	X	X	○	X	○	X
	DOLBY PRO LOGIC II GAME		○	○	X	X	X	X	X	X	X	X	○	X	○	X
	DOLBY PRO LOGIC		○	○	X	X	X	X	X	X	X	X	○	X	○	X
	NEURAL SURROUND		○	○	X	X	X	X	X	X	X	X	X	X	○	X

- : Mode selectable in default status
- : Selectable mode
- X : Non-selectable mode

NOTE :

- *1: This mode is not available when the Surround Back speaker setup is set to "None".
- *2: This mode is not available when the Surround Back speaker setup is set to "1sp" or "None".

Basic Operation

Basic Operation

Button	Surround Mode	Note	Input signals														
			ANALOG	LINEAR PCM	DTS				DOLBY DIGITAL					DVD-AUDIO			
					DTS ES DSCRT (With Flag)	DTS ES MTRX (With Flag)	DTS (5.1ch)	DTS 96/24	DOLBY DIGITAL EX (With Flag)	DOLBY DIGITAL EX (With no Flag)	DOLBY DIGITAL (5.1ch)	DOLBY DIGITAL (3, 4, 5ch)	DOLBY DIGITAL (2ch)	DVD-Audio (multi ch)	DVD-Audio (2ch)	176.4/ 192kHz	
DIRECT	DIRECT		○	○	○	○	○	○	○	○	○	○	○	○	×	○	○
DSP SIMULATION	5CH/7CH STEREO	*1	○	○	○	○	○	○	○	○	○	○	○	○	○	×	×
	MONO MOVIE		○	○	○	○	○	○	○	○	○	○	○	○	○	×	×
	ROCK ARENA		○	○	○	○	○	○	○	○	○	○	○	○	○	×	×
	JAZZ CLUB		○	○	○	○	○	○	○	○	○	○	○	○	○	×	×
	VIDEO GAME		○	○	○	○	○	○	○	○	○	○	○	○	○	×	×
	MATRIX		○	○	○	○	○	○	○	○	○	○	○	○	○	×	×
	VIRTUAL		○	○	○	○	○	○	○	○	○	○	○	○	○	×	×
STEREO	STEREO		●	●	○	○	○	○	○	○	○	○	○	○	○	●	●

- : Mode selectable in default status
- : Selectable mode
- ×

NOTE :

*1: If the Surround Back speaker setup is set to "None", then "5CH STEREO" is displayed.

Using the DENON original surround modes

The AVR-1707 is equipped with a high performance digital signal processor (DSP) that uses digital signal processing to recreate sound fields artificially. One of seven surround modes can be selected according to the program source and parameters can be further adjusted to achieve even more realistic sound fields.

Types of surround modes and their features

5CH/7CH STEREO (NOTE 1)	This mode lets you enjoy stereo sound with 7 speakers. The front L (R) channel signals are played from the surround and surround back L (R) channels and only the in-phase component of the L and R channels is played on the center channel.
MONO MOVIE (NOTE 2)	This mode recreates the atmosphere of an expansive sound field for movie sources recorded in monaural.
ROCK ARENA	This mode recreates the atmosphere of a live concert in an arena.
JAZZ CLUB	This mode recreates the atmosphere of a live concert in a club with low ceilings, hard walls and the artist just in front of you.
VIDEO GAME	This mode provides a rich sense of presence for video games.
MATRIX	This mode recreates music sources recorded in stereo with an enhanced sense of expansion.
VIRTUAL	This mode can be used to enjoy surround sound with only front speakers or when using headphones.

NOTE 1: "5CH STEREO" is displayed when "SB CH OUT" is set to "OFF".

NOTE 2: When playing sources recorded in monaural, the sound will be one-sided if signals are only input to one channel (left or right), so input signals to both channels. If you have a source component with only one audio output (monophonic camcorder, etc.) obtain a "Y" adapter cable to split the mono output to two outputs, and connect to the L and R inputs.



- Depending on the program source being played, the effect may not be very noticeable. In this case, try other surround modes, without worrying about their names, to create a sound field suited to your tastes.

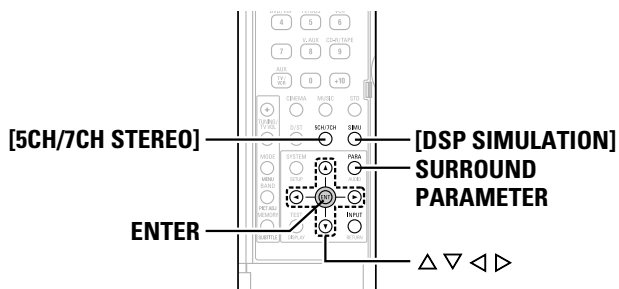
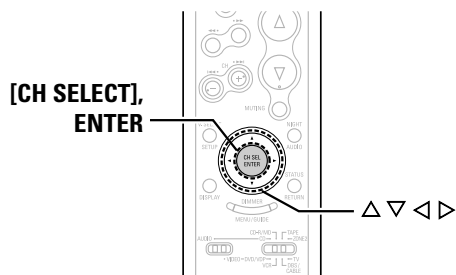
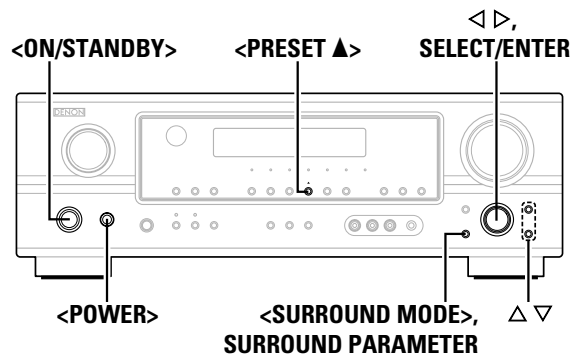

About the button names in this explanation
 < > : Buttons on the main unit
 [] : Buttons on the remote control unit
Button name only :
 Buttons on the main unit and remote control unit

Selecting the DSP surround simulation

To operate the surround mode and the surround parameters from the remote control unit

1 Press **[DSP SIMULATION]**.

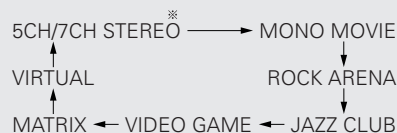

* The 5CH/7CH STEREO mode can be selected directly by pressing **[5CH/7CH STEREO]**.

2 Press **SURROUND PARAMETER**.

3 Press Δ ∇ to select the item, then press \triangleleft \triangleright to set.

* The surround parameter switches in the following order each time **SURROUND PARAMETER** is pressed for the different surround modes.

• When the **MONO MOVIE**, **ROCK ARENA**, **JAZZ CLUB** and **VIDEO GAME** mode:

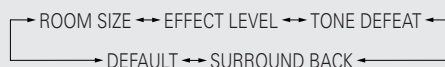

• When the **MATRIX** mode:

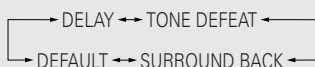

• When the **VIRTUAL** mode:

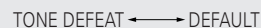

* If you do want the bass and treble to be adjusted, turn off the tone defeat mode.

SB CH OUT

- **ON:**
Surround back channel played.
- **OFF:**
Surround back channel not played.

ROOM SIZE:

Adjust the imaginary size of the recreated sound field space. (Does not express size of room in which played.)
 There are five parameters: "small", "med.s", "medium", "med.l" and "large".

EFFECT LEVEL:

Adjust the strength of the surround effect.

DELAY TIME: (MATRIX mode only)

Adjust the delay time between "0 ms" and "110 ms".

4 Press **[ENTER]** or **[SURROUND PARAMETER]**.



- Select "DEFAULT Y/N" and press \triangleleft to reset all the settings.

Operating the surround mode and the surround parameters from the main unit's panel

1 Use **<SELECT/ENTER>** to select the surround mode.

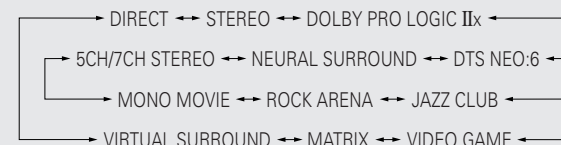

* To select the surround mode while adjusting the surround parameters, tone defeat or tone control, press **<SURROUND MODE>**, then operate the selector.

2 Perform steps 2 to 4 under "Selecting the DSP surround simulation".