

# DENON

AV SURROUND RECEIVER

# AVR-1906

---

OPERATING INSTRUCTIONS

MODE D'EMPLOI

## SAFETY PRECAUTIONS



**CAUTION**  
**RISK OF ELECTRIC SHOCK**  
**DO NOT OPEN**



### CAUTION:

**TO REDUCE THE RISK OF ELECTRIC SHOCK, DO NOT REMOVE COVER (OR BACK). NO USER-SERVICEABLE PARTS INSIDE. REFER SERVICING TO QUALIFIED SERVICE PERSONNEL.**



The lightning flash with arrowhead symbol, within an equilateral triangle, is intended to alert the user to the presence of uninsulated "dangerous voltage" within the product's enclosure that may be of sufficient magnitude to constitute a risk of electric shock to persons.



The exclamation point within an equilateral triangle is intended to alert the user to the presence of important operating and maintenance (servicing) instructions in the literature accompanying the appliance.

### WARNING:

**TO REDUCE THE RISK OF FIRE OR ELECTRIC SHOCK, DO NOT EXPOSE THIS APPLIANCE TO RAIN OR MOISTURE.**

## FCC INFORMATION (For US customers)

### 1. PRODUCT

This product complies with Part 15 of the FCC Rules. Operation is subject to the following two conditions: (1) this product may not cause harmful interference, and (2) this product must accept any interference received, including interference that may cause undesired operation.

### 2. IMPORTANT NOTICE: DO NOT MODIFY THIS PRODUCT

This product, when installed as indicated in the instructions contained in this manual, meets FCC requirements. Modification not expressly approved by DENON may void your authority, granted by the FCC, to use the product.

### 3. NOTE

This product has been tested and found to comply with the limits for a Class B digital device, pursuant to Part 15 of the FCC Rules. These limits are designed to provide reasonable protection against harmful interference in a residential installation.

This product generates, uses and can radiate radio frequency energy and, if not installed and used in accordance with the instructions, may cause harmful interference to radio communications. However, there is no guarantee that interference will not occur in a particular installation. If this product does cause harmful interference to radio or television reception, which can be determined by turning the product OFF and ON, the user is encouraged to try to correct the interference by one or more of the following measures:

- Reorient or relocate the receiving antenna.
- Increase the separation between the equipment and receiver.
- Connect the product into an outlet on a circuit different from that to which the receiver is connected.
- Consult the local retailer authorized to distribute this type of product or an experienced radio/TV technician for help.

## SAFETY INSTRUCTIONS

1. Read Instructions – All the safety and operating instructions should be read before the product is operated.
2. Retain Instructions – The safety and operating instructions should be retained for future reference.
3. Heed Warnings – All warnings on the product and in the operating instructions should be adhered to.
4. Follow Instructions – All operating and use instructions should be followed.
5. Cleaning – Unplug this product from the wall outlet before cleaning. Do not use liquid cleaners or aerosol cleaners.
6. Attachments – Do not use attachments not recommended by the product manufacturer as they may cause hazards.
7. Water and Moisture – Do not use this product near water – for example, near a bath tub, wash bowl, kitchen sink, or laundry tub; in a wet basement; or near a swimming pool; and the like.
8. Accessories – Do not place this product on an unstable cart, stand, tripod, bracket, or table. The product may fall, causing serious injury to a child or adult, and serious damage to the product. Use only with a cart, stand, tripod, bracket, or table recommended by the manufacturer, or sold with the product. Any mounting of the product should follow the manufacturer's instructions, and should use a mounting accessory recommended by the manufacturer.
9. A product and cart combination should be moved with care. Quick stops, excessive force, and uneven surfaces may cause the product and cart combination to overturn.
10. Ventilation – Slots and openings in the cabinet are provided for ventilation and to ensure reliable operation of the product and to protect it from overheating, and these openings must not be blocked or covered. The openings should never be blocked by placing the product on a bed, sofa, rug, or other similar surface. This product should not be placed in a built-in installation such as a bookcase or rack unless proper ventilation is provided or the manufacturer's instructions have been adhered to.
11. Power Sources – This product should be operated only from the type of power source indicated on the marking label. If you are not sure of the type of power supply to your home, consult your product dealer or local power company. For products intended to operate from battery power, or other sources, refer to the operating instructions.
12. Grounding or Polarization – This product may be equipped with a polarized alternating-current line plug (a plug having one blade wider than the other). This plug will fit into the power outlet only one way. This is a safety feature. If you are unable to insert the plug fully into the outlet, try reversing the plug. If the plug should still fail to fit, contact your electrician to replace your obsolete outlet. Do not defeat the safety purpose of the polarized plug.
13. Power-Cord Protection – Power-supply cords should be routed so that they are not likely to be walked on or pinched by items placed upon or against them, paying particular attention to cords at plugs, convenience receptacles, and the point where they exit from the product.
15. Outdoor Antenna Grounding – If an outside antenna or cable system is connected to the product, be sure the antenna or cable system is grounded so as to provide some protection against voltage surges and built-up static charges. Article 810 of the National Electrical Code, ANSI/NFPA 70, provides information with regard to proper grounding of the mast and supporting structure, grounding of the lead-in wire to an antenna discharge unit, size of grounding conductors, location of antenna-discharge unit, connection to grounding electrodes, and requirements for the grounding electrode. See Figure A.
16. Lightning – For added protection for this product during a lightning storm, or when it is left unattended and unused for long periods of time, unplug it from the wall outlet and disconnect the antenna or cable system. This will prevent damage to the product due to lightning and power-line surges.
17. Power Lines – An outside antenna system should not be located in the vicinity of overhead power lines or other electric light or power circuits, or where it can fall into such power lines or circuits. When installing an outside antenna system, extreme care should be taken to keep from touching such power lines or circuits as contact with them might be fatal.
18. Overloading – Do not overload wall outlets, extension cords, or integral convenience receptacles as this can result in a risk of fire or electric shock.
19. Object and Liquid Entry – Never push objects of any kind into this product through openings as they may touch dangerous voltage points or short-out parts that could result in a fire or electric shock. Never spill liquid of any kind on the product.
20. Servicing – Do not attempt to service this product yourself as opening or removing covers may expose you to dangerous voltage or other hazards. Refer all servicing to qualified service personnel.
21. Damage Requiring Service – Unplug this product from the wall outlet and refer servicing to qualified service personnel under the following conditions:
  - a) When the power-supply cord or plug is damaged,
  - b) If liquid has been spilled, or objects have fallen into the product,
  - c) If the product has been exposed to rain or water,
  - d) If the product does not operate normally by following the operating instructions. Adjust only those controls that are covered by the operating instructions as an improper adjustment of other controls may result in damage and will often require extensive work by a qualified technician to restore the product to its normal operation,
  - e) If the product has been dropped or damaged in any way, and
  - f) When the product exhibits a distinct change in performance – this indicates a need for service.
22. Replacement Parts – When replacement parts are required, be sure the service technician has used replacement parts specified by the manufacturer or have the same characteristics as the original part. Unauthorized substitutions may result in fire, electric shock, or other hazards.
23. Safety Check – Upon completion of any service or repairs to this product, ask the service technician to perform safety checks to determine that the product is in proper operating condition.
24. Wall or Ceiling Mounting – The product should be mounted to a wall or ceiling only as recommended by the manufacturer.
25. Heat – The product should be situated away from heat sources such as radiators, heat registers, stoves, or other products (including amplifiers) that produce heat.

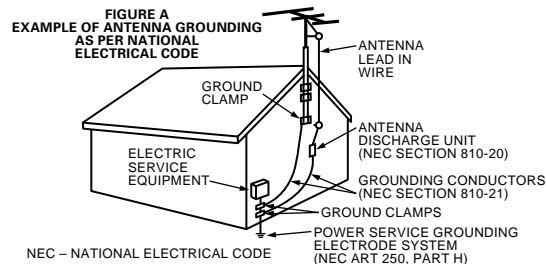

■ System setup menu / Menu de configuration système

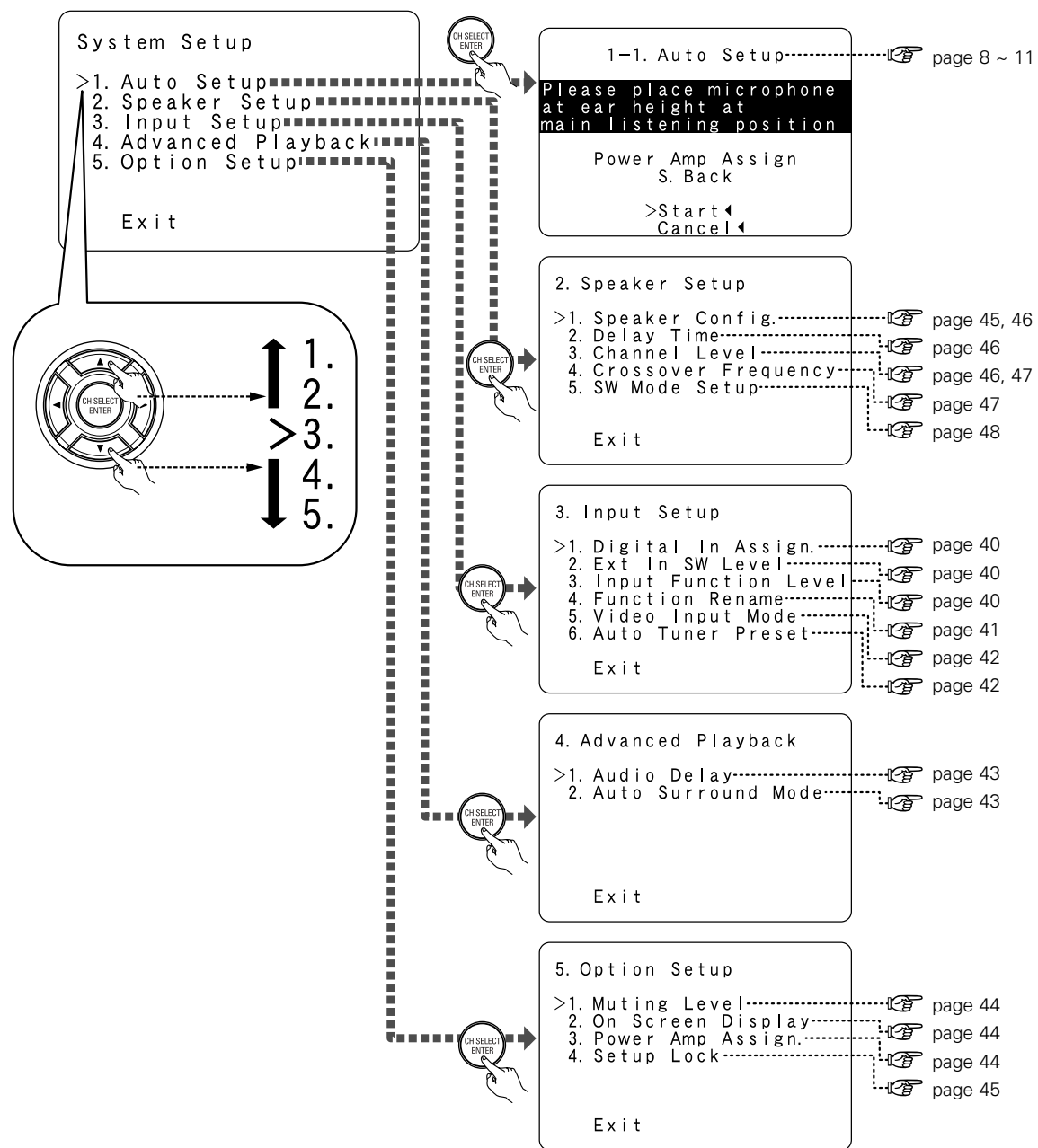

page 8 ~ 11

page 45, 46

page 46

page 46, 47

page 47

page 48

page 40

page 40

page 40

page 41

page 42

page 42

page 43

page 43

page 44

page 44

page 44

page 45

# Getting Started

Thank you for choosing the DENON AVR-1906 A/V Surround Receiver. This remarkable component has been engineered to provide superb surround sound listening with home theater sources, such as DVD, as well as providing outstanding high fidelity reproduction of your favorite music sources.

As this product is provided we recommend with an immense array of features, before you begin hookup and operation that you review the contents of this manual before proceeding.

## Contents

### Getting Started

|   |   |
|---|---|
| <b>Accessories</b> .....                                | 2 |
| <b>Before using</b> .....                               | 2 |
| <b>Cautions on installation</b> .....                   | 2 |
| <b>Cautions on handling</b> .....                       | 2 |
| <b>Preparing the remote control unit</b> .....          | 2 |
| <b>Inserting the batteries</b> .....                    | 3 |
| <b>Operating range of the remote control unit</b> ..... | 3 |
| <b>Part names and functions</b>                         |   |
| Front panel .....                                       | 3 |
| Remote control unit .....                               | 4 |

### Easy Setup and Operation

|   |        |
|---|--------|
| <b>Easy setup flow</b> .....                        | 4      |
| <b>Speaker system layout</b> .....                  | 5      |
| <b>Speaker connections</b> .....                    | 5, 6   |
| <b>Connecting a DVD player and monitor TV</b> ..... | 7      |
| <b>Auto Setup</b>                                   |        |
| Connecting a microphone .....                       | 8      |
| Turning on the power .....                          | 8      |
| Starting Auto Setup .....                           | 9      |
| About error messages .....                          | 10     |
| Check of the measurement results .....              | 10, 11 |
| <b>Playing a DVD with surround sound</b> .....      | 11     |

### Connecting Other Sources

|   |    |
|---|----|
| <b>Cable indications</b> .....                                  | 11 |
| <b>The video conversion function</b> .....                      | 12 |
| <b>On-screen display signals</b> .....                          | 12 |
| <b>Connecting a TV/DBS tuner</b> .....                          | 13 |
| <b>Connecting a video camera or video game</b> .....            | 13 |
| <b>Connecting the external inputs (EXT. IN) terminals</b> ..... | 13 |
| <b>Connecting a CD player</b> .....                             | 13 |
| <b>Connecting a VCR</b> .....                                   | 14 |
| <b>Connecting a tape deck</b> .....                             | 14 |
| <b>Connecting a CD recorder or MD recorder</b> .....            | 14 |
| <b>Connecting the antenna terminals</b> .....                   | 15 |

|  |    |
|--|----|
| <b>Connecting the MULTI ZONE terminals</b> ..... | 16 |
| ZONE2 out connections .....                      | 16 |
| ZONE2 speaker out connections .....              | 16 |
| <b>CONNECTING the pre-out terminals</b> .....    | 17 |
| <b>Connecting the power supply cord</b> .....    | 17 |

### Basic Operation

|   |        |
|---|--------|
| <b>Playback</b>   |        |
| Playing the input source .....  | 18     |
| Playback using the external input (EXT. IN) terminals .....                       | 18     |
| Turning the sound off temporarily (MUTING) .....                                  | 18     |
| Listening over headphones .....   | 19     |
| Combining the currently playing sound with the desired image (VIDEO SELECT) ..... | 19     |
| Selecting the front speakers .....  | 19     |
| Checking the currently playing program source .....                               | 19     |
| Input mode .....  | 19, 20 |
| <b>Surround</b>   |        |
| Playing audio sources (CDs and DVDs)  |        |
| 2-channel playback modes .....  | 21     |
| Dolby Pro Logic IIx (Pro Logic II) mode .....                                     | 21, 22 |
| DTS NEO:6 mode .....  | 22     |
| Dolby Digital mode and DTS surround .....   | 23, 24 |
| Night mode .....  | 24     |
| Adjusting the audio delay .....   | 25     |
| <b>DENON original surround modes</b>  |        |
| Surround modes and their features .....   | 26     |
| DSP surround simulation .....   | 27     |
| Tone control setting  |        |
| • Adjusting the sound quality .....   | 28     |
| • Tone defeat mode .....  | 28     |
| Channel Level .....   | 28     |
| <b>Listening to the radio</b>   |        |
| Auto preset memory .....  | 29     |
| Auto tuning .....   | 29     |
| Manual tuning .....   | 30     |
| Preset stations .....   | 30     |
| Checking the preset stations .....  | 30     |
| Recalling preset stations .....   | 30     |

### Advanced Operation

|  |        |
|--|--------|
| <b>Remote control unit</b>   |        |
| Operating DENON audio components .....   | 31     |
| Preset memory .....  | 32     |
| Operating a component stored in the preset memory .....                                | 32~34  |
| Punch through .....  | 34     |
| <b>Multi zone music entertainment system</b> .....                                     | 35, 36 |
| Outputting a program source to amplifier, etc., in a different room (ZONE2 mode) ..... | 37     |
| Remote control unit operations during multi-source playback .....                      | 37     |
| <b>Other functions</b>   |        |
| Playing one source while recording another (REC OUT mode) .....                        | 38     |
| Last function memory .....   | 38     |
| Initialization of the microprocessor .....   | 38     |

### Advanced Setup – Part 1

|   |    |
|---|----|
| <b>Navigating through the System Setup Menu</b> ..... | 39 |
| <b>On-screen display and front display</b> .....      | 39 |
| <b>Input Setup</b>                                    |    |
| Setting the Digital In Assign. .....                  | 40 |
| Setting the Ext In SW Level .....                     | 40 |
| Setting the Input Function Level .....                | 40 |
| Setting the Function Rename .....                     | 41 |
| Setting the Video Input Mode .....                    | 42 |
| Setting the Auto Tuner Preset .....                   | 42 |
| <b>Advanced Playback</b>                              |    |
| Setting the Audio Delay .....                         | 43 |
| Setting the Auto Surround Mode .....                  | 43 |
| <b>Option Setup</b>                                   |    |
| Setting the Muting Level .....                        | 44 |
| Setting the On-Screen Display .....                   | 44 |
| Setting the Power Amp Assign. .....                   | 44 |
| Setting the Setup Lock .....                          | 45 |

### Advanced Setup – Part 2

|  |        |
|--|--------|
| <b>Speaker Setup</b>                               |        |
| Setting the Speaker Config. .....                  | 45, 46 |
| Setting the Delay Time .....                       | 46     |
| Setting the Channel Level .....                    | 46, 47 |
| Setting the Crossover Frequency .....              | 47     |
| Setting the SW Mode Setup .....                    | 48     |
| <b>System setup items and default values</b> ..... | 49, 50 |

|                              |    |
|------------------------------|----|
| <b>Troubleshooting</b> ..... | 51 |
|------------------------------|----|

|                                     |       |
|-------------------------------------|-------|
| <b>Additional information</b> ..... | 52~57 |
|-------------------------------------|-------|

|                             |    |
|-----------------------------|----|
| <b>Specifications</b> ..... | 58 |
|-----------------------------|----|

|                                   |                    |
|-----------------------------------|--------------------|
| <b>List of preset codes</b> ..... | End of this manual |
|-----------------------------------|--------------------|

Getting Started

Accessories

Check that the following parts are included in addition to the main unit:

|                                       |                                    |
|---------------------------------------|------------------------------------|
| ① Operating instructions .....1       | ⑤ R6P/AA batteries .....2          |
| ② Warranty .....1                     | ⑥ AM loop antenna .....1           |
| ③ Service station list .....1         | ⑦ FM indoor antenna .....1         |
| ④ Remote control unit (RC-978) .....1 | ⑧ Omnidirectional microphone.....1 |



Before using

Pay attention to the following before using this unit:

• Moving the unit

To prevent short-circuits or damaged wires in the connection cables, always unplug the power supply cord and disconnect the connection cables between all other audio components when moving the unit.

• Before turning the power switch on

Check once again that all connections are correct and that there are not problems with the connection cables. Always set the power switch to the standby position before connecting and disconnecting connection cables.

• Store these instructions in a safe place.

After reading, store this instructions along with the warranty card in a safe place.

• Note that the illustrations in these instructions may differ from the actual unit for explanation purposes.

• V. AUX terminals

The AVR-1906's front panel is equipped with V. AUX terminals. Remove the cap covering the terminals when you want to use them.

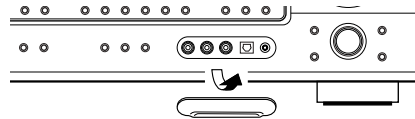

Getting Started

Cautions on installation

Noise or disturbance of the picture may be generated if this unit or any other electronic equipment using microprocessors is used near a tuner or TV.

If this happens, take the following steps:

- Install this unit as far away as possible from the tuner or TV.
- Run the antenna wires from the tuner or TV away from this unit's power supply cord and input/output connection cables.
- Noise or disturbance tends to occur particularly when using indoor antennas or 300 Ω/ohm feeder wires. **We recommend using outdoor antennas and 75 Ω/ohm coaxial cables.**

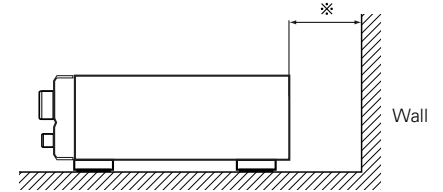
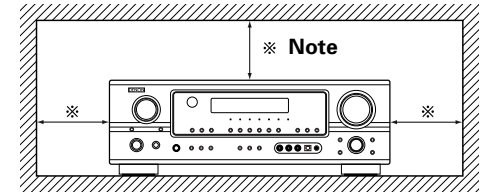

Note:

**For heat dispersal, do not install this unit in a confined space such as a bookcase or similar enclosure.**

Cautions on handling

• Switching the input source when input terminals are not connected.

A clicking noise may be produced if the input source is switched when nothing is connected to the input terminals. If this happens, either turn down the MASTER VOLUME control knob or connect components to the input terminals.

• Muting of PRE OUT terminals, PHONES jack and SPEAKER terminals.

The PRE OUT terminals, PHONES jack and SPEAKER terminals include a muting circuit. Because of this, the output signals are greatly attenuated for several seconds after the power switch is turned on or the input source, surround mode or any other set-up is changed. If the volume is turned up during this time, the output will be very high after the muting circuit stops functioning. Always wait until the muting circuit turns off before adjusting the volume.

• Whenever the power switch is in the STANDBY state, the unit is still connected to AC line voltage.

**Please be sure to turn off the power switch or unplug the cord when you leave home for, say, a vacation.**

Preparing the remote control unit

The included remote control unit (RC-978) can be used to operate not only the AVR-1906 but other remote control compatible DENON components as well. In addition, the memory contains control signals for other remote control units, so it can be used to operate non-DENON remote control compatible products.

Getting Started

Inserting the batteries

- 1 Remove the remote control unit's rear cover.

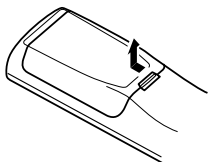

- 2 Set two R6P/AA batteries in the battery compartment in the indicated direction.

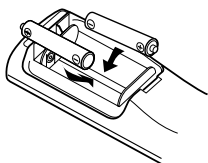

- 3 Put the rear cover back on.

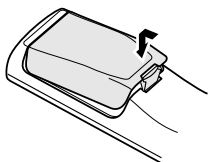

Notes on batteries:

- Replace the batteries with new ones if the set does not operate even when the remote control unit is operated nearby the unit. (The included batteries are only for verifying operation.)
- When inserting the batteries, be sure to do so in the proper direction, following the “+” and “-” marks in the battery compartment.
- To prevent damage or leakage of battery fluid:
  - Do not use a new battery together with an old one.
  - Do not use two different types of batteries.
  - Do not short-circuit, disassemble, heat or dispose of batteries in flames.
- If the battery fluid should leak, carefully wipe the fluid off the inside of the battery compartment and insert new batteries.
- When replacing the batteries, have the new batteries ready and insert them as quickly as possible.

Operating range of the remote control unit

- Point the remote control unit at the remote sensor on the main unit as shown in the diagram.
- The remote control unit can be used from a straight distance of approximately 23 feet from the main unit, but this distance will be shorter if there are obstacles in the way or if the remote control unit is not pointed directly at the remote sensor.
- The remote control unit can be operated at a horizontal angle of up to 30 degrees with respect to the remote sensor.

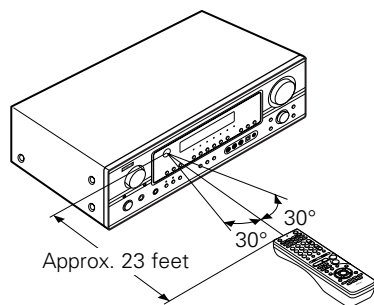

NOTE:

- It may be difficult to operate the remote control unit if the remote sensor is exposed to direct sunlight or strong artificial light.
- Do not press buttons on the main unit and remote control unit simultaneously. Doing so may result in malfunction.
- Neon signs or other devices emitting pulse-type noise nearby may result in malfunction, so keep the set as far away from such devices as possible.

Getting Started

Part names and functions

Front panel

For details on the functions of these parts, refer to the pages given in parentheses ( ).

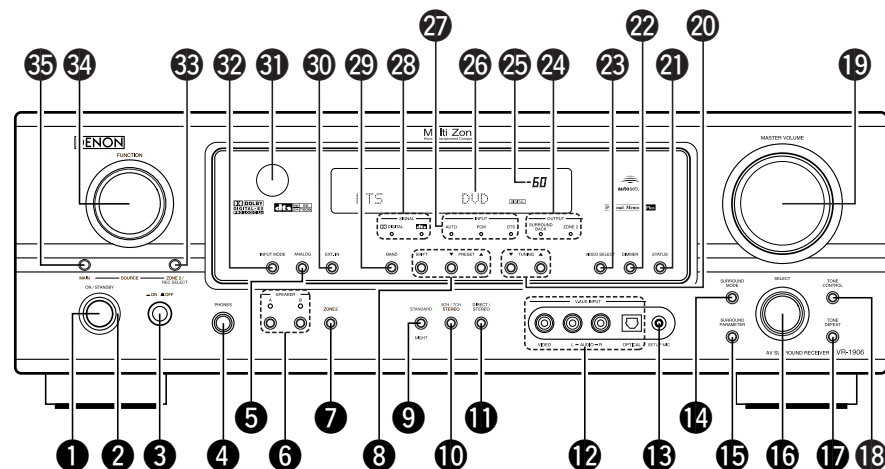

- |   |   |
|---|---|
| 1 Power ON/STANDBY switch .....(8)            | 19 MASTER VOLUME control knob .....(18)     |
| 2 Power indicator .....(8)                    | 20 TUNING ▲ (up)/▼ (down) buttons .....(29) |
| 3 Power switch .....(8, 38)                   | 21 STATUS button .....(19, 24)              |
| 4 Headphones jack (PHONES) .....(19)          | 22 DIMMER button .....(19)                  |
| 5 ANALOG button .....(20)                     | 23 VIDEO SELECT button .....(19)            |
| 6 SPEAKER A/B buttons .....(19, 38)           | 24 OUTPUT indicator .....(23, 37)           |
| 7 ZONE2 button .....(37)                      | 25 Master volume indicator .....(18)        |
| 8 Preset station select buttons .....(29, 30) | 26 Display                                  |
| 9 STANDARD/NIGHT button .....(21~24)          | 27 INPUT mode indicator .....(20)           |
| 10 5CH/7CH STEREO button .....(26)            | 28 SIGNAL indicator .....(20)               |
| 11 DIRECT/STEREO button .....(21)             | 29 BAND button .....(29)                    |
| 12 V. AUX INPUT terminals .....(13)           | 30 EXT. IN button .....(18)                 |
| 13 SETUP MIC jack .....(8)                    | 31 Remote control sensor .....(3)           |
| 14 SURROUND MODE button .....(18)             | 32 INPUT MODE button .....(19)              |
| 15 SURROUND PARAMETER button .....(21)        | 33 ZONE2/REC SELECT button .....(37, 38)    |
| 16 SELECT knob .....(18, 21, 28)              | 34 FUNCTION knob .....(18, 37)              |
| 17 TONE DEFEAT button .....(28)               | 35 MAIN button .....(18)                    |
| 18 TONE CONTROL button .....(28)              |   |



Getting Started

Remote control unit

For details on the functions of these parts, refer to the pages given in parentheses ( ).

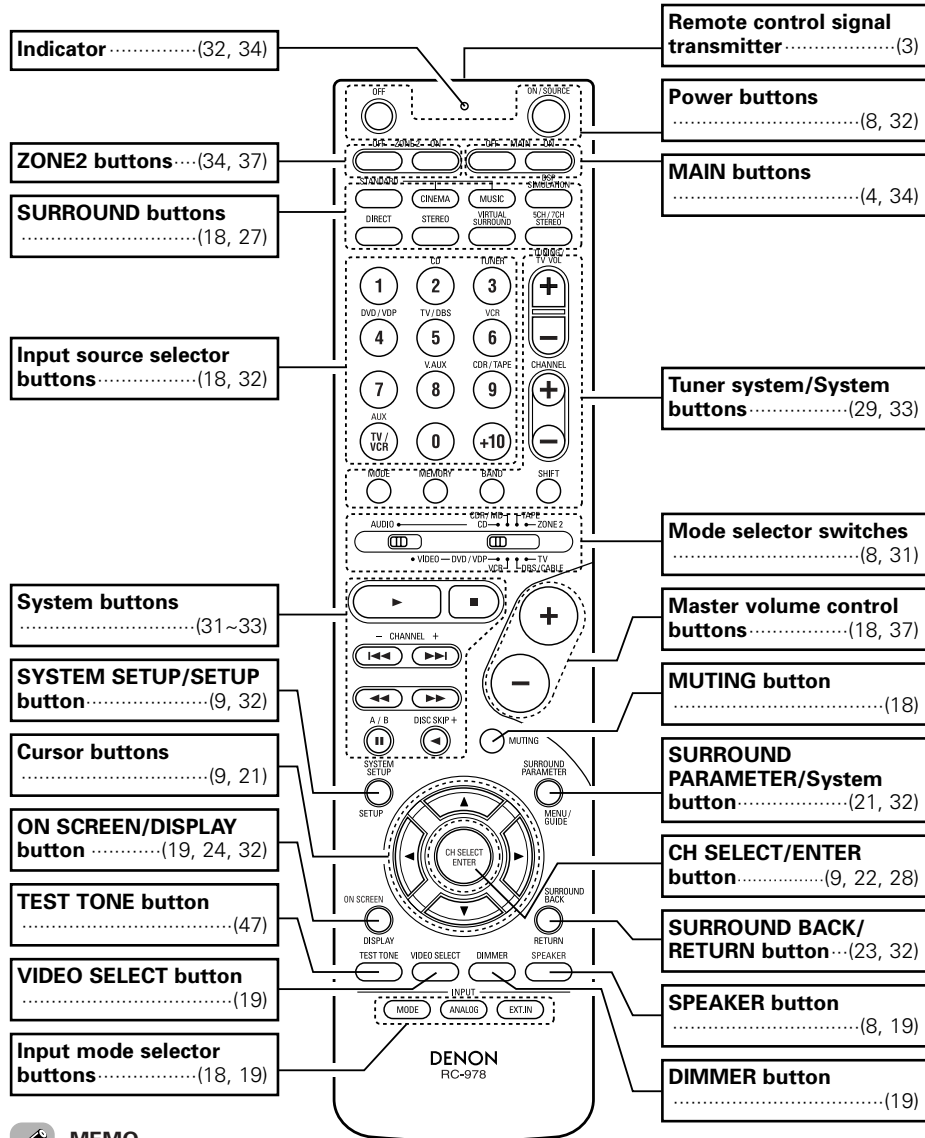

MEMO

- The Dolby Surround Pro Logic II(x) Cinema or Music mode can be chosen directly by pressing the **CINEMA** or **MUSIC** button on the remote control unit during playback in the Dolby Surround Pro Logic II(x) mode.
- The DTS NEO:6 Cinema or Music mode can be chosen directly by pressing the **CINEMA** or **MUSIC** button on the remote control unit during playback in the DTS NEO:6 mode.
- The main zone output can be turned on and off with the **MAIN** button.

Easy Setup and Operation

- This section contains the basic steps necessary to configure the AVR-1906 according to your listening room environment and the source equipment and loudspeakers you are using.
- For optimum performance, we recommend using the Auto Setup function.
- If you wish, you can set the various settings manually without using Auto Setup (page 45 ~ 47).

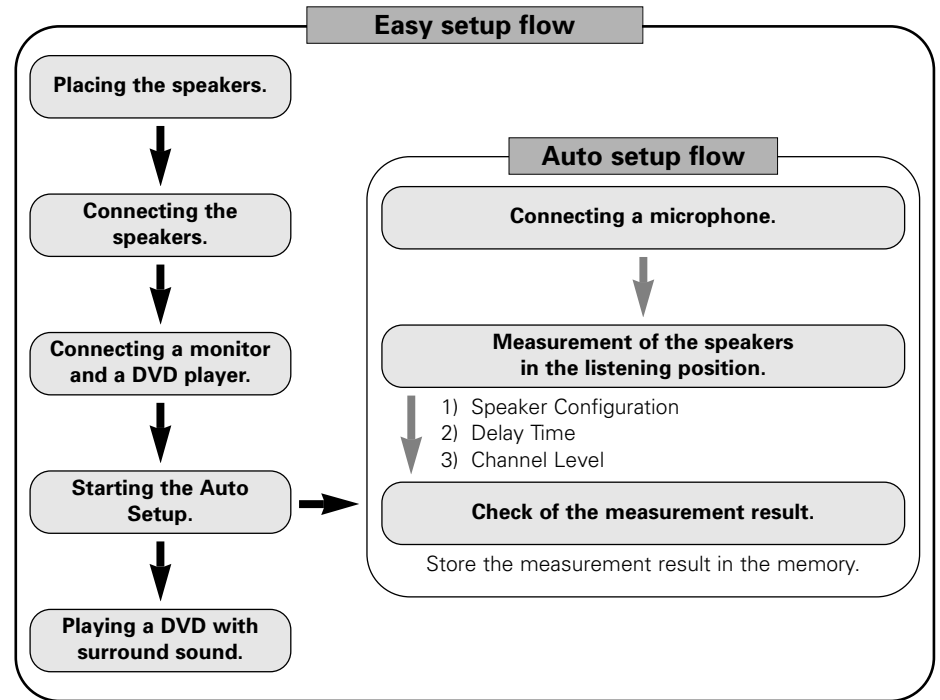

Easy Setup and Operation

Speaker system layout

Basic system layout

The following is an example of the basic layout for a system consisting of eight speaker systems and a television monitor:

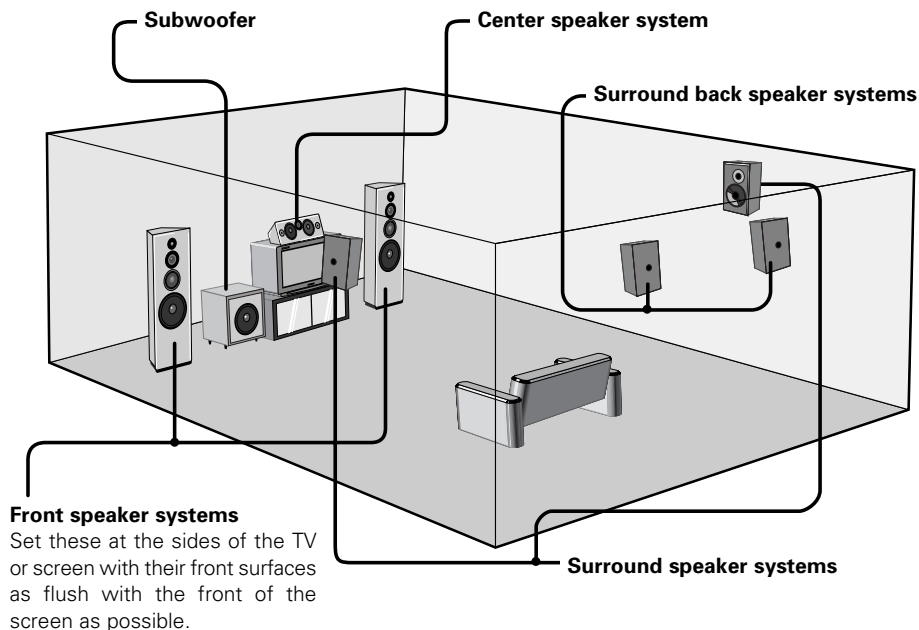

Front speaker systems

Set these at the sides of the TV or screen with their front surfaces as flush with the front of the screen as possible.

Easy Setup and Operation

Speaker connections

- Connect the speaker terminals with the speakers making sure that like polarities are matched (⊕ with ⊕, ⊖ with ⊖). Mismatching of polarities will result in weak central sound, unclear orientation of the various instruments, and the stereo image being impaired.
- When making connections, take care that none of the individual conductors of the speaker cable come in contact with adjacent terminals, with other speaker cable conductors, or with the rear panel.

NOTE:

**NEVER touch the speaker terminals when the power is on. Doing so could result in electric shocks.**

Speaker impedance

- When speaker systems A and B are used separately, speakers with an impedance of 6 to 16 Ω/ohms can be connected for use as front speakers.
- Be careful when using two pairs of front speakers (A + B) at the same time, since speakers with an impedance of 12 to 16 Ω/ohms in this case must be used.
- Speakers with an impedance of 6 to 16 Ω/ohms can be connected for use as center and surround and surround back speakers.
- The protector circuit may be activated if the unit is operated for long periods of time at high volumes when speakers with an impedance lower than the specified impedance are connected.

Note on speaker impedance

The protector circuit may be activated if the unit is operated for long periods of time at high volumes when speakers with an impedance lower than the specified impedance (for example speakers with an impedance of less than 4 Ω/ohms) are connected. If the protector circuit is activated, the speaker output is cut off. Turn off the unit's power, wait for the unit to cool down, improve the ventilation around the unit, then turn the power back on.

Connecting the speaker cables

1. Loosen by turning counterclockwise.
2. Insert the cable.
3. Tighten by turning clockwise.

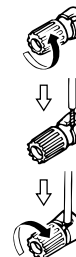

Connecting banana plugs

Turn clockwise to tighten, then insert the banana plug.

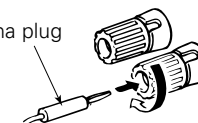

Protector circuit

This unit is equipped with a high-speed protection circuit. The purpose of this circuit is to protect the speakers under circumstances such as when the output of the power amplifier is inadvertently short-circuited and a large current flows, when the temperature surrounding the unit becomes unusually high, or when the unit is used at high output over a long period which results in an extreme temperature rise.

When the protection circuit is activated, the speaker output is cut off and the power supply indicator flashes. Should this occur, please follow these steps: be sure to switch off the power of this unit, check whether there are any faults with the wiring of the speaker cables or input cables, and wait for the unit to cool down if it is very hot. Improve the ventilation condition around the unit and switch the power back on.

If the protection circuit is activated again even though there are no problems with the wiring or the ventilation around the unit, switch off the power and contact a DENON service center.



Easy Setup and Operation

■ Connections

When making connections, also refer to the operating instructions of the other components.

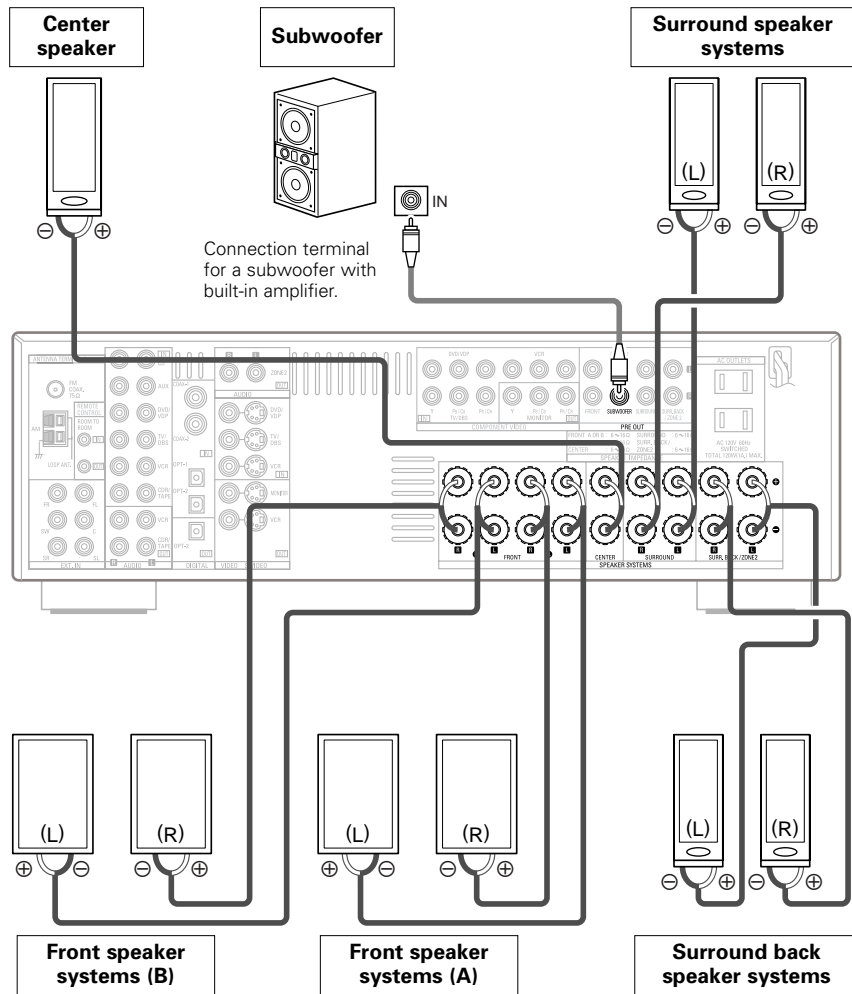

**Precautions when connecting speakers:**  
If a speaker is placed near a TV or video monitor, the colors on the screen may be disturbed by the speaker's magnetism. If this should happen, move the speaker away to a position where it does not cause this effect.

**NOTE:**  
• When using only one surround back speaker, connect it to the left channel.

Easy Setup and Operation

■ Bi-Amp connections

Certain loudspeakers are equipped with two sets of input terminals, for bi-amplification. The AVR-1906 Power Amp Assign. mode allows you to power bi-amp-capable speakers with two amplifier channels (see page 44). Be sure to consult the owner's manual of your bi-amp-capable speakers for further information before proceeding.

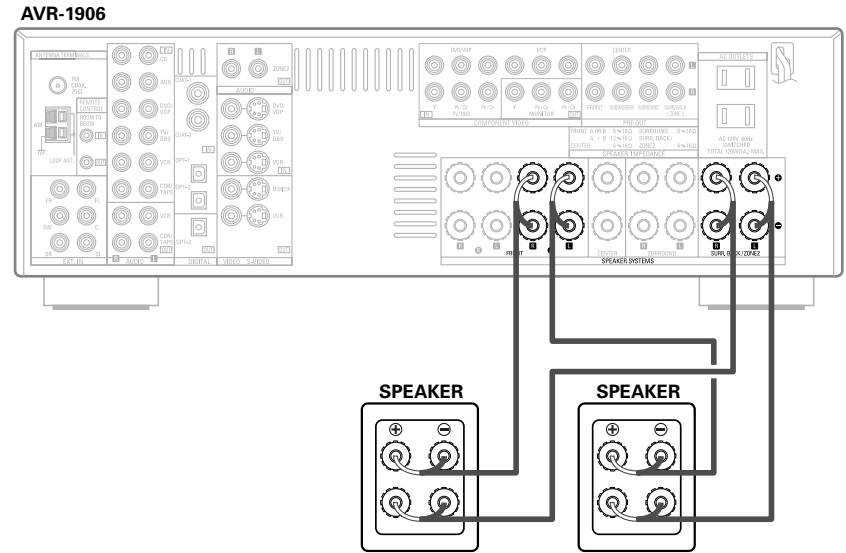

**NOTE:**  
• When making Bi-Amp connections, be sure to remove the short-circuiting bar included with the speaker.

Easy Setup and Operation

Connecting a DVD player and monitor TV

- To connect the video output from the DVD player to the AVR-1906, you only need to choose one connection type. Component video connection offers the best quality (and is required for progressive DVD playback), followed by S-Video, while composite video offers the lowest picture quality of the three connection types. For more information about the video up conversion function (page 12).
- To connect the digital audio output from the DVD player, you can choose from either the coaxial or optical connections. If you choose to use the coaxial connection, it needs to be assigned. For more information about Digital Input Assignment (page 40).
- Connect a non-DVD video disc player (such as a laser disc, VCD/SVCD, or future high definition disc player) to the DVD/VDP terminals in the same way.

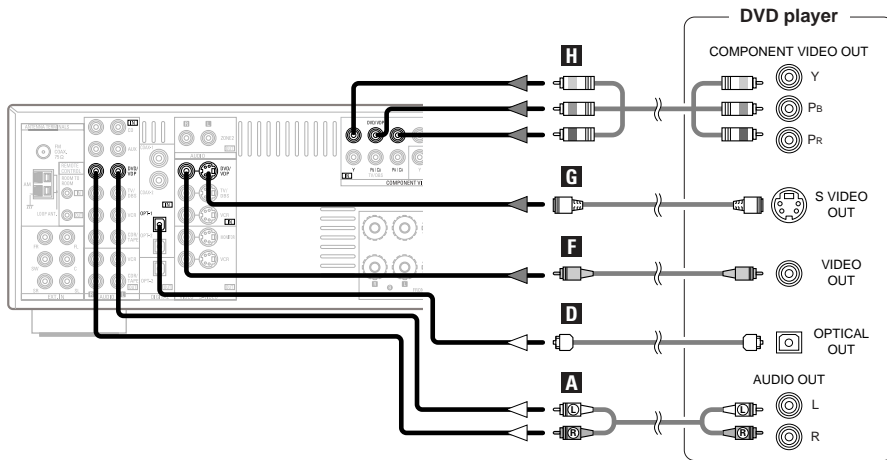

\* Audio signal flow is shown with white arrows; video signal flow is shown with gray arrows.

Easy Setup and Operation

- For best picture quality (especially with progressive DVD and other high definition sources), choose the component video connection to your monitor TV. S-Video and composite video outputs are also provided if your TV does not have component video inputs.

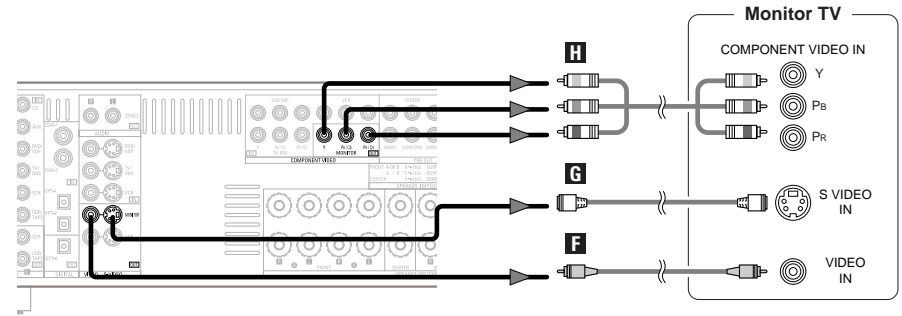

NOTE:

- The component video input and/or output terminals may be labeled differently on some TVs, monitors or video components (Y, Pb, Pr; Y, Cb, Cr; Y, B-Y, R-Y). Check the owner's manuals for the other components for further information.

Easy Setup and Operation

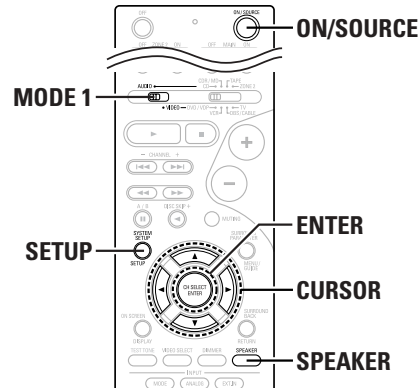
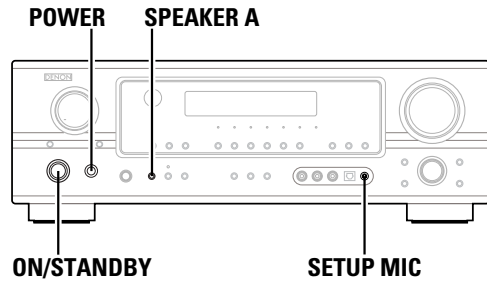

**Auto Setup**

The Auto Setup function of this unit performs an analysis of the speaker system to permit an appropriate automatic setting.

**Measurement and setting details**

- ①: This sets the speaker connection, polarity, and bass reproduction ability.
- ②: This sets the delay time from each speaker corresponding to the listening position.
- ③: This sets the volume that is output from each speaker.



**For accurate measurements**

- Keep quiet during the auto setup procedure. It is recommended that you turn off the power of any air-conditioner, projector or other equipment that may produce noise.
- Do not stand between the microphone and speakers while Auto Setup is performed.
- Do not place any obstacles between the microphone and speakers. Also, be sure to point the speakers towards the listening position.

**NOTE:**

- A loud test tone is output during the measurement. Please consider this should you be planning night time measurements, and consider not allowing small children into the listening room at this time.

**Connecting a microphone**

- 1** Connect the microphone for Auto Setup to the **SETUP MIC** jack on the front panel of the unit.

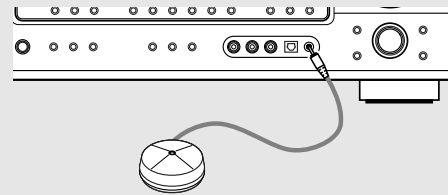

- 2** Place the microphone for Auto Setup at the actual listening position which will be at the same height as your ears.

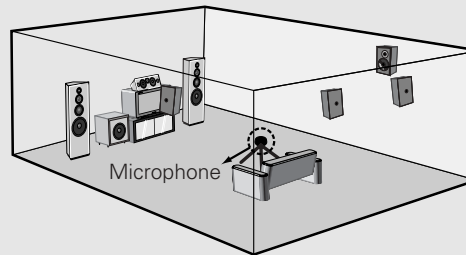

※ Place the microphone on a tripod or level surface.

Easy Setup and Operation

**Turning on the power**

- 1** Turn on your subwoofer.
- 2** Turn on your monitor (TV).
- 3** Press the **POWER** switch.
  - **ON:**  
The power turns on and the indicator lights. Set the **POWER** switch to this position to turn the power on and off from the included remote control unit.
  - **OFF:**  
The power turns off and the indicator is off. In this position, the power cannot be turned on and off from the remote control unit.
- 4** Press the **ON/STANDBY** switch on the main unit or **ON/SOURCE** button on the remote control unit.
  - Turn on the power.
- 5** Press the **SPEAKER A** button to turn the speakers on.
- 6** Set the **MODE 1** switch to “**AUDIO**” (only when operating with the remote control unit).

Easy Setup and Operation

Starting Auto Setup

**1** Press the **SETUP** button.

- The “System Setup” menu appears.

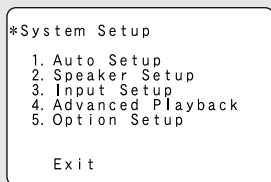

**2** Press the **CURSOR**  $\triangle$  or  $\nabla$  button to select “Auto Setup”, then press the **ENTER** button.

- The “Auto Setup” screen appears.

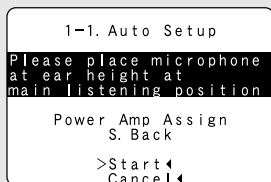

**3** Press the **CURSOR**  $\triangle$  or  $\nabla$  button to select “Power Amp Assign”, then press the **CURSOR**  $\triangleleft$  or  $\triangleright$  button to select “S. Back”, “ZONE2” or “Bi-Amp”.

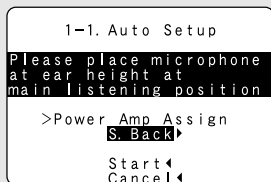

- ※ When “S. Back” is selected, the test tone during Auto Setup will be output from the surround back speaker.
- ※ When “ZONE2” is selected, change the setting to “ZONE2”. The test tone during Auto Setup is set so that it will not be output to ZONE2 (Another room).
- ※ When “Bi-Amp” is selected, change the setting to “Bi-Amp”. The test tone during Auto Setup is set so that it will be output from the Bi-Amp speaker.

**4** Press the **CURSOR**  $\triangle$  or  $\nabla$  button to select “Start”, then press the **CURSOR**  $\triangleleft$  button.

- Start the measurements.

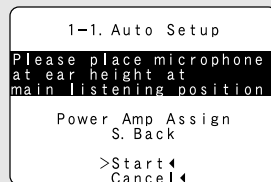

※ Measurement of each channel is performed as follows:

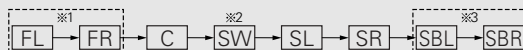

- ※ 1: Only the front speakers (A) are measured, front speakers (B) are not available. Even if the front speakers (B) are set, the setting automatically switches to the front speakers (A) once measurements are completed.
- ※ 2: The subwoofer speaker is measured twice.
- ※ 3: When “ZONE2” and “Bi-Amp” are selected, these are not displayed.

After each channel is measured, “Calculating” appears. The display switches to the Auto Setup check screen automatically.

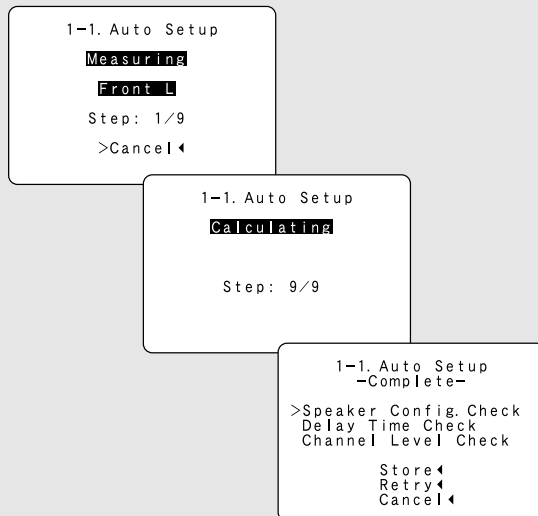

Easy Setup and Operation



- Measurement is cancelled if the **MASTER VOLUME** control knob is operated while the Auto Setup is performed.
- If the **output volume and crossover frequency of your subwoofer speaker can be changed, then set the volume to halfway and the crossover filter to maximum or switch off the low-pass filter.**

■ About automatic retry

To confirm the results of the measurements, remeasurement is automatically performed. Remeasurement is performed up to 2 times. During this time, “Retry1” or “Retry2” is displayed on the screen.

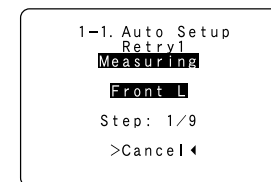

NOTE:

- When measurements have been made using the measurement microphone, speakers with built-in filters, such as a subwoofer, might be set to a value that differs from the physical distance because of the internal electrical delay.

Easy Setup and Operation

About error messages

- These error screens may be displayed when performing Auto Setup measurement and the automatic measurements can not be completed because of the speaker arrangement, measurement environment, or other factors. Please check the following matters, reset the pertinent items, and measure again.
- When there is too much noise in the room, the speakers may not be detected properly. Should this happen, perform the measurements when the noise level is low, or switch off the power of the equipment that is producing the noise for the duration of the measurements.

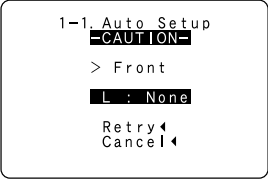
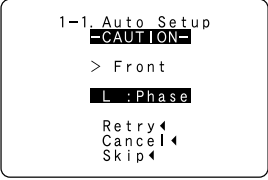
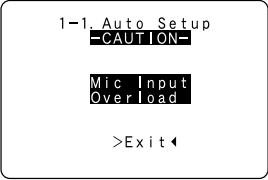
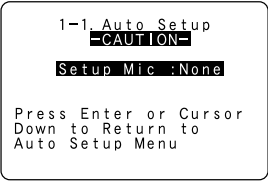
| Screen example  | Cause  | Measures   |
|---|--|--|
|    | <p>① This screen will be displayed when the speakers required for producing suitable reproduction have not been detected.</p> <ul style="list-style-type: none"> <li>• The front L or front R speaker was not properly detected.</li> <li>• Only one channel of the surround speakers was detected.</li> <li>• Sound was output from the R channel when only one surround back speaker was connected.</li> <li>• The surround back speaker was detected, but the surround speaker was not detected.</li> </ul> | <ul style="list-style-type: none"> <li>• Check that the pertinent speakers are properly connected.</li> </ul>  |
|    | <p>② This screen will be displayed when the speaker polarity is connected in reverse.</p>  | <ul style="list-style-type: none"> <li>• Check the polarity of the pertinent speakers. For some speakers, this screen may be displayed even though the speakers are properly connected. If so, select "Skip".</li> </ul> |
|   | <p>③ This screen will be displayed when accurate measurements cannot be made due to the input level of the microphone being too high.</p>  | <ul style="list-style-type: none"> <li>• Set up the speakers so that their position is farther away from the listening position.</li> <li>• Lower the volume of the subwoofer speaker.</li> </ul>                        |
|  | <p>④ This screen will be displayed when the measurement microphone is not connected.</p>   | <ul style="list-style-type: none"> <li>• Connect the measurement microphone to the microphone connector.</li> </ul>  |

Easy Setup and Operation

Check of the measurement results

**1** Press the **CURSOR**  $\Delta$  or  $\nabla$  button to select an item, then press the **ENTER** button.

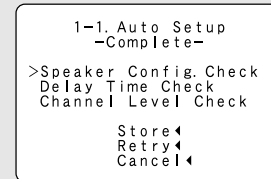

※ The measurement results of each item can be checked here.

**2** Press the **ENTER** button.

- The verification screen appears.

**Example:** Speaker Config. Check

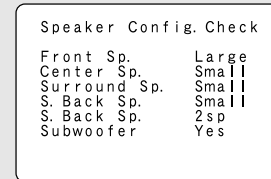

**3** Press the **ENTER** button again once you have checked the results.

Easy Setup and Operation

**4** Press the **CURSOR**  $\Delta$  or  $\nabla$  button to select from the following three items based on the measurement results, then press the **CURSOR**  $\triangleleft$  button.

**Store:**  
Store the checked measurement values.  
All parameters are stored.

**Retry:**  
Perform the measurement again.  
Measurement is repeated.

**Cancel:**  
Cancel the checked measurement values.

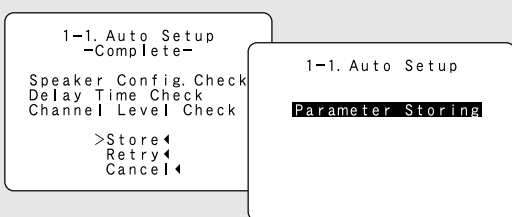

Playing a DVD with surround sound

**1** Disconnect the microphone from the unit.

**2** Select the input source to be played.

**3** Select the play (surround) mode.

**4** Start DVD playback.

**5** Adjust the volume.

Connecting Other Sources

Cable indications

The hookup diagrams on the subsequent pages assume the use of the following optional connection cables (not supplied).

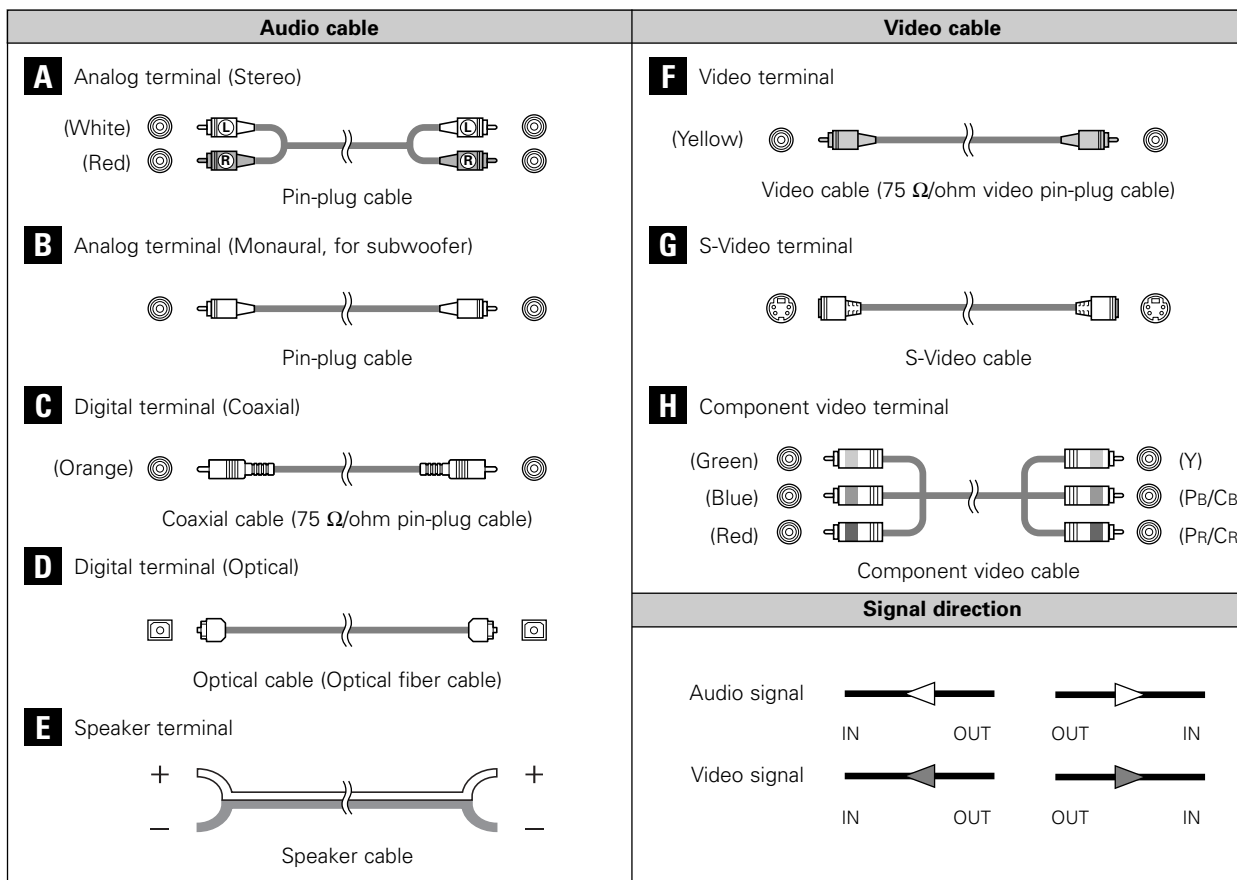

NOTE:

- Do not plug in the power supply cord until all connections have been completed.
- When making connections, also refer to the operating instructions of the other components.
- Be sure to connect the left and right channels properly (left with left, right with right).
- Note that binding pin-plug cables together with power supply cords or placing them near a power transformer will result in hum or other noise.



Connecting Other Sources

The video conversion function

With the AVR-1906, the Video signal and the S-Video signal which were inputted are mutually converted. And also the Video signal and the S-Video signal which were inputted are converted into a higher quality.

The flow of the video signals.

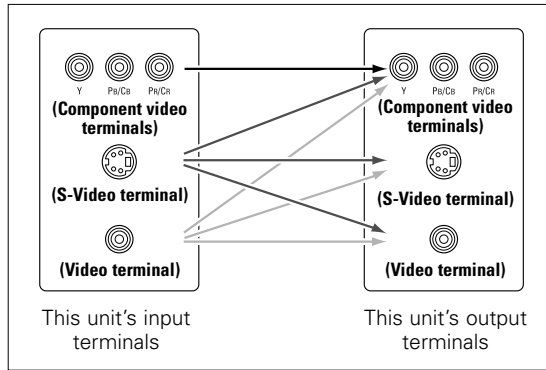

**Cautions on the video conversion function:**

When the component video terminals are used to connect the AVR-1906 with a TV (or monitor, projector, etc.) and the video (yellow) or S-Video terminals are used to connect the AVR-1906 with a VTR, depending on the combination of the TV and VTR the picture may flicker in the horizontal direction, be distorted, be out of sync not display at all when playing video tapes.

If this happens, connect a commercially available video stabilizer, etc., with a TBC (time base corrector) function between the AVR-1906 and the VTR, or if your VTR has a TBC function, turn it on.

Connecting Other Sources

On-screen display signals

|   | Signals input to the AVR-1906        |                               | On-screen display signal output                            |   |  |
|---|--------------------------------------|-------------------------------|--|---|--|
|   | VIDEO signal input terminal (yellow) | S-Video signal input terminal | Video signal output to VIDEO MONITOR OUT terminal (yellow) | Video signal output to S-Video MONITOR OUT terminal | Video signal output to Color Difference (Component) Video MONITOR OUT terminal |
| 1 | ×                                    | ×                             | ○  | ○   | ○  |
| 2 | ○                                    | ×                             | ○  | ○   | ○  |
| 3 | ×                                    | ○                             | ○  | ○   | ○  |
| 4 | ○                                    | ○                             | ×  | ○   | ○  |

(○: Signal

×: No signal)

(○: On-screen signals output

×: On-screen signals not output)

Connecting Other Sources

Connecting a TV/DBS tuner

- For best picture quality choose the component video connection to your TV or DBS tuner. S-Video and composite video inputs are also provided if your TV or DBS tuner does not have component video outputs.
- To connect the digital audio output from the TV or DBS tuner, you can choose from either the coaxial or optical connections. If you choose to use the coaxial connection, it needs to be assigned. For more information about Digital Input Assignment (🔧 page 40).

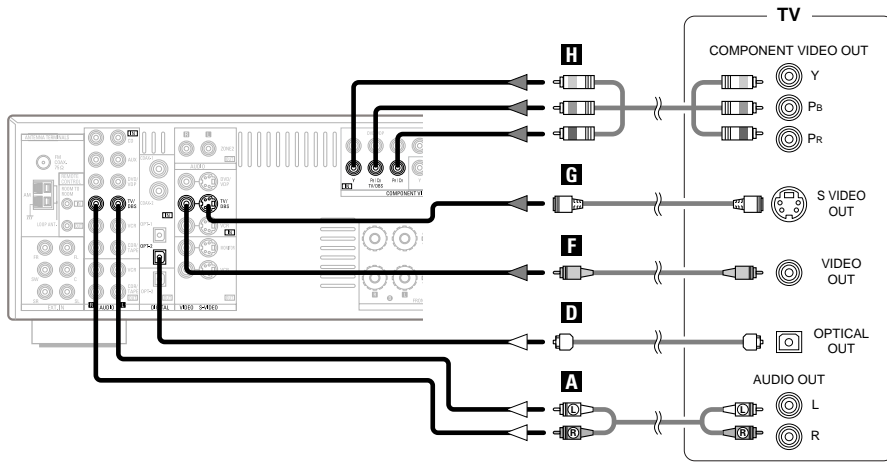

Connecting a video camera or video game

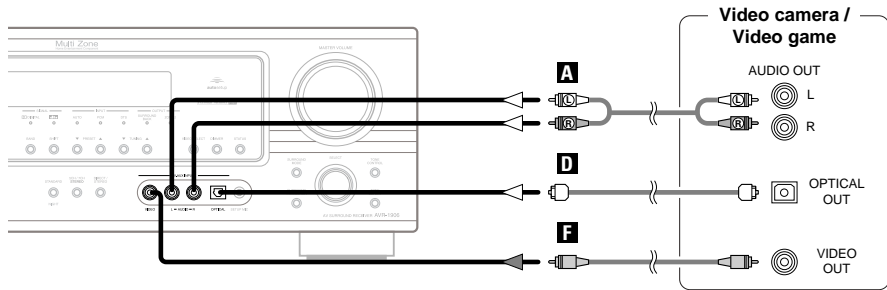

Connecting Other Sources

Connecting the external inputs (EXT. IN) terminals

- These terminals are for inputting multi-channel audio signals from an external decoder, or a component with a different type of multi-channel decoder, such as a DVD Audio player, a multi-channel Super Audio CD player, or another future multi-channel sound format decoder.
- The video signal connection is the same as that for a DVD player.
- For instructions on playback using the external input (EXT. IN) terminals (🔧 page 18).

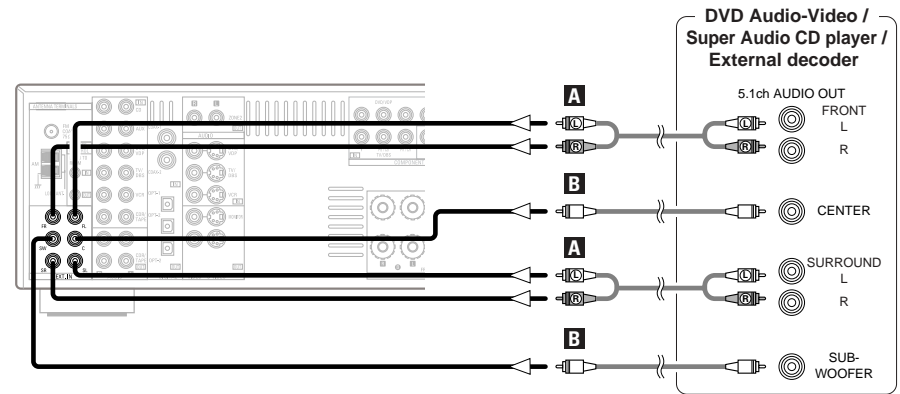

- With discs on which special copyright protection measures have been taken, the digital signals may not be output from the DVD player. In this case, connect the DVD player's analog multi-channel output to the AVR-1906's EXT. IN terminals for playback. Also refer to your DVD player's operating instructions.

Connecting a CD player

To connect the digital audio output from the CD player, you can choose either coaxial or optical connection. If you choose to use the optical connection, it needs to be assigned. For more information about Digital Input Assignment (🔧 page 40).

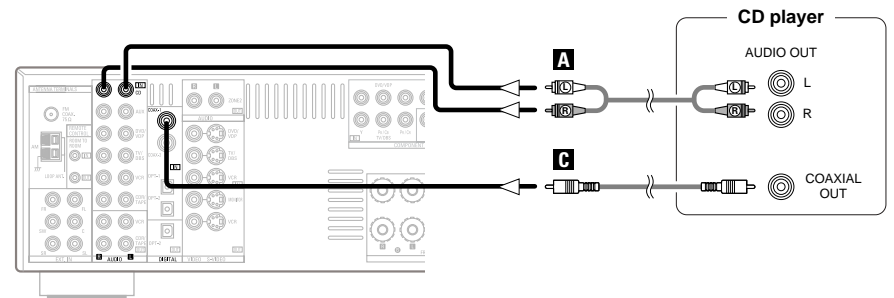

Connecting Other Sources

Connecting a VCR

- For best picture quality choose the component video connection to your VCR. S-Video and composite video outputs are also provided.
- If you wish to perform analog dubbing from a digital source, such as a DVD recorder to an analog recorder such as a cassette deck, you will need to connect the analog inputs and outputs as shown below, in addition to the digital audio connections.
- The digital inputs and outputs connection is the same as that for a CD (MD) recorder.

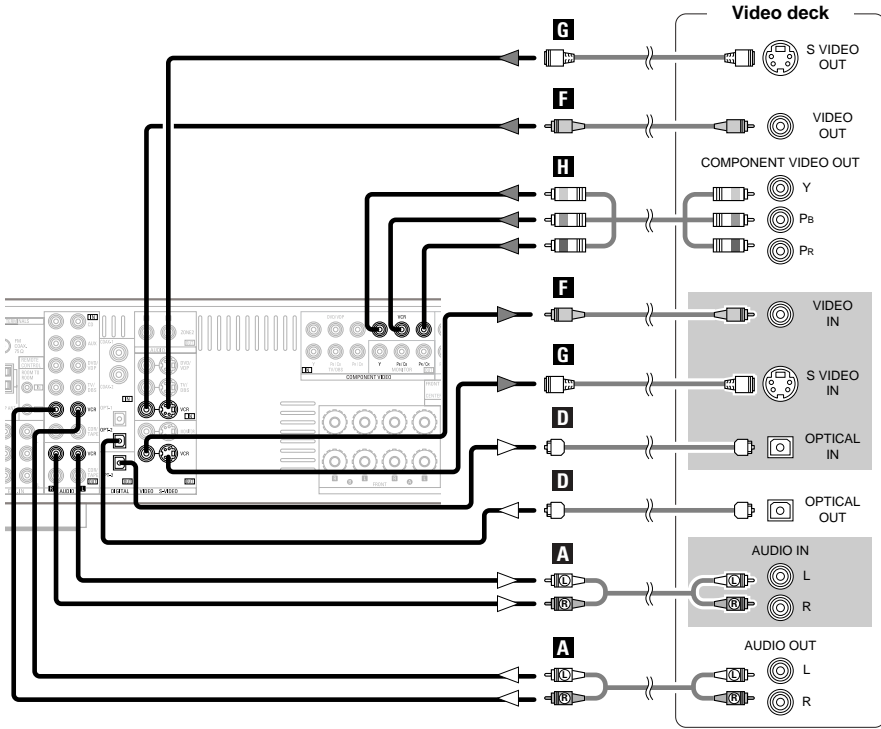

NOTE:

- When recording to a VCR, it is necessary that the type of cable used with the playback source equipment be the same type that is connected to the AVR-1906 VCR OUTPUT terminal.  
**Example:** VCR IN → S-Video cable : VCR OUT → S-Video cable  
 VCR IN → Video cable : VCR OUT → Video cable

Connecting Other Sources

Connecting a tape deck

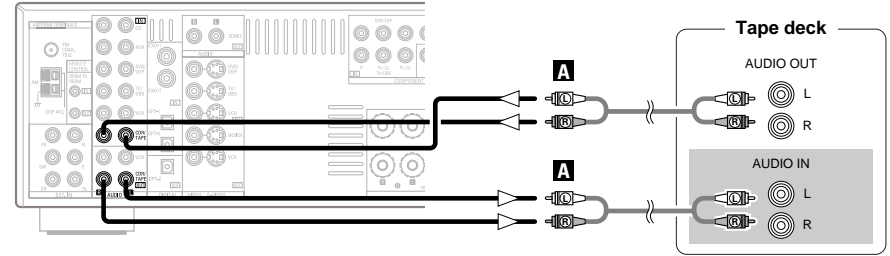

- If humming noise is generated, move the tape deck further away from the source of such noise.

Connecting a CD recorder or MD recorder

If you wish to perform analog dubbing from a digital source, such as a CD or MD recorder to an analog recorder such as a tape deck, you will need to connect the analog inputs and outputs as shown below, in addition to the digital audio connections.

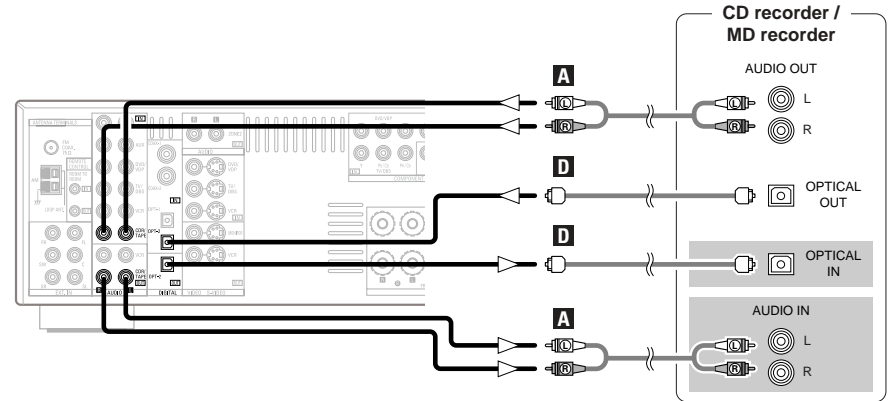

NOTE:

- Do not connect the output of the component connected to the OPTICAL 2 OUT terminal on the AVR-1906's rear panel to any terminal other than the OPTICAL 2 IN terminal (see page 40).

Connecting Other Sources

Connecting the antenna terminals

An F-type FM antenna cable plug can be connected directly to the unit.

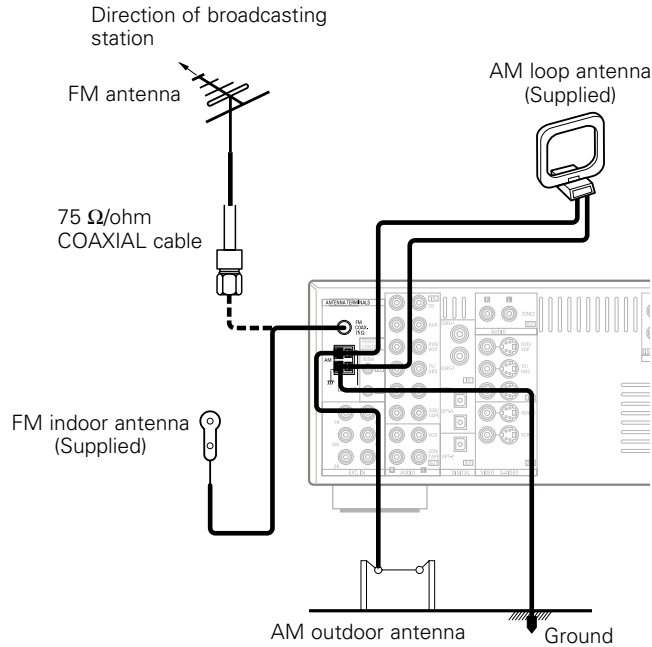

Connecting Other Sources

AM loop antenna assembly

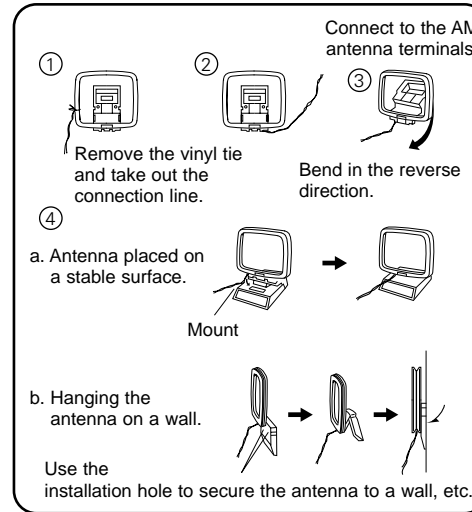

**Note to CATV system installer:**  
 This reminder is provided to call the CATV system installer's attention to Article 820-40 of the NEC which provides guidelines for proper grounding and, in particular, specifies that the cable ground shall be connected to the grounding system of the building, as close to the point of cable entry as practical.

**NOTE:**

- Do not connect two FM antennas simultaneously.
- Even if an external AM antenna is used, do not disconnect the AM loop antenna.
- Make sure the AM loop antenna lead terminals do not touch metal parts of the panel.

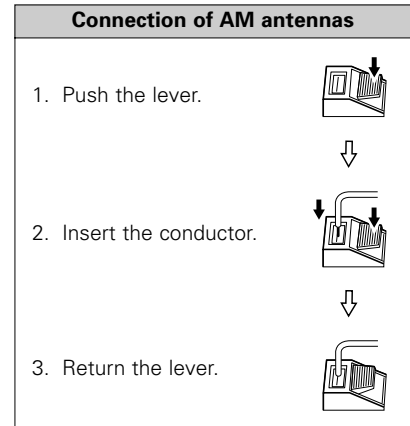

Connecting Other Sources

Connecting the MULTI ZONE terminals

※ For instructions on operations using the MULTI ZONE functions (page 35~37).

ZONE2 out connections

- If another power amplifier or pre-main (integrated) amplifier is connected, the ZONE2 out (variable/fixed level) terminals can be used to play a different program source in ZONE2 the same time (page 35, 36).
- When a sold separately room-to-room remote control unit (DENON RC-616, 617 or 618) is wired and connected between the MAIN ZONE and ZONE2, the remote-controllable devices in the MAIN ZONE can be controlled from ZONE2 using the remote control unit.

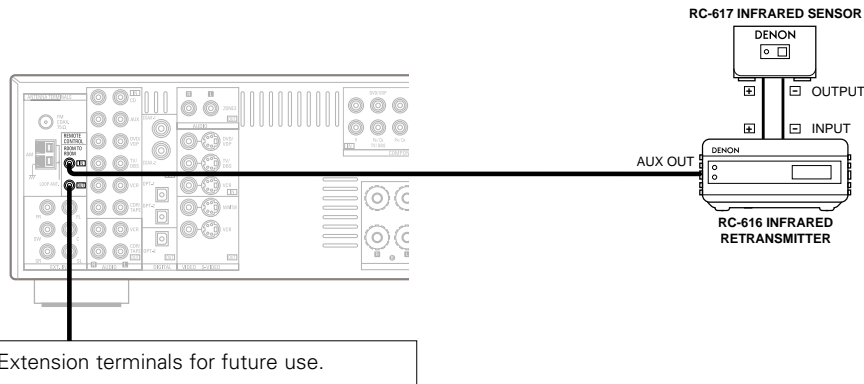
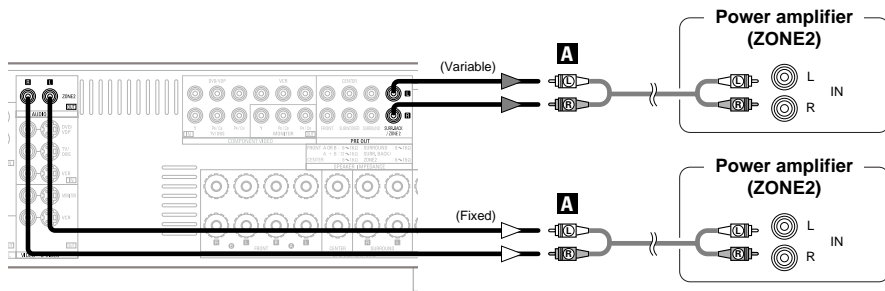

**NOTE:**  
 • For instructions on installation and operation of separately sold devices, refer to the devices' operating instructions.

Connecting Other Sources

ZONE2 speaker out connections

- When the power amplifier is assigned to the ZONE2 output channel at "Power Amp Assign." in the "System Setup" menu, the surround back speaker terminals can be used as the ZONE2 speaker out terminals (page 36).
- The connections diagram below is an example for when the surround back speaker is assigned to the ZONE2 stereo 2 channel. In this case, surround back speaker out can not be used for MAIN ZONE.

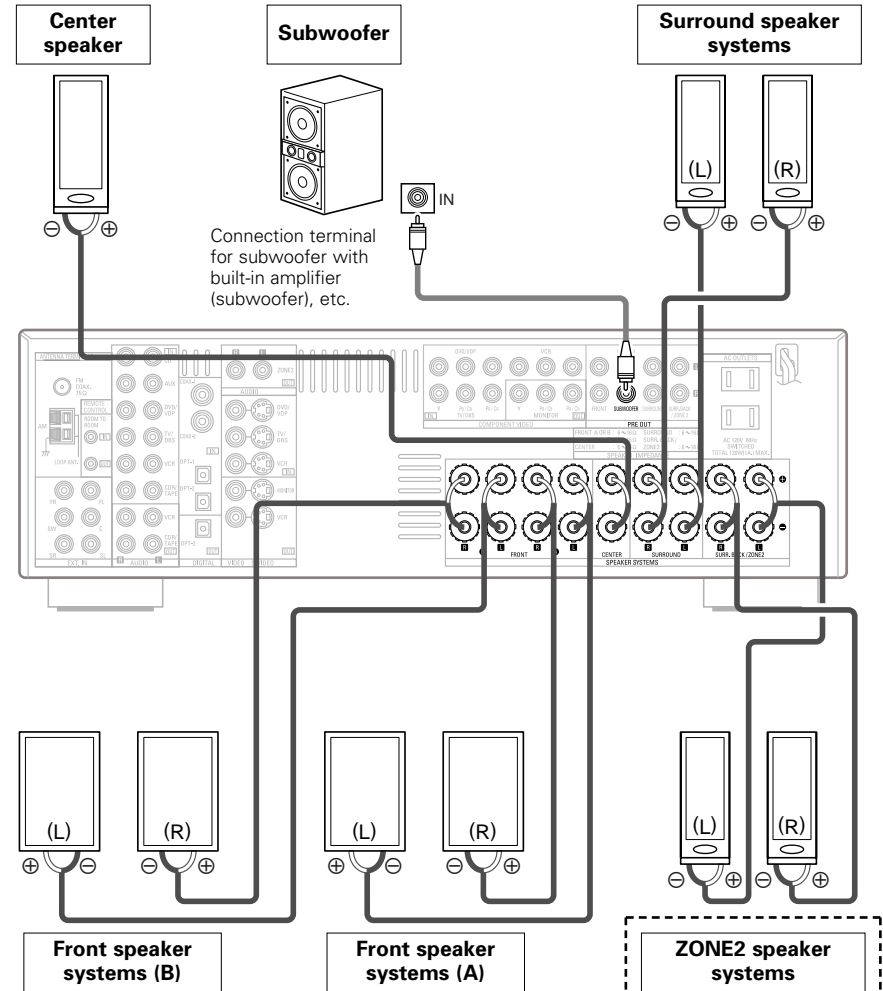

**NOTE:**  
 • The settings must be changed to use this speaker for ZONE2 (page 44).

Connecting Other Sources

Connecting the pre-out terminals

- Use these terminals if you wish to connect external power amplifier(s) to increase the power of the front, center, surround and surround back sound channels, or for connection to powered loudspeakers.
- When using only one surround back speaker, connect it to the left channel.

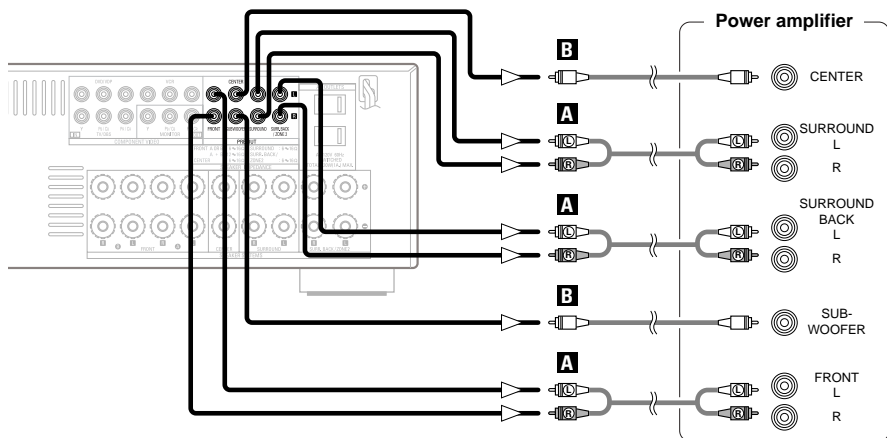

Connecting Other Sources

Connecting the power supply cord

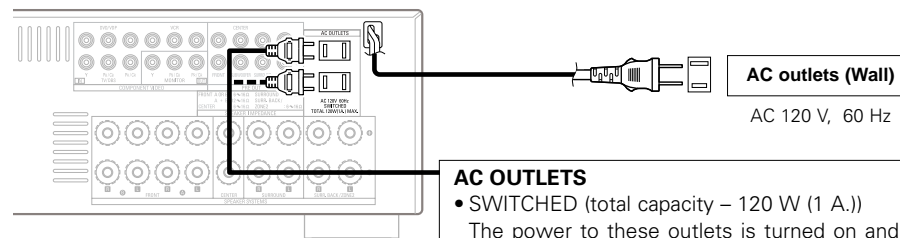

**AC OUTLETS**

- **SWITCHED** (total capacity – 120 W (1 A.))  
The power to these outlets is turned on and off in conjunction with the **POWER** switch on the main unit, and when the power is switched between on and standby from the remote control unit.  
No power is supplied from these outlets when this unit's power is at standby. Never connect equipment whose total power consumption exceeds 120 W (1 A.).

**NOTE:**

- Only use the AC OUTLETS for connecting audio equipment. Never use it for hair driers, TVs or other electrical appliances.



# Basic Operation

## Playback

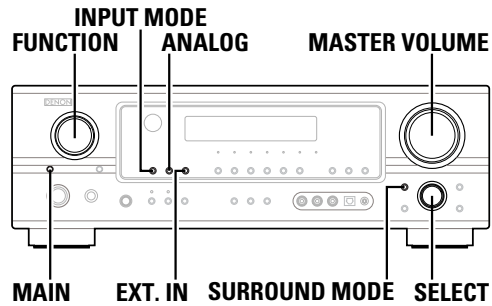

### Playing the input source

#### 1 Select the input source to be played.

Example: CD

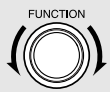

(Main unit)



(Remote control unit)

※ To select the input source when ZONE2/REC OUT is selected, press the **MAIN** button, then operate the input function selector.

#### 2 Select the play (surround) mode.

Example: STEREO



(Main unit)



(Remote control unit)

※ To select the surround mode while adjusting the surround parameters, tone defeat or tone control, press the **SURROUND MODE** button and then operate the selector.

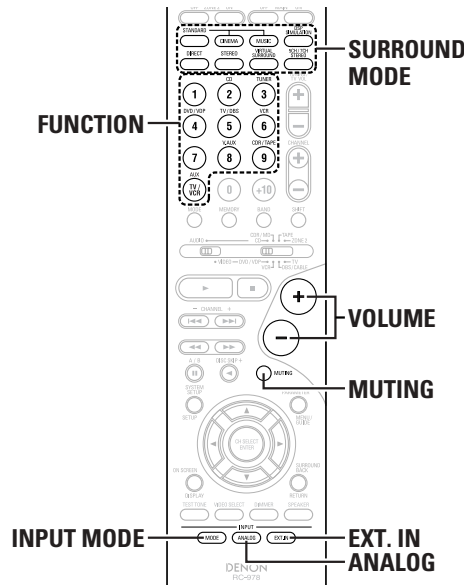

#### 3 Start playback on the selected component.

※ For operating instructions, refer to the component's manual.

#### 4 Adjust the volume.



(Main unit)



(Remote control unit)

The volume level is displayed on the master volume level display.

※ The volume can be adjusted within the range of -70 to 0 to 18 dB, in steps of 1 dB. However, when the channel level is set as described (page 28), if the volume for any channel is set at +1 dB or greater, the volume cannot be adjusted up to 18 dB. (In this case the maximum volume is adjusted to "18 dB — (Maximum value of channel level)".)

### Playback using the external input (EXT. IN) terminals

The signals being input to the external decoder input terminals are played without passing through the surround circuitry.

#### Press the EXT. IN button to select the external input.



- Canceling the external input mode:  
Press the **INPUT MODE** or **ANALOG** button to switch to the desired input mode (page 19, 20).
- The external input mode can be set for any input source. To watch video while listening to sound, select the input source to which the video signal is connected, then set this mode.
- If the subwoofer output level is too high, set the "SW ATT." surround parameter to "ON".

#### NOTE:

- When the input mode is set to the external input (EXT. IN), the play mode (DIRECT, VIRTUAL SURROUND, STEREO, STANDARD (DOLBY/DTS SURROUND), 5CH/7CH STEREO or DSP SIMULATION) cannot be selected.
- In play modes other than the external input mode, the signals connected to the EXT. IN terminals cannot be reproduced. In addition, signals cannot be output from channels not connected to the input terminals.

### Turning the sound off temporarily (MUTING)

Use this to turn off the audio output temporarily.

#### Press the MUTING button.

- You can adjust the muting level (page 44).



- Canceling the MUTING mode:
  - ① Press the **MUTING** button again.
  - ② Press the **VOLUME** button on the remote control unit, or adjust the volume up or down via the front panel **MASTER VOLUME** knob.

Basic Operation

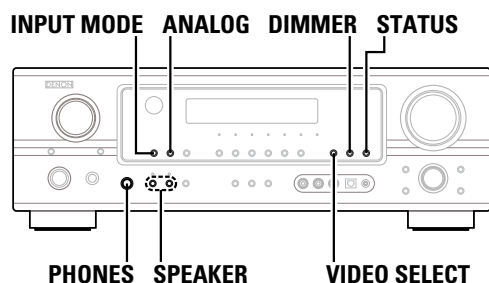

**Listening over headphones**

Connect the headphones to the **PHONES** jack.

- The pre-out output (including the speaker output) is automatically turned off when headphones are connected.

**NOTE:**

- To prevent hearing loss, do not raise the volume level excessively when using headphones.

**Combining the currently playing sound with the desired image (VIDEO SELECT)**

Press the **VIDEO SELECT** button repeatedly until the desired source appears on the display.

IN=V SOURCE

- ※ Use this switch to monitor a video source other than the audio source.



• Canceling simulcast playback:

- ① Select "SOURCE" by pressing the **VIDEO SELECT** button.
- ② Switch the program source to the component connected to the video input terminals.

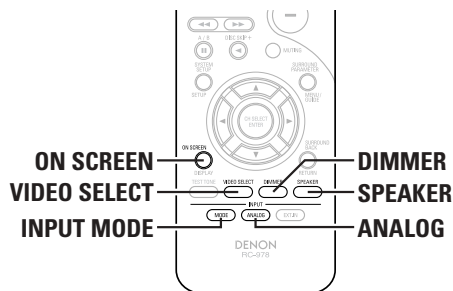

**Selecting the front speakers**

Press the **SPEAKER A** or **B** button to turn the corresponding speaker pair on.

- ※ The front speaker A, B setting can be also be changed with the **SPEAKER** button on the remote control unit.

**Checking the currently playing program source**

**■ On-screen display**

Press the **ON SCREEN** button.

- ※ Each time an operation is performed, a description of that operation appears on the display connected to the unit's VIDEO MONITOR OUT terminal. Also, the unit's operating status can be checked during playback.
- ※ Such information as the position of the input selector and the surround parameter settings is output in sequence.

**■ Front panel display**

Press the **STATUS** button.

- ※ Descriptions of the unit's operations are also displayed on the front panel display. In addition, the display can be switched to check the unit's operating status while playing a source.

Basic Operation

**■ Using the dimmer function**

Press the **DIMMER** button.

- ※ The display brightness changes in four steps (bright, medium, dim and off).

**Input mode**

The AVR-1906 has an AUTO signal detection mode that automatically identifies the type of incoming audio signals, but is also equipped with a manual mode that can be switched according to the type of input audio signals.

**■ Selecting the AUTO, PCM and DTS modes**

Press the **INPUT MODE** button.

- ※ The mode switches as shown below each time the **INPUT MODE** button is pressed:



**AUTO** (auto mode):

In this mode, the types of signals being input to the digital and analog input terminals for the selected input source are detected and the program in the AVR-1906's surround decoder is selected automatically upon playback. This mode can be selected for all input sources other than TUNER. The presence or absence of digital signals is detected, the signals input to the digital input terminals are identified and decoding and playback are performed automatically with the DTS, Dolby Digital or PCM (2 channel stereo) format. If no digital signal is being input, the analog input terminals are selected. Use this mode to play Dolby Digital signals.

**PCM** (exclusive PCM signal playback mode):

Decoding and playback are only performed when PCM signals are being input. Note that noise may be generated when using this mode to play signals other than PCM signals.

**DTS** (exclusive DTS signal playback mode):

Decoding and playback are only performed when DTS signals are being input.

Basic Operation

■ Selecting the analog mode

Press the **ANALOG** button to switch to the analog input.

**ANALOG** (exclusive analog audio signal playback mode):  
The signals input to the analog input terminals are decoded and played.

**NOTE:**

- Input mode when playing DTS sources:  
Noise will be output if DTS-compatible CDs or LDs are played in the "ANALOG" or "PCM" mode.  
When playing DTS-compatible sources, be sure to connect the source component to the digital input terminals (OPTICAL/COAXIAL) and set the input mode to "DTS".

Basic Operation

■ Input mode display

- In the AUTO mode  

|       |     |     |
|-------|-----|-----|
| INPUT |     |     |
| AUTO  | PCM | DTS |
| ☀     | ○   | ○   |
- In the DIGITAL PCM mode  

|       |     |     |
|-------|-----|-----|
| INPUT |     |     |
| AUTO  | PCM | DTS |
| ○     | ☀   | ○   |
- In the DIGITAL DTS mode  

|       |     |     |
|-------|-----|-----|
| INPUT |     |     |
| AUTO  | PCM | DTS |
| ○     | ○   | ☀   |
- In the ANALOG mode  

|       |     |     |
|-------|-----|-----|
| INPUT |     |     |
| AUTO  | PCM | DTS |
| ○     | ○   | ○   |

Depending on the input signal.

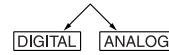

DIGITAL

DIGITAL

ANALOG

■ Input signal display

- DOLBY DIGITAL  

|           |       |
|-----------|-------|
| SIGNAL    |       |
| ☐ DIGITAL | ☐ dts |
| ☀         | ○     |
- DTS  

|           |       |
|-----------|-------|
| SIGNAL    |       |
| ☐ DIGITAL | ☐ dts |
| ○         | ☀     |
- PCM  

|           |       |
|-----------|-------|
| SIGNAL    |       |
| ☐ DIGITAL | ☐ dts |
| ○         | ○     |

※ The "DIGITAL" indicator lights when digital signals are being input properly. If the "DIGITAL" indicator does not light, check whether the Digital In Assign. setup (page 40) and connections are correct and whether the component's power is turned on.

**NOTE:**

- The "DIGITAL" indicator will light when playing CD-ROMs containing data other than audio signals, but no sound will be heard.

Basic Operation

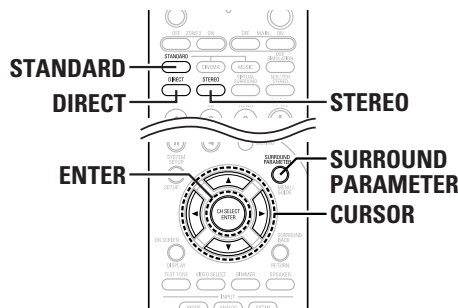
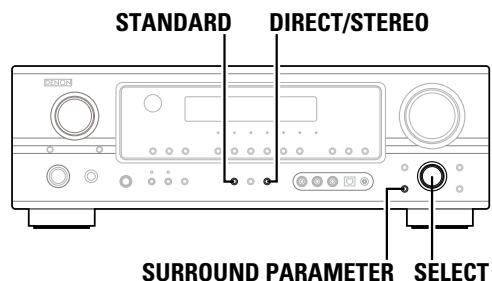

Surround

Playing audio sources (CDs and DVDs)  
2-channel playback modes

- The AVR-1906 is equipped with 2-channel playback modes exclusively for music.
- Select the mode to suit your tastes.

■ DIRECT mode

Use this mode to achieve good quality 2-channel sound while watching images. In this mode, the audio signals bypass such circuits as the tone circuit and are transmitted directly, resulting in good quality sound.

Press the **DIRECT/STEREO** button on the main unit or the **DIRECT** button on the remote control unit to select the **DIRECT** mode.

■ STEREO mode

Use this mode to adjust the tone and achieve the desired sound while watching images.

Press the **DIRECT/STEREO** button on the main unit or the **STEREO** button on the remote control unit to select the **STEREO** mode.

Dolby Pro Logic IIx (Pro Logic II) mode

- To play in the PLIIx mode, set "S. BackSp" at the "Speaker Configuration" setting to "1sp" or "2sp".
- To play in the PLIIx mode, set "Surround Back" at the "Power Amp Assign." setting.

1 Press the **STANDARD** button to select the Dolby Pro Logic IIx mode.

- The Dolby Pro Logic II indicator lights.



※ The mode switches as shown below each time the **STANDARD** button is pressed.

DOLBY PLIIx ← → DTS NEO:6

2 Play a program source.

※ For operating instructions, refer to the manuals of the respective components.

3 Press the **SURROUND PARAMETER** button to select the surround parameter mode.

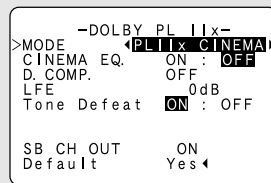

Basic Operation

4 Turn the **SELECT** knob, and press the **CURSOR** ◀ or ▶ button to select the optimum mode for the source.

※ When the "SB CH OUT" parameter is set to "ON". (Set "S. BACK" at system setup to "SMALL" or "LARGE".)

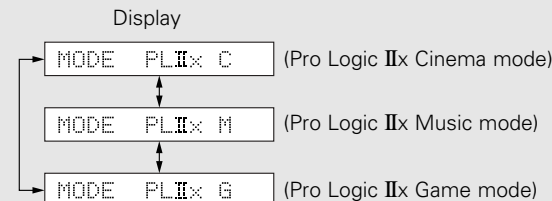

※ When the "SB CH OUT" parameter is set to "OFF". (Set "S. BACK" at system setup to "NONE".)

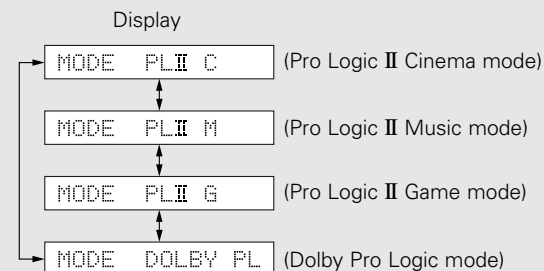

5 Press the **SURROUND PARAMETER** button, and press the **CURSOR** ▲ or ▼ button to select the various parameters.

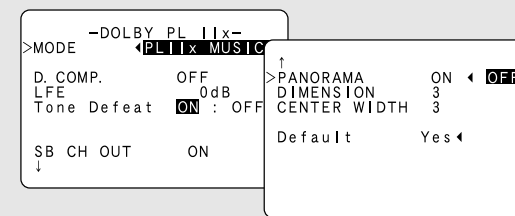

※ See "Surround parameters ①" for a description of the various parameters.

## Basic Operation

**6** Turn the **SELECT** knob, and press the **CURSOR** ◀ or ▶ button to set the various surround parameters.

※ When the surround parameters are set using the buttons on the main unit, stop operating the buttons after completing the settings. The settings are automatically finalized and the normal display reappears after several seconds.

**7** Press the **ENTER** button to finish the surround parameter mode.



• When making parameter settings, the display will return to the regular condition several seconds after the last button was pressed and the setting will be completed.

## ■ Surround parameters ①

### Pro Logic IIx and Pro Logic II Mode:

The Cinema mode is for use with stereo television shows and all programs encoded in Dolby Surround.

The Music mode is recommended for stereo music and surround-encoded stereo music sources.

The Pro Logic mode offers the same robust surround processing as original Pro Logic in case the source content is not of optimum quality.

The Game mode is for playing games. The game mode can only be used with 2-channel audio sources.

Select one of the modes ("Cinema", "Music", "Pro Logic" or "Game").

#### • Panorama Control:

This mode extends the front stereo image to include the surround speakers for an exciting "wraparound" effect with side wall imaging.

Select "OFF" or "ON".

#### • Dimension Control:

This control gradually adjusts the soundfield either towards the front or towards the rear.

The control can be set in 7 steps from 0 to 6.

#### • Center Width Control:

This control adjusts the center image so it may be heard only from the center speaker; only from the left/right speakers as a phantom image; or from all three front speakers to varying degrees.

The control can be set in 8 steps from 0 to 7.

### DTS NEO:6 mode

**1** Press the **STANDARD** button to select the **DTS NEO:6** mode.

※ The mode switches as shown below each time the button is pressed.

DOLBY PLIIx ← → DTS NEO:6

**2** Play a program source.

**3** Press the **SURROUND PARAMETER** button to select the surround parameter mode.

**4** Turn the **SELECT** knob, and press the **CURSOR** ◀ or ▶ button to select the optimum mode for the source.

**5** Press the **SURROUND PARAMETER** button, and press the **CURSOR** △ or ▽ button to select the various parameters.

**6** Turn the **SELECT** knob, and press the **CURSOR** ◀ or ▶ button to set the various surround parameters.

※ When the surround parameters are set using the buttons on the main unit, stop operating the buttons after completing the settings. The settings are automatically finalized and the normal display reappears after several seconds.

**7** Press the **ENTER** button to finish the surround parameter mode.



• When making parameter settings, the display will return to the regular condition several seconds after the last button was pressed and the setting will be completed.

## Basic Operation

## ■ Surround parameters ②

### DTS NEO:6 Mode:

#### • Cinema:

This mode is optimum for playing movies. Decoding is performed with emphasis on separation performance to achieve the same atmosphere with 2-channel sources as with 6.1-channel sources.

This mode is effective for playing sources recorded in conventional surround formats as well, because the in-phase component is assigned mainly to the center channel (C) and the reversed phase component to the surround (SL, SR and SB channels).

#### • Music:

This mode is suited mainly for playing music. The front channel (FL and FR) signals bypass the decoder and are played directly so there is no loss of sound quality, and the effect of the surround signals output from the center (C) and surround (SL, SR and SB) channels add a natural sense of expansion to the sound field.

### CENTER IMAGE (0.0 to 1.0: default 0.3):

The center image parameter for adjusting the expansion of the center channel in the DTS NEO:6 MUSIC mode has been added.

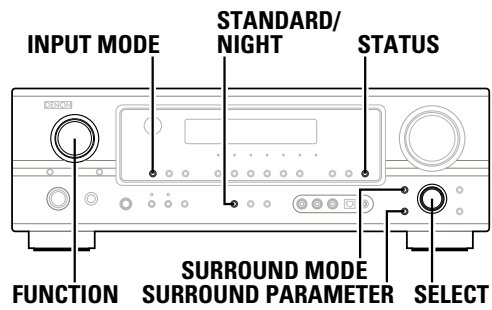

**Dolby Digital mode and DTS surround (only with digital input)**

**1** Select an input source set to digital (COAXIAL/OPTICAL) (page 40).

Example: DVD

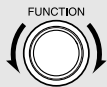

(Main unit)



(Remote control unit)

**2** Press the **INPUT MODE** button to set the input mode to "AUTO" or "DTS".

**3** Press the **STANDARD** button to select the **STANDARD (Dolby/DTS Surround)** mode.

※ When performing this operation from the main unit's panel, press the **SURROUND MODE** button, then turn the **SELECT** knob and select Dolby Pro Logic IIx or DTS NEO:6.

**4** Play a program source with the **DOLBY DIGITAL** or **DTS** symbol.

- The Dolby Digital indicator lights when playing Dolby Digital sources.
- The DTS indicator lights when playing DTS sources.



— Lights



— Lights

- ※ Operate the **SURROUND BACK** button to switch Surround Back CH ON/OFF.
- The **SURROUND BACK** indicator lights when the **SURROUND BACK** button is on.



— Lights

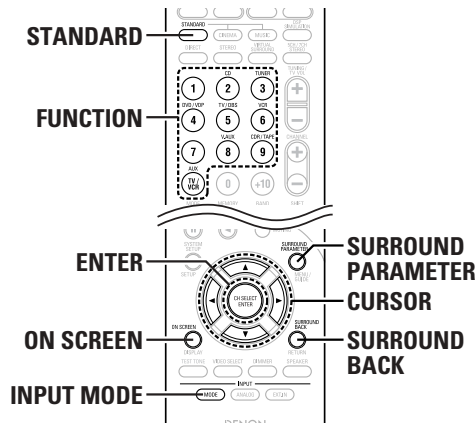

**5** Press the **SURROUND PARAMETER** button.  
• The surround parameter menu is displayed.

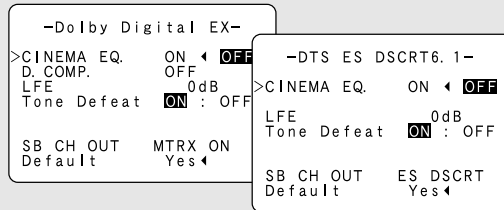

**6** Press the **SURROUND PARAMETER** button, and press the **CURSOR**  $\Delta$  or  $\nabla$  button to select the various parameters.

**7** Turn the **SELECT** knob, and press the **CURSOR**  $\triangleleft$  or  $\triangleright$  button to adjust the parameter settings.

**8** Press the **ENTER** button to finish the surround parameter mode.



- When making parameter settings, the display will return to the regular condition several seconds after the last button was pressed and the setting will be completed.

**Surround parameters ③**

**CINEMA EQ.** (Cinema Equalizer):

The Cinema EQ function gently decreases the level of the extreme high frequencies, compensating for overly-bright sounding motion picture soundtracks. Select this function if the sound from the front speakers is too bright. This function only works in the Dolby Pro Logic IIx, Dolby Digital, DTS Surround and DTS NEO:6 modes. (The same contents are set for all operating modes.)

**D.COMP.** (Dynamic Range Compression):

Motion picture soundtracks have tremendous dynamic range (the contrast between very soft and very loud sounds). For listening late at night, or whenever the maximum sound level is lower than usual, the Dynamic Range Compression allows you to hear all of the sounds in the soundtrack (but with reduced dynamic range). (This only works when playing program sources recorded in Dolby Digital or DTS). Select one of the four parameters ("OFF", "LOW", "MID" (middle) or "HI" (high)). Set to OFF for normal listening.

**LFE** (Low Frequency Effect):

This sets the level of the LFE (Low Frequency Effect) sounds included in the source when playing program sources recorded in Dolby Digital or DTS.

If the sound produced from the subwoofer sounds distorted due to the LFE signals when playing Dolby Digital or DTS sources when the peak limiter is turned off with the subwoofer peak limit level setting (system setup menu), adjust the level as necessary.

Program source and adjustment range:

1. Dolby Digital: -10 dB to 0 dB
2. DTS Surround: -10 dB to 0 dB

※ **When DTS encoded movie software is played, it is recommended that the LFE LEVEL be set to 0 dB for correct DTS playback.**

※ **When DTS encoded music software is played, it is recommended that the LFE LEVEL be set to -10 dB for correct DTS playback.**

**TONE:**

This enables the tone control. This can be set individually for the separate surround modes other than DIRECT mode.



Basic Operation

**SB CH OUT** (Surround Back):

(1) Multi-channel source

- **OFF:**  
Playback is conducted without using the surround back speaker.
- **NON MTRX:**  
The same signals as those of the surround channels are output from the surround back channels.
- **MTRX ON:**  
The surround back channel is reproduced using digital matrix processing.
- **ES MTRX:**  
When playing DTS signals, the surround back signals undergo digital matrix processing for playback.
- **ES DSCRT:**  
When a signal identifying the source as a discrete 6.1-channel source is included in the DTS signals, the surround back signals included in the source are played.
- **PLIIx Cinema:**  
Processing is performed with the Cinema mode of the PLIIx decoder and the surround back channel is reproduced.
- **PLIIx Music:**  
Processing is performed with the Music mode of the PLIIx decoder and the surround back channel is reproduced.

(2) 2ch source

- **OFF:**  
Playback is conducted without using the surround back speaker.
  - **ON:**  
Playback is conducted using the surround back speaker.
- ※ This operation can be performed directly by pressing the **SURROUND BACK** button.

■ **Checking the input signal**

The input signal can be checked by pressing the remote control unit's **ON SCREEN** button.

**SIGNAL:**

Displays the type of signal (DTS, DOLBY DIGITAL, PCM, etc.).

**fs:**

Displays the input signal's sampling frequency.

**FORMAT:**

Displays the input signal's number of channels.  
"Number of front channels/Number of surround channels/ LFE on/off".  
"SURROUND" is displayed for 2-channel signal sources recorded in Dolby Surround.

**OFFSET:**

Displays the dialog normalization offset value.

**FLAG:**

Displays the special identification signal recorded in the input signal.  
"MATRIX" is displayed when matrix processing is conducted on the surround back channel, "DISCRETE" is displayed when discrete processing is conducted.  
Not displayed if an identification signal has not been recorded.

• In addition, screen information is displayed in the following order when the **ON SCREEN** button is pressed repeatedly:

- OSD-1 Input signal
- OSD-2 Input/output
- OSD-3 Auto surround mode
- OSD-4~10 Tuner preset stations

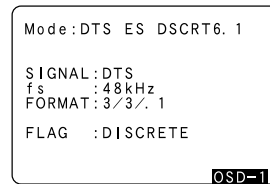
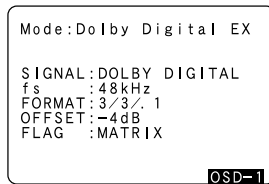

**NOTE:**

- OSD-3:  
This is displayed when the auto surround mode is set to "ON" and the input mode is set to "Auto".  
It is not displayed when the input mode is set to "Analog" or "EXT. IN".

Basic Operation

■ **Dialog normalization**

The dialog normalization function is activated automatically when playing Dolby Digital program sources.

Dialog normalization is a basic function of Dolby Digital which automatically normalizes the dialog level (standard level) of the signals which are recorded at different levels for different program sources, such as DVD, DTV and other future formats that will use Dolby Digital.

These contents can be verified with the **STATUS** or **ON SCREEN** buttons.

Display

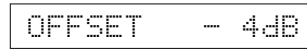

The number indicates the normalization level when the currently playing program is normalized to the standard level.

**Night mode**

When listening at night or at lower volumes, the night mode improves listenability.

**Press and hold the STANDARD/NIGHT button for several seconds to enter the night mode.**



- Canceling night mode:  
Press and hold the **STANDARD/NIGHT** button again.
- The night mode only works when playing program sources recorded in Dolby Digital or DTS.

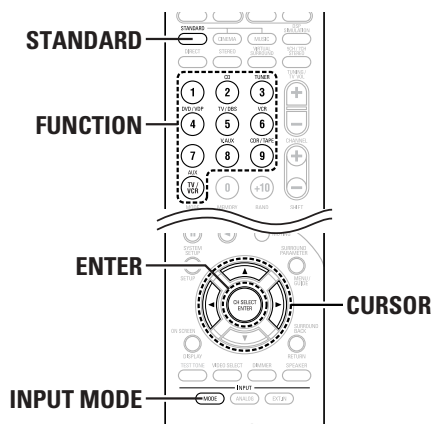
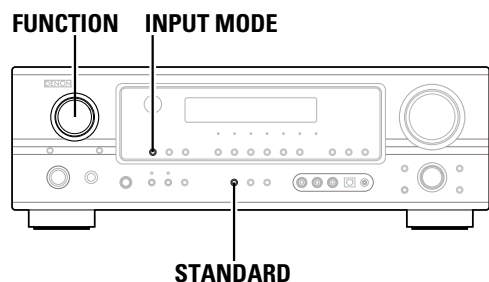

**Adjusting the audio delay**

- When watching a DVD or other video source, the picture on the monitor may seem delayed with respect to the sound. In this case, adjust the audio delay to delay the sound and synchronize it with the picture.
- The audio delay setting is stored separately for each input source.
- This adjustment can be performed with the system setup (page 43) or from the remote control unit, as described below.

**1 Select the input source.**

Example: DVD

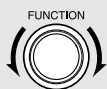

(Main unit)



(Remote control unit)

**2 Press the INPUT MODE button to set the input mode to “AUTO”.**

**3 Select Dolby/DTS Surround.**



(Main unit)



(Remote control unit)

**4 Play a program source (DVD, etc.).**

**5 Press the CURSOR  $\Delta$  button.**

- Switch to the Audio Delay adjustment screen.

**6 Press the CURSOR  $\triangleleft$  or  $\triangleright$  button to set the delay time (0 ms ~ 200 ms).**

※ With a movie source, for example, adjust so that the movement of the actors' lips is synchronized with the sound.

**7 Press the ENTER button to complete the setting.**



- The audio delay setting does not apply when playing in the EXT. IN mode or in the analog input direct or stereo mode.

## DENON original surround modes

This unit is equipped with a high performance DSP (Digital Signal Processor) which uses digital signal processing to synthetically recreate the sound field. One of 7 preset surround modes can be selected according to the program source and the parameters can be adjusted according to the conditions in the listening room to achieve a more realistic, powerful sound.

### Surround modes and their features

|   |                          |   |
|---|--------------------------|---|
| 1 | <b>5CH/7CH STEREO</b>    | The front left channel signals are output to the surround and surround back left channels, the front right channel signals are output to the surround and surround back right channels, and the in-phase component of the left and right channels is output to the center channel. Use this mode to enjoy stereo sound. |
| 2 | <b>MONO MOVIE (NOTE)</b> | Select this when watching monaural movies for a greater sense of expansion.   |
| 3 | <b>ROCK ARENA</b>        | Use this mode to achieve the feeling of a live concert in an arena with reflected sounds coming from all directions.  |
| 4 | <b>JAZZ CLUB</b>         | This mode creates the sound field of a live house with a low ceiling and hard walls. This mode gives jazz a very vivid realism.   |
| 5 | <b>VIDEO GAME</b>        | Use this to enjoy video game sources.   |
| 6 | <b>MATRIX</b>            | Select this to emphasize the sense of expansion for music sources recorded in stereo. Signals consisting of the component difference of the input signals (the component that provides the sense of expansion) processed for delay are output from the surround channel.  |
| 7 | <b>VIRTUAL</b>           | Select this mode to enjoy a virtual sound field, produced from the front 2-channel speakers or headphones.  |

※ Depending on the program source being played, the effect may not be very noticeable.  
In this case, try other surround modes, without worrying about their names, to create a sound field suited to your tastes.

**NOTE:** When playing sources recorded in monaural, the sound will be one-sided if signals are only input to one channel (left or right), so input signals to both channels. If you have a source component with only one audio output (monophonic camcorder, etc.) obtain a "Y" adapter cable to split the mono output to two outputs, and connect to the L and R inputs.

### ■ Personal memory plus

This set is equipped with a personal memorize function that automatically memorizes the surround modes and input modes selected for the different sources. When the input source is switched, the modes set for that source last time it was used are automatically recalled.

※ The surround parameters, tone control settings and playback level balance for the different output channels are memorized for each surround mode.

Basic Operation

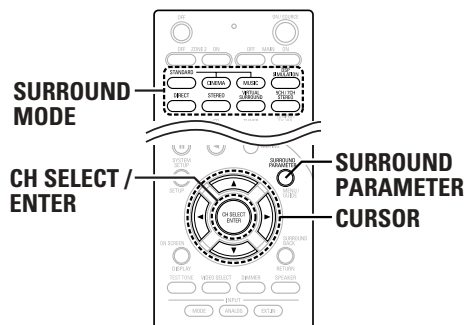
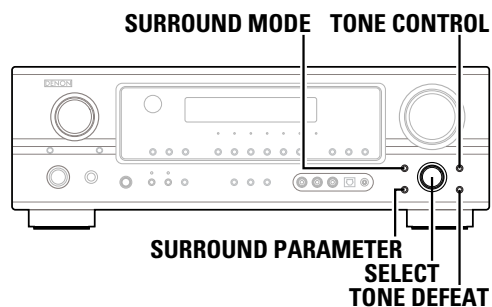

DSP surround simulation

■ To operate the surround mode and the surround parameters from the remote control unit

1 Select the surround mode for the input channel.

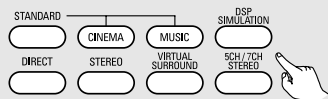

(Remote control unit)

※ The surround mode switches in the following order each time the **DSP SIMULATION** button is pressed:

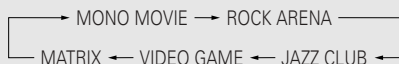

2 Press the **SURROUND PARAMETER** button to enter the surround parameter setting mode.

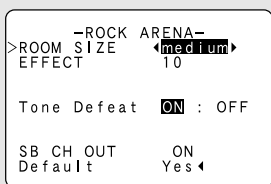

※ The surround parameter switches in the following order each time the **SURROUND PARAMETER** button is pressed for the different surround modes.

3 Press the **SURROUND PARAMETER** button, and press the **CURSOR**  $\Delta$  or  $\nabla$  button to select the various parameters.

4 Press the **CURSOR**  $\triangleleft$  or  $\triangleright$  button to adjust the parameter settings.

5 Press the **ENTER** button to finish the surround parameter mode.



• When making parameter settings, the display will return to the regular condition several seconds after the last button was pressed and the setting will be completed.

■ Operating the surround mode and the surround parameters from the main unit's panel

1 Turn the **SELECT** knob to select the surround mode.

※ When turned clockwise:



Basic Operation

※ When turned counterclockwise:

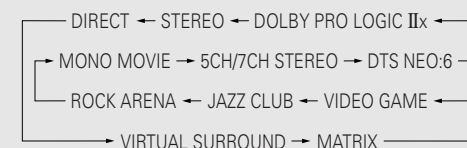

※ To select the surround mode while adjusting the surround parameters, tone defeat or tone control, press the **SURROUND MODE** button, then operate the selector.

2 Press and hold in the **SURROUND PARAMETER** button to select the parameter you want to set.

※ The parameters which can be set differ for the different surround modes are displayed. (Refer to "Surround modes and parameters" (page 57).)

3 Display the parameter you want to adjust, then turn the **SELECT** knob to set it.



• When making parameter settings, the display will return to the regular condition several seconds after the last button was pressed and the setting will be completed.

■ Surround parameters ④

**ROOM SIZE:**

This sets the size of the sound field. There are five settings: "small", "med.s" (medium-small), "medium", "med.l" (medium-large) and "large". "small" recreates a small sound field, "large" a large sound field.

**EFFECT LEVEL:**

This sets the strength of the surround effect. The level can be set in 15 steps from 1 to 15. Lower the level if the sound seems distorted.

**DELAY TIME:**

The delay time can be set within the range of 0 to 110 ms only in the matrix mode.

**TOPE CONTROL:**

This can be set individually for each surround mode except DIRECT.

## Basic Operation

**Tone control setting****■ Adjusting the sound quality (tone)**

The tone control function will not work in the DIRECT mode.

**1 Press the TONE CONTROL button.**

- ※ The tone switches as follows each time the **TONE CONTROL** button is pressed.

BASS ←→ TREBLE

**2 Turn the SELECT knob to adjust the level of the bass or treble.**

- ※ To increase the bass or treble:  
Turn the control clockwise. (The bass or treble sound can be increased up to +12 dB in steps of 2 dB.)
- ※ To decrease the bass or treble:  
Turn the control counterclockwise. (The bass or treble sound can be decreased down to -12 dB in steps of 2 dB.)

**■ Tone defeat mode**

If you do not want the bass and treble to be adjusted, turn on the tone defeat mode.

**Press the TONE DEFEAT button.**

- ※ The signals do not pass through the bass and treble adjustment circuits, thus resulting in higher quality sound.

**Channel Level**

You can adjust the channel level either according to the playback sources or to suit your taste, as described below.

**1 Press the CH SELECT button to select the speaker whose level you want to adjust.**

- ※ The channel switches as shown below each time the button is pressed.

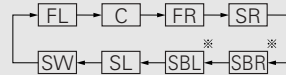

- ※ When the surround back speaker setting is set to "1sp" for "Speaker Configuration", this is set to "SB".
- ※ "SB" appears only when the "Power Amp Assign." setting is the surround back mode.

**2 Press the CURSOR ◀ or ▶ button to adjust the level of the selected speaker.**

- ※ The default setting of the channel level is 0 dB.
- ※ The level of the selected speaker can be adjusted within the range of +12 to -12 dB by pressing the **CURSOR** buttons.
- ※ The SW channel level can be turned off by decreasing it one step from -12 dB.

OFF ↔ -12 dB ↔ +12 dB

Basic Operation

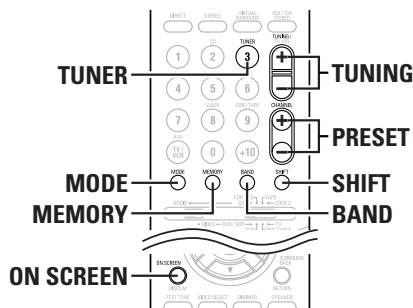
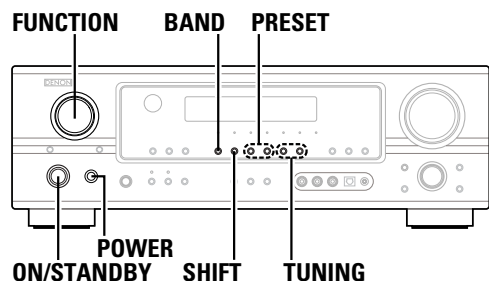

Listening to the radio

Auto preset memory

- This unit is equipped with a function for automatically searching for FM broadcast stations and storing them in the preset memory.
- The “Auto tuner preset” operation can also be performed at “System setup” (page 42).

Hold the **PRESET ▲** button and press the **POWER** switch on the main unit.

- The unit automatically begins searching for FM broadcast stations.
- ※ When the first FM broadcast station is found, that station is stored in the preset memory at channel A1. Subsequent stations are automatically stored in order at preset channels A1 to A8, B1 to B8, C1 to C8, D1 to D8, E1 to E8, F1 to F8 and G1 to G8 for a maximum of 56 stations.
- ※ Channel A1 is tuned in after the auto preset memory operation is completed.



- If an FM station cannot be preset automatically due to poor reception, use the “Manual tuning” operation to tune in the station, then preset it using the manual “Preset memory” operation.
- To interrupt this function, press the **ON/STANDBY** switch.

■ DEFAULT SETTINGS

| Auto tuner presets |  |
|--------------------|--|
| A1 ~ A8            | 87.5 / 89.1 / 98.1 / 107.9 / 90.1 / 90.1 / 90.1 / 90.1 MHz |
| B1 ~ B8            | 520 / 600 / 1000 / 1400 / 1500 / 1710 kHz, 90.1 / 90.1 MHz |
| C1 ~ C8            | 90.1 MHz   |
| D1 ~ D8            | 90.1 MHz   |
| E1 ~ E8            | 90.1 MHz   |
| F1 ~ F8            | 90.1 MHz   |
| G1 ~ G8            | 90.1 MHz   |

Basic Operation

Auto tuning

**1** Set the input source to “TUNER”.

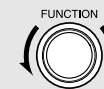

(Main unit)



(Remote control unit)

**2** Watching the display, press the **BAND** button to select the desired band (AM or FM).

**3** Press the **MODE** button to set the auto tuning mode.



**4** Press the **TUNING (+) or (-) button**.

- ※ Automatic searching begins, then stops when a station is tuned in.



- When in the auto tuning mode on the FM band, the “STEREO” indicator lights on the display when a stereo broadcast is tuned in. At open frequencies, the noise is muted and the “TUNED” and “STEREO” indicators turn off.



## Basic Operation

## Manual tuning

- 1** Set the input source to “TUNER”.
- 2** Watching the display, press the **BAND** button to select the desired band (AM or FM).
- 3** Press the **MODE** button to set the manual tuning mode.  
 ※ Check that the display’s “AUTO” indicator turns off.
- 4** Press the **TUNING** (+) or (–) button to tune in the desired station.  
 ※ The frequency changes continuously when the button is held in.



- When the manual tuning mode is set, FM stereo broadcasts are received in monaural and the “STEREO” indicator turns off.

## Preset stations

- 1** Use the “Auto tuning” or “Manual tuning” operation to tune in the station to be preset in the memory.
- 2** Press the **MEMORY** button.
- 3** Press the **SHIFT** button and select the desired memory block (A to G).
- 4** Press the **PRESET** (+) or (–) button to select the desired preset channel (1 to 8).
- 5** Press the **MEMORY** button again.
  - Store the station in the preset memory.



- To preset other channels, repeat steps 1 to 4.  
 A total of 56 broadcast stations can be preset — 8 stations (channels 1 to 8) in each of blocks A to G.

## Basic Operation

## Checking the preset stations

The preset (broadcast) stations can be checked on the on-screen display.

Press the **ON SCREEN** button repeatedly until the “Tuner Preset Stations” screen appears on the OSD.

| Tuner Preset Stations |             |
|-----------------------|-------------|
| A1                    | FM 87.50MHz |
| A2                    | FM 89.10MHz |
| A3                    | FM 98.10MHz |
| A4                    | FM107.90MHz |
| A5                    | FM 90.10MHz |
| A6                    | FM 90.10MHz |
| A7                    | FM 90.10MHz |
| A8                    | FM 90.10MHz |

OSD-4

## Recalling preset stations

- 1** Watching the display, press the **SHIFT** button to select the preset memory block.
- 2** Watching the display, press the **PRESET** ▲ (+) or ▼ (–) button to select the desired preset channel.

# Advanced Operation

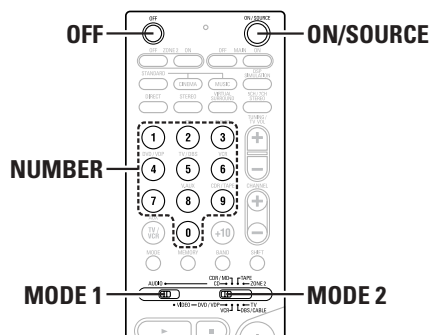

## Remote control unit

### Operating DENON audio components

**1** Set the **MODE 1** switch to “AUDIO”.

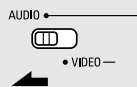

**2** Set the **MODE 2** switch to the position for the component to be operated (CD, CDR/MD or TAPE).

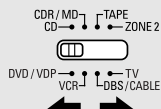

**3** Operate the audio component.

- ※ For details, refer to the component’s operating instructions.
- ※ While this remote control is compatible with a wide range of infrared controlled components, it may be the case that some component models cannot be operated with this remote control.

### 1. CD player (CD), CD recorder and MD recorder (CDR/MD) system buttons

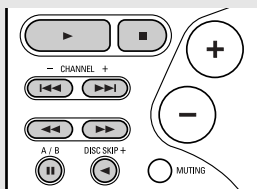

- ◀▶ : Manual search (forward and reverse)
- : Stop
- ▶ : Play
- ◀▶▶▶ : Auto search (cue)
- ⏸ : Pause
- DISC SKIP + : Switch discs (for CD changers only)

### 2. Tape deck (TAPE) system buttons

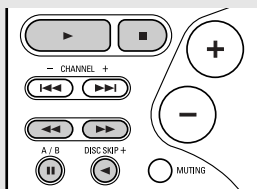

- ◀◀ : Rewind
- ▶▶ : Fast-forward
- : Stop
- ▶ : Forward play
- ◀ : Reverse play
- A/B : Switch between decks A and B

### 3. Tuner system buttons

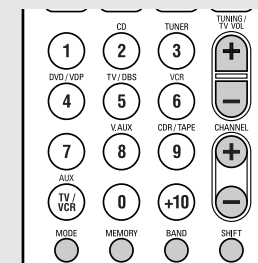

- SHIFT : Switch preset channel range
- CHANNEL +, - : Preset channel up/down
- TUNING +, - : Frequency up/down
- BAND : Switch between the AM and FM bands
- MODE : Switch between auto and mono
- MEMORY : Preset memory



- TUNER can be operated when the switch is at “AUDIO” position.

Advanced Operation

**Preset memory**

- DENON and other makes of components can be operated by setting the preset memory.
- This remote control unit can be used to operate components of other manufacturers without using the learning function by registering the manufacturer of the component as shown in the list of preset codes (End of this manual).
- Operation is not possible for some models.

**1 Set the MODE 1 switch to “AUDIO” or “VIDEO”.**

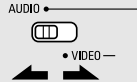

※ Set to the AUDIO side for the CD, Tape deck or CDR/MD position, and to the VIDEO side for the DVD/VDP, DBS/CABLE, VCR or TV position.

**2 Set the MODE 2 switch to the component to be registered.**

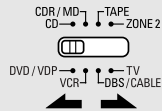

**3 Press the ON/SOURCE and OFF button at the same time.**

- The indicator starts flashing.

**4 Referring to the included list of preset codes, press the NUMBER buttons to input the preset code (a 3-digit number) for the manufacturer of the component whose signals you want to store in the memory.**

**5 To store the codes of another component in the memory, repeat steps 1 to 4.**



- The signals for the pressed buttons are emitted while setting the preset memory. To avoid accidental operation, cover the remote control unit's transmitting window while setting the preset memory.
- Depending on the model and year of manufacture, this function cannot be used for some models, even if they are of makes listed in the list of preset codes.
- Some manufacturers use more than one type of remote control code. Refer to the included list of preset codes to change the number and verify correct operation.
- The preset memory can be set for one component only among the following: CDR/MD, DVD/VDP and DBS/CABLE.

■ The preset codes are as follows upon shipment from the factory and after resetting:

- TV, VCR .....HITACHI
- CD, TAPE.....DENON
- CDR/MD .....DENON (CDR)
- DVD/VDP .....DENON (DVD)
- DBS/CABLE.....ABC (CABLE)

**Operating a component stored in the preset memory**

**1 Set the MODE 1 switch to “AUDIO” or “VIDEO”.**

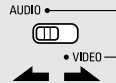

※ Set to the AUDIO side for the CD, Tape deck or CDR/MD position, and to the VIDEO side for the DVD/VDP, DBS/CABLE, VCR or TV position.

**2 Set the MODE 2 switch to the component you want to operate.**

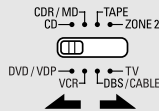

**3 Operate the component.**

- ※ For details, refer to the component's operating instructions.
- ※ Some models cannot be operated with this remote control unit.

Advanced Operation

**1. Digital video disc player (DVD) system buttons**

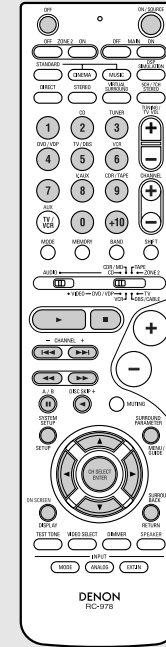

- ON/SOURCE** : Power on/standby
- OFF** : DENON DVD power off
- ◀▶** : Manual search (forward and reverse)
- : Stop
- ▶** : Play
- ◀▶** : Auto search (to beginning of track)
- ||** : Pause
- 0 ~ 9, +10** : Number
- DISC SKIP +** : Disc skip (for DVD changer only)
- DISPLAY** : Switch display
- MENU** : Menu
- RETURN** : Return
- SETUP** : Setup
- ▲, ▼, ◀, ▶** : Cursor up, down, left and right
- ENTER** : Enter setting



- Some manufacturers use different names for the DVD remote control buttons, so also refer to the instructions on remote control for that component.

Advanced Operation

2. Video disc player (VDP) system buttons

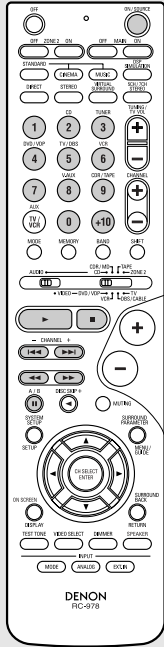

- ON/SOURCE** : Power on/standby
- ◀◀, ▶▶** : Manual search (forward and reverse)
- : Stop
- ▶** : Play
- ◀◀, ▶▶** : Auto search (cue)
- ||** : Pause
- 0 ~ 9, +10** : Number

Advanced Operation

3. Video deck (VCR) system buttons

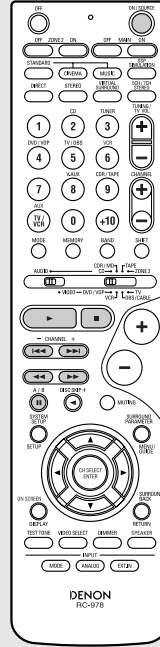

- ON/SOURCE** : Power on/standby
- ◀◀, ▶▶** : Manual search (forward and reverse)
- : Stop
- ▶** : Play
- ||** : Pause
- Channel +, -** : Channel up/down

4. Digital broadcast satellite (DBS) tuner and cable (CABLE) system buttons

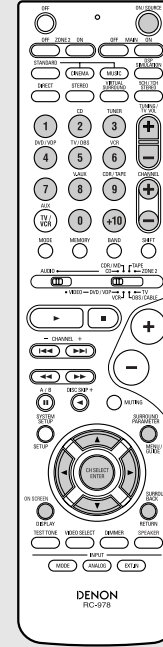

- ON/SOURCE** : Power on/standby
- MENU** : Menu
- RETURN** : Return
- ▲, ▼, ◀, ▶** : Cursor up, down, left and right
- ENTER** : Enter
- CHANNEL +, -** : Channel up/down
- 0 ~ 9, +10** : Number
- DISPLAY** : Switch display
- VOL +, -** : Volume up/down

5. Monitor TV (TV) system buttons

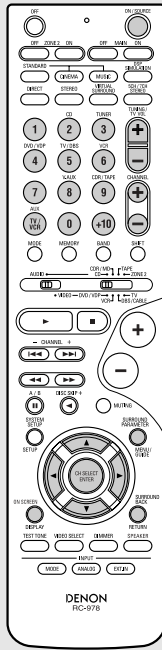

- ON/SOURCE** : Power on/standby
- MENU** : Menu
- RETURN** : Return
- ▲, ▼, ◀, ▶** : Cursor up, down, left and right
- ENTER** : Enter
- CHANNEL +, -** : Channel up/down
- 0 ~ 9, +10** : Number
- DISPLAY** : Switch display
- TV/VCR** : Switch between TV and video player
- VOL +, -** : Volume up/down



- For CD, CDR, MD and TAPE components, the buttons can be operated in the same way as for DENON audio components (page 31).
- A TV can be operated when the switch is at the DVD/VDP, VCR, TV position.

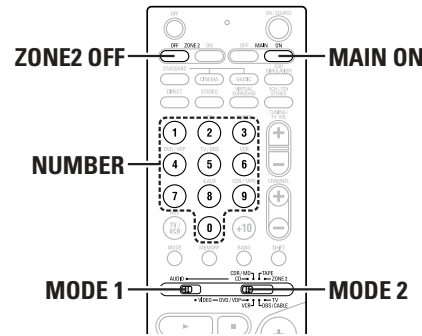

**Punch through**

“Punch Through” is a function allowing you to operate the **PLAY**, **STOP**, **MANUAL SEARCH** and **AUTO SEARCH** buttons on CD, TAPE, CDR/MD, DVD/VDP or VCR components when in the DBS/CABLE or TV mode. By default, nothing is set.

**1** Set the **MODE 1** switch to “VIDEO”.

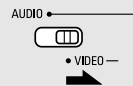

**2** Set the **MODE 2** switch to the component to be registered (DBS/CABLE or TV).

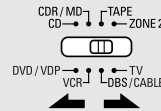

**3** Press the **ZONE2 OFF** and **MAIN ON** buttons at the same time.

- The indicator starts flashing.

**4** Input the number of the component you want to set.

|            | No. |
|------------|-----|
| CD         | 1   |
| TAPE       | 2   |
| CDR/MD     | 3   |
| DVD/VDP    | 4   |
| VCR        | 5   |
| No setting | 0   |

**Multi zone music entertainment system**

- When the outputs of the ZONE2 OUT terminals are wired and connected to integrated amplifiers installed in other rooms, different sources can be played in rooms other than the MAIN ZONE in which this unit and the playback devices are installed. (Refer to ZONE2 on the diagram below.)
- ZONE2 speaker out and pre-out can be used when "ZONE2" is selected at "Power Amp Assign." in the "System Setup" menu. In this case, surround back speaker out cannot be used for MAIN ZONE.
- When a sold separately room-to-room remote control unit (DENON RC-616, 617 or 618) is wired and connected between the MAIN ZONE and ZONE2, the remote-controllable devices in the MAIN ZONE can be controlled from ZONE2 using the remote control unit.



- For the AUDIO outputs, use high quality pin-plug cables and wire in such a way that there is no humming or noise.
- For instructions on installation and operation of separately sold devices, refer to the devices' operating instructions.
- When the main unit is set to the recording output mode, ZONE2 remote control button cannot be operated.

**■ When using the SURR.BACK/ZONE2 amplifier as the SURROUND BACK**

- 7.1-channel playback using the surround back speaker is possible in the MAIN ZONE.
- To use the ZONE2 line output, turn on the **ZONE2** button.
- The ZONE2 OUT terminal's output level cannot be adjusted with the remote control unit.

**[System configuration and connections example]**

Using external amplifier.

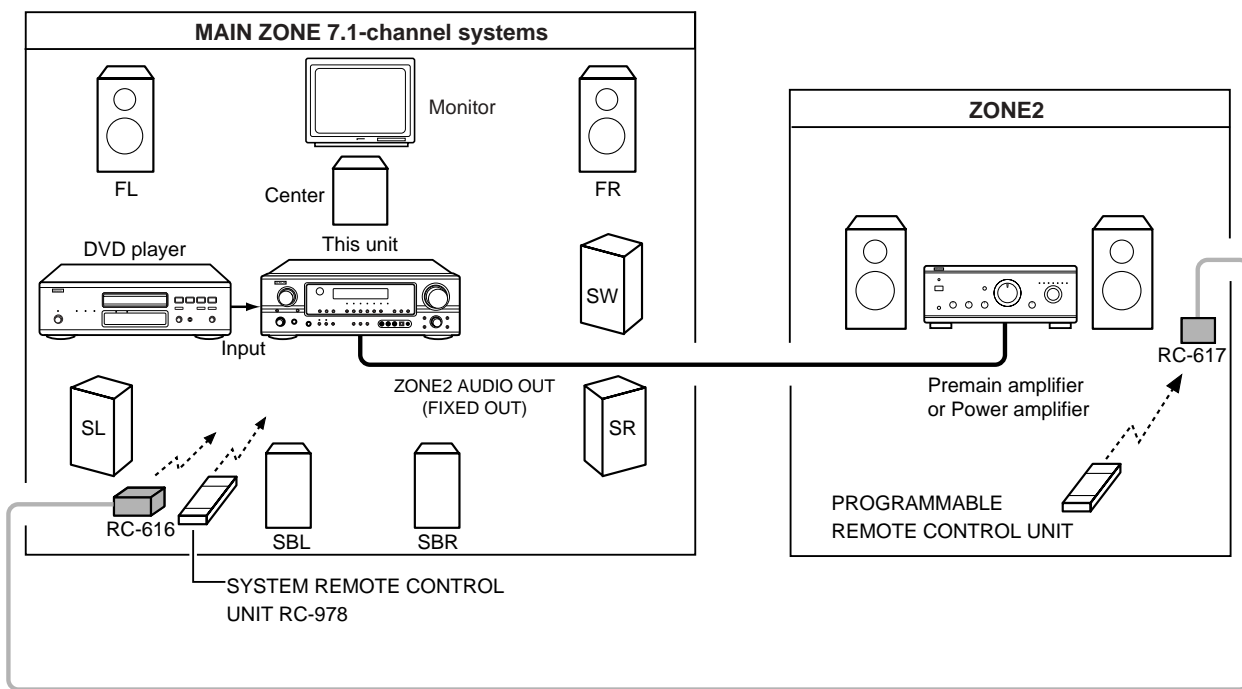

— : ROOM-TO-ROOM REMOTE CONTROL SYSTEM (separately sold) control line  
 — : MULTI SOURCE AUDIO signal cable  
 ※ Refer to "Connections" (page 16).

Advanced Operation

Advanced Operation

■ When using the SURR.BACK/ZONE2 amplifier as the ZONE2

- The SPEAKER OUT, LINE OUT and PRE OUT terminals can be used simultaneously in ZONE2.
- To use the ZONE2, turn on the **ZONE2** button.
- The output of the ZONE2 SPEAKER OUT terminals can be adjusted with the remote control unit's **ZONE2 VOLUME** button.

[System configuration and connections example]

Using this unit's internal amplifier as the ZONE2.

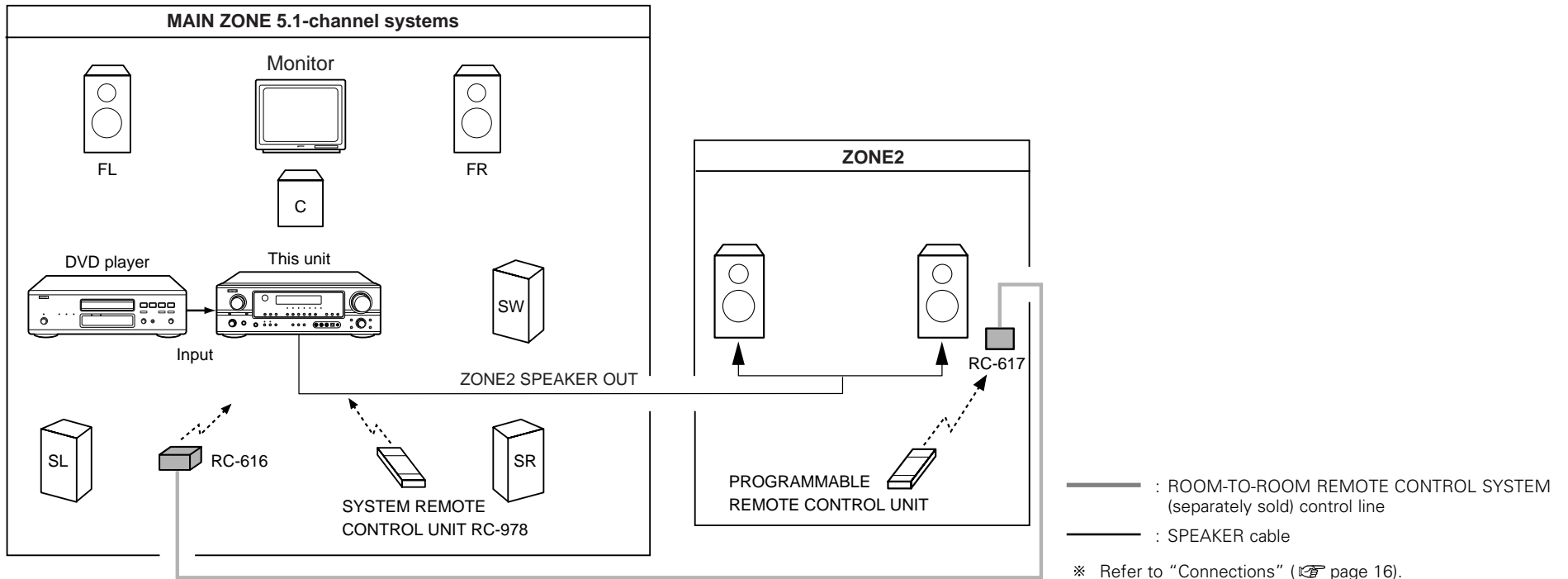

Advanced Operation

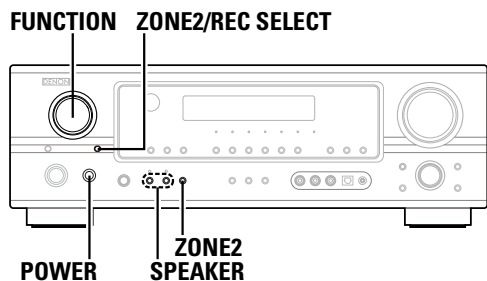

Outputting a program source to amplifier, etc., in a different room (ZONE2 mode)

**1** Press the **ZONE2/REC SELECT** button to display the “ZONE2 SOURCE” on the display.

※ The display switches as follows each time the button is pressed.

ZONE2 ↔ REC

**2** Turn the **FUNCTION** knob to select the source you want to output appears on the display.

**3** Start playing the source to be output.

※ For operating instructions, refer to the manuals of the respective components.

※ To cancel, turn the **FUNCTION** knob and select “SOURCE”.

**4** Press the **ZONE2** button.

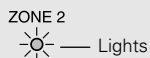

- The signals of the source selected in the ZONE2 mode are also output from the VCR and CDR/TAPE recording output terminals.
- Digital signals are not output to the ZONE2 output terminals.

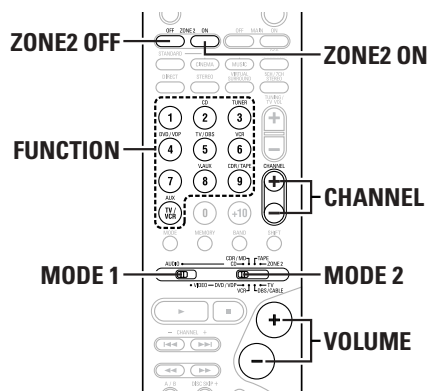

Remote control unit operations during multi-source playback (selecting the source)

**1** Set the **MODE 1** switch to the “AUDIO”.

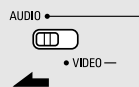

**2** Set the **MODE 2** switch to the “ZONE2”.

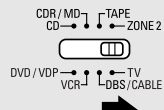

**3** Press the **ZONE2 ON** button.

※ To cancel the ZONE2 mode:  
Press the **ZONE2 OFF** button.

**4** Press the **FUNCTION** button.

※ The ZONE2 source switches directly.

**5** The output level of the **ZONE2 SPEAKER OUT** terminals can be controlled pressing the **VOLUME** button on the remote control unit.

※ Default setting (ZONE2 VOLUME LEVEL):  
--- dB (MINIMUM)

Advanced Operation

**6** When the **ZONE2 SOURCE** function is set to **TUNER**, the preset channel can be selected using the **CHANNEL** button on the remote control unit.

※ This is only possible when the main unit in the ZONE2 mode (page 44).



## Other functions

### Playing one source while recording another (REC OUT mode)

#### 1 Press the **ZONE2/REC SELECT** button to display the “RECOUT SOURCE” on the display.

※ The display switches as follows each time the button is pressed.

ZONE2 ←→ REC

#### 2 Turn the **FUNCTION** knob to select the source you want to output appears on the display.

#### 3 Set the recording mode.

※ For operating instructions, refer to the manual of the component on which you want to record.

※ To cancel, turn the **FUNCTION** knob and select “SOURCE”.



- Recording sources other than digital inputs selected in the REC OUT mode are also output to the ZONE2 audio output terminals.
- Digital signals are not output to the REC SOURCE or audio output terminals.
- The DIGITAL IN's signal selected with the **FUNCTION** knob is output to the DIGITAL OUT (OPTICAL) terminal.

### Last function memory

- This unit is equipped with a last function memory which stores the input and output setting conditions as they were immediately before the power is switched off. This function eliminates the need to perform complicated resettings when the power is switched on.
- The unit is also equipped with a back-up memory. This function provides approximately one week of memory storage when the main unit's **POWER** switch is off and the power supply cord disconnected.

### Initialization of the microprocessor

If the indication on the display is not normal or if the operation of the unit is not correct, then the microprocessor should be reset by the following procedure.

#### 1 Switch off the unit using the main unit's **POWER** switch.

#### 2 Keep both **SPEAKER A** and **B** buttons depressed and turn on the unit by pressing the main unit's **POWER** switch.

#### 3 Check that the entire display is flashing at 1-second intervals and release the buttons.

- The microprocessor will be initialized.



- If step 3 does not work, start over from step 1.
- If the microprocessor has been reset, all the button settings are reset to the default values (the values set upon shipment from the factory).

# Advanced Setup – Part 1

Use System Setup to customize a variety of settings to suit your listening environment. For the contents of a system menu and the initial setting of this unit (see page 49, 50).

## Navigating through the System Setup Menu

You can change the settings using the buttons on the front panel or remote control unit.

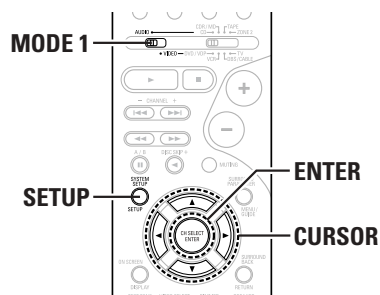

**1** Set the **MODE 1** switch to “AUDIO”.

**2** Press the **SETUP** button to display the “System Setup” menu. Press the **CURSOR**  $\Delta$  or  $\nabla$  button to select the menu, then press the **ENTER** button.

**3** Press the **ENTER** button to enter the selected menu.

**4** To change a setting, first select it by pressing the **CURSOR**  $\Delta$  or  $\nabla$  button, and then change the setting by pressing the **CURSOR**  $\triangleleft$  or  $\triangleright$  button.

**5** Press the **ENTER** button to confirm the new settings.

**6** Press the **SETUP** button to return to the “System Setup” menu and again to return to the main screen.

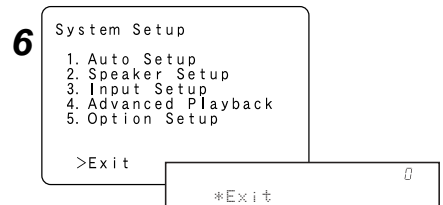
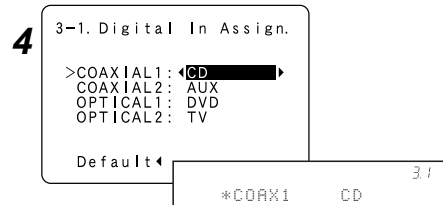
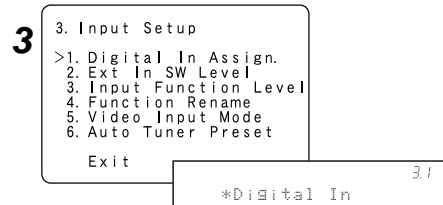
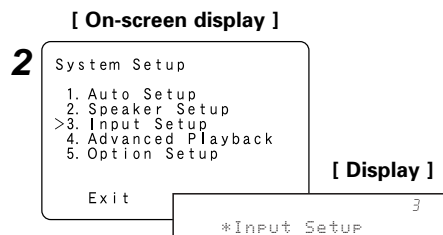

## On-screen display and front display

The AVR-1906 is equipped with an intuitive and easy-to-understand on-screen display, and is equipped with an alphanumeric front panel display that can also be used to check and adjust settings. We recommend that you use the on-screen display when you make system adjustments. Some representative front display and on-screen display examples are shown below.

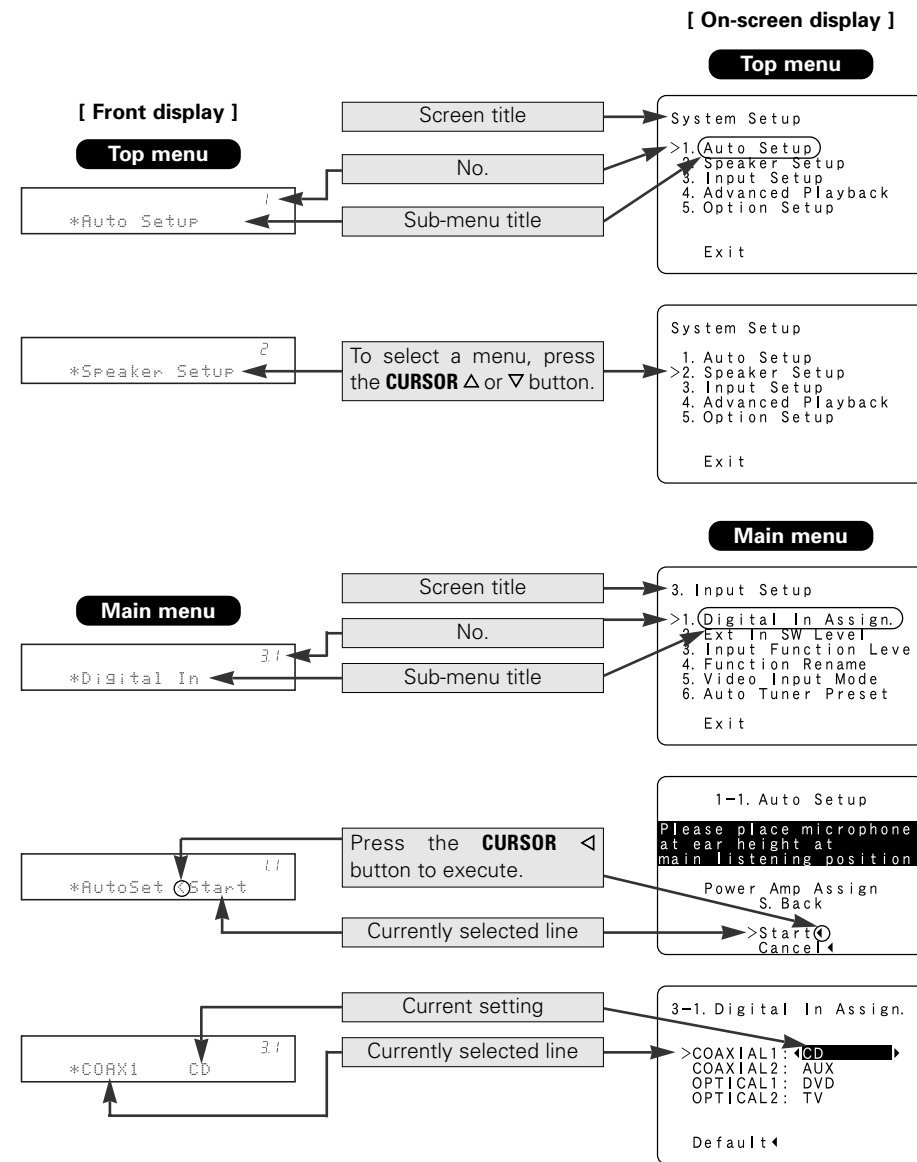

Input Setup

Setting the Digital In Assign.

This setting assigns the digital input terminals of the AVR-1906 for the different input sources.

**1** Press the **CURSOR**  $\Delta$  or  $\nabla$  button to select “Input Setup” at the “System Setup” menu, then press the **ENTER** button.

- The “Input Setup” screen appears.

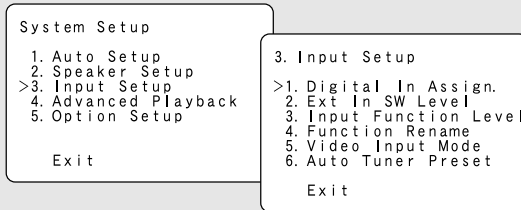

**2** Press the **CURSOR**  $\Delta$  or  $\nabla$  button to select “Digital In Assign.,” then press the **ENTER** button.

- The “Digital In Assign.” screen appears.

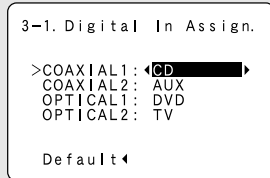

**3** Press the **CURSOR**  $\Delta$  or  $\nabla$  button to select the digital input terminal, then press the **CURSOR**  $\triangleleft$  or  $\triangleright$  button to select the input source.

- ※ Select “OFF” for input sources for which no digital input terminals are used.
- ※ If “Yes” is selected for “Default”, the settings are automatically reset to the default values.

**4** Press the **ENTER** button to enter the setting.  
• The “Input Setup” menu appears.



- The OPTICAL 2 terminal on the AVR-1906’s rear panel is equipped with an optical digital output terminal for recording digital signals on a CD recorder, MD recorder or other digital recorder. Use this for digital recording between a digital audio source (stereo – 2 channels) and a digital audio recorder.
- Do not connect the output of the component connected to the OPTICAL 2 OUT terminal on the AVR-1906’s rear panel to any terminal other than the OPTICAL 2 IN terminal.
- “TUNER” and “V. AUX” cannot be selected with “Setting the Digital In Assign.”.

Setting the Ext In SW Level

Set the method of playback of the analog input signal connected to the Ext. In Subwoofer.

**1** Press the **CURSOR**  $\Delta$  or  $\nabla$  button to select “Ext In SW Level” at the “Input Setup” menu, then press the **ENTER** button.

- The “Ext In SW Level” screen appears.

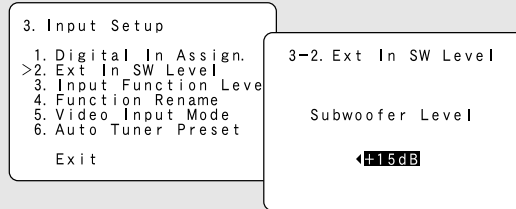

**2** Press the **CURSOR**  $\triangleleft$  or  $\triangleright$  button to select according to the specifications of the player being used.

- ※ Also refer to the player’s operating instructions.
- ※ +15dB (default) recommended (0, +5, +10 or +15 can be selected).

**3** Press the **ENTER** button to enter the setting.  
• The “Input Setup” menu appears.

Setting the Input Function Level

- Correct the playback level of the different input sources.
- Adjust the playback levels of the devices connected to the different input sources to the same level to eliminate the need for adjusting the main volume each time the input source is switched.

**1** Press the **CURSOR**  $\Delta$  or  $\nabla$  button to select “Input Function Level” at the “Input Setup” menu, then press the **ENTER** button.

- The “Input Function Level” screen appears.

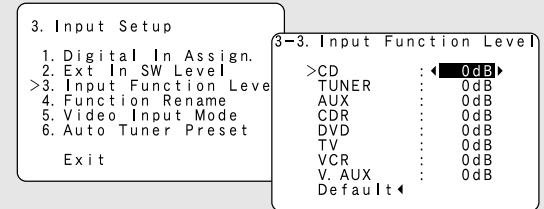

**2** Press the **CURSOR**  $\Delta$  or  $\nabla$  button to select the input source, then press the **CURSOR**  $\triangleleft$  or  $\triangleright$  button to adjust the level.

- ※ The level can be adjusted between –12 dB and +12 dB in units of 1 dB.
- ※ If “Yes” is selected for “Default”, the settings are automatically reset to the default values.

**3** Press the **ENTER** button to enter the setting.  
• The “Input Setup” menu appears.



- After completing this setting, check that the playback levels for the different sources are the same.

**Setting the Function Rename**

The names of the input sources displayed on the front display and the on-screen display can be changed. The names or brands of the devices connected to the input sources can be input.

**1** Press the **CURSOR**  $\Delta$  or  $\nabla$  button to select “Function Rename” at the “Input Setup” menu, then press the **ENTER** button.

- The “Function Rename” screen appears.

```
3. Input Setup
1. Digital In Assign.
2. Ext In SW Level
3. Input Function Level
>4. Function Rename
5. Video Input Mode
6. Auto Tuner Preset
Exit
```

```
3-4. Function Rename
>CD : <CD >
TUNER : TUNER
AUX : AUX
CDR : CDR
DVD : DVD
TV : TV
VCR : VCR
V. AUX : V. AUX
```

**2** Press the **CURSOR**  $\Delta$  or  $\nabla$  button to select the input source whose name you want to change, then press the **CURSOR**  $\triangleleft$  or  $\triangleright$  button.

- The screen switches to the character input screen.

**Example:**

When “CD” is selected and the **CURSOR**  $\triangleleft$  or  $\triangleright$  button is pressed

```
3-4. Function Rename
>CD : <CD >
Default <
```

**3** Press the **CURSOR**  $\triangleleft$  or  $\triangleright$  button to move the cursor (■) to the character, number, symbol or punctuation mark you wish to input, and press the **CURSOR**  $\Delta$  or  $\nabla$  button to select that character.

```
ABCDEFGHIJKLMNOPQRSTUVWXYZ
abcdefghijklmnopqrstuvwxyz
0123456789
'() +, - . / : ; < = > ? [ ] (space)
```

- ※ Up to 5 characters can be input.

**4** Repeat step 3 to complete input of the input source name.

- ※ If you wish to return the input source to its initial setting, press the **CURSOR**  $\nabla$  button while the input source is highlighted.
- ※ If “Yes” is selected for “Default”, the setting is automatically reset to the default name.

```
3-4. Function Rename
>CD : <DENON >
Default <
```

```
3-4. Function Rename
CD : <DENON >
>Default <
```

**5** Once all the characters have been input, press the **ENTER** button.

- The “Function Rename” screen appears.

- ※ Use the same procedure to change other input source names as well.

**6** Press the **ENTER** button to enter the setting.

- The “Input Setup” menu appears.



- When the input source is selected, the display is as shown below.

**Example:**

When the name has been changed to “DENON”

```
[AUTO]
Input: DENON
Mode : STEREO
```

Advanced Setup – Part 1

**Setting the Video Input Mode**

Select the input signal to be output to the composite S-Video and component monitor output terminals using the video conversion function.

**1** Press the **CURSOR**  $\Delta$  or  $\nabla$  button to select **“Video Input Mode”** at the **“Input Setup”** menu, then press the **ENTER** button.

- The “Video Input Mode” screen appears.

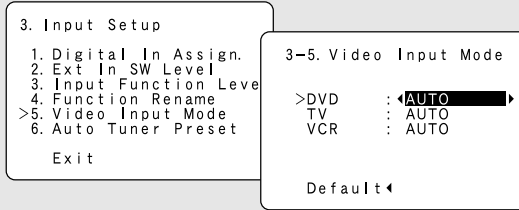

**2** Press the **CURSOR**  $\Delta$  or  $\nabla$  button to select the input source for which you want to set the video input mode.

**3** Press the **CURSOR**  $\triangleleft$  or  $\triangleright$  button to select the mode as below.

※ The details in each mode are as follows.

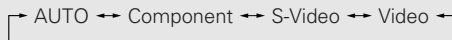

**AUTO:**

When there are multiple input signals, the input signals are detected and the input signal to be output from the video monitor output terminal is selected automatically in the following order: component video, S-Video, composite video.

**Component:**

The signal connected to the component video terminal is always played.  
Video conversion is not conducted, so no image is output from the monitor output terminal when there is no input signal to the component terminal.

**S-Video:**

The signal connected to the S-Video terminal is always played.  
The S-Video input signal is converted and output from the composite and component monitor output terminal.

**Video:**

The signal connected to the composite video terminal is always played.  
The composite video input signal is up-converted and output from the S-Video and component monitor output terminals.

**4** Press the **ENTER** button to enter the setting.

- The “Input Setup” menu appears.



- Down-converting from the component video signal to the S-Video and composite video signal is not possible, so when not using the component video monitor output terminal connect the player using the S-Video or composite video input terminal (page 12).

Advanced Setup – Part 1

**Setting the Auto Tuner Preset**

Use this to automatically search for FM broadcasts and store up to 56 stations at preset channels A1 to 8, B1 to 8, C1 to 8, D1 to 8, E1 to 8, F1 to 8 and G1 to 8.

**1** Press the **CURSOR**  $\Delta$  or  $\nabla$  button to select **“Auto Tuner Preset”** at the **“Input Setup”** menu, then press the **ENTER** button.

- The “Auto Tuner Preset” screen appears.

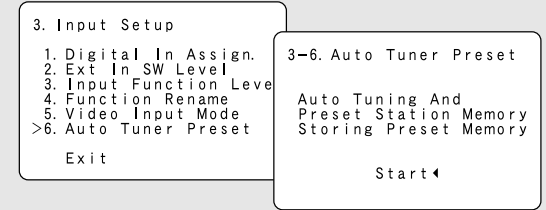

**2** Press the **CURSOR**  $\triangleleft$  button to select **“Start”**.

- “Search” appears on the screen and searching begins.
- “Completed” appears once searching is completed.

**3** Press the **CURSOR**  $\Delta$  or  $\nabla$  button to select **“Exit”**, then press the **ENTER** button.

- The “System Setup” menu appears.

## Advanced playback

## Setting the Audio Delay

- When watching a DVD or other video source, the picture on the monitor may seem delayed with respect to the sound. In this case, adjust the audio delay to delay the sound and synchronize it with the picture.
- The audio delay setting is stored separately for each input source.

### 1 Press the CURSOR $\Delta$ or $\nabla$ button to select “Advanced Playback” at the “System Setup” menu, then press the ENTER button.

- The “Advanced Playback” screen appears.

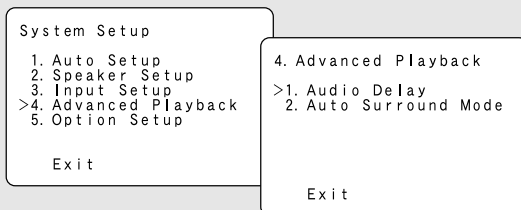

### 2 Press the CURSOR $\Delta$ or $\nabla$ button to select “Audio Delay”, then press the ENTER button.

- The “Audio Delay” screen appears.

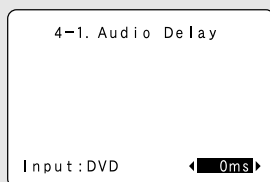

### 3 Press the CURSOR $\triangleleft$ or $\triangleright$ button to set the delay time (0 ms ~ 200 ms).

- With a movie source, for example, adjust so that the movement of the actors' lips is synchronized with the sound.

### 4 Press the ENTER button to enter the setting.

- The “Advanced Playback” menu appears.



- The audio delay setting does not apply when playing in the EXT. IN mode or in the analog input direct mode or stereo mode.

## Setting the Auto Surround Mode

The surround mode used last for the three types of input signals shown below is stored in the memory, and the signal is automatically played with that surround mode the next time it is input.

Note that the surround mode setting is also stored separately for the different input sources.

- ① Analog and PCM 2-channel signals (STEREO)
  - ② 2-channel signals in the Dolby Digital, DTS or another multi-channel format (DOLBY PLIIx Cinema)
  - ③ Multi-channel signals in the Dolby Digital, DTS or another multi-channel format (DOLBY/DTS SURROUND)
- ※ Default settings are indicated in ( ).

### 1 Press the CURSOR $\Delta$ or $\nabla$ button to select “Auto Surround Mode” at the “Advanced Playback” menu, then press the ENTER button.

- The “Auto Surround Mode” screen appears.

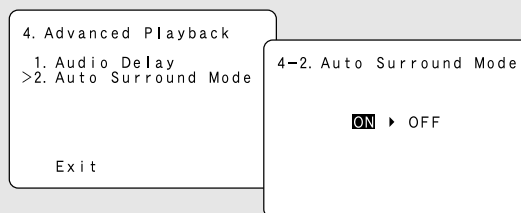

### 2 Press the CURSOR $\triangleleft$ or $\triangleright$ button to select “ON” if you want to use the auto surround mode, or “OFF” if you do not want to use it.

### 3 Press the ENTER button to enter the setting.

- The “Advanced Playback” menu appears.

### 4 Press the CURSOR $\Delta$ or $\nabla$ button to select “Exit”, then press the ENTER button.

- The “System Setup” menu appears.

Option Setup

Setting the Muting Level

This sets the amount of attenuation applied for audio output muting.

**1** Press the **CURSOR**  $\Delta$  or  $\nabla$  button to select “Option Setup” at the “System Setup” menu, then press the **ENTER** button.

- The “Option Setup” screen appears.

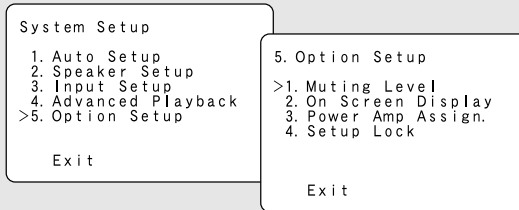

**2** Press the **CURSOR**  $\Delta$  or  $\nabla$  button to select “Muting Level” at the “Option Setup” menu, then press the **ENTER** button.

- The “Muting Level” screen appears.

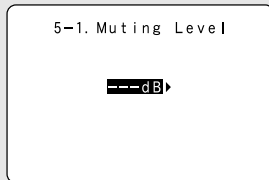

**3** Press the **CURSOR**  $\triangleleft$  or  $\triangleright$  button to select the desired setting.

- 20 dB:**  
Attenuation of the volume by -20 dB from the present level.
- 40 dB:**  
Attenuation of the volume by -40 dB from the present level.
- dB:**  
The volume level is completely muted.

**4** Press the **ENTER** button to enter the setting.

- The “Option Setup” menu appears.

Setting the On-Screen Display (OSD)

- Use this to turn the on-screen display (messages other than the menu screens) “ON” or “OFF”.
- Sets the on-screen display mode.

**1** Press the **CURSOR**  $\Delta$  or  $\nabla$  button to select “On Screen Display” at the “Option Setup” menu, then press the **ENTER** button.

- The “On Screen Display” screen appears.

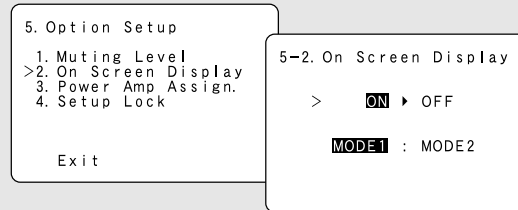

**2** Press the **CURSOR**  $\triangleleft$  or  $\triangleright$  button to select “ON” or “OFF”.

**3** Press the **CURSOR**  $\Delta$  or  $\nabla$  button to select the on-screen display mode, then press the **CURSOR**  $\triangleleft$  or  $\triangleright$  button to select “MODE1” or “MODE2”.

**MODE1:**  
Prevents flickering of the on-screen display when there is no video signal.

**MODE2:**  
Flickering is not prevented.  
Use this mode if the on-screen display does not appear in MODE1, which may happen depending on the TV being used.

**4** Press the **ENTER** button to enter the setting.

- The “Option Setup” menu appears.

Setting the Power Amp Assign.

Make this setting to switch the power amplifier for the surround back channel to ZONE2 or Bi-Amp.

| Power Amp Assign. | SPEAKER OUT  |            | PRE-OUT S.BACK/ZONE |
|-------------------|--------------|------------|---------------------|
|                   | MAIN ZONE    | ZONE2      |                     |
| Surround back     | 7.1ch system | –          | Surround back       |
| ZONE2             | 5.1ch system | 2ch system | ZONE2               |
| Bi-Amp            | 5.1ch system | –          | –                   |

**1** Press the **CURSOR**  $\Delta$  or  $\nabla$  button to select “Power Amp Assign.” at the “Option Setup” menu, then press the **ENTER** button.

- The “Power Amp Assign.” screen appears.

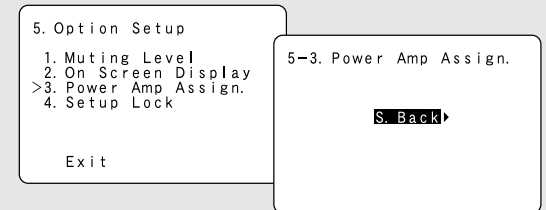

**2** Press the **CURSOR**  $\triangleleft$  or  $\triangleright$  button to select the Amp Assign mode according to the speaker system you want to set up.

**3** Press the **ENTER** button to enter the setting.

- The “Option Setup” menu appears.

Advanced Setup – Part 1

Setting the Setup Lock

The system setup settings can be locked so that they cannot be changed easily.

**1** Press the **CURSOR**  $\Delta$  or  $\nabla$  button to select “Setup Lock” at the “Option Setup” menu, then press the **ENTER** button.

- The “Setup Lock” screen appears.

5. Option Setup  
 1. Muting Level  
 2. On Screen Display  
 3. Power Amp Assign.  
 >4. Setup Lock

5-4. Setup Lock

ON  $\blacktriangleleft$  OFF

Exit

**2** Press the **CURSOR**  $\blacktriangleleft$  button to select “ON”, to lock the system setup settings.

**3** Press the **ENTER** button to finalize the setting and exit the system setup mode.



- When the setup lock function is activated, the settings listed below cannot be changed, and “SETUP LOCKED” is displayed when related buttons are operated.
  - System setup settings
  - Surround parameter settings
  - Tone control settings
  - Channel level settings (including test tones)
- To unlock, press the **SETUP** button again and display the “Setup Lock” screen, then select “OFF” and press the **ENTER** button.
- System setup is complete. Once these settings are made, there is no need to change them unless different AV components are connected or the speakers are repositioned.

Advanced Setup – Part 2

This Speaker Setup section describes the procedures to make speaker settings manually (without using the Auto Setup function), as well as to make manual changes to settings that have already been made by the Auto Setup function.

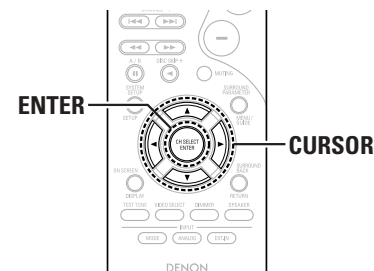

Speaker Setup

Setting the Speaker Config.

The composition of the signals output to each channel and the frequency response are adjusted automatically according to the combination of speakers actually being used.

**1** Press the **CURSOR**  $\Delta$  or  $\nabla$  button to select “Speaker Setup” at the “System Setup” menu, then press the **ENTER** button.

- The “Speaker Setup” screen appears.

System Setup

1. Auto Setup  
 >2. Speaker Setup  
 3. Input Setup  
 4. Advanced Playback  
 5. Option Setup

Exit

2. Speaker Setup

>1. Speaker Config.  
 2. Delay Time  
 3. Channel Level  
 4. Crossover Frequency  
 5. SW Mode Setup

Exit

**2** Press the **CURSOR**  $\Delta$  or  $\nabla$  button to select “Speaker Config.,” then press the **ENTER** button.

- The “Speaker Config.” screen appears.

2-1. Speaker Config.

>Front Sp. **Large**  
 Center Sp. Small  
 Surround Sp. Small  
 S. Back Sp. Small  
 S. Back Sp. 2sp  
 Subwoofer Yes

**3** Press the **CURSOR**  $\Delta$  or  $\nabla$  button to select a speaker, then press the **CURSOR**  $\blacktriangleleft$  or  $\blacktriangleright$  button to select a parameter.

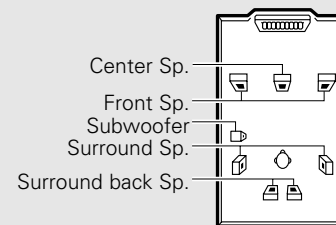

**4** Press the **ENTER** button to enter the setting.

- The “Speaker Setup” menu appears.



- Select “Large” or “Small” not according to the actual size of the speaker but according to the speaker’s capacity for playing low frequency (bass sound below the frequency set for the Crossover Frequency) signals. If you are unsure, try comparing the sound at both settings (setting the volume to a level low enough so as not to damage the speakers) to determine the proper setting.



Advanced Setup – Part 2

■ Parameters

**Large:**

Select this when using speakers that have sufficient ability to reproduce bass sound below the frequency set for the crossover frequency mode.

**Small:**

Select this when using speakers that do not have sufficient ability to reproduce bass sound below the frequency set for the crossover frequency mode. When this is set, bass sound with a frequency below the frequency set for the crossover frequency mode is sent to the subwoofer.

**None:**

Select this when no speakers are installed.

**Yes / No:**

Select "Yes" when a subwoofer is installed, "No" when a subwoofer is not installed.

**2sp / 1sp:**

Set the number of speakers to be used for the surround back channel.

\* If the subwoofer has sufficient low frequency playback capacity, good sound can be achieved even when "Small" is set for the front, center and surround speakers.

**Setting the Delay Time**

Input the distance between the listening position and each speaker to set the delay time for the surround playback.

**Preparations:**

Measure the distances between the listening position and the speakers.

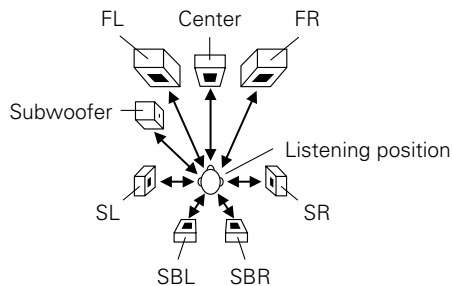

**1** Press the **CURSOR**  $\Delta$  or  $\nabla$  button to select "Delay Time" at the "Speaker Setup" menu, then press the **ENTER** button.

- The "Delay Time" screen appears.

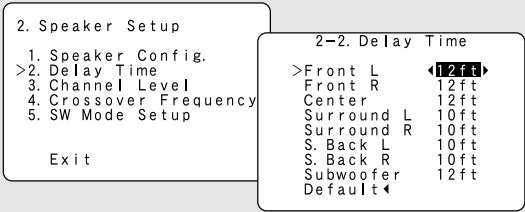

**2** Press the **CURSOR**  $\Delta$  or  $\nabla$  button to select the speaker to be set.

**3** Press the **CURSOR**  $\triangleleft$  or  $\triangleright$  button to set the distance between the speaker and the listening position.

- \* The distance changes in units of 1 foot each time the button is pressed. Select the value closest to the measured distance.
- \* If "Yes" is selected for "Default", the settings are automatically reset to the default values.
- \* **The difference in distance for the various speaker settings must not be greater than 20 ft.**

**4** Press the **ENTER** button to enter the setting.

- The "Speaker Setup" menu appears.

Advanced Setup – Part 2

**Setting the Channel Level**

- Use this setting to balance the playback levels in different channels and make them appear equal.
- From the listening position, listen to the test tones produced from the speakers to adjust the level.
- The levels can also be adjusted directly from the remote control unit (page 47).

**1** Press the **CURSOR**  $\Delta$  or  $\nabla$  button to select "Channel Level" at the "Speaker Setup" menu, then press the **ENTER** button.

- The "Channel Level" screen appears.

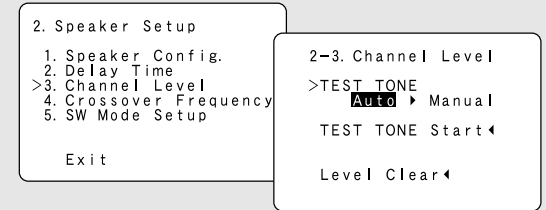

**2** Press the **CURSOR**  $\triangleleft$  or  $\triangleright$  button to select "Auto" or "Manual".

**Auto:**

Adjust the level while listening to the test tones produced automatically from each speaker.

**Manual:**

Select the speaker from which you want to produce the test tone to adjust the level.

**3** Press the **CURSOR**  $\Delta$  or  $\nabla$  button to select "TEST TONE Start", then press the **CURSOR**  $\triangleleft$  button to select "Start".

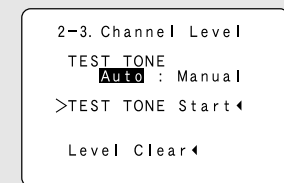

**4** When “Auto” mode is selected:  
**-1** Press the **CURSOR** ◀ or ▶ button to adjust all the speakers to the same volume.

- The test tones are emitted from each speaker in the following order: at 4-second intervals during the first and second cycle, and at the 2-second intervals during the third and subsequent cycles.

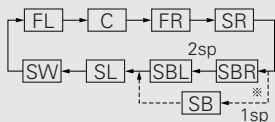

※ When the surround back speaker setting is set to “1sp” for “Speaker Configuration”, this is set to “SB”.

**Example:**

When the volume is set to -12 dB while the test tone is being produced from the Front Lch speaker

|            |        |
|------------|--------|
| Test Tone  | -Auto- |
| >Front L   | -12dB▶ |
| Center     | 0dB    |
| Front R    | 0dB    |
| Surround R | 0dB    |
| S. Back R  | 0dB    |
| S. Back L  | 0dB    |
| Surround L | 0dB    |
| Subwoofer  | 0dB    |

※ The volume can be adjusted between -12 dB and +12 dB in units of 1 dB.

**4** When “Manual” mode is selected:  
**-2** Press the **CURSOR** ▲ or ▼ button to select the speaker, then press the **CURSOR** ◀ or ▶ button to adjust all the speakers to the same volume.

**5** Press the **ENTER** button to enter the setting.  
 • The “Speaker Setup” menu appears.



- To cancel the settings, press the **CURSOR** ▼ button to select “Level Clear” on the “Channel Level” screen, then make the settings again.
- When adjusting the level of an active subwoofer system, you may also need to adjust the subwoofer’s own volume control.
- When you adjust the channel levels while in the system setup channel level mode, the channel level adjustments made will affect all surround modes. Consider this mode a master channel level adjustment mode.
- After you have completed the system setup channel level adjustments, you can then activate the individual surround modes and adjust channel levels that will be remembered for each of those modes. Then, whenever you activate a particular surround sound mode, your preferred channel level adjustments for just that mode will be recalled. Check the instructions for adjusting channel levels within each surround mode (▶ page 28).

■ **Adjusting the test tone**

- Before playing with the surround function, be sure to use the test tones to adjust the playback level from the different speakers. This adjustment can be performed with the system setup (▶ page 46, 47) or from the remote control unit, as described below.
- Adjusting with the remote control unit using the test tones is only possible in the “Auto” mode and only effective in the STANDARD (DOLBY/DTS SURROUND) modes. The adjusted levels for the different modes are automatically stored in the memory.

**1** Press the **STANDARD** button to select the STANDARD (DOLBY/DTS SURROUND) modes.

**2** Press the **TEST TONE** button.  
 • Test tones are output from the different speakers.

**3** Press the **CURSOR** ◀ or ▶ button to adjust so that the volume of the test tones is the same for all the speakers.

**4** After completing the adjustment, press the **TEST TONE** button again.

**Setting the Crossover Frequency**

Set the crossover frequency mode according to the speaker system being used.

**1** Press the **CURSOR** ▲ or ▼ button to select “Crossover Frequency” at the “Speaker Setup” menu, then press the **ENTER** button.  
 • The “Crossover Frequency” screen appears.

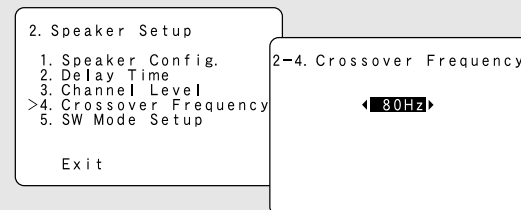

**2** Press the **CURSOR** ◀ or ▶ button to select the frequency.

※ 40 / 60 / 80 / 100 / 120 / 150 / 200 / 250 Hz can be selected.

**3** Press the **ENTER** button to enter the setting.  
 • The “Speaker Setup” menu appears.

## Setting the SW Mode Setup

Set the subwoofer mode according to the speaker system being used.

### 1 Press the CURSOR $\Delta$ or $\nabla$ button to select “SW Mode Setup” at the “Speaker Setup” menu, then press the ENTER button.

- The “Subwoofer Mode Setup” screen appears.

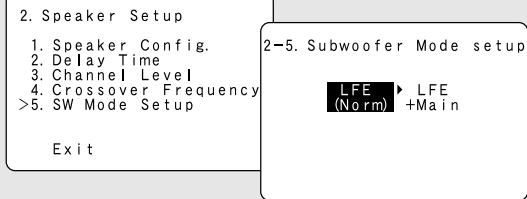

### 2 Press the CURSOR $\triangleleft$ or $\triangleright$ button to select a setting.

### 3 Press the ENTER button to enter the setting.

- The “Speaker Setup” menu appears.

### 4 Press the CURSOR $\Delta$ or $\nabla$ button to select “Exit”, then press the ENTER button.

- The “System Setup” menu appears.



- This screen is not displayed when not using a subwoofer and all speakers are set to small size.

## Assignment of low frequency signal range

The only signals produced from the subwoofer channel are LFE signals (during playback of Dolby Digital or DTS signals) and the low frequency signal range of channels set to “Small” in the setup menu. The low frequency signal range of channels set to “Large” are produced from those channels.

## Crossover Frequency

- When “Subwoofer” is set to “Yes” at the “Speaker Config.” screen, set the frequency (Hz) below which the bass sound of the various speakers is to be output from the subwoofer (the crossover frequency).
- For speakers set to “Small”, sound with a frequency below the crossover frequency is cut, and the cut bass sound is output from the subwoofer instead.
- When “Subwoofer” is set to “No”, the bass sound is output from the speakers set as “Large”.)

### NOTE:

- For ordinary speaker systems, we recommend setting the crossover frequency to 80 Hz. When using small speakers, however, setting the crossover frequency to a higher frequency may improve frequency response for frequencies near the crossover frequency.

## Subwoofer Mode

- The subwoofer mode setting is only valid when “Large” is set for the front speakers and “Yes” is set for the subwoofer in “Setting the Speaker Config.” (page 45).
- When the “LFE+MAIN” playback mode is selected, the low frequency signal range of channels set to “Large” is produced simultaneously from those channels and the subwoofer channel.
  - In this playback mode, the low frequency range expands more uniformly through the room, but depending on the size and shape of the room, interference may result in a decrease of the actual volume of the low frequency range.
- Selection of the “LFE” play mode will play the low frequency signal range of the channel selected with “Large” from that channel only. Therefore, the low frequency signal range that is played from the subwoofer channel is only the low frequency signal range of LFE (only during Dolby Digital or DTS signal playback) and the channels specified as “Small” in the setup menu.
  - Select the play mode that offers the fullest bass.
- When the subwoofer is set to “Yes”, bass sound is output from the subwoofer regardless of the subwoofer mode setting in surround modes other than Dolby/DTS.
- In surround modes other than Dolby Digital and DTS, if the subwoofer is set to “Yes”, the low frequency portion is always output to the subwoofer channel. For details, refer to “Surround modes and parameters” (page 57).

**System setup items and default values (set upon shipment from the factory)**

**1. Auto Setup**

| Auto Setup |            |  | Default setting | Page |
|------------|------------|--|-----------------|------|
| 1          | Auto Setup | <b>Power Amp Assign.</b><br>Set this to switch the surround back channel's power amplifier for ZONE2 or Bi-Amp use . | SURROUND BACK   | 8~11 |

**2. Speaker Setup**

| Speaker Setup |                     |   | Default setting |            |           |                |                     | Page            |                 |           |        |
|---------------|---------------------|---|-----------------|------------|-----------|----------------|---------------------|-----------------|-----------------|-----------|--------|
| 1             | Speaker Config.     | Input the combination of speakers in your system and their corresponding sizes (SMALL for regular speakers, LARGE for full-size, full-range) to automatically set the composition of the signals output from the speakers and the frequency response. | Front Sp.       | Center Sp. | Subwoofer | Surround Sp.   | Surround Back Sp.   | 45              |                 |           |        |
|               |                     |   | Large           | Small      | Yes       | Small          | Small / 2sp         |                 |                 |           |        |
| 2             | Delay Time          | This parameter is for optimizing the timing with which the audio signals are produced from the speakers and subwoofer according to the listening position.  | Front L & R     | Center     | Subwoofer | Surround L & R | Surround Back L & R | 46              |                 |           |        |
|               |                     |   | 12 ft           | 12 ft      | 12 ft     | 10 ft          | 10 ft               |                 |                 |           |        |
| 3             | Channel Level       | This adjusts the volume of the signals output from the speakers and subwoofer for the different channels in order to obtain optimum effects.  | Front L         | Front R    | Center    | Surround L     | Surround R          | Surround Back L | Surround Back R | Subwoofer | 46, 47 |
|               |                     |   | 0 dB            | 0 dB       | 0 dB      | 0 dB           | 0 dB                | 0 dB            | 0 dB            | 0 dB      |        |
| 4             | Crossover Frequency | Sets the frequency (Hz) below which the bass sound of the various speaker is to be output from the subwoofer.   | 80 Hz           |            |           |                |                     | 47              |                 |           |        |
| 5             | SW Mode Setup       | This selects the subwoofer speaker for playing deep bass signals.   | LFE (Normal)    |            |           |                |                     | 48              |                 |           |        |

**3. Input Setup**

| Input Setup |                      |   | Default setting    |  |       |            |           |          |      | Page   |    |    |
|-------------|----------------------|---|--------------------|--|-------|------------|-----------|----------|------|--------|----|----|
| 1           | Digital In Assign.   | This assigns the digital input terminals for the different input sources.                       | Input source       | CD   | AUX   | DVD / VDP  | TV / DBS  |          |      | 40     |    |    |
|             |                      |   | Digital Inputs     | COAX1  | COAX2 | OPT1       | OPT2      |          |      |        |    |    |
| 2           | Ext In SW Level      | Sets the Ext. In Subwoofer terminal playback level.   | Subwoofer = +15 dB |  |       |            |           |          |      | 40     |    |    |
| 3           | Input Function Level | The playback level can be corrected individually for the different input sources.               | CD                 | TUNER  | AUX   | CDR / TAPE | DVD / VDP | TV / DBS | VCR  | V. AUX | 40 |    |
|             |                      |   | 0 dB               | 0 dB   | 0 dB  | 0 dB       | 0 dB      | 0 dB     | 0 dB | 0 dB   |    |    |
| 4           | Function Rename      | The names of the different input source can be changed as desired and displayed on the display. | CD                 | TUNER  | AUX   | CDR        | DVD       | TV       | VCR  | V. AUX | 41 |    |
| 5           | Video Input Mode     | Set the input signal to be output from the monitor output terminal.                             | AUTO               |  |       |            |           |          |      | 42     |    |    |
| 6           | Auto Tuner Preset    | FM stations are received automatically and stored in the memory.                                | A1 ~ A8            | 87.5 / 89.1 / 98.1 / 107.9 / 90.1 / 90.1 / 90.1 / 90.1 MHz |       |            |           |          |      |        |    | 42 |
|             |                      |   | B1 ~ B8            | 520 / 600 / 1000 / 1400 / 1500 / 1710 kHz, 90.1 / 90.1 MHz |       |            |           |          |      |        |    |    |
|             |                      |   | C1 ~ C8            | 90.1 MHz   |       |            |           |          |      |        |    |    |
|             |                      |   | D1 ~ D8            | 90.1 MHz   |       |            |           |          |      |        |    |    |
|             |                      |   | E1 ~ E8            | 90.1 MHz   |       |            |           |          |      |        |    |    |
|             |                      |   | F1 ~ F8            | 90.1 MHz   |       |            |           |          |      |        |    |    |
| G1 ~ G8     | 90.1 MHz             |   |                    |  |       |            |           |          |      |        |    |    |

Advanced Setup – Part 2

Advanced Setup – Part 2

4. Advanced Playback

| Advanced Playback |                           |  | Default setting         | Page |
|-------------------|---------------------------|--|-------------------------|------|
| 1                 | <b>Audio Delay</b>        | Sets the audio delay to delay the sound and synchronize it with the picture. | 0 ms                    | 43   |
| 2                 | <b>Auto Surround Mode</b> | Sets the Auto surround mode function.  | Auto Surround Mode = ON | 43   |

5. Option Setup

| Option Setup |                          |   | Default setting                | Page |
|--------------|--------------------------|---|--------------------------------|------|
| 1            | <b>Muting Level</b>      | This sets the amount of attenuation for audio output muting.  | --- dB (minimum)               | 44   |
| 2            | <b>On Screen Display</b> | This sets whether or not to display the on-screen display that appears on the monitor screen when the controls on the remote control unit or main unit are operated. A setting to prevent flickering. | On Screen Display = ON / MODE1 | 44   |
| 3            | <b>Power Amp Assign.</b> | Set this to switch the surround back channel's power amplifier for ZONE2 or Bi-Amp use.   | Surround Back                  | 44   |
| 4            | <b>Setup Lock</b>        | Sets whether or not to lock the system setup settings so that they cannot be changed.   | Setup Lock = OFF               | 45   |

# Troubleshooting

If a problem should arise, first check the following.







1. Are the connections correct?
2. Have you operated the receiver according to the operating instructions?
3. Are the speakers and other components operating properly?

If this unit is not operating properly, check the items listed in the table below. Should the problem persist, there may be a malfunction. Disconnect the power immediately and contact your store of purchase.

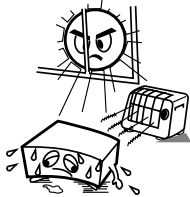
| Symptom   | Cause   | Measures  | Page       |
|---|---|---|------------|
| Display not lit and sound not produced when POWER switch set to on. | • Power supply cord not plugged in securely.  | • Check the insertion of the power supply cord plug.  | 17         |
|   |   | • Turn the power on with the remote control unit after turning the POWER switch on.         | 8          |
| Display lit but sound not produced.                                 | • Speaker cables not securely connected.<br>• Improper setting of the FUNCTION knob.<br>• Volume control set to minimum.<br>• MUTING is on.<br>• Digital signals not input. Digital input selected. | • Connect securely.   | 6          |
|   |   | • Set to a suitable position.   | 18         |
|   |   | • Turn volume up to suitable level.   | 18         |
|   |   | • Switch off MUTING.  | 18         |
|   |   | • Input digital signals or select input terminals to which digital signals are being input. | 19, 20     |
| Display not lit and power indicator is flashing rapidly.            | • Speaker terminals are short-circuited.<br><br>• The ventilation holes of the set are blocked.   | • Switch power off, connect speakers properly, then switch power back on.                   | 5, 6       |
|   |   | • Turn off the set's power, then ventilate it well and allow it to cool down.               | 2, 5       |
|   |   | Once the set has cooled down, turn the power back on.                                       | 2, 5       |
|   | • The unit is operating at continuous high power conditions and/or with inadequate ventilation.   | • Turn off the set's power, then ventilate it well and allow it to cool down.               | 2, 5       |
|   |   | Once the set has cooled down, turn the power back on.                                       | 2, 5       |
|   |   |   |            |
| Sound produced only from one channel.                               | • Incomplete connection of speaker cables.<br>• Incomplete connection of input/output cables.   | • Connect securely.   | 5, 6       |
|   |   | • Connect securely.   | 5~7, 11~17 |
| Positions of instruments reversed during stereo playback.           | • Reverse connections of left and right speakers or left and right input/output cables.   | • Check left and right connections.   | 6          |
| Howling noise produced when volume is high.                         | • Speaker systems too close together.<br>• Floor is unstable and vibrates easily.   | • Separate as much as possible.   | —          |
|   |   | • Use cushions to absorb speaker vibrations transmitted by floor.                           | —          |

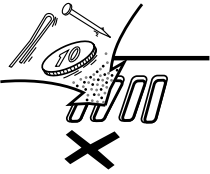
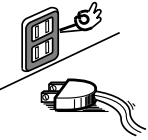
| Symptom   | Cause   | Measures                        | Page |
|---|---|---------------------------------|------|
| Sound is distorted.   | • Stylus pressure too weak.<br>• Dust or dirt on stylus.  | • Apply proper stylus pressure. | —    |
|   |   | • Check stylus.                 | —    |
| This unit does not operate properly when remote control unit is used. | • Batteries dead.<br>• Remote control unit too far from this unit.<br>• Obstacle between this unit and remote control unit.<br>• Different button is being pressed.<br>• ⊕ and ⊖ ends of batteries inserted in reverse. | • Replace with new batteries.   | 3    |
|   |   | • Move closer.                  | 3    |
|   |   | • Remove obstacle.              | 3    |
|   |   | • Press the proper button.      | —    |
|   |   | • Insert batteries properly.    | 3    |

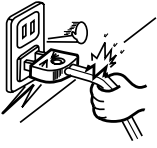
## NOTE ON USE

|  |   |  |
|--|---|--|
| <br>Avoid high temperatures. Allow for sufficient heat dispersion when installed in a rack. | <br>Keep the apparatus free from moisture, water, and dust.                                | <br>Do not let foreign objects into the apparatus.                                    |
|  | <br>Unplug the power cord when not using the apparatus for long periods of time.           | <br>Do not let insecticides, benzene, and thinner come in contact with the apparatus. |
| <br>Handle the power cord carefully. Hold the plug when unplugging the cord.               | <br>* (For apparatuses with ventilation holes)<br>Do not obstruct the ventilation holes. | <br>Never disassemble or modify the apparatus in any way.                           |

# Additional Information

## Optimum surround sound for different sources

There are currently various types of multi-channel signals (signals or formats with more than two channels).

### Types of multi-channel signals

Dolby Digital, Dolby Pro Logic, DTS, high definition 3-1 signals (Japan MUSE Hi-Vision audio), DVD-Audio, Super Audio CD, MPEG multi-channel audio, etc.

“Source” here does not refer to the type of signal (format) but the recorded content. Sources can be divided into two major categories.

### Types of sources

#### Movie audio:

Signals created to be played in movie theaters. In general sound is recorded to be played in movie theaters equipped with multiple surround speakers, regardless of the format (Dolby Digital, DTS, etc.).

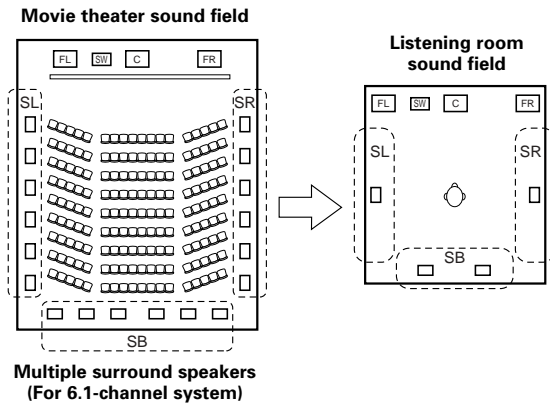

In this case it is important to achieve the same sense of expansion as in a movie theater with the surround channels. To do so, in some cases the number of surround speakers is increased (to four or eight) or speakers with bipolar or dipolar properties are used.

- SL : Surround L channel
- SR : Surround R channel
- SB : Surround back channel (1 speaker or 2 speakers)

#### Other types of audio:

These signals are designed to recreate a 360° sound field using three to five speakers.

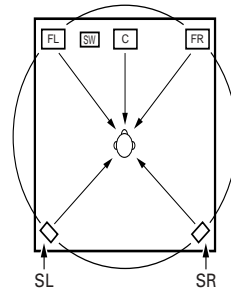

In this case the speakers should surround the listener from all sides to create a uniform sound field from 360°. Ideally the surround speakers should function as “point” sound sources in the same way as the front speakers.

These two types of sources thus have different properties, and different speaker settings, particularly for the surround speakers, are required in order to achieve the ideal sound.

## Surround back speakers

A 6.1-channel system is a conventional 5.1-channel system to which the “surround back” (SB) channel has been added. This makes it easy to achieve sound positioned directly behind the listener, something that was previously difficult with sources designed for conventional multi surround speakers. In addition, the acoustic image extending between the sides and the rear is narrowed, thus greatly improving the expression of the surround signals for sounds moving from the sides to the back and from the front to the point directly behind the listening position.

### Change of positioning and acoustic image with 5.1-channel systems

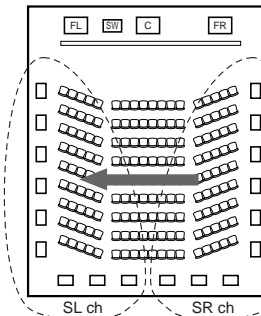

### Movement of acoustic image from SR to SL

### Change of positioning and acoustic image with 6.1-channel systems

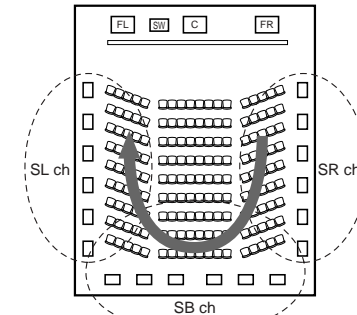

### Movement of acoustic image from SR to SB to SL

**Additional Information**

With this set, speaker(s) for 1 or 2 channels are required to achieve a 6.1-channel system (DTS-ES, etc.). Adding these speakers, however, increases the surround effect not only with sources recorded in 6.1 channels but also with conventional 2- to 5.1-channel sources. Furthermore, all the DENON original surround modes (see page 26) are compatible with 7.1-channel playback, so you can enjoy 7.1-channel sound with any signal source.

**Number of surround back speakers**

Though the surround back channel only consists of 1 channel of playback signals for 6.1-channel sources (DTS-ES, etc.), we recommend using two speakers. When using speakers with dipolar characteristics in particular, it is essential to use two speakers.

Using two speakers results in a smoother blend with the sound of the surround channels and better sound positioning of the surround back channel when listening from a position other than the center.

**Placement of the surround left and right channels when using surround back speakers**

Using surround back speakers greatly improves the positioning of the sound at the rear. Because of this, the surround left and right channels play an important role in achieving a smooth transition of the acoustic image from the front to the back. As shown in the diagram above, in a movie theater the surround signals are also produced from diagonally in front of the listeners, creating an acoustic image as if the sound were floating in space. To achieve these effects, we recommend placing the speakers for the surround left and right channels slightly more towards the front than with conventional surround systems. Doing so sometimes increases the surround effect when playing conventional 5.1-channel sources in the 6.1 surround or DTS-ES Matrix 6.1 mode. Check the surround effects of the various modes before selecting the surround mode.

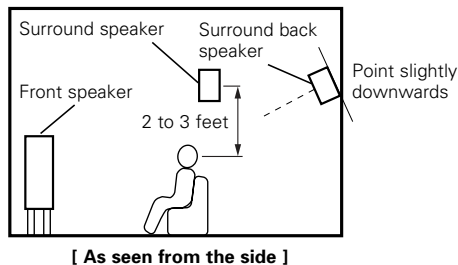
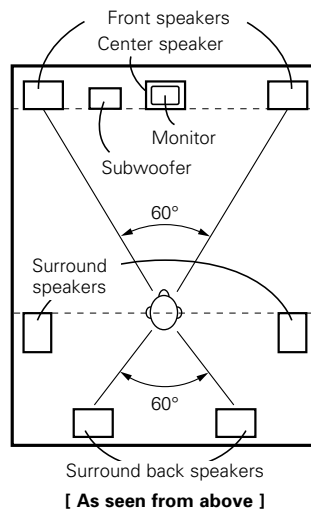

- Set the front speakers with their front surfaces as flush with the TV or monitor screen as possible. Set the center speaker between the front left and right speakers and no further from the listening position than the front speakers.
- Consult the owner's manual for your subwoofer for advice on placing the subwoofer within the listening room.
- If the surround speakers are direct-radiating (monopolar), then place them slightly behind and at an angle to the listening position and parallel to the walls at a position 2 to 3 feet above ear level at the prime listening position.
- When using two surround back speakers, place them at the back facing the front at a narrower distance than the front left and right speakers. When using one surround back speaker, place it at the rear center facing the front at a slightly higher position 0 to 0.7 feet than the surround speakers.
- We recommend installing the surround back speaker(s) at a slightly downward facing angle. This effectively prevents the surround back channel signals from reflecting off the monitor or screen at the front center, resulting in interference and making the sense of movement from the front to the back less sharp.

**Additional Information**

**② Setting for primarily watching movies using diffusion type speakers for the surround speakers**

For the greatest sense of surround sound envelopment, diffuse radiation speakers such as bipolar types, or dipolar types, provide a wider dispersion than is possible to obtain from a direct radiating speaker (monopolar). Place these speakers at either side of the prime listening position, mounted above ear level.

**Path of the surround sound from the speakers to the listening position**

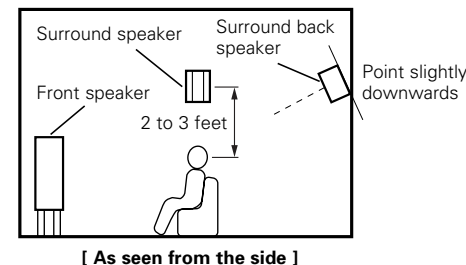
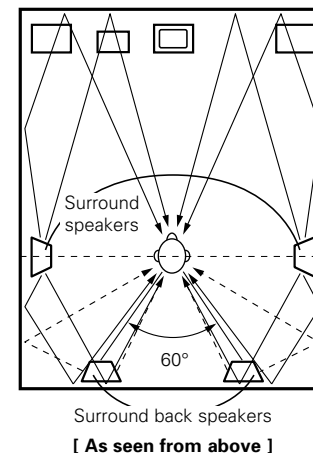

- Set the front speakers, center speaker and subwoofer in the same positions as in example (1).
- It is best to place the surround speakers directly at the side or slightly to the front of the viewing position, and 2 to 3 feet above the ears.
- Same as surround back speaker installation method (1). Using dipolar speakers for the surround back speakers as well is more effective.
- The signals from the surround channels reflect off the walls as shown in the diagram above, creating an enveloping and realistic surround sound presentation.

**Speaker setting examples**

Here we describe a number of speaker settings for different purposes. Use these examples as guides to set up your system according to the type of speakers used and the main usage purpose.

**[1] DTS-ES compatible system (using surround back speakers)**

**① Basic setting for primarily watching movies**

This is recommended when mainly playing movies and using regular single way or 2-way speakers for the surround speakers.



Additional Information

[2] When not using surround back speakers

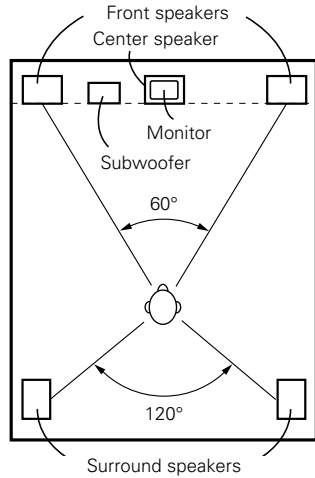

[ As seen from above ]

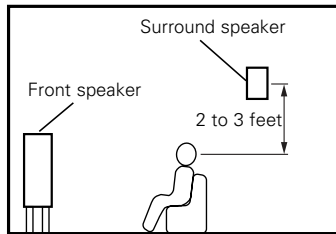

[ As seen from the side ]

- Set the front speakers with their front surfaces as flush with the TV or monitor screen as possible. Set the center speaker between the front left and right speakers and no further from the listening position than the front speakers.
- Consult the owner's manual for your subwoofer for advice on placing the subwoofer within the listening room.
- If the surround speakers are direct-radiating (monopolar), then place them slightly behind and at an angle to the listening position and parallel to the walls at a position 2 to 3 feet above ear level at the prime listening position.

Surround

The AVR-1906 is equipped with a digital signal processing circuit that lets you play program sources in the surround mode to achieve the same sense of presence as in a movie theater.

[1] Dolby Surround

① Dolby Digital

Dolby Digital is the multi-channel digital signal format developed by Dolby Laboratories. Dolby Digital consists of up to "5.1" channels – front left, front right, center, surround left, surround right, and an additional channel exclusively reserved for additional deep bass sound effects (the Low Frequency Effects –LFE– channel, also called the ".1" channel, containing bass frequencies of up to 120 Hz). Unlike the analog Dolby Pro Logic format, Dolby Digital's main channels can all contain full range sound information, from the lowest bass, up to the highest frequencies – 22 kHz. The signals within each channel are distinct from the others, allowing pinpoint sound imaging, and Dolby Digital offers tremendous dynamic range from the most powerful sound effects to the quietest, softest sounds, free from noise and distortion.

■ Dolby Digital and Dolby Pro Logic

| Comparison of home surround systems               | Dolby Digital   | Dolby Pro Logic                         |
|---|---|---|
| No. of recorded channels (elements)               | 5.1 ch  | 2 ch                                    |
| No. of playback channels                          | 5.1 ch  | 4 ch                                    |
| Playback channels (max.)                          | L, R, C, SL, SR, SW   | L, R, C, S (SW – recommended)           |
| Audio processing                                  | Digital discrete processing Dolby Digital encoding / decoding | Analog matrix processing Dolby Surround |
| High frequency playback limit of surround channel | 20 kHz  | 7 kHz                                   |

Additional Information

■ Dolby Digital compatible media and playback methods

Symbol indicating Dolby Digital compatibility: DIGITAL

The following are general examples. Also refer to the player's operating instructions.

| Media                                     | Dolby Digital output terminals                          | Playback method (reference page)              |
|---|---|---|
| LD (VDP)                                  | Coaxial Dolby Digital RF output terminal ※ 1            | Set the input mode to "AUTO" (👉 page 19, 20). |
| DVD                                       | Optical or coaxial digital output (same as for PCM) ※ 2 | Set the input mode to "AUTO" (👉 page 19, 20). |
| Others (satellite broadcasts, CATV, etc.) | Optical or coaxial digital output (same as for PCM)     | Set the input mode to "AUTO" (👉 page 19, 20). |

- ※ 1: Please use a commercially available adapter when connecting the Dolby Digital RF output terminal of the LD player to the digital input terminal. Please refer to the instruction manual of the adapter when making connection.
- ※ 2: Some DVD digital outputs have the function of switching the Dolby Digital signal output method between "bit stream" and "(convert to) PCM". When playing in Dolby Digital surround on the AVR-1906, switch the DVD player's output mode to "bit stream". In some cases players are equipped with both "bit stream + PCM" and "PCM only" digital outputs. In this case connect the "bit stream + PCM" terminals to the AVR-1906.

② Dolby Pro Logic II

- Dolby Pro Logic II is a new multi-channel playback format developed by Dolby Laboratories using feedback logic steering technology and offering improvements over conventional Dolby Pro Logic circuits.
- Dolby Pro Logic II can be used to decode not only sources recorded in Dolby Surround (※) but also regular stereo sources into five channels (front left, front right, center, surround left and surround right) to achieve surround sound.

**Additional Information**

- Whereas with conventional Dolby Pro Logic the surround channel playback frequency band was limited, Dolby Pro Logic II offers a wider band range (20 Hz to 20 kHz or greater). In addition, the surround channels were monaural (the surround left and right channels were the same) with previous Dolby Pro Logic, but with Dolby Pro Logic II they are played as stereo signals.
- Various parameters can be set according to the type of source and the contents, so it is possible to achieve optimum decoding (ⓘ page 57).

**③ Dolby Pro Logic IIx**

Dolby Pro Logic IIx furthers the matrix decoding technology of Dolby Pro Logic II to decode audio signals recorded on two channels into up to 7.1 playback channels, including the surround back channel. Dolby Pro Logic IIx also allows 5.1-channel sources to be played in up to 7.1 channels. The mode can be selected according to the source. The Music mode is best suited for playing music, the Cinema mode for playing movies, and the Game mode for playing games. The Game mode can only be used with 2-channel audio sources.

**※ Sources recorded in Dolby Surround**

- These are sources in which three or more channels of surround have been recorded as two channels of signals using Dolby Surround encoding technology.
- Dolby Surround is used for the sound tracks of movies recorded on DVDs, LDs and video cassette tapes, as well as for stereo broadcast signals from FM radio, TV, satellite broadcasts and cable TV.
- Decoding these signals with Dolby Pro Logic II makes it possible to achieve multi-channel surround playback. The signals can also be played on ordinary stereo equipment, in which case they provide normal stereo sound.
- There are two types of DVD Dolby surround recording signals.
  - ① 2-channel PCM stereo signals
  - ② 2-channel Dolby Digital signals
- When either of these signals is input to the AVR-1906, the surround mode is automatically set to Dolby Pro Logic II when the DOLBY/DTS SURROUND mode is selected.

**■ Sources recorded in Dolby Surround are indicated with the logo symbol shown below**

Dolby Surround logo symbol: 

Manufactured under license from Dolby Laboratories. "Dolby", "Pro Logic" and the double-D symbol are trademarks of Dolby Laboratories.

**[2] DTS Digital Surround**

Digital Theater Surround (also called simply DTS) is a multi-channel digital signal format developed by Digital Theater Systems.

DTS offers the same "5.1" playback channels as Dolby Digital (front left, front right, center, surround left and surround right) as well as the stereo 2-channel mode. The signals for the different channels are fully independent, eliminating the risk of deterioration of sound quality due to interference between signals, crosstalk, etc.

DTS features a relatively higher bit rate as compared to Dolby Digital (1234 kbps for CDs and LDs, 1536 kbps for DVDs) so it operates with a relatively low compression rate. Because of this the amount of data is great, and when DTS playback is used in movie theaters, a separate CD-ROM synchronized with the film is played.

With LDs and DVDs, there is of course no need for an extra disc; the pictures and sound can be recorded simultaneously on the same disc, so the discs can be handled in the same way as discs with other formats.

There are also music CDs recorded in DTS. These CDs include 5.1-channel surround signals (compared to two channels on current CDs). They do not include picture data, but they offer surround playback on CD players that are equipped with digital outputs (PCM type digital output required).

DTS surround track playback offers the same intricate, grand sound as in a movie theater, right in your own listening room.

**■ DTS compatible media and playback methods**

Symbols indicating DTS compatibility:  and 

The following are general examples. Also refer to the player's operating instructions.

MANUFACTURED UNDER LICENSE FROM DIGITAL THEATER SYSTEMS, INC.  
 U.S. PAT. NO'S. 5,451,942; 5,956,674; 5,974,380; 5,978,762; 6,226,616; 6,487,535 AND OTHER U.S. AND WORLDWIDE PATENTS ISSUED AND PENDING.  
 "DTS", "DTS-ES", "Neo:6", AND "DTS 96/24" ARE TRADEMARKS OF DIGITAL THEATER SYSTEMS, INC. © 1996, 2003 DIGITAL THEATER SYSTEMS, INC. ALL RIGHTS RESERVED.

**Additional Information**

| Media    | Dolby Digital output terminals                          | Playback method (reference page)  |
|----------|---|---|
| CD       | Optical or coaxial digital output (same as for PCM) ※ 2 | Set the input mode to "AUTO" or "DTS" (ⓘ page 19, 20). Never set the mode to "ANALOG" or "PCM". ※ 1 |
| LD (VDP) | Optical or coaxial digital output (same as for PCM) ※ 2 | Set the input mode to "AUTO" or "DTS" (ⓘ page 19, 20). Never set the mode to "ANALOG" or "PCM". ※ 1 |
| DVD      | Optical or coaxial digital output (same as for PCM) ※ 3 | Set the input mode to "AUTO" or "DTS" (ⓘ page 19, 20).  |

- ※ 1: DTS signals are recorded in the same way on CDs and LDs as PCM signals. Because of this, the un-decoded DTS signals are output as random "hissing" noise from the CD or LD player's analog outputs. If this noise is played with the amplifier set at a very high volume, it may possibly cause damage to the speakers. To avoid this, be sure to switch the input mode to "AUTO" or "DTS" before playing CDs or LDs recorded in DTS. Also, never switch the input mode to "ANALOG" or "PCM" during playback. The same holds true when playing CDs or LDs on a DVD player or LD/DVD compatible player. For DVDs, the DTS signals are recorded in a special way so this problem does not occur.
- ※ 2: The signals provided at the digital outputs of a CD or LD player may undergo some sort of internal signal processing (output level adjustment, sampling frequency conversion, etc.). In this case the DTS-encoded signals may be processed erroneously, in which case they cannot be decoded by the AVR-1906, or may only produce noise. Before playing DTS signals for the first time, turn down the master volume to a low level, start playing the DTS disc, then check whether the DTS indicator on the AVR-1906 (ⓘ page 23) lights before turning up the master volume.
- ※ 3: A DVD player with DTS-compatible digital output is required to play DTS DVDs. A DTS Digital Output logo is featured on the front panel of compatible DVD players. Recent DENON DVD player models feature DTS-compatible digital output – consult the player's owner's manual for information on configuring the digital output for DTS playback of DTS-encoded DVDs.

**Additional Information****[3] DTS-ES Extended Surround™**

DTS-ES Extended Surround is a new multi-channel digital signal format developed by Digital Theater Systems Inc. While offering high compatibility with the conventional DTS Digital Surround format, DTS-ES Extended Surround greatly improves the 360-degree surround impression and space expression thanks to further expanded surround signals. This format has been used professionally in movie theaters since 1999.

In addition to the 5.1 surround channels (FL, FR, C, SL, SR and LFE), DTS-ES Extended Surround also offers the SB (Surround Back, sometimes also referred to as "surround center") channel for surround playback with a total of 6.1 channels. DTS-ES Extended Surround includes two signal formats with different surround signal recording methods, as described below.

**■ DTS-ES™ Discrete 6.1**

DTS-ES Discrete 6.1 is the newest recording format. With it, all 6.1 channels (including the SB channel) are recorded independently using a digital discrete system. The main feature of this format is that because the SL, SR and SB channels are fully independent, the sound can be designed with total freedom and it is possible to achieve a sense that the acoustic images are moving about freely among the background sounds surrounding the listener from 360 degrees.

Though maximum performance is achieved when sound tracks recorded with this system are played using a DTS-ES decoder, when played with a conventional DTS decoder the SB channel signals are automatically down-mixed to the SL and SR channels, so none of the signal components are lost.

**■ DTS-ES™ Matrix 6.1**

With this format, the additional SB channel signals undergo matrix encoding and are input to the SL and SR channels beforehand. Upon playback they are decoded to the SL, SR and SB channels. The performance of the encoder used at the time of recording can be fully matched using a high precision digital matrix decoder developed by DTS, thereby achieving surround sound more faithful to the producer's sound design aims than with conventional 5.1- or 6.1-channel systems.

In addition, the bit stream format is 100% compatible with conventional DTS signals, so the effect of the Matrix 6.1 format can be achieved even with 5.1-channel signal sources. Of course it is also possible to play DTS-ES Matrix 6.1 encoded sources with a DTS 5.1-channel decoder.

When DTS-ES Discrete 6.1 or Matrix 6.1 encoded sources are decoded with a DTS-ES decoder, the format is automatically detected upon decoding and the optimum playing mode is selected. However, some Matrix 6.1 sources may be detected as having a 5.1-channel format, so the DTS-ES Matrix 6.1 mode must be set manually to play these sources. (For instructions on selecting the surround mode (▶ page 23).)

The DTS-ES decoder includes another function, the DTS Neo:6 surround mode for 6.1-channel playback of digital PCM and analog signal sources.

**■ DTS Neo:6™ surround**

This mode applies conventional 2-channel signals to the high precision digital matrix decoder used for DTS-ES Matrix 6.1 to achieve 6.1-channel surround playback. High precision input signal detection and matrix processing enable full band reproduction (frequency response of 20 Hz to 20 kHz or greater) for all 6.1 channels, and separation between the different channels is improved to the same level as that of a digital discrete system.

DTS Neo:6 surround includes two modes for selecting the optimum decoding for the signal source.

**• DTS Neo:6 Cinema**

This mode is optimum for playing movies. Decoding is performed with emphasis on separation performance to achieve the same atmosphere with 2-channel sources as with 6.1-channel sources.

This mode is effective for playing sources recorded in conventional surround formats as well, because the in-phase component is assigned mainly to the center channel (C) and the reversed phase component to the surround (SL, SR and SB) channels.

**• DTS Neo:6 Music**

This mode is suited mainly for playing music. Changes in the sound quality are reduced by decoding with emphasis on the front channel signals (FL and FR), and a natural sense of expansion is given to the sound field by the effect of the surround signals output from the center (C) and surround (SL, SR and SB) channels.

**Additional Information****[4] DTS 96/24**

The sampling frequency, number of bits and number of channels used for recording of music, etc., in studios have been increasing in recent years, and there are a growing number of high quality signal sources, including 96 kHz/24-bit 5.1-channel sources.

For example, there are high picture/sound quality DVD video sources with 96 kHz/24-bit stereo PCM audio tracks.

However, because the data rate for these audio tracks is extremely high, there are limits to recording them on two channels only, and since the quality of the pictures must be restricted it is common to only include still pictures.

In addition, 96 kHz/24-bit 5.1-channel surround is possible with DVD audio sources, but DVD audio players are required to play them with this high quality.

DTS 96/24 is a multi-channel digital signal format developed by Digital Theater Systems Inc. in order to deal with this situation.

Conventional surround formats used sampling frequencies of 48 or 44.1 kHz, so 20 kHz was about the maximum playback signal frequency. With DTS 96/24, the sampling frequency is increased to 96 or 88.2 kHz to achieve a wide frequency range of over 40 kHz.

In addition, DTS 96/24 has a resolution of 24-bits, resulting in the same frequency band and dynamic range as 96 kHz/24-bit PCM. As with conventional DTS Surround, DTS 96/24 is compatible with a maximum of 5.1 channels, so sources recorded using DTS 96/24 can be played in high sampling frequency, multiple channel audio with such normal media as DVD videos and CDs.

Thus, with DTS 96/24, the same 96 kHz/24-bit multi-channel surround sound as with DVD-Audio can be achieved while viewing DVD-Video images on a conventional DVD-Video player (\*1). Furthermore, with DTS 96/24 compatible CDs, 88.2 kHz/24-bit multi-channel surround can be achieved using normal CD/LD players (\*1).

Even with the high quality multi-channel signals, the recording time is the same as with conventional DTS surround sources.

What's more, DTS 96/24 is fully compatible with the conventional DTS surround format, so DTS 96/24 signal sources can be played with a sampling frequency of 48 kHz or 44.1 kHz on conventional DTS or DTS-ES surround decoders (\*2).

\*1 A DVD player with DTS digital output capabilities (for CD/LD players, a player with digital outputs for conventional DTS CDs/LDs) and a disc recorded in DTS 96/24 are required.

\*2 The resolution is 24 or 20 bits, depending on the decoder.

**Surround modes and parameters**

| Mode                | Signals and adjustability in the different modes |        |              |                   |           |                                    |                          |                          |                             |  |          |
|---------------------|--|--------|--------------|-------------------|-----------|------------------------------------|--------------------------|--------------------------|-----------------------------|--|----------|
|                     | Channel output                                   |        |              |                   |           | When playing Dolby Digital signals | When playing DTS signals | When playing PCM signals | When playing ANALOG signals | When playing Dolby Digital and DTS signals |          |
|                     | FRONT L/R  | CENTER | SURROUND L/R | SURROUND BACK L/R | SUBWOOFER |                                    |                          |                          |                             | D. COMP.                                   | LFE      |
| DIRECT              | ○  | ×      | ×            | ×                 | ⊙         | ○                                  | ○                        | ○                        | ○                           | ○ (OFF)                                    | ○ (0 dB) |
| STEREO              | ○  | ×      | ×            | ×                 | ⊙         | ○                                  | ○                        | ○                        | ○                           | ○ (OFF)                                    | ○ (0 dB) |
| EXTERNAL INPUT      | ○  | ⊙      | ⊙            | ×                 | ⊙         | ×                                  | ×                        | ×                        | ○                           | ×  | ×        |
| DOLBY PRO LOGIC II  | ○  | ⊙      | ⊙            | ⊙                 | ⊙         | ○*                                 | ○*                       | ○                        | ○                           | ○ (OFF)                                    | ○ (0 dB) |
| DOLBY PRO LOGIC IIx | ○  | ⊙      | ⊙            | ⊙                 | ⊙         | ○*                                 | ○*                       | ○                        | ○                           | ○ (OFF)                                    | ○ (0 dB) |
| DTS NEO:6           | ○  | ⊙      | ⊙            | ⊙                 | ⊙         | ○*                                 | ○*                       | ○                        | ○                           | ○ (OFF)                                    | ○ (0 dB) |
| DOLBY DIGITAL       | ○  | ⊙      | ⊙            | ⊙                 | ⊙         | ○                                  | ×                        | ×                        | ×                           | ○ (OFF)                                    | ○ (0 dB) |
| DTS SURROUND        | ○  | ⊙      | ⊙            | ⊙                 | ⊙         | ×                                  | ○                        | ×                        | ×                           | ○ (OFF)                                    | ○ (0 dB) |
| 5CH/7CH STEREO      | ○  | ⊙      | ⊙            | ⊙                 | ⊙         | ○                                  | ○                        | ○                        | ○                           | ○ (OFF)                                    | ○ (0 dB) |
| ROCK ARENA          | ○  | ⊙      | ⊙            | ⊙                 | ⊙         | ○                                  | ○                        | ○                        | ○                           | ○ (OFF)                                    | ○ (0 dB) |
| JAZZ CLUB           | ○  | ⊙      | ⊙            | ⊙                 | ⊙         | ○                                  | ○                        | ○                        | ○                           | ○ (OFF)                                    | ○ (0 dB) |
| VIDEO GAME          | ○  | ⊙      | ⊙            | ⊙                 | ⊙         | ○                                  | ○                        | ○                        | ○                           | ○ (OFF)                                    | ○ (0 dB) |
| MONO MOVIE          | ○  | ⊙      | ⊙            | ⊙                 | ⊙         | ○                                  | ○                        | ○                        | ○                           | ○ (OFF)                                    | ○ (0 dB) |
| MATRIX              | ○  | ⊙      | ⊙            | ⊙                 | ⊙         | ○                                  | ○                        | ○                        | ○                           | ○ (OFF)                                    | ○ (0 dB) |
| VIRTUAL             | ○  | ×      | ×            | ×                 | ⊙         | ○                                  | ○                        | ○                        | ○                           | ○ (OFF)                                    | ○ (0 dB) |

○ : Signal / Adjustable

×

⊙ : Turned on or off by speaker configuration setting

○ : Able

×

\* : Only for 2 ch contents

○ : Able

×

| Mode                | Signals and adjustability in the different modes |              |            |      |                    |              |             |                  |                         |           |              |              |         |
|---------------------|--|--------------|------------|------|--------------------|--------------|-------------|------------------|-------------------------|-----------|--------------|--------------|---------|
|                     | SB CH OUT (MODE)                                 | TONE CONTROL | CINEMA EQ. | MODE | Surround parameter |              |             |                  |                         |           |              |              |         |
|                     |  |              |            |      | ROOM SIZE          | EFFECT LEVEL | DELAY TIME  | SUBWOOFER ON/OFF | PRO LOGIC II / IIx only |           |              | NEO:6 MUSIC  | EXT. IN |
|                     |  |              |            |      |                    |              |             |                  | PANORAMA                | DIMENSION | CENTER WIDTH | CENTER IMAGE | SW ATT  |
| DIRECT              | ×  | ×            | ×          | ×    | ×                  | ×            | ×           | ○ (OFF)          | ×                       | ×         | ×            | ×            | ×       |
| STEREO              | ×  | ○ (0 dB)     | ×          | ×    | ×                  | ×            | ×           | ×                | ×                       | ×         | ×            | ×            | ×       |
| EXTERNAL INPUT      | ×  | ×            | ×          | ×    | ×                  | ×            | ×           | ×                | ×                       | ×         | ×            | ×            | ○       |
| DOLBY PRO LOGIC II  | ○  | ○ (0 dB)     | ○ (OFF)    | ○    | ×                  | ×            | ×           | ×                | ○ (OFF)                 | ○ (3)     | ○ (3)        | ×            | ×       |
| DOLBY PRO LOGIC IIx | ○  | ○ (0 dB)     | ○ (OFF)    | ○    | ×                  | ×            | ×           | ×                | ○ (OFF)                 | ○ (3)     | ○ (3)        | ×            | ×       |
| DTS NEO:6           | ○  | ○ (0 dB)     | ○ (OFF)    | ○    | ×                  | ×            | ×           | ×                | ×                       | ×         | ×            | ○ (0.3)      | ×       |
| DOLBY DIGITAL       | ○  | ○ (0 dB)     | ○ (OFF)    | ×    | ×                  | ×            | ×           | ×                | ×                       | ×         | ×            | ×            | ×       |
| DTS SURROUND        | ○  | ○ (0 dB)     | ○ (OFF)    | ×    | ×                  | ×            | ×           | ×                | ×                       | ×         | ×            | ×            | ×       |
| 5CH/7CH STEREO      | ○  | ○ (0 dB)     | ×          | ×    | ×                  | ×            | ×           | ×                | ×                       | ×         | ×            | ×            | ×       |
| ROCK ARENA          | ○  | ○ (0 dB)     | ×          | ×    | ○ (Medium)         | ○ (10)       | ×           | ×                | ×                       | ×         | ×            | ×            | ×       |
| JAZZ CLUB           | ○  | ○ (0 dB)     | ×          | ×    | ○ (Medium)         | ○ (10)       | ×           | ×                | ×                       | ×         | ×            | ×            | ×       |
| VIDEO GAME          | ○  | ○ (0 dB)     | ×          | ×    | ○ (Medium)         | ○ (10)       | ×           | ×                | ×                       | ×         | ×            | ×            | ×       |
| MONO MOVIE          | ○  | ○ (0 dB)     | ×          | ×    | ○ (Medium)         | ○ (10)       | ×           | ×                | ×                       | ×         | ×            | ×            | ×       |
| MATRIX              | ○  | ○ (0 dB)     | ×          | ×    | ×                  | ×            | ○ (30 msec) | ×                | ×                       | ×         | ×            | ×            | ×       |
| VIRTUAL             | ×  | ×            | ×          | ×    | ×                  | ×            | ×           | ×                | ×                       | ×         | ×            | ×            | ×       |

○ : Adjustable

×

# Specifications

## ■ Audio section

### • Power amplifier

#### Rated output:

|                |  |
|----------------|--|
| Front:         | 85 W +85 W<br>(8 Ω/ohms, 20 Hz ~ 20 kHz with 0.08% T.H.D.)<br>120 W + 120 W<br>(6 Ω/ohms, 1 kHz with 0.7% T.H.D.)  |
| Center:        | 85 W<br>(8 Ω/ohms, 20 Hz ~ 20 kHz with 0.08% T.H.D.)<br>120 W<br>(6 Ω/ohms, 1 kHz with 0.7% T.H.D.)                |
| Surround:      | 85 W + 85 W<br>(8 Ω/ohms, 20 Hz ~ 20 kHz with 0.08% T.H.D.)<br>120 W + 120 W<br>(6 Ω/ohms, 1 kHz with 0.7% T.H.D.) |
| Surround Back: | 85 W + 85 W<br>(8 Ω/ohms, 20 Hz ~ 20 kHz with 0.08% T.H.D.)<br>120 W + 120 W<br>(6 Ω/ohms, 1 kHz with 0.7% T.H.D.) |

#### Output terminals:

|                              |  |
|------------------------------|--|
| Front:                       | A or B      6 ~ 16 Ω/ohms<br>A + B      12 ~ 16 Ω/ohms |
| Center, Surround, Surr.Back: | 6 ~ 16 Ω/ohms  |

### • Analog

#### Input sensitivity /

#### input impedance:

200 mV / 47 kΩ/kohms

#### Frequency response:

10 Hz ~ 100 kHz: +1, -3 dB (DIRECT mode)

#### S/N:

98 dB (IHF-A weighted) (DIRECT mode)

#### Distortion:

0.008% (20 Hz ~ 20 kHz) (DIRECT mode)

#### Rated output:

1.2 V

## ■ Video section

### • Standard video terminals

#### Input / output level

#### and impedance:

1 Vp-p, 75 Ω/ohms

#### Frequency response:

5 Hz ~ 10 MHz — +1, -3 dB

### • S-Video terminals

#### Input / output level

#### and impedance:

Y (brightness) signal — 1 Vp-p, 75 Ω/ohms

C (color) signal — 0.286 Vp-p, 75 Ω/ohms

#### Frequency response:

5 Hz ~ 10 MHz — +1, -3 dB

### • Color component video terminal

#### Input / output level

#### and impedance:

Y (brightness) signal — 1 Vp-p, 75 Ω/ohms

P<sub>B</sub>/C<sub>B</sub> (blue) signal — 0.7 Vp-p, 75 Ω/ohms

P<sub>R</sub>/C<sub>R</sub> (red) signal — 0.7 Vp-p, 75 Ω/ohms

#### Frequency response:

DC ~ 100 MHz — 0, -3 dB

## ■ Tuner section

[FM] (note: μV at 75 Ω/ohms,

0 dBf=1 × 10<sup>-15</sup> W)

[AM]

#### Receiving Range:

87.50 MHz ~ 107.90 MHz

520 kHz ~ 1710 kHz

#### Usable Sensitivity:

1.0 μV (11.2 dBf)

18 μV

#### 50 dB Quieting

#### Sensitivity:

MONO 1.6 μV (15.3 dBf)

STEREO 23 μV (38.5 dBf)

#### S/N (IHF-A):

MONO 77 dB (IHF-A weighted)

STEREO 72 dB (IHF-A weighted)

#### Total Harmonic Distortion

#### (at 1 kHz):

MONO 0.15 % (1 kHz)

STEREO 0.3 % (1 kHz)

## ■ General

#### Power supply:

AC 120 V, 60 Hz

#### Power consumption:

5.1 A

#### Maximum external

#### dimensions:

434 (W) × 147 (H) × 417 (D) mm

(17-3/32" × 5-25/32" × 16-27/64")

#### Mass:

11.7 (25 lbs 13 oz) kg

## ■ Remote control unit (RC-978)

#### Batteries:

R6P/AA Type (two batteries)

#### External dimensions:

55 (W) × 225 (H) × 34.5 (D) mm

(2-11/64" × 8-55/64" × 1-9/64")

#### Mass:

165 g (Approx. 5.8 oz) (including batteries)

\* For purposes of improvement, specifications and design are subject to change without notice.

## ■ List of preset codes / Liste de codes pré-réglés

### DVD

|            |                     |
|------------|---------------------|
| Denon      | 014, <b>*[1111]</b> |
| Aiwa       | 009                 |
| Hitachi    | 010                 |
| JVC        | 006, 011            |
| Konka      | 012, 013            |
| Magnavox   | 005                 |
| Mitsubishi | 004                 |
| Panasonic  | 014                 |
| Philips    | 005, 015, 016, 017  |
| Pioneer    | 003, 008            |
| Sanyo      | 018                 |
| Sony       | 002, 019, 020       |
| Toshiba    | 001, 021, 022       |
| Zenith     | 023                 |

### VDP

|            |                    |
|------------|--------------------|
| Denon      | 028, 029, 112      |
| Magnavox   | 026                |
| Mitsubishi | 028                |
| Panasonic  | 029, 030           |
| Philips    | 026                |
| Pioneer    | 028, 031           |
| RCA        | 032                |
| Sony       | 033, 034, 035, 036 |

### VCR

|         |                                   |
|---------|-----------------------------------|
| Admiral | 081                               |
| Aiko    | 095                               |
| Aiwa    | 009                               |
| Akai    | 026, 027, 070, 072, 082, 083, 084 |
| Alba    | 055                               |
| Amstrad | 009                               |
| ASA     | 042                               |
| Asha    | 087                               |

|                 |  |
|-----------------|--|
| Audio Dynamic   | 005, 085   |
| Audiovox        | 088  |
| Beaumark        | 087  |
| Broksonic       | 086, 093   |
| Calix           | 088  |
| Candle          | 006, 087, 088, 089, 090  |
| Canon           | 049, 057   |
| Capehart        | 025, 055, 056, 071   |
| Carver          | 015  |
| CCE             | 095  |
| Citizen         | 006, 007, 087, 088, 089, 090, 095  |
| Craig           | 007, 087, 088, 091, 115  |
| Curtis Mathes   | 006, 049, 073, 080, 087, 090, 092  |
| Cybernex        | 087  |
| Daewoo          | 025, 055, 059, 074, 089, 093, 095, 096   |
| Daytron         | 025, 055   |
| DBX             | 005, 085   |
| Dumont          | 053  |
| Dynatech        | 009  |
| Electrohome     | 001, 088, 097  |
| Electroponic    | 088  |
| Emerson         | 001, 009, 017, 027, 086, 088, 089, 092, 093, 097, 100, 101, 102, 103, 104, 117 |
| Fisher          | 009, 028, 031, 053, 054, 091, 099, 115   |
| GE              | 007, 011, 049, 050, 051, 052, 073, 080, 087                                    |
| Go Video        | 047, 048   |
| Goldstar        | 000, 006, 012, 062, 088  |
| Gradiente       | 094  |
| Grundig         | 042  |
| Harley Davidson | 094  |
| Harman Kardon   | 040, 062   |
| Hi-Q            | 091  |
| Hitachi         | 009, 013, 023, 026, 058, <b>*[108]</b> , 109, 110, 111                         |

|                 |   |
|-----------------|---|
| JC Penny        | 004, 005, 007, 023, 028, 049, 062, 085, 087, 088                |
| Jensen          | 013, 026  |
| JVC             | 004, 005, 006, 026, 029, 043, 044, 045, 046, 085                |
| Kenwood         | 004, 005, 006, 026, 029, 033, 045, 085, 090                     |
| Kodak           | 088   |
| Lloyd           | 009, 094  |
| LXI             | 088   |
| Magnavox        | 015, 016, 042, 049, 063, 106                                    |
| Magnin          | 087   |
| Marantz         | 004, 005, 006, 015, 042, 049, 085, 090                          |
| Marta           | 088   |
| MEI             | 049   |
| Memorex         | 009, 033, 049, 053, 060, 081, 087, 088, 091, 094, 115           |
| Metz            | 123, 124, 125, 126, 127, 128                                    |
| MGA             | 001, 017, 027, 041, 097   |
| MGN Technology  | 087   |
| Midland         | 011   |
| Minolta         | 013, 023  |
| Mitsubishi      | 001, 003, 008, 013, 014, 017, 027, 029, 039, 040, 041, 045, 097 |
| Motorola        | 081   |
| Montgomery Ward | 001, 002, 007, 009, 049, 063, 081, 115, 117                     |
| MTC             | 009, 087, 094   |
| Multitech       | 007, 009, 011, 087, 090, 094                                    |
| NAD             | 038   |
| NEC             | 004, 005, 006, 018, 026, 029, 045, 061, 062, 085                |
| Nikko           | 088   |
| Noblex          | 087   |
| Optimus         | 081, 088  |

|             |   |
|-------------|---|
| Optonica    | 021   |
| Panasonic   | 024, 049, 064, 066, 067, 068, 069, 107                          |
| Perdio      | 009   |
| Pentax      | 009, 013, 023, 058, 090   |
| Philco      | 015, 016, 049   |
| Philips     | 015, 021, 042, 049, 105   |
| Pilot       | 088   |
| Pioneer     | 005, 013, 029, 036, 037, 038, 045, 085                          |
| Portland    | 025, 055, 090   |
| Proscan     | 063, 080  |
| Pulsar      | 060   |
| Quartz      | 033   |
| Quasar      | 034, 035, 049   |
| Radio Shack | 001, 002, 021, 081, 087, 088, 091, 094, 097, 098, 115           |
| Radix       | 088   |
| Randex      | 088   |
| RCA         | 007, 013, 019, 023, 058, 063, 064, 065, 073, 080, 082, 087      |
| Realistic   | 009, 021, 031, 033, 049, 053, 081, 087, 088, 091, 094, 097, 098 |
| Ricoh       | 055   |
| Salora      | 033, 041  |
| Samsung     | 007, 011, 051, 059, 070, 083, 087, 089, 113                     |
| Sanky       | 081   |
| Sansui      | 005, 026, 029, 045, 061, 085, 114                               |
| Sanyo       | 032, 033, 053, 087, 091, 115, 116                               |
| SBR         | 042   |
| Scott       | 017, 020, 086, 089, 093, 117                                    |
| Sears       | 013, 023, 028, 031, 033, 053, 054, 088, 091, 098, 099, 115      |
| Sentra      | 055   |
| Sharp       | 001, 002, 021, 097  |
| Shogun      | 087   |
| Sony        | 075, 076, 077, 078, 079, 121, 122                               |
| STS         | 023   |

|                  |  |
|------------------|--|
| Sylvania         | 009, 015, 016, 017, 041, 049, 094                          |
| Symphonic        | 009, 094   |
| Tandy            | 009  |
| Tashiko          | 009, 088   |
| Tatung           | 004, 026, 030  |
| Teac             | 004, 009, 026, 094   |
| Technics         | 024, 049   |
| Teknika          | 009, 010, 022, 049, 088, 094                               |
| TMK              | 087, 092   |
| Toshiba          | 013, 017, 020, 041, 059, 089, 098, 099, 117                |
| Totevision       | 007, 087, 088  |
| Unirech          | 087  |
| Vectror Research | 005, 062, 085, 089, 090                                    |
| Victor           | 005, 045, 046, 085   |
| Video Concepts   | 005, 027, 085, 089, 090                                    |
| Videosonic       | 007, 087   |
| Wards            | 013, 021, 023, 087, 088, 089, 091, 094, 097, 118, 119, 120 |
| XR-1000          | 094  |
| Yamaha           | 004, 005, 006, 026, 062, 085                               |
| Zenith           | 060, 078, 079  |

**TV**

|               |   |
|---------------|---|
| Admiral       | 045, 121                                    |
| Adventura     | 122   |
| Aiko          | 054   |
| Akai          | 016, 027, 046                               |
| Alleron       | 062   |
| A-Mark        | 007   |
| Amtron        | 061   |
| Anam          | 006, 007, 036                               |
| Anam National | 061, 147                                    |
| AOC           | 003, 007, 033, 038, 039, 047, 048, 049, 133 |
| Archer        | 007   |
| Audiovox      | 007, 061                                    |

|               |  |
|---------------|--|
| Bauer         | 155  |
| Belcor        | 047  |
| Bell & Howell | 045, 118   |
| Bradford      | 061  |
| Brockwood     | 003, 047   |
| Candle        | 003, 030, 031, 032, 038, 047, 049, 050, 122                          |
| Capehart      | 003  |
| Celebrity     | 046  |
| Circuit City  | 003  |
| Citizen       | 029, 030, 031, 032, 034, 038, 047, 049, 050, 054, 061, 095, 122, 123 |
| Concerto      | 031, 047, 049  |
| Colortyme     | 003, 047, 049, 135   |
| Contec        | 013, 051, 052, 061   |
| Cony          | 051, 052, 061  |
| Craig         | 004, 061   |
| Crown         | 029  |
| Curtis Mathes | 029, 034, 038, 044, 047, 049, 053, 095, 118                          |
| Daewoo        | 027, 029, 039, 048, 049, 054, 055, 106, 107, 137                     |
| Daytron       | 003, 049   |
| Dimensia      | 044  |
| Dixi          | 007, 015, 027  |
| Electroband   | 046  |
| Electrohome   | 029, 056, 057, 058, 147  |
| Elta          | 027  |
| Emerson       | 029, 051, 059, 060, 061, 062, 118, 123, 124, 139, 148                |
| Envision      | 038  |
| Etron         | 027  |
| Fisher        | 014, 021, 063, 064, 065, 118   |
| Formenti      | 155  |
| Fortress      | 012  |
| Fujitsu       | 004, 062   |
| Funai         | 004, 062   |

|                |  |
|----------------|--|
| Futuretech     | 004  |
| GE             | 020, 036, 037, 040, 044, 058, 066, 088, 119, 120, 125, 147   |
| Goldstar       | 000, 015, 029, 031, 039, 048, 051, 056, 057, 067, 068, 069, 116                                    |
| Grundy         | 062  |
| Hitachi        | 029, 031, 051, 052, 070, 111, 112, 113, 124, <b>*[134]</b>   |
| Hitachi Pay TV | 151  |
| Infinity       | 017, 071   |
| Janeil         | 122  |
| JBL            | 017, 071   |
| JC Penny       | 020, 034, 039, 040, 041, 044, 048, 050, 058, 066, 069, 076, 088, 090, 095, 125, 136, 159           |
| JCB            | 046  |
| JVC            | 019, 051, 052, 072, 073, 091, 117, 126   |
| Kawasho        | 018, 046   |
| Kenwood        | 038, 056, 057  |
| Kloss          | 010, 032   |
| Kloss Novabeam | 005, 122, 127, 131   |
| KTV            | 074, 123   |
| Loewe          | 071  |
| Logik          | 144  |
| Luxman         | 031  |
| LXI            | 008, 014, 017, 024, 040, 044, 063, 071, 075, 076, 077, 118, 125                                    |
| Magnavox       | 005, 010, 017, 030, 033, 038, 050, 056, 071, 078, 079, 085, 089, 108, 109, 110, 127, 131, 132, 145 |
| Marantz        | 015, 017, 071, 080   |
| Matsui         | 027  |
| Memorex        | 014, 027, 045, 083, 118, 144   |
| Metz           | 160, 161, 162, 163   |
| MGA            | 001, 039, 048, 056, 057, 058, 065, 081, 083  |
| Midland        | 125  |

|                   |   |
|-------------------|---|
| Minutz            | 066   |
| Mitsubishi        | 001, 016, 039, 048, 056, 057, 058, 065, 081, 082, 083, 105      |
| Montgomery Ward   | 011, 020, 144, 145, 146   |
| Motorola          | 121, 147  |
| MTC               | 031, 034, 039, 048, 095   |
| NAD               | 008, 075, 076, 128  |
| National          | 002, 036, 061, 147  |
| National Quenties | 002   |
| NEC               | 031, 038, 039, 048, 057, 084, 086, 135, 147                     |
| Nikko             | 054   |
| NTC               | 054   |
| Optimus           | 128   |
| Optonica          | 011, 012, 093, 121  |
| Orion             | 004, 139  |
| Panasonic         | 002, 009, 017, 036, 037, 071, 141, 143, 147                     |
| Philco            | 005, 010, 030, 050, 051, 056, 079, 085, 127, 131, 132, 145, 147 |
| Philips           | 005, 015, 017, 050, 051, 056, 078, 087, 088, 089, 131, 132, 147 |
| Pioneer           | 124, 128, 142   |
| Portland          | 054   |
| Price Club        | 095   |
| Proscan           | 040, 044, 125   |
| Proton            | 035, 051, 092, 129  |
| Pulsar            | 042   |
| Quasar            | 036, 037, 074, 141  |
| Radio Shack       | 011, 044, 063, 093, 118   |
| RCA               | 040, 044, 125, 130, 137, 151, 152                               |
| Realistic         | 014, 063, 093, 118  |
| Saisho            | 027   |
| Samsung           | 003, 015, 034, 053, 055, 057, 094, 095, 136, 153                |
| Sansui            | 139   |
| Sanyo             | 013, 014, 021, 022, 063, 064, 081, 096                          |

|                |   |
|----------------|---|
| SBR            | 015   |
| Schneider      | 015   |
| Scott          | 062   |
| Sears          | 008, 014, 021, 022, 023, 024, 025, 040, 052, 057, 062, 063, 064, 065, 073, 075, 076, 097, 098, 125, 159 |
| Sharp          | 011, 012, 013, 026, 093, 099, 100, 104, 121   |
| Siemens        | 013   |
| Signature      | 045, 144  |
| Simpson        | 050   |
| Sony           | 043, 046, 138, 146, 150   |
| Soundesign     | 030, 050, 062   |
| Spectricon     | 007, 033  |
| Squareview     | 004   |
| Supre-Macy     | 032, 122  |
| Supreme        | 046   |
| Sylvania       | 005, 010, 017, 030, 078, 079, 085, 089, 101, 127, 131, 132, 145, 155                                    |
| Symphonic      | 004, 148  |
| Tandy          | 012, 121  |
| Tatung         | 036, 124  |
| Technics       | 037   |
| Teknika        | 001, 030, 032, 034, 052, 054, 078, 083, 095, 144, 156, 157  |
| Tera           | 035, 129  |
| Toshiba        | 008, 014, 034, 063, 075, 076, 095, 097, 136, 158, 159   |
| Universal      | 020, 066, 088   |
| Victor         | 019, 073, 126   |
| Video Concepts | 016   |
| Viking         | 032, 122  |
| Wards          | 005, 045, 066, 078, 085, 088, 089, 093, 102, 103, 131, 132, 148   |
| Zenith         | 042, 114, 115, 140, 144, 149  |
| Zonda          | 007   |



**CABLE**

|                    |                         |
|--------------------|-------------------------|
| ABC                | 006, *[007], 008, 009   |
| Archer             | 010, 011                |
| Century            | 011                     |
| Citizen            | 011                     |
| Colour Voice       | 012, 013                |
| Comtronic          | 014                     |
| Eastern            | 015                     |
| Garrard            | 011                     |
| Gemini             | 030, 033, 034           |
| General Instrument | 030, 031, 032           |
| Hytex              | 006                     |
| Jasco              | 011                     |
| Jerrold            | 009, 016, 017, 026, 032 |
| Magnavox           | 018                     |
| Movie Time         | 019                     |
| NSC                | 019                     |
| Oak                | 000, 006, 020           |
| Panasonic          | 001, 005                |
| Philips            | 011, 012, 013, 018, 021 |
| Pioneer            | 002, 003, 022           |
| RCA                | 029                     |
| Regency            | 015                     |
| Samsung            | 014, 023                |
| Scientific Atlanta | 004, 024, 025           |
| Signal             | 014                     |
| SL Marx            | 014                     |
| Starcom            | 009                     |
| Stargate           | 014                     |
| Television         | 014                     |
| Tocom              | 007, 016                |
| TV86               | 019                     |
| Unika              | 011                     |
| United Artists     | 006                     |
| Universal          | 010, 011                |
| Viewstar           | 018, 019                |
| Zenith             | 027, 028                |

**DBS (SATELLITE)**

|                     |                         |
|---------------------|-------------------------|
| Alphastar           | 054                     |
| Chaparral           | 035, 036                |
| Dishnet             | 053                     |
| Drake               | 037, 038                |
| Echostar Dish       | 062, 066                |
| GE                  | 048, 055, 056           |
| General Instruments | 039, 040, 041           |
| Grundig             | 070, 071, 072, 073      |
| Hitachi             | 058, 059                |
| Hughes Network      | 063, 064, 065, 069      |
| JVC                 | 057                     |
| Kathrein            | 074, 075, 076, 083      |
| Magnavox            | 060                     |
| Nokia               | 070, 080, 084, 085, 086 |
| Philips             | 060                     |
| Primestar           | 051                     |
| Proscan             | 048, 055, 056           |
| RCA                 | 048, 055, 056, 068      |
| Realistic           | 042                     |
| Sierra I            | 036                     |
| Sierra II           | 036                     |
| Sierra III          | 036                     |
| Sony                | 049, 067                |
| STS1                | 043                     |
| STS2                | 044                     |
| STS3                | 045                     |
| SRS4                | 046                     |
| Technisat           | 077, 078, 079, 081, 082 |
| Toshiba             | 047, 050                |
| Uniden              | 061                     |

**CD**

|          |               |
|----------|---------------|
| Denon    | *[111]        |
| Aiwa     | 001, 035, 043 |
| Burmster | 002           |
| Carver   | 003, 035      |

|          |                         |
|----------|-------------------------|
| Emerson  | 004, 005, 006, 007      |
| Fisher   | 003, 008, 009, 010      |
| JVC      | 018, 019                |
| Kenwood  | 011, 012, 013, 014, 017 |
| Magnavox | 006, 015, 035           |
| Marantz  | 016, 028, 035           |
| MCS      | 016, 024                |
| Onkyo    | 025, 027                |
| Optimus  | 017, 020, 021, 022, 023 |
| Philips  | 014, 032, 033, 035      |
| Pioneer  | 006, 022, 030           |
| Sears    | 006                     |
| Sony     | 023, 031                |
| Teac     | 002, 009, 028           |
| Technics | 016, 029, 036           |
| Wards    | 035, 037                |
| Yamaha   | 038, 039, 040, 041      |
| Zenith   | 042                     |

**CDR**

|         |             |
|---------|-------------|
| Denon   | *[111], 112 |
| Philips | 112         |

**MD**

|         |          |
|---------|----------|
| Denon   | 113      |
| Kenwood | 003, 004 |
| Onkyo   | 007      |
| Sharp   | 005      |
| Sony    | 006      |

**TAPE**

|               |          |
|---------------|----------|
| Denon         | *[111]   |
| Aiwa          | 001, 002 |
| Carver        | 002      |
| Harman/Kardon | 002, 003 |
| JVC           | 004, 005 |
| Kenwood       | 006      |

|           |               |
|-----------|---------------|
| Magnavox  | 002           |
| Marantz   | 002           |
| Onkyo     | 016, 018      |
| Optimus   | 007, 008      |
| Panasonic | 012           |
| Philips   | 002           |
| Pioneer   | 007, 008, 009 |
| Sony      | 013, 014, 015 |
| Technics  | 012           |
| Victor    | 004           |
| Wards     | 007           |
| Yamaha    | 010, 011      |

\*[ ] : Preset codes set upon shipment from the factory.

\*[ ] : Les codes pré-réglés diffèrent en fonction des livraisons de l'usine.

| <b>DVD preset codes<br/>Codes pré-réglés DVD</b> | <b>111</b> | <b>014</b> |
|--|------------|------------|
| <b>DENON</b>                                     | DVD-555    | DVD-800    |
| Model No.  | DVD-755    | DVD-1600   |
| Modèle numéro                                    | DVD-900    | DVD-2000   |
|  | DVD-910    | DVD-2500   |
|  | DVD-955    | DVD-3000   |
|  | DVD-1000   | DVD-3300   |
|  | DVD-1200   |            |
|  | DVD-1500   |            |
|  | DVD-1710   |            |
|  | DVD-1910   |            |
|  | DVD-2200   |            |
|  | DVD-2800   |            |
|  | DVD-2800II |            |
|  | DVD-2900   |            |
|  | DVD-2910   |            |
|  | DVD-3800   |            |
|  | DVD-3910   |            |
|  | DVD-5900   |            |
|  | DVD-5910   |            |
|  | DVD-9000   |            |
|  | DVM-715    |            |
|  | DVM-1800   |            |
|  | DVM-1805   |            |
|  | DVM-1815   |            |
|  | DVM-2815   |            |
|  | DVM-4800   |            |

**DENON**  
TOKYO, JAPAN  
[www.denon.com](http://www.denon.com)

Denon Brand Company, D&M Holdings Inc.  
Printed in China 00D 511 4324 004