

# DENON

AV SURROUND RECEIVER

# AVR-1907

---

OPERATING INSTRUCTIONS

☐ SAFETY PRECAUTIONS



**CAUTION**  
RISK OF ELECTRIC SHOCK  
DO NOT OPEN



**CAUTION:**

**TO REDUCE THE RISK OF ELECTRIC SHOCK, DO NOT REMOVE COVER (OR BACK). NO USER-SERVICEABLE PARTS INSIDE. REFER SERVICING TO QUALIFIED SERVICE PERSONNEL.**



The lightning flash with arrowhead symbol, within an equilateral triangle, is intended to alert the user to the presence of uninsulated "dangerous voltage" within the product's enclosure that may be of sufficient magnitude to constitute a risk of electric shock to persons.



The exclamation point within an equilateral triangle is intended to alert the user to the presence of important operating and maintenance (servicing) instructions in the literature accompanying the appliance.

**WARNING:**

**TO REDUCE THE RISK OF FIRE OR ELECTRIC SHOCK, DO NOT EXPOSE THIS APPLIANCE TO RAIN OR MOISTURE.**

# SAFETY INSTRUCTIONS

1. Read Instructions – All the safety and operating instructions should be read before the product is operated.
2. Retain Instructions – The safety and operating instructions should be retained for future reference.
3. Heed Warnings – All warnings on the product and in the operating instructions should be adhered to.
4. Follow Instructions – All operating and use instructions should be followed.
5. Cleaning – Unplug this product from the wall outlet before cleaning. Do not use liquid cleaners or aerosol cleaners.
6. Attachments – Do not use attachments not recommended by the product manufacturer as they may cause hazards.
7. Water and Moisture – Do not use this product near water – for example, near a bath tub, wash bowl, kitchen sink, or laundry tub; in a wet basement; or near a swimming pool; and the like.
8. Accessories – Do not place this product on an unstable cart, stand, tripod, bracket, or table. The product may fall, causing serious injury to a child or adult, and serious damage to the product. Use only with a cart, stand, tripod, bracket, or table recommended by the manufacturer, or sold with the product. Any mounting of the product should follow the manufacturer's instructions, and should use a mounting accessory recommended by the manufacturer.
9. A product and cart combination should be moved with care. Quick stops, excessive force, and uneven surfaces may cause the product and cart combination to overturn.
10. Ventilation – Slots and openings in the cabinet are provided for ventilation and to ensure reliable operation of the product and to protect it from overheating, and these openings must not be blocked or covered. The openings should never be blocked by placing the product on a bed, sofa, rug, or other similar surface. This product should not be placed in a built-in installation such as a bookcase or rack unless proper ventilation is provided or the manufacturer's instructions have been adhered to.
11. Power Sources – This product should be operated only from the type of power source indicated on the marking label. If you are not sure of the type of power supply to your home, consult your product dealer or local power company. For products intended to operate from battery power, or other sources, refer to the operating instructions.
12. Grounding or Polarization – This product may be equipped with a polarized alternating-current line plug (a plug having one blade wider than the other). This plug will fit into the power outlet only one way. This is a safety feature. If you are unable to insert the plug fully into the outlet, try reversing the plug. If the plug should still fail to fit, contact your electrician to replace your obsolete outlet. Do not defeat the safety purpose of the polarized plug.



13. Power-Cord Protection – Power-supply cords should be routed so that they are not likely to be walked on or pinched by items placed upon or against them, paying particular attention to cords at plugs, convenience receptacles, and the point where they exit from the product.
15. Outdoor Antenna Grounding – If an outside antenna or cable system is connected to the product, be sure the antenna or cable system is grounded so as to provide some protection against voltage surges and built-up static charges. Article 810 of the National Electrical Code, ANSI/NFPA 70, provides information with regard to proper grounding of the mast and supporting structure, grounding of the lead-in wire to an antenna discharge unit, size of grounding conductors, location of antenna-discharge unit, connection to grounding electrodes, and requirements for the grounding electrode. See Figure A.
16. Lightning – For added protection for this product during a lightning storm, or when it is left unattended and unused for long periods of time, unplug it from the wall outlet and disconnect the antenna or cable system. This will prevent damage to the product due to lightning and power-line surges.
17. Power Lines – An outside antenna system should not be located in the vicinity of overhead power lines or other electric light or power circuits, or where it can fall into such power lines or circuits. When installing an outside antenna system, extreme care should be taken to keep from touching such power lines or circuits as contact with them might be fatal.
18. Overloading – Do not overload wall outlets, extension cords, or integral convenience receptacles as this can result in a risk of fire or electric shock.
19. Object and Liquid Entry – Never push objects of any kind into this product through openings as they may touch dangerous voltage points or short-out parts that could result in a fire or electric shock. Never spill liquid of any kind on the product.
20. Servicing – Do not attempt to service this product yourself as opening or removing covers may expose you to dangerous voltage or other hazards. Refer all servicing to qualified service personnel.
21. Damage Requiring Service – Unplug this product from the wall outlet and refer servicing to qualified service personnel under the following conditions:
  - a) When the power-supply cord or plug is damaged,
  - b) If liquid has been spilled, or objects have fallen into the product,
  - c) If the product has been exposed to rain or water,
  - d) If the product does not operate normally by following the operating instructions. Adjust only those controls that are covered by the operating instructions as an improper adjustment of other controls may result in damage and will often require extensive work by a qualified technician to restore the product to its normal operation,
  - e) If the product has been dropped or damaged in any way, and
  - f) When the product exhibits a distinct change in performance – this indicates a need for service.
22. Replacement Parts – When replacement parts are required, be sure the service technician has used replacement parts specified by the manufacturer or have the same characteristics as the original part. Unauthorized substitutions may result in fire, electric shock, or other hazards.
23. Safety Check – Upon completion of any service or repairs to this product, ask the service technician to perform safety checks to determine that the product is in proper operating condition.
24. Wall or Ceiling Mounting – The product should be mounted to a wall or ceiling only as recommended by the manufacturer.
25. Heat – The product should be situated away from heat sources such as radiators, heat registers, stoves, or other products (including amplifiers) that produce heat.

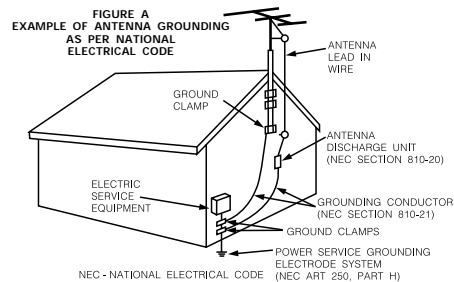

**FCC INFORMATION (For US customers)**

**1. PRODUCT**

This product complies with Part 15 of the FCC Rules. Operation is subject to the following two conditions: (1) this product may not cause harmful interference, and (2) this product must accept any interference received, including interference that may cause undesired operation.

**2. IMPORTANT NOTICE: DO NOT MODIFY THIS PRODUCT**

This product, when installed as indicated in the instructions contained in this manual, meets FCC requirements. Modification not expressly approved by DENON may void your authority, granted by the FCC, to use the product.

**3. NOTE**







This product has been tested and found to comply with the limits for a Class B digital device, pursuant to Part 15 of the FCC Rules. These limits are designed to provide reasonable protection against harmful interference in a residential installation.

This product generates, uses and can radiate radio frequency energy and, if not installed and used in accordance with the instructions, may cause harmful interference to radio communications. However, there is no guarantee that interference will not occur in a particular installation. If this product does cause harmful interference to radio or television reception, which can be determined by turning the product OFF and ON, the user is encouraged to try to correct the interference by one or more of the following measures:

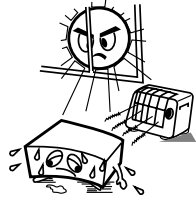
- Reorient or relocate the receiving antenna.
- Increase the separation between the equipment and receiver.
- Connect the product into an outlet on a circuit different from that to which the receiver is connected.
- Consult the local retailer authorized to distribute this type of product or an experienced radio/TV technician for help.

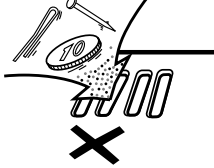
This Class B digital apparatus complies with Canadian ICES-003.  
Cet appareil numérique de la classe B est conforme à la norme NMB-003 du Canada.

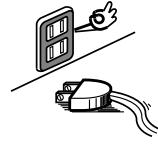
**NOTE ON USE**

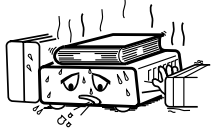
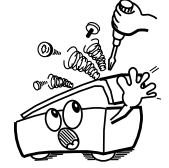
 <ul style="list-style-type: none"> <li>• Avoid high temperatures. Allow for sufficient heat dispersion when installed in a rack.</li> </ul>	 <ul style="list-style-type: none"> <li>• Keep the apparatus free from moisture, water, and dust.</li> </ul>	 <ul style="list-style-type: none"> <li>• Do not let foreign objects into the apparatus.</li> </ul>
	 <ul style="list-style-type: none"> <li>• Unplug the power cord when not using the apparatus for long periods of time.</li> </ul>	 <ul style="list-style-type: none"> <li>• Do not let insecticides, benzene, and thinner come in contact with the apparatus.</li> </ul>
<ul style="list-style-type: none"> <li>• Handle the power cord carefully. Hold the plug when unplugging the cord.</li> </ul>	 <p>* (For apparatuses with ventilation holes)</p> <ul style="list-style-type: none"> <li>• Do not obstruct the ventilation holes.</li> </ul>	 <ul style="list-style-type: none"> <li>• Never disassemble or modify the apparatus in any way.</li> </ul>

Thank you for choosing the DENON AVR-1907 AV Surround Receiver. This remarkable component has been engineered to provide superb surround sound listening with home theater sources such as DVD, as well as providing outstanding high fidelity reproduction of your favorite music sources.

As this product is provided with an immense array of features, we recommend that before you begin hookup and operation that you review the contents of this manual before proceeding.

## Contents

### Getting Started

Accessories .....	2
Before using .....	2
Cautions on installation .....	3
About the remote control unit .....	3
Inserting the batteries .....	3
Operating range of the remote control unit .....	3
Part names and functions	
Front panel .....	4
Display .....	4
Rear panel .....	5
Remote control unit .....	5, 6

### Easy Setup Procedure

Easy to setup flow .....	7
Speaker layout [Basic layout] .....	7
Speaker connections .....	8
Connecting a DVD player and monitor .....	9
Auto Setup	
① Connecting a microphone .....	10
② Before performing the Auto Setup procedure .....	10
③ Perform the Auto Setup procedure .....	11
④ Assigning power amplifiers .....	11
⑤ Switching the front speaker .....	11
⑥ Starting Auto Setup .....	11
⑦ Checking and storing the measurement results .....	12
Error messages .....	12
Check the parameter .....	13

### Connecting Other Sources

Cable indications .....	13
The video conversion function .....	14
On screen display signals .....	14
Connecting a TV/DBS tuner .....	15
Connecting a video camera or video game .....	15
Connecting the external inputs (EXT. IN) terminals .....	15
Connecting a CD player .....	16
Connecting a tape deck .....	16
Connecting a VCR .....	16
Connecting a CD recorder or MD recorder .....	17
Connecting the antenna terminals .....	17, 18
Connecting the XM terminal .....	18
Connecting the iPod® .....	18
Connecting the MULTI ZONE terminals	
ZONE2 out connections .....	19
ZONE2 speaker out connections .....	19
Connecting the PRE OUT terminals .....	20
Connecting the power supply cord .....	20

### Basic Operation

Playing the input source .....	21
Turning the sound off temporarily (MUTING) .....	22
Listening over headphones .....	22
Switching the front speakers .....	22
Checking the currently playing program source, etc. ....	22
Switching the brightness of the display .....	22
Using the surround modes	
Types of surround modes and their features .....	22, 23
Selecting the play mode (DIRECT/STEREO) .....	23
Selecting the Dolby Digital and DTS Surround mode (only with digital input) .....	24
Selecting the Dolby Pro Logic IIx (Pro Logic II) mode .....	25
Selecting the DTS NEO:6 mode .....	26
Selecting the NEURAL SURROUND mode .....	26
Checking the input signals .....	26
Surround modes and parameters .....	27 ~ 29

### Using the DENON original surround modes

Types of surround modes and their features .....	30
Selecting the DSP surround simulation .....	31
Setting the tone control .....	32
Adjusting the speaker volume .....	32
Using the fader function .....	32

### Listening to the radio

Auto preset memory .....	33
Auto tuning .....	33
Manual tuning .....	33
Preset memory .....	34
Checking the preset stations .....	34
Recalling preset stations .....	34

### XM Satellite Radio

Checking the XM signal strength and Radio ID .....	35
Channel selection .....	35
Category search .....	35

### Advanced Operation

Night mode .....	36
User mode function	
Storing the settings in the memory .....	36
Calling the settings out .....	36
Combining the currently playing sound with the desired image (VIDEO SELECT function) .....	36
Personal memory plus function .....	36
Playing the iPod® .....	37
Listening to music .....	38
Viewing still pictures and videos (only for iPods equipped with the slideshow / video function) .....	38
Disconnecting the iPod .....	38
Multi zone music entertainment system .....	39, 40
Outputting a program source to amplifier, etc., in the ZONE2 room (ZONE2 SELECT mode) .....	41
Remote control unit operations during multi-source playback .....	41
Recording (audio and/or video) .....	42
About the memory functions .....	42
Initialization of the microprocessor (Reset) .....	42

**Advanced Setup – Part 1**

System setup items and default values .....43 ~ 45  
 Navigating through the System Setup Menu .....46  
 About the on screen display and front display .....47  
**Audio Input Setup**  
 Setting the Digital In Assignment .....47  
 Setting the EXT IN Subwoofer Level .....48  
 Setting the iPod Assignment .....48  
 Setting the Input Function Level .....48  
 Setting the Function Rename .....49  
 Setting the Tuner Presets .....49, 50  
**Video Setup**  
 Setting the Component In Assignment .....51  
 Setting the Video Convert .....51  
 Setting the Audio Delay .....51  
 Setting the On Screen Display (OSD) .....52  
**Advanced Playback**  
 Setting the 2ch Direct/Stereo .....52  
 Setting the Auto Surround Mode .....52  
**Option Setup**  
 Setting the Power Amplifier Assignment .....53  
 Setting the Volume Control .....53  
 Setting the Setup Lock .....54

**Advanced Setup – Part 2**

**Speaker Setup**  
 Setting the Speaker Configuration .....54, 55  
 Setting the Subwoofer Setup .....55  
 Setting the Distance .....55, 56  
 Setting the Channel Level .....56, 57  
 Setting the Crossover Frequency .....57

**Operating the remote control unit**

Operating DENON audio components .....58  
 Setting the preset memory function .....58  
 Operating a component stored in the preset memory .....59 ~ 61  
 Setting the punch through function .....62

**Additional Information** ..... 63, 64

**Troubleshooting** .....65, 66

**Specifications** .....66

List of preset codes .....End of this manual

# Getting Started

**Accessories**

Check that the following parts are attached in addition to the main unit:

① Operating instructions .....1	⑤ R6P/AA batteries .....2
② Warranty (for North America model only).....1	⑥ AM loop antenna .....1
③ Service station list .....1	⑦ FM indoor antenna .....1
④ Remote control unit (RC-1046).....1	⑧ Setup microphone (DM-S205) (Approx. 20 ft / 6 m) .....1

**Before using**

Pay attention to the following before using this unit:

- **Moving the unit.**  
To prevent short-circuits or damaged wires in the connection cables, always unplug the power supply cord and disconnect the connection cables between all other audio components when moving the unit.
- **Cautions on using mobile phones.**  
Using a mobile phone near this unit may result in noise. If so, move the mobile phone away from this unit when it is in use.
- **Before turning the power operation button on.**  
Check once again that all connections are correct and that there are not problems with the connection cables. Always set the power operation button to the standby position before connecting and disconnecting connection cables.
- **Store these instructions in a safe place.**  
After reading, store this instructions along with the warranty card in a safe place.
- **Whenever the power operation button is in the STANDBY state, the unit is still connected to AC line voltage.**  
Please be sure to turn off the power operation button or unplug the cord when you leave home for, say, a vacation.
- **Note that the illustrations in these instructions may differ from the actual unit for explanation purposes.**

## Getting Started

## Cautions on installation

**Note:**  
For heat dispersal, do not install this unit in a confined space such as a bookcase or similar enclosure.

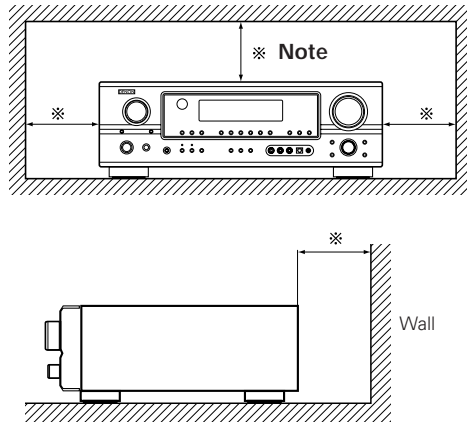

## About the remote control unit

In addition to controlling the AVR-1907, the attached remote control unit (RC-1046) can also be used to control the following products:

- ① DENON component products
- ② Component products other than DENON:
  - Set using the preset memory function (☞ page 58).

## Inserting the batteries

- ① Remove the remote control unit's rear cover.
- ② Set two R6P/AA batteries in the battery compartment in the indicated direction.

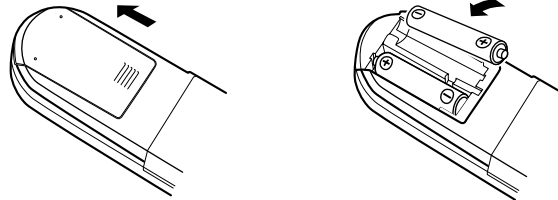

- ③ Put the rear cover back on.

## Notes on batteries:

- Replace the batteries with new ones if the set does not operate even when the remote control unit is operated nearby the unit. (The attached batteries are only for verifying operation.)
- When inserting the batteries, be sure to do so in the proper direction, following the "⊕" and "⊖" marks in the battery compartment.
- To prevent damage or leakage of battery fluid:
  - Do not use a new battery together with an old one.
  - Do not use two different types of batteries.
  - Do not short-circuit, disassemble, heat or dispose of batteries in flames.
- Remove the batteries from the remote if it will not be in use for long periods.
- If the battery fluid should leak, carefully wipe the fluid off the inside of the battery compartment and insert new batteries.
- When replacing the batteries, have the new batteries ready and insert them as quickly as possible.

## Getting Started

## Operating range of the remote control unit

- Point the remote control unit at the remote sensor when operating it.
- The remote control unit can be used from a distance of approximately 23 feet/7 meters, at a horizontal angle of up to 30° with respect to the sensor.

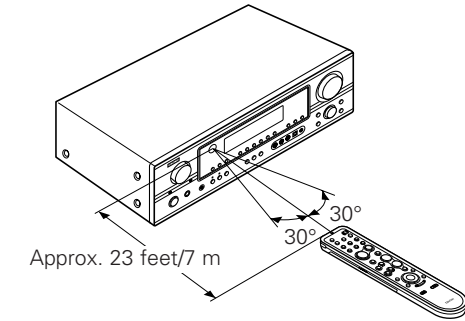

## NOTE:

- It may be difficult to operate the remote control unit if the remote sensor is exposed to direct sunlight or strong artificial light.

Getting Started

Part names and functions

For details on the functions of these parts, refer to the pages given in parentheses ( ).

Front panel

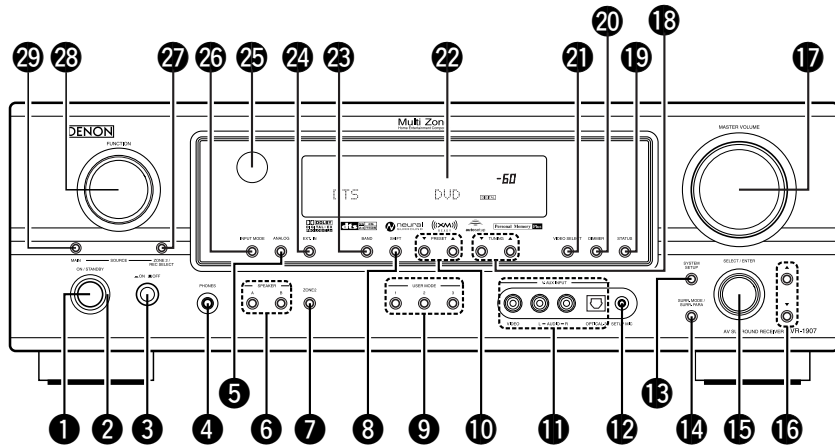

- 1 Power operation button (ON/STANDBY) .....(10)
- 2 Power indicator .....(10)
- 3 Power switch .....(10, 42)
- 4 Headphones jack (PHONES) .....(22)
- 5 ANALOG button .....(21)
- 6 SPEAKER buttons .....(22, 42)
- 7 ZONE2 button .....(40)
- 8 SHIFT button .....(34)
- 9 USER MODE buttons .....(36)
- 10 PRESET buttons .....(33)
- 11 V. AUX INPUT terminals

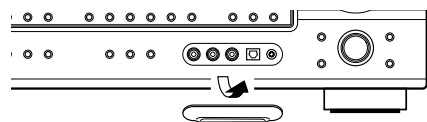

- 12 SETUP MIC jack .....(10)
- 13 SYSTEM SETUP button .....(11)
- 14 SURR. MODE/SURR. PARA button .....(21, 31)
- 15 SELECT/ENTER knob .....(11, 31)



• The **SELECT/ENTER** knob on the main unit operates in the same way as the **CURSOR** ◀ and ▶ buttons on the remote control unit.



- The control functions in the same way as the **CURSOR** ◀ button when turned counterclockwise, as the **CURSOR** ▶ button when turned clockwise.
- The control functions in the same way as the **ENTER** button when pressed the knob.

- 16 Cursor buttons (Δ, ▽) .....(11)
- 17 MASTER VOLUME control knob .....(21)
- 18 TUNING buttons (▲, ▼) .....(33)
- 19 STATUS button .....(22)
- 20 DIMMER button .....(22)
- 21 VIDEO SELECT button .....(36)
- 22 Display
- 23 BAND button .....(33)
- 24 EXT. IN button .....(22)
- 25 Remote control sensor .....(3)
- 26 INPUT MODE button .....(21)
- 27 ZONE2/REC SELECT button .....(41)
- 28 FUNCTION knob .....(21)
- 29 MAIN button .....(21)

Getting Started

Display

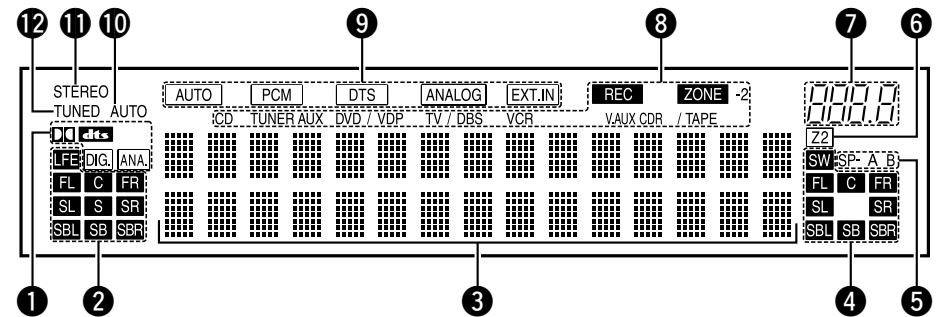

- 1 Input signal indicators
- 2 Input signal channel indicators
  - The audio channel(s) included in the input signal light(s).
  - This lights when the digital signal is inputted.
- 3 Information display
- 4 Output signal channel indicators
  - The audio channels that can be output light.
- 5 Speaker indicators
  - This lights corresponding to the settings of the front speakers of the various surround modes.
- 6 ZONE2 output indicator
- 7 Master volume indicator
  - This displays the volume level.
  - The Setup item number is displayed in System Setup.

- 8 ZONE2/REC SELECT indicators
  - Lights while selecting the ZONE2 or REC SELECT mode. (Off when the "SOURCE" is selected.)
- 9 Input mode indicators
- 10 AUTO indicator
  - This lights when the broadcast station is selected in the AUTO tuning mode.
- 11 STEREO indicator
  - This lights when an FM stereo broadcast has been received.
- 12 TUNED indicator
  - This lights when an FM/AM broadcast has been received.

Getting Started

Rear panel

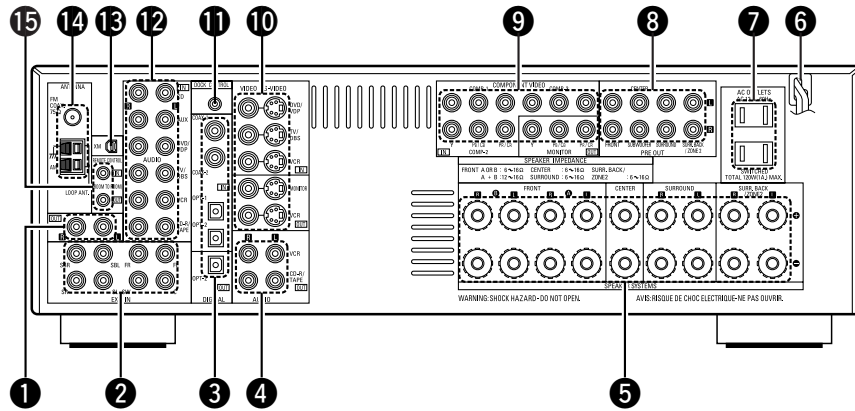

- 1 ZONE2 terminals .....(19)
- 2 EXT. IN terminals .....(15)
- 3 DIGITAL terminals  
(Optical/Coaxial) .....(9, 16)
- 4 AUDIO OUT terminals .....(14)
- 5 Speaker terminals .....(8)
- 6 Power supply cord .....(20)
- 7 AC outlets .....(20)
- 8 PRE OUT terminals .....(20)
- 9 COMPONENT VIDEO terminals .....(9)
- 10 VIDEO/S-VIDEO terminals .....(9)
- 11 DOCK CONTROL jack .....(18)
- 12 AUDIO IN terminals .....(9)
- 13 XM terminal .....(18)
- 14 ANTENNA terminals .....(17)
- 15 REMOTE CONTROL jacks .....(19)

Getting Started

Remote control unit

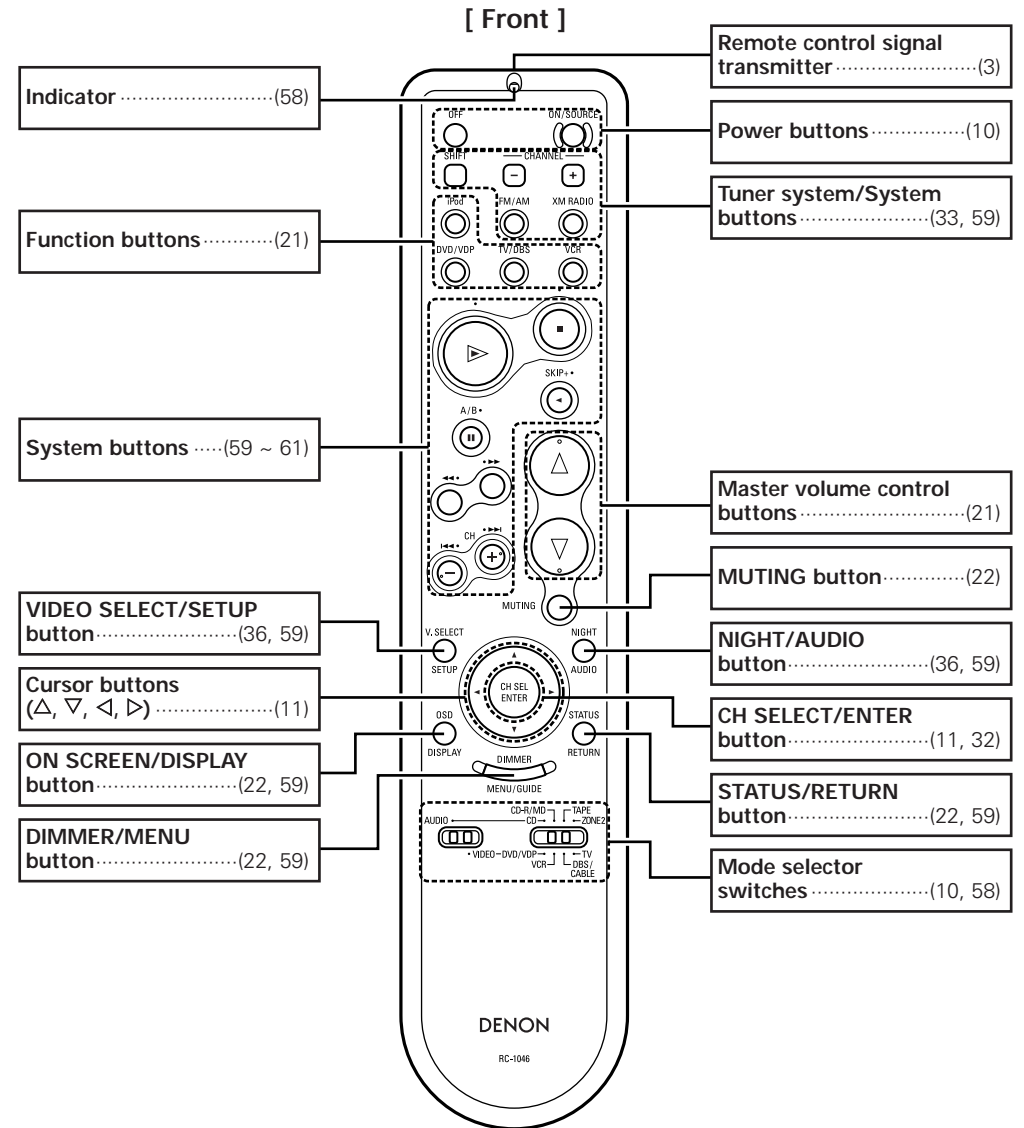

NOTE:

- If buttons on the front or rear are pressed strongly, the button on the opposite side will be activated too.



[ Rear ]

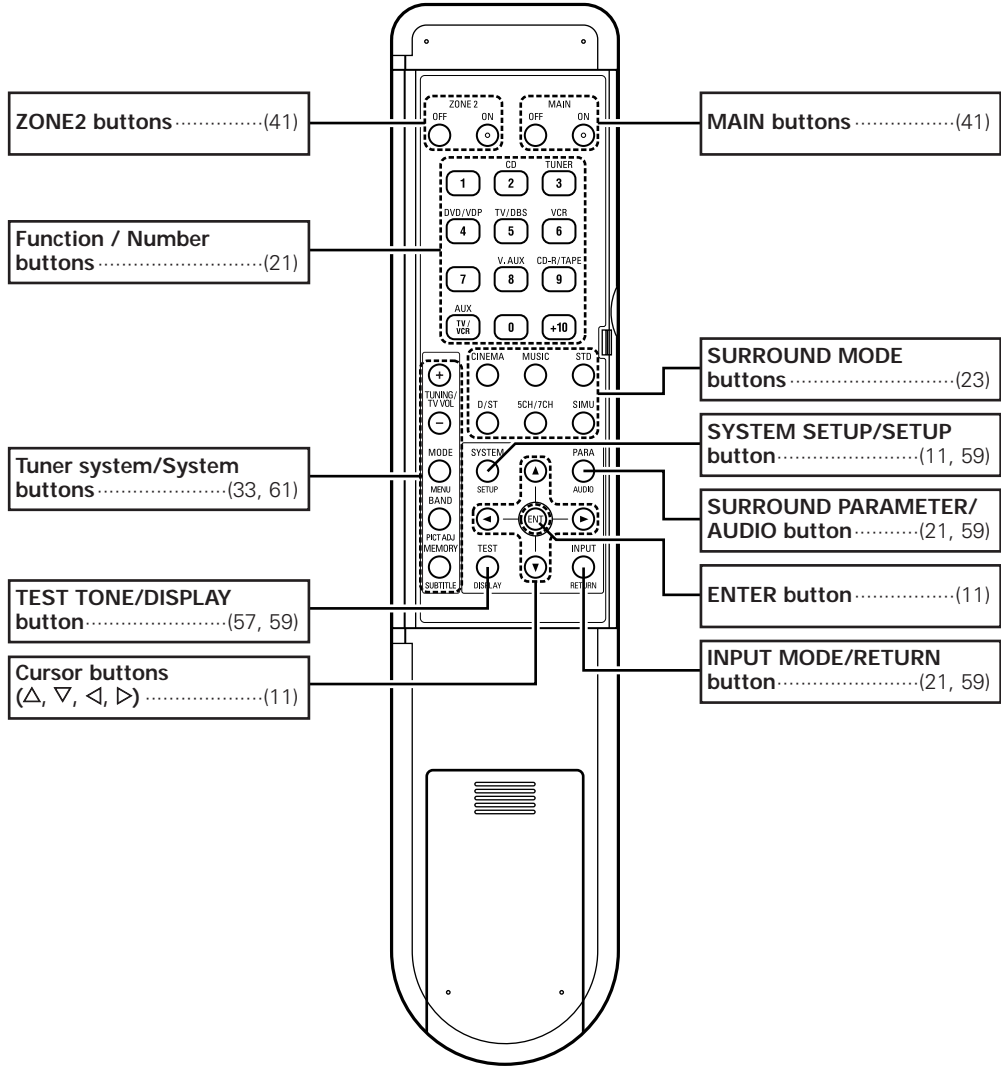

**NOTE:**

- If buttons on the front or rear are pressed strongly, the button on the opposite side will be activated too.

# Easy Setup Procedure

- This section contains the basic steps necessary to configure the AVR-1907 according to your listening room environment and the source equipment and loudspeakers you are using.
- To set the sound field manually (🔧 page 54 ~ 57).

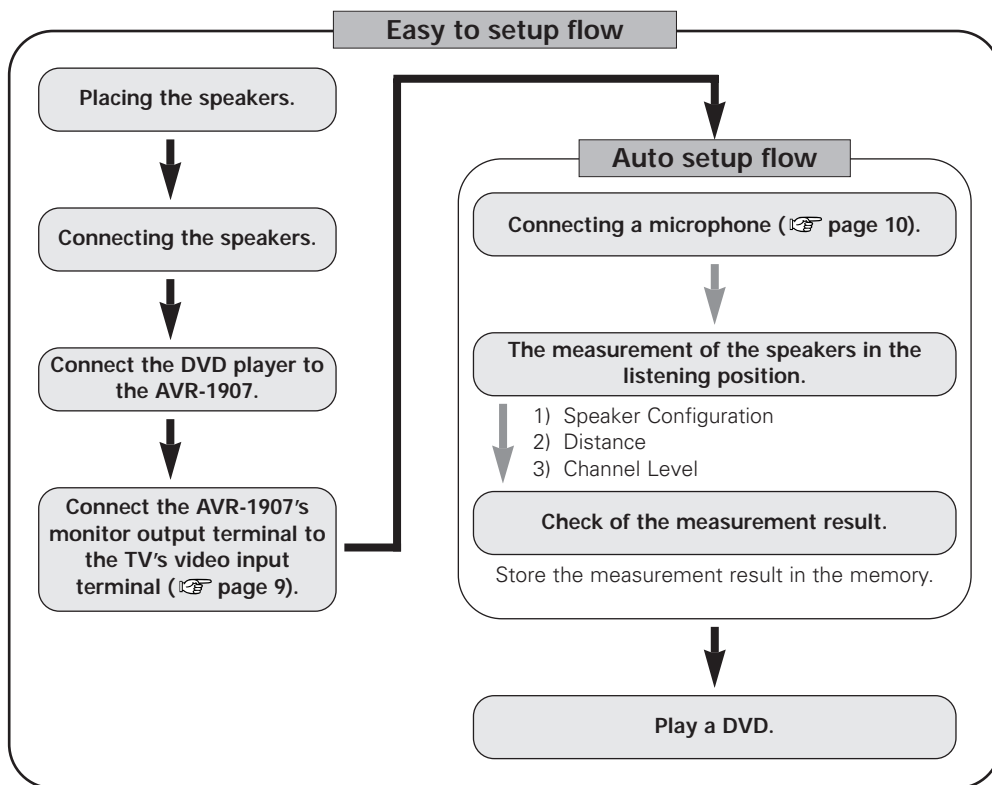

- Do not plug in the power supply cord until all connections have been completed.

## Speaker layout [Basic layout]

Example of basic layout with eight speakers and a monitor.

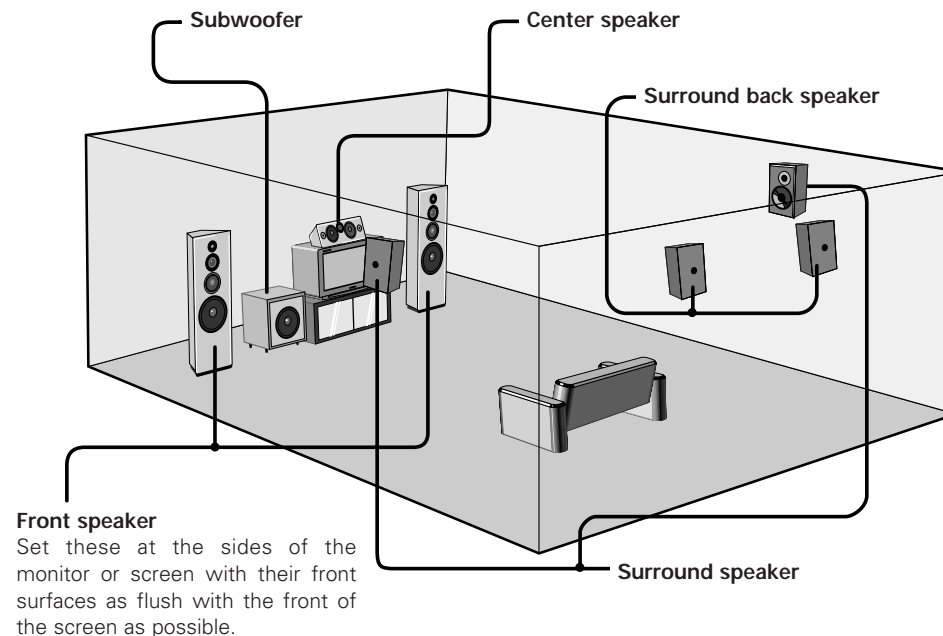

Easy Setup Procedure

**Speaker connections**

Connect the speaker terminals with the speakers making sure that like polarities are matched (⊕ with ⊕, ⊖ with ⊖).

**NOTE:**  
When making connections, take care that none of the individual conductors of the speaker cable come in contact with adjacent terminals, with other speaker cable conductors, or with the rear panel and screws.  
**NEVER touch the speaker terminals when the power is on. Doing so could result in electric shocks.**

**Connecting the speaker cables**

1. Loosen by turning counterclockwise.
  2. Insert the cable.
  3. Tighten by turning clockwise.
- Either tightly twist or terminate the core wires.

**Connecting banana plugs**

Turn clockwise to tighten, then insert the banana plug.

**Speaker impedance**

Speaker	Impedance
Front A, B	6 ~ 16 Ω/ohms
Front A+B	12 ~ 16 Ω/ohms
Center	6 ~ 16 Ω/ohms
Surround	
Surround back / ZONE2	

**Note on speaker impedance**

When using speakers with an impedance below the designated value (for example 4 Ω/ohms), playing for long periods of time with the volume high could cause the temperature to rise, activating the protection circuit. When the protection circuit is activated, the output to the speakers is cut off and the power indicator blinks. If this happens, unplug the power cord, wait for the set to cool off and improve ventilation around the unit. Also check the wiring of the input cables and the speaker cables. After doing this, plug the power cord back in and turn the unit's power back on. If the protection circuit is activated again even though there are no problems with the wiring or the ventilation around the unit, switch off the power and contact a DENON service center.

Easy Setup Procedure

**Connections**

- With the AVR-1907, up to ten speakers can be connected for surround playback.
- When making connections, also refer to the operating instructions of the other components.

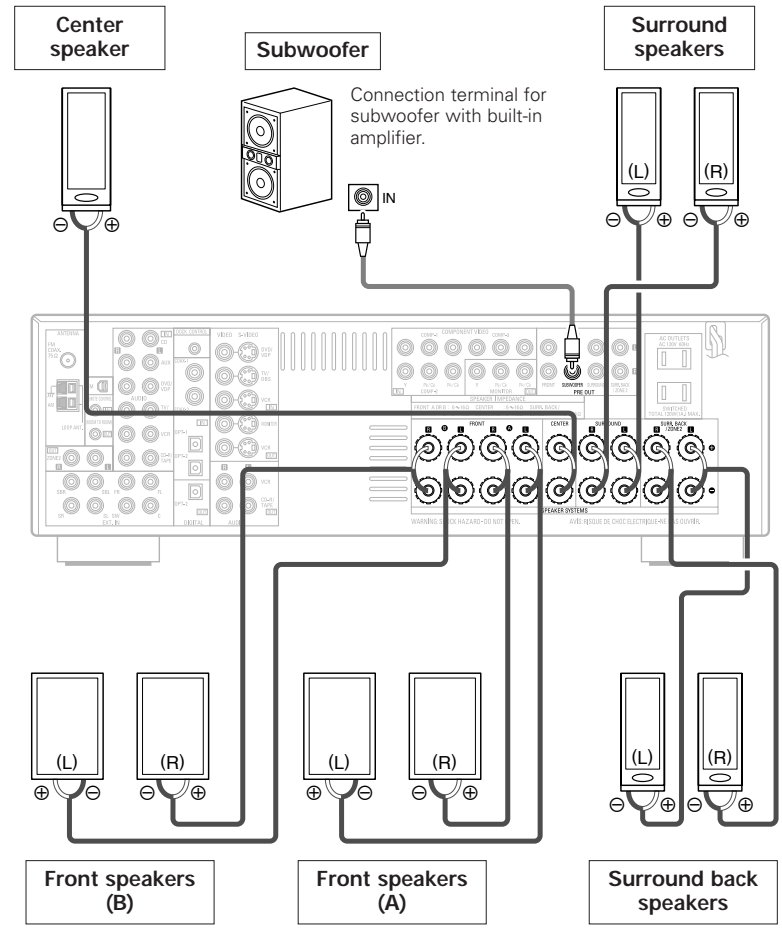

When using only one surround back speaker, connect it to the left channel.

Easy Setup Procedure

Connecting a DVD player and monitor

- To connect the video output from the DVD player to the AVR-1907, you only need to choose one connection type. For more information about the video up conversion function (🔗 page 14).
- To connect the digital audio output from the DVD player, you can choose from either the coaxial or optical connections. If you choose to use the coaxial connection, it needs to be assigned. For more information about Digital Input Assignment (🔗 page 47).

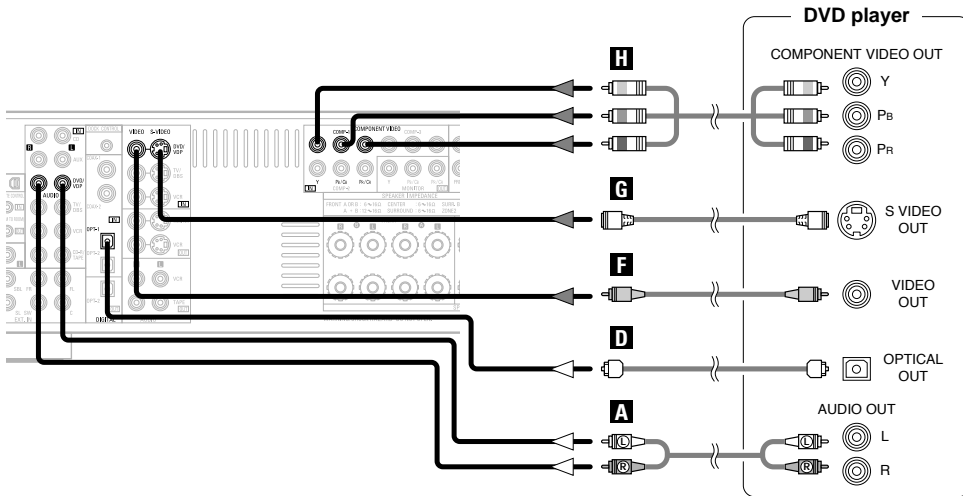

※ Audio signal flow is shown with white arrows, video signal flow is shown with gray arrows.



- The AVR-1907 is equipped with another set of input terminals for a non-DVD video disc player (such as laser disc, VCD/SVCD, or future high definition disc player). The above connection guidelines for DVD also apply to the VDP input.

Easy Setup Procedure

- For best picture quality (especially with progressive DVD and other high definition sources), choose the component video connection to your monitor. S-Video and composite video outputs are also provided if your monitor does not have component video inputs.

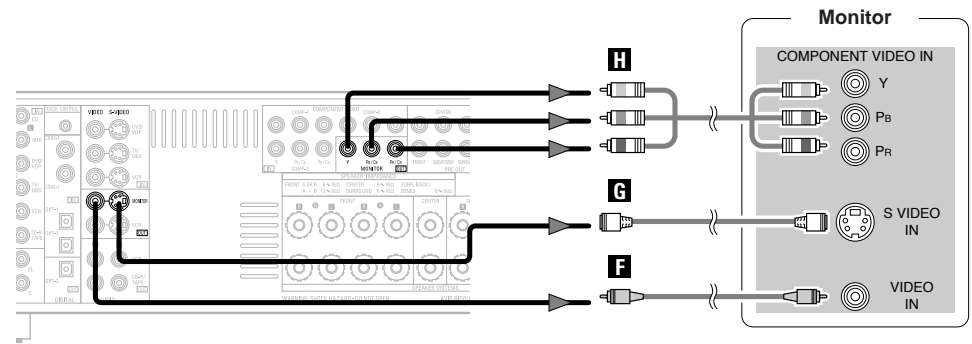

- The component video input and/or output terminals may be labelled differently on some monitors or video components. Check the owner's manuals for other components for further information.

Easy Setup Procedure

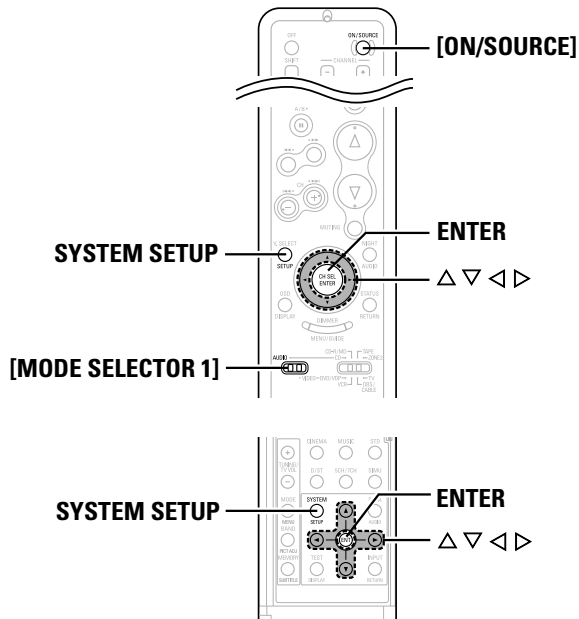
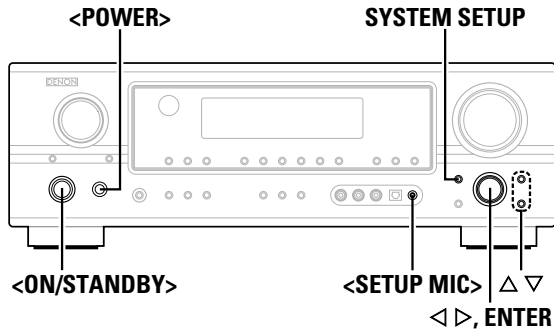

**About the button names in this explanation**  
 < > : Buttons on the main unit  
 [ ] : Buttons on the remote control unit  
**Button name only :**  
 Buttons on the main unit and remote control unit

Easy Setup Procedure

Auto Setup

The AVR-1907's auto setup use the attached microphone to measure the acoustic properties in the room and automatically make the optimum settings.



- To make the sound field settings manually (👉 page 54 ~ 57).

① Connecting a microphone

1 Connect the attached setup microphone to <SETUP MIC>.

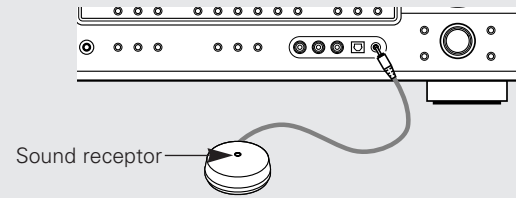

2 Mount the setup microphone on a camera tripod, etc., and set with the receptor pointing towards the ceiling.

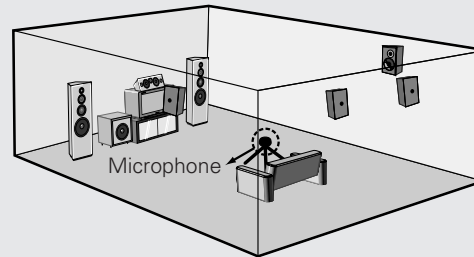

- ※ Place the setup microphone's sound receptor at the height of the ears in the listening position.
- ※ It is not possible to measure properly if there are any obstacles between the speakers and microphone. Check that there are no obstacles.

**NOTE:**

- Once the settings are completed, disconnect the setup microphone.

② Before performing the Auto Setup procedure

1 Turn on your subwoofer.

- ※ Set the volume to halfway and set the crossover frequency to the maximum or Low pass filter off if your subwoofer can adjust the output volume and the crossover frequency.
- ※ Some subwoofers have a standby mode. Be sure to turn this function off before performing the Auto Setup procedure.

2 Turn on your monitor.

3 Press <POWER>.

- ON:  
The power indicator lights red.
- OFF:  
The power turns off and the indicator is off.

4 Press <ON/STANDBY> or [ON/SOURCE].  
 • The power indicator blinks green and the power turns on.

5 Set [MODE SELECTOR 1] to "AUDIO".

Easy Setup Procedure

③ Perform the Auto Setup procedure

1 Press **SYSTEM SETUP**.

2 Press  $\Delta$   $\nabla$  to select “Auto Setup”, then press **ENTER**.

3 Press  $\Delta$   $\nabla$  to select “Auto Setup”, then press **ENTER**.

※ The message “Connect Microphone” is displayed if no microphone is connected. If so, connect the auto setup microphone.

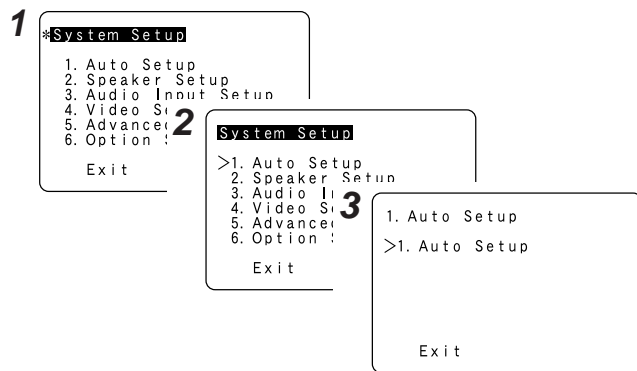

• “System Setup” menu is not displayed when using headphones.

④ Assigning power amplifiers

The surround back output can be assigned to the “Front” or “ZONE2” output.

Press  $\Delta$   $\nabla$  to select “Power Amp Assign”, then press  $\triangleleft$   $\triangleright$  to set.

**Surround Back:**

Assign to use as surround back speaker.

**ZONE2:**

Assign to use as “ZONE2” speakers.

**Front A, Front B:**

Assign to use the “Front A” or “Front B” speakers with bi-amp connections.

※ When assigned to “Front” or “ZONE2”, skip the surround back channel measurement.

※ During the auto setup procedure, test tones are not output to “ZONE2”.

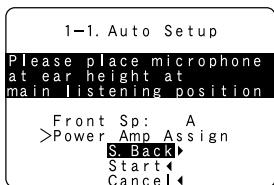

⑤ Switching the front speaker

Press  $\Delta$   $\nabla$  to select “Front Sp”, then press  $\triangleleft$   $\triangleright$  to select the speaker.

Front A  $\longleftrightarrow$  Front B  $\longleftrightarrow$  Front A+B

⑥ Starting Auto Setup

Press  $\Delta$   $\nabla$  to select “Start”, then press  $\triangleleft$ .

• Start the measurements.

※ Measurement of each channel is performed as follows:

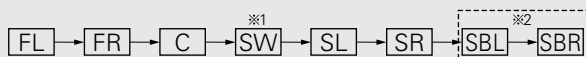

※ 1: The subwoofer speaker is measured twice.

※ 2: Not displayed when “ZONE2” and “Front” are set at “Setting the Power Amplifier Assignment” (page 53). After each channel is measured, “Calculating” appears. The display switches to the Auto Setup check screen automatically.

Easy Setup Procedure

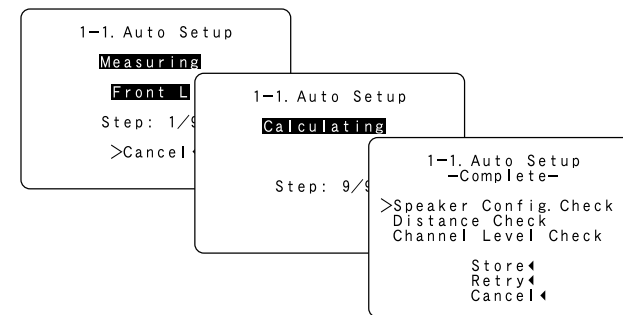

**NOTE:**

- Do not change the speaker connections or subwoofer volume after making the measurements.
- Do not turn off the power while the data is being stored.

**Cautions during measurements:**

- Loud test tones are output during the measurements. Be careful for example when small children are nearby.
- Proper measurements may not be possible if there are obstacles between the speaker and the setup microphone.
- During the measurements, do not stand between or near the speakers and setup microphone.
- To avoid influencing the measurements, turn off the power of air-conditioners or any other equipment producing sound in the room. Perform the measurements with the room as quiet as possible.
- Measurement is cancelled when **VOLUME** is operated while the Auto Setup is performed.

**□ About automatic retry**

To confirm the results of the measurements, remeasurement is automatically performed.

Remeasurement is performed up to two times. During this time, “Retry1” or “Retry2” is displayed on the screen.

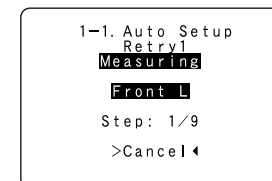

Easy Setup Procedure

Easy Setup Procedure

⑦ Checking and storing the measurement results

**1** Press  $\Delta$   $\nabla$  to select an item, then press **ENTER**.  
 ※ The measurement results of each item can be checked here.

**2** After checking, press **ENTER**, then press  $\Delta$   $\nabla$  to set.

- Store:**  
All the settings are stored in the memory.
- Retry:**  
Perform the measurement again.  
Measurement is repeated.
- Cancel:**  
Cancel the auto setup settings.

**3** When “Store” is selected:  
Press **ENTER**.

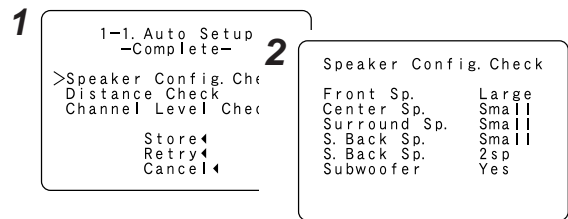

 When measurements have been made using the measurement microphone, speakers with a built-in filter such as subwoofers might be set with a value that differs from the physical distance because of the internal electrical delay.

Error messages

- These error screens may be displayed when performing Auto Setup measurement and the automatic measurements can not be completed because of the speaker arrangement, measurement environment, or other factors. Please check the following matters, reset the pertinent items, and measure again.
- When there is too much noise in the room, the speakers may not be detected properly. Should this happen, perform the measurements when the noise level is low, or switch off the power of the equipment that is producing the noise for the duration of the measurements.

Press  $\Delta$   $\nabla$  to select the items, then press  $\triangleleft$ .

Example	Cause	Measures
<pre> 1-1. Auto Setup -CAUTION- &gt; Front L : None Retry Cancel                     </pre>	① This screen will be displayed when the speakers required for producing suitable reproduction have not been detected.	• Check that the pertinent speakers are properly connected.
<pre> 1-1. Auto Setup -CAUTION- &gt; Front L : Phase Retry Cancel Skip                     </pre>	② This screen will be displayed when the speaker polarity is connected in reverse.	• Check the polarity of the pertinent speakers. For some speakers, this screen may be displayed even though the speakers are properly connected. If so, select “Skip”.
<pre> 1-1. Auto Setup -CAUTION- Mic Input Overload &gt;Exit                     </pre>	③ This screen will be displayed when accurate measurements cannot be made due to the input level of the microphone being too high.	• Set up the speakers so that their position is farther away from the listening position. • Lower the volume of the subwoofer speaker.
<pre> 1-1. Auto Setup -CAUTION- Setup Mic :None Press Enter or Cursor Down to Return to Auto Setup Menu                     </pre>	④ This screen will be displayed when the measurement microphone is not connected.	• Connect the measurement microphone to the microphone connector.

Easy Setup Procedure

Check the parameter

- The results of the measured items can be checked.
- This item is displayed, after the measurement result of the “Auto Setup” is decided.

**1** Press  $\Delta$   $\nabla$  to select “Parameter Check”, then press ENTER.

**2** Press  $\Delta$   $\nabla$  to select the item, then press ENTER.

**3** Press ENTER.

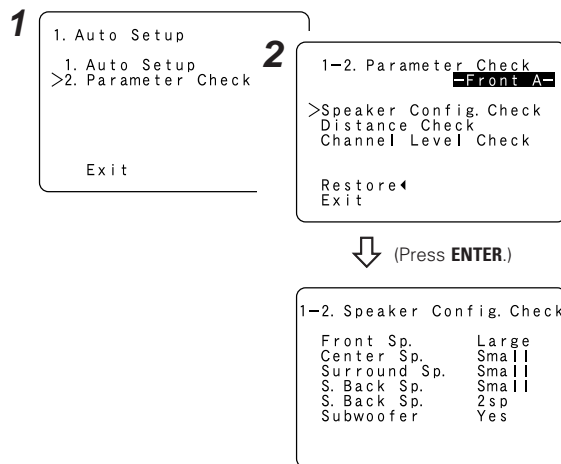

Example: Speaker Configuration Check



- To reset: Press  $\Delta$   $\nabla$  to select “Restore” at the “Parameter Check” screen, then press  $\triangleleft$ .

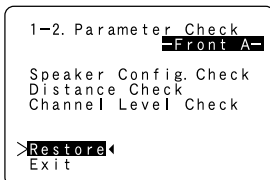

# Connecting Other Sources

## Cable indications

The hookup diagrams on the subsequent pages assume the use of the following optional connection cables (not supplied).

Audio cable	Video cable
<p><b>A</b> Analog connections (Stereo)</p> <p>(White)    </p> <p>(Red)    </p> <p>Pin-plug cable</p> <p><b>B</b> Analog connections (Monaural, for subwoofer)</p> <p> </p> <p>Pin-plug cable</p> <p><b>C</b> Digital connections (Coaxial)</p> <p>(Orange)   </p> <p>Coaxial cable (75 <math>\Omega</math>/ohms pin-plug cable)</p> <p><b>D</b> Digital connections (Optical)</p> <p> </p> <p>Optical fiber cable</p> <p><b>E</b> Speaker connections</p> <p> </p> <p>Speaker cable</p>	<p><b>F</b> Video connections</p> <p>(Yellow)  </p> <p>Video cable (75 <math>\Omega</math>/ohms video pin-plug cable)</p> <p><b>G</b> S-Video connections</p> <p> </p> <p>S-Video cable</p> <p><b>H</b> Component video connections</p> <p>(Green)    (Y)</p> <p>(Blue)    (Pb/Cb)</p> <p>(Red)    (Pr/Cr)</p> <p>Component video cable</p>
Signal direction	
<p>Audio signal </p> <p>Video signal </p>	

**NOTE:**

- Do not plug in the power supply cord until all connections have been completed.
- When making connections, also refer to the operating instructions of the other components.
- Be sure to connect the left and right channels properly (left with left, right with right).
- Do not bundle power cords together with speaker cables. Doing so could result in humming or noise.



Connecting Other Sources

Connecting Other Sources

The video conversion function

With the AVR-1907, the Video signal and the S-Video signal which were inputted are mutually converted. And also the Video signal and the S-Video signal which were inputted are converted into a higher quality.

The flow of the video signals.

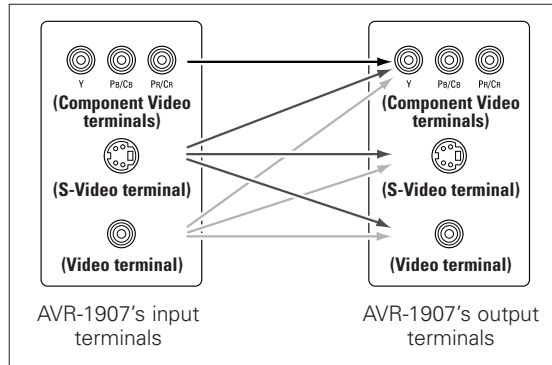

Cautions on the video conversion function:

- When the component video terminals are used to connect the AVR-1907 with a TV (or monitor, projector, etc.) and the video (yellow) or S-Video terminals are used to connect the AVR-1907 with a VCR, depending on the combination of the TV and VCR the picture may flicker in the horizontal direction, be distorted, be out of sync not display at all when playing video tapes. If this happens, connect a commercially available video stabilizer, etc., with a TBC (time base corrector) function between the AVR-1907 and the VCR, or if your VCR has a TBC function, turn it on.

On screen display signals

	Signals input to the AVR-1907		On screen display signal output		
	VIDEO signal input terminal (yellow)	S-Video signal input terminal	Video signal output to VIDEO MONITOR OUT terminal (yellow)	Video signal output to S-Video MONITOR OUT terminal	Video signal output to Component (Color Difference) Video MONITOR OUT terminal
1	×	×	○	○	○
2	○	×	○	○	○
3	×	○	○	○	○
4	○	○	○	○	○

(○: Signal      ×: No signal)      (○: On screen signals output      ×: On screen signals not output)

Connecting Other Sources

Connecting a TV/DBS tuner

- For best picture quality choose the component video connection to your TV or DBS tuner. S-Video and composite video outputs are also provided.
- To connect the digital audio output from the TV or DBS tuner, you can choose from either the coaxial or optical connections. If you choose to use the coaxial connection, it needs to be assigned. For more information about Digital Input Assignment (page 47).

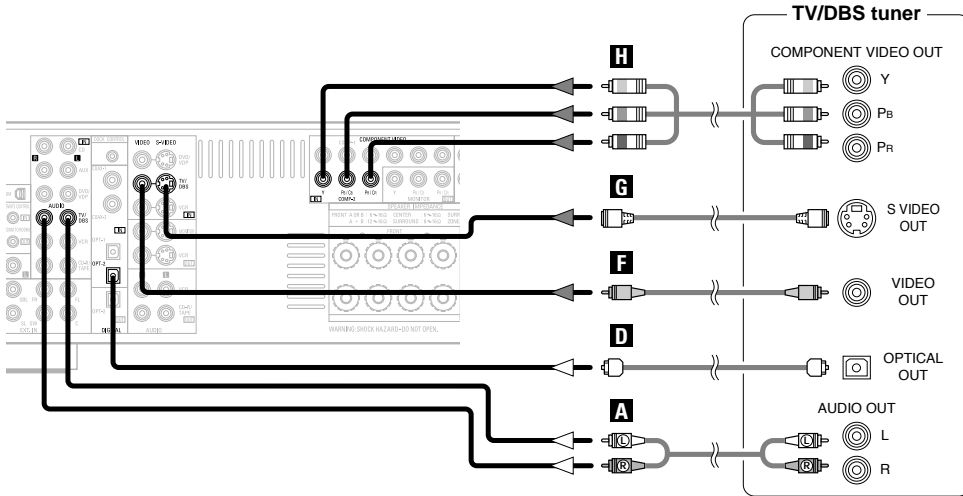

Connecting Other Sources

Connecting the external inputs (EXT. IN) terminals

- These terminals are for inputting multi-channel audio signals from an outboard decoder, or a component with a different type of multi-channel decoder, such as a DVD-Audio player, or a multi-channel Super Audio CD player, or other future multi-channel sound format decoder.
- The video signal connection is the same as that for a DVD player (page 9).
- For instructions on playback using the external input (EXT. IN) terminals (page 21).

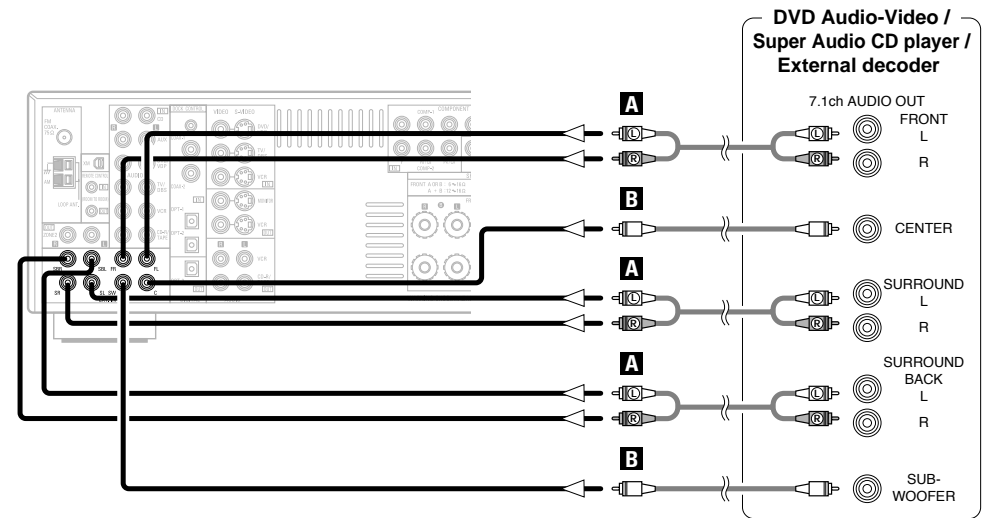

Connecting a video camera or video game

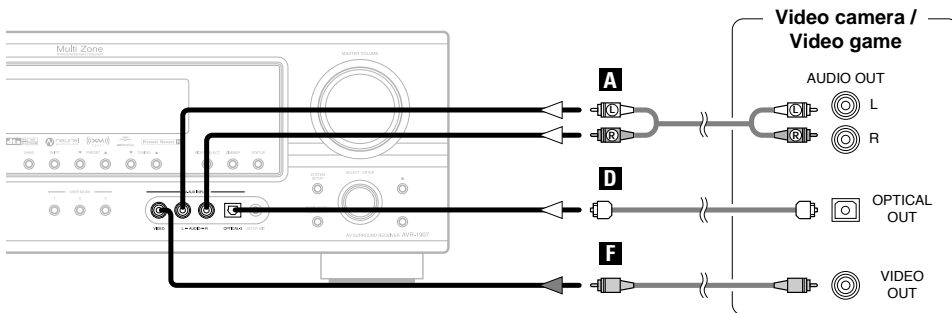

- With discs on which special copyright protection measures have been taken, however, the digital signals may not be output from the DVD player. In this case, connect the DVD player's analog multi-channel output to the AVR-1907's EXT. IN terminals for playback. Also refer to your DVD player's operating instructions.

Connecting Other Sources

Connecting a CD player

To connect the digital audio output from the CD player, you can choose from either the coaxial or optical connections. If you choose to use the optical connection, it needs to be assigned. For more information about Digital Input Assignment (📖 page 47).

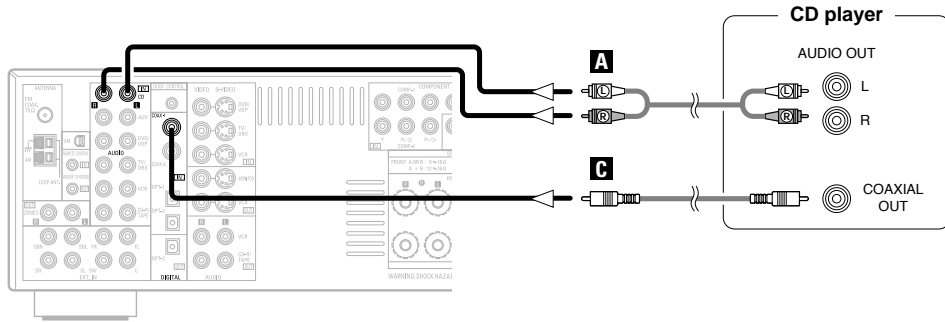

Connecting a tape deck

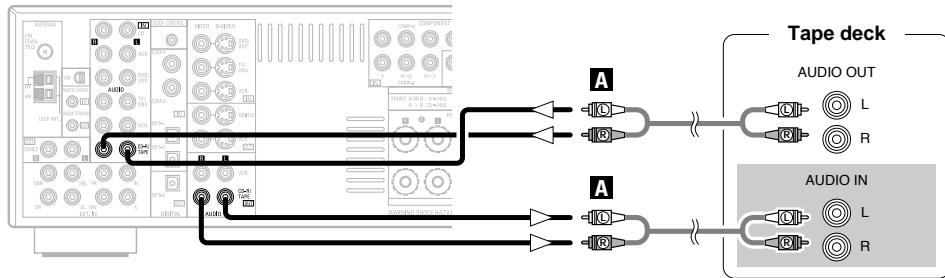

Connecting Other Sources

Connecting a VCR

- For best picture quality choose the component video connection to your VCR. S-Video and composite video outputs are also provided.
- If you wish to perform analog dubbing from a digital source, such as a DVD recorder to an analog recorder such as a cassette deck, you will need to connect the analog inputs and outputs as shown below, in addition to the digital audio connections.
- The digital inputs and outputs connection is the same as that for a CD (MD) recorder.
- If you choose to use the coaxial or optical connection, it needs to be assigned. For more information about Digital Input Assignment (📖 page 47).

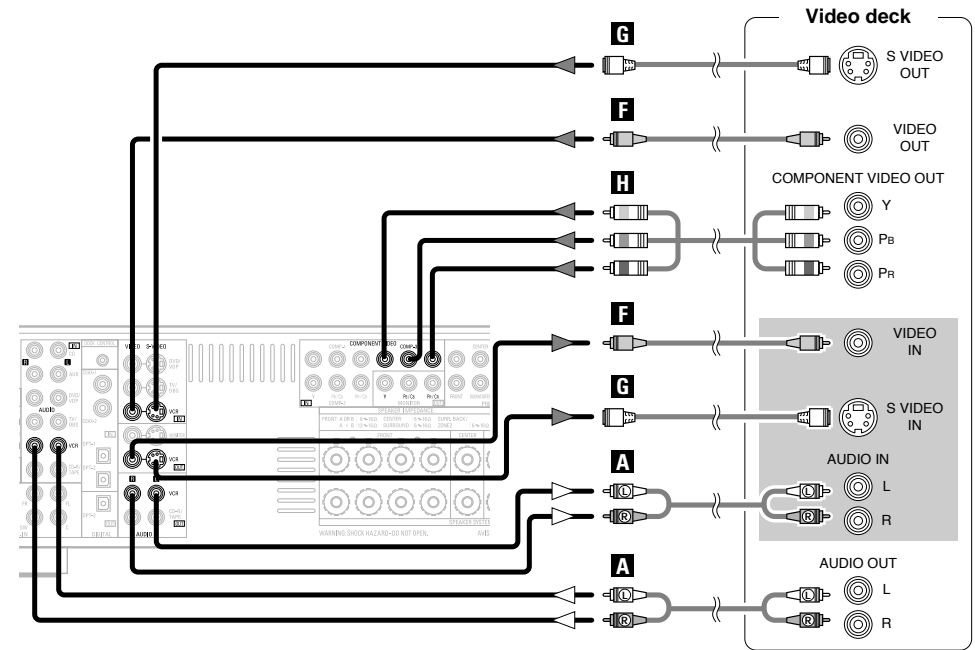

- When recording to a VCR, it is necessary that the type of cable used with the playback source equipment be the same type that is connected to the AVR-1907 VCR OUT terminal.

**Example:** TV IN → S-Video cable : VCR OUT → S-Video cable  
 TV IN → Video cable : VCR OUT → Video cable

Connecting Other Sources

Connecting a CD recorder or MD recorder

- If you wish to perform analog dubbing from a digital source, such as a CD or MD recorder to an analog recorder such as a tape deck, you will need to connect the analog inputs and outputs as shown below, in addition to the digital audio connections.
- If you choose to use the coaxial or optical connection, it needs to be assigned. For more information about Digital Input Assignment (see page 47).

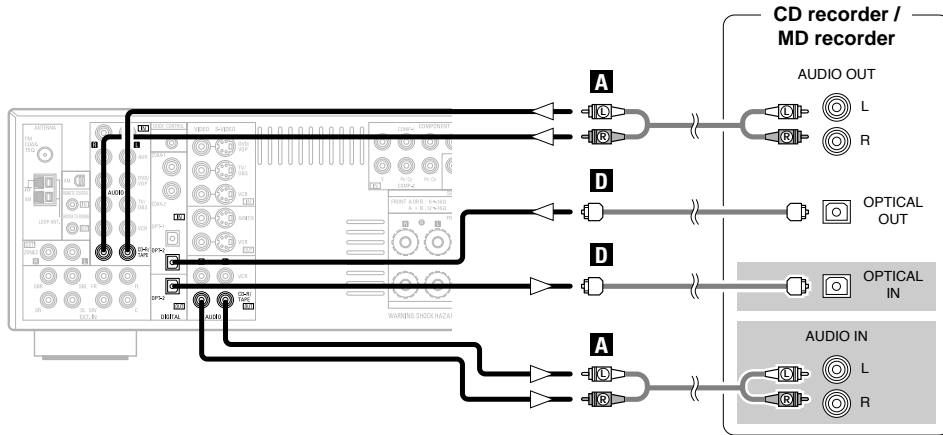

- The source selected for MAIN ZONE is output from the digital output terminal (OPT-2). The source selected in the REC SELECT mode is not associated with the output from the digital output terminal (OPT-2).

**NOTE:**

- Do not connect the output of the component connected to the OPTICAL 2 OUT terminal on the AVR-1907's rear panel to any terminal other than the OPTICAL 2 IN terminal.

Connecting Other Sources

Connecting the antenna terminals

An F-type FM antenna cable plug can be connected directly.

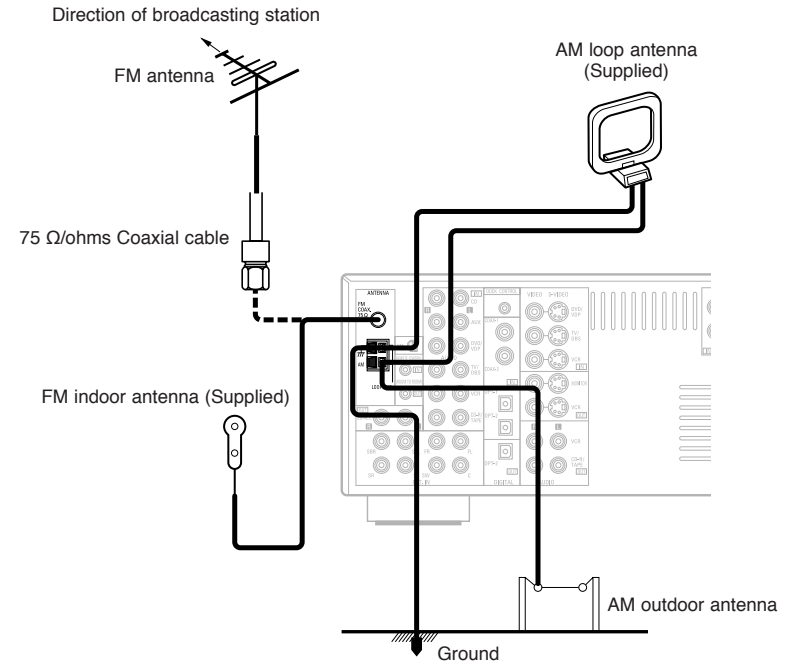

AM loop antenna assembly

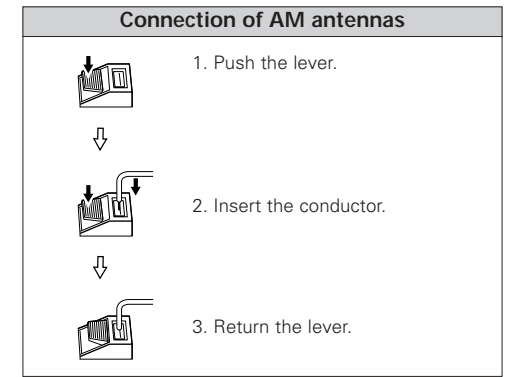
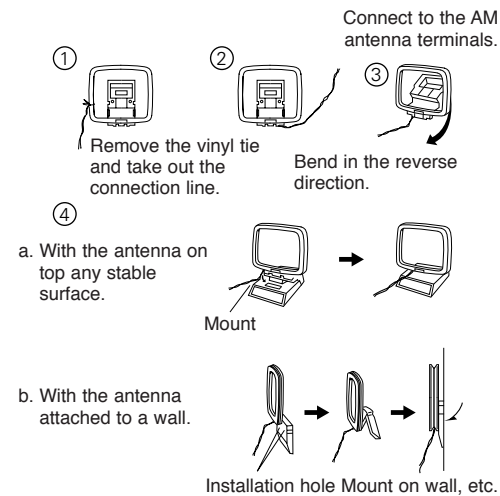

Connecting Other Sources

**NOTE:**

- Do not connect two FM antennas simultaneously.
- Even if an external AM antenna is used, do not disconnect the AM loop antenna.
- Make sure the AM loop antenna lead terminals do not touch metal parts of the panel.

**Note to CATV system installer:**

This reminder is provided to call the CATV system installer's attention to Article 820-40 of the NEC which provides guidelines for proper grounding and, in particular, specifies that the cable ground shall be connected to the grounding system of the building, as close to the point of cable entry as practical.

Connecting the XM terminal

- AVR-1907 is the XM Ready® receiver. You can receive XM® Satellite Radio by connecting to the XM Passport System (sold separately) and subscribing to the XM service.
- Plug the XM Passport System into XM terminal on the rear panel.
- Position the XM Passport System near a south-facing window to receive the best signal. For details, see "XM Satellite Radio" (page 34, 35).  
When making connections, also refer to the operating instructions of the XM Passport System.

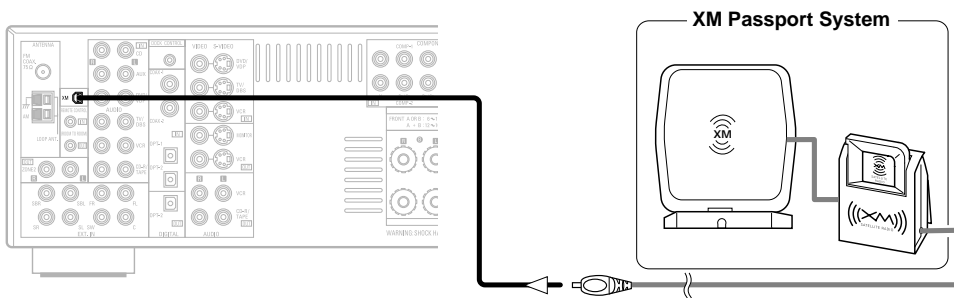

**NOTE:**

- Keep the power supply cord unplugged until the XM Passport System connection has been completed.

- The XM name and related logo are registered trademarks of XM Satellite Radio Inc. All rights reserved.
- XM Ready is a registered trademark of XM Satellite Radio Inc. All rights reserved.

Connecting Other Sources

Connecting the iPod®

When using an iPod, you must connect the Control Dock for iPod (ASD-1R, sold separately) and the DOCK CONTROL jack on the AVR-1907 with a mini-jack and assign the iPod to any AUDIO and/or S-VIDEO terminal(s).

The diagram below shows an example of connections for when the iPod is assigned to the DVD/VDP terminal.

- ※ For instructions on assigning the iPod to a specific terminal, see "Setting the iPod Assignment" (page 48).
- ※ For instructions on playing the iPod, see "Playing the iPod" (page 37).

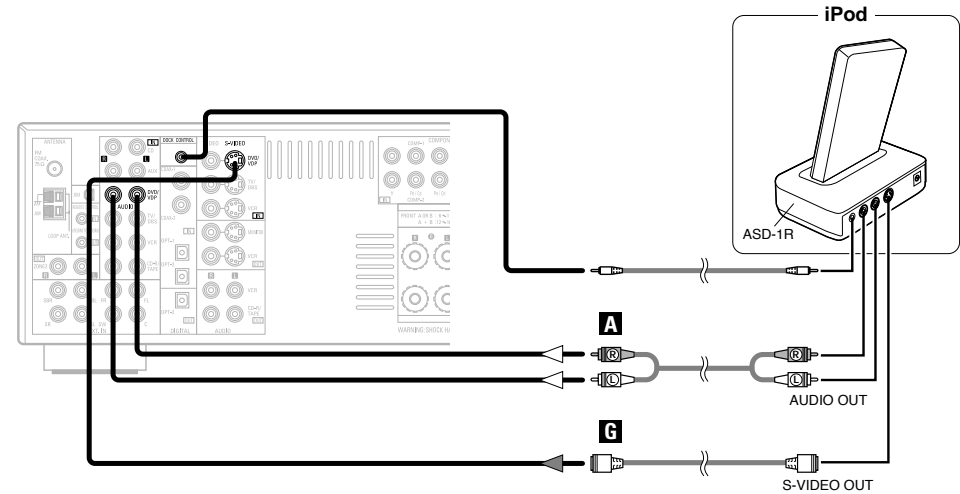

- The optional standard Control Dock for iPod is DENON ASD-1R sold separately.

Connecting Other Sources

Connecting the MULTI ZONE terminals

\* For instructions on operations using the MULTI ZONE functions (page 39 ~ 41).

ZONE2 out connections

- When the power amplifier is assigned to the ZONE2 output channel at “Power Amp Assignment” in the “System Setup” menu, the surround back pre-out terminals can be used as the ZONE2 pre-out terminals (page 53).
- If another power amplifier or pre-main (integrated) amplifier is connected, the ZONE2 out (variable/fixed level) terminals can be used to play a different program source in ZONE2 the same time (page 39, 40).
- When a sold separately room-to-room remote control unit (DENON RC-616, 617 or 618) is wired and connected between the MAIN ZONE and ZONE2, the remote-controllable devices in the MAIN ZONE can be controlled from ZONE2 using the remote control unit.

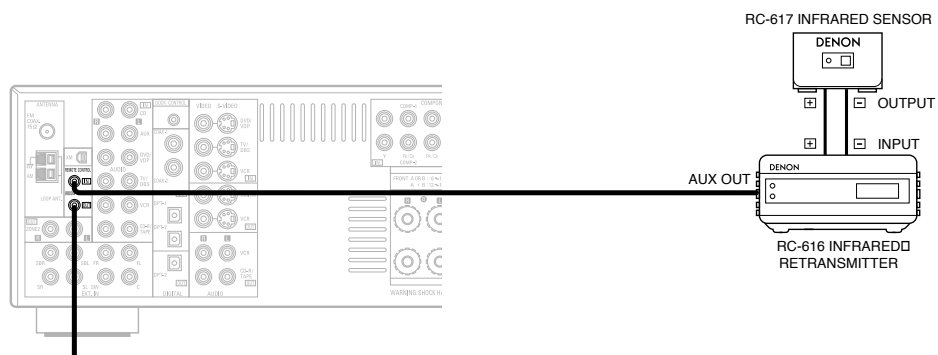
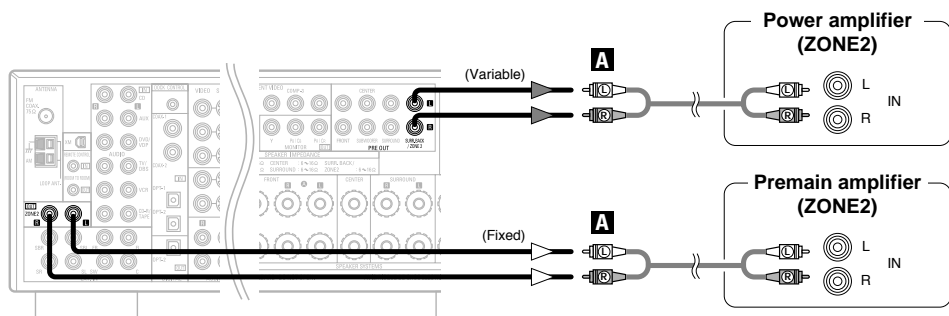

**NOTE:**  
 • For instructions on installation and operation of separately sold devices, refer to the devices' operating instructions.

Connecting Other Sources

ZONE2 speaker out connections

- When the power amplifier is assigned to the ZONE2 output channel at “Power Amp Assignment” in the “System Setup” menu, the surround back speaker terminals can be used as the ZONE2 speaker out terminals (page 53).
- The connections diagram below is an example for when the surround back speaker is assigned to the ZONE2 stereo 2 channel. In this case, surround back speaker out can not be used for MAIN ZONE.

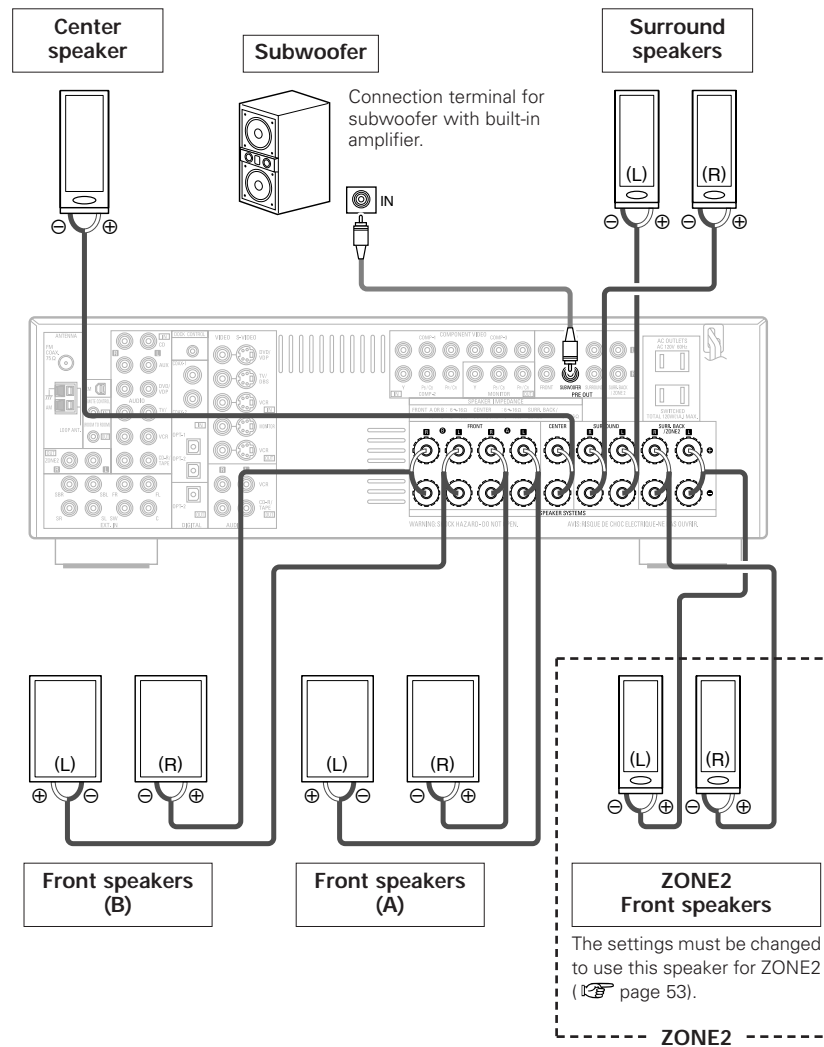

Connecting Other Sources

Connecting the PRE OUT terminals

- Use these terminals if you wish to connect external power amplifier(s) to increase the power of the front, center, surround and surround back sound channels, or for connection to powered loudspeakers.
- When using only one surround back speaker, connect it to the left channel.

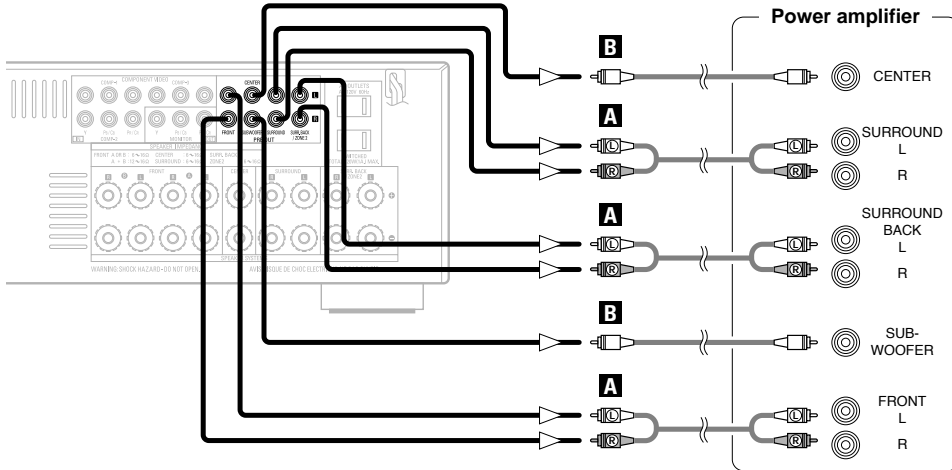

Connecting Other Sources

Connecting the power supply cord

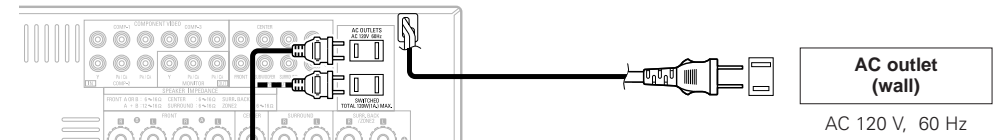

**AC OUTLETS**

- **SWITCHED** (total capacity – 120 W (1 A))  
The power to the outlet is turned on and off in conjunction with the **POWER** switch on the main unit, and when the power is switched between on and standby from the remote control unit.  
No power is supplied from this outlet when this unit's power is at standby. Never connect equipment whose total power consumption exceeds 120 W (1 A).

**NOTE:**

- Insert the plugs securely. Incomplete connections will result in the generation of noise.
- Only use the AC OUTLETS for audio equipment. Never use it for hair driers, monitors or other electrical appliances.

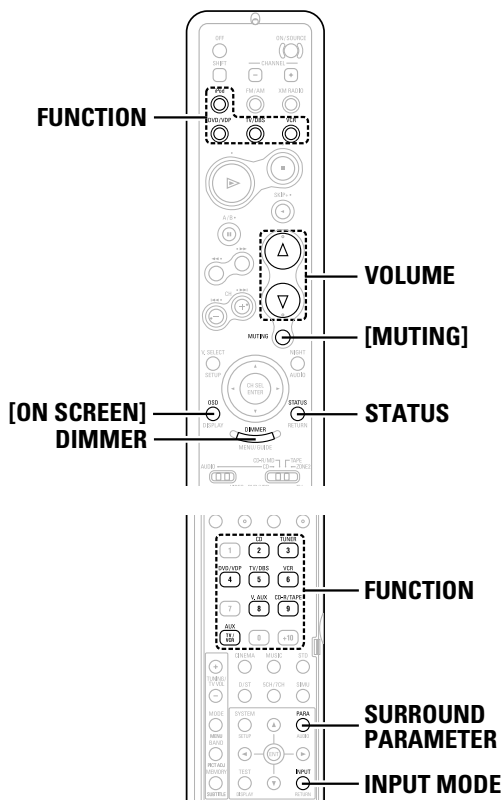
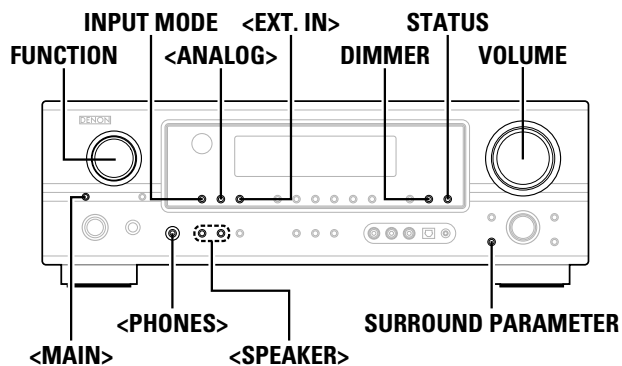

**About the button names in this explanation**  
 < > : Buttons on the main unit  
 [ ] : Buttons on the remote control unit  
**Button name only :**  
 Buttons on the main unit and remote control unit

## Basic Operation

### Playing the input source

#### 1 Use **FUNCTION** to select the input source you want to play.

※ To select the input source when ZONE2/REC SELECT is selected, press <MAIN> then operate <FUNCTION>.

#### 2 Press **INPUT MODE**.

• The input mode indicator lights.

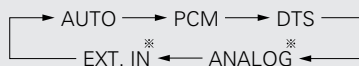

※ Press <ANALOG> to select "ANALOG", <EXT. IN> to select "EXT. IN".

#### **AUTO** (All auto mode):

The type of input signal is detected and the AVR-1907's surround mode is switched automatically. Can be selected for sources for which the "Digital In Assignment" (page 47) is made. The mode switches automatically to DTS / Dolby Digital / PCM. The input switches to the analog input terminals is no digital signals are being input.

#### **PCM** (exclusive PCM signal playback mode) and **DTS** (exclusive DTS signal playback mode):

Played when the various signals are input. Noise may be generated when a mode different from the input signal is set.

#### **ANALOG** (exclusive analog audio signal playback mode) and **EXT. IN** (External decoder input terminal selection mode):

The signals input to the various input terminals are played.  
 ※ To lower the subwoofer channel level in the EXT. IN mode, press **SURROUND PARAMETER** and select "SW. ATT". For some players the playback level of the SW channel may be seen strong. If so, set to "ON".

#### 3 Start playback on the selected component.

※ For operating instructions, refer to the component's manual.

#### 4 Use **VOLUME** to adjust the volume.

• The volume level is displayed on the master volume level display.

※ The volume can be adjusted between the range of -80 ~ 0 ~ 18 dB. Depending on the channel level settings and the different surround mode settings and when in the down-mix mode, it may not be possible to adjust the volume to 18 dB.



- Canceling the EXT. IN mode:  
Press **INPUT MODE** or <ANALOG> to switch to the desired input mode.
- To use the EXT. IN mode together with a picture, select the input source to which the video signal is connected first, then set the input mode.
- The "DIGITAL" indicator lights when digital signals are being input properly. If the "DIGITAL" indicator does not light, check whether the "Digital In Assignment" (page 47) and connections are correct.

#### **NOTE:**

- When the input mode is set to the external input (EXT. IN), the surround mode cannot be set.
- In play modes other than the external input mode, the signals connected to these terminals cannot be played.

#### **Cautions when playing DTS sources:**

- For DTS sources, be sure to connect the device to the digital input terminal and set "AUTO" or "DTS" for the input source. Noise will be generated if you play in the "ANALOG" or "PCM" mode.
- When playing DTS signals in the "AUTO" mode, noise may be generated when you first start playing and during searching. If so, play in the "DTS" mode.



## Basic Operation

## Turning the sound off temporarily (MUTING)

Press **[MUTING]**.

※ You can adjust the muting level (🔊 page 53).



- Canceling MUTING mode:  
To cancel the muting mode, either press **[MUTING]** or adjust the volume.

## Listening over headphones

Connect the headphones to **<PHONES>**.

- No sound is produced from the speakers automatically.

## NOTE:

- To prevent hearing loss, be careful not to raise the volume level excessively when using headphones.

## Switching the front speakers

Press **<SPEAKER>** to turn the corresponding speaker pair on.

※ The front speaker A, B setting can be also be changed with **<SPEAKER>**.

Checking the currently playing program source, etc.

 On screen display

Press **[ON SCREEN]**.

- The current program source and various settings are displayed on the monitor screen.

 Front panel display

Press **STATUS**.

- The current program source and various settings are indicated on the display.

## Switching the brightness of the display

Press **DIMMER**.

※ The brightness of the display can be adjusted in three steps. The display can also be turned off.

## Basic Operation

## Using the surround modes

## Types of surround modes and their features

The AVR-1907 is equipped with many surround modes. We recommend using the surround modes as described below in order to achieve the maximum effect for the specific signal source.

※  is a 6.1-channel/7.1-channel surround mode.

## Sources recorded in Dolby Digital EX

**DOLBY DIGITAL EX / +PLIIx\*** (🔊 page 24)

- This mode is optimized for playing sources recorded in Dolby Digital EX.

## Sources recorded in DTS-ES

**DTS-ES DSCRT 6.1 / MTRX 6.1, +PLIIx\*** (🔊 page 24)

- This is the optimum mode for playing sources recorded in DTS-ES.

Dolby Digital or DTS Surround (5.1 ch sources)  
2 ch sources recorded in Dolby Surround

**DOLBY DIGITAL / DOLBY DIGITAL+PLIIx\* /  
DTS SURROUND / DTS 96/24 / DTS+PLIIx\* /  
DTS+NEO:6** (🔊 page 24)

- This mode is optimized for playing 5.1-channel or 7.1-channel music.
- For Dolby Surround recording sources, Dolby Pro Logic II playback is conducted.

## 2-channel sources recorded in XM HD Surround

**NEURAL SURROUND** (🔊 page 26)

- This is the optimum mode for playing sources recorded in XM HD Surround.

Basic Operation

Sources recorded in stereo  
Sources recorded in monaural

**DIRECT / STEREO**

- Effective for achieving pure playback.
- If there is no need for tone control or distribution of the low frequencies in function of the speaker configuration, select the DIRECT mode to achieve the best sound quality.

**DENON Original Surround Modes** (☞ page 30, 31)

- Select these for 7.1-channel playback with sources recorded in stereo or monaural.
- The effects are different for each of the surround modes. Select the one most suited for the source being used.

**DTS NEO:6** (☞ page 26)

- This is a surround mode for playing 6.1- or 7.1-channel stereo sources developed by Digital Theater Systems.
- One of two playing modes, MUSIC (for music sources) or CINEMA (for movie sources), can be selected according to your preferences.

**DOLBY PRO LOGIC IIx\*** (☞ page 25)

- Developed by Dolby Laboratories, this surround mode provides 7.1-channel surround sound with conventional stereo (2-channel) sources.
- Select CINEMA mode for movie surround soundtracks, MUSIC for music sources, and GAME for 2-channel game box audio sources.



- Surround modes marked with an asterisk (\*) cannot be used when the surround back speaker is set to "NONE".
- The "+PLIIx Cinema" mode cannot be selected when only one surround back speaker is being used.

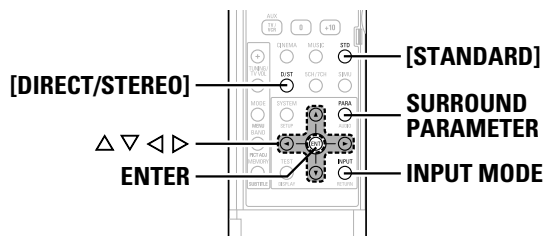
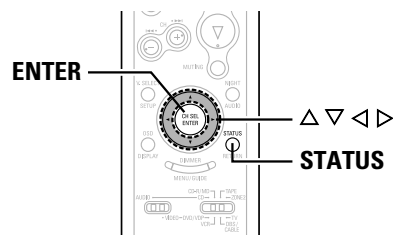
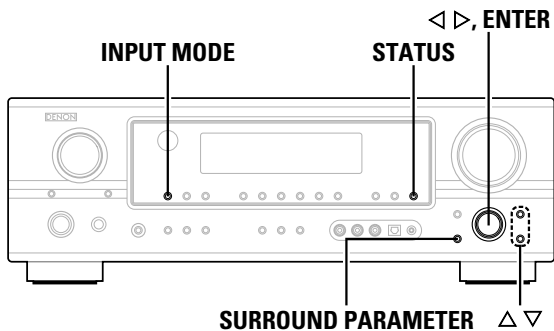

**About the button names in this explanation**

< > : Buttons on the main unit  
[ ] : Buttons on the remote control unit

**Button name only :**  
Buttons on the main unit and remote control unit

Basic Operation

**Selecting the play mode (DIRECT/STEREO)**

The AVR-1907 is equipped with two 2-channel playback modes exclusively for music. Select the mode to suit your tastes.

**DIRECT mode**

This mode is for playing with high quality sound. The audio signals are transmitted directly, without passing through the tone circuits, etc.

Press **[DIRECT/STEREO]** to select "DIRECT".

DIRECT ←→ STEREO





**STEREO mode**

Use this mode to adjust the tone and achieve the desired sound.

Press **[DIRECT/STEREO]** to select "STEREO".

Basic Operation

Selecting the Dolby Digital and DTS Surround mode (only with digital input)

- 1 Select an input source for which digital (COAXIAL or OPTICAL) is set (☞ page 47).
- 2 Press INPUT MODE to select "AUTO".
- 3 Press [STANDARD] to select "STANDARD (Dolby/DTS Surround)".
- 4 Play a program source with the ,  mark.
  - "  DIGITAL " or "  " lights, depending on the source.
- 5 Press SURROUND PARAMETER.
- 6 Press  $\Delta$   $\nabla$  to select the item, then press  $\triangleleft$   $\triangleright$  to set.

CINEMA EQ.:

Use this if movie dialogues sound harsh to lower the treble sound.  
 ※ Effective source mode  
 Dolby Pro Logic IIx / Dolby Pro Logic / Dolby Digital / DTS Surround / DTS NEO:6

D.COMP.:

The dynamic range is compressed. Select one of four modes: "OFF", "LOW", "MID" (middle) or "HIGH".  
 ※ Effective source mode  
 Dolby Digital / DTS (For DTS sources, only displayed for compatible software.)



LFE:

To play the various types of software properly, we recommend setting to the values shown below.  
 • To play Dolby Digital software: "0 dB"  
 • To play DTS movie software: "0 dB"  
 • To play DTS music software: "-10 dB"

TONE:

Adjust the tone control.  
 ※ Can be set in surround modes other than direct mode.  
 ※ Can be set separately for the different surround modes. (Adjusted together for the Dolby/DTS SURROUND modes.)

SB CH OUT:

Select the play mode or surround back channel playback method.  
 • The "   " or "  " indicator lights.

(1) For multi-channel sources

- **SB OFF (OFF):**  
Not played.
- **NON MTRX:**  
Surround channel signal played.
- **MTRX ON:**  
Surround channel signal played with digital matrix processing.
- **ES MTRX:**  
DTS signal played with digital matrix processing.
- **ES DSCRT:**  
Signal included in DTS-ES discrete 6.1-channel sources played.
- **PLIIx CINEMA:**  
Decoded in Dolby Pro Logic IIx Cinema mode, surround back signal played.  
 ※ Set the surround back speaker to "2sp" at "Speaker Configuration" (☞ page 54, 55).
- **PLIIx MUSIC:**  
Decoded in Dolby Pro Logic IIx Music mode, surround back signal played.  
 ※ Set the surround back speaker to "1sp" or "2sp" at "Speaker Configuration" (☞ page 54, 55).

(2) For 2-channel sources

- **OFF:** Not played.
- **ON:** Surround channel signal played.

7 Press ENTER or SURROUND PARAMETER.

5

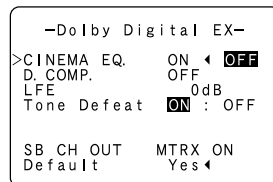

Example: Dolby Digital

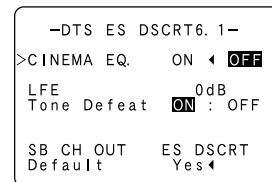

Example: DTS



- Select "Default Yes" and press  $\triangleleft$  to reset all the settings.

Dialog normalization function

This operates automatically when playing Dolby Digital sources. This is a function for automatically correcting the standard signal level for different program sources. The correction value can be checked by pressing STATUS.

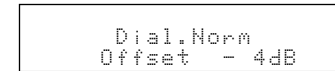

The numbers are the correction value when corrected to the standard level.

Basic Operation

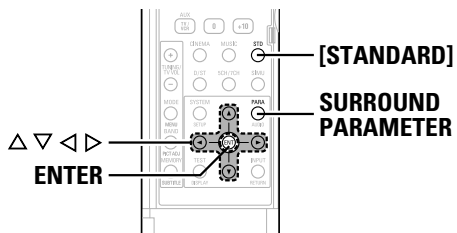
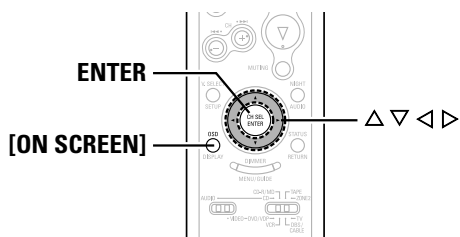
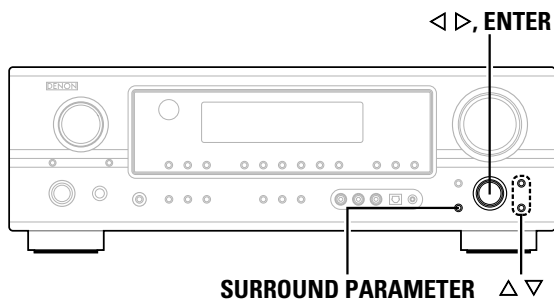

**About the button names in this explanation**  
 < > : Buttons on the main unit  
 [ ] : Buttons on the remote control unit  
**Button name only :**  
 Buttons on the main unit and remote control unit

**Selecting the Dolby Pro Logic IIx (Pro Logic II) mode**

It is possible to play analog input signals and digital input signals (2-channels) in the surround mode. This mode is optimal for playing program sources recorded in Dolby Surround.

**1** Press [STANDARD] to select “DOLBY PLIIx”.

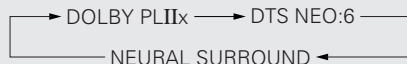

**2** Play a program source.

**3** Press SURROUND PARAMETER.

**4** Press < > to select the play mode.

**CINEMA:**

This mode is suited for playing movie sources recorded in Dolby Surround and general sources recorded in stereo.

**MUSIC:**

This mode is suited for playing stereo music signals in the surround mode. With music signals, the sound field expansion differs according to the type of music, the recording conditions (live/studio), etc.. Because of this, the MUSIC mode offers a number of optional parameters for further adjusting the sound field.

**GAME:**

This mode is optimum for games. The GAME mode can only be used for 2-channel audio sources.

**PL:**

This mode is compatible with conventional Dolby Pro Logic sources.

**5** Press  $\Delta$   $\nabla$  to select the item, then press < > to set.

When “MUSIC” mode is selected:

**PANORAMA:**

This is effective when the surround effect seems weak.

**DIMENSION:**

This shifts the center of the sound field image to the front or surround side. This compensates for when the sound field image seems unbalanced. (0 to 6, default : 3)

**CENTER WIDTH:**

A natural expansion to the front can be achieved by adjusting the center signal's output balance between the center and front channels. (0 to 7, default : 3)

**6** Press ENTER or SURROUND PARAMETER.

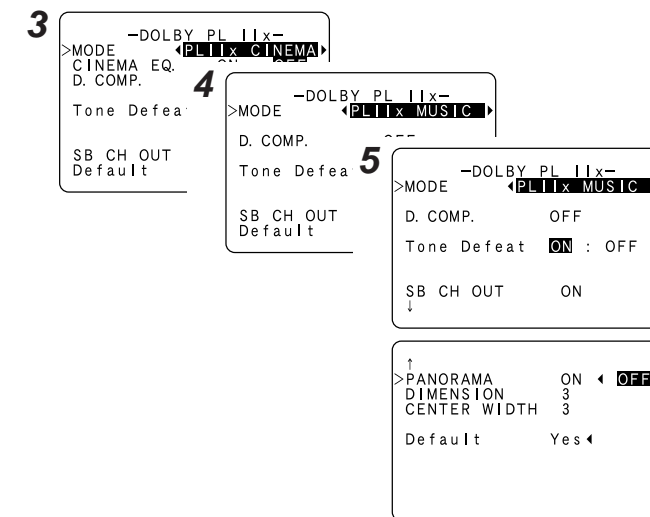

(When “MUSIC” is selected)

Basic Operation

Selecting the DTS NEO:6 mode

It is possible to play analog input signals and digital input signals (2-channels) in the surround mode.

1 Press [STANDARD] to select "DTS NEO:6".

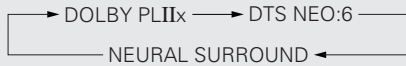

2 Play a program source.

3 Press SURROUND PARAMETER.

4 Press ◀▶ to select the play mode.

CINEMA:

This mode is optimum for playing movies. Decoding is performed with emphasis on separation performance to achieve the same atmosphere with 2-channel sources as with 6.1-channel sources.

MUSIC:

This mode is suited mainly for playing music.

5 Press ▲▼ to select the item, then press ◀▶ to set.

When "MUSIC" mode is selected:

CNTR. IMAGE:

The expansion of the center channel can be adjusted. (0.0 to 1.0, default : 0.3)

6 Press ENTER or SURROUND PARAMETER.

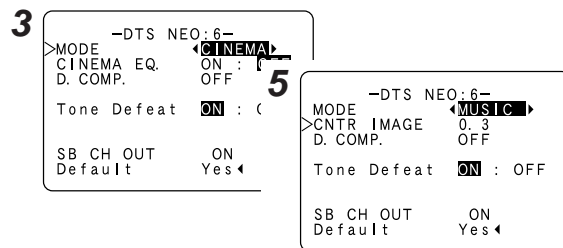

(When "MUSIC" is selected)

Selecting the NEURAL SURROUND mode

It is possible to play analog input signals and digital input signals (2-channels) in the surround mode.

This is the optimum mode for playing sources recorded in XM HD Surround (see page 34, 35).

1 Press [STANDARD] to select "NEURAL SURROUND".

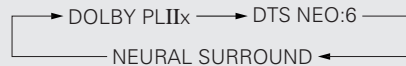

2 Play a program source.

3 Press SURROUND PARAMETER.

4 Press ▲▼ to select the item, then press ◀▶ to set.

5 Press ENTER or SURROUND PARAMETER.

Checking the input signals

1 Press [ON SCREEN].

SIGNAL:

Displays the type of input signal.

fs:

Displays the input signal's sampling frequency.

FORMAT:

Displays the input signal's number of channels (front / surround / LFE on/off). "SURROUND" is displayed for 2-channel signal sources recorded in Dolby Surround.

Basic Operation

OFFSET:

Displays the dialog normalization offset value.

FLAG:

"MATRIX" is displayed if the input signal has undergone matrix processing, "DISCRETE" is displayed if the input signal has undergone discrete processing.

2 Press [ON SCREEN] again.

- ※ OSD-1 : Input signal
- OSD-2 : Input/output settings
- OSD-3 : Auto surround mode
- OSD-4 ~ 6 : USER MODE 1 ~ 3
- OSD-7 ~ 13 : Tuner preset stations

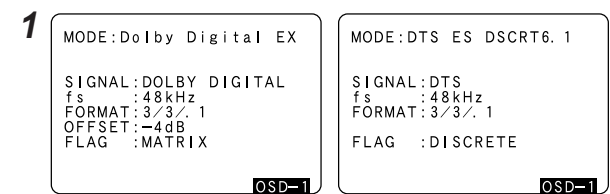

Example: Dolby Digital

Example: DTS



- "OSD-1"- "FLAG" is not displayed if there is no FLAG identification signal in the input signal.
- OSD-3: This is displayed when the auto surround mode is set to "ON" (see page 52) and the input mode is set to "AUTO". It is not displayed when the input mode is set to "ANALOG" or "EXT. IN".

Surround modes and parameters

Surround Mode	Signals and adjustability in the different modes																			
	Channel output					Parameter (default values are shown in parentheses)														
	FRONT L/R	CENTER	SURROUND L/R	SURROUND BACK L/R	SUB-WOOFER	D. COMP *1	LFE *2	SB CH OUT	TONE CONTROL	CINEMA EQ.	MODE	ROOM SIZE	EFFECT LEVEL	Dolby Digital NIGHT mode	DELAY TIME	PRO LOGIC II/IIx MUSIC MODE only			NEO:6 MUSIC MODE only	EXT. IN only
															PANORAMA	DIMENSION	CENTER WIDTH	CENTER IMAGE	SW ATT	
STEREO	○	×	×	×	⊙	○ (OFF)	○ (0 dB)	×	○ (0 dB)	×	×	×	×	○ (OFF)	×	×	×	×	×	×
EXT. IN	○	⊙	⊙	⊙	⊙	×	×	×	×	×	×	×	×	×	×	×	×	×	×	○
DOLBY PRO LOGIC IIx	○	⊙	⊙	⊙	⊙	○ (OFF)	×	○	○ (0 dB)	○ (NOTE 2)	○ (CINEMA)	×	×	○ (OFF)	×	○ (OFF)	○ (3)	○ (3)	×	×
DOLBY PRO LOGIC II	○	⊙	⊙	×	⊙	○ (OFF)	×	○	○ (0 dB)	○ (NOTE 3)	○ (CINEMA)	×	×	○ (OFF)	×	○ (OFF)	○ (3)	○ (3)	×	×
DTS NEO:6	○	⊙	⊙	⊙	⊙	○ (OFF)	×	○	○ (0 dB)	○ (NOTE 2)	○ (CINEMA)	×	×	○ (OFF)	×	×	×	×	○ (0.3)	×
DOLBY DIGITAL	○	⊙	⊙	⊙	⊙	○ (OFF)	○ (0 dB)	○	○ (0 dB)	○ (OFF)	×	×	×	○ (OFF)	×	×	×	×	×	×
DTS SURROUND	○	⊙	⊙	⊙	⊙	○ (OFF)	○ (0 dB)	○	○ (0 dB)	○ (OFF)	×	×	×	×	×	×	×	×	×	×
NEURAL SURROUND	○	⊙	⊙	⊙	⊙	×	×	○	○	×	×	×	×	×	×	×	×	×	×	×
5CH/7CH STEREO	○	⊙	⊙	⊙	⊙	○ (OFF)	○ (0 dB)	○	○ (0 dB)	×	×	×	×	○ (OFF)	×	×	×	×	×	×
MONO MOVIE	○	⊙	⊙	⊙	⊙	○ (OFF)	○ (0 dB)	○	○ (0 dB)	×	×	○ (Medium)	○ (10)	○ (OFF)	×	×	×	×	×	×
ROCK ARENA	○	⊙	⊙	⊙	⊙	○ (OFF)	○ (0 dB)	○	○ (NOTE 1)	×	×	○ (Medium)	○ (10)	○ (OFF)	×	×	×	×	×	×
JAZZ CLUB	○	⊙	⊙	⊙	⊙	○ (OFF)	○ (0 dB)	○	○ (0 dB)	×	×	○ (Medium)	○ (10)	○ (OFF)	×	×	×	×	×	×
VIDEO GAME	○	⊙	⊙	⊙	⊙	○ (OFF)	○ (0 dB)	○	○ (0 dB)	×	×	○ (Medium)	○ (10)	○ (OFF)	×	×	×	×	×	×
MATRIX	○	⊙	⊙	⊙	⊙	○ (OFF)	○ (0 dB)	○	○ (0 dB)	×	×	×	×	○ (OFF)	○ (30 msec)	×	×	×	×	×
VIRTUAL	○	×	×	×	⊙	○ (OFF)	○ (0 dB)	×	○ (0 dB)	×	×	×	×	○ (OFF)	×	×	×	×	×	×

○ : Signal  
 × : No signal  
 ⊙ : Turned on or off by speaker configuration setting

○ : Adjustable  
 × : Not adjustable  
 NOTE 1 : BASS +6 dB, TREBLE +4 dB  
 NOTE 2 : This parameter is available when the "MODE" is set to "CINEMA".  
 NOTE 3 : This parameter is available when the "MODE" is set to "CINEMA" or "PL".  
 \*1: When playing Dolby Digital and DTS signals.  
 \*2: When playing Dolby Digital, DTS, DVD-Audio and Super Audio CD.

○ : Signal  
 × : No signal

○ : Adjustable  
 × : Not adjustable

□ Differences in surround mode names depending on the input signals

Button	Surround Mode	Note	Input signals													
			ANALOG	LINEAR PCM	DTS				DOLBY DIGITAL					DVD-AUDIO		
					DTS ES DSCRT (With Flag)	DTS ES MTRX (With Flag)	DTS (5.1ch)	DTS 96/24	DOLBY DIGITAL EX (With Flag)	DOLBY DIGITAL EX (With no Flag)	DOLBY DIGITAL (5.1ch)	DOLBY DIGITAL (3, 4, 5ch)	DOLBY DIGITAL (2ch)	DVD-Audio (multi ch)	DVD-Audio (2ch)	176.4/ 192kHz
STANDARD																
DTS SURROUND																
	DTS ES DSCRT6.1	*1	×	×	●	×	×	×	×	×	×	×	×	×	×	×
	DTS ES MTRX6.1	*1	×	×	×	●	×	×	×	×	×	×	×	×	×	×
	DTS SURROUND		×	×	○	○	●	×	×	×	×	×	×	×	×	×
	DTS 96/24		×	×	×	×	●	×	×	×	×	×	×	×	×	×
	DTS + PLIIx CINEMA	*2	×	×	○	○	○	○	×	×	×	×	×	×	×	×
	DTS + PLIIx MUSIC	*1	×	×	○	○	○	○	×	×	×	×	×	×	×	×
	DTS + NEO:6	*1	×	×	×	○	○	○	×	×	×	×	×	×	×	×
	DTS NEO:6 CINEMA		○	○	×	×	×	×	×	×	×	×	○	×	○	×
	DTS NEO:6 MUSIC		○	○	×	×	×	×	×	×	×	×	○	×	○	×
DOLBY SURROUND																
	DOLBY DIGITAL EX	*1	×	×	×	×	×	×	○	○	○	○	×	×	×	×
	DOLBY DIGITAL		×	×	×	×	×	×	○	●	●	●	×	×	×	×
	DOLBY DIGITAL+PLIIx CINEMA	*2	×	×	×	×	×	×	●	○	○	○	×	×	×	×
	DOLBY DIGITAL+PLIIx MUSIC	*1	×	×	×	×	×	×	○	○	○	○	×	×	×	×
	DOLBY PRO LOGIC IIx CINEMA		○	○	×	×	×	×	×	×	×	×	●	×	○	×
	DOLBY PRO LOGIC IIx MUSIC		○	○	×	×	×	×	×	×	×	×	○	×	○	×
	DOLBY PRO LOGIC IIx GAME		○	○	×	×	×	×	×	×	×	×	○	×	○	×
	DOLBY PRO LOGIC II CINEMA		○	○	×	×	×	×	×	×	×	×	○	×	○	×
	DOLBY PRO LOGIC II MUSIC		○	○	×	×	×	×	×	×	×	×	○	×	○	×
	DOLBY PRO LOGIC II GAME		○	○	×	×	×	×	×	×	×	×	○	×	○	×
	DOLBY PRO LOGIC		○	○	×	×	×	×	×	×	×	×	○	×	○	×
	NEURAL SURROUND		○	○	×	×	×	×	×	×	×	×	×	×	○	×

- : Mode selectable in default status
- : Selectable mode
- ×

**NOTE :**

\*1: This mode is not available when the Surround Back speaker setup is set to "None".

\*2: This mode is not available when the Surround Back speaker setup is set to "1sp" or "None".

Basic Operation

Basic Operation

Button	Surround Mode	Note	Input signals														
			ANALOG	LINEAR PCM	DTS				DOLBY DIGITAL					DVD-AUDIO			
					DTS ES DSCRT (With Flag)	DTS ES MTRX (With Flag)	DTS (5.1ch)	DTS 96/24	DOLBY DIGITAL EX (With Flag)	DOLBY DIGITAL EX (With no Flag)	DOLBY DIGITAL (5.1ch)	DOLBY DIGITAL (3, 4, 5ch)	DOLBY DIGITAL (2ch)	DVD-Audio (multi ch)	DVD-Audio (2ch)	176.4/ 192kHz	
DIRECT	DIRECT		○	○	○	○	○	○	○	○	○	○	○	○	×	○	○
DSP SIMULATION	5CH/7CH STEREO	*1	○	○	○	○	○	○	○	○	○	○	○	○	○	×	×
	MONO MOVIE		○	○	○	○	○	○	○	○	○	○	○	○	○	×	×
	ROCK ARENA		○	○	○	○	○	○	○	○	○	○	○	○	○	×	×
	JAZZ CLUB		○	○	○	○	○	○	○	○	○	○	○	○	○	×	×
	VIDEO GAME		○	○	○	○	○	○	○	○	○	○	○	○	○	×	×
	MATRIX		○	○	○	○	○	○	○	○	○	○	○	○	○	×	×
	VIRTUAL		○	○	○	○	○	○	○	○	○	○	○	○	○	×	×
STEREO	STEREO		●	●	○	○	○	○	○	○	○	○	○	○	○	●	●

- : Mode selectable in default status
- : Selectable mode
- ×

**NOTE :**

\*1: If the Surround Back speaker setup is set to "None", then "5CH STEREO" is displayed.



## Using the DENON original surround modes

The AVR-1907 is equipped with a high performance digital signal processor (DSP) that uses digital signal processing to recreate sound fields artificially. One of seven surround modes can be selected according to the program source and parameters can be further adjusted to achieve even more realistic sound fields.

### Types of surround modes and their features

<b>5CH/7CH STEREO (NOTE 1)</b>	This mode lets you enjoy stereo sound with seven speakers. The front L (R) channel signals are played from the surround and surround back L (R) channels and only the in-phase component of the L and R channels is played on the center channel.
<b>MONO MOVIE (NOTE 2)</b>	This mode recreates the atmosphere of an expansive sound field for movie sources recorded in monaural.
<b>ROCK ARENA</b>	This mode recreates the atmosphere of a live concert in an arena.
<b>JAZZ CLUB</b>	This mode recreates the atmosphere of a live concert in a club with low ceilings, hard walls and the artist just in front of you.
<b>VIDEO GAME</b>	This mode provides a rich sense of presence for video games.
<b>MATRIX</b>	This mode recreates music sources recorded in stereo with an enhanced sense of expansion.
<b>VIRTUAL</b>	This mode can be used to enjoy surround sound with only front speakers or when using headphones.

**NOTE 1:** "5CH STEREO" is displayed when "SB CH OUT" is set to "OFF".

**NOTE 2:** When playing sources recorded in monaural, the sound will be one-sided if signals are only input to one channel (left or right), so input signals to both channels. If you have a source component with only one audio output (monophonic camcorder, etc.) obtain a "Y" adapter cable to split the mono output to two outputs, and connect to the L and R inputs.



- Depending on the program source being played, the effect may not be very noticeable. In this case, try other surround modes, without worrying about their names, to create a sound field suited to your tastes.

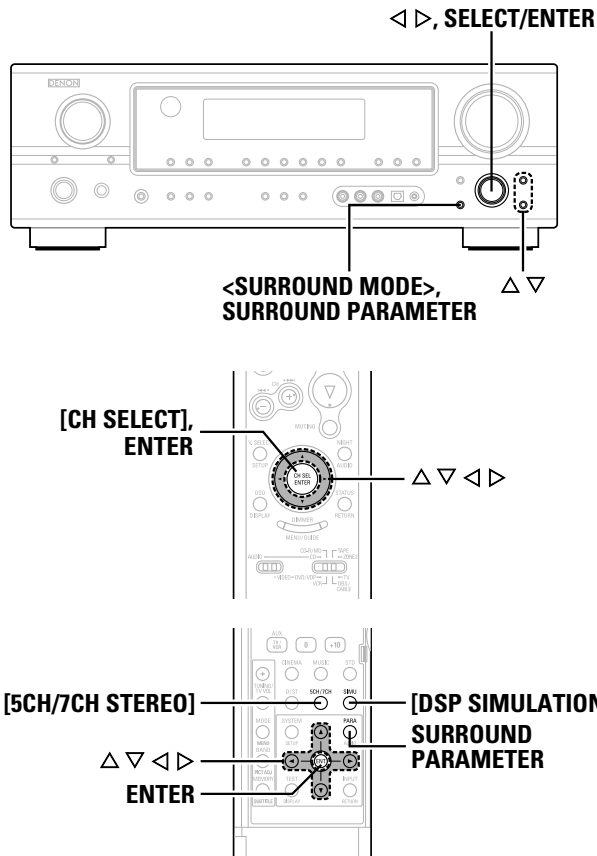

**About the button names in this explanation**  
 < > : Buttons on the main unit  
 [ ] : Buttons on the remote control unit  
**Button name only :**  
 Buttons on the main unit and remote control unit

**Selecting the DSP surround simulation**

To operate the surround mode and the surround parameters from the remote control unit

**1 Press [DSP SIMULATION].**

```

    5CH/7CH STEREO*  →  MONO MOVIE
    ↑                   ↓
    VIRTUAL             ROCK ARENA
    ↑                   ↓
    MATRIX ← VIDEO GAME ← JAZZ CLUB
    
```

※ The 5CH/7CH STEREO mode can be selected directly by pressing [5CH/7CH STEREO].

**2 Press SURROUND PARAMETER.**

**3 Press <▽> to select the item, then press <> to set.**

**SB CH OUT**  
 • ON:  
 Surround back channel played.  
 • OFF:  
 Surround back channel not played.

**ROOM SIZE:**  
 Adjust the imaginary size of the recreated sound field space. (Does not express size of room in which played.)  
 There are five parameters: "small", "med.s", "medium", "med.l" and "large".

**EFFECT LEVEL:**  
 Adjust the strength of the surround effect.

**DELAY TIME: (MATRIX mode only)**  
 Adjust the delay time between "0 ms" and "110 ms".

**4 Press ENTER or SURROUND PARAMETER.**



• Select "Default Yes" and press <◀ to reset all the settings.

Operating the surround mode and the surround parameters from the main unit's panel

**1 Use <SELECT/ENTER> to select the surround mode.**

```

    DIRECT ↔ STEREO ↔ DOLBY PRO LOGIC IIx
    ↙           ↘
    5CH/7CH STEREO ↔ NEURAL SURROUND ↔ DTS NEO:6
    ↙           ↘
    MONO MOVIE ↔ ROCK ARENA ↔ JAZZ CLUB
    ↙           ↘
    VIRTUAL SURROUND ↔ MATRIX ↔ VIDEO GAME
    
```

※ To select the surround mode while adjusting the surround parameters, tone defeat or tone control, press <SURROUND MODE>, then operate the selector.

**2 Perform steps 2 to 4 under "Selecting the DSP surround simulation".**

Basic Operation

Setting the tone control

Adjust the bass and treble to suit your tastes.

Adjusting the tone

1 Press **SURROUND PARAMETER**.

2 Press  $\Delta \nabla$  to select "TONE DEFEAT".

※ In the direct mode, "TONE" cannot be selected.

3 Press  $\triangleright$  to select "OFF".

4 Press  $\Delta \nabla$  to select "Bass" or "Treble", then press  $\triangleleft \triangleright$  to set the level.

※ Can be adjusted within the range of -10 dB to +10 dB.

5 Press **ENTER** or **SURROUND PARAMETER**.

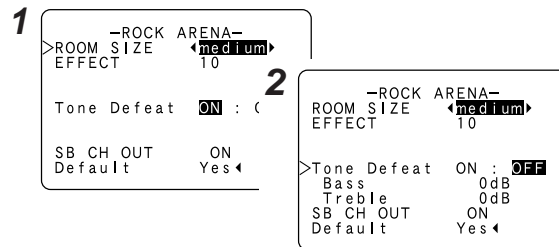

When you do not want to adjust the tone

Set "Tone Defeat" to "ON" at step 3 in "Adjusting the tone".

Adjusting the speaker volume

1 Press **[CH SELECT]**.

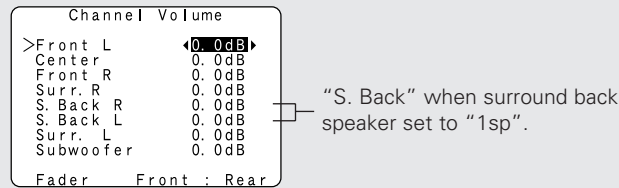

2 Press **[CH SELECT]** to select the speaker.

※ The settable speaker switches each time this button is pressed.

3 Press **[ $\triangleleft \triangleright$ ]** to adjust the volume.

※ The SW channel level can be turned off by decreasing it one step from -12.0 dB.

OFF  $\leftrightarrow$  -12.0 dB  $\leftrightarrow$  +12.0 dB

Basic Operation

Using the fader function

With this function, the volume of all the front side speakers or all the rear side speakers can be adjusted (attenuated) at once.

1 Press **[CH SELECT]**.

2 Press  $\Delta \nabla$  or **[CH SELECT]** to select "Fader".

3 Press  $\triangleleft$  to attenuate the volume of all the front side speakers,  $\triangleright$  to attenuate the volume of all the rear side speakers.

※ The fader function does not affect the subwoofer.

※ It is possible to adjust so that the volume of the speaker whose volume is the lowest is -12 dB.

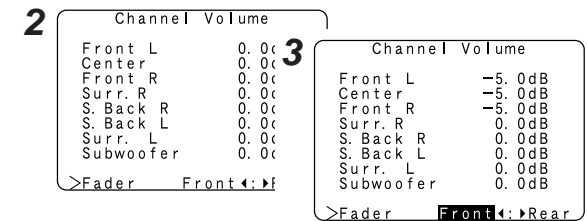

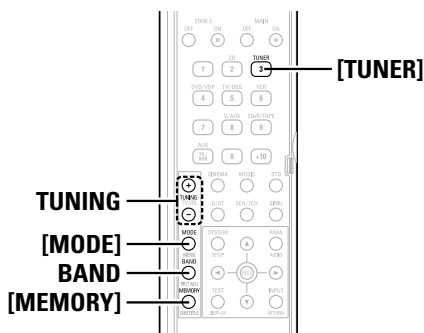
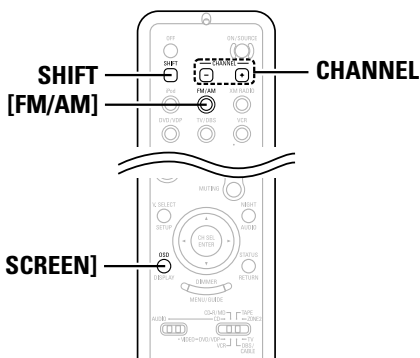
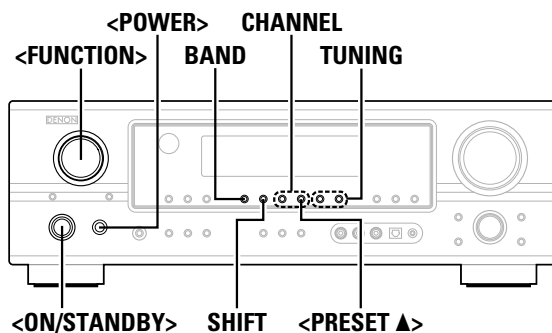

**About the button names in this explanation**  
 < > : Buttons on the main unit  
 [ ] : Buttons on the remote control unit  
**Button name only :**  
 Buttons on the main unit and remote control unit

**Listening to the radio**

Check that the remote control unit is set to "AUDIO".

**Auto preset memory**

This unit is equipped with a function for automatically searching for FM broadcast stations and storing them in the preset memory.

**1** Switch off the unit using <POWER>.

**2** Hold <PRESET Δ> and press <POWER>.  
 • The unit automatically begins searching for FM broadcast stations.

- ※ When the first FM broadcast station is found, that station is stored in the preset memory at channel A1. Subsequent stations are automatically stored in order at preset channels A1 to A8, B1 to B8, C1 to C8, D1 to D8, E1 to E8, F1 to F8 and G1 to G8 for a maximum of 56 stations.
- ※ Channel A1 is tuned in after the auto preset memory operation is completed.

- If an FM station cannot be preset automatically due to poor reception, use the "Manual tuning" operation to tune in the station, then preset it using the manual "Preset memory" operation.
- To interrupt this function, press <ON/STANDBY>.

**Auto tuning**

**1** Use <FUNCTION> to select "TUNER" or press [TUNER].

**2** Press BAND to select "AM", "FM" or "XM".  
 ※ When listening to the XM Satellite Radio (see page 34, 35).

**3** Press [MODE] to set the auto tuning mode.  
 • The "AUTO" indicator lights.

**4** Press TUNING.  
 • Automatic searching begins.

- If tuning does not stop at the desired station, use to the "Manual tuning" operation.
- "AM" or "FM" can be selected directly by pressing [FM/AM].

**Manual tuning**

**1** Use <FUNCTION> to select "TUNER" or press [TUNER].

**2** Press BAND to select "AM", "FM" or "XM".  
 ※ When listening to the XM Satellite Radio (see page 34, 35).

**3** Press [MODE] to set the manual tuning mode.  
 ※ Check that the display's "AUTO" indicator turns off.

**4** Press TUNING.  
 ※ The frequency changes continuously when the button is held in.

- When the manual tuning mode is set, FM stereo broadcasts are received in monaural and the "STEREO" indicator turns off.
- "AM" or "FM" can be selected directly by pressing [FM/AM].

## Basic Operation

## Preset memory

- 1** Use the “Auto tuning” or “Manual tuning” operation to tune in the station to be preset in the memory.
- 2** Press **[MEMORY]**.
- 3** Press **SHIFT** to select the desired memory block (A to G).
- 4** Press **CHANNEL** to select the desired preset channel (1 to 8).
- 5** Press **[MEMORY]** again.
  - Store the station in the preset memory.



- To preset other channels, repeat steps 2 to 5.  
A total of 56 broadcast stations can be preset — 8 stations (channels 1 to 8) in each of blocks A to G.
- The memory block can also be selected by pressing **SHIFT**.

## Checking the preset stations

Press **[ON SCREEN]** repeatedly until the “Tuner Preset Stations” screen appears on the on screen display.

```

Tuner Preset Stations
A1 FM 87.50MHz
A2 FM 89.10MHz
A3 FM 98.10MHz
A4 FM107.90MHz
A5 FM 90.10MHz
A6 FM 90.10MHz
A7 FM 90.10MHz
A8 FM 90.10MHz
OSD-7
  
```

## Recalling preset stations

- 1** Press **SHIFT** to select the memory block.
- 2** Press **CHANNEL** to select the desired preset channel.

## Basic Operation

## XM Satellite Radio

AVR-1907 is the XM Ready receiver. You can receive XM<sup>®</sup> Satellite Radio by connecting to the XM Passport System (sold separately) and subscribing to the XM service.

 **Introducing XM Satellite Radio**

There's a world of audio listening pleasure beyond AM and FM. XM Satellite Radio. Select from over 170 channels of music, news, sports, comedy, talk, and entertainment. Coast-to-coast coverage. Digital quality sound. With all music channels 100% commercial free. Questions?: Visit [www.xmradio.com](http://www.xmradio.com).

 **How to Subscribe**

Listeners can subscribe by visiting XM on the Web at [www.xmradio.com](http://www.xmradio.com) or by calling XM's Listener Care at (800) 967-2346. Customers should have their Radio ID and credit card ready. The Radio ID can be found by selecting channel 0 on the radio.

 **A Warning Against Reverse Engineering**

It is prohibited to copy, decompile, disassemble, reverse engineer, or manipulate any technology incorporated in receivers compatible with the XM Satellite Radio system. Furthermore, the AMBE<sup>®</sup> voice compression software included in this product is protected by intellectual property rights including patent rights, copyrights, and trade secrets of Digital Voice Systems, Inc. The user of this or any other software contained in an XM Radio is explicitly prohibited from attempting to copy, decompile, reverse engineer, or disassemble the object code, or in any other way convert the object code into human-readable form. The software is licensed solely for use within this product.

Hardware and required \$12.95 monthly service subscription sold separately. Other fees and taxes, including a one-time activation fee may apply. Subscription fee is consumer only. All fees and programming subject to change. Channels with frequent explicit language are indicated with an XL. Channel blocking is available for XM radio receivers by calling 1-800-XMRADIO. Subscriptions subject to Customer Agreement available at [xmradio.com](http://xmradio.com). XM service only available in the 48 contiguous United States. ©2006 XM Satellite Radio Inc. All rights reserved.

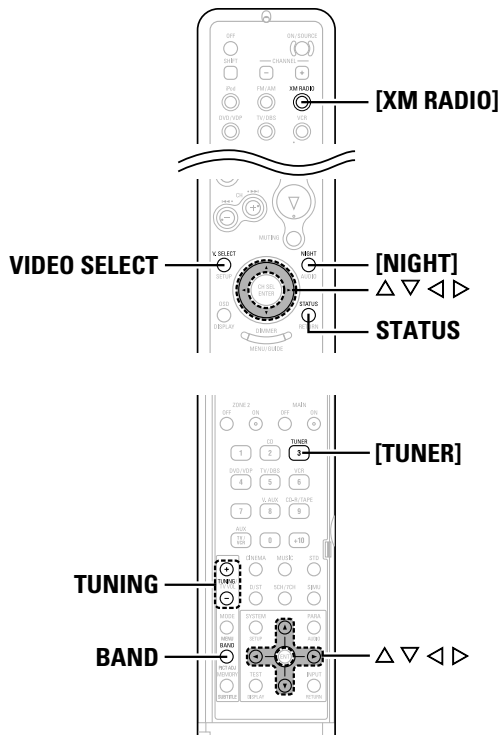
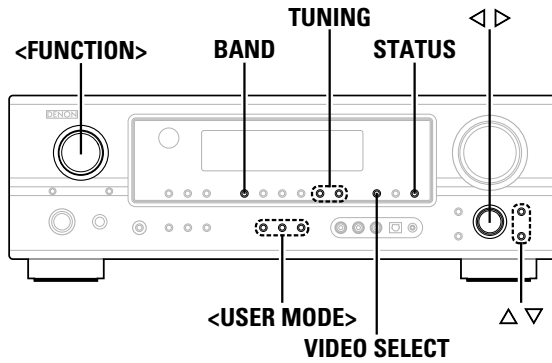

**About the button names in this explanation**  
 < > : Buttons on the main unit  
 [ ] : Buttons on the remote control unit  
**Button name only :**  
 Buttons on the main unit and remote control unit

Checking the XM signal strength and Radio ID

- 1 Use <FUNCTION> to select “TUNER” or press [TUNER].
- 2 Press BAND to select “XM”.
- 3 Press STATUS until “SIGNAL” is displayed.
  - The display changes as shown below according to the receiving condition.

Display	Condition
GOOD	Signal strength is good
MARGINAL	Signal strength is marginal
WEAK	Signal strength is poor
NO	Loss of the signal

- 4 Adjust the antenna location until “SIGNAL:GOOD” is displayed.
- 5 Press STATUS until the XM channel (ex.XM001) is displayed.
- 6 Press TUNING to select channel 0 (XM000).

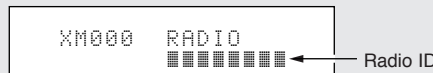

Channel selection

- 1 Use <FUNCTION> to select “TUNER” or press [TUNER].

- 2 Press BAND to select “XM”.

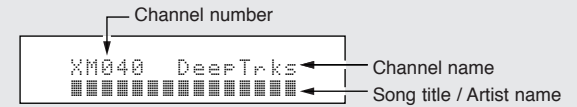

- 3 Press TUNING to reach the desired channel.

- \* The channel changes continuously when you press and hold TUNING.
- \* When the artist name and song title are received, they are displayed.

Category search

- 1 Press < > in the XM mode.
  - The current category name is displayed.

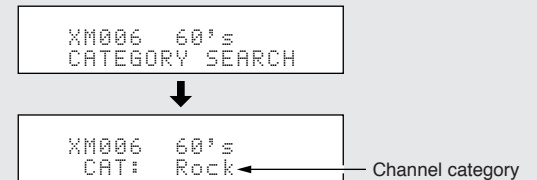

- 2 Press < > to select the category, and press Δ ∇ to select the channel within the selected category.



- “LOADING” is displayed while receiving the channel or information.
- “UPDATING” is displayed while updating encryption code.
- When the selected channel is not available, “XM ---” is displayed.
- Information on the artist name, song title, category and signal level can be checked using STATUS.
- The XM Satellite Radio channels can be preset in the same way as AM/FM band (page 34).
- “XM” can be selected directly by pressing [XM RADIO].

## Advanced Operation

### Night mode

The night mode can be set when playing Dolby Digital sources. The dialogues are easier to hear at night and when listening with the volume low.

Press **[NIGHT]**.



- Canceling night mode:  
Press **[NIGHT]** again.
- When the night mode is set to "ON", the "D.COMP" surround parameter can not be selected.

### User mode function

The AVR-1907 is equipped with a function for storing the selected input source, the auto surround mode and input mode in the memory and selecting these settings when you want to use them.

#### Storing the settings in the memory

- 1 The following are stored in the memory:**
  - ① Currently set input source
  - ② Currently set surround mode
  - ③ Currently set input mode

- 2 Press <USER MODE> until "Memory" is displayed.**

#### Calling the settings out

Press <USER MODE> at which the settings you want to call out are stored.

### Combining the currently playing sound with the desired image (VIDEO SELECT function)

Press **VIDEO SELECT** until the desired image appears on the monitor.



- To cancel, press **VIDEO SELECT** to select "SOURCE".
- The video source selected with the video select function is stored in the memory for the different input sources.

### Personal memory plus function

The surround mode last selected and the input mode setting are stored individually for the different input sources.

- ※ The surround parameters, tone control settings and playback level balance for the different output channels are memorized for each surround mode.

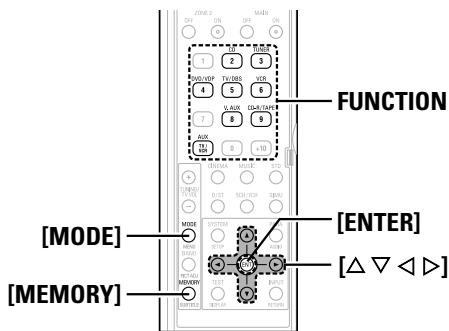
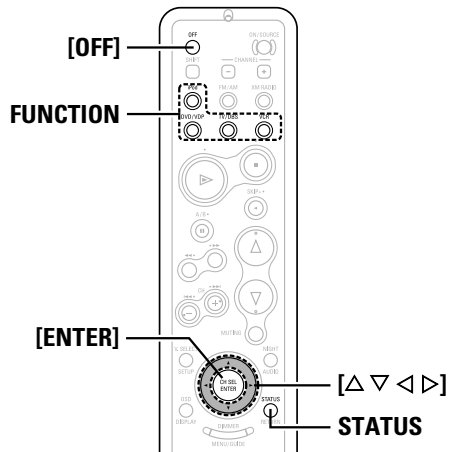
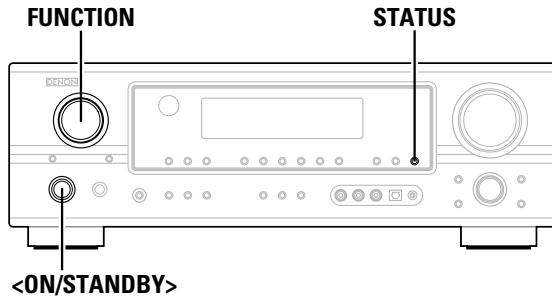

**About the button names in this explanation**  
 < > : Buttons on the main unit  
 [ ] : Buttons on the remote control unit  
**Button name only :**  
 Buttons on the main unit and remote control unit

**Playing the iPod®**

The music recorded on the iPod can be played when using a Control Dock for iPod (ASD-1R, sold separately). The iPod can be controlled using the buttons on the main unit and the remote control unit.

**Made for iPod** iPod is a trademark of Apple Computer, Inc., registered in the U.S. and other countries.

※ With the iPod, non-copyrighted contents and contents that may be legally reproduced or played may be reproduced and played by individuals for their personal use. Violating copyrights is prohibited by law.



• The optional standard Control Dock for iPod is DENON ASD-1R sold separately.

**NOTE:**  
 • DENON will accept no responsibility whatsoever for loss or damage of data on an iPod occurring when the iPod is used connected to the AVR-1907.  
 • Some of the functions may not operate, depending on the type of iPod and the software version.

**1** Connect the AVR-1907 and iPod using the Control Dock for iPod (ASD-1R) (page 18).

**2** Assign the input terminal at “Setting the iPod Assignment” (page 48).

**3** Use **FUNCTION** to select the function assigned in step 2.

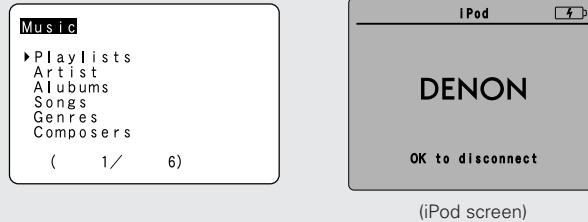

※ If the screens above are not displayed, the iPod may not be properly connected. Check the connections and settings.



## Advanced Operation

## Listening to music

**1** Press [ $\Delta$   $\nabla$ ] to select the music file, then press [ENTER] or [ $\triangleright$ ].

※ Press [ $\triangleleft$ ] to return to the music menu screen.

**2** Press [ENTER] or [ $\triangleright$ ].

- Playback starts.

**Pause:**

Press [ENTER] during playback.  
Press again to resume.

**Manual search:**

Press and hold in [ $\Delta$   $\nabla$ ] during playback.

- $\Delta$ : Fast reverse
- $\nabla$ : Fast forward

**Track search:**

Press [ $\Delta$   $\nabla$ ] during playback.

- $\Delta$ : Move to beginning of previous track
- $\nabla$ : Move to beginning of next track

**Stop:**

Press [ENTER] for at least 2 seconds during playback.

**Repeat play:**

Press [MODE].

The mode switches as follows each time [MODE] is pressed.

- **RPT One:** Single track repeat
- **RPT All:** All track repeat

**Shuffle play:**

Press [MEMORY].

The mode switches as follows each time [MEMORY] is pressed.

- **SFL Songs:** Single track shuffle
- **SFL Albums:** Album shuffle

※ The mode switches between the Browse mode and the Remote mode if [MODE] is pressed for at least 2 seconds.  
In the Remote mode, only [ $\Delta$   $\nabla$   $\triangleleft$   $\triangleright$ ] and [ENTER] can be used.



- When **STATUS** is pressed during playback, the front panel display switches between the title name, artist name and album name.
- Depending on the iPod's software version, it may not be possible to operate the iPod from the AVR-1907. Use the latest version of the software. Information on the latest version of the software can be obtained on the Apple Computer website.
- If you do not want the on screen display to be displayed while playing the iPod, set "Function/Mode Status" at "Setting the On Screen Display" to "OFF" (page 52).
- With the AVR-1907 it is possible to display folder names and file names on the screen like titles. The AVR-1907 can display up to 64 characters, consisting of numbers, capital letters and small letters. A "?" mark is displayed in place of non-compatible characters.

### Viewing still pictures and videos (only for iPods equipped with the slideshow / video function)

Use this procedure to view photo and video data stored on the iPod on a monitor.

**1** Press [MODE] for at least 2 seconds to switch from the Browse mode to the Remote mode.

- "Remote iPod" is displayed on the AVR-1907's display.

**2** Watching the iPod's screen, press [ $\Delta$   $\nabla$ ] to select "Photos" or "Video", then press [ENTER] or [ $\triangleright$ ].

- The iPod's photo and video data are displayed on the monitor.



- To output photo or video data recorded on the iPod to the monitor, the iPod's "TV Out" setting (under "Video Settings") must be set to "ON".  
For details, refer to the iPod's operating instructions.

## Advanced Operation

## Disconnecting the iPod

Press <ON/STANDBY> or [OFF] and set the AVR-1907's power to the standby mode.

※ The iPod can be disconnected after switching to a function other than the one to which the iPod input is assigned.

Advanced Operation

Multi zone music entertainment system

- When the outputs of the ZONE2 OUT terminals are wired and connected to integrated amplifiers installed in other rooms, different sources can be played in rooms other than the MAIN ZONE in which this unit and the playback devices are installed. (Refer to ZONE2 of the diagram the right.)
- ZONE2 speaker out and pre-out can be used when "ZONE2" is selected at "Power Amp Assignment" in the "System Setup" menu. In this case, surround back speaker out cannot be used for MAIN ZONE.
- When a sold separately room-to-room remote control unit (DENON RC-616, 617 or 618) is wired and connected between the MAIN ZONE and ZONE2, the remote-controllable devices in the MAIN ZONE can be controlled from ZONE2 using the remote control unit.



- For the AUDIO outputs, use high quality pin-plug cables and wire in such a way that there is no humming or noise.
- For instructions on installation and operation of separately sold devices, refer to the devices' operating instructions.
- When the main unit is set to the recording output mode, ZONE2 remote control button cannot be operated.

Advanced Operation

When using the SURR.BACK/ZONE2 amplifier as the SURROUND BACK

- 7.1-channel playback using the surround back speaker is possible in the MAIN ZONE.
- To use the ZONE2 line output, turn on **ZONE2**.
- The ZONE2 OUT terminal's output level cannot be adjusted with the remote control unit.

[System configuration and connections example]

Using external amplifier.

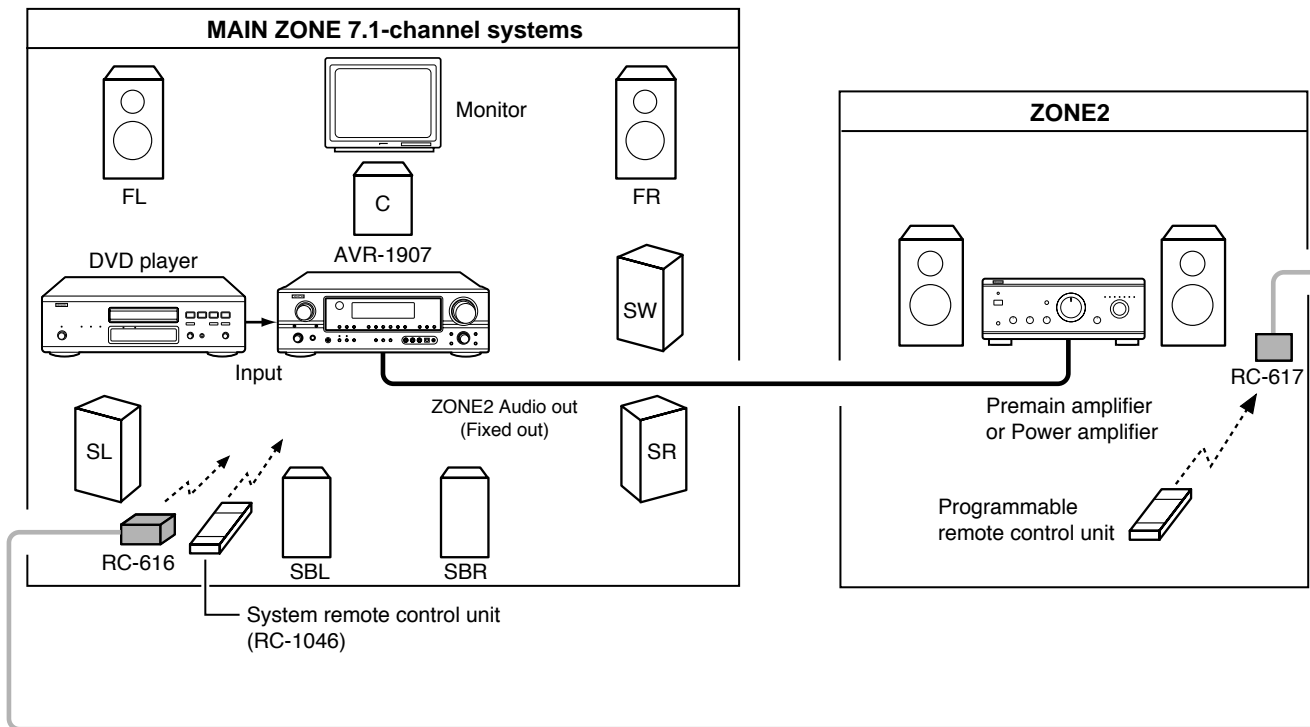

— : Room-to-room remote control system (separately sold) control line

— : Multi source audio signal cable

\* Refer to "Connections" (page 19).

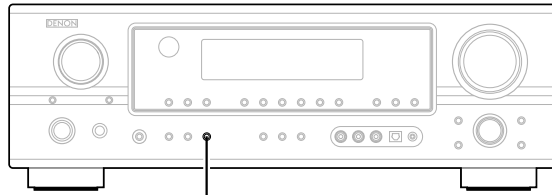

ZONE2

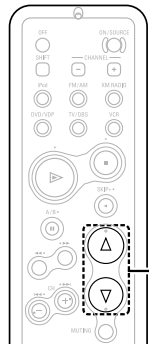

VOLUME

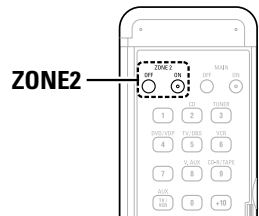

ZONE2

When using the SURR.BACK/ZONE2 amplifier as the ZONE2

- The SPEAKER OUT, LINE OUT and PRE OUT terminals can be used simultaneously in ZONE2.
- To use the ZONE2, turn on **ZONE2**.
- The output of the ZONE2 SPEAKER OUT terminals can be adjusted with **[VOLUME]** (ZONE2).

[System configuration and connections example]

Using this unit's internal amplifier as the ZONE2.

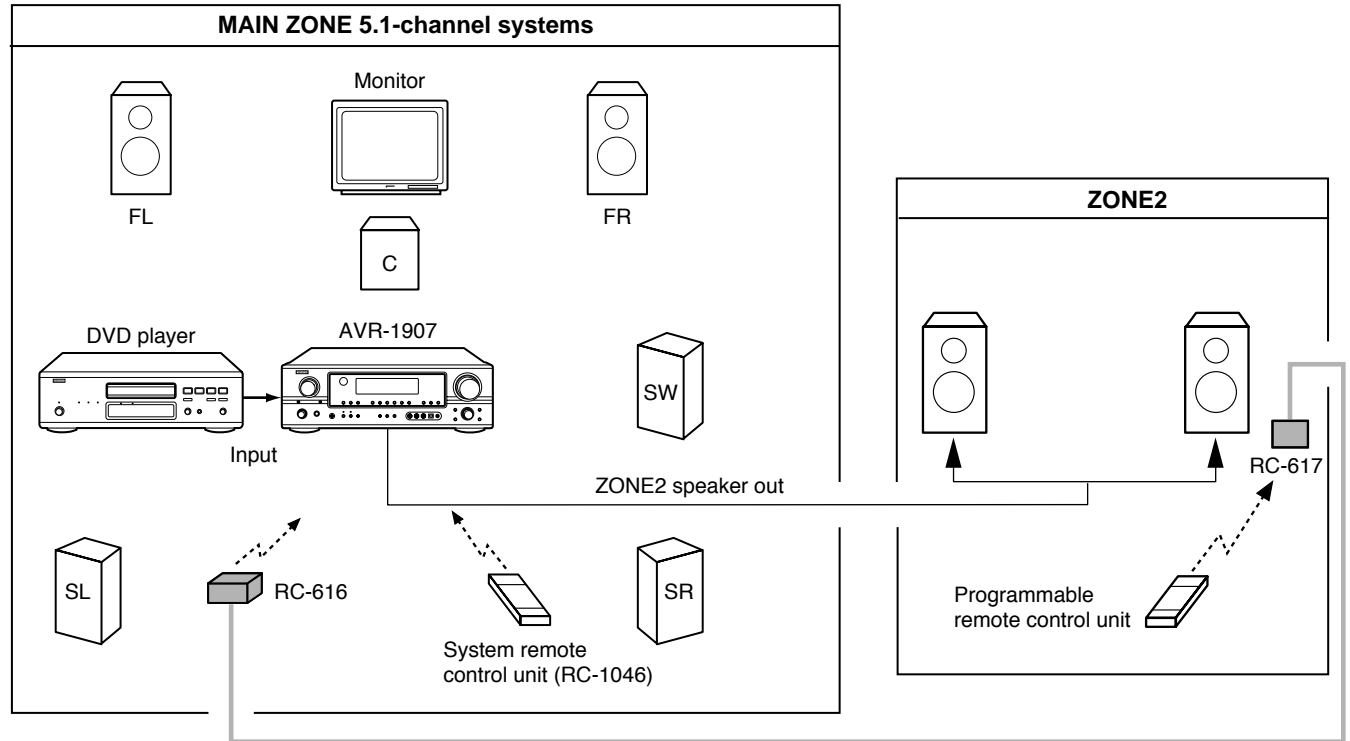

— : Room-to-room remote control system (separately sold) control line

— : Speaker cable

\* Refer to "Connections" (📄 page 19).

**About the button names in this explanation**

< > : Buttons on the main unit

[ ] : Buttons on the remote control unit

**Button name only :**

Buttons on the main unit and remote control unit

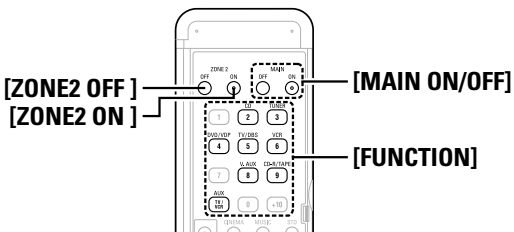
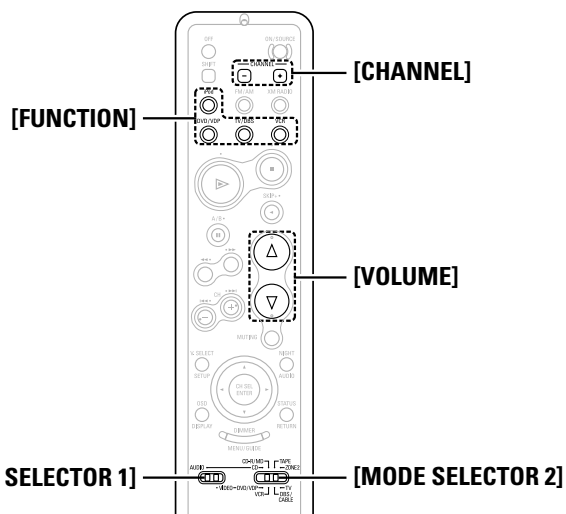
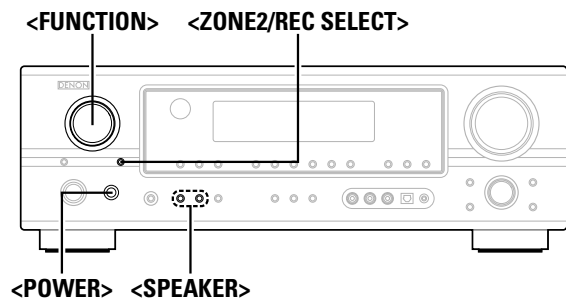

**About the button names in this explanation**  
 < > : Buttons on the main unit  
 [ ] : Buttons on the remote control unit  
**Button name only :**  
 Buttons on the main unit and remote control unit

**Outputting a program source to amplifier, etc., in the ZONE2 room (ZONE2 SELECT mode)**

**1** Press <ZONE2/REC SELECT> to display the “ZONE2 SOURCE” on the display.

ZONE2 ← → RECOUT

**2** With “ZONE2 SOURCE” displayed, turn <FUNCTION> to select the source you want to output appears on the display.

- The “ZONE -2” indicator and the indicator for the selected source light.

**3** Start playing the source to be output.

※ For operating instructions, refer to the manuals of the respective components.



- The signals of the source selected in the ZONE2 mode are also output from the VCR and CD-R/TAPE recording output terminals.
  - Digital signals are not output from the ZONE2 audio output terminals.
  - About the MULTI ZONE connections (page 39, 40).
  - The source selected for MAIN ZONE is output from the digital output terminal (OPT-2).
- The source selected in the REC SELECT mode is not associated with the output from the digital output terminal (OPT-2).

**Remote control unit operations during multi-source playback**

This is only possible when the main unit in the ZONE2 mode (page 53).

**1** Set [MODE SELECTOR 1] to the “AUDIO”.

**2** Set [MODE SELECTOR 2] to the “ZONE2”.

**3** Press [ZONE2 ON].

- The “Z2” indicator lights.

※ To cancel the ZONE2 mode:  
Press [ZONE2 OFF].

**4** Press [FUNCTION].

- The “ZONE -2” indicator and the indicator for the selected source light.

※ The ZONE2 source switches directly.

**5** The output level of the ZONE2 SPEAKER OUT terminals can be controlled pressing [VOLUME].

※ Default setting (ZONE2 volume level):  
--- dB (Minimum)

**6** When the ZONE2 SOURCE function is set to “TUNER”, the preset channel can be selected pressing [CHANNEL].



- When using ZONE2, it is possible to turn the power for the MAIN ZONE only on or off by pressing [MAIN ON/OFF].

## Advanced Operation

## Recording (audio and/or video)

- 1 Press **<ZONE2/REC SELECT>** until **“RECOUT”** appears on the display.

ZONE2 ← → RECOUT

- 2 Use **<FUNCTION>** to select the source to be recorded (audio and/or video).

- The “**REC**” indicator and the indicator for the selected source light.

- 3 Record (the audio or video signals).

- ※ For operations, see the operating instructions of the device from which you are recording (audio or video signals).



- To cancel, press **<ZONE2/REC SELECT>** and set the function to “ZONE2”.

**NOTE:**

- When the REC OUT mode is selected, **[ZONE2]** and **[FUNCTION]** (ZONE2) cannot be operated.
- Digital signals are not output from the analog REC OUT terminal.

## Advanced Operation

## About the memory functions

 **Last function memory**

The various settings set when the AVR-1907's power is switched to standby are stored in the memory. When the power is turned back on, the settings made when the power was switched to standby are recalled.

 **Backup memory**

The various settings are stored in the memory for about 1 week, even when the power is turned off or the power cord is unplugged.

## Initialization of the microprocessor (Reset)

Use the procedure described below to reset the microprocessor if the display is abnormal or if the buttons on the main unit or the remote control unit do not operate.

- 1 Switch off the unit using **<POWER>**.

- 2 Hold the following **<SPEAKER>** (A and B) and press **<POWER>**.

- 3 Check that the entire display is blinking with an interval of about 1 second, and release your fingers from the 2 buttons.

- The microprocessor will be initialized.



- If step 3 does not work, start over from step 1.
- If the microprocessor has been reset, all the settings are reset to the default values.

# Advanced Setup – Part 1

## System setup items and default values

### 1. Auto Setup

```

1. Auto Setup
>1. Auto Setup
  2. Parameter Check

Exit
    
```

Items		Default settings	Page
1	<b>Auto Setup</b> The AVR-1907 performs an analysis of the speaker system and measures the acoustic characteristics of your room to permit an appropriate automatic setting.	-	9 ~ 12

### 2. Speaker Setup

```

2. Speaker Setup
>1. Speaker Config.
  2. Subwoofer Setup
  3. Distance
  4. Channel Level
  5. Crossover Frequency

Exit
    
```

Items		Default settings							Page	
1	<b>Speaker Configuration</b> Automatically set the output component and properties for the various channels according to the combination of speakers to be actually used for surround playback.	Front Sp.	Center Sp.	Subwoofer	Surround Sp.	Surround Back Sp.			54, 55	
		Large	Small	Yes	Small	Small / 2sp				
2	<b>Subwoofer Setup</b> Select the method of playback of the subwoofer for playing the low bass signals.	LFE (Normal)							55	
3	<b>Distance</b> This parameter is for optimizing the timing with which the audio signals are produced from the speakers and subwoofer according to the listening position.	Front L & R	Center	Subwoofer	Surround L & R	Surround Back			55, 56	
		12 ft	12 ft	12 ft	10 ft	10 ft				
4	<b>Channel Level</b> Set the volume of the various speakers so that the sound output from the speakers and the subwoofer seems to have the same volume level.	Front L	Front R	Center	Surround L	Surround R	Surround Back L	Surround Back R	Subwoofer	56, 57
		0 dB	0 dB	0 dB	0 dB	0 dB	0 dB	0 dB	0 dB	
5	<b>Crossover Frequency</b> Set the frequency (Hz) below which the bass sound of the various speakers is to be output from the subwoofer.	80 Hz							57	

Advanced Setup – Part 1

Advanced Setup – Part 1

3. Audio Input Setup

3. Audio Input Setup
- >1. Digital In Assign
  - 2. EXT IN SW Level
  - 3. iPod Assign
  - 4. Input Function Level
  - 5. Function Rename
  - 6. Tuner Presets

Items		Default settings					Page				
1	<b>Digital In Assignment</b> This assigns the different input function for the digital input terminals.	<b>Digital Inputs</b>	COAX 1	COAX 2	OPT 1	OPT 2	OPT 3	47			
		<b>Input Function</b>	CD	AUX	DVD / VDP	TV / DBS	V. AUX				
2	<b>EXT IN Subwoofer Level</b> Sets the playback level of the analog signal that was input to the EXT. IN subwoofer terminal.	SW Level = +15 dB					48				
3	<b>iPod Assignment</b> It is possible to assign the Control Dock for iPod's (ASD-1R, sold separately) audio and/or video signals to any input terminals on the AVR-1907 and play them.	iPod Function = OFF					48				
4	<b>Input Function Level</b> The playback level is corrected individually for the different input sources.	CD	TUNER	AUX	CDR / TAPE	DVD / VDP	TV / DBS	VCR	V. AUX	48	
		0 dB	0 dB	0 dB	0 dB	0 dB	0 dB	0 dB	0 dB		
5	<b>Function Rename</b> The name of the input function that is displayed can be changed.	CD	TUNER	AUX	CDR / TAPE	DVD / VDP	TV / DBS	VCR	V. AUX	49	
6	<b>Tuner Presets</b> Up to 56 FM stations can be preset automatically.	<b>Auto Preset Memory</b>	A1 – A8	87.5/89.1/98.1/107.9/90.1/90.1/90.1/90.1 MHz							49
			B1 – B8	520/600/1000/1400/1500/1710 kHz, 90.1/90.1 MHz							
			C1 – C8	90.1 MHz							
			D1 – D8	90.1 MHz							
			E1 – E8	90.1 MHz							
			F1 – F8	90.1 MHz							
			G1 – G8	90.1 MHz							
	Preset channels that are not used often can be skipped.	<b>Preset Skip</b>	All preset channels = ON							49	
	The preset channels can be given the names you want.	<b>Preset Name</b>	-							50	

4. Video Setup

4. Video Setup
- >1. Component In Assign
  - 2. Video Convert
  - 3. Audio Delay
  - 4. On Screen Display

Items		Default settings			Page
1	<b>Component In Assignment</b> This assigns the different input sources for the component video input terminals.	COMP1	COMP2	COMP3	51
		DVD / VDP	TV / DBS	VCR	
2	<b>Video Convert</b> This sets whether or not to use the video conversion function.	ON			51
3	<b>Audio Delay</b> Adjust the time delay between the video and audio signals.	0 ms			51
4	<b>On Screen Display</b> Set whether or not to display the on screen display for indications other than the menu screens.	Function/Mode = ON Master Volume = ON Mode = Mode 1			52

Advanced Setup – Part 1

Advanced Setup – Part 1

5. Advanced Playback

5. Advanced Playback  
 >1. 2ch Direct/Stereo  
 2. Auto Surround Mode

Items		Default settings	Page
1	<b>2ch Direct/Stereo</b> Make the 2-channel direct mode and stereo mode speaker settings.	Basic	52
2	<b>Auto Surround Mode</b> Set whether or not to store the surround mode last played for the input signal.	Auto Surround Mode = ON	52

6. Option Setup

6. Option Setup  
 >1. Power Amp Assign  
 2. Volume Control  
 3. Setup Lock

Items		Default settings	Page
1	<b>Power Amp Assign</b> To suit your preference, a surround back channel's power amplifier can be assigned to the front channel ("Front A" or "Front B") for bi-amp playback, ZONE2.	S. Back	53
2	<b>Volume Control</b> This sets the volume level of output.	Vol.Limit = OFF P. On Lev. = LAST Mute Lev. = FULL	53
3	<b>Setup Lock</b> This sets whether or not to lock the system setup settings so that they cannot be changed.	Setup Lock = OFF	54



Use System Setup to customize a variety of settings to suit your listening environment. For the contents of a system menu and the initial setting of this unit (see page 44, 45).

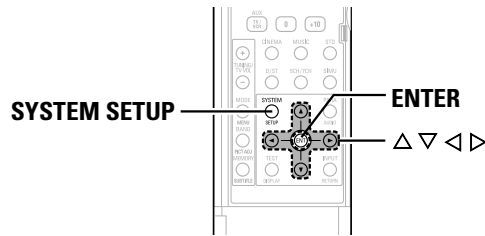
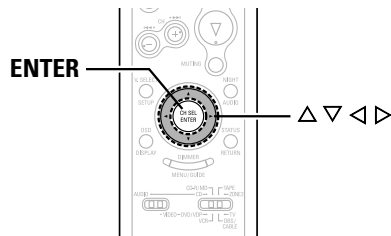
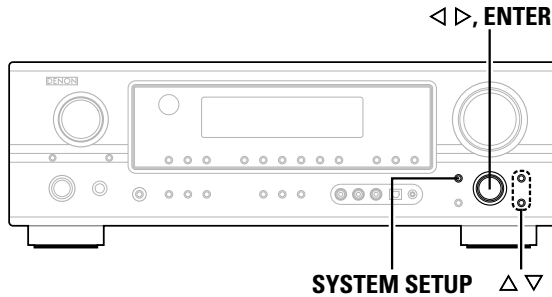

### Navigating through the System Setup Menu

- 1 Press SYSTEM SETUP.**
  - The “System Setup” menu appears.
- 2 Press  $\Delta$   $\nabla$  to select the item you want to set, then press ENTER.**
- 3 Press  $\Delta$   $\nabla$  again to select the item you want to set, then press ENTER.**
- 4 To change the setting:**
  - Press  $\Delta$   $\nabla$  to select the item you want to change, then press  $\triangleleft$   $\triangleright$  to change the setting.
  - ※ Select “Default Yes”, then press  $\triangleleft$  to reset to the default setting.
- 5 Press ENTER and set a new item.**
- 6 Press SYSTEM SETUP to return to the “System Setup” menu or the main menu.**

	[ On screen display ]	[ Display ]
<b>2</b>	<pre>System Setup 1. Auto Setup 2. Speaker Setup &gt;3. Audio Input Setup 4. Video Setup</pre>	<pre>*SYSTEM SETUP 3 Audio In Setup</pre>
<b>3</b>	<pre>3. Audio Input Setup &gt;1. Digital In Assign 2. EXT IN SW Level 3. iPod Assign 4. Input Function Level</pre>	<pre>*Audio In Setup 3.1 Digital In</pre>
<b>4</b>	<pre>3-1. Digital In Assign &gt;COAXIAL1 : &lt;CD&gt; COAXIAL2 : AUX OPTICAL1 : DVD/VDP OPTICAL2 : TV/DBS</pre>	<pre>*Digital In 3.1 COAX1&lt;CD &gt;</pre>
<b>6</b>	<pre>System Setup 1. Auto Setup 2. Speaker Setup 3. Audio Input Setup 4. Video Setup 5. Advanced Playback 6. Option Setup &gt;Exit</pre>	<pre>*SYSTEM SETUP Exit</pre>

**About the button names in this explanation**  
 $\triangleleft$   $\triangleright$  : Buttons on the main unit  
 $[ ]$  : Buttons on the remote control unit  
**Button name only :**  
 Buttons on the main unit and remote control unit

About the on screen display and front display

The AVR-1907 is equipped with an intuitive and easy-to-understand on screen display, and is equipped with an alphanumeric front panel display that can also be used to check and adjust settings. We recommend that you use the on screen display when you make system adjustments. Some representative front display and on screen display examples are shown below.

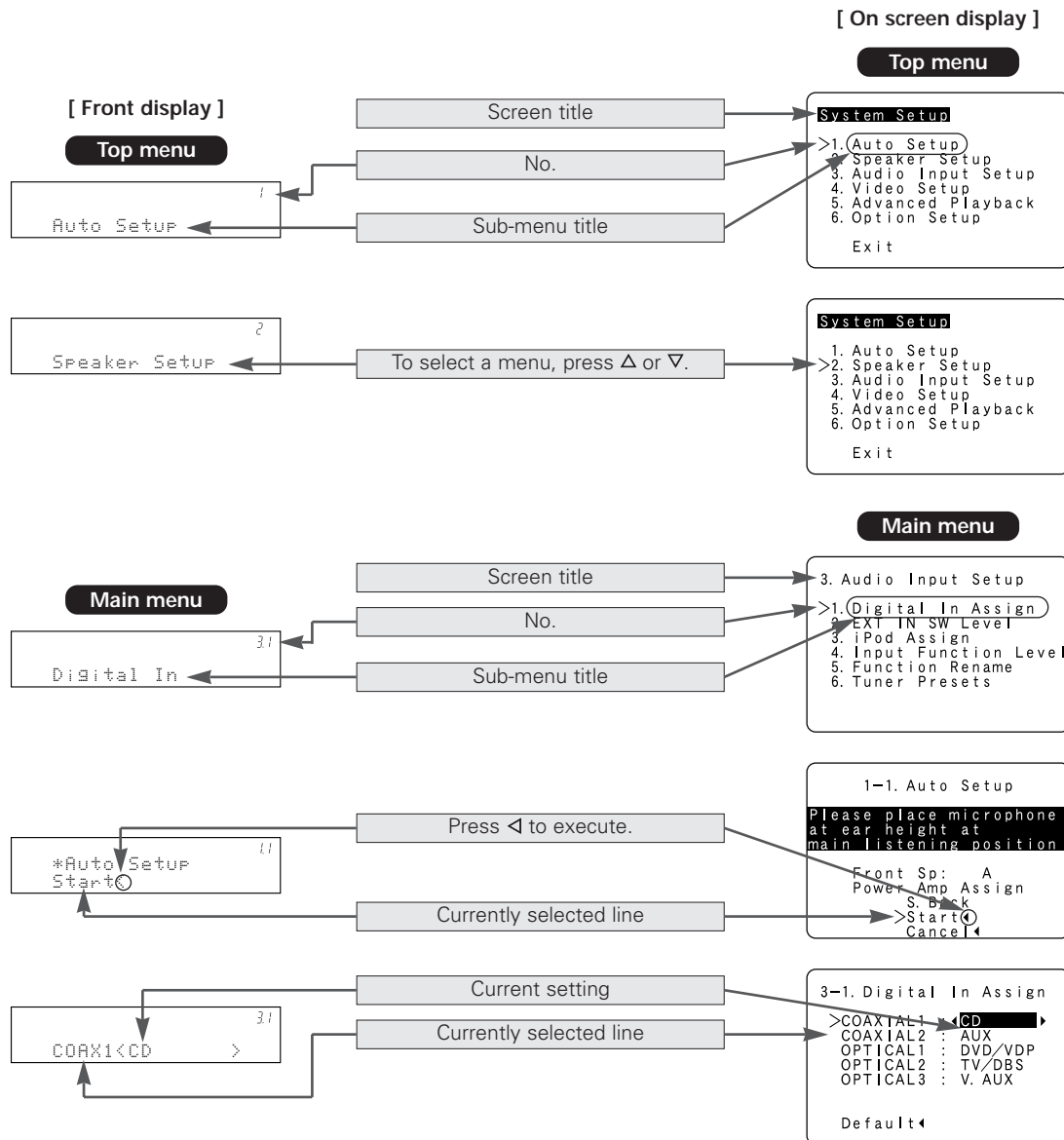

Audio Input Setup

Setting the Digital In Assignment

This assigns the different input function for the digital input terminals.

**1** Press  $\Delta$   $\nabla$  to select “Audio Input Setup”, then press ENTER.

**2** Press  $\Delta$   $\nabla$  to select “Digital In Assign”, then press ENTER.

**3** Press  $\Delta$   $\nabla$  to select the input terminals, then press  $\triangleleft$   $\triangleright$  to set.

**CD, AUX, DVD, TV, VCR, V. AUX, CDR:**

Assign the different function according to the devices connected to the AVR-1907's input terminals.

**4** Press ENTER.

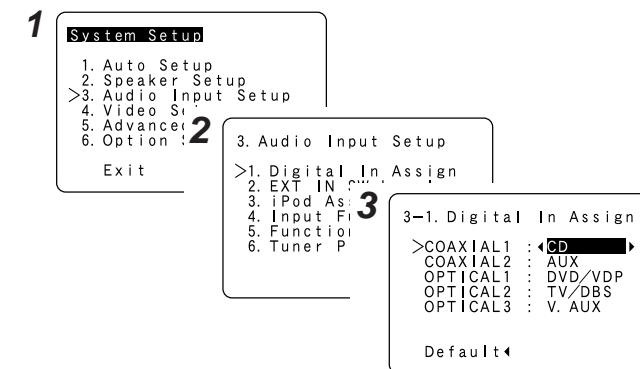

- “TUNER” cannot be selected on the “Digital In Assign” screen.
- It is not possible to make the “Digital In Assignment” settings for the function assigned at “iPod Assignment”.

Advanced Setup – Part 1

Setting the EXT IN Subwoofer Level

Sets the playback level of the analog signal that was input to the EXT. IN subwoofer terminal.

- 1 Press  $\Delta$   $\nabla$  to select “EXT IN SW Level”, then press ENTER.
- 2 Press  $\triangleleft$   $\triangleright$  to set.
- 3 Press ENTER.

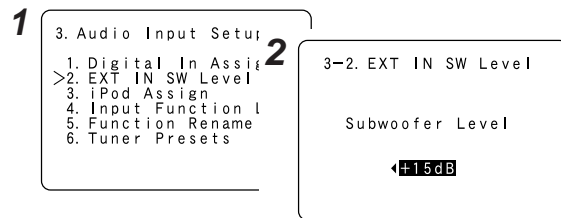

Setting the iPod Assignment

It is possible to assign the Control Dock for iPod's (ASD-1R, sold separately) audio and/or video signals to any input terminals on the AVR-1907 and play them.

- 1 Press  $\Delta$   $\nabla$  to select “iPod Assign”, then press ENTER.
- 2 Press  $\triangleleft$   $\triangleright$  to set.

OFF:

This is the factory default setting.

CD, AUX, CDR/TAPE:

When using a Control Dock for iPod, it is possible to connect with the audio input terminal of the assigned function.

DVD/VDP, TV/DBS, VCR, V. AUX:

When using a Control Dock for iPod, it is possible to connect with the audio and video input terminals of the assigned function.

- 3 Press ENTER.

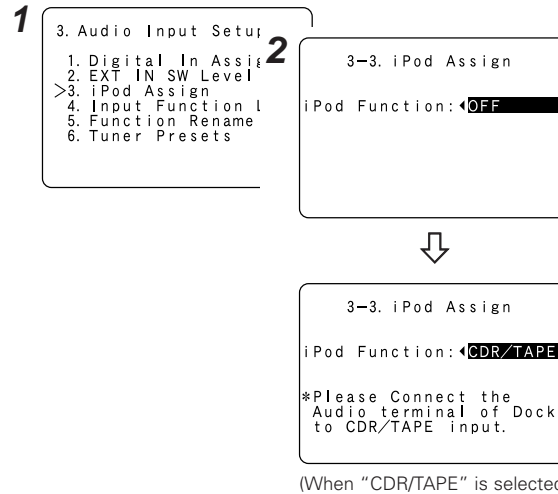

Advanced Setup – Part 1

Setting the Input Function Level

The playback level is corrected individually for the different input sources.

- 1 Press  $\Delta$   $\nabla$  to select “Input Function Level”, then press ENTER.
  - 2 Press  $\Delta$   $\nabla$  to select the input source, then press  $\triangleleft$   $\triangleright$  to set.
  - 3 Press ENTER.
- ※ The volume can be adjusted within the range -12 dB to +12 dB.

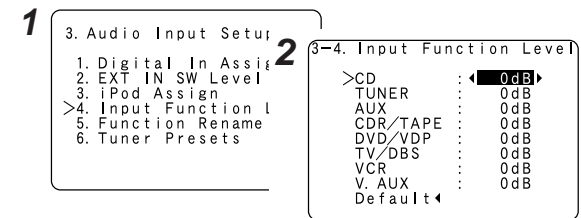

After completing this setting, check that the playback levels for the different sources are the same.

**Setting the Function Rename**

The name of the input function that is displayed can be changed.

**1** Press  $\Delta \nabla$  to select “Function Rename”, then press **ENTER**.

**2** Press  $\Delta \nabla$  to select the input function, then press  $\triangleleft \triangleright$  to set.

**3** Press  $\triangleleft \triangleright$  to move the cursor (■) to the desired position, then press  $\Delta \nabla$  to select the character.

※ Up to 8 characters can be input.  
The characters that can be input are shown below.

ABCDEFGHIJKLMNOPQRSTUVWXYZ  
abcdefghijklmnopqrstuvwxyz01234  
56789  
!"#%&'()\*+,-./:;<=>?@[ \ ] (space)

**4** Repeat step 3 to input the input source name.

※ To set the input function name back to how it was:  
① Press  $\triangleleft \triangleright$  to highlight the input function name, then press  $\Delta \nabla$ .  
② Press  $\Delta \nabla$  to select “Default Yes”, then press  $\triangleleft$ .

**5** Once all the characters have been input, press **ENTER**.

**1** 3. Audio Input Setup  
1. Digital In Assig  
2. EXT IN SW Level  
3. iPod Assign  
4. Input Function l  
5. Function Rename  
6. Tuner Presets

**2** 3-5. Function Rename  
>CD : CD  
TUNER : TUNER  
AUX : AUX  
CDR/TAPE : CDR/TAPE  
DVD/VDP : DVD/VDP  
TV/DBS : TV/DBS  
VCR : VCR  
V. AUX : V. AUX

**3** 3-5. Function Renar  
>CD : CD  
Default

**4** 3-5. Function Rename  
>CD : DENON  
Default

**Setting the Tuner Presets**

**Auto Preset Memory**  
Up to 56 FM stations can be preset automatically.

**1** Press  $\Delta \nabla$  to select “Tuner Presets”, then press **ENTER**.

**2** Press  $\Delta \nabla$  to select “Auto Preset Memory”, then press **ENTER**.

**3** Press  $\triangleleft$  to select “Yes”.  
• “Search” blinks on the screen and searching begins.  
• “Completed” appears once searching is completed.

**1** 3. Audio Input Setup  
1. Digital In Assign  
2. EXT IN SW Level  
3. iPod Assign  
4. Input Function Level  
5. Function Rename  
>6. Tuner Presets

**2** 3-6. Tuner Presets  
>Auto Preset Memory  
Preset : 3  
Preset l

3-6. Auto Preset Memory  
Auto Tuning And  
Preset Station Memory  
Storing Preset Memory  
Start



• If an FM station cannot be preset automatically due to poor reception, use the “Manual tuning” operation (page 33) to tune in the station, then preset it using the manual “Preset memory” operation (page 34).

**Preset Skip**

Preset channels that are not used often can be skipped.

**1** Press  $\Delta \nabla$  to select “Preset Skip”, then press **ENTER**.

**2** Press  $\Delta \nabla$  to select the preset channel, then press  $\triangleleft \triangleright$  to set.

**ON, OFF:**  
Select “OFF” to skip the preset channel, “ON” if you do not want to skip.

※ When  $\nabla$  is pressed at the very bottom of the screen, then the next preset memory block appears.

**3** Press  $\triangleleft \triangleright$  to select the preset memory block.

**4** Repeat steps 2 and 3.

**5** Press **ENTER**.

**1** 3-6. Tuner Presets  
Auto Preset Memory  
>Preset Skip  
Preset l

**2** 3-6. Preset Skip  
Block A  
>A1FM 87.50MHz ON OFF  
A2FM 89.10MHz ON OFF  
A3FM 98.10MHz ON OFF  
A4FM 107.90MHz ON OFF  
A5FM 90.10MHz ON OFF  
A6FM 90.10MHz ON OFF  
A7FM 90.10MHz ON OFF  
A8FM 90.10MHz ON OFF

**3** 3-6. Preset Skip  
>Block B  
B1AM 520kHz ON OFF  
B2AM 600kHz ON OFF  
B3AM 1000kHz ON OFF  
B4AM 1400kHz ON OFF  
B5AM 1500kHz ON OFF  
B6AM 1710kHz ON OFF  
B7FM 90.10MHz ON OFF  
B8FM 90.10MHz ON OFF

Advanced Setup – Part 1

Preset Name

The preset channels can be given the names you want. (Except the XM channels.)

**1** Press  $\Delta \nabla$  to select “Preset Name”, then press **ENTER**.

**2** Press  $\Delta \nabla$  to select the preset channel, then press  $\triangleright$  to set.

**3** Press  $\triangleleft \triangleright$  to move the cursor (■) to the desired position, then press  $\Delta \nabla$  to select the character.

※ Up to 8 characters can be input.  
The characters that can be input are shown below.

```

A B C D E F G H I J K L M N O P Q R S T U V W X Y Z
a b c d e f g h i j k l m n o p q r s t u v w x y z 0 1 2 3 4
5 6 7 8 9
! " # % & ' ( ) * + , - . / : ; < = > ? @ [ \ ] (space)
    
```

**4** Repeat step 3 to input the preset channel name.

※ To set the preset channel name back to how it was:  
① Press  $\triangleleft \triangleright$  to highlight the preset channel, then press  $\Delta \nabla$ .  
② Press  $\Delta \nabla$  to select “Default Yes”, then press  $\triangleleft$ .

**5** Once all the characters have been input, press **ENTER**.

**6** Press **ENTER**.

Advanced Setup – Part 1

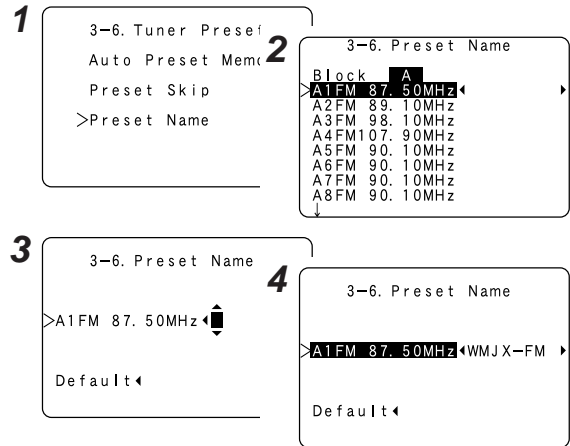

Advanced Setup – Part 1

Video Setup

Setting the Component In Assignment

This assigns the different input sources for the component video input terminals.

**1** Press  $\Delta \nabla$  to select “Video Setup”, then press **ENTER**.

**2** Press  $\Delta \nabla$  to select “Component In Assign”, then press **ENTER**.

**3** Press  $\Delta \nabla$  to select the input terminals, then press  $\triangleleft \triangleright$  to set.

DVD/VDP, TV/DBS, VCR, V.AUX:

Assign the different input sources to “COMP1”, “COMP2” or “COMP3”.

**4** Press **ENTER**.

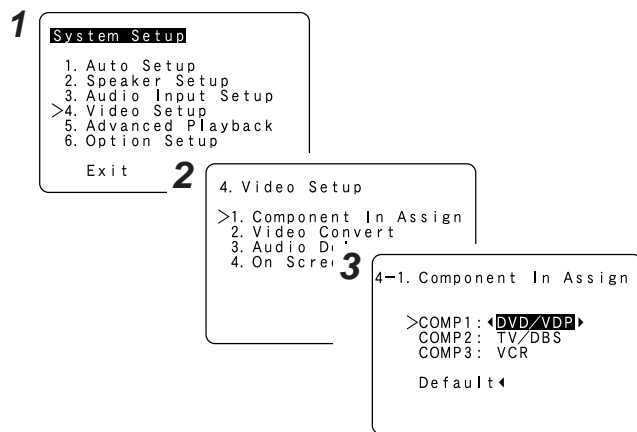

- It is not possible to make the “Component In Assignment” settings for the function assigned at “iPod Assignment”.

Setting the Video Convert

This sets whether or not to use the video conversion function.

**1** Press  $\Delta \nabla$  to select “Video Convert”, then press **ENTER**.

**2** Press  $\Delta \nabla$  to select the input source, then press  $\triangleleft \triangleright$  to set.

ON, OFF:

Select “ON” to use the video conversion function, “OFF” if you do not want to use it.

**3** Press **ENTER**.

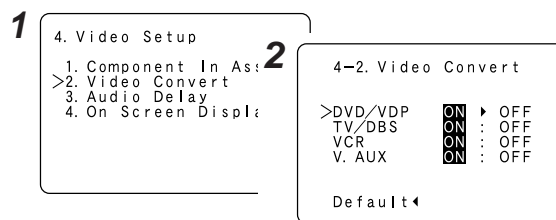

- Down-converting from the component video signal to the S-Video and composite video signal is not possible, so when not using the component video monitor output terminal connect the player using the S-Video or composite video input terminal (page 14).
- When a non-standard video signal from a game machine or some other source is input, the video conversion function might not operate. If this happens, please set the conversion mode to “OFF”.
- When the video conversion function has been used, information such as that of text broadcasts which has been added to the video signal might not be output. If this happens, please set the conversion mode to “OFF”.

Advanced Setup – Part 1

Setting the Audio Delay

Adjust the time delay between the video and audio signals.

**1** Press  $\Delta \nabla$  to select “Audio Delay”, then press **ENTER**.

**2** Press  $\triangleleft \triangleright$  to set.

0 ms ~ 200 ms:

Adjust the time delay.

※ With a movie source, for example, adjust so that the movement of the actors’ lips is synchronized with the sound.

**3** Press **ENTER**.

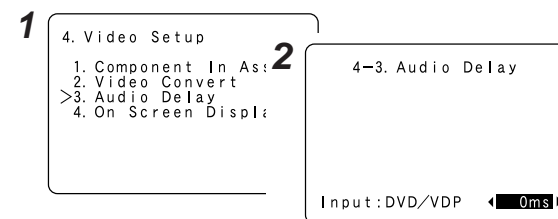

- By default, this menu is not displayed when no digital signals are being input.
- To make this setting for the component video signal, select the delay time and turn the on screen display off, then check that the timing of the component video and audio match.
- The audio delay setting does not apply when playing in the EXT. IN mode or in the analog input direct mode or stereo mode (Front speaker setting “Large” and TONE DEFEAT “ON”).

Advanced Setup – Part 1

Setting the On Screen Display (OSD)

Set whether or not to display the on screen display for indications other than the menu screens.

**1** Press  $\Delta$   $\nabla$  to select “On Screen Display”, then press ENTER.

**2** Press  $\Delta$   $\nabla$  to select the item, then press  $\triangleleft$   $\triangleright$  to set.

Function/Mode Status:

• ON, OFF:

Select “ON” to display the on screen display when the input source is selected, “OFF” if you do not want to display it.

Master Volume Status:

• ON, OFF:

Select “ON” to display the on screen display when the main volume is adjusted, “OFF” if you do not want to display it.

Display Mode:

• MODE1:

Flickering is not prevented.

• MODE2:

Prevents flickering of the on screen display when there is no video signal.

Use this mode if the on screen display is not displayed in “MODE1”.

**3** Press ENTER.

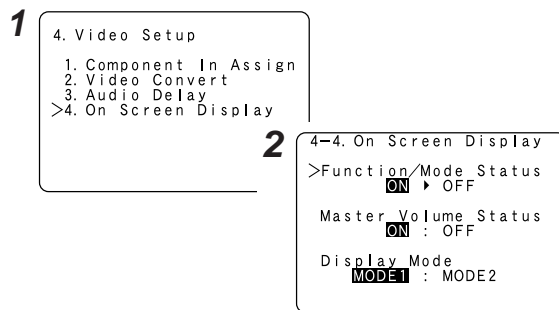

Advanced Playback

Setting the 2ch Direct/Stereo

Make the 2-channel direct mode and stereo mode speaker settings.

**1** Press  $\Delta$   $\nabla$  to select “Advanced Playback”, then press ENTER.

**2** Press  $\Delta$   $\nabla$  to select “2ch Direct / Stereo”, then press ENTER.

**3** Press  $\triangleleft$   $\triangleright$  to select “Basic” or “Custom”.

Basic:

The “Speaker Setup” settings are displayed.

Custom:

The speaker settings for the 2-channel direct and stereo modes can be changed.

**4** Press  $\Delta$   $\nabla$  to select the item, then press  $\triangleleft$   $\triangleright$  to set.

※ For a description of the settings for the different items, see pages 54 ~ 57.

**5** Press ENTER.

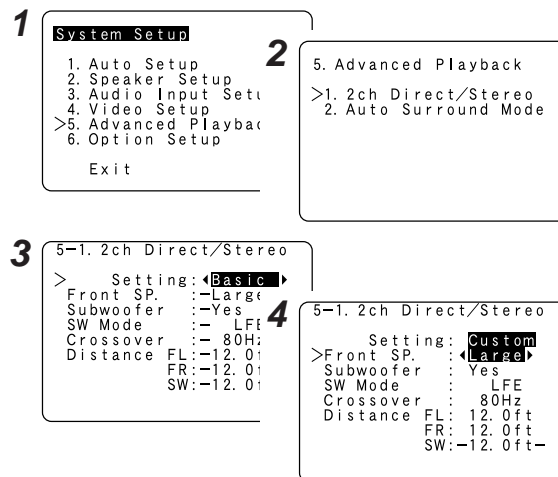

Advanced Setup – Part 1

Setting the Auto Surround Mode

Set whether or not to store the surround mode last played for the input signal.

The surround mode used at last for the three types of input signals shown below is stored in the memory, and the signal is automatically played with that surround mode the next time it is input.

- ① Analog and PCM 2-channel signals (STEREO)
  - ② 2-channel signals of Dolby Digital, DTS or other multi-channel format (DOLBY PLIIx Cinema)
  - ③ Multi-channel signals of Dolby Digital, DTS or other multi-channel format (DOLBY/DTS SURROUND)
- ※ Default settings are indicated in ( ).

**1** Press  $\Delta$   $\nabla$  to select “Auto Surround Mode”, then press ENTER.

**2** Press  $\triangleleft$   $\triangleright$  to set.

**3** Press ENTER.

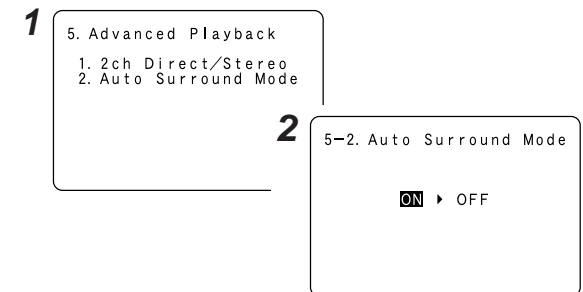

Option Setup

Setting the Power Amplifier Assignment

To suit your preference, a surround back channel's power amplifier can be assigned to the front channel ("Front A" or "Front B") for bi-amp playback, ZONE2.

Power Amplifier Assignment	SPEAKER OUT		PRE-OUT
	MAIN ZONE	ZONE2	S.BACK/ZONE2
Surround Back	7.1ch system	–	Surround back
ZONE2	5.1ch system	2ch system	ZONE2
Bi-Amp	5.1ch system	–	–

1 Press  $\Delta \nabla$  to select "Option Setup", then press ENTER.

2 Press  $\Delta \nabla$  to select "Power Amp Assign", then press ENTER.

3 Press  $\triangleleft \triangleright$  to set.

**S. Back:**  
The surround back speakers are used in MAIN ZONE.

**ZONE2:**  
This mode assigns the surround back amplifier channels to provide ZONE2 speaker-level outputs from the surround back speaker terminals.

**Front A, Front B:**  
This provides a bi-amp mode for the two main front speakers, replicating the front A or front B amplifier channel's outputs.

4 Press ENTER.

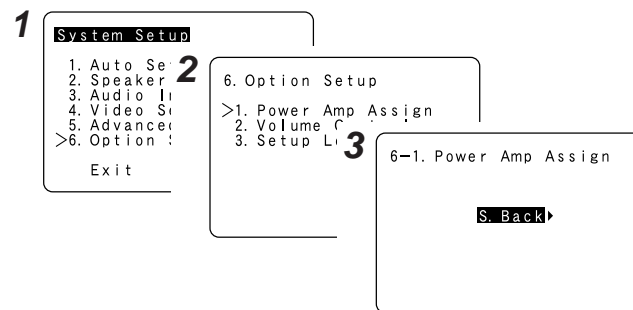

### Front Bi-Amp connections

Dynamic sound with a range wider than that of full range systems can be played by connecting bi-amp compatible speakers to the AVR-1907. Be sure to consult the owner's manual of your bi-amp-capable speakers for further information before proceeding.

**Speaker [R]**      **Speaker [L]**

**NOTE:**

- When making bi-amp connections, be sure to remove the short-circuiting bar included with the speaker.

Setting the Volume Control

This sets the volume level of output.

1 Press  $\Delta \nabla$  to select "Volume Control", then press ENTER.

2 Press  $\Delta \nabla$  to select the item, then press  $\triangleleft \triangleright$  to set.

**Volume Limit:**  
Set the volume's upper limit.

- OFF:**  
If you do not want to set a volume limit, select "OFF". In this case, the volume can be set to the AVR-1907's maximum volume (output) level of +18 dB, which is extremely loud.
- 20 dB, -10 dB, 0 dB:**  
The volume cannot be increased above the selected levels.

**Power On Level:**  
Set the volume level when the power is turned on. You can adjust the MAIN ZONE volume level within the range of -80 to +18 dB.

- LAST:**  
The volume set when the AVR-1907 was last used is stored in the memory and set when the power is turned on.
- (Mute):  
The volume is always muted when the power is turned on.

**Mute Level:**  
Set the level of volume attenuation in the mute mode.

- FULL:**  
The volume is fully muted.
- 20 dB, -40 dB:**  
The volume is lowered 20 dB or 40 dB from the current level.

3 Press ENTER.

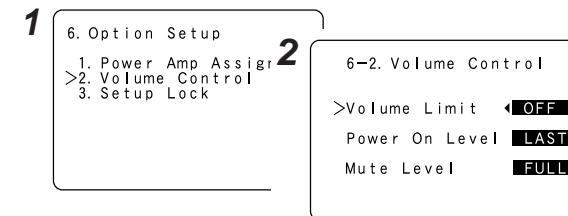



Advanced Setup – Part 1

Setting the Setup Lock

This sets whether or not to lock the system setup settings so that they cannot be changed.

**1** Press  $\Delta \nabla$  to select “Setup Lock”, then press **ENTER**.

**2** Press  $\triangleleft$  to select “ON”, then press **ENTER**.

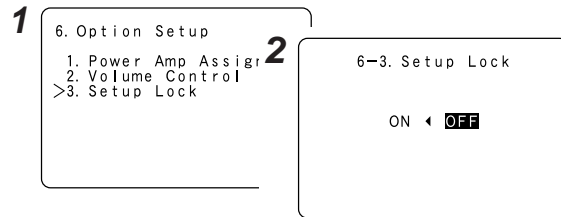

- When the setup lock function is activated, the settings listed below cannot be changed, and “SETUP LOCKED” is displayed when related buttons are operated.
  - System setup settings
  - Surround parameter settings
  - Tone control settings
  - Channel level settings (including test tones)
- To unlock, press **SYSTEM SETUP** again and display the “Setup Lock” screen, then select “OFF” and press **ENTER**.

Advanced Setup – Part 2

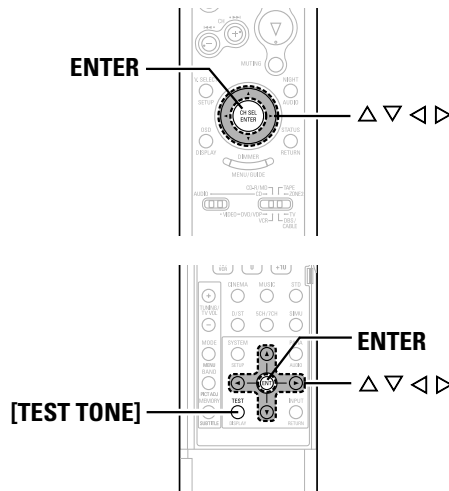
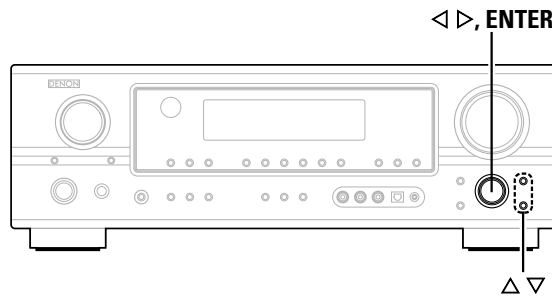

**About the button names in this explanation**  
 $\triangleleft$   $\triangleright$  : Buttons on the main unit  
 [ ] : Buttons on the remote control unit  
**Button name only :**  
 Buttons on the main unit and remote control unit

Speaker Setup

- If the “Auto Setup” procedure has already been performed, there is no need to make this setting.
- Perform this setting if you wish to make the settings for your speaker systems manually.

Setting the Speaker Configuration

Automatically set the output component and properties for the various channels according to the combination of speakers to be actually used for surround playback.

**1** Press  $\Delta \nabla$  to select “Speaker Setup”, then press **ENTER**.

**2** Press  $\Delta \nabla$  to select “Speaker Config.”, then press **ENTER**.

**3** Press  $\Delta \nabla$  to select the speaker, then press  $\triangleleft \triangleright$  to set.

- Large:**  
 Select this when using large speakers with ample low frequency reproduction capabilities.
- Small:**  
 Select this when using small speakers without ample low frequency reproduction capabilities.
- None:**  
 Select this when no speaker is connected.
- Yes / No:**  
 Select “Yes” when a subwoofer is connected, “No” when no subwoofer is connected.
- 2sp / 1sp:**  
 Select the number of surround back speakers.

Advanced Setup – Part 2

- ※ A subwoofer with sufficient low frequency playback capability can better handle deep bass than most main and surround speakers, and the system's overall performance will be greatly enhanced when "Small" is set for the main (front) and surround speakers.
- ※ When "Front" is set to "Small", "Subwoofer" is automatically set to "Yes", and when "Subwoofer" is set to "No", "Front" is automatically set to "Large".

4 Press ENTER.

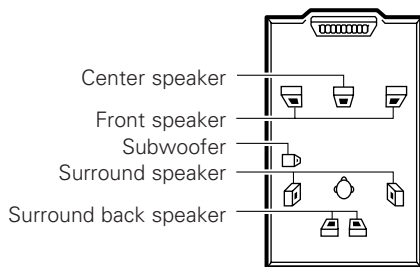
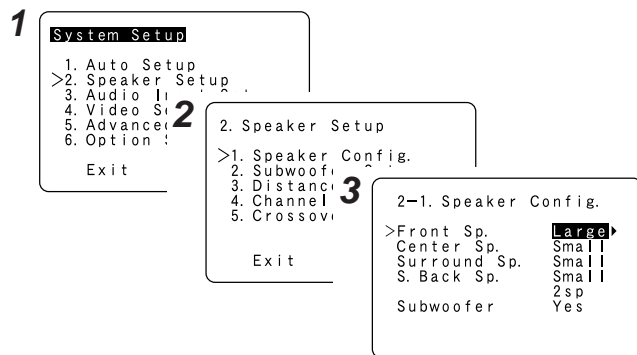

- Select "Large" or "Small" not according to the actual size of the speaker but according to the speaker's capacity for playing low frequency (bass sound below the frequency set for the Crossover Frequency) signals. If you do not know, try comparing the sound at both settings (setting the volume to a level low enough so as not to damage the speakers) to determine the proper setting.

Setting the Subwoofer Setup

Select the method of playback of the subwoofer for playing the low bass signals.

1 Press  $\Delta$   $\nabla$  to select "Subwoofer Setup", then press ENTER.

2 Press  $\triangleleft$   $\triangleright$  to set.

LFE (Normal):

For any channel(s) that are set to "Large", low frequencies in that channel's corresponding source are directed to that loudspeaker only. The low frequencies played from the subwoofer are only the LFE signals and the low frequencies of channels set to "Small".

LFE+Main:

Low frequencies from speaker channels that have been set to "Large" are reproduced from those speakers as well as from the subwoofer(s).

3 Press ENTER.

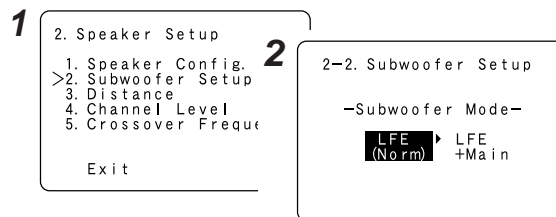

- The subwoofer mode setting is only valid when and "Yes" is set for the subwoofer in the "Setting the Speaker Configuration".
- Select the "LFE+Main" mode if you want low frequency signals to always be played from the subwoofer channel.
- Select the mode achieving a voluminous bass sound when playing music or movie sources.

Advanced Setup – Part 2

Setting the Distance

This parameter is for optimizing the timing with which the audio signals are produced from the speakers and subwoofer according to the listening position.

Preparations:

Measure the distances between the listening position and the speakers (L1 to L8 on the diagram at the below).

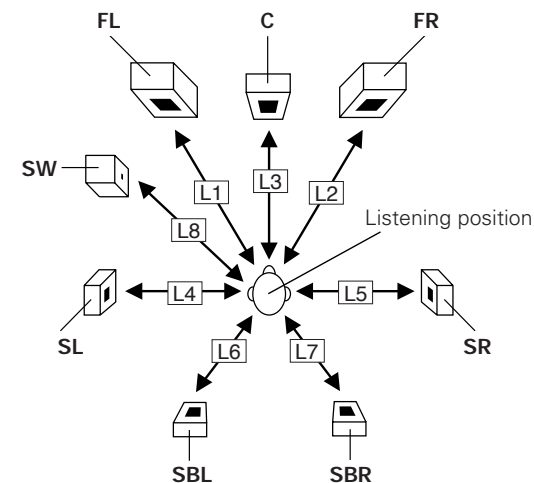

1 Press  $\Delta$   $\nabla$  to select "Distance", then press ENTER.

2 Press  $\Delta$   $\nabla$  to select the speaker, then press  $\triangleleft$   $\triangleright$  to set.

3 Press ENTER.

Advanced Setup – Part 2

**1** 2. Speaker Setup

- 1. Speaker Config.
- 2. Subwoofer Setup
- >3. Distance
- 4. Channel Level
- 5. Crossover Frequ

Exit

**2** 2-3. Distance

>Front L	12.0ft	..... L1
Front R	12.0ft	..... L2
Center	12.0ft	..... L3
Surround L	10.0ft	..... L4
Surround R	10.0ft	..... L5
S. Back L	10.0ft	..... L6
S. Back R	10.0ft	..... L7
Subwoofer	12.0ft	..... L8
Default		



- The distance changes in units of 0.5 foot each time the button is pressed. Select the value closest to the measured distance.
- Please note that the difference of distance for every speaker should be 20 ft or less.

Setting the Channel Level

Set the volume of the various speakers so that the sound output from the speakers and the subwoofer seems to have the same volume level.

**1** Press  $\Delta \nabla$  to select “Channel Level”, then press ENTER.

**2** Press  $\triangleleft \triangleright$  to set.

**Auto:**

Adjust the level while listening to the test tones produced automatically from each speaker.  
Test tones are automatically emitted from each speaker.

**Manual:**

Adjust with the speaker from which the test tone is output switched manually.

**3** Press  $\Delta \nabla$  to select “Test Tone Start”, then press  $\triangleleft$  to select “Yes”.

**4** When “Auto” mode is selected:  
Press  $\triangleleft \triangleright$  to adjust the volume.

-1 • Test tones are output automatically, in the order shown below.

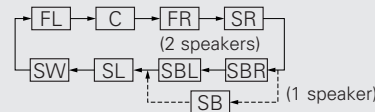

※ The volume can be adjusted within the range -12 dB to +12 dB.

**4** When “Manual” mode is selected:

Press  $\Delta \nabla$  to select the speaker, then press  $\triangleleft \triangleright$  to adjust the volume.

**5** Press ENTER.

Advanced Setup – Part 2

**1** 2. Speaker Setup

- 1. Speaker Config.
- 2. Subwoofer Setup
- 3. Distance
- >4. Channel Level
- 5. Crossover Frequ

Exit

**2** 2-4. Channel Level

>Test Tone

Auto  $\triangleright$  Manual

Test Tone Start  $\triangleleft$

Level Clear  $\triangleleft$

**3** 2-4. Channel Level

Test Tone

Auto : Manual -1

>Test Tone Start

Level Clear  $\triangleleft$

**4** Test Tone -Auto-

>Front L	-12.0dB
Center	0.0dB
Front R	0.0dB
Surround R	0.0dB
S. Back R	0.0dB
S. Back L	0.0dB
Surround L	0.0dB
Subwoofer	0.0dB



- To cancel the setting, press  $\nabla$  and select “Level Clear”, then press  $\triangleleft$  and select “Yes”.

2-4. Channel Level

Test Tone

Auto : Manual

Test Tone Start  $\triangleleft$

>Level Clear  $\triangleleft$

- To adjust the channel level separately for the different play modes after setting the channel level, perform the operation on page 32.

Advanced Setup – Part 2

□ Adjusting the test tone using the remote control unit

Adjustment of the test tones using the remote control unit is only possible in the “Auto” mode and only valid in the STANDARD (Dolby/DTS Surround) mode. The adjusted levels are automatically stored for the different surround modes.

**1** Press [TEST TONE].

- Test tones are output from the different speakers.

**2** Press ◀ ▶ to adjust the volume.

**3** Press [TEST TONE].

**Setting the Crossover Frequency**

Set the frequency (Hz) below which the bass sound of the various speakers is to be output from the subwoofer.

For speakers that are set to “Small”, frequencies under the crossover frequency are cut before the signal is output, and the low frequency component that was cut is output from the subwoofer or the speakers that are set to “Large”.

**1** Press △ ▽ to select “Crossover Frequency”, then press ENTER.

**2** Press ◀ ▶ to set.

40, 60, 80, 90, 100, 110, 120, 150, 200, 250 Hz:

Set as desired according to your speakers’ bass playback ability.

**3** Press ENTER.

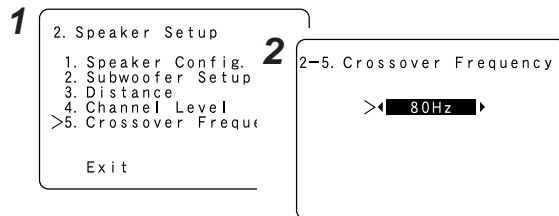

- The crossover frequency mode is valid only when subwoofer is set to “ON”, and when one or more speakers are set to “Small”, as described in section “Setting the Speaker Configuration” (page 54, 55).
- If “LFE+Main” is set at “Subwoofer Setup”, “SW:LFE+Main” (page 55) is displayed at the top right of the screen.

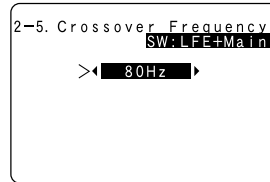

- Set to “80 Hz” when using regular speakers. When using small speakers, we recommend setting to a higher frequency.

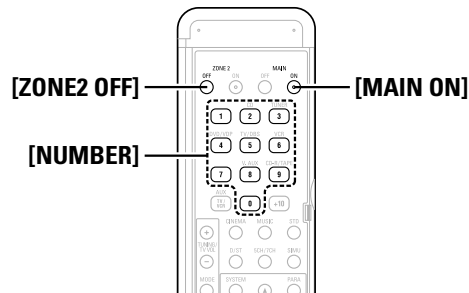
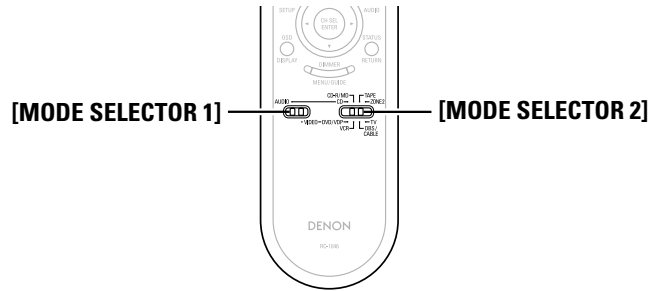

## Operating the remote control unit

### Operating DENON audio components

- 1** Set **[MODE SELECTOR 1]** to “AUDIO”.
- 2** Set **[MODE SELECTOR 2]** to the position for the component to be operated (CD, CD-R/MD or TAPE).
- 3** Operate the audio component.
  - ※ For details, refer to the component’s operating instructions.
  - ※ While this remote control is compatible with a wide range of infrared controlled components, it may be the case that some component models cannot be operated with this remote control.

### Setting the preset memory function

- DENON and other makes of components can be operated by setting the preset memory.
- This remote control unit can be used to operate components of other manufacturers without using the learning function by registering the manufacturer of the component as shown in the list of preset codes (☞ End of this manual).
- Operation is not possible for some models.

- 1** Set **[MODE SELECTOR 1]** to “AUDIO” or “VIDEO”.

※ Set to the AUDIO side for the CD, TAPE or CD-R/MD position, and to the VIDEO side for the DVD/VDP, DBS/CABLE, VCR or TV position.

- 2** Set **[MODE SELECTOR 2]** to the component to be registered.

- 3** Press **[ZONE2 OFF]** and **[MAIN ON]** at the same time.
  - The indicator starts flashing.

- 4** Referring to the included list of preset codes, press **[NUMBER]** to input the preset code (a 3-digit number) for the manufacturer of the component whose signals you want to store in the memory.

- 5** To store the codes of another component in the memory, repeat steps 1 to 4.



- The signals for the pressed buttons are emitted while setting the preset memory. To avoid accidental operation, cover the remote control unit’s transmitting window while setting the preset memory.
- Depending on the model and year of manufacture, this function cannot be used for some models, even if they are of makes listed in the list of preset codes.
- Some manufacturers use more than one type of remote control code. Refer to the included list of preset codes to change the number and verify correct operation.
- The preset memory can be set for one component only among the following: CD-R/MD, DVD/VDP and DBS/CABLE.

Operating the remote control unit

Operating a component stored in the preset memory

**1** Set **[MODE SELECTOR 1]** to "AUDIO" or "VIDEO".

※ Set to the AUDIO side for the CD, TAPE or CD-R/MD position, and to the VIDEO side for the DVD/VDP, DBS/CABLE, VCR or TV position.

**2** Set **[MODE SELECTOR 2]** to the component you want to operate.

**3** Operate the component.

※ For details, refer to the component's operating instructions.  
 ※ Some models cannot be operated with this remote control unit.

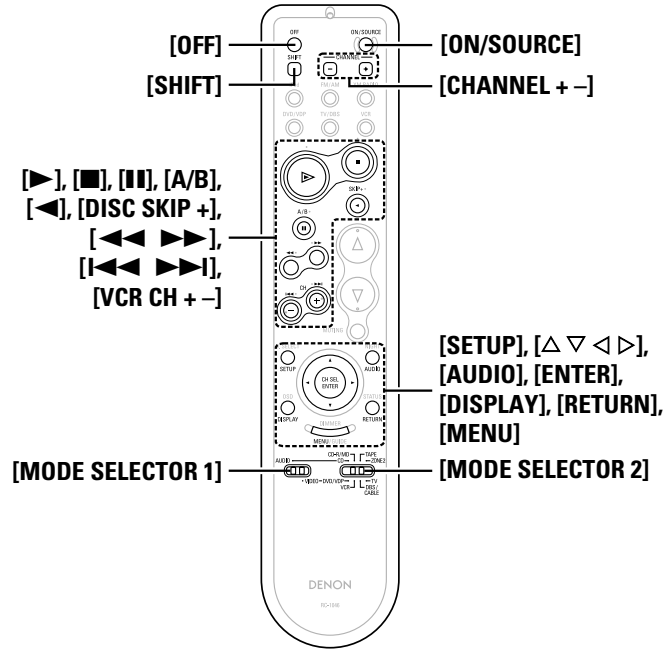

Operating the remote control unit

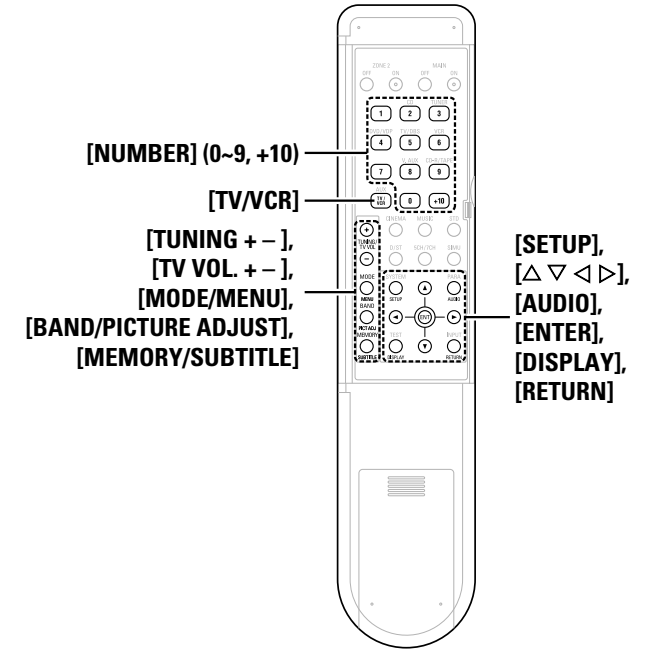

## Operating the remote control unit

## Operating the remote control unit

## □ Functions of buttons for the different devices

## [Front]

Device operated	CD player	CD recorder	MD recorder	Tape deck	DVD player	Video disc player	Video deck	Satellite tuner	Cable TV	TV (Monitor)
<b>MODE SELECTOR 1</b>	<b>AUDIO</b>				<b>VIDEO</b>					
<b>MODE SELECTOR 2</b>	<b>CD</b>	<b>CD-R / MD</b>		<b>TAPE</b>	<b>DVD / VDP</b>		<b>VCR</b>	<b>DBS / CABLE</b>		<b>TV</b>
<b>OFF</b>	–	–	–	–	Power off	–	–	–	–	–
<b>ON / SOURCE</b>	–	–	–	–	Power on	Power on /Standby	Power on /Standby	Power on /Standby	Power on /Standby	Power on /Standby
<b>SHIFT</b>	Preset channel selection	Preset channel selection	Preset channel selection	Preset channel selection	–	–	–	–	–	–
<b>CHANNEL –</b>	Preset channel selection	Preset channel selection	Preset channel selection	Preset channel selection	Channels –	Channels –	Channels –	Channels –	Channels –	Channels –
<b>CHANNEL +</b>	Preset channel selection	Preset channel selection	Preset channel selection	Preset channel selection	Channels +	Channels +	Channels +	Channels +	Channels +	Channels +
<b>▶</b>	Play	Play	Play	Forward play	Play	Play	Play	Punch through	Punch through	Punch through
<b>■</b>	Stop	Stop	Stop	Stop	Stop	Stop	Stop			
<b>II, A/B</b>	Pause	Pause	Pause	A/B switching	Pause	Pause	Pause			
<b>◀, DISC SKIP +</b>	Disc skip +	–	–	Reverse play	Disc skip	–	–			
<b>◀◀</b>	Search (reverse)	Search (reverse)	Search (reverse)	Rewind	Search (reverse)	Search (reverse)	Search (reverse)			
<b>▶▶</b>	Search (forward)	Search (forward)	Search (forward)	Fast forward	Search (forward)	Search (forward)	Search (forward)			
<b>I◀◀, VCR CH –</b>	Skip (reverse)	Skip (reverse)	Skip (reverse)	–	Skip (reverse)	Skip (reverse)	Channels –			
<b>▶▶I, VCR CH +</b>	Skip (forward)	Skip (forward)	Skip (forward)	–	Skip (forward)	Skip (forward)	Channels +			
<b>SETUP</b>	–	–	–	–	Setup	–	–	–	–	–
<b>△ ▽ ◀ ▷</b>	–	–	–	–	Cursor operation	–	–	Cursor operation	Cursor operation	Cursor operation
<b>AUDIO</b>	–	–	–	–	Audio	–	–	–	–	–
<b>ENTER</b>	–	–	–	–	Enter	–	–	Enter	Enter	Enter
<b>DISPLAY</b>	–	–	–	–	Display selection	–	–	Display selection	Display selection	Display selection
<b>RETURN</b>	–	–	–	–	Return	–	–	Return	Return	Return
<b>MENU</b>	–	–	–	–	Menu	–	–	Menu	Menu	Menu

## Operating the remote control unit

## Operating the remote control unit

[Rear]

Device operated	CD player	CD recorder	MD recorder	Tape deck	DVD player	Video disc player	Video deck	Satellite tuner	Cable TV	TV (Monitor)
<b>MODE SELECTOR 1</b>	<b>AUDIO</b>				<b>VIDEO</b>					
<b>MODE SELECTOR 2</b>	<b>CD</b>	<b>CD-R / MD</b>		<b>TAPE</b>	<b>DVD / VDP</b>		<b>VCR</b>	<b>DBS / CABLE</b>		<b>TV</b>
<b>NUMBER (0 ~ 9, +10)</b>	–	–	–	–	Number input / Track selection	Number input / Track selection	–	Channels	Channels	Channels
<b>TV / VCR</b>	–	–	–	–	Input mode selection	Input mode selection	Input mode selection	Input mode selection	Input mode selection	Input mode selection
<b>TUNING + / TV VOL +</b>	Tuning	Tuning	Tuning	Tuning	Volume control +	Volume control +	Volume control +	Volume control +	Volume control +	Volume control +
<b>TUNING – / TV VOL –</b>	Tuning	Tuning	Tuning	Tuning	Volume control –	Volume control –	Volume control –	Volume control –	Volume control –	Volume control –
<b>MODE / MENU</b>	Auto/Manual switching	Auto/Manual switching	Auto/Manual switching	Auto/Manual switching	Menu	–	–	Menu	Menu	Menu
<b>SETUP</b>	–	–	–	–	Setup	–	–	–	–	–
<b>△ ▽ ◀ ▶</b>	–	–	–	–	Cursor operation	–	–	Cursor operation	Cursor operation	Cursor operation
<b>AUDIO</b>	–	–	–	–	Audio	–	–	–	–	–
<b>BAND / PICTURE ADJUST</b>	AM/FM/XM switching	AM/FM/XM switching	AM/FM/XM switching	AM/FM/XM switching	Picture adjust	–	–	–	–	–
<b>ENTER</b>	–	–	–	–	Enter	–	–	Enter	Enter	Enter
<b>MEMORY / SUBTITLE</b>	Preset memory	Preset memory	Preset memory	Preset memory	Subtitle	–	–	–	–	–
<b>DISPLAY</b>	–	–	–	–	Display selection	–	–	Display selection	Display selection	Display selection
<b>RETURN</b>	–	–	–	–	Return	–	–	Return	Return	Return
<b>Default setting (Preset code)</b>	DENON (111)	DENON (111)	–	DENON (111)	DENON (111)	–	HITACHI (108)	–	ABC (007)	HITACHI (134)
<b>Special remarks</b>	①	①		①	①, ②		①	①, ③		①, ③

**Special remarks:**

- ① It is only possible to set the preset memory for one device per mode. When a new code is preset, the previous code is automatically deleted.
- ② Note that the function names of the DVD buttons on the remote control unit may differ for some brands. Check beforehand.
- ③ The CD, CD-R/MD, TAPE, VCR or DVD/VDP buttons can be assigned to a TV or satellite tuner (or cable TV) (page 62).



Operating the remote control unit

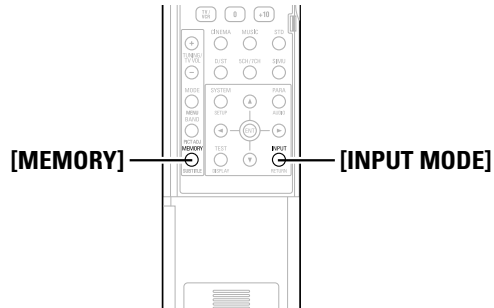
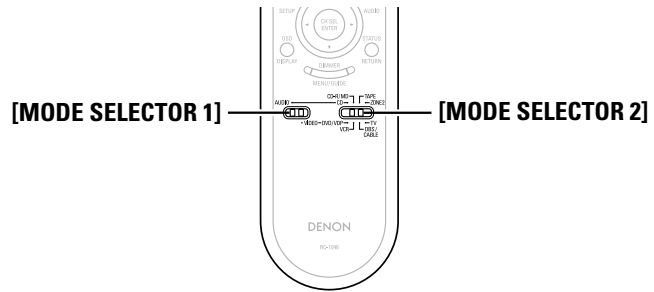

Operating the remote control unit

Setting the punch through function

“Punch Through” is a function allowing you to operate **▶**, **■**, **◀◀**, **▶▶**, **◀◀▶** and **▶▶◀** on CD, TAPE, CD-R/MD, DVD/VDP or VCR components when in the DBS/CABLE or TV mode. By default, nothing is set.

- 1** Set **[MODE SELECTOR 1]** to “VIDEO”.
- 2** Set **[MODE SELECTOR 2]** to the component to be registered (DBS/CABLE or TV).
- 3** Press **[MEMORY]** and **[INPUT MODE]** at the same time.
  - The indicator starts flashing.
- 4** Input the number of the component you want to set.

	No.
CD	1
TAPE	2
CD-R/MD	3
DVD/VDP	4
VCR	5
No setting	0

# Additional Information

## About the speakers

### Surround back speakers

Sound position directly to the rear can be achieved easily by adding a surround back speaker to a 5.1-channel system. In addition, the acoustic image extending between the sides and the rear is narrowed, thus greatly improving the expression of the surround signals for sounds moving from the sides to the back and from the front to the point directly behind the listening position.

Change of positioning and acoustic image with 5.1-channel systems

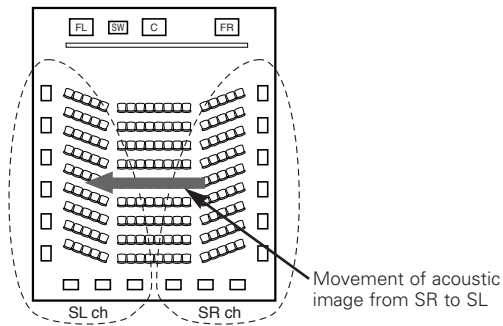

Change of positioning and acoustic image with 6.1-channel systems

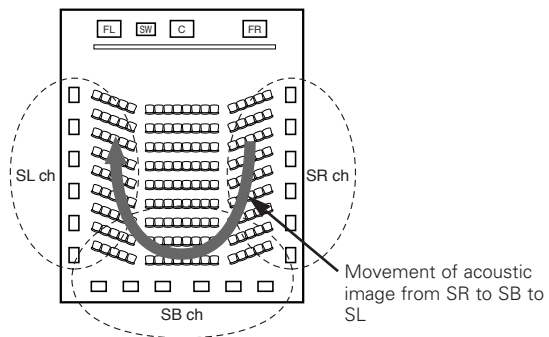

In addition to sources recorded in 6.1-channels, the surround effect of conventional 2- to 5.1-channel sources can also be enhanced.

### Number of surround back speakers

We recommend using two speakers. When using dipolar speakers in particular, be sure to use two speakers.

### Placement of the surround left and right channels when using surround back speakers

We recommend installing the speakers for the surround "L" and "R" channels a bit forward.

## Examples of speaker layouts

Below we introduce examples of speaker layouts. Refer to these to arrange your speakers according to their type and how you want to use them.

### [1] Using surround back speaker(s)

#### ① When mainly playing movies

Recommended when your surround speakers are single or 2-way speakers.

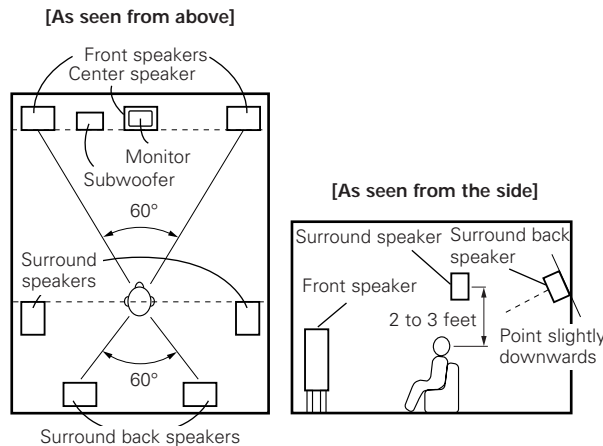

#### ② When playing movies and musics

[As seen from above]

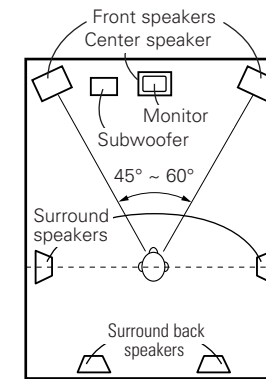

[As seen from the side]

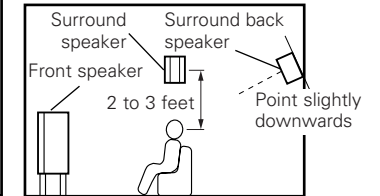

#### [2] When not using surround back speakers

[As seen from above]

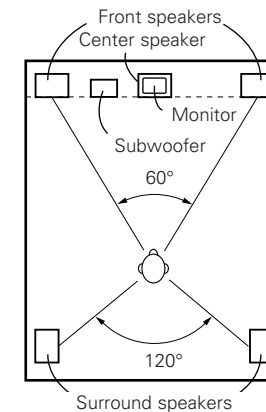

[As seen from the side]

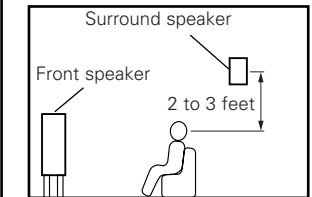

## Additional Information

**Surround**

The AVR-1907 is equipped with a digital signal processing circuit that lets you play program sources in the surround mode to achieve the same sense of presence as in a movie theater.

**Dolby Surround****[1] Dolby Digital**

Dolby Digital is the multi-channel digital signal format developed by Dolby Laboratories.

A total of 5.1-channels are played: three front channels ("FL", "FR" and "C"), two surround channels ("SL" and "SR") and the "LFE" channel for low frequencies.

Because of this, there is no crosstalk between channels and a realistic sound field with a "three-dimensional" feeling (sense of distance, movement and positioning) is achieved.

A real, overpowering sense of presence is achieved when playing movie sources in AV rooms as well.

**[2] Dolby Pro Logic II**

Dolby Pro Logic II is a matrix decoding technology developed by Dolby Laboratories. Regular music such as that on CDs is encoded into 5 channels to achieve an excellent surround effect.

The surround channel signals are converted into stereo and full band signals (with a frequency response of 20 Hz to 20 kHz or greater) to create a "three-dimensional" sound image offering a rich sense of presence for all stereo sources.

**[3] Dolby Pro Logic IIx**

Dolby Pro Logic IIx is a further improved version of the Dolby Pro Logic II matrix decoding technology.

Audio signals recorded in 2 channels are decoded to achieve a natural sound with up to 7.1-channels.

There are three modes: "Music" suited for playing music, "Cinema" suited for playing movies, and "Game" which is optimum for playing games.

**Sources recorded in Dolby Surround**

Sources recorded in Dolby Surround are indicated with the following logo marks.

Dolby Surround support mark: 

Manufactured under license from Dolby Laboratories. "Dolby", "Pro Logic" and the double-D symbol are trademarks of Dolby Laboratories.

**DTS Digital Surround**

DTS Digital Surround is a digital surround format developed by Digital Theater Systems of the United States.

The number of playback channels and the playing band is the same as for Dolby Digital (5.1-channels).

The compression rate of the audio data when it was recorded on the medium is lower than for Dolby Digital, so there is more information when the data is decoded, resulting in richer, clearer sound quality.

MANUFACTURED UNDER LICENSE FROM DIGITAL THEATER SYSTEMS, INC.

U.S. PAT. NO'S. 5,451,942; 5,956,674; 5,974,380; 5,978,762; 6,226,616; 6,487,535 AND OTHER U.S. AND WORLD-WIDE PATENTS ISSUED AND PENDING.

"DTS", "DTS-ES", "Neo:6", AND "DTS 96/24" ARE TRADEMARKS OF DIGITAL THEATER SYSTEMS, INC. © 1996, 2003 DIGITAL THEATER SYSTEMS, INC. ALL RIGHTS RESERVED.

**DTS-ES™**

DTS-ES is a new surround format developed by Digital Theater Systems.

A sound image and sense of positioning can be achieved by adding a surround back ("SB") channel to the conventional 5.1-channels.

**DTS-ES™ Discrete 6.1:**

This is the latest format, in which all 6.1-channels, including the "SB" channel, are recorded independently. Since the different channels are independent, the sound can be designed with total freedom.

**DTS-ES™ Matrix 6.1:**

With this format, the "SB" channel is matrix-encoded and inserted into the "SL" and "SR" channels, then decoded for the "SL", "SR" and "SB" channels upon playback. This achieves a surround sound more faithful to the artist's sound design intentions than with conventional 5.1- or 6.1-channel systems.

**DTS 96/24**

DTS 96/24 is a multi-channel digital signal format developed by Digital Theater Systems.

The sampling frequency is raised to achieve 5.1-channel playback with high quality sound (sampling frequency: 96 kHz, quantization: 24 bits).

## Additional Information

**DTS NEO:6 surround**

This is a matrix decoding technology for 6.1-channel surround playback of 2-channel sources.

The optimum decoding for the type of signal source to be played can be selected. There are two modes.

**DTS NEO:6 CINEMA:**

This mode is suited for playing movies. It achieves the same type of sound as in a movie theater, even with 2 channels.

**DTS NEO:6 MUSIC:**

This mode is suited for playing music. A natural sense of expansion is added to the sound field.

**Neural Surround**

Neural Surround™, a breakthrough in audio technology, will bring the excitement of surround music to more of America's listening audience. It provides the rich envelopment and discrete image detail of surround sound in a format 100 % compatible with stereo. With superior spectral resolution and channel separation, Neural Surround™ draws the brain's attention to sonic details in musical instruments, vocals, and ambience that are typically masked by other playback systems. This allows the listener to fully experience the richness and subtleties in recorded performance as never before. As the chosen format for XM Satellite Radio's new XM HD surround programming, Neural Surround will help deliver more surround music to more listeners than any other broadcast format. XM Satellite Radio will be the first radio company -to broadcast surround sound on the radio 24 hours a day and will offer three channels fully dedicated to Neural Surround™ music. This alone will amount to more than 25,000 hours of Neural Surround™ music each year.



- This product is manufactured under license from Neural Audio Corporation. D&M Holdings Inc. hereby grants the user a non-exclusive, non-transferable, limited license right exercisable to use the NA SURROUND Technology and other US and World Wide Patents Pending technology. "Neural" and "Neural Audio" and "Neural Surround" Are trademarks of Neural Audio Corporation. All Rights Reserved.

# Troubleshooting

If a problem should arise, first check the following.

1. Are the connections correct?
2. Have you operated the receiver according to the Operating Instructions?
3. Are the speakers and other components operating properly?

If this unit is not operating properly, check the items listed in the table below. Should the problem persist, there may be a malfunction. Disconnect the power immediately and contact your store of purchase.

Symptom	Cause	Measures	Page
Display not lit and sound not produced when POWER switch set to on.	<ul style="list-style-type: none"> <li>Power supply cord not plugged in securely.</li> </ul>	<ul style="list-style-type: none"> <li>Check the insertion of the power supply cord plug.</li> </ul>	20
Display lit but sound not produced.	<ul style="list-style-type: none"> <li>Speaker cables not securely connected.</li> <li>FUNCTION knob position is not appropriate.</li> <li>Volume control set to minimum.</li> <li>MUTING is on.</li> <li>No digital signal is being input.</li> </ul>	<ul style="list-style-type: none"> <li>Connect securely.</li> </ul>	8
		<ul style="list-style-type: none"> <li>Switch to the proper position.</li> </ul>	21
		<ul style="list-style-type: none"> <li>Turn volume up to suitable level.</li> </ul>	21
		<ul style="list-style-type: none"> <li>Switch off MUTING.</li> <li>Properly select a digital signal input source.</li> </ul>	22 47
Nothing is displayed on monitor.	<ul style="list-style-type: none"> <li>AVR-1907's video output terminals and monitor's input terminals are not properly connected.</li> <li>Monitor's input setting is wrong.</li> <li>Player connected with component terminal, TV connected with video terminal (yellow) or S-Video terminal.</li> </ul>	<ul style="list-style-type: none"> <li>Check that the connections are correct.</li> </ul>	9, 13 ~ 20
		<ul style="list-style-type: none"> <li>Set the monitor's input selector to the terminals to which video signals are connected.</li> </ul>	—
		<ul style="list-style-type: none"> <li>Down-conversion is not possible for progressive video signals. Make the interlace settings on the player.</li> </ul>	—
No DTS sound is produced.	<ul style="list-style-type: none"> <li>DVD player's audio output setting is not set to bit stream.</li> <li>DVD player is not DTS-compatible.</li> <li>AVR-1907's input setting is set to analog.</li> </ul>	<ul style="list-style-type: none"> <li>Make the DVD player's default settings.</li> </ul>	—
		<ul style="list-style-type: none"> <li>Use a DTS-compatible player.</li> </ul>	—
		<ul style="list-style-type: none"> <li>Set to "AUTO" or "DTS".</li> </ul>	21
Copying from DVD to VCR is not possible.	<ul style="list-style-type: none"> <li>Copying between a source such as DVD and a VCR is not usually possible, as DVDs are often encoded with copy-protection signals that prevent VCR recording.</li> </ul>	<ul style="list-style-type: none"> <li>Copying is not possible.</li> </ul>	—

Symptom	Cause	Measures	Page
No sound is produced from subwoofer.	<ul style="list-style-type: none"> <li>Subwoofer's power is not on.</li> <li>Subwoofer's initial setting is set to "NO".</li> <li>Subwoofer's output is not connected.</li> <li>The subwoofer's channel volume level is set to "OFF".</li> </ul>	<ul style="list-style-type: none"> <li>Turn on the power.</li> <li>Set the setting to "YES".</li> <li>Connect properly.</li> <li>Turn the subwoofer's channel volume level up.</li> </ul>	— 54, 55 8 32
No test tones are produced.	<ul style="list-style-type: none"> <li>Surround mode is set to a mode other than STANDARD (Dolby/DTS Surround).</li> </ul>	<ul style="list-style-type: none"> <li>Set to STANDARD (Dolby/DTS Surround).</li> </ul>	—
No sound is produced from surround speakers.	<ul style="list-style-type: none"> <li>Surround mode is set to "STEREO".</li> </ul>	<ul style="list-style-type: none"> <li>Set to a mode other than "STEREO".</li> </ul>	—
This unit does not operate properly when remote control unit is used.	<ul style="list-style-type: none"> <li>Batteries dead.</li> <li>Remote control unit too far from this unit.</li> <li>Obstacle between this unit and remote control unit.</li> <li>Different button is being pressed.</li> <li>⊕ and ⊖ ends of batteries inserted in reverse.</li> </ul>	<ul style="list-style-type: none"> <li>Replace with new batteries.</li> <li>Move closer.</li> </ul>	3 3
		<ul style="list-style-type: none"> <li>Remove obstacle.</li> </ul>	3
		<ul style="list-style-type: none"> <li>Press the proper button.</li> </ul>	—
		<ul style="list-style-type: none"> <li>Insert batteries properly.</li> </ul>	3
Power has turned off and the power indicator is blinking red.	<ul style="list-style-type: none"> <li>The set's internal temperature has risen and the protection circuit has been activated.</li> <li>The core wires of the speaker cables are touching each other or the AVR-1907's rear panel, activating the protection circuit.</li> <li>AVR-1907 is malfunctioning.</li> </ul>	<ul style="list-style-type: none"> <li>Put the AVR-1907 in a well-ventilated place.</li> </ul>	8
		<ul style="list-style-type: none"> <li>Turn off the power, then wait for the set to fully cool off before turning the power back on.</li> </ul>	8
		<ul style="list-style-type: none"> <li>Check the connections of all the speaker cables.</li> </ul>	8
		<ul style="list-style-type: none"> <li>Turn off the power and contact a DENON customer service center.</li> </ul>	8
Sound is only produced from the center speaker.	<ul style="list-style-type: none"> <li>You are playing a monaural source (TV, AM radio broadcast, etc.) in the STANDARD (Dolby/DTS Surround) mode.</li> </ul>	<ul style="list-style-type: none"> <li>When playing monaural sources, select a surround mode other than STANDARD (Dolby/DTS Surround) mode.</li> </ul>	30, 31
"DOLBY DIGITAL" is not displayed.	<ul style="list-style-type: none"> <li>DVD player's digital audio output setting is not proper.</li> </ul>	<ul style="list-style-type: none"> <li>Check the DVD player's audio output setting. For details, see the DVD player's operating instructions.</li> </ul>	—
"CHECK ANTENNA" is displayed in the XM mode.	<ul style="list-style-type: none"> <li>AVR-1907's XM connectors and the XM Passport System is not properly connected.</li> </ul>	<ul style="list-style-type: none"> <li>Check that the connection are correct.</li> </ul>	35
"NO SIGNAL" is displayed in the XM mode.	<ul style="list-style-type: none"> <li>The signal cannot be received.</li> </ul>	<ul style="list-style-type: none"> <li>Reposition your XM Passport System.</li> </ul>	35

Troubleshooting

Troubleshooting

Symptom	Cause	Measures	Page
"OFF AIR" is displayed in the XM mode.	• The selected channel is not currently broadcasting.	• Select the another channel.	35
Receiving only XM channels 0 and 1.	• The XM Tuner is not activated.	• Contact XM Radio.	35

# Specifications

**Audio section**

- **Power amplifier**  
**Rated output:**

Front (A, B):  
 85 W + 85 W (8 Ω/ohms, 20 Hz ~ 20 kHz with 0.08 % T.H.D.)  
 120 W + 120 W (6 Ω/ohms, 1 kHz with 0.7 % T.H.D.)  
 Center:  
 85 W (8 Ω/ohms, 20 Hz ~ 20 kHz with 0.08 % T.H.D.)  
 120 W (6 Ω/ohms, 1 kHz with 0.7 % T.H.D.)  
 Surround:  
 85 W + 85 W (8 Ω/ohms, 20 Hz ~ 20 kHz with 0.08 % T.H.D.)  
 120 W + 120 W (6 Ω/ohms, 1 kHz with 0.7 % T.H.D.)  
 Surround Back:  
 85 W + 85 W (8 Ω/ohms, 20 Hz ~ 20 kHz with 0.08 % T.H.D.)  
 120 W + 120 W (6 Ω/ohms, 1 kHz with 0.7 % T.H.D.)  
**Output terminals:**  
 Front: A or B 6 ~ 16 Ω/ohms  
 A + B 12 ~ 16 Ω/ohms  
 Center, Surround, Surround. Back: 6 ~ 16 Ω/ohms

- **Analog**

**Input sensitivity / input impedance:** 200 mV / 47 kΩ/kohms  
**Frequency response:** 10 Hz ~ 100 kHz: +1, -3 dB (DIRECT mode)  
**S/N:** 98 dB (DIRECT mode)

**Video section**

- **Standard video terminals**

**Input / output level and impedance:** 1 Vp-p, 75 Ω/ohms  
**Frequency response:** 5 Hz ~ 10 MHz — +1, -3 dB

- **S-Video terminals**

**Input / output level and impedance:** Y (brightness) signal — 1 Vp-p, 75 Ω/ohms  
 C (color) signal — 0.286 Vp-p, 75 Ω/ohms  
**Frequency response:** 5 Hz ~ 10 MHz — +1, -3 dB

- **Color component video terminal**

**Input / output level and impedance:** Y (brightness) signal — 1 Vp-p, 75 Ω/ohms  
 Pb/Cb signal — 0.7 Vp-p, 75 Ω/ohms  
 Pr/Cr signal — 0.7 Vp-p, 75 Ω/ohms  
**Frequency response:** DC ~ 100 MHz — +0, -3 dB

**Tuner section**

	[FM]	[AM]
<b>Receiving Range:</b>	87.5 MHz ~ 107.9 MHz	520 kHz ~ 1710 kHz
<b>Usable Sensitivity:</b>	1.0 μV (11.2 dBf)	18 μV
<b>50 dB Quieting Sensitivity:</b>	MONO 1.6 μV (15.3 dBf) STEREO 23 μV (38.5 dBf)	
<b>S/N (IHF-A):</b>	MONO 77 dB STEREO 72 dB	
<b>Total Harmonic Distortion (at 1 kHz):</b>	MONO 0.15 % STEREO 0.3 %	

(note: μV at 75 Ω/ohms, 0 dBf = 1 x 10<sup>-16</sup> W)

**General**

**Power supply:** AC 120 V, 60 Hz  
**Power consumption:** 5.1 A  
 1 W Max (Standby)  
**Maximum external dimensions:** 434 (W) x 147 (H) x 417 (D) mm (17-3/32" x 5-25/32" x 16-27/64")  
**Mass:** 11.8 kg (26 lbs)

**Remote control unit (RC-1046)**

**Batteries:** R6P/AA Type (Two batteries)  
**External dimensions:** 52 (W) x 243 (H) x 21 (D) mm (2-3/64" x 9-9/16" x 53/64")  
**Mass:** 175 g (Approx. 6.2 oz) (included batteries)

\* For purposes of improvement, specifications and design are subject to change without notice.

## ☐ List of preset codes

### DVD

Denon	014, *[111]
Aiwa	009
Hitachi	010
JVC	006, 011
Konka	012, 013
Magnavox	005
Mitsubishi	004
Panasonic	014
Philips	005, 015, 016, 017
Pioneer	003, 008
Sanyo	018
Sony	002, 019, 020
Toshiba	001, 021, 022
Zenith	023

### VDP

Denon	028, 029, 112
Magnavox	026
Mitsubishi	028
Panasonic	029, 030
Philips	026
Pioneer	028, 031
RCA	032
Sony	033, 034, 035, 036

### VCR

Admiral	081
Aiko	095
Aiwa	009
Akai	026, 027, 070, 072, 082, 083, 084
Alba	055
Amstrad	009

ASA	042
Asha	087
Audio Dynamic	005, 085
Audiovox	088
Beaumarck	087
Broksonic	086, 093
Calix	088
Candle	006, 087, 088, 089, 090
Canon	049, 057
Capehart	025, 055, 056, 071
Carver	015
CCE	095
Citizen	006, 007, 087, 088, 089, 090, 095
Craig	007, 087, 088, 091, 115
Curtis Mathes	006, 049, 073, 080, 087, 090, 092
Cybernex	087
Daewoo	025, 055, 059, 074, 089, 093, 095, 096
Daytron	025, 055
DBX	005, 085
Dumont	053
Dynatech	009
Electrohome	001, 088, 097
Electroponic	088
Emerson	001, 009, 017, 027, 086, 088, 089, 092, 093, 097, 100, 101, 102, 103, 104, 117
Fisher	009, 028, 031, 053, 054, 091, 099, 115
GE	007, 011, 049, 050, 051, 052, 073, 080, 087

Go Video	047, 048
Goldstar	000, 006, 012, 062, 088
Gradiente	094
Grundig	042
Harley Davidson	094
Harman Kardon	040, 062
Hi-Q	091
Hitachi	009, 013, 023, 026, 058, *[108], 109, 110, 111
JC Penny	004, 005, 007, 023, 028, 049, 062, 085, 087, 088
Jensen	013, 026
JVC	004, 005, 006, 026, 029, 043, 044, 045, 046, 085
Kenwood	004, 005, 006, 026, 029, 033, 045, 085, 090
Kodak	088
Lloyd	009, 094
LXI	088
Magnavox	015, 016, 042, 049, 063, 106
Magnin	087
Marantz	004, 005, 006, 015, 042, 049, 085, 090
Marta	088
MEI	049
Memorex	009, 033, 049, 053, 060, 081, 087, 088, 091, 094, 115
Metz	123, 124, 125, 126, 127, 128
MGA	001, 017, 027, 041, 097
MGN Technology	087
Midland	011

Minolta	013, 023
Mitsubishi	001, 003, 008, 013, 014, 017, 027, 029, 039, 040, 041, 045, 097
Motorola	081
Montgomery Ward	001, 002, 007, 009, 049, 063, 081, 115, 117
MTC	009, 087, 094
Multitech	007, 009, 011, 087, 090, 094
NAD	038
NEC	004, 005, 006, 018, 026, 029, 045, 061, 062, 085
Nikko	088
Noblex	087
Optimus	081, 088
Optonica	021
Panasonic	024, 049, 064, 066, 067, 068, 069, 107
Perdio	009
Pentax	009, 013, 023, 058, 090
Philco	015, 016, 049
Philips	015, 021, 042, 049, 105
Pilot	088
Pioneer	005, 013, 029, 036, 037, 038, 045, 085
Portland	025, 055, 090
Proscan	063, 080
Pulsar	060
Quartz	033
Quasar	034, 035, 049
Radio Shack	001, 002, 021, 081, 087, 088, 091, 094, 097, 098, 115

Radix	088	Technics	024, 049	Bell & Howell	045, 118	Fujitsu	004, 062
Randex	088	Teknika	009, 010, 022, 049, 088, 094	Bradford	061	Funai	004, 062
RCA	007, 013, 019, 023, 058, 063, 064, 065, 073, 080, 082, 087	TMK	087, 092	Brockwood	003, 047	Futuretech	004
Realistic	009, 021, 031, 033, 049, 053, 081, 087, 088, 091, 094, 097, 098	Toshiba	013, 017, 020, 041, 059, 089, 098, 099, 117	Candle	003, 030, 031, 032, 038, 047, 049, 050, 122	GE	020, 036, 037, 040, 044, 058, 066, 088, 119, 120, 125, 147
Ricoh	055	Totevision	007, 087, 088	Capehart	003	Goldstar	000, 015, 029, 031, 039, 048, 051, 056, 057, 067, 068, 069, 116
Salora	033, 041	Unirech	087	Celebrity	046	Grundy	062
Samsung	007, 011, 051, 059, 070, 083, 087, 089, 113	Vectror Research	005, 062, 085, 089, 090	Circuit City	003	Hitachi	029, 031, 051, 052, 070, 111, 112, 113, 124, <b>*[134]</b>
Sanky	081	Victor	005, 045, 046, 085	Citizen	029, 030, 031, 032, 034, 038, 047, 049, 050, 054, 061, 095, 122, 123	Hitachi Pay TV	151
Sansui	005, 026, 029, 045, 061, 085, 114	Video Concepts	005, 027, 085, 089, 090	Concerto	031, 047, 049	Infinity	017, 071
Sanyo	032, 033, 053, 087, 091, 115, 116	Videosonic	007, 087	Colortyme	003, 047, 049, 135	Janeil	122
SBR	042	Wards	013, 021, 023, 087, 088, 089, 091, 094, 097, 118, 119, 120	Contec	013, 051, 052, 061	JBL	017, 071
Scott	017, 020, 086, 089, 093, 117	XR-1000	094	Cony	051, 052, 061	JC Penny	020, 034, 039, 040, 041, 044, 048, 050, 058, 066, 069, 076, 088, 090, 095, 125, 136, 159
Sears	013, 023, 028, 031, 033, 053, 054, 088, 091, 098, 099, 115	Yamaha	004, 005, 006, 026, 062, 085	Craig	004, 061	JCB	046
Sentra	055	Zenith	060, 078, 079	Crown	029	JVC	019, 051, 052, 072, 073, 091, 117, 126
Sharp	001, 002, 021, 097	<b>TV</b>		Curtis Mathes	029, 034, 038, 044, 047, 049, 053, 095, 118	Kawasho	018, 046
Shogun	087	Admiral	045, 121	Daewoo	027, 029, 039, 048, 049, 054, 055, 106, 107, 137	Kenwood	038, 056, 057
Sony	075, 076, 077, 078, 079, 121, 122	Adventura	122	Daytron	003, 049	Kloss	010, 032
STS	023	Aiko	054	Dimensia	044	Kloss Novabeam	005, 122, 127, 131
Sylvania	009, 015, 016, 017, 041, 049, 094	Akai	016, 027, 046	Dixi	007, 015, 027	KTV	074, 123
Symphonic	009, 094	Alleron	062	Electroband	046	Loewe	071
Tandy	009	A-Mark	007	Electrohome	029, 056, 057, 058, 147	Logik	144
Tashiko	009, 088	Amtron	061	Elta	027	Luxman	031
Tatung	004, 026, 030	Anam	006, 007, 036	Emerson	029, 051, 059, 060, 061, 062, 118, 123, 124, 139, 148	LXI	008, 014, 017, 024, 040, 044, 063, 071, 075, 076, 077, 118, 125
Teac	004, 009, 026, 094	Anam National	061, 147	Envision	038		
		AOC	003, 007, 033, 038, 039, 047, 048, 049, 133	Etron	027		
		Archer	007	Fisher	014, 021, 063, 064, 065, 118		
		Audiovox	007, 061	Formenti	155		
		Bauer	155	Fortress	012		
		Belcor	047				

Magnavox	005, 010, 017, 030, 033, 038, 050, 056, 071, 078, 079, 085, 089, 108, 109, 110, 127, 131, 132, 145
Marantz	015, 017, 071, 080
Matsui	027
Memorex	014, 027, 045, 083, 118, 144
Metz	160, 161, 162, 163
MGA	001, 039, 048, 056, 057, 058, 065, 081, 083
Midland	125
Minutz	066
Mitsubishi	001, 016, 039, 048, 056, 057, 058, 065, 081, 082, 083, 105
Montgomery Ward	011, 020, 144, 145, 146
Motorola	121, 147
MTC	031, 034, 039, 048, 095
NAD	008, 075, 076, 128
National	002, 036, 061, 147
National Quenties	002
NEC	031, 038, 039, 048, 057, 084, 086, 135, 147
Nikko	054
NTC	054
Optimus	128
Optonica	011, 012, 093, 121
Orion	004, 139
Panasonic	002, 009, 017, 036, 037, 071, 141, 143, 147
Philco	005, 010, 030, 050, 051, 056, 079, 085, 127, 131, 132, 145, 147

Philips	005, 015, 017, 050, 051, 056, 078, 087, 088, 089, 131, 132, 147
Pioneer	124, 128, 142
Portland	054
Price Club	095
Proscan	040, 044, 125
Proton	035, 051, 092, 129
Pulsar	042
Quasar	036, 037, 074, 141
Radio Shack	011, 044, 063, 093, 118
RCA	040, 044, 125, 130, 137, 151, 152
Realistic	014, 063, 093, 118
Saisho	027
Samsung	003, 015, 034, 053, 055, 057, 094, 095, 136, 153
Sansui	139
Sanyo	013, 014, 021, 022, 063, 064, 081, 096
SBR	015
Schneider	015
Scott	062
Sears	008, 014, 021, 022, 023, 024, 025, 040, 052, 057, 062, 063, 064, 065, 073, 075, 076, 097, 098, 125, 159
Sharp	011, 012, 013, 026, 093, 099, 100, 104, 121
Siemens	013
Signature	045, 144
Simpson	050
Sony	043, 046, 138, 146, 150
Soundesign	030, 050, 062
Spectricon	007, 033

Squareview	004
Supre-Macy	032, 122
Supreme	046
Sylvania	005, 010, 017, 030, 078, 079, 085, 089, 101, 127, 131, 132, 145, 155
Symphonic	004, 148
Tandy	012, 121
Tatung	036, 124
Technics	037
Teknika	001, 030, 032, 034, 052, 054, 078, 083, 095, 144, 156, 157
Tera	035, 129
THOMSON	165, 166
Toshiba	008, 014, 034, 063, 075, 076, 095, 097, 136, 158, 159
Universal	020, 066, 088
Victor	019, 073, 126
Video Concepts	016
Viking	032, 122
Wards	005, 045, 066, 078, 085, 088, 089, 093, 102, 103, 131, 132, 148
Zenith	042, 114, 115, 140, 144, 149
Zonda	007

**CABLE**

ABC	006, *[007], 008, 009
Archer	010, 011
Century	011
Citizen	011
Colour Voice	012, 013
Comtronic	014

Eastern	015
Garrard	011
Gemini	030, 033, 034
General Instrument	030, 031, 032
Hytex	006
Jasco	011
Jerrold	009, 016, 017, 026, 032
Magnavox	018
Movie Time	019
NSC	019
Oak	000, 006, 020
Panasonic	001, 005
Philips	011, 012, 013, 018, 021
Pioneer	002, 003, 022
RCA	029
Regency	015
Samsung	014, 023
Scientific Atlanta	004, 024, 025
Signal	014
SL Marx	014
Starcom	009
Stargate	014
Teleview	014
Tocom	007, 016
TV86	019
Unika	011
United Artists	006
Universal	010, 011
Viewstar	018, 019
Zenith	027, 028

**DBS (SATELLITE)**

Alphastar	054
Chaparral	035, 036
Dishnet	053
Drake	037, 038



Echostar Dish	062, 066
GE	048, 055, 056
General Instruments	039, 040, 041
Grundig	070, 071, 072, 073
Hitachi	058, 059
Hughes Network	063, 064, 065, 069
JVC	057
Kathrein	074, 075, 076, 083
Magnavox	060
Nokia	070, 080, 084, 085, 086
Philips	060
Primestar	051
Proscan	048, 055, 056
RCA	048, 055, 056, 068
Realistic	042
Sierra I	036
Sierra II	036
Sierra III	036
Sony	049, 067
STS1	043
STS2	044
STS3	045
SRS4	046
Technisat	077, 078, 079, 081, 082
Toshiba	047, 050
Uniden	061

**CD**

Denon	*[111], 044
Aiwa	001, 035, 043
Burmster	002
Carver	003, 035
Emerson	004, 005, 006, 007
Fisher	003, 008, 009, 010
JVC	018, 019
Kenwood	011, 012, 013, 014, 017

Magnavox	006, 015, 035
Marantz	016, 028, 035
MCS	016, 024
Onkyo	025, 027
Optimus	017, 020, 021, 022, 023
Philips	014, 032, 033, 035
Pioneer	006, 022, 030
Sears	006
Sony	023, 031
Teac	002, 009, 028
Technics	016, 029, 036
Wards	035, 037
Yamaha	038, 039, 040, 041
Zenith	042

**CDR**

Denon	*[111], 112
Philips	112

**MD**

Denon	113
Kenwood	003, 004
Onkyo	007
Sharp	005
Sony	006

**TAPE**

Denon	*[111]
Aiwa	001, 002
Carver	002
Harman/Kardon	002, 003
JVC	004, 005
Kenwood	006
Magnavox	002
Marantz	002
Onkyo	016, 018

Optimus	007, 008
Panasonic	012
Philips	002
Pioneer	007, 008, 009
Sony	013, 014, 015
Technics	012
Victor	004
Wards	007
Yamaha	010, 011

\*[ ] : Preset codes set upon shipment from the factory.

DVD preset codes			
	111 (default)	014	
DENON Model No.	DVD-555	DVD-2900	DVD-800
	DVD-755	DVD-2910	DVD-1600
	DVD-900	DVD-3800	DVD-2000
	DVD-910	DVD-3910	DVD-2500
	DVD-955	DVD-5900	DVD-3000
	DVD-1000	DVD-5910	DVD-3300
	DVD-1200	DVD-9000	
	DVD-1500	DVM-715	
	DVD-1710	DVM-1800	
	DVD-1910	DVM-1805	
	DVD-2200	DVM-1815	
DVD-2800	DVM-2815		
DVD-2800II	DVM-4800		

**DENON**

TOKYO, JAPAN  
[www.denon.com](http://www.denon.com)

Denon Brand Company, D&M Holdings Inc.  
Printed in China 00D 511 4493 003