

DENON

INTEGRATED NETWORK AV RECEIVER

AVR-2312CI



- Explains all operations of your receiver. Open the included CD-ROM on your computer for detailed operating instructions.
- Explique tout le fonctionnement de votre récepteur. Ouvrez le CD-ROM inclus sur votre ordinateur pour pouvoir consulter la notice d'utilisation détaillée.
- Explica todas las operaciones del receptor. Abra el CD-ROM en el ordenador para ver instrucciones detalladas de funcionamiento.

Getting Started

Explains how to easily install, connect and setup a 5.1-channel home theater system.

Mise en route

Explique comment installer, connecter et configurer facilement un système de home cinéma 5.1 canaux.

Antes de empezar

Explica cómo instalar, conectar y configurar fácilmente un sistema de cine en casa de 5.1 canales.

* D&M Holdings is striving to be a paperless company in order to help preserve the environment. Your cooperation and understanding is appreciated.
* D&M Holdings s'efforce d'être une société "sans papier" afin de contribuer à préserver l'environnement. Nous sommes sensibles à votre coopération et votre compréhension.
* D&M Holdings se esfuerza por ser una empresa sin papel para ayudar a conservar el medio ambiente. Se valora su cooperación y comprensión.

SAFETY PRECAUTIONS



CAUTION
RISK OF ELECTRIC SHOCK
DO NOT OPEN



CAUTION:
TO REDUCE THE RISK OF ELECTRIC SHOCK, DO NOT REMOVE COVER (OR BACK). NO USER-SERVICEABLE PARTS INSIDE. REFER SERVICING TO QUALIFIED SERVICE PERSONNEL.

The lightning flash with arrowhead symbol, within an equilateral triangle, is intended to alert the user to the presence of uninsulated "dangerous voltage" within the product's enclosure that may be of sufficient magnitude to constitute a risk of electric shock to persons.

The exclamation point within an equilateral triangle is intended to alert the user to the presence of important operating and maintenance (servicing) instructions in the literature accompanying the appliance.

WARNING:
TO REDUCE THE RISK OF FIRE OR ELECTRIC SHOCK, DO NOT EXPOSE THIS APPLIANCE TO RAIN OR MOISTURE.



CAUTION:
HOT SURFACE. DO NOT TOUCH.

The top surface over the internal heat sink may become hot when operating this product continuously. Do not touch hot areas, especially around the "Hot surface mark" and the top panel.

PRECAUTION:
SURFACE CHAUDE. NE PAS TOUCHER.

La surface supérieure du dissipateur de chaleur peut devenir chaude si vous utilisez ce produit en continu. Ne touchez pas les zones chaudes, tout particulièrement vers l'inscription "Hot surface mark" et le panneau supérieur.

PRECAUCIÓN:
SUPERFICIE CALIENTE. NO TOCAR.

La superficie superior sobre el disipador de calor interno podría llegar a calentarse al operar este producto de forma continua. No toque las áreas calientes, especialmente las situadas alrededor de la "Hot surface mark" y del panel superior.

IMPORTANT SAFETY INSTRUCTIONS

1. Read these instructions.
2. Keep these instructions.
3. Heed all warnings.
4. Follow all instructions.
5. Do not use this apparatus near water.
6. Clean only with dry cloth.
7. Do not block any ventilation openings. Install in accordance with the manufacturer's instructions.
8. Do not install near any heat sources such as radiators, heat registers, stoves, or other apparatus (including amplifiers) that produce heat.
9. Do not defeat the safety purpose of the polarized or grounding-type plug. A polarized plug has two blades with one wider than the other. A grounding type plug has two blades and a third grounding prong. The wide blade or the third prong are provided for your safety. If the provided plug does not fit into your outlet, consult an electrician for replacement of the obsolete outlet.
10. Protect the power cord from being walked on or pinched particularly at plugs, convenience receptacles, and the point where they exit from the apparatus.
11. Only use attachments/accessories specified by the manufacturer.
12. Use only with the cart, stand, tripod, bracket, or table specified by the manufacturer, or sold with the apparatus. When a cart is used, use caution when moving the cart/apparatus combination to avoid injury from tip-over.
13. Unplug this apparatus during lightning storms or when unused for long periods of time.
14. Refer all servicing to qualified service personnel. Servicing is required when the apparatus has been damaged in any way, such as power-supply cord or plug is damaged, liquid has been spilled or objects have fallen into the apparatus, the apparatus has been exposed to rain or moisture, does not operate normally, or has been dropped.
15. Batteries shall not be exposed to excessive heat such as sunshine, fire or the like.



CAUTION:

To completely disconnect this product from the mains, disconnect the plug from the wall socket outlet.

The mains plug is used to completely interrupt the power supply to the unit and must be within easy access by the user.

PRECAUTION:

Pour déconnecter complètement ce produit du courant secteur, débranchez la prise de la prise murale.

La prise secteur est utilisée pour couper complètement l'alimentation de l'appareil et l'utilisateur doit pouvoir y accéder facilement.

PRECAUCIÓN:

Para desconectar completamente este producto de la alimentación eléctrica, desconecte el enchufe del enchufe de la pared.

El enchufe de la alimentación eléctrica se utiliza para interrumpir por completo el suministro de alimentación eléctrica a la unidad y debe de encontrarse en un lugar al que el usuario tenga fácil acceso.

FCC INFORMATION (For US customers)

1. COMPLIANCE INFORMATION

Product Name: Integrated Network AV Receiver

Model Number: AVR-2312CI

This product complies with Part 15 of the FCC Rules. Operation is subject to the following two conditions: (1) this product may not cause harmful interference, and (2) this product must accept any interference received, including interference that may cause undesired operation.

Denon Electronics (USA), LLC

(a D & M Holdings Company)

100 Corporate Drive

Mahwah, NJ 07430-2041

Tel. (800) 497-8921

2. IMPORTANT NOTICE: DO NOT MODIFY THIS PRODUCT

This product, when installed as indicated in the instructions contained in this manual, meets FCC requirements. Modification not expressly approved by DENON may void your authority, granted by the FCC, to use the product.

3. IMPORTANT

When connecting this product to network hub or router, use only a shielded STP or ScTP LAN cable which is available at retailer.

Follow all installation instructions. Failure to follow instructions could void your authority, granted by the FCC, to use the product.

4. NOTE

This product has been tested and found to comply with the limits for a Class B digital device, pursuant to Part 15 of the FCC Rules. These limits are designed to provide reasonable protection against harmful interference in a residential installation.

This product generates, uses and can radiate radio frequency energy and, if not installed and used in accordance with the instructions, may cause harmful interference to radio communications. However, there is no guarantee that interference will not occur in a particular installation. If this product does cause harmful interference to radio or television reception, which can be determined by turning the product OFF and ON, the user is encouraged to try to correct the interference by one or more of the following measures:

- Reorient or relocate the receiving antenna.
- Increase the separation between the equipment and receiver.
- Connect the product into an outlet on a circuit different from that to which the receiver is connected.
- Consult the local retailer authorized to distribute this type of product or an experienced radio/TV technician for help.

For Canadian customers:

This Class B digital apparatus complies with Canadian ICES-003.

Cet appareil numérique de la classe B est conforme à la norme NMB-003 du Canada.

□ NOTES ON USE / OBSERVATIONS RELATIVES A L'UTILISATION / NOTAS SOBRE EL USO

WARNINGS	AVERTISSEMENTS	ADVERTENCIAS
<ul style="list-style-type: none"> • Avoid high temperatures. Allow for sufficient heat dispersion when installed in a rack. • Handle the power cord carefully. Hold the plug when unplugging the cord. • Keep the unit free from moisture, water, and dust. • Unplug the power cord when not using the unit for long periods of time. • Do not obstruct the ventilation holes. • Do not let foreign objects into the unit. • Do not let insecticides, benzene, and thinner come in contact with the unit. • Never disassemble or modify the unit in any way. • Ventilation should not be impeded by covering the ventilation openings with items, such as newspapers, tablecloths or curtains. • Naked flame sources such as lighted candles should not be placed on the unit. • Observe and follow local regulations regarding battery disposal. • Do not expose the unit to dripping or splashing fluids. • Do not place objects filled with liquids, such as vases, on the unit. • Do not handle the mains cord with wet hands. • When the switch is in the OFF (STANDBY) position, the equipment is not completely switched off from MAINS. • The equipment shall be installed near the power supply so that the power supply is easily accessible. 	<ul style="list-style-type: none"> • Eviter des températures élevées. Tenir compte d'une dispersion de chaleur suffisante lors de l'installation sur une étagère. • Manipuler le cordon d'alimentation avec précaution. Tenir la prise lors du débranchement du cordon. • Protéger l'appareil contre l'humidité, l'eau et la poussière. • Débrancher le cordon d'alimentation lorsque l'appareil n'est pas utilisé pendant de longues périodes. • Ne pas obstruer les trous d'aération. • Ne pas laisser des objets étrangers dans l'appareil. • Ne pas mettre en contact des insecticides, du benzène et un diluant avec l'appareil. • Ne jamais démonter ou modifier l'appareil d'une manière ou d'une autre. • Ne pas recouvrir les orifices de ventilation avec des objets tels que des journaux, nappes ou rideaux. Cela entraverait la ventilation. • Ne jamais placer de flamme nue sur l'appareil, notamment des bougies allumées. • Veillez à respecter les lois en vigueur lorsque vous jetez les piles usagées. • L'appareil ne doit pas être exposé à l'eau ou à l'humidité. • Ne pas poser d'objet contenant du liquide, par exemple un vase, sur l'appareil. • Ne pas manipuler le cordon d'alimentation avec les mains mouillées. • Lorsque l'interrupteur est sur la position OFF (STANDBY), l'appareil n'est pas complètement déconnecté du SECTEUR (MAINS). • L'appareil sera installé près de la source d'alimentation, de sorte que cette dernière soit facilement accessible. 	<ul style="list-style-type: none"> • Evite altas temperaturas. Permita la suficiente dispersión del calor cuando está instalado en la consola. • Maneje el cordón de energía con cuidado. Sostenga el enchufe cuando desconecte el cordón de energía. • Mantenga el equipo libre de humedad, agua y polvo. • Desconecte el cordón de energía cuando no utilice el equipo por mucho tiempo. • No obstruya los orificios de ventilación. • No deje objetos extraños dentro del equipo. • No permita el contacto de insecticidas, gasolina y diluyentes con el equipo. • Nunca desarme o modifique el equipo de ninguna manera. • La ventilación no debe quedar obstruida por haberse cubierto las aperturas con objetos como periódicos, manteles o cortinas. • No deberán colocarse sobre el aparato fuentes inflamables sin protección, como velas encendidas. • A la hora de deshacerse de las pilas, respete la normativa para el cuidado del medio ambiente. • No exponer el aparato al goteo o salpicaduras cuando se utilice. • No colocar sobre el aparato objetos llenos de líquido, como jarros. • No maneje el cable de alimentación con las manos mojadas. • Cuando el interruptor está en la posición OFF (STANDBY), el equipo no está completamente desconectado de la alimentación MAINS. • El equipo se instalará cerca de la fuente de alimentación de manera que resulte fácil acceder a ella.

□ CAUTIONS ON INSTALLATION PRÉCAUTIONS D'INSTALLATION EMPLAZAMIENTO DE LA INSTALACIÓN

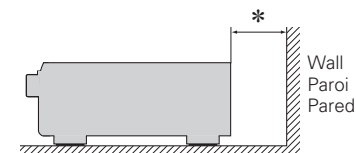
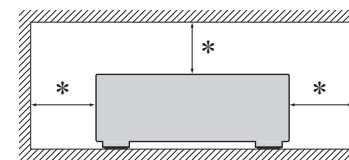

* For proper heat dispersal, do not install this unit in a confined space, such as a bookcase or similar enclosure.

- More than 12 in. (0.3 m) is recommended.
- Do not place any other equipment on this unit.

* Pour permettre la dissipation de chaleur requise, n'installez pas cette unité dans un espace confiné tel qu'une bibliothèque ou un endroit similaire.

- Une distance de plus de 0,3 m (12 po) est recommandée.
- Ne placez aucun matériel sur cet appareil.

* Para la dispersión del calor adecuadamente, no instale este equipo en un lugar confinado tal como una librería o unidad similar.

- Se recomienda dejar más de 0,3 m (12 pulg.) alrededor.
- No coloque ningún otro equipo sobre la unidad.

Read before use

Thank you for purchasing this DENON product.

This manual explains the Setup Wizard that you will need to perform directly after removing the product from its packaging, before you start using the product.

The Setup Wizard displays easy to follow guidance on your television screen that shows you how to connect and configure speakers, various other devices, and network functions for full enjoyment of this unit.

Contents

Read before use	1
Accessories	1
About this manual	1
Cautions on handling	1
Preparing the Setup Wizard	2
SETUP WIZARD	4
Playback (Basic operation)	7
Important information	7
Selecting the input source	7
Adjusting the master volume	8
Turning off the sound temporarily	8

Accessories

Check that the following parts are supplied with the product.

① Getting Started	1
② CD-ROM (Owner's manual)	1
③ Warranty (for North America model only)	1
④ Service network list	1
⑤ Power cord	1
⑥ Remote control unit (RC-1156)	1
⑦ R6/AA batteries	2
⑧ Setup microphone (DM-A409)	1
⑨ AM loop antenna	1
⑩ FM indoor antenna	1

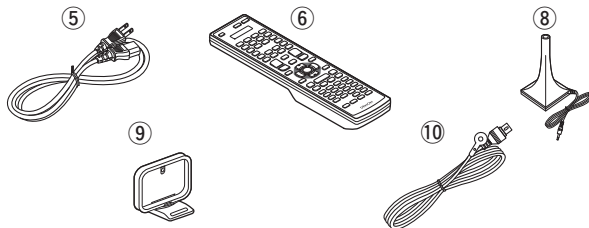

About this manual

❑ Operation buttons

The operations described in this manual are based mainly on remote control operation.

❑ Symbols

- This symbol indicates a reference page on which related information is described.
- This mark indicates the page of the owner's manual on the CD-ROM provided.
- This symbol indicates a supplementary information and tips for operations.

NOTE This symbol indicates points to remember operations or function limitations.

❑ Illustrations

Note that the illustrations in this manual is for explanation purposes and may differ from the actual unit.

❑ About the CD-ROM

(Getting Started / Owner's manual)



You need to have Adobe Reader® installed on your computer to view the owner's manuals on the CD-ROM. Click the Adobe Reader® banner in the CD-ROM menu to install the Adobe Reader® (for Windows).

Cautions on handling

• Before turning the power on

Check once again that all connections are correct and that there are no problems with the connection cables.

- Power is supplied to some of the circuitry even when the unit is set to the standby mode. When going on vacation or leaving home for long periods of time, be sure to unplug the power cord from the power outlet.

• About condensation

If there is a major difference in temperature between the inside of the unit and the surroundings, condensation (dew) may form on the operating parts inside the unit, causing the unit not to operate properly.

If this happens, let the unit sit for an hour or two with the power turned off and wait until there is little difference in temperature before using the unit.

• Cautions on using mobile phones

Using a mobile phone near this unit may result in noise. If that occurs, move the mobile phone away from this unit when it is in use.

• Moving the unit

Turn off the power and unplug the power cord from the power outlet. Next, disconnect the connection cables to other system units before moving the unit.

• About care



- Wipe the cabinet and control panel clean with a soft cloth.
- Follow the instructions when using a chemical cleaner.
- Benzene, paint thinner or other organic solvents as well as insecticide may cause material changes and discoloration if brought into contact with the unit, and should therefore not be used.

Preparing the Setup Wizard

This section describes how to prepare the Setup Wizard before use.

- ❑ Do not plug the power plug of the main unit into the wall socket until these preparations are complete.
- ❑ Speaker connections are performed using the Setup Wizard. Do not connect the speakers yet.

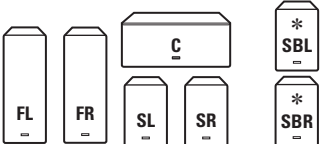
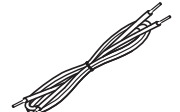
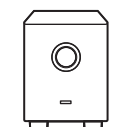
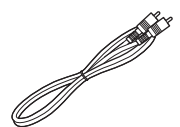
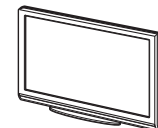
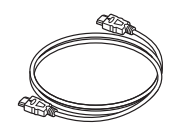
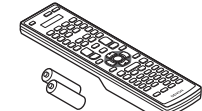
What you need for this step

<p>Speaker (sold separately)</p>  <p>* If you wish to enjoy 7.1-channel, prepare a surround back speaker.</p>	<p>Speaker cable (sold separately)</p>  <p>• Prepare enough for the number of speakers you will use.</p>
<p>Subwoofer (with built-in amplifier) (sold separately)</p> 	<p>Audio cable (sold separately)</p> 
<p>TV (sold separately)</p> 	<p>HDMI cable (sold separately)</p> 
<p>Remote control unit / R6/AA batteries (supplied)</p> 	<p>Setup microphone (supplied)</p> 
<p>Power cord (supplied)</p> 	

1 Place and layout speakers

Before installing the speakers, connect the speaker cables to the speakers. For details on how to connect the speaker cables, see the speaker instruction manual.

- ✎ Connect the speaker cables to the main unit using the Setup Wizard.

❑ When 5.1-channel installed

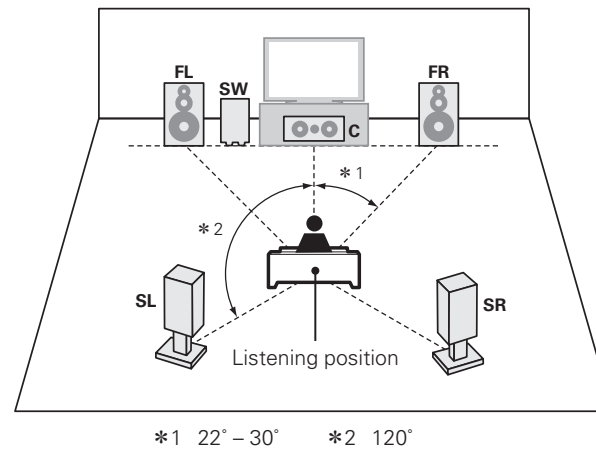

❑ When 7.1-channel (Surround back speaker) installed

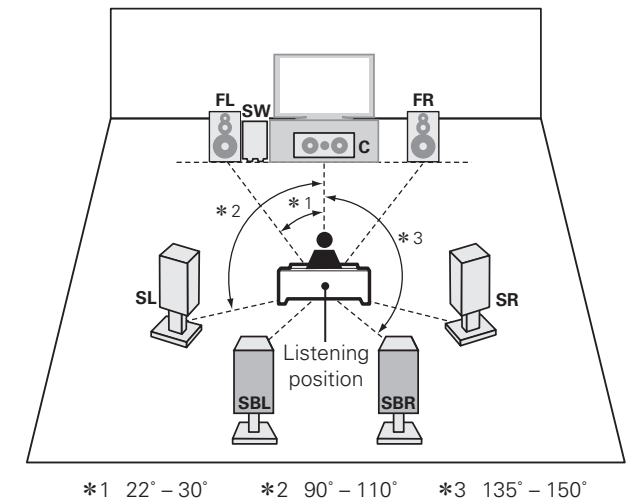

- FL** Front speaker (L)
- FR** Front speaker (R)
- C** Center speaker
- SW** Subwoofer
- SL** Surround speaker (L)
- SR** Surround speaker (R)
- SBL** Surround back speaker (L)
- SBR** Surround back speaker (R)

- Install the surround speakers in a position 2 to 3 ft (60 to 90 cm) higher than ear level.

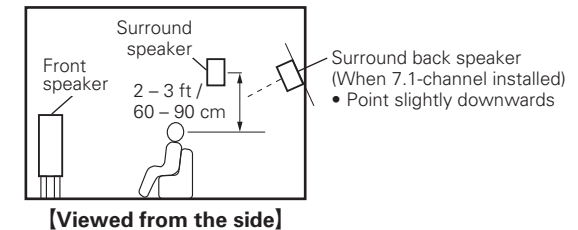

2 Connect this unit to the television using an HDMI cable (sold separately)

NOTE

If this unit is connected using cables other than the HDMI cable, the Setup Wizard will not be displayed.

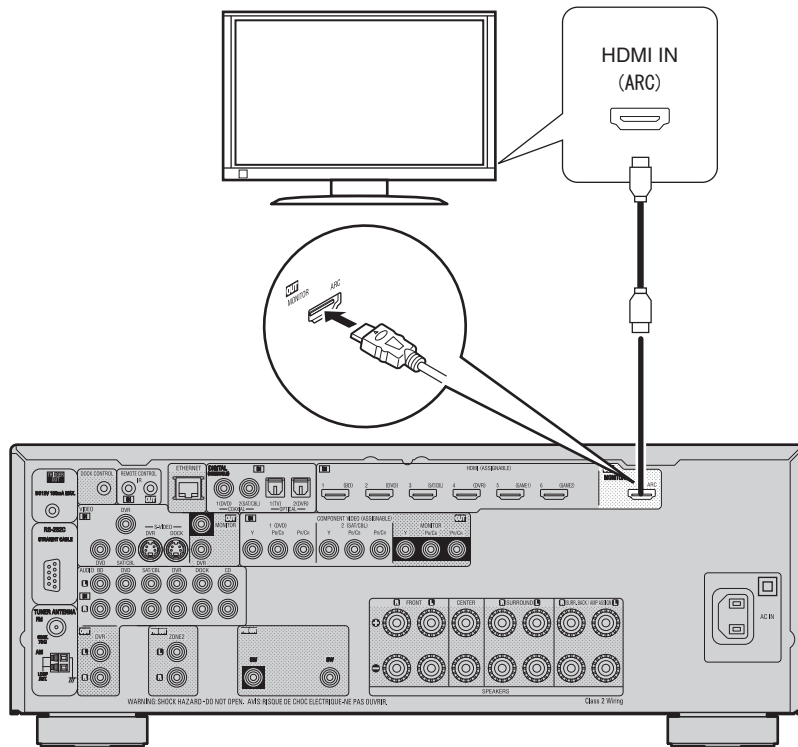

3 Turn the television power on, and switch the video input to this unit (HDMI input)

For details on how to operate the television, see the television instruction manual.



- ① Power on
- ② Switch the input to this unit (HDMI input)

4 Insert the provided batteries into the remote control unit

- ① Slide the rear lid in the direction of the arrow and remove it.

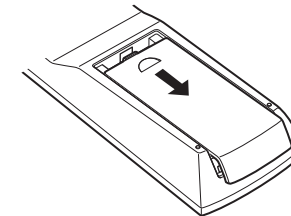

- ② Load the two batteries properly as indicated by the marks in the battery compartment.

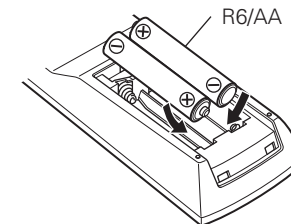

- ③ Put the rear cover back on.

➔ Start Setup Wizard on next page

SETUP WIZARD

When preparations are complete, start the Setup Wizard.

Use the Setup Wizard to perform connections and settings as shown in the following steps. Perform the operations as described in the instructions on the screen. You can skip or cancel at each section if necessary.

1 Language Select

Set the language for the instructions on the television screen.

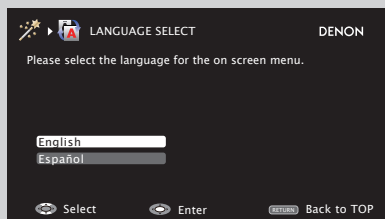

These settings can be changed in the following menu even after setting the Setup Wizard (page 116 "Language").

NOTE If your language is not available, select "English".

2 Speaker Connection

Connect the speakers for surround sound.

NOTE

Connections for speakers other than 5.1 channel or 7.1 channel speakers cannot be set using the Setup Wizard.

Select "Others", and then select "Skip" in "2. Speaker Connection" to proceed to "3. Speaker Calibration". (For details on the setting method, see page 57 "Speaker installation/connection (Advanced connection)".)



3 Speaker Calibration

Configure the settings for your speakers, and for the optimum surround sound for your room.

These settings can be changed in the following menu even after setting the Setup Wizard (page 19 "Set up speakers (Audyssey® Auto Setup)").



4 Source Setup

Set the connecting terminals for each device to be set, and connect to the terminals.

These settings can be changed in the following menu even after setting the Setup Wizard (page 88 "Input Assign").



5 Remote Setup

Configure the settings so that devices connected to this unit can be operated using the provided remote control.

These settings can be changed in the following menu even after setting the Setup Wizard (page 114 "Remote Setup Guide").



6 Network Setup

Configure to playback audio files saved onto a computer or Internet radio.

These settings can be changed in the following menu even after setting the Setup Wizard (page 108 "Network Setup").

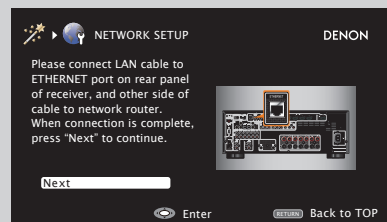

This completes the Setup Wizard.

Basic operation of Setup Wizard



Move to the item that you want to configure using Δ / ∇ .

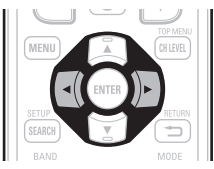

Move to the item that you want to configure using \triangleleft / \triangleright .



Enters the selection.



Returns to the start of each setting.
or
Cancels the Setup Wizard.

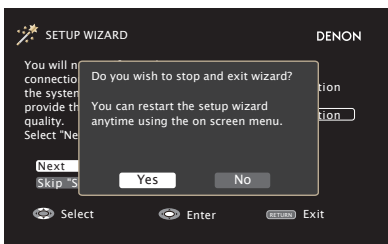
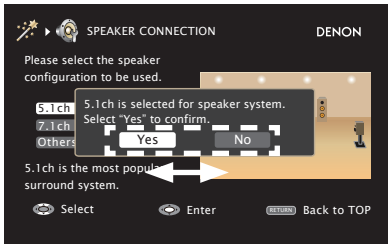
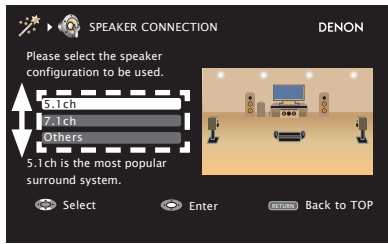

1 Insert the main unit power plug into the wall socket.

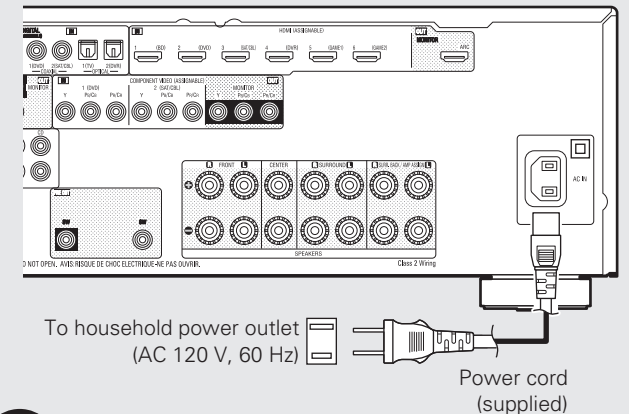

2 Press ZONE SELECT to switch the zone mode to (M) (MAIN ZONE).

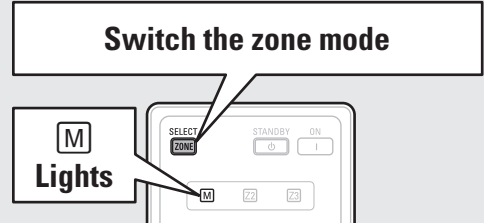

- This remote control can be operated in three separate zones, MAIN ZONE and ZONE2.
- Set the remote control to MAIN ZONE to operate the Setup Wizard.

When power is switched to standby

Press **STANDBY** (⏻).

[Power indicator status in standby mode]

- Normal standby : Off
- When "HDMI Control" (🔌📺 page 106) is set to "ON" : Red

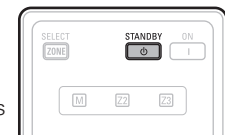

NOTE

During power standby, a minimal amount of power is consumed. To totally cut off the power, remove the power cord from the power outlet.

Getting Started

3 Press AMP to set the remote control unit to AMP-operation mode.

Switch the AMP-operation mode



- This remote control is a preset remote control that can be used to control connected devices.

4 Press ON (I) to the this unit. The power switches on, and the Setup Wizard start screen is displayed on the television screen.

Power on

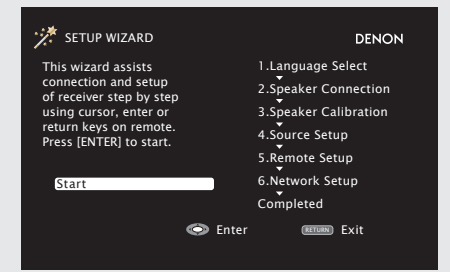

5 Press ENTER. Start the Setup Wizard.

Setup Wizard has started. Please follow the message on screen

- 🔧 To start the Setup Wizard again after exiting it, select "SETUP WIZARD" in the menu (🔌📺 page 82 "Menu map").

Connecting the speakers

The speakers are connected in "2. Speaker Connection" of the Setup Wizard but if you did not use or cancelled the Setup Wizard, connect the speakers as shown below. For details, see the included CD-ROM (Owner's manual).

Connect

Carefully check the left (L) and right (R) channels and + (red) and - (black) polarities on the speakers being connected to the this unit, and be sure to interconnect the channels and polarities correctly.

Connecting the speaker cables

Peel off about 0.03 ft/10 mm of sheathing from the tip of the speaker cable, then either twist the core wire tightly or terminate it.

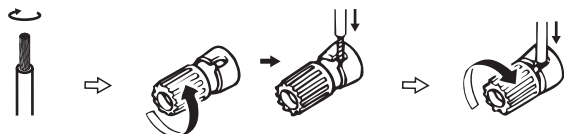

NOTE

- Connect so that the speaker cable core wires do not protrude from the speaker terminal. The protection circuit may be activated if the core wires touch the rear panel or if the + and - sides touch each other (page 138 "Protection Circuit").
- Never touch the speaker terminals while the power supply is connected. Doing so could result in electric shock. (When the Setup Wizard is running, follow the instructions in the Setup Wizard screen for making connections.)
- Use speakers with the speaker impedances shown below.

Speaker terminals	Speaker impedance
FRONT	6 - 16 Ω
CENTER	
SURROUND	
SURR. BACK / AMP ASSIGN	

5.1-channel

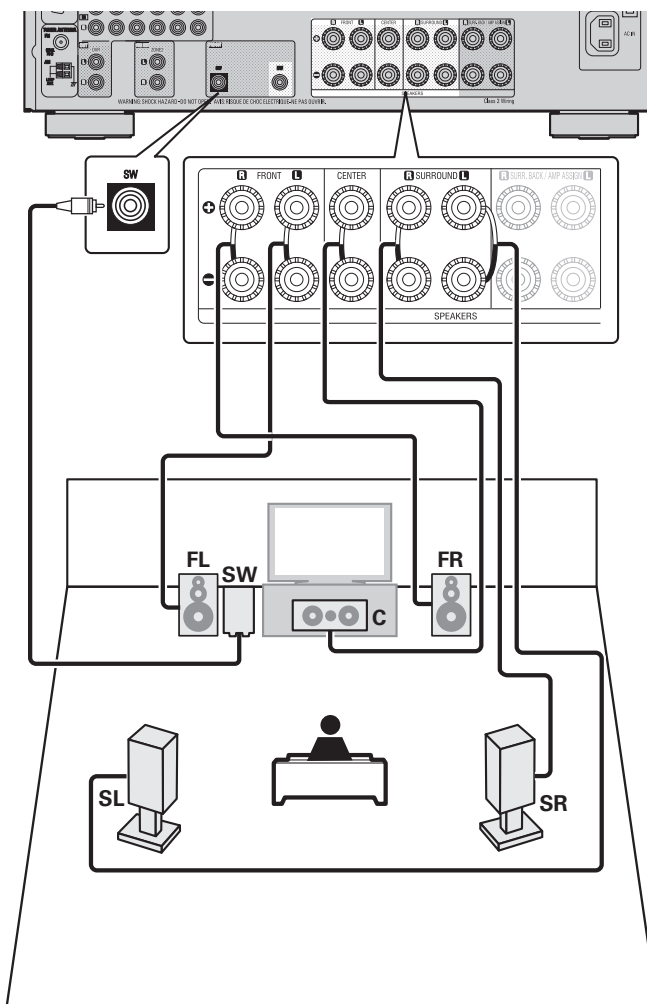

7.1-channel

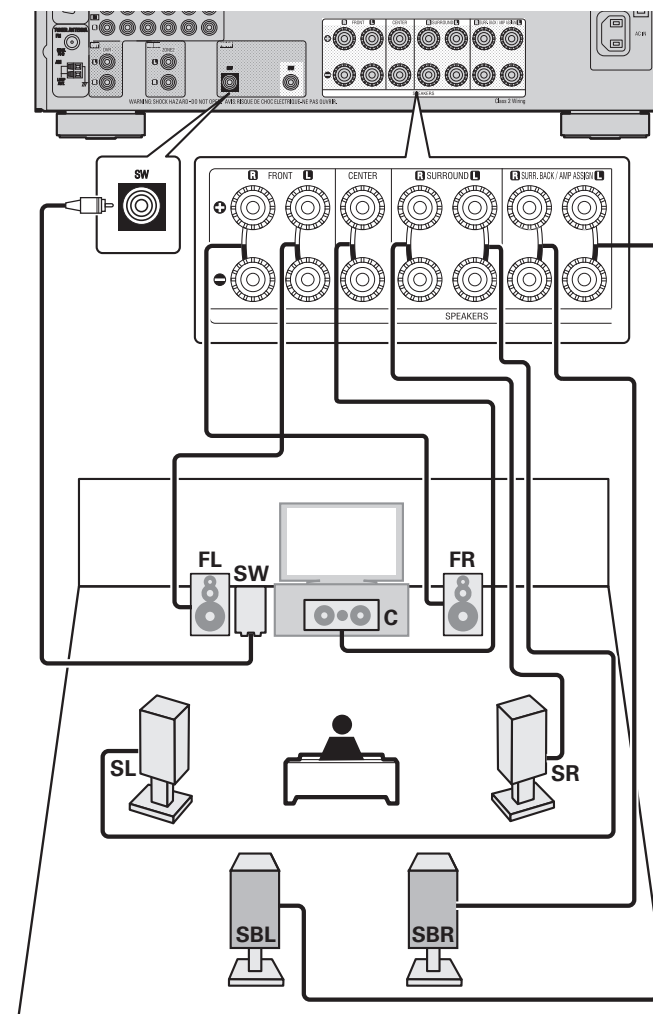

Playback (Basic operation)

Here, we explain how to perform simple operations.
For details, see the included CD-ROM (Owner's manual).

Important information

Before starting playback, make the connections between the different devices and the settings on the unit.

NOTE

Also refer to the operating instructions of the connected devices when playing them.

Selecting the input source

Press the input source select button (BD, SAT/CBL, TV, NET/USB, DVD, V.AUX, DOCK, TUNER, GAME1, GAME2, DVR or CD) to be played back.

The desired input source can be selected directly.



You can also use the following operation to select an input source.

Using the knob on the main unit

Turn **SOURCE SELECT**.

- Turning **SOURCE SELECT** switches the input source, as shown below.

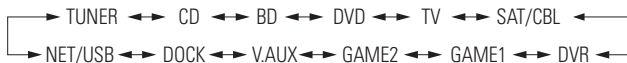

- When **iPod** on the main unit is pressed, the input source of this unit is switched to "DOCK" or "NET/USB" and the connected iPod is automatically played (page 32 "iPod play function").

Selecting the input source

Using the "SOURCE SELECT" menu

Switch the remote control unit to the **M** (MAIN_ZONE) mode when performing this operation (page 118 "Operating AV device").

If the remote control unit is in **Z2** (ZONE2) mode, the "SOURCE SELECT" menu will not be displayed when **SOURCE SELECT** is pressed.



- When using with an iPod connected directly to the USB port of this unit, select "**USB** (USB/iPod)" for the input source.
- Input sources that are not going to be used can be set ahead of time. Make this setting at "Source Delete" (page 113).
- To turn off the source selection menu without selecting an input source, press **SOURCE SELECT** again.
- When **SOURCE SELECT** is pressed, the AMP-operation mode starts automatically (page 118).

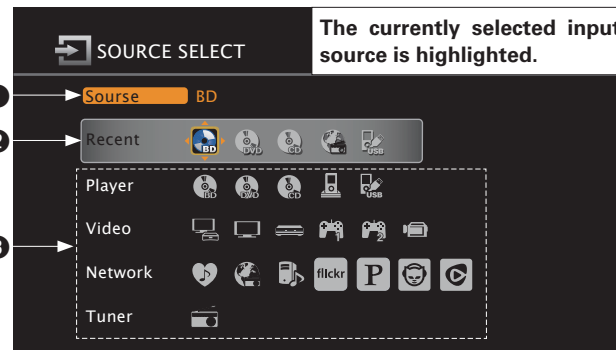

1 Input Source

The name of the highlighted input source is displayed.

2 Recently used sources

The recently used input sources (up to five) are displayed.

3 Icons for the input sources in the different categories are displayed.

1 Press **SOURCE SELECT**.

Display the "SOURCE SELECT" menu.

2 Use **Δ∇◀▶** to select the input source, then press **ENTER**.

The input source is set and the source selection menu is turned off.

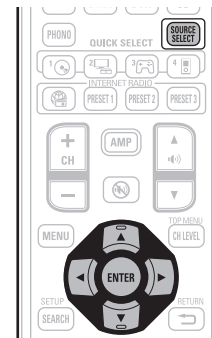

Adjusting the master volume

Use to adjust the volume.

- When the "Volume Display" setting (page 113) is "Relative" [Adjustable range]

--- -80.5dB - 18.0dB

- When the "Volume Display" setting (page 113) is "Absolute" [Adjustable range]

0.0 - 99.0

- The variable range differs according to the input signal and channel level setting.



You can also operate via the main unit. In this case, perform the following operations.

Turn **MASTER VOLUME** to adjust the volume.

Turning off the sound temporarily

Press .

- The power indicator flashes green.
- "MUTE" indicator on the display lights.
- appears on a TV screen.



- The sound is reduced to the level set at "Mute Level" (page 113).
- To cancel, press again. Muting can also be canceled by adjusting the master volume.

Other operations

See the following items on the included CD-ROM (Owner's manual).

- Playing a Blu-ray Disc player/DVD player
- Playing a CD player
- Playing an iPod®
- Tuning in radio stations
- Playing a network audio
- Playing a USB memory device
- Selecting a listening mode (SURROUND MODE)
- Convenient functions
- Playback in ZONE2 (Separate room)
- How to make detailed settings
- Operating the connected devices by remote control unit



This completes the basic settings and operations.
For details on how to change settings or detailed explanations of operations, see the included CD-ROM (Owner's manual).







V00

DENON
www.denon.com

D&M Holdings Inc.
Printed in China 5421 10062 003D