

DENON

AV SURROUND RECEIVER

AVR-2807

OPERATING INSTRUCTIONS

BEDIENUNGSANLEITUNG

MODE D'EMPLOI

ISTRUZIONI PER L'USO

INSTRUCCIONES DE FUNCIONAMIENTO

GEBRUIKSAANWIJZING

BRUKSANVISNING

SAFETY PRECAUTIONS



CAUTION
RISK OF ELECTRIC SHOCK
DO NOT OPEN



CAUTION:

TO REDUCE THE RISK OF ELECTRIC SHOCK, DO NOT REMOVE COVER (OR BACK). NO USER-SERVICEABLE PARTS INSIDE. REFER SERVICING TO QUALIFIED SERVICE PERSONNEL.



The lightning flash with arrowhead symbol, within an equilateral triangle, is intended to alert the user to the presence of uninsulated "dangerous voltage" within the product's enclosure that may be of sufficient magnitude to constitute a risk of electric shock to persons.



The exclamation point within an equilateral triangle is intended to alert the user to the presence of important operating and maintenance (servicing) instructions in the literature accompanying the appliance.

WARNING:

TO REDUCE THE RISK OF FIRE OR ELECTRIC SHOCK, DO NOT EXPOSE THIS APPLIANCE TO RAIN OR MOISTURE.

• DECLARATION OF CONFORMITY

We declare under our sole responsibility that this product, to which this declaration relates, is in conformity with the following standards:

EN60065, EN55013, EN55020, EN61000-3-2 and EN61000-3-3.
Following the provisions of 73/23/EEC, 89/336/EEC and 93/68/EEC Directive.

• ÜBEREINSTIMMUNGSERKLÄRUNG

Wir erklären unter unserer Verantwortung, daß dieses Produkt, auf das sich diese Erklärung bezieht, den folgenden Standards entspricht:

EN60065, EN55013, EN55020, EN61000-3-2 und EN61000-3-3.
Entspricht den Verordnungen der Direktive 73/23/EEC, 89/336/EEC und 93/68/EEC.

• DECLARATION DE CONFORMITE

Nous déclarons sous notre seule responsabilité que l'appareil, auquel se réfère cette déclaration, est conforme aux standards suivants:

EN60065, EN55013, EN55020, EN61000-3-2 et EN61000-3-3.
D'après les dispositions de la Directive 73/23/EEC, 89/336/EEC et 93/68/EEC.

• DICHIARAZIONE DI CONFORMITÀ

Dichiariamo con piena responsabilità che questo prodotto, al quale la nostra dichiarazione si riferisce, è conforme alle seguenti normative: EN60065, EN55013, EN55020, EN61000-3-2 e EN61000-3-3.

In conformità con le condizioni delle direttive 73/23/EEC, 89/336/EEC e 93/68/EEC.

QUESTO PRODOTTO E' CONFORME

AL D.M. 28/08/95 N. 548

• DECLARACIÓN DE CONFORMIDAD

Declaramos bajo nuestra exclusiva responsabilidad que este producto al que hace referencia esta declaración, está conforme con los siguientes estándares:

EN60065, EN55013, EN55020, EN61000-3-2 y EN61000-3-3.
Siguiendo las provisiones de las Directivas 73/23/EEC, 89/336/EEC y 93/68/EEC.

• EENVORMIGHEIDSVERKLARING

Wij verklaren uitsluitend op onze verantwoordelijkheid dat dit produkt, waarop deze verklaring betrekking heeft, in overeenstemming is met de volgende normen:

EN60065, EN55013, EN55020, EN61000-3-2 en EN61000-3-3.
Volgens de bepalingen van de Richtlijnen 73/23/EEC, 89/336/EEC en 93/68/EEC.

• ÖVERENSSTÄMMELSESINTYG

Härmed intygas helt på eget ansvar att denna produkt, vilken detta intyg avser, uppfyller följande standarder:

EN60065, EN55013, EN55020, EN61000-3-2 och EN61000-3-3.
Enligt stadgarna i direktiv 73/23/EEC, 89/336/EEC och 93/68/EEC.

CAUTION:

To completely disconnect this product from the mains, disconnect the plug from the wall socket outlet.

When setting up this product, make sure that the AC outlet you are using is easily acceptable.

VORSICHT:

Um dieses Gerät vollständig von der Stromversorgung abzutrennen, trennen Sie bitte den Netzstecker von der Wandsteckdose ab.

Stellen Sie bei der Aufstellung dieses Gerätes sicher, dass die zu verwendende Wechselstrom-Steckdose leicht zugänglich ist.

PRECAUTION:

Pour déconnecter complètement ce produit du courant secteur, débranchez la prise de la prise murale.

Lors de l'installation de ce produit, assurez-vous que la prise CA que vous utilisez est compatible.

ATTENZIONE:

Per scollegare definitivamente questo prodotto dalla rete di alimentazione elettrica, togliere la spina dalla relativa presa.

Durante l'installazione, assicurarsi che la presa in CA utilizzata sia facilmente raggiungibile.

PRECAUCIÓN:

Para desconectar completamente este producto de la alimentación eléctrica, desconecte el enchufe del enchufe de la pared.

Al ajustar este producto, asegúrese de que la toma de salida de CA que esté utilizando sea fácilmente aceptable.

VOORZICHTIGHEID:

Om de voeding van dit product volledig te onderbreken moet de stekker uit het stopcontact worden getrokken.





Let er bij het plaatsen van dit product op dat het te gebruiken stopcontact goed bereikbaar is.

FÖRSIKTIHETSMÅTT:

Koppla loss stickproppen från eluttaget för att helt skilja produkten från nätet.

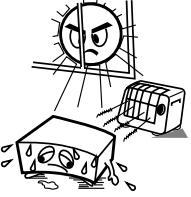
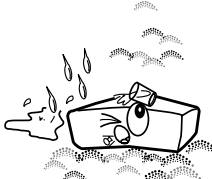
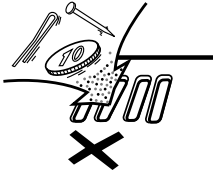
Vid installationen av produkten ska du se till att eluttaget den ansluts till är nära utrustningen.

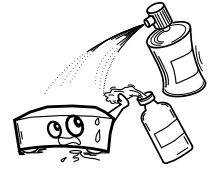
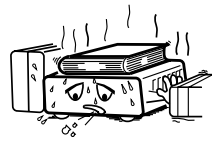
NOTE ON USE / HINWEISE ZUM GEBRAUCH / OBSERVATIONS RELATIVES A L'UTILISATION / NOTE SULL'USO / NOTAS SOBRE EL USO / ALVORENS TE GEBRUIKEN / OBSERVERA

 <ul style="list-style-type: none"> • Avoid high temperatures. Allow for sufficient heat dispersion when installed in a rack. • Vermeiden Sie hohe Temperaturen. Beachten Sie, daß eine ausreichend Luftzirkulation gewährleistet wird, wenn das Gerät auf ein Regal gestellt wird. • Éviter des températures élevées. Tenir compte d'une dispersion de chaleur suffisante lors de l'installation sur une étagère. • Evitate di esporre l'unità a temperature alte. Assicuratevi che ci sia un'adeguata dispersione del calore quando installate l'unità in un mobile per componenti audio. • Evite altas temperaturas. Permita la suficiente dispersión del calor cuando está instalado en la consola. • Vermijd hoge temperaturen. Zorg voor een degelijk hitteafvoer indien het apparaat op een rek wordt geplaatst. • Undvik höga temperaturer. Se till att det finns möjlighet till god värmeavledning vid montering i ett rack. 	 <ul style="list-style-type: none"> • Keep the apparatus free from moisture, water, and dust. • Halten Sie das Gerät von Feuchtigkeit, Wasser und Staub fern. • Protéger l'appareil contre l'humidité, l'eau et la poussière. • Tenete l'unità lontana dall'umidità, dall'acqua e dalla polvere. • Mantenga el equipo libre de humedad, agua y polvo. • Laat geen vochtigheid, water of stof in het apparaat binnendringen. • Utsätt inte apparaten för fukt, vatten och damm. 	 <ul style="list-style-type: none"> • Do not let foreign objects into the apparatus. • Keine fremden Gegenstände in das Gerät kommen lassen. • Ne pas laisser des objets étrangers dans l'appareil. • E' importante che nessun oggetto è inserito all'interno dell'unità. • No deje objetos extraños dentro del equipo. • Laat geen vreemde voorwerpen in dit apparaat vallen. • Se till att främmande föremål inte tränger in i apparaten. 	<p>CAUTION:</p> <ul style="list-style-type: none"> • Minimum distances around the apparatus for sufficient ventilation. • The ventilation should not be impeded by covering the ventilation openings with items, such as newspapers, table-cloths, curtains, etc.. • No naked flame sources, such as lighted candles, should be placed on the apparatus. • Attention should be drawn to the environmental aspects of battery disposal. • The use of apparatus in tropical and/or moderate climates. <p>ACHTUNG:</p> <ul style="list-style-type: none"> • Die Belüftung sollte auf keinen Fall durch das Abdecken der Belüftungsöffnungen durch Gegenstände wie beispielsweise Zeitungen, Tischtücher, Vorhänge o. Ä. behindert werden. • Auf dem Gerät sollten keinerlei direkten Feuerquellen wie beispielsweise angezündete Kerzen aufgestellt werden. • Bitte beachten Sie bei der Entsorgung der Batterien die geltenden Umweltbestimmungen. • Das Gerät sollte keinerlei Flüssigkeit, also keinem Tropfen oder Spritzen ausgesetzt werden. • Auf dem Gerät sollten keinerlei mit Flüssigkeit gefüllten Behälter wie beispielsweise Vasen aufgestellt werden.
 <ul style="list-style-type: none"> • Handle the power cord carefully. Hold the plug when unplugging the cord. • Gehen Sie vorsichtig mit dem Netzkabel um. Halten Sie das Kabel am Stecker, wenn Sie den Stecker herausziehen. • Manipuler le cordon d'alimentation avec précaution. Tenir la prise lors du débranchement du cordon. • Maneggiare il filo di alimentazione con cura. Agitare per la spina quando scollegate il cavo dalla presa. • Maneje el cordón de energía con cuidado. Sostenga el enchufe cuando desconecte el cordón de energía. • Hanteer het netsnoer voorzichtig. Houd het snoer bij de stekker vast wanneer deze moet worden aan- of losgekoppeld. • Hantera nätkabeln varsamt. Håll i kabeln när den kopplas från el-uttaget. 	 <ul style="list-style-type: none"> • Unplug the power cord when not using the apparatus for long periods of time. • Wenn das Gerät eine längere Zeit nicht verwendet werden soll, trennen Sie das Netzkabel vom Netzstecker. • Débrancher le cordon d'alimentation lorsque l'appareil n'est pas utilisé pendant de longues périodes. • Disinnestate il filo di alimentazione quando avete l'intenzione di non usare il filo di alimentazione per un lungo periodo di tempo. • Desconecte el cordón de energía cuando no utilice el equipo por mucho tiempo. • Neem altijd het netsnoer uit het stopcontact wanneer het apparaat gedurende een lange periode niet wordt gebruikt. • Koppla ur nätkabeln om apparaten inte kommer att användas i lång tid. 	 <ul style="list-style-type: none"> • Do not let insecticides, benzene, and thinner come in contact with the apparatus. • Lassen Sie das Gerät nicht mit Insektiziden, Benzin oder Verdünnungsmitteln in Berührung kommen. • Ne pas mettre en contact des insecticides, du benzène et un diluant avec l'appareil. • Assicuratevi che l'unità non venga in contatto con insetticidi, benzolo o solventi. • No permita el contacto de insecticidas, gasolina y diluyentes con el equipo. • Laat geen insektenverdelgende middelen, benzine of verfverdunder met dit apparaat in contact komen. • Se till att inte insektsmedel på spraybruk, bensen och thinner kommer i kontakt med apparatens hölje. 	<p>ATTENTION:</p> <ul style="list-style-type: none"> • La ventilation ne doit pas être gênée en recouvrant les ouvertures de la ventilation avec des objets tels que journaux, rideaux, tissus, etc. • Aucune flamme nue, par exemple une bougie, ne doit être placée sur l'appareil. • Veillez à respecter l'environnement lorsque vous jetez les piles usagées. • L'appareil ne doit pas être exposé à l'eau ou à l'humidité. • Aucun objet contenant du liquide, par exemple un vase, ne doit être placé sur l'appareil. <p>PRECAUZIONI:</p> <ul style="list-style-type: none"> • Le aperture di ventilazione non devono essere ostruite coprendole con oggetti, quali giornali, tovaglie, tende e così via. • Non posizionare sull'apparecchiatura fiamme libere, come ad esempio le candele accese. • Prestare attenzione agli aspetti legati alla tutela dell'ambiente quando si smaltisce la batteria. • L'apparecchiatura non deve essere esposta a gocciolii o spruzzi. • Non posizionare sull'apparecchiatura nessun oggetto contenete liquidi, come ad esempio i vasi. <p>PRECAUCIÓN:</p> <ul style="list-style-type: none"> • La ventilación no debe quedar obstruida por hacerse cubierto las aperturas con objetos como periódicos, manteles, cortinas, etc. • No debe colocarse sobre el aparato ninguna fuente inflamable sin protección, como velas encendidas. • A la hora de deshacerse de las pilas, respete la normativa para el cuidado del medio ambiente. • No se expondrá el aparato al goteo o salpicaduras cuando se utilice. • No se colocarán sobre el aparato objetos llenos de líquido, como jarras.
	 <p>* (For apparatuses with ventilation holes)</p> <ul style="list-style-type: none"> • Do not obstruct the ventilation holes. • Die Belüftungsöffnungen dürfen nicht verdeckt werden. • Ne pas obstruer les trous d'aération. • Non coprite i fori di ventilazione. • No obstruya los orificios de ventilación. • De ventilatieopeningen mogen niet worden geblokkeerd. • Tapp inte till ventilationsöppningarna. 	 <ul style="list-style-type: none"> • Never disassemble or modify the apparatus in any way. • Versuchen Sie niemals das Gerät auseinander zu nehmen oder auf jegliche Art zu verändern. • Ne jamais démonter ou modifier l'appareil d'une manière ou d'une autre. • Non smontate mai, né modificate l'unità in nessun modo. • Nunca desarme o modifique el equipo de ninguna manera. • Nooit dit apparaat demonteren of op andere wijze modificeren. • Ta inte isär apparaten och försök inte bygga om den. 	<p>PRECAUCIÓN:</p> <ul style="list-style-type: none"> • La ventilación no debe quedar obstruida por hacerse cubierto las aperturas con objetos como periódicos, manteles, cortinas, etc. • No debe colocarse sobre el aparato ninguna fuente inflamable sin protección, como velas encendidas. • A la hora de deshacerse de las pilas, respete la normativa para el cuidado del medio ambiente. • No se expondrá el aparato al goteo o salpicaduras cuando se utilice. • No se colocarán sobre el aparato objetos llenos de líquido, como jarras. <p>WAARSCHUWING:</p> <ul style="list-style-type: none"> • De ventilatie mag niet worden belemmerd door de ventilatieopeningen af te dekken met bijvoorbeeld kranten, een tafelkleed, gordijnen, enz. • Plaats geen open vlammen, bijvoorbeeld een brandende kaars, op het apparaat. • Houd u steeds aan de milieuvorschriften wanneer u gebruikte batterijen wegdoet. • Stel het apparaat niet bloot aan druppels of spatten. • Plaats geen voorwerpen gevuld met water, bijvoorbeeld een vaas, op het apparaat. <p>OBSERVERA:</p> <ul style="list-style-type: none"> • Ventilationen bör inte förhindras genom att täcka för ventilationsöppningarna med föremål såsom tidningar, bordsdukar, gardiner osv. • Inga blottade brandkällor, såsom tända ljus, bör placeras på apparaten. • Tank på miljöaspekterna när du bortskaffar batterier. • Apparaten får inte utsättas för vätska. • Inga objekt med vätskor, såsom vaser, får placeras på apparaten.

A NOTE ABOUT RECYCLING:

This product's packaging materials are recyclable and can be reused. Please dispose of any materials in accordance with the local recycling regulations.

When discarding the unit, comply with local rules or regulations.

Batteries should never be thrown away or incinerated but disposed of in accordance with the local regulations concerning chemical waste.

This product and the accessories packed together constitute the applicable product according to the WEEE directive except batteries.

**HINWEIS ZUM RECYCLING:**

Das Verpackungsmaterial dieses Produktes ist für zum Recyceln geeignet und kann wieder verwendet werden. Bitte entsorgen Sie alle Materialien entsprechend der örtlichen Recycling-Vorschriften.

Beachten Sie bei der Entsorgung des Gerätes die örtlichen Vorschriften und Bestimmungen.

Die Batterien dürfen nicht in den Hausmüll geworfen oder verbrannt werden; bitte geben Sie die Batterien gemäß örtlichen Bestimmungen an den Sammelstellen oder Sondermüllplätzen ab.

Dieses Produkt zusammen mit den Zubehörteilen ist das geltende Produkt der WEEE-Direktive, davon ausgenommen sind die Batterien.

UNE REMARQUE CONCERNANT LE RECYCLAGE:

Les matériaux d'emballage de ce produit sont recyclables et peuvent être réutilisés. Veuillez disposer de tout matériau conformément aux règlements de recyclage locaux.

Lorsque vous mettez cet appareil au rebut, respectez les lois ou réglementations locales.

Les piles ne doivent jamais être jetées ou incinérées, mais mises au rebut conformément aux règlements locaux concernant les déchets chimiques.

Ce produit et les accessoires emballés ensemble sont des produits conformes à la directive DEEE sauf pour les piles.

NOTA RELATIVA AL RICICLAGGIO:

I materiali di imballaggio di questo prodotto sono riutilizzabili e riciclabili. Smaltire i materiali conformemente alle normative locali sul riciclaggio.

Per smaltire l'unità, osservare la normativa in vigore nel luogo di utilizzo.

Non gettare le batterie, né incenerirle, ma smaltirle conformemente alla normativa locale sui rifiuti chimici.

Questo prodotto e gli accessori inclusi nell'imballaggio sono applicabili alla direttiva RAEE, ad eccezione delle batterie.

ACERCA DEL RECICLAJE:

Los materiales de embalaje de este producto son reciclables y se pueden volver a utilizar. Disponga de estos materiales siguiendo los reglamentos de reciclaje de su localidad.

Cuando se deshaga de la unidad, cumpla con las reglas o reglamentos locales.

Las pilas nunca deberán tirarse ni incinerarse. Deberá disponer de ellas siguiendo los reglamentos de su localidad relacionados con los desperdicios químicos.

Este producto junto con los accesorios empacutados es el producto aplicable a la directiva RAEE excepto pilas.

EEN AANTEKENING WAT BETREFT HET RECYCLEREN:

Het inpakmateriaal van dit product is recycleerbaar en kan opnieuw gebruikt worden. Er wordt verzocht om zich van elk afvalmateriaal te ontdoen volgens de plaatselijke voorschriften.

Volg voor het wegdoen van de speler de voorschriften voor de verwijdering van wit- en bruingoed op.

Batterijen mogen nooit worden weggegooid of verbrand, maar moeten volgens de plaatselijke voorschriften betreffende chemisch afval worden verwijderd.

Op dit product en de meegeleverde accessoires, m.u.v. de batterijen is de richtlijn voor afgedankte elektrische en elektronische apparaten (WEEE) van toepassing.

EN KOMMENTAR OM ÅTERVINNING:

Produktens emballage är återvinningsbart och kan återanvändas. Kassera det enligt lokala återvinningsbestämmelser.

När du kasserar enheten ska du göra det i överensstämmelse med lokala regler och bestämmelser.

Batterier får absolut inte kastas i soporna eller brännas. Kassera dem enligt lokala bestämmelser för kemiskt avfall.

Denna apparat och de tillbehör som levereras med den är de som uppfyller gällande WEEE-direktiv, med undantag av batterierna.

Getting Started

Thank you for choosing the DENON AVR-2807 AV Surround Receiver. This remarkable component has been engineered to provide superb surround sound listening with home theater sources such as DVD, as well as providing outstanding high fidelity reproduction of your favorite music sources.

As this product is provided with an immense array of features, we recommend that before you begin hookup and operation that you review the contents of this manual before proceeding.

Contents

Getting Started	
Accessories	3
Before using	3
Cautions on installation	3
About the remote control unit	3
Inserting the batteries	3
Operating range of the remote control unit	3
Part names and functions	
Front panel	4
Display	4
Rear panel	5
Remote control unit	5
Easy Setup Procedure	
Easy to setup flow	6
Speaker layout [Basic layout]	6
Speaker connections	7
Connecting a DVD player and monitor	8
Auto Setup/Room Equalizer (Room EQ) Functions	9
① Connecting a microphone	9
② Before performing the Auto Setup procedure	10
③ Perform the Auto Setup procedure	10
④ Assigning power amplifiers	10
⑤ Switching the front speaker	10
⑥ Preliminary measurements	11
⑦ Speaker measurements	11
⑧ Checking and storing the measurement results	12
Error messages	12
Connecting Other Sources	
Cable indications	13
The video conversion function	14
Relationship between the video input signal and monitor output according to the video convert settings	14, 15

The analog video to HDMI conversion function	15
Connecting equipment with HDMI terminals [To convert analog video signals to HDMI signals]	16
Connecting a TV tuner	16
Connecting a DBS tuner	16
Connecting the external inputs (EXT. IN) terminals	17
Connecting a video camera or video game	17
Connecting a CD player	17
Connecting a turntable	17
Connecting a DVD recorder	18
Connecting a VCR	18
Connecting a tape deck	18
Connecting a CD recorder or MD recorder	19
Connecting equipment with HDMI terminals	19
Connecting the antenna terminals	20
Connecting the iPod	20
Connecting the RS-232C terminal	20
Connecting the TRIGGER OUT jacks	21
Connecting the MULTI ZONE terminals	
ZONE2 out connections	21
ZONE2 speaker out connections	21
Connecting the PRE OUT terminals	22
Connecting the power supply cord	22

Basic Operation

Playing the input source	23
Selecting the room equalizer mode	24
Turning the sound off temporarily (MUTING)	24
Listening over headphones	24
Switching the front speakers	24
Checking the currently playing program source, etc.	24
Switching the brightness of the display	24

Using the surround modes

Types of surround modes and their features	25
Selecting the play mode (PURE DIRECT / DIRECT / STEREO)	25
Selecting the Dolby Digital and DTS Surround mode (only with digital input)	26, 27
Selecting the Dolby Pro LogicIIx (Pro LogicII) mode	27
Selecting the DTS NEO:6 mode	28
Checking the input signals	28
Surround modes and parameters	29 ~ 31

Using the DENON original surround modes

Types of surround modes and their features	32
Selecting the DSP surround simulation	33
Setting the tone control	34
Adjusting the speaker volume	34
Using the fader function	35

Listening to the radio

Auto tuning	35
Manual tuning	35
Preset memory	35
Checking the preset stations	36
Recalling preset stations	36
RDS (Radio Data System)	36
RDS search	37
PTY search	37
TP search	37
RT (Radio Text)	37

Advanced Operation

Night mode	38
User mode function	38
Combining the currently playing sound with the desired image (VIDEO SELECT function)	38
Personal memory plus function	38
Playing the iPod	39
Listening to music	39
Viewing still pictures and videos (only for iPods equipped with the slideshow / video function)	39
Disconnecting the iPod	39
Multi zone music entertainment system	
Multi-zone playback using the ZONE2 output terminals	40
Multi-zone playback using the SPEAKER terminals	40
Outputting a program source to amplifier, etc., in the ZONE2 room (ZONE2 SELECT mode)	41
Remote control unit operations during multi-source playback	41
Recording (audio and/or video)	42
About the memory functions	42
Initialization of the microprocessor	42

Getting Started

Getting Started

Advanced Setup – Part 1	
System setup items and default values	43 ~ 45
Navigating through the System Setup Menu	46
About the display	46
Audio Input Setup	
Setting the Digital In Assignment.....	47
Setting the EXT. IN Subwoofer Level	47
Setting the iPod Assignment	47
Setting the Input Function Level	48
Setting the Function Rename.....	48
Setting the Tuner Presets.....	48, 49
Video Setup	
Setting the HDMI In Assignment.....	49, 50
Setting the Component In Assignment.....	50
Setting the Video Convert	50
Setting the HDMI Out Setup.....	51
Setting the Audio Delay.....	51
Setting the On Screen Display (OSD)	52
Advanced Playback	
Setting the 2ch Direct/Stereo.....	52
Setting the Dolby Digital Downmix Option Setup.....	53
Setting the Auto Surround Mode	53
Setting the Manual Equalizer Setup	53, 54
Option Setup	
Setting the Power Amplifier Assignment.....	54
Setting the Volume Control	55
Setting the Trigger Out	55
Setting the Setup Lock.....	56

Advanced Setup – Part 2	
Speaker Setup	
Setting the Speaker Configuration	56, 57
Setting the Subwoofer Setup.....	57
Setting the Distance.....	57, 58
Setting the Channel Level	58, 59
Setting the Crossover Frequency.....	59
Others Setup	
Setting the Room Equalizer Setup	60
Setting the Direct Mode Setup	60
Setting the MIC Input Select.....	61
Check the parameter.....	61

Operating the remote control unit	
Operating DENON audio components	62
Setting the preset memory function	62
Operating a component stored in the preset memory	63
Setting the learning function	64
Using the system call function	64
Registering.....	64
Operating.....	64
Setting the punch through function	65
Resetting the remote control unit	
Resetting the learning function	65
Resetting the punch through setting	65

Additional Information	66 ~ 68
-------------------------------------	---------

Troubleshooting	69
------------------------------	----

Specifications	70
-----------------------------	----

List of preset codesEnd of this manual

Getting Started

Accessories

Check that the following parts are attached in addition to the main unit:

- ① Operating instructions 1
- ② Service station list..... 1
- ③ Power supply cord (Approx. 1.5 m) 1
- ④ Remote control unit (RC-1030) 1
- ⑤ R6P/AA batteries 3
- ⑥ AM loop antenna 1
- ⑦ FM indoor antenna..... 1
- ⑧ Setup microphone (DM-S205) (Approx. 6 m) 1

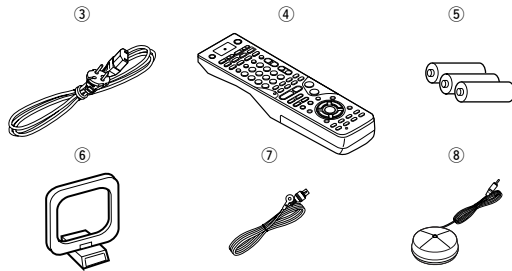

Before using

Pay attention to the following before using this unit:

• Moving the unit

To prevent short-circuits or damaged wires in the connection cables, always unplug the power supply cord and disconnect the connection cables between all other audio components when moving the unit.

• Before turning the power switch on

Check once again that all connections are correct and that there are not problems with the connection cables. Always set the power switch to the standby position before connecting and disconnecting connection cables.

• Store these instructions in a safe place.

After reading, store this instructions along with the warranty card in a safe place.

• Whenever the power switch is in the STANDBY state, the unit is still connected to AC line voltage. Please be sure to turn off the power switch or unplug the cord when you leave home for, say, a vacation.

• Note that the illustrations in these instructions may differ from the actual unit for explanation purposes.

Cautions on installation

Note:

For heat dispersal, do not install this unit in a confined space such as a bookcase or similar enclosure.

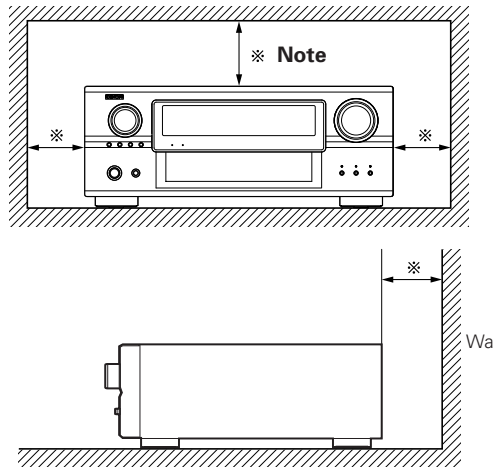

About the remote control unit

In addition to controlling the AVR-2807, the attached remote control unit (RC-1030) can also be used to control the following products:

- ① DENON component products
- ② Component products other than DENON:
 - Set using the preset memory function (☞ page 62, 63).
 - Set using the learning function (☞ page 64).

Inserting the batteries

- ① Remove the remote control
- ② Set 3 R6P/AA batteries in the battery compartment in the indicated direction.

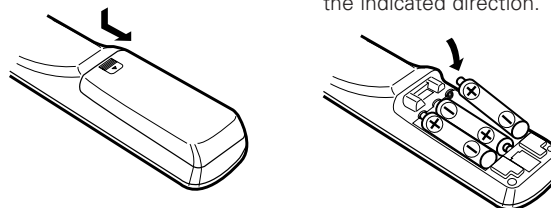

- ③ Put the rear cover back on.

Getting Started

Notes on batteries:

- Replace the batteries with new ones if the set does not operate even when the remote control unit is operated nearby the unit. (The attached batteries are only for verifying operation.)
- When inserting the batteries, be sure to do so in the proper direction, following the “⊕” and “⊖” marks in the battery compartment.
- To prevent damage or leakage of battery fluid:
 - Do not use a new battery together with an old one.
 - Do not use two different types of batteries.
 - Do not short-circuit, disassemble, heat or dispose of batteries in flames.
- Remove the batteries from the remote control unit when you do not plan to use it for an extended period of time.
- If the battery fluid should leak, carefully wipe the fluid off the inside of the battery compartment and insert new batteries.
- When replacing the batteries, have the new batteries ready and insert them as quickly as possible.

Operating range of the remote control unit

- Point the remote control unit at the remote sensor when operating it.
- The remote control unit can be used from a distance of up to about 7 meters, at a horizontal angle of up to 30° with respect to the sensor.

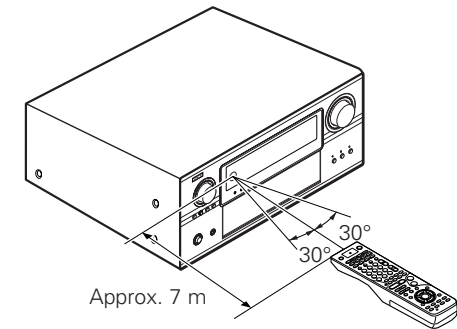

NOTE:

- It may be difficult to operate the remote control unit if the remote sensor is exposed to direct sunlight or strong artificial light.

Getting Started

Part names and functions

For details on the functions of these parts, refer to the pages given in parentheses ().

Front panel

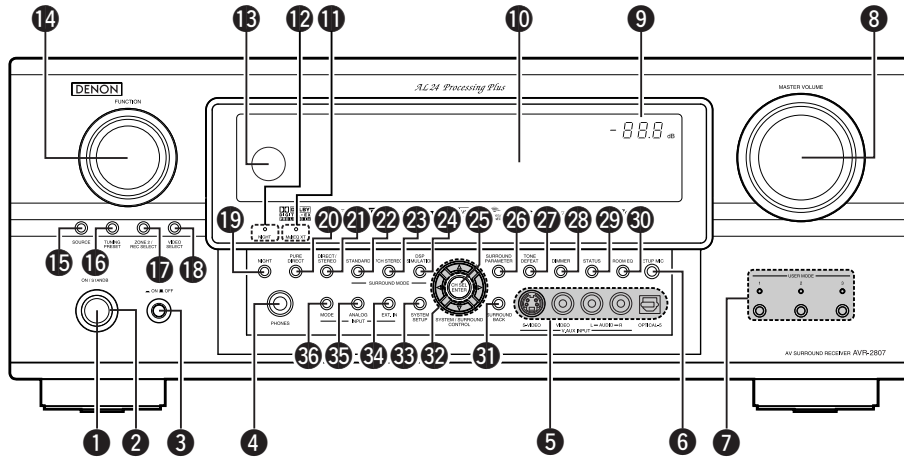

- 1 Power ON/STANDBY button(10)
- 2 Power indicator(10)
- 3 Power switch(10)
- 4 Headphones jack (PHONES)(25)
- 5 V.AUX INPUT terminals(17)
- 6 SETUP MIC jack(9)
- 7 USER MODE buttons(38)
- 8 MASTER VOLUME control knob(23)
- 9 Master volume indicator
- 10 Display
- 11 MultEQ XT indicator(24)
- 12 NIGHT indicator(38)
- 13 Remote control sensor(3)
- 14 FUNCTION knob(23)
- 15 SOURCE button(23)
- 16 TUNING PRESET button(36)
- 17 ZONE2/REC SELECT button(41, 42)
- 18 VIDEO SELECT button(38)
- 19 NIGHT button(38)
- 20 PURE DIRECT button(25)
- 21 DIRECT/STEREO button(25)
- 22 STANDARD button(26)
- 23 7CH STEREO button(33)
- 24 DSP SIMULATION button(33)
- 25 CH SELECT/ENTER button(10, 34)
- 26 SURROUND PARAMETER button(26)
- 27 TONE DEFEAT button(34)
- 28 DIMMER button(24)
- 29 STATUS button(24)
- 30 ROOM EQ button(24)
- 31 SURROUND BACK button(26)
- 32 Cursor (Δ, ▽, ◀, ▶) buttons(10)
- 33 SYSTEM SETUP button(10)
- 34 EXT. IN button(23)
- 35 ANALOG button(23)
- 36 INPUT MODE button(23)

Getting Started

Display

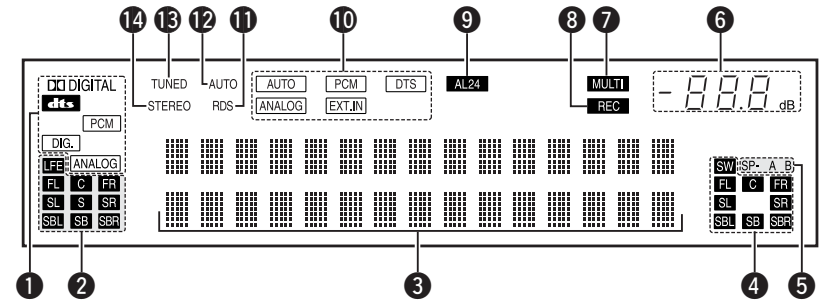

- 1 Input signal indicator
- 2 Input signal channel indicator
 - The audio channel(s) included in the input signal light(s).
 - This lights when the digital signal is inputted.
- 3 Information display
- 4 Output signal channel indicator
 - The audio channels that can be output light.
- 5 Speaker indicator
 - This lights corresponding to the settings of the surround speakers of the various surround modes.
- 6 Master volume indicator
 - This displays the volume level.
 - The Setup item number is displayed in System Setup.
- 7 MULTI (zone) indicator
 - ZONE2 mode is selected in ZONE2/REC SELECT.
- 8 REC indicator
 - REC OUT mode is selected in ZONE2/REC SELECT.
- 9 AL24 indicator
 - This lights when the following mode is selected while inputting digital (PCM) signals.
 - PURE DIRECT / DIRECT / STEREO / MULTI CH PURE DIRECT / MULTI CH DIRECT / MULTI CH IN
- 10 Input mode indicator
- 11 RDS indicator
 - This lights when an RDS broadcast has been received.
- 12 AUTO indicator
 - This lights when the broadcast station is selected in the AUTO tuning mode.
- 13 TUNED indicator
 - This lights when an FM/AM broadcast has been received.
- 14 STEREO indicator
 - This lights when an FM stereo broadcast has been received.

Getting Started

Rear panel

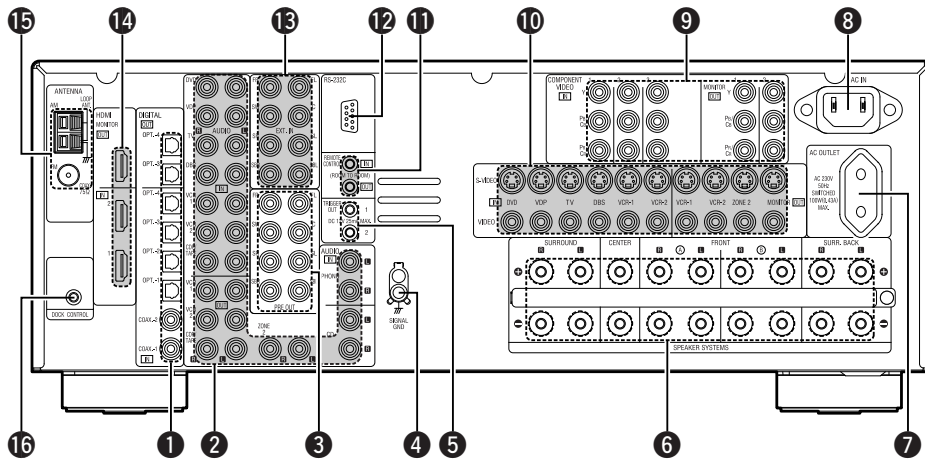

- 1 DIGITAL terminals (Optical/Coaxial)(8)
- 2 AUDIO terminals(8)
- 3 PRE OUT terminals(22)
- 4 SIGNAL GND terminal(17)
- 5 TRIGGER OUT jacks(21)
- 6 Speaker terminals(7)
- 7 AC outlet(22)
- 8 AC inlet(22)
- 9 COMPONENT VIDEO terminals(8)
- 10 VIDEO/S-VIDEO terminals(8)
- 11 REMOTE CONTROL jacks(21)
- 12 RS-232C terminal(20)
- 13 EXT. IN terminals(17)
- 14 HDMI terminals(19)
- 15 ANTENNA terminals(20)
- 16 DOCK CONTROL jack(20)

Getting Started

Remote control unit

To operate the AVR-2807, use the mode selector buttons to select "TAPE", "CDR/MD" or "CD", mode.

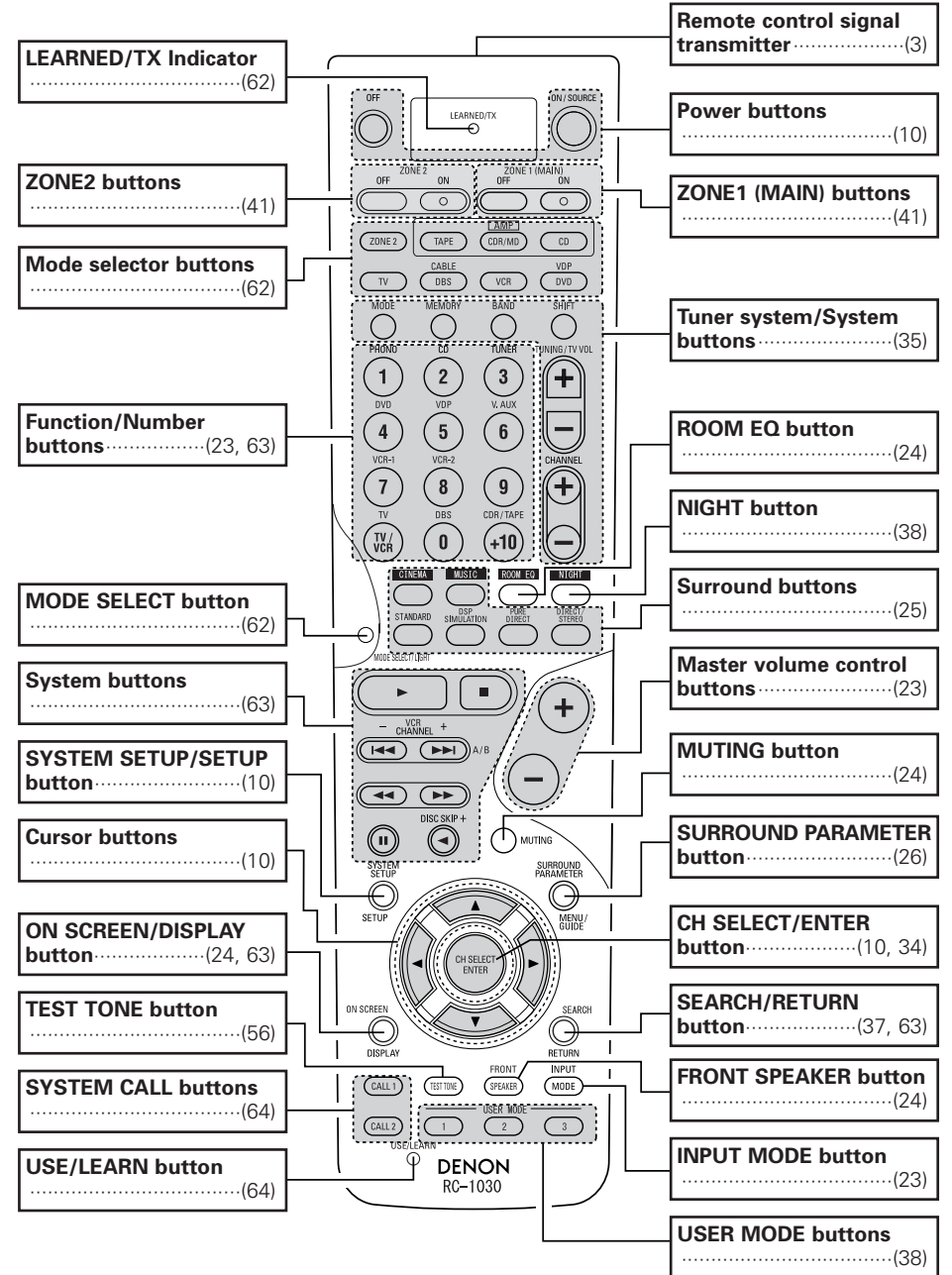

Easy Setup Procedure

- This section contains the basic steps necessary to configure the AVR-2807 according to your listening room environment and the source equipment and loudspeakers you are using.
- To set the sound field manually, see pages 56 ~59.

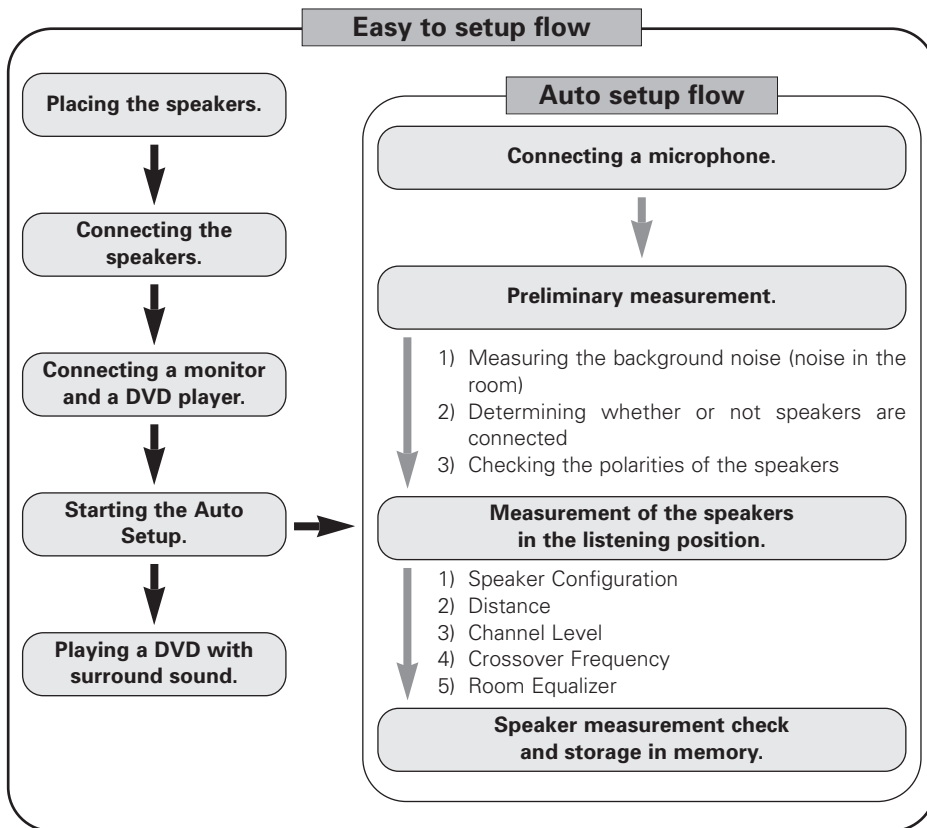

Speaker layout [Basic layout]

Example of basic layout with 8 speakers and a monitor.

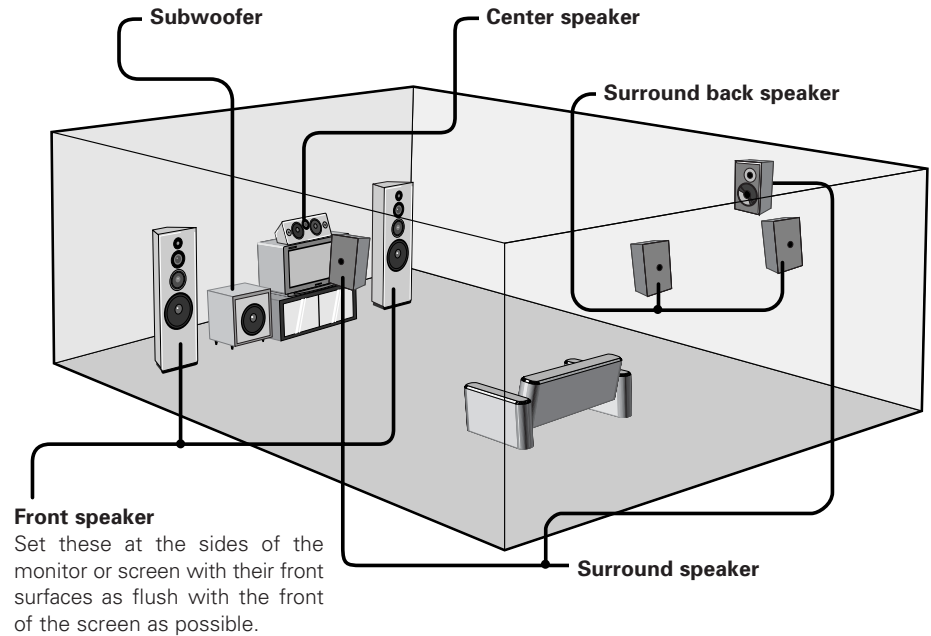

Easy Setup Procedure

Speaker connections

Connect the speaker terminals with the speakers making sure that like polarities are matched (⊕ with ⊕, ⊖ with ⊖).

NOTE:
When making connections, take care that none of the individual conductors of the speaker cable come in contact with adjacent terminals, with other speaker cable conductors, or with the rear panel and screws.
NEVER touch the speaker terminals when the power is on. Doing so could result in electric shocks.

Connecting the speaker cables

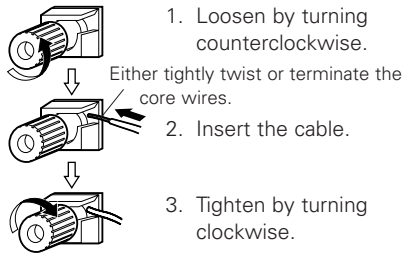

Speaker impedance

Speaker	Impedance
Front A, B	6 ~ 16 Ω/ohms
Front A+B	8 ~ 16 Ω/ohms
Center	6 ~ 16 Ω/ohms
Surround	
Surround back	

Note on speaker impedance

When using speakers with an impedance below the designated value (for example 4 Ω/ohms), playing for long periods of time with the volume high could cause the temperature to rise, activating the protection circuit.

When the protection circuit is activated, the output to the speakers is cut off and the power indicator blinks. If this happens, unplug the power cord, wait for the set to cool off and improve ventilation around the unit. Also check the wiring of the input cables and the speaker cables. After doing this, plug the power cord back in and turn the unit's power back on.

If the protection circuit is activated again even though there are no problems with the wiring or the ventilation around the unit, switch off the power and contact a DENON service center.

Easy Setup Procedure

Connections

- With the AVR-2807, up to 10 speakers can be connected for surround playback.
- When making connections, also refer to the operating instructions of the other components.

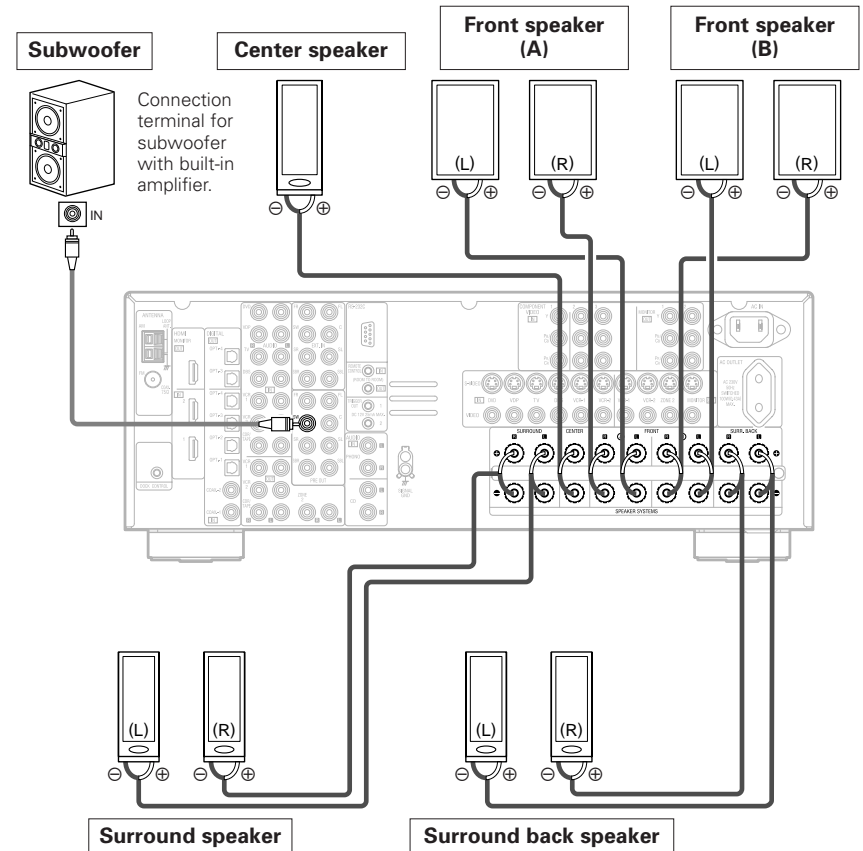

When using only one surround back speaker, connect it to the left channel.

Easy Setup Procedure

Connecting a DVD player and monitor

- To connect the video output from the DVD player to the AVR-2807, you only need to choose one connection type. For more information about the video up conversion function (page 14, 15).
- To connect the digital audio output from the DVD player, you can choose from either the coaxial or optical connections. If you choose to use the optical connection, it needs to be assigned. For more information about Digital Input Assignment (page 47).

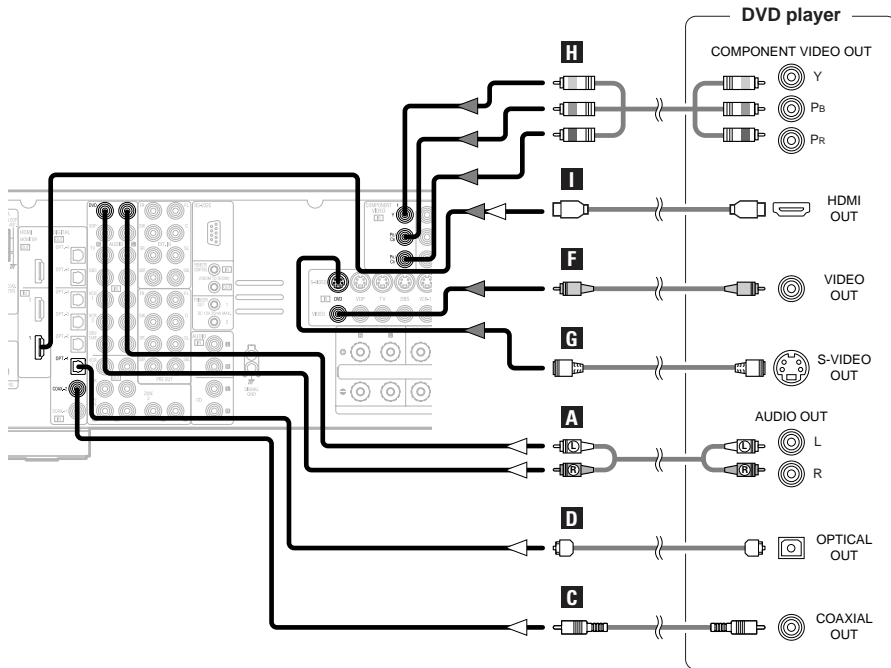

※ Audio signal flow is shown with white arrows, video signal flow is shown with gray arrows.



- The AVR-2807 is equipped with another set of input terminals for a non-DVD video disc player (such as laser disc, VCD/SVCD, or future high definition disc player). The above connection guidelines for DVD also apply to the VDP input.

Easy Setup Procedure

- For best picture quality (especially with progressive DVD and other high definition sources), choose the component video or HDMI connection to your monitor. S-Video and composite video outputs are also provided if your monitor does not have component video inputs.

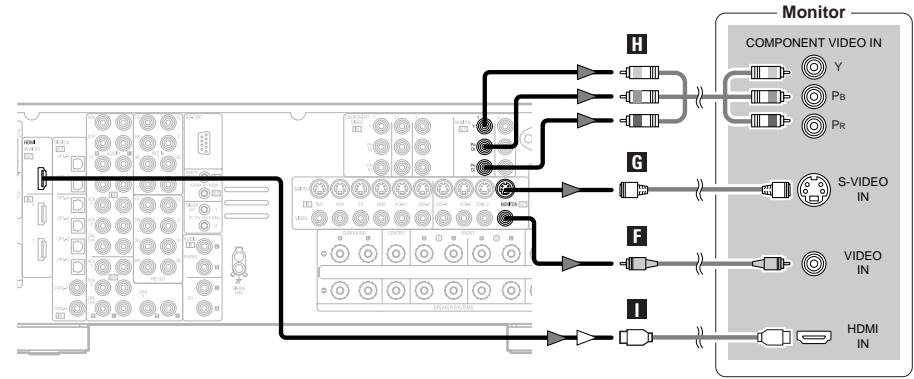

- The AVR-2807 is equipped with HDMI terminals, so it can be connected to a DVD player or monitor using an HDMI cable.
- The component video input and/or output terminals may be labelled differently on some monitors or video components. Check the owner's manuals for other components for further information.
- The COMPONENT MONITOR OUT-1 and the COMPONENT MONITOR OUT-2 can be used simultaneously.
- Audio signals are only output from the HDMI monitor out terminal when audio signals are input to the HDMI input terminal.
- When connecting the AVR-2807 and DVD player using an HDMI cable, also connect the AVR-2807 and monitor using an HDMI cable (page 19).

Easy Setup Procedure

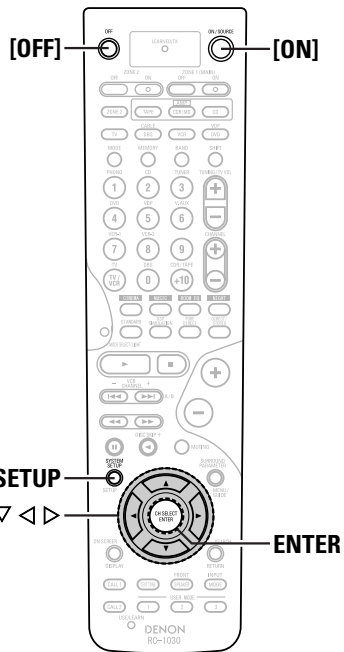
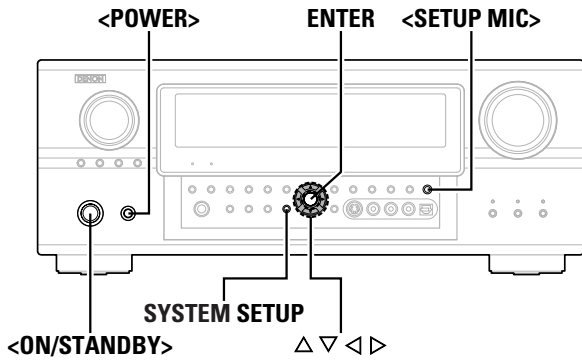

About the button names in this explanation
 < > : Buttons on the main unit
 [] : Buttons on the remote control unit
Button name only :
 Buttons on the main unit and remote control unit

Auto Setup/Room Equalizer (Room EQ) Functions

- The AVR-2807's auto setup and room equalizer functions use the attached microphone to measure the acoustic properties in the room and automatically make the optimum settings.
- The optimum listening environment at all listening positions in the home theater is achieved so multiple listeners can enjoy listening at the same time.
 As shown in Example ①, as you make the measurements, move the microphone successively to the different positions within the listening area surrounded by the speakers. For best results, make the measurements at 6 locations.
- When the auto setup procedure is performed, one of the following 3 correction curves can be selected for the room equalizer function.
 Even if the home theater is only used by a small number of people, as in Example ②, more effective equalization can be achieved by taking the measurements in the area around the listening position.

Audyssey:
 The frequency response of all the speakers is adjusted to achieve the optimum environment for the room's acoustics.
Front:
 This adjusts the characteristics of each speaker to the characteristics of the front speakers.
Flat:
 This the frequency response of all speakers flat. This mode is optimum for playing multi-channel signal music.



- To make the sound field settings manually, see pages 56 ~ 59.

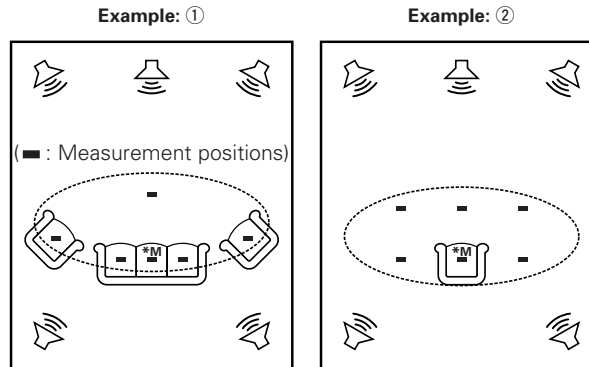

Easy Setup Procedure

■ About the main listening position (*M)

The "main listening position" refers to either the center of the listening position or the position in which the user sits when using the system alone. The distance to the speakers is measured from this position.

① Connecting a microphone

1 Connect the attached setup microphone to <SETUP MIC>.

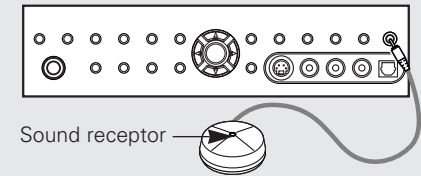

2 Mount the setup microphone on a camera tripod, etc., and set with the receptor pointing towards the ceiling.

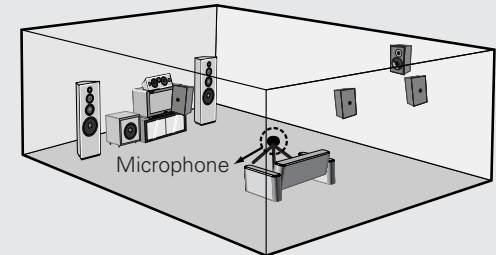

- ※ Place the setup microphone's sound receptor at the height of the ears in the listening position.
- ※ Be sure that at the beginning, the measurement is started with the microphone set up at the main listening position.
- ※ It is not possible to measure properly if there are any obstacles between the speakers and microphone. Check that there are no obstacles.

NOTE:
 • Once the settings are completed, disconnect the setup microphone.

Easy Setup Procedure

② Before performing the Auto Setup procedure

1 Turn on your subwoofer.

- ※ Set the volume to halfway and set the crossover frequency to the maximum or Low pass filter off if your subwoofer can adjust the output volume and the crossover frequency.
- ※ Some subwoofers have a standby mode. Be sure to turn this function off before performing the Auto Setup procedure.

2 Turn on your monitor.

3 Press <POWER>.

- ON:**
The power indicator lights red.
- OFF:**
The power turns off and the indicator is off.

4 Press <ON/STANDBY> or [ON].

- The power indicator blinks green and the power turns on.

③ Perform the Auto Setup procedure

1 Press SYSTEM SETUP.

2 Press Δ ∇ to select “Auto Setup / Room EQ”, then press ENTER.

3 Press Δ ∇ to select “Auto Setup”, then press ENTER.

- ※ The message “Connect Microphone” is displayed if no microphone is connected. If so, connect the auto setup microphone.

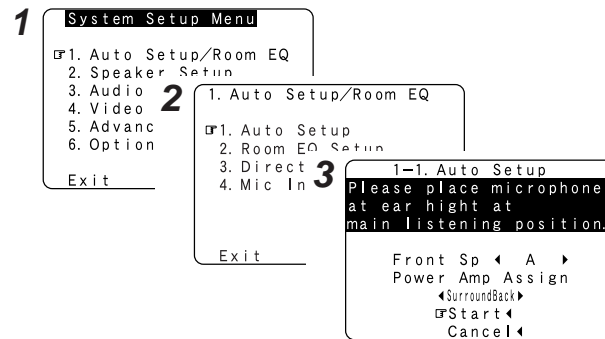

- “System Setup Menu” is not displayed when using headphones.

Easy Setup Procedure

④ Assigning power amplifiers

The surround back output can be assigned to the “Front” or “ZONE2” output.

Press Δ ∇ to select “Power Amp Assign”, then press \triangleleft \triangleright to set.

Surround Back:
Assign to use as surround back speaker.

Front A, Front B:
Assign to use the “Front A” (or “Front B”) speakers with bi-amp connections.

ZONE2:
Assign to use as “ZONE2” speakers.

- ※ When assigned to “Front”, skip the surround back channel measurement.
- ※ During the auto setup procedure, test tones are not output to “ZONE2”.

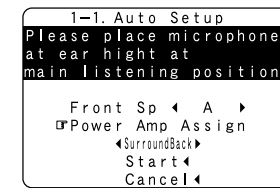

⑤ Switching the front speaker

Press Δ ∇ to select “Front Sp”, then press \triangleleft \triangleright to select the speaker.



Easy Setup Procedure

⑥ Preliminary measurements

This procedure is used to automatically determine the background noise, whether or not speakers are connected, and the polarities of the connected speakers.

- 1 Press $\Delta \nabla$ to select “Start”, then press \triangleleft .
 - The preliminary measurements start.
- 2 Press $\Delta \nabla$ to select “Speaker Detect Check”, then press ENTER.
- 3 Press ENTER again.

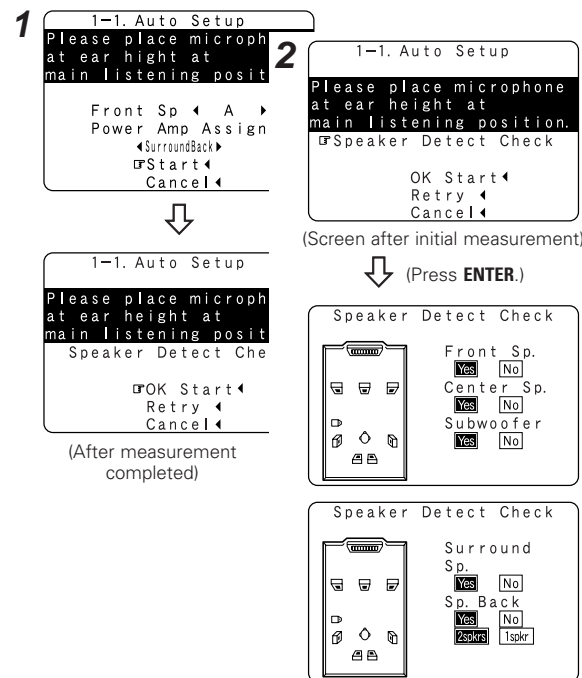

Cautions during measurements:

- Loud test tones are output during the measurements. Be careful for example when small children are nearby.
- Proper measurements may not be possible if there are obstacles between the speaker and the setup microphone.
- During the measurements, do not stand between or near the speakers and setup microphone.
- To avoid influencing the measurements, turn off the power of air-conditioners or any other equipment producing sound in the room. Perform the measurements with the room as quiet as possible.
- Measurement is cancelled when **VOLUME** is operated while the Auto Setup is performed.

⑦ Speaker measurements

With these measurements, the “Speaker Configuration”, “Distance”, “Channel Level”, “Crossover Frequency” and “Room EQ” settings are analyzed automatically. The main listening position is measured first, so leave the microphone where it is.

- 1 Press $\Delta \nabla$ to select “OK Start”, then press \triangleleft .
 - Measurements for the first point start.
- 2 Move the microphone to the second point and press \triangleleft .
 - Measurements for the second point start.
- 3 Perform step 2 repeatedly.
 - Measurements can be ended when there are 6 or less measurement locations; however, to obtain better results, measurements at **6 locations** is recommended.

Easy Setup Procedure

- 4 Press $\Delta \nabla$ to select “Calculate”, then press \triangleleft .
 - The speaker is analyzed.

- ※ Once the calculations are completed, a screen for confirming the results of the measurements appears.
- ※ The amount of time required for the analysis depends on the number of speakers and the number of measuring points. The greater the number of speakers and measuring points, the longer the time required.

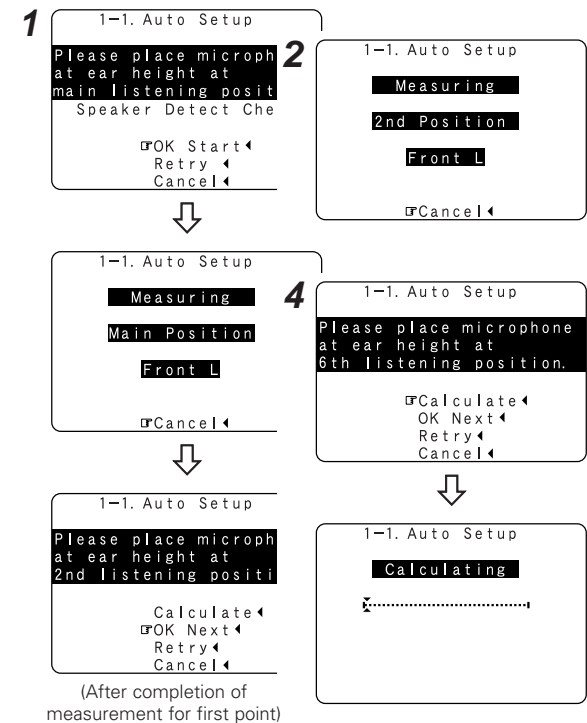

NOTE:

- Do not change the speaker connections or subwoofer volume after making the measurements.



- If the results are not as expected or if an error message is displayed, select “Retry” and perform the measurements again (page 12).
- If the results of remeasurement are still not as expected or if an error message is displayed, turn off the power switch and check the speaker connections. Then start the measurements again from the beginning.

Easy Setup Procedure

⑧ Checking and storing the measurement results

The measurement results displayed at “⑦ Speaker measurements” can be checked and stored in the memory.

1 Press Δ ∇ to select the item, then press ENTER.

※ Press **ENTER** to switch to the second screen.

2 After checking, press ENTER, then press Δ ∇ to set.

Store:
All the settings are stored in the memory.

Cancel:
Cancel the auto setup settings.

3 When “Store” is selected:

- Press \triangleleft .
- After the data is stored, the “Auto Setup / Room EQ” screen appears automatically.

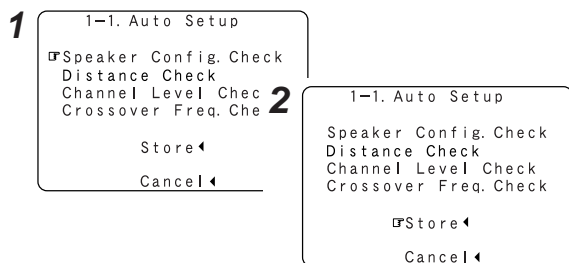

- When measurements have been made using the measurement microphone, speakers with a built-in filter such as subwoofers might be set with a value that differs from the physical distance because of the internal electrical delay.

NOTE:
• Do not turn off the power while the data is being stored.

Easy Setup Procedure

Error messages

An error message is displayed if the measurements could not be completed automatically due to the speaker layout, the measuring environment, etc. Please check the following matters, reset the pertinent items, and measure again. Be sure to turn off the AVR-2807's power before checking the speaker connections.

Example	Cause	Measures
	<p>① The speakers required for producing suitable reproduction have not been detected.</p> <p>※ If multiple errors occur, press \triangleleft \triangleright to check the contents.</p>	<ul style="list-style-type: none"> • Check that the pertinent speakers are properly connected.
	<p>② The speaker polarity is connected in reverse.</p> <p>※ If multiple errors occur, press \triangleleft \triangleright to check the contents.</p>	<ul style="list-style-type: none"> • Check the polarity of the pertinent speakers. • For some speakers, the screen below may be displayed even though the speakers are properly connected. If so, select “Skip\triangleleft”.
	<p>③ There is too much ambient noise in the room and the measurements cannot be made accurately.</p> <p>④ The sound level that is output from the speakers and/or subwoofer is too low.</p>	<ul style="list-style-type: none"> • Either turn off the power of the device that generated the noise during the measurements or move the device away. • Try again at a time when it is quieter. • Check the placement and orientation of the loudspeakers. • Adjust the subwoofer's output level.
	<p>⑤ The measurement microphone is not connected, or all of speakers have not been detected.</p>	<ul style="list-style-type: none"> • Connect the attached setup microphone to <SETUP MIC>. • Check the speaker connection.

Connecting Other Sources

Cable indications

The hookup diagrams on the subsequent pages assume the use of the following optional connection cables (not supplied).

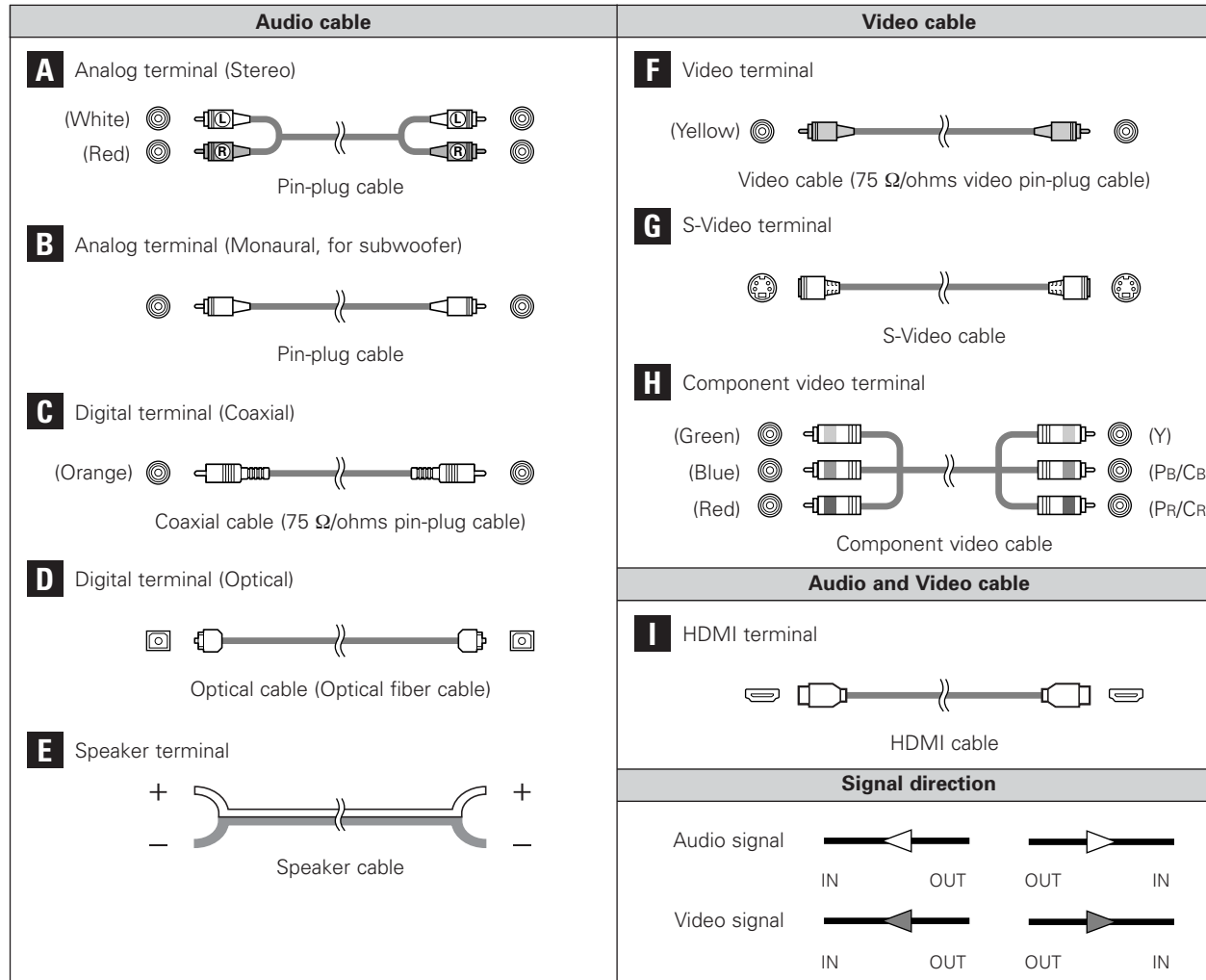

NOTE:

- Do not plug in the power supply cord until all connections have been completed.
- When making connections, also refer to the operating instructions of the other components.
- Be sure to connect the left and right channels properly (left with left, right with right).
- Do not bundle power cords together with speaker cables. Doing so could result in humming or noise.

Connecting Other Sources

The video conversion function

- Even if the formats of the video signals from the various players differ, the different formats can be converted and the signals output to the monitor from a single video output terminal. We recommend outputting with the format offering the highest quality video signals possible.
- With analog video signal connections, generally quality is higher in the order shown below.

The flow of the video signals.

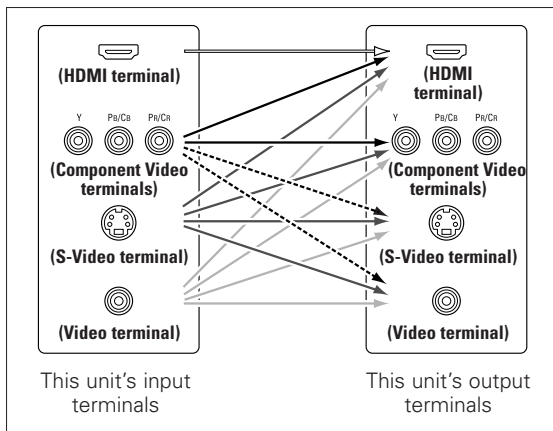

---: only MAIN ZONE 480i/576i

Connecting Other Sources

Relationship between the video input signal and monitor output according to the video convert settings

Video convert	Input signals				MONITOR OUT			
	HDMI	COMPONENT	S-VIDEO	VIDEO	HDMI	COMPONENT	S-VIDEO	VIDEO
ON	X	X	X	X	X	X	X	X
	X	X	X	O	VIDEO	VIDEO	VIDEO	VIDEO
	X	X	O	X	S-VIDEO	S-VIDEO	S-VIDEO	S-VIDEO
	X	X	O	O	S-VIDEO	S-VIDEO	S-VIDEO	S-VIDEO
	X	O (1080p)	X	X	X	COMPONENT	X	X
	X	O (480p ~ 720p)	X	X	COMPONENT	COMPONENT	X	X
	X	O (480i/576i)	X	X	COMPONENT	COMPONENT	COMPONENT	COMPONENT
	X	O (1080p)	X	O	VIDEO	COMPONENT *1	VIDEO	VIDEO
	X	O (480p ~ 720p)	X	O	COMPONENT *1	COMPONENT *1	X *3	VIDEO
	X	O (480i/576i)	X	O	COMPONENT *1	COMPONENT *1	COMPONENT	VIDEO
	X	O (1080p)	O	X	S-VIDEO	COMPONENT *2	S-VIDEO	S-VIDEO
	X	O (480p ~ 720p)	O	X	COMPONENT *2	COMPONENT *2	S-VIDEO	S-VIDEO
	X	O (480i/576i)	O	X	COMPONENT *2	COMPONENT *2	S-VIDEO	S-VIDEO
	X	O (1080p)	O	O	S-VIDEO	COMPONENT *2	S-VIDEO	S-VIDEO
	X	O (480p ~ 720p)	O	O	COMPONENT *2	COMPONENT *2	S-VIDEO	S-VIDEO
	X	O (480i/576i)	O	O	COMPONENT *2	COMPONENT *2	S-VIDEO	S-VIDEO
	O	X	X	X	HDMI	X	X	X
	O	X	X	O	HDMI *1	VIDEO	VIDEO	VIDEO
	O	X	O	X	HDMI *2	S-VIDEO	S-VIDEO	S-VIDEO
	O	X	O	O	HDMI *2	S-VIDEO	S-VIDEO	S-VIDEO
	O	O (Other than 480i/576i)	X	X	HDMI	COMPONENT	X	X
	O	O (480i/576i)	X	X	HDMI	COMPONENT	COMPONENT	COMPONENT
	O	O (1080p)	X	O	HDMI *1	COMPONENT *1	VIDEO	VIDEO
	O	O (480p ~ 720p)	X	O	HDMI *1	COMPONENT *1	X *3	VIDEO
	O	O (480i/576i)	X	O	HDMI *1	COMPONENT *1	COMPONENT	VIDEO
	O	O (Other than 480i/576i)	O	X	HDMI *2	COMPONENT *2	S-VIDEO	S-VIDEO
	O	O (480i/576i)	O	X	HDMI *2	COMPONENT *2	S-VIDEO	S-VIDEO
	O	O (Other than 480i/576i)	O	O	HDMI *2	COMPONENT *2	S-VIDEO	S-VIDEO
	O	O (480i/576i)	O	O	HDMI *2	COMPONENT *2	S-VIDEO	S-VIDEO

O : Signal input
 X : No signal
 480p ~ 720p : 480p/576p/1080i/720p

X : Not output
 *1 : On screen display superimposed on video signal and output.
 *2 : On screen display superimposed on S-Video signal and output.
 *3 : Video signals are output when the "Analog to HDMI convert" is set to "OFF".
 COMPONENT : On screen display only displayed for **SYSTEM SETUP**, **SURROUND PARAMETER** and **ON SCREEN** buttons.
 HDMI : The on screen display is displayed when the "Analog to HDMI convert" is set to "ON".
 Video signals are not output when the "Analog to HDMI convert" is set to "OFF".



- The MAIN ZONE video conversion function is compatible with the following format: NTSC, PAL, SECAM, NTSC4.43, PAL-N, PAL-M and PAL-60.
- When SECAM signals of video input are up-converted, the signals are output in PAL format from the S-Video terminal.
- When the input signal is a component 480p, 576p, 1080i or 720p signal, the signal up-converted to HDMI is output with that resolution.
- When the input signal is a video, S-Video or component 480i or 576i signals, the signal up-converted to HDMI is output according to the setting made at "i/p Convert" under "HDMI Out Setup" (page 51).
- Signals up-converted to HDMI are output to the HDMI monitor with the resolution at which they are input. Note that resolutions of 1080p are not handled.

Connecting Other Sources

Video convert	S-VIDEO MONITOR OUT	Input signals				MONITOR OUT			
		HDMI	COMPONENT	S-VIDEO	VIDEO	HDMI	COMPONENT	S-VIDEO	VIDEO
OFF	–	×	×	×	×	×	×	×	×
	–	×	×	×	○	×	×	×	VIDEO
	–	×	×	○	×	×	×	S-VIDEO	×
	Used	×	×	○	○	×	×	S-VIDEO	VIDEO *2
	Not used	×	×	○	○	×	×	–	VIDEO
	–	×	○	×	×	×	COMPONENT	×	×
	–	×	○	×	○	×	COMPONENT *1	×	VIDEO
	–	×	○	○	×	×	COMPONENT *2	S-VIDEO	×
	Used	×	○	○	○	×	COMPONENT *2	S-VIDEO	VIDEO *2
	Not used	×	○	○	○	×	COMPONENT *1	–	VIDEO
	–	○	×	×	×	HDMI	×	×	×
	–	○	×	×	○	HDMI	×	×	VIDEO
	–	○	×	○	×	HDMI	×	S-VIDEO	×
	Used	○	×	○	○	HDMI	×	S-VIDEO	VIDEO *2
	Not used	○	×	○	○	HDMI	×	–	VIDEO
	–	○	○	×	×	HDMI	COMPONENT	×	×
	–	○	○	×	○	HDMI	COMPONENT *1	×	VIDEO
	–	○	○	○	×	HDMI	COMPONENT *2	S-VIDEO	×
	Used	○	○	○	○	HDMI	COMPONENT *2	S-VIDEO	VIDEO *2
	Not used	○	○	○	○	HDMI	COMPONENT *1	–	VIDEO

○ : Signal input
 × : No signal

× : Not output
 *1 : On screen display superimposed on video signal and output.
 *2 : On screen display superimposed on S-Video signal and output.
 COMPONENT : On screen display only displayed for **SYSTEM SETUP**, **SURROUND PARAMETER** and **ON SCREEN** buttons.
 HDMI : The on screen display is displayed when the "Analog to HDMI convert" is set to "ON".

Connecting Other Sources

The analog video to HDMI conversion function

- The AVR-2807's video up-conversion function lets you output analog video input signals (component – 480i/576i, 480p/576p, 1080i or 720p; S-Video and composite video – 480i/576i) to the HDMI monitor output terminal.
- On the AVR-2807, it is possible to convert 480i/576i component video, S-Video and composite video input signals to 480p/576p format and output them from the HDMI monitor output terminal.



- The resolutions with which the monitor is compatible can be checked using the **STATUS** button on the main unit or the **ON SCREEN** button on the remote control unit.
- It is not possible to down-convert from HDMI input signals to the component, S-Video or composite video monitor output terminals.
- If you do not want to use the function for converting analog video signals to HDMI signals, select "OFF" for "Analog to HDMI Convert" at "Setting the HDMI Out Setup" (page 51).
- Video down conversion to the MAIN ZONE's monitor output is only possible when the component video input resolution is 480i (interlaced standard definition video – NTSC format, for North America) or 576i (interlaced standard definition video – PAL format, for Europe and other countries).
- To set the video conversion function for the MAIN ZONE to "OFF" (page 50).

On screen display for component video outputs and HDMI output

- When viewing component video signals or HDMI signals via the AVR-2807, the on screen display is displayed on the monitor when the "System Setup" operations are performed and when the remote control unit's **ON SCREEN** button is operated.
- When only component video signals are input to the AVR-2807, the characters of the on screen display are not displayed over the picture.

Connecting Other Sources

Connecting equipment with HDMI terminals
[To convert analog video signals to HDMI signals]

- The AVR-2807 is equipped with a function for converting analog video signals into HDMI signals. You can do this by either a component or a video or a S-Video connection.
- Audio signals are not output from the HDMI monitor output terminal, so also make analog or digital audio connections. To play sound using digital audio connections, assign the digital terminal (coaxial or optical) at "Setting the Digital In Assignment" (🔧 page 47).

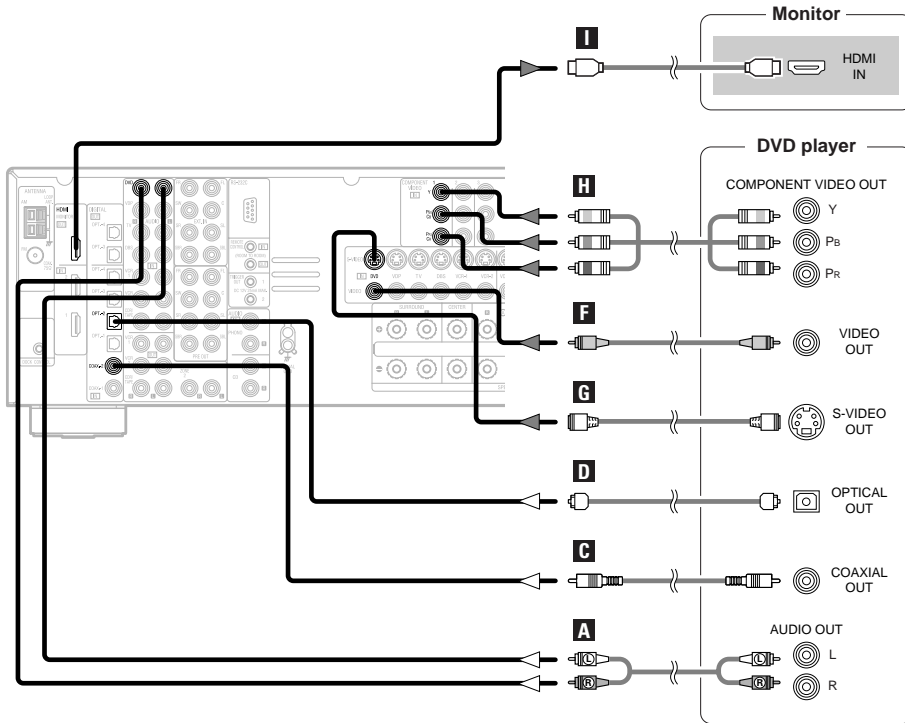

- When "OFF" is set at "i/p Convert" under "Setting the HDMI Out Setup", use a monitor compatible with input resolutions of 480i/576i.
- If your monitor is not equipped with an HDMI terminal, connect the AVR-2807 to the monitor using the component video, S-Video, or composite video terminals.

Connecting Other Sources

Connecting a TV tuner

- For best picture quality choose the component video connection to your TV tuner. S-Video and composite video outputs are also provided if your TV tuner does not have component video inputs.
- To connect the digital audio output from the TV tuner, you can choose from either the coaxial or the optical connections. If you choose to use the coaxial or the optical connection, it needs to be assigned. For more information about Digital Input Assignment (🔧 page 47).

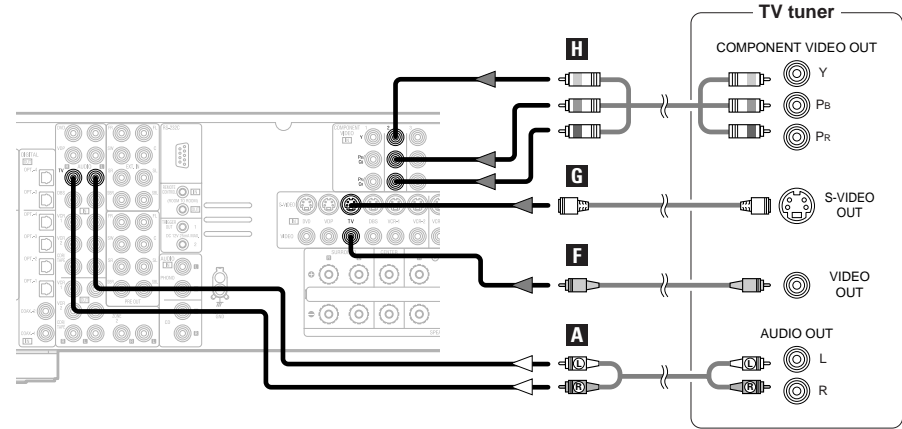

Connecting a DBS tuner

- For best picture quality choose the component video connection to your DBS tuner. S-Video and composite video outputs are also provided.
- To connect the digital audio output from the DBS tuner, you can choose from either the coaxial or optical connections. If you choose to use the coaxial connection, it needs to be assigned. For more information about Digital Input Assignment (🔧 page 47).

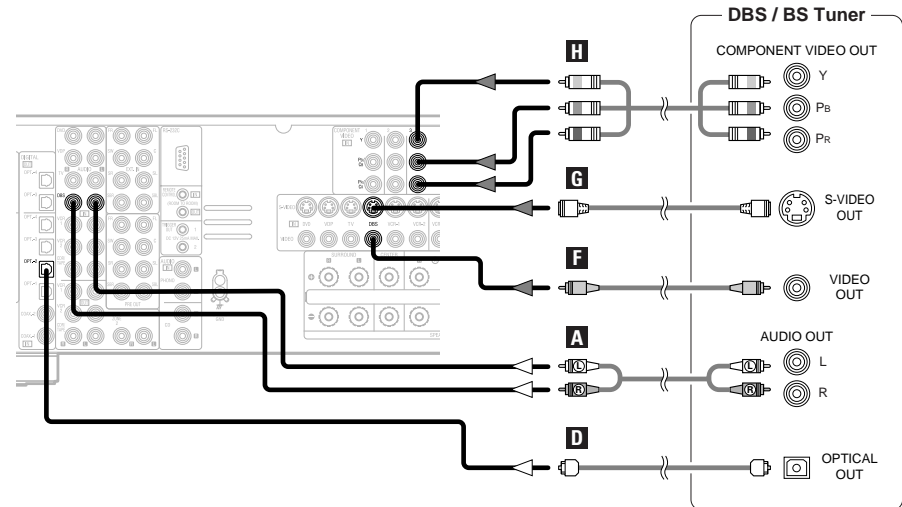

Connecting Other Sources

Connecting the external inputs (EXT. IN) terminals

- These terminals are for inputting multi-channel audio signals from an outboard decoder, or a component with a different type of multi-channel decoder, such as a DVD-Audio player, or a multi-channel Super Audio CD player, or other future multi-channel sound format decoder.
- The video signal connection is the same as that for a DVD player (page 8).
- For instructions on playback using the external input (EXT. IN) terminals (page 23).

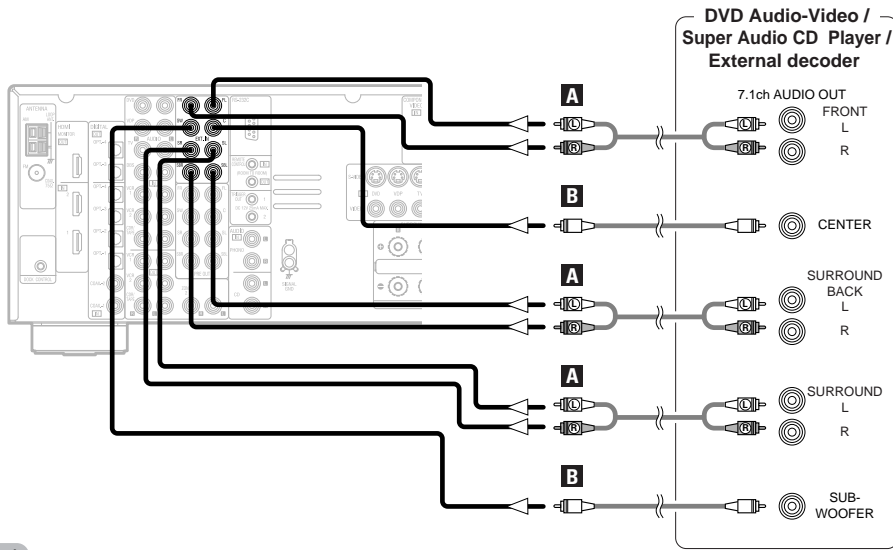

- With discs on which special copyright protection measures have been taken, however, the digital signals may not be output from the DVD player. In this case, connect the DVD player's analog multi-channel output to the AVR-2807's EXT. IN terminals for playback. Also refer to your DVD player's operating instructions.

Connecting a video camera or video game

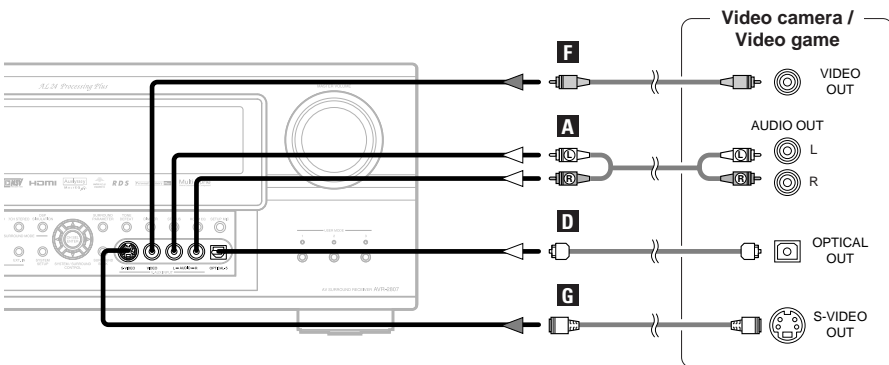

Connecting Other Sources

Connecting a CD player

To connect the digital audio output from the CD player, you can choose from either the coaxial or optical connections. If you choose to use the optical connection, it needs to be assigned. For more information about Digital Input Assignment (page 47).

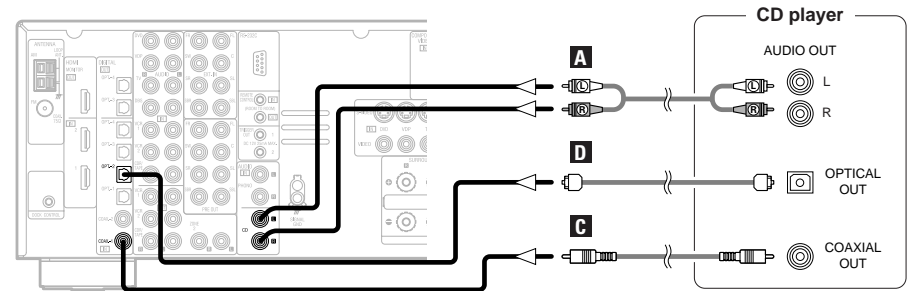

Connecting a turntable

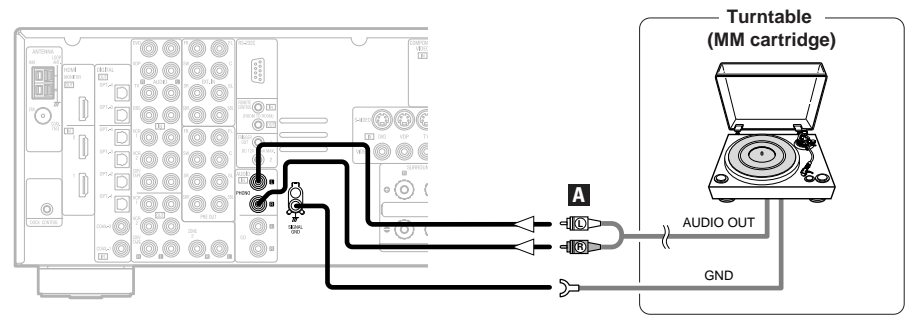

- The phono input can accept signals from moving magnet (MM) and high output moving coil (MC) phono cartridges. If your turntable is equipped with a low output MC cartridge, you will need to use a separate MC head amplifier or step-up MC transformer.

NOTE:

- If humming or other noise is generated when the ground wire is connected to the SIGNAL GND terminal, disconnect the ground wire.

Connecting Other Sources

Connecting a DVD recorder

- For best picture quality choose the component video connection to your DVD recorder. S-Video and composite video outputs are also provided. If you choose to use the component video connection, it needs to be assigned. For more information about Component Input Assignment (page 50).
- If you wish to perform analog dubbing from a digital sources, such as a DVD recorder to an analog recorder such as a cassette deck, you will need to connect the analog inputs and outputs as shown below, in addition to the digital audio connections.

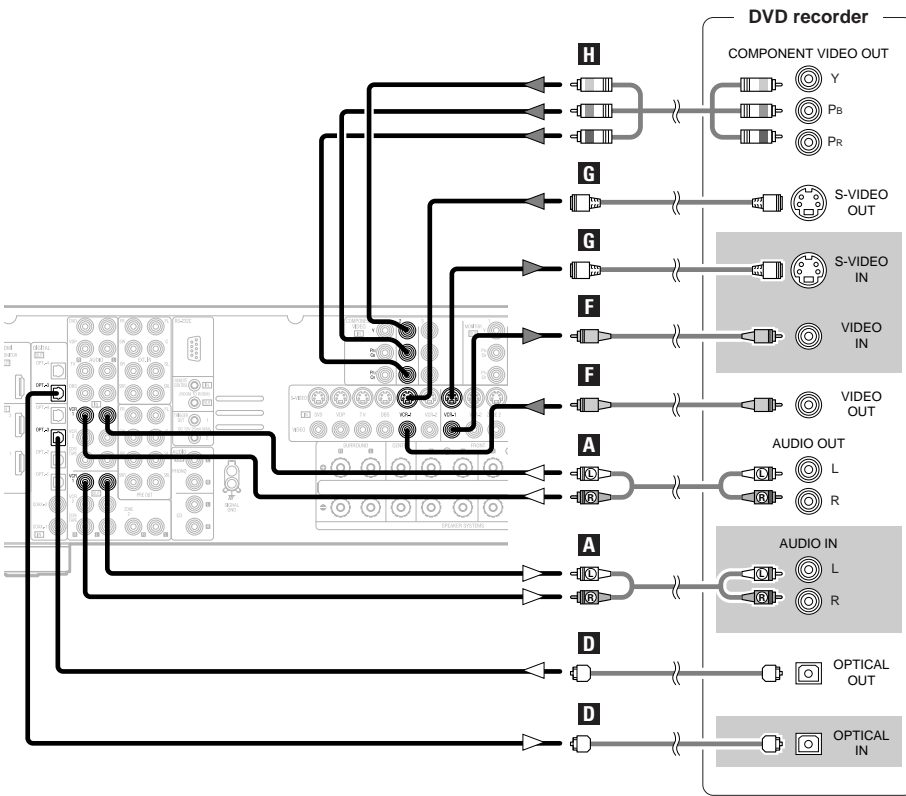

- When recording to a DVD recorder, it is necessary that the type of cable used with the playback source equipment be the same type that is connected to the AVR-2807 VCR-1 (to 2) OUTPUT terminal.
Example: VCR-1 IN → S-Video cable : VCR-1 OUT → S-Video cable
 VCR-1 IN → Video cable : VCR-1 OUT → Video cable

NOTE:
 • Do not connect the output of the component connected to the OPTICAL 3 OUT terminal on the AVR-2807's rear panel to any terminal other than the OPTICAL 3 IN terminal.

Connecting Other Sources

Connecting a VCR

There are 2 sets of video deck (VCR) terminals, so 2 video decks can be connected for simultaneous recording or video copying.

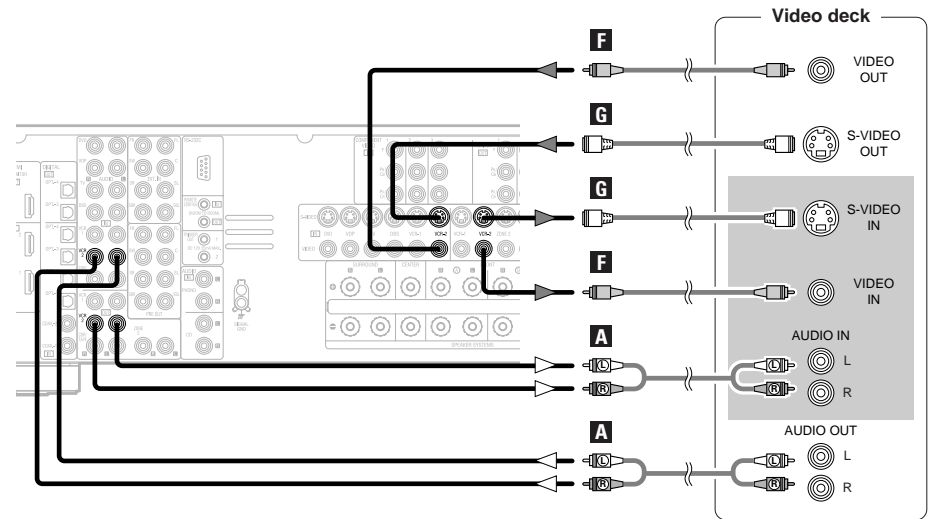

- When recording to a VCR, it is necessary that the type of cable used with the playback source equipment be the same type that is connected to the AVR-2807 VCR-1 (to 2) OUTPUT terminal.
Example: VCR-2 IN → S-Video cable : VCR-2 OUT → S-Video cable
 VCR-2 IN → Video cable : VCR-2 OUT → Video cable

Connecting a tape deck

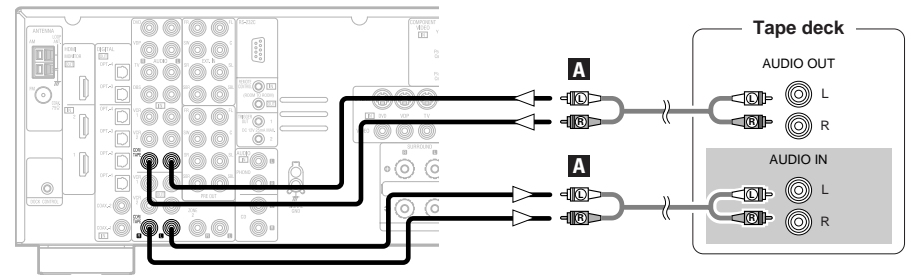

Connecting Other Sources

Connecting a CD recorder or MD recorder

If you wish to perform analog dubbing from a digital source, such as a CD or MD recorder to an analog recorder such as a cassette deck, you will need to connect the analog inputs and outputs as shown below, in addition to the digital audio connections.

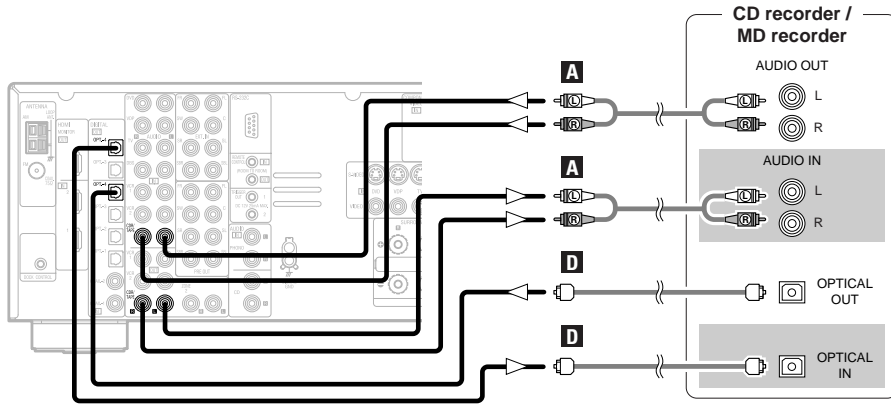

NOTE:

- Do not connect the output of the component connected to the OPTICAL 4 OUT terminal on the AVR-2807's rear panel to any terminal other than the OPTICAL 4 IN terminal.

Connecting equipment with HDMI terminals

- A simple 1-cable connection (using a commercially available cable) with a device having an HDMI (High-Definition Multimedia Interface) terminal allows digital transfer of the digital images of DVD-Video and other sources, and the multi-channel sound of DVD-Audio and DVD-Video.
- To provide audio output from AVR-2807's audio output terminal, select "Amp" at the "HDMI In Assign".
- To provide audio output from the TV, select "TV" at the "HDMI In Assign" (page 49, 50).

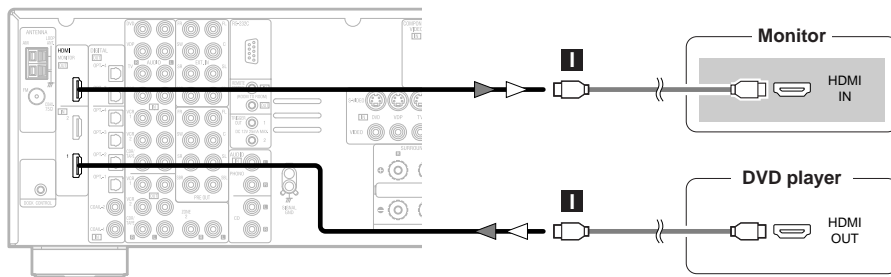

Connecting Other Sources

Copyright Protection System

To play back the digital video and audio of DVD-Video and DVD-Audio through an HDMI/DVI-D connection, both the connected player and monitor are required to support a copyright protection system called HDCP (High-bandwidth Digital Content Protection System). HDCP is copy protection technology that comprises data encryption and authentication of the partner equipment. The AVR-2807 supports HDCP. Please see the user's manual of your video display for more information about this.

Input signals		
DVD-Video	LINEAR PCM	○
	Dolby Digital	○
	DTS	○
DVD-Audio	LINEAR PCM PACKED PCM (with CPPM / without CPPM)	○
CD	LINEAR PCM	○
Super Audio CD	Multi area	×
	Stereo area	×
	CD area	○

* The AVR-2807 is HDMI Ver. 1.1 compatible.



- If your digital monitor or DVD player only supports DVI-D, please obtain and use an HDMI-DVI conversion cable or adaptor, available from your dealer.

NOTE:

- The audio signals on the multi/stereo area of Super Audio CDs are not output. If the Super Audio CD is a hybrid CD, only the audio signals in the CD area are output.
- Use a compatible player to play DVD-Audio discs that are copyright protected by CPPM.
- Among the devices that support HDMI, some devices can control other devices via the HDMI terminal; however, the AVR-2807 cannot be controlled by another device via the HDMI terminal.
- The audio signals from the HDMI terminal (including the sampling frequency and bit length) may be limited by the equipment that is connected.
- The video signals are not output properly if a device not compatible with HDCP is used.
- When "OFF" is set at "i/p Convert" under "Setting the HDMI Out Setup", use a monitor compatible with input resolutions of 480i/576i.
- The video signals input from the HDMI input terminals are output to the HDMI monitor with their original resolution, so the image will not be displayed if the resolutions of the input signal and the monitor being used are not matched. In this case, change the setting of the resolution on the source device (player) to one which the monitor can handle.
- For stable signal transfer, we recommend using cables that are a maximum of 5 meters in length.

Connections with an HDMI/DVI-D conversion cable (adapter)

- The HDMI video stream signals (video signals) are theoretically compatible with DVI-D. When connecting to a monitor, etc., equipped with DVI-D terminals, it is possible to connect using an HDMI/DVI-D conversion cable, but depending on the combination of devices used the image might not be output.
- When using an HDMI/DVI-D conversion adapter, the image may not be output properly due to poor contact with the connected cable, etc..

Connecting Other Sources

Connecting the antenna terminals

An FM antenna cable plug can be connected directly.

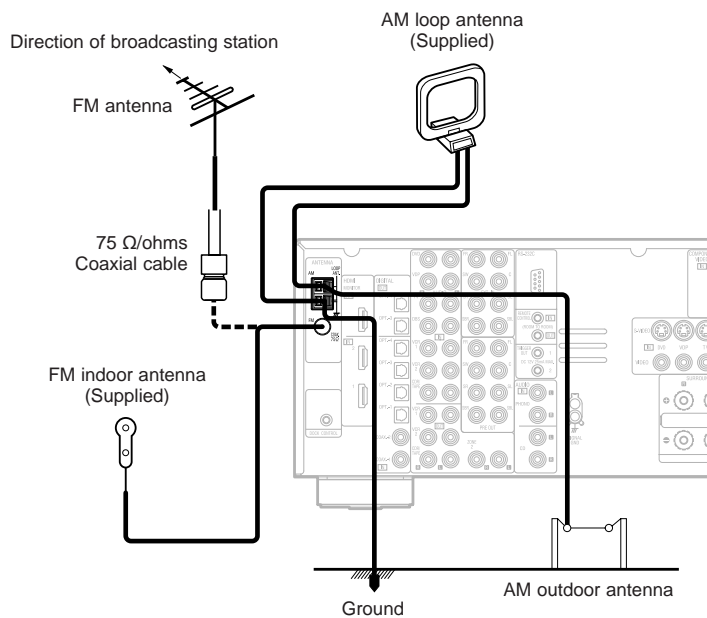

AM loop antenna assembly

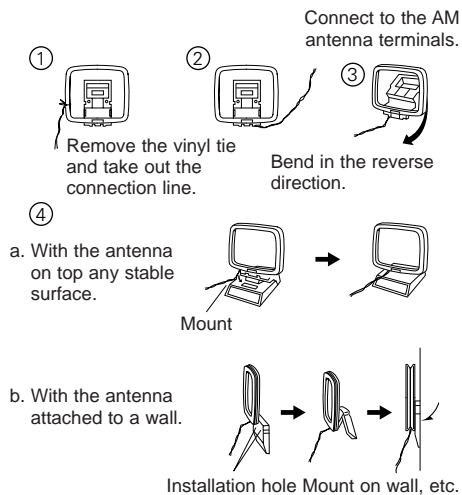

Connection of AM antennas

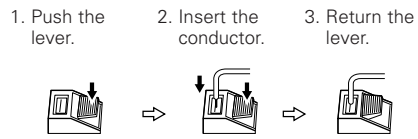

NOTE:

- Do not connect 2 FM antennas simultaneously.
- Even if an external AM antenna is used, do not disconnect the AM loop antenna.
- Make sure the AM loop antenna lead terminals do not touch metal parts of the panel.

Connecting Other Sources

Connecting the iPod®

When using an iPod, you must connect the DENON original iPod Dock and the DOCK CONTROL jack on the AVR-2807 with a mini-jack and assign the iPod to any AUDIO and/or S-VIDEO terminal(s).

The diagram below shows an example of connections for when the iPod is assigned to the VDP terminal.

- ※ For instructions on assigning the iPod to a specific terminal, see "Setting the iPod Assignment" (page 47).
- ※ For instructions on playing the iPod, see "Playing the iPod" (page 39).

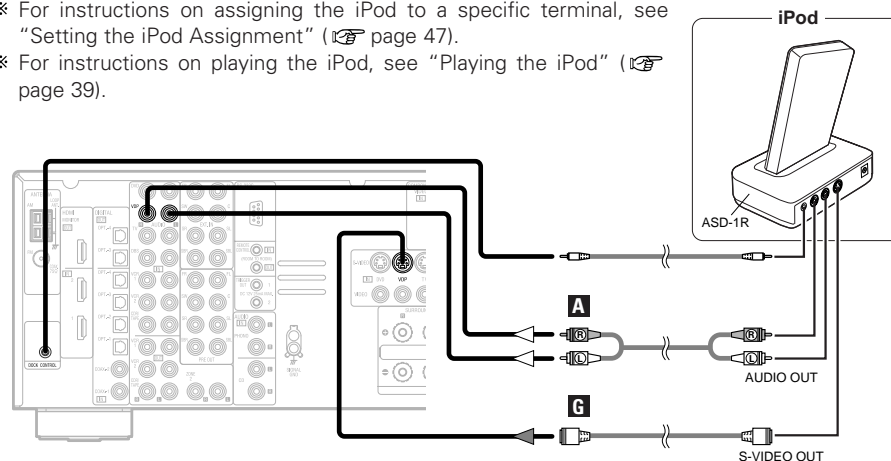

- The optional standard iPod Dock is DENON ASD-1R sold separately.

Connecting the RS-232C terminal

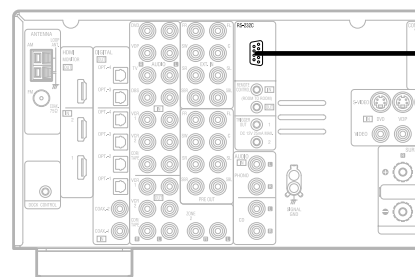

This is a control expansion terminal for factory use only. Consult your dealer for details.

Perform the following operation before using an external controller connected to the RS-232C terminal:

1. Press the **ON/STANDBY** button on the main unit and set the unit to the operating mode.
2. Perform the operation to turn off the power from the external control.
3. Check that the product has been set to the standby mode.

After checking the above, check the connections of the external controller. Operation is possible.

Connecting Other Sources

Connecting the TRIGGER OUT jacks

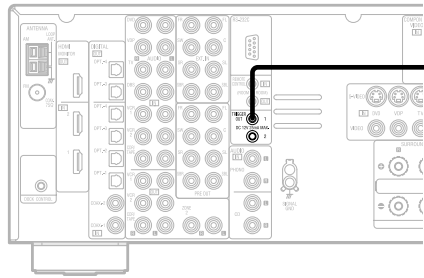

Turn the DC 12 V voltage on and off for the individual functions and surround modes. For details, see "Setting the Trigger Out" (page 55).

Connecting the MULTI ZONE terminals

※ For instructions on operations using the MULTI ZONE functions (page 40, 41).

ZONE2 out connections

- If another pre-main (integrated) amplifier is connected, the ZONE2 out (fixed level) terminals can be used to play a different program source in ZONE2 the same time (page 40).

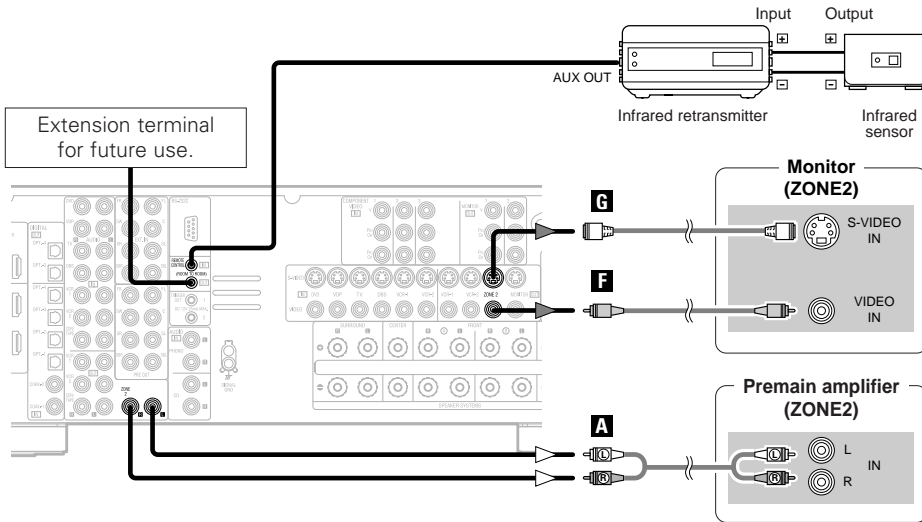

- For the AUDIO output, use high quality pin-plug cables and wire in such a way that there is no humming or noise.
- For instructions on installation and operation of separately sold devices, refer to the devices' operating instructions.

Connecting Other Sources

ZONE2 speaker out connections

- When the surround back's power amplifier is assigned to the ZONE2 output channel at "Power Amp Assign" in the "System Setup Menu", the surround back speaker terminals can be used as the ZONE2 speaker out terminals (page 54).
- The connections diagram below is an example for when the surround back speaker is assigned to the ZONE2 stereo 2 channel. In this case, surround back speaker out can not be used for MAIN ZONE.

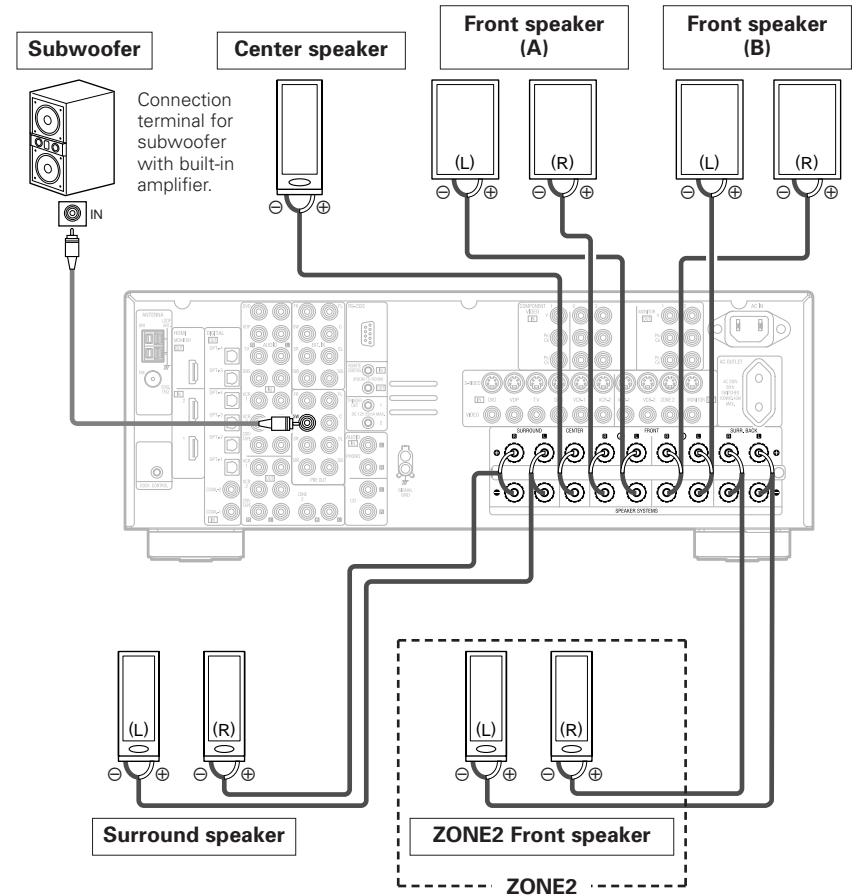

Connecting Other Sources

Connecting the PRE OUT terminals

- Use these terminals if you wish to connect external power amplifier(s) to increase the power of the front, center, surround and surround back sound channels, or for connection to powered loudspeakers.
- When using only one surround back speaker, connect it to the left channel.

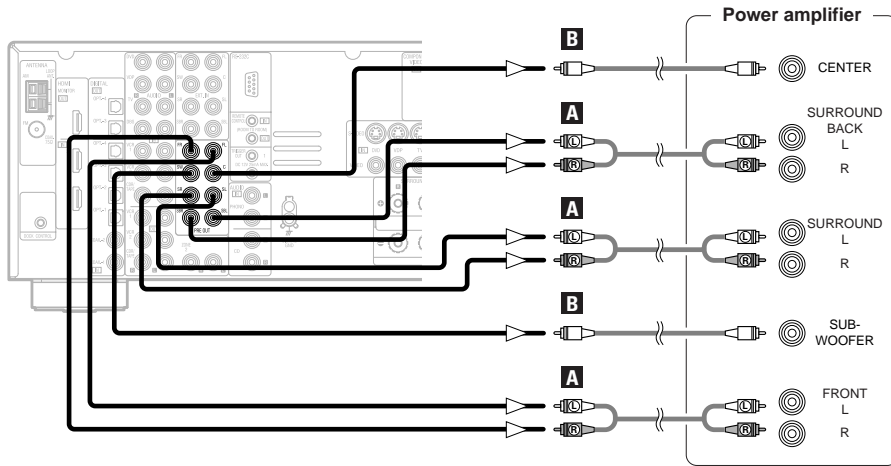

Connecting Other Sources

Connecting the power supply cord

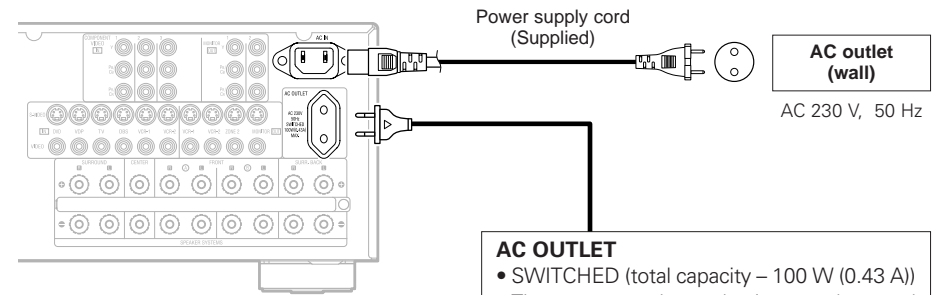

NOTE:

- Insert the plugs securely. Incomplete connections will result in the generation of noise.
- Only use the AC OUTLET for audio equipment. Never use it for hair driers, monitors or other electrical appliances.

AC OUTLET

- **SWITCHED** (total capacity – 100 W (0.43 A))
The power to the outlet is turned on and off in conjunction with the **POWER** switch on the main unit, and when the power is switched between on and standby from the remote control unit. No power is supplied from this outlet when this unit's power is at standby. Never connect equipment whose total power consumption exceeds 100 W (0.43 A).

Basic Operation

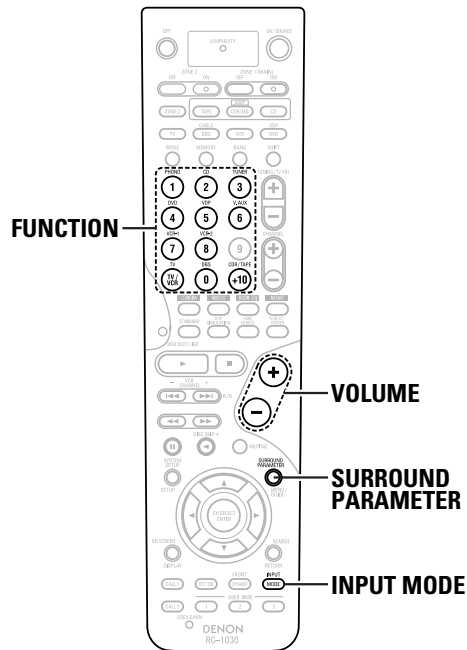
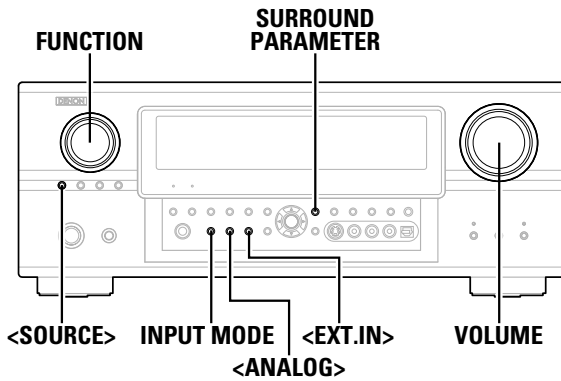

About the button names in this explanation
 < > : Buttons on the main unit
 [] : Buttons on the remote control unit
Button name only :
 Buttons on the main unit and remote control unit

Playing the input source

1 Use FUNCTION to select the input source you want to play.

※ To select the input source when ZONE2/REC SELECT, VIDEO SELECT or TUNING PRESET is selected, press <SOURCE> then operate <FUNCTION>.

2 Press INPUT MODE.

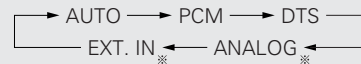

※ Press <ANALOG> to select "ANALOG", <EXT. IN> to select "EXT. IN".

AUTO (All auto mode):

The type of input signal is detected and the AVR-2807's surround mode is switched automatically. Can be selected for sources for which the "Digital In Assign" (page 47) is made.

The mode switches automatically to DTS/ Dolby Digital/ PCM. The input switches to the analog input terminals is no digital signals are being input.

PCM (exclusive PCM signal playback mode) and **DTS** (exclusive DTS signal playback mode):

Played when the various signals are input. Noise may be generated when a mode different from the input signal is set.

ANALOG (exclusive analog audio signal playback mode) and **EXT. IN** (External decoder input terminal selection mode):

The signals input to the various input terminals are played.

※ To lower the subwoofer channel level in the EXT. IN mode, press **SURROUND PARAMETER** and select "SW. ATT". For some players the playback level of the SW channel may be seen strong. If so, set to "ON".

3 Start playback on the selected component.

※ For operating instructions, refer to the component's manual.

4 Use VOLUME to adjust the volume.

- The volume level is displayed on the master volume level display.

- ※ The volume can be adjusted between the range of -80 ~ 0 ~ 18 dB. Depending on the channel level settings and the different surround mode settings and when in the down-mix mode, it may not be possible to adjust the volume to 18 dB.



- Canceling the EXT. IN mode:
Press **INPUT MODE** or <ANALOG> to switch to the desired input mode.
- To use the EXT. IN mode together with a picture, select the input source to which the video signal is connected first, then set the input mode.
- The "DIG." indicator lights when digital signals are being input properly. If the "DIG." indicator does not light, check whether the "Digital In Assign" (page 47) and connections are correct.

NOTE:

- When the input mode is set to the external input (EXT. IN), the surround mode cannot be set.
- In play modes other than the external input mode, the signals connected to these terminals cannot be played.

Cautions when playing DTS sources:

- For DTS sources, be sure to connect the device to the digital input terminal and set "AUTO" or "DTS" for the input source. Noise will be generated if you play in the ANALOG or PCM mode.
- When playing DTS signals in the "AUTO" mode, noise may be generated when you first start playing and during searching. If so, play in the "DTS" mode.

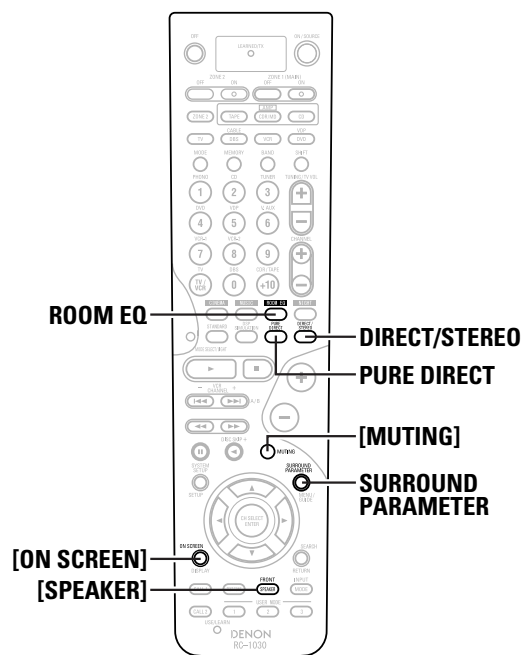
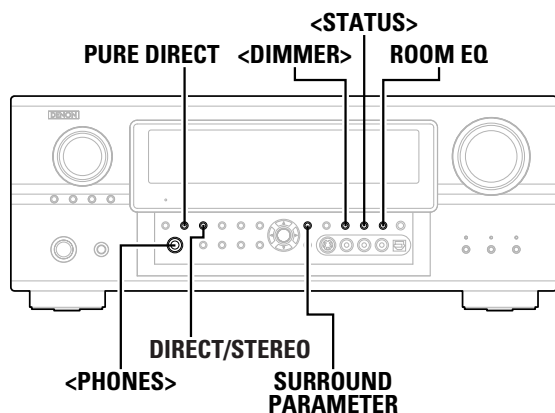

About the button names in this explanation
 < > : Buttons on the main unit
 [] : Buttons on the remote control unit
Button name only :
 Buttons on the main unit and remote control unit

Selecting the room equalizer mode

The room equalizer function offers 3 correction curves: "Audyssey", "Front" and "Flat". These modes can be selected after performing the auto setup procedure.

Press ROOM EQ.



- The "MultEQ XT" indicator lights green when "Audyssey" is selected, red when "Front" or "Flat" is selected.

※ The indicator lights red if the speaker settings are changed after the auto setup measurements have been made (🔧 page 56 ~ 59).

Audyssey, Front, Flat:

See page 60.

Manual:

Selects the setting value that was set in the Manual Equalizer Setup (🔧 page 53, 54).

Turning the sound off temporarily (MUTING)

Press [MUTING].

※ You can adjust the muting level (🔧 page 55).



- Canceling MUTING mode:
To cancel the muting mode, either press [MUTING] or adjust the volume.

Listening over headphones

Connect the headphones to <PHONES>.

- No sound is produced from the speakers automatically.

NOTE:

- To prevent hearing loss, be careful not to raise the volume level excessively when using headphones.

Switching the front speakers

Press [SPEAKER].

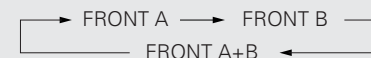

Checking the currently playing program source, etc.

■ **On screen display**

Press [ON SCREEN].

- The current program source and various settings are displayed on the monitor screen.

■ **Front panel display**

Press <STATUS>.

- The current program source and various settings are indicated on the display.

Switching the brightness of the display

Press <DIMMER>.

※ The brightness of the display can be adjusted in 3 steps. The display can also be turned off.

Basic Operation

Using the surround modes

Types of surround modes and their features

The AVR-2807 is equipped with many surround modes. We recommend using the surround modes as described below in order to achieve the maximum effect for the specific signal source.

*  is a 6.1-channel/7.1-channel surround mode.

Sources recorded in Dolby Digital EX

DOLBY DIGITAL EX / +PLIIx* (page 26)
 • This mode is optimized for playing sources recorded in Dolby Digital EX.

Sources recorded in DTS-ES

DTS-ES DSCRT 6.1 / MTRX 6.1, +PLIIx* (page 26)
 • This is the optimum mode for playing sources recorded in DTS-ES.

Dolby Digital or DTS Surround (5.1 ch sources)
 2 ch sources recorded in Dolby Surround

WIDE SCREEN (page 32, 33)
 • Effective for 2-channel sources recorded in Dolby Surround or for 7.1-channel playback with 5.1-channel sources.

DOLBY DIGITAL / DOLBY DIGITAL+PLIIx* / DTS SURROUND / DTS 96/24 / DTS+PLIIx* / DTS+NEO:6 (page 26)
 • This mode is optimized for playing 5.1-channel or 7.1-channel music.
 • For Dolby Surround recording sources, Dolby Pro LogicII playback is conducted.

Sources recorded in stereo
 Sources recorded in monaural

PURE DIRECT
 • Use this mode to play analog input music sources with extremely high quality.

DIRECT / STEREO
 • Effective for achieving pure playback.
 • If there is no need for tone control or distribution of the low frequencies in function of the speaker configuration, select the DIRECT mode to achieve the best sound quality.

DENON Original Surround Modes (page 32, 33)
 • Select these for 7.1-channel playback with sources recorded in stereo or monaural.
 • The effects are different for each of the surround modes. Select the one most suited for the source being used.

DTS NEO:6 (page 28)
 • This is a surround mode for playing 6.1- or 7.1-channel stereo sources developed by Digital Theater Systems.
 • One of 2 playing modes, MUSIC (for music sources) or CINEMA (for movie sources), can be selected according to your preferences.

DOLBY PRO LOGICIIx* (page 27)
 • Developed by Dolby Laboratories, this surround mode provides 7.1-channel surround sound with conventional stereo (2-channel) sources.
 • Select CINEMA mode for movie surround soundtracks, MUSIC for music sources, and GAME for 2-channel game box audio sources.



- Surround modes marked with an asterisk (*) cannot be used when the surround back speaker is set to "NONE".
- The "+PLIIx Cinema" mode cannot be selected when only one surround back speaker is being used.

Basic Operation

Selecting the play mode
 (PURE DIRECT / DIRECT / STEREO)

The AVR-2807 is equipped with 3 2-channel playback modes exclusively for music. Select the mode to suit your tastes.

PURE DIRECT mode

This mode reproduces the sound with extremely high quality. The audio signals do not pass through the tone circuits, etc., and the display and surrounding circuits that could affect the audio signals are turned "OFF".

Press **PURE DIRECT**.

DIRECT mode

This mode is for playing with high quality sound. The audio signals are transmitted directly, without passing through the tone circuits, etc.

Press **DIRECT/STEREO** to select "DIRECT".

DIRECT ←→ STEREO

* When press **SURROUND PARAMETER**:
 The subwoofer output can be controlled directly.

STEREO mode

Use this mode to adjust the tone and achieve the desired sound.

Press **DIRECT/STEREO** to select "STEREO".



- The system setup function cannot be used when the PURE DIRECT mode is set. To use the system setup function, cancel the PURE DIRECT mode.
- If the HDMI input terminal is selected, video outputs are output in the PURE DIRECT mode.
- The channel level and surround parameters in the PURE DIRECT mode are the same as in the DIRECT mode.

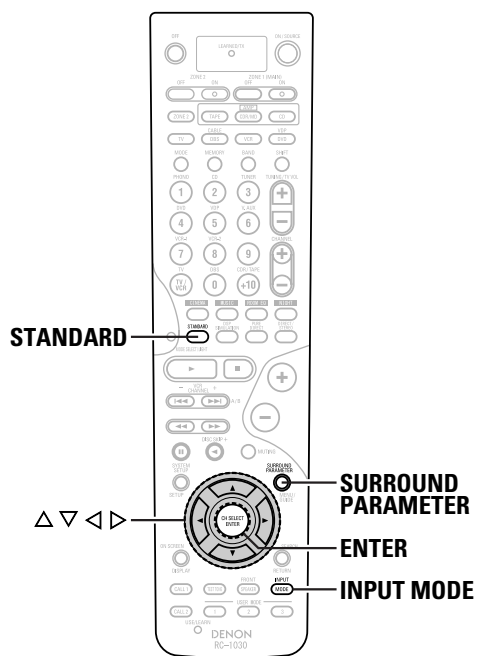
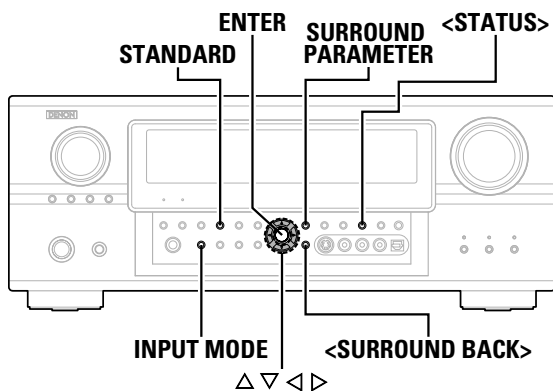

About the button names in this explanation

- < > : Buttons on the main unit
- [] : Buttons on the remote control unit

Button name only :

Buttons on the main unit and remote control unit

Selecting the Dolby Digital and DTS Surround mode (only with digital input)

- 1** Select an input source for which digital (COAXIAL, OPTICAL etc.) is set (☞ page 47 or 49 ~ 50).
- 2** Press **INPUT MODE** to select "AUTO".
- 3** Press **STANDARD** to select "STANDARD".
- 4** Play a program source with the mark.
 * " DIGITAL " or " " lights, depending on the source.
- 5** Press **SURROUND PARAMETER**.
 * The surround back channel can be switched on and off using **<SURROUND BACK>**.
- 6** Press $\Delta \nabla$ to select the item, then press $\triangleleft \triangleright$ to set.

CINEMA EQ.:

Use this if movie dialogues sound harsh to lower the treble sound.

- * Effective source / mode
 Dolby Pro LogicIIx / Dolby Pro Logic / Dolby Digital / DTS Surround / DTS NEO:6 / WIDE SCREEN

D.COMP.:

The dynamic range is compressed. Select one of 4 modes: "OFF", "LOW", "MID" (middle) or "HI" (high).

- * Effective source / mode
 Dolby Digital / DTS (For DTS sources, only displayed for compatible software.)

LFE:

To play the various types of software properly, we recommend setting to the values shown below.

- To play Dolby Digital software: "0 dB"
- To play DTS movie software: "0 dB"
- To play DTS music software: "-10 dB"

TOPE:

Adjust the tone control.

- * Can be set in surround modes other than direct mode.
- * Can be set separately for the different surround modes. (Adjusted together for the Dolby/DTS SURROUND modes.)

SB CH OUT:

Select the play mode or surround back channel playback method.

(1) For multi-channel sources

- **SB OFF (OFF):**
Not played.
- **NON MTRX:**
Surround channel signal played.
- **MTRX ON:**
Surround channel signal played with digital matrix processing.
- **ES MTRX:**
DTS signal played with digital matrix processing.
- **ES DSCRT:**
Signal included in DTS-ES discrete 6.1-channel sources played.
- **PLIIx CINEMA:**
Decoded in Dolby Pro LogicIIx Cinema mode, surround back signal played.
 * Set the surround back speaker to "2spkr" at "Speaker Configuration" (☞ page 56, 57)

• **PLIIx MUSIC:**

Decoded in Dolby Pro LogicIIx Music mode, surround back signal played.
 * Set the surround back speaker to "1spkr" or "2spkr" at "Speaker Configuration" (☞ page 56, 57)

(2) For 2-channel sources

- **OFF:** Not played.
- **ON:** Surround channel signal played.
- * Can also be operated using **<SURROUND BACK>**.

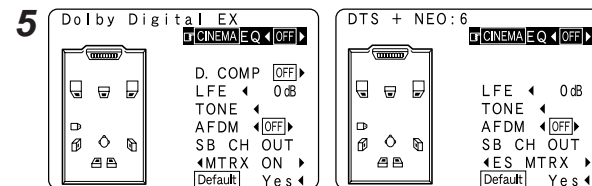

Example: Dolby Digital

Example: DTS

Basic Operation

AFDM (Auto Flag Detect Mode):

• **ON:**

When software including Dolby Digital EX or DTS-ES 6.1-channel identification signals is played, 6.1-channel playback is performed automatically. The surround mode is set according to the program source being played. The "SB CH OUT" parameter on the surround parameters screen cannot be selected.

• **OFF:**

Not detected automatically. The surround mode can be selected freely.

Example: When playing Dolby Digital software (with EX flag)

- ① When "AFDM" is "ON", the "DOLBY DIGITAL + PLIIx CINEMA" mode is set automatically.
- ② To play in the Dolby Digital EX mode, set "AFDM" to "OFF" and select "MTRX ON" at "SB CH OUT".

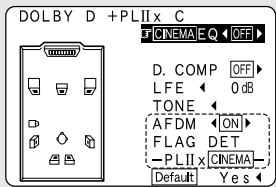

Example: ①

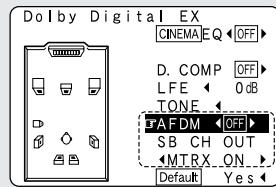

Example: ②

※ Some discs recorded in Dolby Digital EX do not include EX flag. If the playing mode does not switch automatically when the AFDM turns "ON" during playback, manually set "SB CH OUT" to "PLIIx Cinema" or "MTRX ON".

7 Press ENTER or SURROUND PARAMETER.



- Select "Default Yes" and press < to reset all the settings.

Dialog normalization function

This operates automatically when playing Dolby Digital sources. This is a function for automatically correcting the standard signal level for different program sources. The correction value can be checked by pressing <STATUS>.

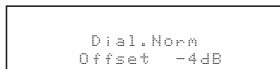

The numbers are the correction value when corrected to the standard level.

Selecting the Dolby Pro LogicIIx (Pro LogicII) mode

It is possible to play analog input signals and digital input signals (2-channels) in the surround mode.

This mode is optimal for playing program sources recorded in Dolby Surround.

1 Press STANDARD to select "DOLBY PLIIx".

DOLBY PLIIx ←→ DTS NEO:6

2 Play a program source.

3 Press SURROUND PARAMETER.

4 Press <> to select the play mode.

CINEMA:

This mode is suited for playing movie sources recorded in Dolby Surround and general sources recorded in stereo.

MUSIC:

This mode is suited for playing stereo music signals in the surround mode. With music signals, the sound field expansion differs according to the type of music, the recording conditions (live/studio), etc.. Because of this, the MUSIC mode offers a number of optional parameters for further adjusting the sound field.

GAME:

This mode is optimum for games. The GAME mode can only be used for 2-channel audio sources.

PL:

This mode is compatible with conventional Dolby Pro Logic sources.

- ※ Optional parameters can only be set in the MUSIC mode. Select "OPTIONS", then press <. Press ENTER to return to the previous screen.

Basic Operation

5 When "MUSIC" is selected: Press Δ ∇ to select the item, then press < > to set.

PANORAMA:

This is effective when the surround effect seems weak.

DIMENSION:

This shifts the center of the sound field image to the front or surround side. This compensates for when the sound field image seems unbalanced. (0 to 6, default : 3)

CENTER WIDTH:

A natural expansion to the front can be achieved by adjusting the center signal's output balance between the center and front channels. (0 to 7, default : 3)

6 Press ENTER or SURROUND PARAMETER.

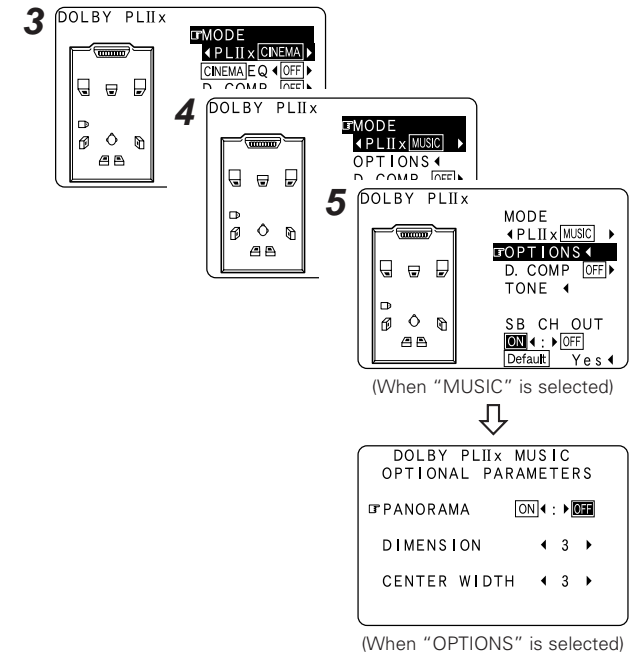

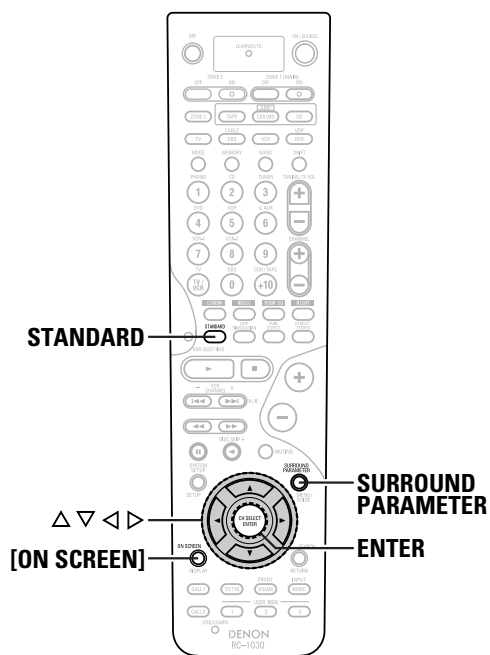
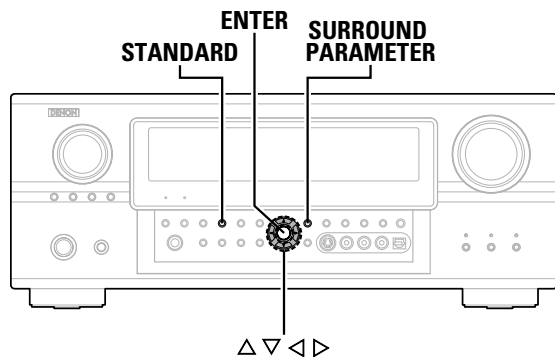

About the button names in this explanation

< > : Buttons on the main unit
 [] : Buttons on the remote control unit

Button name only :

Buttons on the main unit and remote control unit

Selecting the DTS NEO:6 mode

It is possible to play analog input signals and digital input signals (2-channels) in the surround mode.

1 Press **STANDARD** to select “DTS NEO:6”.

DOLBY PLIIx ← → DTS NEO:6

2 Play a program source.

3 Press **SURROUND PARAMETER**.

4 Press < > to select the play mode.

CINEMA:

This mode is optimum for playing movies. Decoding is performed with emphasis on separation performance to achieve the same atmosphere with 2-channel sources as with 6.1-channel sources.

MUSIC:

This mode is suited mainly for playing music.

5 When “MUSIC” is selected:
 Press $\Delta \nabla$ to select “CNTR. IMAGE”, then press < > to set.

CNTR. IMAGE:

The expansion of the center channel can be adjusted. (0.0 to 1.0, default : 0.3)

6 Press **ENTER** or **SURROUND PARAMETER**.

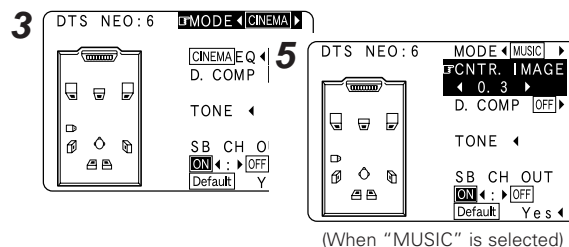

Checking the input signals

1 Press **[ON SCREEN]**.

Room EQ:

Displays the type of equalizer currently set.

SIGNAL:

Displays the type of input signal.

fs:

Displays the input signal’s sampling frequency.

FORMAT:

Displays the input signal’s number of channels (front / surround / LFE on/off).
 “SURROUND” is displayed for 2-channel signal sources recorded in Dolby Surround.

OFFSET:

Displays the dialog normalization offset value.

FLAG:

“MATRIX” is displayed if the input signal has undergone matrix processing, “DISCRETE” is displayed if the input signal has undergone discrete processing.

2 Press **[ON SCREEN]** again.

- **OSD-1** : Input signal
- **OSD-2** : HDMI monitor information
- **OSD-3** : Input/output settings
- **OSD-4** : Auto surround mode
- **OSD-5 ~ 7** : USER MODE 1 ~ 3
- **OSD-8 ~ 14** : Tuner preset stations

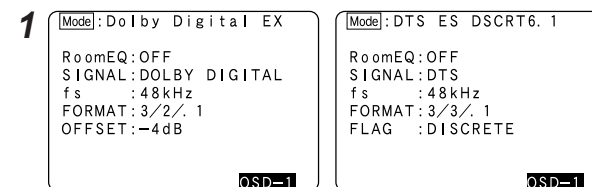

Example: Dolby Digital

Example: DTS



• “OSD-1” “FLAG” is not displayed if there is no FLAG identification signal in the input signal.

• OSD-2:

The monitor’s resolution is displayed when an HDMI monitor is connected to the AVR-2807.

• OSD-4:

This is displayed when the auto surround mode is set to “ON” (page 23) and the input mode is set to “AUTO”. It is not displayed when the input mode is set to “ANALOG” or “EXT. IN”.

Surround modes and parameters

Surround Mode	Signals and adjustability in the different modes																					
	Channel output					Parameter (default values are shown in parentheses)																
	FRONT L/R	CENTER	SURROUND L/R	SURROUND BACK L/R	SUB-WOOFER	D. COMP *1	LFE *2	AFDM *1	SB CH OUT	TONE CONTROL	CINEMA EQ.	MODE	ROOM SIZE	EFFECT LEVEL	Dolby Digital	DELAY TIME	SUBWOOFER ON/OFF	PRO LOGICII/IIx MUSIC MODE only			NEO:6 MUSIC MODE only	EXT. IN only
															NIGHT mode			PANORAMA	DIMENSION	CENTER WIDTH	CENTER IMAGE	SW ATT
PURE DIRECT, DIRECT	○	×	×	×	⊙	○ (OFF)	○ (0 dB)	×	×	×	×	×	×	○ (OFF)	×	○	×	×	×	×	×	×
MULTI CH DIRECT	○	⊙	⊙	⊙	⊙	×	○ (0 dB)	○ (ON)	○	×	×	×	×	×	×	×	×	×	×	×	×	×
STEREO	○	×	×	×	⊙	○ (OFF)	○ (0 dB)	×	×	○ (0 dB)	×	×	×	○ (OFF)	×	×	×	×	×	×	×	×
EXT. IN	○	⊙	⊙	⊙	⊙	×	×	×	×	×	×	×	×	×	×	×	×	×	×	×	×	○
MULTI CH IN	○	⊙	⊙	⊙	⊙	×	○ (0 dB)	○ (ON)	○	○ (0 dB)	×	×	×	×	×	×	×	×	×	×	×	×
WIDE SCREEN	○	⊙	⊙	⊙	⊙	○ (OFF)	○ (0 dB)	×	○	○ (0 dB)	○ (OFF)	×	○ (ON, 10)	○ (OFF)	×	×	×	×	×	×	×	×
DOLBY PRO LOGICIIx	○	⊙	⊙	⊙	⊙	○ (OFF)	×	×	○	○ (0 dB)	○ (NOTE3)	○ (CINEMA)	×	×	○ (OFF)	×	×	○ (OFF)	○ (3)	○ (3)	×	×
DOLBY PRO LOGICII	○	⊙	⊙	×	⊙	○ (OFF)	×	×	○	○ (0 dB)	○ (NOTE4)	○ (CINEMA)	×	×	○ (OFF)	×	×	○ (OFF)	○ (3)	○ (3)	×	×
DTS NEO:6	○	⊙	⊙	⊙	⊙	○ (OFF)	×	×	○	○ (0 dB)	○ (NOTE3)	○ (CINEMA)	×	×	○ (OFF)	×	×	×	×	×	○ (0.3)	×
DOLBY DIGITAL	○	⊙	⊙	⊙	⊙	○ (OFF)	○ (0 dB)	○ (ON)	○	○ (0 dB)	○ (OFF)	×	×	×	○ (OFF)	×	×	×	×	×	×	×
DTS SURROUND	○	⊙	⊙	⊙	⊙	○ (OFF)	○ (0 dB)	○ (ON)	○	○ (0 dB)	○ (OFF)	×	×	×	×	×	×	×	×	×	×	×
7CH STEREO	○	⊙	⊙	⊙	⊙	○ (OFF)	○ (0 dB)	×	○	○ (0 dB)	×	×	×	○ (OFF)	×	×	×	×	×	×	×	×
SUPER STADIUM	○	⊙	⊙	⊙	⊙	○ (OFF)	○ (0 dB)	×	○	○ (NOTE1)	×	×	○ (Medium)	○ (10)	○ (OFF)	×	×	×	×	×	×	×
ROCK ARENA	○	⊙	⊙	⊙	⊙	○ (OFF)	○ (0 dB)	×	○	○ (NOTE2)	×	×	○ (Medium)	○ (10)	○ (OFF)	×	×	×	×	×	×	×
JAZZ CLUB	○	⊙	⊙	⊙	⊙	○ (OFF)	○ (0 dB)	×	○	○ (0 dB)	×	×	○ (Medium)	○ (10)	○ (OFF)	×	×	×	×	×	×	×
CLASSIC CONCERT	○	⊙	⊙	⊙	⊙	○ (OFF)	○ (0 dB)	×	○	○ (0 dB)	×	×	○ (Medium)	○ (10)	○ (OFF)	×	×	×	×	×	×	×
MONO MOVIE	○	⊙	⊙	⊙	⊙	○ (OFF)	○ (0 dB)	×	○	○ (0 dB)	×	×	○ (Medium)	○ (10)	○ (OFF)	×	×	×	×	×	×	×
VIDEO GAME	○	⊙	⊙	⊙	⊙	○ (OFF)	○ (0 dB)	×	○	○ (0 dB)	×	×	○ (Medium)	○ (10)	○ (OFF)	×	×	×	×	×	×	×
MATRIX	○	⊙	⊙	⊙	⊙	○ (OFF)	○ (0 dB)	×	○	○ (0 dB)	×	×	×	×	○ (OFF)	○ (30 msec)	×	×	×	×	×	×
VIRTUAL	○	×	×	×	⊙	○ (OFF)	○ (0 dB)	×	×	○ (0 dB)	×	×	×	×	×	×	×	×	×	×	×	×

○ : Signal
 × : No signal
 ⊙ : Turned on or off by speaker configuration setting

○ : Adjustable
 × : Not adjustable
 NOTE1 : BASS +6 dB, TREBLE 0 dB
 NOTE2 : BASS +6 dB, TREBLE +4 dB
 NOTE3 : This parameter is available when the "MODE" is set to "CINEMA".
 NOTE4 : This parameter is available when the "MODE" is set to "CINEMA" or "PL".
 *1: When playing Dolby Digital and DTS signals.
 *2: When playing Dolby Digital, DTS, DVD-Audio and Super Audio CD.

○ : Signal
 × : No signal

○ : Adjustable
 × : Not adjustable

■ Differences in surround mode names depending on the input signals

Button	Surround Mode	Note	Input signals													
			ANALOG	LINEAR PCM	DTS				DOLBY DIGITAL					DVD-AUDIO		
					DTS ES DSCRT (With Flag)	DTS ES MTRX (With Flag)	DTS (5.1ch)	DTS 96/24	DOLBY DIGITAL EX (With Flag)	DOLBY DIGITAL EX (With no Flag)	DOLBY DIGITAL (5.1/5/4ch)	DOLBY DIGITAL (4/3ch)	DOLBY DIGITAL (2ch)	DVD-Audio (multi ch)	DVD-Audio (2ch)	176.4/192kHz
STANDARD																
DTS SURROUND																
	DTS ES DSCRT6.1	*1	×	×	● ◎	×	×	×	×	×	×	×	×	×	×	×
	DTS ES MTRX6.1	*1	×	×	×	● ◎	×	×	×	×	×	×	×	×	×	×
	DTS SURROUND		×	×	○	○	●	×	×	×	×	×	×	×	×	×
	DTS 96/24		×	×	×	×	×	●	×	×	×	×	×	×	×	×
	DTS + PLIIx CINEMA	*2	×	×	○	○	○	○	×	×	×	×	×	×	×	×
	DTS + PLIIx MUSIC	*1	×	×	○	○	○	○	×	×	×	×	×	×	×	×
	DTS + NEO:6	*1	×	×	×	○	○	○	×	×	×	×	×	×	×	×
	DTS NEO:6 CINEMA		○	○	×	×	×	×	×	×	×	×	○	×	○	×
	DTS NEO:6 MUSIC		○	○	×	×	×	×	×	×	×	×	○	×	○	×
DOLBY SURROUND																
	DOLBY DIGITAL EX	*1	×	×	×	×	×	×	○	○	○	×	×	×	×	×
	DOLBY DIGITAL		×	×	×	×	×	×	○	●	●	●	×	×	×	×
	DOLBY DIGITAL+PLIIx CINEMA	*2	×	×	×	×	×	×	● ◎	○	○	×	×	×	×	×
	DOLBY DIGITAL+PLIIx MUSIC	*1	×	×	×	×	×	×	○	○	○	×	×	×	×	×
	DOLBY PRO LOGICIIx CINEMA		○	○	×	×	×	×	×	×	×	×	●	×	○	×
	DOLBY PRO LOGICIIx MUSIC		○	○	×	×	×	×	×	×	×	×	○	×	○	×
	DOLBY PRO LOGICIIx GAME		○	○	×	×	×	×	×	×	×	×	○	×	○	×
	DOLBY PRO LOGICII CINEMA		○	○	×	×	×	×	×	×	×	×	○	×	○	×
	DOLBY PRO LOGICII MUSIC		○	○	×	×	×	×	×	×	×	×	○	×	○	×
	DOLBY PRO LOGICII GAME		○	○	×	×	×	×	×	×	×	×	○	×	○	×
	DOLBY PRO LOGIC		○	○	×	×	×	×	×	×	×	×	○	×	○	×
MULTI CH IN																
	MULTI CH IN		×	×	×	×	×	×	×	×	×	×	×	×	●	×
	MULTI IN + PLIIx CINEMA	*2	×	×	×	×	×	×	×	×	×	×	×	×	○	×
	MULTI IN + PLIIx MUSIC	*1	×	×	×	×	×	×	×	×	×	×	×	×	○	×

- : Mode selectable in default status
- ◎ : Mode fixed when AFDM is "ON"
- : Selectable mode
- ×

NOTE :

- *1: This mode is not available when the Surround Back speaker setup is set to "None".
- *2: This mode is not available when the Surround Back speaker setup is set to "1spkr" or "None".

Basic Operation

Basic Operation

Button	Surround Mode	Note	Input signals														
			ANALOG	LINEAR PCM	DTS				DOLBY DIGITAL					DVD-AUDIO			
					DTS ES DSCRT (With Flag)	DTS ES MTRX (With Flag)	DTS (5.1ch)	DTS 96/24	DOLBY DIGITAL EX (With Flag)	DOLBY DIGITAL EX (With no Flag)	DOLBY DIGITAL (5.1/5/4ch)	DOLBY DIGITAL (4/3ch)	DOLBY DIGITAL (2ch)	DVD-Audio (multi ch)	DVD-Audio (2ch)	176.4/192kHz	
DIRECT																	
	DIRECT		○	○	○	○	○	○	○	○	○	○	○	○	×	○	○
	MULTI CH DIRECT		×	×	×	×	×	×	×	×	×	×	×	○	×	×	
	M DIRECT + PLIIx CINEMA	*2	×	×	×	×	×	×	×	×	×	×	×	○	×	×	
	M DIRECT + PLIIx MUSIC	*1	×	×	×	×	×	×	×	×	×	×	×	○	×	×	
PURE DIRECT																	
	PURE DIRECT		○	○	○	○	○	○	○	○	○	○	○	×	○	○	
	MULTI CH PURE DIRECT		×	×	×	×	×	×	×	×	×	×	×	○	×	×	
	M PURE D + PLIIx CINEMA	*2	×	×	×	×	×	×	×	×	×	×	×	○	×	×	
	M PURE D + PLIIx MUSIC	*1	×	×	×	×	×	×	×	×	×	×	×	○	×	×	
DSP SIMULATION																	
	7CH STEREO	*3	○	○	○	○	○	○	○	○	○	○	○	○	○	○	×
	WIDE SCREEN		○	○	○	○	○	○	○	○	○	○	○	○	○	○	×
	SUPER STADIUM		○	○	○	○	○	○	○	○	○	○	○	○	○	○	×
	ROCK ARENA		○	○	○	○	○	○	○	○	○	○	○	○	○	○	×
	JAZZ CLUB		○	○	○	○	○	○	○	○	○	○	○	○	○	○	×
	CLASSIC CONCERT		○	○	○	○	○	○	○	○	○	○	○	○	○	○	×
	MONO MOVIE		○	○	○	○	○	○	○	○	○	○	○	○	○	○	×
	VIDEO GAME		○	○	○	○	○	○	○	○	○	○	○	○	○	○	×
	MATRIX		○	○	○	○	○	○	○	○	○	○	○	○	○	○	×
	VIRTUAL		○	○	○	○	○	○	○	○	○	○	○	○	○	○	×
STEREO																	
	STEREO		●	●	○	○	○	○	○	○	○	○	○	○	○	●	●

- : Mode selectable in default status
- : Selectable mode
- ×

NOTE :

- *1: This mode is not available when the Surround Back speaker setup is set to "None".
- *2: This mode is not available when the Surround Back speaker setup is set to "1spkr" or "None".
- *3: If the Surround Back speaker setup is set to "None", then "5CH STEREO" is displayed.

Using the DENON original surround modes

The AVR-2807 is equipped with a high performance digital signal processor (DSP) that uses digital signal processing to recreate sound fields artificially. One of 10 surround modes can be selected according to the program source and parameters can be further adjusted to achieve even more realistic sound fields.

Types of surround modes and their features

7CH STEREO (NOTE 1)	This mode lets you enjoy stereo sound with 7 speakers. The front L (R) channel signals are played from the surround and surround back L (R) channels and only the in-phase component of the L and R channels is played on the center channel.
WIDE SCREEN	This mode recreates the atmosphere of watching a movie in a theater with a large screen. In this mode, all sources are played in the 7.1-channel mode.
SUPER STADIUM	This mode recreates the atmosphere of watching a game of baseball, soccer or other sport in a stadium.
ROCK ARENA	This mode recreates the atmosphere of a live concert in an arena.
JAZZ CLUB	This mode recreates the atmosphere of a live concert in a club with low ceilings, hard walls and the artist just in front of you.
CLASSIC CONCERT	This mode recreates the atmosphere of a concert hall with rich reverberations.
MONO MOVIE (NOTE 2)	This mode recreates the atmosphere of an expansive sound field for movie sources recorded in monaural.
VIDEO GAME	This mode provides a rich sense of presence for video games.
MATRIX	This mode recreates music sources recorded in stereo with an enhanced sense of expansion.
VIRTUAL	This mode can be used to enjoy surround sound with only front speakers or when using headphones.

NOTE 1: "5CH STEREO" is displayed when "SB CH OUT" is set to "OFF".

NOTE 2: When playing sources recorded in monaural, the sound will be one-sided if signals are only input to one channel (left or right), so input signals to both channels. If you have a source component with only one audio output (monophonic camcorder, etc.) obtain a "Y" adapter cable to split the mono output to two outputs, and connect to the L and R inputs.



- Depending on the program source being played, the effect may not be very noticeable. In this case, try other surround modes, without worrying about their names, to create a sound field suited to your tastes.

Basic Operation

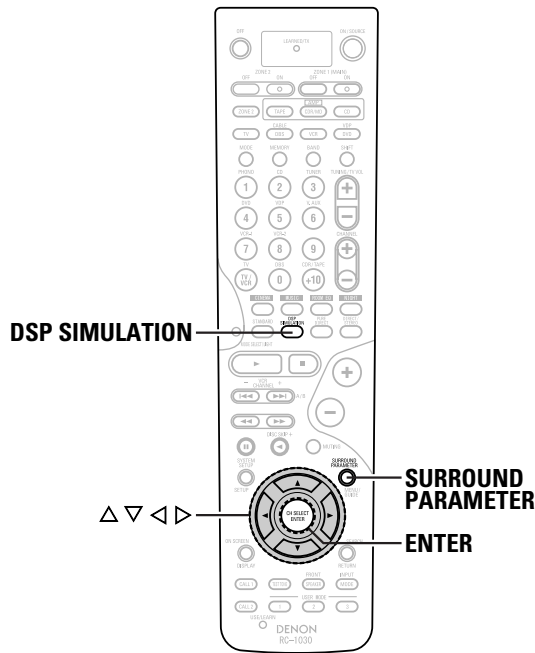
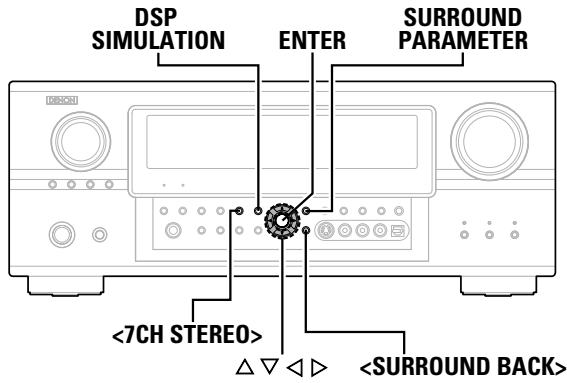

About the button names in this explanation

- < > : Buttons on the main unit
- [] : Buttons on the remote control unit

Button name only :

Buttons on the main unit and remote control unit

Basic Operation

Selecting the DSP surround simulation

1 Press [DSP SIMULATION].

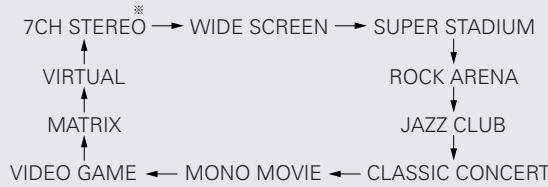

※ The 7CH STEREO mode can be selected directly by pressing <7CH STEREO>.

2 Press SURROUND PARAMETER.

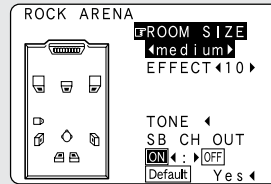

3 Press Δ ∇ to select the item, then press \triangleleft \triangleright to set.

EFFECT: (WIDE SCREEN mode only)

Effect signals with the multi-surround speaker effects are played. When set to "OFF", the SL/ SR channels are played from the SBL/ SBR channels, respectively.

LEVEL: (WIDE SCREEN mode only)

Adjust the strength of effect signals "1" to "15".

SB CH OUT

- ON: Surround back channel played.
- OFF: Surround back channel not played.

※ This operation can also be performed using <SURROUND BACK>.

ROOM SIZE:

Adjust the imaginary size of the recreated sound field space. (Does not express size of room in which played.) There are 5 parameters: "small", "med.s", "medium", "med.l" and "large".

EFFECT LEVEL:

Adjust the strength of the surround effect.

DELAY TIME: (MATRIX mode only)

Adjust the delay time between "0 ms" and "300 ms".

4 Press ENTER or SURROUND PARAMETER.



- Select "Default Yes" and press \triangleleft to reset all the settings.

Basic Operation

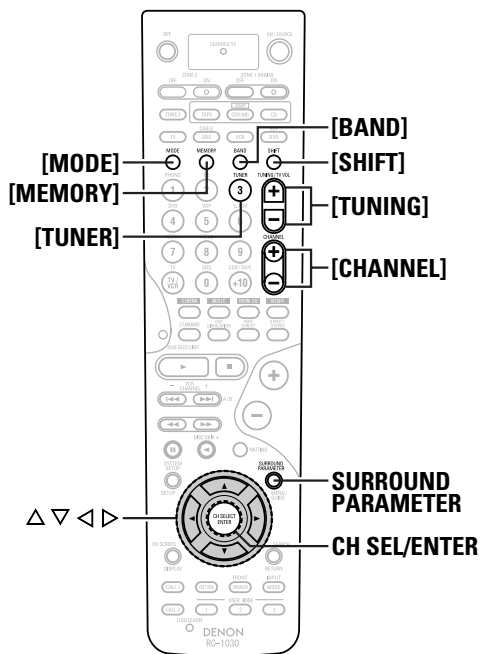
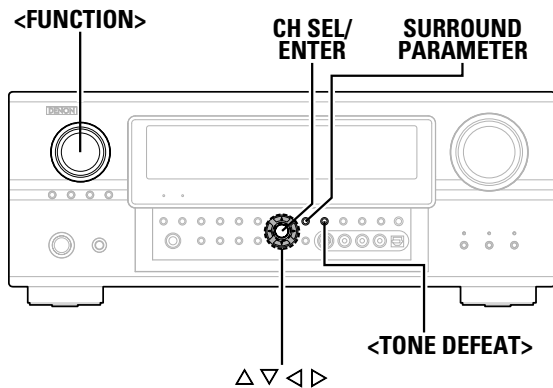

About the button names in this explanation

- < > : Buttons on the main unit
- [] : Buttons on the remote control unit

Button name only :

Buttons on the main unit and remote control unit

Setting the tone control

Adjust the bass and treble to suit your tastes.

Adjusting the tone

- 1 Press SURROUND PARAMETER.
- 2 Press $\Delta \nabla$ to select "TONE", then press \triangleleft .
* In the direct mode, "TONE" cannot be selected.
- 3 Press \triangleright to select "OFF".
- 4 Press $\Delta \nabla$ to select "Bass" or "Treble", then press $\triangleleft \triangleright$ to set the level.
* Can be adjusted within the range of -6 dB to +6 dB.
- 5 Press ENTER.
- 6 Press ENTER or SURROUND PARAMETER.

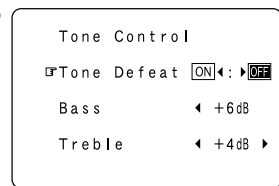
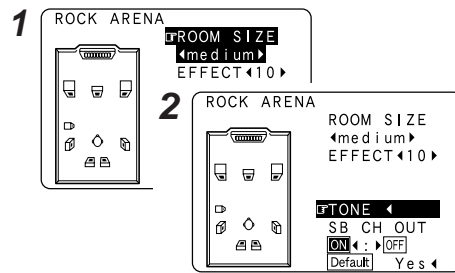

Basic Operation

When you do not want to adjust the tone

Either press <TONE DEFEAT> or set "Tone Defeat" to "ON" at step 3 in "Adjusting the tone".

Adjusting the speaker volume

- 1 Press CH SEL/ENTER.

Channel Vol.			
FL	◀ 0.0dB▶	SR	0.0dB
C	0.0dB	SBR	0.0dB
FR	0.0dB	SBL	0.0dB
SW	0.0dB	SL	0.0dB
Fader			
FRONT		◀▶	REAR

* "SB" when surround back speaker set to "1spkr". Not displayed when "None" set.
- 2 Press $\Delta \nabla$ or CH SEL/ENTER to select the speaker.
* The settable speaker switches each time this button is pressed.
- 3 Press $\triangleleft \triangleright$ to adjust the volume.
* Can be adjusted within the range of -12 dB to +12 dB.

Basic Operation

Using the fader function

With this function, the volume of all the front side speakers or all the rear side speakers can be adjusted (attenuated) at once.

- 1 Press **CH SEL/ENTER**.
- 2 Press **△ ▽** or **CH SEL/ENTER** to select “Fader”.
- 3 Press **◀** to attenuate the volume of all the front side speakers, **▶** to attenuate the volume of all the rear side speakers.

- ※ The fader function does not affect the subwoofer.
- ※ It is possible to adjust so that the volume of the speaker whose volume is the lowest is -12 dB.

2

Channel Vol.			
FL	0.0dB	SR	0.0dB
C	0.0dB	SBR	0.0dB
FR	0.0dB	SBL	0.0dB
SW	0.0dB	SL	0.0dB

Fader
FRONT ◀ : ▶ REAR

3

Channel Vol.			
FL	-0.5dB	SR	0.0dB
C	-0.5dB	SBR	0.0dB
FR	-0.5dB	SBL	0.0dB
SW	0.0dB	SL	0.0dB

Fader
FRONT ◀ : ▶ REAR

Basic Operation

Preset memory

- 1 Use the “Auto tuning” or “Manual tuning” operation to tune in the station to be preset in the memory.
- 2 Press **[MEMORY]**.
- 3 Press **[SHIFT]** to select the desired memory block (A to G).
- 4 Press **[CHANNEL]** to select the desired preset channel (1 to 8).
- 5 Press **[MEMORY]** again.
 - Store the station in the preset memory.



- To preset other channels, repeat steps 2 to 5. A total of 56 broadcast stations can be preset — 8 stations (channels 1 to 8) in each of blocks A to G.
- The memory block can also be selected by pressing **[SHIFT]**.

Listening to the radio

Check that the remote control unit is set to “AMP”.

Auto tuning

- 1 Either turn **<FUNCTION>** or press **[TUNER]** to select “TUNER”.
- 2 Press **[BAND]** to select “AM” or “FM”.
- 3 Press **[MODE]** to set the auto tuning mode.
 - The “AUTO” indicator lights.
- 4 Press **[TUNING]**.
 - Automatic searching begins.



- If tuning does not stop at the desired station, use to the “Manual tuning” operation.

Manual tuning

- 1 Either turn **<FUNCTION>** or press **[TUNER]** to select “TUNER”.
- 2 Press **[BAND]** to select “AM” or “FM”.
- 3 Press **[MODE]** to set the manual tuning mode.
 - ※ Check that the display’s “AUTO” indicator turns off.
- 4 Press **[TUNING]** to tune in the desired station.
 - ※ The frequency changes continuously when the button is held in.



- When the manual tuning mode is set, FM stereo broadcasts are received in monaural and the “STEREO” indicator turns off.

Basic Operation

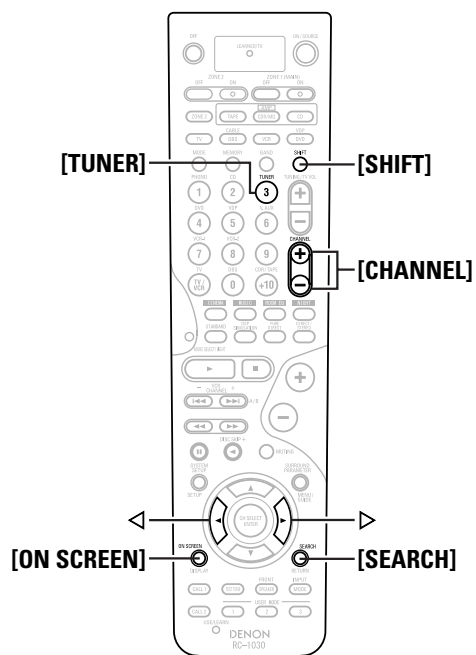
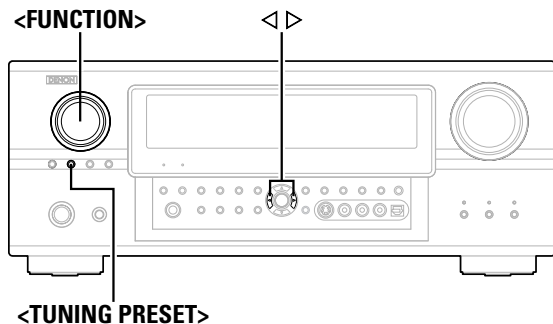

About the button names in this explanation
 < > : Buttons on the main unit
 [] : Buttons on the remote control unit
Button name only :
 Buttons on the main unit and remote control unit

Checking the preset stations

Press **[ON SCREEN]** repeatedly until the “Tuner Preset Stations” screen appears on the OSD.

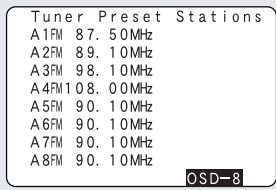

Recalling preset stations

■ Main unit

- 1 Press <TUNING PRESET>.
- 2 Turn <FUNCTION> and select the desired preset channel.

■ Remote control unit

- 1 Press [SHIFT] to select the memory block.
- 2 Press [CHANNEL] to select the desired preset channel.

Basic Operation

RDS (Radio Data System)

RDS (works only on the FM band) is a broadcasting service which allows station to send additional information along with the regular radio program signal.

■ Program Type (PTY)

PTY identifies the type of RDS program.

NEWS	News	WEATHER	Weather
AFFAIRS	Current Affairs	FINANCE	Finance
INFO	Information	CHILDREN	Children's programmes
SPORT	Sports	SOCIAL	Social Affairs
EDUCATE	Education	RELIGION	Religion
DRAMA	Drama	PHONE IN	Phone In
CULTURE	Culture	TRAVEL	Travel
SCIENCE	Science	LEISURE	Leisure
VARIED	Varied	JAZZ	Jazz Music
POP M	Pop Music	COUNTRY	Country Music
ROCK M	Rock Music	NATION M	National Music
EASY M	Easy Listening Music	OLDIES	Oldies Music
LIGHT M	Light Classical	FOLK M	Folk Music
CLASSICS	Serious Classical	DOCUMENT	Documentary
OTHER M	Other Music		

■ Traffic Program (TP)

TP identifies programs that carry traffic announcements.

■ Radio Text (RT)

RT allows the RDS station to send text messages that appear on the display.

NOTE:

- The operations described below pressing **[SEARCH]** will not function in areas in which there are no RDS broadcasts.

Basic Operation

RDS search

1 Either turn <FUNCTION> or press [TUNER] to select “TUNER”.

2 Press [SEARCH] to select “RDS”.

3 Press [CHANNEL].
 • Automatically begin the RDS search operation.

※ If no RDS stations is found with above operation, all the reception band are searched.

2 [R D S]
New tuning system for your convenience!
1 Push [Search]
RDS-RDS station
PTY-Pro
TP-Tra
RT-Rad
2 Tune by preset [Up]
CHB5 FM105.50MHz

3 [R D S] [Search]
New tuning system for your convenience!
1 Push [Search]
RDS-RDS station
PTY-Program category
TP-Traffic info.
RT-Radio Text
2 Tune by preset [Up/Down]



- To continue searching, repeat step 2.
- If no other RDS station is found when all the frequencies are searched, “NO RDS” is displayed.

PTY search

1 Either turn <FUNCTION> or press [TUNER] to select “TUNER”.

2 Press [SEARCH] to select “PTY”.

3 Press <Left> <Right> to call out the desired program type.

4 Press [CHANNEL].
 • Automatically begin the PTY search operation.

※ If there is no station broadcasting the designated program type with above operation, all the reception bands are searched.

2 [R D S]
New tuning system for your convenience!
1 Push [Search]
RDS-RDS station
PTY-Pro
TP-Tra
RT-Rad
2 Tune by CHB5 FM105.

3 [R D S - P T Y] [Search]
1 Select category by <Left> button
NEWS AFFAIRS
INFO SPORT
EDUCATE DRAMA
2 Tune by CHB5 FM105.

4 [R D S - P T Y] [Search]
1 Select category by <Left> button
NEWS AFFAIRS
INFO SPORT
EDUCATE DRAMA
~Next~
2 Tune by preset [Up/Down]



- To continue searching, repeat step 3.
- If no other station broadcasting the designated program type is found when all the frequencies are searched, “NO PTY” is displayed.

TP search

1 Either turn <FUNCTION> or press [TUNER] to select “TUNER”.

2 Press [SEARCH] to select “TP”.

3 Press [CHANNEL].
 • Automatically begin the TP search operation.

※ If no TP station is found with above operation, all the reception bands are searched.

2 [R D S]
New tuning system for your convenience!
1 Push [Search]
RDS-RDS station
PTY-Program category
TP-Traffic info.
RT-Radio Text
2 Tune by preset [Up]
CHB5 FM105.50MHz

3 [R D S] [Search]
New tuning system for your convenience!
1 Push [Search]
RDS-RDS station
PTY-Program category
TP-Traffic info.
RT-Radio Text
2 Tune by preset [Up/Down]

Basic Operation



- To continue searching, repeat step 2.
- If no other TP station is found when all the frequencies are searched, “NO TP” is displayed.

RT (Radio Text)

1 Either turn <FUNCTION> or press [TUNER] to select “TUNER”.

2 Press [SEARCH] to select “RT”, then press <Left> <Right> to select “ON”.

※ While receiving an RDS broadcast station, the text data broadcast from the station is displayed.

[R D S]
New tuning system for your convenience!
1 Push [Search]
RDS-RDS station
PTY-Program category
TP-Traffic info.
RT-Radio Text [ON]

CHB5 FM105.50MHz



- To turn the display off, press <Left> <Right>.
- If no text data is being broadcast, “NO TEXT DATA” is displayed.

Advanced Operation

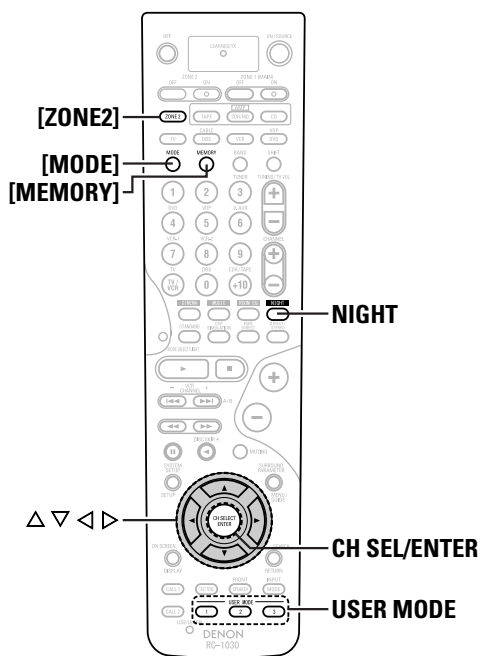
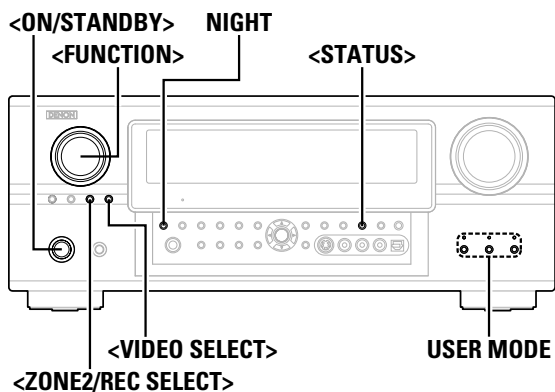

About the button names in this explanation
 < > : Buttons on the main unit
 [] : Buttons on the remote control unit
Button name only :
 Buttons on the main unit and remote control unit

Advanced Operation

Night mode

The night mode can be set when playing Dolby Digital sources. The dialogues are easier to hear at night and when listening with the volume low.

Press NIGHT.

- The "NIGHT" indicator lights.



- Canceling night mode:
Press **NIGHT** again.
- When the night mode is set to "ON", the "D.COMP" surround parameter can not be selected.

User mode function

The AVR-2807 is equipped with a function for storing the selected input source, the auto surround mode and input mode in the memory and selecting these settings when you want to use them.

■ Storing the settings in the memory

1 The following are stored in the memory:

- ① Currently set input source
- ② Currently set surround mode
- ③ Currently set input mode

2 Press and hold USER MODE.

- ※ Press and hold in until the selected user mode indicator lights.

■ Calling the settings out

Press **USER MODE** at which the settings you want to call out are stored.

- The selected user mode display lights.

Combining the currently playing sound with the desired image (VIDEO SELECT function)

Press **<VIDEO SELECT>**, turn **<FUNCTION>** until the desired image appears on the display.



- To cancel, press **<VIDEO SELECT>** and turn **<FUNCTION>** to select "SOURCE".
- The video source selected with the video select function is stored in the memory for the different input sources.
- It is not possible to select HDMI input signals.
- When playing HDMI video input signals, the analog video signal of another function cannot be selected for the HDMI video output.

Personal memory plus function

The surround mode last selected and the input mode setting are stored individually for the different input sources.

- ※ The surround parameters, tone control settings and playback level balance for the different output channels are memorized for each surround mode.

Advanced Operation

Playing the iPod®

The music recorded on the iPod can be played when using a DENON original Dock (ASD-1R). The iPod can be controlled using the buttons on the main unit and the remote control unit.



iPod is a trademark of Apple Computer, Inc., registered in the U.S. and other countries.

※ With the iPod, non-copyrighted contents and contents that may be legally reproduced or played may be reproduced and played by individuals for their personal use. Violating copyrights is prohibited by law.

1 Connect the AVR-2807 and iPod using the DENON original Dock (☞ page 20).

2 Assign the input terminal at “Setting the iPod Assignment” (☞ page 47).

3 Use FUNCTION to select the function assigned in step 2.

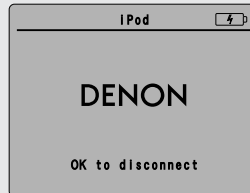

(iPod screen)

※ If the screens above are not displayed, the iPod may not be properly connected. Check the connections and settings.



• The optional standard iPod Dock is DENON ASD-1R sold separately.

NOTE:

- DENON will accept no responsibility whatsoever for loss or damage of data on an iPod occurring when the iPod is used connected to the AVR-2807.
- Some of the functions may not operate, depending on the type of iPod and the software version.

Listening to music

1 Press Δ ∇ to select the music file, then press ENTER or \triangleright .

※ Press \triangleleft to return to the music menu screen.

2 Press ENTER or \triangleright .

- Playback starts.

Pause:

Press **ENTER** during playback.
Press again to resume.

Manual search:

Press and hold in Δ ∇ during playback.

- Δ : Fast reverse
- ∇ : Fast forward

Track search:

Press Δ ∇ during playback.

- Δ : Move to beginning of previous track
- ∇ : Move to beginning of next track

Stop:

Press **ENTER** for at least 2 seconds during playback.

Repeat play:

Press **[MODE]**.
The mode switches as follows each time **[MODE]** is pressed.

- **RPT One**: Single track repeat
- **RPT All** : All track repeat

Shuffle play:

Press **[MEMORY]**.
The mode switches as follows each time **[MEMORY]** is pressed.

- **SFL Songs** : Single track shuffle
- **SFL Albums**: Album shuffle

※ The mode switches between the Browse mode and the Remote mode if **[MODE]** is pressed for at least 2 seconds.
In the Remote mode, only Δ ∇ \triangleleft \triangleright and **ENTER** can be used.



- When **<STATUS>** is pressed during playback, the front panel display switches between the title name, artist name and album name.
- Depending on the iPod's software version, it may not be possible to operate the iPod from the AVR-2807. Use the latest version of the software. Information on the latest version of the software can be obtained on the Apple Computer website.
- If you do not want the on screen display to be displayed while playing the iPod, set “Function/Mode Status” at “Setting the On Screen Display” to “OFF” (☞ page 52).
- With the AVR-2807 it is possible to display folder names and file names on the screen like titles. The AVR-2807 can display up to 64 characters, consisting of numbers, capital letters and small letters. A “?” mark is displayed in place of non-compatible characters.

Viewing still pictures and videos (only for iPods equipped with the slideshow / video function)

Use this procedure to view photo and video data stored on the iPod on a monitor.

1 Press **[MODE]** for at least 2 seconds to switch from the Browse mode to the Remote mode.

- “Remote iPod” is displayed on the AVR-2807's display.

2 Watching the iPod's screen, press Δ ∇ to select “Photos” or “Video”, then press ENTER or \triangleright .

- The iPod's photo and video data are displayed on the monitor.



• To output photo or video data recorded on the iPod to the monitor, the iPod's “TV Out” setting (under “Video Settings”) must be set to “ON”.

For details, refer to the iPod's operating instructions.

Disconnecting the iPod

Press **<ON/STANDBY>** and set the AVR-2807's power to the standby mode.

※ The iPod can be disconnected after switching to a function other than the one to which the iPod input is assigned.

Advanced Operation

Multi zone music entertainment system

- When the outputs of the ZONE2 output terminals are wired and connected to power amplifiers installed in other rooms, different sources can be played in rooms other than the MAIN ZONE in which this unit and the playback devices are installed. (Refer to ZONE2 on the diagram below.)
- Settings can be made at “Power Amp Assign” in the “System Setup Menu” so that the same source as the ZONE2 output terminals can be played from the speakers connected to the ZONE2 speaker terminals (☞ page 21).

※ To control playback devices other than the ones above, either use that device’s remote control unit or preset a separately sold programmable remote control unit.



• For instructions on installation and operation of separately sold devices, refer to the devices’ operating instructions.

Multi-zone playback using the ZONE2 output terminals

■ When using the power amplifier as the MAIN ZONE output

The AVR-2807 is equipped with ZONE2 output terminals for which the volume is fixed output level and composite video output terminals as the ZONE2 output terminals.

[System configuration and connections example]

- Using this AVR-2807 external amplifier as the ZONE2.

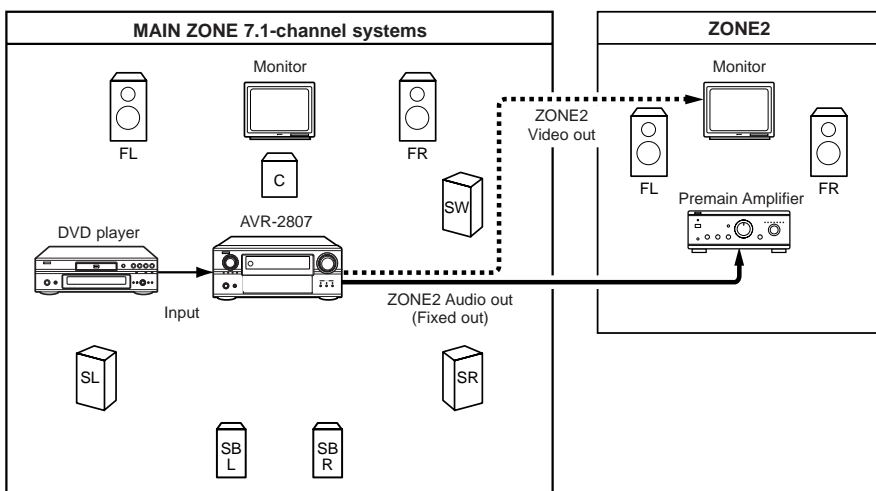

- : Multi source video signal cable
- : Multi source audio signal cable
- : Speaker cable

※ Refer to “Connections” (☞ page 21).

Advanced Operation

Multi-zone playback using the SPEAKER terminals

■ When using the SURROUND BACK amplifier as the ZONE2 output

When the surround back’s power amplifier is assigned to the ZONE2 output channel at “Power Amp Assign” in the “System Setup Menu”, the surround back speaker terminals can be used as the ZONE2 speaker out terminals (☞ page 54).

[System configuration and connections example]

- Using this AVR-2807 internal amplifier as the ZONE2.

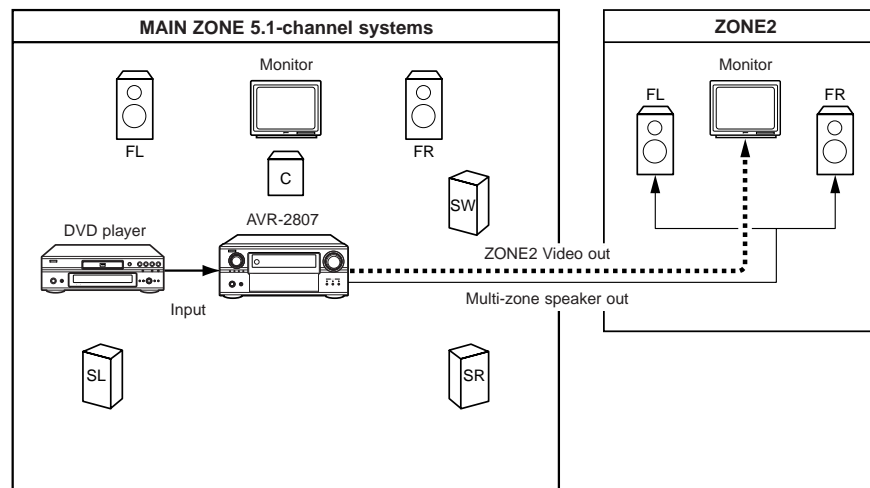

Advanced Operation

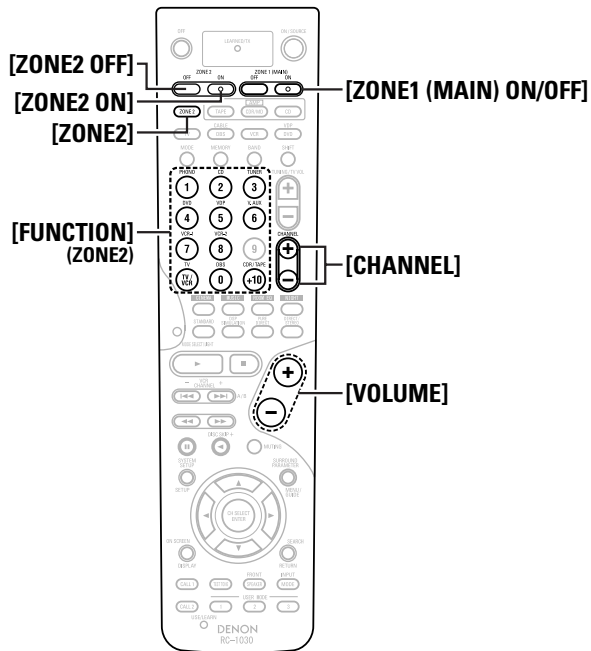
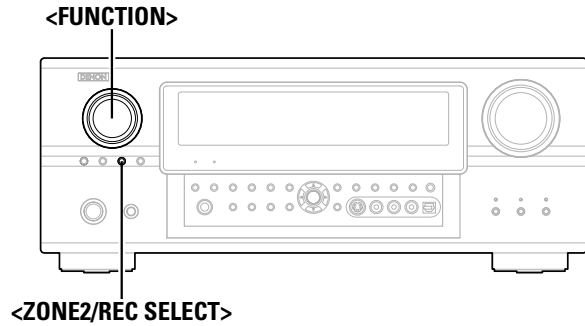

About the button names in this explanation
 < > : Buttons on the main unit
 [] : Buttons on the remote control unit
Button name only :
 Buttons on the main unit and remote control unit

Outputting a program source to amplifier, etc., in the ZONE2 room (ZONE2 SELECT mode)

- 1** Press <ZONE2/REC SELECT> to display the "ZONE2 SOURCE" on the display.
 - The "MULTI" indicator lights.

ZONE2 ← → RECOUT
- 2** With "ZONE2 SOURCE" displayed, turn <FUNCTION> to select the source you want to output appears on the display.
- 3** Start playing the source to be output.
 - ※ For operating instructions, refer to the manuals of the respective components.



- The signals of the source selected in the ZONE2 mode are also output from the VCR-1, VCR-2 and CDR/TAPE recording output terminals.
- Digital signals are not output from the ZONE2 audio output terminals.
- About the MULTI ZONE connections (page 40).

Advanced Operation

Remote control unit operations during multi-source playback

- 1** Press [ZONE2] to select "ZONE2".
- 2** Press [ZONE2 ON] to turn on the zone power.
 - ※ Press [ZONE2 OFF] to turn off the zone power.
- 3** Select the input source you wish to output.
 - ※ When the function is set to TUNER, the preset channel can be selected using [CHANNEL].
- 4** The volume of the outputs of the different zones can be adjusted with [VOLUME].
 - ※ The ZONE2 volume can be adjusted only when "ZONE2" is selected at "Power Amp Assign" in the "System Setup Menu" (page 54).
 - ※ Default volume setting:
ZONE2 : -40 dB
 - ※ The zone volume can be adjusted within the range of -70 to 18 dB.



- When using ZONE2, it is possible to turn the power for the MAIN ZONE (main zone) only on or off by pressing [ZONE1 (MAIN) ON/OFF].

Advanced Operation

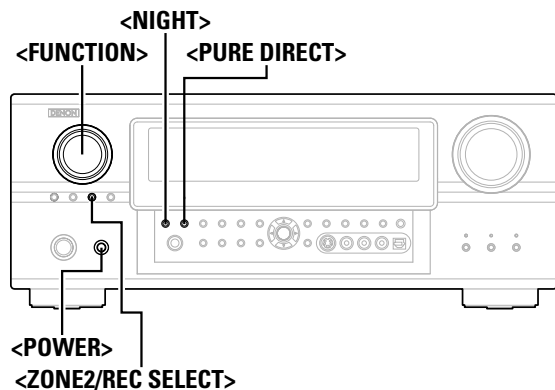

About the button names in this explanation

- < > : Buttons on the main unit
- [] : Buttons on the remote control unit

Button name only :

Buttons on the main unit and remote control unit

Recording (audio and/or video)

1 Press <ZONE2/REC SELECT> until “RECOUT” appears on the display.

ZONE2 ←→ RECOUT

2 Use <FUNCTION> to select the source to be recorded (audio and/or video).

- The “ REC ” indicator lights.

3 Record (the audio or video signals).

※ For operations, see the operating instructions of the device from which you are recording (audio or video signals).



- To cancel, press <ZONE2/REC SELECT> and set the function to “ZONE2”.

NOTE:

- When the REC OUT mode is selected, [ZONE2] and [FUNCTION] (ZONE2) cannot be operated.
- Digital signals are not output from the analog REC OUT, OPTICAL 3 OUT and OPTICAL 4 OUT terminals.

Advanced Operation

About the memory functions

■ **Last function memory**

The various settings set when the AVR-2807’s power is switched to standby are stored in the memory. When the power is turned back on, the settings made when the power was switched to standby are recalled.

■ **Backup memory**

The various settings are stored in the memory for about 1 week, even when the power is turned off or the power cord is unplugged.

Initialization of the microprocessor

Use the procedure described below to reset the microprocessor if the display is abnormal or if the buttons on the main unit or the remote control unit do not operate.

1 Switch off the unit using <POWER>.

2 Hold the following <PURE DIRECT> and <NIGHT>, and press <POWER>.

3 Check that the entire display is blinking with an interval of about 1 second, and release your fingers from the 2 buttons.

- The microprocessor will be initialized.



- If step 3 does not work, start over from step 1.
- If the microprocessor has been reset, all the settings are reset to the default values.

Advanced Setup – Part 1

System setup items and default values

1. Auto Setup/Room EQ

- 1. Auto Setup/Room EQ
- 1. Auto Setup
- 2. Room EQ Setup
- 3. Direct Mode Setup
- 4. Mic Input Select
- 5. Parameter Check
- Exit

Items		Default settings			Page
1	Auto Setup	This unit performs an analysis of the speaker system and measures the acoustic characteristics of your room to permit an appropriate automatic setting.			9 ~ 12
2	Room EQ Setup	Set the Room Equalizer setting with "All" or "Assign" for each surround mode.			60
3	Direct Mode Setup	Set the ON/OFF setting of Room Equalizer, in the case of the surround mode is in "Direct" or "Pure Direct".			60
4	Mic Input Select	Sets whether the setup microphone is connected to the pin jack (V. AUX L channel) or mIni jack (SETUP MIC).			61

2. Speaker Setup

- 2. Speaker Setup
- 1. Speaker Config.
- 2. Subwoofer Setup
- 3. Distance
- 4. Channel Level
- 5. Crossover Frequency
- Exit

Items		Default settings					Page
1	Speaker Config.	Automatically set the output component and properties for the various channels according to the combination of speakers to be actually used for surround playback.					56, 57
		Front Sp.	Center Sp.	Subwoofer	Surround Sp.	Surround Back Sp.	
		Large	Small	Yes	Small	Small / 2spkrs	
2	Subwoofer Setup	Select the method of playback of the subwoofer for playing the low bass signals.					57
3	Distance	This parameter is for optimizing the timing with which the audio signals are produced from the speakers and subwoofer according to the listening position.					57, 58
		Front L & R	Center	Subwoofer	Surround L & R	Surround Back	
		3.6 m (12 ft)	3.6 m (12 ft)	3.6 m (12 ft)	3.0 m (10 ft)	3.0 m (10 ft)	
4	Channel Level	Set the volume of the various speakers so that the sound output from the speakers and the subwoofer seems to have the same volume level.					58, 59
		Front L	Front R	Center	Surround L	Surround R	
		0 dB	0 dB	0 dB	0 dB	0 dB	
5	Crossover Frequency	Set the frequency (Hz) below which the bass sound of the various speakers is to be output from the subwoofer.					59
		80 Hz					

Advanced Setup – Part 1

3. Audio Input Setup

- 3. Audio Input Setup
- 1. Digital In Assign
- 2. EXT. IN Subwoofer Level
- 3. iPod Assign
- 4. Input Function Lev.
- 5. Function Rename
- 6. Tuner Presets
- Exit

Items			Default settings										Page	
1	Digital In Assign	This assigns the digital input terminals for the different input sources.	Input source		CD	DVD	VDP	TV	DBS	VCR-1	VCR-2	CDR / TAPE	V.AUX	47
			Digital Inputs		COAX 1	COAX 2	OPT 1	OFF	OPT 2	OPT 3	OFF	OPT 4	OPT 5	
2	EXT. IN Subwoofer Level	Sets the playback level of the analog signal that was input to the EXT. IN subwoofer terminal.	SW Level = +15 dB										47	
3	iPod Assign	It is possible to assign the DENON original Dock's audio and/or video signals to any input terminals on the AVR-2807 and play them.	iPod Function = OFF										47	
4	Input Function Lev.	The playback level is corrected individually for the different input sources.	TUNER	PHONO	CD	CDR / TAPE	DVD	VDP	TV	DBS	VCR-1	VCR-2	V.AUX	48
			0 dB	0 dB	0 dB	0 dB	0 dB	0 dB	0 dB	0 dB	0 dB	0 dB	0 dB	
5	Function Rename	The name of the input function that is displayed can be changed.	TUNER	PHONO	CD	CDR / TAPE	DVD	VDP	TV	DBS	VCR-1	VCR-2	V.AUX	48
6	Tuner Presets	Up to 56 FM stations can be preset automatically.	Auto Preset Memory	A1 ~ A8	87.5/89.1/98.1/108.0/90.1/90.1/90.1/90.1 MHz									48
				B1 ~ B8	522/603/999/1404/1611 kHz, 90.1/90.1/90.1 MHz									
				C1 ~ C8	90.1 MHz									
				D1 ~ D8	90.1 MHz									
				E1 ~ E8	90.1 MHz									
				F1 ~ F8	90.1 MHz									
				G1 ~ G8	90.1 MHz									
		Preset channels that are not used often can be skipped.	Preset Skip	All preset channels = ON									49	
		The preset channels can be given the names you want.	Preset Name	-									49	

4. Video Setup

- 4. Video Setup
- 1. HDMI In Assign
- 2. Component In Assign
- 3. Video Convert
- 4. HDMI Out Setup
- 5. Audio Delay
- 6. On Screen Display
- Exit

Items			Default settings							Page
1	HDMI In Assign	The HDMI input terminals are assigned for the different input sources. Select the HDMI audio signal playback method.	DVD	VDP	TV	DBS	VCR-1	VCR-2	V.AUX	49, 50
			NONE	NONE	NONE	NONE	NONE	NONE	NONE	
2	Component In Assign	This assigns the component video input terminals for the different input sources.	DVD	VDP	TV	DBS	VCR-1	VCR-2	V.AUX	50
			1-RCA	NONE	2-RCA	3-RCA	NONE	NONE	NONE	
3	Video Convert	This sets whether or not to use the video conversion function.	ON							50
4	HDMI Out Setup	Set whether or not to up-convert from analog video signals to HDMI. When this function is used, the format of the signal output from the HDMI terminal can be set.	Convert = ON i/p Convert = ON Color Space = Y Cb Cr RGB Mode = Normal							51
5	Audio Delay	Adjust the time delay between the video and audio signals.	0 ms							51
6	On Screen Display	Set whether or not to display the on screen display for indications other than the menu screens.	Function/Mode = ON Master Volume = ON Mode = Mode 1							52

Advanced Setup – Part 1

Advanced Setup – Part 1

5. Advanced Playback

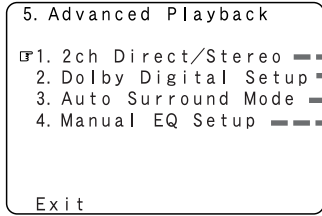

Items		Default settings	Page
1	2ch Direct/Stereo	Make the 2-channel direct mode and stereo mode speaker settings.	Basic 52
2	Dolby Digital Setup	Turn the audio compression on or off when down-mixing Dolby Digital signals.	OFF 53
3	Auto Surround Mode	Set whether or not to store the surround mode last played for the input signal.	Auto Surround Mode = ON 53
4	Manual EQ Setup	Adjust the tone of the various speakers while listening to the playback signals.	All Channels and Frequency = 0 dB 53, 54

6. Option Setup

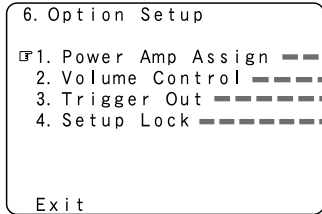

Items		Default settings	Page											
1	Power Amp Assign	To suit your preference, a surround back channel's power amplifier can be assigned to the front channel ("Front A" or "Front B") for bi-amp playback, ZONE2.	S. Back 54											
2	Volume Control	This sets the volume level of output.	Vol.Limit = OFF P. On Lev. = LAST Mute Lev. = FULL 55											
3	Trigger Out	Use the DC12V output of the AVR-2807's two trigger out jacks in association with the various input sources and surround modes.	ZONE = MAIN, All Surround Modes = ON											
			Trigger Out 1	TUNER	PHONO	CD	CDR / TAPE	DVD	VDP	TV	DBS	VCR-1	VCR-2	V.AUX
				OFF	OFF	OFF	OFF	ON	ON	ON	ON	ON	ON	ON
			Trigger Out 2	ZONE = 2										
			TUNER	PHONO	CD	CDR / TAPE	DVD	VDP	TV	DBS	VCR-1	VCR-2	V.AUX	
			ON	ON	ON	ON	ON	ON	ON	ON	ON	ON	ON	
4	Setup Lock	This sets whether or not to lock the system setup settings so that they cannot be changed.	Setup Lock = OFF 56											

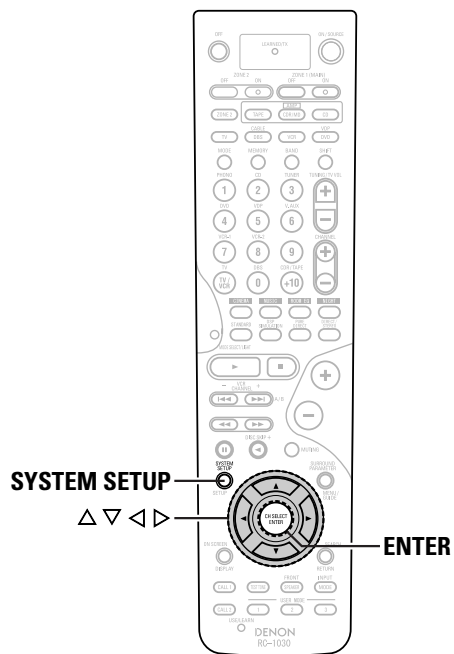
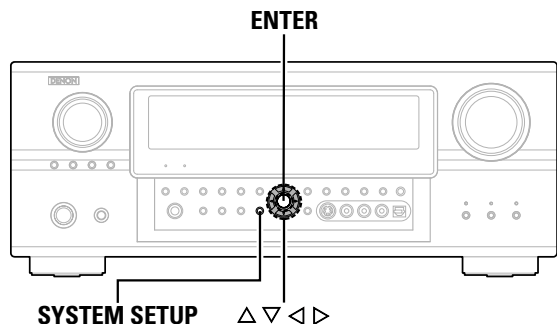

About the button names in this explanation

< > : Buttons on the main unit
 [] : Buttons on the remote control unit

Button name only :

Buttons on the main unit and remote control unit

Navigating through the System Setup Menu

- 1** Press **SYSTEM SETUP**.
 • The “System Setup Menu” appears.
- 2** Press △▽ to select the item you want to set, then press **ENTER**.
- 3** Press △▽ again to select the item you want to set, then press **ENTER**.
- 4** To change the setting:
 Press △▽ to select the item you want to change, then press ◀▶ to change the setting.
 ※ Select “Default Yes”, then press ◀ to reset to the default setting.
- 5** Press **ENTER** and set a new item.
- 6** Press **SYSTEM SETUP** to return to the “System Setup Menu” or the main menu.

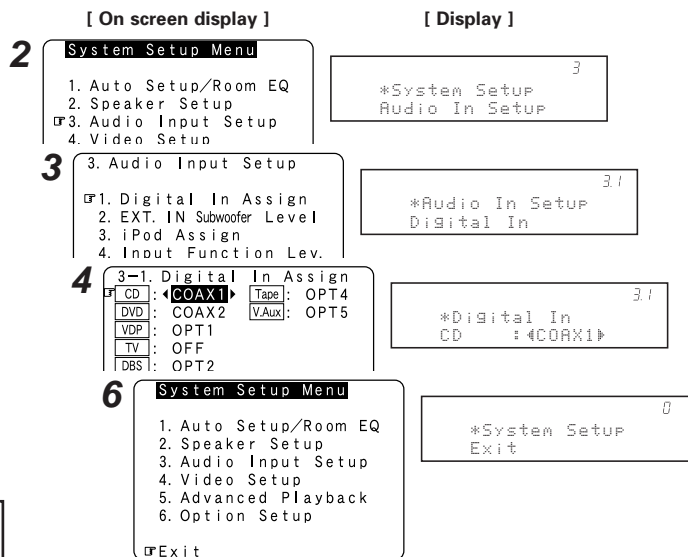

About the display

In addition to the easily understandable on screen display, the AVR-2807 is also equipped with displays for checking the settings. Use this when making settings and operating. Below are some examples of typical displays.

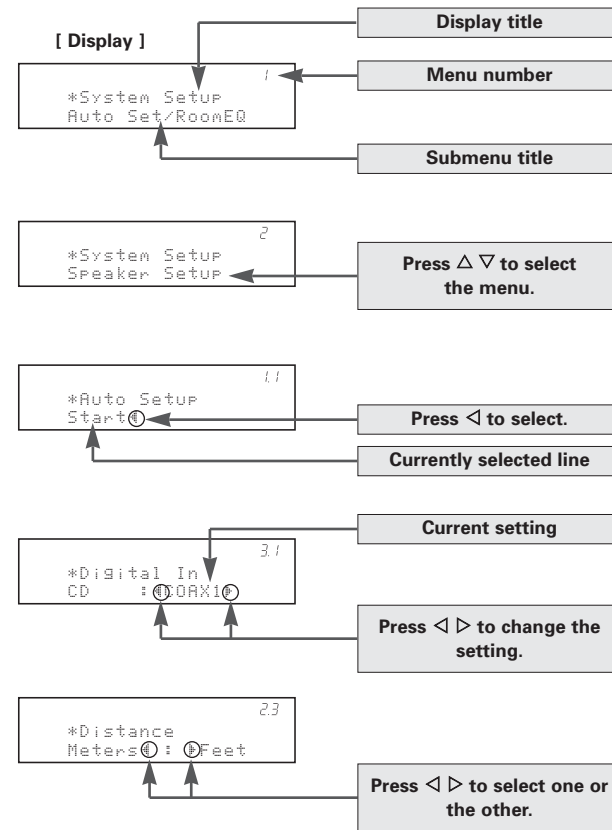

Advanced Setup – Part 1

Audio Input Setup

Setting the Digital In Assignment

This assigns the digital input terminals for the different input sources.

1 Press Δ ∇ to select “Audio Input Setup”, then press **ENTER**.

2 Press Δ ∇ to select “Digital In Assign”, then press **ENTER**.

3 Press Δ ∇ to select the input source, then press \triangleleft \triangleright to set.

COAX1, COAX2, OPT1, OPT2, OPT3, OPT4, OPT5:

Assign the different terminals according to the devices connected to the AVR-2807’s input terminals.

※ The HDMI input terminal is displayed when it is assigned to the input source at “HDMI In Assign” (page 49, 50).

4 Press **ENTER**.

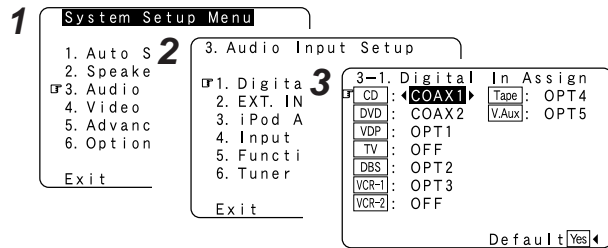

- “PHONO” and “TUNER” cannot be selected on the “Digital In Assign” screen.
- It is not possible to make the “Digital In Assign” settings for the function assigned at “iPod Assign”.

Setting the EXT. IN Subwoofer Level

Sets the playback level of the analog signal that was input to the EXT. IN subwoofer terminal.

1 Press Δ ∇ to select “EXT. IN Subwoofer Level”, then press **ENTER**.

2 Press \triangleleft \triangleright to set.

3 Press **ENTER**.

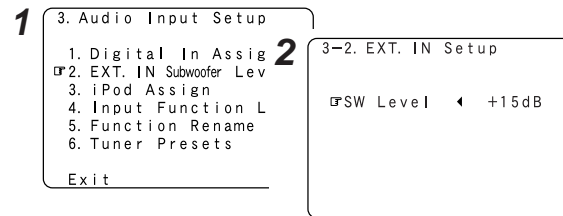

Advanced Setup – Part 1

Setting the iPod Assignment

It is possible to assign the DENON original Dock’s audio and video signals to any input terminals on the AVR-2807 and play them.

1 Press Δ ∇ to select “iPod Assign”, then press **ENTER**.

2 Press \triangleleft \triangleright to set.

OFF:

This is the factory default setting.

CD, CDR/TAPE:

When using a DENON original Dock, it is possible to connect with the audio input terminal of the assigned function.

DVD, VDP, DBS, TV, VCR-1, VCR-2, V.Aux:

When using a DENON original Dock, it is possible to connect with the audio and video input terminals of the assigned function.

3 Press **ENTER**.

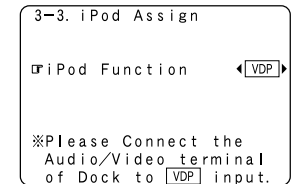
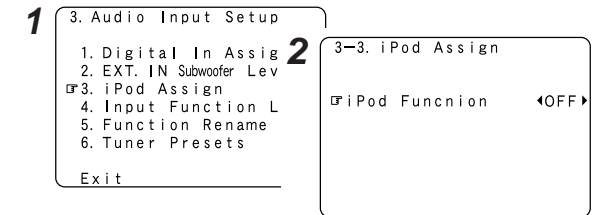

(When “VDP” is selected)

Advanced Setup – Part 1

Setting the Input Function Level

The playback level is corrected individually for the different input sources.

1 Press Δ ∇ to select “Input Function Lev.”, then press **ENTER**.

2 Press Δ ∇ to select the input source, then press \triangleleft \triangleright to set.

※ The volume can be adjusted within the range -12 dB to +12 dB.

3 Press **ENTER**.



• After completing this setting, check that the playback levels for the different sources are the same.

Advanced Setup – Part 1

Setting the Tuner Presets

■ Auto Preset Memory

Up to 56 FM stations can be preset automatically.

1 Press Δ ∇ to select “Tuner Presets”, then press **ENTER**.

2 Press Δ ∇ to select “Auto Preset Memory”, then press **ENTER**.

3 Press \triangleleft to select “Yes”.

- “Search” blinks on the screen and searching begins.
- “Completed” appears once searching is completed.



• If an FM station cannot be preset automatically due to poor reception, use the “Manual tuning” operation (page 35) to tune in the station, then preset it using the manual “Preset memory” operation (page 35).

Setting the Function Rename

The name of the input function that is displayed can be changed.

1 Press Δ ∇ to select “Function Rename”, then press **ENTER**.

2 Press Δ ∇ to select the input function, then press \triangleleft \triangleright to set.

3 Press \triangleleft \triangleright to move the cursor (■) to the desired position, then press Δ ∇ to select the character.

※ Up to 8 characters can be input.
The characters that can be input are shown below.

ABCDEFGHIJKLMNOPQRSTUVWXYZ
abcdefghijklmnopqrstuvwxyz0123456789
!"#%&'()*+,-./:;<=>@[\] (space)

4 Repeat step 3 to input the input source name.

※ To set the input function name back to how it was:

- ① Press \triangleleft \triangleright to highlight the input function name, then press Δ ∇ .
- ② Press Δ ∇ to select “Default Yes”, then press \triangleleft .

5 Once all the characters have been input, press **ENTER**.

Advanced Setup – Part 1

■ Preset Skip

Preset channels that are not used often can be skipped.

1 Press Δ ∇ to select “Preset Skip”, then press ENTER.

2 Press Δ ∇ to select the preset channel, then press \triangleleft \triangleright to set.

ON, OFF:

Select “OFF” to skip the preset channel, “ON” if you do not want to skip.

※ When ∇ is pressed at the very bottom of the screen, then the next preset memory block appears.

3 Press \triangleleft \triangleright to select the preset memory block.

4 Repeat steps 2 and 3.

5 Press ENTER.

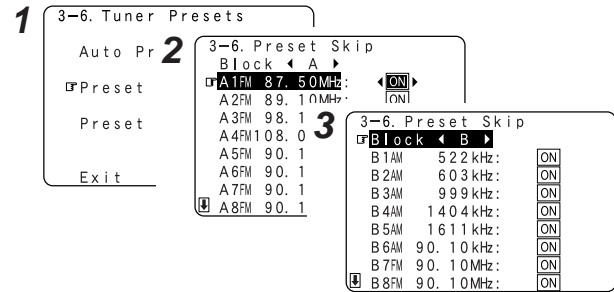

■ Preset Name

The preset channels can be given the names you want.

1 Press Δ ∇ to select “Preset Name”, then press ENTER.

2 Press Δ ∇ to select the preset channel, then press \triangleleft \triangleright to set.

3 Press \triangleleft \triangleright to move the cursor (■) to the desired position, then press Δ ∇ to select the character.

※ Up to 8 characters can be input. The characters that can be input are shown below.

A B C D E F G H I J K L M N O P Q R S T U V W X Y
Z a b c d e f g h i j k l m n o p q r s t u v w x y z 0 1 2
3 4 5 6 7 8 9
! " # % & ' () * + , - . / : ; < = > ? @ [\] (space)

4 Repeat step 3 to input the preset channel name.

※ To set the preset channel name back to how it was:
① Press \triangleleft \triangleright to highlight the preset channel, then press Δ ∇ .
② Press Δ ∇ to select “Default Yes”, then press \triangleleft .

5 Once all the characters have been input, press ENTER.

6 Press ENTER.

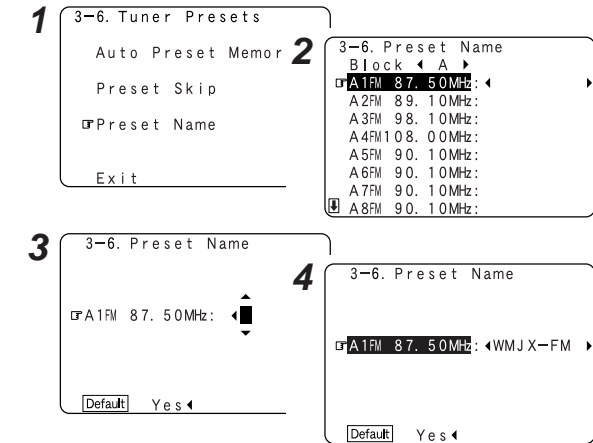

Advanced Setup – Part 1

Video Setup

Setting the HDMI In Assignment

The HDMI input terminals are assigned for the different input sources.

Select the HDMI audio signal playback method.

1 Press Δ ∇ to select “Video Setup”, then press ENTER.

2 Press Δ ∇ to select “HDMI In Assign”, then press ENTER.

3 Press Δ ∇ to select the input source, then press \triangleleft \triangleright to set.

HDMI1, HDMI2:

Assign the “HDMI1” or “HDMI2” input terminal to the input function.

4 Press Δ ∇ to select “Audio”, then press \triangleleft \triangleright to select where to output the audio signals.

AMP:

Output the speakers connected to the AVR-2807.

TV:

Output the TV connected to the AVR-2807.

5 If no audio signal is included in the input signal: Press Δ ∇ to select the input source, then press \triangleleft \triangleright to set.

EXT. IN, ANALOG:

If there is no HDMI audio signal, the signal automatically switches to the input from the set terminal.

6 Press ENTER.

Advanced Setup – Part 1

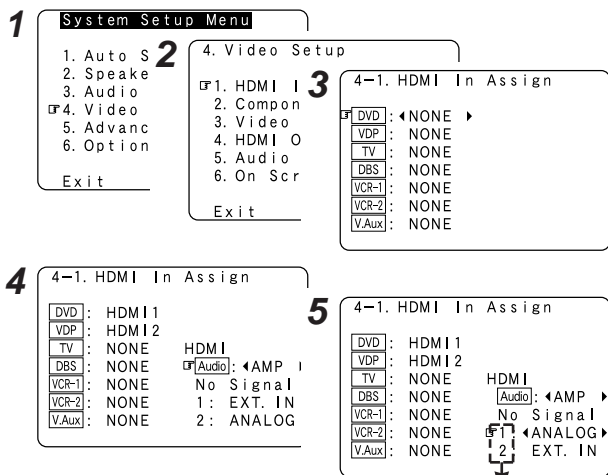

※ Compatible with HDMI1 and HDMI2.



- If a monitor is connected with an HDMI cable but the monitor is not compatible with HDMI audio signal playback, only the video signals are output to the monitor from the AVR-2807.
- Audio signals input from the analog and digital terminals are not output to the TV.
- With HDMI, the video and audio signals are transferred simultaneously. When HDMI is assigned to an input source, the digital audio input assignment switches to HDMI along with the video input. When this setting is made for input sources to which a digital audio input (COAXIAL or OPTICAL) is previously assigned, the digital audio assignment is set to HDMI. In this case, reassign the digital input using the procedure described at "Digital In Assign" (page 47).
- It is not possible to make the "HDMI In Assign" settings for the function assigned at "iPod Assign".

Setting the Component In Assignment

This assigns the component video input terminals for the different input sources.

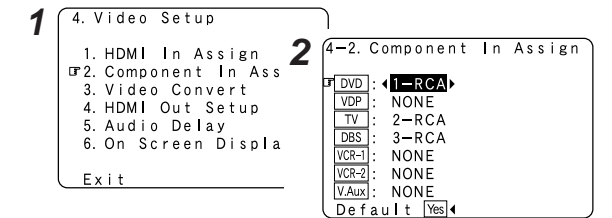
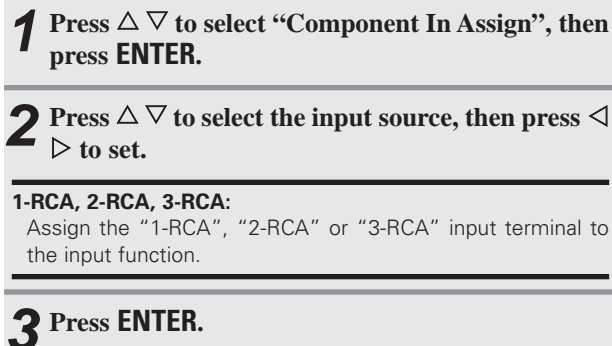

- Signals input to the component video input terminal are output simultaneously from component video monitor output terminals 1 and 2.
- It is not possible to make the "Component In Assign" settings for the function assigned at "iPod Assign".

Advanced Setup – Part 1

Setting the Video Convert

This sets whether or not to use the video conversion function.

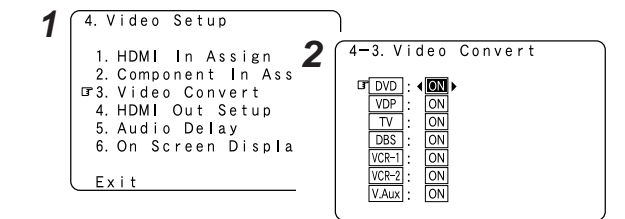
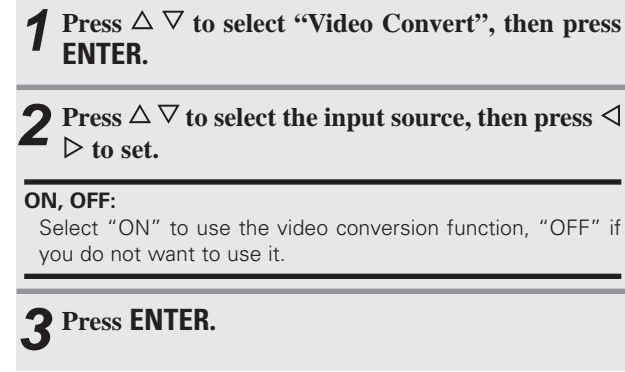

- If the resolution of the input component video signal is something other than 480i/576i, down-conversion from the component video signal to S-Video or video signals is not possible. If you do not want to use the component video output terminal, connect the player to the S-Video or video input terminal (page 14, 15).
- When a non-standard video signal from a game machine or some other source is input, the video conversion function might not operate. If this happens, please set the conversion mode to "OFF".
- When the video conversion function has been used, information such as that of text broadcasts which has been added to the video signal might not be output. If this happens, please set the conversion mode to "OFF".

Advanced Setup – Part 1

Setting the HDMI Out Setup

Set whether or not to up-convert from analog video signals to HDMI. When this function is used, the format of the signal output from the HDMI terminal can be set.

1 Press Δ ∇ to select “HDMI Out Setup”, then press **ENTER**.

2 Press Δ ∇ to select the item, then press \triangleleft \triangleright to set.

Analog to HDMI Convert:

- **ON:**
Setting for converting analog video signals into HDMI signals.
- **OFF:**
Setting for not converting analog video signals into HDMI signals.

i/p Convert:

- **ON:**
When the video input signal is a video, S-Video or 480i/576i component video signal, the resolution is converted to 480p/576p and the signal is output from the HDMI monitor output terminal.
- **OFF:**
The video input signal is output as such from the HDMI monitor output terminal without being converted.

Color Space:

- **Y Cb Cr:**
The Y Cb Cr format video signals is output via the HDMI output terminal.
- **RGB:**
The RGB format video signals is output via the HDMI output terminal.

RGB Mode Setup:

- **Normal:**
Signals are output via the HDMI output terminal with a digital RGB video range (data range) of 16 (black) to 235 (white).
- **Enhanced:**
Signals are output via the HDMI output connector with a digital RGB video range (data range) of 0 (black) to 255 (white).

3 Press **ENTER**.

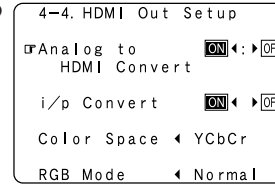
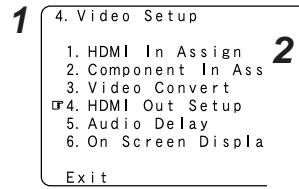

- When the HDMI terminals are connected, the black may seem to stand out, depending on the TV or the monitor. In this case, set this to “Enhanced”.
- When “Y Cb Cr” is selected under “Color Space”, “RGB Mode Setup” will have no effect.
- When “OFF” is selected under “i/p Convert”, the signal is output with the same resolution as input from the video, S-Video and component video terminals. The OSD, however, is output with a resolution of 480i, so use a monitor compatible with this resolution.
- “i/p Convert”, “Color Space” and “RGB Mode Setup” are only displayed when “Analog to HDMI Convert” is set to “ON”.
- When connecting to an HDCP compatible monitor equipped with DVI-D terminal using an HDMI/DVI-D converter cable, the signals are output in RGB format, regardless of the “Color Space” setting.
- To view the on screen display using an HDMI monitor, set “Analog to HDMI Convert” at “HDMI Out Setup” to “ON” (default).

Advanced Setup – Part 1

Setting the Audio Delay

Adjust the time delay between the video and audio signals.

1 Press Δ ∇ to select “Audio Delay”, then press **ENTER**.

2 Press \triangleleft \triangleright to set.

0 ms ~ 200 ms:

Adjust the time delay.

※ With a movie source, for example, adjust so that the movement of the actors’ lips is synchronized with the sound.

3 Press **ENTER**.

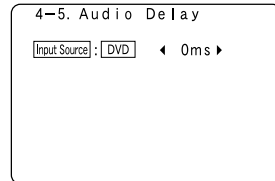
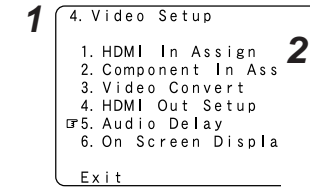

- By default, this menu is not displayed when no digital signals are being input.
- To make this setting for the component video signal, select the delay time and turn the on screen display off, then check that the timing of the component video and audio match.
- The audio delay setting does not apply when playing in the EXT. IN mode or in the analog input direct mode or stereo mode (Front speaker setting “Large”, TONE DEFEAT “ON” and Room EQ “OFF”).

Advanced Setup – Part 1

Setting the On Screen Display (OSD)

Set whether or not to display the on screen display for indications other than the menu screens.

1 Press Δ ∇ to select “On Screen Display”, then press ENTER.

2 Press Δ ∇ to select the item, then press \triangleleft \triangleright to set.

Function/Mode Status:

• **ON, OFF:**

Select “ON” to display the on screen display when the input source is selected, “OFF” if you do not want to display it.

Master Volume Status:

• **ON, OFF:**

Select “ON” to display the on screen display when the main volume is adjusted, “OFF” if you do not want to display it.

Display Mode:

• **Mode 1:**

Flickering is not prevented.

• **Mode 2:**

Prevents flickering of the on screen display when there is no video signal.

Use this mode if the on screen display is not displayed in “Mode1”.

3 Press ENTER.

1 4. Video Setup

1. HDMI In Assign
2. Component In Ass
3. Video Convert
4. HDMI Out Setup
5. Audio Delay
6. On Screen Display

Exit

2 4-6. On Screen Display

Function/Mode Status
 ON \triangleleft : \triangleright OFF

Master Volume Status
 ON \triangleleft : OFF

Display Mode
 Mode1 \triangleleft : \triangleright Mode2

Advanced Playback

Setting the 2ch Direct/Stereo

Make the 2-channel direct mode and stereo mode speaker settings.

1 Press Δ ∇ to select “Advanced Playback”, then press ENTER.

2 Press Δ ∇ to select “2ch Direct / Stereo”, then press ENTER.

- The current settings are displayed.

3 Press \triangleleft \triangleright to select “Custom”.

4 Press Δ ∇ to select the item, then press \triangleleft \triangleright to set.

Large:

Select this when using large speakers with ample low frequency reproduction capabilities.

Small:

Select this when using small speakers without ample low frequency reproduction capabilities.

Yes, No:

Select “Yes” when a subwoofer is connected, “No” when no subwoofer is connected.

LFE:

For any channel(s) that are set to “Large”, low frequencies in that channel’s corresponding source are directed to that loudspeaker only. The low frequencies played from the subwoofer are only the LFE signals and the low frequencies of channels set to “Small”.

LFE+Main:

Low frequencies from speaker channels that have been set to “Large” are reproduced from those speakers as well as from the subwoofer(s).

5 Press ENTER.

Advanced Setup – Part 1

1 System Setup Menu

1. Auto Setup/Room
2. Speaker Setup
3. Audio Input Setu
4. Video Setup
5. Advanced Playbac
6. Option Setup

Exit

2 5. Advanced Playback

1. 2ch Direct/Stereo
2. Dolby Digital Setup
3. Auto Surround Mode
4. Manual EQ Setup

Exit

3 5-1. 2ch Direct/Stereo

Setting : \triangleleft Basic \triangleright

Front : \triangleleft Large \triangleright

Subwoofer : \triangleleft Yes \triangleright

Subwoofer Mode : \triangleleft LFE \triangleright

5-1. 2ch Direct/Stereo

Crossover : 80Hz

Distance FL: 3.60m

FR: 3.60m

4 5-1. 2ch Direct/Stereo

Setting : \triangleleft Custom \triangleright

Front : \triangleleft Large \triangleright

Subwoofer : \triangleleft Yes \triangleright

Subwoofer Mode : \triangleleft LFE \triangleright

Advanced Setup – Part 1

Setting the Dolby Digital Downmix Option Setup

Turn the audio compression on or off when down-mixing Dolby Digital signals.

1 Press $\Delta \nabla$ to select “Dolby Digital Setup”, then press **ENTER**.

2 Press $\triangleleft \triangleright$ to set.

ON:

The dynamic range is compressed automatically according to the combination of speakers being used.
Set “Compression” to “ON” if it seems that sound is distorted because the input level exceeds the allowable input for the front speakers.

OFF:

The dynamic range is not compressed.
Normally using in this mode.

3 Press **ENTER**.

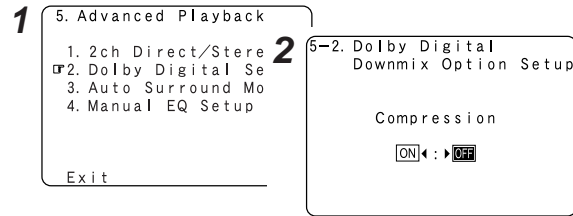

•When a center speaker or surround speakers are not connected, the sounds in those channels are directed to the front speakers.

Setting the Auto Surround Mode

Set whether or not to store the surround mode last played for the input signal.

The surround mode used at last for the 4 types of input signals shown below is stored in the memory, and the signal is automatically played with that surround mode the next time it is input.

- ① Analog and PCM 2-channel signals (STEREO)
 - ② 2-channel signals of Dolby Digital, DTS or other multi-channel format (DOLBY PLIIx Cinema)
 - ③ Multi-channel signals of Dolby Digital, DTS or other multi-channel format (DOLBY/DTS SURROUND)
 - ④ PCM multi-channel signals other than Dolby Digital and DTS (MULTI CH IN)
- ※ Default settings are indicated in ().
※ During playback in the PURE DIRECT mode, the surround mode does not change even if the input signal is changed.

1 Press $\Delta \nabla$ to select “Auto Surround Mode”, then press **ENTER**.

2 Press $\triangleleft \triangleright$ to set.

3 Press **ENTER**.

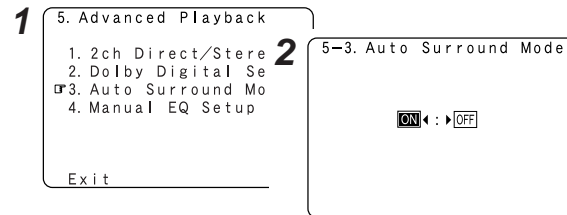

Advanced Setup – Part 1

Setting the Manual Equalizer Setup

Adjust the tone of the various speakers while listening to the playback signals.

1 Press $\Delta \nabla$ to select “Manual EQ Setup”, then press **ENTER**.

2 Press $\triangleleft \triangleright$ to set, then press **ENTER**.

All CH:

All channels can be adjusted simultaneously.

L/R CH:

The left and right channels of the pair of speakers can be adjusted simultaneously.

Each CH:

The channels can be adjusted separately.

3 Press $\triangleleft \triangleright$ to select the speaker.

※ The display changes as follows.

① Select “L/R CH”

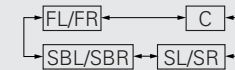

② Select “Each CH”

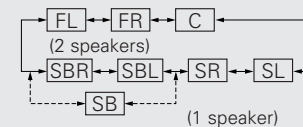

③ Select “All CH”

In this case, speaker selection is not performed.

4 Press $\Delta \nabla$ to select the frequency, then press $\triangleleft \triangleright$ to adjust.

※ The level of the various frequencies can be adjusted between -20 dB and +6 dB.

5 Press **ENTER**.

Advanced Setup – Part 1

1 5. Advanced Playback

- 2ch Direct/Stere
- Dolby Digital Se
- Auto Surround Mo
- Manual EQ Setup

Exit

2 5-4. Manual EQ

Default Yes ◀
Base Curve Copy ◀

Adjust CH ◀L/R CH ▶

Exit

3 Manual EQ ◀ Front L/R ▶

63Hz	0.0
125Hz	0.0
250Hz	0.0
500Hz	0.0
1 kHz	0.0
2 kHz	0.0
4 kHz	0.0
8 kHz	0.0
16 kHz	0.0

4 Manual EQ ◀ Front L/R ▶

63Hz	0.0	0.0
125Hz	0.0	0.0
250Hz	0.0	0.0
500Hz	0.0	0.0
1 kHz	0.0	0.0
2 kHz	0.0	0.0
4 kHz	0.0	0.0
8 kHz	0.0	0.0
16 kHz	0.0	0.0



- “Base Curve Copy” is displayed after performing the Auto Setup.

Manually adjusting the room equalizer’s “Flat” correction curve set with the auto setup procedure

1 Press Δ ∇ to select “Base Curve Copy”, then press \triangleleft .

2 Press \triangleleft to select “Yes”, then press ENTER.

- The type of the copied correction curve is displayed in the upper right of this screen.

1 5-4. Manual EQ

Default Yes ◀
Base Curve Copy ◀

Adjust CH ◀L/R CH ▶

Exit

2 5-4. Manual EQ

Curve: -Flat-

Base Curve Copy?

Yes ◀ : ▶ No

Option Setup

Setting the Power Amplifier Assignment

To suit your preference, a surround back channel’s power amplifier can be assigned to the front channel (“Front A” or “Front B”) for bi-amp playback, ZONE2.

1 Press Δ ∇ to select “Option Setup”, then press ENTER.

2 Press Δ ∇ to select “Power Amp Assign”, then press ENTER.

3 Press \triangleleft \triangleright to set.

S. Back:
The surround back speakers are used in MAIN ZONE.

Front A, Front B:
This provides a bi-amp mode for the 2 main front speakers, replicating the front A or front B amplifier channel’s outputs.

ZONE2:
This mode assigns the surround back amplifier channels to provide ZONE2 speaker-level outputs from the surround back speaker terminals.

4 Press ENTER.

Advanced Setup – Part 1

1 System Setup Menu

- Auto S
- Speake
- Audio
- Video
- Advanc
- Option

Exit

2 6. Option Setup

- Power
- Volume
- Trigge
- Setup

Exit

3 6-1. Power Amp Assign

S. Back : ◀S. Back ▶

Front Bi-Amp connections

Dynamic sound with a range wider than that of full range systems can be played by connecting bi-amp compatible speakers to the AVR-2807. Be sure to consult the owner’s manual of your bi-amp-capable speakers for further information before proceeding.

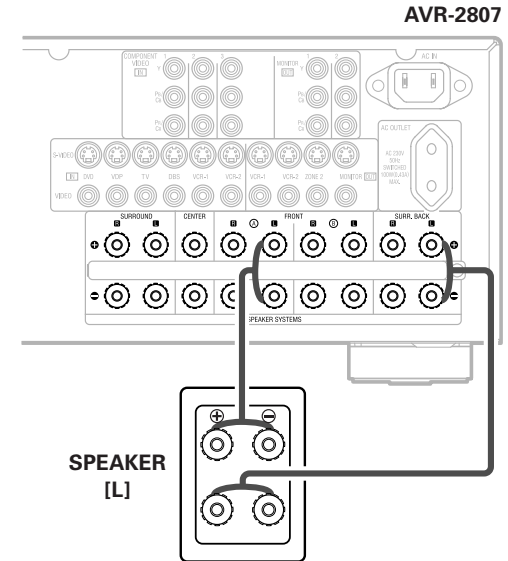

NOTE:

- When making bi-amp connections, be sure to remove the short-circuiting bar included with the speaker.

Advanced Setup – Part 1

Setting the Volume Control

This sets the volume level of output.

1 Press $\Delta \nabla$ to select “Volume Control”, then press **ENTER**.

2 Press $\Delta \nabla$ to select the item, then press $\triangleleft \triangleright$ to set.

Vol. Limit:

Set the volume’s upper limit.

• **OFF:**

If you do not want to set a volume limit, select “OFF”.

In this case, the volume can be set to the AVR-2807’s maximum volume (output) level of +18 dB, which is extremely loud.

• **-20 dB, -10 dB, 0 dB:**

The volume cannot be increased above the selected levels.

P. On Lev.:

Set the volume level when the power is turned on.

You can adjust the MAIN ZONE volume level within the range of -80 to +18 dB (and ZONE2 volume level within the range of -70 to +18 dB).

• **LAST**

The volume set when the AVR-2807 was last used is stored in the memory and set when the power is turned on.

• **--- (Mute)**

The volume is always muted when the power is turned on.

Mute Lev.:

Set the level of volume attenuation in the mute mode.

• **FULL**

The volume is fully muted.

• **-20 dB, -40 dB**

The volume is lowered 20 dB (or 40 dB) from the current level.

3 Press **ENTER**.

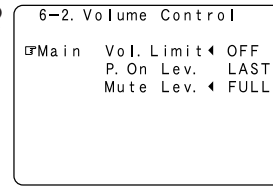
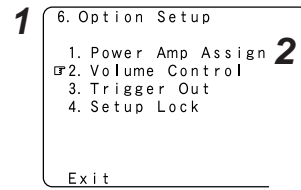

- When the power amplifier is assigned to either of the ZONE2 channels at “Power Amp Assign”, “-VAR-” (only variable) is displayed and the fixed level cannot be set.

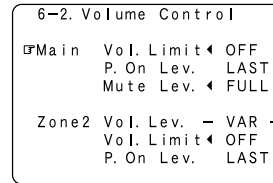

Setting the Trigger Out

Use the DC12V output of the AVR-2807’s 2 trigger out jacks in association with the various input sources and surround modes. If “ZONE = MAIN” is selected, settings can be made for the individual surround modes.

1 Press $\Delta \nabla$ to select “Trigger Out”, then press **ENTER**.

2 Press $\Delta \nabla$ to select the trigger out jacks, then press **ENTER**.

3 Press $\triangleleft \triangleright$ to select “MAIN” or “ZONE2”.

※ The power supplied from the trigger out jack turns on and off when the power for the set zone is turned on and off.

4 Press $\Delta \nabla$ to select the input source, then press $\triangleleft \triangleright$ to set.

ON, OFF:

When that input source is selected, the power supplied from the trigger out jack turns on (or off).

5 When “MAIN” was selected at step 3: Press $\Delta \nabla$ to select the surround mode, then press $\triangleleft \triangleright$ to set.

ON:

If “ON” is selected when an input source set to “ON” is selected, the power supplied from the trigger out jack turns on.

OFF:

If “OFF” is selected when an input source set to “ON” is selected, the power supplied from the trigger out jack turns off.

6 Press **ENTER**.

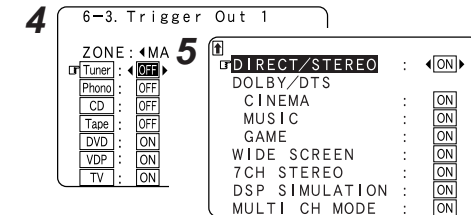
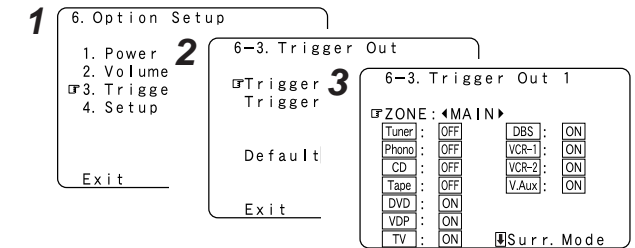

Advanced Setup – Part 1

Advanced Setup – Part 1

Setting the Setup Lock

This sets whether or not to lock the system setup settings so that they cannot be changed.

1 Press Δ ∇ to select “Setup Lock”, then press **ENTER**.

2 Press \triangleleft to select “ON”, then press **ENTER**.

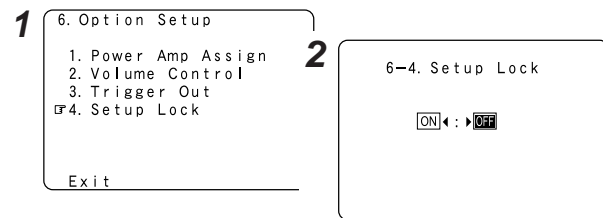

- When the setup lock function is activated, the settings listed below cannot be changed, and “SETUP LOCKED!” is displayed when related buttons are operated.
 - System setup settings
 - Surround parameter settings
 - Tone control settings
 - Channel level settings (including test tones)
 - Room EQ settings
- To unlock, press **SYSTEM SETUP** again and display the “Setup Lock” screen, then select “OFF” and press **ENTER**.

Advanced Setup – Part 2

Speaker Setup

- If the “Auto Setup” procedure has already been performed, there is no need to make this setting.
- Perform this setting if you wish to make the settings for your speaker systems manually.

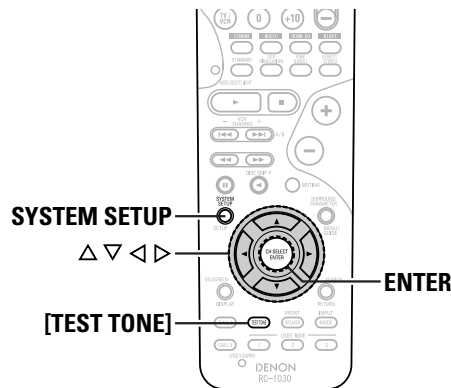
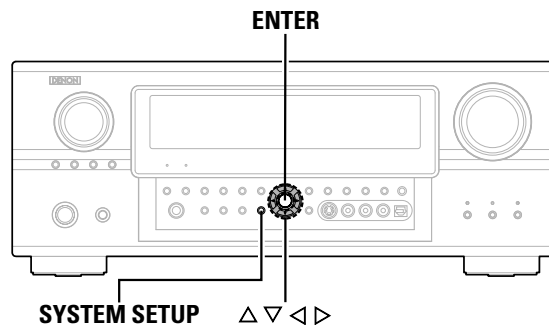

About the button names in this explanation
 \triangleleft \triangleright : Buttons on the main unit
 [] : Buttons on the remote control unit
Button name only :
 Buttons on the main unit and remote control unit

Setting the Speaker Configuration

Automatically set the output component and properties for the various channels according to the combination of speakers to be actually used for surround playback.

1 Press Δ ∇ to select “Speaker Setup”, then press **ENTER**.

2 Press Δ ∇ to select “Speaker Config.”, then press **ENTER**.

3 Press Δ ∇ to select the speaker, then press \triangleleft \triangleright to set.

Large:

Select this when using large speakers with ample low frequency reproduction capabilities.

Small:

Select this when using small speakers without ample low frequency reproduction capabilities.

None:

Select this when no speaker is connected.

Yes / No:

Select “Yes” when a subwoofer is connected, “No” when no subwoofer is connected.

2spkr / 1spkr:

Select the number of surround back speakers.

※ A subwoofer with sufficient low frequency playback capability can better handle deep bass than most main and surround speakers, and the system’s overall performance will be greatly enhanced when “Small” is set for the main (front) and surround speakers.

※ When “Front” is set to “Small”, “Subwoofer” is automatically set to “Yes”, and when “Subwoofer” is set to “No”, “Front” is automatically set to “Large”.

4 Press **ENTER**.

Advanced Setup – Part 2

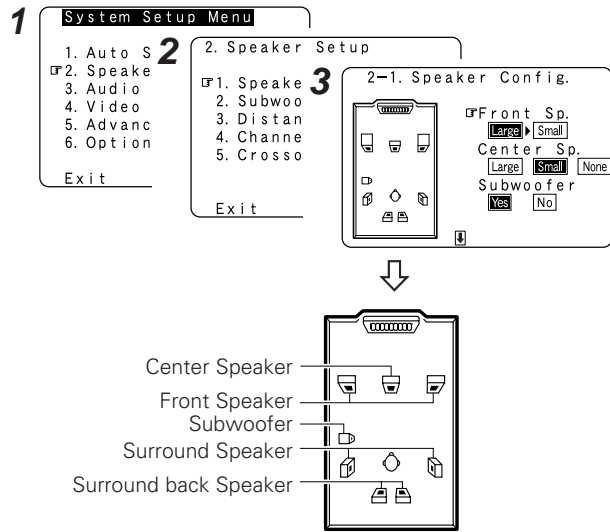

- Select “Large” or “Small” not according to the actual size of the speaker but according to the speaker’s capacity for playing low frequency (bass sound below the frequency set for the Crossover Frequency) signals. If you do not know, try comparing the sound at both settings (setting the volume to a level low enough so as not to damage the speakers) to determine the proper setting.

Setting the Subwoofer Setup

Select the method of playback of the subwoofer for playing the low bass signals.

1 Press Δ ∇ to select “Subwoofer Setup”, then press ENTER.

2 Press \triangleleft \triangleright to set.

LFE:

For any channel(s) that are set to “Large”, low frequencies in that channel’s corresponding source are directed to that loudspeaker only. The low frequencies played from the subwoofer are only the LFE signals and the low frequencies of channels set to “Small”.

LFE+Main:

Low frequencies from speaker channels that have been set to “Large” are reproduced from those speakers as well as from the subwoofer(s).

3 Press ENTER.

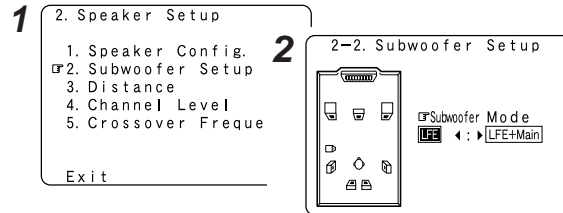

- The subwoofer mode setting is only valid when and “Yes” is set for the subwoofer in the “Setting the Speaker Configuration”.
- Select the “LFE+Main” mode if you want low frequency signals to always be played from the subwoofer channel.
- Select the mode achieving a voluminous bass sound when playing music or movie sources.

Advanced Setup – Part 2

Setting the Distance

This parameter is for optimizing the timing with which the audio signals are produced from the speakers and subwoofer according to the listening position.

Preparations:

Measure the distances between the listening position and the speakers (L1 to L8 on the diagram at the below).

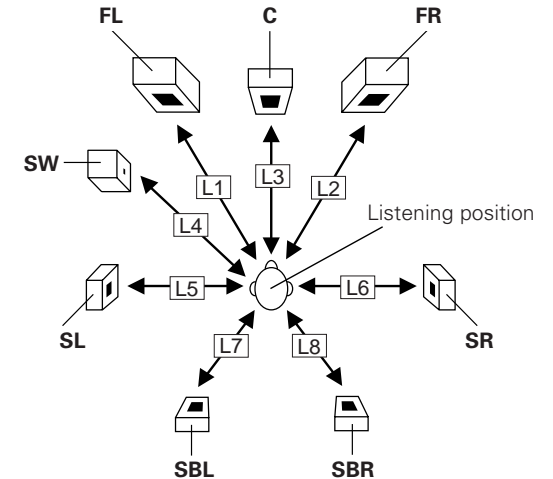

1 Press Δ ∇ to select “Distance”, then press ENTER.

2 Press \triangleleft \triangleright to select “Meters” or “Feet”.

Advanced Setup – Part 2

3 Press Δ ∇ to select the speaker, then press \triangleleft \triangleright to set.

4 Press ENTER.

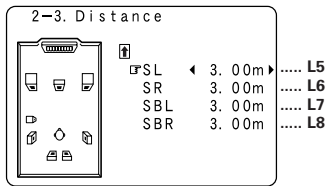
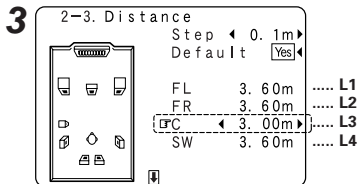
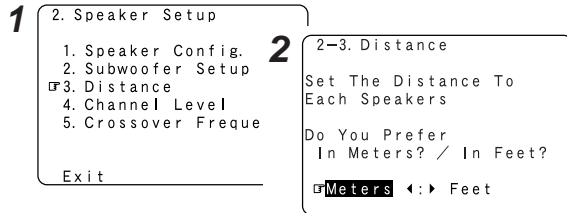

- Press Δ to select “Step”, then press \triangleleft \triangleright to change the amount of variation if so desired.
- The distance changes in units of 0.1 meters (1 foot) or 0.01 meters (0.1 foot) each time the button is pressed. Select the value closest to the measured distance.
- Please note that the difference of distance for every speaker should be 6.0 m (20 ft) or less. If you set an invalid distance, a CAUTION notice, such as screen right will appear. In such cases, move the appropriate speaker to the position of the displayed value.

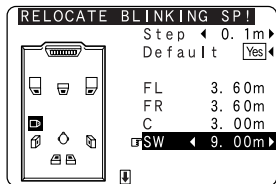

Setting the Channel Level

Set the volume of the various speakers so that the sound output from the speakers and the subwoofer seems to have the same volume level.

1 Press Δ ∇ to select “Channel Level”, then press ENTER.

2 Press \triangleleft \triangleright to set.

Auto:

Adjust the level while listening to the test tones produced automatically from each speaker. Test tones are automatically emitted from each speaker.

Manual:

Adjust with the speaker from which the test tone is output switched manually.

3 Press Δ ∇ to select “Test Tone Start”, then press \triangleleft to select “Yes”.

4 When “Auto” mode is selected: Press \triangleleft \triangleright to adjust the volume.

- 1 • Test tones are output automatically, in the order shown below.

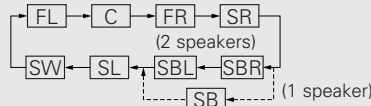

※ The volume can be adjusted within the range -12 dB to +12 dB.

4 When “Manual” mode is selected: Press Δ ∇ to select the speaker, then press \triangleleft \triangleright to adjust the volume.

5 Press ENTER.

Advanced Setup – Part 2

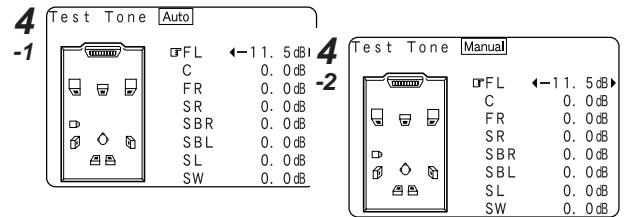
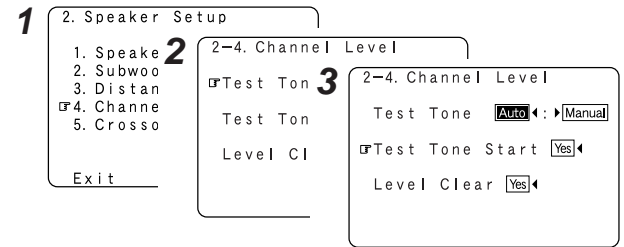

- To cancel the setting, press ∇ and select “Level Clear”, then press \triangleleft and select “Yes”.

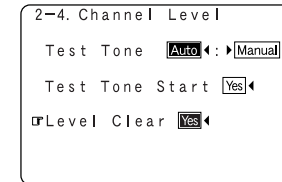

- To adjust the channel level separately for the different play modes after setting the channel level, perform the operation on page 34.

Advanced Setup – Part 2

■ Adjusting the test tone using the remote control unit

Adjustment of the test tones using the remote control unit is only possible in the “Auto” mode and only valid in the STANDARD (Dolby Surround and DTS Surround) mode. The adjusted levels are automatically stored for the different surround modes.

- 1 Press [TEST TONE].
 - Test tones are output from the different speakers.
- 2 Press ◀ ▶ to adjust the volume.
- 3 Press [TEST TONE].

Setting the Crossover Frequency

Set the frequency (Hz) below which the bass sound of the various speakers is to be output from the subwoofer. For speakers that are set to “Small”, frequencies under the crossover frequency are cut before the signal is output, and the low frequency component that was cut is output from the subwoofer or the speakers that are set to “Large”.

- 1 Press △ ▽ to select “Crossover Frequency”, then press ENTER.
- 2 Press ◀ ▶ to set.

40, 60, 80, 90, 100, 110, 120, 150, 200, 250 Hz:
Set as desired according to your speakers' bass playback ability.

Advanced:
The crossover frequency can be set individually for the different speakers.
- 3 Press ENTER.

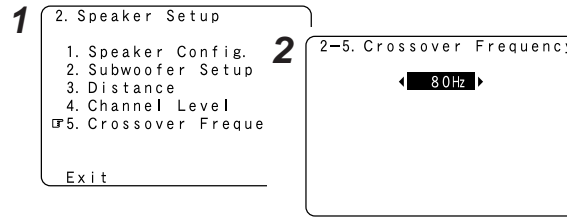

- The crossover frequency mode is valid only when subwoofer is set to “ON”, and when one or more speakers are set to “Small”, as described in section “Setting the Speaker Configuration” (page 56, 57).
- If “LFE+Main” is set at “Subwoofer Setup”, “SW:LFE+Main” (page 57) is displayed at the top right of the screen.

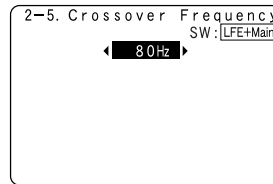

- Set to “80 Hz” when using regular speakers. When using small speakers, we recommend setting to a higher frequency.

Advanced Setup – Part 2

■ Setting the crossover frequency individually for the different channels

- 1 Press ◀ ▶ to select “Advanced” at the “Crossover Frequency” screen.
- 2 Press △ ▽ to select the speaker, then press ◀ ▶ to set.
- 3 Press ENTER.

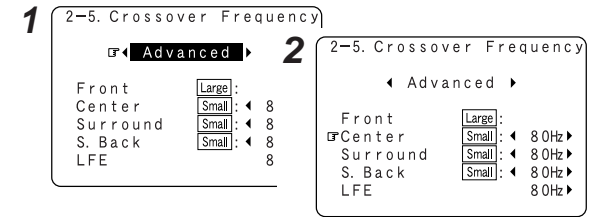

- If “LFE” is selected at “Setting the Subwoofer Setup” (page 57), the frequencies can only be selected for speakers set to “Small” at “Setting the Speaker Configuration” (page 56, 57).

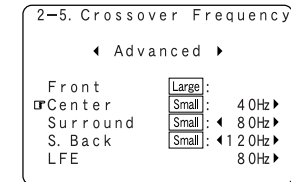

- If “LFE+Main” is set at “Setting the Subwoofer Setup” (page 57), the frequencies can be selected regardless of the speaker size setting.

Advanced Setup – Part 2

Others Setup

Setting the Room Equalizer Setup

Set the Room Equalizer setting with “All” or “Assign” for each surround mode.

1 Press Δ ∇ to select “Room EQ Setup”, then press **ENTER**.

2 Press \triangleleft \triangleright to set, then press **ENTER**.

All:
Sets the equalizer for all surround modes.

Assign:
Sets the equalizer individually for each surround mode (👉 page 24).

3 When “All” is selected:
Press \triangleleft \triangleright to set.

OFF:
The equalizer is not used.

Audyssey:
Adjusts the frequency response of all speakers to correct the effects of room acoustics.

Front:
Adjusts the frequency response of the surround speakers to match the characteristics of the front channel speakers.

Flat:
Adjusts the frequency response of all speakers to the flattest response. This mode is suitable for multi-channel music surround sound sources.

Manual:
Selects the setting value that was set in the “Setting the Manual Equalizer Setup” (👉 page 53, 54).

4 Press **ENTER**.

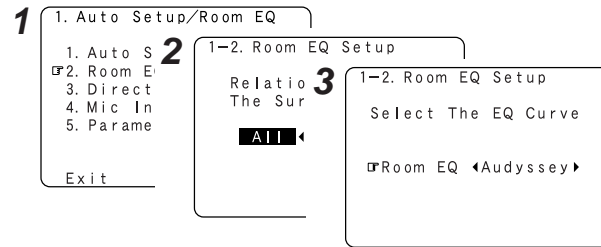

- The equalizer setting of “Audyssey”, “Front” and “Flat” can be selected after performing the Auto Setup.
- When the speaker set as “None” with the Auto Setup is changed to on manually, the equalizer of “Audyssey”, “Front” and “Flat” cannot be used.
- When headphones are connected, the Room Equalizer cannot be used.

Advanced Setup – Part 2

Setting the Direct Mode Setup

Set the ON/OFF setting of Room Equalizer, in the case of the surround mode is in “Direct” or “Pure Direct”.

1 Press Δ ∇ to select “Direct Mode Setup”, then press **ENTER**.

2 Press \triangleleft \triangleright to set.

ON, OFF:
Select “ON” to use the room equalizer, “OFF” if you do not want to use it.

3 Press **ENTER**.

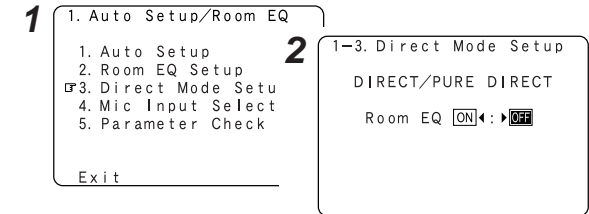

Advanced Setup – Part 2

Setting the MIC Input Select

Sets whether the setup microphone is connected to the pin jack (V. AUX L channel) or mini jack (SETUP MIC).

1 Press $\Delta \nabla$ to select “Mic Input Select”, then press ENTER.

2 Press $\triangleleft \triangleright$ to set.

Mic:
Select this to use the included microphone.
Normally set to this setting.

V.Aux L:
Select this when using a microphone other than the one included.

3 Press ENTER.

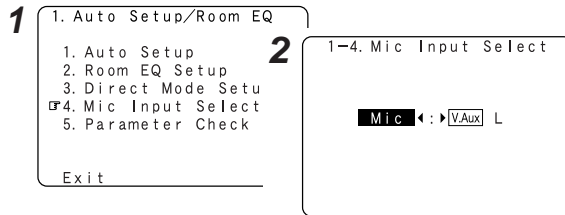

Check the parameter

1 Press $\Delta \nabla$ to select “Parameter Check”, then press ENTER.

2 Press $\Delta \nabla$ to select the item, then press ENTER.

※ For instructions on checking the results of each item (page 12).

3 Press $\Delta \nabla$ to select “EQ Parameter Check”, then press ENTER.

4 Press $\Delta \nabla$ to select the type of equalizer, then press ENTER.

5 Press $\triangleleft \triangleright$ to select the speaker.

※ The display is only an approximate picture of the response and that correction is happening at all frequencies.

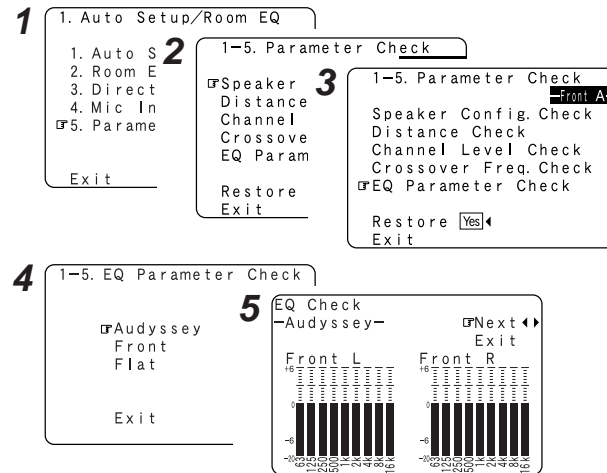

Advanced Setup – Part 2



- To reset:
Press $\Delta \nabla$ to select “Restore” at the “Parameter Check” screen, then press \triangleleft .

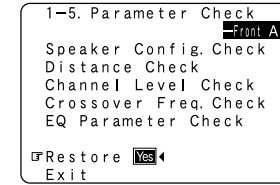

Operating the remote control unit

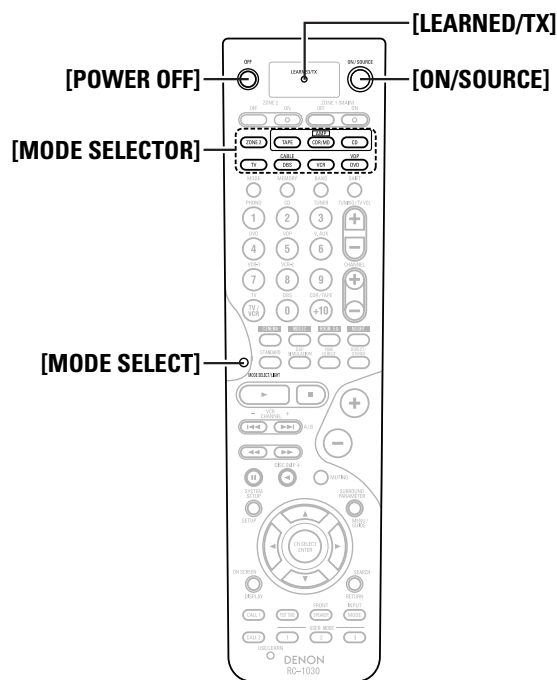

- It may not be possible to use some of the buttons, depending on the model and age of your equipment.

Operating DENON audio components

1 Press [MODE SELECTOR] or [MODE SELECT] for the device to be operated.

- The button for the selected mode lights.

※ The mode switches as shown below each time [MODE SELECT] is pressed:

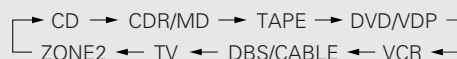

2 Operate the component.

※ For details, refer to the component's operating instructions.

Setting the preset memory function

The various devices can be operated by setting the preset memory on the included remote control unit.

For some models the remote control unit or the device may not operate properly. In this case, use the learning function (page 64) to store your device's remote control signals in the included remote control unit.

1 Press [ON/SOURCE] and [POWER OFF] at the same time.

- The "LEARNED/TX" indicator blinks.

2 Press [MODE SELECTOR] for the device to be set in the preset memory.

- [MODE SELECTOR] and the "LEARNED/TX" indicator blinks.

3 Input the (4-digit) number for the brand of the device to be set in the preset memory, as shown on the list of preset codes (End of this manual).

- When stored correctly, [MODE SELECTOR] and the "LEARNED/TX" indicator lights.



- There may be several preset codes for some brands. If the remote control unit does not work properly with one code, try inputting another code.
- Buttons that have been learned have priority over the signals set with the preset memory function. If a learned button setting is not needed, please erase it (page 65).

NOTE:

- The preset memory can be set for one component only among the following: CDR/MD, DVD/VDP and DBS/CABLE.

Operating the remote control unit

Operating a component stored in the preset memory

1 Press **[MODE SELECTOR]** for the device to be operated.

2 Operate the component.

※ For details, refer to the component's operating instructions.

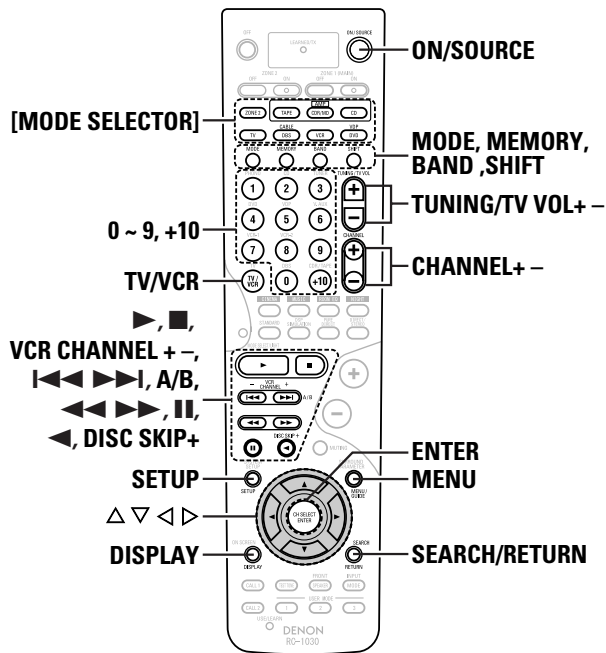

Special remarks:

- ① It is only possible to set the preset memory for one device per mode. When a new code is preset, the previous code is automatically deleted.
- ② Note that the function names of the DVD buttons on the remote control unit may differ for some brands. Check beforehand.
- ③ The CD, VCR or DVD buttons can be assigned to a TV or satellite tuner (or cable TV) (page 65).

Operating the remote control unit

■ Functions of buttons for the different devices

Device operated	CD player	CD recorder or MD recorder	Tape deck	Tuner	DVD player or Video disc player	Video deck	Satellite tuner or Cable TV	TV (Monitor)
MODE SELECTOR	CD	CDR / MD	TAPE	AMP (CD, CDR/MD or TAPE)	DVD / VDP	VCR	DBS / CABLE	TV
ON / SOURCE	-	-	-	-	Power on/Standby	Power on/Standby	Power on/Standby	Power on/Standby
MODE	-	-	-	Auto/Manual switching	-	-	-	-
MEMORY	-	-	-	Preset memory	-	-	-	-
BAND	-	-	-	AM/FM switching	-	-	-	-
SHIFT	-	-	-	Preset channel selection	-	-	-	-
0 ~ 9, +10	-	-	-	-	Number input/Track selection	-	Channels	Channels
TUNING / TV VOL + -	-	-	-	Tuning	-	-	Volume control	Volume control
CHANNEL + -	-	-	-	Preset channel selection	-	Station selection	Channel selection	Channel selection
▶	Play	Play	Play	-	Play	Play	-	-
■	Stop	Stop	Stop	-	Stop	Stop	-	-
VCR CHANNEL + - / I◀▶II	Auto search (to beginning of track)	Auto search (to beginning of track)	-	-	Auto search (to beginning of track)	Channel selection	-	-
A / B	-	-	A/B switching	-	-	-	-	-
◀▶▶▶	Manual search (forward/reverse)	Manual search (forward/reverse)	Fast forward/Rewind	-	Manual search (forward/reverse)	Manual search (forward/reverse)	-	-
II	Pause	Pause	Pause	-	Pause	Pause	-	-
◀	-	-	Reverse play	-	-	-	-	-
DISC SKIP +	Disc skip (for CD changer only)	-	-	-	Disc skip (for DVD changer only)	-	-	-
SETUP	-	-	-	-	Setup	-	-	-
MENU	-	-	-	-	Menu	-	Menu	Menu
DISPLAY	-	-	-	-	Display selection	-	Display selection	Display selection
RETURN / SEARCH	-	-	-	RDS search	Return	-	Return	Return
△▽◀▶	-	-	-	-	Cursor operation	-	Cursor operation	Cursor operation
ENTER	-	-	-	-	Enter	-	Enter	Enter
TV / VCR	-	-	-	-	-	Input mode selection	Input mode selection	Input mode selection
Default setting (preset code)	DENON (0000)	DENON CDR (0000)	DENON (0000)	-	DENON DVD (0000)	HITACHI (3010)	ABC CABLE (4007)	HITACHI (4539)
Special remarks	①	①	①	①	①, ②	①	①, ③	①, ③

Operating the remote control unit

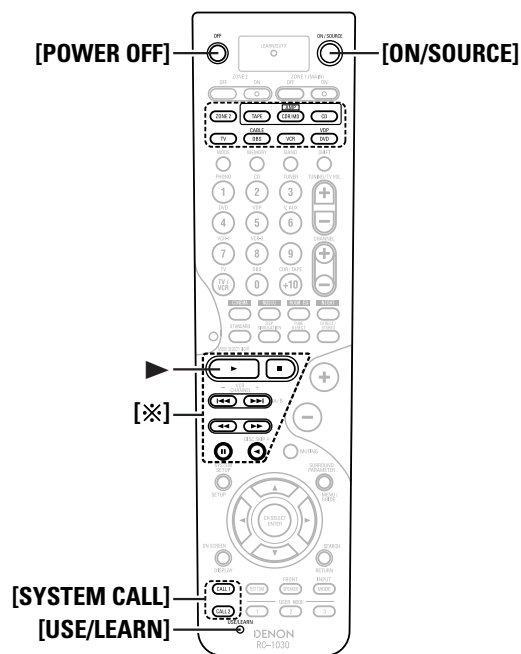

Setting the learning function

- If your AV device is a brand other than DENON or if operation is not possible using the preset memory function, the signals of a remote control unit of that device can be stored in the AVR-2807's remote control unit.
- For some remote control units, it may not be possible to learn the signals or the device may not operate properly after the signals are learnt. In this case, use the remote control unit of that device.

1 Press **[USE/LEARN]** with the tip of a pen etc., to set the learn mode.

- **[MODE SELECTOR]** and the "LEARNED/TX" indicator blinks.

2 Press **[MODE SELECTOR]** for the device to be operated.

- **[MODE SELECTOR]** and the "LEARNED/TX" indicator blinks.

3 Press the button to be set.

- The "LEARNED/TX" indicator stops blinking and **[MODE SELECTOR]** lights.

※ If a button that cannot be learnt is pressed, **[MODE SELECTOR]** and the "LEARNED/TX" indicator blinks.

4 Point the remote control units straight at each other and press and hold in the button on the other remote control unit to be learnt on the AVR-2807's remote control unit.

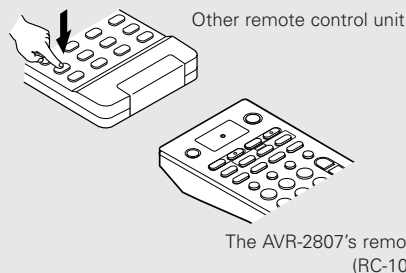

5 **[MODE SELECTOR]** and the "LEARNED/TX" indicator lights, release the button on the other remote control unit.

- **[MODE SELECTOR]** and the "LEARNED/TX" indicator blinks again.

※ Other buttons can be learnt by repeating steps 2 ~ 5.

6 Press **[USE/LEARN]**.



- To cancel the learning function mode, press **[USE/LEARN]**.
- If the codes could not be stored, the "LEARNED/TX" indicator start flashing rapidly. For limited number of models, codes cannot be stored in RC-1030.
- If **[MODE SELECTOR]** and the "LEARNED/TX" indicator start flashing rapidly, this means that the memory is already full, and the code you have just attempted to store was not stored. To "learn" that code, first perform the resetting operation (see page 65).

Operating the remote control unit

Using the system call function

- A series of operations can be registered at a single button.
- This function makes it possible to for example turn the amplifier's power on, select the input source, turn the monitor power's on, turn the source device's power on and start playback, all by pressing a single button once.
- Up to 10 signals each can be stored at **[SYSTEM CALL]** (1 or 2).

Registering

1 Press **[ON/SOURCE]** and **[POWER OFF]** at the same time.

- The "LEARNED/TX" indicator blinks.

2 Press **[SYSTEM CALL 1]**.

- The unit enters the system call mode, and the **[MODE SELECTOR]** and the "LEARNED/TX" indicator light.

※ Press **[SYSTEM CALL 1]** even when you want to register at **[SYSTEM CALL 2]**.

3 Press **[MODE SELECTOR]** for the device you want to register in the system call memory.

4 Press the buttons whose operations you want to register in the order in which the operations are to be performed.

Example: Press **[ON]**.

↓
Press **[CD]** of **[MODE SELECTOR]**.

↓
Press **[▶]**.

※ Repeat steps 3, 4 to register the desired buttons.

5 Press the system call button at which you want to register the operations (**[SYSTEM CALL 1]** or **[SYSTEM CALL 2]**).

Operating

Press **[SYSTEM CALL]** (1 or 2) at which the operation are registered.

- The stored signals are transmitted successively.

Operating the remote control unit

Setting the punch through function

CD, CDR/MD, TAPE, DVD/VDP or VCR mode buttons can be assigned to unused TV and DBS/CABLE mode buttons.

For example, when CD mode operations are assigned to TV mode buttons, the CD mode can be operated while in the TV mode ([※]).

- 1** Press **[ON/SOURCE]** and **[POWER OFF]** at the same time.
 - The “LEARNED/TX” indicator blinks.
- 2** Press **[▶]**.
 - **[MODE SELECTOR]** (TV and DBS/CABLE) and the “LEARNED/TX” indicator blinks.
- 3** Press **[MODE SELECTOR]** for which punch through is to be set (TV or DBS/CABLE).
 - **[MODE SELECTOR]** (CD, CDR/MD, TAPE, DVD/VDP or VCR) and the “LEARNED/TX” indicator blinks.
- 4** Press **[MODE SELECTOR]** for the device to be punched through (CD, CDR/MD, TAPE, DVD/VDP or VCR).
 - **[MODE SELECTOR]** that was set will light.

Operating the remote control unit

Resetting the remote control unit

Resetting the learning function

- 1** Press **[USE/LEARN]** with the tip of a pen etc., to set the learn mode.
 - **[MODE SELECTOR]** and the “LEARNED/TX” indicator blinks.
- 2** Press **[MODE SELECTOR]** for the device to be reset.
 - **[MODE SELECTOR]** and the “LEARNED/TX” indicator blinks.
- 3** Hold for 4 seconds or longer **[MODE SELECTOR]** of the equipment that is to be reset and **[ON/SOURCE]**.
 - **[MODE SELECTOR]** and the “LEARNED/TX” indicator blinks again.
- 4** Press **[USE/LEARN]**.

Resetting the punch through setting

- 1** Press **[ON/SOURCE]** and **[POWER OFF]** at the same time.
 - The “LEARNED/TX” indicator blinks.
- 2** Press **[▶]**.
 - **[MODE SELECTOR]** (TV or DBS/CABLE) and the “LEARNED/TX” indicator blinks.
- 3** Press **[MODE SELECTOR]** (TV or DBS/CABLE) that is to be reset.
 - **[MODE SELECTOR]** (CD, CDR/MD, TAPE, DVD/VDP or VCR) and the “LEARNED/TX” indicator blinks.
- 4** Press **[MODE SELECTOR]** of the equipment that is to be reset again.

Additional Information

About the speakers

Surround back speakers

Sound position directly to the rear can be achieved easily by adding a surround back speaker to a 5.1-channel system. In addition, the acoustic image extending between the sides and the rear is narrowed, thus greatly improving the expression of the surround signals for sounds moving from the sides to the back and from the front to the point directly behind the listening position.

Change of positioning and acoustic image with 5.1-channel systems

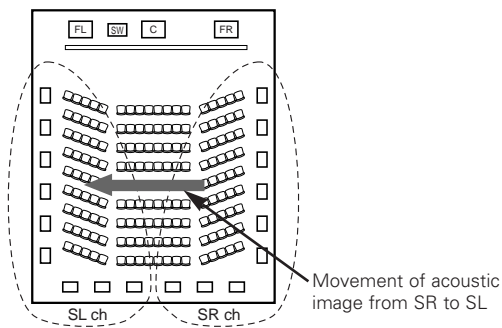

Change of positioning and acoustic image with 6.1-channel systems

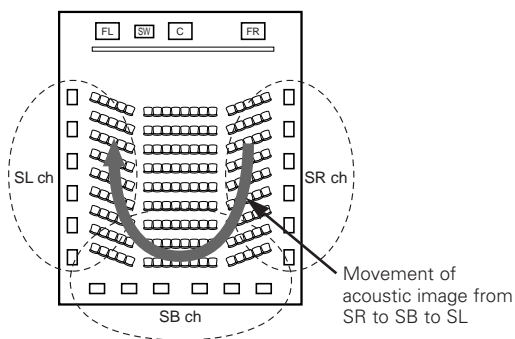

In addition to sources recorded in 6.1-channels, the surround effect of conventional 2- to 5.1-channel sources can also be enhanced.

Number of surround back speakers

We recommend using 2 speakers.

When using dipolar speakers in particular, be sure to use 2 speakers.

Placement of the surround left and right channels when using surround back speakers

We recommend installing the speakers for the surround "L" and "R" channels a bit forward.

Examples of speaker layouts

Below we introduce examples of speaker layouts. Refer to these to arrange your speakers according to their type and how you want to use them.

[1] Using surround back speaker(s)

① When mainly playing movies

Recommended when your surround speakers are single or 2-way speakers.

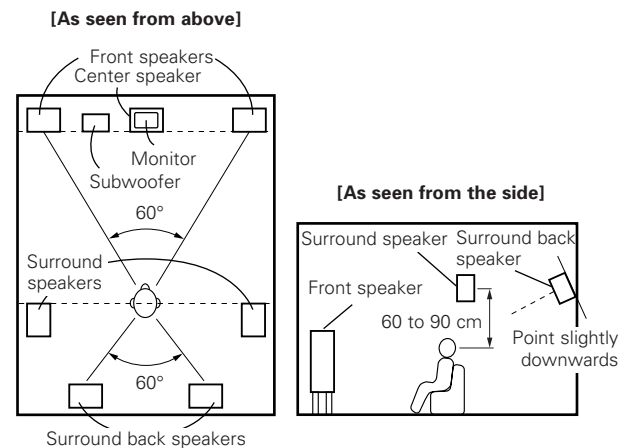

② When playing movies and musics

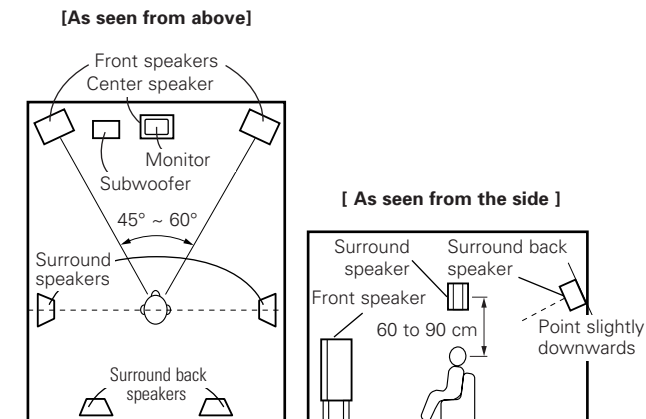

[2] When not using surround back speakers

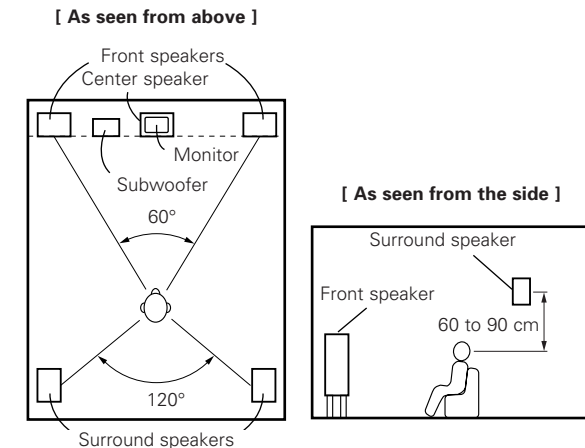

Additional Information

Surround

The AVR-2807 is equipped with a digital signal processing circuit that lets you play program sources in the surround mode to achieve the same sense of presence as in a movie theater.

Dolby Surround**[1] Dolby Digital**

Dolby Digital is the multi-channel digital signal format developed by Dolby Laboratories.

A total of 5.1-channels are played: 3 front channels ("FL", "FR" and "C"), 2 surround channels ("SL" and "SR") and the "LFE" channel for low frequencies.

Because of this, there is no crosstalk between channels and a realistic sound field with a "three-dimensional" feeling (sense of distance, movement and positioning) is achieved.

A real, overpowering sense of presence is achieved when playing movie sources in AV rooms as well.

[2] Dolby Pro LogicII

Dolby Pro LogicII is a matrix decoding technology developed by Dolby Laboratories. Regular music such as that on CDs is encoded into 5 channels to achieve an excellent surround effect. The surround channel signals are converted into stereo and full band signals (with a frequency response of 20 Hz to 20 kHz or greater) to create a "three-dimensional" sound image offering a rich sense of presence for all stereo sources.

[3] Dolby Pro LogicIIx

Dolby Pro LogicIIx is a further improved version of the Dolby Pro LogicII matrix decoding technology.

Audio signals recorded in 2 channels are decoded to achieve a natural sound with up to 7.1-channels.

There are 3 modes: "Music" suited for playing music, "Cinema" suited for playing movies, and "Game" which is optimum for playing games.

■ Sources recorded in Dolby Surround

Sources recorded in Dolby Surround are indicated with the following logo marks.

Dolby Surround support mark: 

Manufactured under license from Dolby Laboratories. "Dolby", "Pro Logic" and the double-D symbol are trademarks of Dolby Laboratories.

DTS Digital Surround

DTS Digital Surround is a digital surround format developed by Digital Theater Systems of the United States.

The number of playback channels and the playing band is the same as for Dolby Digital (5.1-channels).

The compression rate of the audio data when it was recorded on the medium is lower than for Dolby Digital, so there is more information when the data is decoded, resulting in richer, clearer sound quality.

MANUFACTURED UNDER LICENSE FROM DIGITAL THEATER SYSTEMS, INC.

U.S. PAT. NO'S. 5,451,942; 5,956,674; 5,974,380; 5,978,762; 6,226,616; 6,487,535 AND OTHER U.S. AND WORLD-WIDE PATENTS ISSUED AND PENDING.

"DTS", "DTS-ES", "Neo:6", AND "DTS 96/24" ARE TRADEMARKS OF DIGITAL THEATER SYSTEMS, INC. © 1996, 2003 DIGITAL THEATER SYSTEMS, INC. ALL RIGHTS RESERVED.

DTS-ES™

DTS-ES is a new surround format developed by Digital Theater Systems.

A sound image and sense of positioning can be achieved by adding a surround back ("SB") channel to the conventional 5.1-channels.

DTS-ES™ Discrete 6.1:

This is the latest format, in which all 6.1-channels, including the "SB" channel, are recorded independently. Since the different channels are independent, the sound can be designed with total freedom.

DTS-ES™ Matrix 6.1:

With this format, the "SB" channel is matrix-encoded and inserted into the "SL" and "SR" channels, then decoded for the "SL", "SR" and "SB" channels upon playback. This achieves a surround sound more faithful to the artist's sound design intentions than with conventional 5.1- or 6.1-channel systems.

Additional Information

DTS NEO:6 surround

This is a matrix decoding technology for 6.1-channel surround playback of 2-channel sources.

The optimum decoding for the type of signal source to be played can be selected. There are 2 modes.

DTS NEO:6 CINEMA:

This mode is suited for playing movies. It achieves the same type of sound as in a movie theater, even with 2 channels.

DTS NEO:6 MUSIC:

This mode is suited for playing music. A natural sense of expansion is added to the sound field.

DTS 96/24

DTS 96/24 is a multi-channel digital signal format developed by Digital Theater Systems.

The sampling frequency is raised to achieve 5.1-channel playback with high quality sound (sampling frequency: 96 kHz, quantization: 24 bits).

Additional Information

Audyssey MultEQ XT

Audyssey MultEQ XT is a technology designed to provide the optimum listening environment for multiple listeners within the listening area. Test data collected from multiple listening points is analyzed comprehensively and equalization that improves the sound quality for the entire listening area is performed.

Audyssey MultEQ XT not only corrects frequency response problems in large listening areas, it also fully automates the surround system setup.

For a detailed description, see page 9.



- Audyssey MultEQ XT is a trademark of Audyssey Laboratories. It is licensed under US and National Patent Applications 20030235318 and 10/700,220. Additional U.S. and Foreign Patents pending. MultEQ and the Audyssey MultEQ logo are trademarks of Audyssey Laboratories, Inc.. All rights reserved.

AL24 Processing Plus

AL24 Processing Plus is an analog waveform reproduction technology compatible with sampling frequencies of 192 kHz.

This brings the sound closer to that of analog waveforms and improves the ability to play sound at low volumes with reverberations that are normally absorbed by the hall.

HDMI (High Definition Multimedia Interface)

HDMI is a digital interface standard for next generation TVs based on DVI (Digital Visual Interface) standards and optimized for use in consumer equipment.

Non-compressed digital video and multi-channel audio signals are transmitted with a single connection.

HDMI is also compatible with HDCP (High-bandwidth Digital Contents Protection), a technology for protecting copyrights that encrypts digital video signals in the same way as with DVI.

HDMI

- "HDMI", "HDMI" and "High-Definition Multimedia Interface" are trademarks or registered trademarks of HDMI Licensing LLC.

Additional Information

Troubleshooting

If a problem should arise, first check the following.

1. Are the connections correct?
2. Have you operated the receiver according to the Operating Instructions?
3. Are the speakers and other components operating properly?

If this unit is not operating properly, check the items listed in the table below. Should the problem persist, there may be a malfunction. Disconnect the power immediately and contact your store of purchase.

Symptom	Cause	Measures	Page
Display not lit and sound not produced when POWER switch set to on.	<ul style="list-style-type: none"> Power supply cord not plugged in securely. 	<ul style="list-style-type: none"> Check the insertion of the power supply cord plug. 	22
Display lit but sound not produced.	<ul style="list-style-type: none"> Speaker cables not securely connected. FUNCTION knob position is not appropriate. Volume control set to minimum. MUTING is on. No digital signal is being input. 	<ul style="list-style-type: none"> Connect securely. 	7
		<ul style="list-style-type: none"> Switch to the proper position. 	23
		<ul style="list-style-type: none"> Turn volume up to suitable level. Switch off MUTING. 	23 24
		<ul style="list-style-type: none"> Properly select a digital signal input source. 	47
Nothing is displayed on monitor.	<ul style="list-style-type: none"> AVR-2807's video output terminals and monitor's input terminals are not properly connected. Monitor's input setting is wrong. The PURE DIRECT mode is set. Player connected with component terminal, TV connected with video terminal (yellow) or S-Video terminal. 	<ul style="list-style-type: none"> Check that the connections are correct. 	8, 13 ~ 22
		<ul style="list-style-type: none"> Set the monitor's input selector to the terminals to which video signals are connected. 	—
		<ul style="list-style-type: none"> Set a surround mode other than the PURE DIRECT mode. Down-conversion is not possible for progressive video signals. Make the interlace settings on the player. 	25 —
No DTS sound is produced.	<ul style="list-style-type: none"> DVD player's audio output setting is not set to bit stream. DVD player is not DTS-compatible. AVR-2807's input setting is set to analog 	<ul style="list-style-type: none"> Make the DVD player's default settings. 	—
		<ul style="list-style-type: none"> Use a DTS-compatible player. 	—
		<ul style="list-style-type: none"> Set to "AUTO" or "DTS". 	23
Copying from DVD to VCR is not possible.	<ul style="list-style-type: none"> Copying between a source such as DVD and a VCR is not usually possible, as DVDs are often encoded with copy-protection signals that prevent VCR recording. 	<ul style="list-style-type: none"> Copying is not possible. 	—
No sound is produced from subwoofer.	<ul style="list-style-type: none"> Subwoofer's power is not on. Subwoofer's initial setting is set to "NO". Subwoofer's output is not connected. The subwoofer's channel volume level is set to "OFF". 	<ul style="list-style-type: none"> Turn on the power. Set the setting to "YES". 	— 57
		<ul style="list-style-type: none"> Connect properly. 	7, 22
		<ul style="list-style-type: none"> Turn the subwoofer's channel volume level up. 	34

Symptom	Cause	Measures	Page
No test tones are produced.	<ul style="list-style-type: none"> Surround mode is set to a mode other than Dolby/DTS Surround. 	<ul style="list-style-type: none"> Set to Dolby/DTS Surround. 	—
No sound is produced from surround speakers.	<ul style="list-style-type: none"> Surround mode is set to "STEREO". 	<ul style="list-style-type: none"> Set to a mode other than "STEREO". 	—
This unit does not operate properly when remote control unit is used.	<ul style="list-style-type: none"> Batteries dead. Remote control unit too far from this unit. Obstacle between this unit and remote control unit. Different button is being pressed. ⊕ and ⊖ ends of batteries inserted in reverse. 	<ul style="list-style-type: none"> Replace with new batteries. Move closer. 	3 3
		<ul style="list-style-type: none"> Remove obstacle. Press the proper button. Insert batteries properly. 	3 — 3
An image is not projected with an HDMI connection.	<ul style="list-style-type: none"> AVR-2807's HDMI output terminals and monitor's input terminals are not properly connected. No HDMI signal is being input. The connected monitor equipment or other equipments do not support HDCP. The output format of the connected player (HDMI FORMAT) does not match the supported input format of connected monitor equipments. 	<ul style="list-style-type: none"> Check the HDMI connection. 	19
		<ul style="list-style-type: none"> Properly select HDMI signal input source. The AVR-2807 will not output video signal unless the other equipment supports HDCP. 	49, 50 19
		<ul style="list-style-type: none"> Check whether the output format of the connected player (HDMI FORMAT) matches the supported input format of connected monitor equipments. 	19
The HDMI audio is not output.	<ul style="list-style-type: none"> The AVR-2807 does not play HDMI audio signals. The HDMI audio signals are not output from the connected monitor device. 	<ul style="list-style-type: none"> Set the HDMI audio playback setting at the "HDMI In Assign" settings to "AMP". 	49
		<ul style="list-style-type: none"> Set the HDMI audio playback setting at the "HDMI In Assign" settings to "TV". 	49
Power has turned off and the power indicator is blinking red.	<ul style="list-style-type: none"> The set's internal temperature has risen and the protection circuit has been activated. The core wires of the speaker cables are touching each other or the AVR-2807's rear panel, activating the protection circuit. AVR-2807 is malfunctioning. 	<ul style="list-style-type: none"> Put the AVR-2807 in a well-ventilated place. 	7
		<ul style="list-style-type: none"> Turn off the power, then wait for the set to fully cool off before turning the power back on. 	7
		<ul style="list-style-type: none"> Check the connections of all the speaker cables. 	7
Sound is only produced from the center speaker.	<ul style="list-style-type: none"> You are playing a monaural source (TV, AM radio broadcast, etc.) in the DOLBY/DTS SURROUND mode. 	<ul style="list-style-type: none"> Turn off the power and contact a DENON customer service center. 	7
		<ul style="list-style-type: none"> When playing monaural sources, select a surround mode other than DOLBY/DTS SURROUND mode. 	32, 33
"DOLBY DIGITAL" is not displayed.	<ul style="list-style-type: none"> DVD player's digital audio output setting is not proper. 	<ul style="list-style-type: none"> Check the DVD player's audio output setting. For details, see the DVD player's operating instructions. 	—

Specifications

■ Audio section

• Power amplifier

Rated output:

Front (A, B):
 110 W + 110 W (8 Ω/ohms, 20 Hz ~ 20 kHz with 0.05 % T.H.D.)
 140 W + 140 W (6 Ω/ohms, 1 kHz with 0.7 % T.H.D.)

Center:

110 W (8 Ω/ohms, 20 Hz ~ 20 kHz with 0.05 % T.H.D.)
 140 W (6 Ω/ohms, 1 kHz with 0.7 % T.H.D.)

Surround:

110 W + 110 W (8 Ω/ohms, 20 Hz ~ 20 kHz with 0.05 % T.H.D.)
 140 W + 140 W (6 Ω/ohms, 1 kHz with 0.7 % T.H.D.)

Surround Back:

110 W + 110 W (8 Ω/ohms, 20 Hz ~ 20 kHz with 0.05 % T.H.D.)
 140 W + 140 W (6 Ω/ohms, 1 kHz with 0.7 % T.H.D.)

Dynamic power:

120 W x 2 ch (8 Ω/ohms)
 170 W x 2 ch (4 Ω/ohms)

Output terminals:

Front: A or B 6 ~ 16 Ω/ohms
 A + B 8 ~ 16 Ω/ohms
 Center, Surround, Surr. Back 6 ~ 16 Ω/ohms

• Analog

Input sensitivity / input impedance:

200 mV / 47 kΩ/kohms

Frequency response:

10 Hz ~ 100 kHz: +0, -3 dB (DIRECT mode)

S/N:

102 dB (DIRECT mode)

Distortion:

0.005% (20 Hz ~ 20 kHz) (DIRECT mode)

Rated output:

1.2 V

• Digital

D/A output:

Rated output — 2 V (at 0 dB playback)
 Total harmonic distortion — 0.008 % (1 kHz, at 0 dB)
 S/N ratio — 102 dB
 Dynamic range — 96 dB
 Format — Digital audio interface

Digital input:

• Phono equalizer (PHONO input — REC OUT)

Input sensitivity:

2.5 mV

RIAA deviation:

±1 dB (20 Hz to 20 kHz)

S/N:

74 dB (A weighting, with 5 mV input)

Rated output / Maximum output:

150 mV / 8 V

Distortion factor:

0.03% (1 kHz, 3 V)

■ Video section

• Standard video terminals

Input / output level and impedance: 1 Vp-p, 75 Ω/ohms

Frequency response:

5 Hz ~ 10 MHz — +0, -3 dB

• S-Video terminals

Input / output level and impedance:

Y (brightness) signal — 1 Vp-p, 75 Ω/ohms
 C (color) signal — 0.3 (PAL) / 0.286 (NTSC) Vp-p, 75 Ω/ohms
 5 Hz ~ 10 MHz — +0, -3 dB

Frequency response:

• Color component video terminal

Input / output level and impedance:

Y (brightness) signal — 1 Vp-p, 75 Ω/ohms
 Pb/Cb signal — 0.7 Vp-p, 75 Ω/ohms
 Pr/Cr signal — 0.7 Vp-p, 75 Ω/ohms
 5 Hz ~ 100 MHz — +0, -3 dB

Frequency response:

■ Tuner section

[FM]

(note: μV at 75 Ω/ohms, 0 dBf = 1 x 10⁻¹⁵ W)

Receiving Range:

87.5 MHz ~ 108.0 MHz

Usable Sensitivity:

1.0 μV (11.2 dBf)

50 dB Quieting Sensitivity:

MONO 1.6 μV (15.3 dBf)

STEREO 23 μV (38.5 dBf)

S/N (IHF-A):

MONO 77 dB

STEREO 72 dB

Total Harmonic Distortion (at 1 kHz):

MONO 0.15%

STEREO 0.3%

[AM]

522 kHz ~ 1611 kHz

18 μV

■ General

Power supply:

AC 230 V, 50 Hz

Power consumption:

500 W
 1 W Max (Standby)

Maximum external dimensions:

434 (W) x 171 (H) x 429 (D) mm

Mass:

14.0 kg

■ Remote control unit (RC-1030)

Batteries:

R6P/AA Type (3 batteries)

External dimensions:

58 (W) x 230 (H) x 37 (D) mm

Mass:

230 g (included batteries)

* For purposes of improvement, specifications and design are subject to change without notice.

■ List of preset codes / Liste von voreingestellten Codes / Liste de codes pré-réglés / Lista dei codici pre-regolati /
Lista de códigos pre-ajustados / Lijst van vooringestelde codes / Förteckning över förinställda koder

CD					
ADC	0004	DKK	0001	Magnavox	0023, 0044
Acoustic Research	0048	DMX Electronics	0023	Marantz	0006, 0023, 0030
Adcom	0021, 0038	Denon	0000	Matsui	0023
Aiwa	0003, 0018, 0023	Dual	0034, 0035	McIntosh	0042
Akai	0022	Dynamic Bass	0029	Memorex	0021, 0024, 0028, 0030, 0044
Alba	0058	EEC	0034	Meridian	0023
Alto	0059	Eclipse	0059	Micromega	0023
Arcam	0023	Elektra	0046, 0051	Miro	0001
Ariston	0059	Emerson	0021, 0024, 0044, 0054	Mission	0023
Audio Alchemy	0034	Fisher	0014, 0027, 0029, 0045	Mitsubishi	0022
Audio Pro	0051	GE	0002	Myryad	0023
Audio Research	0023	Garrard	0039, 0041, 0046, 0048, 0049	NAD	0001
Audio-Technica	0025	Gemini	0059	NEC	0010, 0038
AudioTon	0023	Genexxa	0007, 0024, 0044, 0050	NSM	0023
Audiolab	0023	GoldStar	0047	Nagaoka	0004
Audiomeca	0023	Goodmans	0039, 0041, 0044, 0058, 0059	Naim	0023
BSR	0034, 0039	Grundig	0023	Nakamichi	0020
Bestar	0024	HCM	0059	Nikko	0024, 0025, 0027, 0059
Burmester	0048	Harman/Kardon	0023, 0026, 0050	Onkyo	0016
Bush	0039, 0058	Hiro	0059	Optimus	0001, 0007, 0009, 0013, 0019, 0028, 0029, 0034, 0035, 0041, 0044, 0045, 0048, 0050, 0051, 0053
CDC	0048	Hitachi	0007, 0021	PMG	0024
CEC	0027	IR	0001	Panasonic	0006, 0043, 0065
Cairn	0023	Inkel	0030, 0035, 0051	Parasound	0034, 0048
California Audio Labs	0006, 0043	JVC	0012, 0061, 0064	Philips	0023, 0042
Cambridge	0059	Kenwood	0005, 0008, 0009, 0033	Pink Triangle	0059
Carrera	0034	Kodak	0042	Pioneer	0007, 0044, 0053
Carver	0023, 0029, 0051	Krell	0023	Polk Audio	0023
Condor	0024	Kyocera	0004	Poppy	0024
Craig	0058	LXI	0044	Proton	0023
Crown	0017	Linn	0023	QED	0023
Cyrus	0023	Luxman	0015	Quad	0023
DAK	0039	MCS	0006, 0010	Quasar	0006
DBX	0040	MTC	0048, 0059	RCA	0002, 0007, 0011, 0021, 0029, 0044, 0053, 0066
				Radiotone	0058, 0059
				Realistic	0021, 0024, 0028, 0029, 0030, 0048
				Revox	0023
				Roadstar	0052
				Rotel	0023, 0048
				Royal	0048
				SAE	0023
				STS	0004
				Sansui	0023, 0036, 0044, 0059
				Sanyo	0013, 0029, 0045
				Schneider	0058
				Scott	0021, 0024, 0044
				Sears	0044
				Sharp	0009, 0030
				Sherwood	0030, 0035, 0050
				Shure	0010
				Sonic Frontiers	0023
				Sony	0001, 0056, 0057
				Soundesign	0019, 0049
				SuperTech	0059
				Synergy	0059
				Tandy	0007
				Tascam	0048
				Teac	0027, 0030, 0046, 0048, 0058, 0059
				Technics	0006, 0037, 0043
				Thomson	0011
				Thorens	0023
				Universum	0011, 0023, 0051
				Vector Research	0034, 0047
				Victor	0012

Wards	0011, 0023
Watson	0058
Yamaha	0008, 0025, 0032
Yorx	0052
Zenith	0058

MD

BSR	1000
Condor	1000
Denon	1111
Denver	1003
JVC	1015
Kenwood	1004, 1005, 1012
Luxman	1009
Onkyo	1007
Optimus	1013
Orion	1011
Pioneer	1013, 1017
Schneider	1000
Sharp	1006
Sherwood	1014
Sony	1001, 1002
Technics	1016
Universum	1018
Yamaha	1008

DBS

ABsat	3549
AGS	3528, 3531
ASLF	3533
Akai	3507
Akena	3528
Alba	3516
Allsat	3507
Alltech	3533
Alpha	3528
AlphaStar	3542
Amitronica	3533

Amstrad	3550
Anglo	3533
Ankaro	3533
Armstrong	3510
Asat	3507
Astacom	3528
Astra	3510, 3521
Astro	3506
Athena	3528
Axiel	3528
BT	3528, 3531
Bestar	3510
Blaupunkt	3506
Boca	3510
British Sky Broadcasting	3550
Broco	3533
Bubu Sat	3533
Canal Digital	3551
Canal Satellite	3551
Canal+	3551
Chaparral	3508
CityCom	3501, 3546
Colombia	3528
Columbia	3502
Columbus	3528
Condor	3521
Conrad	3501, 3521
Crown	3510
Cyrus	3507
D-box	3536
DNT	3507
Daewoo	3533
Discovery	3531, 3528
Dynasat	3529
EP Sat	3516
Echostar	3505, 3513, 3518, 3533, 3543, 3551, 3556, 3560, 3569

Einhell	3510, 3533
Elta	3507
Emme Esse	3529, 3556
Engel	3533
Eurocrypt	3516
Eurosat	3510
Eurosky	3510, 3521
Eurostar	3529, 3564, 3565
Expressvu	3543
FTE	3554
Fenner	3528
Ferguson	3532
Finlandia	3516
Finlux	3516
Foxtel	3558
Fracarro	3556
Fuba	3506
GE	3519
Galaxis	3512, 3554
Gardiner	3546
General Instrument	3555
Gold Box	3551
Gooding	3520
Goodmans	3516
Gradiente	3559
Granada	3516
Grundig	3506, 3520, 3540, 3550
HTS	3543
Helium	3521
Hirschmann	3506, 3568
Hitachi	3516, 3547
Houston	3528
Hughes Network Systems	3539, 3574, 3575
Humax	3554
Huth	3510
IR	3506, 3516
ISkyB	3559

InVideo	3556
Indovision	3559
Intertronic	3510
Intervision	3521, 3524
JOK	3531
JVC	3520, 3543
K-SAT	3533
Kathrein	3506, 3507, 3523, 3527
Kreiselmeier	3506
La Sat	3521
Lenco	3533
Lifesat	3533
Loewe	3510
Lorenzen	3521, 3538
Magnavox	3535, 3537
Manata	3531
Manhattan	3516
Marantz	3507
Maspro	3540
Matsui	3520
Max	3521
MediaSat	3551
Mediamarkt	3510
Medion	3533
Mega	3507
Memorex	3537
Metronic	3510
Metz	3506
Micro	3533
Micro Elektronik	3533
Microtec	3533
Minerva	3520
Mitsubishi	3539
Morgan's	3502, 3510
Multichoice	3526, 3558
Myryad	3507
Mysat	3533
Netsat	3559

Neuhaus	3533
Neusat	3533
Next Level	3555
Nikko	3533
Nokia	3516, 3536, 3541, 3557, 3563, 3573
Nordmende	3516
Okano	3510, 3528
Orbit	3562
Oxford	3528
Pace	3509, 3516, 3517, 3534, 3545, 3550, 3559
Palladium	3520
Panasat	3522, 3558
Panasonic	3511, 3530, 3550
Panda	3516
Patriot	3528
Philips	3503, 3507, 3516, 3520, 3531, 3535, 3537, 3539, 3540, 3551, 3567, 3574
Pioneer	3514, 3551
Prima	3545
Profile	3531
Promax	3516
Prosat	3524
Proscan	3515
Pye	3520
Quadral	3524
Quelle	3521
RCA	3504, 3515, 3519, 3552
RFT	3507
Radio Shack	3555
Radiola	3507
Roadstar	3533
Rover	3524, 3533
SEG	3538
SKR	3533
SKY	3553, 3559

SM Electronic	3533
Saba	3531
Sabre	3516
Sagem	3548, 3572
Samsung	3571
Sat Team	3533
Satec	3533
Satline	3524
Schneider	3528
Seemann	3510
Seleco	3556
Siemens	3506
Skantin	3533
Sky Television	3561
Skymaster	3524, 3533
Skymax	3507
Smart	3502
Sony	3525, 3550
Star	3559
Star Choice	3555
Strong	3502, 3558
Sumida	3510
Sunsat	3533
Sunstar	3510
Super Sat	3529
TPS	3548
Tantec	3516
Tatung	3516
Technisat	3570
Technowelt	3521
Teco	3510
Teleka	3510
Telestar	3500
Televes	3516
Televisa	3559
Thomson	3516, 3532, 3551, 3566
Thorn	3516
Tonna	3528

Toshiba	3539, 3544
Triax	3501
Uniden	3535, 3537
Unisat	3507, 3510
Universum	3506, 3520
VTech	3546
Variosat	3506
Ventana	3507
Vestel	3538
Wela	3533
Wewa	3516
Wisi	3506, 3516
World Sat	3531
XSat	3528
Xcom Multimedia	3528
Zehnder	3500, 3546
Zenith	3553
Zeta Technology	3507
Zwergnase	3510

VCR

ASA	3006, 3018
AVP	3034
Adelsound	3002
Admiral	3014, 3026
Adventura	3000
Adyson	3017
Aiko	3030
Aiwa	3000, 3006, 3033, 3034
Akai	3009, 3020, 3031
Akiba	3017
Akura	3017
Alba	3017, 3026, 3030, 3031, 3034
Allstar	3018
America Action	3030
American High	3005
Amstrad	3000, 3030

Anam	3006, 3023, 3028, 3029, 3030
Anam National	3023, 3028, 3036, 3050
Anitech	3017
Ansonic	3002
Aristona	3018
Asha	3029
Asuka	3006
Audiosonic	3030
Audiovox	3006
Baird	3000, 3009, 3019
Basic Line	3017, 3030
Beaumarck	3029
Bell & Howell	3019
Bestar	3030
Blaupunkt	3023, 3025, 3028
Blue Sky	3030
Bondstec	3017
Brandt	3032
Brandt Electronic	3009
Broksonic	3001, 3021, 3024, 3026, 3033, 3037
Bush	3017, 3026, 3030, 3034
CCE	3017, 3030
CGE	3000
Calix	3006
Canon	3005
Carena	3026
Carrefour	3012
Carver	3018
Cathay	3030
Cimline	3017
Cineral	3030
Citizen	3006, 3030
Colt	3017
Combitech	3034
Condor	3030
Craig	3006, 3013, 3017, 3029

Crown	3017, 3030	GE	3005, 3014, 3015, 3029, 3044	Imperial	3000	Marta	3006
Curtis Mathes	3005, 3009, 3015, 3023, 3044	GEC	3018	Ingersol	3002	Matsui	3002, 3026, 3033, 3034
Cybernex	3029	Galaxis	3030	Inno Hit	3017, 3029	Matsushita	3005, 3023, 3036
Cyrus	3018	Garrard	3000	Interfunk	3018	Medion	3033
Daewoo	3012, 3030, 3043	General Technic	3033	Intervision	3000, 3006, 3026, 3030	Memorex	3000, 3005, 3006, 3008, 3013, 3014, 3019, 3023, 3026, 3029, 3033, 3036, 3037, 3046, 3050, 3052
Dansai	3017	Genexxa	3019	Irradio	3017, 3018	Memphis	3017
De Graaf	3010	Go Video	3035	JVC	3009, 3016	Metz	3006, 3023, 3025, 3036, 3050
Decca	3000, 3018	GoldHand	3017	Jensen	3009	Minerva	3025
Denon	3010	GoldStar	3006, 3007, 3027	KEC	3006, 3030	Minolta	3010
Diamant	3006	Goodmans	3000, 3006, 3017, 3030	KLH	3017	Mitsubishi	3011, 3014, 3016, 3018
Domland	3026	Gradiente	3000	Kaisui	3017	Motorola	3005, 3014
Dual	3009	Graetz	3009, 3019, 3029	Kendo	3020, 3026	Multitech	3000, 3017
Dumont	3000, 3018, 3019	Granada	3018, 3019	Kenwood	3007, 3009, 3016	Murphy	3000
Dynatech	3000	Grandin	3000, 3006, 3017	Kimari	3013	Myryad	3018
ESC	3029, 3030	Grundig	3017, 3018, 3025, 3028	Kneissel	3034	NAD	3019
Elbe	3007	HCM	3017	Kodak	3005, 3006	NAP	3008
Elcatech	3017	HI-Q	3013	Korpel	3017	NEC	3007, 3009, 3016, 3019
Electrohome	3006	Hanimex	3034	Kuba Electronic	3013	National	3028
Electroponic	3006	Hanseatic	3006	Kyoto	3017	Neckermann	3018
Elin	3029	Harley Davidson	3000	LXI	3006	Nesco	3017
Elsay	3017	Harman/Kardon	3007, 3018	Lenco	3030	Nikkai	3017, 3030
Elta	3017, 3030	Harwood	3017	Leyco	3017	Nikko	3006
Emerex	3003	Hinari	3002, 3017, 3029, 3034	Lloyd's	3000	Noblex	3029
Emerson	3000, 3001, 3006, 3011, 3021, 3024, 3026, 3030, 3037	Hisawa	3034	Loewe	3002, 3006, 3018, 3023, 3036, 3050	Nokia	3009, 3019, 3020, 3029
Ferguson	3009, 3032	Hischito	3012	Logik	3002, 3017, 3029	Nordmende	3009, 3032
Fidelity	3000	Hitachi	3000, 3002, 3009, 3010, 3029	Luxor	3011, 3014, 3019, 3020	Oceanic	3000, 3009
Finlandia	3018, 3019	Hornophone	3018	M Electronic	3000, 3007	Okano	3031, 3033
Finlux	3000, 3010, 3018, 3019	Hughes Network Systems	3010	MEI	3005	Olympus	3005, 3028
Firstline	3006, 3011, 3012, 3017, 3026	Hypson	3017	MGA	3011, 3029	Optimus	3006, 3014, 3019, 3023, 3035, 3036, 3047, 3048, 3050, 3052
Fisher	3013, 3019	IR	3002, 3009, 3010, 3012, 3013, 3017, 3018, 3019, 3020, 3026, 3028, 3029, 3033	MGN Technology	3029	Orion	3001, 3002, 3021, 3024, 3026, 3033, 3034, 3037
Flint	3026	ITT	3009, 3019, 3020, 3029	MTC	3000, 3029	Osaki	3000, 3006, 3017
Fuji	3004, 3005	ITV	3006, 3030	Magnasonic	3030		
Fujitsu	3000			Magnavox	3000, 3005, 3008, 3018, 3022, 3038		
Funai	3000			Magnin	3029		
				Manesth	3012, 3017		
				Marantz	3005, 3018		

Otake	3026
Otto Versand	3018
Palladium	3006, 3009, 3017
Panasonic	3005, 3023, 3027, 3028, 3036, 3040, 3048, 3050, 3052, 3053
Pathe Cinema	3002, 3011
Pathe Marconi	3009
Penney	3005, 3006, 3007, 3010, 3029
Pentax	3010
Perdio	3000
Philco	3005, 3007, 3026, 3037
Philips	3005, 3018, 3038, 3041, 3049, 3051
Phonola	3018
Pilot	3006
Pioneer	3016, 3018
Polk Audio	3018
Portland	3030
Pro Vision	3030
Profitronic	3029
Proline	3000
Proscan	3015, 3044
Prosonic	3030
Protec	3017
Pulsar	3008
Pye	3018
Quasar	3005, 3023, 3036, 3050
Quelle	3018
RCA	3005, 3010, 3014, 3015, 3020, 3022, 3029, 3044
RFT	3017
Radialva	3006, 3014
Radio Shack	3000, 3046
Radiola	3018
Radix	3006
Randex	3006

Realistic	3000, 3005, 3006, 3013, 3014, 3019
ReplayTV	3039, 3040
Rex	3009
Roadstar	3006, 3017, 3029, 3030
Runco	3008
SBR	3018
SEG	3029
SEI	3002, 3018
STS	3010
Saba	3009, 3032
Saisho	3002, 3026
Salora	3011, 3020
Samsung	3012, 3029, 3035
Sanky	3008, 3014
Sansui	3000, 3009, 3016, 3026, 3037
Sanwa	3002
Sanyo	3013, 3019, 3029
Saville	3034
Schaub Lorenz	3000, 3009, 3019
Schneider	3000, 3017, 3018
Scott	3011, 3012, 3021, 3024
Sears	3000, 3005, 3006, 3010, 3013, 3019
Seleco	3009
Semp	3012
Sentra	3017
Sharp	3014
Shintom	3017, 3019
Shivaki	3006
Shogun	3029
Shorai	3002
Siemens	3006, 3018, 3019, 3025
Siera	3018
Silva	3006
Singer	3012, 3017
Sinudyne	3002, 3018

Sonneclair	3017
Sontec	3006
Sony	3000, 3003, 3004, 3005, 3042, 3045
Soundwave	3006, 3026
Ssangyong	3017
Stern	3030
Sunkai	3033
Sunstar	3000
Suntronic	3000
Sunwood	3017
Supra	3006
Sylvania	3000, 3005, 3011, 3018
Symphonic	3000
TMK	3029
Taisho	3002, 3026
Tandberg	3030
Tandy	3000, 3019
Tashiko	3000
Tatung	3000, 3009, 3018
Teac	3000, 3009, 3030, 3043
Tec	3017, 3030
Tech Line	3017
Technics	3005, 3023, 3028
Teknika	3000, 3005, 3006
Teleavia	3009
Telefunken	3009, 3032
Teletech	3017
Tenosal	3017
Tensai	3000
Thomas	3000
Thomson	3009, 3015, 3016, 3032
Thorn	3009, 3019
Tivo	3041, 3042
Tokai	3017
Toshiba	3009, 3011, 3012, 3018
Totevision	3006, 3029
Uher	3029

Ultravox	3030
Unitech	3029
Universum	3000, 3006, 3018, 3020, 3025, 3029
Vector	3012
Vector Research	3007
Victor	3009, 3016
Video Concepts	3012
Videosonic	3029
Wards	3000, 3005, 3010, 3013, 3014, 3015, 3017, 3018, 3022, 3029, 3044
Watson	3018
White Westinghouse	3017, 3026, 3030
XR-1000	3000, 3005, 3017
Yamaha	3007
Yamishi	3017
Yokan	3017
Yoko	3029
Zenith	3000, 3004, 3008, 3026, 3037

CDR

Denon	0000, 0001
HHB	0500
Kenwood	0501
Marantz	0501
NAD	0503
Philips	0501
Pioneer	0500, 0502
RCA	0502

CABLE

ABC	4001, 4002, 4005, 4006
Alcatel	4028, 4029
Americast	4030
Bell & Howell	4005

Bell South	4030
Birmingham Cable Communications	4012
British Telecom	4001
Cable & Wireless	4034
Cabletime	4018, 4024
Daeryung	4002
Filmnet	4017
France Telecom	4019, 4028, 4029
Galaxi	4002
General Instrument	4020, 4025
GoldStar	4008
Hamlin	4003, 4011
Jerrold	4001, 4004, 4005, 4012, 4020, 4025
MNet	4017
Macab	4026
Memorex	4000
Motorola	4020, 4035
Mr. Zap	4036
Noos	4026
Ono	4034
PVP Stereo Visual Matrix	4001
Pace	4009, 4032, 4034
Panasonic	4000, 4007
Paragon	4000
Philips	4015, 4016
Pioneer	4008, 4023, 4027, 4037
Pulsar	4000
Quasar	4000
Regal	4011, 4014
Runco	4000
Sagem	4026
Samsung	4008
Scientific Atlanta	4002, 4006, 4013, 4021, 4027, 4037
Sony	4031

Starcom	4001
Supercable	4012
Tele+1	4017
Tocom	4004
Toshiba	4000
United Cable	4001
Videoway	4010
Visionetics	4033
Visiopass	4019
Zenith	4000, 4022, 4030

TV

A-Mark	4501
A.R. Systems	4593
AOC	4501, 4508, 4512, 4519, 4554
AWA	4502
Acura	4502
Admiral	4531, 4545, 4585
Adventura	4516
Adyson	4564
Aiko	4530
Aiwa	4612
Akai	4502, 4512, 4562, 4565, 4596
Akib	4572
Akiba	4514, 4565, 4571, 4572, 4584
Akura	4565, 4569
Alaron	4552, 4563
Alba	4502, 4513, 4514, 4565, 4579, 4607
Allorgan	4572
Allstar	4514
Ambassador	4550
America Action	4553
Amplivision	4564
Ampro	4619

Amstrad	4502, 4514, 4549, 4550, 4579, 4581
Anam	4501, 4502, 4553, 4568
Anam National	4522, 4568, 4605
Anglo	4569
Anitech	4502
Ansonic	4502, 4514, 4578
Arcam	4563, 4564
Archer	4501
Aristona	4514, 4593
Asora	4502
Asuka	4565
Atlantic	4561
AudioTon	4564, 4569
Audiosonic	4514, 4536
Audiovox	4501, 4530, 4553, 4583, 4599
Autovox	4561
BPL	4571
BSR	4572
BTC	4565
Baird	4526, 4527, 4557, 4558, 4562, 4564
Basic Line	4502, 4565
Baur	4514, 4590, 4592
Baysonic	4553
Bazin	4564
Beaumark	4551
Beko	4578, 4615
Belcor	4508
Bell & Howell	4505, 4542
Beon	4514
Best	4578
Bestar	4514, 4578, 4580
Binatone	4564
Blaupunkt	4560, 4573, 4574
Blue Sky	4565, 4607
Blue Star	4571

Boots	4564
Bradford	4553
Brandt	4536, 4575
Brinkmann	4512, 4582
Britannia	4563
Brockwood	4508
Broksonic	4501, 4567, 4585
Bush	4502, 4513, 4514, 4565, 4571, 4572, 4576, 4579, 4580, 4607
CCE	4514, 4564
CGE	4578, 4582
CS Electronics	4563
CXC	4553
Candle	4512, 4516, 4523, 4555
Canton	4565
Carad	4598
Carena	4514, 4584
Carnivale	4512
Carrefour	4513
Carver	4521, 4548
Cascade	4502
Cathay	4514
Celebrity	4500
Centurion	4514
Cimline	4502
Cineral	4530, 4583
Citizen	4512, 4515, 4516, 4523, 4524, 4530, 4555, 4570
City	4502
Clairtone	4554
Clarivox	4514
Clatronic	4578
Concerto	4523
Condor	4578
Contec	4502, 4513, 4553, 4554, 4563
Continental Edison	4536, 4588

Cosmel	4514
Craig	4553
Crosley	4521
Crown	4502, 4514, 4515, 4553, 4578, 4582
Curtis Mathes	4505, 4512, 4515, 4517, 4518, 4521, 4523, 4524, 4531, 4539, 4542, 4547, 4583, 4586, 4618, 4622, 4626
Cybertron	4565
DER	4557, 4558
Daewoo	4502, 4508, 4514, 4515, 4530, 4542, 4580, 4583, 4599, 4600
Dainichi	4565
Dansai	4514
Dayton	4502
Daytron	4508
De Graaf	4562
Decca	4514, 4526
Denko	4569
Denon	4539
Denver	4514
Desmet	4502, 4514
Diamant	4514
Dixi	4502, 4514
Dual	4514, 4564
Dual Tec	4564
Dumont	4506, 4508, 4525
Dwin	4617, 4620
ECE	4514
Elbe	4564
Electroband	4500, 4554
Electa	4569
Elin	4514
Elite	4565
Elta	4502

Emerson	4508, 4515, 4542, 4550, 4551, 4552, 4553, 4554, 4567, 4570, 4571, 4585, 4599, 4600
Emperor	4571
Envision	4512
Erres	4504, 4514
Etron	4502
Euromann	4514, 4569
Europa	4514
Europhon	4564
Expert	4561
Exquisit	4514
Fenner	4502, 4580
Ferguson	4514, 4527, 4536, 4557, 4558, 4575
Fidelity	4558, 4563
Filsai	4564
Finlandia	4562
Finlux	4514, 4525, 4526, 4552
Firstline	4502, 4563, 4564, 4572, 4607
Fisher	4542, 4544, 4562, 4564, 4578
Flint	4584
Forgestone	4558
Formenti	4514
Fortress	4531
Fraba	4514, 4578
Friac	4502, 4578
Frontech	4545, 4569
Fujitsu	4526, 4552, 4561, 4609
Funai	4549, 4552, 4553, 4569, 4572
Futuretech	4553
GBC	4502, 4565, 4580

GE	4510, 4511, 4517, 4518, 4522, 4531, 4538, 4551, 4571, 4583, 4618, 4622, 4626
GEC	4514, 4526, 4564
GPM	4565
Galaxi	4514
Galaxis	4514, 4578
Geloso	4502
General	4555
General Technic	4502
Genexxa	4545, 4565
Gibraltar	4506, 4508, 4512
GoldStar	4508, 4512, 4514, 4515, 4523, 4536, 4551, 4564
Gooding	4588
Goodmans	4513, 4514, 4526, 4552, 4564, 4579, 4580, 4600
Gorenje	4578
Gradiente	4520, 4523, 4548
Graetz	4545
Granada	4514, 4526, 4562, 4564
vrandin	4571, 4598
Grundig	4514, 4525, 4560, 4588, 4593, 4595
Grunpy	4552, 4553
HCM	4502, 4571, 4581
Halifax	4564
Hallmark	4551
Hampton	4563, 4564
Hanimex	4572
Hanseatic	4514, 4593
Hantarex	4514
Hantor	4514
Harley Davidson	4552
Harman/Kardon	4521
Harvard	4553
Harwood	4502, 4514, 4581

Hema	4502, 4564
Hikona	4565
Hinari	4502, 4513, 4514, 4552, 4565
Hisawa	4571, 4584
Hitachi	4505, 4513, 4523, 4536, 4539, 4541, 4545, 4564, 4594
Hornophone	4514
Huanyu	4563, 4580
Hyper	4502, 4563, 4564
Hypson	4514, 4569, 4571
ICE	4564, 4569, 4579
ICeS	4565
IR	4503, 4504, 4513, 4514, 4525, 4526, 4527, 4531, 4534, 4535, 4536, 4545, 4557, 4558, 4559, 4560, 4561, 4563, 4564, 4566, 4572, 4573, 4578, 4580, 4590, 4592, 4593
ITS	4579
ITT	4545
ITV	4514, 4569
Iberia	4514
Imperial	4578, 4582
Indiana	4514
Infinity	4521
Ingelen	4545
Ingersol	4502
Inno Hit	4526
Innova	4514
Inteq	4506
Interbuy	4514, 4569
Interfunk	4514, 4545, 4592
Internal	4514
Intervision	4514, 4564, 4569
Irradio	4565, 4579

Isukai	4565	Liesenkotter	4514, 4573	Minoka	4581	Optimus	4542, 4547, 4568, 4605
JBL	4521	Lifetec	4514, 4565, 4580	Minutz	4510	Optonica	4531, 4546
JCB	4500	Loewe	4592	Mitsubishi	4508, 4513, 4531, 4535, 4540, 4551, 4592	Orion	4514, 4550, 4552, 4567, 4572, 4576, 4585
JVC	4513, 4520, 4532, 4557, 4579, 4606	Logik	4505	Mivar	4563	Orline	4514, 4565
Janeil	4516	Lumatron	4564	Monaco	4502	Osaki	4526, 4564, 4565, 4569, 4581
KB Aristocrat	4545	Luxman	4523	Motorola	4522, 4531	Osio	4514
KEC	4553	Luxor	4559	Multibroadcast	4558	Oso	4565
KTV	4512, 4515, 4553, 4554, 4564, 4570	M Electronic	4502, 4514, 4536, 4545, 4564, 4580, 4587	Multitech	4502, 4553, 4563, 4564	Osume	4526
Kaisui	4502, 4563, 4564, 4565, 4571	MEI	4554	Murphy	4515, 4526, 4545, 4563	Otto Versand	4513, 4514, 4564, 4590, 4592, 4593
Kamp	4563	MGA	4508, 4512, 4540, 4551	Myryad	4593	Pael	4563
Kapsch	4545, 4561	MTC	4508, 4512, 4523, 4524, 4554, 4563, 4592	NAD	4543, 4547, 4551	Palladium	4578, 4582
Karcher	4598	Magnafon	4527, 4563	NEC	4508, 4512, 4513, 4523, 4548, 4584, 4589	Panama	4564, 4569
Kasui	4571	Magnavox	4509, 4512, 4513, 4521, 4533, 4552, 4555, 4556, 4624	NEI	4514	Panasonic	4518, 4522, 4537, 4545, 4566, 4568, 4577, 4605
Kathrein	4593	Magnum	4514	NTC	4530	Panavision	4514
Kawasho	4563	Majestic	4505	Nakimura	4514, 4580	Pathe Cinema	4563
Kaypani	4519	Manesth	4564, 4569	Nakio	4587	Pausa	4502
Kendo	4514	Marantz	4512, 4514, 4521, 4593	National	4566	Penney	4501, 4507, 4508, 4510, 4511, 4512, 4515, 4517, 4518, 4523, 4524, 4538, 4543, 4551, 4618, 4626
Kennedy	4561	Mark	4514	Neckermann	4514, 4590, 4593	Perdio	4514, 4545
Kenwood	4508, 4512	Matsui	4502, 4503, 4513, 4514, 4526, 4550, 4562, 4564, 4572, 4576, 4579, 4588	Nesco	4552	Philco	4508, 4509, 4512, 4521, 4533, 4539, 4585
Kingsley	4563	Matsushita	4568, 4605	Netsat	4514	Philips	4504, 4514, 4521, 4558, 4580, 4593
Kloss	4516	Mediator	4504, 4514	Neufunk	4514, 4593	Phoenix	4563
Kneissel	4514, 4580, 4598	Medion	4607	New Tech	4564	Phonola	4504, 4514
Kolster	4514	Megas	4598	Nicamagic	4563	Pilot	4508, 4512, 4515
Konka	4602, 4603, 4604, 4613, 4614	Megatron	4501, 4539, 4551	Nikkai	4514, 4526, 4563, 4565, 4569	Pioneer	4536, 4545, 4547, 4608
Korpel	4514	Memorex	4502, 4505, 4523, 4540, 4542, 4551, 4552, 4568, 4585	Nikko	4512, 4530, 4551	Plantron	4502
Kosmos	4514	Metz	4577	Nobliko	4525, 4563	Playsonic	4564
Koyoda	4502	Midland	4506, 4515, 4517, 4518, 4538, 4618	Nokia	4587	Portland	4508, 4515, 4530
Kyoshu	4581	Minerva	4525, 4588	Nordmende	4536	Precision	4564
Kyoto	4545			Noshi	4507	Prima	4569
LG	4523			Novak	4504		
LXI	4517, 4521, 4542, 4543, 4551, 4618			Novatronic	4514		
Leyco	4514, 4526, 4569, 4572			Oceanic	4545		
Liesenk & Tter	4514			Okano	4502, 4514, 4569, 4578		
				Omega	4569		
				Onwa	4553		

Princeton	4616
Prinz	4559
Prism	4518
Profex	4502
Profi	4502
Profitronic	4514
Proline	4526
Proscan	4517, 4618
Prosonic	4514
Protech	4502, 4514, 4564, 4569, 4582, 4607
Proton	4501, 4519, 4551, 4586
Pulsar	4506, 4508
Pye	4504
Quasar	4518, 4522, 4546, 4568, 4605
Quelle	4503, 4514, 4525, 4573, 4574, 4590, 4592
Questa	4513
R-Line	4514
RBM	4525
RCA	4507, 4508, 4517, 4518, 4529, 4531, 4538, 4608, 4618, 4621, 4622, 4623, 4626, 4627
RFT	4526
Radialva	4514, 4565
Radio Shack	4508, 4512, 4515, 4517, 4523, 4542, 4546, 4551, 4553, 4618
Radiola	4504, 4514
Radiomarelli	4514
Radiotone	4502, 4514, 4569
Rank Arena	4513
Realistic	4508, 4512, 4515, 4523, 4542, 4546, 4551, 4553
Recor	4514
Redstar	4514

Reflex	4514
Revox	4514
Rex	4545, 4561, 4569
Rhapsody	4554, 4563
Roadstar	4502, 4565, 4569, 4582
Royal Lux	4581
Runco	4506, 4512, 4589, 4597
SBR	4504, 4514, 4558
SEG	4513, 4564, 4569, 4607
SEI	4550, 4572
SEI-Sinudyne	4514
SKY	4514
SSS	4508, 4553
Saba	4536, 4545, 4575
Sagem	4598
Saisho	4502, 4503, 4550, 4569
Salora	4545, 4559
Sampo	4512, 4515, 4519
Samsung	4502, 4508, 4512, 4514, 4515, 4523, 4524, 4529, 4551, 4564, 4569, 4578, 4593, 4595
Samsux	4515
Sandra	4563
Sansei	4583
Sansui	4585
Sanyo	4503, 4513, 4526, 4542, 4544, 4562
Schneider	4514, 4565, 4579, 4607
Scimitsu	4508
Scotch	4551
Scotland	4545
Scott	4508, 4551, 4552, 4553, 4567
Sears	4517, 4521, 4523, 4542, 4543, 4544, 4549, 4551, 4552, 4618
Seleco	4545, 4561

Semivox	4553
Semp	4543
Sencora	4502
Sentra	4565
Serino	4598, 4563, 4584
Sharp	4513, 4515, 4531, 4546, 4610, 4611
Shintoshi	4514
Shogun	4508
Shorai	4572
Siemens	4514, 4560, 4573, 4574
Signature	4505
Silva	4563
Silver	4513
Simpson	4555, 4556
Sinudyne	4550, 4572
Sky-Worth	4514
Solavox	4545
Sonitron	4562
Sonoko	4502, 4514
Sonolor	4545, 4562
Sontec	4514
Sony	4500, 4503, 4513, 4528, 4590, 4605
Sound & Vision	4580
Soundesign	4551, 4552, 4553, 4555
Soundwave	4514, 4582
Spectricon	4501
Squareview	4549
Ssangyong	4502
Standard	4502, 4564, 4565
Starlite	4553
Stenway	4565, 4571
Stern	4545, 4561
Strato	4514, 4569
Stylandia	4564
Sunkai	4572, 4576
Sunstar	4502, 4514, 4579

Sunwood	4514
SuperTech	4563
Supra	4523
Supre-Macy	4516
Supreme	4500
Susumu	4565
Sylvania	4509, 4512, 4521, 4533
Symphonic	4549, 4553
Sysline	4514
Sytong	4563
TMK	4523, 4550, 4551
TNCi	4506
TVTEXT 95	4593
Tandberg	4577
Tandy	4515, 4526, 4531, 4545, 4564, 4565
Tashiko	4513, 4564
Tatung	4501, 4514, 4522, 4526, 4564
Teac	4502, 4514, 4569, 4571, 4581, 4582, 4584, 4607
Tec	4564
Technics	4518, 4568, 4605
Technol Ace	4552
Techwood	4501, 4518, 4523
Teknika	4505, 4508, 4515, 4521, 4523, 4524, 4530, 4540, 4552, 4553, 4555
Telefunken	4523, 4534, 4536, 4575, 4601
Telegazi	4514
Telemeister	4514
Telesonic	4514
Telestar	4514
Teletech	4502
Teleton	4513, 4555, 4561, 4564
Televideon	4563
Temco	4572

Tennessee	4514
Tensai	4565, 4572
Texet	4563, 4565
Thomson	4536, 4601, 4627
Thorn	4514, 4526, 4557, 4558, 4590, 4592
Tokai	4502, 4514, 4545
Tomashi	4571
Toshiba	4513, 4524, 4525, 4542, 4543, 4591, 4625
Tosonic	4554
Totevision	4515
Trans Continens	4564
Tristar	4558, 4565
Triumph	4550
Tsoschi	4571
Uher	4561
Ultravox	4514, 4563
Unic Line	4514
United	4514
Universal	4511
Universum	4514, 4569, 4578
Univox	4514, 4545
Vector Research	4512
Vestel	4514
Victor	4513, 4520, 4568, 4605
Videologic	4565, 4563
Videotechnic	4564
Vidikron	4521
Vidtech	4508, 4513, 4551
Viking	4516
Vision	4564
Vistar	4561
Voxson	4545
Waltham	4564
Wards	4505, 4508, 4509, 4510, 4511, 4512, 4521, 4523, 4528, 4533, 4546, 4551, 4552

Watson	4514
Watt Radio	4563
Wega	4513
Wegavox	4502
White Westinghouse	4514, 4563, 4585, 4599, 4600
Windstar	4571
Xrypton	4514
Yamaha	4508, 4512
Yamishi	4564, 4571, 4584
Yokan	4514
Yoko	4514, 4564, 4569
Zanussi	4561
Zenith	4505, 4506, 4530, 4585, 4600
Zonda	4501

LD

Aiwa	2507
Carver	2502, 2505, 2510
Cyrus	2511
Denon	1111, 1112, 1113
Disco Vision	2500
Funai	2507
GoldStar	2503
Harman/Kardon	2505
Hitachi	2500
Magnavox	2505, 2509
Marantz	2502, 2505
Mitsubishi	2501
NAD	2501
Optimus	2501
Panasonic	2508
Philips	2502, 2505, 2511
Pioneer	2500, 2501
Polk Audio	2505
Quasar	2508

Radiola	2511
Realistic	2507
Renaissance	2510
Salora	2502
Samsung	2510
Sega	2500
Sony	2504, 2506
Technics	2508
Telefunken	2501
Theta Digital	2505
Yamaha	2509

DVD

Afreey	2039
Aiwa	2022
Akai	2015
Apex	2028, 2049
Bush	2035
Denon	0000, 0001
Emerson	2014
Fisher	2027
GE	2003
Go Video	2044
Gradiente	2023
Harman/Kardon	2013, 2041
Hitachi	2012, 2025
Hiteker	2028
JMB	2037
JVC	2010, 2017
Kenwood	2000, 2006, 2032, 2048
Konka	2043, 2045, 2046, 2047
LG	2014
Lecson	2038
Magnavox	2001, 2030
Marantz	2007
Microsoft	2003
Mitsubishi	2002
NAD	2036

Onkyo	2001, 2016, 2018
Optimus	2011
Oritron	2023
Panasonic	2000, 2020, 2031
Philco	2035
Philips	2001, 2007
Pioneer	2004, 2011, 2020
Princeton	2029
Proline	2024
Proscan	2003
RCA	2003, 2011, 2042
REC	2034
Realmagic	2029
Roadstar	2034
SM Electronic	2035
Sampo	2039
Samsung	2012
Sanyo	2027
Sharp	2019
Sherwood	2021
Sony	2005
Teac	2011
Technics	2000
Techwood	2036
Theta Digital	2011
Thomson	2003, 2009
Toshiba	2001
Universum	2014
Wesder	2040
Wharfedale	2033, 2038
Yamaha	2000, 2008
Yamakawa	2026
Zenith	2001, 2014

TAPE

Aiwa	1502, 1516, 1517
Akai	1525, 1529
Arcam	1506

Carver	1502
Denon	0000
Fisher	1505
Garrard	1527, 1529
Grundig	1502
Harman/Kardon	1502, 1514
Inkel	1503, 1504, 1528
JVC	1521, 1522, 1523
Kenwood	1503, 1504
Magnavox	1502
Marantz	1500, 1502
Memorex	1509, 1510
Mitsubishi	1525, 1529
Myryad	1502
Onkyo	1511, 1512, 1524
Optimus	1501, 1518, 1528, 1529
Panasonic	1519
Philips	1502
Phonotrend	1528
Pioneer	1501, 1509, 1510, 1518
Polk Audio	1502
RCA	1501, 1518
Revox	1502, 1515
Sansui	1500, 1502
Sanyo	1505
Sherwood	1528
Sony	1513, 1520, 1526
Tae Kwang	1529
Teac	1525, 1527
Technics	1519
Thorens	1502
Victor	1521, 1522, 1523
Wards	1501
Yamaha	1507, 1508

DVD preset codes DVD-Voreinstellungscodes Codes pré réglés DVD Codici di preselezione DVD Códigos de preajuste de DVD DVD-voorkeuzecodes Förinställda DVD-koder	0000	0001
DENON		
Model No.	DVD-550	DVD-2800
Modellnr	DVD-700	DVD-2800II
Modèle numéro	DVD-900	DVD-2900
Modello No	DVD-1000	DVD-2910
Nº de modelo	DVD-1400	DVD-3800
Modelnr	DVD-1500	DVD-3910
Modellnr	DVD-1710	DVD-A11
	DVD-1910	DVD-A1
	DVD-2200	DVD-A1XV
		DVD-800
		DVD-1600
		DVD-2000
		DVD-2500
		DVD-3000
		DVD-3300





DENON
TOKYO, JAPAN
www.denon.com

Denon Brand Company, D&M Holdings Inc.
Printed in Japan 00D 511 4452 206